



A D T

FCC TEST REPORT (15.247)

REPORT NO.: RF110418C16

MODEL NO.: PG86310

FCC ID: NM8PG86310

RECEIVED: Apr. 18, 2011

TESTED: Apr. 25 ~ May 03, 2011

ISSUED: May 12, 2011

APPLICANT: HTC Corporation

ADDRESS: No. 23, Xinghua Rd., Taoyuan City, Taoyuan, 330
Taiwan

ISSUED BY: Bureau Veritas Consumer Products Services
(H.K.) Ltd., Taoyuan Branch

LAB ADDRESS: No. 47, 14th Ling, Chia Pau Tsuen, Lin Kou
Hsiang, Taipei Hsien 244, Taiwan, R.O.C.

TEST LOCATION: No. 19, Hwa Ya 2nd Rd, Wen Hwa Tsuen, Kwei
Shan Hsiang, Taoyuan Hsien 333, Taiwan, R.O.C.

This test report consists of 63 pages in total. It may be duplicated completely for legal use with the approval of the applicant. It should not be reproduced except in full, without the written approval of our laboratory. The client should not use it to claim product certification, approval, or endorsement by TAF or any government agency. The test results in the report only apply to the tested sample.





TABLE OF CONTENTS

RELEASE CONTROL RECORD.....	4
1. CERTIFICATION.....	5
2. SUMMARY OF TEST RESULTS	6
2.1 MEASUREMENT UNCERTAINTY	6
3. GENERAL INFORMATION.....	7
3.1 GENERAL DESCRIPTION OF EUT	7
3.2 DESCRIPTION OF TEST MODES.....	9
3.2.1 CONFIGURATION OF SYSTEM UNDER TEST	9
3.2.2 TEST MODE APPLICABILITY AND TESTED CHANNEL DETAIL	10
3.3 GENERAL DESCRIPTION OF APPLIED STANDARDS	12
3.4 DESCRIPTION OF SUPPORT UNITS	12
4. TEST TYPES AND RESULTS	13
4.1 RADIATED EMISSION MEASUREMENT	13
4.1.1 LIMITS OF RADIATED EMISSION MEASUREMENT.....	13
4.1.2 TEST INSTRUMENTS	14
4.1.3 TEST PROCEDURES	15
4.1.4 DEVIATION FROM TEST STANDARD	15
4.1.5 TEST SETUP	16
4.1.6 EUT OPERATING CONDITIONS	16
4.1.7 TEST RESULT.....	17
4.2 CONDUCTED EMISSION MEASUREMENT	28
4.2.1 LIMITS OF CONDUCTED EMISSION MEASUREMENT.....	28
4.2.2 TEST INSTRUMENTS	28
4.2.3 TEST PROCEDURES	29
4.2.4 DEVIATION FROM TEST STANDARD	29
4.2.5 TEST SETUP	30
4.2.6 EUT OPERATING CONDITIONS	30
4.2.7 TEST RESULTS	31
4.3 6dB BANDWIDTH MEASUREMENT	35
4.3.1 LIMITS OF 6dB BANDWIDTH MEASUREMENT.....	35
4.3.2 TEST INSTRUMENTS	35
4.3.3 TEST PROCEDURE	35
4.3.4 DEVIATION FROM TEST STANDARD	35
4.3.5 TEST SETUP	36
4.3.6 EUT OPERATING CONDITIONS	36
4.3.7 TEST RESULTS	37
4.4 MAXIMUM OUTPUT POWER.....	40



4.4.1	LIMITS OF MAXIMUM OUTPUT POWER MEASUREMENT	40
4.4.2	INSTRUMENTS.....	40
4.4.3	TEST PROCEDURE	40
4.4.4	DEVIATION FROM TEST STANDARD	41
4.4.5	TEST SETUP	41
4.4.6	EUT OPERATING CONDITIONS	41
4.4.7	TEST RESULTS	42
4.5	POWER SPECTRAL DENSITY MEASUREMENT	43
4.5.1	LIMITS OF POWER SPECTRAL DENSITY MEASUREMENT	43
4.5.2	TEST INSTRUMENTS	43
4.5.3	TEST PROCEDURE	43
4.5.4	DEVIATION FROM TEST STANDARD	44
4.5.5	TEST SETUP	44
4.5.6	EUT OPERATING CONDITION	44
4.5.7	TEST RESULTS	45
4.6	BAND EDGES MEASUREMENT	48
4.6.1	LIMITS OF BAND EDGES MEASUREMENT	48
4.6.2	TEST INSTRUMENTS	48
4.6.3	TEST PROCEDURE	48
4.6.4	DEVIATION FROM TEST STANDARD	48
4.6.5	EUT OPERATING CONDITION	48
4.6.6	TEST RESULTS	49
5.	PHOTOGRAPHS OF THE TEST CONFIGURATION.....	61
6.	INFORMATION ON THE TESTING LABORATORIES	62
7.	APPENDIX A - MODIFICATIONS RECORDERS FOR ENGINEERING CHANGES TO THE EUT BY THE LAB.....	63



A D T

RELEASE CONTROL RECORD

ISSUE NO.	REASON FOR CHANGE	DATE ISSUED
Original release	N/A	May 12, 2011



A D T

1. CERTIFICATION

PRODUCT: Smart Phone

MODEL: PG86310

BRAND: hTC

APPLICANT: HTC Corporation

TEST SAMPLE: Production Unit

TESTED: Apr. 25 ~ May 03, 2011

STANDARDS: **FCC Part 15, Subpart C (Section 15.247)**

ANSI C63.4-2003

ANSI C63.10-2009

The above equipment (Model: PG86310) has been tested by **Bureau Veritas Consumer Products Services (H.K.) Ltd., Taoyuan Branch**, and found compliance with the requirement of the above standards. The test record, data evaluation & Equipment Under Test (EUT) configurations represented herein are true and accurate accounts of the measurements of the sample's EMC characteristics under the conditions specified in this report.

PREPARED BY :  , **DATE** : May 12, 2011
Pettie Chen / Specialist

APPROVED BY :  , **DATE** : May 12, 2011
Gary Chang / Assistant Manager



2. SUMMARY OF TEST RESULTS

The EUT has been tested according to the following specifications:

APPLIED STANDARD: FCC PART 15, SUBPART C (SECTION 15.247)			
STANDARD SECTION	TEST TYPE AND LIMIT	RESULT	REMARK
15.207	AC Power Conducted Emission	PASS	Meet the requirement of limit. Minimum passing margin is -12.48dB at 2.930MHz.
15.247(a)(2)	Spectrum Bandwidth of a Direct Sequence Spread Spectrum System Limit: min. 500kHz	PASS	Meet the requirement of limit.
15.247(b)	Maximum Output Power Limit: max. 30dBm	PASS	Meet the requirement of limit.
15.247(d)	Radiated Emissions Limit: Table 15.209	PASS	Meet the requirement of limit. Minimum passing margin is -1.3dB at 2390.00MHz.
15.247(e)	Power Spectral Density Limit: max. 8dBm	PASS	Meet the requirement of limit.
15.247(d)	Band Edge Measurement Limit: 20dB less than the peak value of fundamental frequency	PASS	Meet the requirement of limit.
15.203	Antenna Requirement	PASS	No antenna connector is used.

2.1 MEASUREMENT UNCERTAINTY

Where relevant, the following measurement uncertainty levels have been estimated for tests performed on the EUT as specified in CISPR 16-4-2:

MEASUREMENT	FREQUENCY	UNCERTAINTY
Conducted emissions	9kHz~30MHz	2.44dB
Radiated emissions	30MHz ~ 200MHz	3.19dB
	200MHz ~1000MHz	3.21dB
	1GHz ~ 18GHz	2.26dB
	18GHz ~ 40GHz	1.94dB

This uncertainty represents an expanded uncertainty expressed at approximately the 95% confidence level using a coverage factor of $k = 2$.



3. GENERAL INFORMATION

3.1 GENERAL DESCRIPTION OF EUT

EUT	Smart Phone
MODEL NO.	PG86310
FCC ID	NM8PG86310
POWER SUPPLY	5.0Vdc (adapter or host equipment) 3.7Vdc (battery) 3.8Vdc (battery)
MODULATION TYPE	CCK, DQPSK, DBPSK for DSSS 64QAM, 16QAM, QPSK, BPSK for OFDM
MODULATION TECHNOLOGY	DSSS, OFDM
TRANSFER RATE	802.11b:11.0/ 5.5/ 2.0/ 1.0Mbps 802.11g: 54.0/ 48.0/ 36.0/ 24.0/ 18.0/ 12.0/ 9.0/ 6.0Mbps 802.11n (20MHz): up to 150.0Mbps
OPERATING FREQUENCY	2412 ~ 2462MHz
NUMBER OF CHANNEL	11
OUTPUT POWER	166.0mW
ANTENNA TYPE	PIFA antenna with -1.0dBi gain
ANTENNA CONNECTOR	NA
I/O PORTS	Refer to users' manual
DATA CABLE	Refer to Note as below
ACCESSORY DEVICES	Refer to Note as below

NOTE:

1. The EUT is a Smart Phone. The test data are separated into following test reports.

	TEST STANDARD	REFERENCE REPORT
WLAN 802.11b/g/n	FCC Part 15, Subpart C (Section 15.247)	RF99110418C16
BLUETOOTH		RF99110418C16-1
GSM 850, GPRS 850, EGPRS 850, WCDMA 850	FCC Part 22	RF99110418C16-2
GSM 1900, GPRS 1900, EGPRS 1900, WCDMA 1900	FCC Part 24	RF99110418C16-3

2. The EUT provides one completed transmitter and one receiver.

MODULATION MODE	TX FUNCTION
802.11b	1TX
802.11g	1TX
802.11n (20MHz)	1TX

3. The EUT has following accessories.

NO.	PRODUCT	BRAND	MODEL	DESCRIPTION
1	Power Adapter	hTC	TC X250 (X= U, B, E, C, A)	I/P: 100-240Vac, 50-60Hz, 200mA O/P: 5Vdc, 1A 1.25m non-shielded cable without core Manufacturer: Emerson
2				I/P: 100-240Vac, 50-60Hz, 200mA O/P: 5Vdc, 1A 1.25m non-shielded cable without core Manufacturer: Delta
3				I/P: 100-240Vac, 50-60Hz, 200mA O/P: 5Vdc, 1A 1.25m non-shielded cable without core Manufacturer: Phihong
4	Battery	hTC	BG86100	Rating: 3.8Vdc, 1730mAh, 6.57W/hr Manufacturer: HT ENERGY
5				Rating: 3.7Vdc, 1730mAh, 6.40W/hr Manufacturer: HT ENERGY
6	USB cable	Chant Sincere Co., LTD (COXOC)	DC M410	1.30m shielded cable without core
7		Foxlink		1.25m shielded cable without core
8		MEC		1.27m shielded cable without core
9		Chant Sincere Co., LTD (COXOC)		1.27m shielded cable without core
10	Earphone	Cotron	RC E160	1.23m non-shielded cable without core

*Item 1, 4, 10 were the worst for the final test.

*The adapter model: TC U250 was tested.

4. The above EUT information is declared by manufacturer and for more detailed features description, please refer to the manufacturer's specifications or user's manual.

3.2 DESCRIPTION OF TEST MODES

11 channels are provided for 802.11b, 802.11g and 802.11n (20MHz):

CHANNEL	FREQUENCY	CHANNEL	FREQUENCY
1	2412MHz	7	2442MHz
2	2417MHz	8	2447MHz
3	2422MHz	9	2452MHz
4	2427MHz	10	2457MHz
5	2432MHz	11	2462MHz
6	2437MHz		

3.2.1 CONFIGURATION OF SYSTEM UNDER TEST

Test Mode A

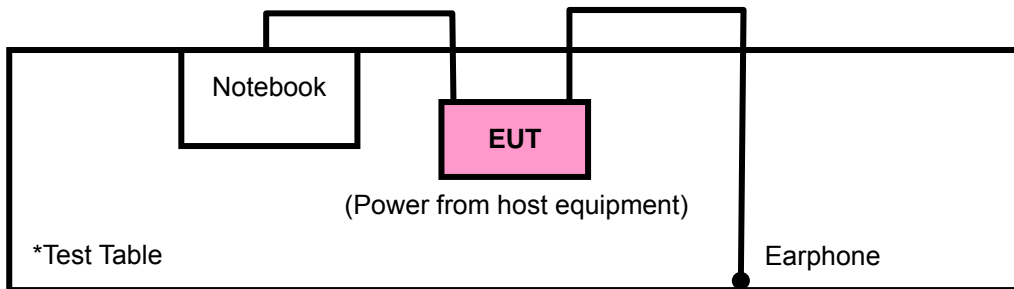

Test Mode B

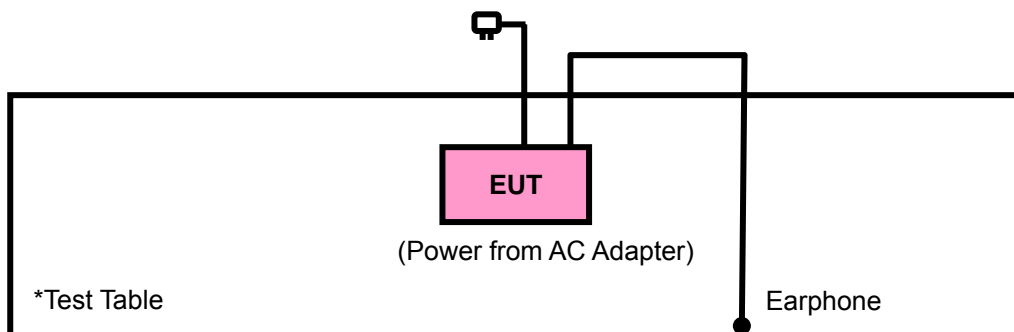



3.2.2 TEST MODE APPLICABILITY AND TESTED CHANNEL DETAIL

EUT CONFIGURE MODE	APPLICABLE TO				DESCRIPTION
	RE≥1G	RE<1G	PLC	APCM	
A	√	√	√	√	Power from host equipment
B	-	√	√	-	Power from adapter

Where **RE≥1G**: Radiated Emission above 1GHz **RE<1G**: Radiated Emission below 1GHz
PLC: Power Line Conducted Emission **APCM**: Antenna Port Conducted Measurement

NOTE: “-”: Means no effect.

RADIATED EMISSION TEST (ABOVE 1GHz):

- Pre-Scan has been conducted to determine the worst-case mode from all possible combinations between available modulations, XYZ axis and antenna ports (if EUT with antenna diversity architecture).
- Following channel(s) was (were) selected for the final test as listed below.

EUT CONFIGURE MODE	MODE	AVAILABLE CHANNEL	TESTED CHANNEL	MODULATION TECHNOLOGY	MODULATION TYPE	DATA RATE (Mbps)	AXIS
A	802.11b	1 to 11	1, 6, 11	DSSS	DBPSK	1.0	Z
A	802.11g	1 to 11	1, 6, 11	OFDM	BPSK	6.0	Z
A	802.11n (20MHz)	1 to 11	1, 6, 11	OFDM	BPSK	6.5	Z

RADIATED EMISSION TEST (BELOW 1GHz):

- Pre-Scan has been conducted to determine the worst-case mode from all possible combinations between available modulations, XYZ axis and antenna ports (if EUT with antenna diversity architecture).
- Following channel(s) was (were) selected for the final test as listed below.

EUT CONFIGURE MODE	MODE	AVAILABLE CHANNEL	TESTED CHANNEL	MODULATION TECHNOLOGY	MODULATION TYPE	DATA RATE (Mbps)	AXIS
A, B	802.11g	1 to 11	6	OFDM	BPSK	6.0	Z

POWER LINE CONDUCTED EMISSION TEST:

- Pre-Scan has been conducted to determine the worst-case mode from all possible combinations between available modulations, data rates and antenna ports (if EUT with antenna diversity architecture).
- Following channel(s) was (were) selected for the final test as listed below.

EUT CONFIGURE MODE	MODE	AVAILABLE CHANNEL	TESTED CHANNEL	MODULATION TECHNOLOGY	MODULATION TYPE	DATA RATE (Mbps)
A, B	802.11g	1 to 11	6	OFDM	BPSK	6.0



BANDEDGE MEASUREMENT:

- Pre-Scan has been conducted to determine the worst-case mode from all possible combinations between available modulations, data rates and antenna ports (if EUT with antenna diversity architecture).
- Following channel(s) was (were) selected for the final test as listed below.

EUT CONFIGURE MODE	MODE	AVAILABLE CHANNEL	TESTED CHANNEL	MODULATION TECHNOLOGY	MODULATION TYPE	DATA RATE (Mbps)
A	802.11b	1 to 11	1, 11	DSSS	DBPSK	1.0
A	802.11g	1 to 11	1, 11	OFDM	BPSK	6.0
A	802.11n (20MHz)	1 to 11	1, 11	OFDM	BPSK	6.5

ANTENNA PORT CONDUCTED MEASUREMENT:

- This item includes all test value of each mode, but only includes spectrum plot of worst value of each mode.
- Pre-Scan has been conducted to determine the worst-case mode from all possible combinations between available modulations, data rates and antenna ports (if EUT with antenna diversity architecture).
- Following channel(s) was (were) selected for the final test as listed below.

EUT CONFIGURE MODE	MODE	AVAILABLE CHANNEL	TESTED CHANNEL	MODULATION TECHNOLOGY	MODULATION TYPE	DATA RATE (Mbps)
A	802.11b	1 to 11	1, 6, 11	DSSS	DBPSK	1.0
A	802.11g	1 to 11	1, 6, 11	OFDM	BPSK	6.0
A	802.11n (20MHz)	1 to 11	1, 6, 11	OFDM	BPSK	6.5

TEST CONDITION:

APPLICABLE TO	ENVIRONMENTAL CONDITIONS	INPUT POWER	TESTED BY
RE≥1G	25deg. C, 64%RH, 1021 hPa	120Vac, 60Hz	David Huang
RE<1G	25deg. C, 64%RH, 1021 hPa	120Vac, 60Hz	David Huang
PLC	25deg. C, 64%RH, 1021 hPa	120Vac, 60Hz	David Huang
APCM	23deg. C, 68%RH, 1009 hPa	120Vac, 60Hz	Brad Wu



A D T

3.3 GENERAL DESCRIPTION OF APPLIED STANDARDS

The EUT is a RF Product. According to the specifications of the manufacturer, it must comply with the requirements of the following standards:

FCC Part 15, Subpart C (15.247)

ANSI C63.4-2003

ANSI C63.10-2009

All test items have been performed and recorded as per the above standards.

NOTE: The EUT is also considered as a kind of computer peripheral, because the connection to computer is necessary for typical use. It has been verified to comply with the requirements of FCC Part 15, Subpart B, Class B (DoC). The test report has been issued separately.

3.4 DESCRIPTION OF SUPPORT UNITS

The EUT has been tested as an independent unit together with other necessary accessories or support units. The following support units or accessories were used to form a representative test configuration during the tests.

NO.	PRODUCT	BRAND	MODEL NO.	SERIAL NO.	FCC ID
1	NOTEBOOK	Dell	D830	10026042688	FCC DoC Approved

NO.	SIGNAL CABLE DESCRIPTION OF THE ABOVE SUPPORT UNITS
1	NA

NOTE: All power cords of the above support units are non shielded (1.8m).



4. TEST TYPES AND RESULTS

4.1 RADIATED EMISSION MEASUREMENT

4.1.1 LIMITS OF RADIATED EMISSION MEASUREMENT

Emissions radiated outside of the specified bands, shall be according to the general radiated limits in 15.209 as following:

FREQUENCIES (MHz)	FIELD STRENGTH (microvolts/meter)	MEASUREMENT DISTANCE (meters)
0.009 ~ 0.490	2400/F(kHz)	300
0.490 ~ 1.705	24000/F(kHz)	30
1.705 ~ 30.0	30	30
30 ~ 88	100	3
88 ~ 216	150	3
216 ~ 960	200	3
Above 960	500	3

NOTE:

1. The lower limit shall apply at the transition frequencies.
2. Emission level (dBuV/m) = 20 log Emission level (uV/m).
3. As shown in 15.35(b), for frequencies above 1000MHz, the field strength limits are based on average detector, however, the peak field strength of any emission shall not exceed the maximum permitted average limits, specified above by more than 20dB under any condition of modulation.



A D T

4.1.2 TEST INSTRUMENTS

DESCRIPTION & MANUFACTURER	MODEL NO.	SERIAL NO.	DATE OF CALIBRATION	DUE DATE OF CALIBRATION
Test Receiver ROHDE & SCHWARZ	ESI7	838496/016	Dec. 27, 2010	Dec. 26, 2011
Spectrum Analyzer ROHDE & SCHWARZ	FSU43	100115	Aug. 02, 2010	Aug. 01, 2011
BILOG Antenna SCHWARZBECK	VULB9168	9168-155	Apr. 12, 2011	Apr. 11, 2012
HORN Antenna SCHWARZBECK	BBHA 9120D	9120D-408	Jan. 06, 2011	Jan. 05, 2012
HORN Antenna SCHWARZBECK	BBHA 9170	BBHA9170243	Dec. 27, 2010	Dec. 26, 2011
Preamplifier Agilent	8449B	3008A01961	Nov. 02, 2010	Nov. 01, 2011
Preamplifier Agilent	8447D	2944A10738	Nov. 02, 2010	Nov. 01, 2011
RF signal cable HUBER+SUHNNER	SUCOFLEX 104	274041/4	Aug. 21, 2010	Aug. 20, 2011
RF signal cable HUBER+SUHNNER	SUCOFLEX 104	283397/4	Aug. 21, 2010	Aug. 20, 2011
Software ADT.	ADT_Radiated_ V7.6.15.9.2	NA	NA	NA
Antenna Tower inn-co GmbH	MA 4000	010303	NA	NA
Antenna Tower Controller inn-co GmbH	CO2000	019303	NA	NA
Turn Table ADT.	TT100.	TT93021704	NA	NA
Turn Table Controller ADT.	SC100.	SC93021704	NA	NA

- NOTE:**
1. The calibration interval of the above test instruments is 12 months and the calibrations are traceable to NML/ROC and NIST/USA.
 2. The test was performed in HwaYa Chamber 4.
 3. The horn antenna and HP preamplifier (model: 8449B) are used only for the measurement of emission frequency above 1GHz if tested.
 4. The FCC Site Registration No. is 988962.
 5. The IC Site Registration No. is IC7450F-4.

4.1.3 TEST PROCEDURES

- a. The EUT was placed on the top of a rotating table 0.8 meters above the ground at a 3 meters semi-anechoic chamber. The table was rotated 360 degrees to determine the position of the highest radiation.
- b. The EUT was set 3 meters away from the interference-receiving antenna, which was mounted on the top of a variable-height antenna tower.
- c. The antenna is a broadband antenna, and its height is varied from one meter to four meters above the ground to determine the maximum value of the field strength. Both horizontal and vertical polarizations of the antenna are set to make the measurement.
- d. For each suspected emission, the EUT was arranged to its worst case and then the antenna was tuned to heights from 1 meter to 4 meters and the rotatable table was turned from 0 degrees to 360 degrees to find the maximum reading.
- e. The test-receiver system was set to Peak Detect Function and Specified Bandwidth with Maximum Hold Mode.
- f. If the emission level of the EUT in peak mode was lower than the limit specified, then testing could be stopped and the peak values of the EUT would be reported. Otherwise the emissions would be re-tested one by one using peak, quasi-peak or average method as specified and then reported in a data sheet.

NOTE:

1. The resolution bandwidth and video bandwidth of test receiver/spectrum analyzer is 120kHz for Quasi-peak detection at frequency below 1GHz.
2. The resolution bandwidth of test receiver/spectrum analyzer is 1MHz and video bandwidth is 3MHz for Peak detection at frequency above 1GHz.
3. The resolution bandwidth of test receiver/spectrum analyzer is 1MHz and the video bandwidth is 10Hz for Average detection (AV) at frequency above 1GHz.
4. All modes of operation were investigated and the worst-case emissions are reported.

4.1.4 DEVIATION FROM TEST STANDARD

No deviation.

4.1.5 TEST SETUP

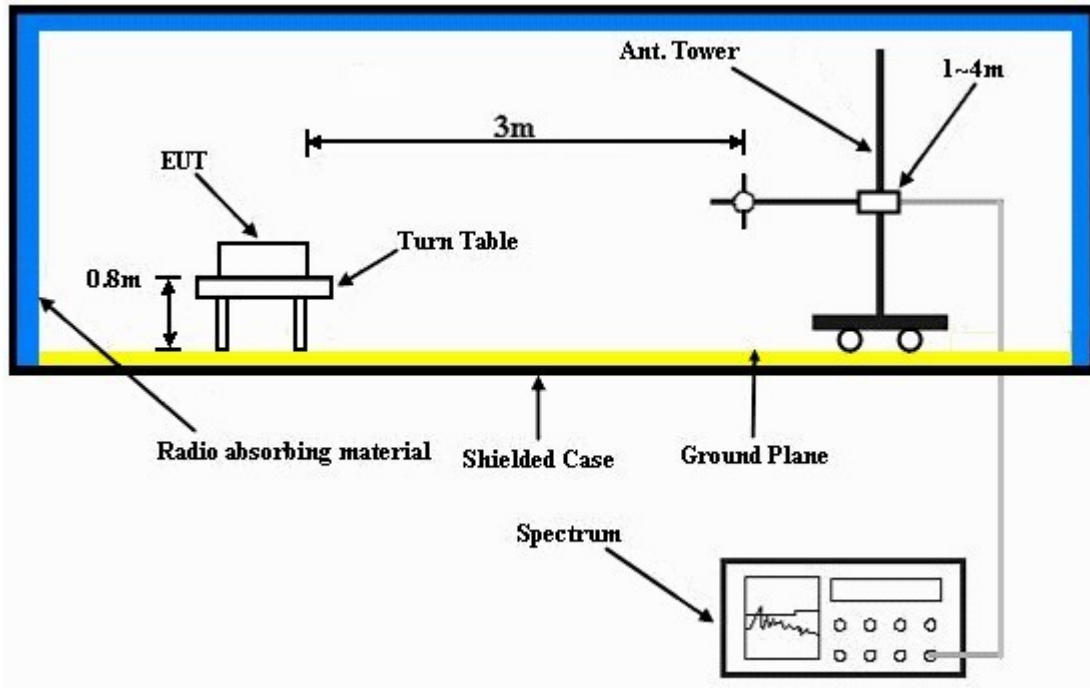

For the actual test configuration, please refer to the attached file (Test Setup Photo).

4.1.6 EUT OPERATING CONDITIONS

TEST MODE A

- a. Connected the EUT to notebook and placed on a testing table.
- b. Use the software to control the EUT under transmission condition continuously at specific channel frequency.
- c. The necessary accessories enable the system in full functions.

TEST MODE B

- a. Placed the EUT on a testing table.
- b. Use the software to control the EUT under transmission condition continuously at specific channel frequency.



A D T

4.1.7 TEST RESULT

802.11b

EUT TEST CONDITION		MEASUREMENT DETAIL	
CHANNEL	Channel 1	FREQUENCY RANGE	1 ~ 25GHz
INPUT POWER (SYSTEM)	120Vac, 60Hz	DETECTOR FUNCTION	Peak (PK) Average (AV)
ENVIRONMENTAL CONDITIONS	25deg. C, 64%RH 1012 hPa	TESTED BY	David Huang

ANTENNA POLARITY & TEST DISTANCE: HORIZONTAL AT 3 M								
NO.	FREQ. (MHz)	EMISSION LEVEL (dBuV/m)	LIMIT (dBuV/m)	MARGIN (dB)	ANTENNA HEIGHT (m)	TABLE ANGLE (Degree)	RAW VALUE (dBuV)	CORRECTION FACTOR (dB/m)
1	2390.00	58.1 PK	74.0	-15.9	1.22 H	199	26.20	31.90
2	2390.00	47.3 AV	54.0	-6.7	1.22 H	199	15.40	31.90
3	*2412.00	107.2 PK			1.22 H	199	75.30	31.90
4	*2412.00	103.6 AV			1.22 H	199	71.70	31.90
5	4824.00	45.6 PK	74.0	-28.4	1.00 H	347	7.60	38.00
6	4824.00	33.1 AV	54.0	-20.9	1.00 H	347	-4.90	38.00
ANTENNA POLARITY & TEST DISTANCE: VERTICAL AT 3 M								
NO.	FREQ. (MHz)	EMISSION LEVEL (dBuV/m)	LIMIT (dBuV/m)	MARGIN (dB)	ANTENNA HEIGHT (m)	TABLE ANGLE (Degree)	RAW VALUE (dBuV)	CORRECTION FACTOR (dB/m)
1	2390.00	58.6 PK	74.0	-15.4	1.27 V	179	26.70	31.90
2	2390.00	47.5 AV	54.0	-6.5	1.27 V	179	15.60	31.90
3	*2412.00	106.7 PK			1.27 V	179	74.80	31.90
4	*2412.00	102.9 AV			1.27 V	179	71.00	31.90
5	4824.00	46.0 PK	74.0	-28.0	1.00 V	64	8.00	38.00
6	4824.00	32.7 AV	54.0	-21.3	1.00 V	64	-5.30	38.00

- REMARKS:**
1. Emission level (dBuV/m) = Raw Value (dBuV) + Correction Factor (dB/m).
 2. Correction Factor (dB/m) = Antenna Factor (dB/m) + Cable Factor (dB).
 3. The other emission levels were very low against the limit.
 4. Margin value = Emission level – Limit value.
 5. “ * “: Fundamental frequency.



A D T

EUT TEST CONDITION		MEASUREMENT DETAIL	
CHANNEL	Channel 6	FREQUENCY RANGE	1 ~ 25GHz
INPUT POWER (SYSTEM)	120Vac, 60Hz	DETECTOR FUNCTION	Peak (PK) Average (AV)
ENVIRONMENTAL CONDITIONS	25deg. C, 64%RH 1012 hPa	TESTED BY	David Huang

ANTENNA POLARITY & TEST DISTANCE: HORIZONTAL AT 3 M								
NO.	FREQ. (MHz)	EMISSION LEVEL (dBuV/m)	LIMIT (dBuV/m)	MARGIN (dB)	ANTENNA HEIGHT (m)	TABLE ANGLE (Degree)	RAW VALUE (dBuV)	CORRECTION FACTOR (dB/m)
1	2390.00	53.7 PK	74.0	-20.3	1.21 H	220	21.80	31.90
2	2390.00	42.5 AV	54.0	-11.5	1.21 H	220	10.60	31.90
3	*2437.00	107.8 PK			1.19 H	203	75.80	32.00
4	*2437.00	103.9 AV			1.19 H	203	71.90	32.00
5	4874.00	46.9 PK	74.0	-27.1	1.00 H	57	8.80	38.10
6	4874.00	34.4 AV	54.0	-19.6	1.00 H	57	-3.70	38.10
ANTENNA POLARITY & TEST DISTANCE: VERTICAL AT 3 M								
NO.	FREQ. (MHz)	EMISSION LEVEL (dBuV/m)	LIMIT (dBuV/m)	MARGIN (dB)	ANTENNA HEIGHT (m)	TABLE ANGLE (Degree)	RAW VALUE (dBuV)	CORRECTION FACTOR (dB/m)
1	2390.00	52.1 PK	74.0	-21.9	1.23 V	88	20.20	31.90
2	2390.00	42.0 AV	54.0	-12.0	1.23 V	88	10.10	31.90
3	*2437.00	106.5 PK			1.23 V	88	74.50	32.00
4	*2437.00	102.6 AV			1.23 V	88	70.60	32.00
5	4874.00	45.8 PK	74.0	-28.2	1.00 V	214	7.70	38.10
6	4874.00	33.4 AV	54.0	-20.6	1.00 V	214	-4.70	38.10

- REMARKS:**
1. Emission level (dBuV/m) = Raw Value (dBuV) + Correction Factor (dB/m).
 2. Correction Factor (dB/m) = Antenna Factor (dB/m) + Cable Factor (dB).
 3. The other emission levels were very low against the limit.
 4. Margin value = Emission level – Limit value.
 5. “ * ”: Fundamental frequency.



A D T

EUT TEST CONDITION		MEASUREMENT DETAIL	
CHANNEL	Channel 11	FREQUENCY RANGE	1 ~ 25GHz
INPUT POWER (SYSTEM)	120Vac, 60Hz	DETECTOR FUNCTION	Peak (PK) Average (AV)
ENVIRONMENTAL CONDITIONS	25deg. C, 64%RH 1012 hPa	TESTED BY	David Huang

ANTENNA POLARITY & TEST DISTANCE: HORIZONTAL AT 3 M								
NO.	FREQ. (MHz)	EMISSION LEVEL (dBuV/m)	LIMIT (dBuV/m)	MARGIN (dB)	ANTENNA HEIGHT (m)	TABLE ANGLE (Degree)	RAW VALUE (dBuV)	CORRECTION FACTOR (dB/m)
1	*2462.00	107.3 PK			1.44 H	200	75.20	32.10
2	*2462.00	103.5 AV			1.44 H	200	71.40	32.10
3	2483.50	60.5 PK	74.0	-13.5	1.44 H	200	28.30	32.20
4	2483.50	48.1 AV	54.0	-5.9	1.44 H	200	15.90	32.20
5	4924.00	45.2 PK	74.0	-28.8	1.00 H	46	7.00	38.20
6	4924.00	33.6 AV	54.0	-20.4	1.00 H	46	-4.60	38.20
ANTENNA POLARITY & TEST DISTANCE: VERTICAL AT 3 M								
NO.	FREQ. (MHz)	EMISSION LEVEL (dBuV/m)	LIMIT (dBuV/m)	MARGIN (dB)	ANTENNA HEIGHT (m)	TABLE ANGLE (Degree)	RAW VALUE (dBuV)	CORRECTION FACTOR (dB/m)
1	*2462.00	105.5 PK			1.22 V	171	73.40	32.10
2	*2462.00	101.7 AV			1.22 V	171	69.60	32.10
3	2483.50	58.1 PK	74.0	-15.9	1.22 V	171	25.90	32.20
4	2483.50	47.3 AV	54.0	-6.7	1.22 V	171	15.10	32.20
5	4924.00	45.8 PK	74.0	-28.2	1.00 V	167	7.60	38.20
6	4924.00	33.4 AV	54.0	-20.6	1.00 V	167	-4.80	38.20

- REMARKS:**
1. Emission level (dBuV/m) = Raw Value (dBuV) + Correction Factor (dB/m).
 2. Correction Factor (dB/m) = Antenna Factor (dB/m) + Cable Factor (dB).
 3. The other emission levels were very low against the limit.
 4. Margin value = Emission level – Limit value.
 5. “ * ”: Fundamental frequency.



A D T

802.11g

EUT TEST CONDITION		MEASUREMENT DETAIL	
CHANNEL	Channel 1	FREQUENCY RANGE	1 ~ 25GHz
INPUT POWER (SYSTEM)	120Vac, 60Hz	DETECTOR FUNCTION	Peak (PK) Average (AV)
ENVIRONMENTAL CONDITIONS	25deg. C, 64%RH 1012 hPa	TESTED BY	David Huang

ANTENNA POLARITY & TEST DISTANCE: HORIZONTAL AT 3 M								
NO.	FREQ. (MHz)	EMISSION LEVEL (dBuV/m)	LIMIT (dBuV/m)	MARGIN (dB)	ANTENNA HEIGHT (m)	TABLE ANGLE (Degree)	RAW VALUE (dBuV)	CORRECTION FACTOR (dB/m)
1	2390.00	68.1 PK	74.0	-5.9	1.46 H	199	36.20	31.90
2	2390.00	51.6 AV	54.0	-2.4	1.46 H	199	19.70	31.90
3	*2412.00	106.2 PK			1.46 H	199	74.30	31.90
4	*2412.00	93.3 AV			1.46 H	199	61.40	31.90
5	4824.00	37.0 PK	74.0	-37.0	1.00 H	192	-1.00	38.00
6	4824.00	34.5 AV	54.0	-19.5	1.00 H	192	-3.50	38.00

ANTENNA POLARITY & TEST DISTANCE: VERTICAL AT 3 M								
NO.	FREQ. (MHz)	EMISSION LEVEL (dBuV/m)	LIMIT (dBuV/m)	MARGIN (dB)	ANTENNA HEIGHT (m)	TABLE ANGLE (Degree)	RAW VALUE (dBuV)	CORRECTION FACTOR (dB/m)
1	2390.00	66.2 PK	74.0	-7.8	1.26 V	178	34.30	31.90
2	2390.00	50.3 AV	54.0	-3.7	1.26 V	178	18.40	31.90
3	*2412.00	104.6 PK			1.26 V	178	72.70	31.90
4	*2412.00	91.4 AV			1.26 V	178	59.50	31.90
5	4824.00	35.6 PK	74.0	-38.4	1.00 V	167	-2.40	38.00
6	4824.00	33.0 AV	54.0	-21.0	1.00 V	167	-5.00	38.00

- REMARKS:**
1. Emission level (dBuV/m) = Raw Value (dBuV) + Correction Factor (dB/m).
 2. Correction Factor (dB/m) = Antenna Factor (dB/m) + Cable Factor (dB).
 3. The other emission levels were very low against the limit.
 4. Margin value = Emission level – Limit value.
 5. “ * “: Fundamental frequency.



A D T

EUT TEST CONDITION		MEASUREMENT DETAIL	
CHANNEL	Channel 6	FREQUENCY RANGE	1 ~ 25GHz
INPUT POWER (SYSTEM)	120Vac, 60Hz	DETECTOR FUNCTION	Peak (PK) Average (AV)
ENVIRONMENTAL CONDITIONS	25deg. C, 64%RH 1012 hPa	TESTED BY	David Huang

ANTENNA POLARITY & TEST DISTANCE: HORIZONTAL AT 3 M								
NO.	FREQ. (MHz)	EMISSION LEVEL (dBuV/m)	LIMIT (dBuV/m)	MARGIN (dB)	ANTENNA HEIGHT (m)	TABLE ANGLE (Degree)	RAW VALUE (dBuV)	CORRECTION FACTOR (dB/m)
1	2390.00	58.5 PK	74.0	-15.5	1.46 H	200	26.60	31.90
2	2390.00	43.3 AV	54.0	-10.7	1.46 H	200	11.40	31.90
3	*2437.00	106.0 PK			1.46 H	200	74.00	32.00
4	*2437.00	93.0 AV			1.46 H	200	61.00	32.00
5	4874.00	47.3 PK	74.0	-26.7	1.00 H	207	9.20	38.10
6	4874.00	34.0 AV	54.0	-20.0	1.00 H	207	-4.10	38.10
ANTENNA POLARITY & TEST DISTANCE: VERTICAL AT 3 M								
NO.	FREQ. (MHz)	EMISSION LEVEL (dBuV/m)	LIMIT (dBuV/m)	MARGIN (dB)	ANTENNA HEIGHT (m)	TABLE ANGLE (Degree)	RAW VALUE (dBuV)	CORRECTION FACTOR (dB/m)
1	2390.00	53.1 PK	74.0	-20.9	1.26 V	173	21.20	31.90
2	2390.00	42.0 AV	54.0	-12.0	1.26 V	173	10.10	31.90
3	*2437.00	104.2 PK			1.26 V	173	72.20	32.00
4	*2437.00	91.2 AV			1.26 V	173	59.20	32.00
5	4874.00	46.0 PK	74.0	-28.0	1.00 V	117	7.90	38.10
6	4874.00	32.8 AV	54.0	-21.2	1.00 V	117	-5.30	38.10

- REMARKS:**
1. Emission level (dBuV/m) = Raw Value (dBuV) + Correction Factor (dB/m).
 2. Correction Factor (dB/m) = Antenna Factor (dB/m) + Cable Factor (dB).
 3. The other emission levels were very low against the limit.
 4. Margin value = Emission level – Limit value.
 5. “ * ”: Fundamental frequency.



A D T

EUT TEST CONDITION		MEASUREMENT DETAIL	
CHANNEL	Channel 11	FREQUENCY RANGE	1 ~ 25GHz
INPUT POWER (SYSTEM)	120Vac, 60Hz	DETECTOR FUNCTION	Peak (PK) Average (AV)
ENVIRONMENTAL CONDITIONS	25deg. C, 64%RH 1012 hPa	TESTED BY	David Huang

ANTENNA POLARITY & TEST DISTANCE: HORIZONTAL AT 3 M								
NO.	FREQ. (MHz)	EMISSION LEVEL (dBuV/m)	LIMIT (dBuV/m)	MARGIN (dB)	ANTENNA HEIGHT (m)	TABLE ANGLE (Degree)	RAW VALUE (dBuV)	CORRECTION FACTOR (dB/m)
1	*2462.00	105.7 PK			1.19 H	217	73.60	32.10
2	*2462.00	92.6 AV			1.19 H	217	60.50	32.10
3	2483.50	62.1 PK	74.0	-11.9	1.19 H	217	29.90	32.20
4	2483.50	48.0 AV	54.0	-6.0	1.19 H	217	15.80	32.20
5	4924.00	46.9 PK	74.0	-27.1	1.00 H	216	8.70	38.20
6	4924.00	34.5 AV	54.0	-19.5	1.00 H	216	-3.70	38.20
ANTENNA POLARITY & TEST DISTANCE: VERTICAL AT 3 M								
NO.	FREQ. (MHz)	EMISSION LEVEL (dBuV/m)	LIMIT (dBuV/m)	MARGIN (dB)	ANTENNA HEIGHT (m)	TABLE ANGLE (Degree)	RAW VALUE (dBuV)	CORRECTION FACTOR (dB/m)
1	*2462.00	103.7 PK			1.20 V	174	71.60	32.10
2	*2462.00	90.5 AV			1.20 V	174	58.40	32.10
3	2483.50	60.1 PK	74.0	-13.9	1.20 V	174	27.90	32.20
4	2483.50	45.7 AV	54.0	-8.3	1.20 V	174	13.50	32.20
5	4924.00	45.9 PK	74.0	-28.1	1.00 V	141	7.70	38.20
6	4924.00	33.4 AV	54.0	-20.6	1.00 V	141	-4.80	38.20

- REMARKS:**
1. Emission level (dBuV/m) = Raw Value (dBuV) + Correction Factor (dB/m).
 2. Correction Factor (dB/m) = Antenna Factor (dB/m) + Cable Factor (dB).
 3. The other emission levels were very low against the limit.
 4. Margin value = Emission level – Limit value.
 5. “ * ”: Fundamental frequency.



A D T

802.11n (20MHz)

EUT TEST CONDITION		MEASUREMENT DETAIL	
CHANNEL	Channel 1	FREQUENCY RANGE	1 ~ 25GHz
INPUT POWER (SYSTEM)	120Vac, 60Hz	DETECTOR FUNCTION	Peak (PK) Average (AV)
ENVIRONMENTAL CONDITIONS	25deg. C, 64%RH 1012 hPa	TESTED BY	David Huang

ANTENNA POLARITY & TEST DISTANCE: HORIZONTAL AT 3 M

NO.	FREQ. (MHz)	EMISSION LEVEL (dBuV/m)	LIMIT (dBuV/m)	MARGIN (dB)	ANTENNA HEIGHT (m)	TABLE ANGLE (Degree)	RAW VALUE (dBuV)	CORRECTION FACTOR (dB/m)
1	2390.00	64.8 PK	74.0	-9.2	1.46 H	198	32.90	31.90
2	2390.00	52.7 AV	54.0	-1.3	1.46 H	198	20.80	31.90
3	*2412.00	105.5 PK			1.46 H	198	73.60	31.90
4	*2412.00	92.5 AV			1.46 H	198	60.60	31.90
5	4824.00	46.9 PK	74.0	-27.1	1.00 H	231	8.90	38.00
6	4824.00	34.2 AV	54.0	-19.8	1.00 H	231	-3.80	38.00

ANTENNA POLARITY & TEST DISTANCE: VERTICAL AT 3 M

NO.	FREQ. (MHz)	EMISSION LEVEL (dBuV/m)	LIMIT (dBuV/m)	MARGIN (dB)	ANTENNA HEIGHT (m)	TABLE ANGLE (Degree)	RAW VALUE (dBuV)	CORRECTION FACTOR (dB/m)
1	2390.00	64.7 PK	74.0	-9.3	1.22 V	207	32.80	31.90
2	2390.00	49.9 AV	54.0	-4.1	1.22 V	207	18.00	31.90
3	*2412.00	103.0 PK			1.22 V	207	71.10	31.90
4	*2412.00	90.0 AV			1.22 V	207	58.10	31.90
5	4824.00	45.8 PK	74.0	-28.2	1.00 V	210	7.80	38.00
6	4824.00	32.8 AV	54.0	-21.2	1.00 V	210	-5.20	38.00

- REMARKS:**
1. Emission level (dBuV/m) = Raw Value (dBuV) + Correction Factor (dB/m).
 2. Correction Factor (dB/m) = Antenna Factor (dB/m) + Cable Factor (dB).
 3. The other emission levels were very low against the limit.
 4. Margin value = Emission level – Limit value.
 5. “ * “: Fundamental frequency.



A D T

EUT TEST CONDITION		MEASUREMENT DETAIL	
CHANNEL	Channel 6	FREQUENCY RANGE	1 ~ 25GHz
INPUT POWER (SYSTEM)	120Vac, 60Hz	DETECTOR FUNCTION	Peak (PK) Average (AV)
ENVIRONMENTAL CONDITIONS	25deg. C, 64%RH 1012 hPa	TESTED BY	David Huang

ANTENNA POLARITY & TEST DISTANCE: HORIZONTAL AT 3 M								
NO.	FREQ. (MHz)	EMISSION LEVEL (dBuV/m)	LIMIT (dBuV/m)	MARGIN (dB)	ANTENNA HEIGHT (m)	TABLE ANGLE (Degree)	RAW VALUE (dBuV)	CORRECTION FACTOR (dB/m)
1	2390.00	59.3 PK	74.0	-14.7	1.45 H	201	27.40	31.90
2	2390.00	44.1 AV	54.0	-9.9	1.45 H	201	12.20	31.90
3	*2437.00	105.3 PK			1.45 H	201	73.30	32.00
4	*2437.00	92.2 AV			1.45 H	201	60.20	32.00
5	4874.00	47.2 PK	74.0	-26.8	1.00 H	237	9.10	38.10
6	4874.00	34.3 AV	54.0	-19.7	1.00 H	237	-3.80	38.10
ANTENNA POLARITY & TEST DISTANCE: VERTICAL AT 3 M								
NO.	FREQ. (MHz)	EMISSION LEVEL (dBuV/m)	LIMIT (dBuV/m)	MARGIN (dB)	ANTENNA HEIGHT (m)	TABLE ANGLE (Degree)	RAW VALUE (dBuV)	CORRECTION FACTOR (dB/m)
1	2390.00	60.1 PK	74.0	-13.9	1.24 V	203	28.20	31.90
2	2390.00	46.2 AV	54.0	-7.8	1.24 V	203	14.30	31.90
3	*2437.00	103.2 PK			1.24 V	203	71.20	32.00
4	*2437.00	90.3 AV			1.24 V	203	58.30	32.00
5	4874.00	45.9 PK	74.0	-28.1	1.00 V	167	7.80	38.10
6	4874.00	32.9 AV	54.0	-21.1	1.00 V	167	-5.20	38.10

- REMARKS:**
1. Emission level (dBuV/m) = Raw Value (dBuV) + Correction Factor (dB/m).
 2. Correction Factor (dB/m) = Antenna Factor (dB/m) + Cable Factor (dB).
 3. The other emission levels were very low against the limit.
 4. Margin value = Emission level – Limit value.
 5. “ * ”: Fundamental frequency.



A D T

EUT TEST CONDITION		MEASUREMENT DETAIL	
CHANNEL	Channel 11	FREQUENCY RANGE	1 ~ 25GHz
INPUT POWER (SYSTEM)	120Vac, 60Hz	DETECTOR FUNCTION	Peak (PK) Average (AV)
ENVIRONMENTAL CONDITIONS	25deg. C, 64%RH 1012 hPa	TESTED BY	David Huang

ANTENNA POLARITY & TEST DISTANCE: HORIZONTAL AT 3 M								
NO.	FREQ. (MHz)	EMISSION LEVEL (dBuV/m)	LIMIT (dBuV/m)	MARGIN (dB)	ANTENNA HEIGHT (m)	TABLE ANGLE (Degree)	RAW VALUE (dBuV)	CORRECTION FACTOR (dB/m)
1	*2462.00	105.1 PK			1.46 H	201	73.00	32.10
2	*2462.00	92.0 AV			1.46 H	201	59.90	32.10
3	2483.50	64.5 PK	74.0	-9.5	1.46 H	201	32.30	32.20
4	2483.50	51.4 AV	54.0	-2.6	1.46 H	201	19.20	32.20
5	4924.00	47.9 PK	74.0	-26.1	1.00 H	227	9.70	38.20
6	4924.00	34.6 AV	54.0	-19.4	1.00 H	227	-3.60	38.20
ANTENNA POLARITY & TEST DISTANCE: VERTICAL AT 3 M								
NO.	FREQ. (MHz)	EMISSION LEVEL (dBuV/m)	LIMIT (dBuV/m)	MARGIN (dB)	ANTENNA HEIGHT (m)	TABLE ANGLE (Degree)	RAW VALUE (dBuV)	CORRECTION FACTOR (dB/m)
1	*2462.00	103.1 PK			1.20 V	213	71.00	32.10
2	*2462.00	90.1 AV			1.20 V	213	58.00	32.10
3	2483.50	61.4 PK	74.0	-12.6	1.20 V	213	29.20	32.20
4	2483.50	48.2 AV	54.0	-5.8	1.20 V	213	16.00	32.20
5	4924.00	46.1 PK	74.0	-27.9	1.00 V	154	7.90	38.20
6	4924.00	33.3 AV	54.0	-20.7	1.00 V	154	-4.90	38.20

- REMARKS:**
1. Emission level (dBuV/m) = Raw Value (dBuV) + Correction Factor (dB/m).
 2. Correction Factor (dB/m) = Antenna Factor (dB/m) + Cable Factor (dB).
 3. The other emission levels were very low against the limit.
 4. Margin value = Emission level – Limit value.
 5. “ * ”: Fundamental frequency.



A D T

BELOW 1GHz WORST-CASE DATA : 802.11g

EUT TEST CONDITION		MEASUREMENT DETAIL	
CHANNEL	Channel 6	FREQUENCY RANGE	Below 1000MHz
INPUT POWER (SYSTEM)	120Vac, 60Hz	DETECTOR FUNCTION	Quasi-Peak
ENVIRONMENTAL CONDITIONS	25deg. C, 64%RH 1012 hPa	TESTED BY	David Huang
TEST MODE	A		

ANTENNA POLARITY & TEST DISTANCE: HORIZONTAL AT 3 M								
NO.	FREQ. (MHz)	EMISSION LEVEL (dBuV/m)	LIMIT (dBuV/m)	MARGIN (dB)	ANTENNA HEIGHT (m)	TABLE ANGLE (Degree)	RAW VALUE (dBuV)	CORRECTION FACTOR (dB/m)
1	92.12	25.9 QP	43.5	-17.6	2.00 H	115	17.00	8.90
2	158.22	29.3 QP	43.5	-14.2	2.00 H	319	14.80	14.50
3	237.94	34.1 QP	46.0	-11.9	1.00 H	82	21.00	13.10
4	381.82	21.9 QP	46.0	-24.1	1.00 H	247	4.10	17.80
5	574.30	22.1 QP	46.0	-23.9	2.00 H	40	-0.50	22.60
6	772.62	24.7 QP	46.0	-21.3	2.00 H	202	-1.20	25.90

ANTENNA POLARITY & TEST DISTANCE: VERTICAL AT 3 M								
NO.	FREQ. (MHz)	EMISSION LEVEL (dBuV/m)	LIMIT (dBuV/m)	MARGIN (dB)	ANTENNA HEIGHT (m)	TABLE ANGLE (Degree)	RAW VALUE (dBuV)	CORRECTION FACTOR (dB/m)
1	53.23	28.5 QP	40.0	-11.5	1.00 V	4	14.30	14.20
2	158.22	25.0 QP	43.5	-18.5	1.00 V	115	10.50	14.50
3	234.05	30.5 QP	46.0	-15.5	1.00 V	94	17.60	12.90
4	368.21	20.3 QP	46.0	-25.7	1.25 V	91	2.90	17.40
5	471.25	22.1 QP	46.0	-23.9	1.25 V	160	1.90	20.20
6	591.80	24.9 QP	46.0	-21.1	1.25 V	355	1.90	23.00

- REMARKS:**
1. Emission level (dBuV/m) = Raw Value (dBuV) + Correction Factor (dB/m).
 2. Correction Factor (dB/m) = Antenna Factor (dB/m) + Cable Factor (dB).
 3. The other emission levels were very low against the limit.
 4. Margin value = Emission level – Limit value.



A D T

EUT TEST CONDITION		MEASUREMENT DETAIL	
CHANNEL	Channel 6	FREQUENCY RANGE	Below 1000MHz
INPUT POWER (SYSTEM)	120Vac, 60Hz	DETECTOR FUNCTION	Quasi-Peak
ENVIRONMENTAL CONDITIONS	25deg. C, 64%RH 1012 hPa	TESTED BY	David Huang
TEST MODE	B		

ANTENNA POLARITY & TEST DISTANCE: HORIZONTAL AT 3 M								
NO.	FREQ. (MHz)	EMISSION LEVEL (dBuV/m)	LIMIT (dBuV/m)	MARGIN (dB)	ANTENNA HEIGHT (m)	TABLE ANGLE (Degree)	RAW VALUE (dBuV)	CORRECTION FACTOR (dB/m)
1	44.85	29.6 QP	40.0	-10.4	1.50 H	195	15.30	14.30
2	127.81	32.8 QP	43.5	-10.7	2.00 H	104	19.90	12.90
3	163.52	30.6 QP	43.5	-12.9	2.00 H	18	16.30	14.30
4	318.21	24.5 QP	46.0	-21.5	1.00 H	88	8.40	16.10
5	766.72	23.9 QP	46.0	-22.1	1.00 H	113	-1.90	25.80
6	948.48	25.1 QP	46.0	-20.9	1.00 H	99	-3.50	28.60
ANTENNA POLARITY & TEST DISTANCE: VERTICAL AT 3 M								
NO.	FREQ. (MHz)	EMISSION LEVEL (dBuV/m)	LIMIT (dBuV/m)	MARGIN (dB)	ANTENNA HEIGHT (m)	TABLE ANGLE (Degree)	RAW VALUE (dBuV)	CORRECTION FACTOR (dB/m)
1	41.66	36.4 QP	40.0	-3.6	1.50 V	265	22.30	14.10
2	160.95	25.5 QP	43.5	-18.0	1.00 V	154	11.10	14.40
3	460.86	20.9 QP	46.0	-25.1	1.50 V	101	1.00	19.90
4	601.85	24.9 QP	46.0	-21.1	1.00 V	115	1.70	23.20
5	782.21	23.8 QP	46.0	-22.2	2.00 V	103	-2.40	26.20
6	945.46	26.9 QP	46.0	-19.1	1.00 V	103	-1.70	28.60

- REMARKS:**
1. Emission level (dBuV/m) = Raw Value (dBuV) + Correction Factor (dB/m).
 2. Correction Factor (dB/m) = Antenna Factor (dB/m) + Cable Factor (dB).
 3. The other emission levels were very low against the limit.
 4. Margin value = Emission level – Limit value.



A D T

4.2 CONDUCTED EMISSION MEASUREMENT

4.2.1 LIMITS OF CONDUCTED EMISSION MEASUREMENT

FREQUENCY OF EMISSION (MHz)	CONDUCTED LIMIT (dB μ V)	
	Quasi-peak	Average
0.15 ~ 0.5	66 to 56	56 to 46
0.5 ~ 5	56	46
5 ~ 30	60	50

- NOTE:** 1. The lower limit shall apply at the transition frequencies.
2. The limit decreases in line with the logarithm of the frequency in the range of 0.15 to 0.50MHz.
3. All emanations from a class A/B digital device or system, including any network of conductors and apparatus connected thereto, shall not exceed the level of field strengths specified above.

4.2.2 TEST INSTRUMENTS

DESCRIPTION & MANUFACTURER	MODEL NO.	SERIAL NO.	DATE OF CALIBRATION	DUE DATE OF CALIBRATION
Test Receiver ROHDE & SCHWARZ	ESCS30	100289	Nov. 23, 2010	Nov. 22, 2011
RF signal cable Woken	5D-FB	Cable-HYCO2-01	Dec. 30, 2010	Dec. 29, 2011
LISN ROHDE & SCHWARZ	ESH2-Z5	100100	Jan. 06, 2011	Jan. 05, 2012
LISN ROHDE & SCHWARZ	ESH3-Z5	100311	Jul. 08, 2010	Jul. 07, 2011
V-LISN SCHWARZBECK	NNBL 8226-2	8226-142	Jul. 12, 2010	Jul. 11, 2011
LISN ROHDE & SCHWARZ	ENV216	100072	Jun. 11, 2010	Jun. 10, 2011
Software ADT	ADT_Cond_ V7.3.7	NA	NA	NA

- NOTE:** 1. The calibration interval of the above test instruments is 12 months and the calibrations are traceable to NML/ROC and NIST/USA.
2. The test was performed in HwaYa Shielded Room 2.
3. The VCCI Site Registration No. is C-2047.



A D T

4.2.3 TEST PROCEDURES

- a. The EUT was placed 0.4 meters from the conducting wall of the shielded room with EUT being connected to the power mains through a line impedance stabilization network (LISN). Other support units were connected to the power mains through another LISN. The two LISNs provide 50 ohm/ 50uH of coupling impedance for the measuring instrument.
- b. Both lines of the power mains connected to the EUT were checked for maximum conducted interference.
- c. The frequency range from 150kHz to 30MHz was searched. Emission levels under (Limit - 20dB) was not recorded.

NOTE: All modes of operation were investigated and the worst-case emissions are reported.

4.2.4 DEVIATION FROM TEST STANDARD

No deviation.

4.2.5 TEST SETUP

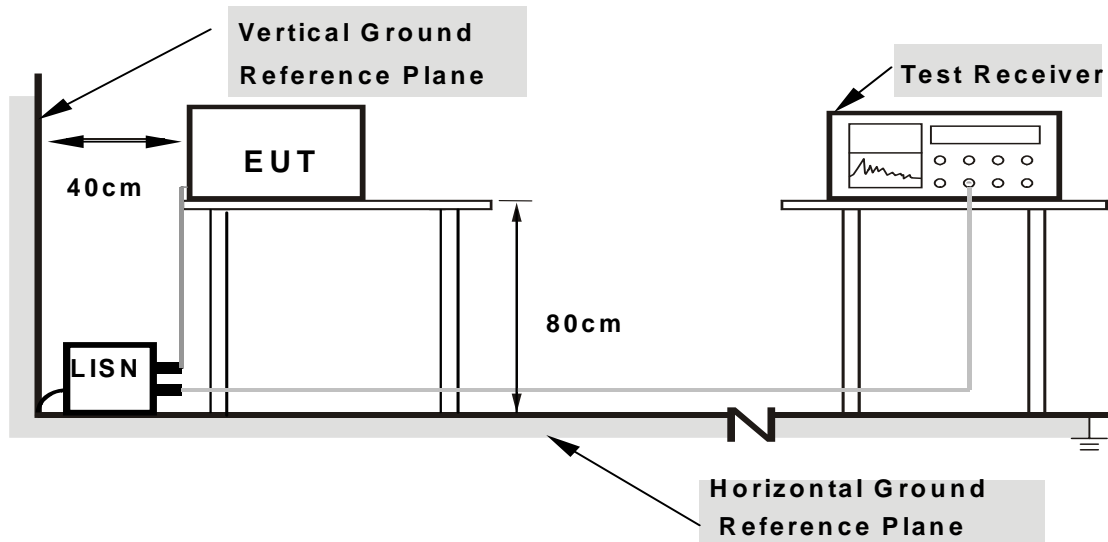

Note: 1.Support units were connected to second LISN.

2.Both of LISNs (AMN) are 80 cm from EUT and at least 80 from other units and other metal planes

For the actual test configuration, please refer to the attached file (Test Setup Photo).

4.2.6 EUT OPERATING CONDITIONS

Same as 4.1.6.

4.2.7 TEST RESULTS

CONDUCTED WORST-CASE DATA : 802.11g

PHASE	Line 1	6dB BANDWIDTH	9kHz
TEST MODE	A		

No	Freq. [MHz]	Corr. Factor (dB)	Reading Value		Emission Level		Limit		Margin	
			[dB (uV)]		[dB (uV)]		[dB (uV)]		(dB)	
			Q.P.	AV.	Q.P.	AV.	Q.P.	AV.	Q.P.	AV.
1	0.191	0.15	51.25	-	51.40	-	63.99	53.99	-12.60	-
2	0.697	0.18	43.24	-	43.42	-	56.00	46.00	-12.58	-
3	0.814	0.18	41.09	-	41.27	-	56.00	46.00	-14.73	-
4	1.113	0.19	42.26	-	42.45	-	56.00	46.00	-13.55	-
5	2.324	0.24	41.29	-	41.53	-	56.00	46.00	-14.47	-
6	4.664	0.35	40.20	-	40.55	-	56.00	46.00	-15.45	-

- REMARKS:**
1. Q.P. and AV. are abbreviations of quasi-peak and average individually.
 2. "-": The Quasi-peak reading value also meets average limit and measurement with the average detector is unnecessary.
 3. The emission levels of other frequencies were very low against the limit.
 4. Margin value = Emission level - Limit value
 5. Correction factor = Insertion loss + Cable loss
 6. Emission Level = Correction Factor + Reading Value.

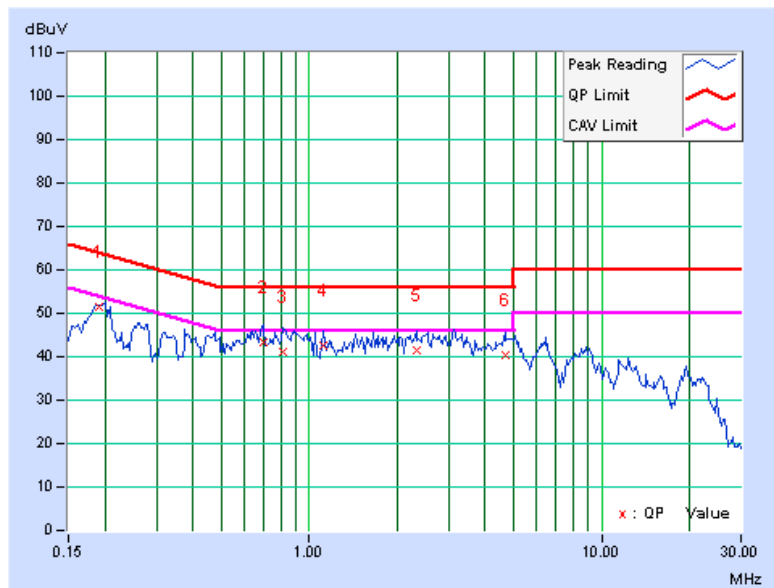



A D T

PHASE	Line 2	6dB BANDWIDTH	9kHz
TEST MODE	A		

No	Freq. [MHz]	Corr. Factor (dB)	Reading Value		Emission Level		Limit		Margin	
			[dB (uV)]		[dB (uV)]		[dB (uV)]		(dB)	
			Q.P.	AV.	Q.P.	AV.	Q.P.	AV.	Q.P.	AV.
1	0.189	0.17	48.74	-	48.91	-	64.08	54.08	-15.17	-
2	0.697	0.20	40.91	-	41.11	-	56.00	46.00	-14.89	-
3	0.998	0.21	40.50	-	40.71	-	56.00	46.00	-15.29	-
4	1.605	0.22	41.29	-	41.51	-	56.00	46.00	-14.49	-
5	3.301	0.29	40.38	-	40.67	-	56.00	46.00	-15.33	-
6	5.000	0.35	40.38	-	40.73	-	56.00	46.00	-15.27	-

- REMARKS:**
1. Q.P. and AV. are abbreviations of quasi-peak and average individually.
 2. "-": The Quasi-peak reading value also meets average limit and measurement with the average detector is unnecessary.
 3. The emission levels of other frequencies were very low against the limit.
 4. Margin value = Emission level - Limit value
 5. Correction factor = Insertion loss + Cable loss
 6. Emission Level = Correction Factor + Reading Value.

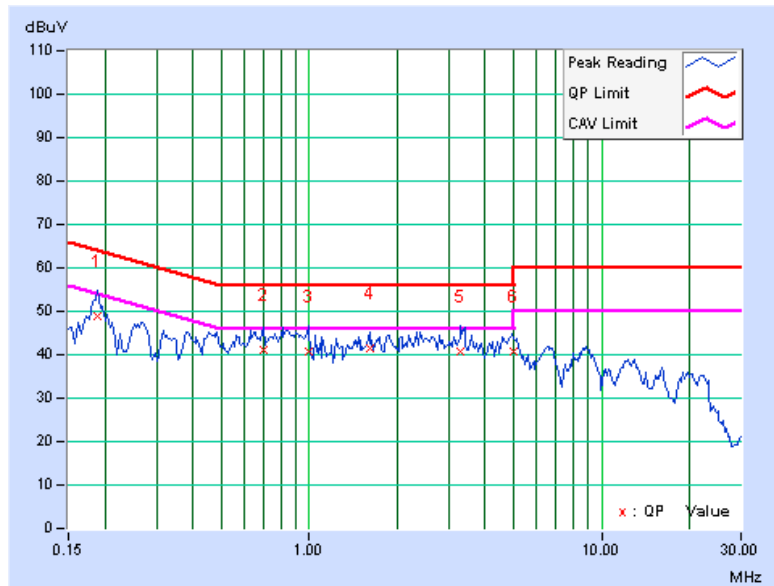



A D T

PHASE	Line 1	6dB BANDWIDTH	9kHz
TEST MODE	B		

No	Freq. [MHz]	Corr. Factor (dB)	Reading Value		Emission Level		Limit		Margin	
			[dB (uV)]		[dB (uV)]		[dB (uV)]		(dB)	
			Q.P.	AV.	Q.P.	AV.	Q.P.	AV.	Q.P.	AV.
1	0.205	0.15	46.51	-	46.66	-	63.42	53.42	-16.76	-
2	0.923	0.19	40.35	-	40.54	-	56.00	46.00	-15.46	-
3	1.309	0.20	41.77	-	41.97	-	56.00	46.00	-14.03	-
4	2.082	0.22	42.77	-	42.99	-	56.00	46.00	-13.01	-
5	2.508	0.25	42.60	-	42.85	-	56.00	46.00	-13.15	-
6	3.469	0.29	42.87	-	43.16	-	56.00	46.00	-12.84	-

- REMARKS:**
1. Q.P. and AV. are abbreviations of quasi-peak and average individually.
 2. "-": The Quasi-peak reading value also meets average limit and measurement with the average detector is unnecessary.
 3. The emission levels of other frequencies were very low against the limit.
 4. Margin value = Emission level - Limit value
 5. Correction factor = Insertion loss + Cable loss
 6. Emission Level = Correction Factor + Reading Value.

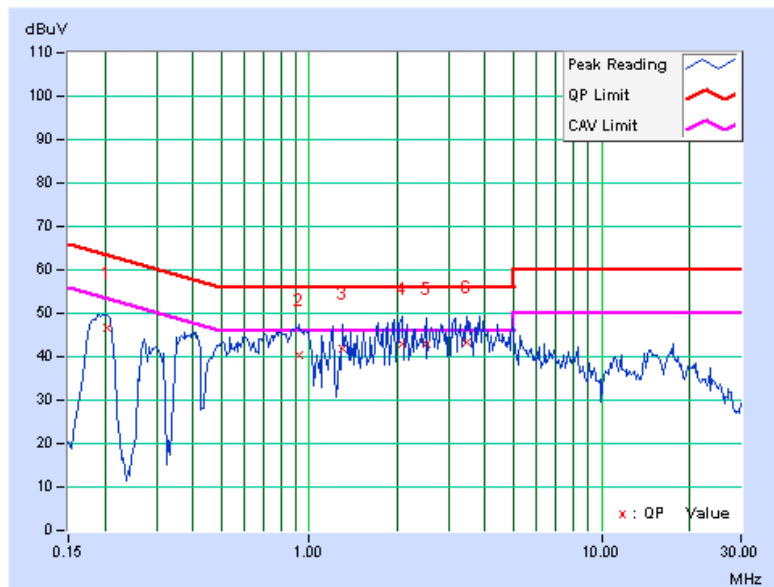



A D T

PHASE	Line 2	6dB BANDWIDTH	9kHz
TEST MODE	B		

No	Freq. [MHz]	Corr. Factor (dB)	Reading Value		Emission Level		Limit		Margin	
			[dB (uV)]		[dB (uV)]		[dB (uV)]		(dB)	
			Q.P.	AV.	Q.P.	AV.	Q.P.	AV.	Q.P.	AV.
1	0.396	0.19	41.86	-	42.05	-	57.93	47.93	-15.89	-
2	0.892	0.21	40.24	-	40.45	-	56.00	46.00	-15.55	-
3	1.613	0.22	42.49	-	42.71	-	56.00	46.00	-13.29	-
4	1.781	0.23	42.61	-	42.84	-	56.00	46.00	-13.16	-
5	2.930	0.27	43.25	-	43.52	-	56.00	46.00	-12.48	-
6	4.582	0.34	40.10	-	40.44	-	56.00	46.00	-15.56	-

- REMARKS:**
1. Q.P. and AV. are abbreviations of quasi-peak and average individually.
 2. "-": The Quasi-peak reading value also meets average limit and measurement with the average detector is unnecessary.
 3. The emission levels of other frequencies were very low against the limit.
 4. Margin value = Emission level - Limit value
 5. Correction factor = Insertion loss + Cable loss
 6. Emission Level = Correction Factor + Reading Value.

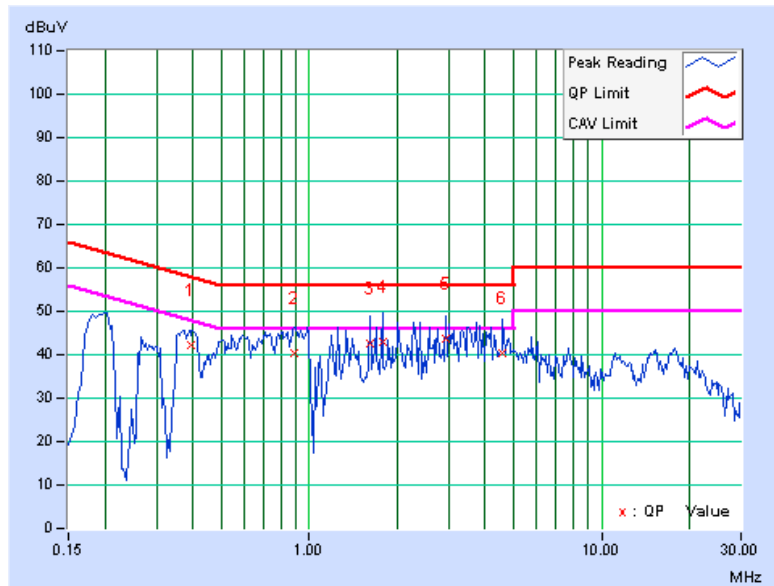

4.3 6dB BANDWIDTH MEASUREMENT

4.3.1 LIMITS OF 6dB BANDWIDTH MEASUREMENT

The minimum of 6dB Bandwidth Measurement is 0.5 MHz.

4.3.2 TEST INSTRUMENTS

DESCRIPTION & MANUFACTURER	MODEL NO.	SERIAL NO.	DATE OF CALIBRATION	DUE DATE OF CALIBRATION
SPECTRUM ANALYZER R&S	FSP40	100039	Jan. 11, 2011	Jan. 10, 2012

NOTE: The calibration interval of the above test instruments is 12 months and the calibrations are traceable to NML/ROC and NIST/USA.

4.3.3 TEST PROCEDURE

The transmitter output was connected to the spectrum analyzer through an attenuator. The bandwidth of the fundamental frequency was measured by spectrum analyzer with 100kHz RBW and 300kHz VBW. The 6dB bandwidth is defined as the total spectrum the power of which is higher than peak power minus 6dB.

4.3.4 DEVIATION FROM TEST STANDARD

No deviation.

4.3.5 TEST SETUP

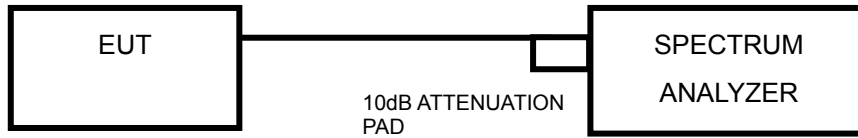

4.3.6 EUT OPERATING CONDITIONS

The software provided by client to enable the EUT under transmission condition continuously at lowest, middle and highest channel frequencies individually.



A D T

802.11g

CHANNEL	CHANNEL FREQUENCY (MHz)	6dB BANDWIDTH (MHz)	MINIMUM LIMIT (MHz)	PASS / FAIL
1	2412	13.92	0.5	PASS
6	2437	15.18	0.5	PASS
11	2462	14.41	0.5	PASS

CH 6

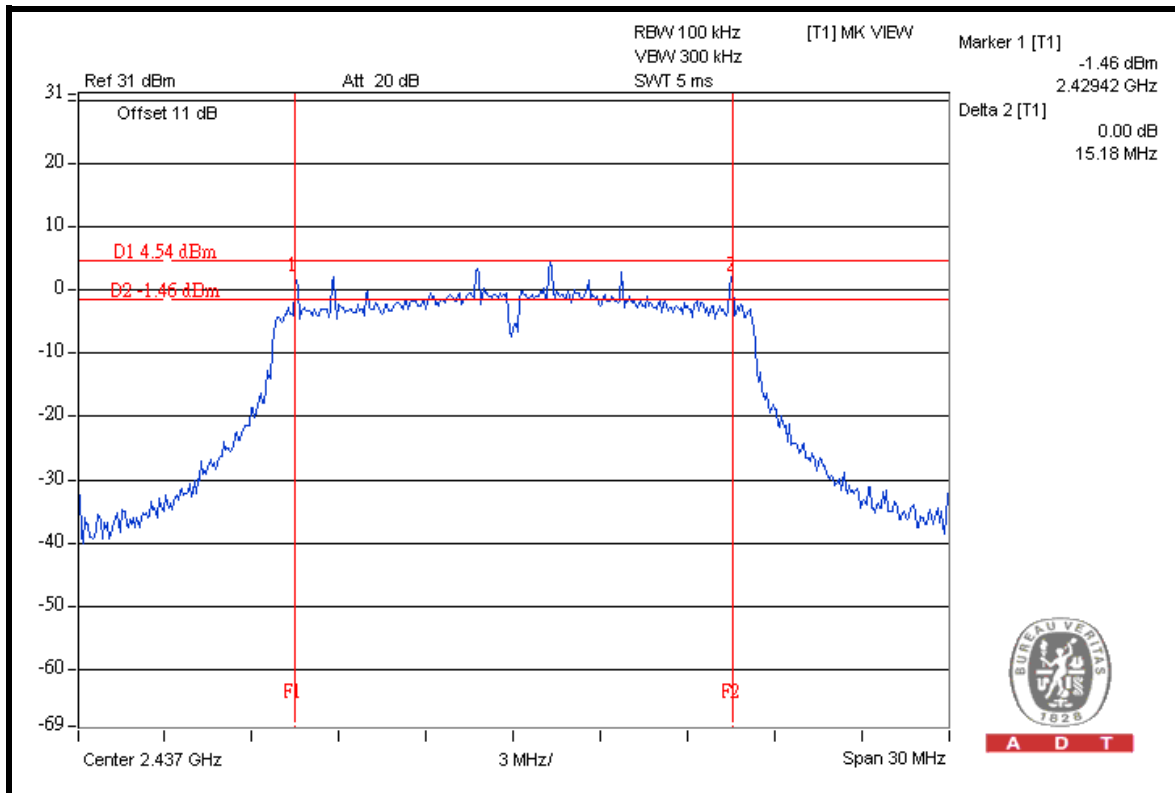



A D T

802.11n (20MHz)

CHANNEL	CHANNEL FREQUENCY (MHz)	6dB BANDWIDTH (MHz)	MINIMUM LIMIT (MHz)	PASS / FAIL
1	2412	14.18	0.5	PASS
6	2437	15.12	0.5	PASS
11	2462	13.95	0.5	PASS

CH 6

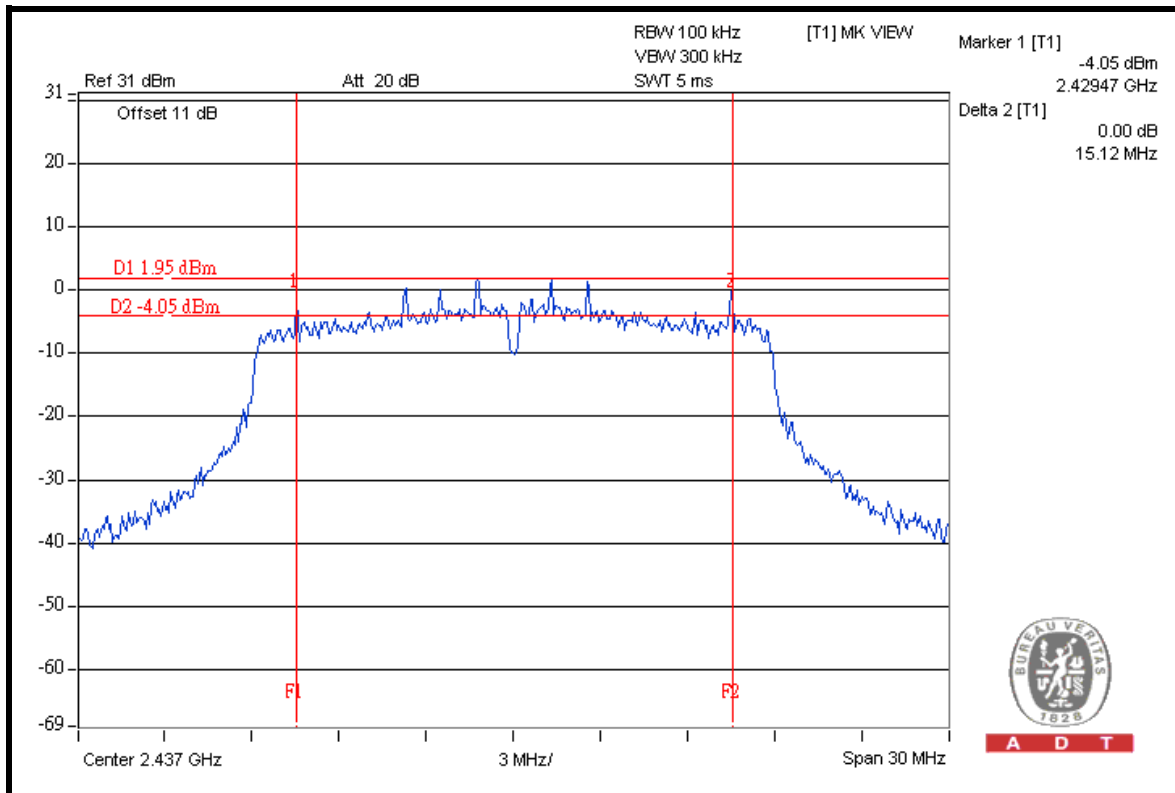

A D T



A D T

4.4 MAXIMUM OUTPUT POWER

4.4.1 LIMITS OF MAXIMUM OUTPUT POWER MEASUREMENT

The Maximum Output Power Measurement is 30dBm.

4.4.2 INSTRUMENTS

DESCRIPTION & MANUFACTURER	MODEL NO.	SERIAL NO.	DATE OF CALIBRATION	DUE DATE OF CALIBRATION
High Speed Peak Power Meter	ML2495A	0842014	Apr. 26, 2011	Apr. 25, 2012
Power Sensor	MA2411B	0738404	Apr. 26, 2011	Apr. 25, 2012

NOTE:

1. The calibration interval of the above test instruments is 12 months and the calibrations are traceable to NML/ROC and NIST/USA.
2. Measurement Bandwidth of ML2495A is 65MHz greater than 6dB bandwidth of emission.

4.4.3 TEST PROCEDURE

A power sensor was used on the output port of the EUT. A power meter was used to read the response of the power sensor. Record the power level.

4.4.4 DEVIATION FROM TEST STANDARD

No deviation.

4.4.5 TEST SETUP

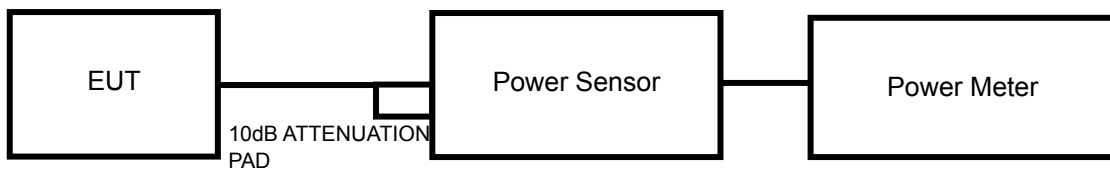

4.4.6 EUT OPERATING CONDITIONS

Same as Item 4.3.6.



4.4.7 TEST RESULTS

802.11b

CHANNEL	CHANNEL FREQUENCY (MHz)	POWER OUTPUT (mW)	POWER OUTPUT (dBm)	POWER LIMIT (dBm)	PASS/FAIL
1	2412	114.8	20.6	30	PASS
6	2437	120.2	20.8	30	PASS
11	2462	112.2	20.5	30	PASS

802.11g

CHANNEL	CHANNEL FREQUENCY (MHz)	POWER OUTPUT (mW)	POWER OUTPUT (dBm)	POWER LIMIT (dBm)	PASS/FAIL
1	2412	154.9	21.9	30	PASS
6	2437	166.0	22.2	30	PASS
11	2462	154.9	21.9	30	PASS

802.11n (20MHz)

CHANNEL	CHANNEL FREQUENCY (MHz)	POWER OUTPUT (mW)	POWER OUTPUT (dBm)	POWER LIMIT (dBm)	PASS/FAIL
1	2412	123.0	20.9	30	PASS
6	2437	131.8	21.2	30	PASS
11	2462	128.8	21.1	30	PASS



A D T

4.5 POWER SPECTRAL DENSITY MEASUREMENT

4.5.1 LIMITS OF POWER SPECTRAL DENSITY MEASUREMENT

The Maximum of Power Spectral Density Measurement is 8dBm.

4.5.2 TEST INSTRUMENTS

DESCRIPTION & MANUFACTURER	MODEL NO.	SERIAL NO.	DATE OF CALIBRATION	DUE DATE OF CALIBRATION
SPECTRUM ANALYZER R&S	FSP40	100039	Jan. 11, 2011	Jan. 10, 2012

NOTE: The calibration interval of the above test instruments is 12 months and the calibrations are traceable to NML/ROC and NIST/USA.

4.5.3 TEST PROCEDURE

The transmitter output was connected to the spectrum analyzer through an attenuator, the bandwidth of the fundamental frequency was measured with the spectrum analyzer using 3kHz RBW and 30kHz VBW, set sweep time = span/3kHz. The power spectral density was measured and recorded.

The sweep time is allowed to be longer than span/3kHz for a full response of the mixer in the spectrum analyzer.

4.5.4 DEVIATION FROM TEST STANDARD

No deviation.

4.5.5 TEST SETUP

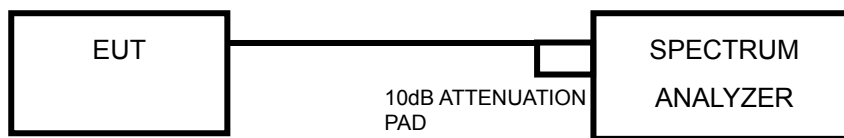

4.5.6 EUT OPERATING CONDITION

Same as Item 4.3.6.



A D T

4.5.7 TEST RESULTS

802.11b

CHANNEL	CHANNEL FREQUENCY (MHz)	RF POWER LEVEL IN 3 kHz BW (dBm)	MAXIMUM LIMIT (dBm)	PASS/FAIL
1	2412	-2.52	8	PASS
6	2437	-2.40	8	PASS
11	2462	-2.51	8	PASS

CH 6

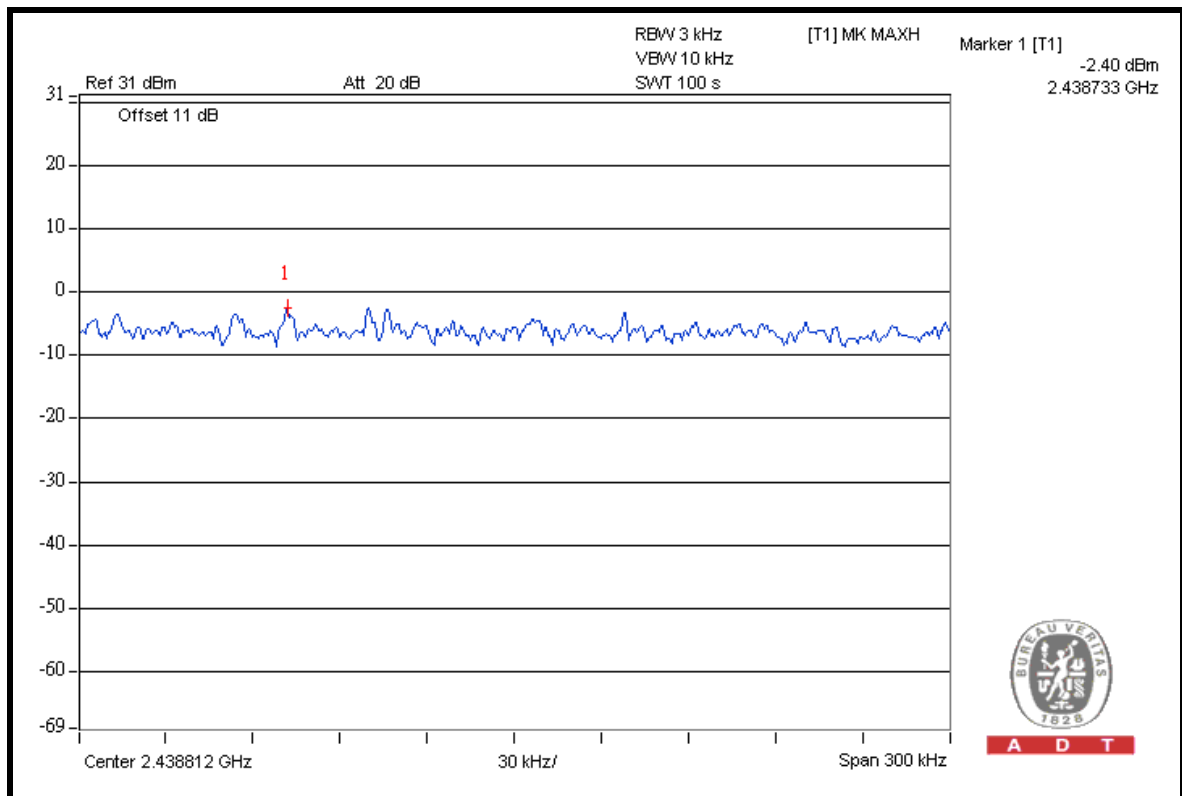



A D T

802.11g

CHANNEL	CHANNEL FREQUENCY (MHz)	RF POWER LEVEL IN 3 kHz BW (dBm)	MAXIMUM LIMIT (dBm)	PASS/FAIL
1	2412	-11.15	8	PASS
6	2437	-10.75	8	PASS
11	2462	-11.18	8	PASS

CH 6

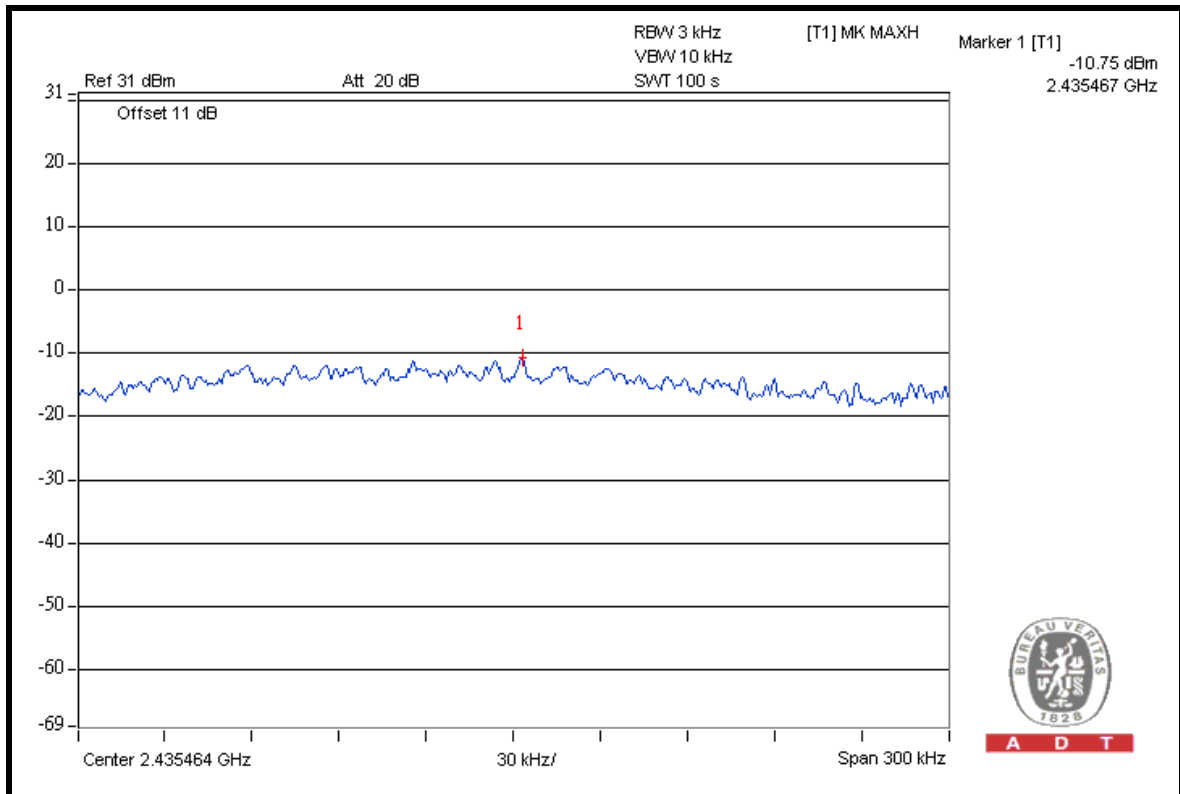



A D T

802.11n (20MHz)

CHANNEL	CHANNEL FREQUENCY (MHz)	RF POWER LEVEL IN 3 kHz BW (dBm)	MAXIMUM LIMIT (dBm)	PASS/FAIL
1	2412	-11.45	8	PASS
6	2437	-11.16	8	PASS
11	2462	-11.36	8	PASS

CH 6

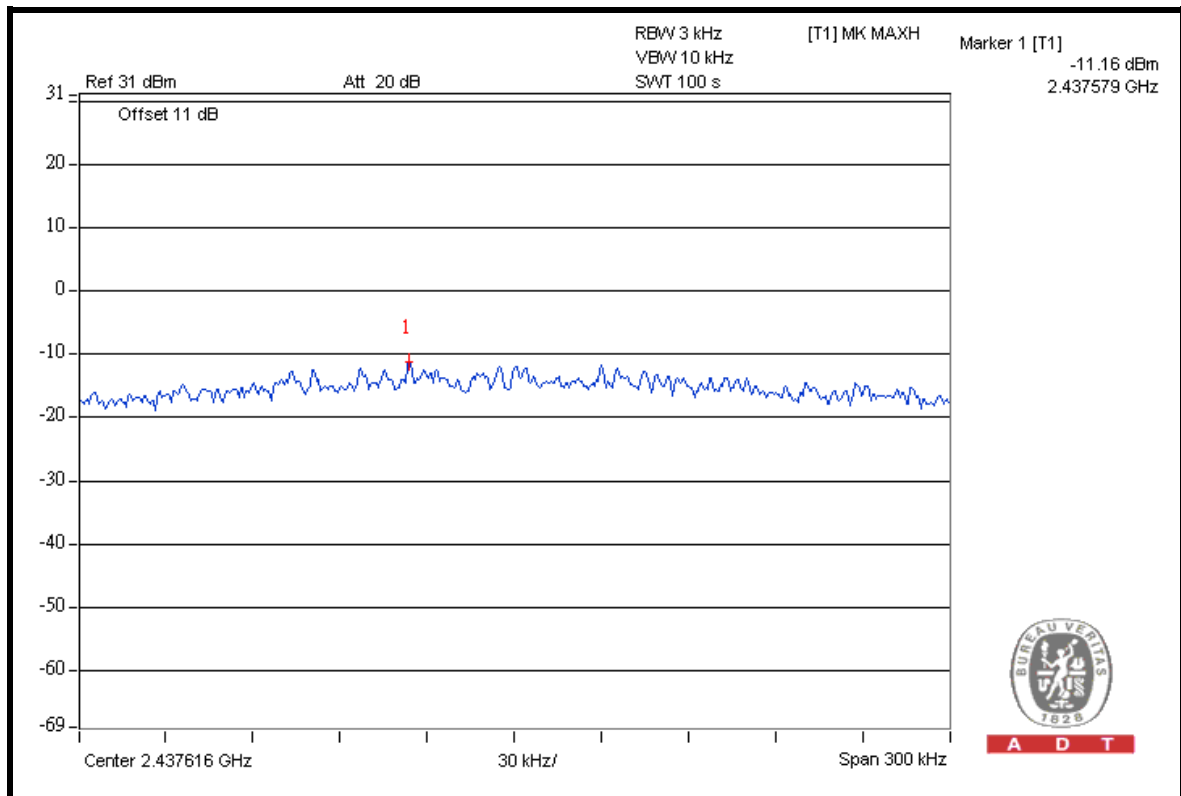

A D T



A D T

4.6 BAND EDGES MEASUREMENT

4.6.1 LIMITS OF BAND EDGES MEASUREMENT

Below -20dB of the highest emission level of operating band (in 100kHz Resolution Bandwidth).

Note: Follow DTS measurement, If the device complies with the use of power option 2 the attenuation under this paragraph shall be 30 dB instead of 20 dB.

4.6.2 TEST INSTRUMENTS

DESCRIPTION & MANUFACTURER	MODEL NO.	SERIAL NO.	DATE OF CALIBRATION	DUE DATE OF CALIBRATION
SPECTRUM ANALYZER R&S	FSP40	100039	Jan. 11, 2011	Jan. 10, 2012

NOTE: The calibration interval of the above test instruments is 12 months and the calibrations are traceable to NML/ROC and NIST/USA.

4.6.3 TEST PROCEDURE

The transmitter output was connected to the spectrum analyzer via a low loss cable. Set both RBW and VBW of spectrum analyzer to 100kHz and 300kHz with suitable frequency span including 100MHz bandwidth from band edge. The band edges was measured and recorded.

The spectrum plots (Peak RBW = 100kHz, VBW = 300kHz; Average RBW = 1MHz, VBW = 10Hz) are attached on the following pages.

4.6.4 DEVIATION FROM TEST STANDARD

No deviation.

4.6.5 EUT OPERATING CONDITION

Same as Item 4.3.6.



4.6.6 TEST RESULTS

The spectrum plots are attached on the following pages. D1 line indicates the highest level, and D2 line indicates the 20dB offset below D1. It shows compliance with the requirement in part 15.247(d).

802.11b

RESTRICT BAND (2310 ~ 2390 MHz)

FREQUENCY (MHz)	FUNDAMENTAL EMISSION (dBuV/m)	DELTA (dB)	MAXIMUM FIELD STRENGTH IN RESTRICT BAND (dBuV/m)	LIMIT (dBuV/m)
2412.00 (PK)	107.2	53.40	53.80	74.00
2412.00 (AV)	103.6	58.63	44.97	54.00

RESTRICT BAND (2483.5 ~ 2500 MHz)

FREQUENCY (MHz)	FUNDAMENTAL EMISSION (dBuV/m)	DELTA (dB)	MAXIMUM FIELD STRENGTH IN RESTRICT BAND (dBuV/m)	LIMIT (dBuV/m)
2462.00 (PK)	107.3	54.25	53.05	74.00
2462.00 (AV)	103.5	56.06	47.44	54.00

NOTE:

1. Delta = Amplitude between the peak of the fundamental and the peak of the band edge emission. Please check following 3 pages.
2. Maximum field strength in restrict band = Fundamental emission – Delta.



A D T

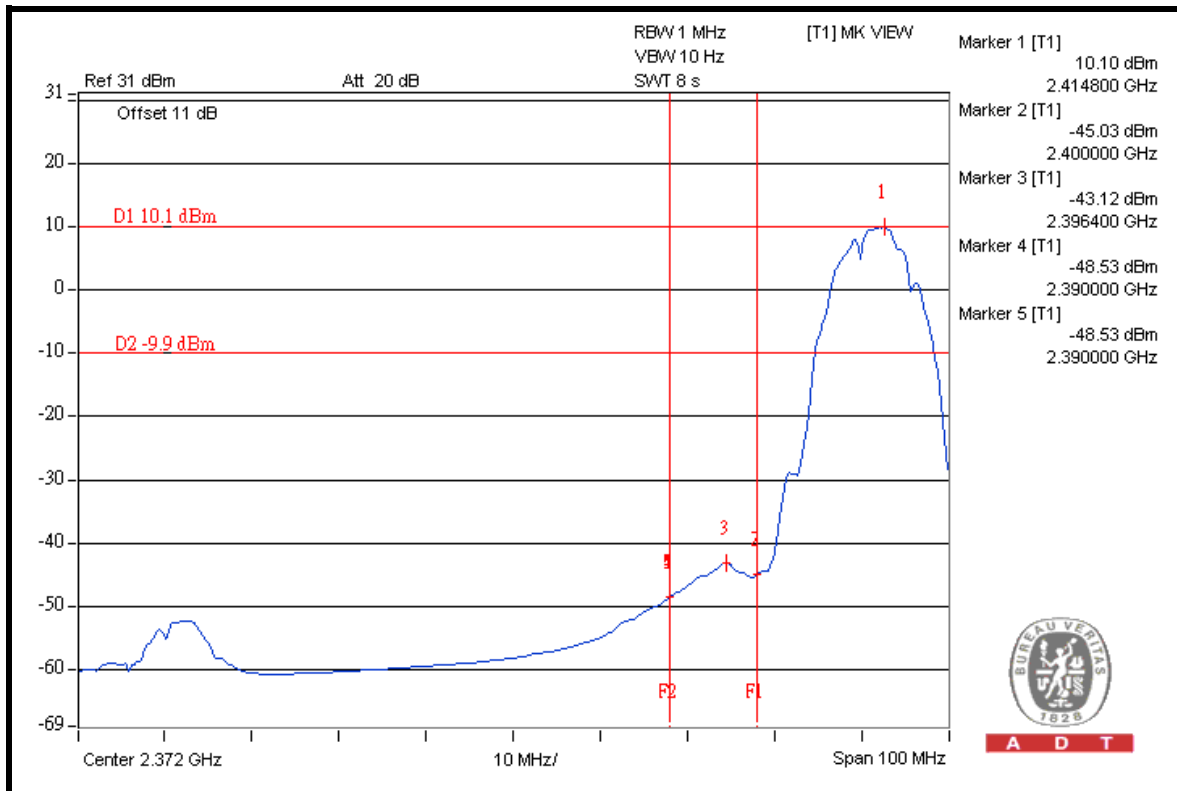
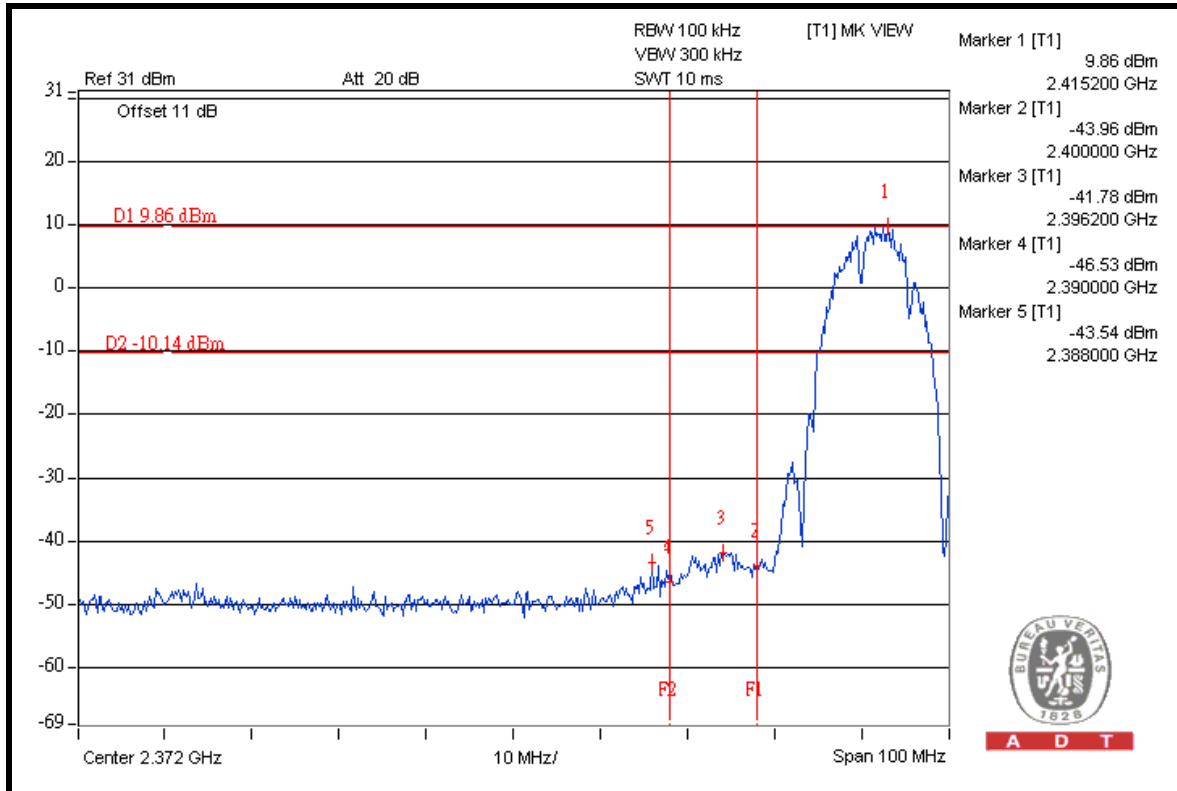



A D T

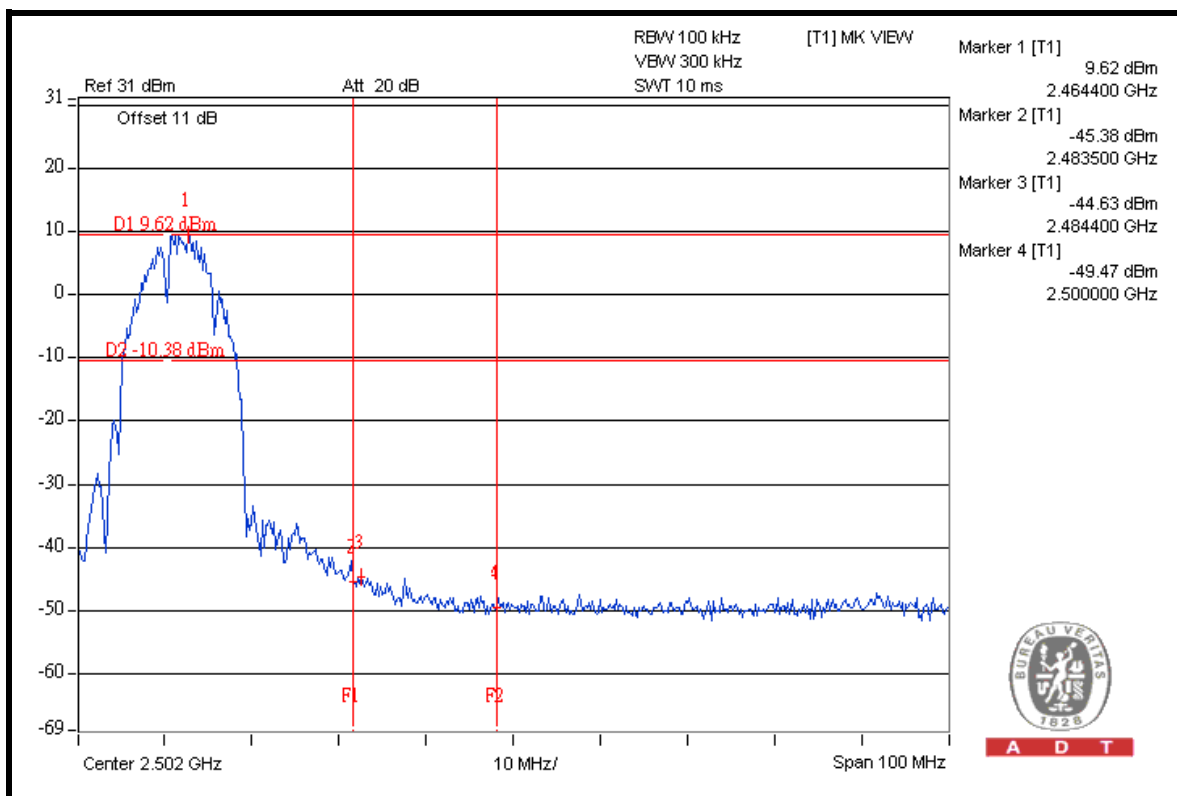
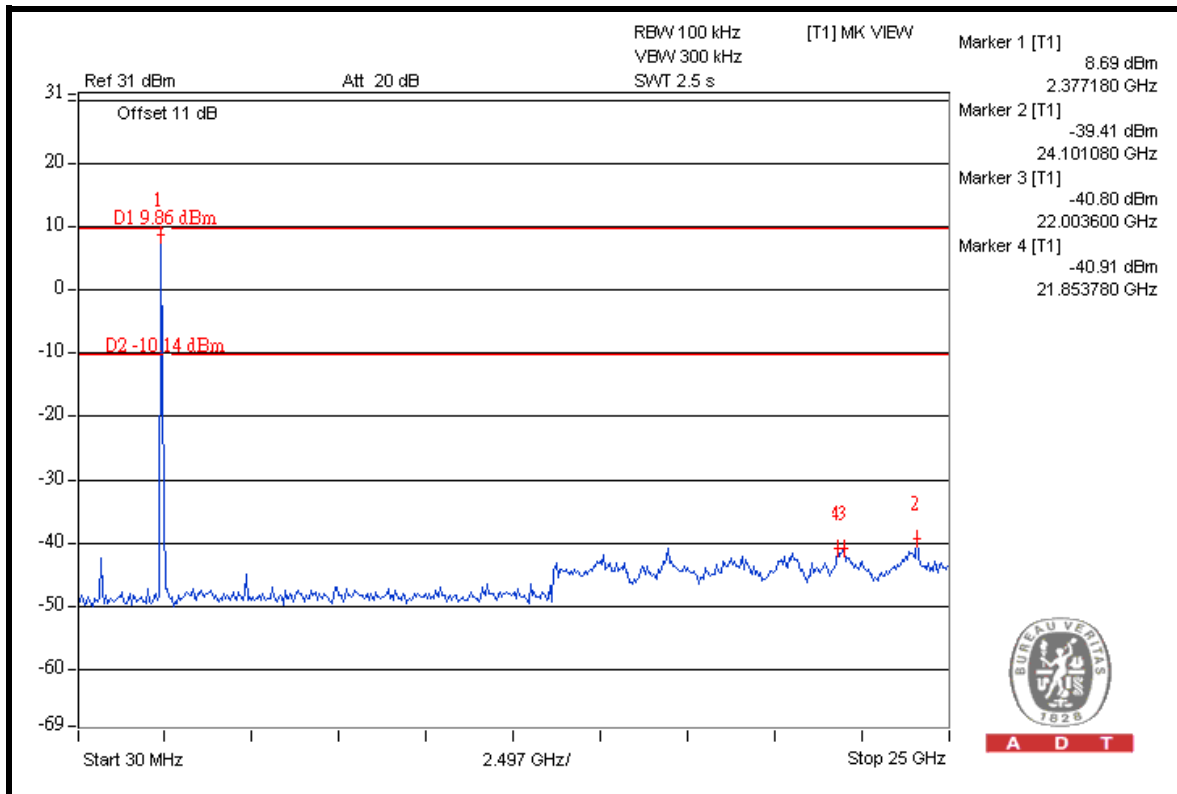



A D T

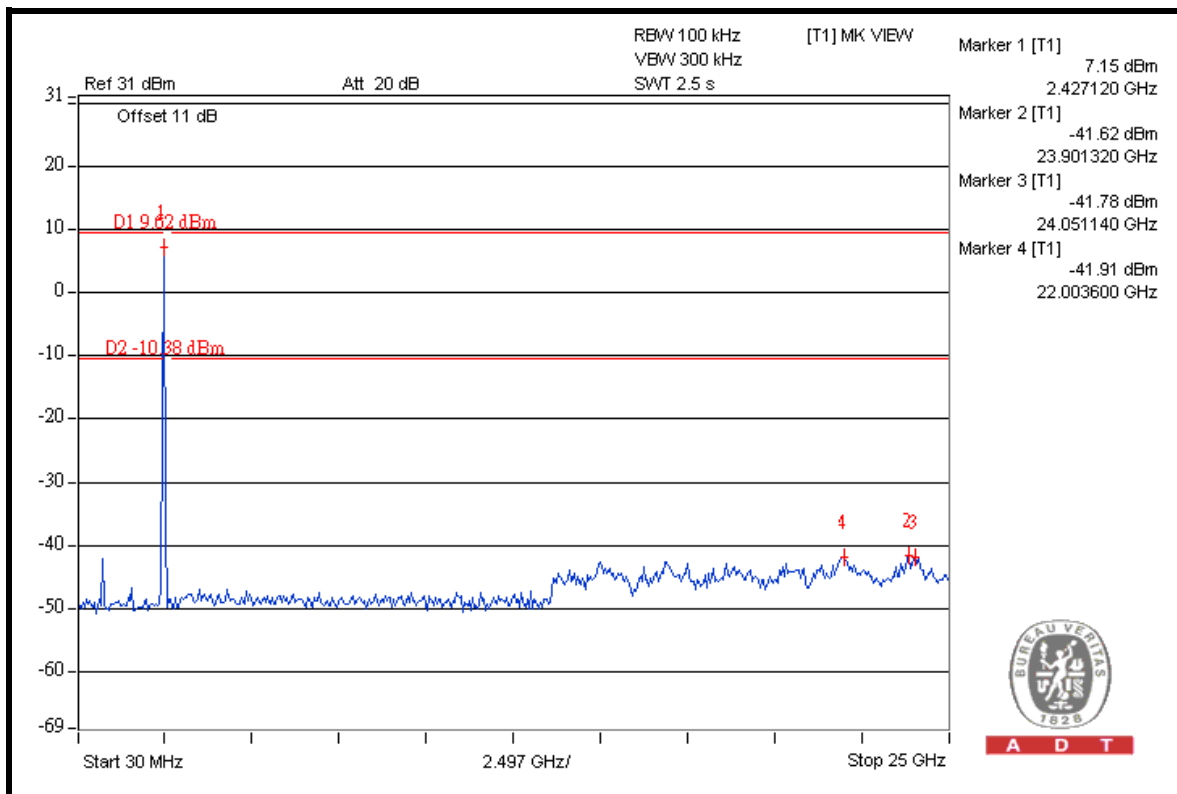
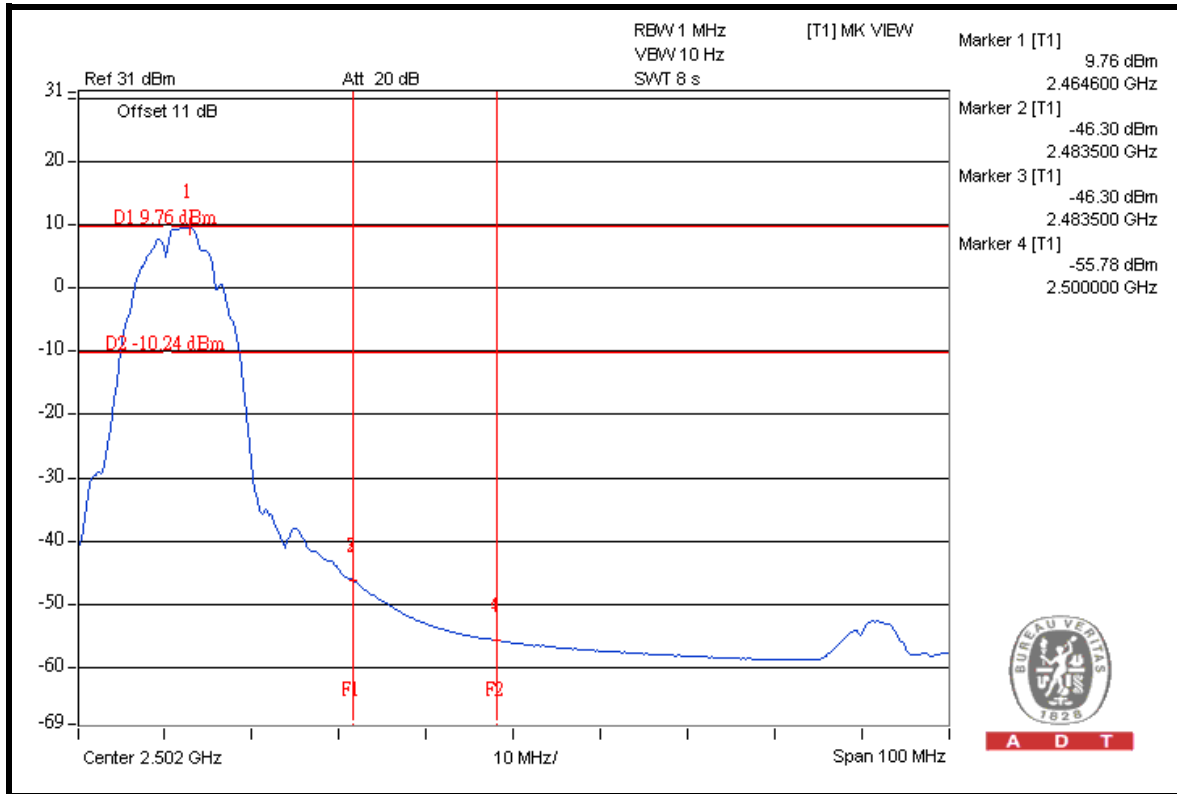



A D T

802.11g

RESTRICT BAND (2310 ~ 2390 MHz)

FREQUENCY (MHz)	FUNDAMENTAL EMISSION (dBuV/m)	DELTA (dB)	MAXIMUM FIELD STRENGTH IN RESTRICT BAND (dBuV/m)	LIMIT (dBuV/m)
2412.00 (PK)	106.2	44.06	62.14	74.00
2412.00 (AV)	93.3	45.13	48.17	54.00

RESTRICT BAND (2483.5 ~ 2500 MHz)

FREQUENCY (MHz)	FUNDAMENTAL EMISSION (dBuV/m)	DELTA (dB)	MAXIMUM FIELD STRENGTH IN RESTRICT BAND (dBuV/m)	LIMIT (dBuV/m)
2462.00 (PK)	105.7	45.07	60.63	74.00
2462.00 (AV)	92.6	44.51	48.09	54.00

NOTE:

1. Delta = Amplitude between the peak of the fundamental and the peak of the band edge emission. Please check following 3 pages.
2. Maximum field strength in restrict band = Fundamental emission – Delta.



A D T

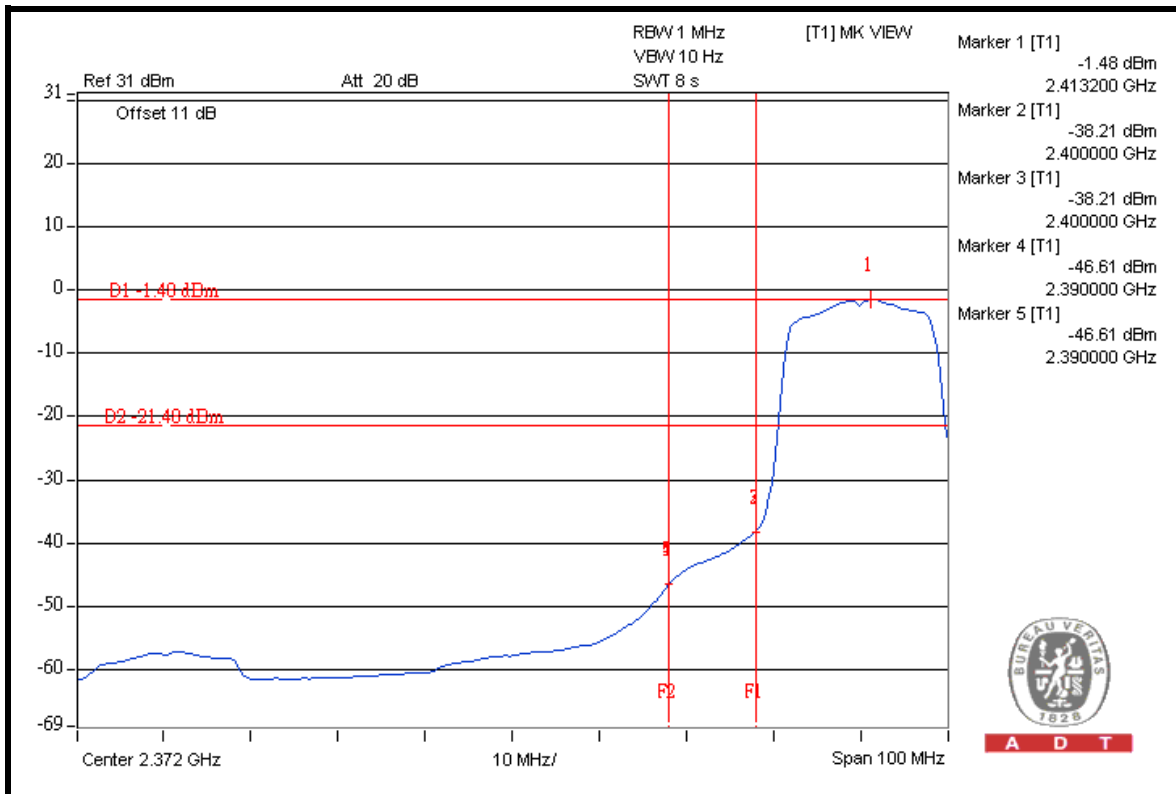
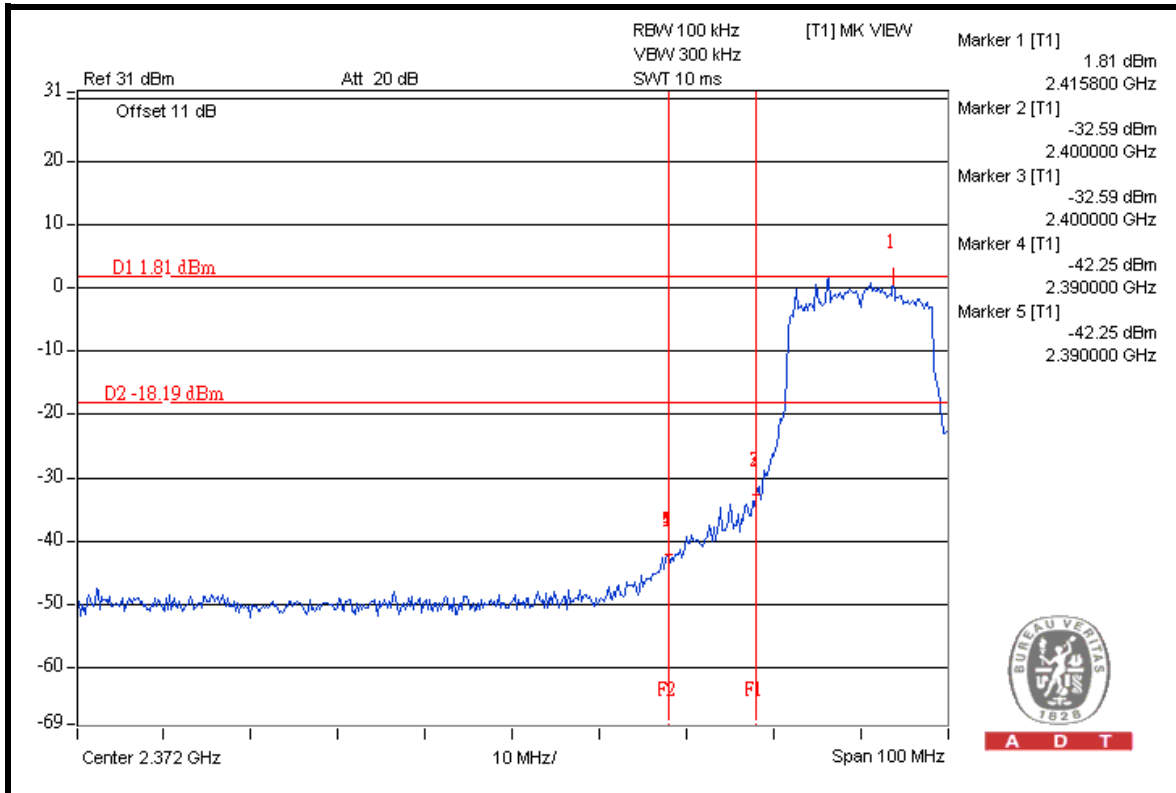



A D T

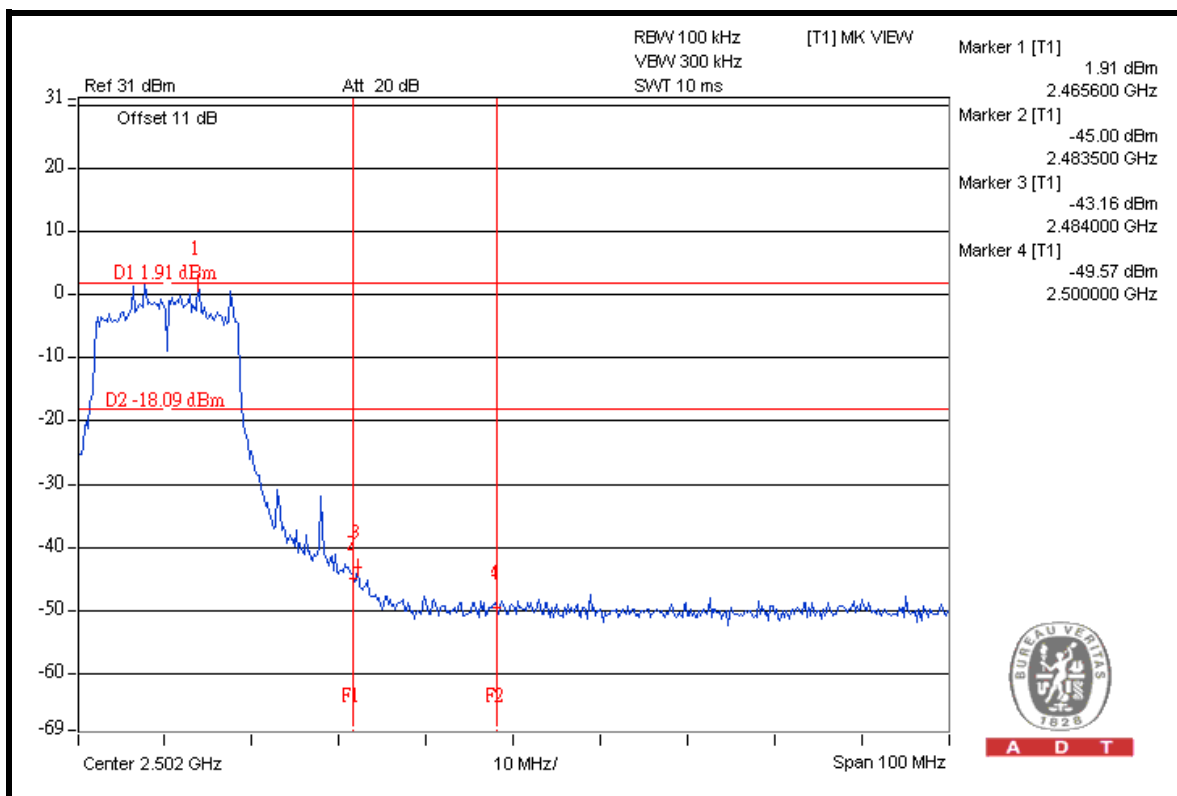
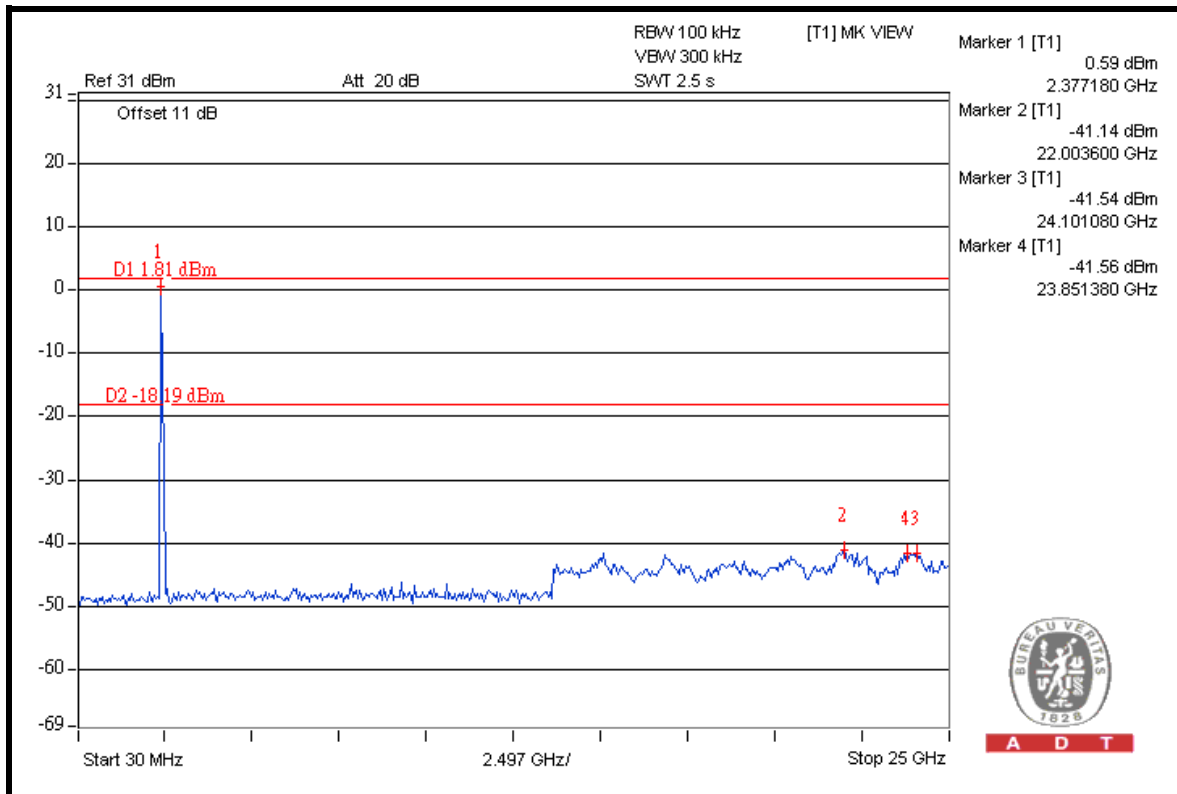



A D T

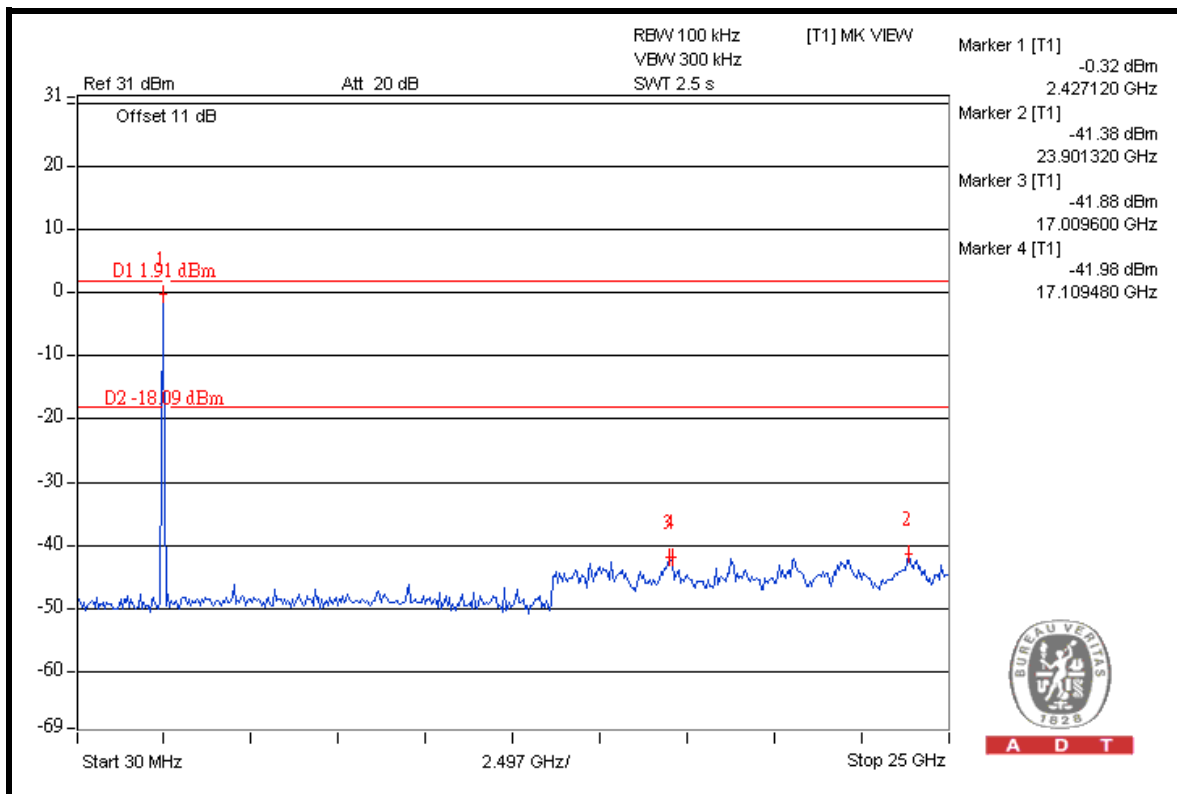
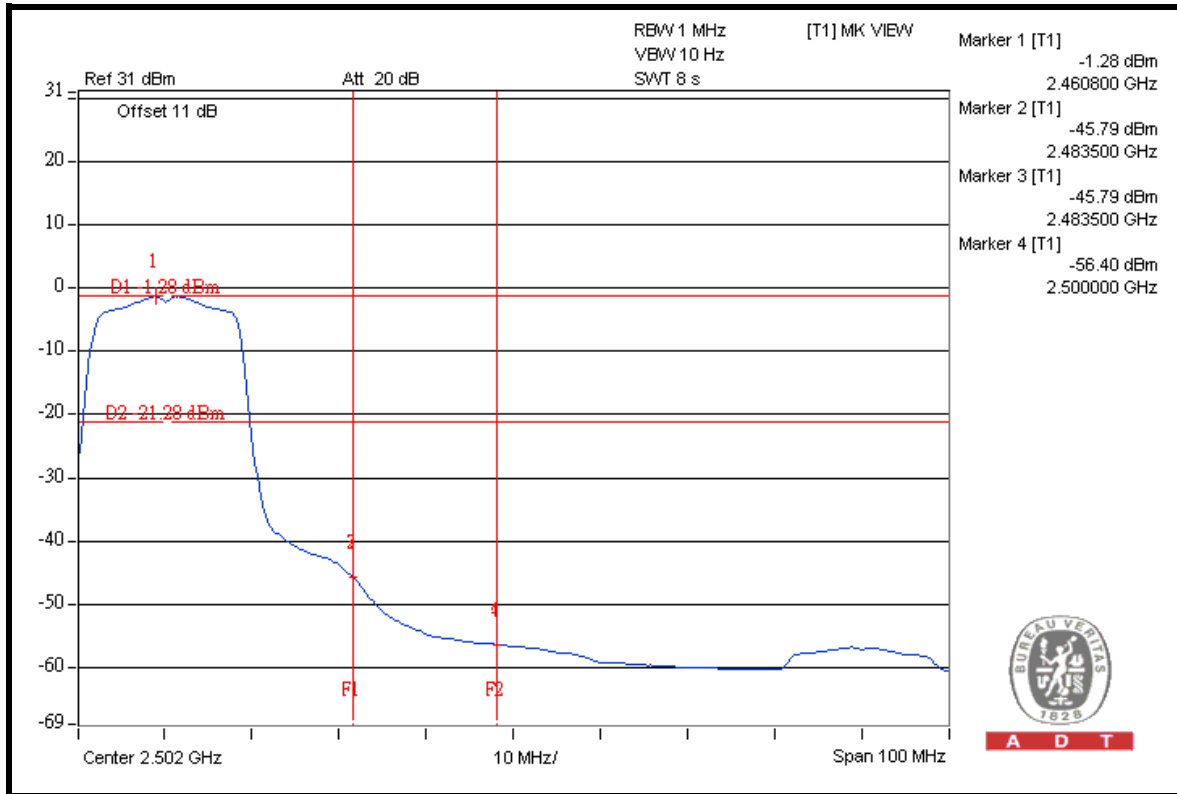



A D T

802.11n (20MHz)

RESTRICT BAND (2310 ~ 2390 MHz)

FREQUENCY (MHz)	FUNDAMENTAL EMISSION (dBuV/m)	DELTA (dB)	MAXIMUM FIELD STRENGTH IN RESTRICT BAND (dBuV/m)	LIMIT (dBuV/m)
2412.00 (PK)	105.5	44.57	60.93	74.00
2412.00 (AV)	92.5	44.55	47.95	54.00

RESTRICT BAND (2483.5 ~ 2500 MHz)

FREQUENCY (MHz)	FUNDAMENTAL EMISSION (dBuV/m)	DELTA (dB)	MAXIMUM FIELD STRENGTH IN RESTRICT BAND (dBuV/m)	LIMIT (dBuV/m)
2462.00 (PK)	105.1	45.90	59.20	74.00
2462.00 (AV)	92.0	43.71	48.29	54.00

NOTE:

1. Delta = Amplitude between the peak of the fundamental and the peak of the band edge emission. Please check following 3 pages.
2. Maximum field strength in restrict band = Fundamental emission – Delta.



A D T

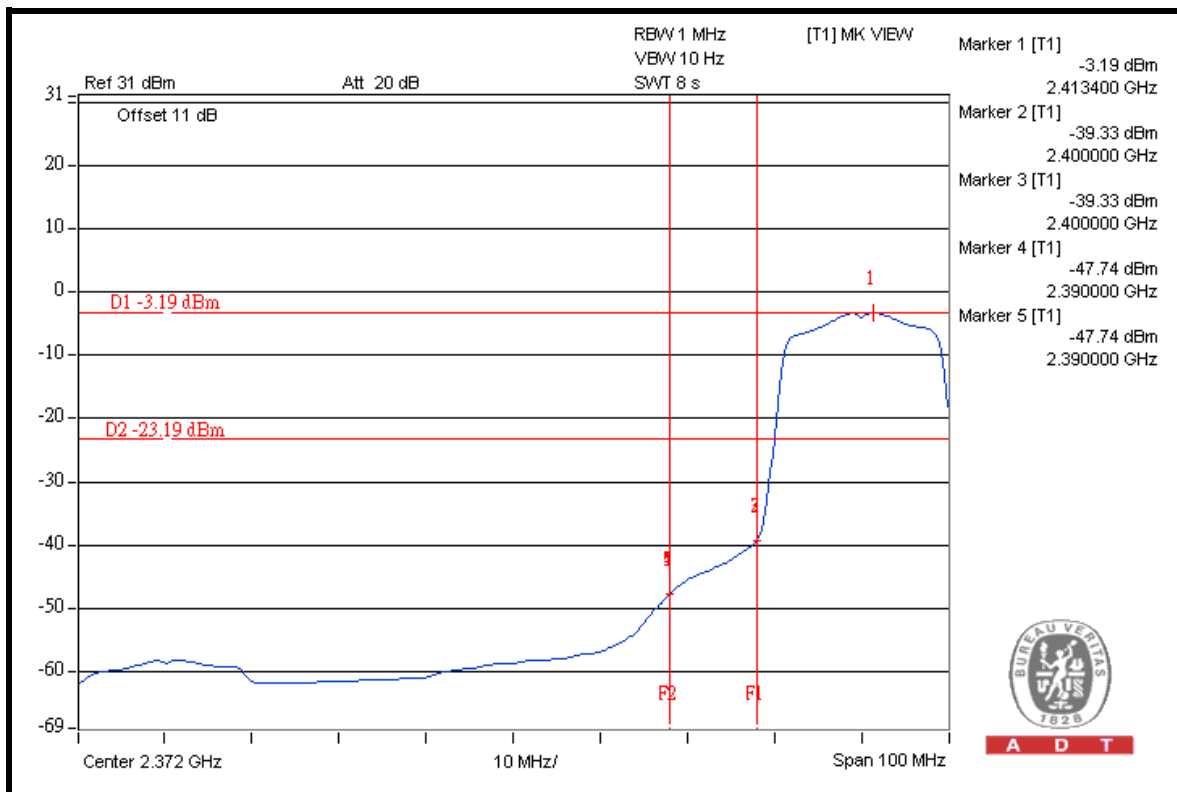
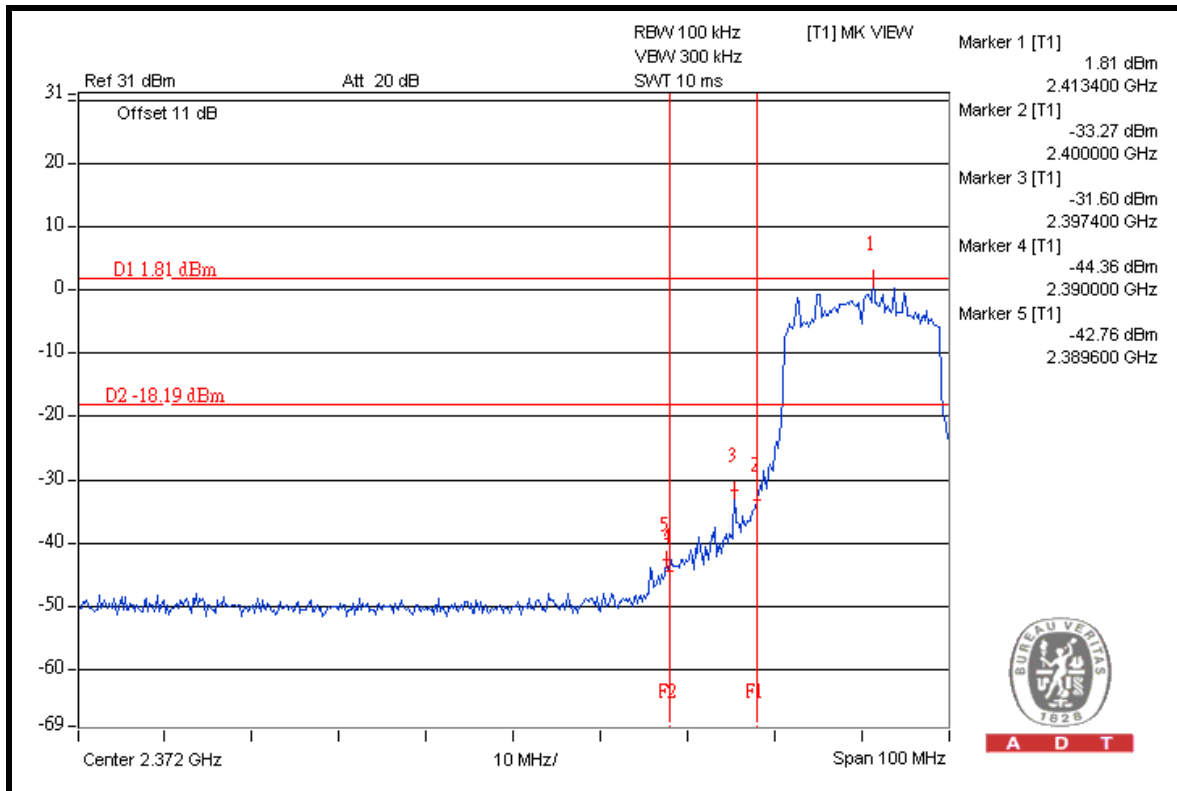



A D T

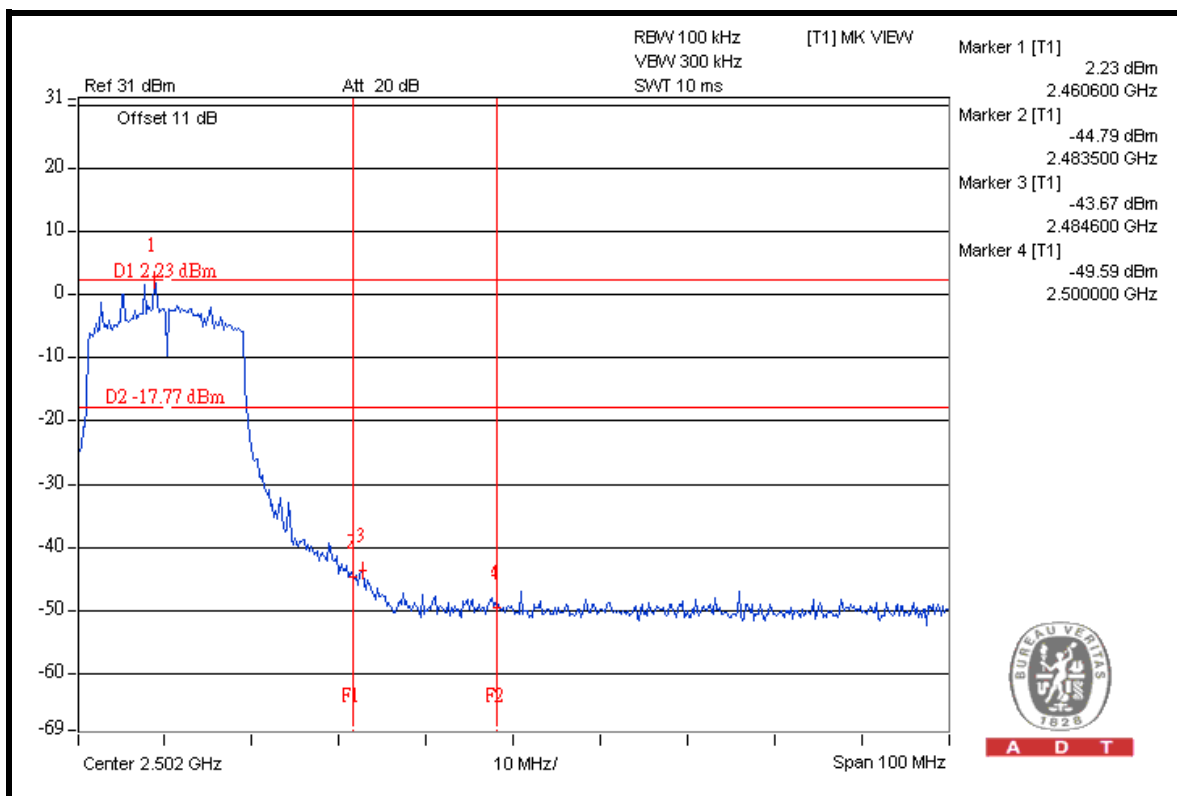
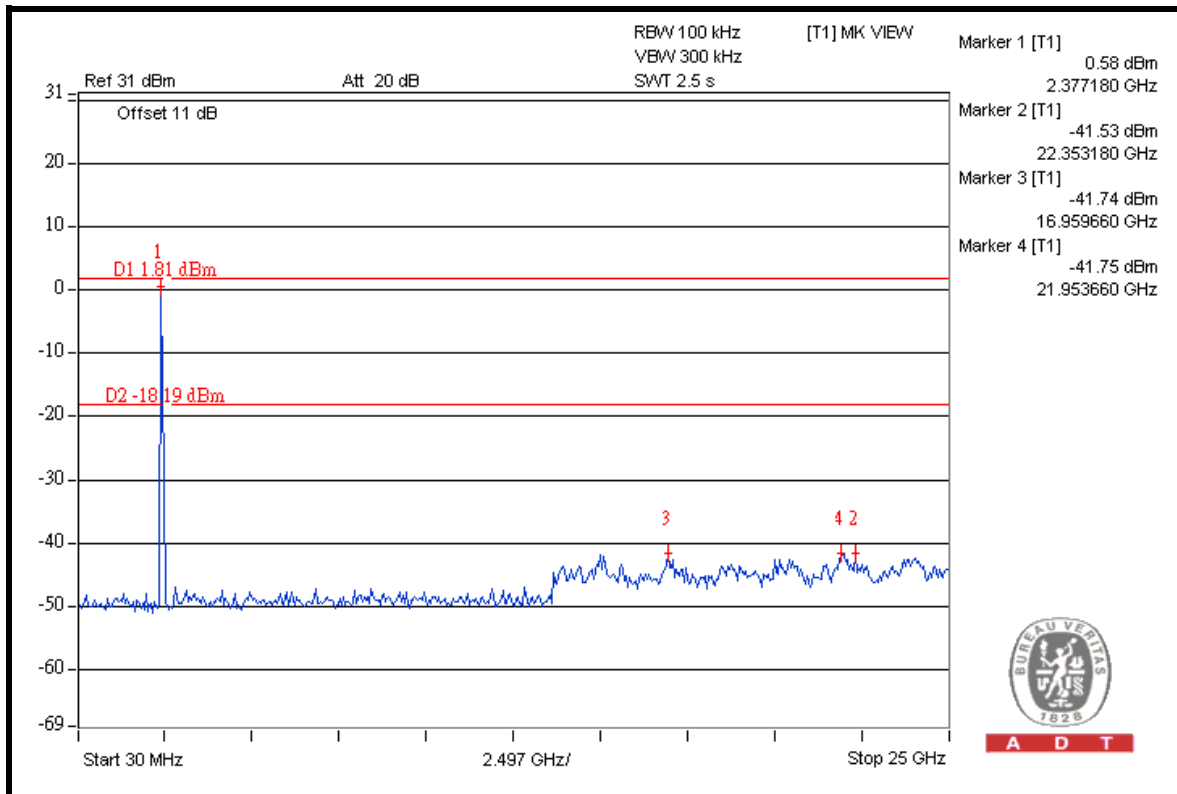



A D T

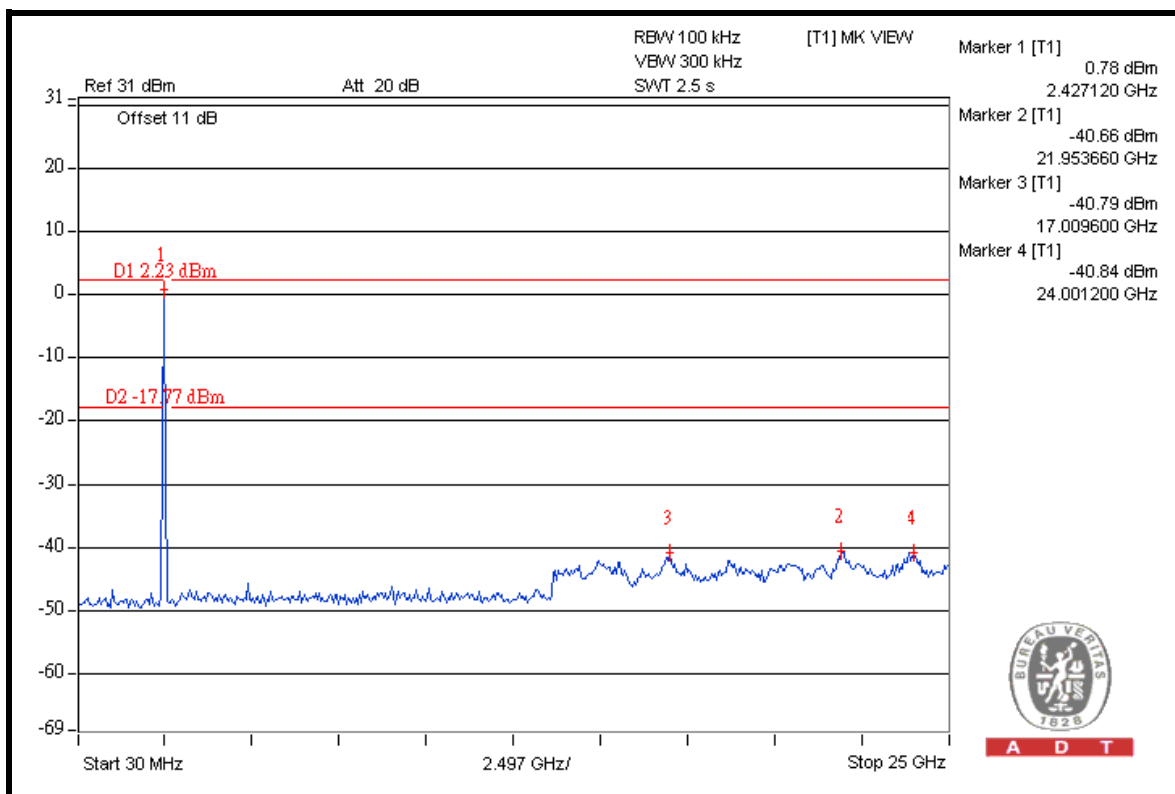
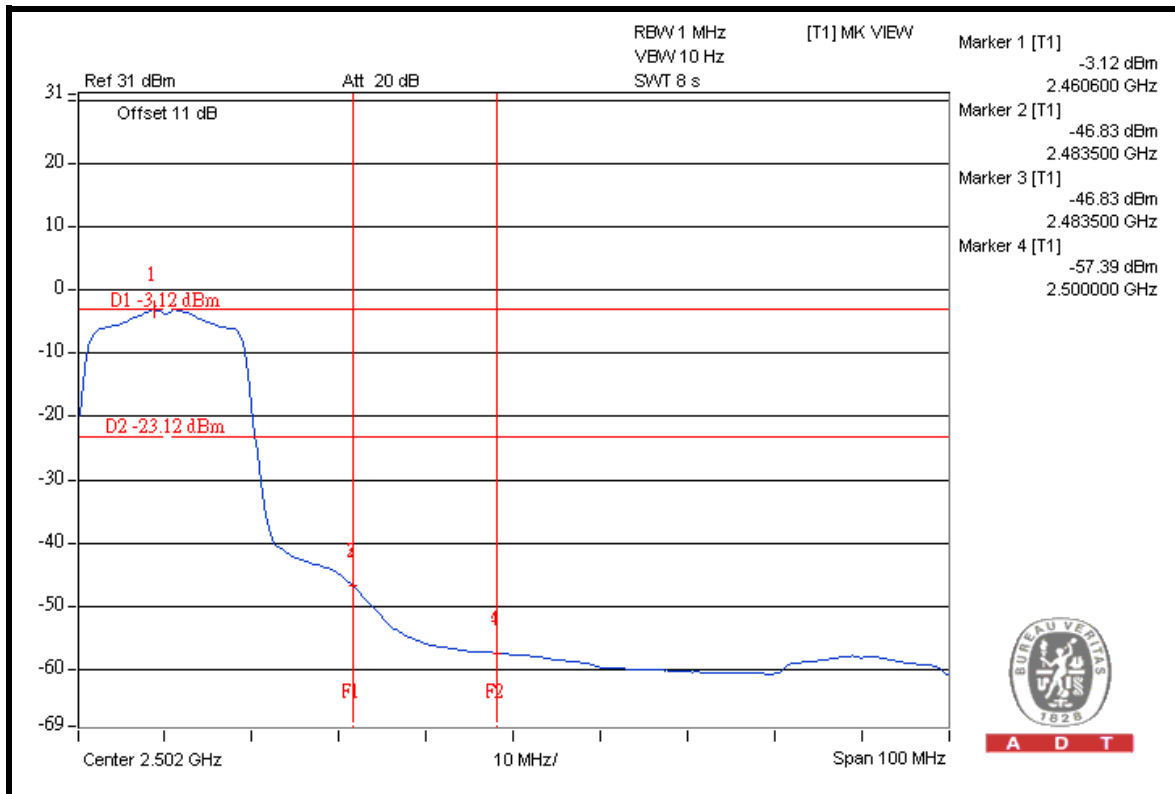



A D T

5. PHOTOGRAPHS OF THE TEST CONFIGURATION

Please refer to the attached file (Test Setup Photo).



A D T

6. INFORMATION ON THE TESTING LABORATORIES

We, Bureau Veritas Consumer Products Services (H.K.) Ltd., Taoyuan Branch., were founded in 1988 to provide our best service in EMC, Radio, Telecom and Safety consultation. Our laboratories are accredited and approved according to ISO/IEC 17025.

Copies of accreditation certificates of our laboratories obtained from approval agencies can be downloaded from our web site:

www.adt.com.tw/index.5.phtml. If you have any comments, please feel free to contact us at the following:

Linko EMC/RF Lab:

Tel: 886-2-26052180

Fax: 886-2-26051924

Hsin Chu EMC/RF Lab:

Tel: 886-3-5935343

Fax: 886-3-5935342

Hwa Ya EMC/RF/Safety/TPCI Lab:

Tel: 886-3-3183232

Fax: 886-3-3185050

Web Site: www.adt.com.tw

The address and road map of all our labs can be found in our web site also.



A D T

7. APPENDIX A - MODIFICATIONS RECORDERS FOR ENGINEERING CHANGES TO THE EUT BY THE LAB

No any modifications are made to the EUT by the lab during the test.

---END---