



A D T

FCC TEST REPORT (WLAN)

REPORT NO.: RF110330C13

MODEL NO.: PG86300

FCC ID: NM8PG86300

RECEIVED: Mar. 30, 2011

TESTED: Apr. 27 ~ May 03, 2011

ISSUED: May 16, 2011

APPLICANT: HTC Corporation

ADDRESS: No. 23, Xinghua Rd., Taoyuan City, Taoyuan, 330
Taiwan

ISSUED BY: Bureau Veritas Consumer Products Services (H.K.)
Ltd., Taoyuan Branch

LAB ADDRESS: No. 47, 14th Ling, Chia Pau Tsuen, Lin Kou Hsiang,
Taipei Hsien 244, Taiwan, R.O.C.

TEST LOCATION: No. 19, Hwa Ya 2nd Rd, Wen Hwa Tsuen, Kwei
Shan Hsiang, Taoyuan Hsien 333, Taiwan, R.O.C.

This test report consists of 63 pages in total. It may be duplicated completely for legal use with the approval of the applicant. It should not be reproduced except in full, without the written approval of our laboratory. The client should not use it to claim product, certification, approval or endorsement by TAF or any government agency. The test results in the report only apply to the tested sample.





A D T

TABLE OF CONTENTS

| | |
|---|----|
| RELEASE CONTROL RECORD | 4 |
| 1. CERTIFICATION..... | 5 |
| 2. SUMMARY OF TEST RESULTS | 6 |
| 2.1 MEASUREMENT UNCERTAINTY..... | 6 |
| 3. GENERAL INFORMATION | 7 |
| 3.1 GENERAL DESCRIPTION OF EUT | 7 |
| 3.2 DESCRIPTION OF TEST MODES | 9 |
| 3.2.1 CONFIGURATION OF SYSTEM UNDER TEST | 9 |
| 3.2.2 TEST MODE APPLICABILITY AND TESTED CHANNEL DETAIL | 10 |
| 3.3 GENERAL DESCRIPTION OF APPLIED STANDARDS | 12 |
| 3.4 DESCRIPTION OF SUPPORT UNITS | 12 |
| 4. TEST TYPES AND RESULTS | 13 |
| 4.1 RADIATED EMISSION MEASUREMENT | 13 |
| 4.1.1 LIMITS OF RADIATED EMISSION MEASUREMENT..... | 13 |
| 4.1.2 TEST INSTRUMENTS..... | 14 |
| 4.1.3 TEST PROCEDURES | 15 |
| 4.1.4 DEVIATION FROM TEST STANDARD..... | 15 |
| 4.1.5 TEST SETUP | 16 |
| 4.1.6 EUT OPERATING CONDITIONS | 16 |
| 4.1.7 TEST RESULTS | 17 |
| 4.2 CONDUCTED EMISSION MEASUREMENT | 28 |
| 4.2.1 LIMITS OF CONDUCTED EMISSION MEASUREMENT..... | 28 |
| 4.2.2 TEST INSTRUMENTS..... | 28 |
| 4.2.3 TEST PROCEDURES | 29 |
| 4.2.4 DEVIATION FROM TEST STANDARD..... | 29 |
| 4.2.5 TEST SETUP | 30 |
| 4.2.6 EUT OPERATING CONDITIONS | 30 |
| 4.2.7 TEST RESULTS | 31 |
| 4.3 6dB BANDWIDTH MEASUREMENT | 35 |
| 4.3.1 LIMITS OF 6dB BANDWIDTH MEASUREMENT | 35 |
| 4.3.2 TEST INSTRUMENTS..... | 35 |
| 4.3.3 TEST PROCEDURE..... | 35 |
| 4.3.4 DEVIATION FROM TEST STANDARD..... | 35 |
| 4.3.5 TEST SETUP | 36 |
| 4.3.6 EUT OPERATING CONDITIONS | 36 |
| 4.3.7 TEST RESULTS | 37 |
| 4.4 MAXIMUM OUTPUT POWER | 40 |
| 4.4.1 LIMITS OF MAXIMUM OUTPUT POWER MEASUREMENT..... | 40 |
| 4.4.2 INSTRUMENTS..... | 40 |



A D T

| | | |
|-------|--|----|
| 4.4.3 | TEST PROCEDURES | 40 |
| 4.4.4 | DEVIATION FROM TEST STANDARD..... | 41 |
| 4.4.5 | TEST SETUP | 41 |
| 4.4.6 | EUT OPERATING CONDITIONS | 41 |
| 4.4.7 | TEST RESULTS | 42 |
| 4.5 | POWER SPECTRAL DENSITY MEASUREMENT | 43 |
| 4.5.1 | LIMITS OF POWER SPECTRAL DENSITY MEASUREMENT | 43 |
| 4.5.2 | TEST INSTRUMENTS..... | 43 |
| 4.5.3 | TEST PROCEDURE..... | 43 |
| 4.5.4 | DEVIATION FROM TEST STANDARD..... | 44 |
| 4.5.5 | TEST SETUP | 44 |
| 4.5.6 | EUT OPERATING CONDITION..... | 44 |
| 4.5.7 | TEST RESULTS | 45 |
| 4.6 | BAND EDGES MEASUREMENT | 48 |
| 4.6.1 | LIMITS OF BAND EDGES MEASUREMENT | 48 |
| 4.6.2 | TEST INSTRUMENTS..... | 48 |
| 4.6.3 | TEST PROCEDURE..... | 48 |
| 4.6.4 | DEVIATION FROM TEST STANDARD..... | 48 |
| 4.6.5 | EUT OPERATING CONDITION..... | 48 |
| 4.6.6 | TEST RESULTS | 49 |
| 5. | PHOTOGRAPHS OF THE TEST CONFIGURATION..... | 61 |
| 6. | INFORMATION ON THE TESTING LABORATORIES | 62 |
| 7. | APPENDIX A - MODIFICATIONS RECORDERS FOR ENGINEERING CHANGES TO THE EUT BY THE LAB..... | 63 |



A D T

RELEASE CONTROL RECORD

| ISSUE NO. | REASON FOR CHANGE | DATE ISSUED |
|------------------|-------------------|--------------|
| Original release | NA | May 16, 2011 |



A D T

1. CERTIFICATION

PRODUCT: Smart Phone

MODEL: PG86300

BRAND: hTC

APPLICANT: HTC Corporation

TESTED: Apr. 27 ~ May 03, 2011

TEST SAMPLE: Production Unit

STANDARDS: FCC Part 15, Subpart C (Section 15.247)

ANSI C63.4-2003

ANSI C63.10-2009

The above equipment (Model: PG86300) has been tested by **Bureau Veritas Consumer Products Services (H.K.) Ltd., Taoyuan Branch**, and found compliance with the requirement of the above standards. The test record, data evaluation & Equipment Under Test (EUT) configurations represented herein are true and accurate accounts of the measurements of the sample's EMC characteristics under the conditions specified in this report.

PREPARED BY : Ivy Lin , DATE: May 16, 2011
Ivy Lin / Specialist

APPROVED BY : Gary Chang , DATE: May 16, 2011
Gary Chang / Assistant Manager



2. SUMMARY OF TEST RESULTS

The EUT has been tested according to the following specifications:

| APPLIED STANDARD: FCC PART 15, SUBPART C (SECTION 15.247) | | | |
|---|--|--------|--|
| STANDARD SECTION | TEST TYPE AND LIMIT | RESULT | REMARK |
| 15.207 | AC Power Conducted Emission | PASS | Meet the requirement of limit. Minimum passing margin is -11.58dB at 0.560MHz. |
| 15.247(a)(2) | Spectrum Bandwidth of a Direct Sequence Spread Spectrum System Limit: min. 500kHz | PASS | Meet the requirement of limit. |
| 15.247(b) | Maximum Output Power Limit: max. 30dBm | PASS | Meet the requirement of limit. |
| 15.247(d) | Radiated Emissions Limit: Table 15.209 | PASS | Meet the requirement of limit. Minimum passing margin is -1.9dB at 2390.00MHz. |
| 15.247(e) | Power Spectral Density Limit: max. 8dBm | PASS | Meet the requirement of limit. |
| 15.247(d) | Band Edge Measurement Limit: 20dB less than the peak value of fundamental frequency | PASS | Meet the requirement of limit. |
| 15.203 | Antenna Requirement | PASS | No antenna connector is used. |

2.1 MEASUREMENT UNCERTAINTY

Where relevant, the following measurement uncertainty levels have been estimated for tests performed on the EUT as specified in CISPR 16-4-2:

| MEASUREMENT | FREQUENCY | UNCERTAINTY |
|---------------------|-----------------|-------------|
| Conducted emissions | 150kHz~30MHz | 2.44 dB |
| Radiated emissions | 30MHz ~ 200MHz | 3.34 dB |
| | 200MHz ~1000MHz | 3.35 dB |
| | 1GHz ~ 18GHz | 2.26 dB |
| | 18GHz ~ 40GHz | 1.94 dB |

This uncertainty represents an expanded uncertainty expressed at approximately the 95% confidence level using a coverage factor of $k = 2$.



A D T

3. GENERAL INFORMATION

3.1 GENERAL DESCRIPTION OF EUT

| | |
|------------------------------|---|
| EUT | Smart Phone |
| MODEL NO. | PG86300 |
| FCC ID | NM8PG86300 |
| POWER SUPPLY | 3.7Vdc (Rechargeable lithium battery) 3.8Vdc (Rechargeable lithium battery) 5.0Vdc (Power adapter) 5.0Vdc (host equipment) |
| MODULATION TYPE | CCK, DQPSK, DBPSK for DSSS 64QAM, 16QAM, QPSK, BPSK for OFDM |
| MODULATION TECHNOLOGY | DSSS, OFDM |
| TRANSFER RATE | 802.11b:11.0/ 5.5/ 2.0/ 1.0Mbps 802.11g: 54.0/ 48.0/ 36.0/ 24.0/ 18.0/ 12.0/ 9.0/ 6.0Mbps 802.11n (20MHz): up to 65.0Mbps |
| OPERATING FREQUENCY | 2412 ~ 2462MHz |
| NUMBER OF CHANNEL | 11 |
| OUTPUT POWER | 169.8mW |
| ANTENNA TYPE | PIFA antenna with -0.5dBi gain |
| ANTENNA CONNECTOR | NA |
| DATA CABLE | NA |
| I/O PORTS | Refer to user's manual |
| ACCESSORY DEVICES | Refer to note as below |

NOTE:

1. The EUT is a Smart Phone. The functions of EUT listed as below:

| | TEST STANDARD | REFERENCE REPORT |
|-------------------------|--|-------------------------|
| WLAN 802.11b/g/n | FCC Part 15, Subpart C (Section 15.247) | RF110330C13 |
| BLUETOOTH V3.0 | | RF110330C13-1 |
| GSM 850 | FCC Part 22 | RF110330C13-2 |
| GSM 1900 | FCC Part 24 | RF110330C13-3 |
| WCDMA | FCC Part 27 | RF110330C13A |



2. The EUT provides one completed transmitter and one receiver.

| MODULATION MODE | TX FUNCTION |
|-----------------|-------------|
| 802.11b | 1TX |
| 802.11g | 1TX |
| 802.11n (20MHz) | 1TX |

3. The communicated functions of EUT listed as below:

| | | 850MHz | 1700MHz | 1900MHz | With 802.11b/g/n + Bluetooth + GPS |
|----|--------|--------|---------|---------|---------------------------------------|
| 2G | GSM | √ | | √ | |
| | GPRS | √ | | √ | |
| | E-GPRS | √ | | √ | |
| 3G | WCDMA | | √ | | |
| | HSDPA | | √ | | |
| | HSUPA | | √ | | |

4. The EUT has following accessories.

| NO. | PRODUCT | BRAND | MODEL | DESCRIPTION | |
|-----|----------------|-----------------------------------|-------------------------------|--|-----------------------------------|
| 1 | Power Adapter | hTC | TC X250 (X= U, B, E, C, A) | I/P: 100-240Vac, 200mA, 50-60Hz O/P: 5Vdc, 1A Manufacture: Emerson | |
| 2 | | | | I/P: 100-240Vac, 200mA, 50-60Hz O/P: 5Vdc, 1A Manufacture: Delta | |
| 3 | | | | I/P: 100-240Vac, 200mA, 50-60Hz O/P: 5Vdc, 1A Manufacture: Phihong | |
| 4 | Battery | hTC | BG86100 | Rating: 3.8Vdc, 1730mAh, 6.57Whr Manufacture: HT ENERGY | |
| 5 | | | | Rating: 3.7Vdc, 1730mAh, 6.40Whr Manufacture: HT ENERGY | |
| 6 | USB cable | Chant Sincere Co., LTD (COXOC) | DC M410 | 1.30m non-shielded cable w/o core | |
| 7 | | | | 1.27m non-shielded cable w/o core | |
| 8 | | | | Foxlink | 1.25m non-shielded cable w/o core |
| 9 | | | | MEC | 1.27m non-shielded cable w/o core |
| 10 | Earphone cable | Merry | RC E160 | 1.23m non-shielded cable without core | |

5. The EUT configured with the following accessories is worst combination for final test.

| ACCESSORY | BRAND | MANUFACTURE | MODEL | REMARK |
|----------------|-----------------------------------|-------------|---------|-------------|
| Power Adapter | hTC | Delta | TC U250 | - |
| Battery | hTC | HT ENERGY | BG86100 | 3.8Vdc |
| USB cable | Chant Sincere Co., LTD (COXOC) | - | DC M410 | 1.27m cable |
| Earphone cable | Merry | - | RC E160 | - |

6. The above EUT information was declared by manufacturer and for more detailed features description, please refer to the manufacturer's specifications or User's Manual.

3.2 DESCRIPTION OF TEST MODES

11 channels are provided for 802.11b, 802.11g and 802.11n (20MHz):

| CHANNEL | FREQUENCY | CHANNEL | FREQUENCY |
|---------|-----------|---------|-----------|
| 1 | 2412MHz | 7 | 2442MHz |
| 2 | 2417MHz | 8 | 2447MHz |
| 3 | 2422MHz | 9 | 2452MHz |
| 4 | 2427MHz | 10 | 2457MHz |
| 5 | 2432MHz | 11 | 2462MHz |
| 6 | 2437MHz | | |

3.2.1 CONFIGURATION OF SYSTEM UNDER TEST

TEST MODE A

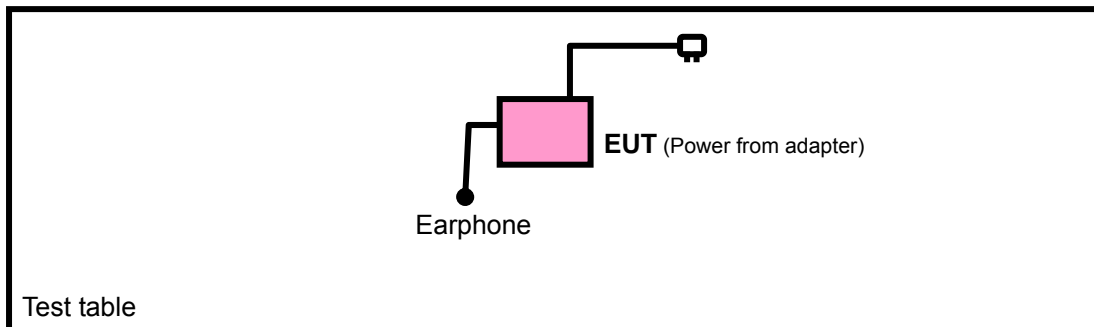

TEST MODE B

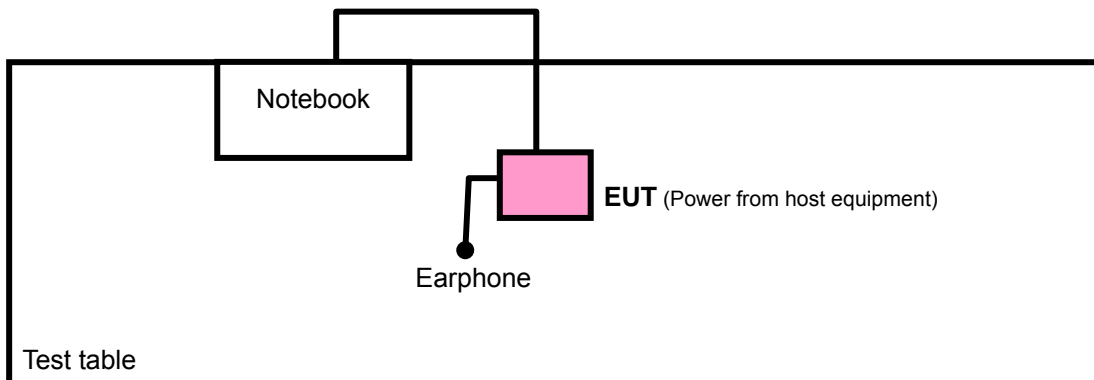



A D T

3.2.2 TEST MODE APPLICABILITY AND TESTED CHANNEL DETAIL

| EUT CONFIGURE MODE | APPLICABLE TO | | | | DESCRIPTION |
|--------------------|---------------|-------|-----|------|----------------------------|
| | RE≥1G | RE<1G | PLC | APCM | |
| A | √ | √ | √ | √ | Power from Adapter (Delta) |
| B | - | √ | √ | - | Power from host equipment |

Where **RE≥1G**: Radiated Emission above 1GHz **RE<1G**: Radiated Emission below 1GHz
PLC: Power Line Conducted Emission **APCM**: Antenna Port Conducted Measurement

NOTE: “-” means no effect.

RADIATED EMISSION TEST (ABOVE 1GHz):

- Pre-Scan has been conducted to determine the worst-case mode from all possible combinations between available modulations, XYZ axis and antenna ports (if EUT with antenna diversity architecture).
- Following channel(s) was (were) selected for the final test as listed below.

| EUT CONFIGURE MODE | MODE | AVAILABLE CHANNEL | TESTED CHANNEL | MODULATION TECHNOLOGY | MODULATION TYPE | DATA RATE (Mbps) | AXIS |
|--------------------|-----------------|-------------------|----------------|-----------------------|-----------------|------------------|------|
| A | 802.11b | 1 to 11 | 1, 6, 11 | DSSS | DBPSK | 1.0 | Z |
| A | 802.11g | 1 to 11 | 1, 6, 11 | OFDM | BPSK | 6.0 | Z |
| A | 802.11n (20MHz) | 1 to 11 | 1, 6, 11 | OFDM | BPSK | 6.5 | Z |

RADIATED EMISSION TEST (BELOW 1GHz):

- Pre-Scan has been conducted to determine the worst-case mode from all possible combinations between available modulations, XYZ axis and antenna ports (if EUT with antenna diversity architecture).
- Following channel(s) was (were) selected for the final test as listed below.

| EUT CONFIGURE MODE | MODE | AVAILABLE CHANNEL | TESTED CHANNEL | MODULATION TECHNOLOGY | MODULATION TYPE | DATA RATE (Mbps) | AXIS |
|--------------------|---------|-------------------|----------------|-----------------------|-----------------|------------------|------|
| A, B | 802.11g | 1 to 11 | 6 | OFDM | BPSK | 6.0 | Z |

POWER LINE CONDUCTED EMISSION TEST:

- Pre-Scan has been conducted to determine the worst-case mode from all possible combinations between available modulations, data rates and antenna ports (if EUT with antenna diversity architecture).
- Following channel(s) was (were) selected for the final test as listed below.

| EUT CONFIGURE MODE | MODE | AVAILABLE CHANNEL | TESTED CHANNEL | MODULATION TECHNOLOGY | MODULATION TYPE | DATA RATE (Mbps) |
|--------------------|---------|-------------------|----------------|-----------------------|-----------------|------------------|
| A, B | 802.11g | 1 to 11 | 6 | OFDM | BPSK | 6.0 |



BANDEDGE MEASUREMENT:

- Pre-Scan has been conducted to determine the worst-case mode from all possible combinations between available modulations, data rates and antenna ports (if EUT with antenna diversity architecture).
- Following channel(s) was (were) selected for the final test as listed below.

| EUT CONFIGURE MODE | MODE | AVAILABLE CHANNEL | TESTED CHANNEL | MODULATION TECHNOLOGY | MODULATION TYPE | DATA RATE (Mbps) |
|--------------------|-----------------|-------------------|----------------|-----------------------|-----------------|------------------|
| A | 802.11b | 1 to 11 | 1, 11 | DSSS | DBPSK | 1.0 |
| A | 802.11g | 1 to 11 | 1, 11 | OFDM | BPSK | 6.0 |
| A | 802.11n (20MHz) | 1 to 11 | 1, 11 | OFDM | BPSK | 6.5 |

ANTENNA PORT CONDUCTED MEASUREMENT:

- This item includes all test value of each mode, but only includes spectrum plot of worst value of each mode.
- Pre-Scan has been conducted to determine the worst-case mode from all possible combinations between available modulations, data rates and antenna ports (if EUT with antenna diversity architecture).
- Following channel(s) was (were) selected for the final test as listed below.

| EUT CONFIGURE MODE | MODE | AVAILABLE CHANNEL | TESTED CHANNEL | MODULATION TECHNOLOGY | MODULATION TYPE | DATA RATE (Mbps) |
|--------------------|-----------------|-------------------|----------------|-----------------------|-----------------|------------------|
| A | 802.11b | 1 to 11 | 1, 6, 11 | DSSS | DBPSK | 1.0 |
| A | 802.11g | 1 to 11 | 1, 6, 11 | OFDM | BPSK | 6.0 |
| A | 802.11n (20MHz) | 1 to 11 | 1, 6, 11 | OFDM | BPSK | 6.5 |

TEST CONDITION:

| APPLICABLE TO | ENVIRONMENTAL CONDITIONS | INPUT POWER | TESTED BY |
|---------------|---------------------------|--------------|-------------|
| RE≥1G | 25deg. C, 65%RH, 1009 hPa | 120Vac, 60Hz | Brad Wu |
| RE<1G | 25deg. C, 65%RH, 1004 hPa | 120Vac, 60Hz | Brad Wu |
| PLC | 25deg. C, 68%RH, 1010 hPa | 120Vac, 60Hz | David Huang |
| APCM | 23deg. C, 68%RH, 1008 hPa | 120Vac, 60Hz | Brad Wu |



A D T

3.3 GENERAL DESCRIPTION OF APPLIED STANDARDS

The EUT is a RF Product. According to the specifications of the manufacturer, it must comply with the requirements of the following standards:

FCC Part 15, Subpart C (15.247)

ANSI C63.4-2003

ANSI C63.10-2009

All test items have been performed and recorded as per the above standards.

NOTE: The EUT is also considered as a kind of computer peripheral, because the connection to computer is necessary for typical use. It has been verified to comply with the requirements of FCC Part 15, Subpart B, Class B (DoC). The test report has been issued separately.

3.4 DESCRIPTION OF SUPPORT UNITS

Test Mode A

The EUT has been tested as an independent unit.

Test Mode B

The EUT has been tested as an independent unit together with other necessary accessories or support units. The following support units or accessories were used to form a representative test configuration during the tests.

| NO. | PRODUCT | BRAND | MODEL NO. | SERIAL NO. | FCC ID |
|-----|----------|-------|-----------|-------------|--------|
| 1 | NOTEBOOK | Dell | D830 | 10026042688 | NA |

| NO. | SIGNAL CABLE DESCRIPTION OF THE ABOVE SUPPORT UNITS |
|-----|---|
| 1 | NA |

NOTE: All power cords of the above support units are non shielded (1.8m).

4. TEST TYPES AND RESULTS

4.1 RADIATED EMISSION MEASUREMENT

4.1.1 LIMITS OF RADIATED EMISSION MEASUREMENT

Emissions radiated outside of the specified bands, shall be according to the general radiated limits in 15.209 as following:

| FREQUENCIES (MHz) | FIELD STRENGTH (microvolts/meter) | MEASUREMENT DISTANCE (meters) |
|-------------------|-----------------------------------|-------------------------------|
| 0.009 ~ 0.490 | 2400/F(kHz) | 300 |
| 0.490 ~ 1.705 | 24000/F(kHz) | 30 |
| 1.705 ~ 30.0 | 30 | 30 |
| 30 ~ 88 | 100 | 3 |
| 88 ~ 216 | 150 | 3 |
| 216 ~ 960 | 200 | 3 |
| Above 960 | 500 | 3 |

NOTE:

1. The lower limit shall apply at the transition frequencies.
2. Emission level (dBuV/m) = 20 log Emission level (uV/m).
3. As shown in 15.35(b), for frequencies above 1000MHz, the field strength limits are based on average detector, however, the peak field strength of any emission shall not exceed the maximum permitted average limits, specified above by more than 20dB under any condition of modulation.



A D T

4.1.2 TEST INSTRUMENTS

| DESCRIPTION & MANUFACTURER | MODEL NO. | SERIAL NO. | DATE OF CALIBRATION | DUE DATE OF CALIBRATION |
|---|------------------------------|-------------|---------------------|-------------------------|
| Test Receiver ROHDE & SCHWARZ | ESIB7 | 100212 | Jul. 22, 2010 | Jul. 21, 2011 |
| Spectrum Analyzer Agilent | E4446A | MY48250266 | Aug. 11, 2010 | Aug. 10, 2011 |
| BILOG Antenna SCHWARZBECK | VULB9168 | 9168-160 | Apr. 13, 2011 | Apr. 12, 2012 |
| HORN Antenna SCHWARZBECK | 9120D | 9120D-405 | Feb. 08, 2011 | Feb. 07, 2012 |
| HORN Antenna SCHWARZBECK | BBHA 9170 | BBHA9170243 | Dec. 27, 2010 | Dec. 26, 2011 |
| Preamplifier Agilent | 8447D | 2944A10633 | Nov. 02, 2010 | Nov. 01, 2011 |
| Preamplifier Agilent | 8449B | 3008A01964 | Nov. 02, 2010 | Nov. 01, 2011 |
| RF signal cable HUBER+SUHNNER | SUCOFLEX 104 | 238141/4 | May 14, 2010 | May 13, 2011 |
| RF signal cable HUBER+SUHNNER | SUCOFLEX 104 | 12738/6 | May 14, 2010 | May 13, 2011 |
| Software ADT. | ADT_Radiated_ V7.6.15.9.2 | NA | NA | NA |
| Antenna Tower inn-co GmbH | MA 4000 | 013303 | NA | NA |
| Antenna Tower Controller inn-co GmbH | CO2000 | 017303 | NA | NA |
| Turn Table ADT. | TT100. | TT93021703 | NA | NA |
| Turn Table Controller ADT. | SC100. | SC93021703 | NA | NA |

- NOTE:**
1. The calibration interval of the above test instruments is 12 months and the calibrations are traceable to NML/ROC and NIST/USA.
 2. The test was performed in HwaYa Chamber 3.
 3. The horn antenna and HP preamplifier (model: 8449B) are used only for the measurement of emission frequency above 1GHz if tested.
 4. The FCC Site Registration No. is 988962.
 5. The IC Site Registration No. is IC 7450F-3.



4.1.3 TEST PROCEDURES

- a. The EUT was placed on the top of a rotating table 0.8 meters above the ground at a 3 meters semi-anechoic chamber. The table was rotated 360 degrees to determine the position of the highest radiation.
- b. The EUT was set 3 meters away from the interference-receiving antenna, which was mounted on the top of a variable-height antenna tower.
- c. The antenna is a broadband antenna, and its height is varied from one meter to four meters above the ground to determine the maximum value of the field strength. Both horizontal and vertical polarizations of the antenna are set to make the measurement.
- d. For each suspected emission, the EUT was arranged to its worst case and then the antenna was tuned to heights from 1 meter to 4 meters and the rotatable table was turned from 0 degrees to 360 degrees to find the maximum reading.
- e. The test-receiver system was set to Peak Detect Function and Specified Bandwidth with Maximum Hold Mode.
- f. If the emission level of the EUT in peak mode was lower than the limit specified, then testing could be stopped and the peak values of the EUT would be reported. Otherwise the emissions would be re-tested one by one using peak, quasi-peak or average method as specified and then reported in a data sheet.

NOTE:

1. The resolution bandwidth and video bandwidth of test receiver/spectrum analyzer is 120kHz for Quasi-peak detection at frequency below 1GHz.
2. The resolution bandwidth of test receiver/spectrum analyzer is 1MHz and video bandwidth is 3MHz for Peak detection at frequency above 1GHz.
3. The resolution bandwidth of test receiver/spectrum analyzer is 1MHz and the video bandwidth is 10Hz for Average detection (AV) at frequency above 1GHz.
4. All modes of operation were investigated and the worst-case emissions are reported.

4.1.4 DEVIATION FROM TEST STANDARD

No deviation.

4.1.5 TEST SETUP

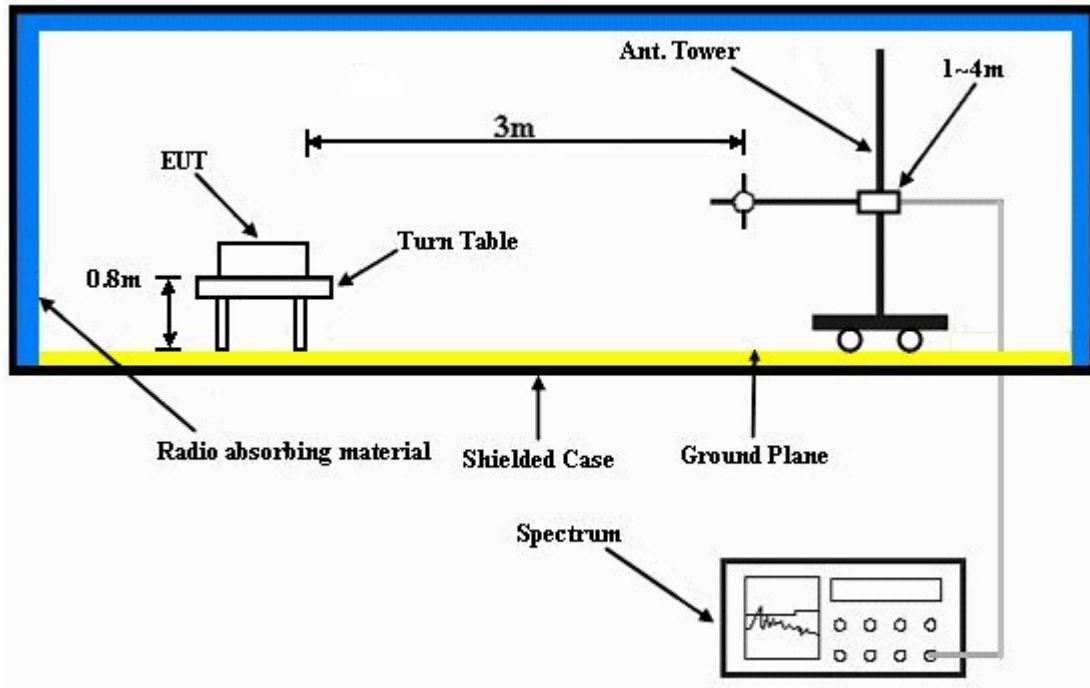

For the actual test configuration, please refer to the attached file (Test Setup Photo).

4.1.6 EUT OPERATING CONDITIONS

TEST MODE A

- Placed the EUT on a testing table.
- Use the software to control the EUT under transmission condition continuously at specific channel frequency.

TEST MODE B

- Connected the EUT to notebook and placed on a testing table.
- The notebook system ran a test program (provided by manufacturer) to enable EUT under transmission condition continuously at specific channel frequency.
- The necessary accessories enable the system in full functions.



A D T

4.1.7 TEST RESULTS

802.11b

| EUT TEST CONDITION | | MEASUREMENT DETAIL | |
|--------------------------|-----------------------------|--------------------|---------------------------|
| CHANNEL | Channel 1 | FREQUENCY RANGE | 1 ~ 25GHz |
| INPUT POWER (SYSTEM) | 120Vac, 60Hz | DETECTOR FUNCTION | Peak (PK) Average (AV) |
| ENVIRONMENTAL CONDITIONS | 25deg. C, 65%RH 1009 hPa | TESTED BY | Brad Wu |

| ANTENNA POLARITY & TEST DISTANCE: HORIZONTAL AT 3 M | | | | | | | | |
|---|-------------|-------------------------|----------------|-------------|--------------------|----------------------|------------------|--------------------------|
| NO. | FREQ. (MHz) | EMISSION LEVEL (dBuV/m) | LIMIT (dBuV/m) | MARGIN (dB) | ANTENNA HEIGHT (m) | TABLE ANGLE (Degree) | RAW VALUE (dBuV) | CORRECTION FACTOR (dB/m) |
| 1 | 2390.00 | 57.9 PK | 74.0 | -16.1 | 1.78 H | 136 | 27.60 | 30.30 |
| 2 | 2390.00 | 47.3 AV | 54.0 | -6.7 | 1.78 H | 136 | 17.00 | 30.30 |
| 3 | *2412.00 | 106.8 PK | | | 1.78 H | 136 | 76.50 | 30.30 |
| 4 | *2412.00 | 103.3 AV | | | 1.78 H | 136 | 73.00 | 30.30 |
| 5 | 4824.00 | 44.0 PK | 74.0 | -30.0 | 1.06 H | 193 | 7.80 | 36.20 |
| 6 | 4824.00 | 31.6 AV | 54.0 | -22.4 | 1.06 H | 193 | -4.60 | 36.20 |
| ANTENNA POLARITY & TEST DISTANCE: VERTICAL AT 3 M | | | | | | | | |
| NO. | FREQ. (MHz) | EMISSION LEVEL (dBuV/m) | LIMIT (dBuV/m) | MARGIN (dB) | ANTENNA HEIGHT (m) | TABLE ANGLE (Degree) | RAW VALUE (dBuV) | CORRECTION FACTOR (dB/m) |
| 1 | 2390.00 | 55.9 PK | 74.0 | -18.1 | 1.00 V | 152 | 25.60 | 30.30 |
| 2 | 2390.00 | 45.9 AV | 54.0 | -8.1 | 1.00 V | 152 | 15.60 | 30.30 |
| 3 | *2412.00 | 105.2 PK | | | 1.00 V | 152 | 74.90 | 30.30 |
| 4 | *2412.00 | 101.3 AV | | | 1.00 V | 152 | 71.00 | 30.30 |
| 5 | 4824.00 | 44.2 PK | 74.0 | -29.8 | 1.01 V | 156 | 8.00 | 36.20 |
| 6 | 4824.00 | 31.9 AV | 54.0 | -22.1 | 1.01 V | 156 | -4.30 | 36.20 |

- REMARKS:**
1. Emission level (dBuV/m) = Raw Value (dBuV) + Correction Factor (dB/m).
 2. Correction Factor (dB/m) = Antenna Factor (dB/m) + Cable Factor (dB).
 3. The other emission levels were very low against the limit.
 4. Margin value = Emission level – Limit value.
 5. “ * ”: Fundamental frequency.



A D T

| EUT TEST CONDITION | | MEASUREMENT DETAIL | |
|--------------------------|-----------------------------|--------------------|---------------------------|
| CHANNEL | Channel 6 | FREQUENCY RANGE | 1 ~ 25GHz |
| INPUT POWER (SYSTEM) | 120Vac, 60Hz | DETECTOR FUNCTION | Peak (PK) Average (AV) |
| ENVIRONMENTAL CONDITIONS | 25deg. C, 65%RH 1009 hPa | TESTED BY | Brad Wu |

| ANTENNA POLARITY & TEST DISTANCE: HORIZONTAL AT 3 M | | | | | | | | |
|---|-------------|-------------------------|----------------|-------------|--------------------|----------------------|------------------|--------------------------|
| NO. | FREQ. (MHz) | EMISSION LEVEL (dBuV/m) | LIMIT (dBuV/m) | MARGIN (dB) | ANTENNA HEIGHT (m) | TABLE ANGLE (Degree) | RAW VALUE (dBuV) | CORRECTION FACTOR (dB/m) |
| 1 | *2437.00 | 106.3 PK | | | 1.76 H | 135 | 75.90 | 30.40 |
| 2 | *2437.00 | 102.8 AV | | | 1.76 H | 135 | 72.40 | 30.40 |
| 3 | 4874.00 | 43.8 PK | 74.0 | -30.2 | 1.05 H | 180 | 7.60 | 36.20 |
| 4 | 4874.00 | 31.3 AV | 54.0 | -22.7 | 1.05 H | 180 | -4.90 | 36.20 |
| 5 | 7311.00 | 48.4 PK | 74.0 | -25.6 | 1.03 H | 214 | 6.20 | 42.20 |
| 6 | 7311.00 | 37.1 AV | 54.0 | -16.9 | 1.03 H | 214 | -5.10 | 42.20 |
| ANTENNA POLARITY & TEST DISTANCE: VERTICAL AT 3 M | | | | | | | | |
| NO. | FREQ. (MHz) | EMISSION LEVEL (dBuV/m) | LIMIT (dBuV/m) | MARGIN (dB) | ANTENNA HEIGHT (m) | TABLE ANGLE (Degree) | RAW VALUE (dBuV) | CORRECTION FACTOR (dB/m) |
| 1 | *2437.00 | 104.8 PK | | | 1.01 V | 150 | 74.40 | 30.40 |
| 2 | *2437.00 | 100.9 AV | | | 1.01 V | 150 | 70.50 | 30.40 |
| 3 | 4874.00 | 44.4 PK | 74.0 | -29.6 | 1.03 V | 62 | 8.20 | 36.20 |
| 4 | 4874.00 | 32.0 AV | 54.0 | -22.0 | 1.03 V | 62 | -4.20 | 36.20 |
| 5 | 7311.00 | 48.6 PK | 74.0 | -25.4 | 1.04 V | 23 | 6.40 | 42.20 |
| 6 | 7311.00 | 37.4 AV | 54.0 | -16.6 | 1.04 V | 23 | -4.80 | 42.20 |

- REMARKS:**
1. Emission level (dBuV/m) = Raw Value (dBuV) + Correction Factor (dB/m).
 2. Correction Factor (dB/m) = Antenna Factor (dB/m) + Cable Factor (dB).
 3. The other emission levels were very low against the limit.
 4. Margin value = Emission level – Limit value.
 5. “ * ”: Fundamental frequency.



A D T

| EUT TEST CONDITION | | MEASUREMENT DETAIL | |
|--------------------------|-----------------------------|--------------------|---------------------------|
| CHANNEL | Channel 11 | FREQUENCY RANGE | 1 ~ 25GHz |
| INPUT POWER (SYSTEM) | 120Vac, 60Hz | DETECTOR FUNCTION | Peak (PK) Average (AV) |
| ENVIRONMENTAL CONDITIONS | 25deg. C, 65%RH 1009 hPa | TESTED BY | Brad Wu |

| ANTENNA POLARITY & TEST DISTANCE: HORIZONTAL AT 3 M | | | | | | | | |
|---|-------------|-------------------------|----------------|-------------|--------------------|----------------------|------------------|--------------------------|
| NO. | FREQ. (MHz) | EMISSION LEVEL (dBuV/m) | LIMIT (dBuV/m) | MARGIN (dB) | ANTENNA HEIGHT (m) | TABLE ANGLE (Degree) | RAW VALUE (dBuV) | CORRECTION FACTOR (dB/m) |
| 1 | *2462.00 | 106.2 PK | | | 1.70 H | 90 | 75.70 | 30.50 |
| 2 | *2462.00 | 102.6 AV | | | 1.70 H | 90 | 72.10 | 30.50 |
| 3 | 2483.50 | 58.0 PK | 74.0 | -16.0 | 1.70 H | 90 | 27.40 | 30.60 |
| 4 | 2483.50 | 47.5 AV | 54.0 | -6.5 | 1.70 H | 90 | 16.90 | 30.60 |
| 5 | 4924.00 | 44.3 PK | 74.0 | -29.7 | 1.18 H | 62 | 8.00 | 36.30 |
| 6 | 4924.00 | 31.8 AV | 54.0 | -22.2 | 1.18 H | 62 | -4.50 | 36.30 |
| ANTENNA POLARITY & TEST DISTANCE: VERTICAL AT 3 M | | | | | | | | |
| NO. | FREQ. (MHz) | EMISSION LEVEL (dBuV/m) | LIMIT (dBuV/m) | MARGIN (dB) | ANTENNA HEIGHT (m) | TABLE ANGLE (Degree) | RAW VALUE (dBuV) | CORRECTION FACTOR (dB/m) |
| 1 | *2462.00 | 104.6 PK | | | 1.00 V | 152 | 74.10 | 30.50 |
| 2 | *2462.00 | 100.7 AV | | | 1.00 V | 152 | 70.20 | 30.50 |
| 3 | 2483.50 | 55.8 PK | 74.0 | -18.2 | 1.00 V | 152 | 25.20 | 30.60 |
| 4 | 2483.50 | 45.6 AV | 54.0 | -8.4 | 1.00 V | 152 | 15.00 | 30.60 |
| 5 | 4924.00 | 44.8 PK | 74.0 | -29.2 | 1.04 V | 66 | 8.50 | 36.30 |
| 6 | 4924.00 | 32.4 AV | 54.0 | -21.6 | 1.04 V | 66 | -3.90 | 36.30 |

- REMARKS:**
1. Emission level (dBuV/m) = Raw Value (dBuV) + Correction Factor (dB/m).
 2. Correction Factor (dB/m) = Antenna Factor (dB/m) + Cable Factor (dB).
 3. The other emission levels were very low against the limit.
 4. Margin value = Emission level – Limit value.
 5. “ * “: Fundamental frequency.



A D T

802.11g

| EUT TEST CONDITION | | MEASUREMENT DETAIL | |
|--------------------------|-----------------------------|--------------------|---------------------------|
| CHANNEL | Channel 1 | FREQUENCY RANGE | 1 ~ 25GHz |
| INPUT POWER (SYSTEM) | 120Vac, 60Hz | DETECTOR FUNCTION | Peak (PK) Average (AV) |
| ENVIRONMENTAL CONDITIONS | 25deg. C, 65%RH 1009 hPa | TESTED BY | Brad Wu |

| ANTENNA POLARITY & TEST DISTANCE: HORIZONTAL AT 3 M | | | | | | | | |
|---|-------------|-------------------------|----------------|-------------|--------------------|----------------------|------------------|--------------------------|
| NO. | FREQ. (MHz) | EMISSION LEVEL (dBuV/m) | LIMIT (dBuV/m) | MARGIN (dB) | ANTENNA HEIGHT (m) | TABLE ANGLE (Degree) | RAW VALUE (dBuV) | CORRECTION FACTOR (dB/m) |
| 1 | 2390.00 | 66.9 PK | 74.0 | -7.1 | 1.79 H | 104 | 36.60 | 30.30 |
| 2 | 2390.00 | 50.2 AV | 54.0 | -3.8 | 1.79 H | 104 | 19.90 | 30.30 |
| 3 | *2412.00 | 105.8 PK | | | 1.79 H | 104 | 75.50 | 30.30 |
| 4 | *2412.00 | 92.8 AV | | | 1.79 H | 104 | 62.50 | 30.30 |
| 5 | 4824.00 | 36.2 PK | 74.0 | -37.8 | 1.08 H | 61 | 0.00 | 36.20 |
| 6 | 4824.00 | 33.8 AV | 54.0 | -20.2 | 1.08 H | 61 | -2.40 | 36.20 |

| ANTENNA POLARITY & TEST DISTANCE: VERTICAL AT 3 M | | | | | | | | |
|---|-------------|-------------------------|----------------|-------------|--------------------|----------------------|------------------|--------------------------|
| NO. | FREQ. (MHz) | EMISSION LEVEL (dBuV/m) | LIMIT (dBuV/m) | MARGIN (dB) | ANTENNA HEIGHT (m) | TABLE ANGLE (Degree) | RAW VALUE (dBuV) | CORRECTION FACTOR (dB/m) |
| 1 | 2390.00 | 65.8 PK | 74.0 | -8.2 | 1.25 V | 180 | 35.50 | 30.30 |
| 2 | 2390.00 | 49.6 AV | 54.0 | -4.4 | 1.25 V | 180 | 19.30 | 30.30 |
| 3 | *2412.00 | 104.3 PK | | | 1.25 V | 180 | 74.00 | 30.30 |
| 4 | *2412.00 | 91.1 AV | | | 1.25 V | 180 | 60.80 | 30.30 |
| 5 | 4824.00 | 35.5 PK | 74.0 | -38.5 | 1.03 V | 216 | -0.70 | 36.20 |
| 6 | 4824.00 | 33.1 AV | 54.0 | -20.9 | 1.03 V | 216 | -3.10 | 36.20 |

- REMARKS:**
1. Emission level (dBuV/m) = Raw Value (dBuV) + Correction Factor (dB/m).
 2. Correction Factor (dB/m) = Antenna Factor (dB/m) + Cable Factor (dB).
 3. The other emission levels were very low against the limit.
 4. Margin value = Emission level – Limit value.
 5. “ * “: Fundamental frequency.



A D T

| EUT TEST CONDITION | | MEASUREMENT DETAIL | |
|--------------------------|-----------------------------|--------------------|---------------------------|
| CHANNEL | Channel 6 | FREQUENCY RANGE | 1 ~ 25GHz |
| INPUT POWER (SYSTEM) | 120Vac, 60Hz | DETECTOR FUNCTION | Peak (PK) Average (AV) |
| ENVIRONMENTAL CONDITIONS | 25deg. C, 65%RH 1009 hPa | TESTED BY | Brad Wu |

| ANTENNA POLARITY & TEST DISTANCE: HORIZONTAL AT 3 M | | | | | | | | |
|---|-------------|-------------------------|----------------|-------------|--------------------|----------------------|------------------|--------------------------|
| NO. | FREQ. (MHz) | EMISSION LEVEL (dBuV/m) | LIMIT (dBuV/m) | MARGIN (dB) | ANTENNA HEIGHT (m) | TABLE ANGLE (Degree) | RAW VALUE (dBuV) | CORRECTION FACTOR (dB/m) |
| 1 | *2437.00 | 105.6 PK | | | 1.80 H | 105 | 75.20 | 30.40 |
| 2 | *2437.00 | 92.5 AV | | | 1.80 H | 105 | 62.10 | 30.40 |
| 3 | 4874.00 | 36.5 PK | 74.0 | -37.5 | 1.12 H | 59 | 0.30 | 36.20 |
| 4 | 4874.00 | 34.1 AV | 54.0 | -19.9 | 1.12 H | 59 | -2.10 | 36.20 |
| 5 | 7311.00 | 48.8 PK | 74.0 | -25.2 | 1.05 H | 220 | 6.60 | 42.20 |
| 6 | 7311.00 | 37.4 AV | 54.0 | -16.6 | 1.05 H | 220 | -4.80 | 42.20 |
| ANTENNA POLARITY & TEST DISTANCE: VERTICAL AT 3 M | | | | | | | | |
| NO. | FREQ. (MHz) | EMISSION LEVEL (dBuV/m) | LIMIT (dBuV/m) | MARGIN (dB) | ANTENNA HEIGHT (m) | TABLE ANGLE (Degree) | RAW VALUE (dBuV) | CORRECTION FACTOR (dB/m) |
| 1 | *2437.00 | 104.1 PK | | | 1.26 V | 184 | 73.70 | 30.40 |
| 2 | *2437.00 | 90.8 AV | | | 1.26 V | 184 | 60.40 | 30.40 |
| 3 | 4874.00 | 35.8 PK | 74.0 | -38.2 | 1.14 V | 235 | -0.40 | 36.20 |
| 4 | 4874.00 | 33.4 AV | 54.0 | -20.6 | 1.14 V | 235 | -2.80 | 36.20 |
| 5 | 7311.00 | 48.5 PK | 74.0 | -25.5 | 1.02 V | 65 | 6.30 | 42.20 |
| 6 | 7311.00 | 37.0 AV | 54.0 | -17.0 | 1.02 V | 65 | -5.20 | 42.20 |

- REMARKS:**
1. Emission level (dBuV/m) = Raw Value (dBuV) + Correction Factor (dB/m).
 2. Correction Factor (dB/m) = Antenna Factor (dB/m) + Cable Factor (dB).
 3. The other emission levels were very low against the limit.
 4. Margin value = Emission level – Limit value.
 5. “ * “: Fundamental frequency.



A D T

| EUT TEST CONDITION | | MEASUREMENT DETAIL | |
|--------------------------|-----------------------------|--------------------|---------------------------|
| CHANNEL | Channel 11 | FREQUENCY RANGE | 1 ~ 25GHz |
| INPUT POWER (SYSTEM) | 120Vac, 60Hz | DETECTOR FUNCTION | Peak (PK) Average (AV) |
| ENVIRONMENTAL CONDITIONS | 25deg. C, 65%RH 1009 hPa | TESTED BY | Brad Wu |

| ANTENNA POLARITY & TEST DISTANCE: HORIZONTAL AT 3 M | | | | | | | | |
|---|-------------|-------------------------|----------------|-------------|--------------------|----------------------|------------------|--------------------------|
| NO. | FREQ. (MHz) | EMISSION LEVEL (dBuV/m) | LIMIT (dBuV/m) | MARGIN (dB) | ANTENNA HEIGHT (m) | TABLE ANGLE (Degree) | RAW VALUE (dBuV) | CORRECTION FACTOR (dB/m) |
| 1 | *2462.00 | 105.3 PK | | | 1.75 H | 101 | 74.80 | 30.50 |
| 2 | *2462.00 | 92.2 AV | | | 1.75 H | 101 | 61.70 | 30.50 |
| 3 | 2483.50 | 64.5 PK | 74.0 | -9.5 | 1.75 H | 101 | 33.90 | 30.60 |
| 4 | 2483.50 | 49.2 AV | 54.0 | -4.8 | 1.75 H | 101 | 18.60 | 30.60 |
| 5 | 4924.00 | 49.1 PK | 74.0 | -24.9 | 1.10 H | 194 | 12.80 | 36.30 |
| 6 | 4924.00 | 37.6 AV | 54.0 | -16.4 | 1.10 H | 194 | 1.30 | 36.30 |
| ANTENNA POLARITY & TEST DISTANCE: VERTICAL AT 3 M | | | | | | | | |
| NO. | FREQ. (MHz) | EMISSION LEVEL (dBuV/m) | LIMIT (dBuV/m) | MARGIN (dB) | ANTENNA HEIGHT (m) | TABLE ANGLE (Degree) | RAW VALUE (dBuV) | CORRECTION FACTOR (dB/m) |
| 1 | *2462.00 | 103.5 PK | | | 1.25 V | 180 | 73.00 | 30.50 |
| 2 | *2462.00 | 90.2 AV | | | 1.25 V | 180 | 59.70 | 30.50 |
| 3 | 2483.50 | 60.0 PK | 74.0 | -14.0 | 1.25 V | 180 | 29.40 | 30.60 |
| 4 | 2483.50 | 45.5 AV | 54.0 | -8.5 | 1.25 V | 180 | 14.90 | 30.60 |
| 5 | 4924.00 | 46.2 PK | 74.0 | -27.8 | 1.15 V | 204 | 9.90 | 36.30 |
| 6 | 4924.00 | 33.6 AV | 54.0 | -20.4 | 1.15 V | 204 | -2.70 | 36.30 |

- REMARKS:**
1. Emission level (dBuV/m) = Raw Value (dBuV) + Correction Factor (dB/m).
 2. Correction Factor (dB/m) = Antenna Factor (dB/m) + Cable Factor (dB).
 3. The other emission levels were very low against the limit.
 4. Margin value = Emission level – Limit value.
 5. “ * ”: Fundamental frequency.



A D T

802.11n (20MHz)

| EUT TEST CONDITION | | MEASUREMENT DETAIL | |
|--------------------------|-----------------------------|--------------------|---------------------------|
| CHANNEL | Channel 1 | FREQUENCY RANGE | 1 ~ 25GHz |
| INPUT POWER (SYSTEM) | 120Vac, 60Hz | DETECTOR FUNCTION | Peak (PK) Average (AV) |
| ENVIRONMENTAL CONDITIONS | 25deg. C, 65%RH 1009 hPa | TESTED BY | Brad Wu |

| ANTENNA POLARITY & TEST DISTANCE: HORIZONTAL AT 3 M | | | | | | | | |
|---|-------------|-------------------------|----------------|-------------|--------------------|----------------------|------------------|--------------------------|
| NO. | FREQ. (MHz) | EMISSION LEVEL (dBuV/m) | LIMIT (dBuV/m) | MARGIN (dB) | ANTENNA HEIGHT (m) | TABLE ANGLE (Degree) | RAW VALUE (dBuV) | CORRECTION FACTOR (dB/m) |
| 1 | 2390.00 | 64.3 PK | 74.0 | -9.7 | 1.50 H | 200 | 34.00 | 30.30 |
| 2 | 2390.00 | 52.1 AV | 54.0 | -1.9 | 1.50 H | 200 | 21.80 | 30.30 |
| 3 | *2412.00 | 105.3 PK | | | 1.50 H | 200 | 75.00 | 30.30 |
| 4 | *2412.00 | 92.3 AV | | | 1.50 H | 200 | 62.00 | 30.30 |
| 5 | 4824.00 | 46.5 PK | 74.0 | -27.5 | 1.04 H | 221 | 10.30 | 36.20 |
| 6 | 4824.00 | 34.0 AV | 54.0 | -20.0 | 1.04 H | 221 | -2.20 | 36.20 |
| ANTENNA POLARITY & TEST DISTANCE: VERTICAL AT 3 M | | | | | | | | |
| NO. | FREQ. (MHz) | EMISSION LEVEL (dBuV/m) | LIMIT (dBuV/m) | MARGIN (dB) | ANTENNA HEIGHT (m) | TABLE ANGLE (Degree) | RAW VALUE (dBuV) | CORRECTION FACTOR (dB/m) |
| 1 | 2390.00 | 64.5 PK | 74.0 | -9.5 | 1.20 V | 205 | 34.20 | 30.30 |
| 2 | 2390.00 | 49.8 AV | 54.0 | -4.2 | 1.20 V | 205 | 19.50 | 30.30 |
| 3 | *2412.00 | 102.8 PK | | | 1.20 V | 205 | 72.50 | 30.30 |
| 4 | *2412.00 | 89.8 AV | | | 1.20 V | 205 | 59.50 | 30.30 |
| 5 | 4824.00 | 45.5 PK | 74.0 | -28.5 | 1.10 V | 234 | 9.30 | 36.20 |
| 6 | 4824.00 | 32.6 AV | 54.0 | -21.4 | 1.10 V | 234 | -3.60 | 36.20 |

- REMARKS:**
1. Emission level (dBuV/m) = Raw Value (dBuV) + Correction Factor (dB/m).
 2. Correction Factor (dB/m) = Antenna Factor (dB/m) + Cable Factor (dB).
 3. The other emission levels were very low against the limit.
 4. Margin value = Emission level – Limit value.
 5. “ * “: Fundamental frequency.



A D T

| EUT TEST CONDITION | | MEASUREMENT DETAIL | |
|--------------------------|-----------------------------|--------------------|---------------------------|
| CHANNEL | Channel 6 | FREQUENCY RANGE | 1 ~ 25GHz |
| INPUT POWER (SYSTEM) | 120Vac, 60Hz | DETECTOR FUNCTION | Peak (PK) Average (AV) |
| ENVIRONMENTAL CONDITIONS | 25deg. C, 65%RH 1009 hPa | TESTED BY | Brad Wu |

| ANTENNA POLARITY & TEST DISTANCE: HORIZONTAL AT 3 M | | | | | | | | |
|---|-------------|-------------------------|----------------|-------------|--------------------|----------------------|------------------|--------------------------|
| NO. | FREQ. (MHz) | EMISSION LEVEL (dBuV/m) | LIMIT (dBuV/m) | MARGIN (dB) | ANTENNA HEIGHT (m) | TABLE ANGLE (Degree) | RAW VALUE (dBuV) | CORRECTION FACTOR (dB/m) |
| 1 | *2437.00 | 105.1 PK | | | 1.46 H | 204 | 74.70 | 30.40 |
| 2 | *2437.00 | 92.0 AV | | | 1.46 H | 204 | 61.60 | 30.40 |
| 3 | 4874.00 | 47.0 PK | 74.0 | -27.0 | 1.01 H | 243 | 10.80 | 36.20 |
| 4 | 4874.00 | 34.2 AV | 54.0 | -19.8 | 1.01 H | 243 | -2.00 | 36.20 |
| 5 | 7311.00 | 49.0 PK | 74.0 | -25.0 | 1.02 H | 196 | 6.80 | 42.20 |
| 6 | 7311.00 | 37.6 AV | 54.0 | -16.4 | 1.02 H | 196 | -4.60 | 42.20 |

| ANTENNA POLARITY & TEST DISTANCE: VERTICAL AT 3 M | | | | | | | | |
|---|-------------|-------------------------|----------------|-------------|--------------------|----------------------|------------------|--------------------------|
| NO. | FREQ. (MHz) | EMISSION LEVEL (dBuV/m) | LIMIT (dBuV/m) | MARGIN (dB) | ANTENNA HEIGHT (m) | TABLE ANGLE (Degree) | RAW VALUE (dBuV) | CORRECTION FACTOR (dB/m) |
| 1 | *2437.00 | 103.0 PK | | | 1.21 V | 206 | 72.60 | 30.40 |
| 2 | *2437.00 | 90.1 AV | | | 1.21 V | 206 | 59.70 | 30.40 |
| 3 | 4874.00 | 46.1 PK | 74.0 | -27.9 | 1.03 V | 66 | 9.90 | 36.20 |
| 4 | 4874.00 | 33.2 AV | 54.0 | -20.8 | 1.03 V | 66 | -3.00 | 36.20 |
| 5 | 7311.00 | 48.5 PK | 74.0 | -25.5 | 1.00 V | 95 | 6.30 | 42.20 |
| 6 | 7311.00 | 37.2 AV | 54.0 | -16.8 | 1.00 V | 95 | -5.00 | 42.20 |

- REMARKS:**
1. Emission level (dBuV/m) = Raw Value (dBuV) + Correction Factor (dB/m).
 2. Correction Factor (dB/m) = Antenna Factor (dB/m) + Cable Factor (dB).
 3. The other emission levels were very low against the limit.
 4. Margin value = Emission level – Limit value.
 5. “ * ”: Fundamental frequency.



A D T

| EUT TEST CONDITION | | MEASUREMENT DETAIL | |
|--------------------------|-----------------------------|--------------------|---------------------------|
| CHANNEL | Channel 11 | FREQUENCY RANGE | 1 ~ 25GHz |
| INPUT POWER (SYSTEM) | 120Vac, 60Hz | DETECTOR FUNCTION | Peak (PK) Average (AV) |
| ENVIRONMENTAL CONDITIONS | 25deg. C, 65%RH 1009 hPa | TESTED BY | Brad Wu |

| ANTENNA POLARITY & TEST DISTANCE: HORIZONTAL AT 3 M | | | | | | | | |
|---|-------------|-------------------------|----------------|-------------|--------------------|----------------------|------------------|--------------------------|
| NO. | FREQ. (MHz) | EMISSION LEVEL (dBuV/m) | LIMIT (dBuV/m) | MARGIN (dB) | ANTENNA HEIGHT (m) | TABLE ANGLE (Degree) | RAW VALUE (dBuV) | CORRECTION FACTOR (dB/m) |
| 1 | *2462.00 | 104.9 PK | | | 1.46 H | 203 | 74.40 | 30.50 |
| 2 | *2462.00 | 91.8 AV | | | 1.46 H | 203 | 61.30 | 30.50 |
| 3 | 2483.50 | 64.2 PK | 74.0 | -9.8 | 1.46 H | 203 | 33.60 | 30.60 |
| 4 | 2483.50 | 51.2 AV | 54.0 | -2.8 | 1.46 H | 203 | 20.60 | 30.60 |
| 5 | 4924.00 | 48.1 PK | 74.0 | -25.9 | 1.01 H | 221 | 11.80 | 36.30 |
| 6 | 4924.00 | 34.7 AV | 54.0 | -19.3 | 1.01 H | 221 | -1.60 | 36.30 |
| ANTENNA POLARITY & TEST DISTANCE: VERTICAL AT 3 M | | | | | | | | |
| NO. | FREQ. (MHz) | EMISSION LEVEL (dBuV/m) | LIMIT (dBuV/m) | MARGIN (dB) | ANTENNA HEIGHT (m) | TABLE ANGLE (Degree) | RAW VALUE (dBuV) | CORRECTION FACTOR (dB/m) |
| 1 | *2462.00 | 102.8 PK | | | 1.18 V | 211 | 72.30 | 30.50 |
| 2 | *2462.00 | 89.8 AV | | | 1.18 V | 211 | 59.30 | 30.50 |
| 3 | 2483.50 | 61.2 PK | 74.0 | -12.8 | 1.18 V | 211 | 30.60 | 30.60 |
| 4 | 2483.50 | 48.0 AV | 54.0 | -6.0 | 1.18 V | 211 | 17.40 | 30.60 |
| 5 | 4924.00 | 46.3 PK | 74.0 | -27.7 | 1.06 V | 220 | 10.00 | 36.30 |
| 6 | 4924.00 | 33.6 AV | 54.0 | -20.4 | 1.06 V | 220 | -2.70 | 36.30 |

- REMARKS:**
1. Emission level (dBuV/m) = Raw Value (dBuV) + Correction Factor (dB/m).
 2. Correction Factor (dB/m) = Antenna Factor (dB/m) + Cable Factor (dB).
 3. The other emission levels were very low against the limit.
 4. Margin value = Emission level – Limit value.
 5. “ * ”: Fundamental frequency.



A D T

BELOW 1GHz WORST-CASE DATA : 802.11g

| EUT TEST CONDITION | | MEASUREMENT DETAIL | |
|--------------------------|-----------------------------|--------------------|---------------|
| CHANNEL | Channel 6 | FREQUENCY RANGE | Below 1000MHz |
| INPUT POWER (SYSTEM) | 120Vac, 60Hz | DETECTOR FUNCTION | Quasi-Peak |
| ENVIRONMENTAL CONDITIONS | 25deg. C, 65%RH 1004 hPa | TESTED BY | Brad Wu |
| TEST MODE | A | | |

| ANTENNA POLARITY & TEST DISTANCE: HORIZONTAL AT 3 M | | | | | | | | |
|---|-------------|-------------------------|----------------|-------------|--------------------|----------------------|------------------|--------------------------|
| NO. | FREQ. (MHz) | EMISSION LEVEL (dBuV/m) | LIMIT (dBuV/m) | MARGIN (dB) | ANTENNA HEIGHT (m) | TABLE ANGLE (Degree) | RAW VALUE (dBuV) | CORRECTION FACTOR (dB/m) |
| 1 | 43.51 | 32.3 QP | 40.0 | -7.7 | 2.00 H | 34 | 17.80 | 14.50 |
| 2 | 90.17 | 28.3 QP | 43.5 | -15.2 | 2.00 H | 340 | 19.70 | 8.60 |
| 3 | 129.06 | 30.8 QP | 43.5 | -12.7 | 2.00 H | 310 | 17.50 | 13.30 |
| 4 | 307.93 | 25.0 QP | 46.0 | -21.0 | 1.50 H | 10 | 9.80 | 15.20 |
| 5 | 654.02 | 22.1 QP | 46.0 | -23.9 | 1.00 H | 4 | -1.30 | 23.40 |
| 6 | 813.45 | 24.4 QP | 46.0 | -21.6 | 1.50 H | 127 | -1.10 | 25.50 |
| ANTENNA POLARITY & TEST DISTANCE: VERTICAL AT 3 M | | | | | | | | |
| NO. | FREQ. (MHz) | EMISSION LEVEL (dBuV/m) | LIMIT (dBuV/m) | MARGIN (dB) | ANTENNA HEIGHT (m) | TABLE ANGLE (Degree) | RAW VALUE (dBuV) | CORRECTION FACTOR (dB/m) |
| 1 | 44.17 | 35.8 QP | 40.0 | -4.2 | 1.00 V | 257 | 21.30 | 14.50 |
| 2 | 156.28 | 25.5 QP | 43.5 | -18.0 | 1.50 V | 10 | 10.80 | 14.70 |
| 3 | 319.60 | 19.0 QP | 46.0 | -27.0 | 1.50 V | 118 | 3.50 | 15.50 |
| 4 | 630.69 | 22.6 QP | 46.0 | -23.4 | 1.50 V | 178 | -0.40 | 23.00 |
| 5 | 768.73 | 23.2 QP | 46.0 | -22.8 | 1.00 V | 22 | -1.70 | 24.90 |
| 6 | 864.00 | 24.9 QP | 46.0 | -21.1 | 2.00 V | 139 | -1.50 | 26.40 |

- REMARKS:**
1. Emission level (dBuV/m) = Raw Value (dBuV) + Correction Factor (dB/m).
 2. Correction Factor (dB/m) = Antenna Factor (dB/m) + Cable Factor (dB).
 3. The other emission levels were very low against the limit.
 4. Margin value = Emission level – Limit value.



A D T

| EUT TEST CONDITION | | MEASUREMENT DETAIL | |
|--------------------------|-----------------------------|--------------------|---------------|
| CHANNEL | Channel 6 | FREQUENCY RANGE | Below 1000MHz |
| INPUT POWER (SYSTEM) | 120Vac, 60Hz | DETECTOR FUNCTION | Quasi-Peak |
| ENVIRONMENTAL CONDITIONS | 25deg. C, 65%RH 1004 hPa | TESTED BY | Brad Wu |
| TEST MODE | B | | |

| ANTENNA POLARITY & TEST DISTANCE: HORIZONTAL AT 3 M | | | | | | | | |
|---|-------------|-------------------------|----------------|-------------|--------------------|----------------------|------------------|--------------------------|
| NO. | FREQ. (MHz) | EMISSION LEVEL (dBuV/m) | LIMIT (dBuV/m) | MARGIN (dB) | ANTENNA HEIGHT (m) | TABLE ANGLE (Degree) | RAW VALUE (dBuV) | CORRECTION FACTOR (dB/m) |
| 1 | 119.34 | 24.5 QP | 43.5 | -19.0 | 1.50 H | 259 | 12.00 | 12.50 |
| 2 | 251.55 | 28.0 QP | 46.0 | -18.0 | 1.00 H | 244 | 14.90 | 13.10 |
| 3 | 366.26 | 23.1 QP | 46.0 | -22.9 | 2.00 H | 319 | 6.50 | 16.60 |
| 4 | 549.03 | 29.0 QP | 46.0 | -17.0 | 1.50 H | 250 | 7.70 | 21.30 |
| 5 | 759.01 | 24.0 QP | 46.0 | -22.0 | 1.00 H | 10 | -0.80 | 24.80 |
| 6 | 897.05 | 26.0 QP | 46.0 | -20.0 | 1.00 H | 319 | -0.90 | 26.90 |

| ANTENNA POLARITY & TEST DISTANCE: VERTICAL AT 3 M | | | | | | | | |
|---|-------------|-------------------------|----------------|-------------|--------------------|----------------------|------------------|--------------------------|
| NO. | FREQ. (MHz) | EMISSION LEVEL (dBuV/m) | LIMIT (dBuV/m) | MARGIN (dB) | ANTENNA HEIGHT (m) | TABLE ANGLE (Degree) | RAW VALUE (dBuV) | CORRECTION FACTOR (dB/m) |
| 1 | 43.51 | 28.1 QP | 40.0 | -11.9 | 1.00 V | 253 | 13.60 | 14.50 |
| 2 | 115.45 | 32.0 QP | 43.5 | -11.5 | 1.00 V | 88 | 19.90 | 12.10 |
| 3 | 249.60 | 28.7 QP | 46.0 | -17.3 | 1.00 V | 340 | 15.70 | 13.00 |
| 4 | 500.42 | 24.1 QP | 46.0 | -21.9 | 1.00 V | 178 | 3.80 | 20.30 |
| 5 | 749.29 | 27.4 QP | 46.0 | -18.6 | 1.50 V | 334 | 2.70 | 24.70 |
| 6 | 961.21 | 26.6 QP | 54.0 | -27.4 | 1.50 V | 196 | -1.10 | 27.70 |

- REMARKS:**
1. Emission level (dBuV/m) = Raw Value (dBuV) + Correction Factor (dB/m).
 2. Correction Factor (dB/m) = Antenna Factor (dB/m) + Cable Factor (dB).
 3. The other emission levels were very low against the limit.
 4. Margin value = Emission level – Limit value.



A D T

4.2 CONDUCTED EMISSION MEASUREMENT

4.2.1 LIMITS OF CONDUCTED EMISSION MEASUREMENT

| FREQUENCY OF EMISSION (MHz) | CONDUCTED LIMIT (dB μ V) | |
|-----------------------------|------------------------------|----------|
| | Quasi-peak | Average |
| 0.15 ~ 0.5 | 66 to 56 | 56 to 46 |
| 0.5 ~ 5 | 56 | 46 |
| 5 ~ 30 | 60 | 50 |

- NOTE:** 1. The lower limit shall apply at the transition frequencies.
2. The limit decreases in line with the logarithm of the frequency in the range of 0.15 to 0.50MHz.
3. All emanations from a class A/B digital device or system, including any network of conductors and apparatus connected thereto, shall not exceed the level of field strengths specified above.

4.2.2 TEST INSTRUMENTS

| DESCRIPTION & MANUFACTURER | MODEL NO. | SERIAL NO. | DATE OF CALIBRATION | DUE DATE OF CALIBRATION |
|----------------------------------|---------------------|----------------|---------------------|-------------------------|
| Test Receiver ROHDE & SCHWARZ | ESCS30 | 100289 | Nov. 23, 2010 | Nov. 22, 2011 |
| RF signal cable Woken | 5D-FB | Cable-HYCO2-01 | Dec. 30, 2010 | Dec. 29, 2011 |
| LISN ROHDE & SCHWARZ | ESH2-Z5 | 100100 | Jan. 06, 2011 | Jan. 05, 2012 |
| LISN ROHDE & SCHWARZ | ESH3-Z5 | 100311 | Jul. 08, 2010 | Jul. 07, 2011 |
| Software ADT | ADT_Cond_ V7.3.7 | NA | NA | NA |

- NOTE:** 1. The calibration interval of the above test instruments is 12 months and the calibrations are traceable to NML/ROC and NIST/USA.
2. The test was performed in HwaYa Shielded Room 2.
3. The VCCI Site Registration No. is C-2047.



A D T

4.2.3 TEST PROCEDURES

- a. The EUT was placed 0.4 meters from the conducting wall of the shielded room with EUT being connected to the power mains through a line impedance stabilization network (LISN). Other support units were connected to the power mains through another LISN. The two LISNs provide 50 ohm/ 50uH of coupling impedance for the measuring instrument.
- b. Both lines of the power mains connected to the EUT were checked for maximum conducted interference.
- c. The frequency range from 150kHz to 30MHz was searched. Emission levels under (Limit - 20dB) was not recorded.

NOTE: All modes of operation were investigated and the worst-case emissions are reported.

4.2.4 DEVIATION FROM TEST STANDARD

No deviation.

4.2.5 TEST SETUP

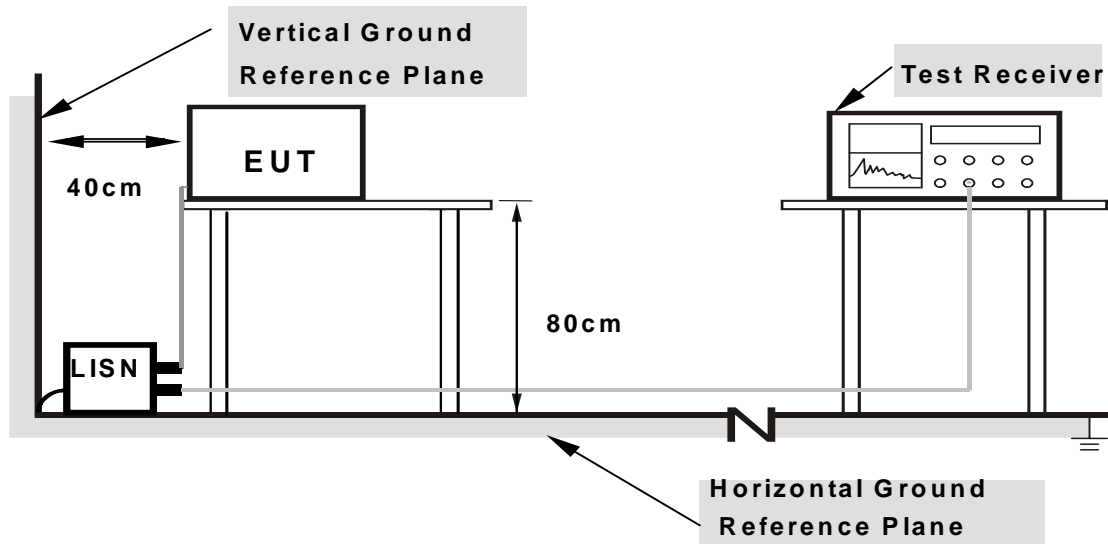

Note: 1.Support units were connected to second LISN.

2.Both of LISNs (AMN) are 80 cm from EUT and at least 80 from other units and other metal planes

For the actual test configuration, please refer to the attached file (Test Setup Photo).

4.2.6 EUT OPERATING CONDITIONS

Same as 4.1.6.

4.2.7 TEST RESULTS

CONDUCTED WORST-CASE DATA : 802.11g

| | | | |
|-----------|--------|---------------|------|
| PHASE | Line 1 | 6dB BANDWIDTH | 9kHz |
| TEST MODE | A | | |

| No | Freq. [MHz] | Corr. Factor (dB) | Reading Value [dB (uV)] | | Emission Level [dB (uV)] | | Limit [dB (uV)] | | Margin (dB) | |
|----|----------------|-------------------------|----------------------------|-----|--------------------------------|-----|--------------------|-------|----------------|-----|
| | | | Q.P. | AV. | Q.P. | AV. | Q.P. | AV. | Q.P. | AV. |
| 1 | 0.384 | 0.17 | 46.06 | - | 46.23 | - | 58.18 | 48.18 | -11.96 | - |
| 2 | 0.533 | 0.17 | 40.46 | - | 40.63 | - | 56.00 | 46.00 | -15.37 | - |
| 3 | 0.634 | 0.18 | 43.32 | - | 43.50 | - | 56.00 | 46.00 | -12.50 | - |
| 4 | 0.830 | 0.18 | 42.11 | - | 42.29 | - | 56.00 | 46.00 | -13.71 | - |
| 5 | 2.246 | 0.23 | 39.70 | - | 39.93 | - | 56.00 | 46.00 | -16.07 | - |
| 6 | 4.223 | 0.33 | 38.20 | - | 38.53 | - | 56.00 | 46.00 | -17.47 | - |

- REMARKS:**
1. Q.P. and AV. are abbreviations of quasi-peak and average individually.
 2. "-": The Quasi-peak reading value also meets average limit and measurement with the average detector is unnecessary.
 3. The emission levels of other frequencies were very low against the limit.
 4. Margin value = Emission level - Limit value
 5. Correction factor = Insertion loss + Cable loss
 6. Emission Level = Correction Factor + Reading Value.

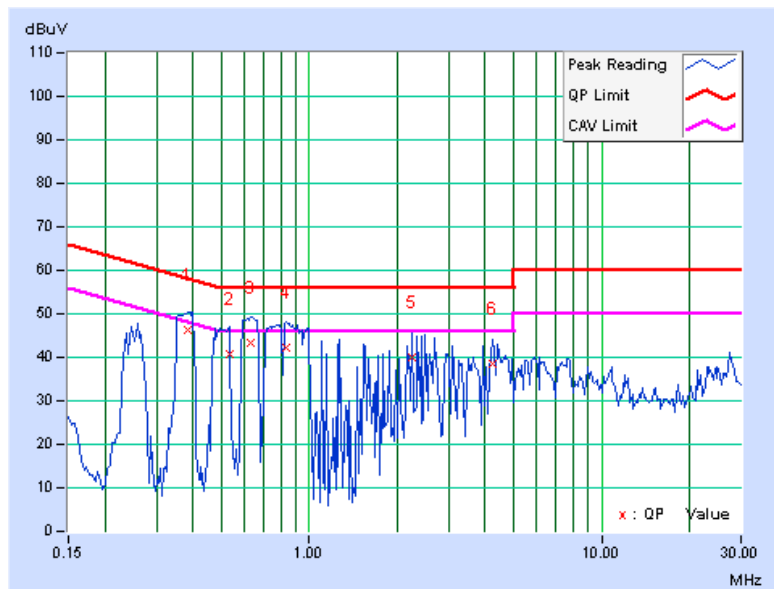



A D T

| | | | |
|-----------|--------|---------------|------|
| PHASE | Line 2 | 6dB BANDWIDTH | 9kHz |
| TEST MODE | A | | |

| No | Freq. [MHz] | Corr. | Reading Value | | Emission Level | | Limit | | Margin | |
|----|----------------|--------|---------------|-----|----------------|-----|-----------|-------|--------|-----|
| | | Factor | [dB (uV)] | | [dB (uV)] | | [dB (uV)] | | (dB) | |
| | | (dB) | Q.P. | AV. | Q.P. | AV. | Q.P. | AV. | Q.P. | AV. |
| 1 | 0.396 | 0.19 | 45.61 | - | 45.80 | - | 57.93 | 47.93 | -12.14 | - |
| 2 | 0.509 | 0.19 | 41.41 | - | 41.60 | - | 56.00 | 46.00 | -14.40 | - |
| 3 | 0.634 | 0.20 | 43.59 | - | 43.79 | - | 56.00 | 46.00 | -12.21 | - |
| 4 | 0.841 | 0.20 | 41.82 | - | 42.02 | - | 56.00 | 46.00 | -13.98 | - |
| 5 | 2.258 | 0.24 | 39.79 | - | 40.03 | - | 56.00 | 46.00 | -15.97 | - |
| 6 | 3.945 | 0.32 | 38.08 | - | 38.40 | - | 56.00 | 46.00 | -17.60 | - |

- REMARKS:**
1. Q.P. and AV. are abbreviations of quasi-peak and average individually.
 2. "-": The Quasi-peak reading value also meets average limit and measurement with the average detector is unnecessary.
 3. The emission levels of other frequencies were very low against the limit.
 4. Margin value = Emission level - Limit value
 5. Correction factor = Insertion loss + Cable loss
 6. Emission Level = Correction Factor + Reading Value.

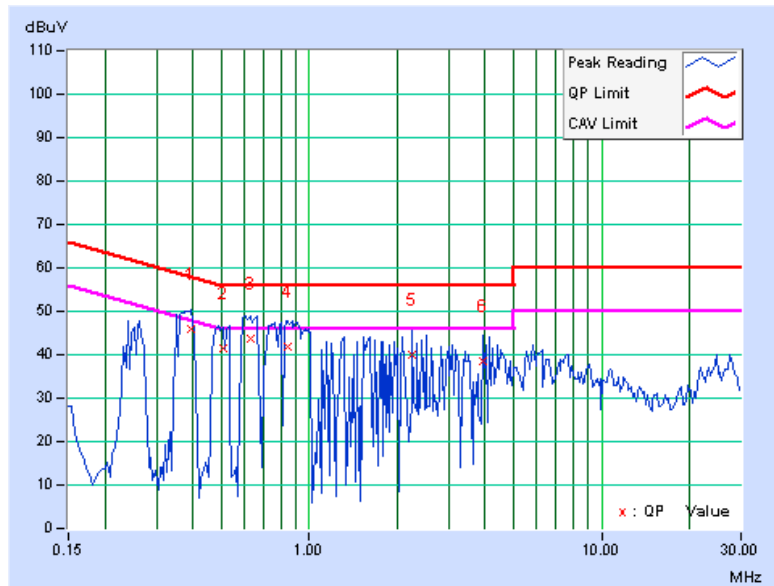



A D T

| | | | |
|-----------|--------|---------------|------|
| PHASE | Line 1 | 6dB BANDWIDTH | 9kHz |
| TEST MODE | B | | |

| No | Freq. [MHz] | Corr. Factor (dB) | Reading Value [dB (uV)] | | Emission Level [dB (uV)] | | Limit [dB (uV)] | | Margin (dB) | |
|----|----------------|-------------------------|----------------------------|-----|-----------------------------|-----|--------------------|-------|----------------|-----|
| | | | Q.P. | AV. | Q.P. | AV. | Q.P. | AV. | Q.P. | AV. |
| 1 | 0.197 | 0.15 | 48.21 | - | 48.36 | - | 63.74 | 53.74 | -15.38 | - |
| 2 | 0.259 | 0.16 | 46.62 | - | 46.78 | - | 61.45 | 51.45 | -14.68 | - |
| 3 | 0.486 | 0.17 | 44.19 | - | 44.36 | - | 56.24 | 46.24 | -11.87 | - |
| 4 | 0.763 | 0.18 | 43.71 | - | 43.89 | - | 56.00 | 46.00 | -12.11 | - |
| 5 | 1.988 | 0.22 | 40.74 | - | 40.96 | - | 56.00 | 46.00 | -15.04 | - |
| 6 | 3.375 | 0.29 | 43.77 | - | 44.06 | - | 56.00 | 46.00 | -11.94 | - |

- REMARKS:**
1. Q.P. and AV. are abbreviations of quasi-peak and average individually.
 2. "-": The Quasi-peak reading value also meets average limit and measurement with the average detector is unnecessary.
 3. The emission levels of other frequencies were very low against the limit.
 4. Margin value = Emission level - Limit value
 5. Correction factor = Insertion loss + Cable loss
 6. Emission Level = Correction Factor + Reading Value.

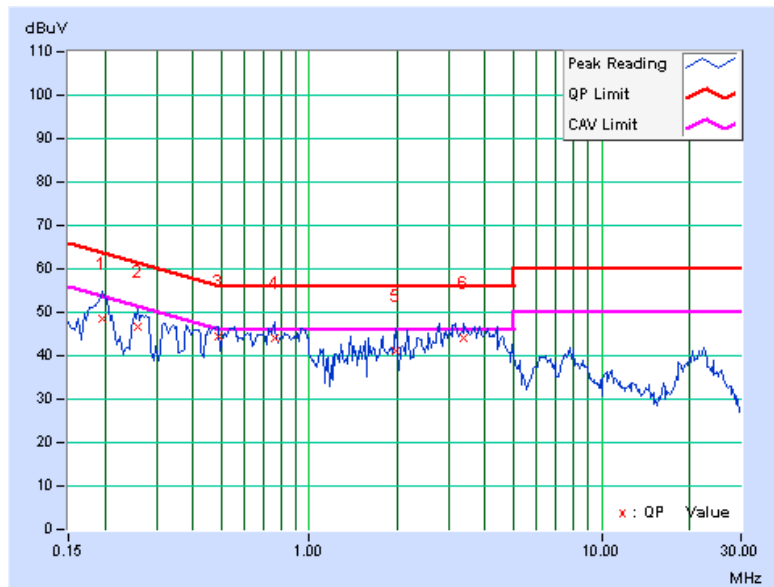



A D T

| | | | |
|-----------|--------|---------------|------|
| PHASE | Line 2 | 6dB BANDWIDTH | 9kHz |
| TEST MODE | B | | |

| No | Freq. [MHz] | Corr. Factor (dB) | Reading Value | | Emission Level | | Limit | | Margin | |
|----------|----------------|-------------------------|---------------|-----|----------------|-----|--------------|--------------|---------------|-----|
| | | | [dB (uV)] | | [dB (uV)] | | [dB (uV)] | | (dB) | |
| | | | Q.P. | AV. | Q.P. | AV. | Q.P. | AV. | Q.P. | AV. |
| 1 | 0.193 | 0.17 | 49.63 | - | 49.80 | - | 63.91 | 53.91 | -14.11 | - |
| 2 | 0.275 | 0.18 | 47.22 | - | 47.40 | - | 60.97 | 50.97 | -13.57 | - |
| 3 | 0.560 | 0.20 | 44.22 | - | 44.42 | - | 56.00 | 46.00 | -11.58 | - |
| 4 | 0.986 | 0.21 | 41.92 | - | 42.13 | - | 56.00 | 46.00 | -13.87 | - |
| 5 | 1.695 | 0.22 | 40.03 | - | 40.25 | - | 56.00 | 46.00 | -15.75 | - |
| 6 | 3.211 | 0.28 | 43.37 | - | 43.65 | - | 56.00 | 46.00 | -12.35 | - |

- REMARKS:**
1. Q.P. and AV. are abbreviations of quasi-peak and average individually.
 2. "-": The Quasi-peak reading value also meets average limit and measurement with the average detector is unnecessary.
 3. The emission levels of other frequencies were very low against the limit.
 4. Margin value = Emission level - Limit value
 5. Correction factor = Insertion loss + Cable loss
 6. Emission Level = Correction Factor + Reading Value.

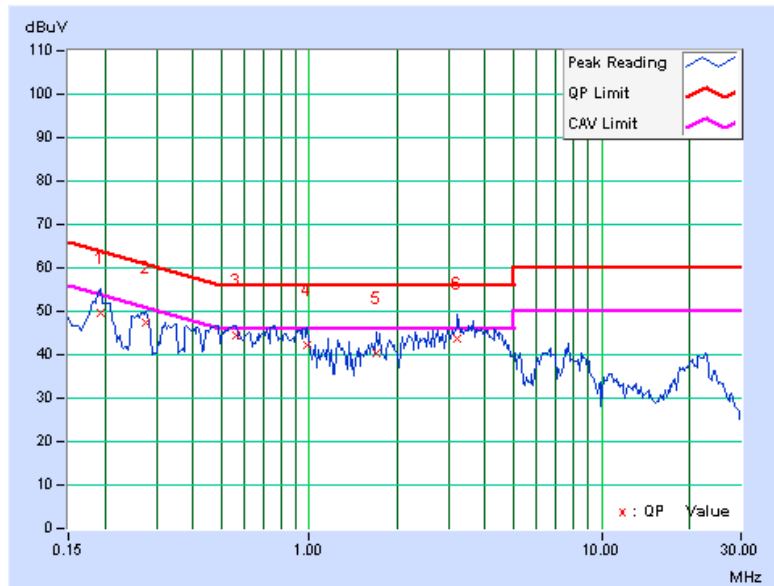

4.3 6dB BANDWIDTH MEASUREMENT

4.3.1 LIMITS OF 6dB BANDWIDTH MEASUREMENT

The minimum of 6dB Bandwidth Measurement is 0.5 MHz.

4.3.2 TEST INSTRUMENTS

| DESCRIPTION & MANUFACTURER | MODEL NO. | SERIAL NO. | DATE OF CALIBRATION | DUE DATE OF CALIBRATION |
|----------------------------|-----------|------------|---------------------|-------------------------|
| SPECTRUM ANALYZER R&S | FSP40 | 100040 | Jul. 17, 2010 | Jul. 16, 2011 |

NOTE: The calibration interval of the above test instruments is 12 months and the calibrations are traceable to NML/ROC and NIST/USA.

4.3.3 TEST PROCEDURE

The transmitter output was connected to the spectrum analyzer through an attenuator. The bandwidth of the fundamental frequency was measured by spectrum analyzer with 100kHz RBW and 300kHz VBW. The 6dB bandwidth is defined as the total spectrum the power of which is higher than peak power minus 6dB.

4.3.4 DEVIATION FROM TEST STANDARD

No deviation.

4.3.5 TEST SETUP

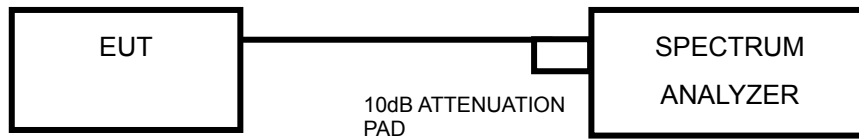

4.3.6 EUT OPERATING CONDITIONS

The software provided by client to enable the EUT under transmission condition continuously at lowest, middle and highest channel frequencies individually.



A D T

4.3.7 TEST RESULTS

802.11b

| CHANNEL | CHANNEL FREQUENCY (MHz) | 6dB BANDWIDTH (MHz) | MINIMUM LIMIT (MHz) | PASS / FAIL |
|---------|-------------------------|---------------------|---------------------|-------------|
| 1 | 2412 | 7.10 | 0.5 | PASS |
| 6 | 2437 | 7.06 | 0.5 | PASS |
| 11 | 2462 | 7.10 | 0.5 | PASS |

CH 11

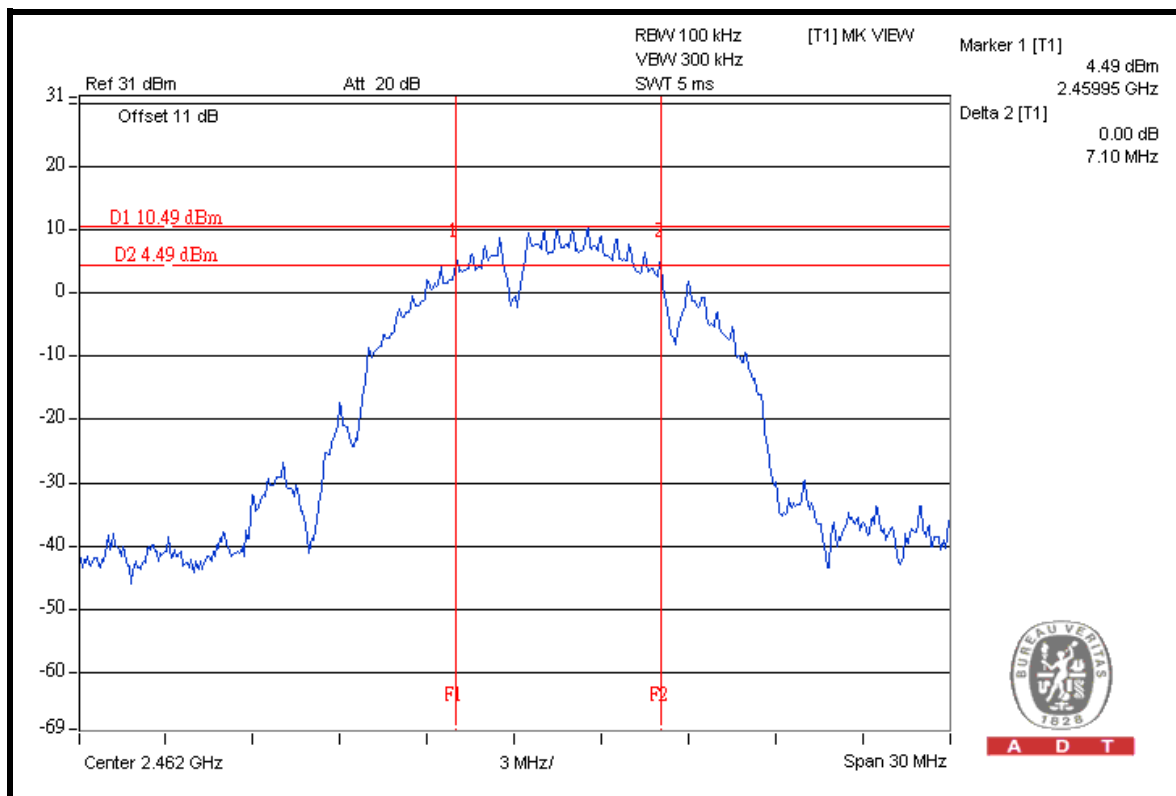



A D T

802.11g

| CHANNEL | CHANNEL FREQUENCY (MHz) | 6dB BANDWIDTH (MHz) | MINIMUM LIMIT (MHz) | PASS / FAIL |
|---------|-------------------------|---------------------|---------------------|-------------|
| 1 | 2412 | 12.86 | 0.5 | PASS |
| 6 | 2437 | 13.88 | 0.5 | PASS |
| 11 | 2462 | 14.86 | 0.5 | PASS |

CH 11

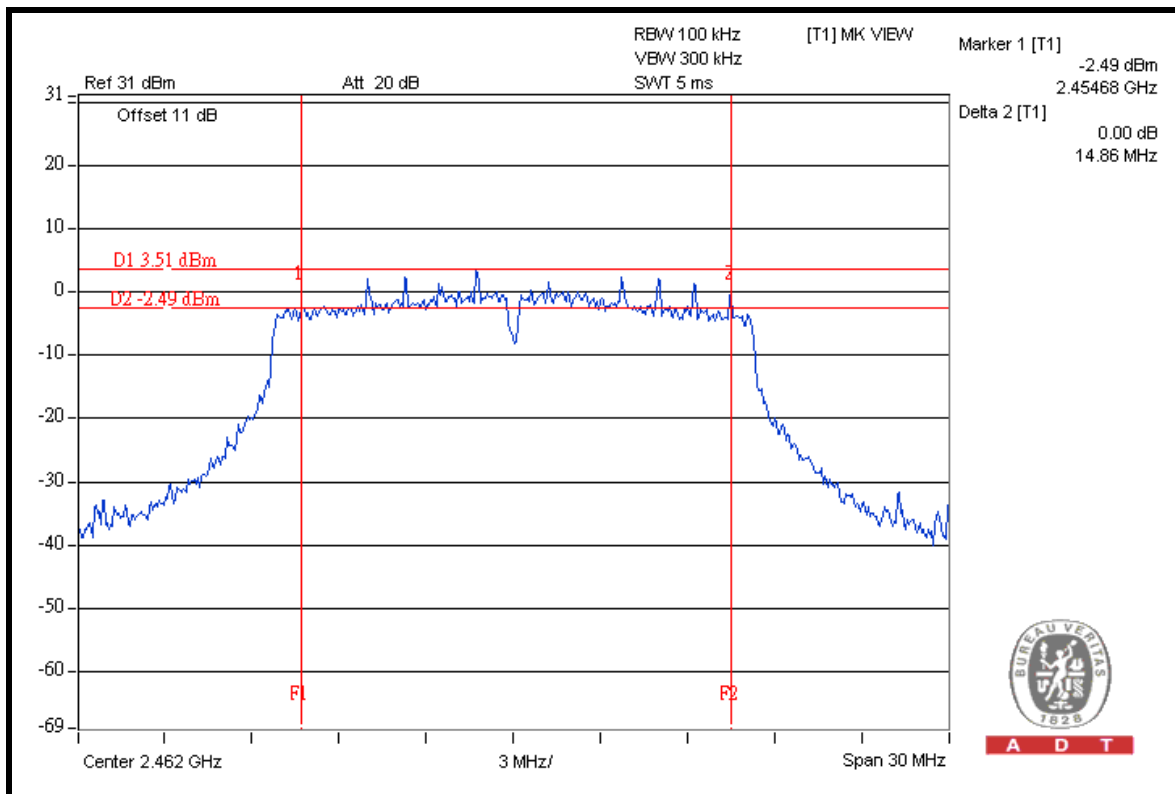



A D T

802.11n (20MHz)

| CHANNEL | CHANNEL FREQUENCY (MHz) | 6dB BANDWIDTH (MHz) | MINIMUM LIMIT (MHz) | PASS / FAIL |
|---------|-------------------------|---------------------|---------------------|-------------|
| 1 | 2412 | 15.28 | 0.5 | PASS |
| 6 | 2437 | 15.08 | 0.5 | PASS |
| 11 | 2462 | 15.93 | 0.5 | PASS |

CH 11

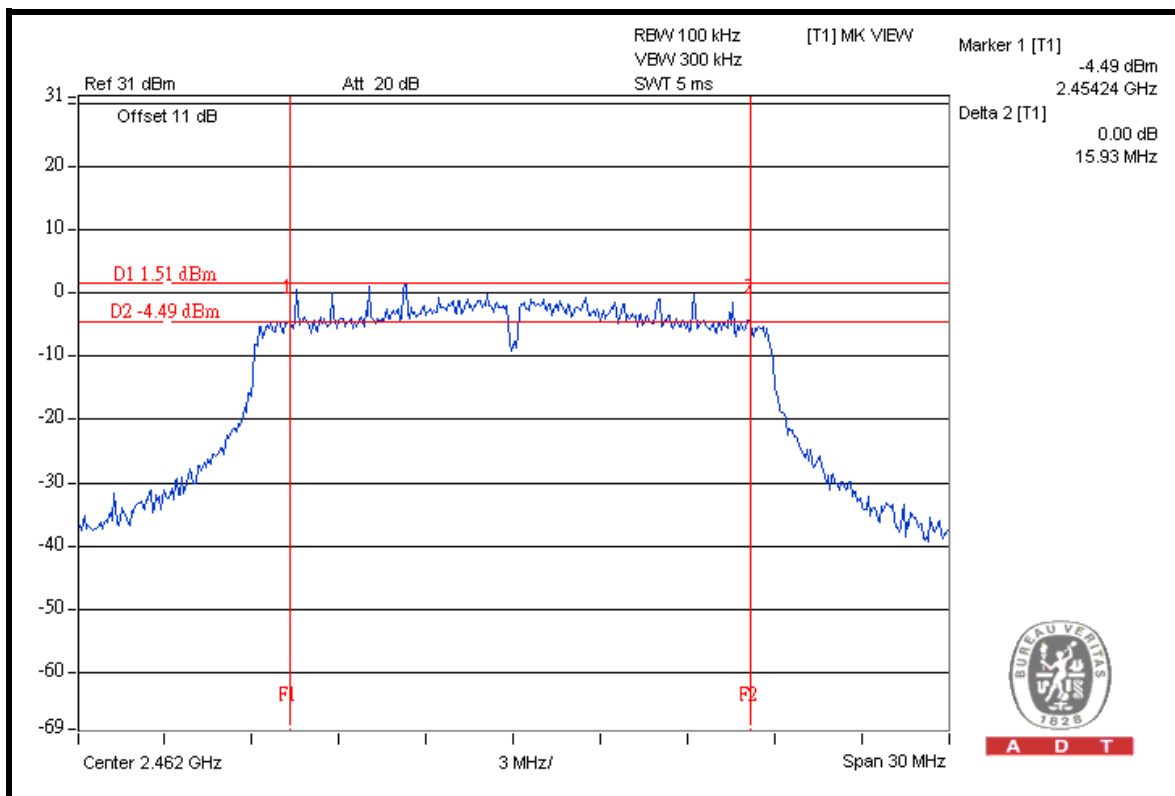



A D T

4.4 MAXIMUM OUTPUT POWER

4.4.1 LIMITS OF MAXIMUM OUTPUT POWER MEASUREMENT

The Maximum Output Power Measurement is 30dBm.

4.4.2 INSTRUMENTS

| DESCRIPTION & MANUFACTURER | MODEL NO. | SERIAL NO. | DATE OF CALIBRATION | DUE DATE OF CALIBRATION |
|-----------------------------|-----------|------------|---------------------|-------------------------|
| High Speed Peak Power Meter | ML2495A | 0824011 | Aug. 02, 2010 | Aug. 01, 2011 |
| Power Sensor | MA2411B | 0738171 | Aug. 02, 2010 | Aug. 01, 2011 |

NOTE:

1. The calibration interval of the above test instruments is 12 months and the calibrations are traceable to NML/ROC and NIST/USA.
2. Measurement Bandwidth of ML2495A is 65MHz greater than 6dB bandwidth of emission.

4.4.3 TEST PROCEDURES

A power sensor was used on the output port of the EUT. A power meter was used to read the response of the power sensor. Record the power level.

4.4.4 DEVIATION FROM TEST STANDARD

No deviation.

4.4.5 TEST SETUP

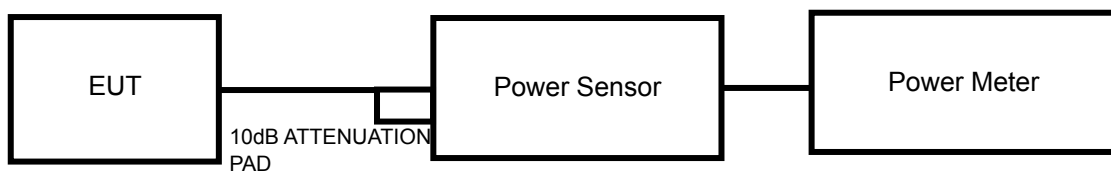

4.4.6 EUT OPERATING CONDITIONS

Same as Item 4.3.6.



4.4.7 TEST RESULTS

802.11b

| CHANNEL | CHANNEL FREQUENCY (MHz) | POWER OUTPUT (mW) | POWER OUTPUT (dBm) | POWER LIMIT (dBm) | PASS/FAIL |
|---------|-------------------------|-------------------|--------------------|-------------------|-----------|
| 1 | 2412 | 112.2 | 20.5 | 30 | PASS |
| 6 | 2437 | 123.0 | 20.9 | 30 | PASS |
| 11 | 2462 | 114.8 | 20.6 | 30 | PASS |

802.11g

| CHANNEL | CHANNEL FREQUENCY (MHz) | POWER OUTPUT (mW) | POWER OUTPUT (dBm) | POWER LIMIT (dBm) | PASS/FAIL |
|---------|-------------------------|-------------------|--------------------|-------------------|-----------|
| 1 | 2412 | 151.4 | 21.8 | 30 | PASS |
| 6 | 2437 | 169.8 | 22.3 | 30 | PASS |
| 11 | 2462 | 154.9 | 21.9 | 30 | PASS |

802.11n (20MHz)

| CHANNEL | CHANNEL FREQUENCY (MHz) | POWER OUTPUT (mW) | POWER OUTPUT (dBm) | POWER LIMIT (dBm) | PASS/FAIL |
|---------|-------------------------|-------------------|--------------------|-------------------|-----------|
| 1 | 2412 | 120.2 | 20.8 | 30 | PASS |
| 6 | 2437 | 131.8 | 21.2 | 30 | PASS |
| 11 | 2462 | 123.0 | 20.9 | 30 | PASS |



4.5 POWER SPECTRAL DENSITY MEASUREMENT

4.5.1 LIMITS OF POWER SPECTRAL DENSITY MEASUREMENT

The Maximum of Power Spectral Density Measurement is 8dBm.

4.5.2 TEST INSTRUMENTS

| DESCRIPTION & MANUFACTURER | MODEL NO. | SERIAL NO. | DATE OF CALIBRATION | DUE DATE OF CALIBRATION |
|----------------------------|-----------|------------|---------------------|-------------------------|
| SPECTRUM ANALYZER R&S | FSP40 | 100040 | Jul. 17, 2010 | Jul. 16, 2011 |

NOTE: The calibration interval of the above test instruments is 12 months and the calibrations are traceable to NML/ROC and NIST/USA.

4.5.3 TEST PROCEDURE

The transmitter output was connected to the spectrum analyzer through an attenuator, the bandwidth of the fundamental frequency was measured with the spectrum analyzer using 3kHz RBW and 30kHz VBW, set sweep time = span/3kHz. The power spectral density was measured and recorded.

The sweep time is allowed to be longer than span/3kHz for a full response of the mixer in the spectrum analyzer.

4.5.4 DEVIATION FROM TEST STANDARD

No deviation.

4.5.5 TEST SETUP

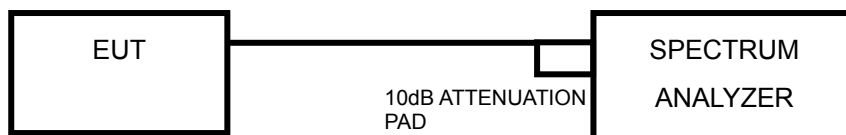

4.5.6 EUT OPERATING CONDITION

Same as Item 4.3.6



A D T

4.5.7 TEST RESULTS

802.11b

| CHANNEL | CHANNEL FREQUENCY (MHz) | RF POWER LEVEL IN 3 kHz BW (dBm) | MAXIMUM LIMIT (dBm) | PASS/FAIL |
|---------|-------------------------|----------------------------------|---------------------|-----------|
| 1 | 2412 | -4.0 | 8 | PASS |
| 6 | 2437 | -3.6 | 8 | PASS |
| 11 | 2462 | -3.9 | 8 | PASS |

CH 6

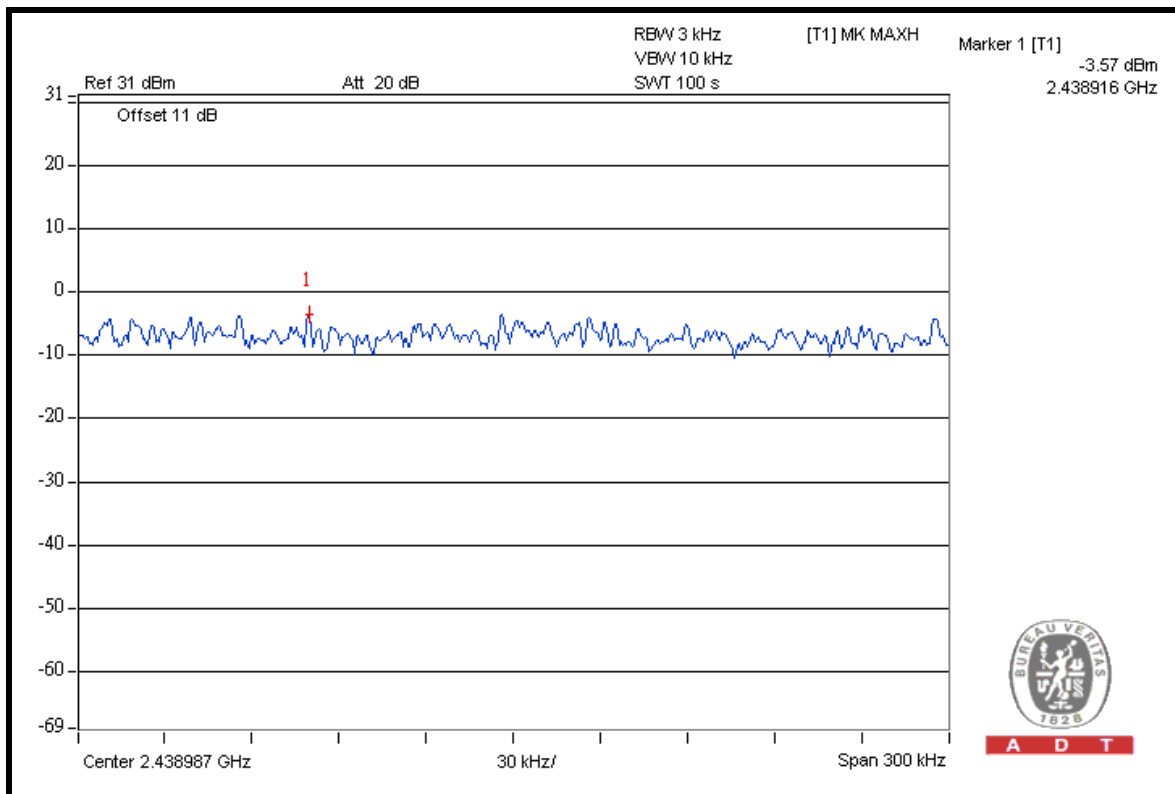



A D T

802.11g

| CHANNEL | CHANNEL FREQUENCY (MHz) | RF POWER LEVEL IN 3 kHz BW (dBm) | MAXIMUM LIMIT (dBm) | PASS/FAIL |
|---------|-------------------------|----------------------------------|---------------------|-----------|
| 1 | 2412 | -12.2 | 8 | PASS |
| 6 | 2437 | -11.4 | 8 | PASS |
| 11 | 2462 | -12.0 | 8 | PASS |

CH 6

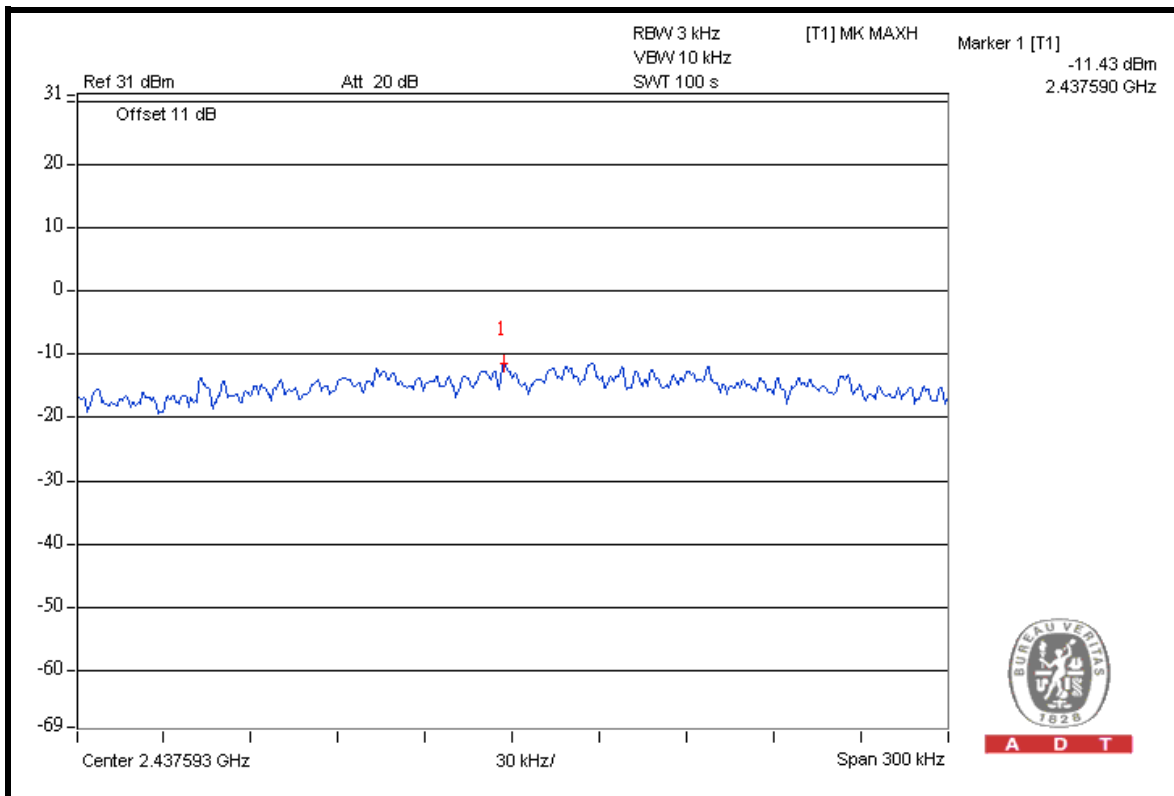



A D T

802.11n (20MHz)

| CHANNEL | CHANNEL FREQUENCY (MHz) | RF POWER LEVEL IN 3 kHz BW (dBm) | MAXIMUM LIMIT (dBm) | PASS/FAIL |
|---------|-------------------------|----------------------------------|---------------------|-----------|
| 1 | 2412 | -12.5 | 8 | PASS |
| 6 | 2437 | -12.1 | 8 | PASS |
| 11 | 2462 | -12.4 | 8 | PASS |

CH 6

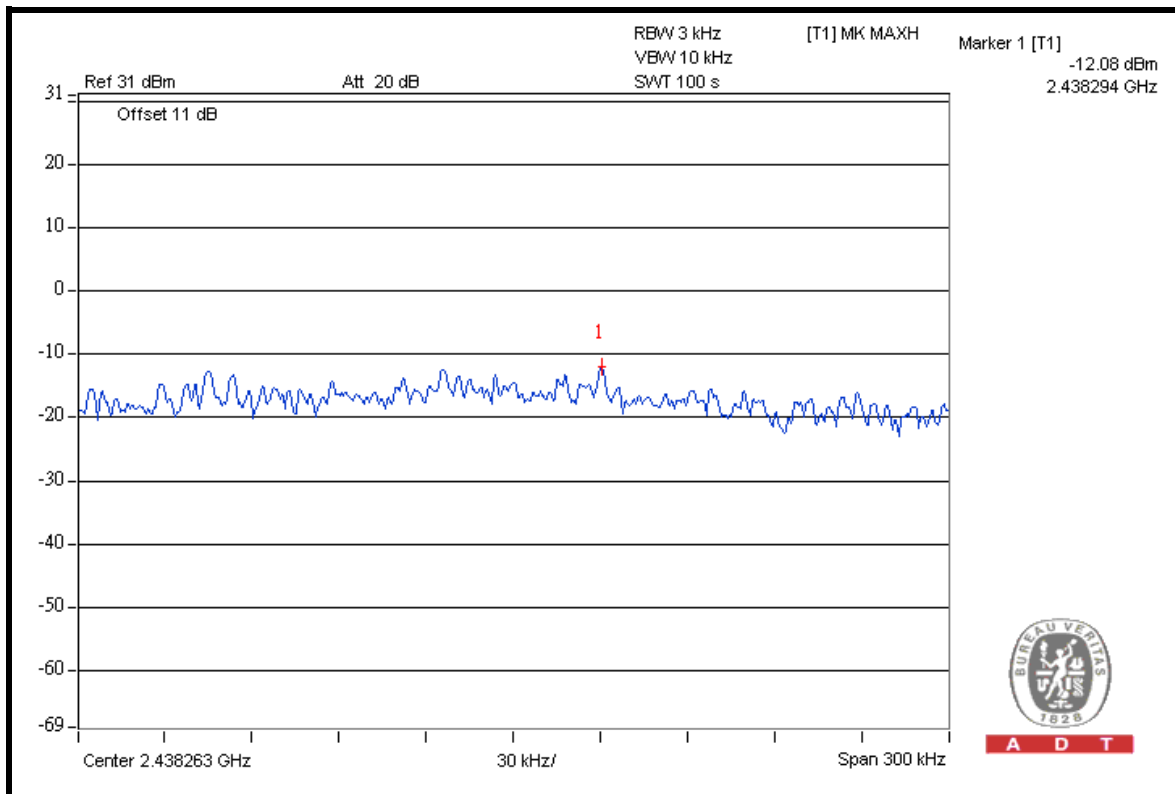

A D T

4.6 BAND EDGES MEASUREMENT

4.6.1 LIMITS OF BAND EDGES MEASUREMENT

Below -20dB of the highest emission level of operating band (in 100kHz Resolution Bandwidth).

4.6.2 TEST INSTRUMENTS

| DESCRIPTION & MANUFACTURER | MODEL NO. | SERIAL NO. | DATE OF CALIBRATION | DUE DATE OF CALIBRATION |
|----------------------------|-----------|------------|---------------------|-------------------------|
| SPECTRUM ANALYZER R&S | FSP40 | 100040 | Jul. 17, 2010 | Jul. 16, 2011 |

NOTE: The calibration interval of the above test instruments is 12 months and the calibrations are traceable to NML/ROC and NIST/USA.

4.6.3 TEST PROCEDURE

The transmitter output was connected to the spectrum analyzer via a low lose cable. Set both RBW and VBW of spectrum analyzer to 100kHz with suitable frequency span including 300kHz bandwidth from band edge. The band edges was measured and recorded.

The spectrum plots (Peak RBW = 100kHz, VBW = 300kHz; Average RBW = 1MHz, VBW = 10Hz) are attached on the following pages.

4.6.4 DEVIATION FROM TEST STANDARD

No deviation.

4.6.5 EUT OPERATING CONDITION

Same as Item 4.3.6.



A D T

4.6.6 TEST RESULTS

The spectrum plots are attached on the following pages. D1 line indicates the highest level, and D2 line indicates the 20dB offset below D1. It shows compliance with the requirement in part 15.247(d).

802.11b

RESTRICT BAND (2310 ~ 2390 MHz)

| FREQUENCY (MHz) | FUNDAMENTAL EMISSION (dBuV/m) | DELTA (dB) | MAXIMUM FIELD STRENGTH IN RESTRICT BAND (dBuV/m) | LIMIT (dBuV/m) |
|-----------------|-------------------------------|------------|--|----------------|
| 2412.00 (PK) | 106.8 | 54.75 | 52.05 | 74.00 |
| 2412.00 (AV) | 103.3 | 58.66 | 44.64 | 54.00 |

RESTRICT BAND (2483.5 ~ 2500 MHz)

| FREQUENCY (MHz) | FUNDAMENTAL EMISSION (dBuV/m) | DELTA (dB) | MAXIMUM FIELD STRENGTH IN RESTRICT BAND (dBuV/m) | LIMIT (dBuV/m) |
|-----------------|-------------------------------|------------|--|----------------|
| 2462.00 (PK) | 106.2 | 53.32 | 52.88 | 74.00 |
| 2462.00 (AV) | 102.6 | 55.81 | 46.79 | 54.00 |

NOTE:

1. Delta = Amplitude between the peak of the fundamental and the peak of the band edge emission. Please check following 3 pages.
2. Maximum field strength in restrict band = Fundamental emission – Delta.



A D T

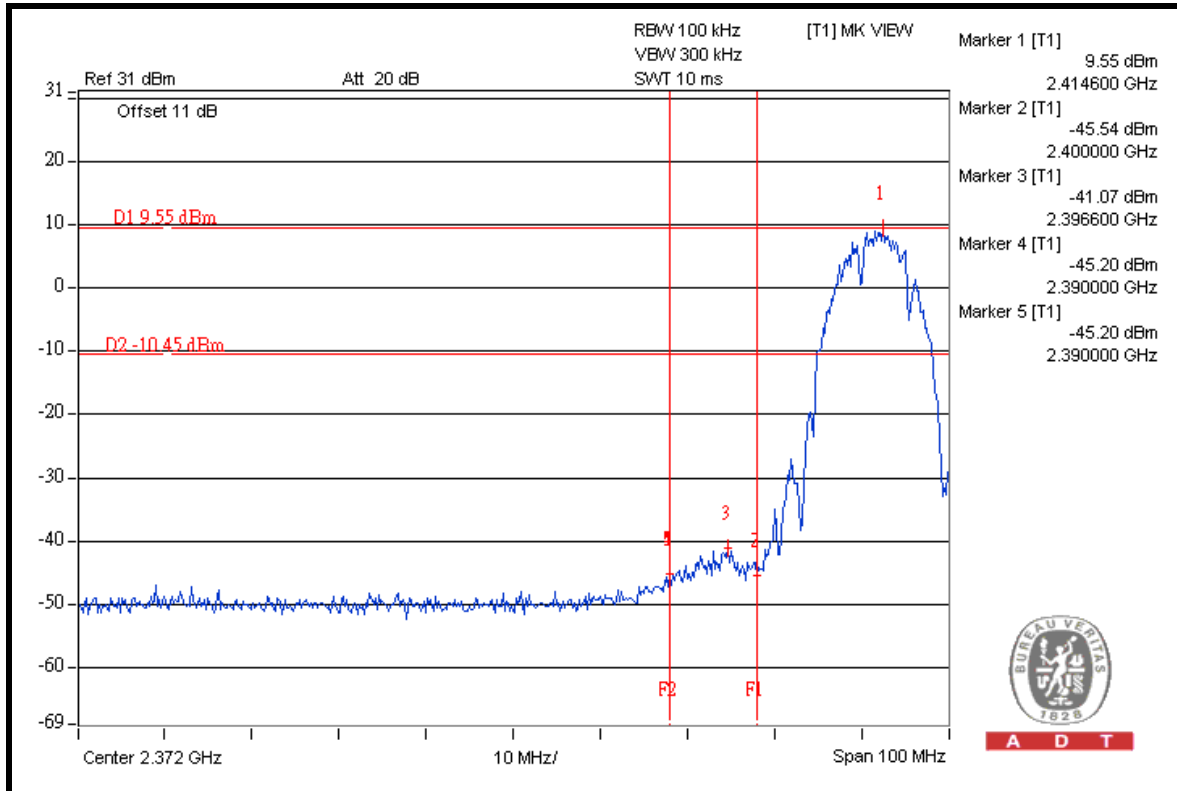

A D T

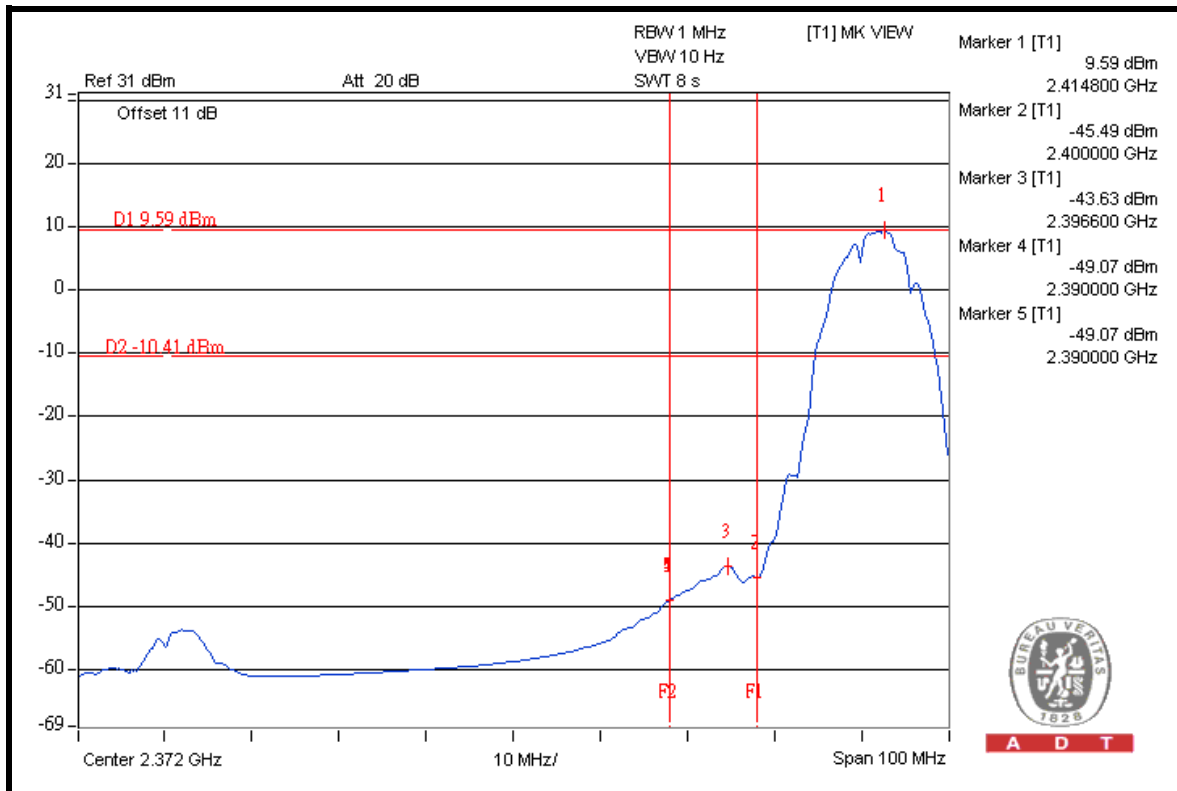

A D T



A D T

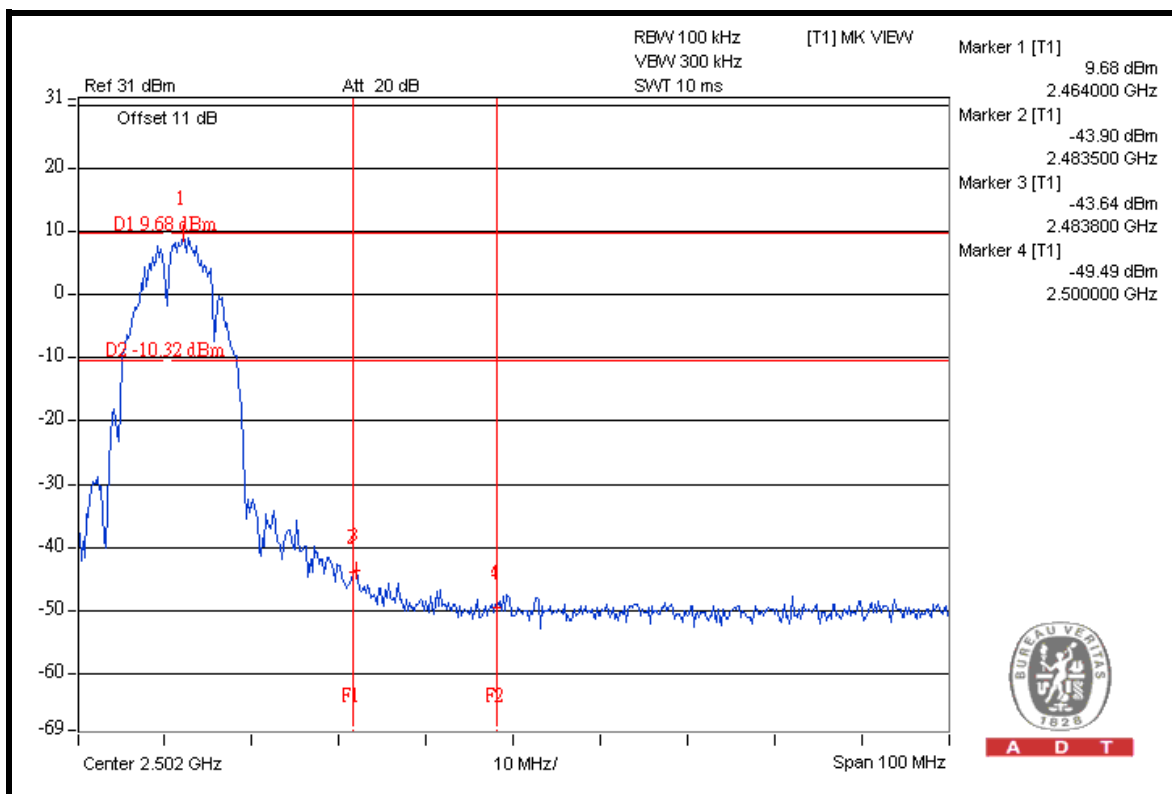
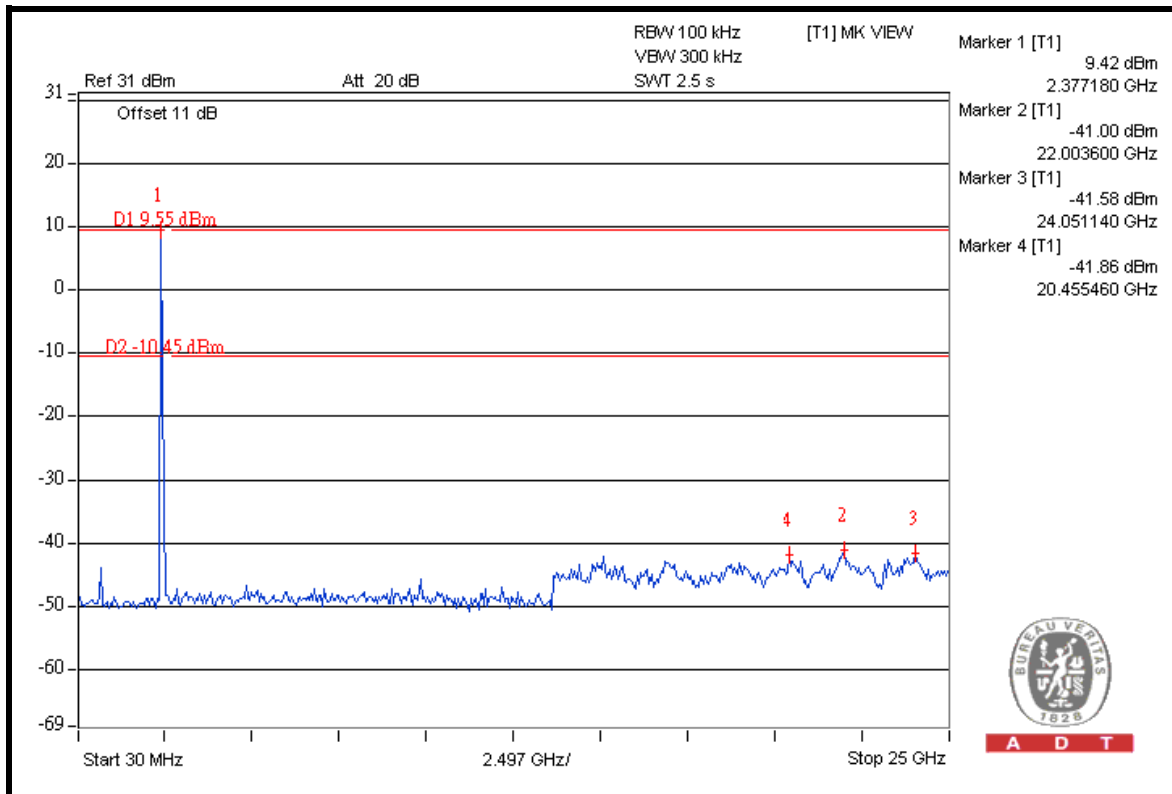



A D T

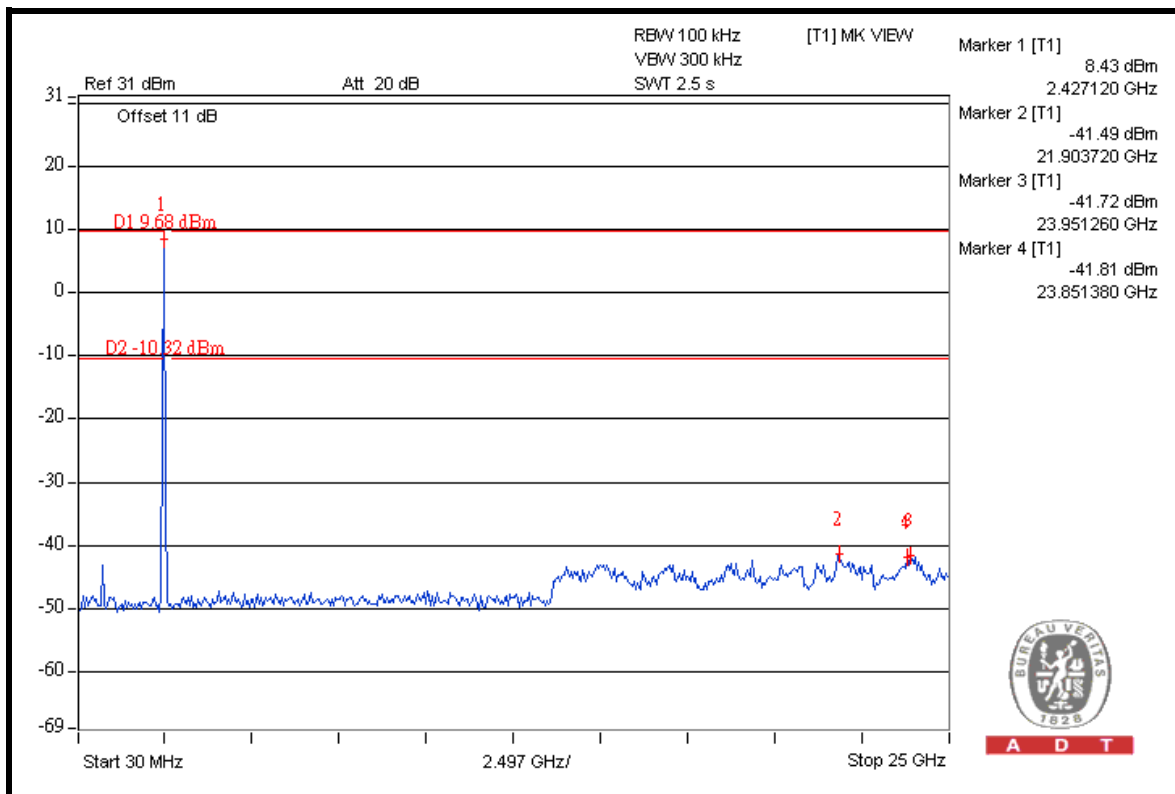
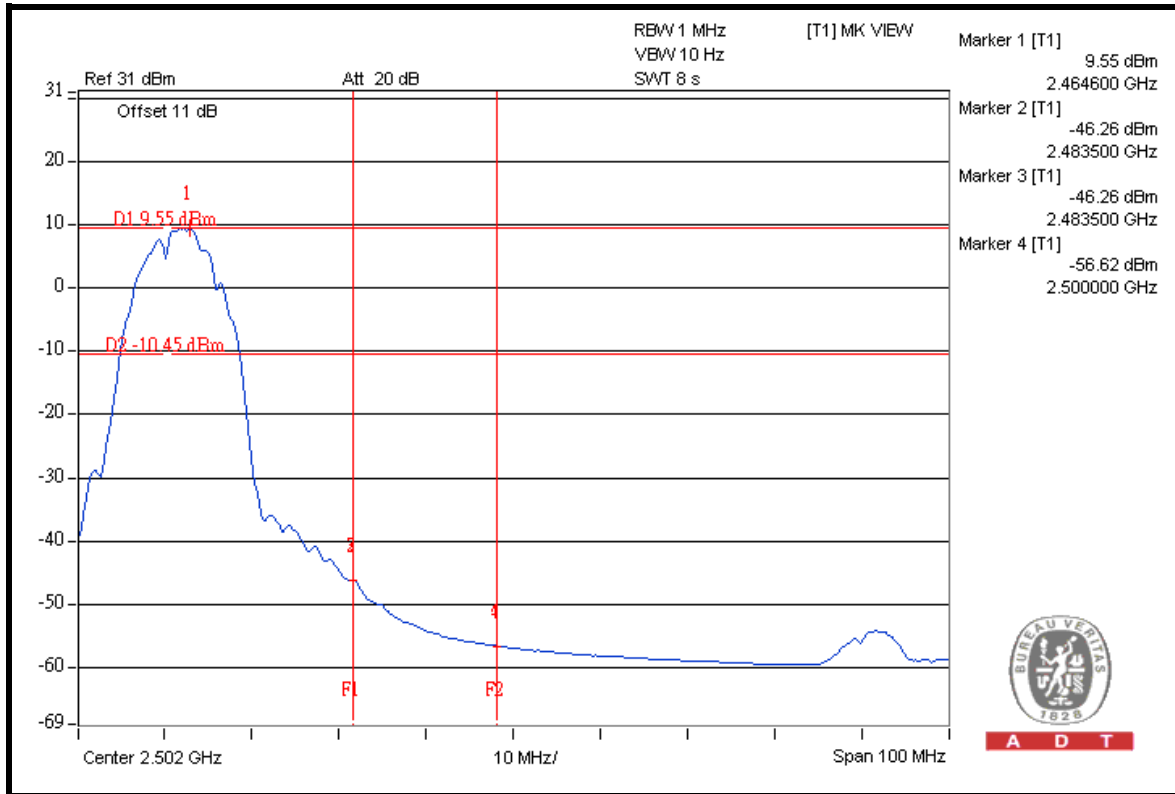



A D T

802.11g

RESTRICT BAND (2310 ~ 2390 MHz)

| FREQUENCY (MHz) | FUNDAMENTAL EMISSION (dBuV/m) | DELTA (dB) | MAXIMUM FIELD STRENGTH IN RESTRICT BAND (dBuV/m) | LIMIT (dBuV/m) |
|-----------------|-------------------------------|------------|--|----------------|
| 2412.00 (PK) | 105.8 | 48.23 | 57.57 | 74.00 |
| 2412.00 (AV) | 92.8 | 46.39 | 46.41 | 54.00 |

RESTRICT BAND (2483.5 ~ 2500 MHz)

| FREQUENCY (MHz) | FUNDAMENTAL EMISSION (dBuV/m) | DELTA (dB) | MAXIMUM FIELD STRENGTH IN RESTRICT BAND (dBuV/m) | LIMIT (dBuV/m) |
|-----------------|-------------------------------|------------|--|----------------|
| 2462.00 (PK) | 105.3 | 48.12 | 57.18 | 74.00 |
| 2462.00 (AV) | 92.2 | 45.83 | 46.37 | 54.00 |

NOTE:

1. Delta = Amplitude between the peak of the fundamental and the peak of the band edge emission. Please check following 3 pages.
2. Maximum field strength in restrict band = Fundamental emission – Delta.



A D T

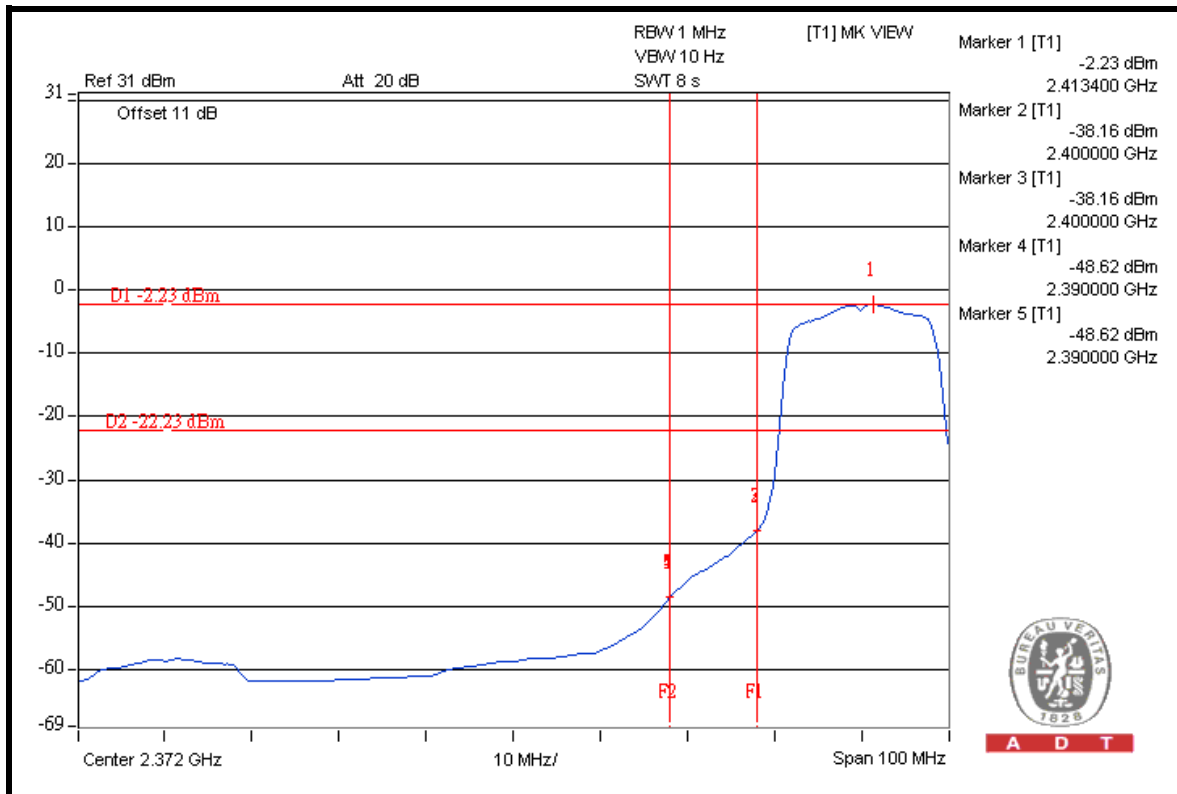
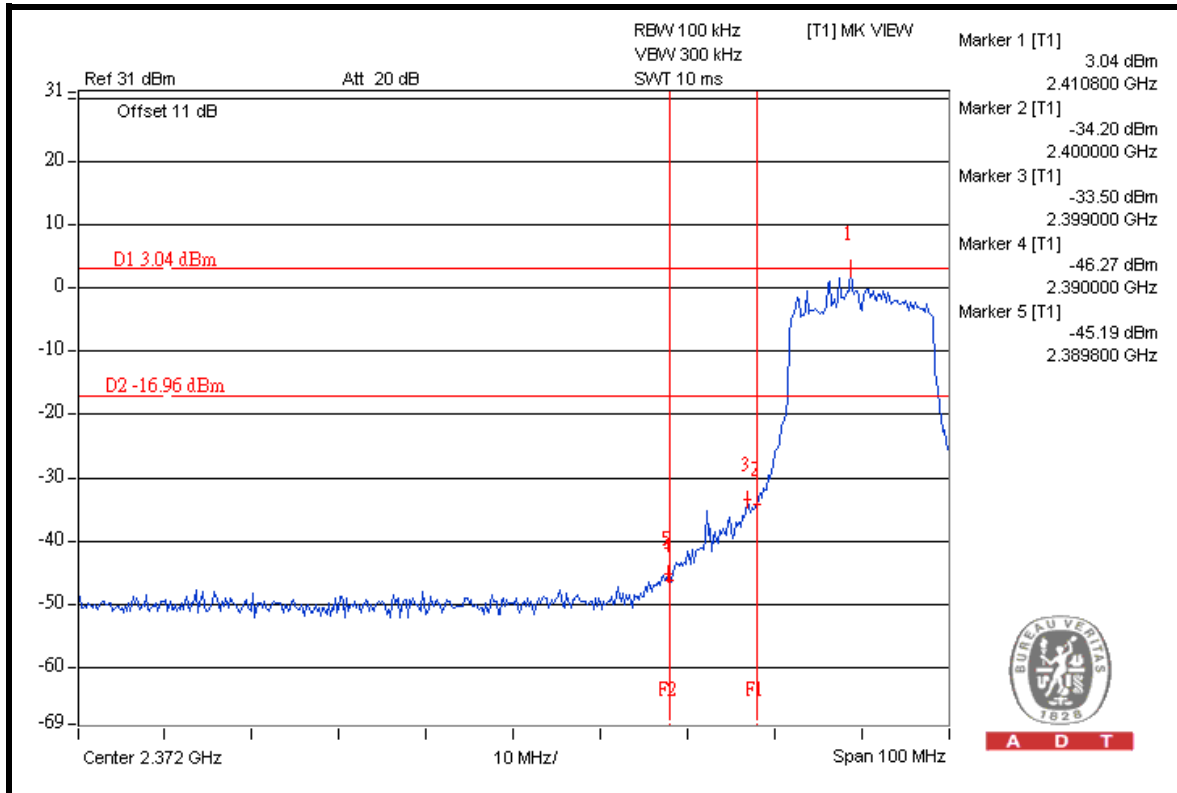



A D T

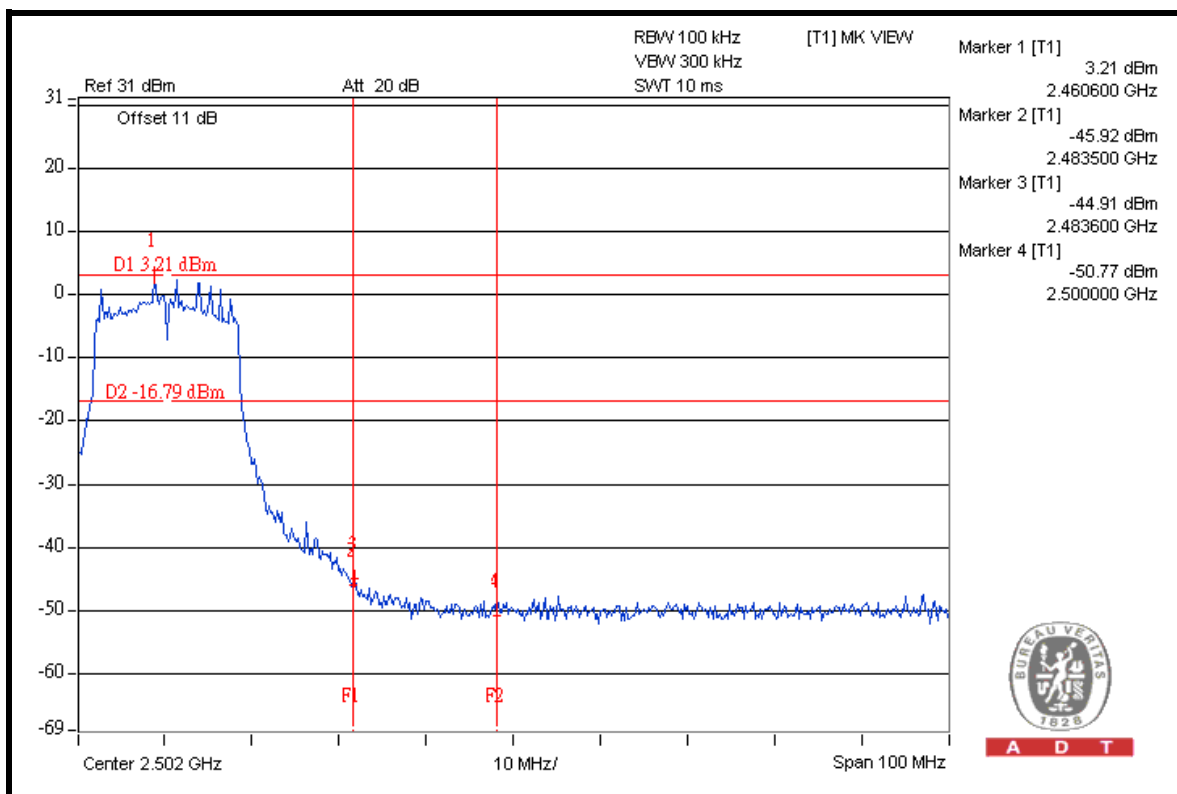
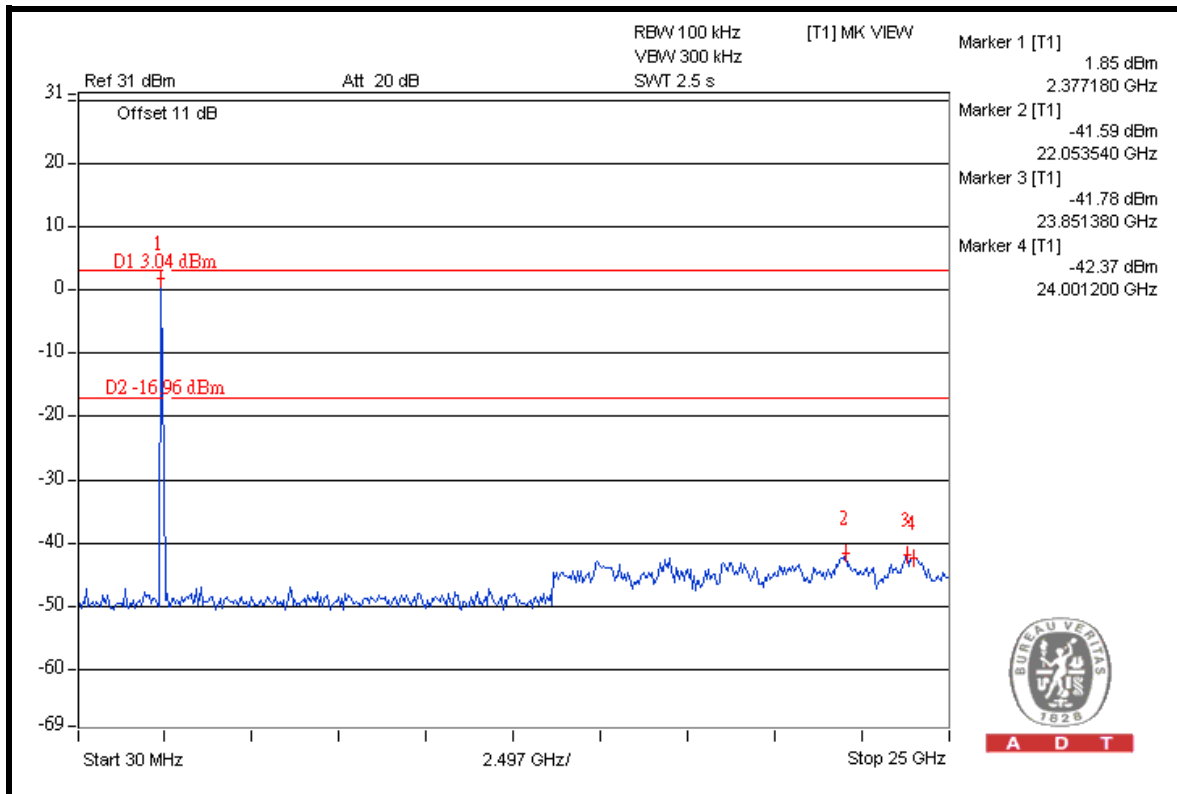



A D T

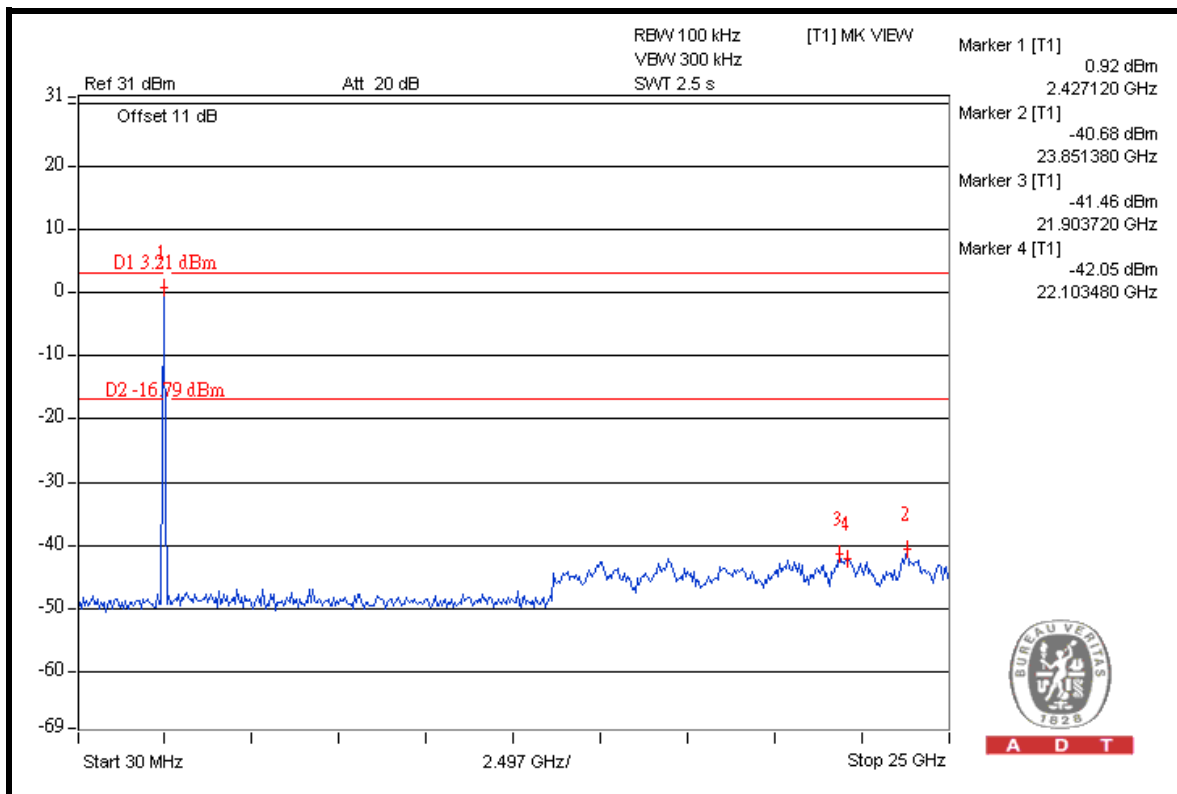
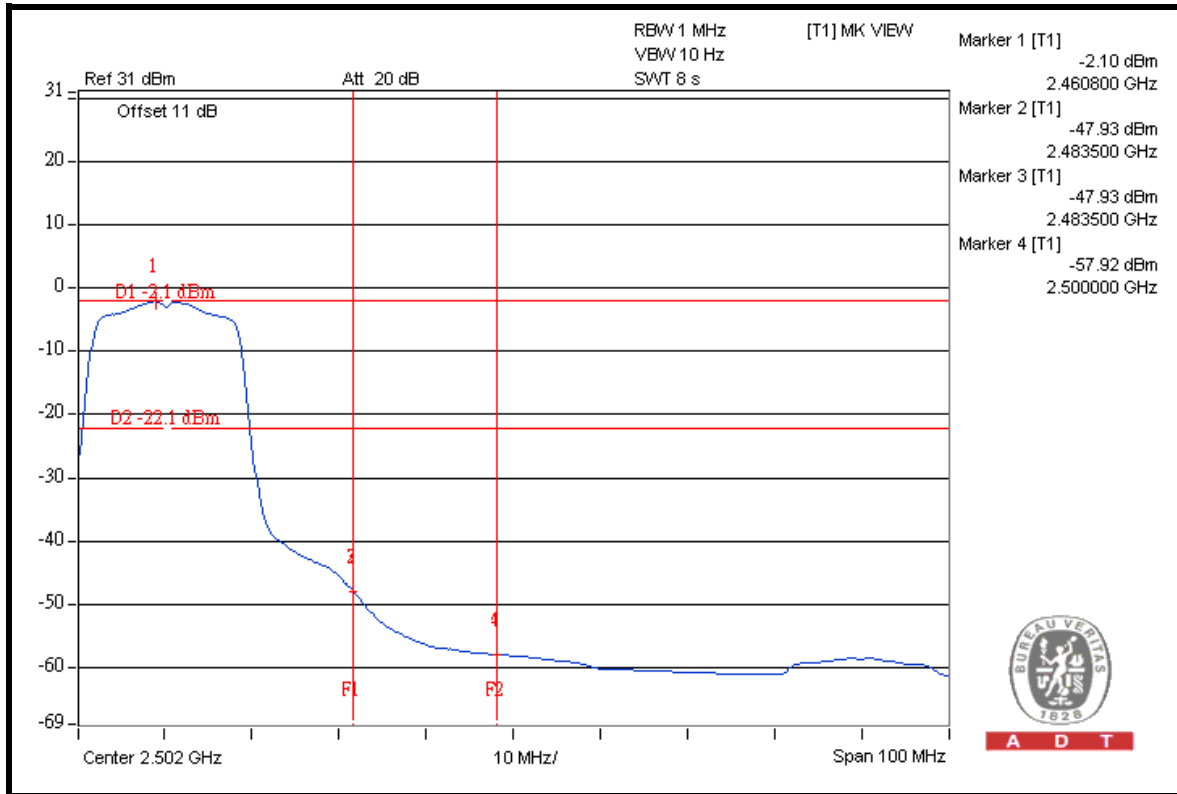



A D T

802.11n (20MHz)

RESTRICT BAND (2310 ~ 2390 MHz)

| FREQUENCY (MHz) | FUNDAMENTAL EMISSION (dBuV/m) | DELTA (dB) | MAXIMUM FIELD STRENGTH IN RESTRICT BAND (dBuV/m) | LIMIT (dBuV/m) |
|-----------------|-------------------------------|------------|--|----------------|
| 2412.00 (PK) | 105.3 | 46.63 | 58.67 | 74.00 |
| 2412.00 (AV) | 92.3 | 45.52 | 46.78 | 54.00 |

RESTRICT BAND (2483.5 ~ 2500 MHz)

| FREQUENCY (MHz) | FUNDAMENTAL EMISSION (dBuV/m) | DELTA (dB) | MAXIMUM FIELD STRENGTH IN RESTRICT BAND (dBuV/m) | LIMIT (dBuV/m) |
|-----------------|-------------------------------|------------|--|----------------|
| 2462.00 (PK) | 104.9 | 46.28 | 58.62 | 74.00 |
| 2462.00 (AV) | 91.8 | 44.68 | 47.12 | 54.00 |

NOTE:

1. Delta = Amplitude between the peak of the fundamental and the peak of the band edge emission. Please check following 2 pages.
2. Maximum field strength in restrict band = Fundamental emission – Delta.



A D T

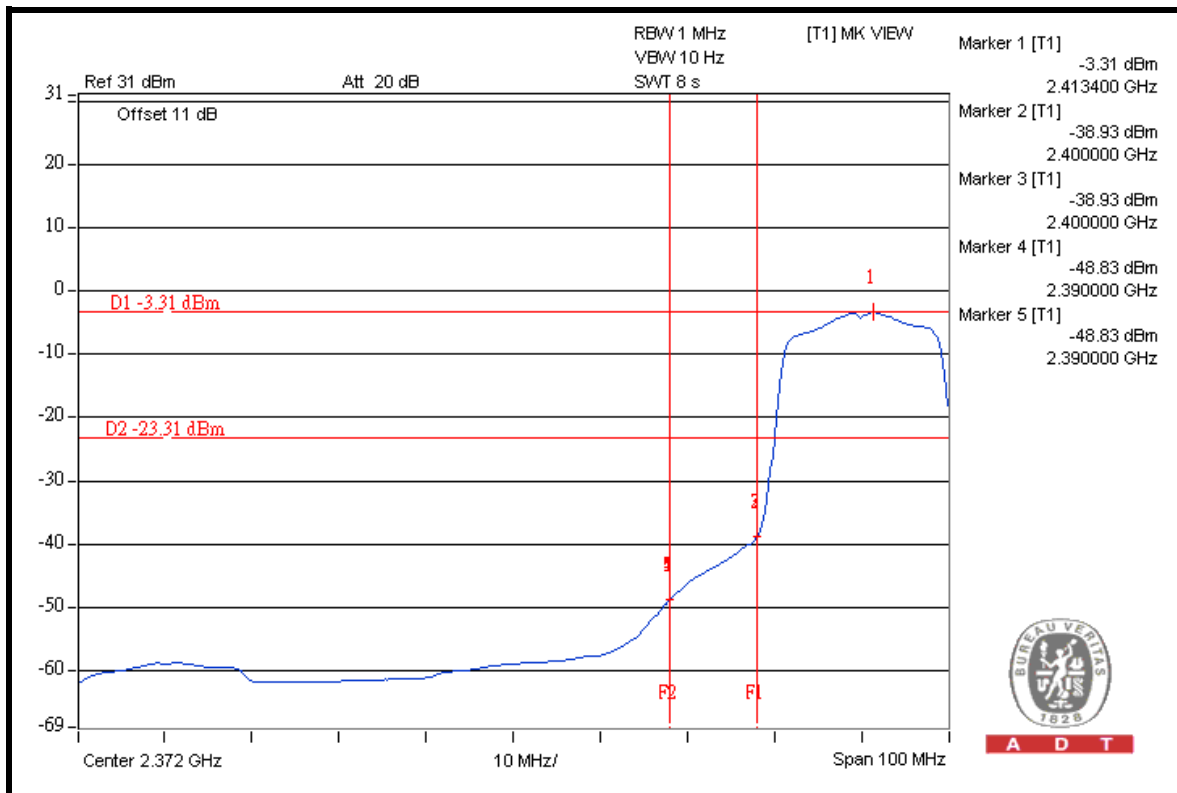
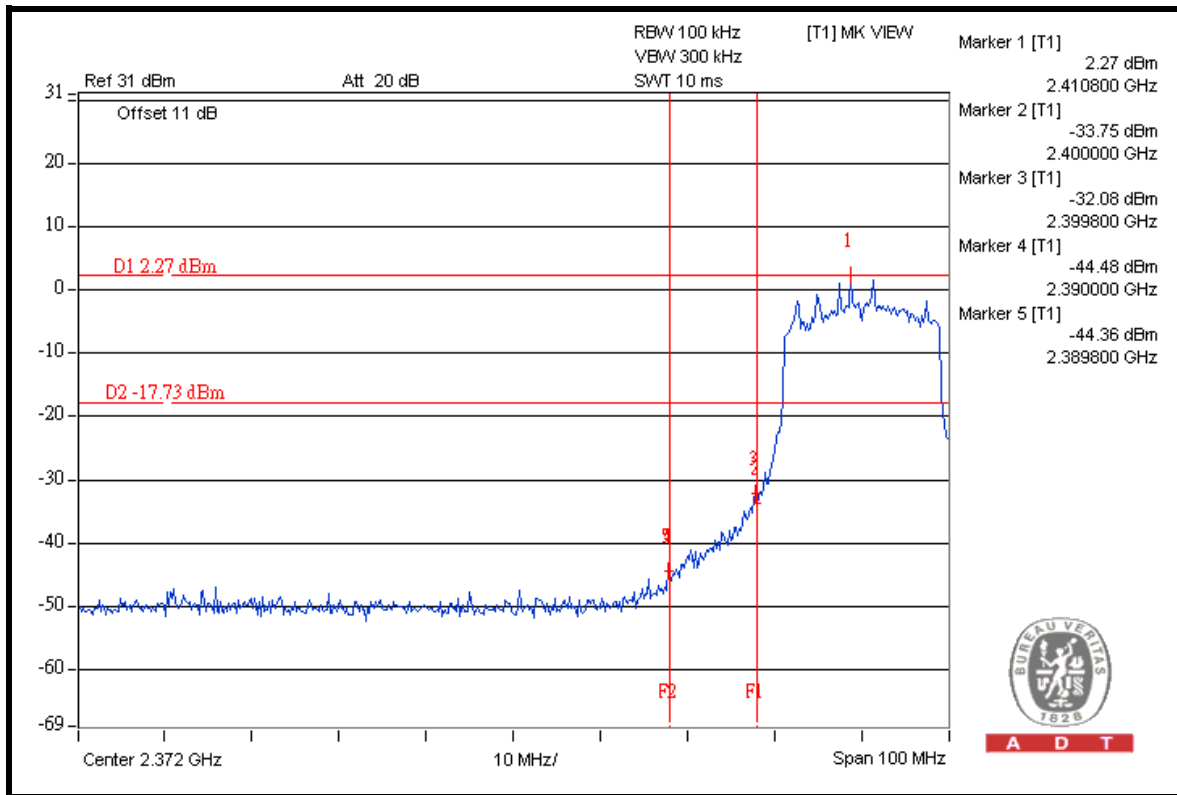



A D T

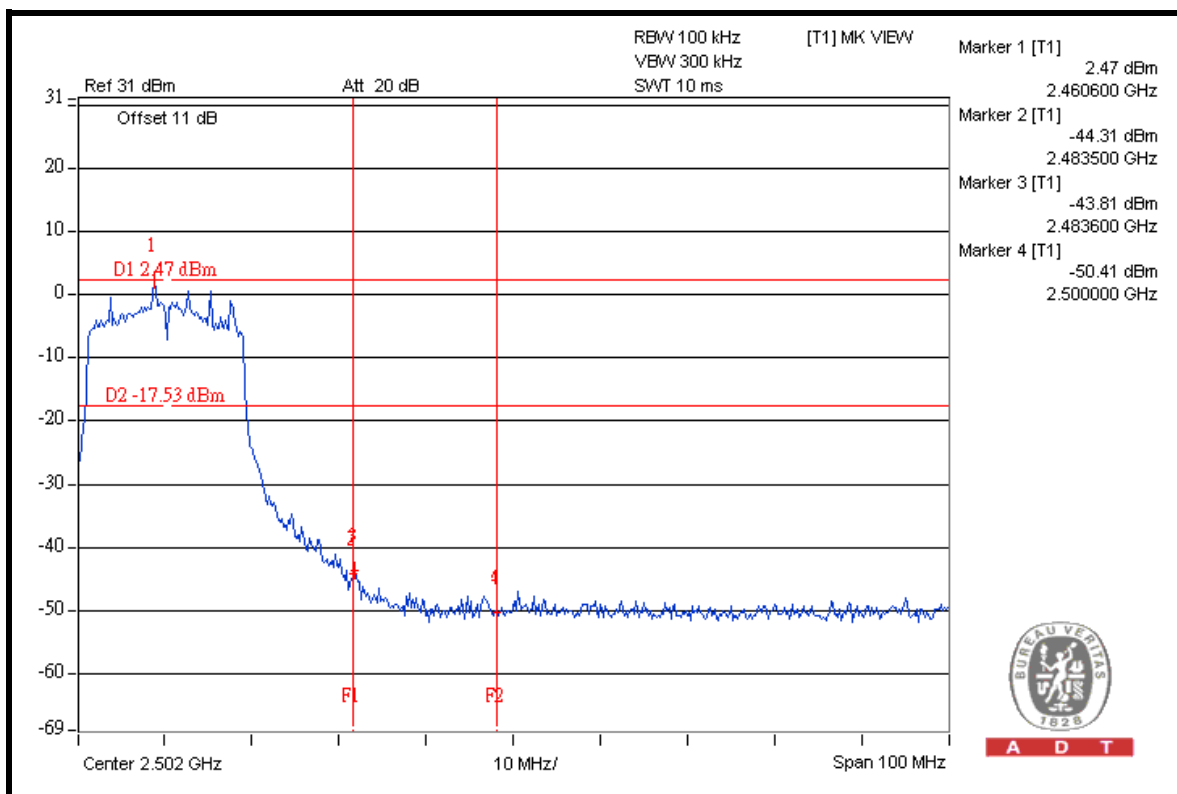
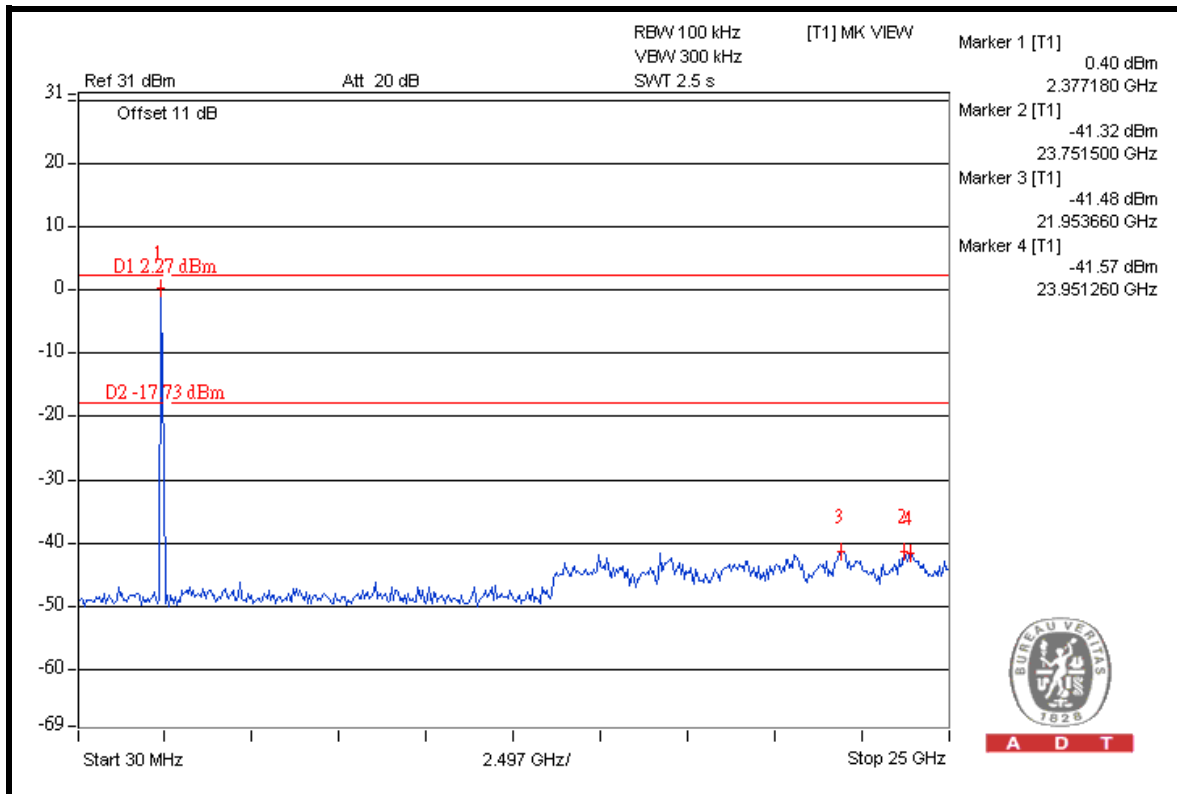



A D T

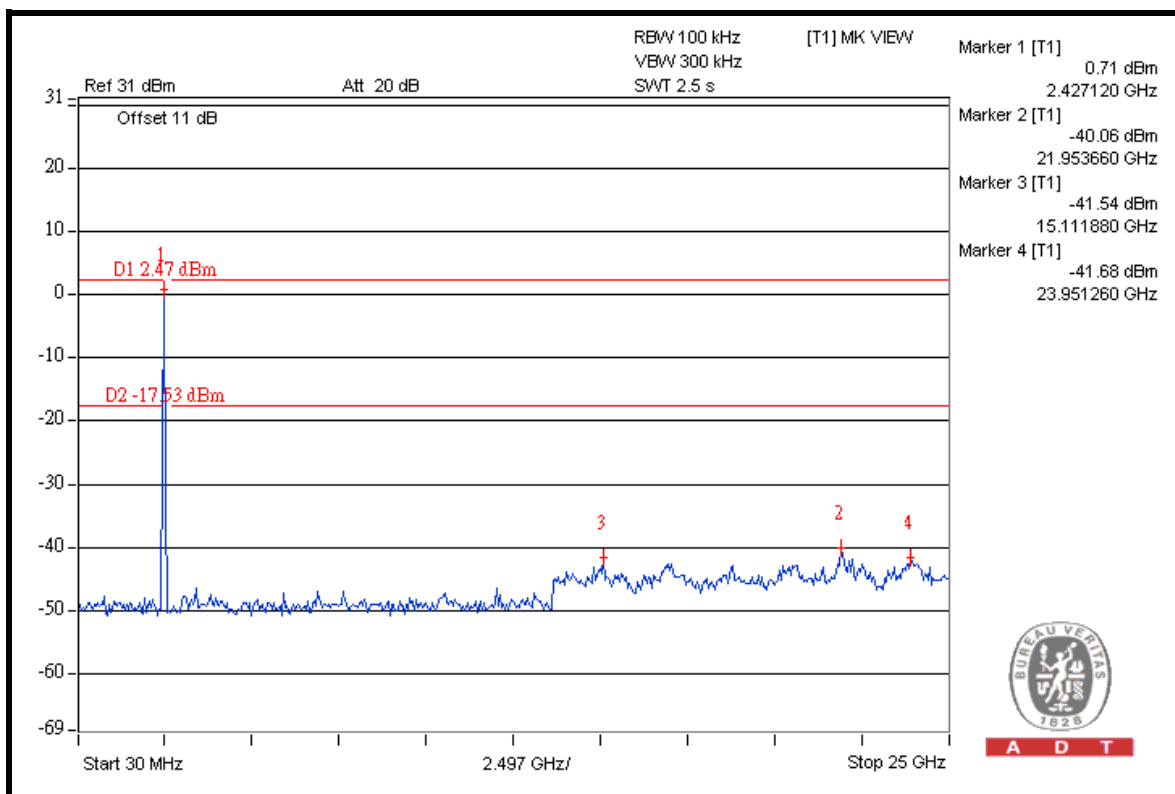
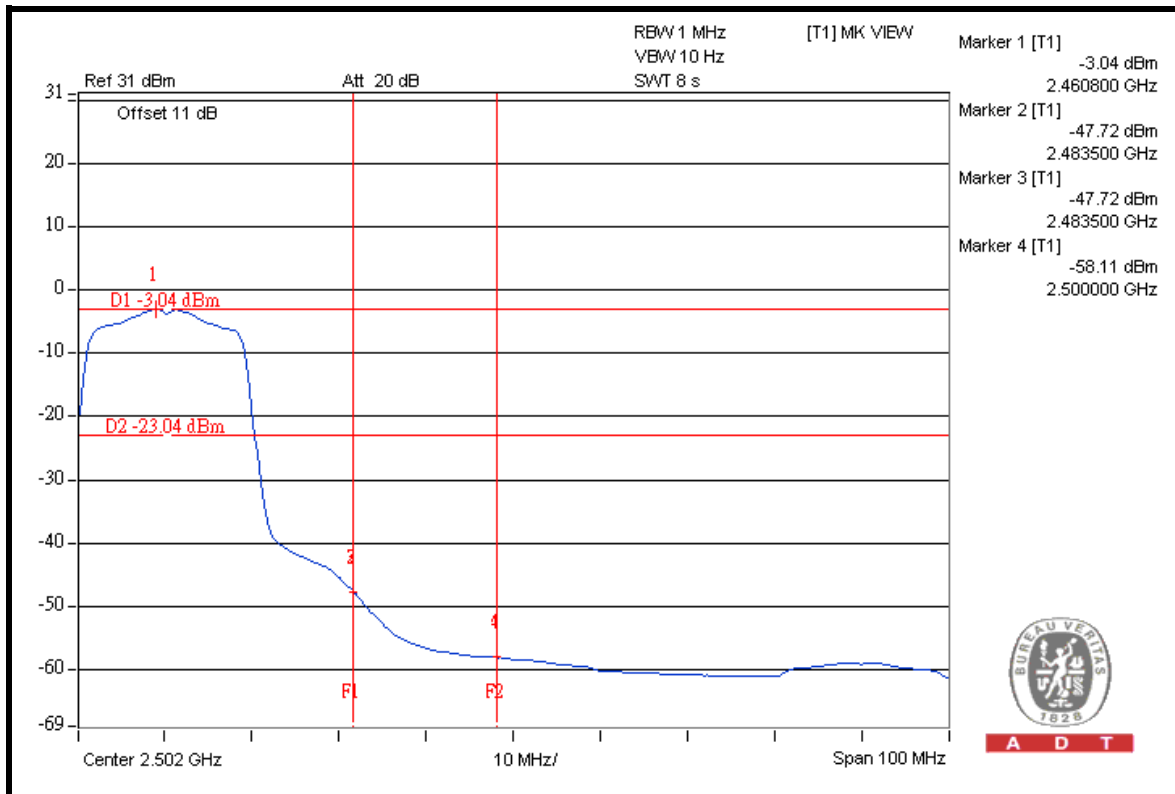



A D T

5. PHOTOGRAPHS OF THE TEST CONFIGURATION

Please refer to the attached file (Test Setup Photo).



A D T

6. INFORMATION ON THE TESTING LABORATORIES

We, Bureau Veritas Consumer Products Services (H.K.) Ltd., Taoyuan Branch, were founded in 1988 to provide our best service in EMC, Radio, Telecom and Safety consultation. Our laboratories are accredited and approved according to ISO/IEC 17025.

Copies of accreditation certificates of our laboratories obtained from approval agencies can be downloaded from our web site: www.adt.com.tw/index.5.phtml. If you have any comments, please feel free to contact us at the following:

Linko EMC/RF Lab:

Tel: 886-2-26052180

Fax: 886-2-26051924

Hsin Chu EMC/RF Lab:

Tel: 886-3-5935343

Fax: 886-3-5935342

Hwa Ya EMC/RF/Safety Telecom Lab:

Tel: 886-3-3183232

Fax: 886-3-3185050

Web Site: www.adt.com.tw

The address and road map of all our labs can be found in our web site also.



A D T

7. APPENDIX A - MODIFICATIONS RECORDERS FOR ENGINEERING CHANGES TO THE EUT BY THE LAB

No any modifications are made to the EUT by the lab during the test.

---END---