

FCC RF Test Report

APPLICANT : HTC Corporation
EQUIPMENT : Smartphone
MODEL NAME : PG58100
FCC ID : NM8PG58100
STANDARD : FCC 47 CFR Part 2, 22(H), 24(E), 27(L)
CLASSIFICATION : PCS Licensed Transmitter Held to Ear (PCE)
Tx/Rx FREQUENCY RANGE : GSM850 : 824.2 ~ 848.8 MHz /
869.2 ~ 893.8 MHz
GSM1900 : 1850.2 ~ 1909.8 MHz /
1930.2 ~ 1989.8 MHz
WCDMA Band IV : 1712.4 MHz ~ 1752.6 MHz
2112.4 MHz ~ 2152.6 MHz

MAX. ERP/EIRP POWER : <Sample 1>
GSM850 (GSM) : 0.43 W
GSM850 (EDGE 8) : 0.13 W
GSM1900 (GSM) : 1.95 W
GSM1900 (EDGE 8) : 0.64 W
WCDMA Band IV (RMC 12.2Kbps) : 0.49 W
<Sample 2>
GSM850 (GSM) : 0.44 W
GSM850 (EDGE 8) : 0.14 W
GSM1900 (GSM) : 1.77 W
GSM1900 (EDGE 8) : 0.64 W
WCDMA Band IV (RMC 12.2Kbps) : 0.50 W

EMISSION DESIGNATOR : GMSK : 248KGXW
8PSK : 244KG7W
QPSK : 4M14F9W

The product was received on Feb. 10, 2011 and completely tested on Apr. 06, 2011. We, SPORTON INTERNATIONAL Inc., would like to declare that the tested sample has been evaluated in accordance with the procedures given in ANSI / TIA / EIA-603-C-2004 and shown compliance with the applicable technical standards.

The test results in this report apply exclusively to the tested model / sample. Without written approval of SPORTON INTERNATIONAL INC., the test report shall not be reproduced except in full.

Reviewed by:

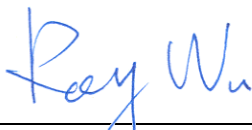

Roy Wu / Manager



SPORTON INTERNATIONAL INC.

No. 52, Hwa Ya 1st Rd., Hwa Ya Technology Park, Kwei-Shan Hsiang, Tao Yuan Hsien, Taiwan, R.O.C.



TABLE OF CONTENTS

REVISION HISTORY.....3

SUMMARY OF TEST RESULT4

1 GENERAL DESCRIPTION.....5

 1.1 Applicant.....5

 1.2 Manufacturer5

 1.3 Feature of Equipment Under Test.....6

 1.4 Testing Site7

 1.5 Applied Standards7

 1.6 Ancillary Equipment List.....7

2 TEST CONFIGURATION OF EQUIPMENT UNDER TEST.....8

 2.1 Test Mode.....8

 2.2 Connection Diagram of Test System10

3 TEST RESULT.....11

 3.1 Conducted Output Power Measurement.....11

 3.2 Effective Radiated Power and Effective Isotropic Radiated Power Measurement13

 3.3 Occupied Bandwidth Measurement20

 3.4 Band Edge Measurement.....26

 3.5 Conducted Emission Measurement32

 3.6 Field Strength of Spurious Radiation Measurement46

 3.7 Frequency Stability Measurement.....64

4 LIST OF MEASURING EQUIPMENTS69

5 UNCERTAINTY OF EVALUATION.....70

APPENDIX A. SETUP PHOTOGRAPHS



REVISION HISTORY

REPORT NO.	VERSION	DESCRIPTION	ISSUED DATE
FG121019	Rev. 01	Initial issue of report	Apr. 18, 2011



SUMMARY OF TEST RESULT

Report Section	FCC Rule	IC Rule	Description	Limit	Result	Remark
3.1	§2.1046	N/A	Conducted Output Power	N/A	PASS	-
3.2	§22.913(a)(2)	RSS-132(4.4) SRSP-503(5.1.3)	Effective Radiated Power	< 7 Watts	PASS	-
3.2	§24.232(c)	RSS-133 (6.4) SRSP-510(5.1.2)	Equivalent Isotropic Radiated Power	< 2 Watts	PASS	-
3.2	§27.50(d)(2)	RSS-139 (6.4) SRSP-513(5.1.2)	Equivalent Isotropic Radiated Power	< 1 Watts	PASS	-
3.3	§2.1049 §22.917(a) §24.238(a) §27.53(g)	N/A	Occupied Bandwidth	N/A	PASS	-
3.4	§2.1051 §22.917(a) §24.238(a) §27.53(g)	RSS-132 (4.5.1) RSS-133 (6.5.1) RSS-139 (6.5)	Band Edge Measurement	< 43+10log ₁₀ (P[Watts])	PASS	-
3.5	§2.1051 §22.917(a) §24.238(a) §27.53(g)	RSS-132 (4.5.1) RSS-133 (6.5.1) RSS-139 (6.5)	Conducted Emission	< 43+10log ₁₀ (P[Watts])	PASS	-
3.6	§2.1053 §22.917(a) §24.238(a) §27.53(g)	RSS-132 (4.5.1) RSS-133 (6.5.1) RSS-139 (6.5)	Field Strength of Spurious Radiation	< 43+10log ₁₀ (P[Watts])	PASS	Under limit 18.57 dB at 2509 MHz
3.7	§2.1055 §22.355 §24.235 §27.54	RSS-132 (4.3) RSS-133 (6.3) RSS-139 (6.3)	Frequency Stability for Temperature & Voltage	< 2.5 ppm	PASS	-



1 General Description

1.1 Applicant

HTC Corporation

No. 23, Xinghua Rd., Taoyuan City, Taoyuan County 330, Taiwan

1.2 Manufacturer

HTC Corporation

No. 23, Xinghua Rd., Taoyuan City, Taoyuan County 330, Taiwan

1.3 Feature of Equipment Under Test

Product Feature & Specification	
Equipment	Smartphone
Model Name	PG58100
FCC ID	NM8PG58100
Sample 1	EUT with LCM-Main, Camera-Main and Video Camera 1
Sample 2	EUT with LCM-2 nd , Camera-2 nd and Video Camera 2
Tx Frequency	GSM850 : 824 MHz ~ 849 MHz GSM1900 : 1850 MHz ~ 1910 MHz WCDMA Band IV : 1710 MHz ~ 1755 MHz
Rx Frequency	GSM850 : 869 MHz ~ 894 MHz GSM1900 : 1930 MHz ~ 1990 MHz WCDMA Band IV : 2110 MHz ~ 2155 MHz
Maximum Output Power to Antenna	GSM850 : 33.33 dBm GSM1900 : 29.99 dBm WCDMA Band IV : 23.55 dBm
Maximum ERP/EIRP	<p><Sample 1> GSM850 (GSM) : 0.43 W (26.36 dBm) GSM850 (EDGE 8) : 0.13 W (21.18 dBm) GSM1900 (GSM) : 1.95 W (32.90 dBm) GSM1900 (EDGE 8) : 0.64 W (28.07 dBm) WCDMA Band IV (RMC 12.2Kbps) : 0.49 W (26.91 dBm)</p> <p><Sample 2> GSM850 (GSM) : 0.44 W (26.40 dBm) GSM850 (EDGE 8) : 0.14 W (21.32 dBm) GSM1900 (GSM) : 1.77 W (32.48 dBm) GSM1900 (EDGE 8) : 0.64 W (28.08 dBm) WCDMA Band IV (RMC 12.2Kbps) : 0.50 W (26.97 dBm)</p>
Antenna Type	Fixed Internal Antenna
Type of Modulation	GSM / GPRS : GMSK EDGE : 8PSK WCDMA : QPSK HSDPA : QPSK / 16QAM HSUPA : BPSK
Type of Emission	GMSK : 248KGXW 8PSK : 244KG7W QPSK : 4M14F9W
EUT Stage	Identical Prototype

Remark:

1. For other wireless features of this EUT, the test report will be issued separately.
2. This test report recorded only product characteristics and test results of PCS Licensed Transmitter Held to Ear (PCE).
3. The above EUT's information was declared by manufacturer. Please refer to the specifications or user's manual for more detailed description.

1.4 Testing Site

Test Site	SPORTON INTERNATIONAL INC.		
Test Site Location	No. 52, Hwa Ya 1 st Rd., Hwa Ya Technology Park, Kwei-Shan Hsiang, Tao Yuan Hsien, Taiwan, R.O.C. TEL: +886-3-327-3456 FAX: +886-3-328-4978		
Test Site No.	Sporton Site No.		FCC/IC Registration No.
	TH02-HY	03CH07-HY	722060/4086B-1

1.5 Applied Standards

According to the specifications of the manufacturer, the EUT must comply with the requirements of the following standards:

- ♦ Preliminary Guidance for Receiving Applications for Certification of 3G Device. May 9, 2006.
- ♦ 47 CFR Part 2, 22(H), 24(E), 27(L)
- ♦ ANSI / TIA / EIA-603-C-2004
- ♦ IC RSS-132 Issue 2
- ♦ IC RSS-133 Issue 5
- ♦ IC RSS-139 Issue 2

Remark:

1. All test items were verified and recorded according to the standards and without any deviation during the test.
2. This EUT has also been tested and complied with the requirements of FCC Part 15, Subpart B (DoC), recorded in a separate test report.

1.6 Ancillary Equipment List

Item	Equipment	Trade Name	Model No.	FCC ID	Data Cable	Power Cord
1.	System Simulator	R&S	CMU200	N/A	N/A	Unshielded, 1.8 m

2 Test Configuration of Equipment Under Test

2.1 Test Mode

During all testing, EUT is in link mode with base station emulator at maximum power level. The spurious emission measurements were carried out in semi-anechoic chamber with 3-meter test range, and EUT is rotated on three test planes to find out the worst emission.

Frequency range investigated for radiated emission is as follows:

1. 30 MHz to 9000 MHz for GSM850.
2. 30 MHz to 18000 MHz for WCDMA Band IV.
3. 30 MHz to 19000 MHz for GSM1900.

Test Modes		
Band	Radiated TCs	Conducted TCs
GSM 850	<ul style="list-style-type: none"> ■ GSM Link for Sample 1 ■ EDGE 8 Link for Sample 1 ■ GSM Link for Sample 2 	<ul style="list-style-type: none"> ■ GSM Link ■ EDGE 8 Link
GSM 1900	<ul style="list-style-type: none"> ■ GSM Link for Sample 1 ■ EDGE 8 Link for Sample 1 ■ GSM Link for Sample 2 	<ul style="list-style-type: none"> ■ GSM Link ■ EDGE 8 Link
WCDMA Band IV	<ul style="list-style-type: none"> ■ RMC 12.2Kbps Link for Sample 1 ■ RMC 12.2Kbps Link for Sample 2 	<ul style="list-style-type: none"> ■ RMC 12.2Kbps Link

Note:

1. The Radiated TCs test was performed together with USB Cable 2 (Charging from Adapter 2), Battery 2 and Earphone 2.
2. The maximum power levels are GSM mode for GMSK link, EDGE multi-slot class 8 mode for 8PSK link, and RMC 12.2Kbps mode for WCDMA band IV, only these modes were used for all tests.
3. Because there are individual antennas for each WWAN, WLAN, and Bluetooth, the co-location test modes are not required.



The conducted power tables are as follows:

Conducted Power (*Unit: dBm)						
Band	GSM850			GSM1900		
Channel	128	189	251	512	661	810
Frequency	824.2	836.4	848.8	1850.2	1880	1909.8
GSM	33.18	33.23	33.33	29.86	29.89	29.99
GPRS 8	33.05	33.17	33.20	29.76	29.84	29.99
GPRS 10	32.48	32.52	32.59	29.47	29.56	29.48
EGPRS 8	26.44	26.48	26.48	25.74	25.76	25.72
EGPRS 10	25.16	25.31	25.42	24.72	24.73	24.67

Conducted Power (*Unit: dBm)			
Band	WCDMA Band IV		
Tx Channel	1312	1413	1513
Rx Channel	1537	1638	1738
Frequency	1712.4	1732.6	1752.6
RMC 12.2K	23.23	23.55	23.33
HSDPA Subtest-1	22.84	23.08	23.17
HSDPA Subtest-2	22.86	23.05	23.04
HSDPA Subtest-3	22.38	22.68	22.62
HSDPA Subtest-4	21.98	22.69	22.33
HSUPA Subtest-1	22.13	22.52	22.68
HSUPA Subtest-2	21.24	21.44	21.51
HSUPA Subtest-3	21.74	21.61	21.82
HSUPA Subtest-4	21.48	21.81	21.91
HSUPA Subtest-5	22.83	22.34	22.81

2.2 Connection Diagram of Test System

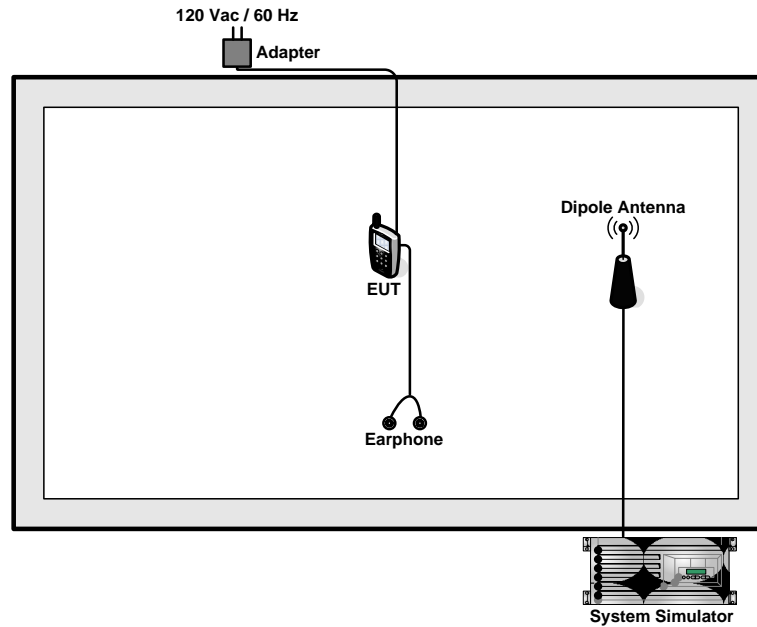

3 Test Result

3.1 Conducted Output Power Measurement

3.1.1 Description of the Conducted Output Power Measurement

A base station simulator was used to establish communication with the EUT. Its parameters were set to transmit the maximum power on the EUT. The measured power in the radio frequency on the transmitter output terminals shall be reported.

3.1.2 Measuring Instruments

See list of measuring instruments of this test report.

3.1.3 Test Procedures

1. The transmitter output port was connected to base station.
2. Set EUT at maximum power through base station.
3. Select lowest, middle, and highest channels for each band and different modulation.

3.1.4 Test Setup

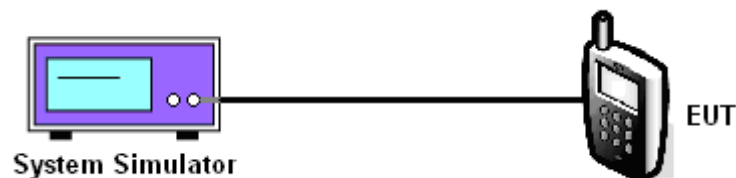

3.1.5 Test Result of Conducted Output Power

Cellular Band				
Modes	Channel	Frequency (MHz)	Conducted Power (dBm)	Conducted Power (Watts)
GSM850 (GSM)	128 (Low)	824.2	33.18	2.08
	189 (Mid)	836.4	33.23	2.10
	251 (High)	848.8	33.33	2.15
GSM850 (EDGE 8)	128 (Low)	824.2	26.44	0.44
	189 (Mid)	836.4	26.48	0.44
	251 (High)	848.8	26.48	0.44

PCS Band				
Modes	Channel	Frequency (MHz)	Conducted Power (dBm)	Conducted Power (Watts)
GSM1900 (GSM)	512 (Low)	1850.2	29.86	0.97
	661 (Mid)	1880.0	29.89	0.97
	810 (High)	1909.8	29.99	1.00
GSM1900 (EDGE 8)	512 (Low)	1850.2	25.74	0.37
	661 (Mid)	1880.0	25.76	0.38
	810 (High)	1909.8	25.72	0.37

AWS Band				
Modes	Channel	Frequency (MHz)	Conducted Power (dBm)	Conducted Power (Watts)
WCDMA Band IV (RMC 12.2Kbps)	1312 (Low)	1712.4	23.23	0.21
	1413 (Mid)	1732.6	23.55	0.23
	1513 (High)	1752.6	23.33	0.22



3.2 Effective Radiated Power and Effective Isotropic Radiated Power Measurement

3.2.1 Description of the ERP/EIRP Measurement

ERP/EIRP is measured by substitution method according to ANSI / TIA / EIA-603-C-2004. The ERP of mobile transmitters must not exceed 7 Watts. The EIRP of mobile transmitters are limited to 2 Watts for 1850~1910 MHz and 1 watt for 1710~1755 MHz.

3.2.2 Measuring Instruments

See list of measuring instruments of this test report.

3.2.3 Test Procedures

1. The EUT was placed on a turntable with 1.0 meter height in a fully anechoic chamber.
2. The EUT was set at 1.2 meters from the receiving antenna, which was mounted on the antenna tower.
3. The table was rotated 360 degrees to determine the position of the highest radiated power.
4. The height of the receiving antenna is adjusted to look for the maximum ERP/EIRP.
5. Taking the record of maximum ERP/EIRP.
6. A dipole antenna was substituted in place of the EUT and was driven by a signal generator.
7. The conducted power at the terminal of the dipole antenna is measured.
8. Repeat step 3 to step 5 to get the maximum ERP/EIRP of the substitution antenna.
9. $ERP/EIRP = P_s + E_t - E_s + G_s = P_s + R_t - R_s + G_s$

P_s (dBm) : Input power to substitution antenna.

G_s (dBi or dBd) : Substitution antenna Gain.

$E_t = R_t + AF$

$E_s = R_s + AF$

AF (dB/m) : Receive antenna factor

R_t : The highest received signal in spectrum analyzer for EUT.

R_s : The highest received signal in spectrum analyzer for substitution antenna.

3.2.4 Test Setup

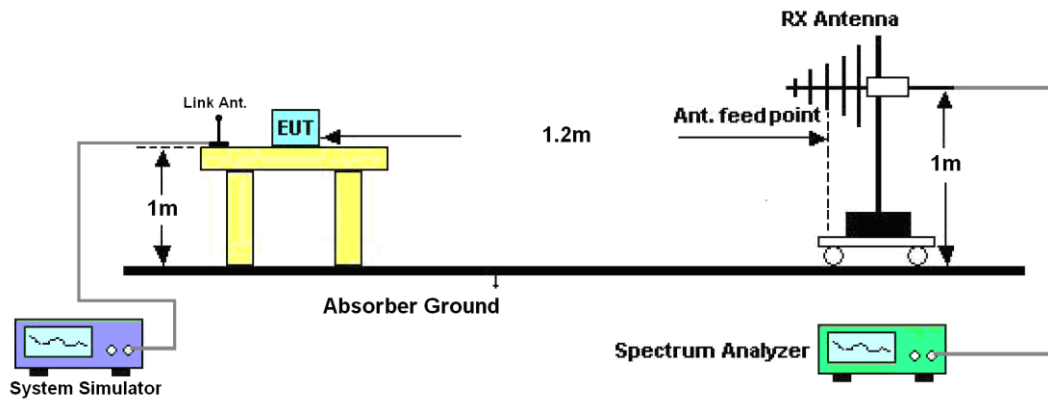



3.2.5 Test Result of ERP

GSM850 (GSM) Radiated Power ERP for Sample 1						
Horizontal Polarization						
Frequency (MHz)	Rt (dBm)	Rs (dBm)	Ps (dBm)	Gs (dBd)	ERP (dBm)	ERP (W)
824.20	-22.38	-48.12	0.00	-1.08	24.66	0.29
836.40	-21.95	-48.28	0.00	-0.93	25.40	0.35
848.80	-21.23	-48.35	0.00	-0.76	26.36	0.43
Vertical Polarization						
Frequency (MHz)	Rt (dBm)	Rs (dBm)	Ps (dBm)	Gs (dBd)	ERP (dBm)	ERP (W)
824.20	-37.55	-47.97	0.00	-1.08	9.34	0.01
836.40	-36.95	-48.01	0.00	-0.93	10.13	0.01
848.80	-35.91	-48.05	0.00	-0.76	11.38	0.01

GSM850 (GSM) Radiated Power ERP for Sample 2						
Horizontal Polarization						
Frequency (MHz)	Rt (dBm)	Rs (dBm)	Ps (dBm)	Gs (dBd)	ERP (dBm)	ERP (W)
824.20	-22.33	-48.12	0.00	-1.08	24.71	0.30
836.40	-22.08	-48.28	0.00	-0.93	25.27	0.34
848.80	-21.19	-48.35	0.00	-0.76	26.40	0.44
Vertical Polarization						
Frequency (MHz)	Rt (dBm)	Rs (dBm)	Ps (dBm)	Gs (dBd)	ERP (dBm)	ERP (W)
824.20	-37.78	-47.97	0.00	-1.08	9.11	0.01
836.40	-37.00	-48.01	0.00	-0.93	10.08	0.01
848.80	-35.07	-48.05	0.00	-0.76	12.22	0.02



GSM850 (EDGE 8) Radiated Power ERP for Sample 1						
Horizontal Polarization						
Frequency (MHz)	Rt (dBm)	Rs (dBm)	Ps (dBm)	Gs (dBd)	ERP (dBm)	ERP (W)
824.20	-26.98	-48.12	0.00	-1.08	20.06	0.10
836.40	-26.83	-48.28	0.00	-0.93	20.52	0.11
848.80	-26.41	-48.35	0.00	-0.76	21.18	0.13
Vertical Polarization						
Frequency (MHz)	Rt (dBm)	Rs (dBm)	Ps (dBm)	Gs (dBd)	ERP (dBm)	ERP (W)
824.20	-42.79	-47.97	0.00	-1.08	4.10	0.00
836.40	-42.45	-48.01	0.00	-0.93	4.63	0.00
848.80	-41.62	-48.05	0.00	-0.76	5.67	0.00

GSM850 (EDGE 8) Radiated Power ERP for Sample 2						
Horizontal Polarization						
Frequency (MHz)	Rt (dBm)	Rs (dBm)	Ps (dBm)	Gs (dBd)	ERP (dBm)	ERP (W)
824.20	-26.87	-48.12	0.00	-1.08	20.17	0.10
836.40	-26.15	-48.28	0.00	-0.93	21.20	0.13
848.80	-26.27	-48.35	0.00	-0.76	21.32	0.14
Vertical Polarization						
Frequency (MHz)	Rt (dBm)	Rs (dBm)	Ps (dBm)	Gs (dBd)	ERP (dBm)	ERP (W)
824.20	-42.75	-47.97	0.00	-1.08	4.14	0.00
836.40	-41.33	-48.01	0.00	-0.93	5.75	0.00
848.80	-39.84	-48.05	0.00	-0.76	7.45	0.01



3.2.6 Test Result of EIRP

GSM1900 (GSM) Radiated Power EIRP for Sample 1						
Horizontal Polarization						
Frequency (MHz)	Rt (dBm)	Rs (dBm)	Ps (dBm)	Gs (dBi)	EIRP (dBm)	EIRP (W)
1850.20	-22.30	-51.88	0.00	1.96	31.54	1.43
1880.00	-23.00	-52.99	0.00	2.00	31.99	1.58
1909.80	-23.84	-54.28	0.00	1.98	32.42	1.75
Vertical Polarization						
Frequency (MHz)	Rt (dBm)	Rs (dBm)	Ps (dBm)	Gs (dBi)	EIRP (dBm)	EIRP (W)
1850.20	-23.10	-52.13	0.00	1.96	30.99	1.26
1880.00	-23.43	-53.17	0.00	2.00	31.74	1.49
1909.80	-23.21	-54.13	0.00	1.98	32.90	1.95

GSM1900 (GSM) Radiated Power EIRP for Sample 2						
Horizontal Polarization						
Frequency (MHz)	Rt (dBm)	Rs (dBm)	Ps (dBm)	Gs (dBi)	EIRP (dBm)	EIRP (W)
1850.20	-22.35	-51.88	0.00	1.96	31.49	1.41
1880.00	-23.91	-52.99	0.00	2.00	31.08	1.28
1909.80	-24.56	-54.28	0.00	1.98	31.70	1.48
Vertical Polarization						
Frequency (MHz)	Rt (dBm)	Rs (dBm)	Ps (dBm)	Gs (dBi)	EIRP (dBm)	EIRP (W)
1850.20	-22.89	-52.13	0.00	1.96	31.20	1.32
1880.00	-24.19	-53.17	0.00	2.00	30.98	1.25
1909.80	-23.63	-54.13	0.00	1.98	32.48	1.77



GSM1900 (EDGE 8) Radiated Power EIRP for Sample 1						
Horizontal Polarization						
Frequency (MHz)	Rt (dBm)	Rs (dBm)	Ps (dBm)	Gs (dBi)	EIRP (dBm)	EIRP (W)
1850.20	-26.84	-51.88	0.00	1.96	27.00	0.50
1880.00	-27.59	-52.99	0.00	2.00	27.40	0.55
1909.80	-28.63	-54.28	0.00	1.98	27.63	0.58
Vertical Polarization						
Frequency (MHz)	Rt (dBm)	Rs (dBm)	Ps (dBm)	Gs (dBi)	EIRP (dBm)	EIRP (W)
1850.20	-27.25	-52.13	0.00	1.96	26.84	0.48
1880.00	-27.57	-53.17	0.00	2.00	27.60	0.58
1909.80	-28.04	-54.13	0.00	1.98	28.07	0.64

GSM1900 (EDGE 8) Radiated Power EIRP for Sample 2						
Horizontal Polarization						
Frequency (MHz)	Rt (dBm)	Rs (dBm)	Ps (dBm)	Gs (dBi)	EIRP (dBm)	EIRP (W)
1850.20	-26.99	-51.88	0.00	1.96	26.85	0.48
1880.00	-27.72	-52.99	0.00	2.00	27.27	0.53
1909.80	-29.12	-54.28	0.00	1.98	27.14	0.52
Vertical Polarization						
Frequency (MHz)	Rt (dBm)	Rs (dBm)	Ps (dBm)	Gs (dBi)	EIRP (dBm)	EIRP (W)
1850.20	-27.72	-52.13	0.00	1.96	26.37	0.43
1880.00	-28.31	-53.17	0.00	2.00	26.86	0.49
1909.80	-28.03	-54.13	0.00	1.98	28.08	0.64



WCDMA Band IV (RMC 12.2Kbps) Radiated Power EIRP for Sample 1						
Horizontal Polarization						
Frequency (MHz)	Rt (dBm)	Rs (dBm)	Ps (dBm)	Gs (dBi)	EIRP (dBm)	EIRP (W)
1712.4	-28.14	-51.88	0.00	1.96	25.70	0.37
1732.6	-28.83	-52.99	0.00	2.00	26.16	0.41
1752.6	-29.85	-54.28	0.00	1.98	26.41	0.44
Vertical Polarization						
Frequency (MHz)	Rt (dBm)	Rs (dBm)	Ps (dBm)	Gs (dBi)	EIRP (dBm)	EIRP (W)
1712.4	-27.93	-52.13	0.00	1.96	26.16	0.41
1732.6	-28.52	-53.17	0.00	2.00	26.65	0.46
1752.6	-29.20	-54.13	0.00	1.98	26.91	0.49

WCDMA Band IV (RMC 12.2Kbps) Radiated Power EIRP for Sample 2						
Horizontal Polarization						
Frequency (MHz)	Rt (dBm)	Rs (dBm)	Ps (dBm)	Gs (dBi)	EIRP (dBm)	EIRP (W)
1712.4	-28.55	-51.88	0.00	1.96	25.29	0.34
1732.6	-29.19	-52.99	0.00	2.00	25.80	0.38
1752.6	-30.01	-54.28	0.00	1.98	26.25	0.42
Vertical Polarization						
Frequency (MHz)	Rt (dBm)	Rs (dBm)	Ps (dBm)	Gs (dBi)	EIRP (dBm)	EIRP (W)
1712.4	-28.25	-52.13	0.00	1.96	25.84	0.38
1732.6	-28.63	-53.17	0.00	2.00	26.54	0.45
1752.6	-29.14	-54.13	0.00	1.98	26.97	0.50

3.3 Occupied Bandwidth Measurement

3.3.1 Description of Occupied Bandwidth Measurement

The emission bandwidth is defined as the width of the signal between two points, located at the 2 sides of the carrier frequency, outside of which all emissions are attenuated at least 26 dB below the transmitter power.

3.3.2 Measuring Instruments

See list of measuring instruments of this test report.

3.3.3 Test Procedures

1. The EUT was connected to Spectrum Analyzer and Base Station via power divider.
2. The 99% and 26 dB occupied bandwidth (BW) of the middle channel for the highest RF powers were measured.

3.3.4 Test Setup

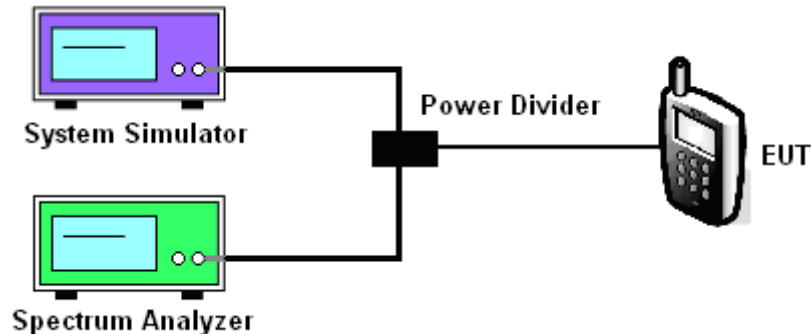



3.3.5 Test Result (Plots) of Occupied Bandwidth

Band :	GSM 850	Power Stage :	High
Test Mode :	GSM Link		

99% Occupied Bandwidth Plot on Channel 189

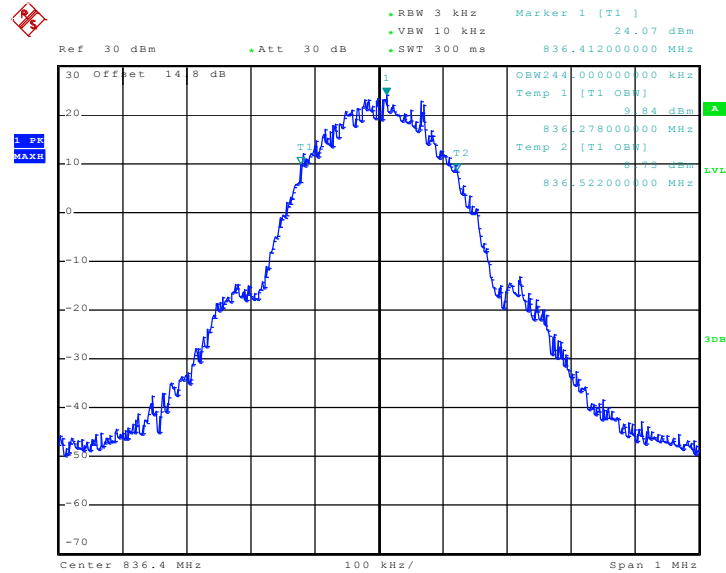

Date: 7.MAR.2011 09:41:37

26dB Bandwidth Plot on Channel 189

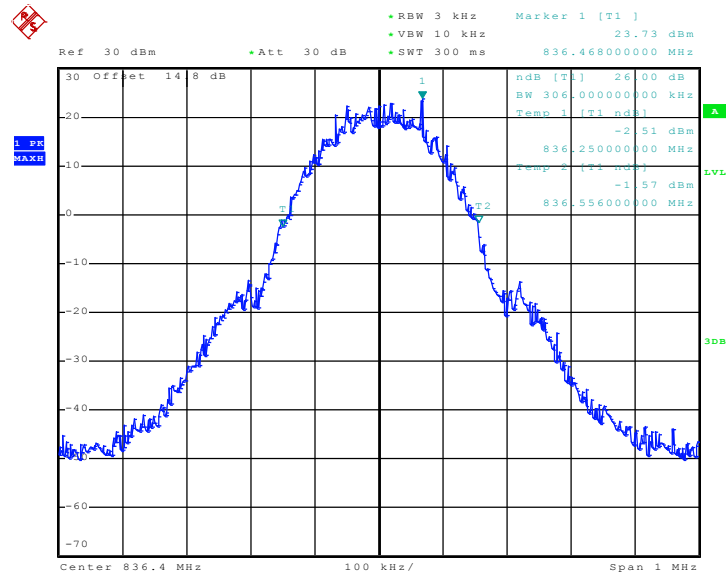

Date: 7.MAR.2011 09:13:45



Band :	GSM 850	Power Stage :	High
Test Mode :	EDGE 8 Link		

99% Occupied Bandwidth Plot on Channel 189

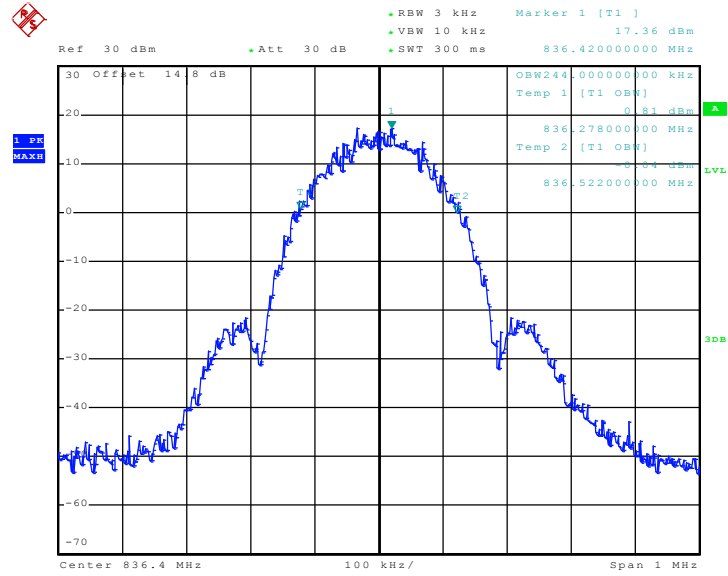

Date: 7.MAR.2011 09:27:59

26dB Bandwidth Plot on Channel 189

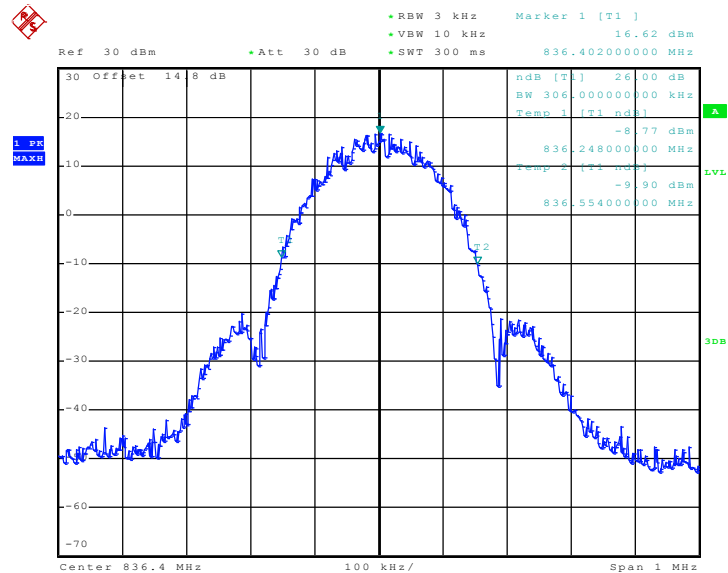

Date: 7.MAR.2011 09:26:40



Band :	GSM 1900	Power Stage :	High
Test Mode :	GSM Link		

99% Occupied Bandwidth Plot on Channel 661

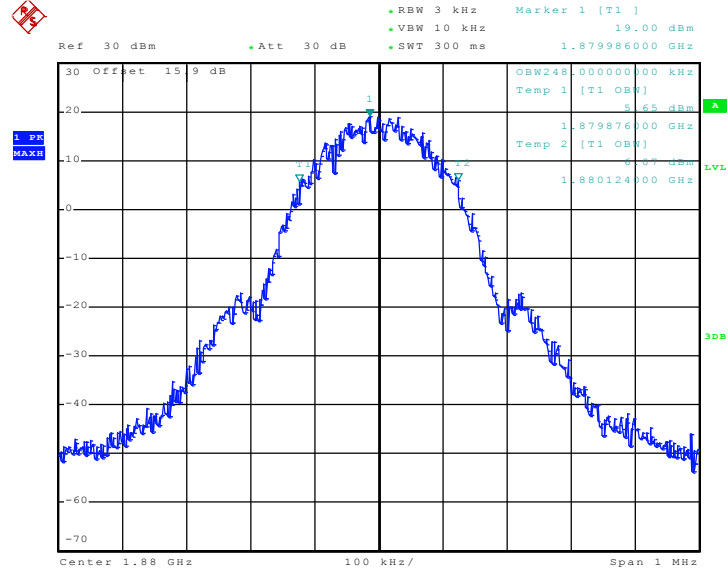

Date: 7.MAR.2011 15:49:21

26dB Bandwidth Plot on Channel 661

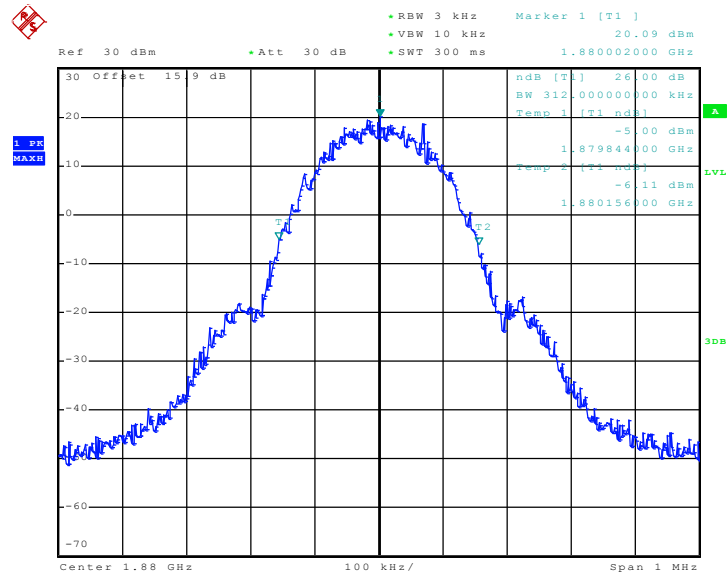

Date: 7.MAR.2011 15:48:02



Band :	GSM 1900	Power Stage :	High
Test Mode :	EDGE 8 Link		

99% Occupied Bandwidth Plot on Channel 661

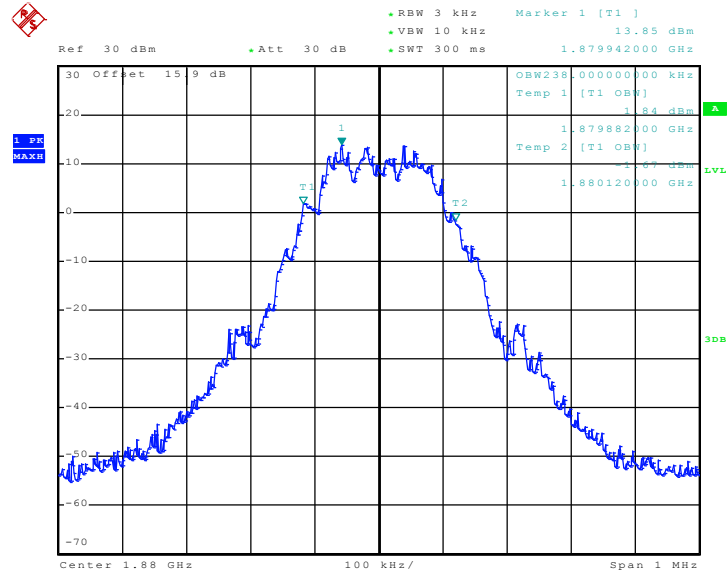

Date: 7.MAR.2011 16:04:25

26dB Bandwidth Plot on Channel 661

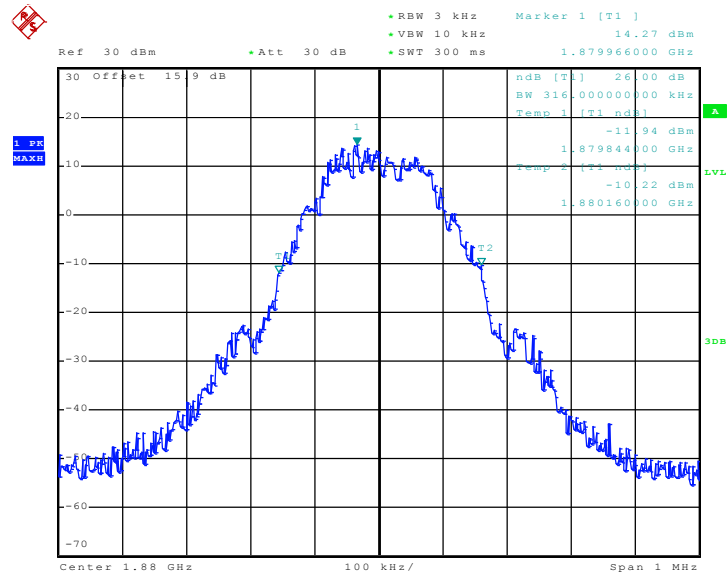

Date: 7.MAR.2011 16:03:06



Band :	WCDMA Band IV	Power Stage :	High
Test Mode :	RMC 12.2Kbps Link		

99% Occupied Bandwidth Plot on Channel 1413

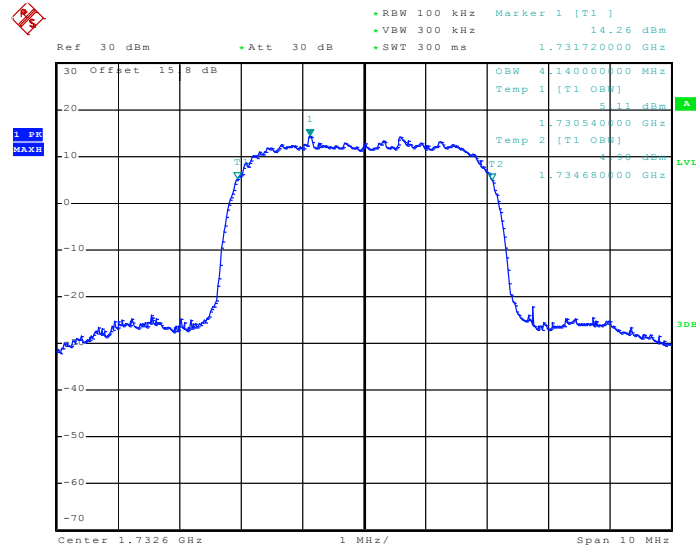

Date: 7.MAR.2011 08:51:13

26dB Bandwidth Plot on Channel 1413

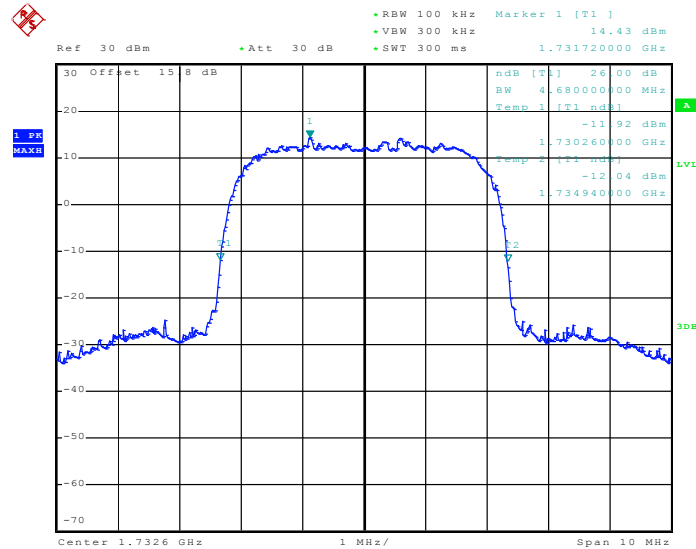

Date: 7.MAR.2011 08:49:55

3.4 Band Edge Measurement

3.4.1 Description of Band Edge Measurement

The power of any emission outside of the authorized operating frequency ranges must be lower than the transmitter power (P) by a factor of at least $43 + 10 \log (P)$ dB.

3.4.2 Measuring Instruments

See list of measuring instruments of this test report.

3.4.3 Test Procedures

1. The EUT was connected to Spectrum Analyzer and Base Station via power divider.
2. The band edges of low and high channels for the highest RF powers were measured. Setting RBW as roughly $BW/100$.

3.4.4 Test Setup

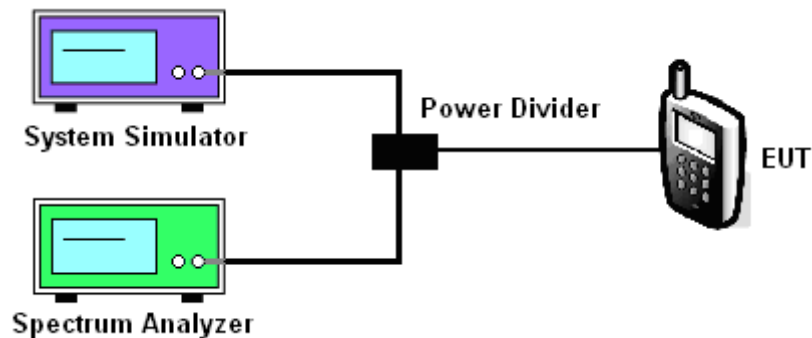



3.4.5 Test Result (Plots) of Conducted Band Edge

Band :	GSM850	Power Stage :	High
Test Mode :	GSM Link		

Lower Band Edge Plot on Channel 128

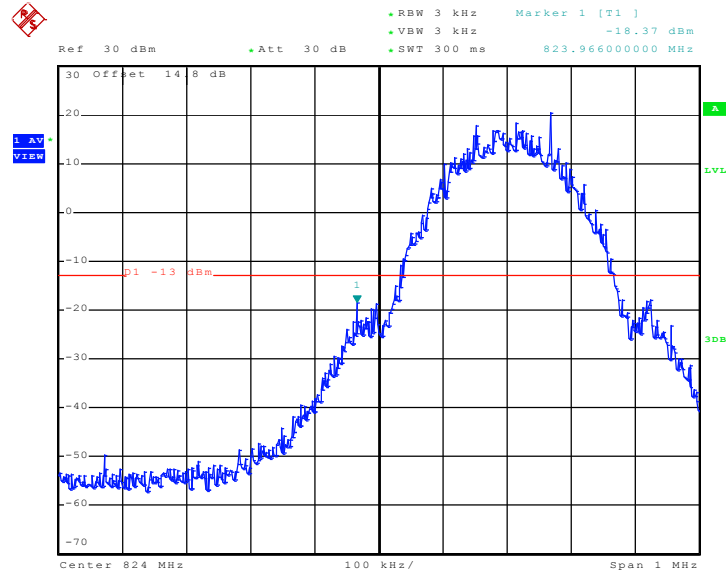

Date: 7.MAR.2011 09:16:56

Higher Band Edge Plot on Channel 251

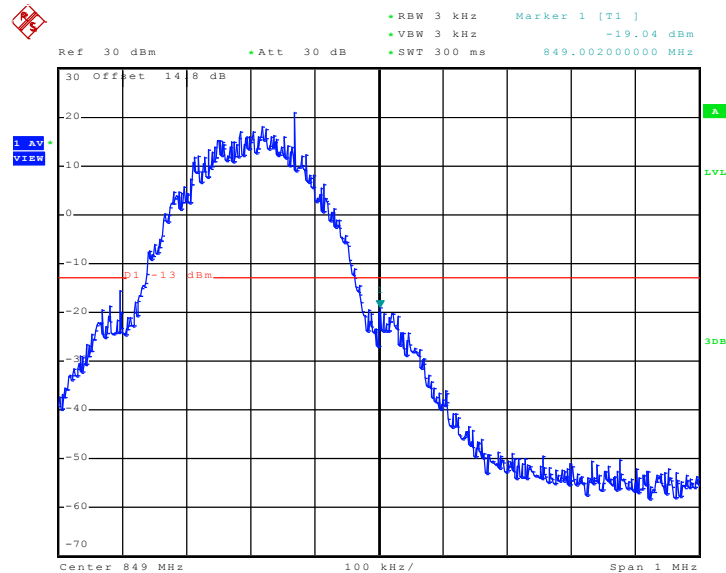

Date: 7.MAR.2011 09:17:22



Band :	GSM850	Power Stage :	High
Test Mode :	EDGE 8 Link		

Lower Band Edge Plot on Channel 128

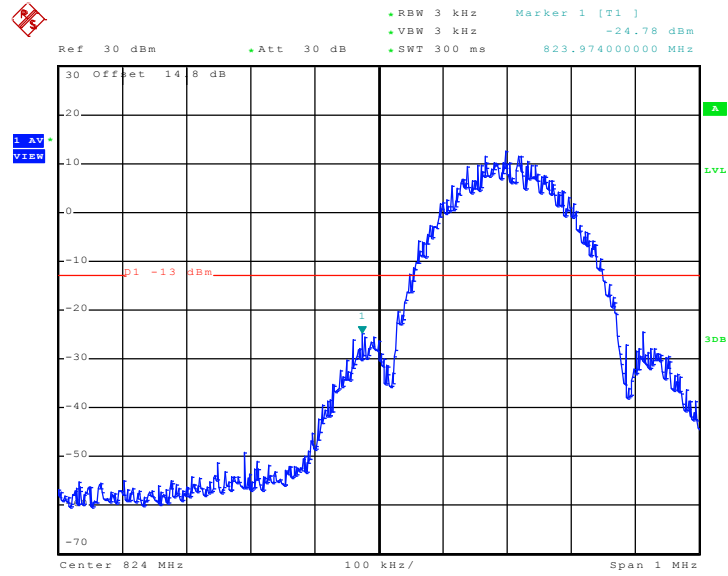

Date: 7.MAR.2011 09:29:51

Higher Band Edge Plot on Channel 251

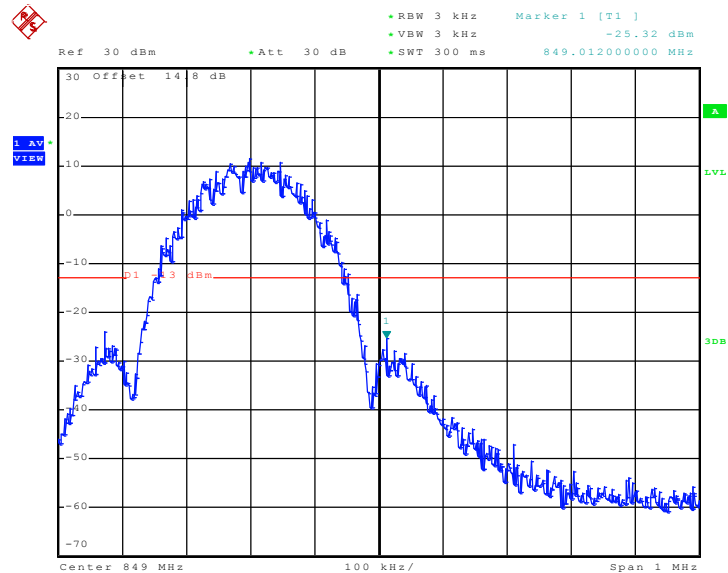

Date: 7.MAR.2011 09:30:17



Band :	GSM1900	Power Stage :	High
Test Mode :	GSM Link		

Lower Band Edge Plot on Channel 512

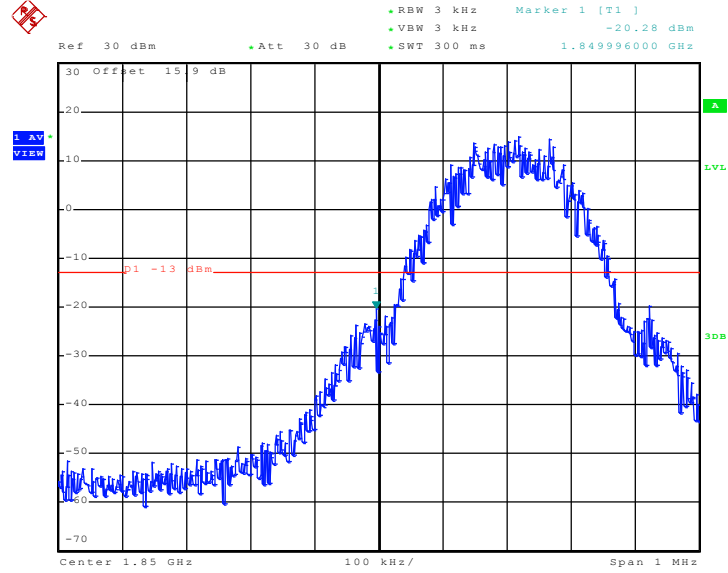

Date: 7.MAR.2011 15:51:13

Higher Band Edge Plot on Channel 810

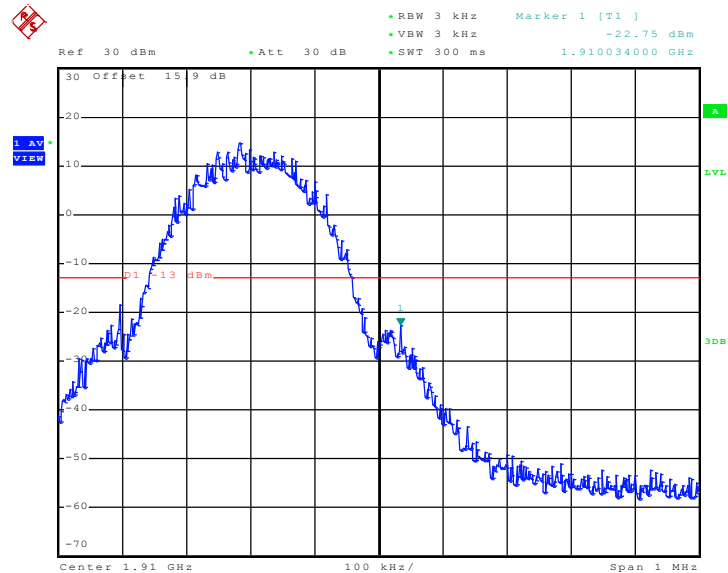

Date: 7.MAR.2011 15:51:39



Band :	GSM1900	Power Stage :	High
Test Mode :	EDGE 8 Link		

Lower Band Edge Plot on Channel 512

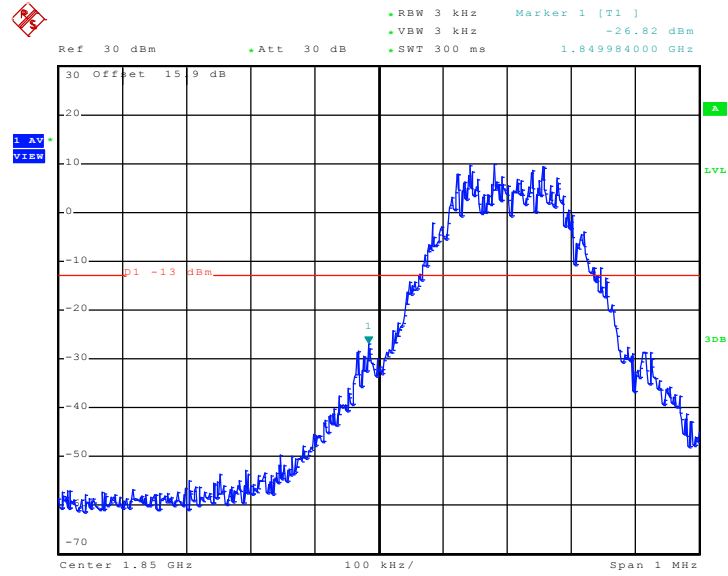

Date: 7.MAR.2011 16:06:16

Higher Band Edge Plot on Channel 810

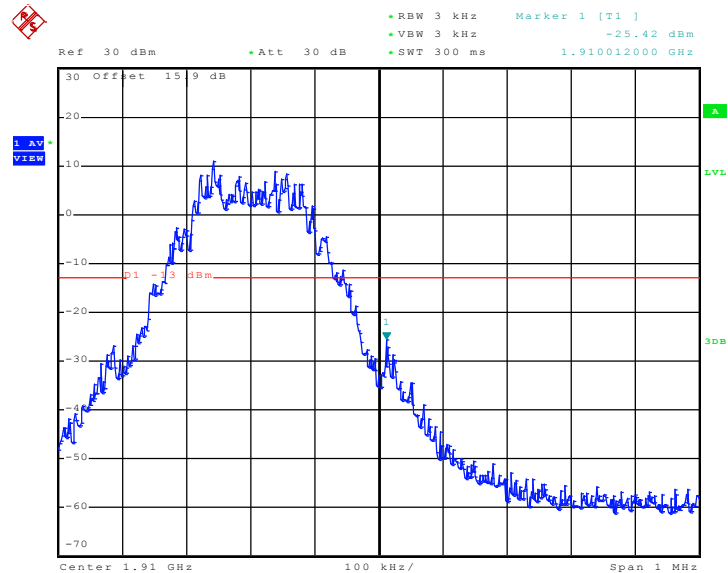

Date: 7.MAR.2011 16:06:43



Band :	WCDMA Band IV	Power Stage :	High
Test Mode :	RMC 12.2Kbps Link		

Lower Band Edge Plot on Channel 1312

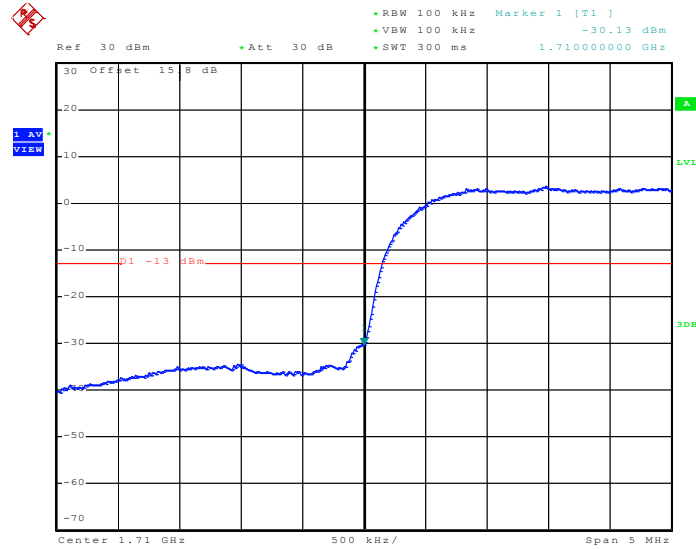

Date: 7.MAR.2011 08:53:07

Higher Band Edge Plot on Channel 1513

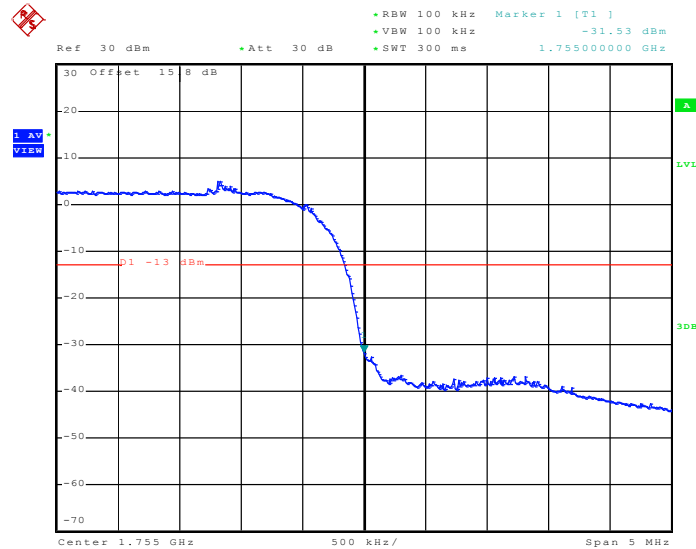

Date: 7.MAR.2011 08:53:33

3.5 Conducted Emission Measurement

3.5.1 Description of Conducted Emission Measurement

The power of any emission outside of the authorized operating frequency ranges must be lower than the transmitter power (P) by a factor of at least $43 + 10 \log (P)$ dB.

It is measured by means of a calibrated spectrum analyzer and scanned from 30 MHz up to a frequency including its 10th harmonic.

3.5.2 Measuring Instruments

See list of measuring instruments of this test report.

3.5.3 Test Procedures

3. The EUT was connected to spectrum analyzer and base station via power divider.
4. The middle channel for the highest RF power within the transmitting frequency was measured.
5. The conducted spurious emission for the whole frequency range was taken.

3.5.4 Test Setup

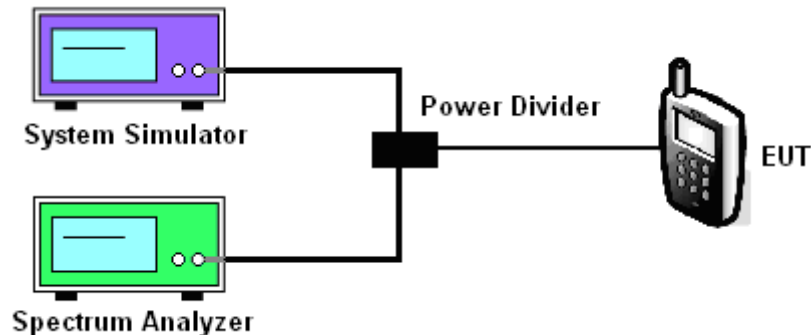

3.5.5 Test Result (Plots) of Conducted Emission

Band :	GSM850	Channel :	CH189
Test Mode :	GSM Link		

Conducted Emission Plot between 30MHz ~ 1GHz

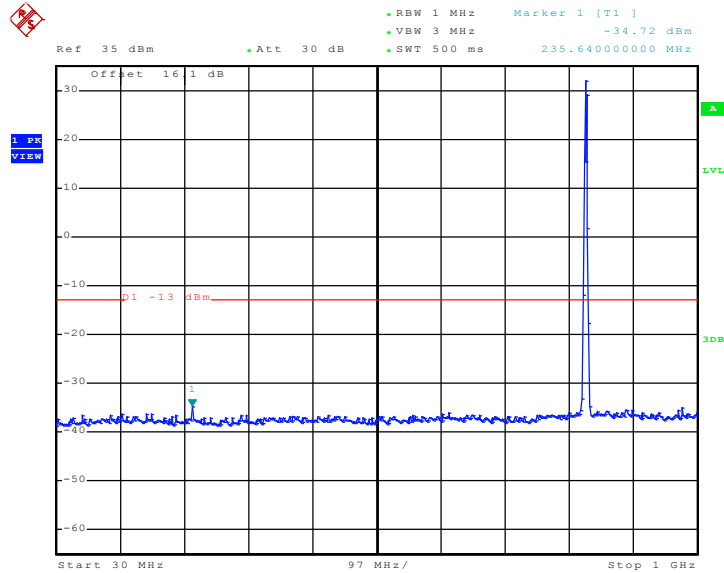

Date: 7.MAR.2011 09:11:40

Conducted Emission Plot between 1GHz ~ 3GHz

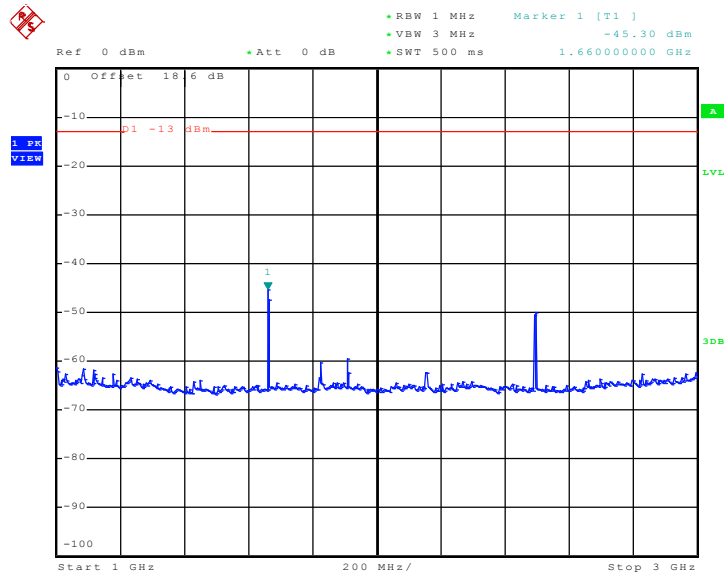

Date: 7.MAR.2011 09:11:56



Conducted Emission Plot between 3GHz ~ 7GHz

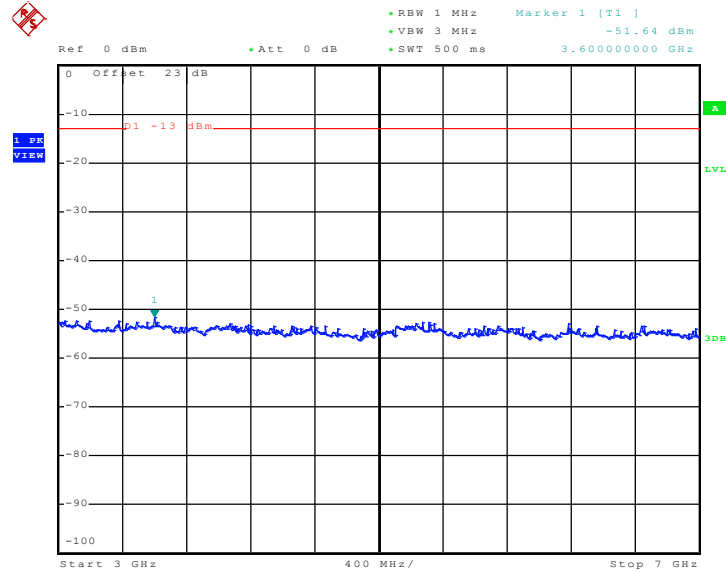

Date: 7.MAR.2011 09:12:09

Conducted Emission Plot between 7GHz ~ 9GHz

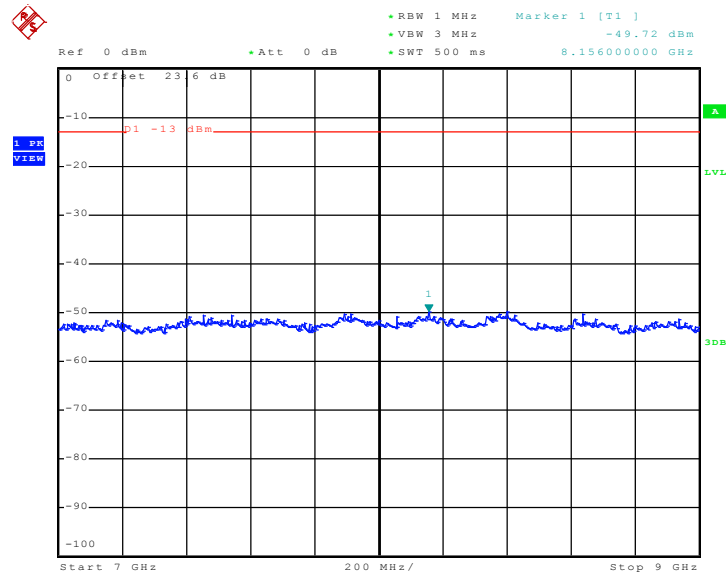

Date: 7.MAR.2011 09:12:21



Band :	GSM850	Channel :	CH189
Test Mode :	EDGE 8 Link		

Conducted Emission Plot between 30MHz ~ 1GHz

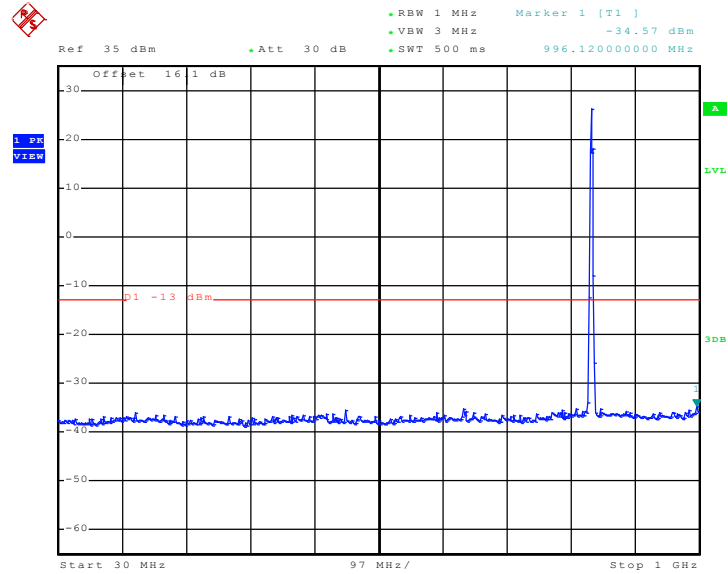

Date: 7.MAR.2011 09:32:59

Conducted Emission Plot between 1GHz ~ 3GHz

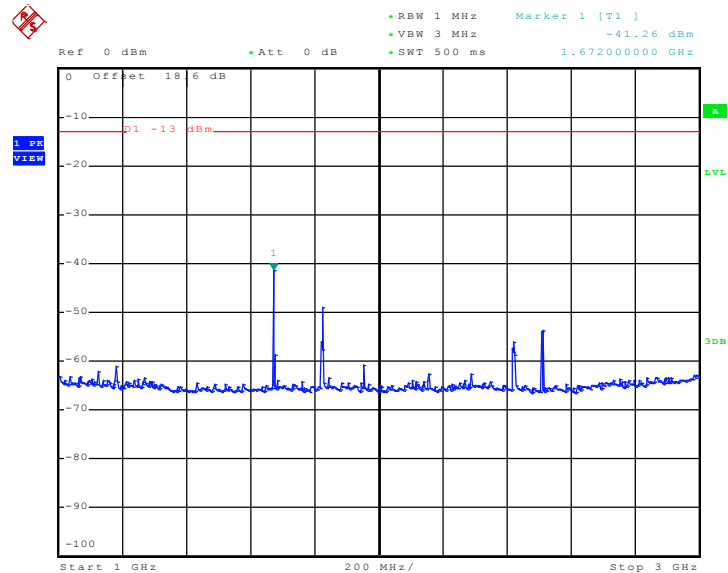

Date: 7.MAR.2011 09:33:18



Conducted Emission Plot between 3GHz ~ 7GHz

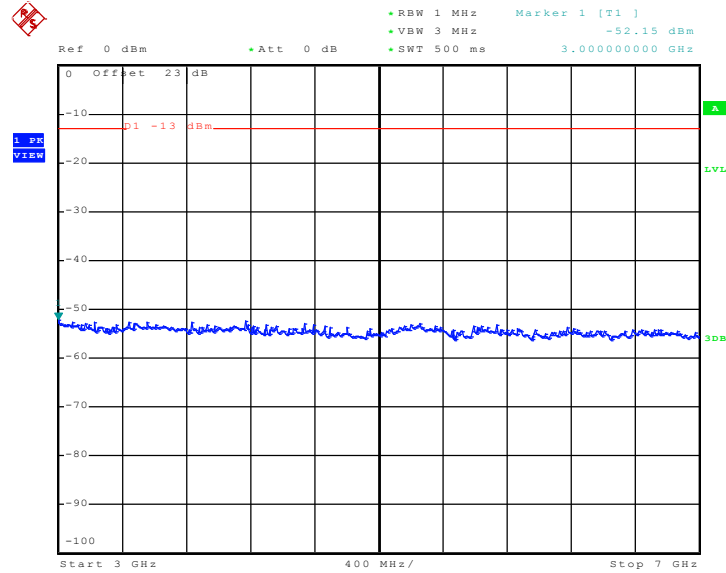

Date: 7.MAR.2011 09:33:30

Conducted Emission Plot between 7GHz ~ 9GHz

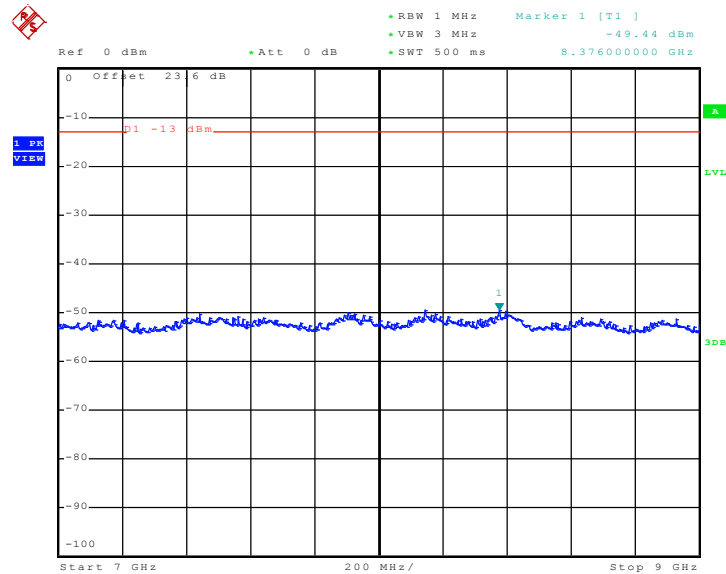

Date: 7.MAR.2011 09:33:42



Band :	GSM1900	Channel :	CH661
Test Mode :	GSM Link		

Conducted Emission Plot between 30MHz ~ 1GHz

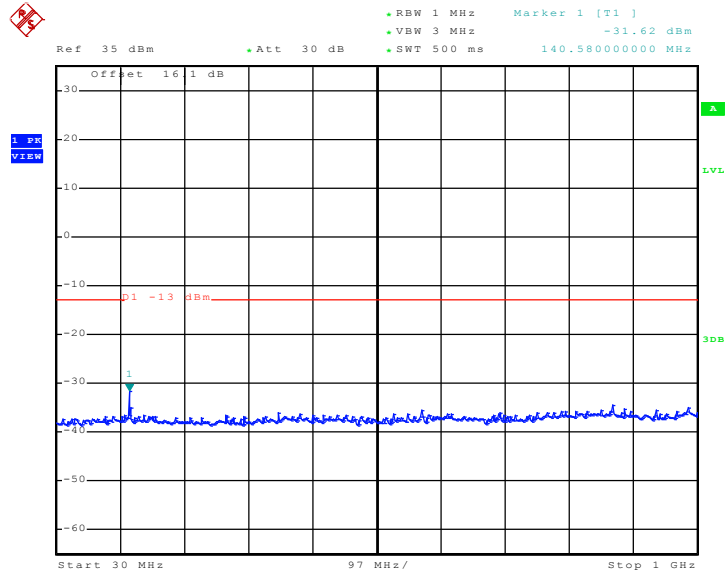

Date: 7.MAR.2011 15:55:08

Conducted Emission Plot between 1GHz ~ 3GHz

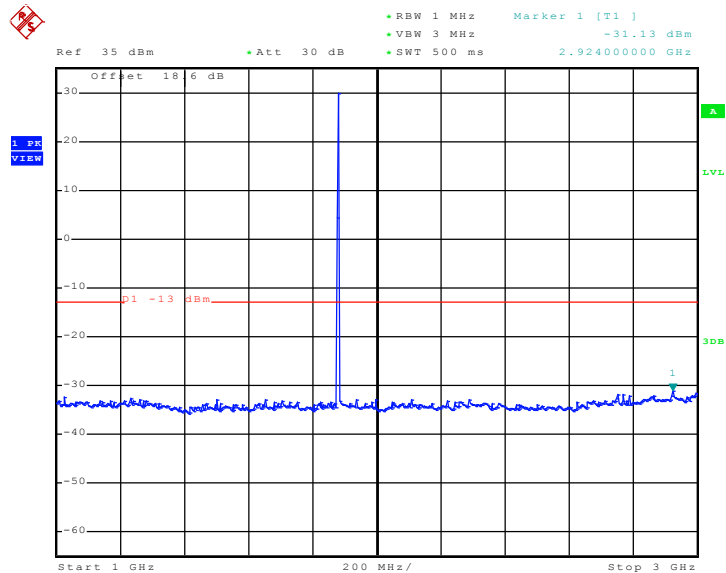

Date: 7.MAR.2011 15:55:21



Conducted Emission Plot between 3GHz ~ 7GHz

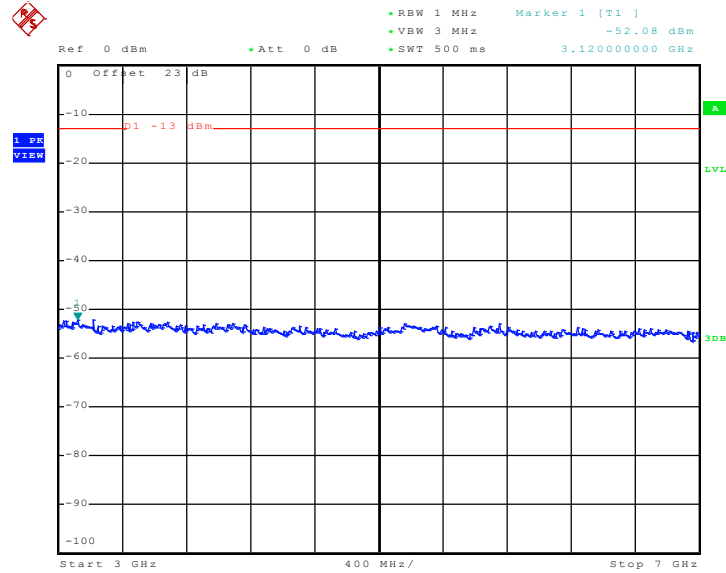

Date: 7.MAR.2011 15:55:40

Conducted Emission Plot between 7GHz ~ 13.6G

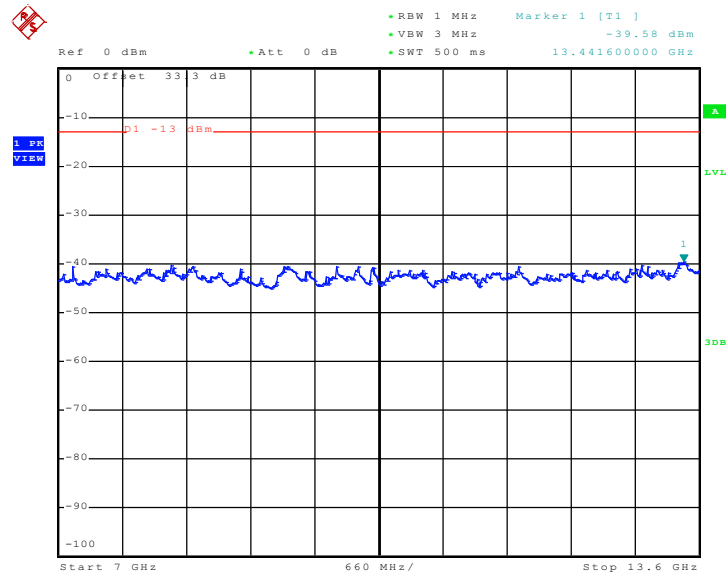

Date: 7.MAR.2011 15:55:53



Conducted Emission Plot between 13.6GHz ~ 19.1GHz

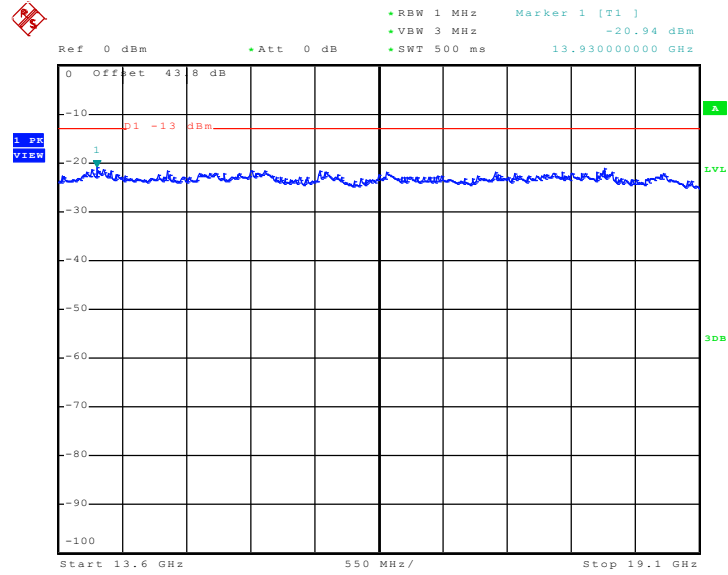

Date: 7.MAR.2011 15:56:05



Band :	GSM1900	Channel :	CH661
Test Mode :	EDGE 8 Link		

Conducted Emission Plot between 30MHz ~ 1GHz

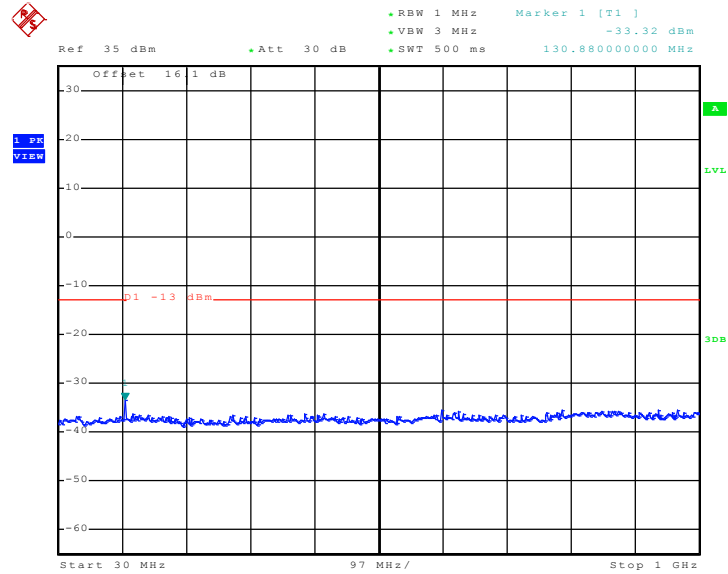

Date: 7.MAR.2011 15:59:16

Conducted Emission Plot between 1GHz ~ 3GHz

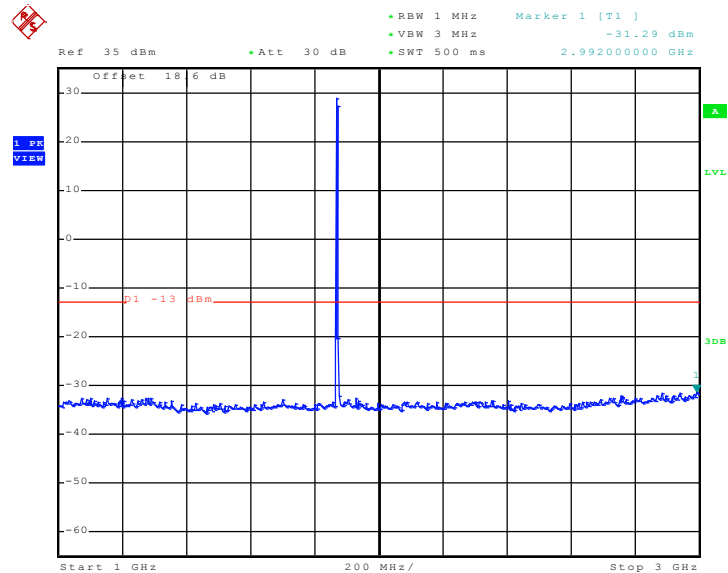

Date: 7.MAR.2011 15:59:28



Conducted Emission Plot between 3GHz ~ 7GHz

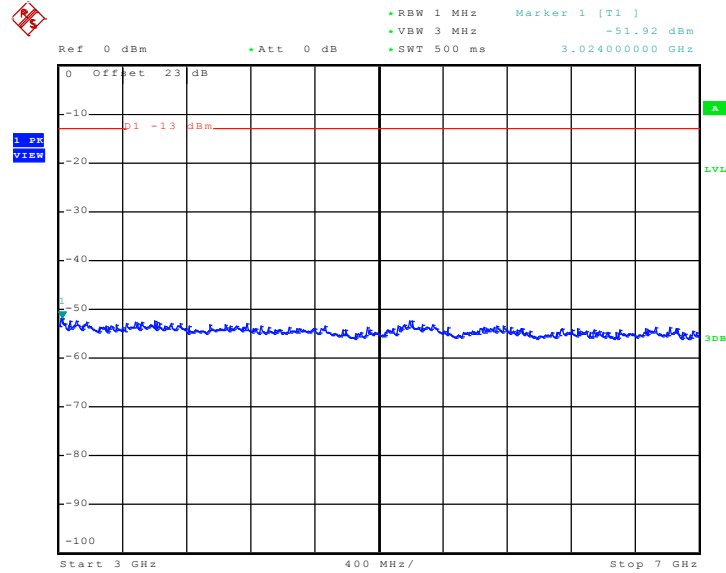

Date: 7.MAR.2011 15:59:44

Conducted Emission Plot between 7GHz ~ 13.6GHz

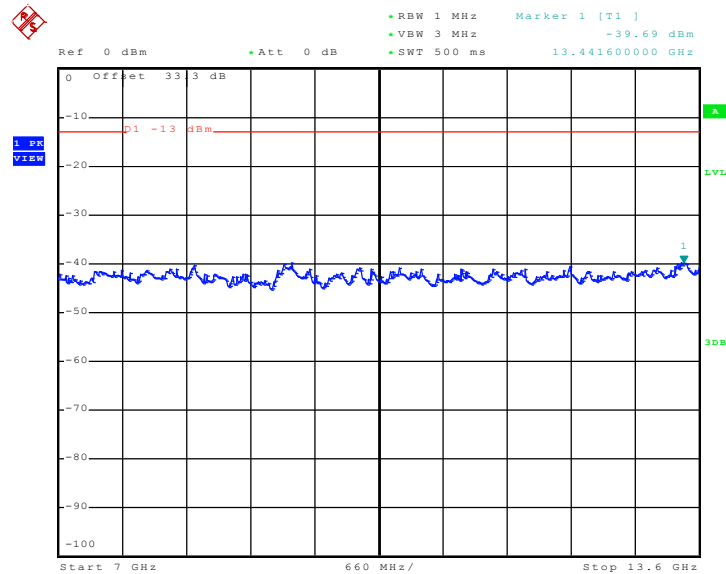

Date: 7.MAR.2011 15:59:57



Conducted Emission Plot between 13.6GHz ~ 19.1GHz

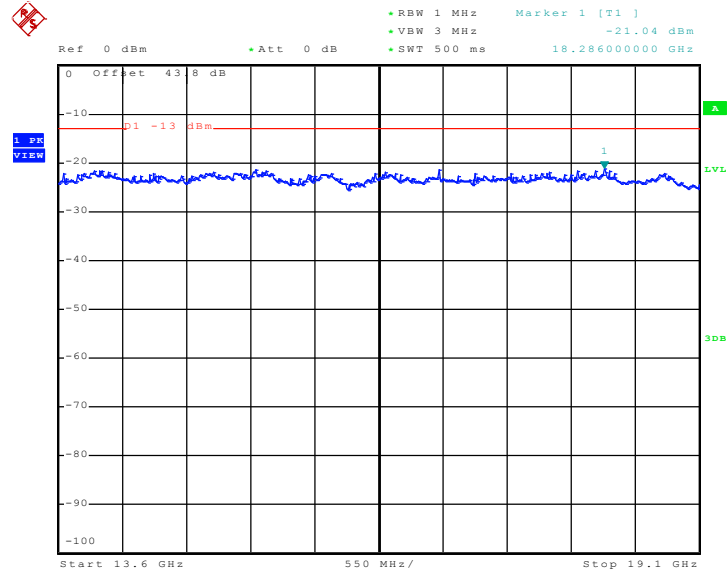

Date: 7.MAR.2011 16:00:09



Band :	WCDMA Band IV	Channel :	CH1413
Test Mode :	RMC 12.2Kbps Link		

Conducted Emission Plot between 30MHz ~ 1GHz

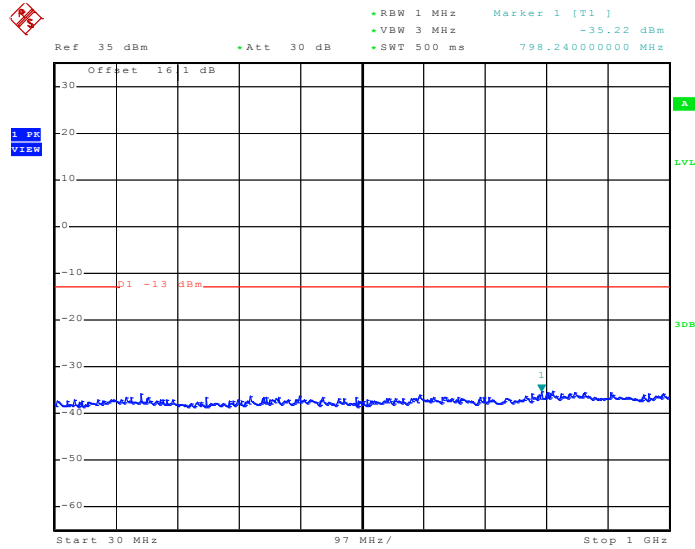

Date: 7.MAR.2011 09:05:02

Conducted Emission Plot between 1GHz ~ 3GHz

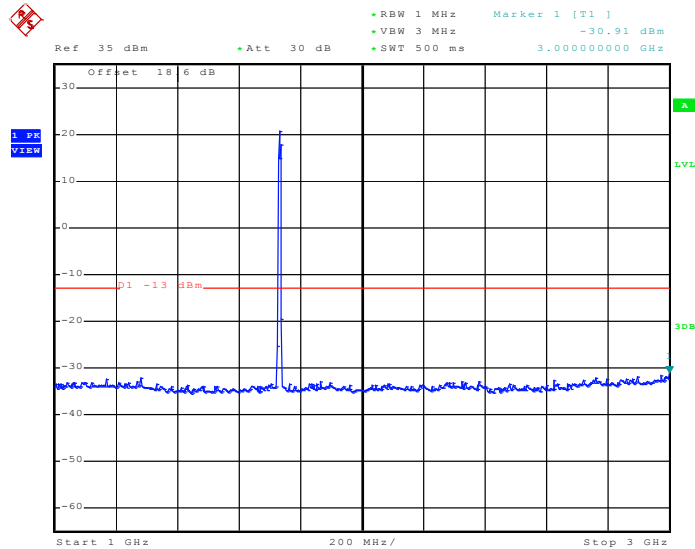

Date: 7.MAR.2011 09:05:15



Conducted Emission Plot between 3GHz ~ 7GHz

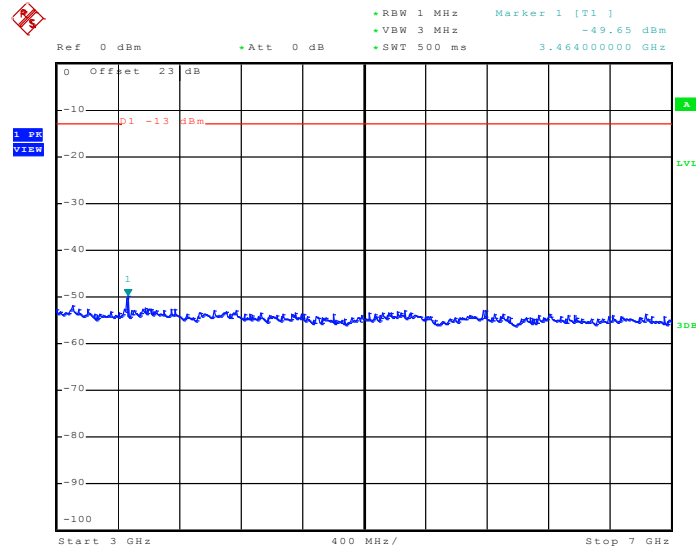

Date: 7.MAR.2011 09:05:31

Conducted Emission Plot between 7GHz ~ 13.6GHz

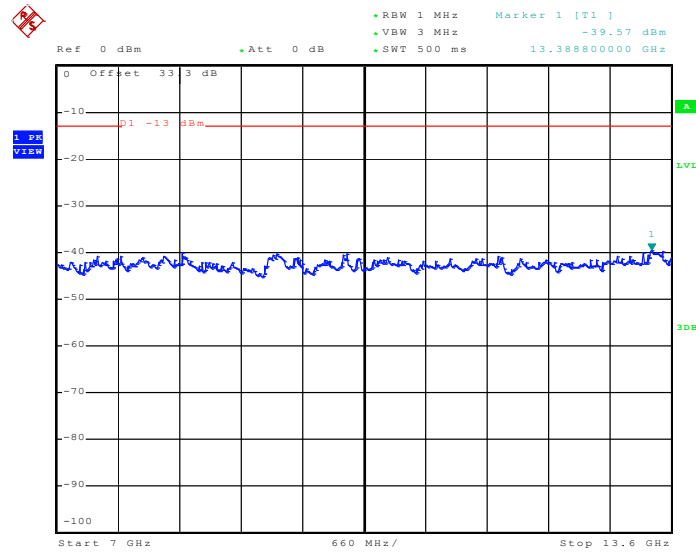

Date: 7.MAR.2011 09:05:44



Conducted Emission Plot between 13.6GHz ~ 18GHz

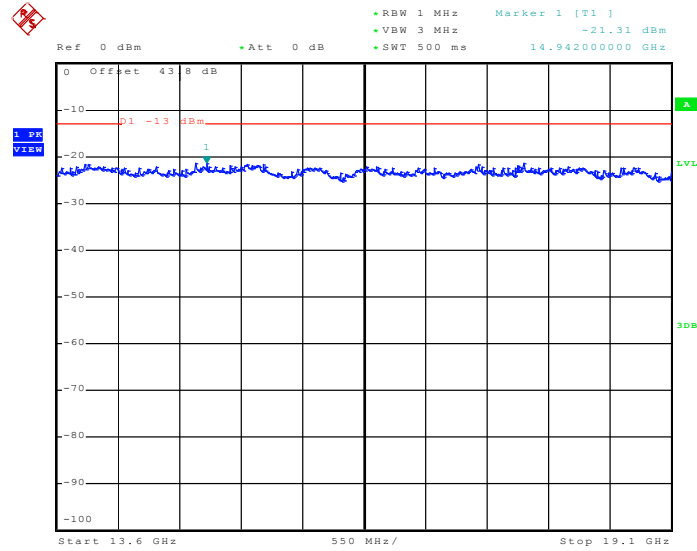

Date: 7.MAR.2011 09:05:56

3.6 Field Strength of Spurious Radiation Measurement

3.6.1 Description of Field Strength of Spurious Radiated Measurement

The radiated spurious emission was measured by substitution method according to ANSI / TIA / EIA-603-C-2004. The power of any emission outside of the authorized operating frequency ranges must be attenuated below the transmitter power (P) by a factor of at least $43 + 10 \log (P)$ dB. The spectrum is scanned from 30 MHz up to a frequency including its 10th harmonic.

3.6.2 Measuring Instruments

See list of measuring instruments of this test report.

3.6.3 Test Procedures

1. The EUT was placed on a rotatable wooden table with 0.8 meter about ground.
2. The EUT was set 3 meters from the receiving antenna, which was mounted on the antenna tower.
3. The table was rotated 360 degrees to determine the position of the highest spurious emission.
4. The height of the receiving antenna is varied between one meter and four meters to search the maximum spurious emission for both horizontal and vertical polarizations.
5. Taking the record of maximum spurious emission.
6. A horn antenna was substituted in place of the EUT and was driven by a signal generator.
7. Tune the output power of signal generator to the same emission level with EUT maximum spurious emission.
8. Taking the record of output power at antenna port.
9. Repeat step 7 to step 8 for another polarization.
10. $EIRP \text{ (dBm)} = S.G. \text{ Power} - Tx \text{ Cable Loss} + Tx \text{ Antenna Gain}$
11. $ERP \text{ (dBm)} = EIRP - 2.15$

3.6.4 Test Setup

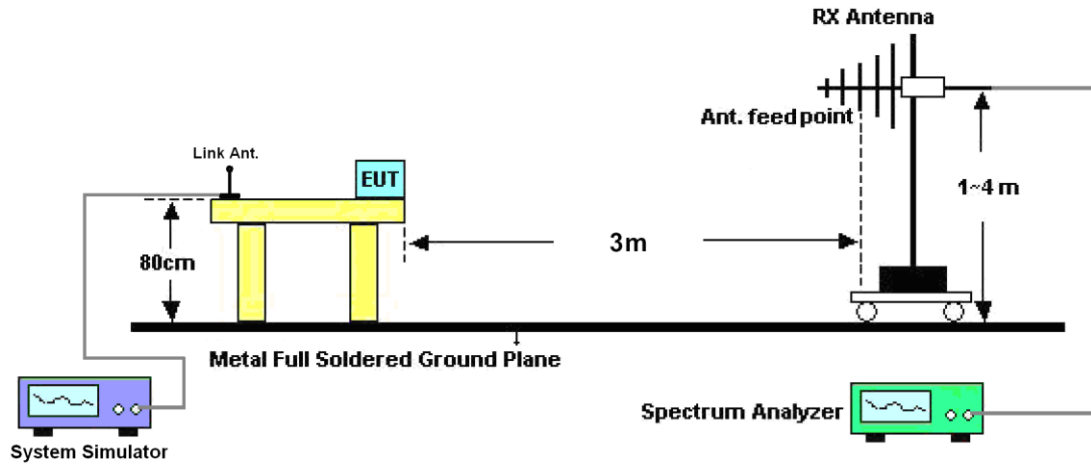



3.6.5 Test Result of Field Strength of Spurious Radiated

Band :	GSM850	Temperature :	22~24°C
Test Mode :	GSM Link for Sample 1	Relative Humidity :	46~51%
Test Engineer :	Ivan Chiang and Kai Wang	Polarization :	Horizontal
Remark :	Spurious emissions within 30-1000MHz were found more than 20dB below limit line.		

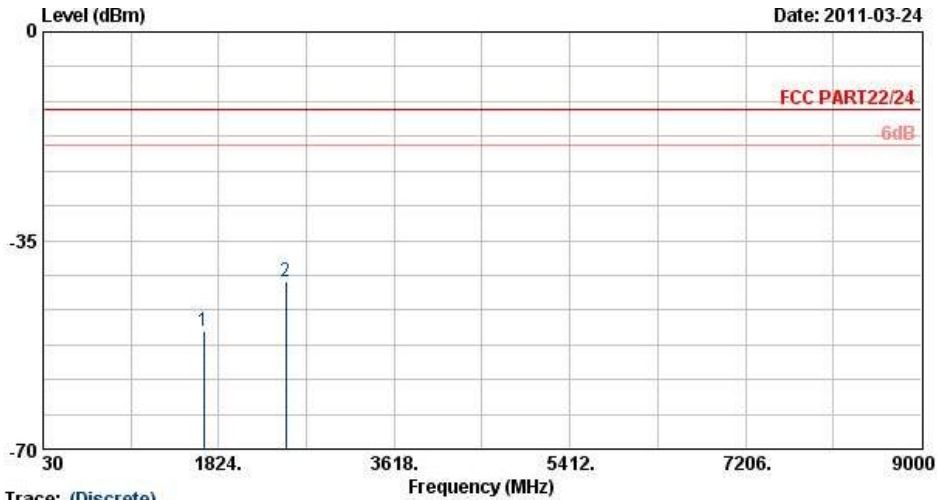

Trace: (Discrete)
 Site : 03CH07-HY
 Condition : FCC PART22/24 HF-ETRP(080306) HORIZONTAL
 Project : FG 121019

Frequency (MHz)	ERP (dBm)	Limit (dBm)	Over Limit (dB)	SPA Reading (dBm)	S.G. Power (dBm)	TX Cable loss (dB)	TX Antenna Gain (dBi)	Polarization (H/V)	Result
1672	-50.23	-13	-37.23	-59.57	-51.95	1.62	5.49	H	Pass
2509	-41.77	-13	-28.77	-55.73	-43.74	2.1	6.22	H	Pass



Band :	GSM850	Temperature :	22~24°C
Test Mode :	GSM Link for Sample 1	Relative Humidity :	46~51%
Test Engineer :	Ivan Chiang and Kai Wang	Polarization :	Vertical
Remark :	Spurious emissions within 30-1000MHz were found more than 20dB below limit line.		

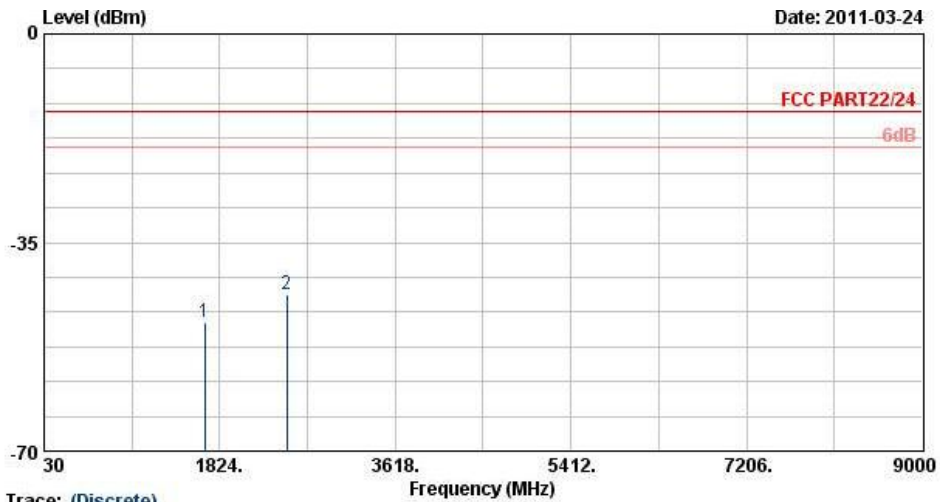

Trace: (Discrete)
 Site : 03CH07-HY
 Condition : FCC PART22/24 HF-ETRP(080306) VERTICAL
 Project : FG 121019

Frequency (MHz)	ERP (dBm)	Limit (dBm)	Over Limit (dB)	SPA Reading (dBm)	S.G. Power (dBm)	TX Cable loss (dB)	TX Antenna Gain (dBi)	Polarization (H/V)	Result
1672	-48.39	-13	-35.39	-59.88	-50.11	1.62	5.49	V	Pass
2509	-43.65	-13	-30.65	-58.13	-45.62	2.1	6.22	V	Pass



Band :	GSM850	Temperature :	22~24°C
Test Mode :	EDGE 8 Link for Sample 1	Relative Humidity :	46~51%
Test Engineer :	Ivan Chiang and Kai Wang	Polarization :	Horizontal
Remark :	Spurious emissions within 30-1000MHz were found more than 20dB below limit line.		

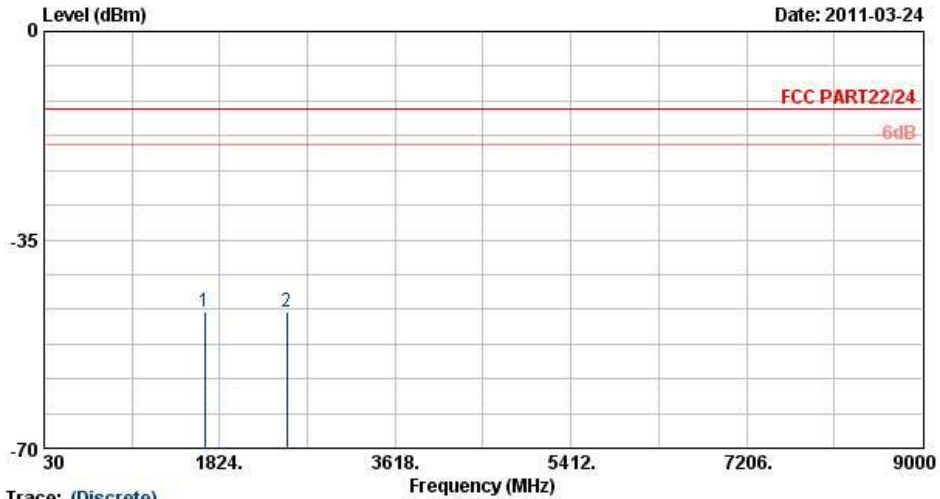

Trace: (Discrete)
 Site : D3CH07-HY
 Condition : FCC PART22/24 HF-ETRP(080306) HORIZONTAL
 Project : FG 121019

Frequency (MHz)	ERP (dBm)	Limit (dBm)	Over Limit (dB)	SPA Reading (dBm)	S.G. Power (dBm)	TX Cable loss (dB)	TX Antenna Gain (dBi)	Polarization (H/V)	Result
1672	-47.04	-13	-34.04	-56.58	-48.76	1.62	5.49	H	Pass
2509	-47.15	-13	-34.15	-61.28	-49.12	2.1	6.22	H	Pass



Band :	GSM850	Temperature :	22~24°C
Test Mode :	EDGE 8 Link for Sample 1	Relative Humidity :	46~51%
Test Engineer :	Ivan Chiang and Kai Wang	Polarization :	Vertical
Remark :	Spurious emissions within 30-1000MHz were found more than 20dB below limit line.		

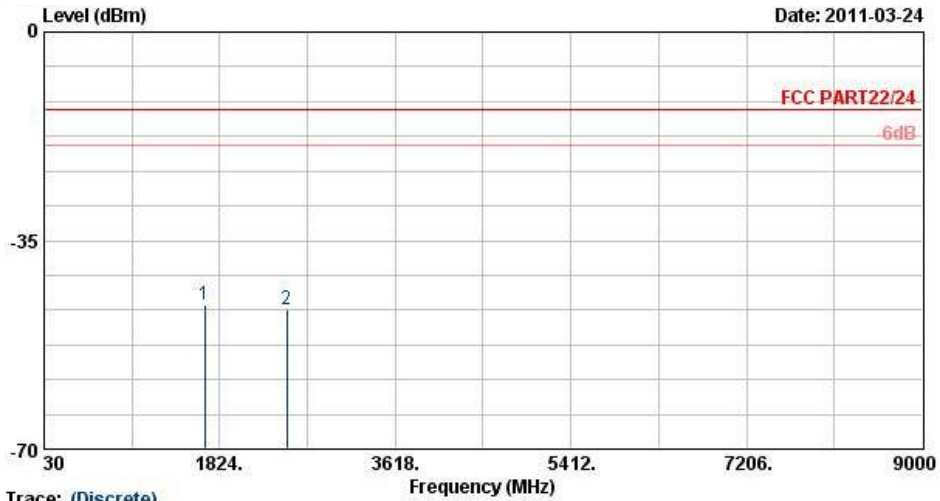

Trace: (Discrete)
 Site : D3CH07-HY
 Condition : FCC PART22/24 HF-ETRP(080306) VERTICAL
 Project : FG 121019

Frequency (MHz)	ERP (dBm)	Limit (dBm)	Over Limit (dB)	SPA Reading (dBm)	S.G. Power (dBm)	TX Cable loss (dB)	TX Antenna Gain (dBi)	Polarization (H/V)	Result
1672	-45.91	-13	-32.91	-57.64	-47.63	1.62	5.49	V	Pass
2509	-46.56	-13	-33.56	-61.11	-48.53	2.1	6.22	V	Pass



Band :	GSM850	Temperature :	22~24°C
Test Mode :	GSM Link for Sample 2	Relative Humidity :	46~51%
Test Engineer :	Ivan Chiang and Kai Wang	Polarization :	Horizontal
Remark :	Spurious emissions within 30-1000MHz were found more than 20dB below limit line.		

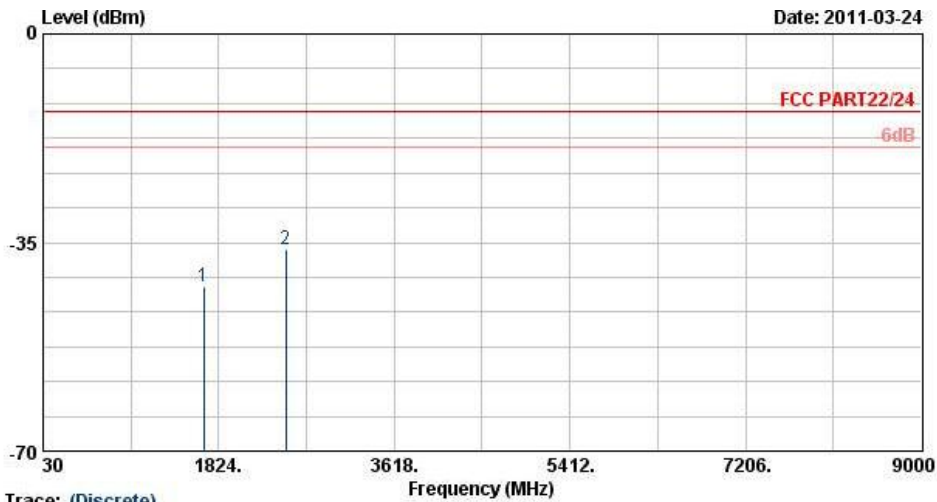

Trace: (Discrete)
 Site : 03CH07-HY
 Condition : FCC PART22/24 HF-EIRP(080306) HORIZONTAL
 Project : FG 121019

Frequency (MHz)	ERP (dBm)	Limit (dBm)	Over Limit (dB)	SPA Reading (dBm)	S.G. Power (dBm)	TX Cable loss (dB)	TX Antenna Gain (dBi)	Polarization (H/V)	Result
1672	-42.50	-13	-29.50	-51.86	-44.22	1.62	5.49	H	Pass
2509	-36.29	-13	-23.29	-50.3	-38.26	2.1	6.22	H	Pass



Band :	GSM850	Temperature :	22~24°C
Test Mode :	GSM Link for Sample 2	Relative Humidity :	46~51%
Test Engineer :	Ivan Chiang and Kai Wang	Polarization :	Vertical
Remark :	Spurious emissions within 30-1000MHz were found more than 20dB below limit line.		

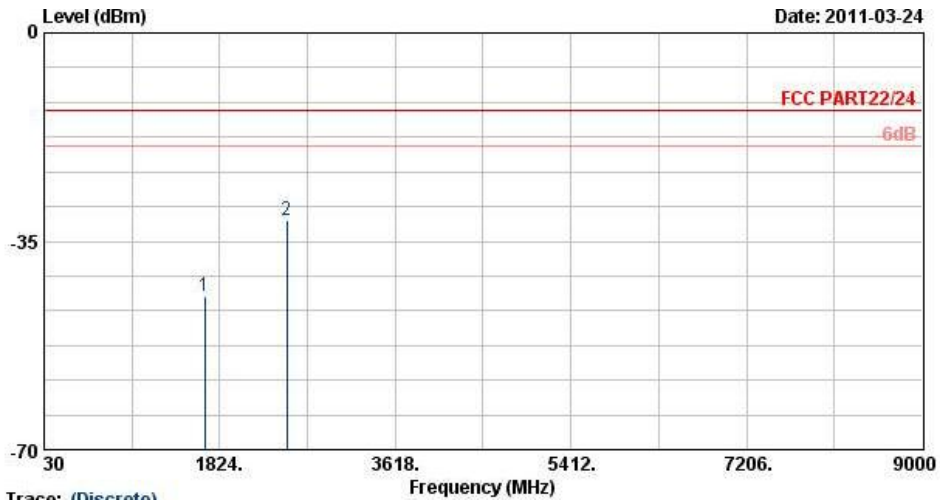

Trace: (Discrete)
 Site : 03CH07-HY
 Condition : FCC PART22/24 HF-ETRP(080306) VERTICAL
 Project : FG 121019

Frequency (MHz)	ERP (dBm)	Limit (dBm)	Over Limit (dB)	SPA Reading (dBm)	S.G. Power (dBm)	TX Cable loss (dB)	TX Antenna Gain (dBi)	Polarization (H/V)	Result
1672	-44.15	-13	-31.15	-55.93	-45.87	1.62	5.49	V	Pass
2509	-31.57	-13	-18.57	-45.9	-33.54	2.1	6.22	V	Pass



Band :	GSM1900	Temperature :	22~24°C
Test Mode :	GSM Link for Sample 1	Relative Humidity :	46~51%
Test Engineer :	Ivan Chiang and Kai Wang	Polarization :	Horizontal
Remark :	Spurious emissions within 30-1000MHz were found more than 20dB below limit line.		

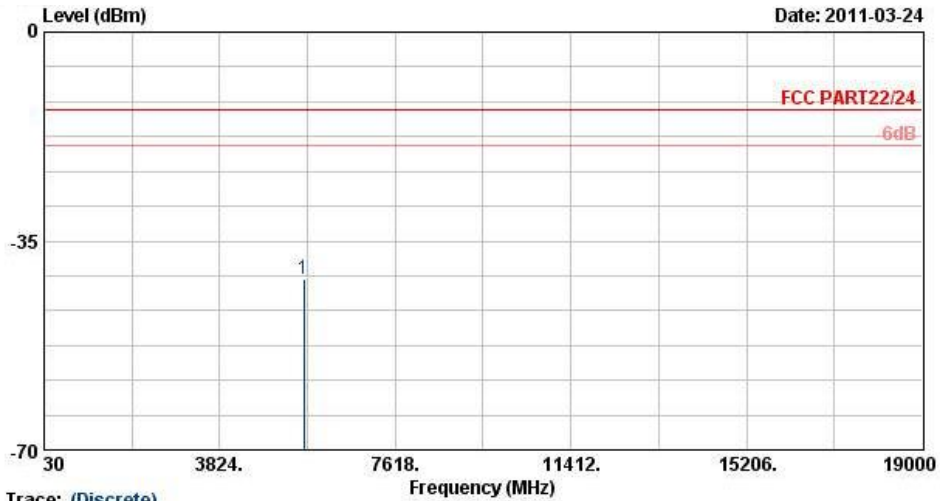

Trace: (Discrete)
 Site : 03CH07-HY
 Condition : FCC PART22/24 HF-ETRP(080306) HORIZONTAL
 Project : FG 121019

Frequency (MHz)	EIRP (dBm)	Limit (dBm)	Over Limit (dB)	SPA Reading (dBm)	S.G. Power (dBm)	TX Cable loss (dB)	TX Antenna Gain (dBi)	Polarization (H/V)	Result
5636	-41.42	-13	-28.42	-62.75	-49.13	2.99	10.70	H	Pass



Band :	GSM1900	Temperature :	22~24°C
Test Mode :	GSM Link for Sample 1	Relative Humidity :	46~51%
Test Engineer :	Ivan Chiang and Kai Wang	Polarization :	Vertical
Remark :	Spurious emissions within 30-1000MHz were found more than 20dB below limit line.		

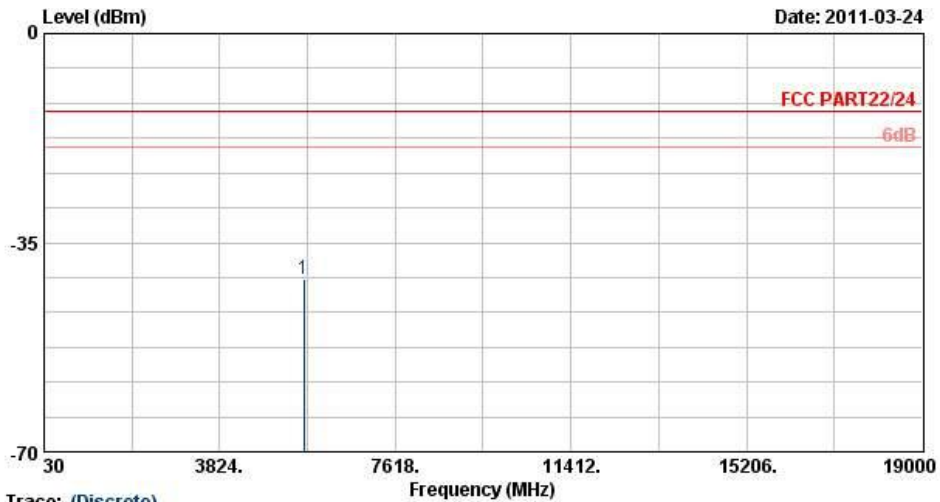

Trace: (Discrete)
 Site : D3CH07-HY
 Condition : FCC PART22/24 HF-ETRP(080306) VERTICAL
 Project : FG 121019

Frequency (MHz)	EIRP (dBm)	Limit (dBm)	Over Limit (dB)	SPA Reading (dBm)	S.G. Power (dBm)	TX Cable loss (dB)	TX Antenna Gain (dBi)	Polarization (H/V)	Result
5636	-41.03	-13	-28.03	-61.8	-48.74	2.99	10.70	V	Pass



Band :	GSM1900	Temperature :	22~24°C
Test Mode :	EDGE 8 Link for Sample 1	Relative Humidity :	46~51%
Test Engineer :	Ivan Chiang and Kai Wang	Polarization :	Horizontal
Remark :	Spurious emissions within 30-1000MHz were found more than 20dB below limit line.		

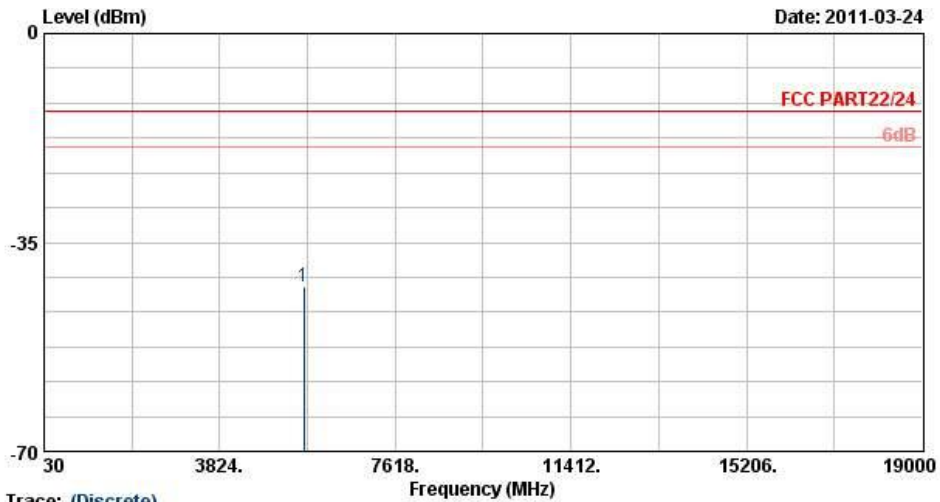

Trace: (Discrete)
 Site : D3CH07-HY
 Condition : FCC PART22/24 HF-ETRP(080306) HORIZONTAL
 Project : FG 121019

Frequency (MHz)	EIRP (dBm)	Limit (dBm)	Over Limit (dB)	SPA Reading (dBm)	S.G. Power (dBm)	TX Cable loss (dB)	TX Antenna Gain (dBi)	Polarization (H/V)	Result
5636	-42.47	-13	-29.47	-63.53	-50.18	2.99	10.70	H	Pass



Band :	GSM1900	Temperature :	22~24°C
Test Mode :	EDGE 8 Link for Sample 1	Relative Humidity :	46~51%
Test Engineer :	Ivan Chiang and Kai Wang	Polarization :	Vertical
Remark :	Spurious emissions within 30-1000MHz were found more than 20dB below limit line.		

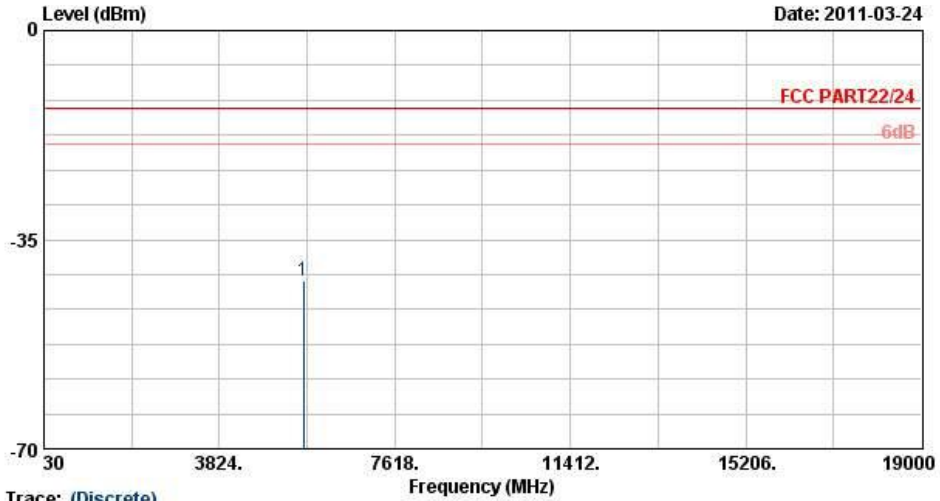

Trace: (Discrete)
 Site : D3CH07-HY
 Condition : FCC PART22/24 HF-ETRP(080306) VERTICAL
 Project : FG 121019

Frequency (MHz)	EIRP (dBm)	Limit (dBm)	Over Limit (dB)	SPA Reading (dBm)	S.G. Power (dBm)	TX Cable loss (dB)	TX Antenna Gain (dBi)	Polarization (H/V)	Result
5636	-41.94	-13	-28.94	-62.72	-49.65	2.99	10.70	V	Pass



Band :	GSM1900	Temperature :	22~24°C
Test Mode :	GSM Link for Sample 2	Relative Humidity :	46~51%
Test Engineer :	Ivan Chiang and Kai Wang	Polarization :	Horizontal
Remark :	1. Spurious emissions within 30-1000MHz were found more than 20dB below limit line. 2. Spurious emissions within 1000MHz ~ 10th harmonic were not found any signals.		

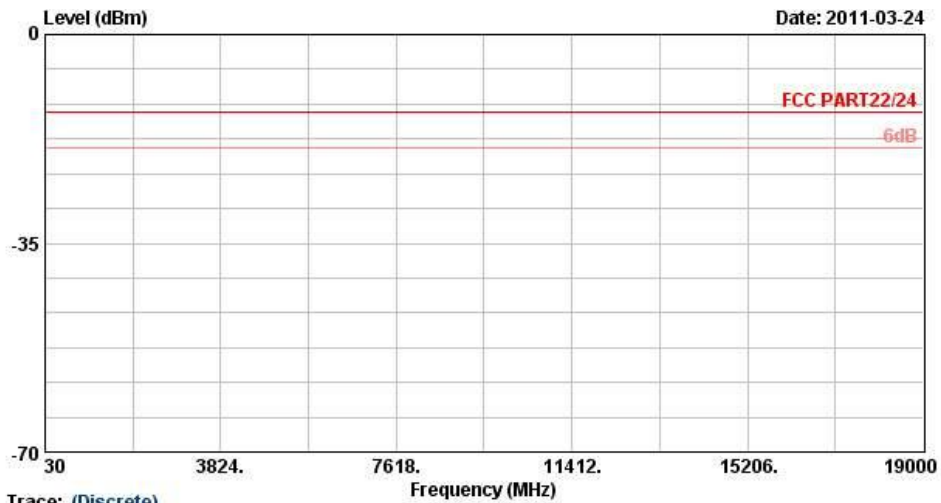

Site : D3CH07-HY
 Condition : FCC PART22/24 HF-ETRP(080306) HORIZONTAL
 Project : FG 121019



Band :	GSM1900	Temperature :	22~24°C
Test Mode :	GSM Link for Sample 2	Relative Humidity :	46~51%
Test Engineer :	Ivan Chiang and Kai Wang	Polarization :	Vertical
Remark :	1. Spurious emissions within 30-1000MHz were found more than 20dB below limit line. 2. Spurious emissions within 1000MHz ~ 10th harmonic were not found any signals.		

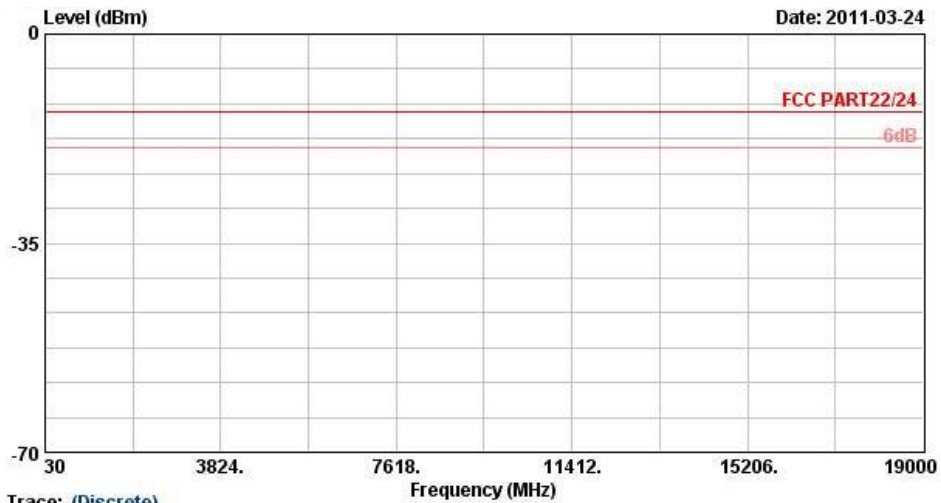

Trace: (Discrete)
 Site : 03CH07-HY
 Condition : FCC PART22/24 HF-ETRP(080306) VERTICAL
 Project : FG 121019



Band :	WCDMA Band IV	Temperature :	22~24°C
Test Mode :	RMC 12.2Kbps Link for Sample 1	Relative Humidity :	46~51%
Test Engineer :	Ivan Chiang and Kai Wang	Polarization :	Horizontal
Remark :	Spurious emissions within 30-1000MHz were found more than 20dB below limit line.		

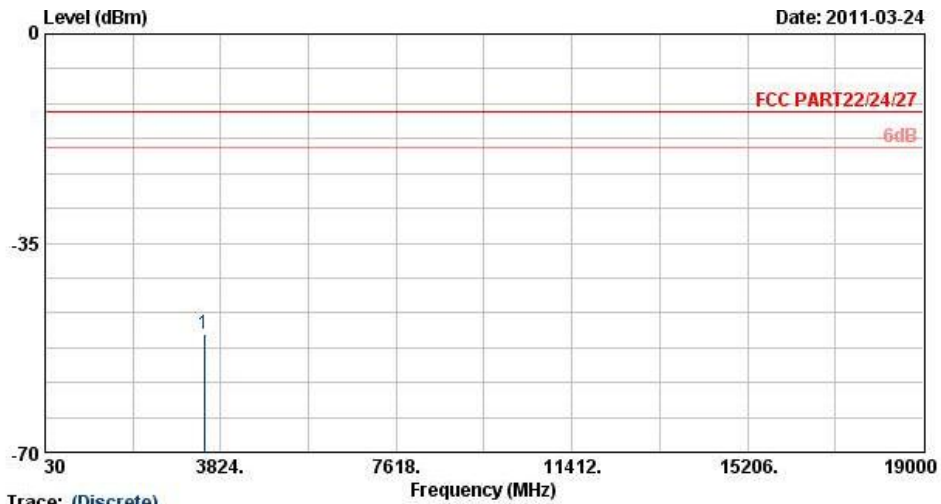

Trace: (Discrete)
 Site : 03CH07-HY
 Condition : FCC PART22/24/27 HF-ETRP(060306) HORIZONTAL
 Project : FG 121019

Frequency (MHz)	EIRP (dBm)	Limit (dBm)	Over Limit (dB)	SPA Reading (dBm)	S.G. Power (dBm)	TX Cable loss (dB)	TX Antenna Gain (dBi)	Polarization (H/V)	Result
3460	-50.32	-13	-37.32	-64.42	-54.15	4.48	8.31	H	Pass



Band :	WCDMA Band IV	Temperature :	22~24°C
Test Mode :	RMC 12.2Kbps Link for Sample 1	Relative Humidity :	46~51%
Test Engineer :	Ivan Chiang and Kai Wang	Polarization :	Vertical
Remark :	Spurious emissions within 30-1000MHz were found more than 20dB below limit line.		

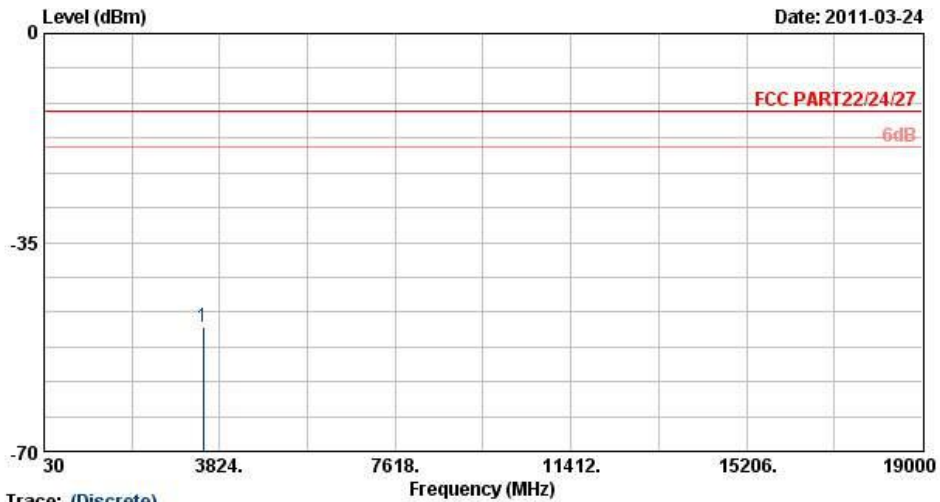

Trace: (Discrete)
 Site : D3CH07-HY
 Condition : FCC PART22/24/27 HF-ETRP(080306) VERTICAL
 Project : FG 121019

Frequency (MHz)	EIRP (dBm)	Limit (dBm)	Over Limit (dB)	SPA Reading (dBm)	S.G. Power (dBm)	TX Cable loss (dB)	TX Antenna Gain (dBi)	Polarization (H/V)	Result
3460	-49.18	-13	-36.18	-64.68	-53.01	4.48	8.31	V	Pass



Band :	WCDMA Band IV	Temperature :	22~24°C
Test Mode :	RMC 12.2Kbps Link for Sample 2	Relative Humidity :	46~51%
Test Engineer :	Ivan Chiang and Kai Wang	Polarization :	Horizontal
Remark :	Spurious emissions within 30-1000MHz were found more than 20dB below limit line.		

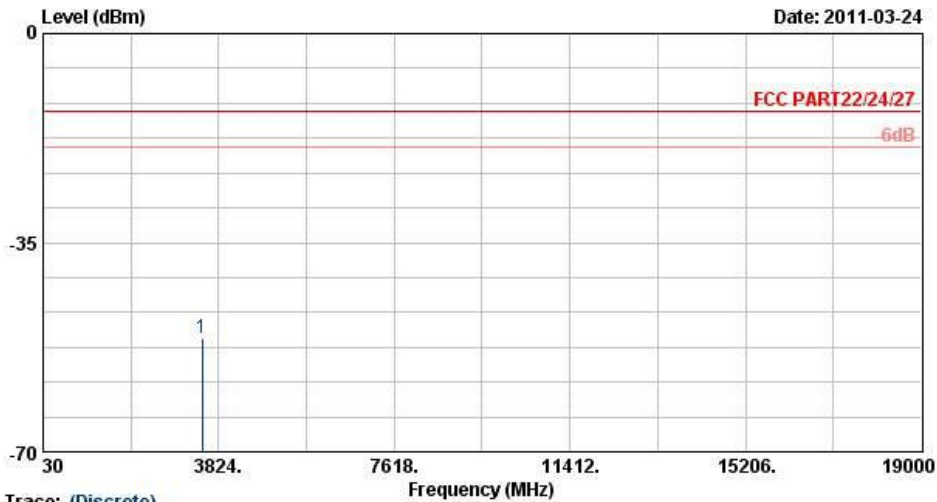

Trace: (Discrete)
 Site : 03CH07-HY
 Condition : FCC PART22/24/27 HF-ETRP(060306) HORIZONTAL
 Project : FC 121019

Frequency (MHz)	EIRP (dBm)	Limit (dBm)	Over Limit (dB)	SPA Reading (dBm)	S.G. Power (dBm)	TX Cable loss (dB)	TX Antenna Gain (dBi)	Polarization (H/V)	Result
3460	-50.95	-13	-37.95	-65.01	-54.78	4.48	8.31	H	Pass



Band :	WCDMA Band IV	Temperature :	22~24°C
Test Mode :	RMC 12.2Kbps Link for Sample 2	Relative Humidity :	46~51%
Test Engineer :	Ivan Chiang and Kai Wang	Polarization :	Vertical
Remark :	Spurious emissions within 30-1000MHz were found more than 20dB below limit line.		

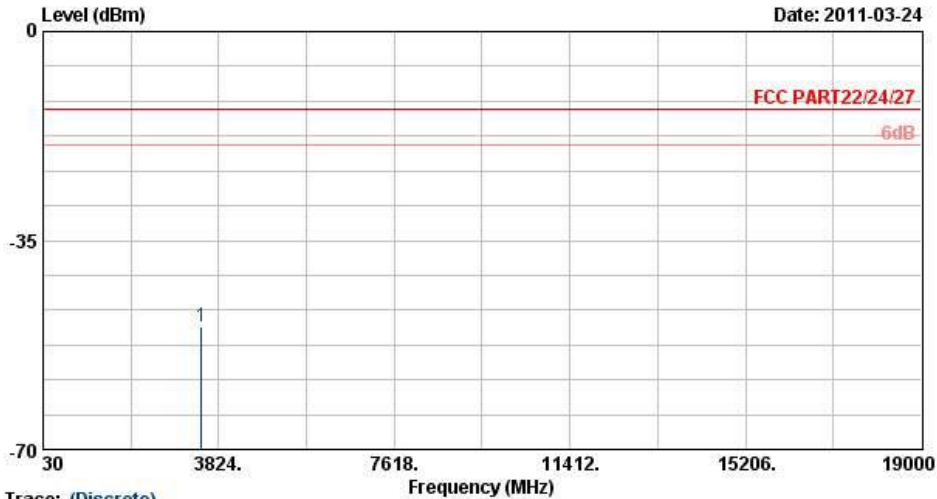

Trace: (Discrete)
 Site : 03CH07-HY
 Condition : FCC PART22/24/27 HF-ETRP(080306) VERTICAL
 Project : FG 121019

Frequency (MHz)	EIRP (dBm)	Limit (dBm)	Over Limit (dB)	SPA Reading (dBm)	S.G. Power (dBm)	TX Cable loss (dB)	TX Antenna Gain (dBi)	Polarization (H/V)	Result
3460	-49.43	-13	-36.43	-64.74	-53.26	4.48	8.31	V	Pass

3.7 Frequency Stability Measurement

3.7.1 Description of Frequency Stability Measurement

The frequency stability shall be measured by variation of ambient temperature and variation of primary supply voltage to ensure that the fundamental emission stays within the authorized frequency block. The frequency stability of the transmitter shall be maintained within $\pm 0.00025\%$ ($\pm 2.5\text{ppm}$) of the center frequency.

3.7.2 Measuring Instruments

See list of measuring instruments of this test report.

3.7.3 Test Procedures for Temperature Variation

1. The EUT was set up in the thermal chamber and connected with the base station.
2. With power OFF, the temperature was decreased to -30°C and the EUT was stabilized for three hours. Power was applied and the maximum change in frequency was recorded within one minute.
3. With power OFF, the temperature was raised in 10°C step up to 50°C . The EUT was stabilized at each step for at least half an hour. Power was applied and the maximum frequency change was recorded within one minute.
4. If the EUT can not be turned on at -30°C , the testing lowest temperature will be raised in 10°C step until the EUT can be turned on.

3.7.4 Test Procedures for Voltage Variation

1. The EUT was placed in a temperature chamber at $25\pm 5^{\circ}\text{C}$ and connected with the base station.
2. The power supply voltage to the EUT was varied from BEP to 115% of the nominal value measured at the input to the EUT.
3. The variation in frequency was measured for the worst case.

3.7.5 Test Setup

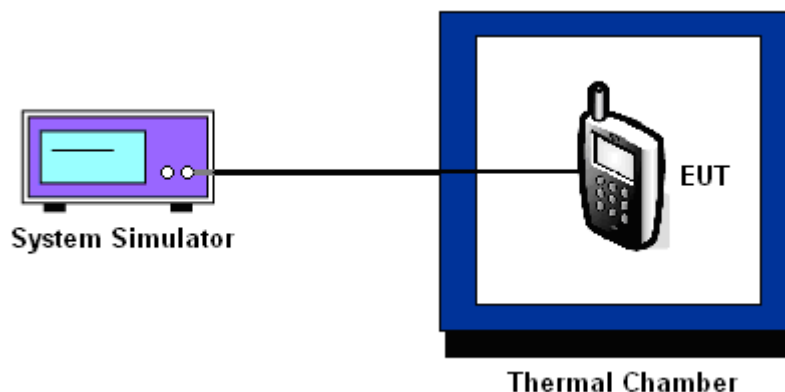

3.7.6 Test Result of Temperature Variation

Band :	GSM 850	Channel :	189
Limit (ppm) :	2.5		

Temperature (°C)	GSM		EDGE 8		Result
	Freq. Dev. (Hz)	Deviation (ppm)	Freq. Dev. (Hz)	Deviation (ppm)	
-30	N/A	N/A	N/A	N/A	PASS
-20	N/A	N/A	N/A	N/A	
-10	31	0.04	52	0.06	
0	-34	-0.04	42	0.05	
10	-24	-0.03	26	0.03	
20	-38	-0.04	-46	-0.05	
30	-29	-0.03	-41	-0.05	
40	-32	-0.04	-19	-0.02	
50	-6	-0.01	-37	-0.04	

Note:

1. The EUT stops transmitting at temperatures -20°C and -30°C.
2. The manufacturer declared that the EUT could work properly between temperatures -10°C~55°C.



Band :	GSM 1900	Channel :	661
Limit (ppm) :	2.5		

Temperature (°C)	GSM		EDGE 8		Result
	Freq. Dev. (Hz)	Deviation (ppm)	Freq. Dev. (Hz)	Deviation (ppm)	
-30	N/A	N/A	N/A	N/A	PASS
-20	N/A	N/A	N/A	N/A	
-10	24	0.01	81	0.04	
0	-31	-0.02	85	0.04	
10	-26	-0.01	50	0.03	
20	-32	-0.02	54	0.03	
30	-27	-0.01	-22	-0.01	
40	-16	-0.01	41	0.02	
50	24	0.01	-23	-0.01	

Note:

1. The EUT stops transmitting at temperatures -20°C and -30°C.
2. The manufacturer declared that the EUT could work properly between temperatures -10°C~55°C.



Band :	WCDMA Band IV	Channel :	1413
Limit (ppm) :	2.5		

Temperature (°C)	RMC 12.2Kbps		Result
	Freq. Dev. (Hz)	Deviation (ppm)	
-30	N/A	N/A	PASS
-20	N/A	N/A	
-10	-29	-0.02	
0	-32	-0.02	
10	-34	-0.02	
20	27	0.02	
30	34	0.02	
40	42	0.02	
50	30	0.02	

Note:

1. The EUT stops transmitting at temperatures -20°C and -30°C.
2. The manufacturer declared that the EUT could work properly between temperatures -10°C~55°C.

3.7.7 Test Result of Voltage Variation

Band & Channel	Mode	Voltage (Volt)	Freq. Dev. (Hz)	Deviation (ppm)	Limit (ppm)	Result
GSM 850 CH189	GSM	3.8	-12	-0.01	2.5	PASS
		BEP	-8	-0.01		
		4.2	-24	-0.03		
	EDGE 8	3.8	-17	-0.02		
		BEP	-22	-0.03		
		4.2	-25	-0.03		
GSM 1900 CH661	GSM	3.8	-33	-0.02		
		BEP	-20	-0.01		
		4.2	-29	-0.02		
	EDGE 8	3.8	40	0.02		
		BEP	-34	-0.02		
		4.2	-20	-0.01		
WCDMA Band IV CH1413	RMC 12.2Kbps	3.8	39	0.02		
		BEP	30	0.02		
		4.2	44	0.03		

Note:

1. Normal Voltage = 3.8V.
2. Battery End Point (BEP) = 3.6 V.

4 List of Measuring Equipments

Instrument	Manufacturer	Model No.	Serial No.	Characteristics	Calibration Date	Due Date	Remark
System Simulator	R&S	CMU200	117995	N/A	Jun. 08, 2009	Jun. 07, 2011	Conducted (TH02-HY)
Spectrum Analyzer	R&S	FSP40	100055	9kHz~40GHz	Jun. 11, 2010	Jun. 10, 2011	Conducted (TH02-HY)
Power Meter	Anritsu	ML2495A	0932001	N/A	Sep. 13, 2010	Sep. 12, 2011	Conducted (TH02-HY)
Power Sensor	Anritsu	MA2411B	0846202	N/A	Sep. 14, 2010	Sep. 13, 2011	Conducted (TH02-HY)
Thermal Chamber	Ten Billion	TTH-D35P	TBN-930701	N/A	Jul. 30, 2010	Jul. 29, 2011	Conducted (TH02-HY)
Bilog Antenna	SCHAFFNER	CBL6111C	2726	30MHz ~ 1GHz	Oct. 31, 2010	Oct. 30, 2011	Radiation (03CH07-HY)
Spectrum Analyzer	R&S	FSP	101067	9KHz ~ 30GHz	Dec. 03, 2010	Dec. 02, 2011	Radiation (03CH07-HY)
Double Ridge Horn Antenna	ESCO	3117	00075962	1GHz ~ 18GHz	Aug. 19, 2010	Aug. 18, 2011	Radiation (03CH07-HY)
SHF-EHF Horn Antenna	SCHWARZBECK	BBHA 9170	BBHA917025 1	15GHz- 40GHz	Oct. 18, 2010	Oct. 17, 2011	Radiation (03CH07-HY)
Pre Amplifier	Agilent	8449B	3008A02362	1GHz~ 26.5GHz	Dec. 06, 2010	Dec. 05, 2011	Radiation (03CH07-HY)
Pre Amplifier	COM-POWER	PA-103A	161241	10-1000MHz.32dB. GAIN	Mar. 29, 2011	Mar. 28, 2012	Radiation (03CH07-HY)
Loop Antenna	R&S	HFH2-Z2	860004/001	9 kHz~30 MHz	Jul. 29, 2010	Jul. 28, 2011	Radiation (03CH07-HY)
System Simulator	R&S	CMU200	117997	N/A	May 14, 2009	May 13, 2011	Radiation (03CH07-HY)

5 Uncertainty of Evaluation

Uncertainty of Radiated Emission Measurement (30 MHz ~ 1000 MHz)

Contribution	Uncertainty of X_i		$u(X_i)$
	dB	Probability Distribution	
Receiver Reading	0.41	Normal (k=2)	0.21
Antenna Factor Calibration	0.83	Normal (k=2)	0.42
Cable Loss Calibration	0.25	Normal (k=2)	0.13
Pre-Amplifier Gain Calibration	0.27	Normal (k=2)	0.14
RCV/SPA Specification	2.50	Rectangular	0.72
Antenna Factor Interpolation for Frequency	1.00	Rectangular	0.29
Site Imperfection	1.43	Rectangular	0.83
Mismatch	+0.39 / -0.41	U-Shape	0.28
Combined Standard Uncertainty $U_c(y)$	1.27		
Measuring Uncertainty for a Level of Confidence of 95% ($U = 2U_c(y)$)	2.54		

Uncertainty of Radiated Emission Measurement (1 GHz ~ 40 GHz)

Contribution	Uncertainty of X_i		$u(X_i)$	C_i	$C_i * u(X_i)$
	dB	Probability Distribution			
Receiver Reading	± 0.10	Normal (k=2)	0.10	1	0.10
Antenna Factor Calibration	± 1.70	Normal (k=2)	0.85	1	0.85
Cable Loss Calibration	± 0.50	Normal (k=2)	0.25	1	0.25
Receiver Correction	± 2.00	Rectangular	1.15	1	1.15
Antenna Factor Directional	± 1.50	Rectangular	0.87	1	0.87
Site Imperfection	± 2.80	Triangular	1.14	1	1.14
Mismatch Receiver VSWR $\Gamma_1 = 0.197$ Antenna VSWR $\Gamma_2 = 0.194$ Uncertainty = $20\text{Log}(1-\Gamma_1*\Gamma_2)$	+0.34 / -0.35	U-Shape	0.244	1	0.244
Combined Standard Uncertainty $U_c(y)$	2.36				
Measuring Uncertainty for a Level of Confidence of 95% ($U = 2U_c(y)$)	4.72				