

Variant FCC RF Test Report

APPLICANT : HTC Corporation
EQUIPMENT : Smart Phone
MODEL NAME : PG32100
FCC ID : NM8PG32100
STANDARD : FCC 47 CFR Part 2, 22(H), 24(E)
CLASSIFICATION : PCS Licensed Transmitter Held to Ear (PCE)
Tx/Rx FREQUENCY RANGE : CDMA2000 BC0 : 824.70 ~ 848.31 MHz /
869.70 ~ 893.31 MHz
CDMA2000 BC1 : 1851.25 ~ 1908.75 MHz /
1931.25 ~ 1988.75 MHz
MAX. ERP/EIRP POWER : <Battery 3>
CDMA2000 BC0 : 0.05 W
CDMA2000 BC1 : 0.20 W
<Battery 1 + Wireless Back Cover>
CDMA2000 BC0 : 0.09 W
CDMA2000 BC1 : 0.24 W

This is a variant report which is only valid together with the original test report. The product was received on Nov. 23, 2010 and completely tested on Mar. 19, 2011. We, SPORTON INTERNATIONAL INC., would like to declare that the tested sample has been evaluated in accordance with the procedures given in ANSI / TIA / EIA-603-C-2004 and shown compliance with the applicable technical standards.

The test results in this report apply exclusively to the tested model / sample. Without written approval of SPORTON INTERNATIONAL INC., the test report shall not be reproduced except in full.

Reviewed by:



Anderson Chiu / Deputy Manager



SPORTON INTERNATIONAL INC.

No. 52, Hwa Ya 1st Rd., Hwa Ya Technology Park, Kwei-Shan Hsiang, Tao Yuan Hsien, Taiwan, R.O.C.



TABLE OF CONTENTS

REVISION HISTORY..... 3

SUMMARY OF TEST RESULT 4

1 GENERAL DESCRIPTION 5

 1.1 Applicant..... 5

 1.2 Manufacturer 5

 1.3 Feature of Equipment Under Test..... 5

 1.4 Testing Site..... 6

 1.5 Applied Standards 6

 1.6 Ancillary Equipment List 6

2 TEST CONFIGURATION OF EQUIPMENT UNDER TEST 7

 2.1 Test Mode..... 7

 2.2 Connection Diagram of Test System 8

3 TEST RESULT 9

 3.1 Effective Radiated Power and Effective Isotropic Radiated Power Measurement 9

 3.2 Field Strength of Spurious Radiation Measurement 13

4 LIST OF MEASURING EQUIPMENT 23

5 UNCERTAINTY OF EVALUATION 24

APPENDIX A. SETUP PHOTOGRAPHS

APPENDIX B. ORIGINAL REPORT



SUMMARY OF TEST RESULT

Report Section	FCC Rule	IC Rule	Description	Limit	Result	Remark
3.1	§22.913(a)(2)	RSS-132(4.4) SRSP-503(5.1.3)	Effective Radiated Power	< 7 Watts	PASS	-
3.1	§24.232(c)	RSS-133 (6.4) SRSP-510(5.1.2)	Equivalent Isotropic Radiated Power	< 2 Watts	PASS	-
3.2	§2.1053 §22.917(a) §24.238(a)	RSS-132 (4.5.1) RSS-133 (6.5.1)	Field Strength of Spurious Radiation	< $43+10\log_{10}(P[\text{Watts}])$	PASS	Under limit 18.61 dB at 11280 MHz

1 General Description

1.1 Applicant

HTC Corporation
1F., No. 6-3, Baoqiang Rd., Xindian City, Taipei, Taiwan

1.2 Manufacturer

HTC Corporation
1F., No. 6-3, Baoqiang Rd., Xindian City, Taipei, Taiwan

1.3 Feature of Equipment Under Test

Product Feature & Specification	
Equipment	Smart Phone
Model Name	PG32100
FCC ID	NM8PG32100
Tx Frequency	CDMA2000 BC0 : 824 MHz ~ 849 MHz CDMA2000 BC1 : 1850 MHz ~1910 MHz
Rx Frequency	CDMA2000 BC0 : 869 MHz ~ 894 MHz CDMA2000 BC1 : 1930 MHz ~ 1990 MHz
Maximum ERP/EIRP	<Battery 3> CDMA2000 BC0 : 0.05 W (16.88 dBm) CDMA2000 BC1 : 0.20 W (22.91 dBm) <Battery 1 + Wireless Back Cover> CDMA2000 BC0 : 0.09 W (19.73 dBm) CDMA2000 BC1 : 0.24 W (23.78 dBm)
Antenna Type	Fixed Internal Antenna
Type of Modulation	QPSK
EUT Stage	Production Unit

Remark:

1. For other wireless features of this EUT, the test report will be issued separately.
2. This test report recorded only product characteristics and test results of PCS Licensed Transmitter Held to Ear (PCE).
3. The above EUT's information was declared by manufacturer. Please refer to the specifications or user's manual for more detailed description.

1.4 Testing Site

Test Site	SPORTON INTERNATIONAL INC.	
Test Site Location	No. 52, Hwa Ya 1 st Rd., Hwa Ya Technology Park, Kwei-Shan Hsiang, Tao Yuan Hsien, Taiwan, R.O.C. TEL: +886-3-327-3456 FAX: +886-3-328-4978	
Test Site No.	Sporton Site No.	FCC/IC Registration No.
	03CH06-HY	722060/4086B-1

1.5 Applied Standards

According to the specifications of the manufacturer, the EUT must comply with the requirements of the following standards:

- ♦ Preliminary Guidance for Receiving Applications for Certification of 3G Device. May 9, 2006.
- ♦ FCC 47 CFR Part 2, 22(H), 24(E)
- ♦ ANSI / TIA / EIA-603-C-2004
- ♦ IC RSS-132 Issue 2
- ♦ IC RSS-133 Issue 5

Remark:

1. All test items were verified and recorded according to the standards and without any deviation during the test.
2. This EUT has also been tested and complied with the requirements of FCC Part 15, Subpart B (DoC), recorded in a separate test report.

1.6 Ancillary Equipment List

Item	Equipment	Trade Name	Model No.	FCC ID	Data Cable	Power Cord
1.	System Simulator	R&S	CMU 200	N/A	N/A	Unshielded, 1.8 m
2.	Earphone	Merry	RC E160	N/A	N/A	N/A

2 Test Configuration of Equipment Under Test

2.1 Test Mode

During all testing, EUT is in link mode with base station emulator at maximum power level. The spurious emission measurements were carried out in semi-anechoic chamber with 3-meter test range, and EUT is rotated on three test planes to find out the worst emission.

Frequency range investigated for radiated emission is as follows:

1. 30 MHz to 9000 MHz for CDMA2000 BC0.
2. 30 MHz to 19000 MHz for CDMA2000 BC1.

Test Modes	
Band	Radiated TCs
CDMA2000 BC0	<ul style="list-style-type: none"> ■ 1xRTT Link Mode + Battery 3 + Earphone + USB Cable 2 (Charging from Adapter 2) ■ 1xRTT Link Mode + Battery 1 + Earphone + Wireless Back Cover + USB Cable 2 (Charging from Adapter 2)
CDMA2000 BC1	<ul style="list-style-type: none"> ■ 1xRTT Link Mode + Battery 3 + Earphone + USB Cable 2 (Charging from Adapter 2) ■ 1xRTT Link Mode + Battery 1 + Earphone + Wireless Back Cover + USB Cable 2 (Charging from Adapter 2)

2.2 Connection Diagram of Test System

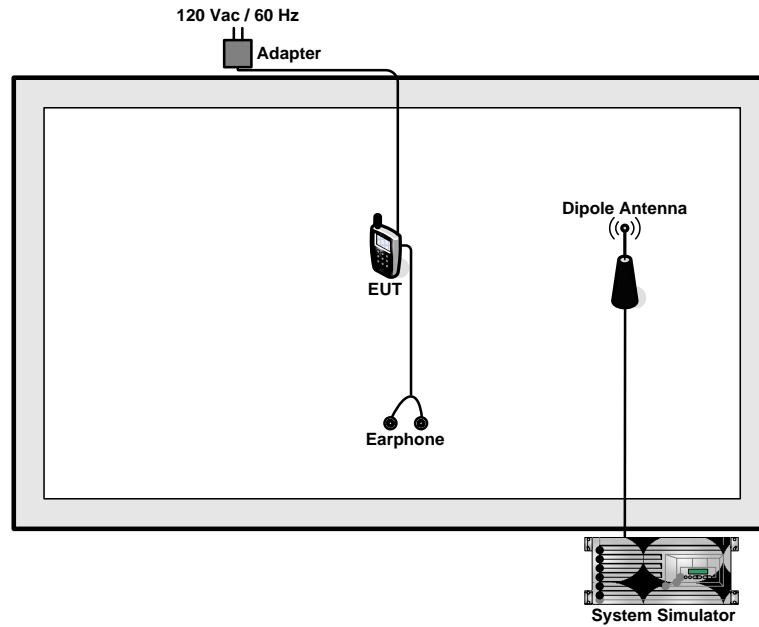



3 Test Result

3.1 Effective Radiated Power and Effective Isotropic Radiated Power Measurement

3.1.1 Description of the ERP/EIRP Measurement

ERP/EIRP is measured by substitution method according to ANSI / TIA / EIA-603-C-2004. The ERP of mobile transmitters must not exceed 7 Watts and the EIRP of mobile transmitters are limited to 2 Watts.

3.1.2 Measuring Instruments

See list of measuring instruments of this test report.

3.1.3 Test Procedures

1. The EUT was placed on a turntable with 1.0 meter height in a fully anechoic chamber.
2. The EUT was set at 1.2 meters from the receiving antenna, which was mounted on the antenna tower.
3. The table was rotated 360 degrees to determine the position of the highest radiated power.
4. The height of the receiving antenna is adjusted to look for the maximum ERP/EIRP.
5. Taking the record of maximum ERP/EIRP.
6. A dipole antenna was substituted in place of the EUT and was driven by a signal generator.
7. The conducted power at the terminal of the dipole antenna is measured.
8. Repeat step 3 to step 5 to get the maximum ERP/EIRP of the substitution antenna.
9. $ERP/EIRP = P_s + E_t - E_s + G_s = P_s + R_t - R_s + G_s$

P_s (dBm) : Input power to substitution antenna.

G_s (dBi or dBd) : Substitution antenna Gain.

$E_t = R_t + AF$

$E_s = R_s + AF$

AF (dB/m) : Receive antenna factor

R_t : The highest received signal in spectrum analyzer for EUT.

R_s : The highest received signal in spectrum analyzer for substitution antenna.

3.1.4 Test Setup

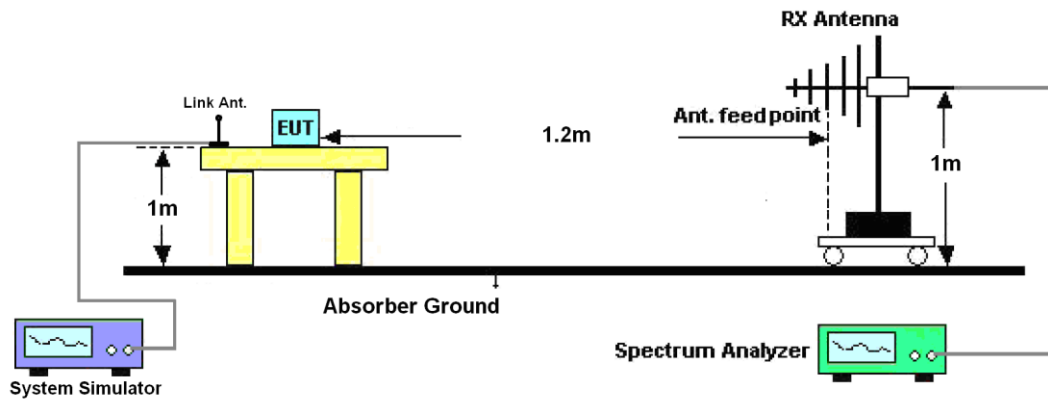



3.1.5 Test Result of ERP

CDMA2000 BC0 1xRTT_RC3+OS55 Radiated Power ERP for Batter 3						
Horizontal Polarization						
Frequency (MHz)	Rt (dBm)	Rs (dBm)	Ps (dBm)	Gs (dBd)	ERP (dBm)	ERP (W)
824.70	-30.73	-48.12	0.00	-1.08	16.31	0.04
836.52	-30.55	-48.28	0.00	-0.93	16.80	0.05
848.31	-30.71	-48.35	0.00	-0.76	16.88	0.05
Vertical Polarization						
Frequency (MHz)	Rt (dBm)	Rs (dBm)	Ps (dBm)	Gs (dBd)	ERP (dBm)	ERP (W)
824.70	-42.49	-47.97	0.00	-1.08	4.40	0.00
836.52	-42.39	-48.01	0.00	-0.93	4.69	0.00
848.31	-43.69	-48.05	0.00	-0.76	3.60	0.00

CDMA2000 BC0 1xRTT_RC3+OS55 Radiated Power ERP for Batter 1 + Wireless Back Cover						
Horizontal Polarization						
Frequency (MHz)	Rt (dBm)	Rs (dBm)	Ps (dBm)	Gs (dBd)	ERP (dBm)	ERP (W)
824.70	-27.50	-48.12	0.00	-1.08	19.54	0.09
836.52	-27.99	-48.28	0.00	-0.93	19.36	0.09
848.31	-27.86	-48.35	0.00	-0.76	19.73	0.09
Vertical Polarization						
Frequency (MHz)	Rt (dBm)	Rs (dBm)	Ps (dBm)	Gs (dBd)	ERP (dBm)	ERP (W)
824.70	-39.65	-47.97	0.00	-1.08	7.24	0.01
836.52	-40.45	-48.01	0.00	-0.93	6.63	0.00
848.31	-40.56	-48.05	0.00	-0.76	6.73	0.00



3.1.6 Test Result of EIRP

CDMA2000 BC1 1xRTT_ RC3+OS55 Radiated Power EIRP for Batter 3						
Horizontal Polarization						
Frequency (MHz)	Rt (dBm)	Rs (dBm)	Ps (dBm)	Gs (dBi)	EIRP (dBm)	EIRP (W)
1851.25	-31.79	-51.88	0.00	1.96	22.05	0.16
1880.00	-32.27	-52.99	0.00	2.00	22.72	0.19
1908.75	-33.35	-54.28	0.00	1.98	22.91	0.20
Vertical Polarization						
Frequency (MHz)	Rt (dBm)	Rs (dBm)	Ps (dBm)	Gs (dBi)	EIRP (dBm)	EIRP (W)
1851.25	-35.13	-52.13	0.00	1.96	18.96	0.08
1880.00	-36.03	-53.17	0.00	2.00	19.14	0.08
1908.75	-37.03	-54.13	0.00	1.98	19.08	0.08

CDMA2000 BC1 1xRTT_ RC3+OS55 Radiated Power EIRP for Batter 1 + Wireless Back Cover						
Horizontal Polarization						
Frequency (MHz)	Rt (dBm)	Rs (dBm)	Ps (dBm)	Gs (dBi)	EIRP (dBm)	EIRP (W)
1851.25	-30.72	-51.88	0.00	1.96	23.12	0.21
1880.00	-31.21	-52.99	0.00	2.00	23.78	0.24
1908.75	-32.63	-54.28	0.00	1.98	23.63	0.23
Vertical Polarization						
Frequency (MHz)	Rt (dBm)	Rs (dBm)	Ps (dBm)	Gs (dBi)	EIRP (dBm)	EIRP (W)
1851.25	-33.72	-52.13	0.00	1.96	20.37	0.11
1880.00	-35.12	-53.17	0.00	2.00	20.05	0.10
1908.75	-36.63	-54.13	0.00	1.98	19.48	0.09



3.2 Field Strength of Spurious Radiation Measurement

3.2.1 Description of Field Strength of Spurious Radiated Measurement

The radiated spurious emission was measured by substitution method according to ANSI / TIA / EIA-603-C-2004. The power of any emission outside of the authorized operating frequency ranges must be attenuated below the transmitter power (P) by a factor of at least $43+10\log_{10}(P[\text{Watts}])$ dB. The spectrum is scanned from 30 MHz up to a frequency including its 10th harmonic.

3.2.2 Measuring Instruments

See list of measuring instruments of this test report.

3.2.3 Test Procedures

1. The EUT was placed on a rotatable wooden table with 0.8 meter about ground.
2. The EUT was set 3 meters from the receiving antenna, which was mounted on the antenna tower.
3. The table was rotated 360 degrees to determine the position of the highest spurious emission.
4. The height of the receiving antenna is varied between one meter and four meters to search the maximum spurious emission for both horizontal and vertical polarizations.
5. Make the measurement with the spectrum analyzer's RBW = 1MHz, VBW = 3MHz, Sweep = 500ms, Taking the record of maximum spurious emission.
6. A horn antenna was substituted in place of the EUT and was driven by a signal generator.
7. Tune the output power of signal generator to the same emission level with EUT maximum spurious emission.
8. Taking the record of output power at antenna port.
9. Repeat step 7 to step 8 for another polarization.
10. $\text{EIRP (dBm)} = \text{S.G. Power} - \text{Tx Cable Loss} + \text{Tx Antenna Gain}$
11. $\text{ERP (dBm)} = \text{EIRP} - 2.15$

3.2.4 Test Setup

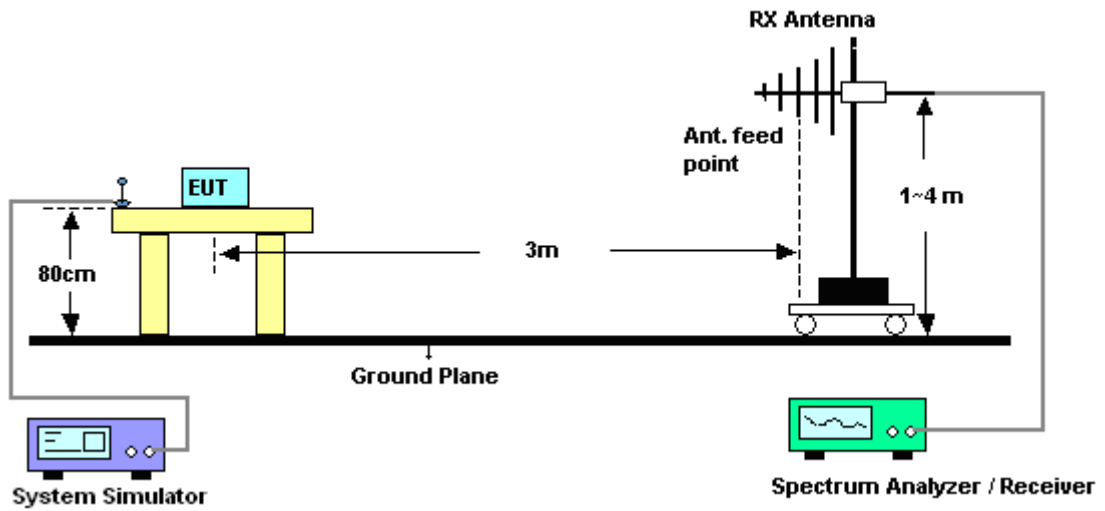



3.2.5 Test Result of Field Strength of Spurious Radiated

Band :	CDMA2000 BC0 + Battery 3 + Earphone + USB Cable 2 (Charging from Adapter 2)	Temperature :	23~24°C
Test Mode :	1xRTT_ RC3+OS55	Relative Humidity :	46~47%
Test Engineer :	Kay Wu	Polarization :	Horizontal
Remark :	Spurious emissions within 30-1000MHz were found more than 20dB below limit line.		

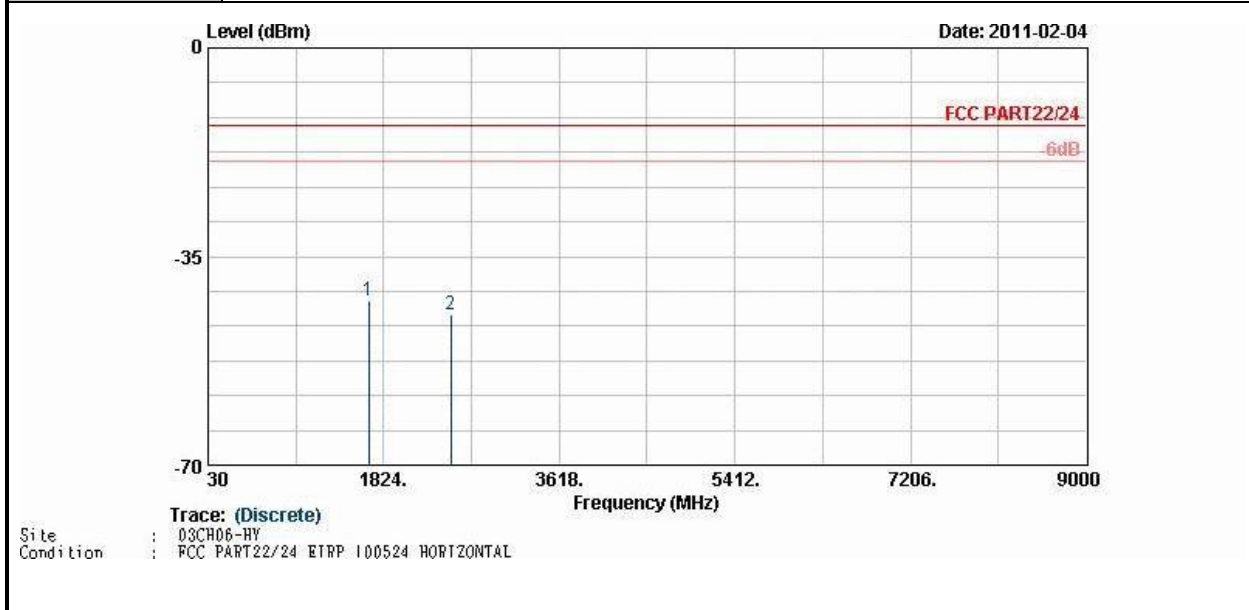

Frequency (MHz)	ERP (dBm)	Limit (dBm)	Over Limit (dB)	SPA Reading (dBm)	S.G. Power (dBm)	TX Cable loss (dB)	TX Antenna Gain (dBi)	Polarization (H/V)	Result
1672	-42.53	-13	-29.53	-53.11	-44.25	1.62	5.49	H	Pass
2509	-44.75	-13	-31.75	-57.32	-46.72	2.1	6.22	H	Pass



Band :	CDMA2000 BC0 + Battery 3 + Earphone + USB Cable 2 (Charging from Adapter 2)	Temperature :	23~24°C
Test Mode :	1xRTT_ RC3+OS55	Relative Humidity :	46~47%
Test Engineer :	Kay Wu	Polarization :	Vertical
Remark :	Spurious emissions within 30-1000MHz were found more than 20dB below limit line.		

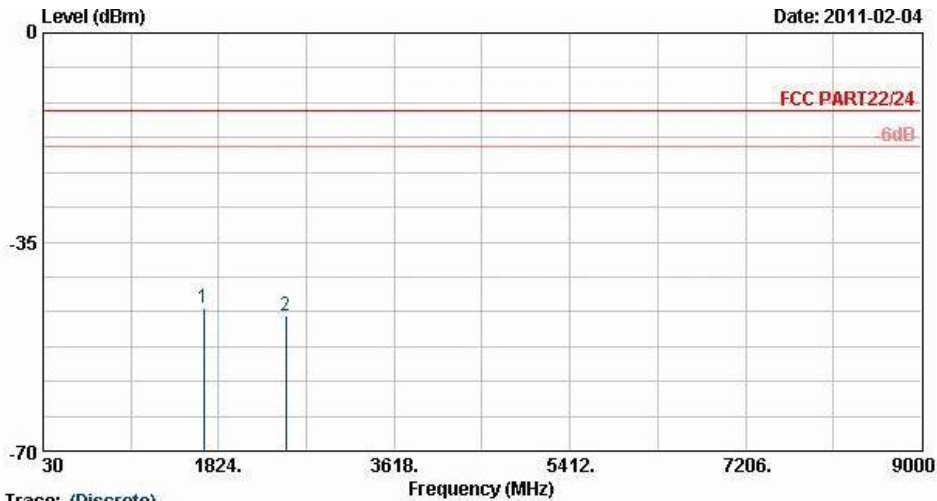

Trace: (Discrete)
 Site : 08CH06-HY
 Condition : FCC PART22/24 ERP 100524 VERTICAL

Frequency (MHz)	ERP (dBm)	Limit (dBm)	Over Limit (dB)	SPA Reading (dBm)	S.G. Power (dBm)	TX Cable loss (dB)	TX Antenna Gain (dBi)	Polarization (H/V)	Result
1672	-45.93	-13	-32.93	-56.58	-47.65	1.62	5.49	V	Pass
2509	-47.41	-13	-34.41	-59.86	-49.38	2.1	6.22	V	Pass



Band :	CDMA2000 BC0 + Battery 1 + Earphone + Wireless Back Cover + USB Cable 2 (Charging from Adapter 2)	Temperature :	23~24°C
Test Mode :	1xRTT_RC3+OS55	Relative Humidity :	46~47%
Test Engineer :	Kay Wu	Polarization :	Horizontal
Remark :	Spurious emissions within 30-1000MHz were found more than 20dB below limit line.		

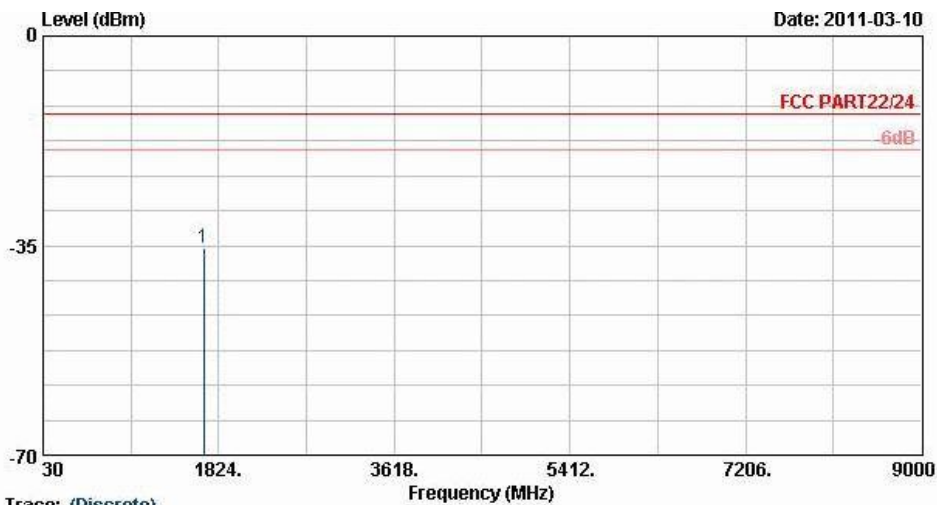

Trace: (Discrete)
 Site : 03CH06-HY
 Condition : FCC PART22/24 ETRP_100524 HORIZONTAL

Frequency (MHz)	ERP (dBm)	Limit (dBm)	Over Limit (dB)	SPA Reading (dBm)	S.G. Power (dBm)	TX Cable loss (dB)	TX Antenna Gain (dBi)	Polarization (H/V)	Result
1672	-35.45	-13	-22.45	-46.9	-37.17	1.62	5.49	H	Pass



Band :	CDMA2000 BC0 + Battery 1 + Earphone + Wireless Back Cover + USB Cable 2 (Charging from Adapter 2)	Temperature :	23~24°C
Test Mode :	1xRTT_RC3+OS55	Relative Humidity :	46~47%
Test Engineer :	Kay Wu	Polarization :	Vertical
Remark :	Spurious emissions within 30-1000MHz were found more than 20dB below limit line.		

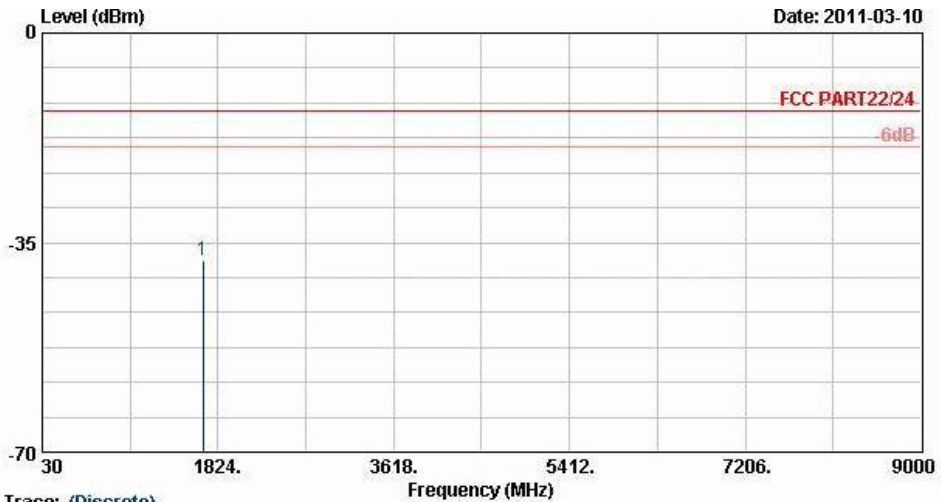

Trace: (Discrete)
 Site : 03CH06-HY
 Condition : FCC PART22/24 ETRP_100524 VERTICAL

Frequency (MHz)	ERP (dBm)	Limit (dBm)	Over Limit (dB)	SPA Reading (dBm)	S.G. Power (dBm)	TX Cable loss (dB)	TX Antenna Gain (dBi)	Polarization (H/V)	Result
1672	-37.99	-13	-24.99	-49.44	-39.71	1.62	5.49	V	Pass



Band :	CDMA2000 BC1 + Battery 3 + Earphone + USB Cable 2 (Charging from Adapter 2)	Temperature :	23~24°C
Test Mode :	1xRTT_ RC3+OS55	Relative Humidity :	46~47%
Test Engineer :	Kay Wu	Polarization :	Horizontal
Remark :	Spurious emissions within 30-1000MHz were found more than 20dB below limit line.		

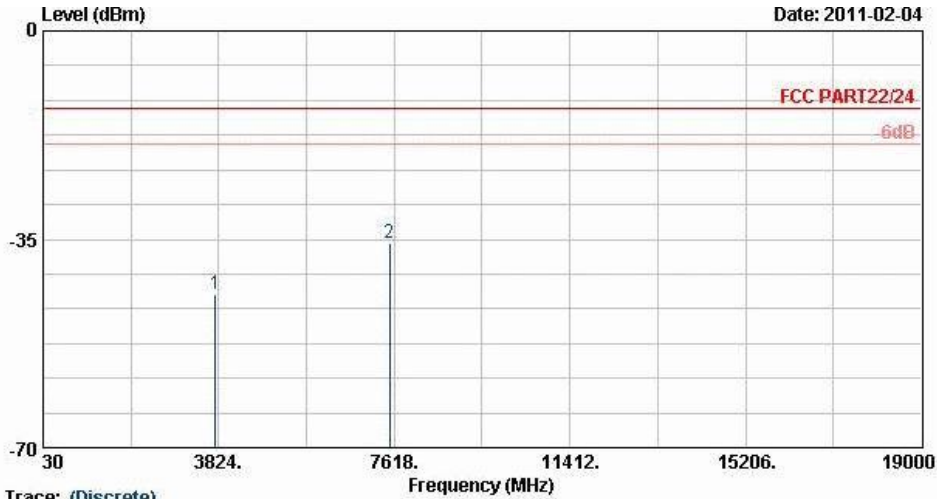

Trace: (Discrete)
 Site : 03CH06-HY
 Condition : FCC PART22/24 ETRP_I00524 HORIZONTAL

Frequency (MHz)	EIRP (dBm)	Limit (dBm)	Over Limit (dB)	SPA Reading (dBm)	S.G. Power (dBm)	TX Cable loss (dB)	TX Antenna Gain (dBi)	Polarization (H/V)	Result
3760	-44.24	-13	-31.24	-61.95	-50.49	2.56	8.81	H	Pass
7520	-35.66	-13	-22.66	-63.1	-44.56	3.22	12.12	H	Pass



Band :	CDMA2000 BC1 + Battery 3 + Earphone + USB Cable 2 (Charging from Adapter 2)	Temperature :	23~24°C
Test Mode :	1xRTT_ RC3+OS55	Relative Humidity :	46~47%
Test Engineer :	Kay Wu	Polarization :	Vertical
Remark :	Spurious emissions within 30-1000MHz were found more than 20dB below limit line.		

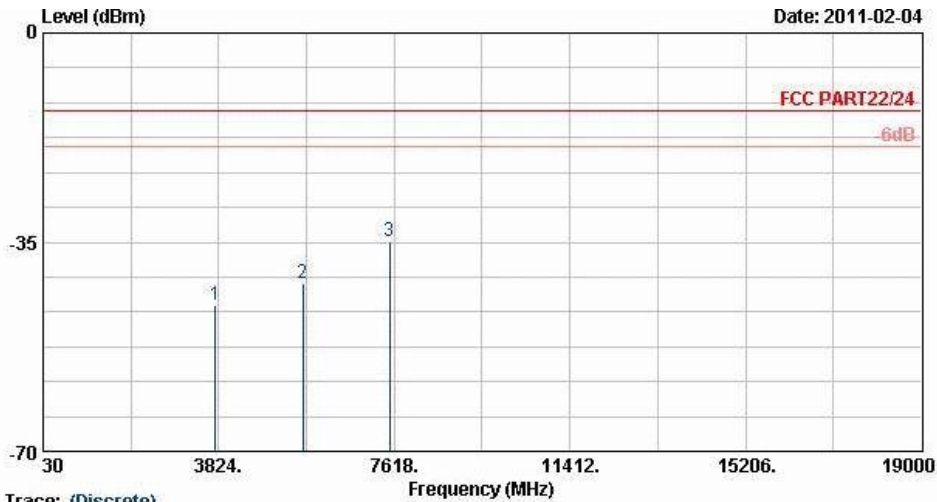

Site : 03CH06-HY
 Condition : FCC PART22/24 ETRP_I00524 VERTICAL

Frequency (MHz)	EIRP (dBm)	Limit (dBm)	Over Limit (dB)	SPA Reading (dBm)	S.G. Power (dBm)	TX Cable loss (dB)	TX Antenna Gain (dBi)	Polarization (H/V)	Result
3760	-45.44	-13	-32.44	-63.39	-51.69	2.56	8.81	V	Pass
5636	-41.77	-13	-28.77	-64.47	-49.51	2.96	10.70	V	Pass
7520	-34.83	-13	-21.83	-62.13	-43.73	3.22	12.12	V	Pass



Band :	CDMA2000 BC1 + Battery 1 + Earphone + Wireless Back Cover + USB Cable 2 (Charging from Adapter 2)	Temperature :	23~24°C
Test Mode :	1xRTT_RC3+OS55	Relative Humidity :	46~47%
Test Engineer :	Kay Wu	Polarization :	Horizontal
Remark :	Spurious emissions within 30-1000MHz were found more than 20dB below limit line.		

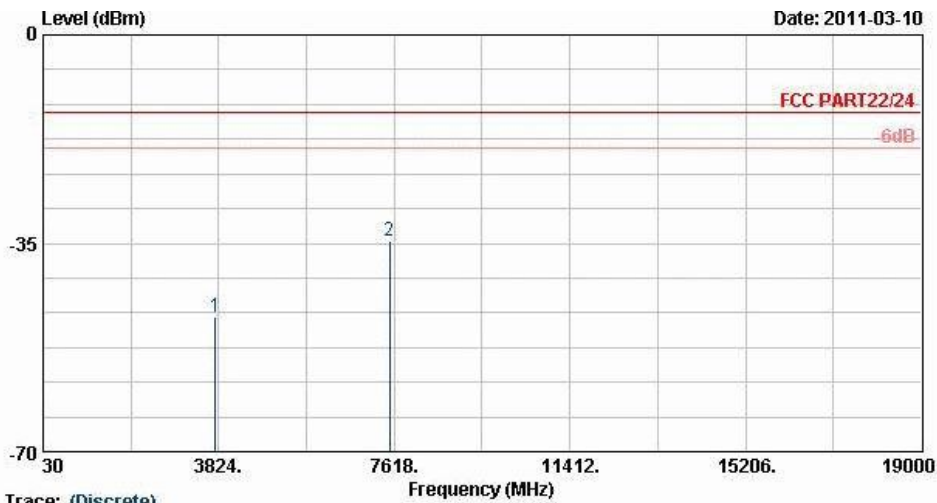

Trace: (Discrete)
 Site : 03CH06-HY
 Condition : FCC PART22/24 ETRP_100524 HORIZONTAL

Frequency (MHz)	EIRP (dBm)	Limit (dBm)	Over Limit (dB)	SPA Reading (dBm)	S.G. Power (dBm)	TX Cable loss (dB)	TX Antenna Gain (dBi)	Polarization (H/V)	Result
3760	-47.39	-13	-34.39	-61.55	-53.64	2.56	8.81	H	Pass
7520	-34.58	-13	-21.58	-60.81	-43.48	3.22	12.12	H	Pass



Band :	CDMA2000 BC1 + Battery 1 + Earphone + Wireless Back Cover + USB Cable 2 (Charging from Adapter 2)	Temperature :	23~24°C
Test Mode :	1xRTT_ RC3+OS55	Relative Humidity :	46~47%
Test Engineer :	Kay Wu	Polarization :	Vertical
Remark :	Spurious emissions within 30-1000MHz were found more than 20dB below limit line.		

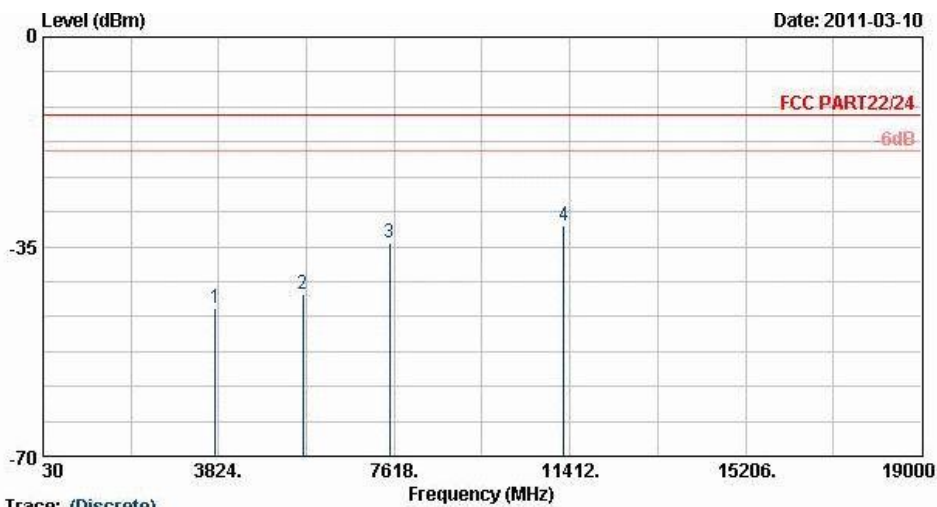

Trace: (Discrete)
 Site : 03CH06-RY
 Condition : FCC PART22/24 ETRP 100524 VERTICAL

Frequency (MHz)	EIRP (dBm)	Limit (dBm)	Over Limit (dB)	SPA Reading (dBm)	S.G. Power (dBm)	TX Cable loss (dB)	TX Antenna Gain (dBi)	Polarization (H/V)	Result
3760	-45.22	-13	-32.22	-59.37	-51.47	2.56	8.81	V	Pass
5636	-42.89	-13	-29.89	-63.82	-50.63	2.96	10.70	V	Pass
7520	-34.24	-13	-21.24	-60.47	-43.14	3.22	12.12	V	Pass
11280	-31.61	-13	-18.61	-61.99	-40.68	4.24	13.31	V	Pass



4 List of Measuring Equipment

Instrument	Manufacturer	Model No.	Serial No.	Characteristics	Calibration Date	Due Date	Remark
Spectrum Analyzer	R&S	FSP40	100057	9KHz-40GHz	Oct. 25, 2010	Oct. 24, 2011	Radiation (03CH06-HY)
EMI Test Receiver	R&S	ESVS10	834468/003	20MHz-1000MHz	Apr. 28, 2010	Apr. 27, 2011	Radiation (03CH06-HY)
Bilog Antenna	SCHAFFNER	CBL6112B	2885	30MHz -2GHz	Oct. 31, 2010	Oct. 31, 2011	Radiation (03CH06-HY)
Double Ridge Horn Antenna	EMCO	3117	00066583	1GHz~18GHz	Aug. 02, 2010	Aug. 01, 2011	Radiation (03CH06-HY)
Double Ridge Horn Antenna	Training Research	AH-0801	95119	8GHz~18GHz	Oct. 20, 2010	Oct. 19, 2011	Radiation (03CH06-HY)
SHF-EHF Horn Antenna	SCHWARZBECK	BBHA 9170	BBHA917025 1	15GHz- 40GHz	Oct. 18, 2010	Oct. 17, 2011	Radiation (03CH06-HY)
Pre Amplifier	Agilent	8449B	3008A01917	1GHz- 26.5GHz	Apr. 15, 2010	Apr. 14, 2011	Radiation (03CH06-HY)
Amplifier	Agilent	310N	186713	9KHz~1GHz	Apr. 15, 2010	Apr. 14, 2011	Radiation (03CH06-HY)
Loop Antenna	R&S	HFH2-Z2	860004/001	9 kHz~30 MHz	Jul. 29, 2010	Jul. 28, 2011	Radiation (03CH06-HY)
System Simulator	R&S	CMU200	116457	N/A	Jun. 08, 2009	Jun. 07, 2011	Radiation (03CH06-HY)

5 Uncertainty of Evaluation

Uncertainty of Radiated Emission Measurement (30 MHz ~ 1000 MHz)

Contribution	Uncertainty of X_i		$u(X_i)$
	dB	Probability Distribution	
Receiver Reading	0.41	Normal (k=2)	0.21
Antenna Factor Calibration	0.83	Normal (k=2)	0.42
Cable Loss Calibration	0.25	Normal (k=2)	0.13
Pre-Amplifier Gain Calibration	0.27	Normal (k=2)	0.14
RCV/SPA Specification	2.50	Rectangular	0.72
Antenna Factor Interpolation for Frequency	1.00	Rectangular	0.29
Site Imperfection	1.43	Rectangular	0.83
Mismatch	+0.39 / -0.41	U-Shape	0.28
Combined Standard Uncertainty $U_c(y)$	1.27		
Measuring Uncertainty for a Level of Confidence of 95% ($U = 2U_c(y)$)	2.54		

Uncertainty of Radiated Emission Measurement (1 GHz ~ 40 GHz)

Contribution	Uncertainty of X_i		$u(X_i)$	C_i	$C_i * u(X_i)$
	dB	Probability Distribution			
Receiver Reading	± 0.10	Normal (k=2)	0.10	1	0.10
Antenna Factor Calibration	± 1.70	Normal (k=2)	0.85	1	0.85
Cable Loss Calibration	± 0.50	Normal (k=2)	0.25	1	0.25
Receiver Correction	± 2.00	Rectangular	1.15	1	1.15
Antenna Factor Directional	± 1.50	Rectangular	0.87	1	0.87
Site Imperfection	± 2.80	Triangular	1.14	1	1.14
Mismatch Receiver VSWR $\Gamma_1 = 0.197$ Antenna VSWR $\Gamma_2 = 0.194$ Uncertainty = $20\text{Log}(1-\Gamma_1*\Gamma_2)$	+0.34 / -0.35	U-Shape	0.244	1	0.244
Combined Standard Uncertainty $U_c(y)$	2.36				
Measuring Uncertainty for a Level of Confidence of 95% ($U = 2U_c(y)$)	4.72				

Appendix A. Setup Photographs

<Radiated Emission>

Battery 3

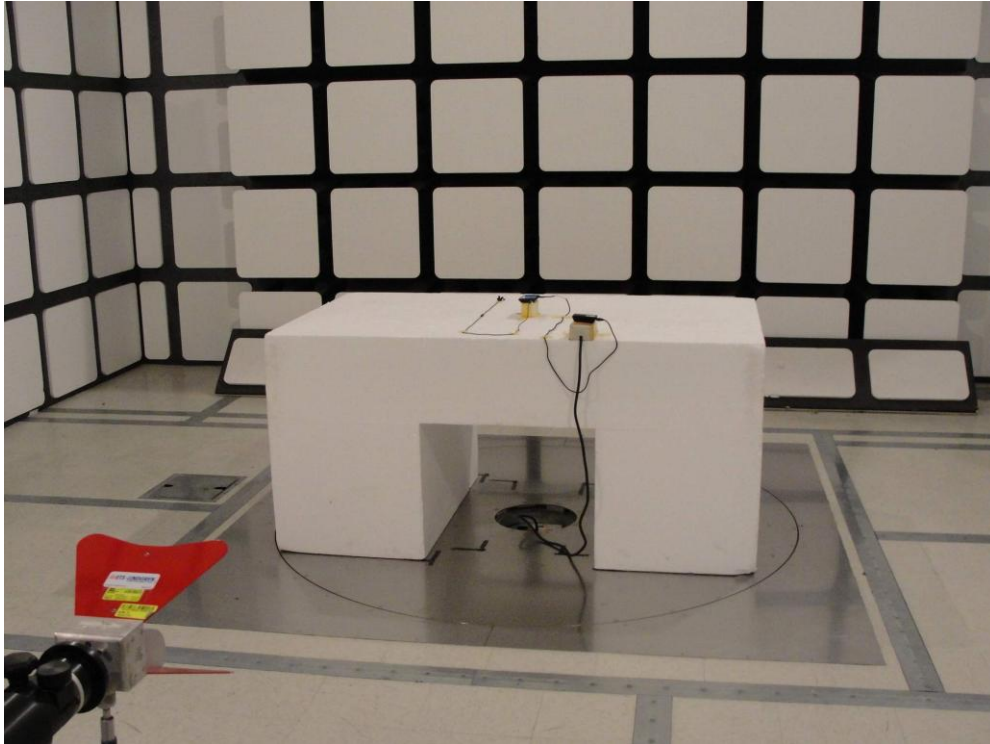

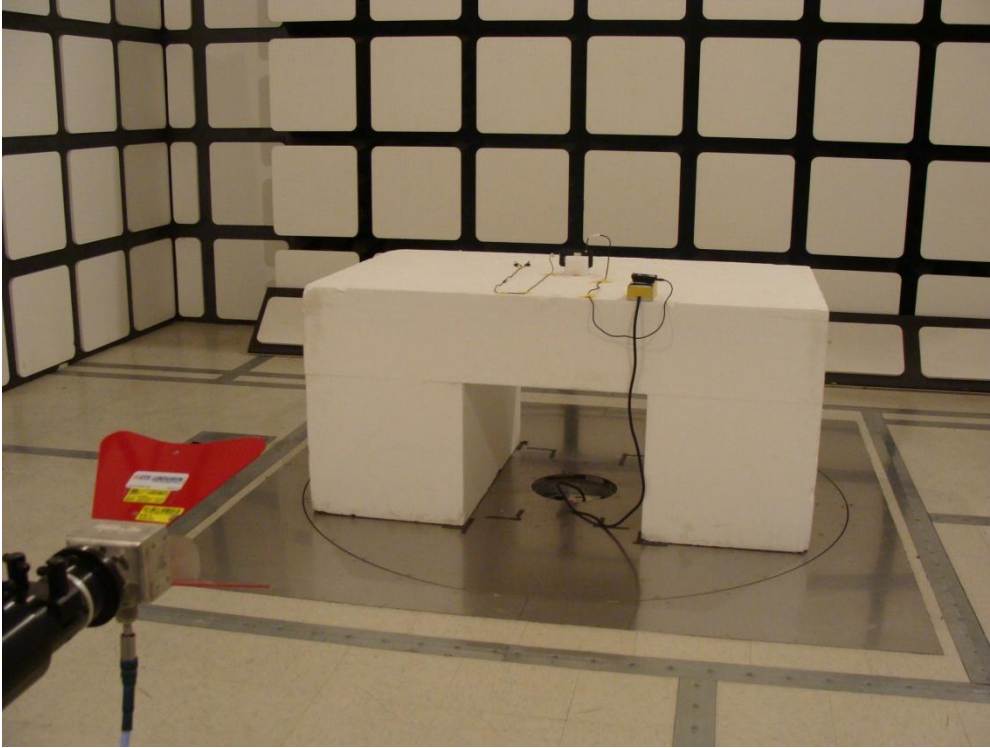
Battery 1 + Wireless Back Cover



Appendix B. Original Report

Please refer to Sporton report number FG0N2344-01 as below.



FCC RF Test Report

APPLICANT : HTC Corporation
EQUIPMENT : Smart Phone
MODEL NAME : PG32100
FCC ID : NM8PG32100
STANDARD : FCC 47 CFR Part 2, 22(H), 24(E)
CLASSIFICATION : PCS Licensed Transmitter Held to Ear (PCE)
Tx/Rx FREQUENCY RANGE : CDMA2000 BC0 : 824.70 ~ 848.31 MHz /
869.70 ~ 893.31 MHz
CDMA2000 BC1 : 1851.25 ~ 1908.75 MHz /
1931.25 ~ 1988.75 MHz
MAX. ERP/EIRP POWER : CDMA2000 BC0 : 0.14 W
CDMA2000 BC1 : 0.25 W
EMISSION DESIGNATOR : 1M28F9W

The product was received on Nov. 23, 2010 and completely tested on Dec. 24, 2010. We, SPORTON INTERNATIONAL INC., would like to declare that the tested sample has been evaluated in accordance with the procedures given in ANSI / TIA / EIA-603-C-2004 and shown compliance with the applicable technical standards.

The test results in this report apply exclusively to the tested model / sample. Without written approval of SPORTON INTERNATIONAL INC., the test report shall not be reproduced except in full.

Reviewed by:

Anderson Chiu

Anderson Chiu / Deputy Manager



SPORTON INTERNATIONAL INC.

No. 52, Hwa Ya 1st Rd., Hwa Ya Technology Park, Kwei-Shan Hsiang, Tao Yuan Hsien, Taiwan, R.O.C.



TABLE OF CONTENTS

REVISION HISTORY..... 3

SUMMARY OF TEST RESULT 4

1 GENERAL DESCRIPTION 5

 1.1 Applicant..... 5

 1.2 Manufacturer 5

 1.3 Feature of Equipment Under Test..... 5

 1.4 Testing Site..... 6

 1.5 Applied Standards 6

 1.6 Ancillary Equipment List 6

2 TEST CONFIGURATION OF EQUIPMENT UNDER TEST 7

 2.1 Test Mode..... 7

 2.2 Connection Diagram of Test System 8

3 TEST RESULT..... 9

 3.1 Conducted Output Power Measurement..... 9

 3.2 Effective Radiated Power and Effective Isotropic Radiated Power Measurement 11

 3.3 Occupied Bandwidth Measurement 14

 3.4 Band Edge Measurement..... 17

 3.5 Conducted Emission Measurement 20

 3.6 Field Strength of Spurious Radiation Measurement 26

 3.7 Frequency Stability Measurement..... 32

4 LIST OF MEASURING EQUIPMENT 36

5 UNCERTAINTY OF EVALUATION 37

APPENDIX A. SETUP PHOTOGRAPHS



REVISION HISTORY

REPORT NO.	VERSION	DESCRIPTION	ISSUED DATE
FG0N2344-01	Rev. 01	Initial issue of report	Jan. 14, 2011



SUMMARY OF TEST RESULT

Report Section	FCC Rule	IC Rule	Description	Limit	Result	Remark
3.1	§2.1046	N/A	Conducted Output Power	N/A	PASS	-
3.2	§22.913(a)(2)	RSS-132(4.4) SRSP-503(5.1.3)	Effective Radiated Power	< 7 Watts	PASS	-
3.2	§24.232(c)	RSS-133 (6.4) SRSP-510(5.1.2)	Equivalent Isotropic Radiated Power	< 2 Watts	PASS	-
3.3	§2.1049 §22.917(a) §24.238(a)	N/A	Occupied Bandwidth	N/A	PASS	-
3.4	§2.1051 §22.917(a) §24.238(a)	RSS-132 (4.5.1) RSS-133 (6.5.1)	Band Edge Measurement	< 43+10log ₁₀ (P[Watts])	PASS	-
3.5	§2.1051 §22.917(a) §24.238(a)	RSS-132 (4.5.1) RSS-133 (6.5.1)	Conducted Emission	< 43+10log ₁₀ (P[Watts])	PASS	-
3.6	§2.1053 §22.917(a) §24.238(a)	RSS-132 (4.5.1) RSS-133 (6.5.1)	Field Strength of Spurious Radiation	< 43+10log ₁₀ (P[Watts])	PASS	Under limit 14.60 dB at 1669 MHz
3.7	§2.1055 §22.355 §24.235	RSS-132(4.3) RSS-133(6.3)	Frequency Stability for Temperature & Voltage	< 2.5 ppm	PASS	-



1 General Description

1.1 Applicant

HTC Corporation

1F., No. 6-3, Baoqiang Rd., Xindian City, Taipei, Taiwan

1.2 Manufacturer

HTC Corporation

1F., No. 6-3, Baoqiang Rd., Xindian City, Taipei, Taiwan

1.3 Feature of Equipment Under Test

Product Feature & Specification	
Equipment	Smart Phone
Model Name	PG32100
FCC ID	NM8PG32100
Tx Frequency	CDMA2000 BC0 : 824 MHz ~ 849 MHz CDMA2000 BC1 : 1850 MHz ~1910 MHz
Rx Frequency	CDMA2000 BC0 : 869 MHz ~ 894 MHz CDMA2000 BC1 : 1930 MHz ~ 1990 MHz
Maximum Output Power to Antenna	CDMA2000 BC0 : 24.14 dBm CDMA2000 BC1 : 24.24 dBm
Maximum ERP/EIRP	CDMA2000 BC0 : 0.14 W (21.35 dBm) CDMA2000 BC1 : 0.25 W (23.91 dBm)
Antenna Type	Fixed Internal Antenna
Type of Modulation	QPSK
Type of Emission	1M28F9W
EUT Stage	Production Unit

Remark:

1. For other wireless features of this EUT, the test report will be issued separately.
2. This test report recorded only product characteristics and test results of PCS Licensed Transmitter Held to Ear (PCE).
3. The above EUT's information was declared by manufacturer. Please refer to the specifications or user's manual for more detailed description.



1.4 Testing Site

Test Site	SPORTON INTERNATIONAL INC.		
Test Site Location	No. 52, Hwa Ya 1 st Rd., Hwa Ya Technology Park, Kwei-Shan Hsiang, Tao Yuan Hsien, Taiwan, R.O.C. TEL: +886-3-327-3456 FAX: +886-3-328-4978		
Test Site No.	Sporton Site No.		FCC/IC Registration No.
	TH02-HY	03CH05-HY	722060/4086B-1

1.5 Applied Standards

According to the specifications of the manufacturer, the EUT must comply with the requirements of the following standards:

- ♦ Preliminary Guidance for Receiving Applications for Certification of 3G Device. May 9, 2006.
- ♦ FCC 47 CFR Part 2, 22(H), 24(E)
- ♦ ANSI / TIA / EIA-603-C-2004
- ♦ IC RSS-132 Issue 2
- ♦ IC RSS-133 Issue 5

Remark:

1. All test items were verified and recorded according to the standards and without any deviation during the test.
2. This EUT has also been tested and complied with the requirements of FCC Part 15, Subpart B (DoC), recorded in a separate test report.

1.6 Ancillary Equipment List

Item	Equipment	Trade Name	Model No.	FCC ID	Data Cable	Power Cord
1.	System Simulator	R&S	CMU 200	N/A	N/A	Unshielded, 1.8 m
2.	Earphone	Merry	RC E160	N/A	N/A	N/A

2 Test Configuration of Equipment Under Test

2.1 Test Mode

During all testing, EUT is in link mode with base station emulator at maximum power level. The spurious emission measurements were carried out in semi-anechoic chamber with 3-meter test range, and EUT is rotated on three test planes to find out the worst emission.

Frequency range investigated for radiated emission is as follows:

1. 30 MHz to 9000 MHz for CDMA2000 BC0.
2. 30 MHz to 19000 MHz for CDMA2000 BC1.

Test Modes		
Band	Radiated TCs	Conducted TCs
CDMA2000 BC0	■ 1xRTT Link Mode	■ 1xRTT Link Mode
CDMA2000 BC1	■ 1xRTT Link Mode	■ 1xRTT Link Mode

Note:

1. The maximum RF output power levels are 1xRTT RC3+SO55 mode for CDMA2000 BC0 and CDMA2000 BC1 on QPSK Link; only these modes were used for all tests.
2. Because there are individual antennas for each WWAN, WLAN, and Bluetooth, the co-location test modes are not required.

The conducted power table is as follows:

Band	Conducted Power (*Unit: dBm)					
	CDMA2000 BC0			CDMA2000 BC1		
Channel	1013	384	777	25	600	1175
Frequency	824.7	836.52	848.31	1851.25	1880	1908.75
1xRTT RC1+SO55	24.02	24.00	23.97	24.10	24.19	23.95
1xRTT RC3+SO55	24.05	24.14	24.00	24.12	24.24	24.09
1xRTT RC3+SO32 (FCH)	24.02	24.09	23.90	24.08	24.23	23.97
1xRTT RC3+SO32 (SCH)	24.00	24.01	23.87	23.06	23.24	23.96
1xEVDO RTAP 153.6K	24.13	24.13	24.05	24.19	23.23	24.05
1xEVDO RETAP 4096K	24.09	24.13	24.10	24.11	24.23	24.12

2.2 Connection Diagram of Test System

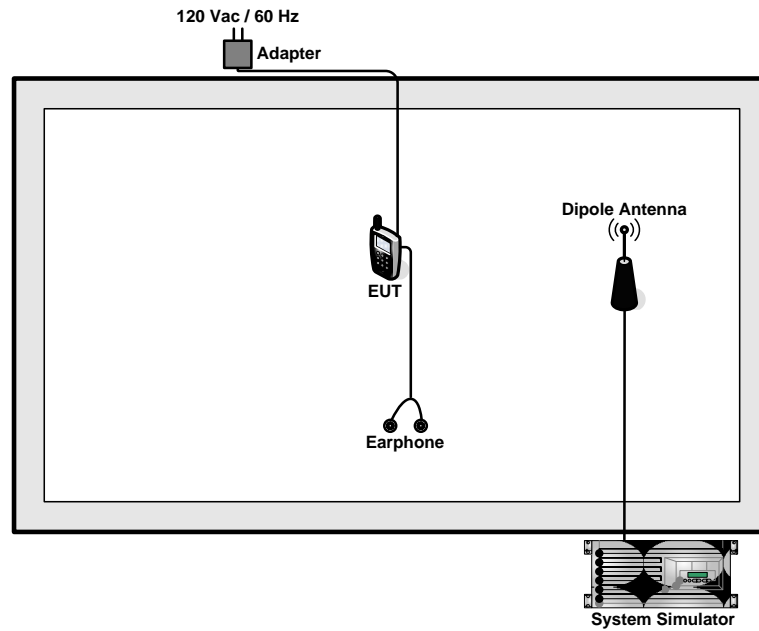

3 Test Result

3.1 Conducted Output Power Measurement

3.1.1 Description of the Conducted Output Power Measurement

A base station simulator was used to establish communication with the EUT. Its parameters were set to transmit the maximum power on the EUT. The measured power in the radio frequency on the transmitter output terminals shall be reported.

3.1.2 Measuring Instruments

See list of measuring instruments of this test report.

3.1.3 Test Procedures

1. The transmitter output port was connected to base station.
2. Set EUT at maximum power through base station.
3. Select lowest, middle, and highest channels for each band and different modulation.

3.1.4 Test Setup

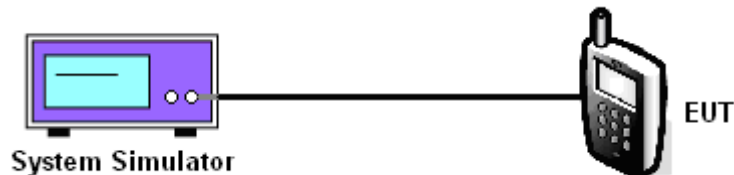



3.1.5 Test Result of Conducted Output Power

CDMA2000 BC0					
Test Mode	Test Status	Channel	Frequency (MHz)	Conducted Power (dBm)	Conducted Power (Watts)
CDMA 2000 1xRTT	RC3+SO55	1013 (Low)	824.70	24.05	0.25
		384 (Mid)	836.52	24.14	0.26
		777 (High)	848.31	24.00	0.25

CDMA2000 BC1					
Test Mode	Test Status	Channel	Frequency (MHz)	Conducted Power (dBm)	Conducted Power (Watts)
CDMA 2000 1xRTT	RC3+SO55	25 (Low)	1851.25	24.12	0.26
		600 (Mid)	1880.00	24.24	0.27
		1175 (High)	1908.75	24.09	0.26



3.2 Effective Radiated Power and Effective Isotropic Radiated Power Measurement

3.2.1 Description of the ERP/EIRP Measurement

ERP/EIRP is measured by substitution method according to ANSI / TIA / EIA-603-C-2004. The ERP of mobile transmitters must not exceed 7 Watts and the EIRP of mobile transmitters are limited to 2 Watts.

3.2.2 Measuring Instruments

See list of measuring instruments of this test report.

3.2.3 Test Procedures

1. The EUT was placed on a turntable with 1.0 meter height in a fully anechoic chamber.
2. The EUT was set at 1.2 meters from the receiving antenna, which was mounted on the antenna tower.
3. The table was rotated 360 degrees to determine the position of the highest radiated power.
4. The height of the receiving antenna is adjusted to look for the maximum ERP/EIRP.
5. Taking the record of maximum ERP/EIRP.
6. A dipole antenna was substituted in place of the EUT and was driven by a signal generator.
7. The conducted power at the terminal of the dipole antenna is measured.
8. Repeat step 3 to step 5 to get the maximum ERP/EIRP of the substitution antenna.
9. $ERP/EIRP = P_s + E_t - E_s + G_s = P_s + R_t - R_s + G_s$

P_s (dBm) : Input power to substitution antenna.

G_s (dBi or dBd) : Substitution antenna Gain.

$E_t = R_t + AF$

$E_s = R_s + AF$

AF (dB/m) : Receive antenna factor

R_t : The highest received signal in spectrum analyzer for EUT.

R_s : The highest received signal in spectrum analyzer for substitution antenna.

3.2.4 Test Setup

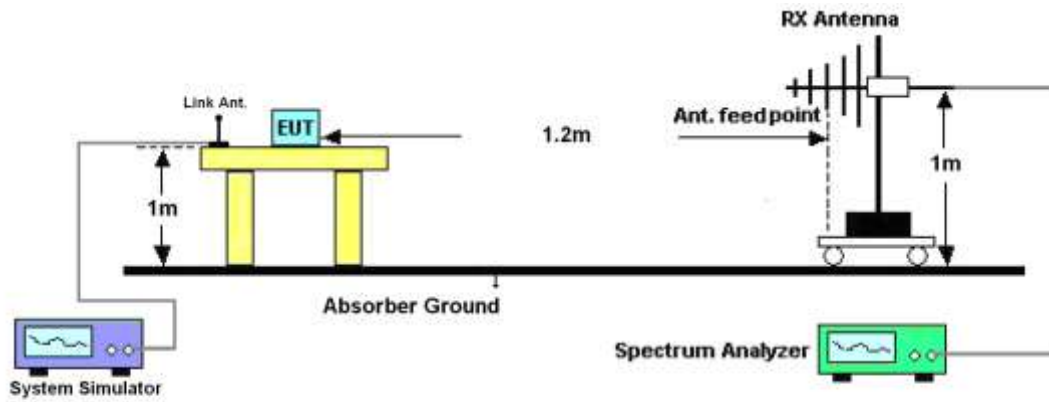



3.2.5 Test Result of ERP

CDMA2000 BC0 1xRTT_RC3+SO55 Radiated Power ERP						
Horizontal Polarization						
Frequency (MHz)	Rt (dBm)	Rs (dBm)	Ps (dBm)	Gs (dBd)	ERP (dBm)	ERP (W)
824.70	-27.18	-48.12	0.00	-1.08	19.86	0.10
836.52	-26.47	-48.28	0.00	-0.93	20.88	0.12
848.31	-26.24	-48.35	0.00	-0.76	21.35	0.14
Vertical Polarization						
Frequency (MHz)	Rt (dBm)	Rs (dBm)	Ps (dBm)	Gs (dBd)	ERP (dBm)	ERP (W)
824.70	-41.52	-47.97	0.00	-1.08	5.37	0.00
836.52	-41.31	-48.01	0.00	-0.93	5.77	0.00
848.31	-40.92	-48.05	0.00	-0.76	6.37	0.00

3.2.6 Test Result of EIRP

CDMA2000 BC1 1xRTT_RC3+SO55 Radiated Power EIRP						
Horizontal Polarization						
Frequency (MHz)	Rt (dBm)	Rs (dBm)	Ps (dBm)	Gs (dBi)	EIRP (dBm)	EIRP (W)
1851.25	-30.41	-51.88	0.00	1.96	23.43	0.22
1880.00	-31.51	-52.99	0.00	2.00	23.48	0.22
1908.75	-32.35	-54.28	0.00	1.98	23.91	0.25
Vertical Polarization						
Frequency (MHz)	Rt (dBm)	Rs (dBm)	Ps (dBm)	Gs (dBi)	EIRP (dBm)	EIRP (W)
1851.25	-34.46	-52.13	0.00	1.96	19.63	0.09
1880.00	-35.44	-53.17	0.00	2.00	19.73	0.09
1908.75	-36.24	-54.13	0.00	1.98	19.87	0.10

3.3 Occupied Bandwidth Measurement

3.3.1 Description of Occupied Bandwidth Measurement

The emission bandwidth is defined as the width of the signal between two points, located at the 2 sides of the carrier frequency, outside of which all emissions are attenuated at least 26 dB below the transmitter power.

3.3.2 Measuring Instruments

See list of measuring instruments of this test report.

3.3.3 Test Procedures

1. The EUT was connected to Spectrum Analyzer and Base Station via power divider.
2. The 99% and 26 dB occupied bandwidth (BW) of the middle channel for the highest RF powers were measured.

3.3.4 Test Setup

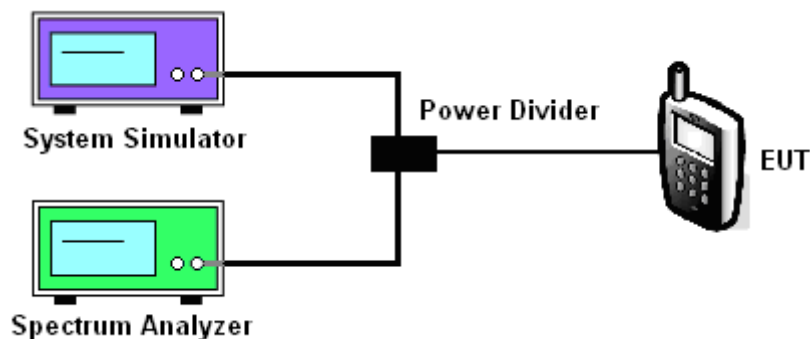



3.3.5 Test Result (Plots) of Occupied Bandwidth

Band :	CDMA2000 BC0	Power Stage :	High
Test Mode :	1xRTT_RC3+SO55		

99% Occupied Bandwidth Plot on Channel 384

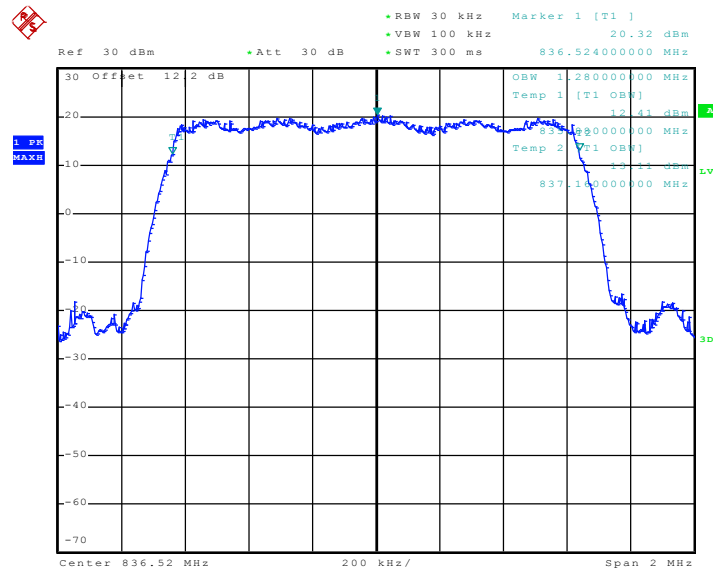

Date: 24.DEC.2010 20:43:36

26dB Bandwidth Plot on Channel 384

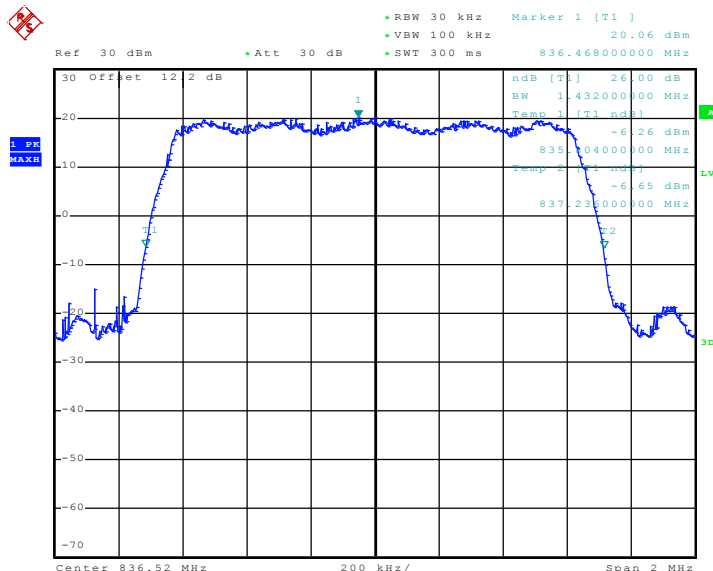

Date: 24.DEC.2010 20:51:00



Band :	CDMA2000 BC1	Power Stage :	High
Test Mode :	1xRTT_RC3+SO55		

99% Occupied Bandwidth Plot on Channel 600

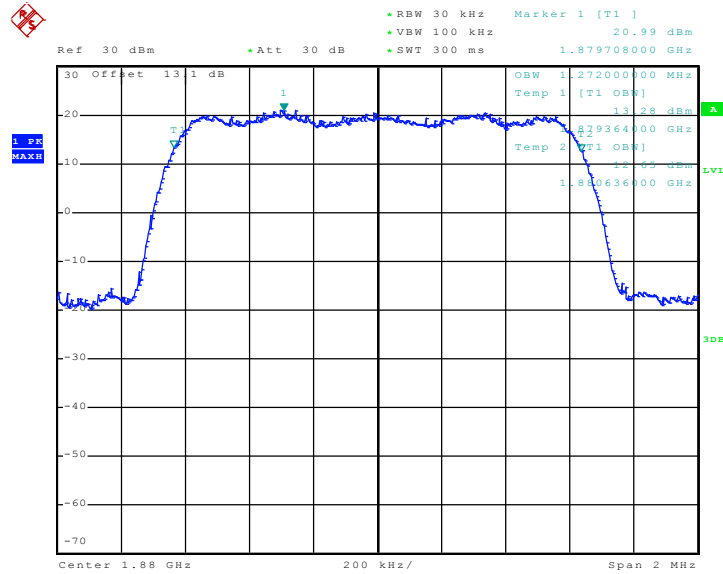

Date: 24.DEC.2010 22:24:29

26dB Bandwidth Plot on Channel 600

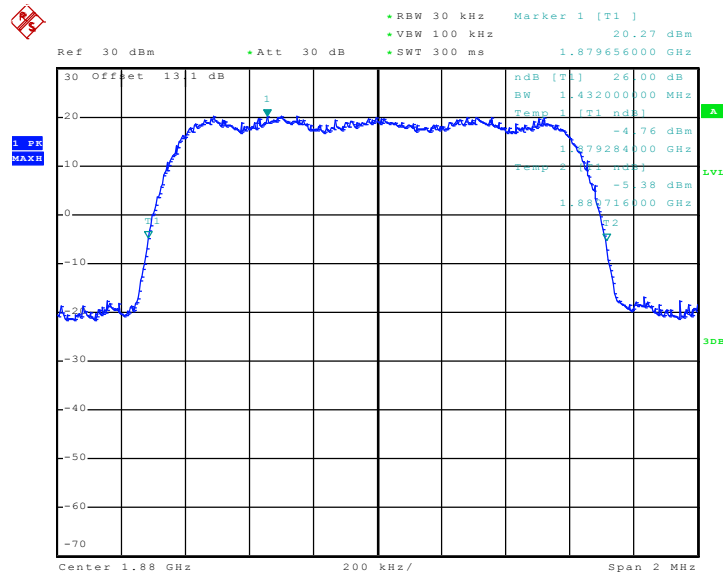

Date: 24.DEC.2010 22:07:22

3.4 Band Edge Measurement

3.4.1 Description of Band Edge Measurement

The power of any emission outside of the authorized operating frequency ranges must be lower than the transmitter power (P) by a factor of at least $43 + 10 \log (P)$ dB.

3.4.2 Measuring Instruments

See list of measuring instruments of this test report.

3.4.3 Test Procedures

1. The EUT was connected to Spectrum Analyzer and Base Station via power divider.
2. The band edges of low and high channels for the highest RF powers were measured. Setting RBW as roughly $BW/100$.
3. The RBW was replaced by 10 kHz, due to the spectrum analyzer IF-Filter including an excess of the limit. A worst case correction factor of $10 \log (1\% BW/\text{measurement RBW})$ was implemented.

3.4.4 Test Setup

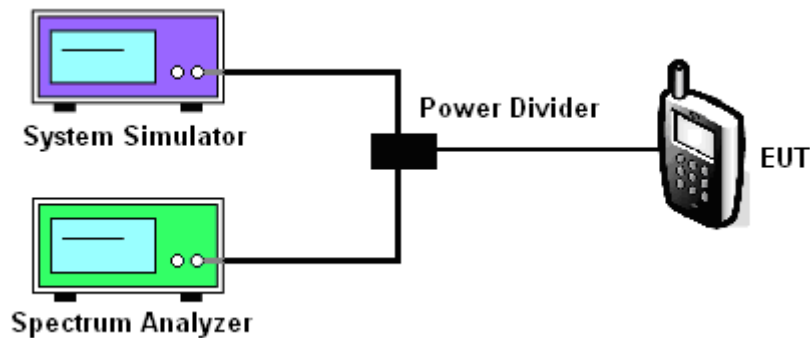



3.4.5 Test Result (Plots) of Conducted Band Edge

Band :	CDMA2000 BC0	Power Stage :	High
Test Mode :	1xRTT_RC3+SO55		

Lower Band Edge Plot on Channel 1013

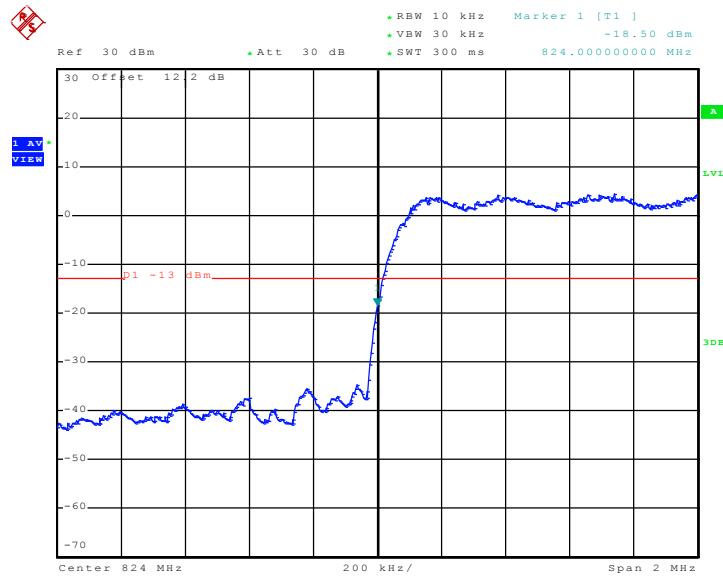

Date: 24.DEC.2010 20:57:40

Higher Band Edge Plot on Channel 777

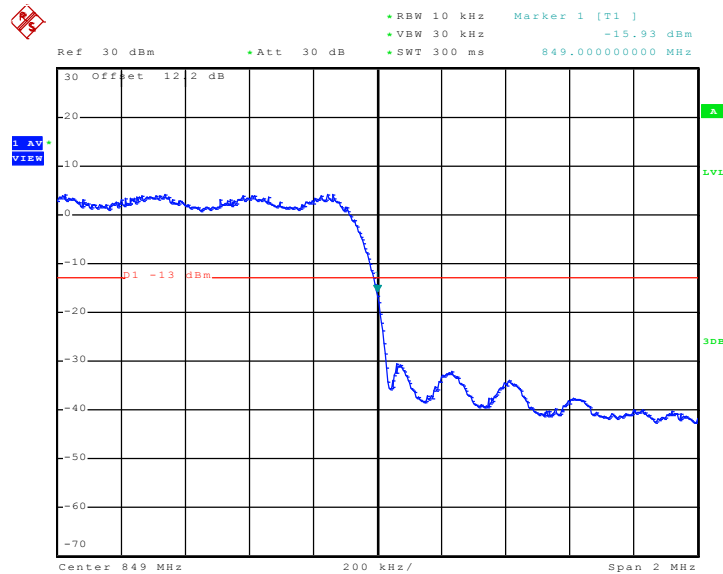

Date: 24.DEC.2010 20:54:50



Band :	CDMA2000 BC1	Power Stage :	High
Test Mode :	1xRTT_RC3+SO55		

Lower Band Edge Plot on Channel 25

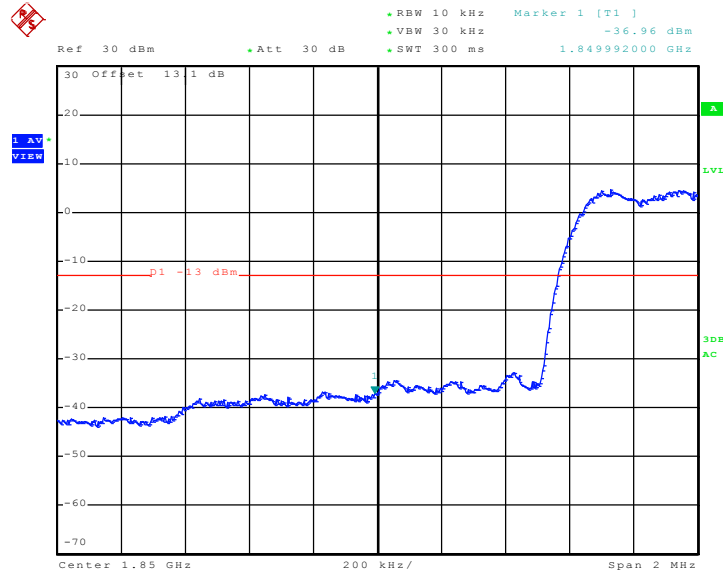

Date: 24.DEC.2010 14:50:23

Higher Band Edge Plot on Channel 1175

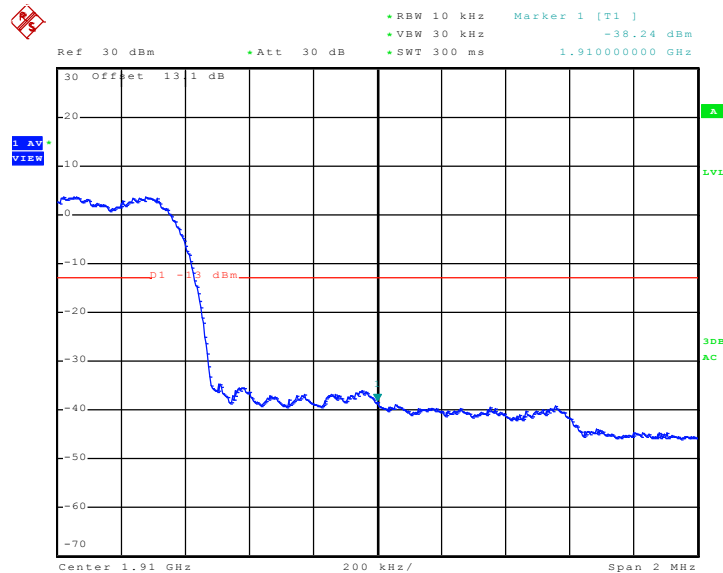

Date: 24.DEC.2010 14:43:59

3.5 Conducted Emission Measurement

3.5.1 Description of Conducted Emission Measurement

The power of any emission outside of the authorized operating frequency ranges must be lower than the transmitter power (P) by a factor of at least $43 + 10 \log (P)$ dB.

It is measured by means of a calibrated spectrum analyzer and scanned from 30 MHz up to a frequency including its 10th harmonic.

3.5.2 Measuring Instruments

See list of measuring instruments of this test report.

3.5.3 Test Procedures

1. The EUT was connected to spectrum analyzer and base station via power divider.
2. The middle channel for the highest RF power within the transmitting frequency was measured.
3. The conducted spurious emission for the whole frequency range was taken.

3.5.4 Test Setup

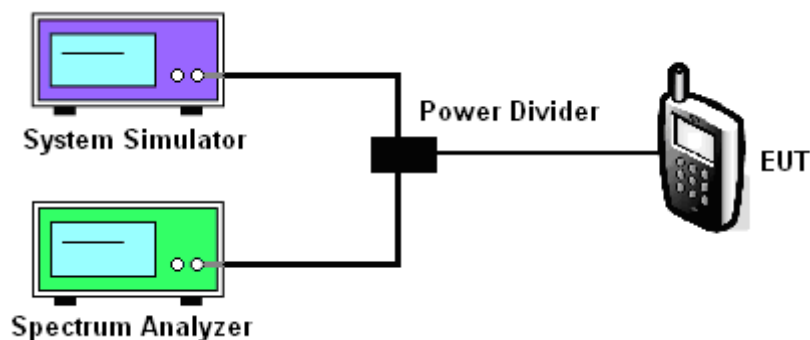



3.5.5 Test Result (Plots) of Conducted Emission

Band :	CDMA2000 BC0	Power Stage :	High
Test Mode :	1xRTT_RC3+SO55		

Conducted Emission Plot between 30MHz ~ 1GHz

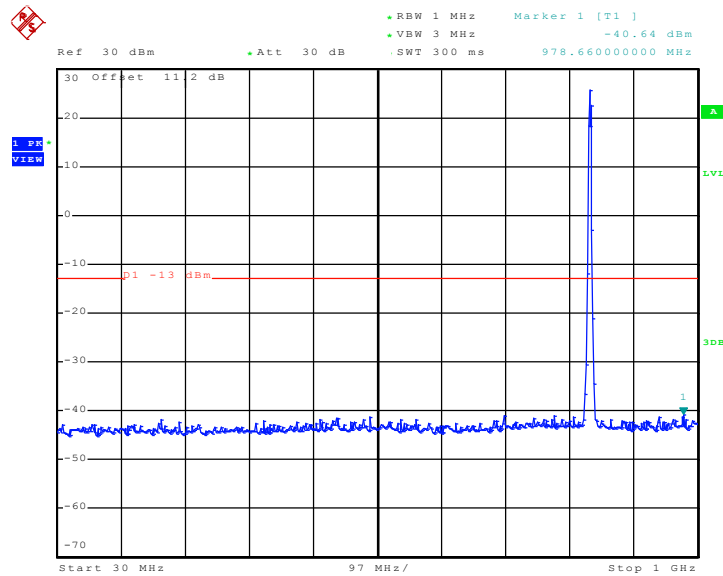

Date: 24.DEC.2010 21:18:55

Conducted Emission Plot between 1GHz ~ 3GHz

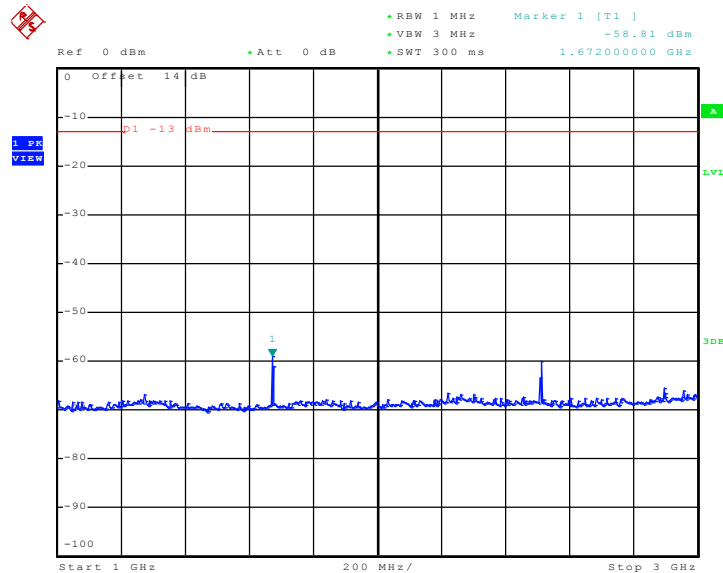

Date: 24.DEC.2010 21:14:27



Conducted Emission Plot between 3GHz ~ 7GHz

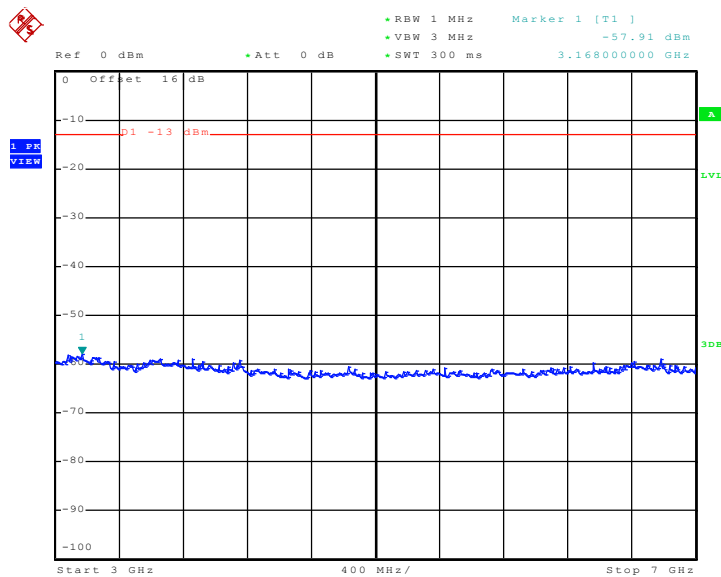

Date: 24.DEC.2010 21:16:20

Conducted Emission Plot between 7GHz ~ 9GHz

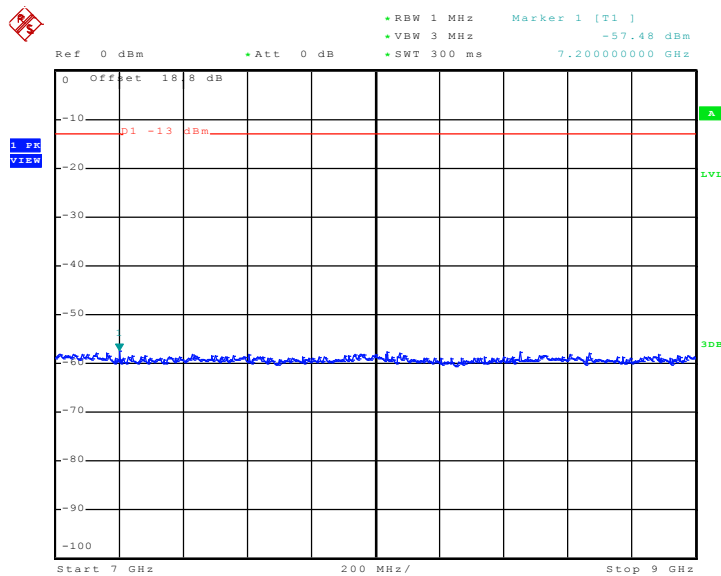

Date: 24.DEC.2010 21:17:13



Band :	CDMA2000 BC1	Power Stage :	High
Test Mode :	1xRTT_RC3+SO55		

Conducted Emission Plot between 30MHz ~ 1GHz

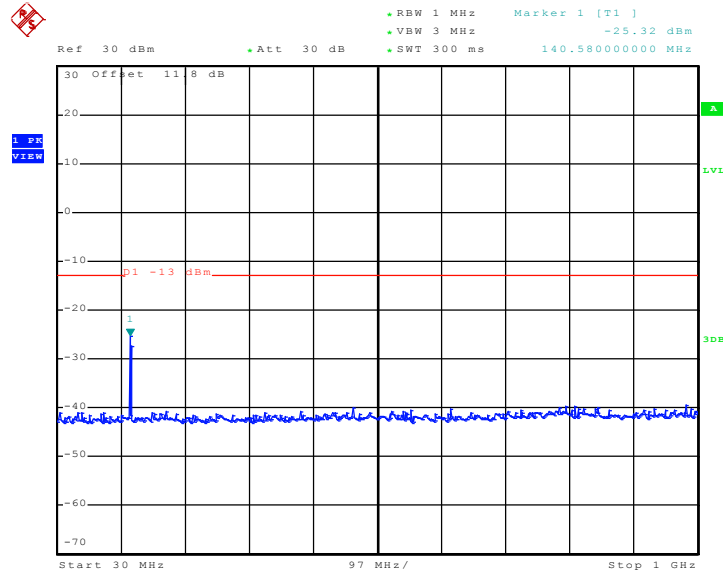

Date: 24.DEC.2010 22:19:03

Conducted Emission Plot between 1GHz ~ 3GHz

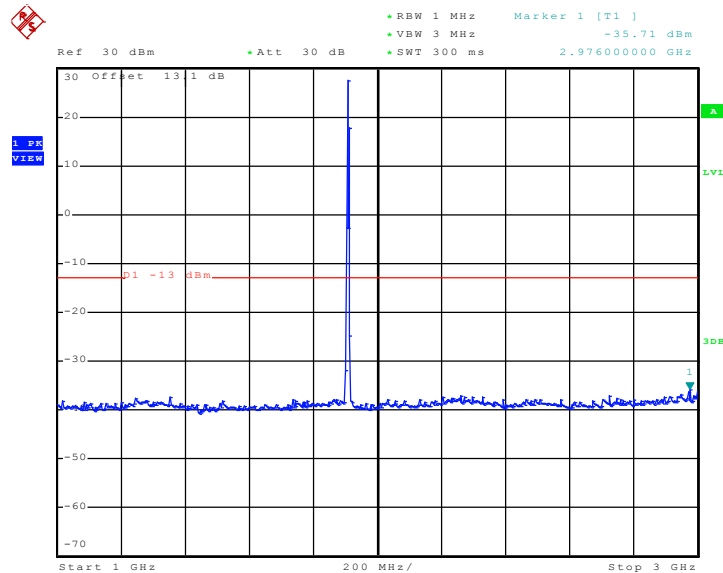

Date: 24.DEC.2010 22:12:36



Conducted Emission Plot between 3GHz ~ 7GHz

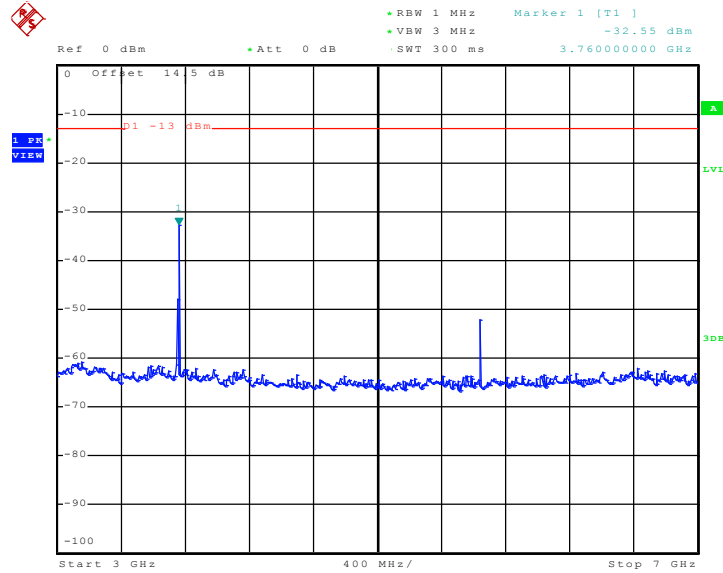

Date: 24.DEC.2010 22:14:26

Conducted Emission Plot between 7GHz ~ 13.6GHz

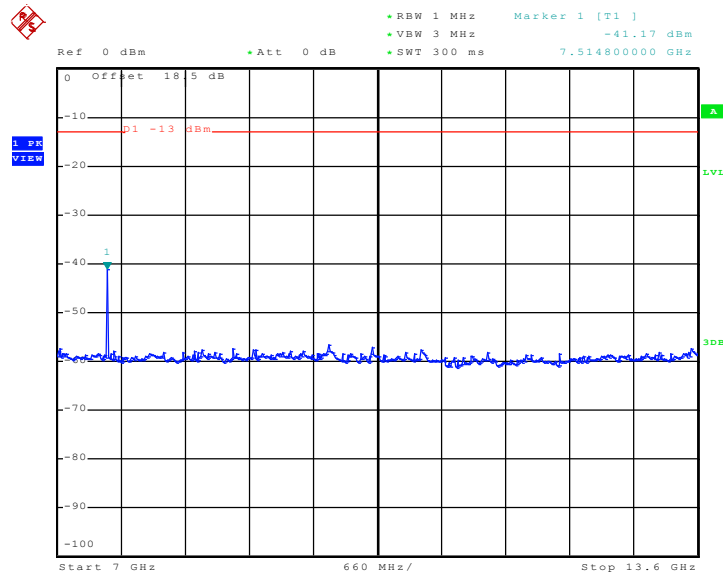

Date: 24.DEC.2010 22:16:32



Conducted Emission Plot between 13.6GHz ~ 19.1GHz

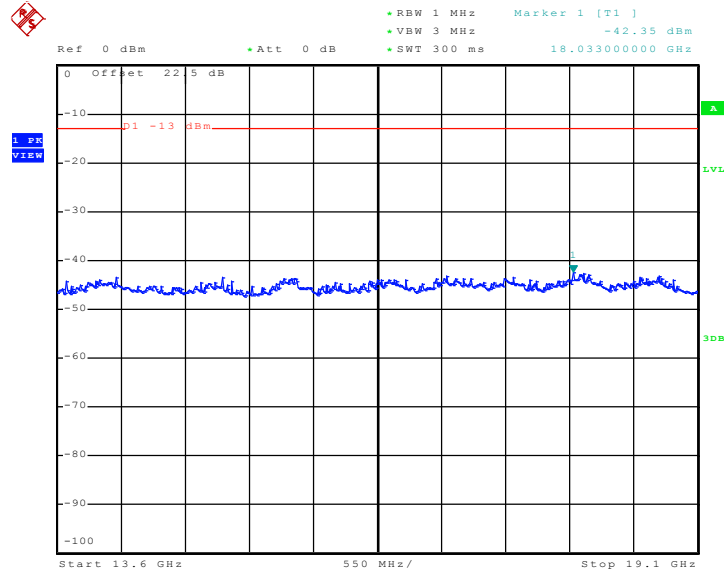

Date: 24.DEC.2010 22:17:32



3.6 Field Strength of Spurious Radiation Measurement

3.6.1 Description of Field Strength of Spurious Radiated Measurement

The radiated spurious emission was measured by substitution method according to ANSI / TIA / EIA-603-C-2004. The power of any emission outside of the authorized operating frequency ranges must be attenuated below the transmitter power (P) by a factor of at least $43+10\log_{10}(P[\text{Watts}])$ dB. The spectrum is scanned from 30 MHz up to a frequency including its 10th harmonic.

3.6.2 Measuring Instruments

See list of measuring instruments of this test report.

3.6.3 Test Procedures

1. The EUT was placed on a rotatable wooden table with 0.8 meter about ground.
2. The EUT was set 3 meters from the receiving antenna, which was mounted on the antenna tower.
3. The table was rotated 360 degrees to determine the position of the highest spurious emission.
4. The height of the receiving antenna is varied between one meter and four meters to search the maximum spurious emission for both horizontal and vertical polarizations.
5. Make the measurement with the spectrum analyzer's RBW = 1MHz, VBW = 3MHz, Sweep = 500ms, Taking the record of maximum spurious emission.
6. A horn antenna was substituted in place of the EUT and was driven by a signal generator.
7. Tune the output power of signal generator to the same emission level with EUT maximum spurious emission.
8. Taking the record of output power at antenna port.
9. Repeat step 7 to step 8 for another polarization.
10. $\text{EIRP (dBm)} = \text{S.G. Power} - \text{Tx Cable Loss} + \text{Tx Antenna Gain}$
11. $\text{ERP (dBm)} = \text{EIRP} - 2.15$

3.6.4 Test Setup

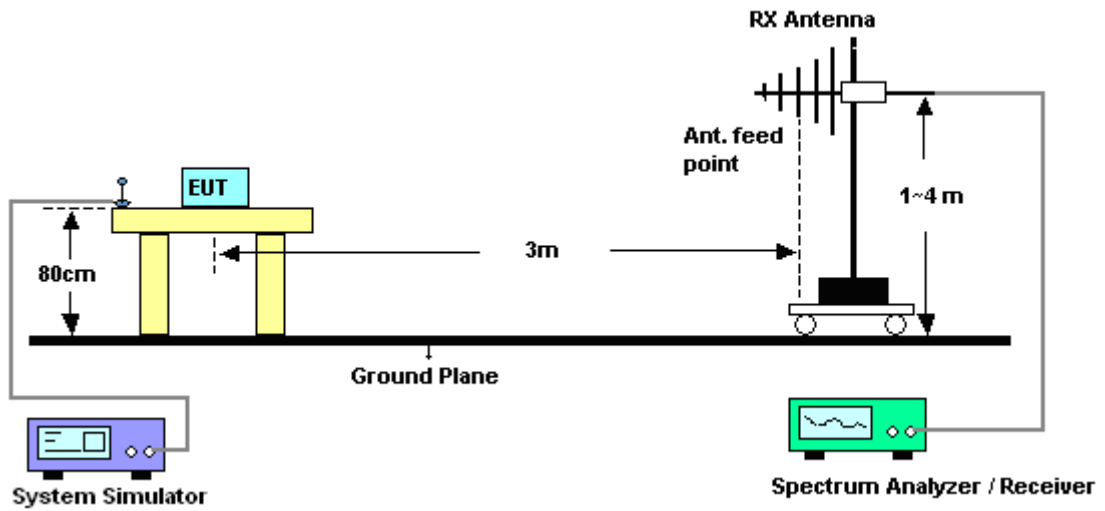



3.6.5 Test Result of Field Strength of Spurious Radiated

Band :	CDMA2000 BC0	Temperature :	20~22°C
Test Mode :	1xRTT_RC3+SO55	Relative Humidity :	47~51%
Test Engineer :	Cona Huang	Polarization :	Horizontal
Remark :	Spurious emissions within 30-1000MHz were found more than 20dB below limit line.		

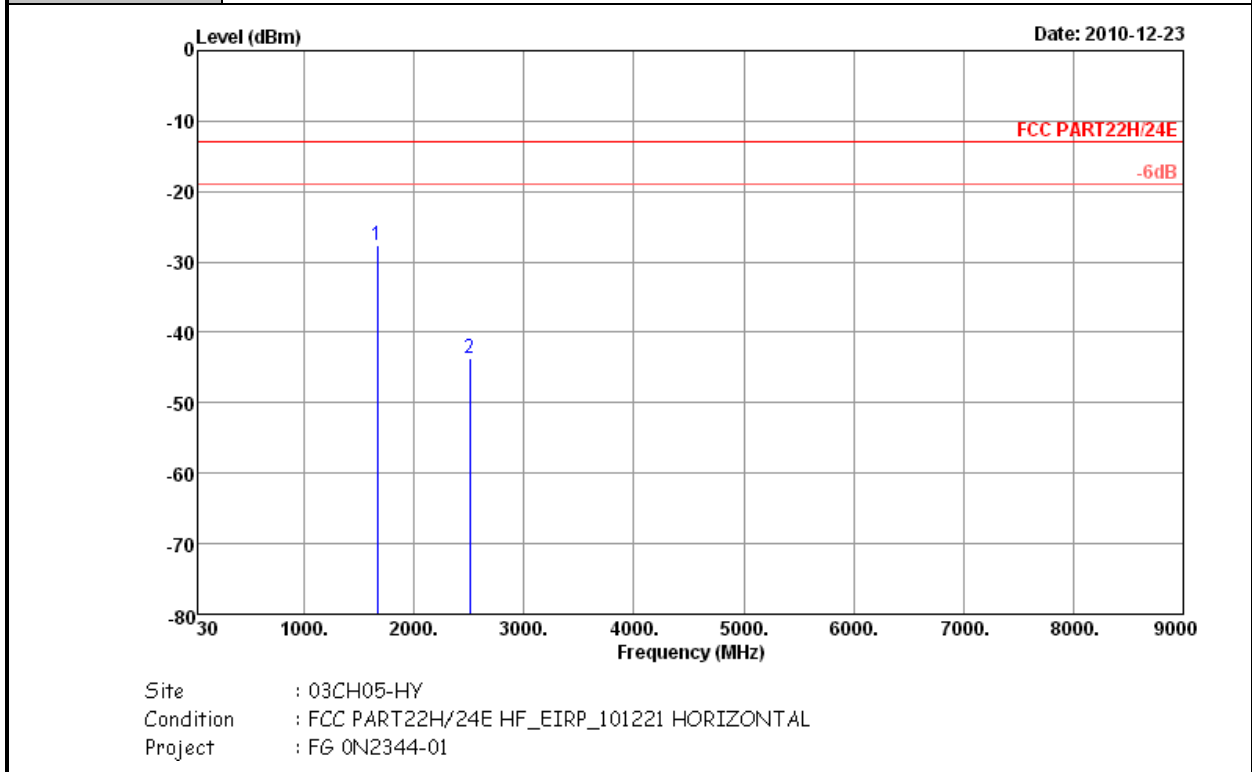

Frequency (MHz)	ERP (dBm)	Limit (dBm)	Over Limit (dB)	SPA Reading (dBm)	S.G. Power (dBm)	TX Cable loss (dB)	TX Antenna Gain (dBi)	Polarization (H/V)	Result
1669	-27.60	-13	-14.60	-35.27	-28.79	2.15	5.49	H	Pass
2509	-43.78	-13	-30.78	-54.9	-45.67	2.38	6.41	H	Pass



Band :	CDMA2000 BC0	Temperature :	20~22°C
Test Mode :	1xRTT_RC3+SO55	Relative Humidity :	47~51%
Test Engineer :	Cona Huang	Polarization :	Vertical
Remark :	Spurious emissions within 30-1000MHz were found more than 20dB below limit line.		

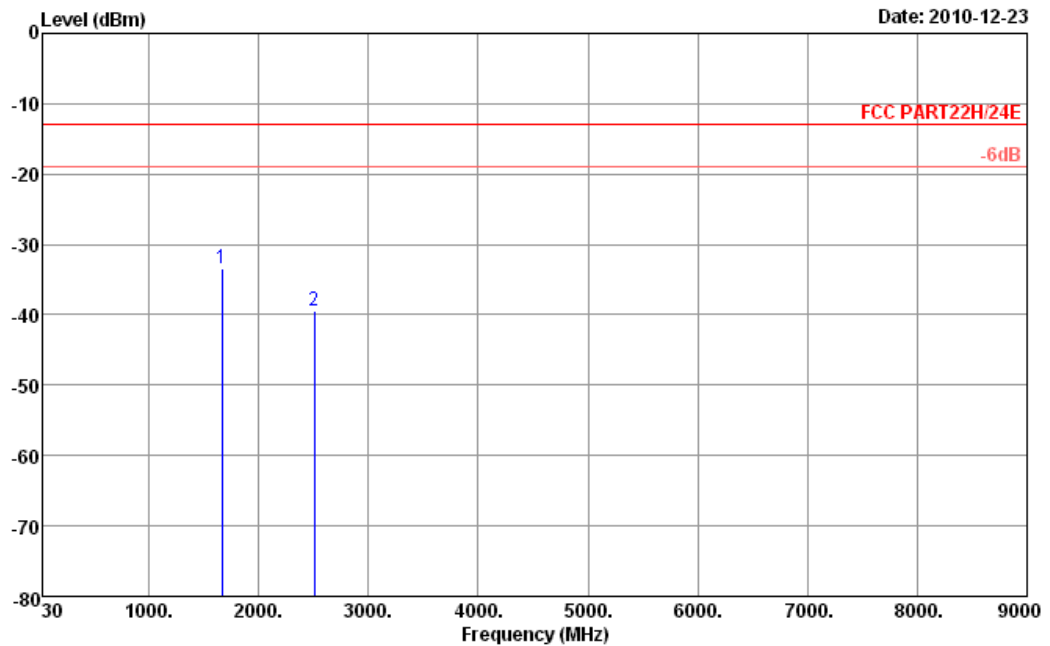

Site : 03CH05-HY
 Condition : FCC PART22H/24E HF_EIRP_101221 VERTICAL
 Project : FG 0N2344-01

Frequency (MHz)	ERP (dBm)	Limit (dBm)	Over Limit (dB)	SPA Reading (dBm)	S.G. Power (dBm)	TX Cable loss (dB)	TX Antenna Gain (dBi)	Polarization (H/V)	Result
1669	-33.44	-13	-20.44	-41.11	-34.63	2.15	5.49	V	Pass
2509	-39.39	-13	-26.39	-50.51	-41.28	2.38	6.41	V	Pass



Band :	CDMA2000 BC1	Temperature :	20~22°C
Test Mode :	1xRTT_RC3+SO55	Relative Humidity :	47~51%
Test Engineer :	Cona Huang	Polarization :	Horizontal
Remark :	Spurious emissions within 30-1000MHz were found more than 20dB below limit line.		

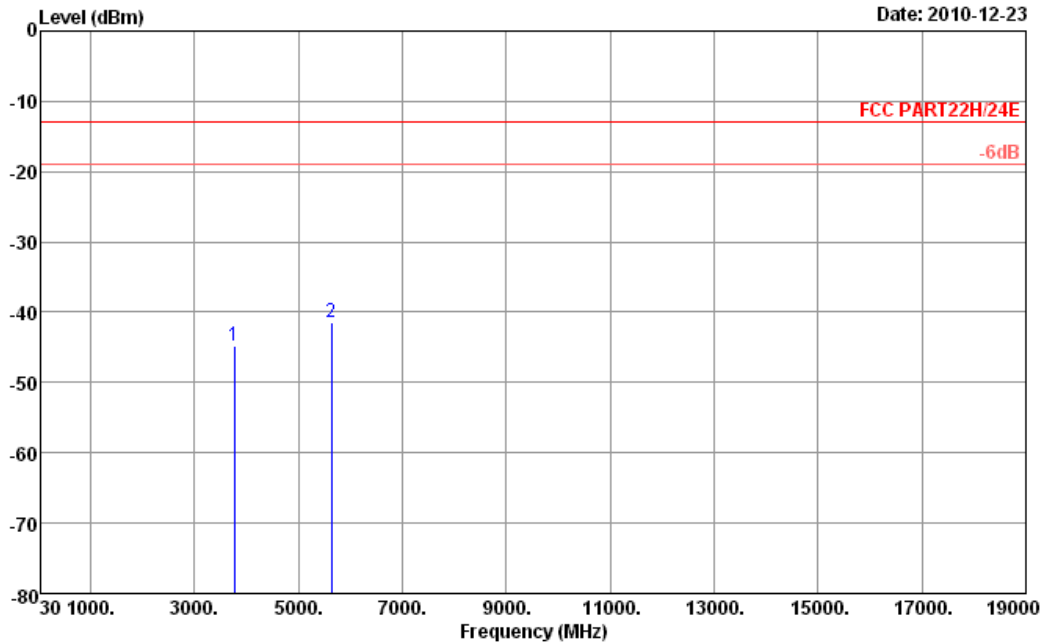

Site : 03CH05-HY
 Condition : FCC PART22H/24E HF_EIRP_101221 HORIZONTAL
 Project : FG 0N2344-01

Frequency (MHz)	EIRP (dBm)	Limit (dBm)	Over Limit (dB)	SPA Reading (dBm)	S.G. Power (dBm)	TX Cable loss (dB)	TX Antenna Gain (dBi)	Polarization (H/V)	Result
3760	-44.72	-13	-31.72	-59.9	-50.85	2.93	9.06	H	Pass
5636	-41.44	-13	-28.44	-62.09	-48.36	3.91	10.83	H	Pass



Band :	CDMA2000 BC1	Temperature :	20~22°C
Test Mode :	1xRTT_RC3+SO55	Relative Humidity :	47~51%
Test Engineer :	Cona Huang	Polarization :	Vertical
Remark :	Spurious emissions within 30-1000MHz were found more than 20dB below limit line.		

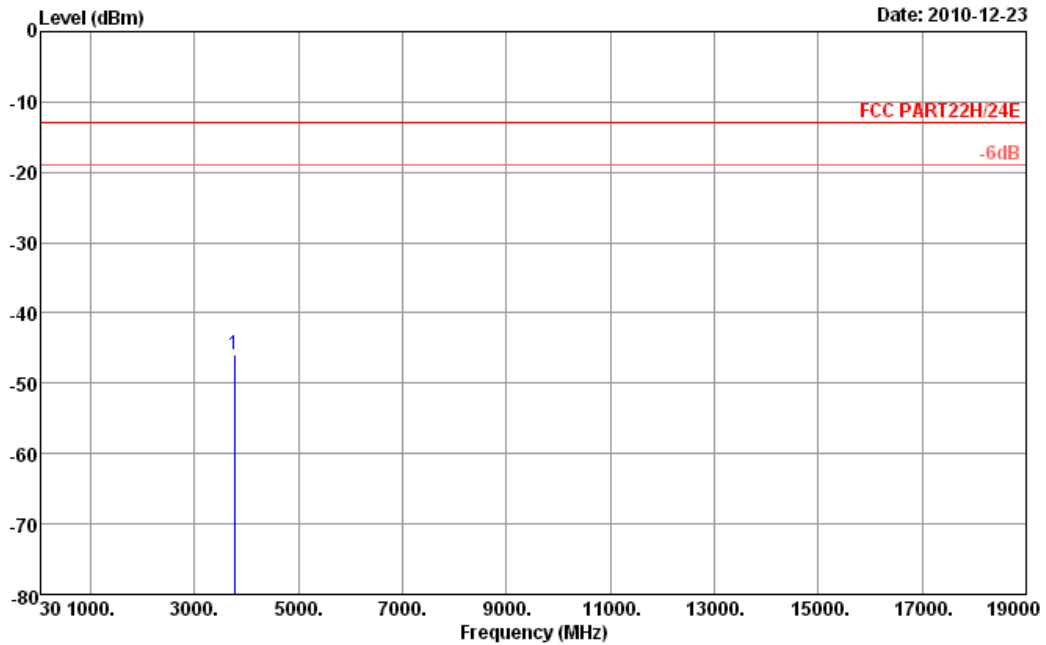

Site : 03CH05-HY
 Condition : FCC PART22H/24E HF_EIRP_101221 VERTICAL
 Project : FG 0N2344-01

Frequency (MHz)	EIRP (dBm)	Limit (dBm)	Over Limit (dB)	SPA Reading (dBm)	S.G. Power (dBm)	TX Cable loss (dB)	TX Antenna Gain (dBi)	Polarization (H/V)	Result
3760	-46.01	-13	-33.01	-61.19	-52.14	2.93	9.06	V	Pass



3.7 Frequency Stability Measurement

3.7.1 Description of Frequency Stability Measurement

The frequency stability shall be measured by variation of ambient temperature and variation of primary supply voltage to ensure that the fundamental emission stays within the authorized frequency block. The frequency stability of the transmitter shall be maintained within $\pm 0.00025\%$ ($\pm 2.5\text{ppm}$) of the center frequency.

3.7.2 Measuring Instruments

See list of measuring instruments of this test report.

3.7.3 Test Procedures for Temperature Variation

1. The EUT was set up in the thermal chamber and connected with the base station.
2. With power OFF, the temperature was decreased to -30°C and the EUT was stabilized for three hours. Power was applied and the maximum change in frequency was recorded within one minute.
3. With power OFF, the temperature was raised in 10°C step up to 50°C . The EUT was stabilized at each step for at least half an hour. Power was applied and the maximum frequency change was recorded within one minute.
4. If the EUT can not be turned on at -30°C , the testing lowest temperature will be raised in 10°C step until the EUT can be turned on.

3.7.4 Test Procedures for Voltage Variation

1. The EUT was placed in a temperature chamber at $25\pm 5^{\circ}\text{C}$ and connected with the base station.
2. The power supply voltage to the EUT was varied from BEP to 115% of the nominal value measured at the input to the EUT.
3. The variation in frequency was measured for the worst case.

3.7.5 Test Setup

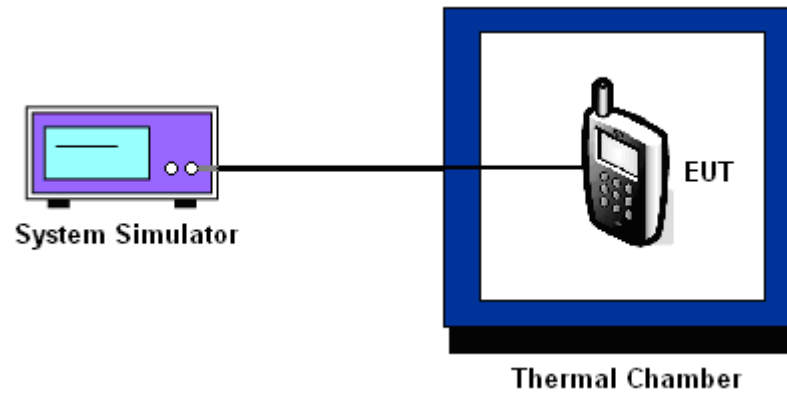



3.7.6 Test Result of Temperature Variation

Band :	CDMA2000 BC0	Channel :	384
Test Mode :	1xRTT_RC3+SO55	Limit (ppm) :	2.5

Temperature (°C)	Freq. Dev. (Hz)	Deviation (ppm)	Result
-30	33	0.04	PASS
-20	34	0.04	
-10	28	0.03	
0	-26	-0.03	
10	-35	-0.04	
20	26	0.03	
30	27	0.03	
40	-39	-0.05	
50	39	0.05	
60	37	0.04	

Band :	CDMA2000 BC1	Channel :	600
Test Mode :	1xRTT_RC3+SO55	Limit (ppm) :	2.5

Temperature (°C)	Freq. Dev. (Hz)	Deviation (ppm)	Result
-30	-33	-0.02	PASS
-20	-16	-0.01	
-10	-27	-0.01	
0	14	0.01	
10	19	0.01	
20	27	0.01	
30	23	0.01	
40	-35	-0.02	
50	20	0.01	
60	20	0.01	



3.7.7 Test Result of Voltage Variation

Band & Channel	Mode	Voltage (Volt)	Freq. Dev. (Hz)	Deviation (ppm)	Limit (ppm)	Result
CDMA2000 BC0 CH384	1xRTT RC3+SO55	3.8	-33	-0.04	2.5	PASS
		BEP	-34	-0.04		
		4.2	35	0.04		
CDMA2000 BC1 CH600	1xRTT RC3+SO55	3.8	-21	-0.01	2.5	PASS
		BEP	26	0.01		
		4.2	31	0.02		

Note :

- 1. Normal Voltage = 3.8V.
- 2. Battery End Point (BEP) = 3.6 V.



4 List of Measuring Equipment

Instrument	Manufacturer	Model No.	Serial No.	Characteristics	Calibration Date	Due Date	Remark
System Simulator	R&S	CMU200	117995	N/A	Mar. 19, 2009	Mar. 18, 2011	Conducted (TH02-HY)
Spectrum Analyzer	R&S	FSP30	101329	9kHz~30GHz	Apr. 26, 2010	Apr. 25, 2011	Conducted (TH02-HY)
Thermal Chamber	Ten Billion	TTH-D35P	TBN-930701	N/A	Jul. 30,2010	Jul. 29, 2011	Conducted (TH02-HY)
Spectrum Analyzer	R&S	FSP30	101352	9KHz-40GHz	Nov. 03, 2010	Nov. 02, 2011	Radiation (03CH05-HY)
Amplifier	COM-POWER	PA-103	161069	1KHz - 1GHz	Mar. 29, 2010	Mar. 28, 2011	Radiation (03CH05-HY)
Bilog Antenna	SCHAFFNER	CBL6111C	2725	30MHz ~ 1GHz	Nov. 06, 2010	Nov. 05, 2011	Radiation (03CH05-HY)
SHF-EHF Horn Antenna	SCHWARZBECK	BBHA 9170	BBHA917025 1	15GHz- 40GHz	Oct. 18, 2010	Oct. 17, 2011	Radiation (03CH05-HY)
Pre Amplifier	Agilent	8449B	3008A01917	1GHz- 26.5GHz	Apr. 15, 2010	Apr. 14, 2011	Radiation (03CH05-HY)
Turn Table	HD	Deis HD 2000	420/611	0 - 360 degree	N/A	N/A	Radiation (03CH05-HY)
Antenna Mast	HD	MA 240	240/666	1 m - 4 m	N/A	N/A	Radiation (03CH05-HY)
Horn Antenna	ESCO	3117	00066584	1GHz ~ 18GHz	Aug. 05, 2010	Aug. 04, 2011	Radiation (03CH05-HY)
Loop Antenna	R&S	HFH2-Z2	860004/001	9 kHz~30 MHz	Jul. 29, 2010	Jul. 28, 2011	Radiation (03CH05-HY)
System Simulator	R&S	CMU200	117995	N/A	Mar. 19, 2009	Mar. 18, 2011	Radiation (03CH05-HY)

5 Uncertainty of Evaluation

Uncertainty of Radiated Emission Measurement (30 MHz ~ 1000 MHz)

Contribution	Uncertainty of X_i		$u(X_i)$
	dB	Probability Distribution	
Receiver Reading	0.41	Normal (k=2)	0.21
Antenna Factor Calibration	0.83	Normal (k=2)	0.42
Cable Loss Calibration	0.25	Normal (k=2)	0.13
Pre-Amplifier Gain Calibration	0.27	Normal (k=2)	0.14
RCV/SPA Specification	2.50	Rectangular	0.72
Antenna Factor Interpolation for Frequency	1.00	Rectangular	0.29
Site Imperfection	1.43	Rectangular	0.83
Mismatch	+0.39 / -0.41	U-Shape	0.28
Combined Standard Uncertainty $U_c(y)$	1.27		
Measuring Uncertainty for a Level of Confidence of 95% ($U = 2U_c(y)$)	2.54		

Uncertainty of Radiated Emission Measurement (1 GHz ~ 40 GHz)

Contribution	Uncertainty of X_i		$u(X_i)$	C_i	$C_i * u(X_i)$
	dB	Probability Distribution			
Receiver Reading	± 0.10	Normal (k=2)	0.10	1	0.10
Antenna Factor Calibration	± 1.70	Normal (k=2)	0.85	1	0.85
Cable Loss Calibration	± 0.50	Normal (k=2)	0.25	1	0.25
Receiver Correction	± 2.00	Rectangular	1.15	1	1.15
Antenna Factor Directional	± 1.50	Rectangular	0.87	1	0.87
Site Imperfection	± 2.80	Triangular	1.14	1	1.14
Mismatch Receiver VSWR $\Gamma_1 = 0.197$ Antenna VSWR $\Gamma_2 = 0.194$ Uncertainty = $20\text{Log}(1-\Gamma_1*\Gamma_2)$	+0.34 / -0.35	U-Shape	0.244	1	0.244
Combined Standard Uncertainty $U_c(y)$	2.36				
Measuring Uncertainty for a Level of Confidence of 95% ($U = 2U_c(y)$)	4.72				

Appendix A. Setup Photographs

<Radiated Emission>

