



# FCC SAR Test Report

**APPLICANT** : HTC Corporation  
**EQUIPMENT** : Smart Phone  
**MODEL NAME** : PG06100  
**FCC ID** : NM8PG06100  
**STANDARD** : FCC 47 CFR Part 2 (2.1093)  
IEEE C95.1-1992  
IEEE 1528-2003  
FCC OET Bulletin 65 Supplement C (Edition 01-01)

The product was received on Jul. 30, 2010 and completely tested on Nov. 19, 2010. We, SPORTON INTERNATIONAL INC., would like to declare that the tested sample has been evaluated in accordance with the procedures and shown the compliance with the applicable technical standards.

The test results in this report apply exclusively to the tested model / sample. Without written approval of SPORTON INTERNATIONAL INC., the test report shall not be reproduced except in full.

Reviewed by:

Roy Wu / Manager



## **SPORTON INTERNATIONAL INC.**

No. 52, Hwa Ya 1<sup>st</sup> Rd., Hwa Ya Technology Park, Kwei-Shan Hsiang, Tao Yuan Hsien, Taiwan, R.O.C.



## Table of Contents

Revision History.....	3
1. Statement of Compliance .....	4
2. Administration Data.....	5
2.1 Testing Laboratory.....	5
2.2 Applicant.....	5
2.3 Manufacturer .....	5
2.4 Application Details .....	5
3. General Information.....	6
3.1 Description of Device Under Test (DUT).....	6
3.2 Product Photos .....	6
3.3 Applied Standards .....	6
3.4 Device Category and SAR Limits .....	6
3.5 Test Conditions .....	7
3.5.1 Ambient Condition .....	7
3.5.2 Test Configuration.....	7
4. Specific Absorption Rate (SAR).....	14
4.1 Introduction.....	14
4.2 SAR Definition .....	14
5. SAR Measurement System.....	15
5.1 E-Field Probe.....	16
5.1.1 E-Field Probe Specification .....	16
5.1.2 E-Field Probe Calibration.....	17
5.2 Data Acquisition Electronics (DAE).....	17
5.3 Robot.....	17
5.4 Measurement Server.....	18
5.5 Phantom.....	19
5.6 Device Holder.....	20
5.7 Data Storage and Evaluation.....	22
5.7.1 Data Storage .....	22
5.7.2 Data Evaluation .....	22
5.8 Test Equipment List.....	24
6. Tissue Simulating Liquids.....	25
7. Uncertainty Assessment .....	27
8. SAR Measurement Evaluation .....	30
8.1 Purpose of System Performance check .....	30
8.2 System Setup .....	30
8.3 Validation Results .....	31
9. DUT Testing Position.....	32
10. Measurement Procedures .....	35
10.1 Spatial Peak SAR Evaluation .....	35
10.2 Scan Procedures.....	36
10.3 SAR Averaged Methods .....	36
10.4 Power Drift Monitoring.....	36
11. SAR Test Results .....	37
11.1 Conducted Power (Unit: dBm).....	37
11.2 Scaling Factor Deriving .....	38
11.3 Test Records for Head SAR Test.....	40
11.4 Test Records for Body SAR Test .....	42
11.5 Linearity Response Check.....	44
11.6 Compare with Different Scan Resolution .....	46
12. References.....	47
Appendix A. Plots of System Performance Check	
Appendix B. Plots of SAR Measurement	
Appendix C. DASYS Calibration Certificate	
Appendix D. Test Setup Photos	
Appendix E. Plots of Duty Cycle	





### 1. Statement of Compliance

The maximum result of Specific Absorption Rate (SAR) found during testing for **HTC Corporation Smart Phone PG06100** are as follows (with expanded uncertainty 21.4 % for 300 MHz to 3 GHz, and 25.6 % for 3 GHz to 6 GHz).

Mode	Position	Measured SAR <sub>1g</sub> (W/kg)	Scaled SAR <sub>1g</sub> (W/kg)
WiMAX	Head	0.494	0.538
	Body (1 cm Gap)	0.539	0.564

They are in compliance with Specific Absorption Rate (SAR) for general population/uncontrolled exposure limits (1.6 W/kg) specified in FCC 47 CFR part 2 (2.1093) and ANSI/IEEE C95.1-1992, and had been tested in accordance with the measurement methods and procedures specified in IEEE 1528-2003 and FCC OET Bulletin 65 Supplement C (Edition 01-01).



## 2. Administration Data

### 2.1 Testing Laboratory

Test Site	SPORTON INTERNATIONAL INC.
Test Site Location	No. 52, Hwa Ya 1 <sup>st</sup> Rd., Hwa Ya Technology Park, Kwei-Shan Hsiang, Tao Yuan Hsien, Taiwan, R.O.C. TEL: +886-3-327-3456 FAX: +886-3-328-4978

### 2.2 Applicant

Company Name	HTC Corporation
Address	No. 23, Xinghua Rd., Taoyuan City, Taiwan

### 2.3 Manufacturer

Company Name	HTC Corporation
Address	No. 23, Xinghua Rd., Taoyuan City, Taiwan

### 2.4 Application Details

Date of Receipt of Application	Jul. 30, 2010
Date of Start during the Test	Nov. 08, 2010
Date of End during the Test	Nov. 19, 2010



### 3. General Information

#### 3.1 Description of Device Under Test (DUT)

Product Feature & Specification	
DUT Type	Smart Phone
Model Name	PG06100
FCC ID	NM8PG06100
Frequency Range	5MHz BW : 2498.5 MHz to 2687.5 MHz 10MHz BW : 2501.0 MHz to 2685.0 MHz
Maximum Average conducted Power	BW 5M : 23.76 dBm BW 10M : 23.42 dBm
Antenna Type	PIFA Antenna
Type of Modulation	Uplink : OFDMA (QPSK / 16QAM) Downlink : OFDMA (QPSK / 16QAM / 64QAM)
DUT Stage	Production Unit

**Remark:**

1. The above DUT's information was declared by manufacturer. Please refer to the specifications or user's manual for more detailed description.
2. The device supports WiFi hotspot, so body SAR was tested at 1 cm separation distance for all 6 faces.

#### 3.2 Product Photos

Please refer to Appendix D.

#### 3.3 Applied Standards

The Specific Absorption Rate (SAR) testing specification, method and procedure for this device is in accordance with the following standards:

- FCC 47 CFR Part 2 (2.1093)
- IEEE C95.1-1992
- IEEE 1528-2003
- FCC OET Bulletin 65 Supplement C (Edition 01-01)
- FCC KDB 615223 D01 v01
- FCC KDB 648474 D01 v01r05
- 2010 TCB Workshop RF Exposure Procedures-Review

#### 3.4 Device Category and SAR Limits

This device belongs to portable device category because its radiating structure is allowed to be used within 20 centimeters of the body of the user. Limit for General Population/Uncontrolled exposure should be applied for this device, it is 1.6 W/kg as averaged over any 1 gram of tissue.



### 3.5 Test Conditions

#### 3.5.1 Ambient Condition

Ambient Temperature	20 to 24 °C
Humidity	< 60 %

#### 3.5.2 Test Configuration

The test device is a 2.6 GHz WiMAX transceiver. It provides one completed transmitter and two receivers. This Smartphone has two built-in antennas and it supports Tx antenna diversity function. Only one transmitting antenna can be used simultaneously.

The device only transmits by PUSC zone type. The other zone types, AMC, and FUSC, are not available on this device. The maximum DL:UL (downlink-to-uplink) symbol ratio is determined according to the PUSC requirements. The system transmits an odd number of symbols using DL-PUSC, consisting of even multiples of traffic and control symbols, plus one symbol for the preamble. The device transmits in multiples of three symbols using UL-PUSC. The OFDMA symbol time allows up to 48 downlink and uplink symbols to be transmitted in each 5 ms frame. The system transmits on 5 ms frames using 5 MHz and 10 MHz channels. TTG and RTG are also included in each frame as DL/UL transmission gaps; therefore, the system can only allow 47 or less symbols per frame. The maximum DL:UL symbol ratio allowed for this device and determined according to these PUSC parameters is 29:18.

For PUSC zone type, the 10 MHz channel bandwidth uses 1024 sub-carriers and 35 sub-channels, with 184 spare/safeguard sub-carriers and 840 available for transmission, consisting of 560 data and 280 pilot sub-carriers. The 5 MHz channel bandwidth uses 512 sub-carriers and 17 sub-channels, with 104 spare/safeguard sub-carriers and 408 available for transmission, consisting 272 data and 136 pilot sub-carriers.

Control signals are transmitted in the first 3 symbols of each uplink burst. The rest of the uplink sub-frame contains normal traffic data bursts. The first 3 symbols are also used for ranging, which is shared with other users. During normal operation, the control symbols are transmitted at reduced power and the traffic symbols may transmit at maximum power. For SAR testing purposes, the configuration of control symbols is dependent on the test software and test equipment setup. The uplink allows a maximum of 15 traffic and 3 control symbols, 18 total, per frame. These conditions are applicable to both 5 and 10 MHz channel configurations used by this device.



The 802.16e/WiMAX device and system operating parameters is as below.

Description	Parameter		Comment
FCC ID	NM8PG06100		Identify all related FCC ID
Radio Service	Part 27 Subpart M		Rule parts
Transmit Frequency Range (MHz)	5MHz BW : 2498.5 MHz to 2687.5 MHz 10MHz BW : 2501.0 MHz to 2685.0 MHz		System parameter
System/Channel Bandwidth (MHz)	5 MHz	10 MHz	System parameter
System Profile	Release 1.0(Revision 1.7.1 2008) Band Class 3 Radio Profile 3A		Defined by WiMAX Forum
Modulation Schemes	QPSK, 16QAM		Identify all applicable UL modulations
Sampling Factor	28/25		System parameter
Sampling Frequency (MHz)	5.6 MHz	11.2 MHz	(F <sub>s</sub> )
Sample Time (ns)	178 ns	89 ns	(1/F <sub>s</sub> )
FFT Size (N <sub>FFT</sub> )	512	1024	(N <sub>FFT</sub> )
Sub-Carrier Spacing (kHz)	10.94 kHz		(Δ f)
Useful Symbol Time (μs)	91.43 μs		(T <sub>b</sub> =1/Δ f)
Guard Time (μs)	11.43 μs		(T <sub>g</sub> =T <sub>b</sub> /cp); cp = cyclic prefix
OFDMA Symbol Time (μs)	102.857 μs		(T <sub>s</sub> =T <sub>b</sub> +T <sub>g</sub> )
Frame Size (ms)	5 ms		System parameter
TTG + RTG (μs or number of symbols)	165.8 μs		Idle time, system parameter
Number of DL OFDMA Symbols per Frame	Max: 29		Identify the allowed & maximum symbols, including both traffic & control symbols
Number of UL OFDMA Symbols per Frame	Max: 18		
DL:UL Symbol Ratios	Max 29:18		For determining UL duty factor
Power Class (dBm)	Power Class 2, 23.0±0.8 dBm		Identify power class and tolerance
Wave1 / Wave2	Wave2: Two antennas for Tx/Rx diversity. ANT1 and ANT2 cannot transmit simultaneously		Describe antenna diversity info and MIMO requirements separately
UL Zone Types (FUSC, PUSC, OFUSC, OPUSC, AMC, TUSC1, TUSC2)	PUSC only. UL AMC is not used in the current profile		Describe separately the symbol and sub-carrier/sub-channel structures applicable to each zone type
Maximum Number of UL Sub-Carriers	Null Sub-Carriers=104 Pilot Sub-Carriers=136 Data Sub-Carrier=272	Null Sub-Carriers=184 Pilot Sub-Carriers=280 Data Sub-Carriers=560	Identify the allowed and tested / to be tested parameters; include separate explanations on the types of control symbols and how the power levels are determined
Measured UL Burst Maximum Average Conducted Power	23.76 dBm	23.42 dBm	
UL Control Symbol Configuration	3 PUSC symbols (used for ranging, CQICH and ACK/NACK)		
UL Control Symbol Maximum Conducted Average Power	70.55 mW	34.27 mW	
UL Burst Peak-to-Average (Conducted) Power Ratio (PAPR)	PAPR is between 7.78 ~ 9.98 dB A Anritus wideband power meter was used to measure this item. Average, peak and PAPR are measured simultaneously. The test records please refer to section 11.1 of this report.		Identify the expected range and measured/tested PAR; explain separately the methods used / to be used to address SAR probe calibration and measurement error issues
Frame Averaged UL Transmission Duty Factor (%)	Duty cycle was measured by a spectrum. The measured duty cycle is 31.2 % to 31.4 %. Theoretical duty cycle is 15 x 102.857 μs / 5000 μs = 30.86 %. cf = 1/(duty cycle) = 3.24. This cf was used for SAR evaluation.		Show calculations separately and explain how the applicable CF ( <i>crest factor</i> ) used / to be use in the SAR measurements is derived and how the control symbols are accounted for





**Time Vector Plots and Duty Cycle**

The plot below shows the waveform characteristics of the signal used in the SAR measurement. The pulse duration corresponds to a DL:UL symbol ratio of 29:18 and control symbols are not active.

The plots of time vector and calculation of duty cycle can be referred to appendix E. The plot A is used to get the frame length of test signal and the plot B is used to get the time of UL data symbols. Since there was no energy in the control symbols, the effective power is only across 15 data symbols. The calculation of duty cycle is as below:

**Duty Cycle = 15 data symbols UL time / Frame Length x 100 %**

Summary table is shown as below.

Zone Type	Modulation	Coding Rate	Duty Cycle (%)	Crest Factor (%)
PUSC	16QAM (5M)	1/2	31.4	3.18
PUSC	16QAM (10M)	1/2	31.2	3.21
PUSC	16QAM (5M)	3/4	31.4	3.18
PUSC	16QAM (10M)	3/4	31.2	3.21
PUSC	QPSK (5M)	1/2	31.4	3.18
PUSC	QPSK (10M)	1/2	31.2	3.21
PUSC	QPSK (5M)	3/4	31.4	3.18
PUSC	QPSK (10M)	3/4	31.2	3.21

**Note:** Crest Factor = 1 / Duty Cycle.



### **Test Software Details**

The DUT use the HyperTerminal (AT Command) installed on a host laptop computer to configure the DUT into the engineering mode. In engineering mode, the transmitter parameters for antenna, BW, modulation, frequency and transmitting maximum power can be set, and the DUT can receive control signal from system simulator, Agilent E6651A, to keep transmitting WiMAX signal. The uplink transmission (signal characteristics such as BW, modulation, frequency and DL:UL ratio) is maintained at a stable condition by the FCH, UL-MAP and DL-MAP information transmitted over the air from the Agilent E6651A. This enables the DUT to transmit at maximum power with a constant duty factor according to the maximum DL:UL symbol ratio 29:18, using a specific modulation, zone type, sub-channel configuration and other operating requirements. The test software for this device serves only one purpose, to configure the DUT into engineering mode during the SAR measurements.

### **Communication Test Set Details**

A system simulator, Agilent E6651A, is used in conjunction with DUT engineering mode to configure the DUT for the SAR measurements. The Agilent E6651A is configured to transmit the downlink signals, containing the respective FCH, DL-MAP and UL-MAP required by the DUT to configure the DUT uplink transmissions. The waveform is configured for a DL:UL symbol ratio of 29:18. The DUT can synchronize itself to the signals received from the Agilent E6651A, both in frequency and time. It then demodulates the DL-MAP and UL-MAP transmitted in each downlink sub-frame and determines the DL:UL symbol ratio (29:18). This downlink burst is repeated in each frame, every 5 ms, to simulate the transmission from a WiMax base station. The UL-MAP received by the DUT is used to configure the uplink burst with all data (traffic) symbols and sub-channels active.

In fact, the DUT have not linked with Agilent E6651A. The DUT only receive the control signal from Agilent E6651A and then transmitting maximum power on the specific configuration. Therefore, no control channel transmissions are requested by the system simulator. SAR measurement were taken in this configuration with the DUT transmitting using the 29:18 ratio, but since there was no energy in the control symbols, the effective power is only across 15 data symbols.

The steps for system simulator setup are as below

1. Set the appropriate source amplitude and attenuation
2. Load the system profile of bandwidth 5M or 10M
3. Set the operating frequency
4. Set the UL modulation to operating mode
5. Set the test mode to UL padding test
6. Set and send the RNG-RSP message
7. Set the run test on

The WiMAX non-TCB testing guidance inquiry has been approved under KDB inquiry 239250.



<Maximum SAR list for each band and position>

Position	CDMA2000 BC0	802.11b/g	Max. SAR Summation
Right Cheek	0.409	0.116	0.525
Right Tilted	0.346	0.022	0.368
Left Cheek	0.431	0.065	0.496
Left Tilted	0.324	0.0011	0.3251
Front Face	0.22	0.022	0.242
Rear Face	0.639	0.144	0.783
Top Side	0.044	0.031	0.075
Bottom Side	0.011	0.015	0.026
Right Side	0.494	0.00872	0.50272
Left Side	0.384	0.11	0.494

Position	CDMA2000 BC0	WiMAX (Main Ant)	Max. SAR Summation
Right Cheek	0.409	0.509	0.918
Right Tilted	0.346	0.119	0.465
Left Cheek	0.431	0.053	0.484
Left Tilted	0.324	0.048	0.372
Front Face	0.22	0.09	0.31
Rear Face	0.639	0.499	1.138
Top Side	0.044	0.112	0.156
Bottom Side	0.011	0.061	0.072
Right Side	0.494	0.023	0.517
Left Side	0.384	0.04	0.424

Position	CDMA2000 BC0	WiMAX (Aux Ant)	Max. SAR Summation
Right Cheek	0.409	0.265	0.674
Right Tilted	0.346	0.243	0.589
Left Cheek	0.431	0.538	0.969
Left Tilted	0.324	0.334	0.658
Front Face	0.22	0.219	0.439
Rear Face	0.639	0.564	1.203
Top Side	0.044	0.022	0.066
Bottom Side	0.011	0.214	0.225
Right Side	0.494	0.546	1.04
Left Side	0.384	0.034	0.418



Position	CDMA2000 BC1	802.11b/g	Max. SAR Summation
Right Cheek	0.724	0.116	0.84
Right Tilted	0.427	0.022	0.449
Left Cheek	0.392	0.065	0.457
Left Tilted	0.396	0.0011	0.3971
Front Face	0.444	0.022	0.466
Rear Face	1.14	0.144	1.284
Top Side	0.287	0.031	0.318
Bottom Side	0.076	0.015	0.091
Right Side	0.349	0.00872	0.35772
Left Side	0.083	0.11	0.193

Position	CDMA2000 BC1	WiMAX (Main Ant)	Max. SAR Summation
Right Cheek	0.724	0.509	1.233
Right Tilted	0.427	0.119	0.546
Left Cheek	0.392	0.053	0.445
Left Tilted	0.396	0.048	0.444
Front Face	0.444	0.09	0.534
Rear Face	1.14	0.499	1.639
Top Side	0.287	0.112	0.399
Bottom Side	0.076	0.061	0.137
Right Side	0.349	0.023	0.372
Left Side	0.083	0.04	0.123

Position	CDMA2000 BC1	WiMAX (Aux Ant)	Max. SAR Summation
Right Cheek	0.724	0.265	0.989
Right Tilted	0.427	0.243	0.67
Left Cheek	0.392	0.538	0.93
Left Tilted	0.396	0.334	0.73
Front Face	0.444	0.219	0.663
Rear Face	1.14	0.564	1.704
Top Side	0.287	0.022	0.309
Bottom Side	0.076	0.214	0.29
Right Side	0.349	0.546	0.895
Left Side	0.083	0.034	0.117



Position	WiMAX (Main Ant)	802.11b/g	Max. SAR Summation
Right Cheek	0.509	0.116	0.625
Right Tilted	0.119	0.022	0.141
Left Cheek	0.053	0.065	0.118
Left Tilted	0.048	0.0011	0.0491
Front Face	0.09	0.022	0.112
Rear Face	0.499	0.144	0.643
Top Side	0.112	0.031	0.143
Bottom Side	0.061	0.015	0.076
Right Side	0.023	0.00872	0.03172
Left Side	0.04	0.11	0.15

Position	WiMAX (Aux Ant)	802.11b/g	Max. SAR Summation
Right Cheek	0.265	0.116	0.381
Right Tilted	0.243	0.022	0.265
Left Cheek	0.538	0.065	0.603
Left Tilted	0.334	0.0011	0.3351
Front Face	0.219	0.022	0.241
Rear Face	0.564	0.144	0.708
Top Side	0.022	0.031	0.053
Bottom Side	0.214	0.015	0.229
Right Side	0.546	0.00872	0.55472
Left Side	0.034	0.11	0.144

**Note:** The maximum SAR summation is calculated based on the same configuration and test position.

The SAR to peak location separation ratio of CDMA2000 BC1 and WiMAX (Main Ant) is as below:

$$\text{Summation SAR} = 1.14 + 0.499 = 1.639$$

$$\text{Peak Location Spacing} = 7.89 \text{ cm}$$

$$\text{SPLSR (SAR to Peak Location Spacing Ratio)} = 1.639 / 7.89 = 0.21$$

The SAR to peak location separation ratio of CDMA2000 BC1 and WiMAX (Aux Ant) is as below:

$$\text{Summation SAR} = 1.14 + 0.564 = 1.704$$

$$\text{Peak Location Spacing} = 7.13 \text{ cm}$$

$$\text{SPLSR (SAR to Peak Location Spacing Ratio)} = 1.704 / 7.13 = 0.238$$

According KDB 648474, the simultaneous transmission SAR was not required, because the SAR summation is less than 1.6 W/kg or SPLSR is less than 0.3. The simultaneous transmission SAR for WWAN and BT was not required, because the output power of Bluetooth (4.94 dBm) is less than  $2P_{\text{Ref}}$  (13.8 dBm).

## 4. Specific Absorption Rate (SAR)

### 4.1 Introduction

SAR is related to the rate at which energy is absorbed per unit mass in an object exposed to a radio field. The SAR distribution in a biological body is complicated and is usually carried out by experimental techniques or numerical modeling. The standard recommends limits for two tiers of groups, occupational/controlled and general population/uncontrolled, based on a person's awareness and ability to exercise control over his or her exposure. In general, occupational/controlled exposure limits are higher than the limits for general population/uncontrolled.

### 4.2 SAR Definition

The SAR definition is the time derivative (rate) of the incremental energy (dW) absorbed by (dissipated in) an incremental mass (dm) contained in a volume element (dv) of a given density ( $\rho$ ). The equation description is as below:

$$\text{SAR} = \frac{d}{dt} \left( \frac{dW}{dm} \right) = \frac{d}{dt} \left( \frac{dW}{\rho dv} \right)$$

SAR is expressed in units of Watts per kilogram (W/kg)

SAR measurement can be either related to the temperature elevation in tissue by

$$\text{SAR} = C \left( \frac{\delta T}{\delta t} \right)$$

Where: C is the specific heat capacity,  $\delta T$  is the temperature rise and  $\delta t$  is the exposure duration, or related to the electrical field in the tissue by

$$\text{SAR} = \frac{\sigma |E|^2}{\rho}$$

Where:  $\sigma$  is the conductivity of the tissue,  $\rho$  is the mass density of the tissue and E is the RMS electrical field strength.

However for evaluating SAR of low power transmitter, electrical field measurement is typically applied.

## **5. SAR Measurement System**

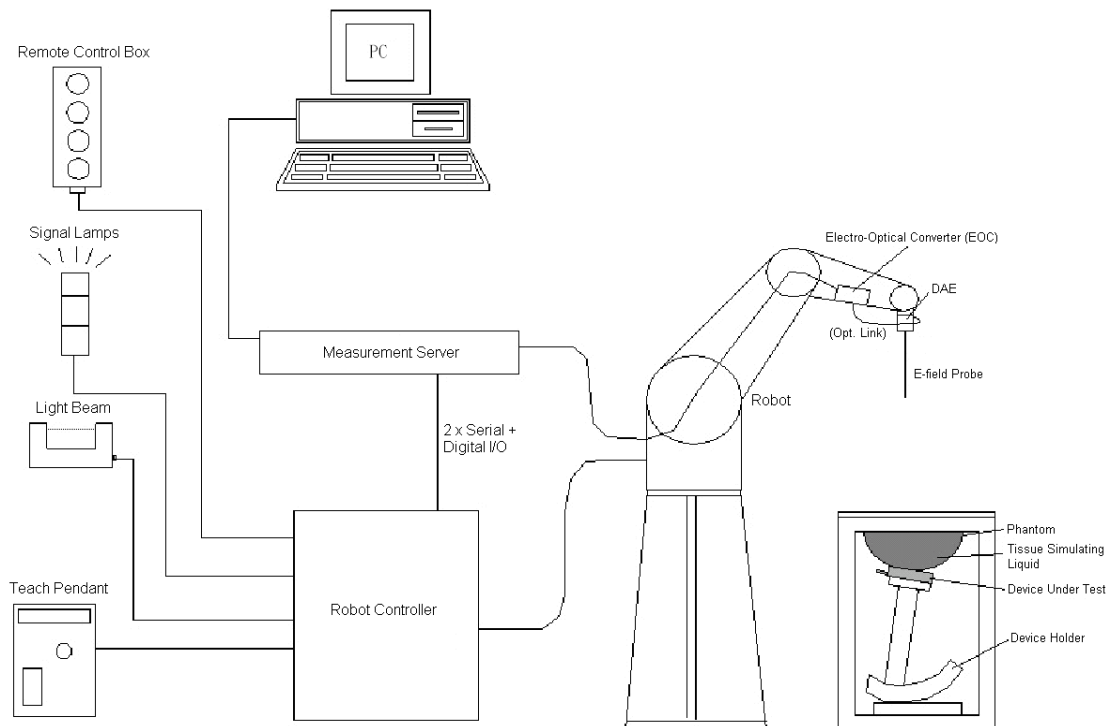

**Fig 5.1 SPEAG DASY4 or DASY5 System Configurations**

The DASY4 or DASY5 system for performance compliance tests is illustrated above graphically. This system consists of the following items:

- A standard high precision 6-axis robot with controller, a teach pendant and software
- A data acquisition electronic (DAE) attached to the robot arm extension
- A dosimetric probe equipped with an optical surface detector system
- The electro-optical converter (ECO) performs the conversion between optical and electrical signals
- A measurement server performs the time critical tasks such as signal filtering, control of the robot operation and fast movement interrupts.
- A probe alignment unit which improves the accuracy of the probe positioning
- A computer operating Windows XP
- DASY4 or DASY5 software
- Remote control with teach pendant and additional circuitry for robot safety such as warning lamps, etc.
- The SAM twin phantom
- A device holder
- Tissue simulating liquid
- Dipole for evaluating the proper functioning of the system

Some of the components are described in details in the following sub-sections.

**5.1 E-Field Probe**

The SAR measurement is conducted with the dosimetric probe (manufactured by SPEAG). The probe is specially designed and calibrated for use in liquid with high permittivity. The dosimetric probe has special calibration in liquid at different frequency. This probe has a built in optical surface detection system to prevent from collision with phantom.

**5.1.1 E-Field Probe Specification**

**<ET3DV6>**

<b>Construction</b>	Symmetrical design with triangular core Built-in optical fiber for surface detection system. Built-in shielding against static charges. PEEK enclosure material (resistant to organic solvents, e.g., DGBE)
<b>Frequency</b>	10 MHz to 3 GHz; Linearity: $\pm 0.2$ dB
<b>Directivity</b>	$\pm 0.2$ dB in HSL (rotation around probe axis) $\pm 0.4$ dB in HSL (rotation normal to probe axis)
<b>Dynamic Range</b>	5 $\mu$ W/g to 100 mW/g; Linearity: $\pm 0.2$ dB
<b>Dimensions</b>	Overall length: 330 mm (Tip: 16 mm) Tip diameter: 6.8 mm (Body: 12 mm) Distance from probe tip to dipole centers: 2.7 mm

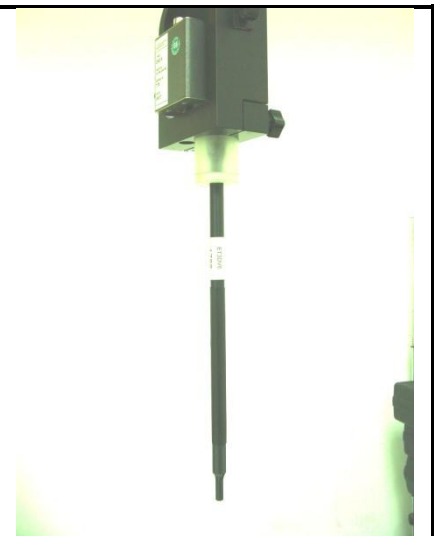

**Fig 5.2 Photo of ET3DV6**

**<EX3DV4 Probe>**

<b>Construction</b>	Symmetrical design with triangular core Built-in shielding against static charges PEEK enclosure material (resistant to organic solvents, e.g., DGBE)
<b>Frequency</b>	10 MHz to 6 GHz; Linearity: $\pm 0.2$ dB
<b>Directivity</b>	$\pm 0.3$ dB in HSL (rotation around probe axis) $\pm 0.5$ dB in tissue material (rotation normal to probe axis)
<b>Dynamic Range</b>	10 $\mu$ W/g to 100 mW/g; Linearity: $\pm 0.2$ dB (noise: typically $< 1$ $\mu$ W/g)
<b>Dimensions</b>	Overall length: 330 mm (Tip: 20 mm) Tip diameter: 2.5 mm (Body: 12 mm) Typical distance from probe tip to dipole centers: 1 mm



**Fig 5.3 Photo of EX3DV4**



### 5.1.2 E-Field Probe Calibration

Each probe needs to be calibrated according to a dosimetric assessment procedure with accuracy better than  $\pm 10\%$ . The spherical isotropy shall be evaluated and within  $\pm 0.25$  dB. The sensitivity parameters (NormX, NormY, and NormZ), the diode compression parameter (DCP) and the conversion factor (ConvF) of the probe are tested. The calibration data can be referred to appendix C of this report.

### 5.2 Data Acquisition Electronics (DAE)

The data acquisition electronics (DAE) consists of a highly sensitive electrometer-grade preamplifier with auto-zeroing, a channel and gain-switching multiplexer, a fast 16 bit AD-converter and a command decoder and control logic unit. Transmission to the measurement server is accomplished through an optical downlink for data and status information as well as an optical uplink for commands and the clock. The input impedance of the DAE is 200 MOhm; the inputs are symmetrical and floating. Common mode rejection is above 80 dB.

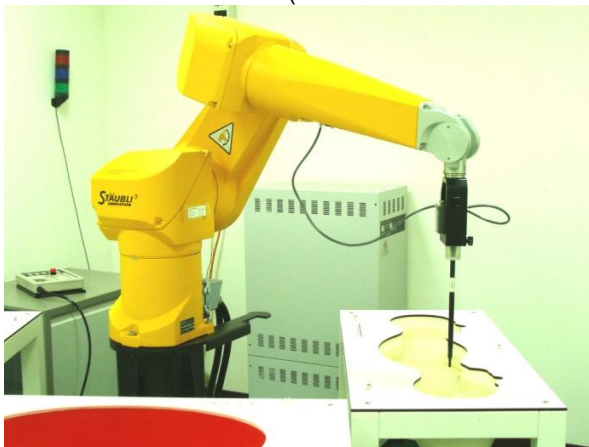

**Fig 5.4 Photo of DAE**

### 5.3 Robot

The SPEAG DASY system uses the high precision robots (DASY4: RX90BL; DASY5: TX90XL) type from Stäubli SA (France). For the 6-axis controller system, the robot controller version (DASY4: CS7MB; DASY5: CS8c) from Stäubli is used. The Stäubli robot series have many features that are important for our application:

- High precision (repeatability  $\pm 0.035$  mm)
- High reliability (industrial design)
- Jerk-free straight movements
- Low ELF interference (the closed metallic construction shields against motor control fields)



**Fig 5.5 Photo of DASY4**



**Fig 5.6 Photo of DASY5**

### **5.4 Measurement Server**

The measurement server is based on a PC/104 CPU board with CPU (DASY4: 166 MHz, Intel Pentium; DASY5: 400 MHz, Intel Celeron), chipdisk (DASY4: 32 MB; DASY5: 128 MB), RAM (DASY4: 64 MB, DASY5: 128 MB). The necessary circuits for communication with the DAE electronic box, as well as the 16 bit AD converter system for optical detection and digital I/O interface are contained on the DASY I/O board, which is directly connected to the PC/104 bus of the CPU board.

The measurement server performs all the real-time data evaluation for field measurements and surface detection, controls robot movements and handles safety operations.



**Fig 5.7 Photo of Server for DASY4**



**Fig 5.8 Photo of Server for DASY5**

**5.5 Phantom**

**<SAM Twin Phantom>**

<b>Shell Thickness</b>	2 ± 0.2 mm; Center ear point: 6 ± 0.2 mm
<b>Filling Volume</b>	Approx. 25 liters
<b>Dimensions</b>	Length: 1000 mm; Width: 500 mm; Height: adjustable feet
<b>Measurement Areas</b>	Left Hand, Right Hand, Flat Phantom



**Fig 5.9 Photo of SAM Phantom**

The bottom plate contains three pair of bolts for locking the device holder. The device holder positions are adjusted to the standard measurement positions in the three sections. A white cover is provided to tap the phantom during off-periods to prevent water evaporation and changes in the liquid parameters. On the phantom top, three reference markers are provided to identify the phantom position with respect to the robot.

**<ELI4 Phantom>**

<b>Shell Thickness</b>	2 ± 0.2 mm (sagging: <1%)
<b>Filling Volume</b>	Approx. 30 liters
<b>Dimensions</b>	Major ellipse axis: 600 mm Minor axis: 400 mm



**Fig 5.10 Photo of ELI4 Phantom**

The ELI4 phantom is intended for compliance testing of handheld and body-mounted wireless devices in the frequency range of 30 MHz to 6 GHz. ELI4 is fully compatible with standard and all known tissue simulating liquids.

## 5.6 Device Holder

### <Device Holder for SAM Twin Phantom>

The SAR in the phantom is approximately inversely proportional to the square of the distance between the source and the liquid surface. For a source at 5 mm distance, a positioning uncertainty of  $\pm 0.5$  mm would produce a SAR uncertainty of  $\pm 20$  %. Accurate device positioning is therefore crucial for accurate and repeatable measurements. The positions in which the devices must be measured are defined by the standards.

The DASY device holder is designed to cope with different positions given in the standard. It has two scales for the device rotation (with respect to the body axis) and the device inclination (with respect to the line between the ear reference points). The rotation center for both scales is the ear reference point (EPR). Thus the device needs no repositioning when changing the angles.

The DASY device holder is constructed of low-loss POM material having the following dielectric parameters: relative permittivity  $\epsilon = 3$  and loss tangent  $\delta = 0.02$ . The amount of dielectric material has been reduced in the closest vicinity of the device, since measurements have suggested that the influence of the clamp on the test results could thus be lowered.



Fig 5.11 Device Holder

**<Laptop Extension Kit>**

The extension is lightweight and made of POM, acrylic glass and foam. It fits easily on the upper part of the mounting device in place of the phone positioned. The extension is fully compatible with the SAM Twin and ELI phantoms.

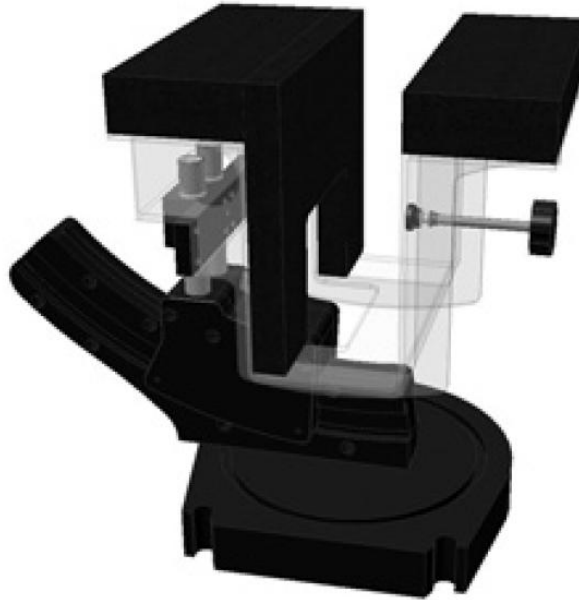

**Fig 5.12 Laptop Extension Kit**



## 5.7 Data Storage and Evaluation

### 5.7.1 Data Storage

The DASY software stores the assessed data from the data acquisition electronics as raw data (in microvolt readings from the probe sensors), together with all the necessary software parameters for the data evaluation (probe calibration data, liquid parameters and device frequency and modulation data) in measurement files. The post-processing software evaluates the desired unit and format for output each time the data is visualized or exported. This allows verification of the complete software setup even after the measurement and allows correction of erroneous parameter settings. For example, if a measurement has been performed with an incorrect crest factor parameter in the device setup, the parameter can be corrected afterwards and the data can be reevaluated.

The measured data can be visualized or exported in different units or formats, depending on the selected probe type (e.g., [V/m], [A/m], [mW/g]). Some of these units are not available in certain situations or give meaningless results, e.g., a SAR-output in a non-lose media, will always be zero. Raw data can also be exported to perform the evaluation with other software packages.

### 5.7.2 Data Evaluation

The DASY post-processing software (SEMCAD) automatically executes the following procedures to calculate the field units from the microvolt readings at the probe connector. The parameters used in the evaluation are stored in the configuration modules of the software :

<b>Probe parameters :</b>	- Sensitivity	Norm <sub>i</sub> , a <sub>10</sub> , a <sub>11</sub> , a <sub>12</sub>
	- Conversion factor	ConvF <sub>i</sub>
	- Diode compression point	dcp <sub>i</sub>
<b>Device parameters :</b>	- Frequency	f
	- Crest factor	cf
<b>Media parameters :</b>	- Conductivity	σ
	- Density	ρ

These parameters must be set correctly in the software. They can be found in the component documents or they can be imported into the software from the configuration files issued for the DASY components. In the direct measuring mode of the multi-meter option, the parameters of the actual system setup are used. In the scan visualization and export modes, the parameters stored in the corresponding document files are used.

The first step of the evaluation is a linearization of the filtered input signal to account for the compression characteristics of the detector diode. The compensation depends on the input signal, the diode type and the DC-transmission factor from the diode to the evaluation electronics. If the exciting field is pulsed, the crest factor of the signal must be known to correctly compensate for peak power.

The formula for each channel can be given as :

$$V_i = U_i + U_i^2 \cdot \frac{cf}{dcp_i}$$

with  $V_i$  = compensated signal of channel i, (i = x, y, z)  
 $U_i$  = input signal of channel i, (i = x, y, z)  
 cf = crest factor of exciting field (DASY parameter)  
 dcp<sub>i</sub> = diode compression point (DASY parameter)

From the compensated input signals, the primary field data for each channel can be evaluated :

$$\text{E-field Probes : } E_i = \sqrt{\frac{V_i}{\text{Norm}_i \cdot \text{ConvF}}}$$

$$\text{H-field Probes : } H_i = \sqrt{V_i} \cdot \frac{a_{i0} + a_{i1}f + a_{i2}f^2}{f}$$

with  $V_i$  = compensated signal of channel i, (i = x, y, z)  
 Norm<sub>i</sub> = sensor sensitivity of channel i, (i = x, y, z),  $\mu\text{V}/(\text{V/m})^2$  for E-field Probes  
 ConvF = sensitivity enhancement in solution  
 a<sub>ij</sub> = sensor sensitivity factors for H-field probes  
 f = carrier frequency [GHz]  
 E<sub>i</sub> = electric field strength of channel i in V/m  
 H<sub>i</sub> = magnetic field strength of channel i in A/m

The RSS value of the field components gives the total field strength (Hermitian magnitude) :

$$E_{\text{tot}} = \sqrt{E_x^2 + E_y^2 + E_z^2}$$

The primary field data are used to calculate the derived field units.

$$\text{SAR} = E_{\text{tot}}^2 \cdot \frac{\sigma}{\rho \cdot 1000}$$

with SAR = local specific absorption rate in mW/g  
 E<sub>tot</sub> = total field strength in V/m  
 σ = conductivity in [mho/m] or [Siemens/m]  
 ρ = equivalent tissue density in g/cm<sup>3</sup>

Note that the density is set to 1, to account for actual head tissue density rather than the density of the tissue simulating liquid.



**5.8 Test Equipment List**

Manufacturer	Name of Equipment	Type/Model	Serial Number	Calibration	
				Last Cal.	Due Date
SPEAG	Dosimetric E-Field Probe	EX3DV4	3731	Sep. 20, 2010	Sep. 19, 2011
SPEAG	2600MHz System Validation Kit	D2600V2	1008	Sep. 24, 2009	Sep. 23, 2011
SPEAG	Data Acquisition Electronics	DAE4	778	Oct. 22, 2010	Oct. 21, 2011
SPEAG	Device Holder	N/A	N/A	NCR	NCR
SPEAG	SAM Phantom	QD 000 P40 C	TP-1303	NCR	NCR
SPEAG	SAM Phantom	QD 000 P40 C	TP-1383	NCR	NCR
SPEAG	SAM Phantom	QD 000 P40 C	TP-1446	NCR	NCR
SPEAG	SAM Phantom	QD 000 P40 C	TP-1477	NCR	NCR
SPEAG	ELI4 Phantom	QD 0VA 001 BB	1026	NCR	NCR
SPEAG	ELI4 Phantom	QD 0VA 001 BA	1029	NCR	NCR
Agilent	PNA Series Network Analyzer	E8358A	US40260131	May 06, 2010	May 05, 2011
Agilent	WiMAX Communication Test Set	E6651A	MY47310158	NCR	NCR
Agilent	Dielectric Probe Kit	85070D	US01440205	NCR	NCR
Agilent	Dual Directional Coupler	778D	50422	NCR	NCR
AR	Power Amplifier	5S1G4M2	0328767	NCR	NCR
R&S	Spectrum Analyzer	FSP7	101131	Mar. 05, 2010	Mar. 04, 2011
Anritsu	Power Meter	ML2495A	0932001	Sep. 13, 2010	Sep. 12, 2011
Anritsu	Power Sensor	MA2411B	0846202	Sep. 14, 2010	Sep. 13, 2011

**Table 5.1 Test Equipment List**

**Note:** The calibration certificate of DASYS can be referred to appendix C of this report.



## **6. Tissue Simulating Liquids**

For the measurement of the field distribution inside the SAM phantom with DASY, the phantom must be filled with around 25 liters of homogeneous body tissue simulating liquid. For head SAR testing, the liquid height from the ear reference point (ERP) of the phantom to the liquid top surface is larger than 15 cm, which is shown in Fig. 6.1. For body SAR testing, the liquid height from the center of the flat phantom to the liquid top surface is larger than 15 cm, which is shown in Fig. 6.2.

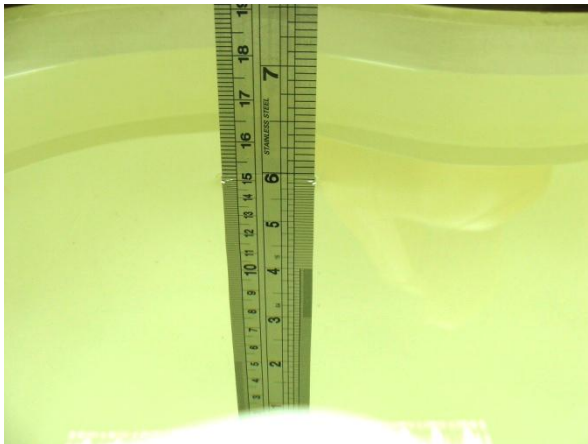

**Fig 6.1 Photo of Liquid Height for Head SAR**



**Fig 6.2 Photo of Liquid Height for Body SAR**

The following table gives the targets for tissue simulating liquid.

Frequency (MHz)	Liquid Type	Conductivity ( $\sigma$ )	$\pm 5\%$ Range	Permittivity ( $\epsilon_r$ )	$\pm 5\%$ Range
2496	Head	1.85	1.76 ~ 1.94	39.14	37.18 ~ 41.10
2593	Head	1.96	1.86 ~ 2.06	39.02	37.07 ~ 40.97
2600	Head	1.96	1.86 ~ 2.06	39.01	37.06 ~ 40.96
2690	Head	2.06	1.96 ~ 2.16	38.89	36.95 ~ 40.83
2496	Body	2.02	1.92 ~ 2.12	52.64	50.01 ~ 55.27
2593	Body	2.15	2.04 ~ 2.26	52.52	49.89 ~ 55.15
2600	Body	2.16	2.05 ~ 2.27	52.51	49.88 ~ 55.14
2690	Body	2.29	2.18 ~ 2.40	52.39	49.77 ~ 55.01

**Table 6.1 Targets of Tissue Simulating Liquid**

The dielectric parameters of the liquids were verified prior to the SAR evaluation using an Agilent 85070D Dielectric Probe Kit and an Agilent Network Analyzer.



The following table shows the measuring results for simulating liquid.

Band	Liquid Type	Temperature (°C)	Frequency (MHz)	Conductivity (σ)	Permittivity (ε <sub>r</sub> )	Measurement Date
2600	Head	21.1	2498.5	1.882	38.65	Nov. 08, 2010
			2501.0	1.883	38.65	
			2593.0	1.966	38.24	
			2685.0	2.053	37.90	
			2687.5	2.056	37.89	
2600	Head	21.4	2498.5	1.866	38.53	Nov. 09, 2010
			2501.0	1.868	38.53	
			2593.0	1.950	38.13	
			2685.0	2.037	37.79	
			2687.5	2.039	37.78	
2600	Head	21.4	2498.5	1.866	38.53	Nov. 19, 2010
			2501.0	1.868	38.53	
			2593.0	1.950	38.13	
			2685.0	2.037	37.79	
			2687.5	2.039	37.78	
2600	Body	21.4	2498.5	2.098	51.31	Nov. 06, 2010
			2501.0	2.099	51.31	
			2593.0	2.200	51.11	
			2685.0	2.253	50.86	
			2687.5	2.256	50.86	
2600	Body	21.2	2498.5	2.056	54.01	Nov. 09, 2010
			2501.0	2.057	54.01	
			2593.0	2.157	53.81	
			2685.0	2.208	53.56	
			2687.5	2.213	53.56	

Table 6.2 Measuring Results for Simulating Liquid

## **7. Uncertainty Assessment**

The component of uncertainty may generally be categorized according to the methods used to evaluate them. The evaluation of uncertainty by the statistical analysis of a series of observations is termed a Type A evaluation of uncertainty. The evaluation of uncertainty by means other than the statistical analysis of a series of observation is termed a Type B evaluation of uncertainty. Each component of uncertainty, however evaluated, is represented by an estimated standard deviation, termed standard uncertainty, which is determined by the positive square root of the estimated variance.

A Type A evaluation of standard uncertainty may be based on any valid statistical method for treating data. This includes calculating the standard deviation of the mean of a series of independent observations; using the method of least squares to fit a curve to the data in order to estimate the parameter of the curve and their standard deviations; or carrying out an analysis of variance in order to identify and quantify random effects in certain kinds of measurement.

A type B evaluation of standard uncertainty is typically based on scientific judgment using all of the relevant information available. These may include previous measurement data, experience and knowledge of the behavior and properties of relevant materials and instruments, manufacture’s specification, data provided in calibration reports and uncertainties assigned to reference data taken from handbooks. Broadly speaking, the uncertainty is either obtained from an outdoor source or obtained from an assumed distribution, such as the normal distribution, rectangular or triangular distributions indicated in Table 7.1

<b>Uncertainty Distributions</b>	<b>Normal</b>	<b>Rectangular</b>	<b>Triangular</b>	<b>U-Shape</b>
Multi-plying Factor <sup>(a)</sup>	1/k <sup>(b)</sup>	1/√3	1/√6	1/√2

(a) standard uncertainty is determined as the product of the multiplying factor and the estimated range of variations in the measured quantity

(b)  $\kappa$  is the coverage factor

**Table 7.1 Standard Uncertainty for Assumed Distribution**

The combined standard uncertainty of the measurement result represents the estimated standard deviation of the result. It is obtained by combining the individual standard uncertainties of both Type A and Type B evaluation using the usual “root-sum-squares” (RSS) methods of combining standard deviations by taking the positive square root of the estimated variances.

Expanded uncertainty is a measure of uncertainty that defines an interval about the measurement result within which the measured value is confidently believed to lie. It is obtained by multiplying the combined standard uncertainty by a coverage factor. Typically, the coverage factor ranges from 2 to 3. Using a coverage factor allows the true value of a measured quantity to be specified with a defined probability within the specified uncertainty range. For purpose of this document, a coverage factor two is used, which corresponds to confidence interval of about 95 %. The DASY uncertainty Budget is showed in Table 7.2 and Table 7.3.



Error Description	Uncertainty Value (±%)	Probability Distribution	Divisor	Ci (1g)	Standard Uncertainty (1g)
<b>Measurement System</b>					
Probe Calibration	5.5	Normal	1	1	± 5.5 %
Axial Isotropy	4.7	Rectangular	√3	0.7	± 1.9 %
Hemispherical Isotropy	9.6	Rectangular	√3	0.7	± 3.9 %
Boundary Effects	1.0	Rectangular	√3	1	± 0.6 %
Linearity	4.7	Rectangular	√3	1	± 2.7 %
System Detection Limits	1.0	Rectangular	√3	1	± 0.6 %
Readout Electronics	0.3	Normal	1	1	± 0.3 %
Response Time	0.8	Rectangular	√3	1	± 0.5 %
Integration Time	2.6	Rectangular	√3	1	± 1.5 %
RF Ambient Noise	3.0	Rectangular	√3	1	± 1.7 %
RF Ambient Reflections	3.0	Rectangular	√3	1	± 1.7 %
Probe Positioner	0.4	Rectangular	√3	1	± 0.2 %
Probe Positioning	2.9	Rectangular	√3	1	± 1.7 %
Max. SAR Eval.	1.0	Rectangular	√3	1	± 0.6 %
<b>Test Sample Related</b>					
Device Positioning	2.9	Normal	1	1	± 2.9 %
Device Holder	3.6	Normal	1	1	± 3.6 %
Power Drift	5.0	Rectangular	√3	1	± 2.9 %
<b>Phantom and Setup</b>					
Phantom Uncertainty	4.0	Rectangular	√3	1	± 2.3 %
Liquid Conductivity (Target)	5.0	Rectangular	√3	0.64	± 1.8 %
Liquid Conductivity (Meas.)	2.5	Normal	1	0.64	± 1.6 %
Liquid Permittivity (Target)	5.0	Rectangular	√3	0.6	± 1.7 %
Liquid Permittivity (Meas.)	2.5	Normal	1	0.6	± 1.5 %
<b>Combined Standard Uncertainty</b>					± 10.7 %
<b>Coverage Factor for 95 %</b>					K = 2
<b>Expanded Uncertainty</b>					± 21.4 %

Table 7.2 Uncertainty Budget of DASy for frequency range 300 MHz to 3 GHz



Error Description	Uncertainty Value (±%)	Probability Distribution	Divisor	Ci (1g)	Standard Uncertainty (1g)
<b>Measurement System</b>					
Probe Calibration	6.55	Normal	1	1	± 6.55 %
Axial Isotropy	4.7	Rectangular	√3	0.7	± 1.9 %
Hemispherical Isotropy	9.6	Rectangular	√3	0.7	± 3.9 %
Boundary Effects	2.0	Rectangular	√3	1	± 1.2 %
Linearity	4.7	Rectangular	√3	1	± 2.7 %
System Detection Limits	1.0	Rectangular	√3	1	± 0.6 %
Readout Electronics	0.3	Normal	1	1	± 0.3 %
Response Time	0.8	Rectangular	√3	1	± 0.5 %
Integration Time	2.6	Rectangular	√3	1	± 1.5 %
RF Ambient Noise	3.0	Rectangular	√3	1	± 1.7 %
RF Ambient Reflections	3.0	Rectangular	√3	1	± 1.7 %
Probe Positioner	0.8	Rectangular	√3	1	± 0.5 %
Probe Positioning	9.9	Rectangular	√3	1	± 5.7 %
Max. SAR Eval.	4.0	Rectangular	√3	1	± 2.3 %
<b>Test Sample Related</b>					
Device Positioning	2.9	Normal	1	1	± 2.9 %
Device Holder	3.6	Normal	1	1	± 3.6 %
Power Drift	5.0	Rectangular	√3	1	± 2.9 %
<b>Phantom and Setup</b>					
Phantom Uncertainty	4.0	Rectangular	√3	1	± 2.3 %
Liquid Conductivity (Target)	5.0	Rectangular	√3	0.43	± 1.8 %
Liquid Conductivity (Meas.)	2.5	Normal	1	0.43	± 1.6 %
Liquid Permittivity (Target)	5.0	Rectangular	√3	0.49	± 1.7 %
Liquid Permittivity (Meas.)	2.5	Normal	1	0.49	± 1.5 %
<b>Combined Standard Uncertainty</b>					± 12.8 %
<b>Coverage Factor for 95 %</b>					K = 2
<b>Expanded Uncertainty</b>					± 25.6 %

Table 7.3 Uncertainty Budget of DASY for frequency range 3 GHz to 6 GHz

## 8. SAR Measurement Evaluation

Each DASY system is equipped with one or more system validation kits. These units, together with the predefined measurement procedures within the DASY software, enable the user to conduct the system performance check and system validation. System validation kit includes a dipole, tripod holder to fix it underneath the flat phantom and a corresponding distance holder.

### 8.1 Purpose of System Performance check

The system performance check verifies that the system operates within its specifications. System and operator errors can be detected and corrected. It is recommended that the system performance check be performed prior to any usage of the system in order to guarantee reproducible results. The system performance check uses normal SAR measurements in a simplified setup with a well characterized source. This setup was selected to give a high sensitivity to all parameters that might fail or vary over time. The system check does not intend to replace the calibration of the components, but indicates situations where the system uncertainty is exceeded due to drift or failure.

### 8.2 System Setup

In the simplified setup for system evaluation, the DUT is replaced by a calibrated dipole and the power source is replaced by a continuous wave that comes from a signal generator. The calibrated dipole must be placed beneath the flat phantom section of the SAM twin phantom with the correct distance holder. The distance holder should touch the phantom surface with a light pressure at the reference marking and be oriented parallel to the long side of the phantom. The equipment setup is shown below:

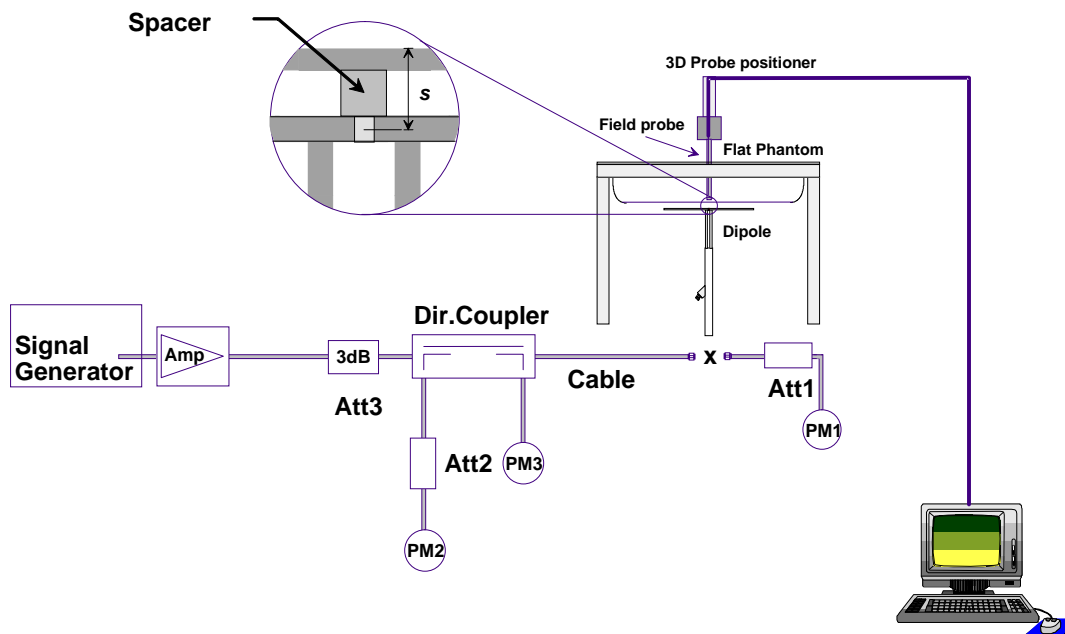
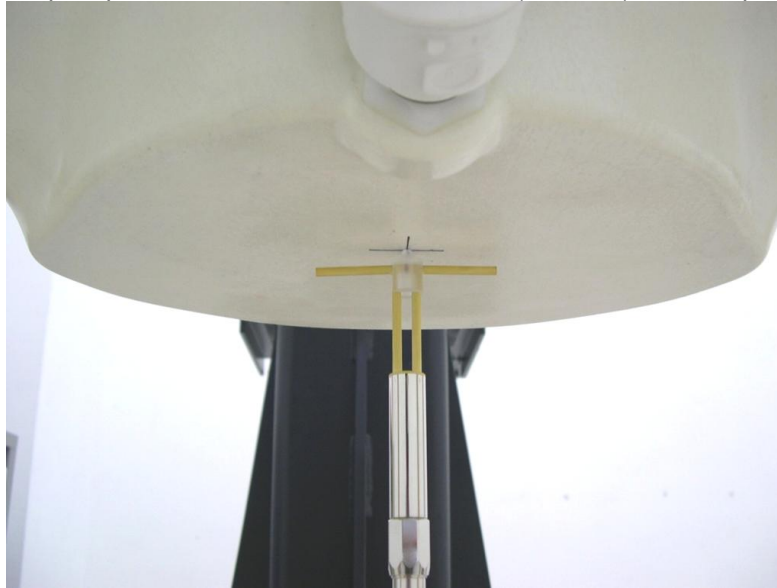

Fig 8.1 System Setup for System Evaluation

1. Signal Generator
2. Amplifier
3. Directional Coupler
4. Power Meter
5. Calibrated Dipole

The output power on dipole port must be calibrated to 20 dBm (100 mW) before dipole is connected.



**Fig 8.2 Photo of Dipole Setup**

**8.3 Validation Results**

Comparing to the original SAR value provided by SPEAG, the validation data should be within its specification of 10 %. Table 8.1 shows the target SAR and measured SAR after normalized to 1W input power. The table below indicates the system performance check can meet the variation criterion and the plots can be referred to Appendix A of this report.

Measurement Date	Liquid Type	Frequency (MHz)	Targeted SAR <sub>1g</sub> (W/kg)	Measured SAR <sub>1g</sub> (W/kg)	Deviation (%)
Nov. 08, 2010	Head	2600	58.50	55.20	-5.64
Nov. 09, 2010	Head	2600	58.50	57.40	-1.88
Nov. 19, 2010	Head	2600	58.50	58.30	-0.34
Nov. 06, 2010	Body	2600	57.90	55.70	-3.80
Nov. 09, 2010	Body	2600	57.90	54.40	-6.04

**Table 8.1 Target and Measurement SAR after Normalized**

## 9. DUT Testing Position

This DUT was tested in ten different positions. They are right cheek, right tilted, left cheek, left tilted, front face of the DUT with phantom 1.0 cm gap, rear face of the DUT with phantom 1.0 cm gap, right side of the DUT with phantom 1.0 cm gap, left side of the DUT with phantom 1.0 cm gap, top side of the DUT with phantom 1.0 cm gap, and bottom side of the DUT with phantom 1.0 cm gap as illustrated below:

### 1. Define two imaginary lines on the handset

- (a) The vertical centerline passes through two points on the front side of the handset - the midpoint of the width  $w_t$  of the handset at the level of the acoustic output, and the midpoint of the width  $w_b$  of the bottom of the handset.
- (b) The horizontal line is perpendicular to the vertical centerline and passes through the center of the acoustic output. The horizontal line is also tangential to the face of the handset at point A.
- (c) The two lines intersect at point A. Note that for many handsets, point A coincides with the center of the acoustic output; however, the acoustic output may be located elsewhere on the horizontal line. Also note that the vertical centerline is not necessarily parallel to the front face of the handset, especially for clamshell handsets, handsets with flip covers, and other irregularly shaped handsets.

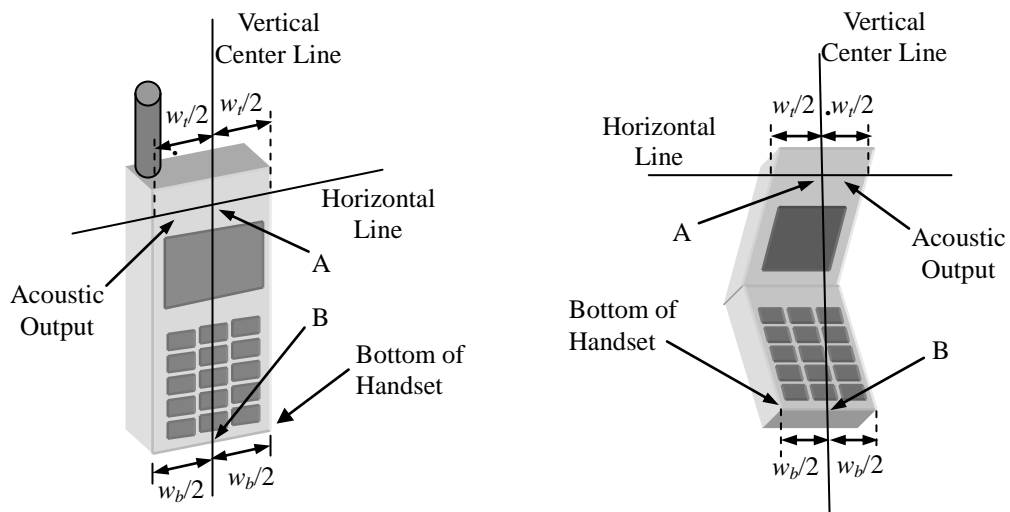
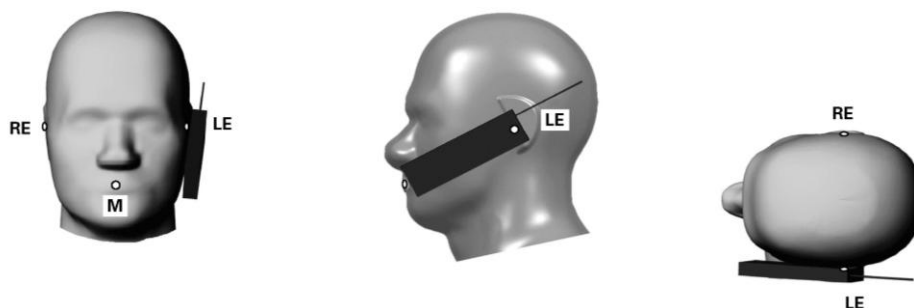

Fig 9.1 Illustration for Handset Vertical and Horizontal Reference Lines



**2. Cheek Position**

- (a) To position the device with the vertical center line of the body of the device and the horizontal line crossing the center piece in a plane parallel to the sagittal plane of the phantom. While maintaining the device in this plane, align the vertical center line with the reference plane containing the three ear and mouth reference point (M: Mouth, RE: Right Ear, and LE: Left Ear) and align the center of the ear piece with the line RE-LE.
- (b) To move the device towards the phantom with the ear piece aligned with the line LE-RE until the phone touched the ear. While maintaining the device in the reference plane and maintaining the phone contact with the ear, move the bottom of the phone until any point on the front side is in contact with the cheek of the phantom or until contact with the ear is lost (see Fig. 9.2).



**Fig 9.2 Illustration for Cheek Position**

**3. Tilted Position**

- (a) To position the device in the “cheek” position described above.
- (b) While maintaining the device the reference plane described above and pivoting against the ear, moves it outward away from the mouth by an angle of 15 degrees or until contact with the ear is lost (see Fig. 9.3).

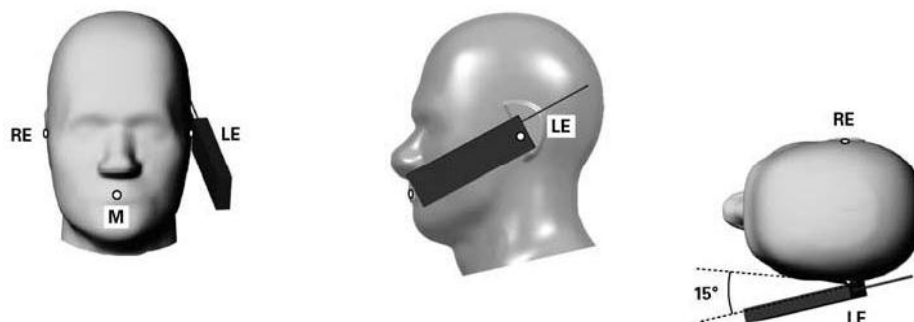

**Fig 9.3 Illustration for Tilted Position**

#### 4. Body Worn Position

- (a) To position the device parallel to the phantom surface for front/rear face or each sides.
- (b) To adjust the device parallel to the flat phantom.
- (c) To adjust the distance between the device surface and the flat phantom to 1.0 cm.

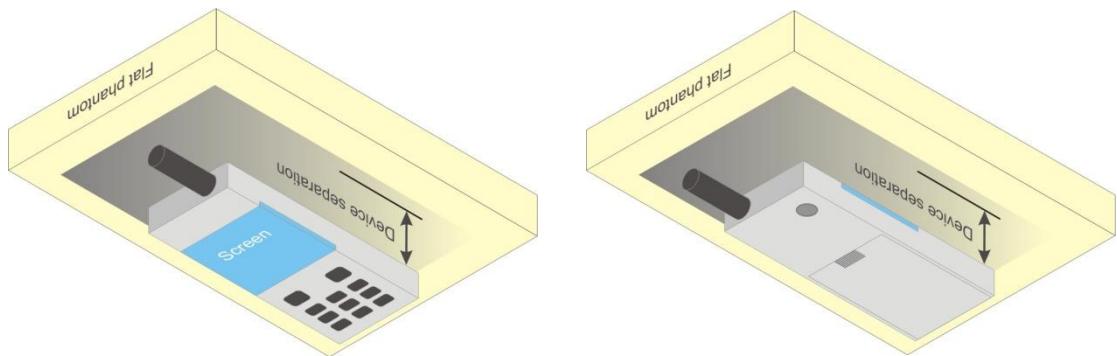

**Fig 9.4 Illustration for Body Worn Position**

#### 5. DUT Setup Photos

Please refer to Appendix E for the test setup photos.

## **10. Measurement Procedures**

The measurement procedures are as follows:

- (a) Set WiMAX system simulator to allow DUT to radiate maximum output power
- (b) Measure output power through RF cable and power meter
- (c) Place the DUT in the positions described in the last section
- (d) Set scan area, grid size and other setting on the DASY software
- (e) Taking data for the middle channel on each testing position
- (f) Find out the largest SAR result on these testing positions of each band
- (g) Measure SAR results for the lowest and highest channels in worst SAR testing position

According to the test standard, the recommended procedure for assessing the peak spatial-average SAR value consists of the following steps:

- (a) Power reference measurement
- (b) Area scan
- (c) Zoom scan
- (d) Power drift measurement

### **10.1 Spatial Peak SAR Evaluation**

The procedure for spatial peak SAR evaluation has been implemented according to the test standard. It can be conducted for 1g and 10g, as well as for user-specific masses. The DASY software includes all numerical procedures necessary to evaluate the spatial peak SAR value.

The base for the evaluation is a "cube" measurement. The measured volume must include the 1g and 10g cubes with the highest averaged SAR values. For that purpose, the center of the measured volume is aligned to the interpolated peak SAR value of a previously performed area scan.

The entire evaluation of the spatial peak values is performed within the post-processing engine (SEMCAD). The system always gives the maximum values for the 1g and 10g cubes. The algorithm to find the cube with highest averaged SAR is divided into the following stages:

- (a) Extraction of the measured data (grid and values) from the Zoom Scan
- (b) Calculation of the SAR value at every measurement point based on all stored data (A/D values and measurement parameters)
- (c) Generation of a high-resolution mesh within the measured volume
- (d) Interpolation of all measured values from the measurement grid to the high-resolution grid
- (e) Extrapolation of the entire 3-D field distribution to the phantom surface over the distance from sensor to surface
- (f) Calculation of the averaged SAR within masses of 1g and 10g

## **10.2 Scan Procedures**

First Area Scan is used to locate the approximate location(s) of the local peak SAR value(s). The measurement grid within an Area Scan is defined by the grid extent, grid step size and grid offset. Next, in order to determine the EM field distribution in a three-dimensional spatial extension, Zoom Scan is required. The Zoom Scan measures 5x5x7 points with step size 8, 8 and 5 mm for 300 MHz to 3 GHz, and 8x8x8 points with step size 4, 4 and 2.5 mm for 3 GHz to 6 GHz. The Zoom Scan is performed around the highest E-field value to determine the averaged SAR-distribution over 10 g.

## **10.3 SAR Averaged Methods**

In DASy, the interpolation and extrapolation are both based on the modified Quadratic Shepard's method. The interpolation scheme combines a least-square fitted function method and a weighted average method which are the two basic types of computational interpolation and approximation.

Extrapolation routines are used to obtain SAR values between the lowest measurement points and the inner phantom surface. The extrapolation distance is determined by the surface detection distance and the probe sensor offset. The uncertainty increases with the extrapolation distance. To keep the uncertainty within 1% for the 1 g and 10 g cubes, the extrapolation distance should not be larger than 5 mm.

## **10.4 Power Drift Monitoring**

All SAR testing is under the DUT install full charged battery and transmit maximum output power. In DASy measurement software, the power reference measurement and power drift measurement procedures are used for monitoring the power drift of DUT during SAR test. Both these procedures measure the field at a specified reference position before and after the SAR testing. The software will calculate the field difference in dB. If the power drift more than 5%, the SAR will be retested.

## 11. SAR Test Results

### 11.1 Conducted Power (Unit: dBm)

Zone Type	Modulation	Coding Rate	Frequency	Ant-0 (Main Antenna)			Ant-1 (Aux. Antenna)		
				Peak Power	Average Power	PAPR	Peak Power	Average Power	PAPR
PUSC	QPSK (BW 5MHz)	1/2	2498.5	31.49	23.44	8.05	32.74	23.65	9.09
			2593.0	30.98	22.98	8.00	32.70	23.00	9.70
			2687.5	31.34	23.56	7.78	32.14	23.76	8.38
		3/4	2498.5	31.50	23.30	8.20	32.45	23.59	8.86
			2593.0	31.08	23.10	7.98	32.71	23.00	9.71
			2687.5	31.32	23.50	7.82	32.14	23.73	8.41
	16QAM (BW 5MHz)	1/2	2498.5	31.47	23.15	8.32	32.56	23.46	9.10
			2593.0	31.02	22.94	8.08	32.84	22.89	9.95
			2687.5	31.30	23.32	7.98	32.12	23.49	8.63
		3/4	2498.5	31.59	23.02	8.57	32.56	23.25	9.31
			2593.0	30.89	22.75	8.14	32.50	22.81	9.69
			2687.5	31.20	23.30	7.90	32.11	23.48	8.63
	QPSK (BW 10MHz)	1/2	2501.0	31.56	23.28	8.28	32.58	23.38	9.20
			2593.0	31.30	23.13	8.17	32.93	22.96	9.97
			2685.0	31.48	23.29	8.19	32.18	23.42	8.76
		3/4	2501.0	31.59	23.26	8.33	32.57	23.28	9.29
			2593.0	31.06	23.07	7.99	32.93	22.95	9.98
			2685.0	31.48	23.27	8.21	32.20	23.41	8.79
	16QAM (BW 10MHz)	1/2	2501.0	31.57	23.03	8.54	32.67	23.11	9.56
			2593.0	31.28	22.93	8.35	32.46	22.71	9.75
			2685.0	31.43	23.24	8.19	32.24	23.31	8.93
		3/4	2501.0	31.47	22.83	8.64	32.77	22.96	9.81
			2593.0	31.02	22.73	8.29	32.83	22.90	9.93
			2685.0	31.30	23.22	8.08	32.27	23.12	9.15

**Note:** An Anritus wideband power meter was used for measuring the conducted power.

**11.2 Scaling Factor Deriving**

The testing was done at DL:UL symbol ratio, 29:18 as this is the maximum achievable ratio for the product. The 18 indicates the number of uplink symbols. Inside the uplink, 15 of the symbols are used for data, and 3 of the symbols are used for sending control information to the network. During the testing, the control symbols contained no information, so did not contribute to the total energy transmitted. To compensate for the maximum energy which may presented in the 3 control symbols, following scheme is used for the up scaling.

**<Scaling Factor for 5MHz BW>**

This device is power class 2 device and the maximum power tolerance is 23.0±0.8 dBm.

The maximum rated output power of 5M BW is 23.80 dBm (239.88 mW).

Maximum power in 5M control traffic is 70.55 mW (5/17 of 239.88 mW).

$$\text{Scaling Factor} = (3 * 70.55 + 15 * 239.88) / (15 * \text{max. measured power of the channel tested})$$

$$= 3809.2 / (15 * \text{max. measured power of the channel tested})$$

**For Ant-0 (Main Antenna)**

Zone Type	Modulation	Coding Rate	Frequency (MHz)	Average Power for Ant-0 (Main Antenna)		Scaling Factor
				(dBm)	(mW)	
PUSC	QPSK (BW 5MHz)	1/2	2498.5	23.44	220.80	1.15
			2593.0	22.98	198.61	1.24
			2687.5	23.56	226.99	1.10
		3/4	2498.5	23.30	213.80	1.15
			2593.0	23.10	204.17	1.17
			2687.5	23.50	223.87	1.07
	16QAM (BW 5MHz)	1/2	2498.5	23.15	206.54	1.39
			2593.0	22.94	196.79	1.22
			2687.5	23.32	214.78	1.12
		3/4	2498.5	23.02	200.45	1.20
			2593.0	22.75	188.36	1.27
			2687.5	23.30	213.80	1.12

**For Ant-1 (Aux. Antenna)**

Zone Type	Modulation	Coding Rate	Frequency (MHz)	Average Power for Ant-1 (Aux. Antenna)		Scaling Factor
				(dBm)	(mW)	
PUSC	QPSK (BW 5MHz)	1/2	2498.5	23.65	231.74	1.04
			2593.0	23.00	199.53	1.20
			2687.5	23.76	237.68	1.01
		3/4	2498.5	23.59	228.56	1.05
			2593.0	23.00	199.53	1.20
			2687.5	23.73	236.05	1.02
	16QAM (BW 5MHz)	1/2	2498.5	23.46	221.82	1.08
			2593.0	22.89	194.54	1.23
			2687.5	23.49	223.36	1.07
		3/4	2498.5	23.25	211.35	1.14
			2593.0	22.81	190.99	1.26
			2687.5	23.48	222.84	1.08

**<Scaling Factor for 10MHz BW>**

This device is power class 2 device and the maximum power tolerance is 23.0±0.8 dBm.  
 The maximum rated output power of 10M BW is 23.80 dBm (239.88 mW).  
 Maximum power in 10M control traffic is 34.27 mW (5/35 of 239.88 mW).  
 Scaling Factor = (3 \* 34.27 + 15 \* 239.88) / (15 \* max. measured power of the channel tested)  
 = 3701.01 / (15 \* max. measured power of the channel tested)

**For Ant-0 (Main Antenna)**

Zone Type	Modulation	Coding Rate	Frequency (MHz)	Average Power for Ant-0 (Main Antenna)		Scaling Factor
				(dBm)	(mW)	
PUSC	QPSK (BW 10MHz)	1/2	2501.0	23.28	212.81	1.16
			2593.0	23.13	205.59	1.22
			2685.0	23.29	213.30	1.15
		3/4	2501.0	23.26	211.84	1.13
			2593.0	23.07	202.77	1.18
			2685.0	23.27	212.32	1.36
	16QAM (BW 10MHz)	1/2	2501.0	23.03	200.91	1.19
			2593.0	22.93	196.34	1.22
			2685.0	23.24	210.86	1.14
		3/4	2501.0	22.83	191.87	1.25
			2593.0	22.73	187.50	1.28
			2685.0	23.22	209.89	1.14

**For Ant-1 (Aux. Antenna)**

Zone Type	Modulation	Coding Rate	Frequency (MHz)	Average Power for Ant-1 (Aux. Antenna)		Scaling Factor
				(dBm)	(mW)	
PUSC	QPSK (BW 10MHz)	1/2	2501.0	23.38	217.77	1.10
			2593.0	22.96	197.70	1.21
			2685.0	23.42	219.79	1.09
		3/4	2501.0	23.28	212.81	1.13
			2593.0	22.95	197.24	1.22
			2685.0	23.41	219.28	1.09
	16QAM (BW 10MHz)	1/2	2501.0	23.11	204.64	1.17
			2593.0	22.71	186.64	1.29
			2685.0	23.31	214.29	1.12
		3/4	2501.0	22.96	197.70	1.21
			2593.0	22.90	194.98	1.23
			2685.0	23.12	205.12	1.17

**<Scaling Up SAR>**

Calculating used follow scheme for scale up SAR.  
 Scaled SAR = Measured SAR \* Scaling Factor



11.3 Test Records for Head SAR Test

Plot No.	Modulation	Coding Rate	BW (MHz)	Frequency (MHz)	Test Position	DUT Status	Battery	Ant.	SAR <sub>1g</sub> (W/kg)	Scaling Factor	Scaling SAR
#57	QPSK	1/2	5	2687.5	Right Cheek	Slide Off	1	1	0.25	1.01	0.253
#58	QPSK	1/2	5	2687.5	Right Tilted	Slide Off	1	1	0.234	1.01	0.236
#59	QPSK	1/2	5	2687.5	Left Cheek	Slide Off	1	1	0.461	1.01	0.466
#60	QPSK	1/2	5	2687.5	Left Tilted	Slide Off	1	1	0.286	1.01	0.289
#61	16QAM	1/2	5	2687.5	Right Cheek	Slide Off	1	1	0.237	1.07	0.254
#62	16QAM	1/2	5	2687.5	Right Tilted	Slide Off	1	1	0.221	1.07	0.236
#63	16QAM	1/2	5	2687.5	Left Cheek	Slide Off	1	1	0.47	1.07	0.503
#64	16QAM	1/2	5	2687.5	Left Tilted	Slide Off	1	1	0.312	1.07	0.334
#65	16QAM	1/2	5	2687.5	Left Cheek	Slide Off	2	1	0.435	1.07	0.465
#133	QPSK	1/2	5	2498.5	Left Cheek	Slide Off	1	1	0.052	1.01	0.053
#134	QPSK	1/2	5	2593.0	Left Cheek	Slide Off	1	1	0.272	1.01	0.275
#66	QPSK	1/2	5	2687.5	Right Cheek	Slide Right	1	1	0.115	1.01	0.116
#67	QPSK	1/2	5	2687.5	Right Tilted	Slide Right	1	1	0.105	1.01	0.106
#68	QPSK	1/2	5	2687.5	Left Cheek	Slide Right	1	1	0.172	1.01	0.174
#69	QPSK	1/2	5	2687.5	Left Tilted	Slide Right	1	1	0.121	1.01	0.122
#70	16QAM	1/2	5	2687.5	Right Cheek	Slide Right	1	1	0.107	1.07	0.114
#71	16QAM	1/2	5	2687.5	Right Tilted	Slide Right	1	1	0.104	1.07	0.111
#72	16QAM	1/2	5	2687.5	Left Cheek	Slide Right	1	1	0.159	1.07	0.170
#73	16QAM	1/2	5	2687.5	Left Tilted	Slide Right	1	1	0.116	1.07	0.124
#74	QPSK	1/2	5	2687.5	Left Cheek	Slide Right	2	1	0.165	1.01	0.167
#75	QPSK	1/2	5	2687.5	Right Cheek	Slide Off	1	0	0.023	1.10	0.025
#76	QPSK	1/2	5	2687.5	Right Tilted	Slide Off	1	0	0.026	1.10	0.029
#77	QPSK	1/2	5	2687.5	Left Cheek	Slide Off	1	0	0.06	1.10	0.066
#78	QPSK	1/2	5	2687.5	Left Tilted	Slide Off	1	0	0.033	1.10	0.036
#79	16QAM	1/2	5	2687.5	Right Cheek	Slide Off	1	0	0.021	1.12	0.024
#80	16QAM	1/2	5	2687.5	Right Tilted	Slide Off	1	0	0.024	1.12	0.027
#81	16QAM	1/2	5	2687.5	Left Cheek	Slide Off	1	0	0.047	1.12	0.053
#82	16QAM	1/2	5	2687.5	Left Tilted	Slide Off	1	0	0.031	1.12	0.035
#83	QPSK	1/2	5	2687.5	Left Cheek	Slide Off	2	0	0.043	1.10	0.047
#84	QPSK	1/2	5	2687.5	Right Cheek	Slide Right	1	0	0.105	1.10	0.116
#85	QPSK	1/2	5	2687.5	Right Tilted	Slide Right	1	0	0.108	1.10	0.119
#86	QPSK	1/2	5	2687.5	Left Cheek	Slide Right	1	0	0.046	1.10	0.051
#87	QPSK	1/2	5	2687.5	Left Tilted	Slide Right	1	0	0.044	1.10	0.048
#88	16QAM	1/2	5	2687.5	Right Cheek	Slide Right	1	0	0.104	1.12	0.116
#89	16QAM	1/2	5	2687.5	Right Tilted	Slide Right	1	0	0.104	1.12	0.116
#90	16QAM	1/2	5	2687.5	Left Cheek	Slide Right	1	0	0.04	1.12	0.045
#91	16QAM	1/2	5	2687.5	Left Tilted	Slide Right	1	0	0.042	1.12	0.047
#92	QPSK	1/2	5	2687.5	Right Tilted	Slide Right	2	0	0.102	1.10	0.112
#135	QPSK	1/2	5	2498.5	Right Cheek	Slide Right	1	0	0.382	1.10	0.420





Plot No.	Modulation	Coding Rate	BW (MHz)	Frequency (MHz)	Test Position	DUT Status	Battery	Ant.	SAR <sub>1g</sub> (W/kg)	Scaling Factor	Scaling SAR
#93	QPSK	1/2	10	2685.0	Right Cheek	Slide Off	1	1	0.243	1.09	0.265
#94	QPSK	1/2	10	2685.0	Right Tilted	Slide Off	1	1	0.223	1.09	0.243
#95	<b>QPSK</b>	<b>1/2</b>	<b>10</b>	<b>2685.0</b>	<b>Left Cheek</b>	<b>Slide Off</b>	<b>1</b>	<b>1</b>	<b>0.494</b>	<b>1.09</b>	<b>0.538</b>
#96	QPSK	1/2	10	2685.0	Left Tilted	Slide Off	1	1	0.285	1.09	0.311
#97	16QAM	1/2	10	2685.0	Right Cheek	Slide Off	1	1	0.235	1.12	0.263
#98	16QAM	1/2	10	2685.0	Right Tilted	Slide Off	1	1	0.217	1.12	0.243
#99	16QAM	1/2	10	2685.0	Left Cheek	Slide Off	1	1	0.462	1.12	0.517
#100	16QAM	1/2	10	2685.0	Left Tilted	Slide Off	1	1	0.275	1.12	0.308
#101	QPSK	1/2	10	2685.0	Left Cheek	Slide Off	2	1	0.471	1.09	0.513
#131	QPSK	1/2	10	2501.0	Left Cheek	Slide Off	2	1	0.051	1.1	0.056
#132	QPSK	1/2	10	2593.0	Left Cheek	Slide Off	2	1	0.264	1.21	0.319
#102	QPSK	1/2	10	2685.0	Right Cheek	Slide Right	1	1	0.092	1.09	0.100
#103	QPSK	1/2	10	2685.0	Right Tilted	Slide Right	1	1	0.099	1.09	0.108
#104	QPSK	1/2	10	2685.0	Left Cheek	Slide Right	1	1	0.174	1.09	0.190
#105	QPSK	1/2	10	2685.0	Left Tilted	Slide Right	1	1	0.128	1.09	0.140
#106	16QAM	1/2	10	2685.0	Right Cheek	Slide Right	1	1	0.092	1.12	0.103
#107	16QAM	1/2	10	2685.0	Right Tilted	Slide Right	1	1	0.097	1.12	0.109
#108	16QAM	1/2	10	2685.0	Left Cheek	Slide Right	1	1	0.168	1.12	0.188
#109	16QAM	1/2	10	2685.0	Left Tilted	Slide Right	1	1	0.123	1.12	0.138
#110	QPSK	1/2	10	2685.0	Left Cheek	Slide Right	2	1	0.105	1.09	0.114
#111	QPSK	1/2	10	2685.0	Right Cheek	Slide Off	1	0	0.028	1.15	0.032
#112	QPSK	1/2	10	2685.0	Right Tilted	Slide Off	1	0	0.025	1.15	0.029
#113	QPSK	1/2	10	2685.0	Left Cheek	Slide Off	1	0	0.05	1.15	0.058
#114	QPSK	1/2	10	2685.0	Left Tilted	Slide Off	1	0	0.032	1.15	0.037
#115	16QAM	1/2	10	2685.0	Right Cheek	Slide Off	1	0	0.027	1.14	0.031
#116	16QAM	1/2	10	2685.0	Right Tilted	Slide Off	1	0	0.024	1.14	0.027
#117	16QAM	1/2	10	2685.0	Left Cheek	Slide Off	1	0	0.043	1.14	0.049
#118	16QAM	1/2	10	2685.0	Left Tilted	Slide Off	1	0	0.03	1.14	0.034
#119	QPSK	1/2	10	2685.0	Left Cheek	Slide Off	2	0	0.045	1.15	0.052
#120	QPSK	1/2	10	2685.0	Right Cheek	Slide Right	1	0	0.119	1.15	0.137
#121	QPSK	1/2	10	2685.0	Right Tilted	Slide Right	1	0	0.103	1.15	0.118
#122	QPSK	1/2	10	2685.0	Left Cheek	Slide Right	1	0	0.046	1.15	0.053
#123	QPSK	1/2	10	2685.0	Left Tilted	Slide Right	1	0	0.042	1.15	0.048
#124	16QAM	1/2	10	2685.0	Right Cheek	Slide Right	1	0	0.108	1.14	0.123
#125	16QAM	1/2	10	2685.0	Right Tilted	Slide Right	1	0	0.099	1.14	0.113
#126	16QAM	1/2	10	2685.0	Left Cheek	Slide Right	1	0	0.039	1.14	0.044
#127	16QAM	1/2	10	2685.0	Left Tilted	Slide Right	1	0	0.042	1.14	0.048
#128	QPSK	1/2	10	2685.0	Right Cheek	Slide Right	2	0	0.198	1.15	0.228
#129	QPSK	1/2	10	2501.0	Right Cheek	Slide Right	2	0	0.439	1.16	0.509
#130	QPSK	1/2	10	2593.0	Right Cheek	Slide Right	2	0	0.251	1.22	0.306

**Remark:**

1. The WiMAX SAR test reduction is referred 2010 TCB Workshop RF Exposure Procedures-Review.
  - a. Use the lowest coding rate for each modulation when the same rated maximum output applies to all coding rates in a modulation
  - b. Test higher coding rates only if the rated maximum output is higher
  - c. Use the scaled SAR to determine test reduction (< 0.8 W/kg etc.)



- d. For each channel bandwidth, if QPSK SAR is < 0.8 W/kg and maximum power > 16QAM, test highest output channel for 16QAM
- 2. The DASY4 system was used for WiMAX head SAR testing.

**11.4 Test Records for Body SAR Test**

Plot No.	Modulation	Coding Rate	BW (MHz)	Frequency (MHz)	Test Position	Earphone	Battery	Ant.	SAR <sub>1g</sub> (W/kg)	Scaling Factor	Scaling SAR
#01	QPSK	1/2	5	2687.5	Front Face	Without	1	1	0.134	1.01	0.135
#02	QPSK	1/2	5	2687.5	Rear Face	Without	1	1	0.539	1.01	0.544
#03	QPSK	1/2	5	2687.5	Top Side	Without	1	1	0.018	1.01	0.018
#04	QPSK	1/2	5	2687.5	Bottom Side	Without	1	1	0.212	1.01	0.214
#05	QPSK	1/2	5	2687.5	Right Side	Without	1	1	0.493	1.01	0.498
#06	QPSK	1/2	5	2687.5	Left Side	Without	1	1	0.034	1.01	0.034
#07	QPSK	1/2	5	2687.5	Rear Face	Without	2	1	0.481	1.01	0.486
#08	16QAM	1/2	5	2687.5	Front Face	Without	1	1	0.131	1.07	0.140
#09	16QAM	1/2	5	2687.5	Rear Face	Without	1	1	0.515	1.07	0.551
#10	16QAM	1/2	5	2687.5	Top Side	Without	1	1	0.014	1.07	0.015
#11	16QAM	1/2	5	2687.5	Bottom Side	Without	1	1	0.199	1.07	0.213
#12	16QAM	1/2	5	2687.5	Right Side	Without	1	1	0.51	1.07	0.546
#13	16QAM	1/2	5	2687.5	Left Side	Without	1	1	0.027	1.07	0.029
#14	16QAM	1/2	5	2687.5	Rear Face	Without	2	1	0.451	1.07	0.483
#15	QPSK	1/2	5	2687.5	Front Face	Without	1	0	0.00724	1.10	0.008
#16	QPSK	1/2	5	2687.5	Rear Face	Without	1	0	0.118	1.10	0.130
#17	QPSK	1/2	5	2687.5	Top Side	Without	1	0	0.000551	1.10	0.001
#18	QPSK	1/2	5	2687.5	Bottom Side	Without	1	0	0.055	1.10	0.061
#19	QPSK	1/2	5	2687.5	Right Side	Without	1	0	0.021	1.10	0.023
#20	QPSK	1/2	5	2687.5	Left Side	Without	1	0	0.00123	1.10	0.001
#21	QPSK	1/2	5	2687.5	Rear Face	Without	2	0	0.094	1.10	0.103
#22	16QAM	1/2	5	2687.5	Front Face	Without	1	0	0.00715	1.12	0.008
#23	16QAM	1/2	5	2687.5	Rear Face	Without	1	0	0.107	1.12	0.120
#24	16QAM	1/2	5	2687.5	Top Side	Without	1	0	N/A	1.12	N/A
#25	16QAM	1/2	5	2687.5	Bottom Side	Without	1	0	0.052	1.12	0.058
#26	16QAM	1/2	5	2687.5	Right Side	Without	1	0	0.019	1.12	0.021
#27	16QAM	1/2	5	2687.5	Left Side	Without	1	0	0.00379	1.12	0.004
#28	16QAM	1/2	5	2687.5	Rear Face	Without	2	0	0.1	1.12	0.112



Plot No.	Modulation	Coding Rate	BW (MHz)	Frequency (MHz)	Test Position	Earphone	Battery	Ant.	SAR <sub>1g</sub> (W/kg)	Scaling Factor	Scaling SAR
#29	QPSK	1/2	10	2685.0	Front Face	Without	1	1	0.201	1.09	0.219
#30	QPSK	1/2	10	2685.0	Rear Face	Without	1	1	0.517	1.09	0.564
#31	QPSK	1/2	10	2685.0	Top Side	Without	1	1	0.02	1.09	0.022
#32	QPSK	1/2	10	2685.0	Bottom Side	Without	1	1	0.15	1.09	0.164
#33	QPSK	1/2	10	2685.0	Right Side	Without	1	1	0.305	1.09	0.332
#34	QPSK	1/2	10	2685.0	Left Side	Without	1	1	0.02	1.09	0.022
#35	QPSK	1/2	10	2685.0	Rear Face	Without	2	1	0.5	1.09	0.545
#133	QPSK	1/2	10	2501.0	Rear Face	Without	1	1	0.094	1.10	0.103
#134	QPSK	1/2	10	2593.0	Rear Face	Without	1	1	0.293	1.20	0.352
#137	QPSK	1/2	10	2685.0	Rear Face	With	1	1	0.474	1.09	0.517
#36	16QAM	1/2	10	2685.0	Front Face	Without	1	1	0.177	1.12	0.198
#37	16QAM	1/2	10	2685.0	Rear Face	Without	1	1	0.478	1.12	0.535
#38	16QAM	1/2	10	2685.0	Top Side	Without	1	1	0.016	1.12	0.018
#39	16QAM	1/2	10	2685.0	Bottom Side	Without	1	1	0.142	1.12	0.159
#40	16QAM	1/2	10	2685.0	Right Side	Without	1	1	0.301	1.12	0.337
#41	16QAM	1/2	10	2685.0	Left Side	Without	1	1	0.018	1.12	0.020
#42	16QAM	1/2	10	2685.0	Rear Face	Without	2	1	0.487	1.12	0.545
#43	QPSK	1/2	10	2685.0	Front Face	Without	1	0	0.00694	1.15	0.008
#44	QPSK	1/2	10	2685.0	Rear Face	Without	1	0	0.104	1.15	0.120
#45	QPSK	1/2	10	2685.0	Top Side	Without	1	0	N/A	1.15	N/A
#46	QPSK	1/2	10	2685.0	Bottom Side	Without	1	0	0.039	1.15	0.045
#47	QPSK	1/2	10	2685.0	Right Side	Without	1	0	0.015	1.15	0.017
#48	QPSK	1/2	10	2685.0	Left Side	Without	1	0	0.000344	1.15	0.000
#49	QPSK	1/2	10	2685.0	Rear Face	Without	2	0	0.084	1.15	0.097
#135	QPSK	1/2	10	2501.0	Rear Face	Without	1	0	0.43	1.16	0.499
#136	QPSK	1/2	10	2593.0	Rear Face	Without	1	0	0.325	1.22	0.397
#50	16QAM	1/2	10	2685.0	Front Face	Without	1	0	0.00746	1.14	0.009
#51	16QAM	1/2	10	2685.0	Rear Face	Without	1	0	0.094	1.14	0.107
#52	16QAM	1/2	10	2685.0	Top Side	Without	1	0	0.098	1.14	0.112
#53	16QAM	1/2	10	2685.0	Bottom Side	Without	1	0	0.046	1.14	0.052
#54	16QAM	1/2	10	2685.0	Right Side	Without	1	0	0.017	1.14	0.019
#55	16QAM	1/2	10	2685.0	Left Side	Without	1	0	0.00173	1.14	0.002
#56	16QAM	1/2	10	2685.0	Rear Face	Without	2	0	0.087	1.14	0.099

**Remark:**

1. The WiMAX SAR test reduction is referred 2010 TCB Workshop RF Exposure Procedures-Review.
  - a. Use the lowest coding rate for each modulation when the same rated maximum output applies to all coding rates in a modulation
  - b. Test higher coding rates only if the rated maximum output is higher
  - c. Use the scaled SAR to determine test reduction (< 0.8 W/kg etc.)
  - d. For each channel bandwidth, if QPSK SAR is < 0.8 W/kg and maximum power > 16QAM, test highest output channel for 16QAM
2. The DASY4 system was used for WiMAX body SAR testing.

**Test Engineer :** A-Rod Chen and Robert Liu

**11.5 Linearity Response Check**

**<Setup and Calculation Procedure>**

Set up the DUT in the position of the worst SAR, i.e. Rear Face of DUT, and keep the separation distance as 1.0 cm. The channel of maximum SAR for each Modulation/Bandwidth is chosen for single point peak SAR testing. Using the same setup as complete 1g SAR and set the Agilent E6651A to configure the device to transmit at specified power and check by Anritus wideband power meter.

The reference line is based on the SAR at the power of 15 mW, and the proportional SARs of its multiples of 15 mW. The measured SAR at different multiple power of 15 mW is also plotted. The deviation is the difference between the reference line and the measured SAR.

The example for QPSK 1/2, BW 5M, 2687.5MHz is as below:

Base value = SAR measured at power of 15 mW = 0.034

2<sup>nd</sup> point (30 mW) = SAR value of 0.034 \* (30 / 15) = 0.068

3<sup>rd</sup> point (60 mW) = SAR value of 0.034 \* (60 / 15) = 0.136

4<sup>th</sup> point (119 mW) = SAR value of 0.034 \* (119 / 15) = 0.272

5<sup>th</sup> point (238 mW) = SAR value of 0.034 \* (238 / 15) = 0.544

**<For QPSK, 1/2, BW 5M, 2687.5MHz, Rear Face, DUT Slide Off, WiMAX Ant-1 (Aux), Configuration #02>**

Average Power (mW)	15	30	60	119	238
Single Point SAR (W/kg)	0.034	0.071	0.141	0.26	0.543
Reference Line (W/kg)	0.034	0.068	0.136	0.272	0.544
Deviation (%)	0.00%	4.41%	3.68%	-4.41%	-0.18%

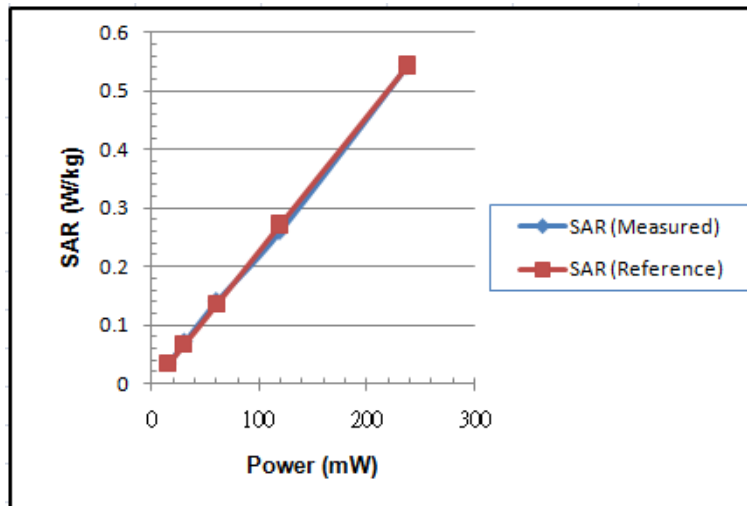

<For 16QAM, 1/2, BW 5M, 2687.5MHz, Rear Face, DUT Slide Off, WiMAX Ant-1 (Aux), Configuration #09>

<b>Average Power (mW)</b>	14	28	56	112	223
<b>Single Point SAR (W/kg)</b>	0.031	0.058	0.128	0.252	0.521
<b>Reference Line (W/kg)</b>	0.031	0.062	0.124	0.248	0.496
<b>Deviation (%)</b>	<b>0.00%</b>	<b>-6.45%</b>	<b>3.23%</b>	<b>1.61%</b>	<b>5.04%</b>

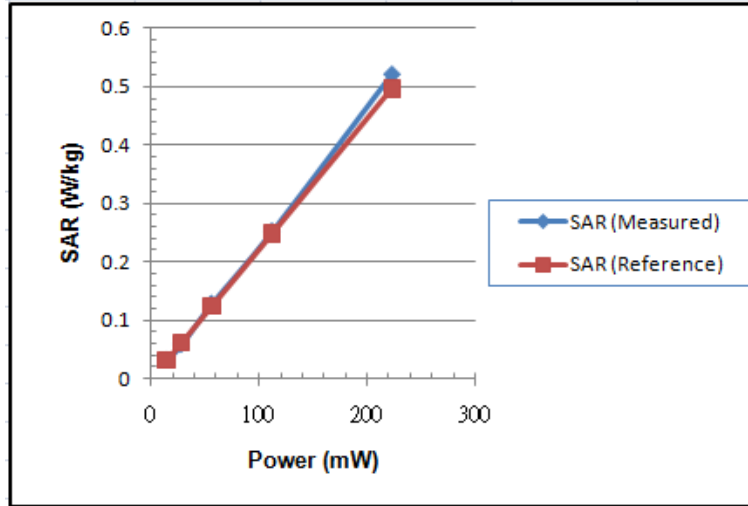

<For QPSK, 1/2, BW 10M, 2685.0MHz, Rear Face, DUT Slide Off, WiMAX Ant-1 (Aux), Configuration #30>

<b>Average Power (mW)</b>	14	28	55	110	220
<b>Single Point SAR (W/kg)</b>	0.033	0.069	0.131	0.279	0.522
<b>Reference Line (W/kg)</b>	0.033	0.066	0.132	0.264	0.528
<b>Deviation (%)</b>	<b>0.00%</b>	<b>4.55%</b>	<b>-0.76%</b>	<b>5.68%</b>	<b>-1.14%</b>

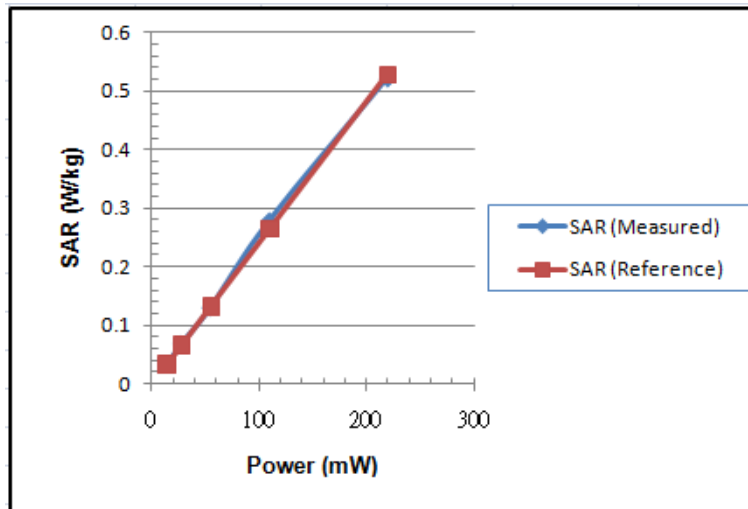

<For 16QAM, 1/2, BW 10M, 2685.0MHz, Rear Face, DUT Slide Off, WiMAX Ant-1 (Aux), Configuration #42>

Average Power (mW)	14	27	54	107	214
Single Point SAR (W/kg)	0.028	0.058	0.115	0.228	0.462
Reference Line (W/kg)	0.028	0.056	0.112	0.224	0.448
Deviation (%)	0.00%	3.57%	2.68%	1.79%	3.13%

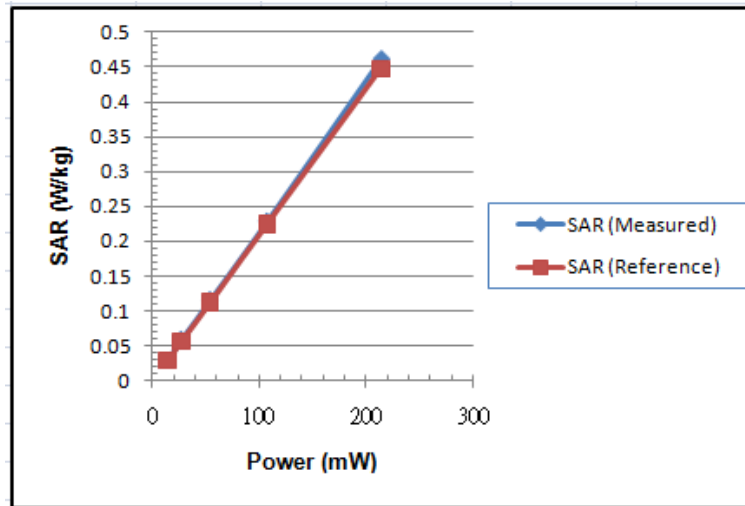

<Conclusion>

From the above test results, the SAR probe can measure SAR correctly under high PAPR of OFDM/OFDMA, and the pretest SAR is not underestimated.

**11.6 Compare with Different Scan Resolution**

Retest the maximum raw 1g SAR with the same DUT setting on the different scan resolution. The test results are shown as below.

Scan Resolution (mm)	Measured SAR <sub>1g</sub> (W/kg)
5.0	0.539
2.5	0.512

<Conclusion>

From the above test results, the different scan resolution has no significant change.



## **12. References**

- [1] FCC 47 CFR Part 2 “Frequency Allocations and Radio Treaty Matters; General Rules and Regulations”
- [2] IEEE Std. C95.1-1992, “IEEE Standard for Safety Levels with Respect to Human Exposure to Radio Frequency Electromagnetic Fields, 3 kHz to 300 GHz”, 1992
- [3] IEEE Std. 1528-2003, “Recommended Practice for Determining the Peak Spatial-Average Specific Absorption Rate (SAR) in the Human Head from Wireless Communications Devices: Measurement Techniques”, December 2003
- [4] FCC OET Bulletin 65 (Edition 97-01) Supplement C (Edition 01-01), “Evaluating Compliance with FCC Guidelines for Human Exposure to Radiofrequency Electromagnetic Fields”, June 2001
- [5] SPEAG DASY System Handbook
- [6] FCC KDB 248227 D01 v01r02, “SAR Measurement Procedures for 802.11 a/b/g Transmitters”, May 2007
- [7] FCC KDB 447498 D01 v04, “Mobile and Portable Device RF Exposure Procedures and Equipment Authorization Policies”, November 2009
- [8] FCC KDB 447498 D02 v02, “SAR Measurement Procedures for USB Dongle Transmitters”, November 2009
- [9] FCC KDB 616217 D01 v01r01, “SAR Evaluation Considerations for Laptop Computers with Antennas Built-in on Display Screens”, November 2009
- [10] FCC KDB 616217 D03 v01, “SAR Evaluation Considerations for Laptop/Notebook/Netbook and Tablet Computers”, November 2009
- [11] FCC KDB 648474 D01 v01r05, “SAR Evaluation Considerations for Handsets with Multiple Transmitters and Antennas”, September 2008
- [12] FCC KDB 941225 D01 v02, “SAR Measurement Procedures for 3G Devices – CDMA 2000 / Ev-Do / WCDMA / HSDPA / HSPA”, October 2007
- [13] FCC KDB 941225 D03 v01, “Recommended SAR Test Reduction Procedures for GSM / GPRS / EDGE”, December 2008



## ***Appendix A. Plots of System Performance Check***

The plots are shown as follows.





## ***Appendix B. Plots of SAR Measurement***

The plots are shown as follows.



## **Appendix C. DASY Calibration Certificate**

The DASY calibration certificates are shown as follows.