



**Calibration Laboratory of
Schmid & Partner
Engineering AG**
Zeughausstrasse 43, 8004 Zurich, Switzerland



S Schweizerischer Kalibrierdienst
C Service suisse d'étalonnage
S Servizio svizzero di taratura
S Swiss Calibration Service

Accredited by the Swiss Accreditation Service (SAS)
The Swiss Accreditation Service is one of the signatories to the EA
Multilateral Agreement for the recognition of calibration certificates

Accreditation No.: **SCS 108**

Client **Sporton (Auden)**

Certificate No: **CD835V3-1045_Sep09**

CALIBRATION CERTIFICATE

Object **CD835V3 - SN: 1045**

Calibration procedure(s) **QA CAL-20.v4
Calibration procedure for dipoles in air**

Calibration date: **September 17, 2009**

Condition of the calibrated item **In Tolerance**

This calibration certificate documents the traceability to national standards, which realize the physical units of measurements (SI).
All calibrations have been conducted in the closed laboratory facility: environment temperature (22 ± 3)°C and humidity < 70%.

Calibration Equipment used (M&TE critical for calibration)

Primary Standards	ID #	Cal Date (Certificate No.)	Scheduled Calibration
Power meter EPM-442A	GB37480704	08-Oct-08 (No. 217-00898)	Oct-09
Power sensor HP 8481A	US37292783	08-Oct-08 (No. 217-00898)	Oct-09
Probe ER3DV6	SN: 2336	22-Dec-08 (No. ER3-2336_Dec08)	Dec-09
Probe H3DV6	SN: 6065	22-Dec-08 (No. H3-6065_-Dec08)	Dec-09
DAE4	SN: 781	20-Feb-09 (No. DAE4-781_Feb09)	Feb-10
Secondary Standards	ID #	Check Date (in house)	Scheduled Check
Power meter R&S NRP	SN: 101748	23-Sep-08 (in house check Dec-08)	In house check: Dec-10
Power sensor R&S NRP-Z91	SN: 100711	25-Aug-08 (in house check Dec-08)	In house check: Dec-10
Power sensor R&S NRP-Z91	SN: 100712	25-Aug-08 (in house check Dec-08)	In house check: Dec-10
Network Analyzer HP 8753E	US37390585	18-Oct-01 (in house check Oct-08)	In house check: Oct-09
RF generator E4433B	MY 41310391	03-Nov-04 (in house check Oct-07)	In house check: Oct-09

Calibrated by:	Name Claudio Leubler	Function Laboratory Technician	Signature
Approved by:	Name Katja Pokovic	Function Technical Manager	Signature

Issued: September 17, 2009

This calibration certificate shall not be reproduced except in full without written approval of the laboratory.



Calibration Laboratory of
Schmid & Partner
Engineering AG
Zeughausstrasse 43, 8004 Zurich, Switzerland



S Schweizerischer Kalibrierdienst
C Service suisse d'étalonnage
S Servizio svizzero di taratura
S Swiss Calibration Service

Accredited by the Swiss Accreditation Service (SAS)
The Swiss Accreditation Service is one of the signatories to the EA
Multilateral Agreement for the recognition of calibration certificates

Accreditation No.: **SCS 108**

References

- [1] ANSI-C63.19-2006
American National Standard for Methods of Measurement of Compatibility between Wireless Communications Devices and Hearing Aids.
- [2] ANSI-C63.19-2007
American National Standard for Methods of Measurement of Compatibility between Wireless Communications Devices and Hearing Aids.

Methods Applied and Interpretation of Parameters:

- **Coordinate System:** y-axis is in the direction of the dipole arms. z-axis is from the basis of the antenna (mounted on the table) towards its feed point between the two dipole arms. x-axis is normal to the other axes. In coincidence with the standards [1, 2], the measurement planes (probe sensor center) are selected to be at a distance of 10 mm above the top edge of the dipole arms.
- **Measurement Conditions:** Further details are available from the hardcopies at the end of the certificate. All figures stated in the certificate are valid at the frequency indicated. The forward power to the dipole connector is set with a calibrated power meter connected and monitored with an auxiliary power meter connected to a directional coupler. While the dipole under test is connected, the forward power is adjusted to the same level.
- **Antenna Positioning:** The dipole is mounted on a HAC Test Arch phantom using the matching dipole positioner with the arms horizontal and the feeding cable coming from the floor. The measurements are performed in a shielded room with absorbers around the setup to reduce the reflections. It is verified before the mounting of the dipole under the Test Arch phantom, that its arms are perfectly in a line. It is installed on the HAC dipole positioner with its arms parallel below the dielectric reference wire and able to move elastically in vertical direction without changing its relative position to the top center of the Test Arch phantom. The vertical distance to the probe is adjusted after dipole mounting with a DASY4 Surface Check job. Before the measurement, the distance between phantom surface and probe tip is verified. The proper measurement distance is selected by choosing the matching section of the HAC Test Arch phantom with the proper device reference point (upper surface of the dipole) and the matching grid reference point (tip of the probe) considering the probe sensor offset. The vertical distance to the probe is essential for the accuracy.
- **Feed Point Impedance and Return Loss:** These parameters are measured using a HP 8753E Vector Network Analyzer. The impedance is specified at the SMA connector of the dipole. The influence of reflections was eliminated by applying the averaging function while moving the dipole in the air, at least 70cm away from any obstacles.
- **E-field distribution:** E field is measured in the x-y-plane with an isotropic ER3D-field probe with 100 mW forward power to the antenna feed point. In accordance with [1, 2], the scan area is 20mm wide, its length exceeds the dipole arm length (180 or 90mm). The sensor center is 10 mm (in z) above the top of the dipole arms. Two 3D maxima are available near the end of the dipole arms. Assuming the dipole arms are perfectly in one line, the average of these two maxima (in subgrid 2 and subgrid 8) is determined to compensate for any non-parallelity to the measurement plane as well as the sensor displacement. The E-field value stated as calibration value represents the maximum of the interpolated 3D-E-field, 10mm above the dipole surface.
- **H-field distribution:** H-field is measured with an isotropic H-field probe with 100mW forward power to the antenna feed point, in the x-y-plane. The scan area and sensor distance is equivalent to the E-field scan. The maximum of the field is available at the center (subgrid 5) above the feed point. The H-field value stated as calibration value represents the maximum of the interpolated H-field, 10mm above the dipole surface at the feed point.



1 Measurement Conditions

DASY system configuration, as far as not given on page 1.

DASY Version	DASY5	V5.0 B127
DASY PP Version	SEMCAD X	V13.4 B125
Phantom	HAC Test Arch	SD HAC P01 BA, #1070
Distance Dipole Top - Probe Center	10 mm	
Scan resolution	dx, dy = 5 mm	area = 20 x 180 mm
Frequency	835 MHz ± 1 MHz	
Forward power at dipole connector	20.0 dBm = 100mW	
Input power drift	< 0.05 dB	

2 Maximum Field values

H-field 10 mm above dipole surface	condition	interpolated maximum
Maximum measured	100 mW forward power	0.457 A/m

Uncertainty for H-field measurement: 8.2% (k=2)

E-field 10 mm above dipole surface	condition	Interpolated maximum
Maximum measured above high end-	100 mW forward power	170.6 V/m
Maximum measured above low end	100 mW forward power	169.8 V/m
Averaged maximum above arm	100 mW forward power	170.2 V/m

Uncertainty for E-field measurement: 12.8% (k=2)

3 Appendix

3.1 Antenna Parameters

Frequency	Return Loss	Impedance
800 MHz	15.7 dB	(44.9 – j14.9) Ohm
835 MHz	40.5 dB	(49.2 - j0.5) Ohm
900 MHz	17.4 dB	(53.0 – j13.7) Ohm
950 MHz	20.2 dB	(47.5 + j9.2) Ohm
960 MHz	14.8 dB	(53.9 + j18.8) Ohm

3.2 Antenna Design and Handling

The calibration dipole has a symmetric geometry with a built-in two stub matching network, which leads to the enhanced bandwidth.

The dipole is built of standard semirigid coaxial cable. The internal matching line is open ended. The antenna is therefore open for DC signals.

Do not apply force to dipole arms, as they are liable to bend. The soldered connections near the feedpoint may be damaged. After excessive mechanical stress or overheating, check the impedance characteristics to ensure that the internal matching network is not affected.

After long term use with 40W radiated power, only a slight warming of the dipole near the feedpoint can be measured.



3.3 Measurement Sheets

3.3.1 Return Loss and Smith Chart

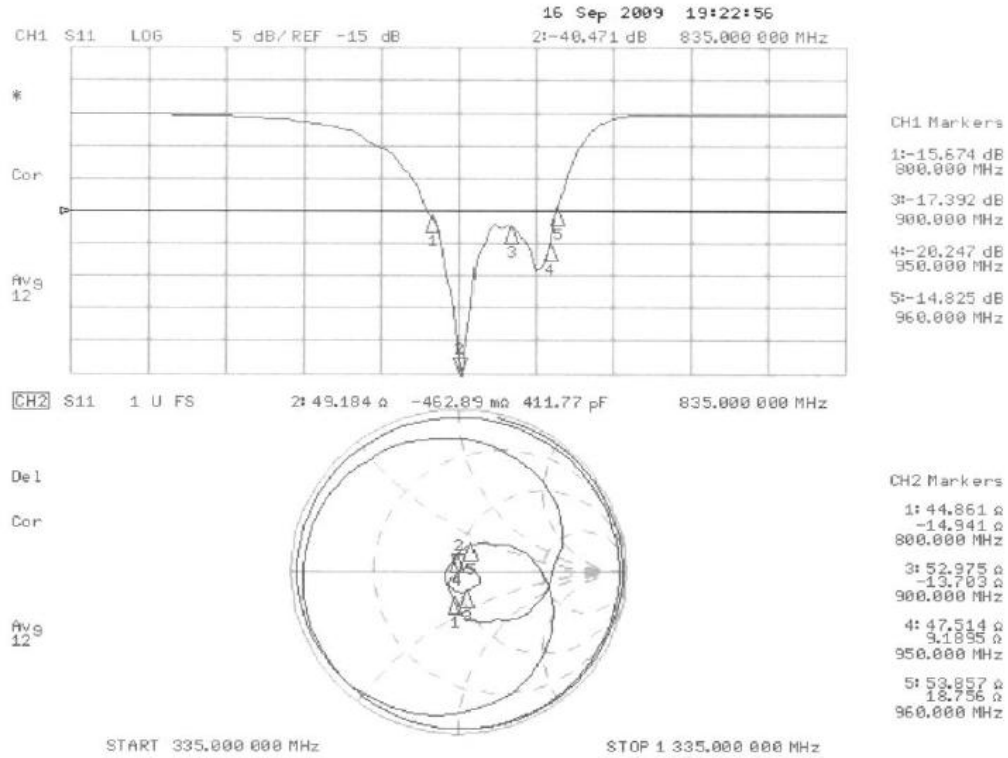

3.3.2 DASYS4 H-field Result

Date/Time: 16.09.2009 10:26:07

Test Laboratory: SPEAG Lab2

H_CD835_1045_090916.da5

DUT: HAC-Dipole 835 MHz; Type: D835V3; Serial: 1045

Communication System: CW; Frequency: 835 MHz; Duty Cycle: 1:1

Medium parameters used: $\sigma = 0$ mho/m, $\epsilon_r = 1$; $\rho = 1$ kg/m³

Phantom section: RF Section

Measurement Standard: DASYS5 (IEEE/IEC)

DASYS5 Configuration:

- Probe: H3DV6 - SN6065; ; Calibrated: 22.12.2008
- Sensor-Surface: (Fix Surface)
- Electronics: DAE4 Sn781; Calibrated: 20.02.2009
- Phantom: HAC Test Arch with AMCC; Type: SD HAC P01 BA; Serial: 1070
- Measurement SW: DASYS5, V5.0 Build 127; SEMCAD X Version 13.4 Build 125

H Scan - measurement distance from the probe sensor center to CD835 Dipole = 10mm/Hearing Aid Compatibility Test (41x361x1):

Measurement grid: dx=5mm, dy=5mm

Maximum value of peak Total field = 0.457 A/m

Probe Modulation Factor = 1

Device Reference Point: 0, 0, -6.3 mm

Reference Value = 0.487 A/m; Power Drift = 0.00195 dB

Hearing Aid Near-Field Category: M4 (AWF 0 dB)

Peak H-field in A/m

Grid 1 0.384 M4	Grid 2 0.410 M4	Grid 3 0.385 M4
Grid 4 0.431 M4	Grid 5 0.457 M4	Grid 6 0.429 M4
Grid 7 0.383 M4	Grid 8 0.401 M4	Grid 9 0.369 M4

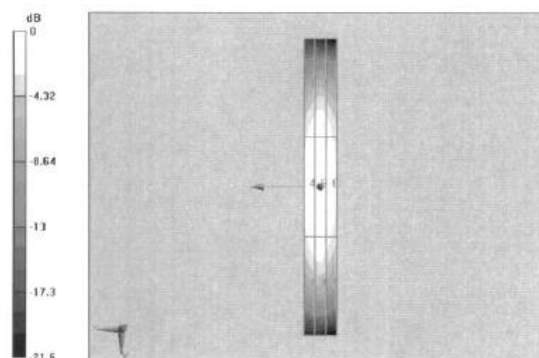

0 dB = 0.457A/m

3.3.3 DASY4 E-field Result

Date/Time: 17.09.2009 09:59:19

Test Laboratory: SPEAG Lab2

E_CD835_1045_090917.da5

DUT: HAC-Dipole 835 MHz; Type: D835V3; Serial: 1045

Communication System: CW; Frequency: 835 MHz; Duty Cycle: 1:1

Medium parameters used: $\sigma = 0$ mho/m, $\epsilon_r = 1$; $\rho = 1000$ kg/m³

Phantom section: RF Section

Measurement Standard: DASY5 (IEEE/IEC)

DASY5 Configuration:

- Probe: ER3DV6 - SN2336; ConvF(1, 1, 1); Calibrated: 22.12.2008
- Sensor-Surface: (Fix Surface)
- Electronics: DAE4 Sn781; Calibrated: 20.02.2009
- Phantom: HAC Test Arch with AMCC; Type: SD HAC P01 BA; Serial: 1070
- Measurement SW: DASY5, V5.0 Build 127; SEMCAD X Version 13.4 Build 125

E Scan - measurement distance from the probe sensor center to CD835 Dipole = 10mm/Hearing Aid Compatibility Test (41x361x1):

Measurement grid: dx=5mm, dy=5mm

Maximum value of peak Total field = 170.6 V/m

Probe Modulation Factor = 1

Device Reference Point: 0, 0, -6.3 mm

Reference Value = 109.7 V/m; Power Drift = -0.035 dB

Hearing Aid Near-Field Category: M4 (AWF 0 dB)

Peak E-field in V/m

Grid 1 164.9 M4	Grid 2 170.6 M4	Grid 3 164.4 M4
Grid 4 87.7 M4	Grid 5 89.9 M4	Grid 6 86.1 M4
Grid 7 165.1 M4	Grid 8 169.8 M4	Grid 9 159.4 M4

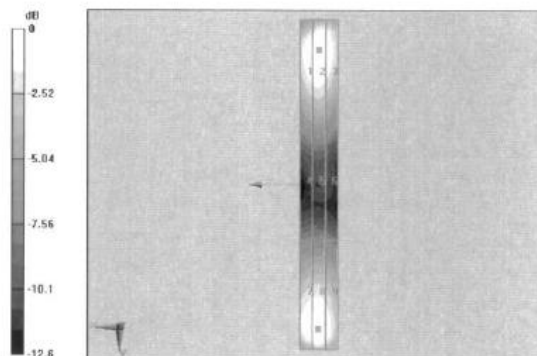

0 dB = 170.6V/m



Calibration Certificate of DAS Y

Calibration Laboratory of
 Schmid & Partner
 Engineering AG
 Zeughausstrasse 43, 8004 Zurich, Switzerland



S Schweizerischer Kalibrierdienst
C Service suisse d'étalonnage
S Servizio svizzero di taratura
S Swiss Calibration Service

Accredited by the Swiss Accreditation Service (SAS)
 The Swiss Accreditation Service is one of the signatories to the EA
 Multilateral Agreement for the recognition of calibration certificates

Accreditation No.: **SCS 108**

Client **Sporton (Auden)**

Certificate No: **CD1880V3-1038_Sep09**

CALIBRATION CERTIFICATE

Object **CD1880V3 - SN: 1038**

Calibration procedure(s) **QA CAL-20.v4
 Calibration procedure for dipoles in air**

Calibration date: **September 17, 2009**

Condition of the calibrated item **In Tolerance**

This calibration certificate documents the traceability to national standards, which realize the physical units of measurements (SI).
 All calibrations have been conducted in the closed laboratory facility: environment temperature (22 ± 3)°C and humidity < 70%.

Calibration Equipment used (M&TE critical for calibration)

Primary Standards	ID #	Cal Date (Certificate No.)	Scheduled Calibration
Power meter EPM-442A	GB37480704	08-Oct-08 (No. 217-00898)	Oct-09
Power sensor HP 8481A	US37292783	08-Oct-08 (No. 217-00898)	Oct-09
Probe ER3DV6	SN: 2336	22-Dec-08 (No. ER3-2336_Dec08)	Dec-09
Probe H3DV6	SN: 6065	22-Dec-08 (No. H3-6065_-Dec08)	Dec-09
DAE4	SN 781	20-Feb-09 (No. DAE4-781_Feb09)	Feb-10

Secondary Standards	ID #	Check Date (in house)	Scheduled Check
Power meter R&S NRP	SN: 101748	23-Sep-08 (in house check Dec-08)	In house check: Dec-10
Power sensor R&S NRP-Z91	SN: 100711	25-Aug-08 (in house check Dec-08)	In house check: Dec-10
Power sensor R&S NRP-Z91	SN: 100712	25-Aug-08 (in house check Dec-08)	In house check: Dec-10
Network Analyzer HP 8753E	US37390585	18-Oct-01 (in house check Oct-08)	In house check: Oct-09
RF generator E4433B	MY 41310391	22-Nov-04 (in house check Oct-07)	In house check: Oct-09

Calibrated by:	Name Claudio Leubler	Function Laboratory Technician	Signature
Approved by:	Name Katja Pokovic	Function Technical Manager	Signature

Issued: September 17, 2009

This calibration certificate shall not be reproduced except in full without written approval of the laboratory.



**Calibration Laboratory of
Schmid & Partner
Engineering AG**
Zeughausstrasse 43, 8004 Zurich, Switzerland



S Schweizerischer Kalibrierdienst
C Service suisse d'étalonnage
S Servizio svizzero di taratura
S Swiss Calibration Service

Accredited by the Swiss Accreditation Service (SAS)
The Swiss Accreditation Service is one of the signatories to the EA
Multilateral Agreement for the recognition of calibration certificates

Accreditation No.: **SCS 108**

References

- [1] ANSI-C63.19-2006
American National Standard for Methods of Measurement of Compatibility between Wireless Communications Devices and Hearing Aids.
- [2] ANSI-C63.19-2007
American National Standard for Methods of Measurement of Compatibility between Wireless Communications Devices and Hearing Aids.

Methods Applied and Interpretation of Parameters:

- *Coordinate System:* y-axis is in the direction of the dipole arms. z-axis is from the basis of the antenna (mounted on the table) towards its feed point between the two dipole arms. x-axis is normal to the other axes. In coincidence with the standards [1, 2], the measurement planes (probe sensor center) are selected to be at a distance of 10 mm above the top edge of the dipole arms.
- *Measurement Conditions:* Further details are available from the hardcopies at the end of the certificate. All figures stated in the certificate are valid at the frequency indicated. The forward power to the dipole connector is set with a calibrated power meter connected and monitored with an auxiliary power meter connected to a directional coupler. While the dipole under test is connected, the forward power is adjusted to the same level.
- *Antenna Positioning:* The dipole is mounted on a HAC Test Arch phantom using the matching dipole positioner with the arms horizontal and the feeding cable coming from the floor. The measurements are performed in a shielded room with absorbers around the setup to reduce the reflections. It is verified before the mounting of the dipole under the Test Arch phantom, that its arms are perfectly in a line. It is installed on the HAC dipole positioner with its arms parallel below the dielectric reference wire and able to move elastically in vertical direction without changing its relative position to the top center of the Test Arch phantom. The vertical distance to the probe is adjusted after dipole mounting with a DAS Y4 Surface Check job. Before the measurement, the distance between phantom surface and probe tip is verified. The proper measurement distance is selected by choosing the matching section of the HAC Test Arch phantom with the proper device reference point (upper surface of the dipole) and the matching grid reference point (tip of the probe) considering the probe sensor offset. The vertical distance to the probe is essential for the accuracy.
- *Feed Point Impedance and Return Loss:* These parameters are measured using a HP 8753E Vector Network Analyzer. The impedance is specified at the SMA connector of the dipole. The influence of reflections was eliminated by applying the averaging function while moving the dipole in the air, at least 70cm away from any obstacles.
- *E-field distribution:* E field is measured in the x-y-plane with an isotropic ER3D-field probe with 100 mW forward power to the antenna feed point. In accordance with [1, 2], the scan area is 20mm wide, its length exceeds the dipole arm length (180 or 90mm). The sensor center is 10 mm (in z) above the top of the dipole arms. Two 3D maxima are available near the end of the dipole arms. Assuming the dipole arms are perfectly in one line, the average of these two maxima (in subgrid 2 and subgrid 8) is determined to compensate for any non-parallelity to the measurement plane as well as the sensor displacement. The E-field value stated as calibration value represents the maximum of the interpolated 3D-E-field, 10mm above the dipole surface.
- *H-field distribution:* H-field is measured with an isotropic H-field probe with 100mW forward power to the antenna feed point, in the x-y-plane. The scan area and sensor distance is equivalent to the E-field scan. The maximum of the field is available at the center (subgrid 5) above the feed point. The H-field value stated as calibration value represents the maximum of the interpolated H-field, 10mm above the dipole surface at the feed point.



1. Measurement Conditions

DASY system configuration, as far as not given on page 1.

DASY Version	DASY5	V5.0 B127
DASY PP Version	SEMCAD X	V13.4 B125
Phantom	HAC Test Arch	SD HAC P01 BA, #1070
Distance Dipole Top - Probe Center	10 mm	
Scan resolution	dx, dy = 5 mm	area = 20 x 90 mm
Frequency	1880 MHz ± 1 MHz	
Forward power at dipole connector	20.0 dBm = 100mW	
Input power drift	< 0.05 dB	

2. Maximum Field values

H-field 10 mm above dipole surface	condition	Interpolated maximum
Maximum measured	100 mW forward power	0.466 A/m

Uncertainty for H-field measurement: 8.2% (k=2)

E-field 10 mm above dipole surface	condition	Interpolated maximum
Maximum measured above high end	100 mW forward power	138.2 V/m
Maximum measured above low end	100 mW forward power	135.3 V/m
Averaged maximum above arm	100 mW forward power	136.8 V/m

Uncertainty for E-field measurement: 12.8% (k=2)

3. Appendix

3.1 Antenna Parameters

Frequency	Return Loss	Impedance
1710 MHz	18.6 dB	(48.6 + j11.6) Ohm
1880 MHz	21.3 dB	(52.9 + j8.4) Ohm
1900 MHz	22.1 dB	(55.5 + j6.3) Ohm
1950 MHz	28.1 dB	(52.8 - j2.9) Ohm
2000 MHz	18.7 dB	(39.6 - j1.0) Ohm

3.2 Antenna Design and Handling

The calibration dipole has a symmetric geometry with a built-in two stub matching network, which leads to the enhanced bandwidth.

The dipole is built of standard semirigid coaxial cable. The internal matching line is open ended. The antenna is therefore open for DC signals.

Do not apply force to dipole arms, as they are liable to bend. The soldered connections near the feedpoint may be damaged. After excessive mechanical stress or overheating, check the impedance characteristics to ensure that the internal matching network is not affected.

After long term use with 40W radiated power, only a slight warming of the dipole near the feedpoint can be measured.



3.3 Measurement Sheets

3.3.1 Return Loss and Smith Chart

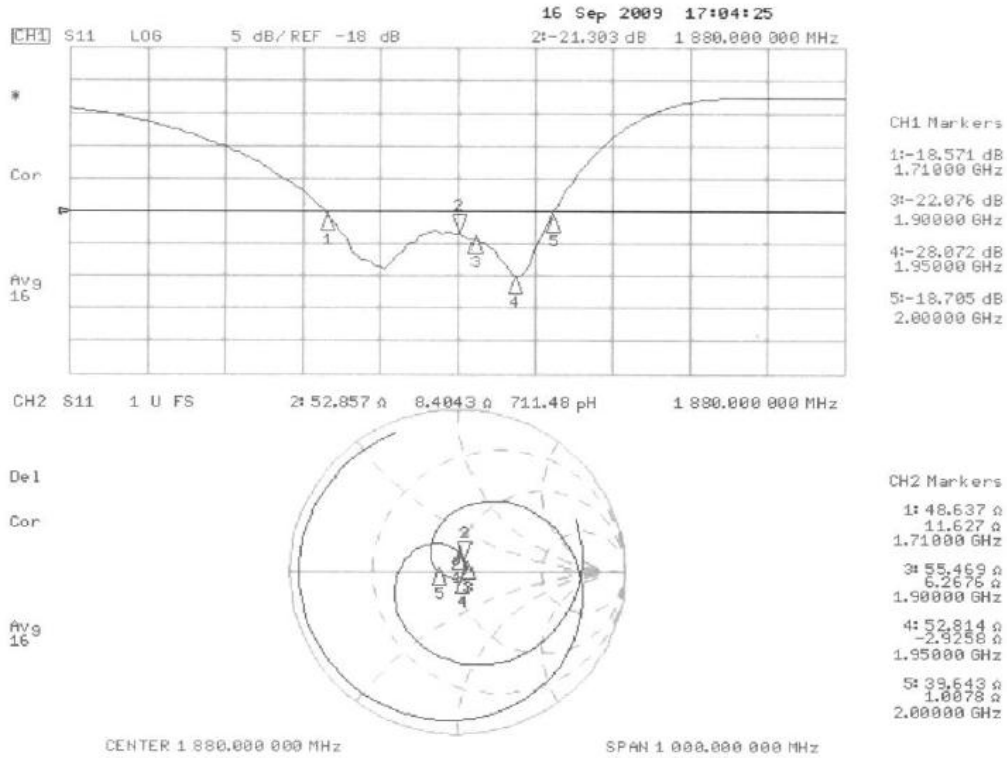

3.3.2 DASY4 H-Field Result

Date/Time: 16.09.2009 14:27:59

Test Laboratory: SPEAG Lab2

H_CD1880_1038_090916.da5

DUT: HAC Dipole 1880 MHz; Type: CD1880V3; Serial: 1038

Communication System: CW; Frequency: 1880 MHz; Duty Cycle: 1:1

Medium parameters used: $\sigma = 0$ mho/m, $\epsilon_r = 1$; $\rho = 1$ kg/m³

Phantom section: RF Section

Measurement Standard: DASY5 (IEEE/IEC)

DASY5 Configuration:

- Probe: H3DV6 - SN6065; ; Calibrated: 22.12.2008
- Sensor-Surface: (Fix Surface)
- Electronics: DAE4 Sn781; Calibrated: 20.02.2009
- Phantom: HAC Test Arch with AMCC; Type: SD HAC P01 BA; Serial: 1070
- Measurement SW: DASY5, V5.0 Build 127; SEMCAD X Version 13.4 Build 125

H Scan - measurement distance from the probe sensor center to CD1880 Dipole = 10mm/Hearing Aid Compatibility Test (41x181x1):

Measurement grid: dx=5mm, dy=5mm

Maximum value of peak Total field = 0.466 A/m

Probe Modulation Factor = 1

Device Reference Point: 0, 0, -6.3 mm

Reference Value = 0.493 A/m; Power Drift = -0.010 dB

Hearing Aid Near-Field Category: M2 (AWF 0 dB)

Peak H-field in A/m

Grid 1 0.397 M2	Grid 2 0.420 M2	Grid 3 0.403 M2
Grid 4 0.442 M2	Grid 5 0.466 M2	Grid 6 0.445 M2
Grid 7 0.407 M2	Grid 8 0.432 M2	Grid 9 0.410 M2

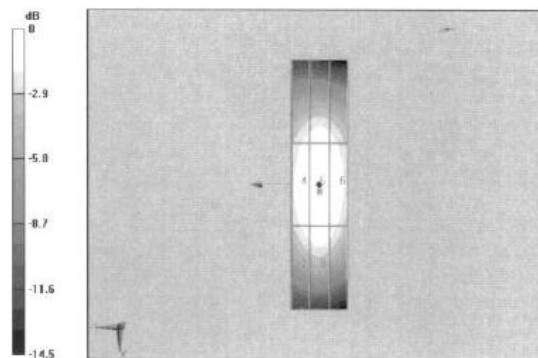

0 dB = 0.466A/m

3.3.3 DASY4 E-Field Result

Date/Time: 17.09.2009 15:13:12

Test Laboratory: SPEAG Lab2

E_CD1880_1038_090917.da5

DUT: HAC Dipole 1880 MHz; Type: CD1880V3; Serial: 1038

Communication System: CW; Frequency: 1880 MHz; Duty Cycle: 1:1

Medium parameters used: $\sigma = 0$ mho/m, $\epsilon_r = 1$; $\rho = 1000$ kg/m³

Phantom section: RF Section

Measurement Standard: DASY5 (IEEE/IEC)

DASY5 Configuration:

- Probe: ER3DV6 - SN2336; ConvF(1, 1, 1); Calibrated: 22.12.2008
- Sensor-Surface: (Fix Surface)
- Electronics: DAE4 Sn781; Calibrated: 20.02.2009
- Phantom: HAC Test Arch with AMCC; Type: SD HAC P01 BA; Serial: 1070
- Measurement SW: DASY5, V5.0 Build 127; SEMCAD X Version 13.4 Build 125

E Scan - measurement distance from the probe sensor center to CD1880 Dipole = 10mm/Hearing Aid Compatibility Test (41x181x1):

Measurement grid: dx=5mm, dy=5mm

Maximum value of peak Total field = 138.2 V/m

Probe Modulation Factor = 1

Device Reference Point: 0, 0, -6.3 mm

Reference Value = 155.9 V/m; Power Drift = -0.00724 dB

Hearing Aid Near-Field Category: M2 (AWF 0 dB)

Peak E-field in V/m

Grid 1 130.2 M2	Grid 2 135.3 M2	Grid 3 132.4 M2
Grid 4 89 M3	Grid 5 91.6 M3	Grid 6 88.1 M3
Grid 7 132.8 M2	Grid 8 138.2 M2	Grid 9 132.4 M2

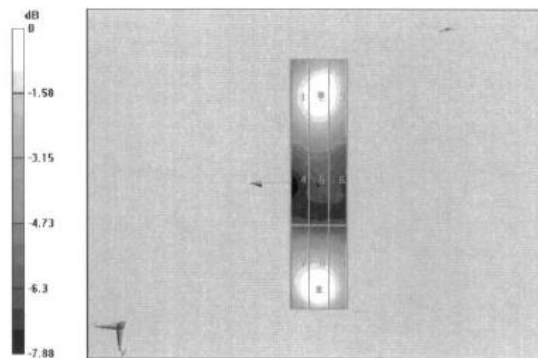

0 dB = 138.2V/m



Calibration Laboratory of Schmid & Partner Engineering AG Zeughausstrasse 43, 8004 Zurich, Switzerland



S Schweizerischer Kalibrierdienst
C Service suisse d'étalonnage
S Servizio svizzero di taratura
S Swiss Calibration Service

Accredited by the Swiss Accreditation Service (SAS)
The Swiss Accreditation Service is one of the signatories to the EA Multilateral Agreement for the recognition of calibration certificates

Accreditation No.: SCS 108

Client Auden

Certificate No: DAE4-910_Sep09

CALIBRATION CERTIFICATE

Object DAE4 - SD 000 D04 BK - SN: 910
Calibration procedure(s) QA CAL-06.v20 Calibration procedure for the data acquisition electronics (DAE)
Calibration date: September 18, 2009
Condition of the calibrated item In Tolerance

This calibration certificate documents the traceability to national standards, which realize the physical units of measurements (SI).
The measurements and the uncertainties with confidence probability are given on the following pages and are part of the certificate.
All calibrations have been conducted in the closed laboratory facility; environment temperature (22 ± 3)°C and humidity < 70%.

Calibration Equipment used (M&TE critical for calibration)

Table with 4 columns: Primary Standards, ID #, Cal Date (Certificate No.), Scheduled Calibration. Includes entries for Keithley Multimeter Type 2001 and Calibrator Box V1.1.

Calibrated by: Name Dominique Steffen, Function Technician, Signature [Handwritten]
Approved by: Name Fin Bornholt, R&D Director, Signature [Handwritten]

Issued: September 18, 2009

This calibration certificate shall not be reproduced except in full without written approval of the laboratory.



Calibration Laboratory of
Schmid & Partner
Engineering AG
Zeughausstrasse 43, 8004 Zurich, Switzerland



S Schweizerischer Kalibrierdienst
C Service suisse d'étalonnage
S Servizio svizzero di taratura
S Swiss Calibration Service

Accredited by the Swiss Accreditation Service (SAS)
The Swiss Accreditation Service is one of the signatories to the EA
Multilateral Agreement for the recognition of calibration certificates

Accreditation No.: **SCS 108**

Glossary

DAE data acquisition electronics
Connector angle information used in DASy system to align probe sensor X to the robot coordinate system.

Methods Applied and Interpretation of Parameters

- **DC Voltage Measurement:** Calibration Factor assessed for use in DASy system by comparison with a calibrated instrument traceable to national standards. The figure given corresponds to the full scale range of the voltmeter in the respective range.
- **Connector angle:** The angle of the connector is assessed measuring the angle mechanically by a tool inserted. Uncertainty is not required.
- The following parameters as documented in the Appendix contain technical information as a result from the performance test and require no uncertainty.
 - **DC Voltage Measurement Linearity:** Verification of the Linearity at +10% and -10% of the nominal calibration voltage. Influence of offset voltage is included in this measurement.
 - **Common mode sensitivity:** Influence of a positive or negative common mode voltage on the differential measurement.
 - **Channel separation:** Influence of a voltage on the neighbor channels not subject to an input voltage.
 - **AD Converter Values with inputs shorted:** Values on the internal AD converter corresponding to zero input voltage
 - **Input Offset Measurement:** Output voltage and statistical results over a large number of zero voltage measurements.
 - **Input Offset Current:** Typical value for information; Maximum channel input offset current, not considering the input resistance.
 - **Input resistance:** DAE input resistance at the connector, during internal auto-zeroing and during measurement.
 - **Low Battery Alarm Voltage:** Typical value for information. Below this voltage, a battery alarm signal is generated.
 - **Power consumption:** Typical value for information. Supply currents in various operating modes.



DC Voltage Measurement

A/D - Converter Resolution nominal

High Range: 1LSB = 6.1 μ V, full range = -100...+300 mV

Low Range: 1LSB = 61nV, full range = -1.....+3mV

DASY measurement parameters: Auto Zero Time: 3 sec; Measuring time: 3 sec

Calibration Factors	X	Y	Z
High Range	403.468 \pm 0.1% (k=2)	402.794 \pm 0.1% (k=2)	403.267 \pm 0.1% (k=2)
Low Range	3.98156 \pm 0.7% (k=2)	3.93790 \pm 0.7% (k=2)	3.95318 \pm 0.7% (k=2)

Connector Angle

Connector Angle to be used in DASYS system	332.5 $^{\circ}$ \pm 1 $^{\circ}$
--	-------------------------------------



Appendix

1. DC Voltage Linearity

High Range	Reading (μV)	Difference (μV)	Error (%)
Channel X + Input	200007.9	0.26	0.00
Channel X + Input	19999.78	-0.42	-0.00
Channel X - Input	-20000.04	-1.04	0.01
Channel Y + Input	199998.4	0.89	0.00
Channel Y + Input	19996.78	-2.72	-0.01
Channel Y - Input	-20001.06	-1.46	0.01
Channel Z + Input	199996.4	-0.15	-0.00
Channel Z + Input	19997.21	-2.39	-0.01
Channel Z - Input	-20000.90	0.01	0.01

Low Range	Reading (μV)	Difference (μV)	Error (%)
Channel X + Input	2000.2	0.25	0.01
Channel X + Input	198.01	-1.79	-0.88
Channel X - Input	-201.04	-1.14	0.57
Channel Y + Input	2000.2	-0.04	-0.00
Channel Y + Input	198.23	-1.77	-0.88
Channel Y - Input	-202.23	-2.23	1.12
Channel Z + Input	1999.7	-0.72	-0.04
Channel Z + Input	197.54	-2.46	-1.23
Channel Z - Input	-202.83	-2.83	1.42

2. Common mode sensitivity

DASY measurement parameters: Auto Zero Time: 3 sec; Measuring time: 3 sec

	Common mode Input Voltage (mV)	High Range Average Reading (μV)	Low Range Average Reading (μV)
Channel X	200	-14.99	-16.70
	-200	18.86	16.76
Channel Y	200	5.73	5.43
	-200	-7.07	-7.23
Channel Z	200	-11.68	-11.63
	-200	10.57	10.18

3. Channel separation

DASY measurement parameters: Auto Zero Time: 3 sec; Measuring time: 3 sec

	Input Voltage (mV)	Channel X (μV)	Channel Y (μV)	Channel Z (μV)
Channel X	200	-	2.48	-1.62
Channel Y	200	2.03	-	5.13
Channel Z	200	2.11	0.30	-



4. AD-Converter Values with inputs shorted

DASY measurement parameters: Auto Zero Time: 3 sec; Measuring time: 3 sec

	High Range (LSB)	Low Range (LSB)
Channel X	16170	16227
Channel Y	15395	15569
Channel Z	16720	16928

5. Input Offset Measurement

DASY measurement parameters: Auto Zero Time: 3 sec; Measuring time: 3 sec

Input 10M Ω

	Average (μ V)	min. Offset (μ V)	max. Offset (μ V)	Std. Deviation (μ V)
Channel X	-0.86	-2.19	0.75	0.58
Channel Y	-0.88	-2.32	0.63	0.57
Channel Z	-1.64	-2.82	0.09	0.57

6. Input Offset Current

Nominal Input circuitry offset current on all channels: <251A

7. Input Resistance

	Zeroing (MOhm)	Measuring (MOhm)
Channel X	0.2000	198.8
Channel Y	0.1999	198.8
Channel Z	0.1999	199.9

8. Low Battery Alarm Voltage (verified during pre test)

Typical values	Alarm Level (VDC)
Supply (+ Vcc)	+7.9
Supply (- Vcc)	-7.6

9. Power Consumption (verified during pre test)

Typical values	Switched off (mA)	Stand by (mA)	Transmitting (mA)
Supply (+ Vcc)	+0.0	+6	+14
Supply (- Vcc)	-0.01	-8	-9



Calibration Certificate of DAS Y

**Calibration Laboratory of
Schmid & Partner
Engineering AG**
Zeughausstrasse 43, 8004 Zurich, Switzerland



S Schweizerischer Kalibrierdienst
C Service suisse d'étalonnage
S Servizio svizzero di taratura
S Swiss Calibration Service

Accredited by the Swiss Accreditation Service (SAS)
The Swiss Accreditation Service is one of the signatories to the EA
Multilateral Agreement for the recognition of calibration certificates

Accreditation No.: **SCS 108**

Client **Sporton (Auden)**

Certificate No: **ER3-2358_Jan10**

CALIBRATION CERTIFICATE

Object **ER3DV6 - SN:2358**

Calibration procedure(s) **QA CAL-02.v5 and QA CAL-25.v2
Calibration procedure for E-field probes optimized for close near field
evaluations in air**

Calibration date: **January 22, 2010**

This calibration certificate documents the traceability to national standards, which realize the physical units of measurements (SI).
The measurements and the uncertainties with confidence probability are given on the following pages and are part of the certificate.

All calibrations have been conducted in the closed laboratory facility: environment temperature (22 ± 3)°C and humidity < 70%.

Calibration Equipment used (M&TE critical for calibration)

Primary Standards	ID #	Cal Date (Certificate No.)	Scheduled Calibration
Power meter E4419B	GB41293874	1-Apr-09 (No. 217-01030)	Apr-10
Power sensor E4412A	MY41495277	1-Apr-09 (No. 217-01030)	Apr-10
Power sensor E4412A	MY41498087	1-Apr-09 (No. 217-01030)	Apr-10
Reference 3 dB Attenuator	SN: S5054 (3c)	31-Mar-09 (No. 217-01026)	Mar-10
Reference 20 dB Attenuator	SN: S5086 (20b)	31-Mar-09 (No. 217-01028)	Mar-10
Reference 30 dB Attenuator	SN: S5129 (30b)	31-Mar-09 (No. 217-01027)	Mar-10
Reference Probe ER3DV6	SN: 2328	3-Oct-09 (No. ER3-2328_Oct09)	Oct-10
DAE4	SN: 789	23-Dec-09 (No. DAE4-789_Dec09)	Dec-10
Secondary Standards	ID #	Check Date (in house)	Scheduled Check
RF generator HP 8648C	US3642U01700	4-Aug-99 (in house check Oct-09)	In house check: Oct-11
Network Analyzer HP 8753E	US37390585	18-Oct-01 (in house check Oct-09)	In house check: Oct 10

Calibrated by: **Claudio Leubler** Laboratory Technician *Claudio Leubler*

Approved by: **Katja Pokovic** Technical Manager *Katja Pokovic*

Issued: January 25, 2010

This calibration certificate shall not be reproduced except in full without written approval of the laboratory.



Calibration Laboratory of Schmid & Partner Engineering AG Zeughausstrasse 43, 8004 Zurich, Switzerland



S Schweizerischer Kalibrierdienst
C Service suisse d'etalonnage
S Servizio svizzero di taratura
S Swiss Calibration Service

Accredited by the Swiss Accreditation Service (SAS)
The Swiss Accreditation Service is one of the signatories to the EA Multilateral Agreement for the recognition of calibration certificates

Accreditation No.: SCS 108

Glossary:

Table with 2 columns: Term and Definition. Terms include NORMx,y,z, DCP, CF, A, B, C, Polarization phi, Polarization theta, Connector Angle.

Calibration is Performed According to the Following Standards:

- a) IEEE Std 1309-2005, "IEEE Standard for calibration of electromagnetic field sensors and probes, excluding antennas, from 9 kHz to 40 GHz", December 2005.

Methods Applied and Interpretation of Parameters:

- NORMx,y,z: Assessed for E-field polarization theta = 0 for XY sensors and theta = 90 for Z sensor...
NORM(f)x,y,z = NORMx,y,z * frequency_response
DCPx,y,z: DCP are numerical linearization parameters assessed based on the data of power sweep with CW signal...
Ax,y,z; Bx,y,z; Cx,y,z, VRx,y,z: A, B, C are numerical linearization parameters assessed based on the data of power sweep for specific modulation signal...
Spherical isotropy (3D deviation from isotropy): in a locally homogeneous field realized using an open waveguide setup.
Sensor Offset: The sensor offset corresponds to the offset of virtual measurement center from the probe tip...
Connector Angle: The angle is assessed using the information gained by determining the NORMx (no uncertainty required).



ER3DV6 SN:2358

January 22, 2010

Probe ER3DV6

SN:2358

Manufactured:	July 7, 2005
Last calibrated:	January 14, 2009
Recalibrated:	January 22, 2010

Calibrated for DAS Y Systems

(Note: non-compatible with DAS Y2 system!)



ER3DV6 SN:2358

January 22, 2010

DASY - Parameters of Probe: ER3DV6 SN:2358

Basic Calibration Parameters

	Sensor X	Sensor Y	Sensor Z	Unc (k=2)
Norm ($\mu\text{V}/(\text{V}/\text{m})^2$)	1.71	1.57	1.60	$\pm 10.1\%$
DCP (mV) ^A	94.0	91.5	96.7	

Modulation Calibration Parameters

UID	Communication System Name	PAR		A dB	B dBuV	C	VR mV	Unc ^E (k=2)
10000	CW	0.00	X	0.00	0.00	1.00	300	$\pm 1.5\%$
			Y	0.00	0.00	1.00	300	
			Z	0.00	0.00	1.00	300	

The reported uncertainty of measurement is stated as the standard uncertainty of measurement multiplied by the coverage factor k=2, which for a normal distribution corresponds to a coverage probability of approximately 95%.

^A numerical linearization parameter: uncertainty not required

^E Uncertainty is determined using the maximum deviation from linear response applying rectangular distribution and is expressed for the square of the field value.



ER3DV6 SN:2358

January 22, 2010

Frequency Response of E-Field

(TEM-Cell:ifi110 EXX, Waveguide R22)

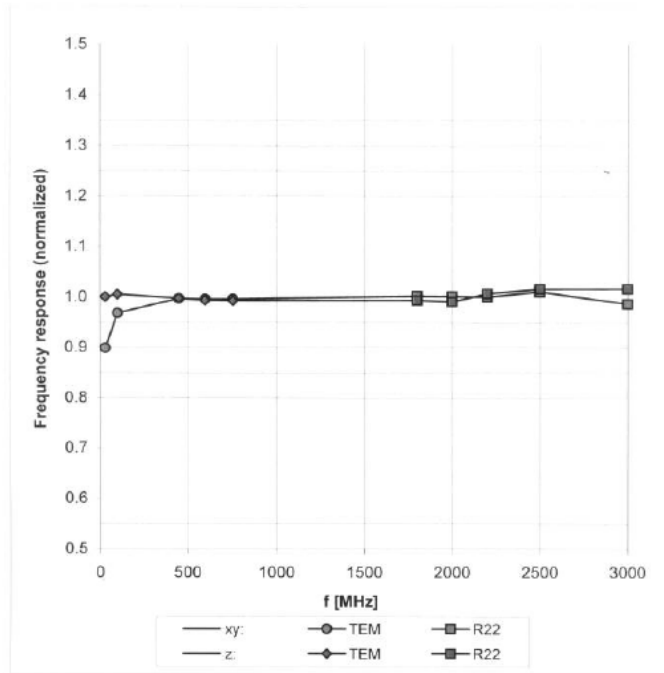

Uncertainty of Frequency Response of E-field: $\pm 6.3\%$ (k=2)



ER3DV6 SN:2358

January 22, 2010

Receiving Pattern (ϕ), $\vartheta = 0^\circ$

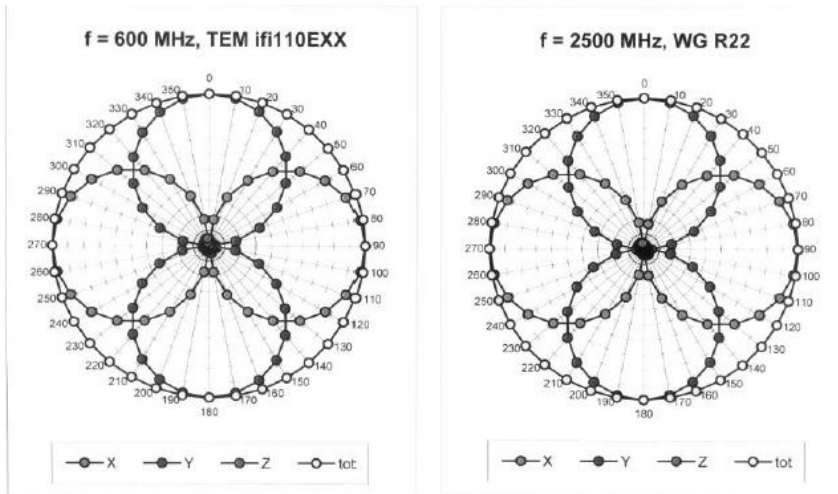

Receiving Pattern (ϕ), $\vartheta = 90^\circ$

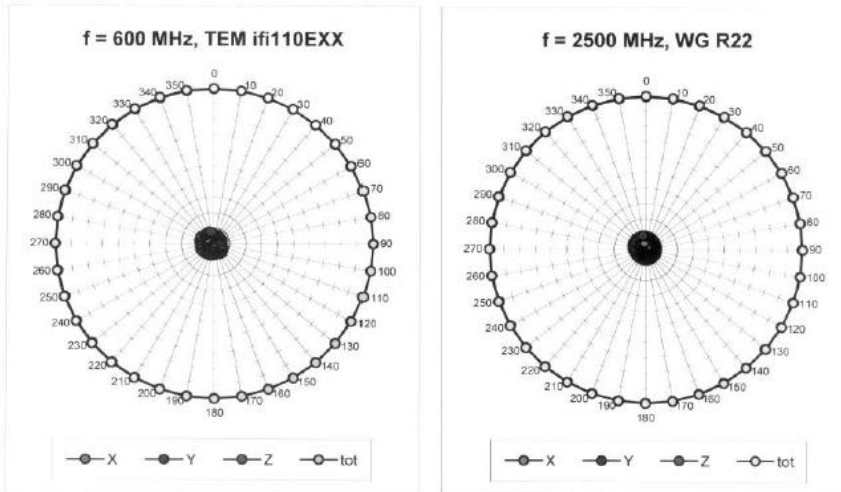



ER3DV6 SN:2358

January 22, 2010

Receiving Pattern (ϕ), $\vartheta = 0^\circ$

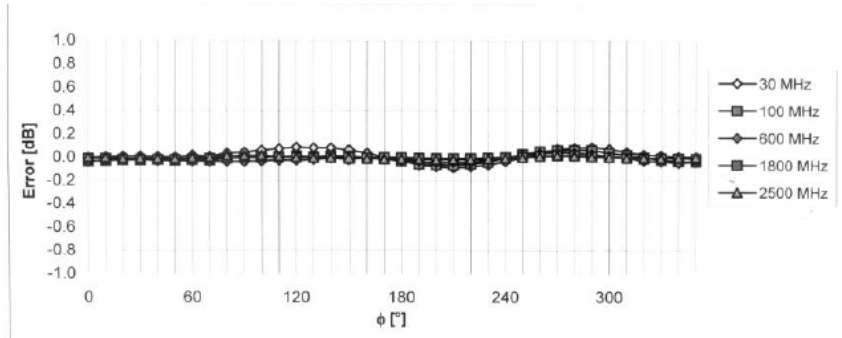

Uncertainty of Axial Isotropy Assessment: $\pm 0.5\%$ ($k=2$)

Receiving Pattern (ϕ), $\vartheta = 90^\circ$

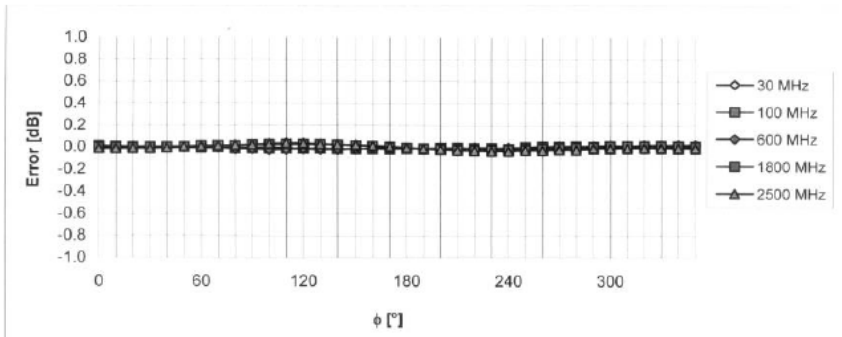

Uncertainty of Axial Isotropy Assessment: $\pm 0.5\%$ ($k=2$)



ER3DV6 SN:2358

January 22, 2010

Dynamic Range f(E-field) (Waveguide R22, f = 1800 MHz)

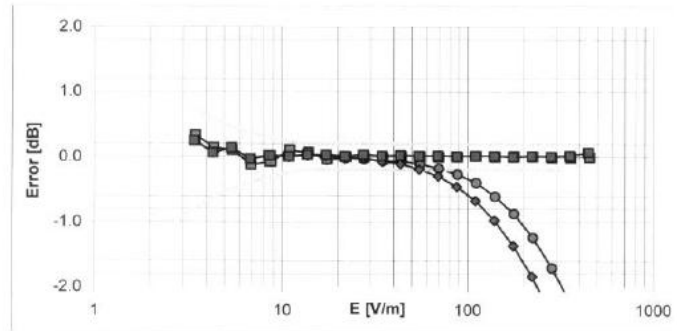
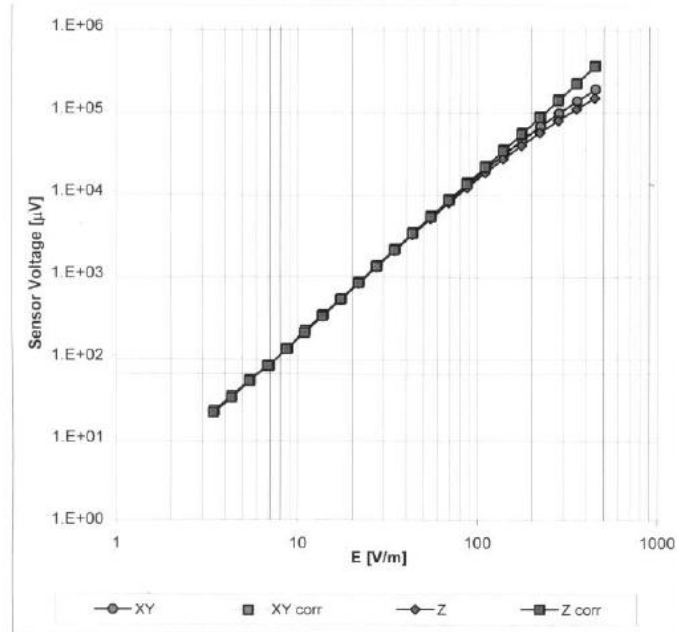

Uncertainty of Linearity Assessment: $\pm 0.6\%$ (k=2)



ER3DV6 SN:2358

January 22, 2010

Deviation from Isotropy in Air Error (ϕ, ϑ), $f = 900$ MHz

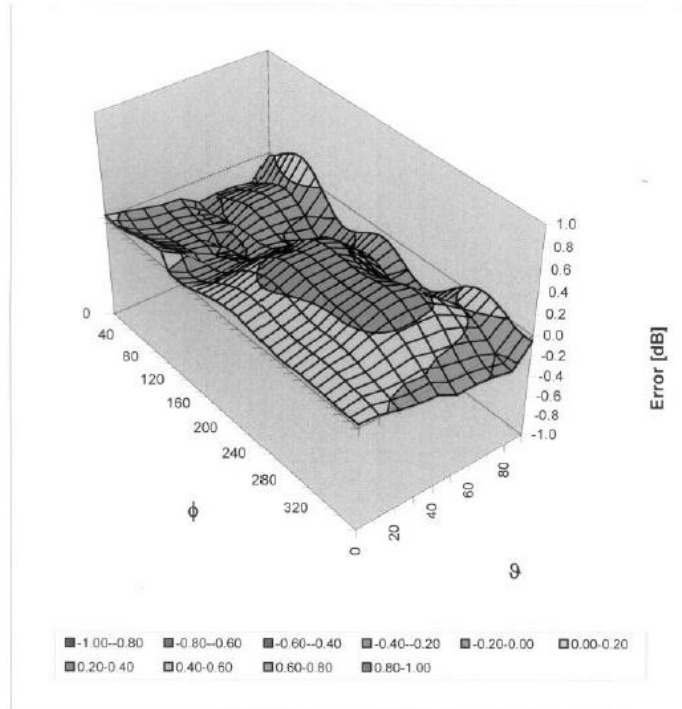

Uncertainty of Spherical Isotropy Assessment: $\pm 2.6\%$ ($k=2$)



ER3DV6 SN:2358

January 22, 2010

Other Probe Parameters

Sensor Arrangement	Rectangular
Connector Angle (°)	-242.4
Mechanical Surface Detection Mode	enabled
Optical Surface Detection Mode	disabled
Probe Overall Length	337 mm
Probe Body Diameter	10 mm
Tip Length	10 mm
Tip Diameter	8.0 mm
Probe Tip to Sensor X Calibration Point	2.5 mm
Probe Tip to Sensor Y Calibration Point	2.5 mm
Probe Tip to Sensor Z Calibration Point	2.5 mm



Calibration Laboratory of Schmid & Partner Engineering AG Zeughausstrasse 43, 8004 Zurich, Switzerland



S Schweizerischer Kalibrierdienst
C Service suisse d'etalonnage
S Servizio svizzero di taratura
S Swiss Calibration Service

Accredited by the Swiss Accreditation Service (SAS)
The Swiss Accreditation Service is one of the signatories to the EA Multilateral Agreement for the recognition of calibration certificates

Accreditation No.: SCS 108

Client Sporton (Auden)

Certificate No: H3-6184_Jan10

CALIBRATION CERTIFICATE

Object: H3DV6 - SN:6184
Calibration procedure(s): QA CAL-03.v5 and QA CAL-25.v2
Calibration procedure for H-field probes optimized for close near field evaluations in air
Calibration date: January 22, 2010

This calibration certificate documents the traceability to national standards, which realize the physical units of measurements (SI).
All calibrations have been conducted in the closed laboratory facility: environment temperature (22 ± 3)°C and humidity < 70%.

Calibration Equipment used (M&TE critical for calibration)

Table with 4 columns: Primary Standards, ID #, Cal Date (Certificate No.), Scheduled Calibration. Lists various power meters, sensors, and attenuators with their respective IDs and calibration dates.

Table with 4 columns: Secondary Standards, ID #, Check Date (in house), Scheduled Check. Lists RF generator and Network Analyzer with their IDs and check dates.

Calibrated by: Claudio Leubler, Laboratory Technician
Approved by: Katja Pokovic, Technical Manager

Issued: January 25, 2010

This calibration certificate shall not be reproduced except in full without written approval of the laboratory.



Calibration Laboratory of
Schmid & Partner
Engineering AG
Zeughausstrasse 43, 8004 Zurich, Switzerland



S Schweizerischer Kalibrierdienst
C Service suisse d'etalonnage
S Servizio svizzero di taratura
S Swiss Calibration Service

Accredited by the Swiss Accreditation Service (SAS)
The Swiss Accreditation Service is one of the signatories to the EA
Multilateral Agreement for the recognition of calibration certificates

Accreditation No.: SCS 108

Glossary:

Table with 2 columns: Term and Definition. Terms include NORMx,y,z, DCP, CF, A, B, C, Polarization phi, Polarization theta, and Connector Angle.

Calibration is Performed According to the Following Standards:

- a) IEEE Std 1309-2005, "IEEE Standard for calibration of electromagnetic field sensors and probes, excluding antennas, from 9 kHz to 40 GHz", December 2005.

Methods Applied and Interpretation of Parameters:

- NORMx,y,z: Assessed for E-field polarization theta = 0 for XY sensors and theta = 90 for Z sensor...
X,Y,Z(f)_a0a1a2= X,Y,Z_a0a1a2* frequency_response (see Frequency Response Chart).
DCPx,y,z: DCP are numerical linearization parameters assessed based on the data of power sweep with CW signal...
Ax,y,z; Bx,y,z; Cx,y,z, VRx,y,z: A, B, C are numerical linearization parameters assessed based on the data of power sweep...
Spherical isotropy (3D deviation from isotropy): in a locally homogeneous field realized using an open waveguide setup.
Sensor Offset: The sensor offset corresponds to the offset of virtual measurement center from the probe tip...
Connector Angle: The angle is assessed using the information gained by determining the X_a0a1a2...



H3DV6 SN:6184

January 22, 2010

Probe H3DV6

SN:6184

Manufactured:	June 8, 2004
Last calibrated:	January 19, 2009
Recalibrated:	January 22, 2010

Calibrated for DASY Systems

(Note: non-compatible with DASY2 system!)



H3DV6 SN:6184

January 22, 2010

DASY - Parameters of Probe: H3DV6 SN:6184

Basic Calibration Parameters

	Sensor X	Sensor Y	Sensor Z	Unc (k=2)
Norm (A/m / $\sqrt{\mu V}$) a0	2.47E-3	2.53E-3	2.97E-3	± 5.1%
Norm (A/m / $\sqrt{\mu V}$) a1	1.05E-5	-6.02E-5	-1.02E-4	± 5.1%
Norm (A/m / $\sqrt{\mu V}$) a2	6.86E-6	-6.86E-7	6.53E-5	± 5.1%
DCP (mV) ^A	82.6	91.0	83.0	

Modulation Calibration Parameters

UID	Communication System Name	PAR		A dB	B dBuV	C	VR mV	Unc ^E (k=2)
10000	CW	0.00	X	0.00	0.00	1.00	300	± 1.5 %
			Y	0.00	0.00	1.00	300	
			Z	0.00	0.00	1.00	300	

The reported uncertainty of measurement is stated as the standard uncertainty of measurement multiplied by the coverage factor k=2, which for a normal distribution corresponds to a coverage probability of approximately 95%.

^A numerical linearization parameter: uncertainty not required

^E Uncertainty is determined using the maximum deviation from linear response applying recatangular distribution and is expressed for the square of the field value.



H3DV6 SN:6184

January 22, 2010

Frequency Response of H-Field

(TEM-Cell:ifi110 EXX, Waveguide R22)

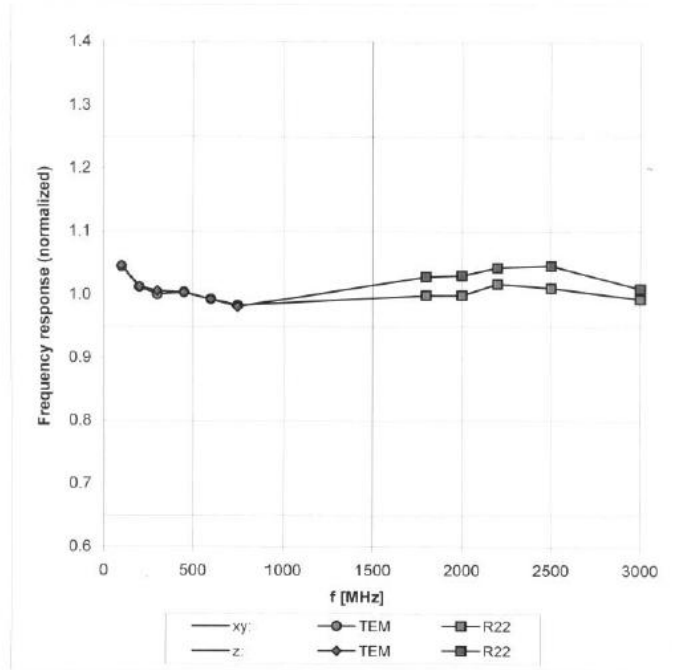

Uncertainty of Frequency Response of H-field: $\pm 6.3\%$ (k=2)



H3DV6 SN:6184

January 22, 2010

Receiving Pattern (ϕ), $\vartheta = 90^\circ$

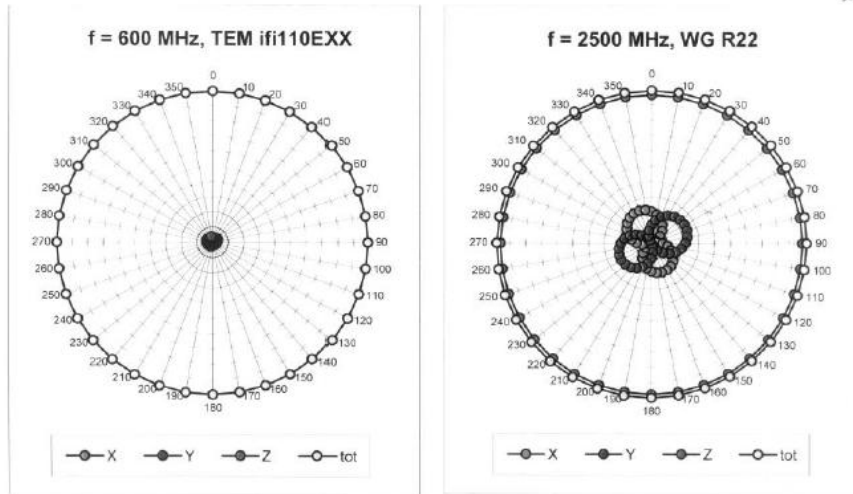

Receiving Pattern (ϕ), $\vartheta = 0^\circ$

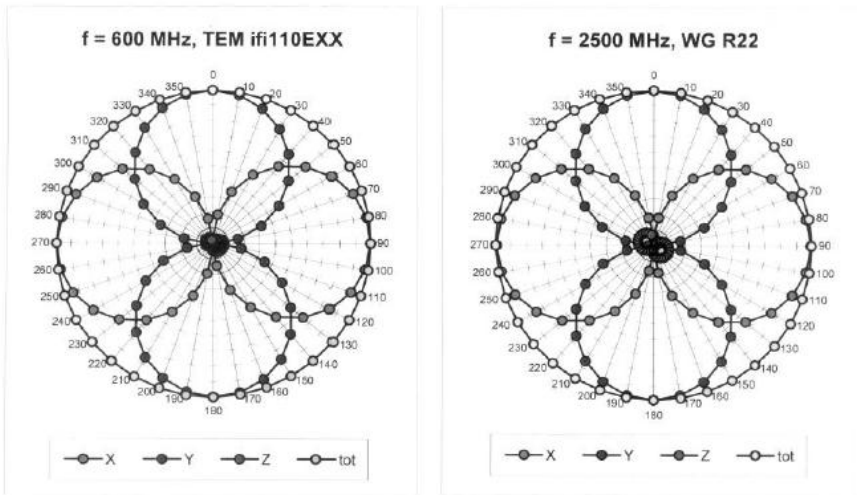



H3DV6 SN:6184

January 22, 2010

Receiving Pattern (ϕ), $\vartheta = 90^\circ$

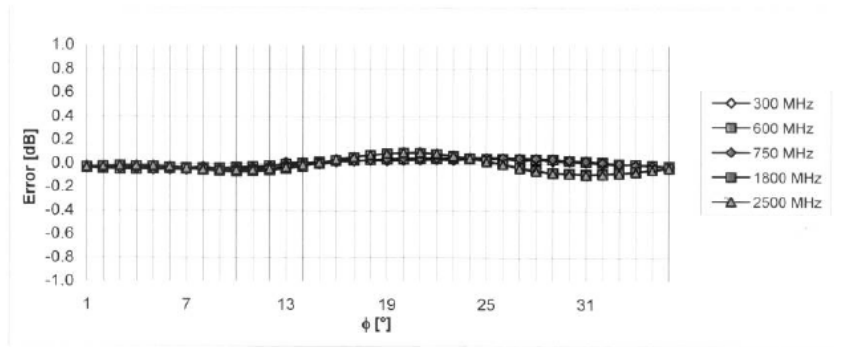

Uncertainty of Axial Isotropy Assessment: $\pm 0.5\%$ (k=2)

Receiving Pattern (ϕ), $\vartheta = 0^\circ$

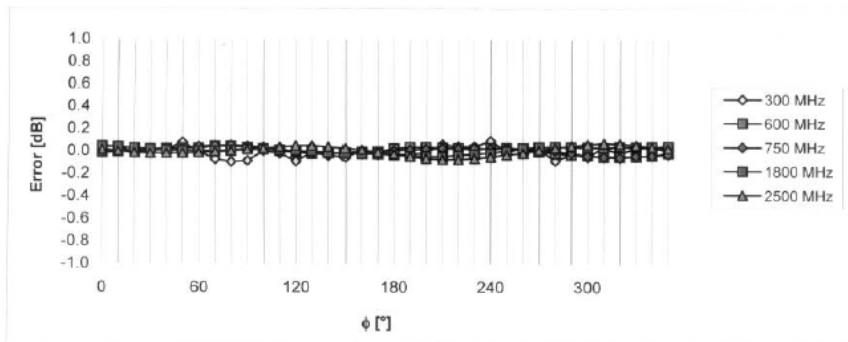

Uncertainty of Axial Isotropy Assessment: $\pm 0.5\%$ (k=2)



H3DV6 SN:6184

January 22, 2010

Dynamic Range f(H-field) (Waveguide R22, f = 1800 MHz)

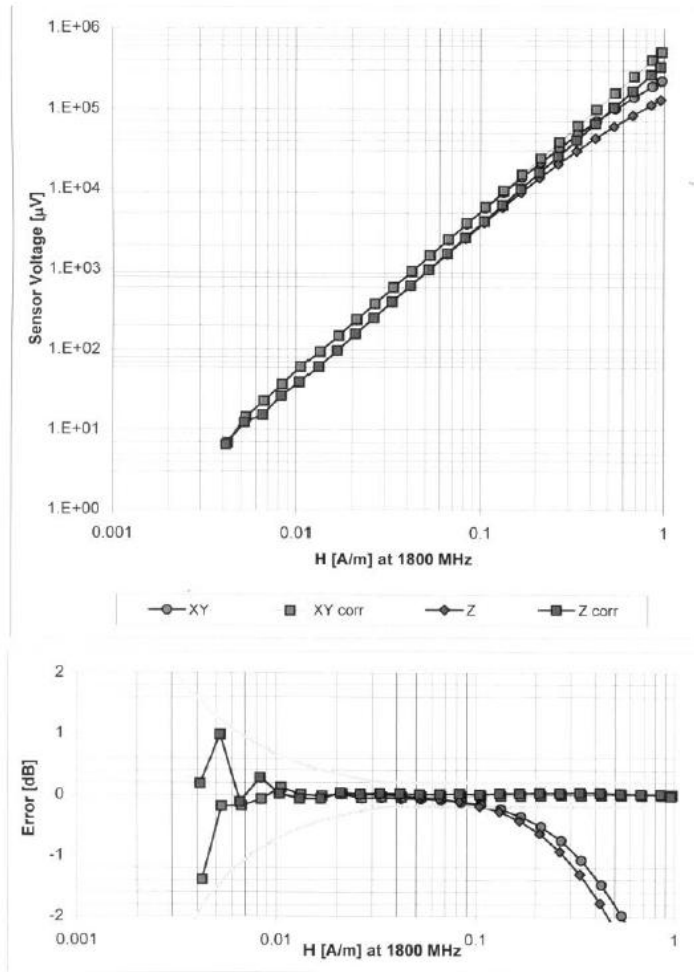

Uncertainty of Linearity Assessment: $\pm 0.6\%$ ($k=2$)



H3DV6 SN:6184

January 22, 2010

Deviation from Isotropy in Air
Error (ϕ, ϑ), $f = 900$ MHz

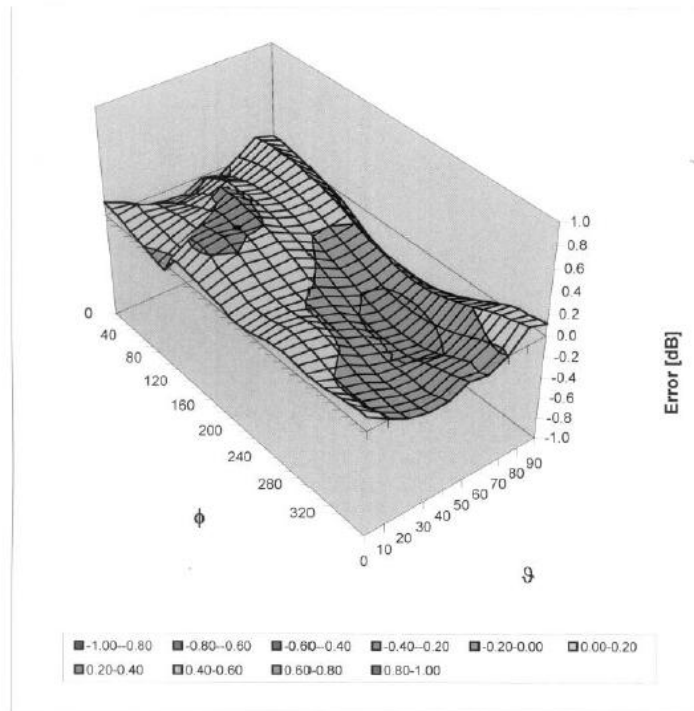

Uncertainty of Spherical Isotropy Assessment: $\pm 2.6\%$ ($k=2$)



H3DV6 SN:6184

January 22, 2010

Other Probe Parameters

Sensor Arrangement	Rectangular
Connector Angle (°)	-245.3
Mechanical Surface Detection Mode	enabled
Optical Surface Detection Mode	disabled
Probe Overall Length	337 mm
Probe Body Diameter	10 mm
Tip Length	20 mm
Tip Diameter	6.0 mm
Probe Tip to Sensor X Calibration Point	3 mm
Probe Tip to Sensor Y Calibration Point	3 mm
Probe Tip to Sensor Z Calibration Point	3 mm