

FCC RF Test Report

APPLICANT : HTC Corporation
EQUIPMENT : Windows Phone
MODEL NAME : PD26110
FCC ID : NM8PD26110
STANDARD : FCC Part 15 Subpart C §15.247
CLASSIFICATION : Digital Spread Spectrum (DSS)

The product was received on Jun. 23, 2010 and completely tested on Jul. 19, 2010. We, SPORTON INTERNATIONAL INC., would like to declare that the tested sample has been evaluated in accordance with the procedures given in ANSI C63.4-2003 and shown the compliance with the applicable technical standards.

The test results in this report apply exclusively to the tested model / sample. Without written approval of SPORTON INTERNATIONAL INC., the test report shall not be reproduced except in full.

Reviewed by:



Roy Wu / Manager



SPORTON INTERNATIONAL INC.

No. 52, Hwa Ya 1st Rd., Hwa Ya Technology Park, Kwei-Shan Hsiang, Tao Yuan Hsien, Taiwan, R.O.C.



TABLE OF CONTENTS

REVISION HISTORY..... 3

SUMMARY OF TEST RESULT 4

1 GENERAL DESCRIPTION..... 5

 1.1 Applicant 5

 1.2 Manufacturer..... 5

 1.3 Feature of Equipment Under Test 5

 1.4 Testing Site 6

 1.5 Applied Standards 6

 1.6 Ancillary Equipment List 6

2 TEST CONFIGURATION OF EQUIPMENT UNDER TEST..... 7

 2.1 RF Output Power 7

 2.2 Test Mode..... 8

 2.3 Connection Diagram of Test System..... 9

 2.4 RF Utility 10

3 TEST RESULT 11

 3.1 Number of Channel Measurement 11

 3.2 20dB Bandwidth Measurement 14

 3.3 Hopping Channel Separation Measurement 21

 3.4 Dwell Time Measurement..... 24

 3.5 Peak Output Power Measurement 26

 3.6 Band Edges Measurement 29

 3.7 Spurious Emission Measurement..... 34

 3.8 AC Conducted Emission Measurement..... 38

 3.9 Radiated Emission Measurement..... 42

 3.10 Antenna Requirements 53

4 LIST OF MEASURING EQUIPMENT..... 54

5 UNCERTAINTY OF EVALUATION..... 55

APPENDIX A. SETUP PHOTOGRAPHS



REVISION HISTORY

REPORT NO.	VERSION	DESCRIPTION	ISSUED DATE
FR062328-05B	Rev. 01	Initial issue of report	Sep. 17, 2010



SUMMARY OF TEST RESULT

Report Section	FCC Rule	IC Rule	Description	Limit	Result	Remark
3.1	15.247(a)(1)	A8.4(2)	Number of Channels	≥ 15 Chs	Pass	-
3.2	15.247(a)(1)	A8.1(a)	20dB Bandwidth	NA	Pass	-
3.3	15.247(a)(1)	A8.1(b)	Channel Separation	$\geq 2/3$ of 20dB BW	Pass	-
3.4	15.247(a)(1)	A8.1(d)	Dwell Time of Each Channel	≤ 0.4 sec in 31.6sec period	Pass	-
3.5	15.247(b)(1)	A8.1(b)	Peak Output Power	≤ 1 W	Pass	-
3.6	15.247(d)	A8.5	Frequency Band Edges	≤ 20 dBc	Pass	-
3.7	15.247(d)	A8.5	Spurious Emission	< 20 dBc	Pass	-
3.8	15.207	Gen 7.2.2	AC Conducted Emission	15.207(a)	Pass	Under limit 7.7 dB at 0.246 MHz
3.9	15.247(d)	A8.5	Transmitter Radiated Emission	15.209(a) & 15.247(d)	Pass	Under limit 4.08 dB at 2483.50 MHz
3.10	15.203 & 15.247(b)	A8.4	Antenna Requirement	N/A	Pass	-

1 General Description

1.1 Applicant

HTC Corporation

1F., No. 6-3, Baoqiang Rd., Xindian City, Taipei, Taiwan

1.2 Manufacturer

HTC Corporation

1F., No. 6-3, Baoqiang Rd., Xindian City, Taipei, Taiwan

1.3 Feature of Equipment Under Test

Product Feature & Specification	
Equipment	Windows Phone
Model Name	PD26110
FCC ID	NM8PD26110
EUT Configuration	Phone 1 : EUT with LCM-Main source Phone 2 : EUT with LCM-2 nd source
Tx/Rx Frequency Range	2400 MHz ~ 2483.5 MHz
Number of Channels	79
Carrier Frequency of Each Channel	2402+n*1 MHz; n=0~78
Channel Spacing	1 MHz
Maximum Output Power to Antenna	Bluetooth (1Mbps) : 4.31 dBm (0.003 W) Bluetooth EDR (2Mbps) : 6.96 dBm (0.005 W) Bluetooth EDR (3Mbps) : 4.80 dBm (0.003 W)
Antenna Type	PIFA Antenna with gain -0.5 dBi
Type of Antenna Connector	N/A
Type of Modulation	Bluetooth (1Mbps) : GFSK Bluetooth EDR (2Mbps) : $\pi/4$ -DQPSK Bluetooth EDR (3Mbps) : 8-DPSK
EUT Stage	Production Unit

Remark:

1. For other wireless features of this EUT, test report will be issued separately.
2. This test report recorded only product characteristics and test results of Digital Spread Spectrum (DSS).
3. The above EUT's information was declared by manufacturer. Please refer to the specifications or user's manual for more detailed description.

1.4 Testing Site

Test Site	SPORTON INTERNATIONAL INC.		
Test Site Location	No. 52, Hwa Ya 1 st Rd., Hwa Ya Technology Park, Kwei-Shan Hsiang, Tao Yuan Hsien, Taiwan, R.O.C. TEL: +886-3-3273456 / FAX: +886-3-3284978		
Test Site No.	Sporton Site No.		FCC/IC Registration No.
	CO05-HY	03CH07HY	TW1022/4086B-1

1.5 Applied Standards

According to the specifications of the manufacturer, the EUT must comply with the requirements of the following standards:

- ♦ FCC Part 15 Subpart C §15.247
- ♦ FCC Public Notice DA 00-705
- ♦ ANSI C63.4-2003
- ♦ IC RSS-210 Issue 7

Remark:

1. All test items were verified and recorded according to the standards and without any deviation during the test.
2. This EUT has also been tested and complied with the requirements of FCC Part 15, Subpart B (DoC), recorded in a separate test report.

1.6 Ancillary Equipment List

Item	Equipment	Trade Name	Model Name	FCC ID	Data Cable	Power Cord
1.	System Simulator	R&S	CMU 200	N/A	N/A	Unshielded, 1.8 m
2.	Bluetooth Base Station	R&S	CBT32	N/A	N/A	Unshielded, 1.8 m
3.	Earphone	Merry	RC E160	N/A	N/A	Unshielded, 1.3m
4.	GPS Station	T&E	GS-50	N/A	N/A	Unshielded, 1.8 m
5.	WLAN AP	D-Link	DIR-628	KA2DIR628A2	N/A	Unshielded, 1.8 m
6.	Notebook	DELL	Vostro 1510	FCC DoC	N/A	AC I/P: Unshielded, 1.2 m DC O/P: Shielded, 1.8 m
7.	Bluetooth Earphone	Nokia	BH-102	PYAHS-107W	N/A	N/A

2 Test Configuration of Equipment Under Test

2.1 RF Output Power

Preliminary tests were performed in different data rate and recorded the RF output power in the following table:

Channel	Frequency	Bluetooth RF Output Power		
		Data Rate / Modulation		
		GFSK	π /4-DQPSK	8-DPSK
		1Mbps	2Mbps	3Mbps
Ch00	2402MHz	3.19 dBm	5.87 dBm	3.72 dBm
Ch39	2441MHz	4.09 dBm	6.73 dBm	4.59 dBm
Ch78	2480MHz	4.31 dBm	6.96 dBm	4.80 dBm

Remark:

1. The data rate was set in 2Mbps for all the test items due to the highest RF output power.
2. The EUT is programmed to transmit signals continuously for all testing.

2.2 Test Mode

The EUT has been associated with peripherals pursuant to ANSI C63.4-2003 and configuration operated in a manner tended to maximize its emission characteristics in a typical application. Frequency range investigated: conduction (150 kHz to 30 MHz), radiation (9 kHz to the 10th harmonic of the highest fundamental frequency or to 40 GHz, whichever is lower).

Pre-scanned tests, X, Y, Z in three orthogonal panels, were conducted to determine the final configuration from all possible combinations.

The following tables are showing the test modes as the worst cases and recorded in this report.

Test Cases			
Test Item	Data Rate / Modulation		
	Bluetooth 1Mbps GFSK	Bluetooth EDR 2Mbps π /4-DQPSK	Bluetooth EDR 3Mbps 8-DPSK
Conducted TCs	Mode 1: CH00_2402 MHz Mode 2: CH39_2441 MHz Mode 3: CH78_2480 MHz	Mode 4: CH00_2402 MHz Mode 5: CH39_2441 MHz Mode 6: CH78_2480 MHz	Mode 7: CH00_2402 MHz Mode 8: CH39_2441 MHz Mode 9: CH78_2480 MHz
Radiated TCs	N/A	Mode 1: CH00_2402 MHz for Phone 1 Mode 2: CH39_2441 MHz for Phone 1 Mode 3: CH78_2480 MHz for Phone 1 Mode 3: CH78_2480 MHz for Phone 2	N/A
AC Conducted Emission	Mode 1 :Phone 1 for GSM850 Idle + Bluetooth Link + WLAN Link + GPS Rx + Earphone + Battery 1 + USB Cable 2 (Charging from Adapter 1) Mode 2 :Phone 1 for WCDMA Band II Idle + Bluetooth Link + WLAN Link + GPS Rx + Earphone + Battery 2 + USB Cable 2 (Charging from Adapter 2) Mode 3 Phone 2 for WCDMA Band II Idle + Bluetooth Link + WLAN Link + GPS Rx + Earphone + Battery 2 + USB Cable 2 (Charging from Adapter 2)		
Remark:			
<ol style="list-style-type: none"> For radiated TCs, the data rate was set in 2Mbps due to the highest RF output power; only the data of these modes was reported. For conducted emission, the worst case is mode 2 only the test data of this mode was reported. Adapter 2, USB Cable 3 and Battery 2 were the configuration for the radiation test. 			

2.3 Connection Diagram of Test System

<Bluetooth Tx Mode>

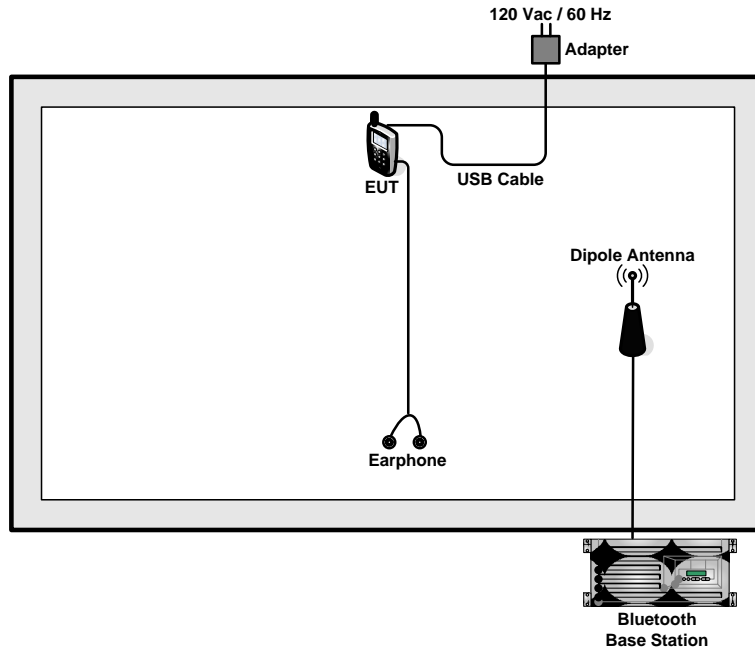

<EUT with Adapter Mode>

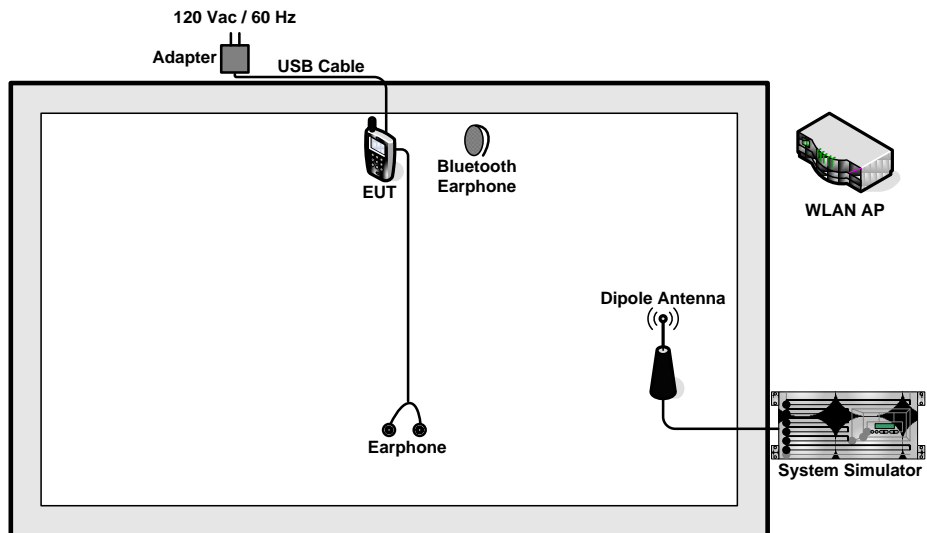

<EUT with Adapter Mode (with GPS Station)>

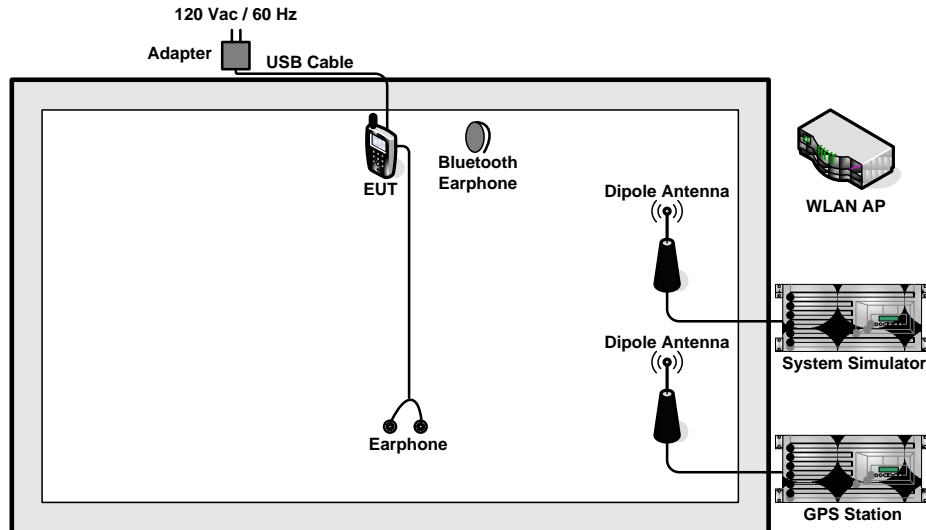

2.4 RF Utility

For Bluetooth function, the RF utility, "Remote 432X controller" was installed in EUT which was programmed in order to make the EUT into the engineering modes to contact with Bluetooth base station for transmitting and receiving signals continuously.

3 Test Result

3.1 Number of Channel Measurement

3.1.1 Limits of Number of Hopping Frequency

Frequency hopping systems in the 2400-2483.5 MHz band shall use at least 15 channels.

3.1.2 Measuring Instruments

See list of measuring instruments of this test report.

3.1.3 Test Procedure

1. The testing follows FCC Public Notice DA 00-705 Measurement Guidelines.
2. The RF output of EUT was connected to the spectrum analyzer by a low loss cable.
3. The modulation types of EUT are irrelevant to number of hopping channels deviation.
4. The EUT must have its hopping function enabled. Use the following spectrum analyzer settings:
Span = the frequency band of operation; $RBW \geq 1\%$ of the span; $VBW \geq RBW$; Sweep = auto;
Detector function = peak; Trace = max hold.
5. The number of hopping frequency used is defined as the device has the numbers of total channel.

3.1.4 Test Setup

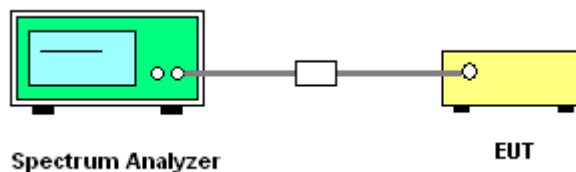



3.1.5 Test Result of Number of Hopping Frequency

Test Mode :	Mode 4~6	Temperature :	27~29°C
Test Engineer :	Lancelot Chen	Relative Humidity :	40~43%
Number of Hopping Channels (Channel)		Limits (Channel)	
79		> 15	
		Pass/Fail	
		Pass	

Number of Hopping Channel Plot on Channel 00 - 78

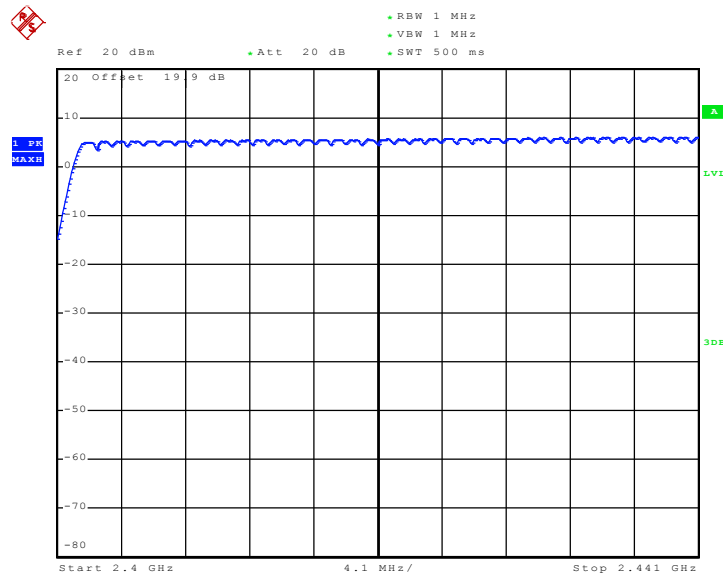

Date: 14.JUL.2010 23:01:32

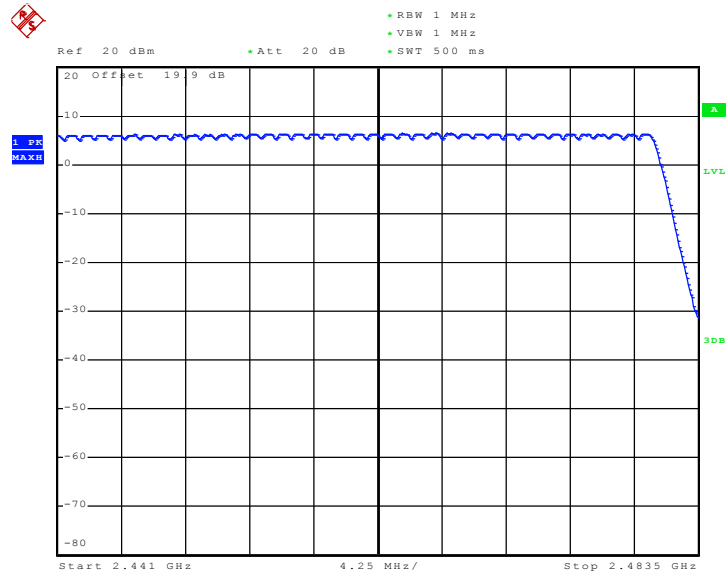

Date: 14.JUL.2010 22:56:26

3.2 20dB Bandwidth Measurement

3.2.1 Limit of 20dB Bandwidth

N/A

3.2.2 Measuring Instruments

See list of measuring instruments of this test report.

3.2.3 Test Procedures

1. The testing follows FCC Public Notice DA 00-705 Measurement Guidelines.
2. The RF output of EUT was connected to the spectrum analyzer by a low loss cable.
3. The EUT should be transmitting at its maximum data rate as the worst cases.
4. Use the following spectrum analyzer settings:
Span = approximately 2 to 3 times the 20 dB bandwidth, centered on a hopping channel;
RBW \geq 1% of the 20 dB bandwidth; VBW \geq RBW; Sweep = auto; Detector function = peak;
Trace = max hold.
5. The marker-delta reading at this point is the 20 dB bandwidth of the emission.

3.2.4 Test Setup

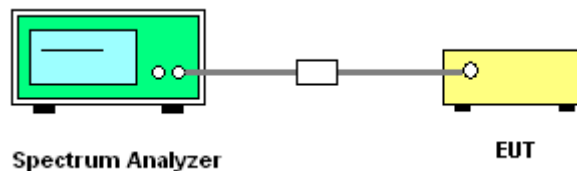



3.2.5 Test Result of 20dB Bandwidth

Test Mode :	Mode 1, 2, 3	Temperature :	27~29°C
Test Engineer :	Lancelot Chen	Relative Humidity :	40~43%

Channel	Frequency (MHz)	20dB Bandwidth (MHz)
00	2402	1.004
39	2441	1.012
78	2480	1.016

20 dB Bandwidth Plot on Channel 00

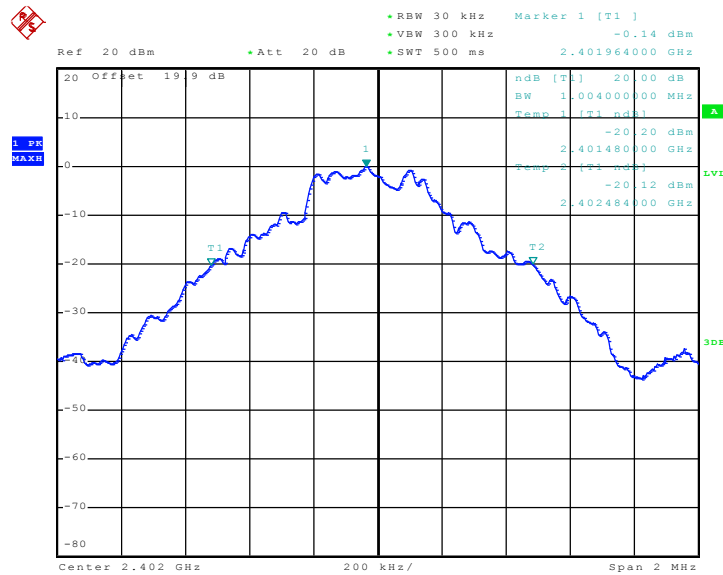

Date: 14.JUL.2010 23:11:06



20 dB Bandwidth Plot on Channel 39

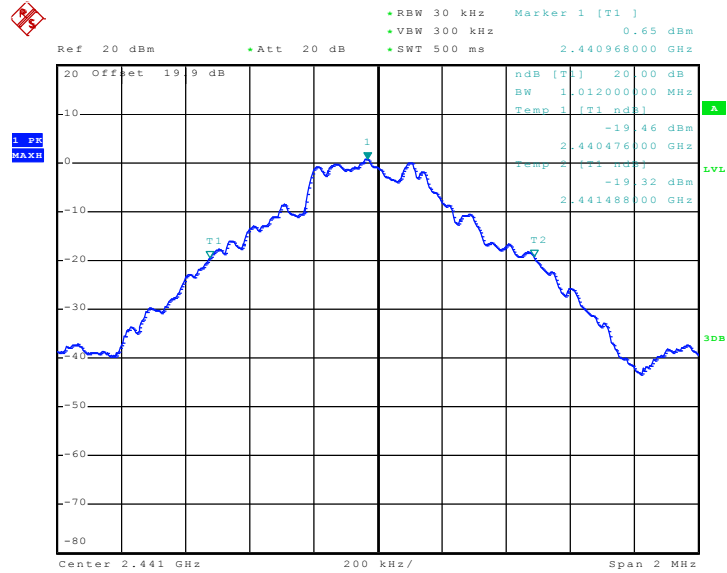

Date: 14.JUL.2010 23:13:20

20 dB Bandwidth Plot on Channel 78

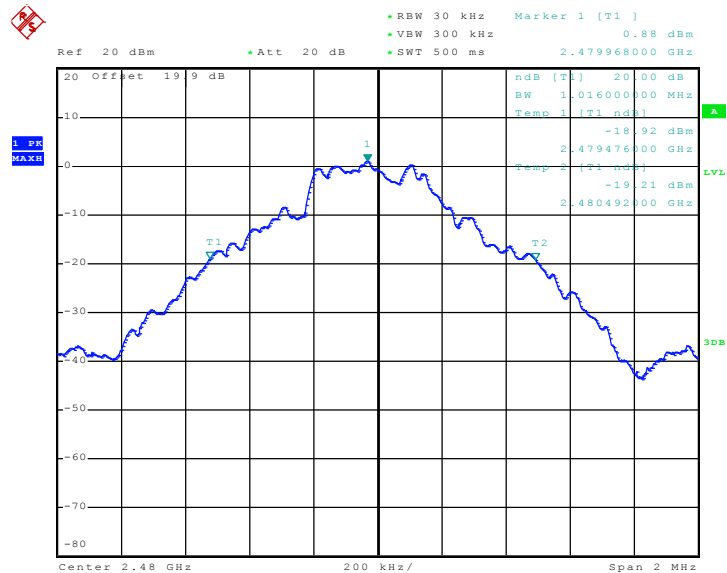

Date: 14.JUL.2010 23:14:37



Test Mode :	Mode 4, 5, 6	Temperature :	27~29°C
Test Engineer :	Lancelot Chen	Relative Humidity :	40~43%

Channel	Frequency (MHz)	20dB Bandwidth (MHz)
00	2402	1.332
39	2441	1.338
78	2480	1.332

20 dB Bandwidth Plot on Channel 00

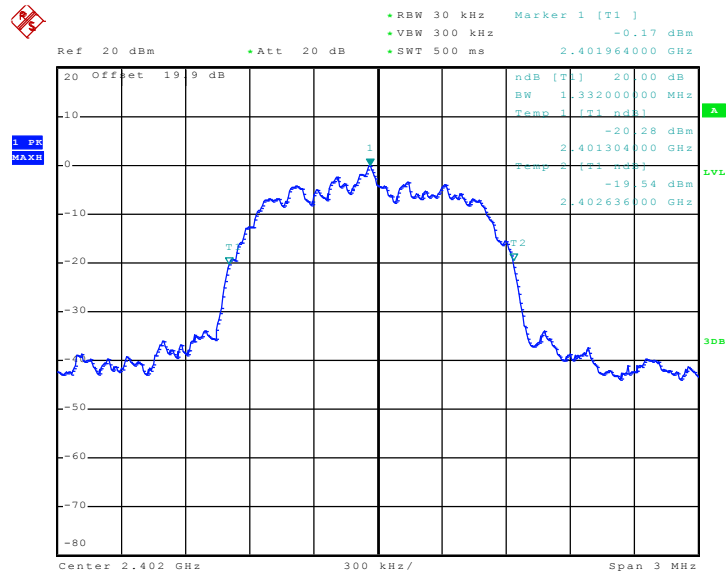

Date: 14.JUL.2010 21:44:18



20 dB Bandwidth Plot on Channel 39

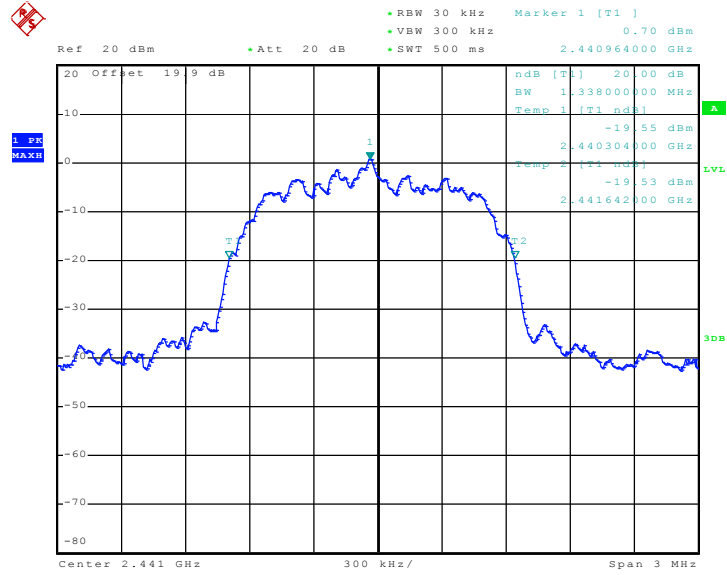

Date: 14.JUL.2010 21:43:57

20 dB Bandwidth Plot on Channel 78

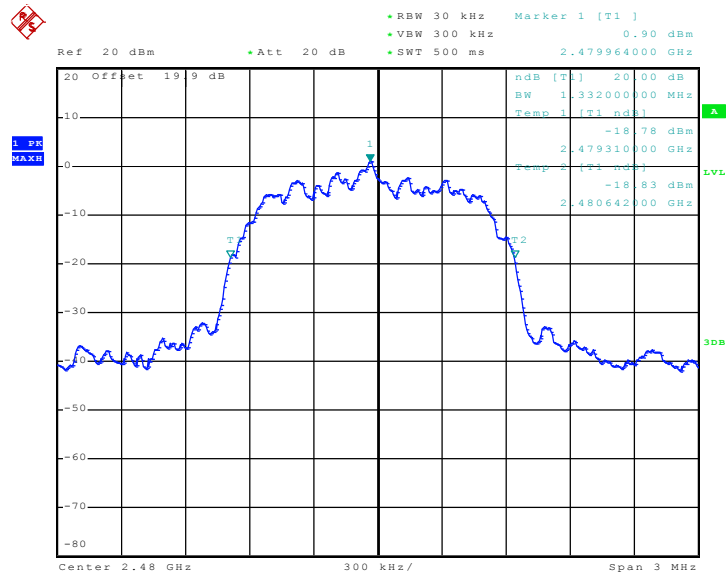

Date: 14.JUL.2010 21:43:32



Test Mode :	Mode 7, 8, 9	Temperature :	27~29°C
Test Engineer :	Lancelot Chen	Relative Humidity :	40~43%

Channel	Frequency (MHz)	20dB Bandwidth (MHz)
00	2402	1.308
39	2441	1.308
78	2480	1.308

20 dB Bandwidth Plot on Channel 00

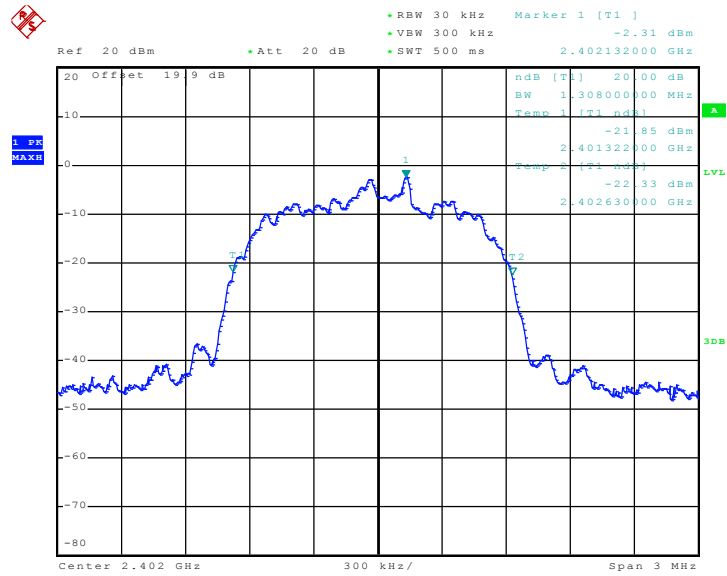

Date: 14.JUL.2010 21:45:48



20 dB Bandwidth Plot on Channel 39

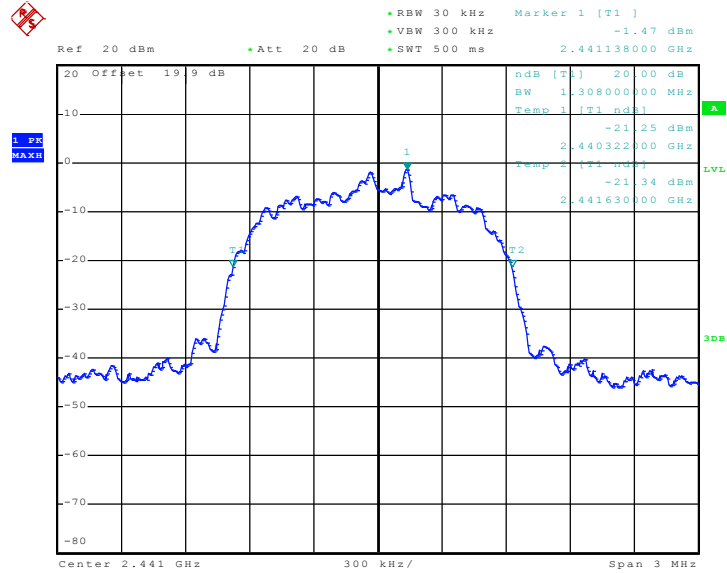

Date: 14.JUL.2010 21:45:24

20 dB Bandwidth Plot on Channel 78

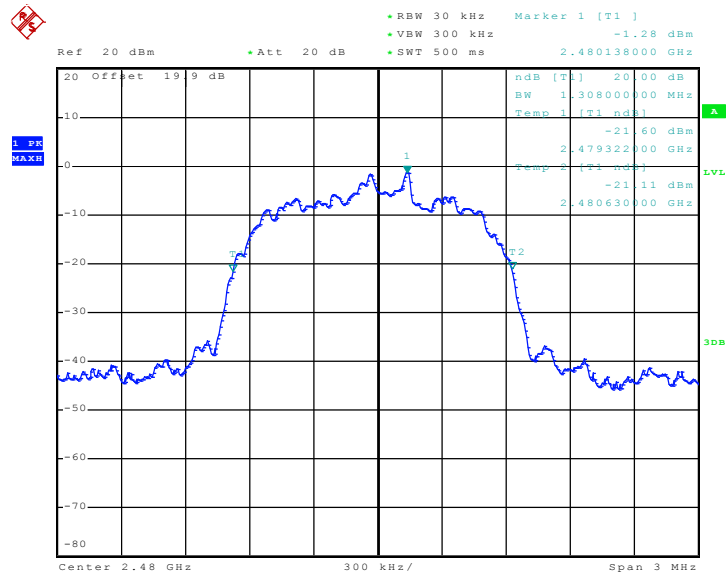

Date: 14.JUL.2010 21:46:10

3.3 Hopping Channel Separation Measurement

3.3.1 Limit of Hopping Channel Separation

Frequency hopping systems operating in the 2400-2483.5 MHz band may have hopping channel carrier frequencies that are separated by 25 kHz or two-thirds of the 20 dB bandwidth of the hopping channel, whichever is greater.

3.3.2 Measuring Instruments

See list of measuring instruments of this test report.

3.3.3 Test Procedures

1. Please refer FCC Public Notice DA 00-705 Measurement Guidelines.
2. The RF output of EUT was connected to the spectrum analyzer by a low loss cable.
3. The EUT should be transmitting at its maximum data rate as the worst cases.
4. Use the following spectrum analyzer settings:
Span = wide enough to capture the peaks of two adjacent channels; $RBW \geq 1\%$ of the span;
VBW \geq RBW; Sweep = auto; Detector function = peak; Trace = max hold.
5. Use the marker-delta function to determine the separation between the peaks of the adjacent channels.

3.3.4 Test Setup

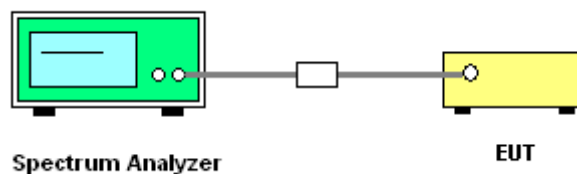



3.3.5 Test Result of Hopping Channel Separation

Test Mode :	Mode 4, 5, 6	Temperature :	27~29°C
Test Engineer :	Lancelot Chen	Relative Humidity :	40~43%

Channel	Frequency (MHz)	Frequency Separation (MHz)	(2/3 of 20dB BW) Limits (MHz)	Pass/Fail
00	2402	1.002	0.888	Pass
39	2441	1.002	0.892	Pass
78	2480	1.002	0.888	Pass

Channel Separation Plot on Channel 00 - 01

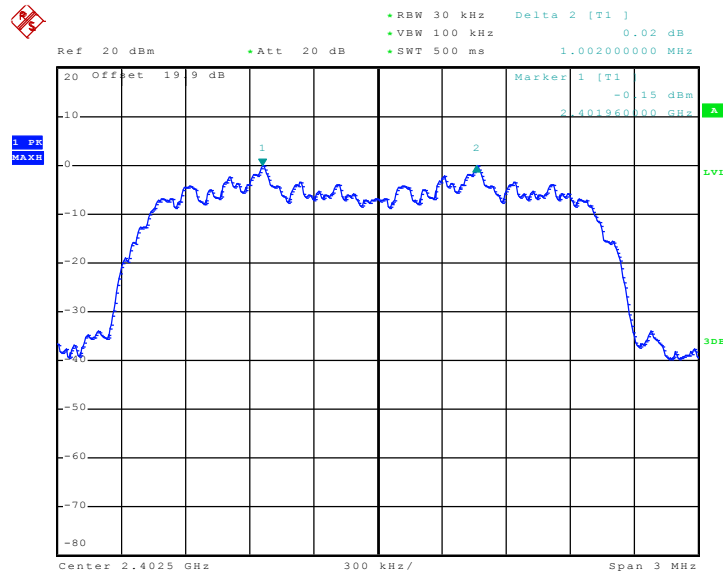

Date: 14.JUL.2010 22:10:46



Channel Separation Plot on Channel 39 - 40

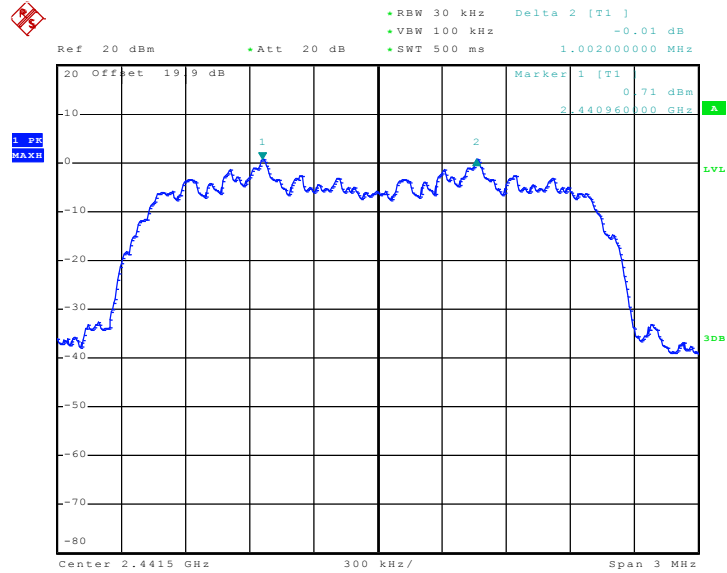

Date: 14.JUL.2010 22:09:09

Channel Separation Plot on Channel 77 - 78

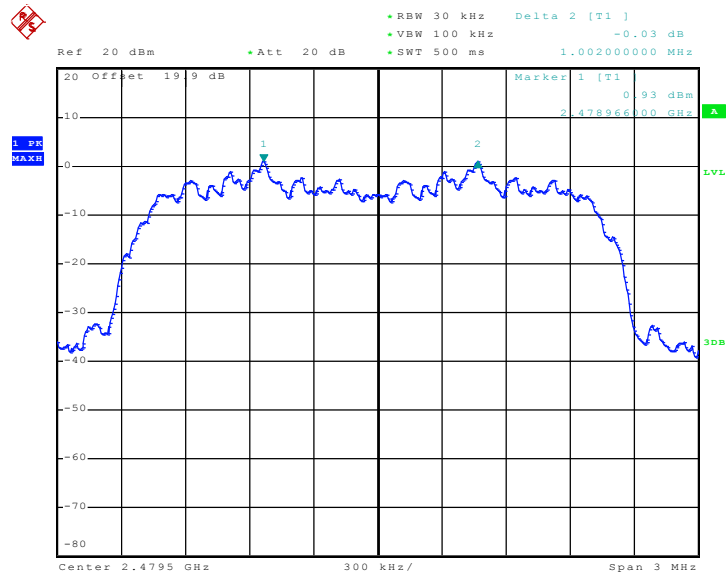

Date: 14.JUL.2010 22:08:17

3.4 Dwell Time Measurement

3.4.1 Limit of Dwell Time

The average time of occupancy on any channel shall not be greater than 0.4 seconds within a period of 0.4 seconds multiplied by the number of hopping channels employed.

3.4.2 Measuring Instruments

See list of measuring instruments of this test report.

3.4.3 Test Procedures

1. The testing follows FCC Public Notice DA 00-705 Measurement Guidelines.
2. The RF output of EUT was connected to the spectrum analyzer by a low loss cable.
3. The EUT should be transmitting at its maximum data rate as the worst cases.
4. The EUT must have its hopping function enabled. Use the following spectrum analyzer settings:
Span = zero span, centered on a hopping channel; RBW = 1 MHz; VBW ≥ RBW; Sweep = as necessary to capture the entire dwell time per hopping channel; Detector function = peak; Trace = max hold.
5. Use the marker-delta function to calculate the dwell time.

3.4.4 Test Setup

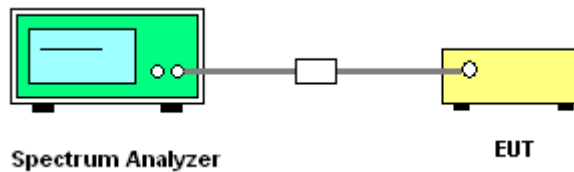

3.4.5 Test Result of Dwell Time

Test Mode :	Mode 5	Temperature :	27~29°C
Test Engineer :	Lancelot Chen	Relative Humidity :	40~43%

Package Mode	Average Hopping Channel	Package Transfer Time (usec)	Dwell Time (sec)	Limits (sec)	Pass/Fail
2DH5	3.30	2948.00	0.31	0.4	Pass

Remark:

1. Dwell Time=79(channels) x 0.4(s) x average hopping channel x package transfer time
2. 79 channels come from the Hopping Channel number.
3. Average Hopping Channel = hops/sweep time
4. t: Package Transfer Time(us)



2DH5 Dwell Time (One Pulse) Plot on Channel 39

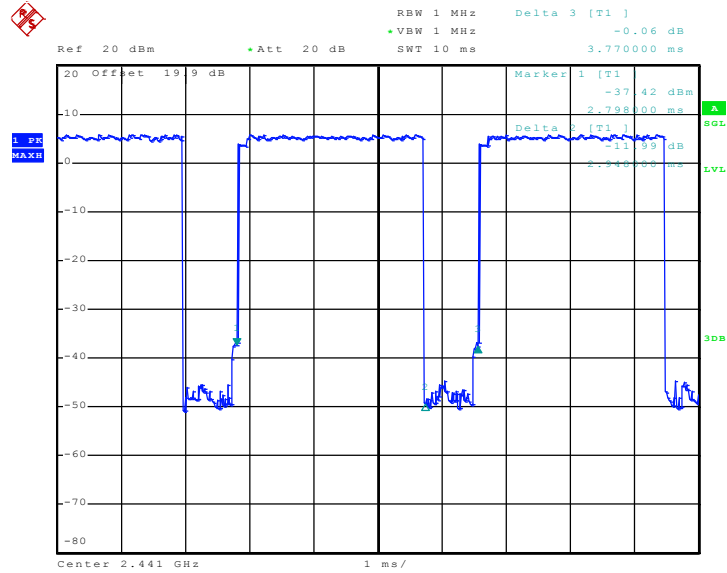

Date: 14.JUL.2010 22:30:44

2DH5 Dwell Time (Count Pulses) Plot on Channel 39

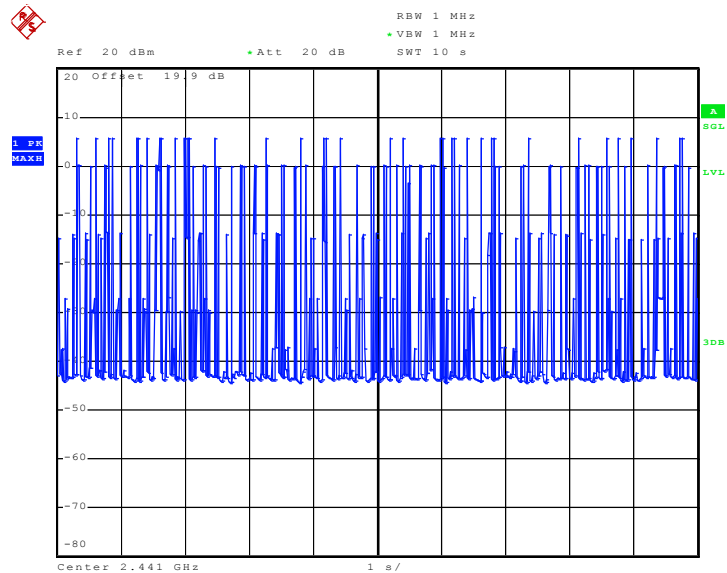

Date: 14.JUL.2010 22:39:43

3.5 Peak Output Power Measurement

3.5.1 Limit of Peak Output Power

Frequency hopping systems operating in the 2400-2483.5 MHz band employing at least 75 non-overlapping hopping channels: 1W (30 dBm).

3.5.2 Measuring Instruments

See list of measuring instruments of this test report.

3.5.3 Test Procedures

1. The testing follows FCC Public Notice DA 00-705 Measurement Guidelines.
2. The RF output of EUT was connected to the spectrum analyzer by a low loss cable.

3.5.4 Test Setup

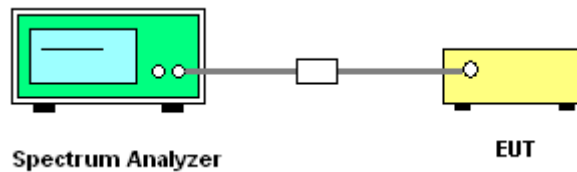

3.5.5 Test Result of Peak Output Power

Test Mode :	Mode 4, 5, 6	Temperature :	27~29°C
Test Engineer :	Lancelot Chen	Relative Humidity :	40~43%

Channel	Frequency (MHz)	RF Power (dBm)		
		π /4-DQPSK	Max. Limits (dBm)	Pass/Fail
		2 Mbps		
00	2402	5.87	30	Pass
39	2441	6.73	30	Pass
78	2480	6.96	30	Pass



Peak Output Power Plot on Channel 00

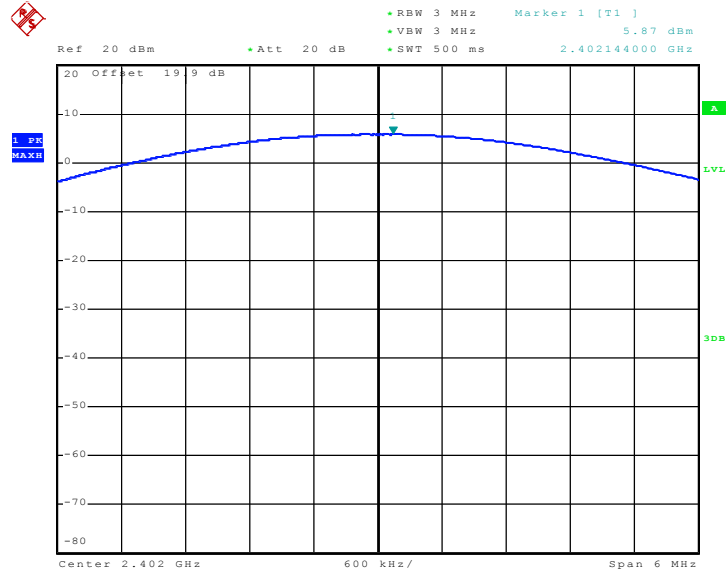

Date: 14.JUL.2010 21:21:43

Peak Output Power Plot on Channel 39

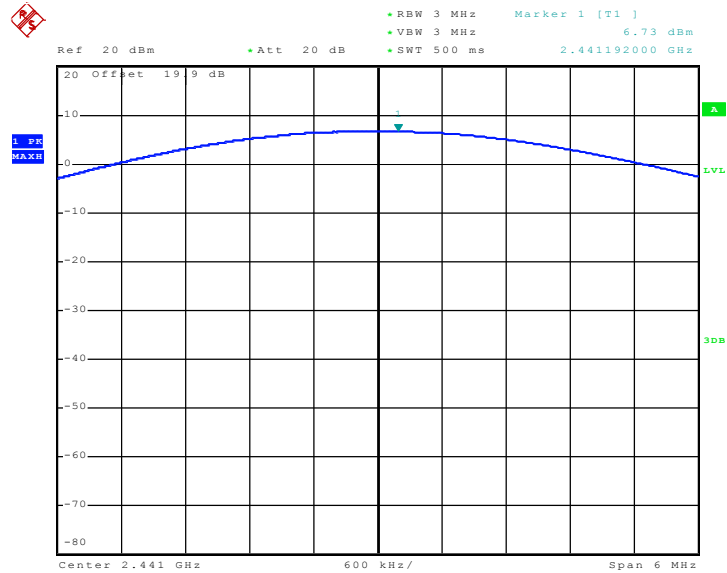

Date: 14.JUL.2010 21:22:11



Peak Output Power Plot on Channel 78

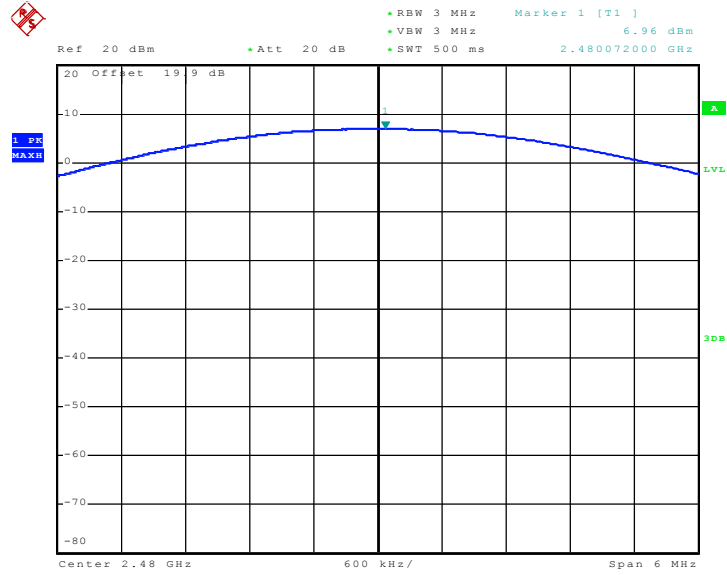

Date: 14.JUL.2010 21:19:05



3.6 Band Edges Measurement

3.6.1 Limit of Band Edges

In any 100 kHz bandwidth outside the intentional radiation frequency band, the radio frequency power shall be at least 20 dB below the highest level of the radiated power. In addition, radiated emissions which fall in the restricted bands must also comply with the radiated emission limits.

3.6.2 Measuring Instruments

See list of measuring instruments of this test report.

3.6.3 Test Procedures

1. The testing follows the guidelines in ANSI C63.4-2003 and FCC Public Notice DA 00-705 Measurement Guidelines.
2. RF antenna conducted test: Set RBW = 300kHz, Video bandwidth (VBW) \geq RBW. Band edge emissions must be at least 20 dB down from the highest emission level within the authorized band as measured with a 300k Hz RBW. Note: If the device complies with the use of power option 2 the attenuation under this paragraph shall be 30 dB instead of 20 dB.
3. Radiated emission test: Applies to band edge emissions that fall in the restricted bands listed in FCC Section 15.205. The maximum permitted average field strength is listed in FCC Section 15.209. A pre-amp is necessary for this measurement. For measurements above 1 GHz, set RBW = 1MHz, VBW = 1MHz, Sweep: Auto for Peak; set RBW = 1MHz, VBW = 10 Hz, Sweep: Auto for Average. If the emission is pulsed, modify the unit for continuous operation; use the settings shown above, then correct the reading by subtracting the peak-average correction factor, derived from the appropriate duty cycle calculation. See FCC Section 15.35(b) and (c).
4. In case the emission is fail due to the used RBW / VBW is too wide, marker-delta method of FCC Public Notice DA 00-705 will be followed.

3.6.4 Test Setup

<Radiated Band Edges>

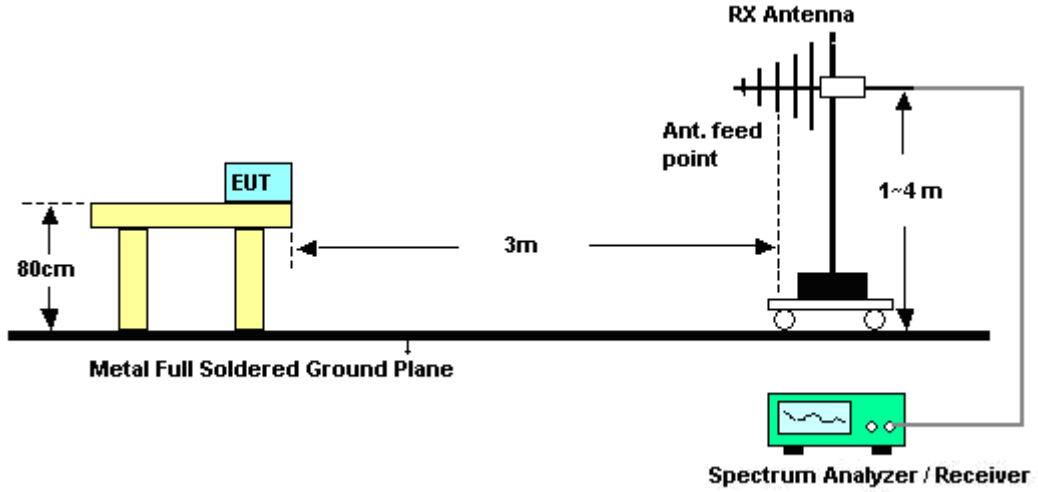

<Conducted Band Edges>

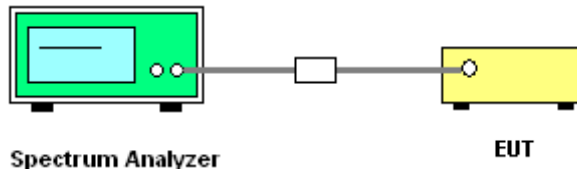



3.6.5 Test Result of Radiated Band Edges

Test Mode :	Mode 1	Temperature :	25~26°C
Test Channel :	00	Relative Humidity :	48~51%
		Test Engineer :	Cona Huang

ANTENNA POLARITY : HORIZONTAL										
Frequency (MHz)	Level (dBuV/m)	Over Limit (dB)	Limit Line (dBuV/m)	Read Level (dBuV)	Antenna Factor (dB)	Cable Loss (dB)	Preamp Factor (dB)	Ant Pos (cm)	Table Pos (deg)	Remark
2388.66	48.17	-25.83	74	43.83	32.13	5.46	33.25	101	19	Peak
2388.66	35.44	-18.56	54	31.1	32.13	5.46	33.25	101	19	Average

ANTENNA POLARITY : VERTICAL										
Frequency (MHz)	Level (dBuV/m)	Over Limit (dB)	Limit Line (dBuV/m)	Read Level (dBuV)	Antenna Factor (dB)	Cable Loss (dB)	Preamp Factor (dB)	Ant Pos (cm)	Table Pos (deg)	Remark
2388.09	47.14	-26.86	74	42.8	32.13	5.46	33.25	100	56	Peak
2388.09	34.79	-19.21	54	30.45	32.13	5.46	33.25	100	56	Average

Test Mode :	Mode 3	Temperature :	25~26°C
Test Channel :	78	Relative Humidity :	48~51%
		Test Engineer :	Cona Huang

ANTENNA POLARITY : HORIZONTAL										
Frequency (MHz)	Level (dBuV/m)	Over Limit (dB)	Limit Line (dBuV/m)	Read Level (dBuV)	Antenna Factor (dB)	Cable Loss (dB)	Preamp Factor (dB)	Ant Pos (cm)	Table Pos (deg)	Remark
2483.5	60.48	-13.52	74	56.04	32.27	5.38	33.21	100	12	Peak
2483.5	48.27	-5.73	54	43.83	32.27	5.38	33.21	100	12	Average

ANTENNA POLARITY : VERTICAL										
Frequency (MHz)	Level (dBuV/m)	Over Limit (dB)	Limit Line (dBuV/m)	Read Level (dBuV)	Antenna Factor (dB)	Cable Loss (dB)	Preamp Factor (dB)	Ant Pos (cm)	Table Pos (deg)	Remark
2483.5	55.62	-18.38	74	51.18	32.27	5.38	33.21	131	38	Peak
2483.5	44.32	-9.68	54	39.88	32.27	5.38	33.21	131	38	Average



Test Mode :	Mode 4	Temperature :	25~26°C
Test Channel :	78	Relative Humidity :	48~51%
		Test Engineer :	Cona Huang

ANTENNA POLARITY : HORIZONTAL										
Frequency (MHz)	Level (dBuV/m)	Over Limit (dB)	Limit Line (dBuV/m)	Read Level (dBuV)	Antenna Factor (dB)	Cable Loss (dB)	Preamp Factor (dB)	Ant Pos (cm)	Table Pos (deg)	Remark
2483.5	61.17	-12.83	74	56.73	32.27	5.38	33.21	100	350	Peak
2483.5	49.92	-4.08	54	45.48	32.27	5.38	33.21	100	350	Average

ANTENNA POLARITY : VERTICAL										
Frequency (MHz)	Level (dBuV/m)	Over Limit (dB)	Limit Line (dBuV/m)	Read Level (dBuV)	Antenna Factor (dB)	Cable Loss (dB)	Preamp Factor (dB)	Ant Pos (cm)	Table Pos (deg)	Remark
2483.5	58.39	-15.61	74	53.95	32.27	5.38	33.21	100	7	Peak
2483.5	48.09	-5.91	54	43.65	32.27	5.38	33.21	100	7	Average



3.6.6 Test Result of Conducted Band Edges

Test Mode :	Mode 4 and 6	Temperature :	27~29°C
Test Channel :	00 and 78	Relative Humidity :	40~43%
		Test Engineer :	Lancelot Chen

Low Band Edge Plot on Channel 00

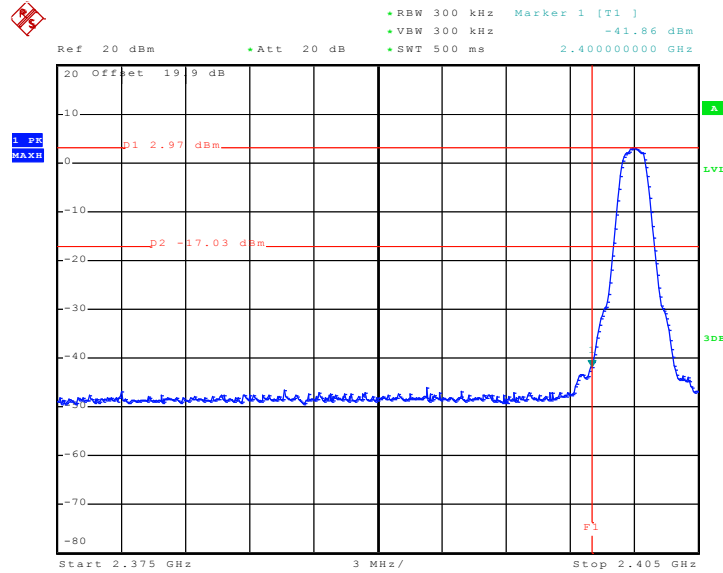

Date: 14.JUL.2010 22:22:11

High Band Edge Plot on Channel 78

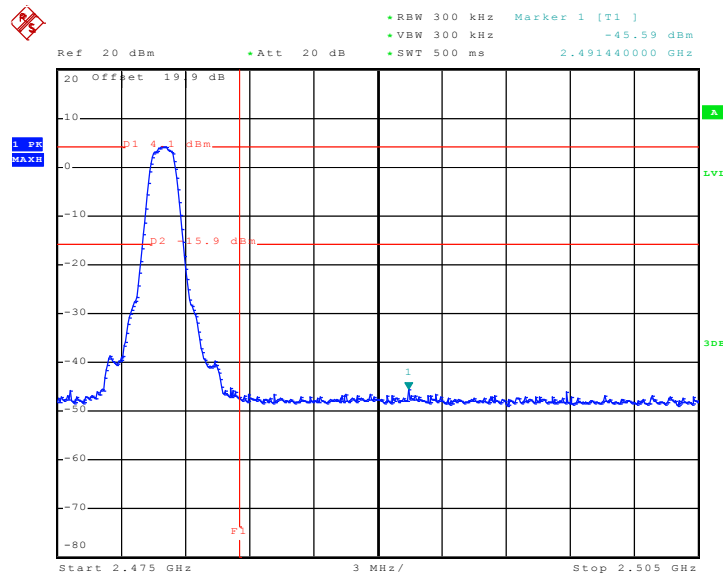

Date: 14.JUL.2010 22:17:12

3.7 Spurious Emission Measurement

3.7.1 Limit of Spurious Emission Measurement

All harmonics/spurs must be at least 20 dB down from the highest emission level within the authorized band.

3.7.2 Measuring Instruments

See list of measuring instruments of this test report.

3.7.3 Test Procedure

1. The transmitter output was connected to the spectrum analyzer via a low lose cable.
2. Set RBW = 100 kHz, Video bandwidth (VBW) \geq RBW, scan up through 10th harmonic. All harmonics / spurs must be at least 20 dB down from the highest emission level within the authorized band as measured with a 100 kHz RBW.

3.7.4 Test Setup

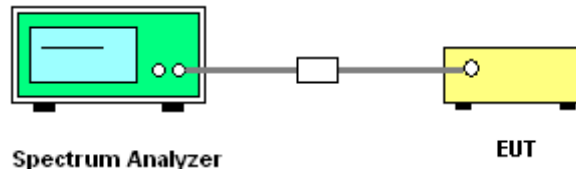

3.7.5 Test Result

Test Mode :	Mode 4	Temperature :	27~29°C
Test Channel :	00	Relative Humidity :	40~43%
		Test Engineer :	Lancelot Chen

Conducted Spurious Emission Plot between 9 kHz ~ 3 GHz

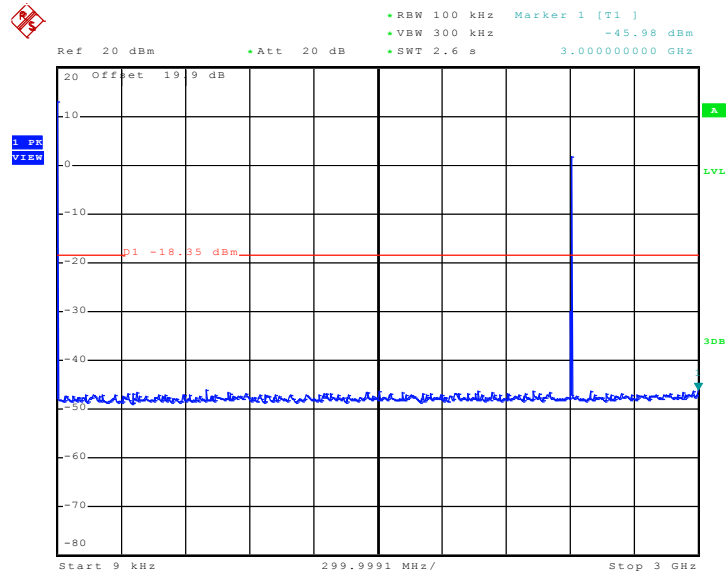

Date: 14.JUL.2010 23:18:16

Conducted Spurious Emission Plot between 1 GHz ~ 25 GHz

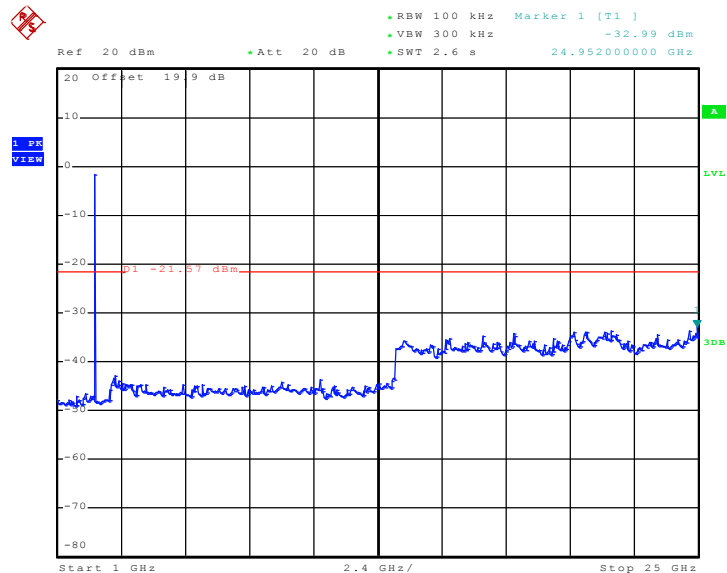

Date: 14.JUL.2010 23:18:51



Test Mode :	Mode 5	Temperature :	27~29°C
Test Channel :	39	Relative Humidity :	40~43%
		Test Engineer :	Lancelot Chen

Conducted Spurious Emission Plot between 9 kHz ~ 3 GHz

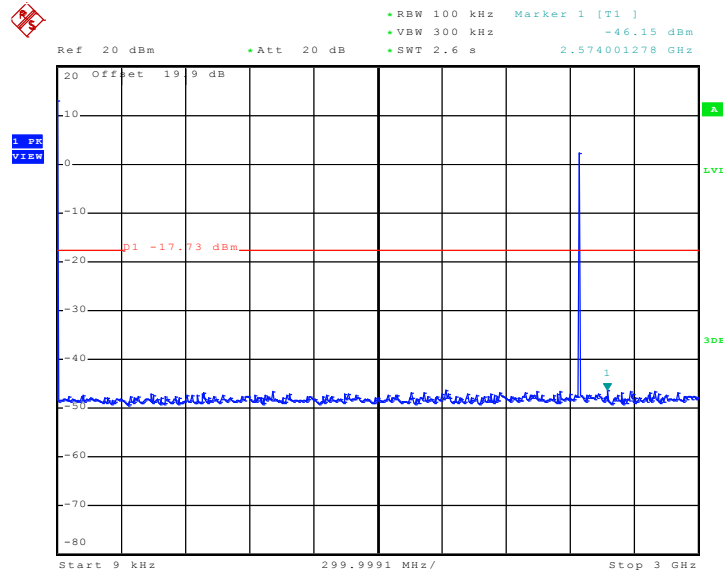

Date: 14.JUL.2010 23:19:22

Conducted Spurious Emission Plot between 1 GHz ~ 25 GHz

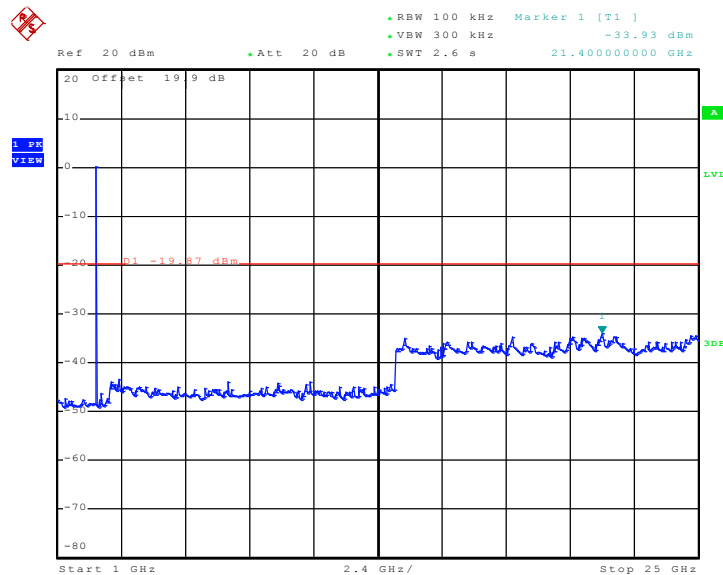

Date: 14.JUL.2010 23:19:46



Test Mode :	Mode 6	Temperature :	27~29°C
Test Channel :	78	Relative Humidity :	40~43%
		Test Engineer :	Lancelot Chen

Conducted Spurious Emission Plot between 9 kHz ~ 3 GHz

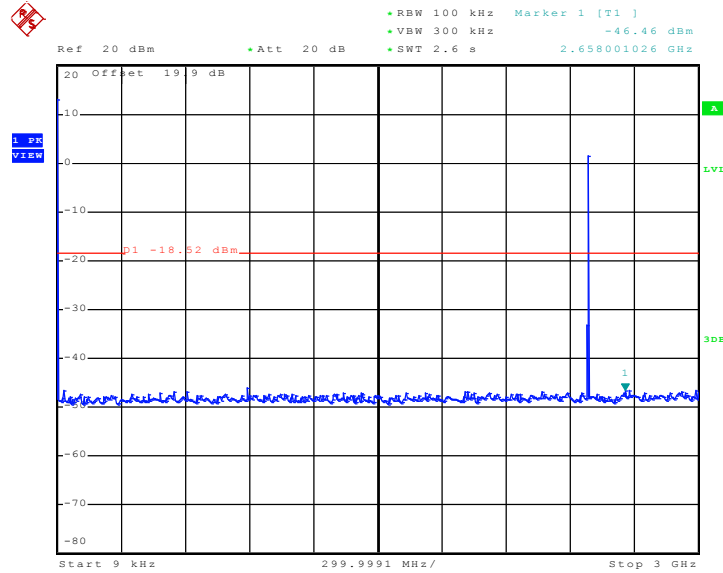

Date: 14.JUL.2010 23:20:15

Conducted Spurious Emission Plot between 1 GHz ~ 25 GHz

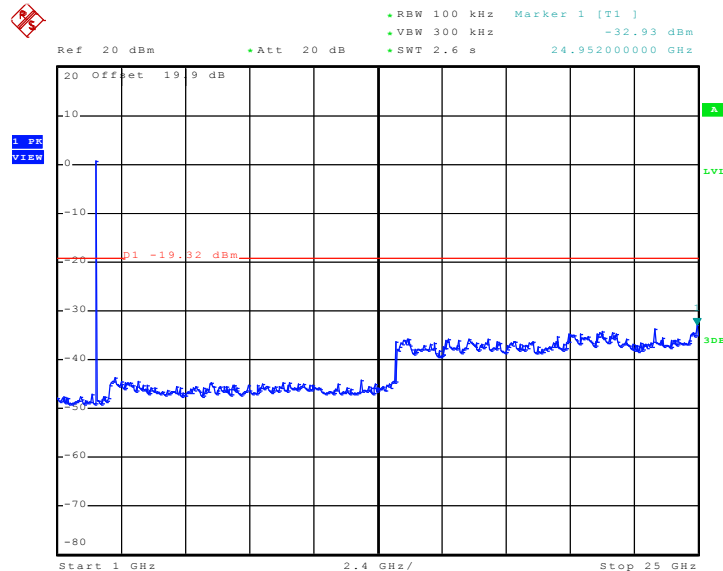

Date: 14.JUL.2010 23:20:38

3.8 AC Conducted Emission Measurement

3.8.1 Limit of AC Conducted Emission

For equipment that is designed to be connected to the public utility (AC) power line, the radio frequency voltage that is conducted back onto the AC power line on any frequency or frequencies within the band 150 kHz to 30 MHz shall not exceed the limits in the following table.

Frequency of emission (MHz)	Conducted limit (dBuV)	
	Quasi-peak	Average
0.15-0.5	66 to 56*	56 to 46*
0.5-5	56	46
5-30	60	50

*Decreases with the logarithm of the frequency.

3.8.2 Measuring Instruments

See list of measuring instruments of this test report.

3.8.3 Test Procedures

1. Please follow the guidelines in ANSI C63.4-2003.
2. The EUT was placed 0.4 meter from the conducting wall of the shielding room was kept at least 80 centimeters from any other grounded conducting surface.
3. Connect EUT to the power mains through a line impedance stabilization network (LISN).
4. All the support units are connecting to the other LISN.
5. The LISN provides 50 ohm coupling impedance for the measuring instrument.
6. The FCC states that a 50 ohm, 50 microhenry LISN should be used.
7. Both sides of AC line were checked for maximum conducted interference.
8. The frequency range from 150 kHz to 30 MHz was searched.
9. Set the test-receiver system to Peak Detect Function and specified bandwidth with Maximum Hold Mode.

3.8.4 Test Setup

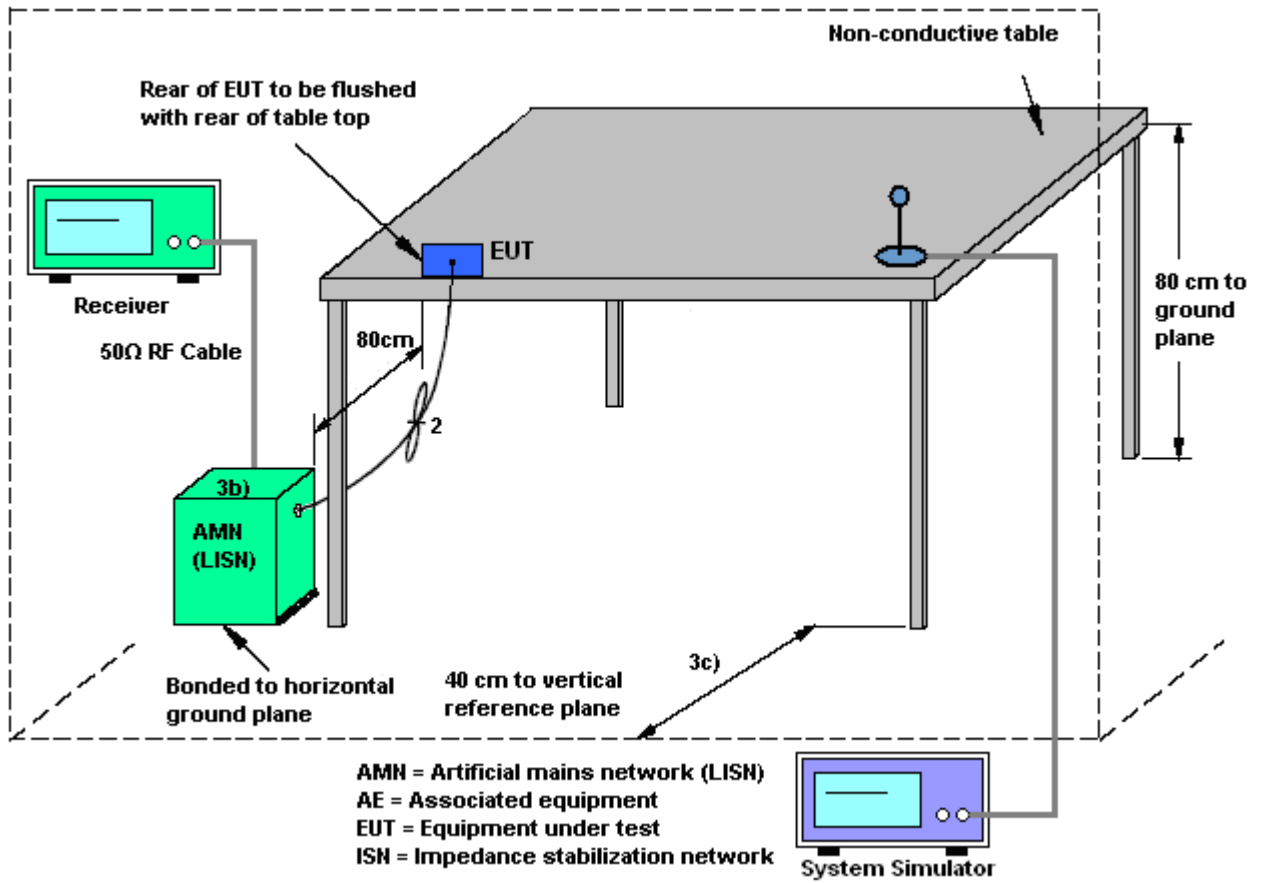

3.8.5 Test Result of AC Conducted Emission

Test Mode :	Mode 2	Temperature :	20~22°C
Test Engineer :	Novic Jiang	Relative Humidity :	40~42%
Test Voltage :	120Vac / 60Hz	Phase :	Line
Function Type :	Phone 1 for WCDMA Band II Idle + Bluetooth Link + WLAN Link + GPS Rx + Earphone + Battery 2 + USB Cable 2 (Charging from Adapter 2)		
Remark :	All emissions not reported here are more than 10 dB below the prescribed limit.		

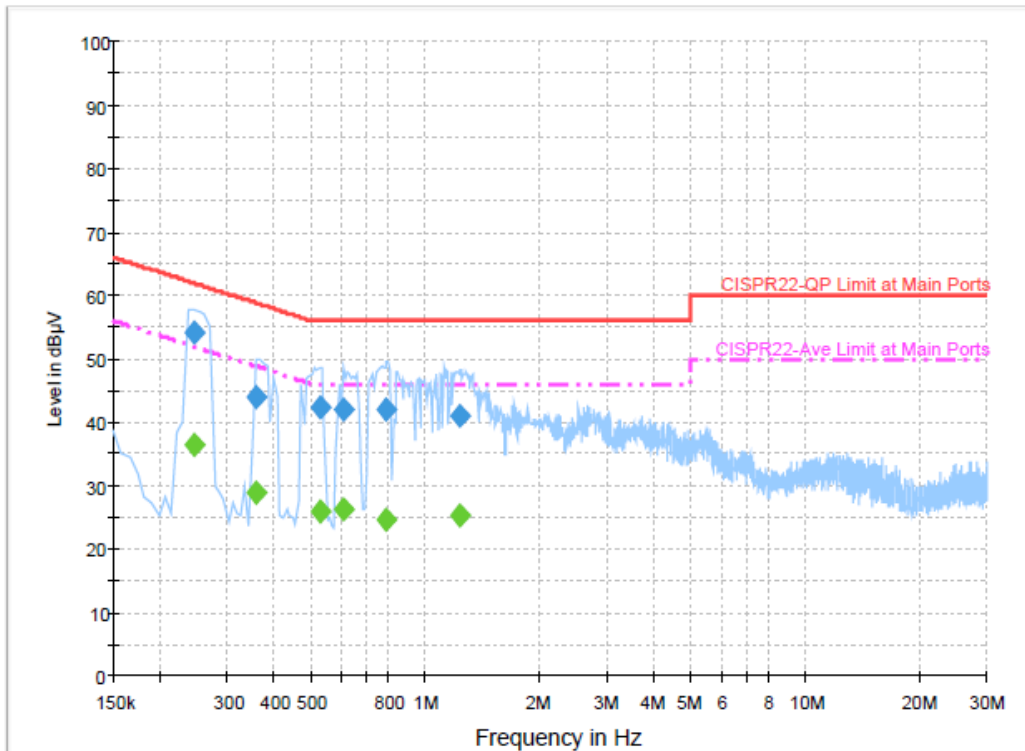

Final Result 1

Frequency (MHz)	QuasiPeak (dBμV)	Filter	Line	Corr. (dB)	Margin (dB)	Limit (dBμV)
0.246000	54.2	Off	L1	19.4	7.7	61.9
0.358000	43.8	Off	L1	19.3	15.0	58.8
0.526000	42.4	Off	L1	19.3	13.6	56.0
0.606000	41.9	Off	L1	19.4	14.1	56.0
0.790000	42.0	Off	L1	19.4	14.0	56.0
1.230000	41.0	Off	L1	19.4	15.0	56.0

Final Result 2

Frequency (MHz)	Average (dBμV)	Filter	Line	Corr. (dB)	Margin (dB)	Limit (dBμV)
0.246000	36.3	Off	L1	19.4	15.6	51.9
0.358000	28.9	Off	L1	19.3	19.9	48.8
0.526000	26.0	Off	L1	19.3	20.0	46.0
0.606000	26.2	Off	L1	19.4	19.8	46.0
0.790000	24.6	Off	L1	19.4	21.4	46.0
1.230000	25.4	Off	L1	19.4	20.6	46.0



Test Mode :	Mode 2	Temperature :	20~22°C
Test Engineer :	Novic Jiang	Relative Humidity :	40~42%
Test Voltage :	120Vac / 60Hz	Phase :	Neutral
Function Type :	Phone 1 for WCDMA Band II Idle + Bluetooth Link + WLAN Link + GPS Rx + Earphone + Battery 2 + USB Cable 2 (Charging from Adapter 2)		
Remark :	All emissions not reported here are more than 10 dB below the prescribed limit.		

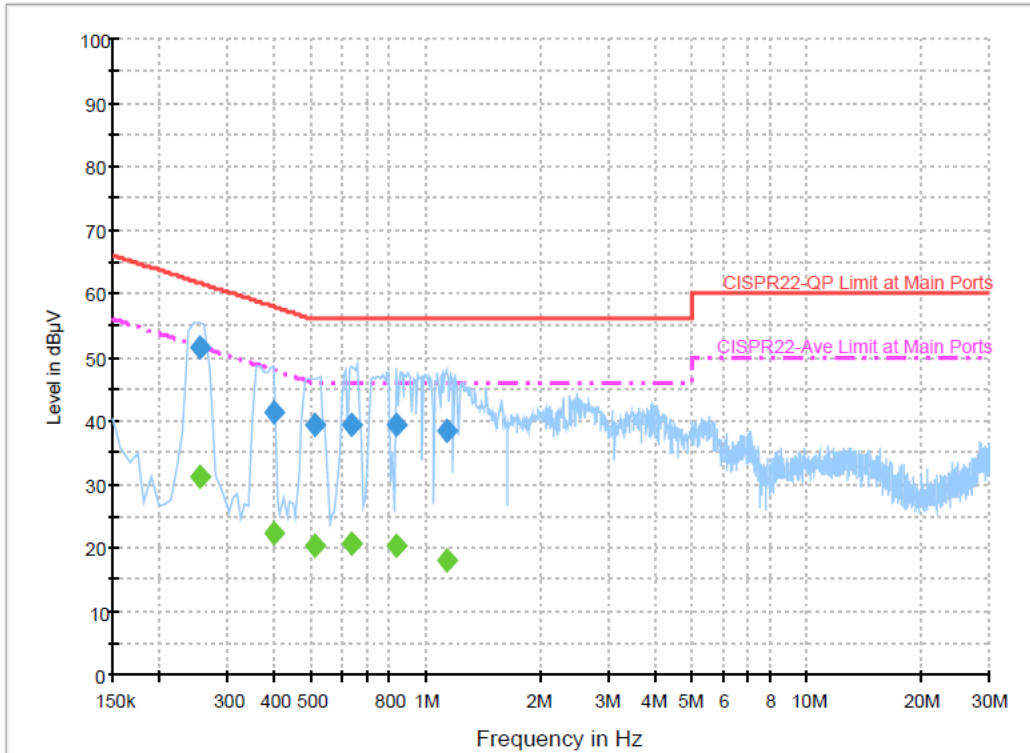

Final Result 1

Frequency (MHz)	QuasiPeak (dBµV)	Filter	Line	Corr. (dB)	Margin (dB)	Limit (dBµV)
0.254000	51.5	Off	N	19.4	10.1	61.6
0.398000	41.2	Off	N	19.4	16.7	57.9
0.510000	39.3	Off	N	19.3	16.7	56.0
0.638000	39.4	Off	N	19.4	16.6	56.0
0.830000	39.2	Off	N	19.4	16.8	56.0
1.126000	38.5	Off	N	19.4	17.5	56.0

Final Result 2

Frequency (MHz)	Average (dBµV)	Filter	Line	Corr. (dB)	Margin (dB)	Limit (dBµV)
0.254000	31.3	Off	N	19.4	20.3	51.6
0.398000	22.2	Off	N	19.4	25.7	47.9
0.510000	20.4	Off	N	19.3	25.6	46.0
0.638000	20.6	Off	N	19.4	25.4	46.0
0.830000	20.2	Off	N	19.4	25.8	46.0
1.126000	18.0	Off	N	19.4	28.0	46.0

3.9 Radiated Emission Measurement

3.9.1 Limit of Radiated Emission

In any 100 kHz bandwidth outside the intentional radiator frequency band, all harmonics/spurious must be at least 20 dB below the highest emission level within the authorized band. In addition, radiated emissions which fall in the restricted bands must also comply with the FCC section 15.209 limits as below.

Frequency (MHz)	Field Strength (microvolts/meter)	Measurement Distance (meters)
0.009 – 0.490	2400/F(kHz)	300
0.490 – 1.705	24000/F(kHz)	30
1.705 – 30.0	30	30
30 – 88	100	3
88 – 216	150	3
216 - 960	200	3
Above 960	500	3

3.9.2 Measuring Instruments

See list of measuring instruments of this test report.

3.9.3 Test Procedures

1. The testing follows the guidelines in FCC Public Notice DA 00-705 Measurement Guidelines.
2. Use the following spectrum analyzer settings:
 - (1) Span = wide enough to fully capture the emission being measured; RBW = 1 MHz for $f \geq 1$ GHz, 100 kHz for $f < 1$ GHz; VBW \geq RBW; Sweep = auto; Detector function = peak; Trace = max hold.
 - (2) Above 18 GHz shall be extrapolated to the specified distance using an extrapolation factor of 20 dB/decade from 3m to 1m.
 Distance extrapolation factor = $20 \log(\text{specific distance [3m]} / \text{test distance [1m]})$ (dB)
3. Follow the guidelines in ANSI C63.4-2003 with respect to maximizing the emission by rotating the EUT, measuring the emission for three EUT orthogonal planes, and adjusting the measurement antenna height and polarization. A pre-amp and a high pass filter are used for this test in order to get the good signal level.

3.9.4 Test Setup

For radiated emissions below 30MHz

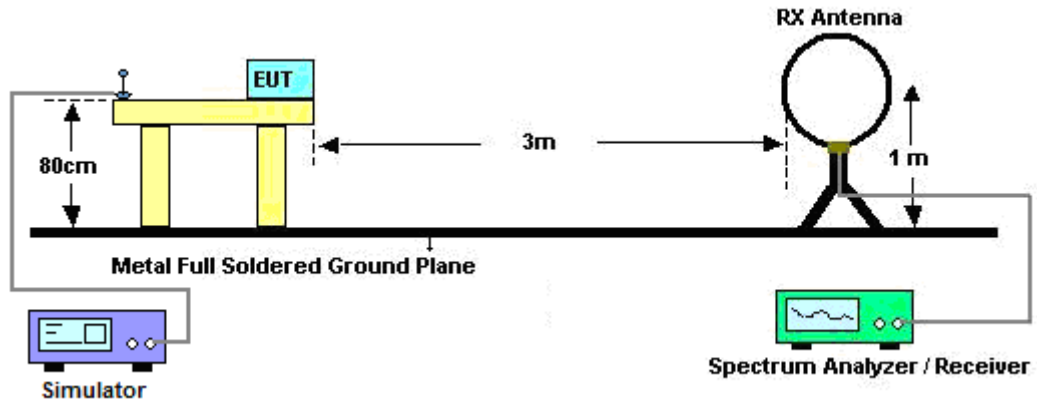

For radiated emissions above 30MHz

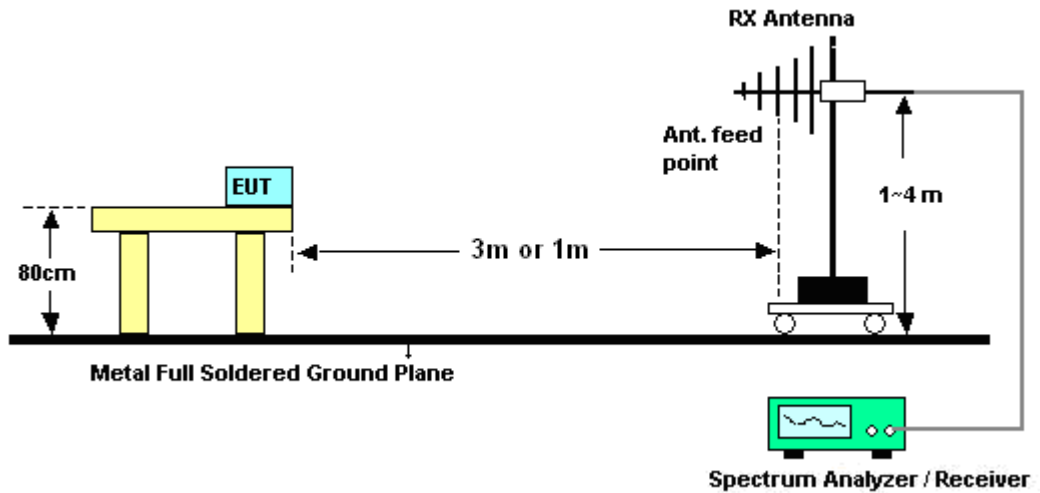



3.9.5 Test Results of Radiated Emissions (9 kHz ~ 30 MHz)

Test Engineer :	Cona Huang	Temperature :	25~26°C	
		Relative Humidity :	48~51%	
Frequency (MHz)	Level (dBuV)	Over Limit (dB)	Limit Line (dBuV)	Remark
-	-	-	-	See Note

Note:

The amplitude of spurious emissions that are attenuated by more than 20dB below the permissible value has no need to be reported.

Distance extrapolation factor = $40 \log(\text{specific distance} / \text{test distance})$ (dB);

Limit line = specific limits (dBuV) + distance extrapolation factor.



3.9.6 Test Result of Radiated Emission (30 MHz ~ 10th Harmonic)

Test Mode :	Mode 1	Temperature :	25~26°C
Test Channel :	00	Relative Humidity :	48~51%
Test Engineer :	Cona Huang	Polarization :	Horizontal
Remark :	2402 MHz is Fundamental Signals which can be ignored.		

Frequency (MHz)	Level (dBuV/m)	Over Limit (dB)	Limit Line (dBuV/m)	Read Level (dBuV)	Antenna Factor (dB)	Cable Loss (dB)	Preamp Factor (dB)	Ant Pos (cm)	Table Pos (deg)	Remark
30.81	22.55	-17.45	40	34.52	18.95	0.54	31.46	-	-	Peak
130.98	23.35	-20.15	43.5	42	11.77	1.15	31.57	-	-	Peak
256.26	34.76	-11.24	46	51.76	12.85	1.57	31.42	105	299	Peak
358.1	27.72	-18.28	46	41.95	15	2.04	31.27	-	-	Peak
648.6	22.79	-23.21	46	30.38	20.44	2.84	30.87	-	-	Peak
867	25.43	-20.57	46	30	22.86	3.29	30.72	-	-	Peak
2388.66	48.17	-25.83	74	43.83	32.13	5.46	33.25	101	19	Peak
2388.66	35.44	-18.56	54	31.1	32.13	5.46	33.25	101	19	Average
2402	96.59	-	-	92.23	32.16	5.44	33.24	101	19	Peak
2402	81.52	-	-	77.18	32.13	5.46	33.25	101	19	Average
2486	33.1	-20.9	54	28.66	32.27	5.38	33.21	101	19	Average
2486	44.58	-29.42	74	40.14	32.27	5.38	33.21	101	19	Peak
8211	54.34	-19.66	74	41.7	36	9.98	33.34	100	152	Peak
8211	40.36	-13.64	54	27.72	36	9.98	33.34	100	152	Average



Test Mode :	Mode 1	Temperature :	25~26°C
Test Channel :	00	Relative Humidity :	48~51%
Test Engineer :	Cona Huang	Polarization :	Vertical
Remark :	2402 MHz is Fundamental Signals which can be ignored.		

Frequency (MHz)	Level (dBuV/m)	Over Limit (dB)	Limit Line (dBuV/m)	Read Level (dBuV)	Antenna Factor (dB)	Cable Loss (dB)	Preamp Factor (dB)	Ant Pos (cm)	Table Pos (deg)	Remark
31.62	33.1	-6.9	40	45.61	18.4	0.55	31.46	100	136	Peak
88.05	23.38	-20.12	43.5	45.36	8.62	0.93	31.53	-	-	Peak
256.26	30	-16	46	47	12.85	1.57	31.42	-	-	Peak
304.9	22.37	-23.63	46	38.33	13.59	1.78	31.33	-	-	Peak
511.4	23.28	-22.72	46	33.48	18.38	2.47	31.05	-	-	Peak
794.2	25.19	-20.81	46	30.6	22.14	3.13	30.68	-	-	Peak
2388.09	47.14	-26.86	74	42.8	32.13	5.46	33.25	100	56	Peak
2388.09	34.79	-19.21	54	30.45	32.13	5.46	33.25	100	56	Average
2402	92.3	-	-	87.94	32.16	5.44	33.24	100	56	Peak
2402	78.22	-	-	73.88	32.13	5.46	33.25	100	56	Average
2486	33.1	-20.9	54	28.66	32.27	5.38	33.21	100	56	Average
2486	44.75	-29.25	74	40.31	32.27	5.38	33.21	100	56	Peak
8217	54.56	-19.44	74	41.92	36	9.99	33.35	100	185	Peak
8217	40.63	-13.37	54	27.99	36	9.99	33.35	100	185	Average



Test Mode :	Mode 2	Temperature :	25~26°C
Test Channel :	39	Relative Humidity :	48~51%
Test Engineer :	Cona Huang	Polarization :	Horizontal
Remark :	2441 MHz is Fundamental Signals which can be ignored.		

Frequency (MHz)	Level (dBuV/m)	Over Limit (dB)	Limit Line (dBuV/m)	Read Level (dBuV)	Antenna Factor (dB)	Cable Loss (dB)	Preamp Factor (dB)	Ant Pos (cm)	Table Pos (deg)	Remark
30.81	22.72	-17.28	40	34.69	18.95	0.54	31.46	100	168	Peak
128.01	23.18	-20.32	43.5	41.82	11.79	1.14	31.57	-	-	Peak
248.97	28.19	-17.81	46	45.42	12.65	1.53	31.41	-	-	Peak
358.1	27.95	-18.05	46	42.18	15	2.04	31.27	-	-	Peak
511.4	24.49	-21.51	46	34.69	18.38	2.47	31.05	-	-	Peak
766.9	27.79	-18.21	46	33.63	21.76	3.09	30.69	-	-	Peak
2388	45.69	-28.31	74	41.35	32.13	5.46	33.25	122	19	Peak
2388	34.34	-19.66	54	30	32.13	5.46	33.25	122	19	Average
2441	95.72	-	-	91.31	32.22	5.41	33.22	122	19	Peak
2441	80.4	-	-	75.99	32.22	5.41	33.22	122	19	Average
2484	45	-29	74	40.56	32.27	5.38	33.21	122	19	Peak
2484	33.27	-20.73	54	28.83	32.27	5.38	33.21	122	19	Average
8187	54.53	-19.47	74	41.89	36	9.97	33.33	100	184	Peak
8187	40.87	-13.13	54	28.23	36	9.97	33.33	100	184	Average



Test Mode :	Mode 2	Temperature :	25~26°C
Test Channel :	39	Relative Humidity :	48~51%
Test Engineer :	Cona Huang	Polarization :	Vertical
Remark :	2441 MHz is Fundamental Signals which can be ignored.		

Frequency (MHz)	Level (dBuV/m)	Over Limit (dB)	Limit Line (dBuV/m)	Read Level (dBuV)	Antenna Factor (dB)	Cable Loss (dB)	Preamp Factor (dB)	Ant Pos (cm)	Table Pos (deg)	Remark
30.81	32.3	-7.7	40	44.27	18.95	0.54	31.46	102	99	Peak
169.05	23.53	-19.97	43.5	44.08	9.74	1.23	31.52	-	-	Peak
239.25	29.19	-16.81	46	47.59	11.49	1.53	31.42	-	-	Peak
304.2	23.28	-22.72	46	39.24	13.59	1.78	31.33	-	-	Peak
358.1	22.44	-23.56	46	36.67	15	2.04	31.27	-	-	Peak
766.9	27.31	-18.69	46	33.15	21.76	3.09	30.69	-	-	Peak
2372	46.02	-27.98	74	41.7	32.11	5.47	33.26	117	65	Peak
2372	34.18	-19.82	54	29.86	32.11	5.47	33.26	117	65	Average
2441	91.05	-	-	86.64	32.22	5.41	33.22	117	65	Peak
2441	76.14	-	-	71.73	32.22	5.41	33.22	117	65	Average
2494	44.46	-29.54	74	39.99	32.3	5.37	33.2	117	65	Peak
2494	33.16	-20.84	54	28.69	32.3	5.37	33.2	117	65	Average
8169	56.19	-17.81	74	41.99	36	11.52	33.32	100	296	Peak
8169	40.26	-13.74	54	26.06	36	11.52	33.32	100	296	Average



Test Mode :	Mode 3	Temperature :	25~26°C
Test Channel :	78	Relative Humidity :	48~51%
Test Engineer :	Cona Huang	Polarization :	Horizontal
Remark :	2480 MHz is Fundamental Signals which can be ignored.		

Frequency (MHz)	Level (dBuV/m)	Over Limit (dB)	Limit Line (dBuV/m)	Read Level (dBuV)	Antenna Factor (dB)	Cable Loss (dB)	Preamp Factor (dB)	Ant Pos (cm)	Table Pos (deg)	Remark
31.62	22.09	-17.91	40	34.6	18.4	0.55	31.46	-	-	Peak
128.01	22.13	-21.37	43.5	40.77	11.79	1.14	31.57	-	-	Peak
245.46	28.26	-17.74	46	45.95	12.19	1.53	31.41	-	-	Peak
360.2	28.45	-17.55	46	42.6	15.06	2.06	31.27	100	186	Peak
626.2	23.27	-22.73	46	31.12	20.27	2.77	30.89	-	-	Peak
805.4	25.82	-20.18	46	31.08	22.27	3.15	30.68	-	-	Peak
2318	45.58	-28.42	74	41.33	32.02	5.51	33.28	100	12	Peak
2318	34.38	-19.62	54	30.13	32.02	5.51	33.28	100	12	Average
2480	95.44	-	-	91	32.27	5.38	33.21	100	12	Peak
2480	80.47	-	-	76.03	32.27	5.38	33.21	100	12	Average
2483.5	60.48	-13.52	74	56.04	32.27	5.38	33.21	100	12	Peak
2483.5	48.27	-5.73	54	43.83	32.27	5.38	33.21	100	12	Average
8097	54.27	-19.73	74	41.64	36	9.9	33.27	100	125	Peak
8097	40.33	-13.67	54	27.7	36	9.9	33.27	100	125	Average



Test Mode :	Mode 3	Temperature :	25~26°C
Test Channel :	78	Relative Humidity :	48~51%
Test Engineer :	Cona Huang	Polarization :	Vertical
Remark :	2480 MHz is Fundamental Signals which can be ignored.		

Frequency (MHz)	Level (dBuV/m)	Over Limit (dB)	Limit Line (dBuV/m)	Read Level (dBuV)	Antenna Factor (dB)	Cable Loss (dB)	Preamp Factor (dB)	Ant Pos (cm)	Table Pos (deg)	Remark
31.62	32.55	-7.45	40	45.06	18.4	0.55	31.46	100	227	Peak
184.98	23.09	-20.41	43.5	44.37	8.98	1.26	31.52	-	-	Peak
235.74	29.18	-16.82	46	48.08	11.02	1.51	31.43	-	-	Peak
304.2	22.72	-23.28	46	38.68	13.59	1.78	31.33	-	-	Peak
360.2	21.23	-24.77	46	35.38	15.06	2.06	31.27	-	-	Peak
598.9	22.94	-23.06	46	31.15	20.03	2.68	30.92	-	-	Peak
2388	46.16	-27.84	74	41.82	32.13	5.46	33.25	131	38	Peak
2388	34.4	-19.6	54	30.06	32.13	5.46	33.25	131	38	Average
2480	92.51	-	-	88.07	32.27	5.38	33.21	131	38	Peak
2480	78.01	-	-	73.57	32.27	5.38	33.21	131	38	Average
2483.5	55.62	-18.38	74	51.18	32.27	5.38	33.21	131	38	Peak
2483.5	44.32	-9.68	54	39.88	32.27	5.38	33.21	131	38	Average
8151	55.46	-18.54	74	41.27	36	11.5	33.31	100	314	Peak
8151	40.89	-13.11	54	26.7	36	11.5	33.31	100	314	Average



Test Mode :	Mode 4	Temperature :	25~26°C
Test Channel :	78	Relative Humidity :	48~51%
Test Engineer :	Cona Huang	Polarization :	Horizontal
Remark :	2480 MHz is Fundamental Signals which can be ignored.		

Frequency (MHz)	Level (dBuV/m)	Over Limit (dB)	Limit Line (dBuV/m)	Read Level (dBuV)	Antenna Factor (dB)	Cable Loss (dB)	Preamp Factor (dB)	Ant Pos (cm)	Table Pos (deg)	Remark
32.16	20.6	-19.4	40	33.11	18.4	0.55	31.46	-	-	Peak
163.92	17.79	-25.71	43.5	37.99	10.1	1.22	31.52	-	-	Peak
247.08	26.68	-19.32	46	44.14	12.42	1.53	31.41	121	251	Peak
316.8	16.43	-29.57	46	32.03	13.92	1.8	31.32	-	-	Peak
653.5	20.47	-25.53	46	28.01	20.48	2.85	30.87	-	-	Peak
851.6	22.25	-23.75	46	27	22.71	3.27	30.73	-	-	Peak
2318	47	-27	74	42.75	32.02	5.51	33.28	100	350	Peak
2318	33.61	-20.39	54	29.36	32.02	5.51	33.28	100	350	Average
2480	95.67	-	-	91.23	32.27	5.38	33.21	100	350	Peak
2480	80.25	-	-	75.81	32.27	5.38	33.21	100	350	Average
2483.5	49.92	-4.08	54	45.48	32.27	5.38	33.21	100	350	Average
2483.5	61.17	-12.83	74	56.73	32.27	5.38	33.21	100	350	Peak
8217	54.21	-19.79	74	41.57	36	9.99	33.35	100	140	Peak
8217	40.5	-13.5	54	27.86	36	9.99	33.35	100	140	Average



Test Mode :	Mode 4	Temperature :	25~26°C
Test Channel :	78	Relative Humidity :	48~51%
Test Engineer :	Cona Huang	Polarization :	Vertical
Remark :	2480 MHz is Fundamental Signals which can be ignored.		

Frequency (MHz)	Level (dBuV/m)	Over Limit (dB)	Limit Line (dBuV/m)	Read Level (dBuV)	Antenna Factor (dB)	Cable Loss (dB)	Preamp Factor (dB)	Ant Pos (cm)	Table Pos (deg)	Remark
31.89	32.05	-7.95	40	44.56	18.4	0.55	31.46	106	234	Peak
92.1	22.29	-21.21	43.5	43.68	9.17	0.96	31.52	-	-	Peak
239.25	29.65	-16.35	46	48.05	11.49	1.53	31.42	-	-	Peak
304.2	22.65	-23.35	46	38.61	13.59	1.78	31.33	-	-	Peak
639.5	24.04	-21.96	46	31.74	20.37	2.81	30.88	-	-	Peak
833.4	25.2	-20.8	46	30.14	22.54	3.23	30.71	-	-	Peak
2382	45.78	-28.22	74	41.46	32.11	5.47	33.26	100	7	Peak
2382	33.99	-20.01	54	29.67	32.11	5.47	33.26	100	7	Average
2480	93.15	-	-	88.71	32.27	5.38	33.21	100	7	Peak
2480	78.77	-	-	74.33	32.27	5.38	33.21	100	7	Average
2483.5	48.09	-5.91	54	43.65	32.27	5.38	33.21	100	7	Average
2483.5	58.39	-15.61	74	53.95	32.27	5.38	33.21	100	7	Peak
8163	55.56	-18.44	74	41.37	36	11.5	33.31	100	333	Peak
8163	41.05	-12.95	54	26.86	36	11.5	33.31	100	333	Average



3.10 Antenna Requirements

3.10.1 Standard Applicable

If directional gain of transmitting antennas is greater than 6dBi, the power shall be reduced by the same level in dB comparing to gain minus 6dBi. The use of a permanently attached antenna or of an antenna that uses a unique coupling to the intentional radiator shall be considered sufficient to comply with the FCC rule.

3.10.2 Antenna Connected Construction

The antennas type used in this product is PIFA Antenna without connector and it is considered to meet antenna requirement.

3.10.3 Antenna Gain

The antenna peak gain of EUT is less than 6 dBi. Therefore, it is not necessary to reduce maximum peak output power limit.

4 List of Measuring Equipment

Instrument	Manufacturer	Model No.	Serial No.	Characteristics	Calibration Date	Due Date	Remark
Spectrum Analyzer	R&S	FSP30	101329	9kHz~30GHz	Apr. 26, 2010	Apr. 25, 2011	Conducted (TH02-HY)
Power Meter	Anritsu	ML2495A	0932001	N/A	Sep. 17, 2009	Sep. 16, 2010	Conducted (TH02-HY)
Power Sensor	Anritsu	MA2411B	0846202	N/A	Sep. 10, 2009	Sep. 09, 2010	Conducted (TH02-HY)
Power Meter	Agilent	E4416A	GB412923 44	N/A	Feb. 25, 2010	Feb. 24, 2011	Conducted (TH02-HY)
Power Sensor	Agilent	E9327A	US404415 48	N/A	Feb. 25, 2010	Feb. 24, 2011	Conducted (TH02-HY)
EMI Test Receive	R&S	ESCS 30	100356	9KHz – 2.75GHz	Aug. 05, 2009	Aug. 04, 2010	Conduction (CO05-HY)
Two-LISN	R&S	ENV216	11-100081	9kHz~30MHz	Nov. 30, 2009	Nov. 29, 2010	Conduction (CO05-HY)
Two-LISN	R&S	ENV216	11-100080	9kHz~30MHz	Nov. 23, 2009	Nov. 22, 2010	Conduction (CO05-HY)
AC Power Source	APC	APC-1000W	N/A	N/A	N/A	N/A	Conduction (CO05-HY)
Bilog Antenna	SCHAFFNER	CBL6111C	2726	30MHz ~ 1GHz	Oct. 31, 2009	Oct. 30, 2010	Radiation (03CH07-HY)
Spectrum Analyzer	R&S	FSP	101067	9KHz ~ 30GHz	Dec. 04, 2009	Dec. 03, 2010	Radiation (03CH07-HY)
Double Ridge Horn Antenna	ESCO	3117	00075962	1GHz ~ 18GHz	Aug. 20, 2009	Aug. 19, 2010	Radiation (03CH07-HY)
SHF-EHF Horn Antenna	SCHWARZBE CK	BBHA 9170	BBHA9170 251	15GHz- 40GHz	Oct. 14, 2009	Oct. 13, 2010	Radiation (03CH07-HY)
Pre Amplifier	Agilent	8449B	3008A023 62	1GHz~ 26.5GHz	Dec.09,2009	Dec. 08, 2010	Radiation (03CH07-HY)
Pre Amplifier	COM-POWER	PA-103A	161241	10-1000MHz.32 dB.GAIN	Mar. 27, 2010	Mar. 26, 2011	Radiation (03CH07-HY)
System Simulator	R&S	CMU200	117995	N/A	Mar. 19, 2009	Mar. 18, 2011	-
GPS Station	T&E	GS-50	N/A	N/A	N/A	N/A	-
Bluetooth Base Station	R&S	CBT32	100519	N/A	May 12, 2009	May 11, 2011	-

5 Uncertainty of Evaluation

Uncertainty of Conducted Emission Measurement (150 kHz ~ 30 MHz)

Contribution	Uncertainty of X_i		$u(X_i)$
	dB	Probability Distribution	
Receiver Reading	0.10	Normal (k=2)	0.05
Cable Loss	0.10	Normal (k=2)	0.05
AMN Insertion Loss	2.50	Rectangular	0.63
Receiver Specification	1.50	Rectangular	0.43
Site Imperfection	1.39	Rectangular	0.80
Mismatch	+0.34 / -0.35	U-Shape	0.24
Combined Standard Uncertainty $U_c(y)$	1.13		
Measuring Uncertainty for a Level of Confidence of 95% ($U = 2U_c(y)$)	2.26		

Uncertainty of Radiated Emission Measurement (30 MHz ~ 1000 MHz)

Contribution	Uncertainty of X_i		$u(X_i)$
	dB	Probability Distribution	
Receiver Reading	0.41	Normal (k=2)	0.21
Antenna Factor Calibration	0.83	Normal (k=2)	0.42
Cable Loss Calibration	0.25	Normal (k=2)	0.13
Pre-Amplifier Gain Calibration	0.27	Normal (k=2)	0.14
RCV/SPA Specification	2.50	Rectangular	0.72
Antenna Factor Interpolation for Frequency	1.00	Rectangular	0.29
Site Imperfection	1.43	Rectangular	0.83
Mismatch	+0.39 / -0.41	U-Shape	0.28
Combined Standard Uncertainty $U_c(y)$	1.27		
Measuring Uncertainty for a Level of Confidence of 95% ($U = 2U_c(y)$)	2.54		



Uncertainty of Radiated Emission Measurement (1 GHz ~ 40 GHz)

Contribution	Uncertainty of X_i		$u(X_i)$	C_i	$C_i * u(X_i)$
	dB	Probability Distribution			
Receiver Reading	±0.10	Normal (k=2)	0.10	1	0.10
Antenna Factor Calibration	±1.70	Normal (k=2)	0.85	1	0.85
Cable Loss Calibration	±0.50	Normal (k=2)	0.25	1	0.25
Receiver Correction	±2.00	Rectangular	1.15	1	1.15
Antenna Factor Directional	±1.50	Rectangular	0.87	1	0.87
Site Imperfection	±2.80	Triangular	1.14	1	1.14
Mismatch Receiver VSWR $\Gamma_1 = 0.197$ Antenna VSWR $\Gamma_2 = 0.194$ Uncertainty = $20\text{Log}(1-\Gamma_1*\Gamma_2)$	+0.34 / -0.35	U-Shape	0.244	1	0.244
Combined Standard Uncertainty $U_c(y)$	2.36				
Measuring Uncertainty for a Level of Confidence of 95% ($U = 2U_c(y)$)	4.72				