

# FCC RF Test Report

APPLICANT : HTC Corporation  
EQUIPMENT : Windows Phone  
MODEL NAME : PD26100  
FCC ID : NM8PD26100  
STANDARD : FCC 47 CFR Part 2, 22(H), 24(E)  
CLASSIFICATION : PCS Licensed Transmitter Held to Ear (PCE)  
Tx/Rx FREQUENCY RANGE : GSM850 : 824.2 ~ 848.8 MHz /  
869.2 ~ 893.8 MHz  
GSM1900 : 1850.2 ~ 1909.8 MHz /  
1930.2 ~ 1989.8 MHz  
WCDMA Band V : 826.4 ~ 846.6 MHz /  
871.4 ~ 891.6 MHz  
WCDMA Band II : 1852.4 ~ 1907.6 MHz /  
1932.4 ~ 1987.6 MHz

MAX. ERP/EIRP POWER : <Phone 1>  
GSM850 (GSM) : 0.90 W  
GSM850 (EDGE 8) : 0.50 W  
GSM1900 (GSM) : 0.87 W  
GSM1900 (EDGE 8) : 0.95 W  
WCDMA Band V (RMC 12.2Kbps) : 0.08 W  
WCDMA Band II (HSDPA) : 0.16 W  
<Phone 2>  
GSM850 (GSM) : 0.81 W  
GSM850 (EDGE 8) : 0.40 W  
GSM1900 (GSM) : 0.53 W  
GSM1900 (EDGE 8) : 0.51 W  
WCDMA Band V (RMC 12.2Kbps) : 0.09 W  
WCDMA Band II (HSDPA) : 0.08 W

EMISSION DESIGNATOR : GMSK : 248KGXW  
8PSK : 248KG7W  
QPSK : 4M20F9W

The product was received on Jun. 23, 2010 and completely tested on Jul. 16, 2010. We, SPORTON INTERNATIONAL INC., would like to declare that the tested sample has been evaluated in accordance with the procedures given in ANSI / TIA / EIA-603-C-2004 and shown compliance with the applicable technical standards.

The test results in this report apply exclusively to the tested model / sample. Without written approval of SPORTON INTERNATIONAL INC., the test report shall not be reproduced except in full.

Reviewed by:



Roy Wu / Manager



## SPORTON INTERNATIONAL INC.

No. 52, Hwa Ya 1<sup>st</sup> Rd., Hwa Ya Technology Park, Kwei-Shan Hsiang, Tao Yuan Hsien, Taiwan, R.O.C.

SPORTON INTERNATIONAL INC.

TEL : 886-3-327-3456

FAX : 886-3-328-4978

FCC ID : NM8PD26100

Page Number : 1 of 75

Report Issued Date : Aug. 05, 2010

Report Version : Rev. 02



# TABLE OF CONTENTS

**REVISION HISTORY..... 3**

**SUMMARY OF TEST RESULT ..... 4**

**1 GENERAL DESCRIPTION ..... 5**

    1.1 Applicant..... 5

    1.2 Manufacturer ..... 5

    1.3 Feature of Equipment Under Test..... 6

    1.4 Testing Site..... 7

    1.5 Applied Standards ..... 7

    1.6 Ancillary Equipment List ..... 7

**2 TEST CONFIGURATION OF EQUIPMENT UNDER TEST ..... 8**

    2.1 Test Mode..... 8

    2.2 Connection Diagram of Test System ..... 9

**3 TEST RESULT ..... 10**

    3.1 Conducted Output Power Measurement..... 10

    3.2 Effective Radiated Power and Effective Isotropic Radiated Power Measurement ..... 12

    3.3 Occupied Bandwidth Measurement ..... 20

    3.4 Band Edge Measurement..... 27

    3.5 Conducted Emission Measurement ..... 34

    3.6 Field Strength of Spurious Radiation Measurement ..... 50

    3.7 Frequency Stability Measurement..... 68

**4 LIST OF MEASURING EQUIPMENT ..... 74**

**5 UNCERTAINTY OF EVALUATION ..... 75**

**APPENDIX A. SETUP PHOTOGRAPHS**



### REVISION HISTORY

REPORT NO.	VERSION	DESCRIPTION	ISSUED DATE
FG062328	Rev. 01	Initial issue of report	Aug. 02, 2010
FG062328	Rev. 02	Remove HSUPA function	Aug. 05, 2010



### SUMMARY OF TEST RESULT

Report Section	FCC Rule	IC Rule	Description	Limit	Result	Remark
3.1	§2.1046	N/A	Conducted Output Power	N/A	PASS	-
3.2	§22.913(a)(2)	RSS-132(4.4) SRSP-503(5.1.3)	Effective Radiated Power	< 7 Watts	PASS	-
3.2	§24.232(c)	RSS-133 (6.4) SRSP-510(5.1.2)	Equivalent Isotropic Radiated Power	< 2 Watts	PASS	-
3.3	§2.1049 §22.917(a) §24.238(a)	N/A	Occupied Bandwidth	N/A	PASS	-
3.4	§2.1051 §22.917(a) §24.238(a)	RSS-132 (4.5.1) RSS-133 (6.5.1)	Band Edge Measurement	< 43+10log <sub>10</sub> (P[Watts])	PASS	-
3.5	§2.1051 §22.917(a) §24.238(a)	RSS-132 (4.5.1) RSS-133 (6.5.1)	Conducted Emission	< 43+10log <sub>10</sub> (P[Watts])	PASS	-
3.6	§2.1053 §22.917(a) §24.238(a)	RSS-132 (4.5.1) RSS-133 (6.5.1)	Field Strength of Spurious Radiation	< 43+10log <sub>10</sub> (P[Watts])	PASS	Under limit 19.50 dB at 5636 MHz
3.7	§2.1055 §22.355 §24.235	RSS-132(4.3) RSS-133(6.3)	Frequency Stability for Temperature & Voltage	< 2.5 ppm	PASS	-



# **1 General Description**

## **1.1 Applicant**

**HTC Corporation**

1F., No. 6-3, Baoqiang Rd., Xindian City, Taipei, Taiwan

## **1.2 Manufacturer**

**HTC Corporation**

1F., No. 6-3, Baoqiang Rd., Xindian City, Taipei, Taiwan



### 1.3 Feature of Equipment Under Test

Product Feature & Specification	
Equipment	Windows Phone
Model Name	PD26100
FCC ID	NM8PD26100
EUT Configuration	Phone 1 : EUT with LCM-Main Phone 2 : EUT with LCM-2nd source
Tx Frequency	GSM850 : 824 MHz ~ 849 MHz GSM1900 : 1850 MHz ~ 1910 MHz WCDMA Band V : 824 MHz ~ 849 MHz WCDMA Band II : 1850 MHz ~ 1910 MHz
Rx Frequency	GSM850 : 869 MHz ~ 894 MHz GSM1900 : 1930 MHz ~ 1990 MHz WCDMA Band V : 869 MHz ~ 894 MHz WCDMA Band II : 1930 MHz ~ 1990 MHz
Maximum Output Power to Antenna	GSM850 : 31.88 dBm GSM1900 : 29.34 dBm WCDMA Band V : 23.59 dBm WCDMA Band II : 23.82 dBm
Maximum ERP/EIRP	<Phone 1> GSM850 (GSM) : 0.90 W (29.56 dBm) GSM850 (EDGE 8) : 0.50 W (26.97 dBm) GSM1900 (GSM) : 0.87 W (29.42 dBm) GSM1900 (EDGE 8) : 0.95 W (29.78 dBm) WCDMA Band V (RMC 12.2Kbps) : 0.08 W (18.90 dBm) WCDMA Band II (HSDPA) : 0.16 W (22.14 dBm) <Phone 2> GSM850 (GSM) : 0.81 W (29.08 dBm) GSM850 (EDGE 8) : 0.40 W (26.04 dBm) GSM1900 (GSM) : 0.53 W (27.25 dBm) GSM1900 (EDGE 8) : 0.51 W (27.08 dBm) WCDMA Band V (RMC 12.2Kbps) : 0.09 W (19.45 dBm) WCDMA Band II (HSDPA) : 0.08 W (19.17 dBm)
Antenna Type	Fixed Internal Antenna
Type of Modulation	GSM / GPRS : GMSK EDGE : 8PSK WCDMA : QPSK HSDPA : QPSK / 16QAM
Type of Emission	GMSK : 248KGXW 8PSK : 248KG7W QPSK : 4M20F9W
EUT Stage	Production Unit

**Remark:**

1. For other wireless features of this EUT, the test report will be issued separately.
2. This test report recorded only product characteristics and test results of PCS Licensed Transmitter Held to Ear (PCE).
3. The above EUT's information was declared by manufacturer. Please refer to the specifications or user's manual for more detailed description.

## 1.4 Testing Site

<b>Test Site</b>	SPORTON INTERNATIONAL INC.		
<b>Test Site Location</b>	No. 52, Hwa Ya 1 <sup>st</sup> Rd., Hwa Ya Technology Park, Kwei-Shan Hsiang, Tao Yuan Hsien, Taiwan, R.O.C. TEL: +886-3-327-3456 FAX: +886-3-328-4978		
<b>Test Site No.</b>	<b>Sporton Site No.</b>		<b>FCC/IC Registration No.</b>
	TH02-HY	03CH07-HY	TW1022/4086B-1

## 1.5 Applied Standards

According to the specifications of the manufacturer, the EUT must comply with the requirements of the following standards:

- ♦ Preliminary Guidance for Receiving Applications for Certification of 3G Device. May 9, 2006.
- ♦ FCC 47 CFR Part 2, 22(H), 24(E)
- ♦ ANSI / TIA / EIA-603-C-2004
- ♦ IC RSS-132 Issue 2
- ♦ IC RSS-133 Issue 5

**Remark:**

1. All test items were verified and recorded according to the standards and without any deviation during the test.
2. This EUT has also been tested and complied with the requirements of FCC Part 15, Subpart B (DoC), recorded in a separate test report.

## 1.6 Ancillary Equipment List

Item	Equipment	Trade Name	Model No.	FCC ID	Data Cable	Power Cord
1.	System Simulator	R&S	CMU200	N/A	N/A	Unshielded, 1.8 m
2.	Earphone	Merry	RC E160	N/A	N/A	Unshielded, 1.3m

## 2 Test Configuration of Equipment Under Test

### 2.1 Test Mode

During all testing, EUT is in link mode with base station emulator at maximum power level. The spurious emission measurements were carried out in semi-anechoic chamber with 3-meter test range, and EUT is rotated on three test planes to find out the worst emission.

Frequency range investigated for radiated emission is as follows:

1. 30 MHz to 9000 MHz for GSM850 and WCDMA Band V.
2. 30 MHz to 19000 MHz for GSM1900 and WCDMA Band II.

Test Modes		
Band	Radiated TCs	Conducted TCs
GSM 850	<ul style="list-style-type: none"> <li>■ GSM Link for Phone 1</li> <li>■ EDGE 8 Link for Phone 1</li> <li>■ GSM Link for Phone 2</li> </ul>	<ul style="list-style-type: none"> <li>■ GSM Link</li> <li>■ EDGE 8 Link</li> </ul>
GSM 1900	<ul style="list-style-type: none"> <li>■ GSM Link for Phone 1</li> <li>■ EDGE 8 Link for Phone 1</li> <li>■ GSM Link for Phone 2</li> </ul>	<ul style="list-style-type: none"> <li>■ GSM Link</li> <li>■ EDGE 8 Link</li> </ul>
WCDMA Band V	<ul style="list-style-type: none"> <li>■ RMC 12.2Kbps Link for Phone 1</li> </ul>	<ul style="list-style-type: none"> <li>■ RMC 12.2Kbps Link</li> </ul>
WCDMA Band II	<ul style="list-style-type: none"> <li>■ HSDPA Link for Phone 1</li> </ul>	<ul style="list-style-type: none"> <li>■ HSDPA Link</li> </ul>

**Note:**

1. The maximum power levels are GSM mode for GMSK link, EDGE multi-slot class 8 mode for 8PSK link, RMC 12.2Kbps mode for WCDMA band V, and HSDPA mode for WCDMA band II, only these modes were used for all tests.
2. Because there are individual antennas for each WWAN, WLAN and Bluetooth, the co-location test modes are not required.
3. Adapter 2, USB Cable 3 and Battery 2 were the configuration for the radiation test.

The conducted power tables are as follows:

Conducted Power (*Unit: dBm)						
Band	GSM850			GSM1900		
Channel	128	189	251	512	661	810
Frequency	824.2	836.4	848.8	1850.2	1880.0	1909.8
GSM	31.88	31.83	31.75	29.34	29.19	29.17
GPRS 8	31.86	31.84	31.75	19.32	19.18	19.15
GPRS 10	31.83	31.80	31.73	29.30	29.13	29.04
EGPRS 8	25.87	25.86	25.77	25.93	25.77	25.74
EGPRS 10	24.83	24.82	24.76	24.91	24.75	24.72



Conducted Power (*Unit: dBm)						
Band	WCDMA Band V			WCDMA Band II		
Channel	4132	4182	4233	9262	9400	9538
Frequency	826.4	836.4	846.6	1852.4	1880.0	1907.6
RMC 12.2K	23.53	23.48	<b>23.59</b>	23.52	23.55	23.67
HSDPA Subtest-1	23.38	23.21	23.45	23.41	23.40	<b>23.82</b>
HSDPA Subtest-2	23.07	22.98	23.19	23.27	23.24	23.44
HSDPA Subtest-3	22.72	22.64	22.73	22.83	22.96	22.92
HSDPA Subtest-4	22.47	22.45	22.59	22.86	22.87	22.94

## 2.2 Connection Diagram of Test System

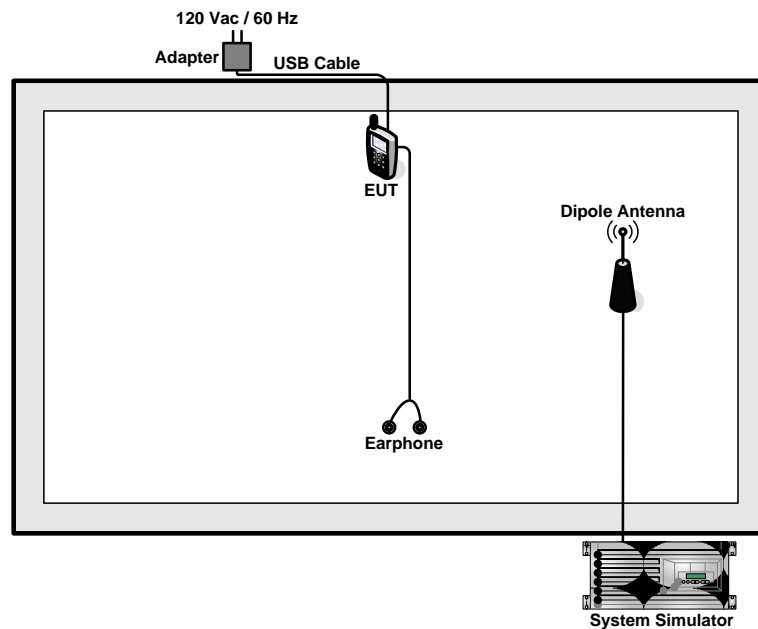

### 3 Test Result

#### 3.1 Conducted Output Power Measurement

##### 3.1.1 Description of the Conducted Output Power Measurement

A base station simulator was used to establish communication with the EUT. Its parameters were set to transmit the maximum power on the EUT. The measured power in the radio frequency on the transmitter output terminals shall be reported.

##### 3.1.2 Measuring Instruments

See list of measuring instruments of this test report.

##### 3.1.3 Test Procedures

1. The transmitter output port was connected to base station.
2. Set EUT at maximum power through base station.
3. Select lowest, middle, and highest channels for each band and different modulation.

##### 3.1.4 Test Setup

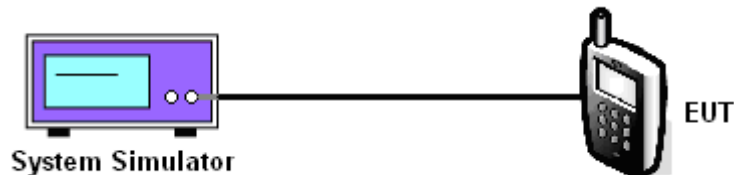

3.1.5 Test Result of Conducted Output Power

Cellular Band				
Modes	Channel	Frequency (MHz)	Conducted Power (dBm)	Conducted Power (Watts)
GSM850 (GSM)	128 (Low)	824.2	31.88	1.54
	189 (Mid)	836.4	31.83	1.52
	251 (High)	848.8	31.75	1.50
GSM850 (EDGE 8)	128 (Low)	824.2	25.87	0.39
	189 (Mid)	836.4	25.86	0.39
	251 (High)	848.8	25.77	0.38
WCDMA Band V (RMC 12.2Kbps)	4132 (Low)	826.4	23.53	0.23
	4182 (Mid)	836.4	23.48	0.22
	4233 (High)	846.6	23.59	0.23

PCS Band				
Modes	Channel	Frequency (MHz)	Conducted Power (dBm)	Conducted Power (Watts)
GSM1900 (GSM)	512 (Low)	1850.2	29.34	0.86
	661 (Mid)	1880.0	29.19	0.83
	810 (High)	1909.8	29.17	0.83
GSM1900 (EDGE 8)	512 (Low)	1850.2	25.93	0.39
	661 (Mid)	1880.0	25.77	0.38
	810 (High)	1909.8	25.74	0.37
WCDMA Band II (HSDPA)	9262 (Low)	1852.4	23.41	0.22
	9400 (Mid)	1880.0	23.40	0.22
	9538 (High)	1907.6	23.82	0.24

## 3.2 Effective Radiated Power and Effective Isotropic Radiated Power Measurement

### 3.2.1 Description of the ERP/EIRP Measurement

ERP/EIRP is measured by substitution method according to ANSI / TIA / EIA-603-C-2004. The ERP of mobile transmitters must not exceed 7 Watts and the EIRP of mobile transmitters are limited to 2 Watts.

### 3.2.2 Measuring Instruments

See list of measuring instruments of this test report.

### 3.2.3 Test Procedures

1. The EUT was placed on an non-conductive rotating platform with 0.8 meter height in a semi-anechoic chamber. The radiated emission at the fundamental frequency was measured at 3 m with a test antenna and a spectrum analyzer with RBW= 3MHz,VBW= 3MHz, and peak detector settings.
2. During the measurement, the EUT was enforced in maximum power and linked with a base station. The highest emission was recorded from analyzer power level (LVL) from the 360 degrees rotation of the turntable and the test antenna raised and lowered over a range from 1 to 4 meters in both horizontally and vertically polarized orientations.
3. Effective Isotropic Radiated Power (EIRP) was measured by substitution method according to TIA/EIA-603-C. The EUT was replaced by dipole antenna (substitution antenna) at same location, and then a known power from S.G. was applied into the dipole antenna through a Tx cable, and then recorded the maximum Analyzer reading through raised and lowered the test antenna. The correction factor (in dB) = S.G. - Tx Cable loss + Substitution antenna gain - Analyzer reading. Then the EUT's EIRP was calculated with the correction factor,  $EIRP = LVL + \text{Correction factor}$  and  $ERP = EIRP - 2.15$ .

### 3.2.4 Test Setup

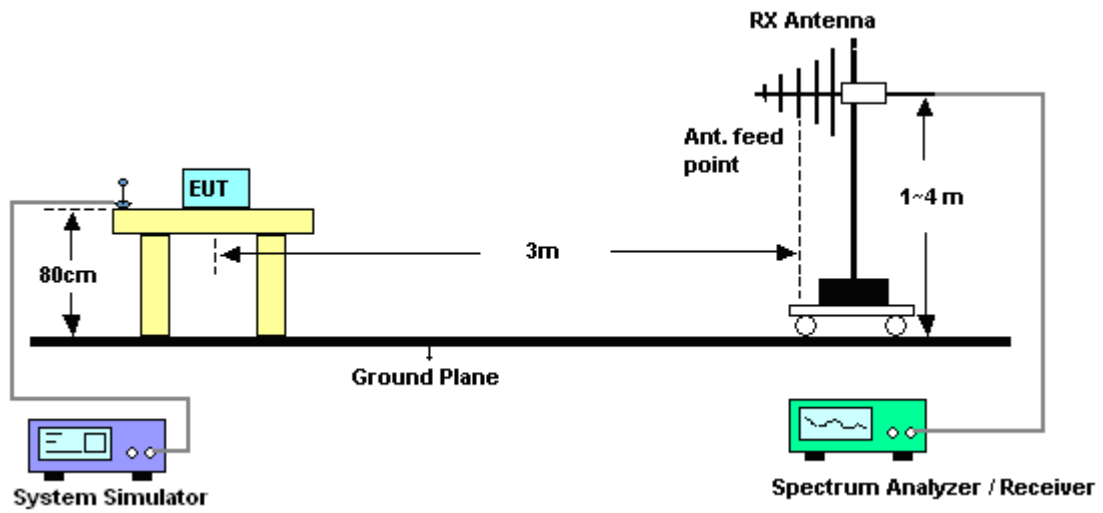

3.2.5 Test Result of ERP

GSM850 (GSM) Radiated Power ERP for Phone 1				
Horizontal Polarization				
Frequency (MHz)	LVL (dBm)	Correction Factor (dB)	ERP (dBm)	ERP (W)
824.2	-2.26	31.97	27.56	0.57
836.4	-1.62	32.44	28.67	0.74
848.8	-0.92	32.63	29.56	0.90
Vertical Polarization				
Frequency (MHz)	LVL (dBm)	Correction Factor (dB)	ERP (dBm)	ERP (W)
824.2	-10.98	35.39	22.26	0.17
836.4	-10.87	35.2	22.18	0.17
848.8	-10.60	35.69	22.94	0.20

\* ERP = LVL (dBm) + Correction Factor (dB) – 2.15

GSM850 (EDGE 8) Radiated Power ERP for Phone 1				
Horizontal Polarization				
Frequency (MHz)	LVL (dBm)	Correction Factor (dB)	ERP (dBm)	ERP (W)
824.2	-5.38	31.97	24.44	0.28
836.4	-4.65	32.44	25.64	0.37
848.8	-3.51	32.63	26.97	0.50
Vertical Polarization				
Frequency (MHz)	LVL (dBm)	Correction Factor (dB)	ERP (dBm)	ERP (W)
824.2	-13.64	35.39	19.60	0.09
836.4	-12.73	35.2	20.32	0.11
848.8	-11.94	35.69	21.60	0.14

\* ERP = LVL (dBm) + Correction Factor (dB) – 2.15



WCDMA Band V (RMC 12.2Kbps) Radiated Power ERP for Phone 1				
Horizontal Polarization				
Frequency (MHz)	LVL (dBm)	Correction Factor (dB)	ERP (dBm)	ERP (W)
826.40	-11.42	31.97	18.40	0.07
836.40	-12.62	32.44	17.67	0.06
846.60	-11.58	32.63	18.90	0.08
Vertical Polarization				
Frequency (MHz)	LVL (dBm)	Correction Factor (dB)	ERP (dBm)	ERP (W)
826.40	-20.88	35.39	12.36	0.02
836.40	-21.64	35.2	11.41	0.01
846.60	-20.58	35.69	12.96	0.02

\* ERP = LVL (dBm) + Correction Factor (dB) – 2.15

GSM850 (GSM) Radiated Power ERP for Phone 2				
Horizontal Polarization				
Frequency (MHz)	LVL (dBm)	Correction Factor (dB)	ERP (dBm)	ERP (W)
824.2	-2.12	31.97	27.70	0.59
836.4	-1.21	32.44	29.08	0.81
848.8	-1.41	32.63	29.07	0.81
Vertical Polarization				
Frequency (MHz)	LVL (dBm)	Correction Factor (dB)	ERP (dBm)	ERP (W)
824.2	-11.77	35.39	21.47	0.14
836.4	-10.49	35.2	22.56	0.18
848.8	-10.96	35.69	22.58	0.18

\* ERP = LVL (dBm) + Correction Factor (dB) – 2.15



GSM850 (EDGE 8) Radiated Power ERP for Phone 2				
Horizontal Polarization				
Frequency (MHz)	LVL (dBm)	Correction Factor (dB)	ERP (dBm)	ERP (W)
824.2	-4.60	31.97	25.22	0.33
836.4	-4.94	32.44	25.35	0.34
848.8	-4.44	32.63	26.04	0.40
Vertical Polarization				
Frequency (MHz)	LVL (dBm)	Correction Factor (dB)	ERP (dBm)	ERP (W)
824.2	-12.61	35.39	20.63	0.12
836.4	-11.55	35.2	21.50	0.14
848.8	-10.89	35.69	22.65	0.18

\* ERP = LVL (dBm) + Correction Factor (dB) – 2.15

WCDMA Band V (RMC 12.2Kbps) Radiated Power ERP for Phone 2				
Horizontal Polarization				
Frequency (MHz)	LVL (dBm)	Correction Factor (dB)	ERP (dBm)	ERP (W)
826.4	-10.37	31.97	19.45	0.09
836.4	-12.58	32.44	17.71	0.06
846.6	-11.40	32.63	19.08	0.08
Vertical Polarization				
Frequency (MHz)	LVL (dBm)	Correction Factor (dB)	ERP (dBm)	ERP (W)
826.4	-19.56	35.39	13.68	0.02
836.4	-21.50	35.2	11.55	0.01
846.6	-20.91	35.69	12.63	0.02

\* ERP = LVL (dBm) + Correction Factor (dB) – 2.15





3.2.6 Test Result of EIRP

GSM1900 (GSM) Radiated Power EIRP for Phone 1				
Horizontal Polarization				
Frequency (MHz)	LVL (dBm)	Correction Factor (dB)	EIRP (dBm)	EIRP (W)
1850.2	-12.53	41.24	28.71	0.74
1880.0	-12.04	41.46	29.42	0.87
1909.8	-12.07	41.21	29.14	0.82
Vertical Polarization				
Frequency (MHz)	LVL (dBm)	Correction Factor (dB)	EIRP (dBm)	EIRP (W)
1850.2	-18.59	41.52	22.93	0.20
1880.0	-18.56	43.10	24.54	0.28
1909.8	-19.67	42.73	23.06	0.20

\* EIRP = LVL (dBm) + Correction Factor (dB)

GSM1900 (EDGE 8) Radiated Power EIRP for Phone 1				
Horizontal Polarization				
Frequency (MHz)	LVL (dBm)	Correction Factor (dB)	EIRP (dBm)	EIRP (W)
1850.2	-11.46	41.24	29.78	0.95
1880.0	-12.32	41.46	29.14	0.82
1909.8	-12.22	41.21	28.99	0.79
Vertical Polarization				
Frequency (MHz)	LVL (dBm)	Correction Factor (dB)	EIRP (dBm)	EIRP (W)
1850.2	-18.02	41.52	23.50	0.22
1880.0	-19.15	43.10	23.95	0.25
1909.8	-20.57	42.73	22.16	0.16

\* EIRP = LVL (dBm) + Correction Factor (dB)



WCDMA Band II (HSDPA) Radiated Power EIRP for Phone 1				
Horizontal Polarization				
Frequency (MHz)	LVL (dBm)	Correction Factor (dB)	EIRP (dBm)	EIRP (W)
1852.40	-20.04	41.24	21.20	0.13
1880.00	-19.32	41.46	22.14	0.16
1907.60	-19.41	41.21	21.80	0.15
Vertical Polarization				
Frequency (MHz)	LVL (dBm)	Correction Factor (dB)	EIRP (dBm)	EIRP (W)
1852.40	-27.34	41.52	14.18	0.03
1880.00	-26.51	43.10	16.59	0.05
1907.60	-28.03	42.73	14.70	0.03

\* EIRP = LVL (dBm) + Correction Factor (dB)

GSM1900 (GSM) Radiated Power EIRP for Phone 2				
Horizontal Polarization				
Frequency (MHz)	LVL (dBm)	Correction Factor (dB)	EIRP (dBm)	EIRP (W)
1850.2	-18.55	41.24	22.69	0.19
1880.0	-18.26	41.46	23.20	0.21
1909.8	-17.95	41.21	23.26	0.21
Vertical Polarization				
Frequency (MHz)	LVL (dBm)	Correction Factor (dB)	EIRP (dBm)	EIRP (W)
1850.2	-15.00	41.52	26.52	0.45
1880.0	-15.85	43.10	27.25	0.53
1909.8	-17.41	42.73	25.32	0.34

\* EIRP = LVL (dBm) + Correction Factor (dB)



GSM1900 (EDGE 8) Radiated Power EIRP for Phone 2				
Horizontal Polarization				
Frequency (MHz)	LVL (dBm)	Correction Factor (dB)	EIRP (dBm)	EIRP (W)
1850.2	-17.37	41.24	23.87	0.24
1880.0	-18.95	41.46	22.51	0.18
1909.8	-20.23	41.21	20.98	0.13
Vertical Polarization				
Frequency (MHz)	LVL (dBm)	Correction Factor (dB)	EIRP (dBm)	EIRP (W)
1850.2	-15.16	41.52	26.36	0.43
1880.0	-16.02	43.10	27.08	0.51
1909.8	-17.61	42.73	25.12	0.33

\* EIRP = LVL (dBm) + Correction Factor (dB)

WCDMA Band II (HSDPA) Radiated Power EIRP for Phone 2				
Horizontal Polarization				
Frequency (MHz)	LVL (dBm)	Correction Factor (dB)	EIRP (dBm)	EIRP (W)
1852.4	-24.31	41.24	16.93	0.05
1880.0	-26.38	41.46	15.08	0.03
1907.6	-25.41	41.21	15.80	0.04
Vertical Polarization				
Frequency (MHz)	LVL (dBm)	Correction Factor (dB)	EIRP (dBm)	EIRP (W)
1852.4	-24.37	41.52	17.15	0.05
1880.0	-23.93	43.10	19.17	0.08
1907.6	-24.63	42.73	18.10	0.06

\* EIRP = LVL (dBm) + Correction Factor (dB)

### 3.3 Occupied Bandwidth Measurement

#### 3.3.1 Description of Occupied Bandwidth Measurement

The emission bandwidth is defined as the width of the signal between two points, located at the 2 sides of the carrier frequency, outside of which all emissions are attenuated at least 26 dB below the transmitter power.

#### 3.3.2 Measuring Instruments

See list of measuring instruments of this test report.

#### 3.3.3 Test Procedures

1. The EUT was connected to Spectrum Analyzer and Base Station via power divider.
2. The 99% and 26 dB occupied bandwidth (BW) of the middle channel for the highest RF powers were measured.

#### 3.3.4 Test Setup

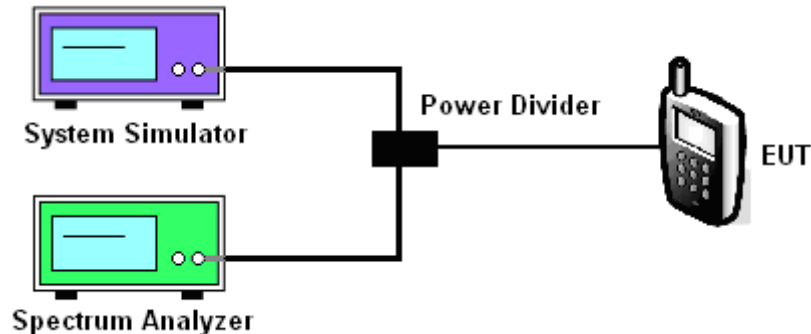



### 3.3.5 Test Result (Plots) of Occupied Bandwidth

<b>Band :</b>	GSM 850	<b>Power Stage :</b>	High
<b>Test Mode :</b>	GSM Link		

99% Occupied Bandwidth Plot on Channel 189

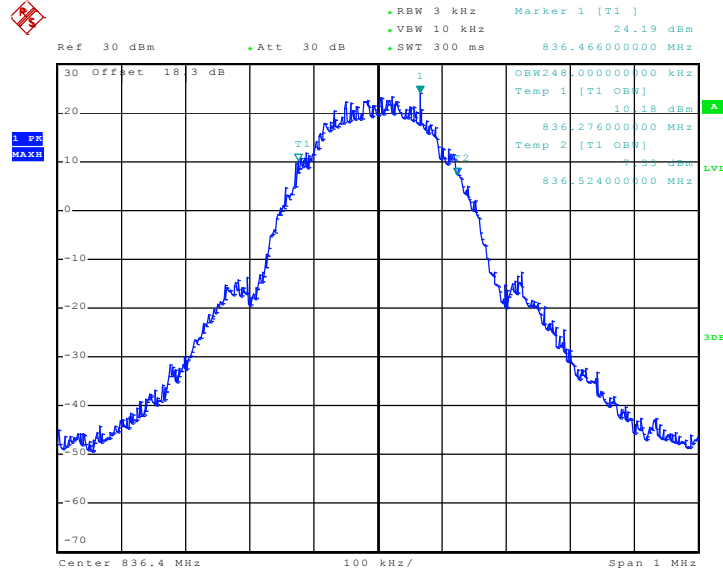

Date: 8.JUL.2010 09:14:17

26dB Bandwidth Plot on Channel 189

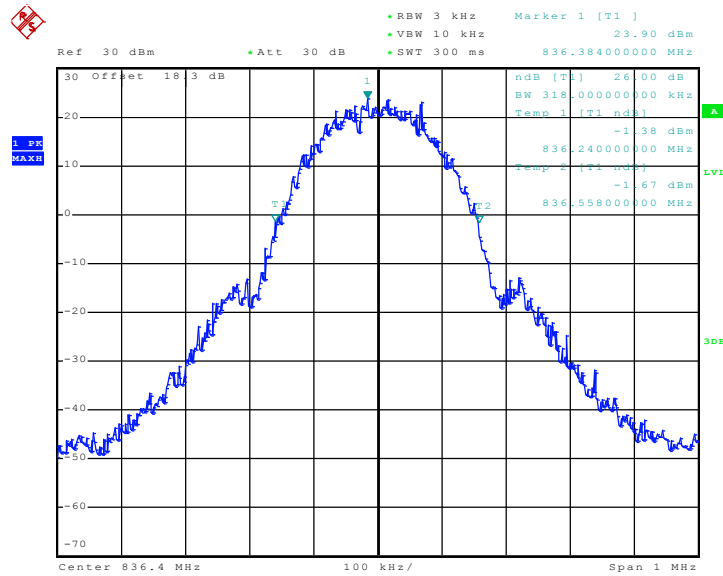

Date: 8.JUL.2010 09:12:57



<b>Band :</b>	GSM 850	<b>Power Stage :</b>	High
<b>Test Mode :</b>	EDGE 8 Link		

**99% Occupied Bandwidth Plot on Channel 189**

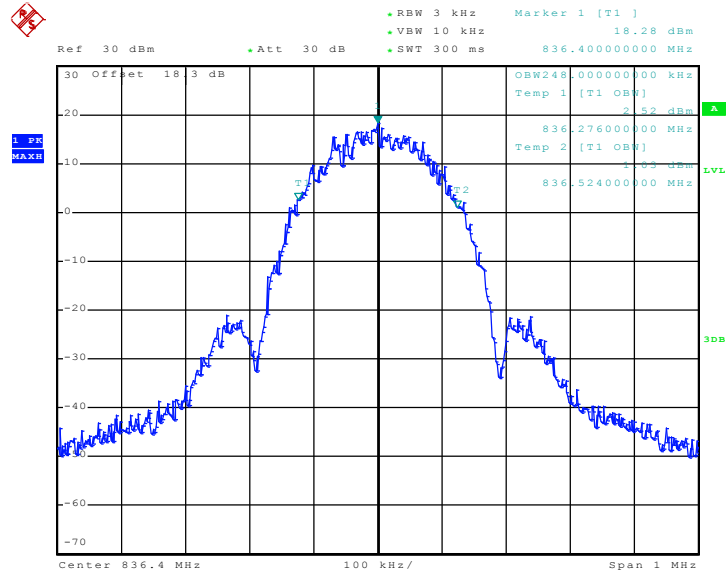

Date: 8.JUL.2010 10:47:39

**26dB Bandwidth Plot on Channel 189**

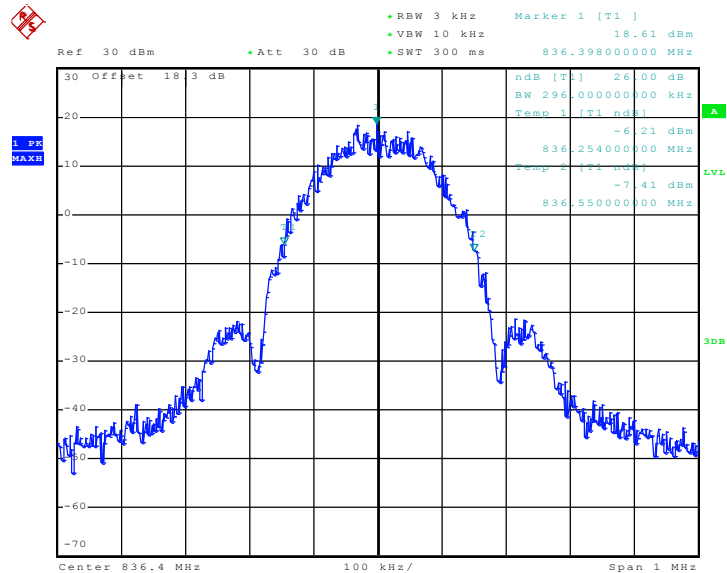

Date: 8.JUL.2010 10:46:20



<b>Band :</b>	GSM 1900	<b>Power Stage :</b>	High
<b>Test Mode :</b>	GSM Link		

**99% Occupied Bandwidth Plot on Channel 661**

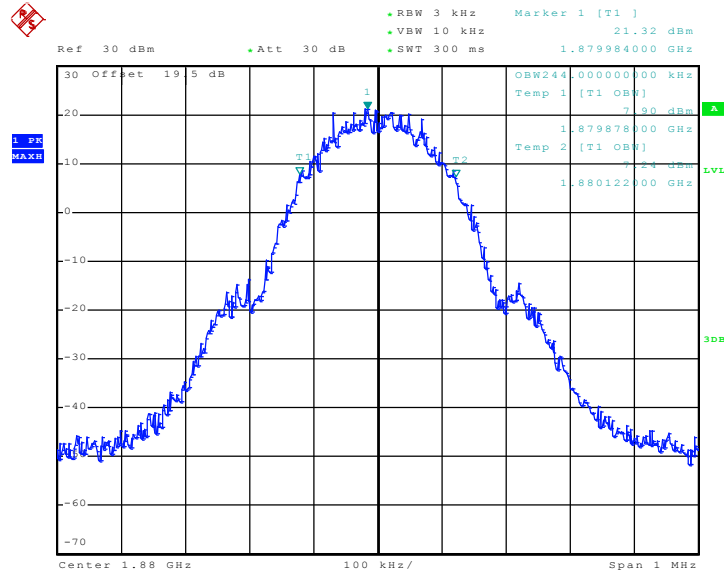

Date: 8.JUL.2010 09:28:39

**26dB Bandwidth Plot on Channel 661**

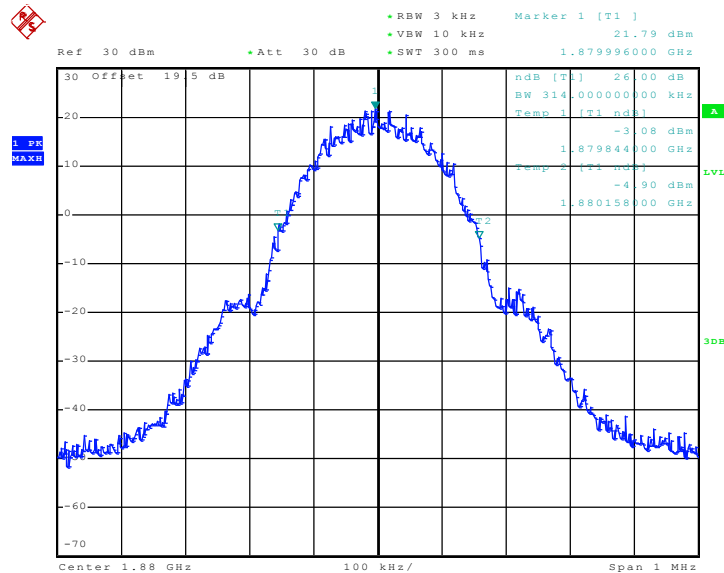

Date: 8.JUL.2010 09:27:19



<b>Band :</b>	GSM 1900	<b>Power Stage :</b>	High
<b>Test Mode :</b>	EDGE 8 Link		

99% Occupied Bandwidth Plot on Channel 661

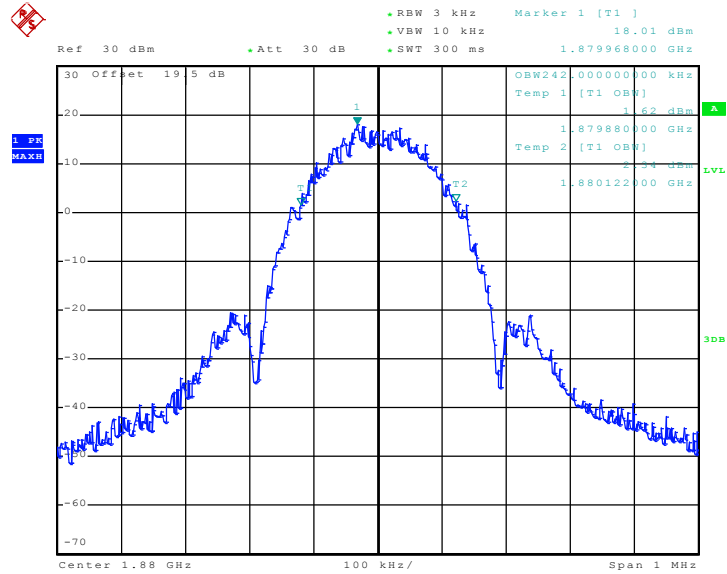

Date: 8.JUL.2010 10:37:47

26dB Bandwidth Plot on Channel 661

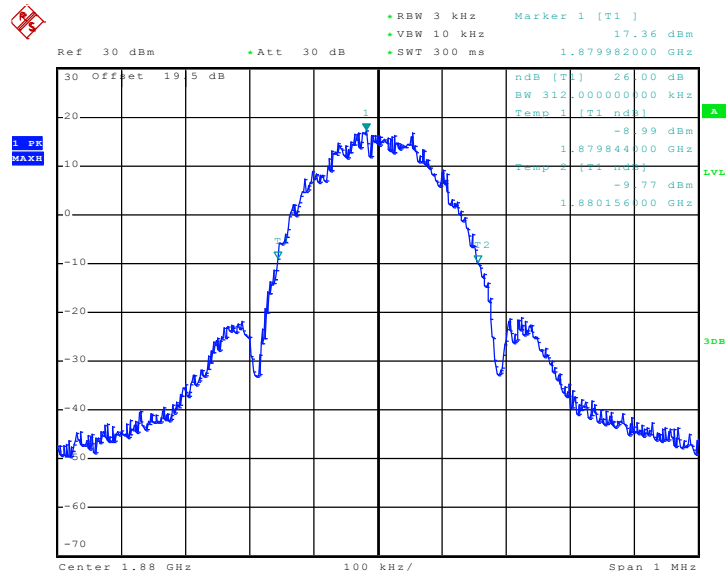

Date: 8.JUL.2010 10:36:28





Band :	WCDMA Band V	Power Stage :	High
Test Mode :	RMC 12.2Kbps Link		

99% Occupied Bandwidth Plot on Channel 4182

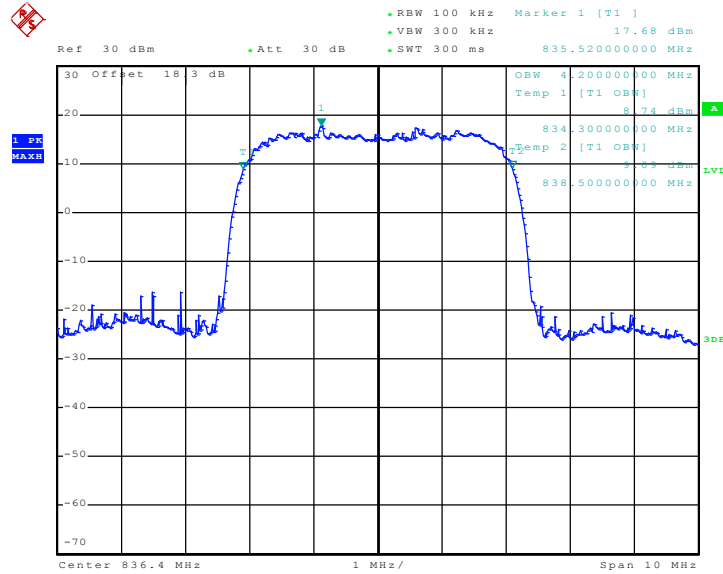

Date: 8.JUL.2010 11:00:01

26dB Bandwidth Plot on Channel 4182

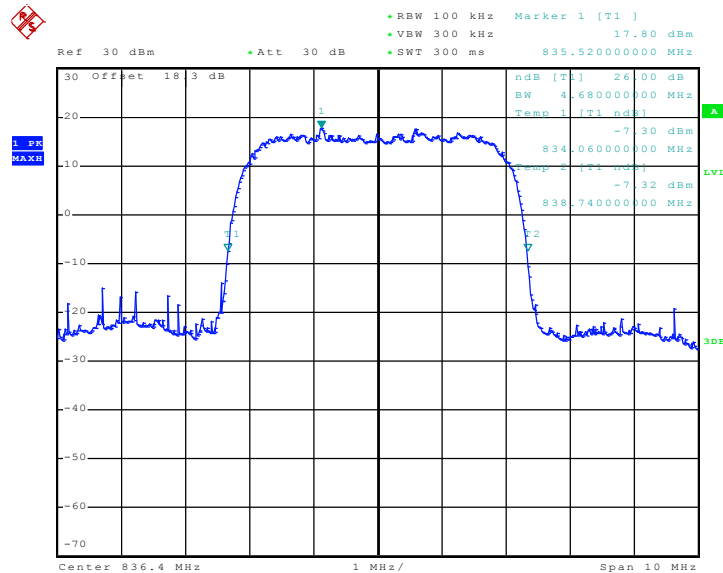

Date: 8.JUL.2010 10:58:42



Band :	WCDMA Band II	Power Stage :	High
Test Mode :	HSDPA Link		

99% Occupied Bandwidth Plot on Channel 9400

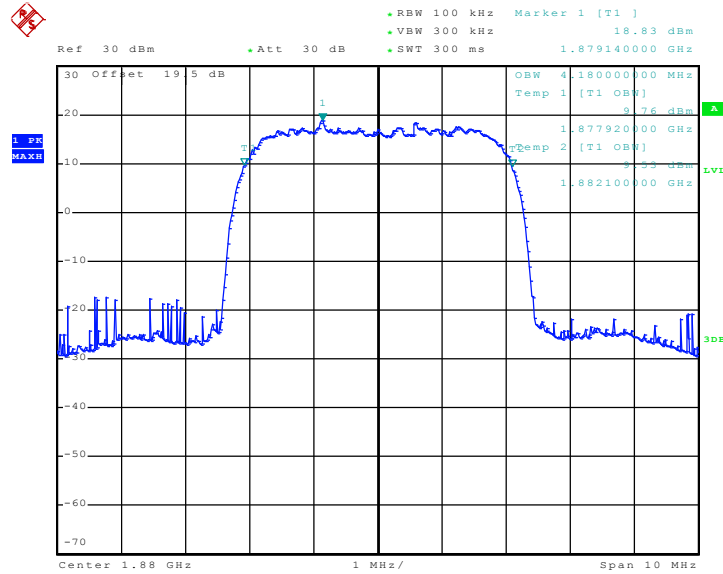

Date: 8.JUL.2010 11:11:45

26dB Bandwidth Plot on Channel 9400

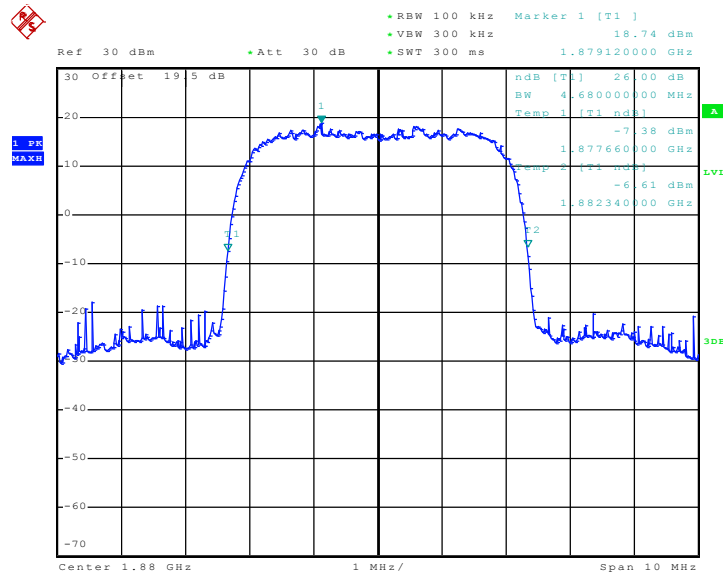

Date: 8.JUL.2010 11:10:26

## 3.4 Band Edge Measurement

### 3.4.1 Description of Band Edge Measurement

The power of any emission outside of the authorized operating frequency ranges must be lower than the transmitter power (P) by a factor of at least  $43 + 10 \log (P)$  dB.

### 3.4.2 Measuring Instruments

See list of measuring instruments of this test report.

### 3.4.3 Test Procedures

1. The EUT was connected to Spectrum Analyzer and Base Station via power divider.
2. The band edges of low and high channels for the highest RF powers were measured. Setting RBW as roughly BW/100.

### 3.4.4 Test Setup

<Conducted Band Edge >

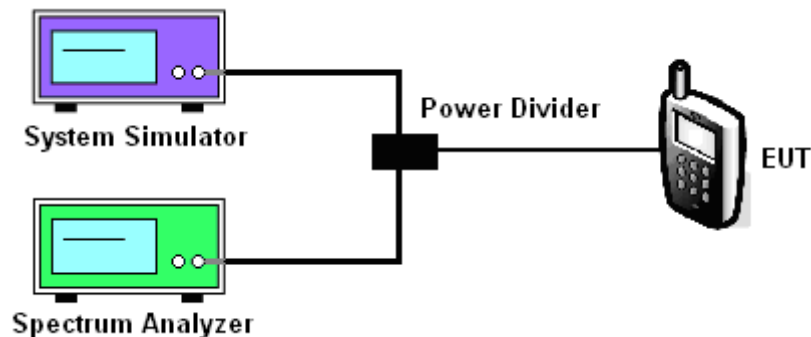



### 3.4.5 Test Result (Plots) of Conducted Band Edge

Band :	GSM850	Power Stage :	High
Test Mode :	GSM Link		

Lower Band Edge Plot on Channel 128

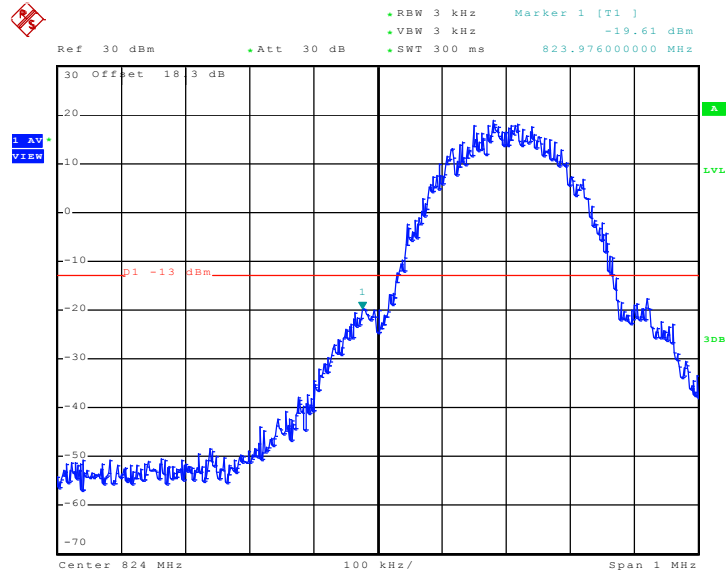

Date: 8.JUL.2010 09:16:42

Higher Band Edge Plot on Channel 251

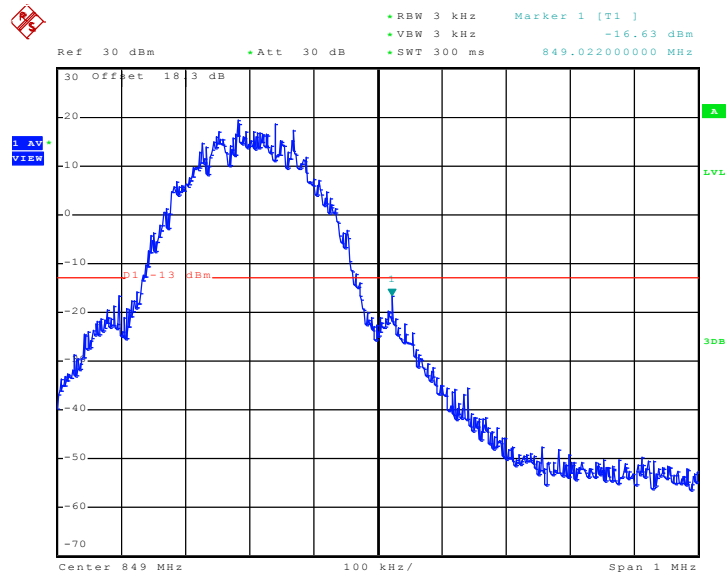

Date: 8.JUL.2010 09:17:08



Band :	GSM850	Power Stage :	High
Test Mode :	EDGE 8 Link		

Lower Band Edge Plot on Channel 128

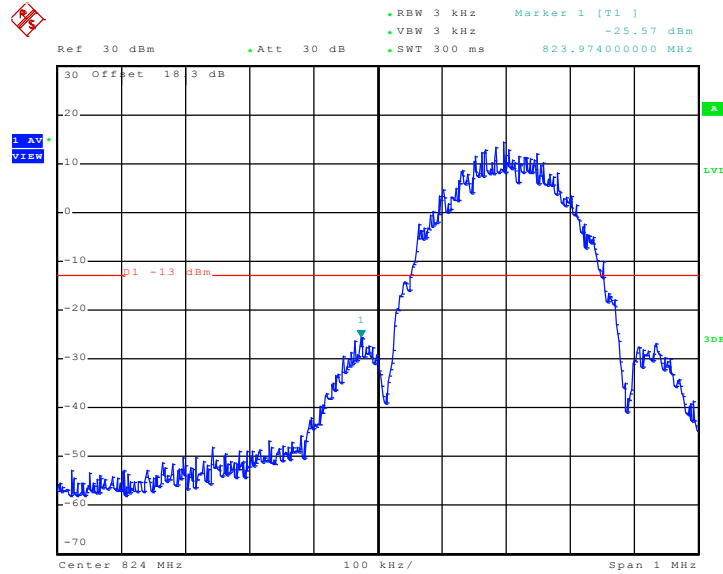

Date: 8.JUL.2010 10:50:34

Higher Band Edge Plot on Channel 251

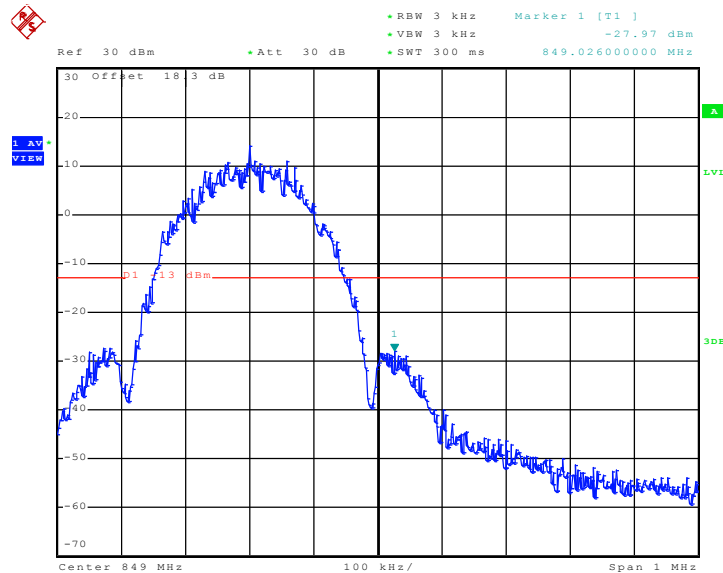

Date: 8.JUL.2010 10:51:00



Band :	GSM1900	Power Stage :	High
Test Mode :	GSM Link		

Lower Band Edge Plot on Channel 512

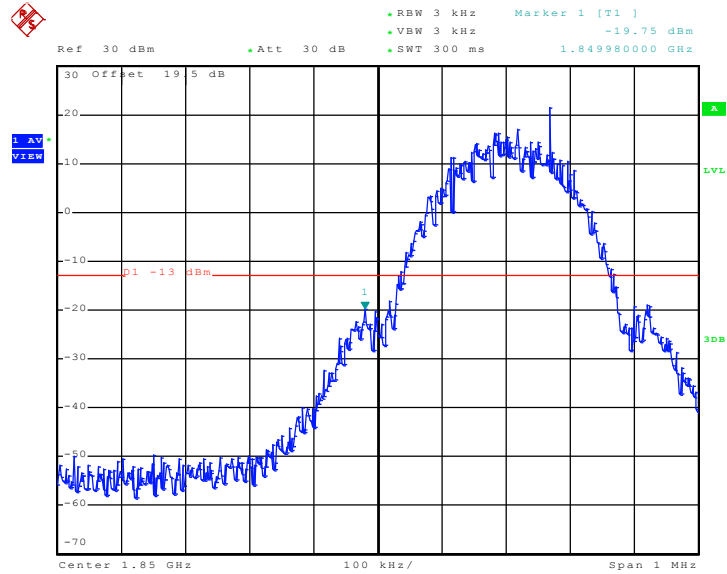

Date: 8.JUL.2010 09:31:16

Higher Band Edge Plot on Channel 810

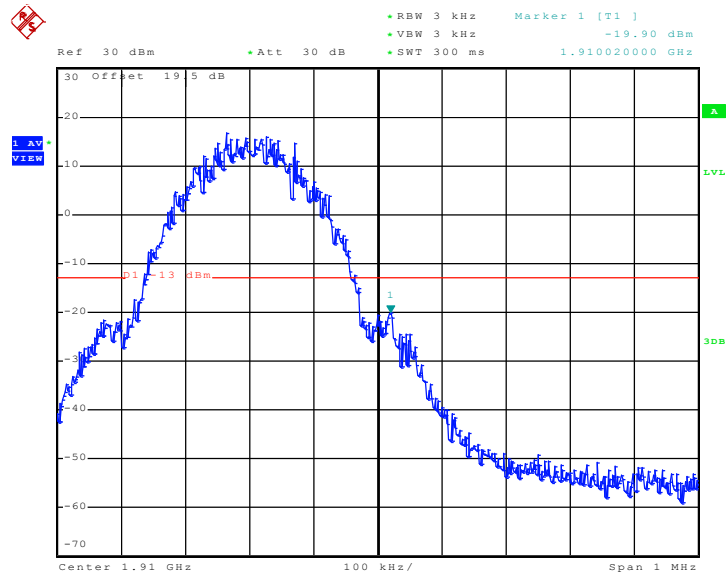

Date: 8.JUL.2010 09:31:43



Band :	GSM1900	Power Stage :	High
Test Mode :	EDGE 8 Link		

Lower Band Edge Plot on Channel 512

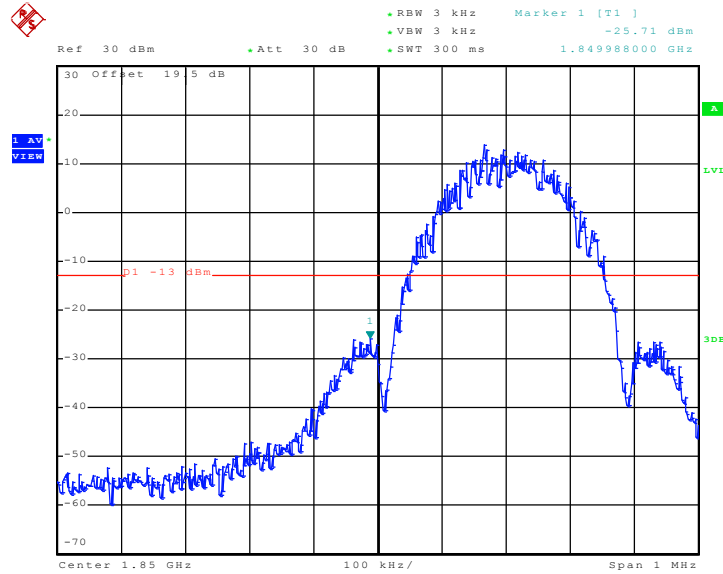

Date: 8.JUL.2010 10:40:39

Higher Band Edge Plot on Channel 810

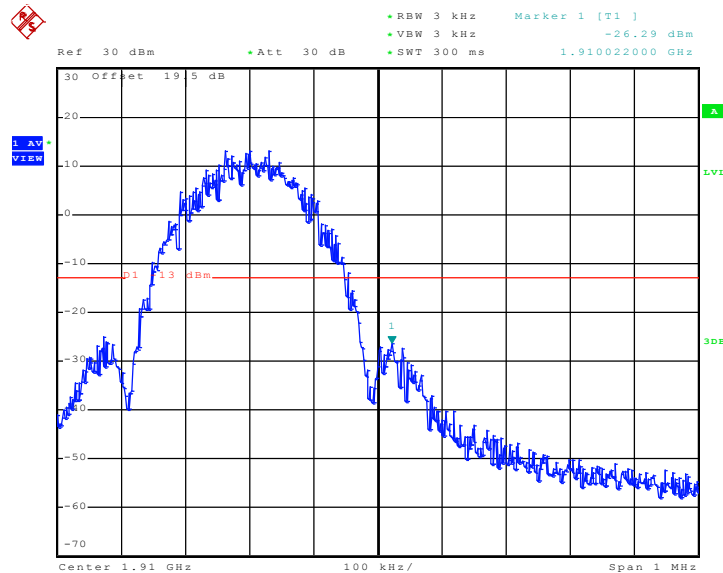

Date: 8.JUL.2010 10:41:06



Band :	WCDMA Band V	Power Stage :	High
Test Mode :	RMC 12.2Kbps Link		

Lower Band Edge Plot on Channel 4132

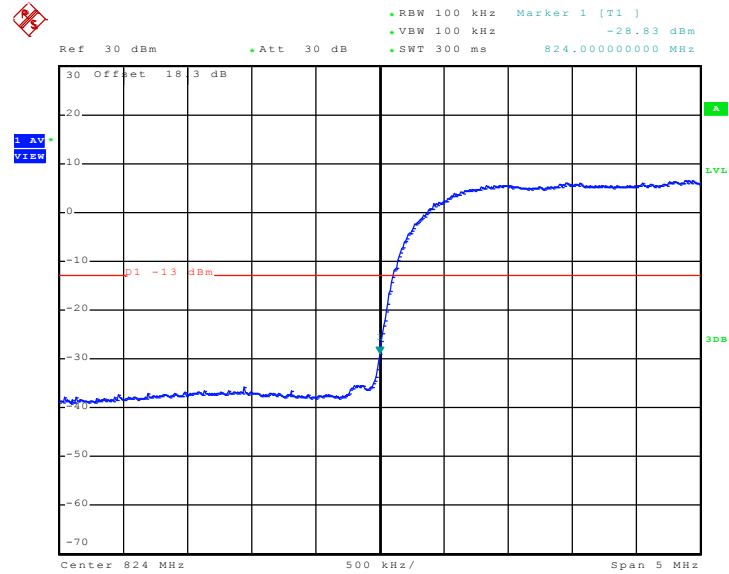

Date: 8.JUL.2010 11:02:59

Higher Band Edge Plot on Channel 4233

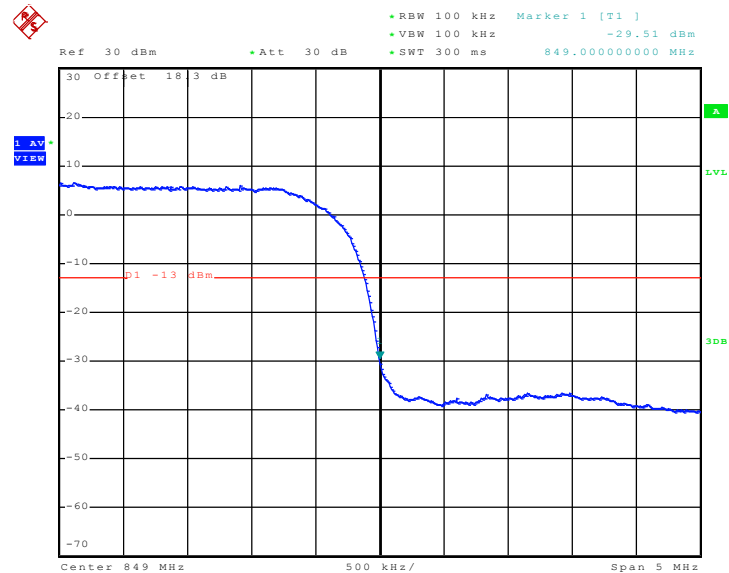

Date: 8.JUL.2010 11:03:26





Band :	WCDMA Band II	Power Stage :	High
Test Mode :	HSDPA Link		

Lower Band Edge Plot on Channel 9262

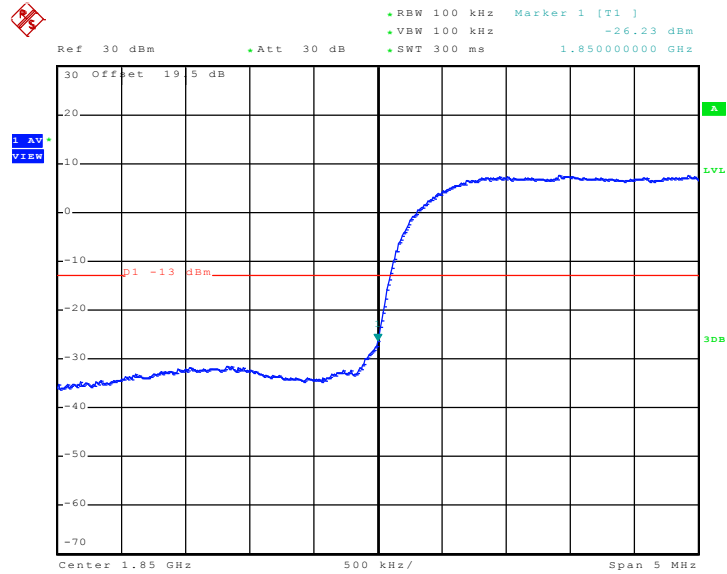

Date: 8.JUL.2010 11:14:52

Higher Band Edge Plot on Channel 9538

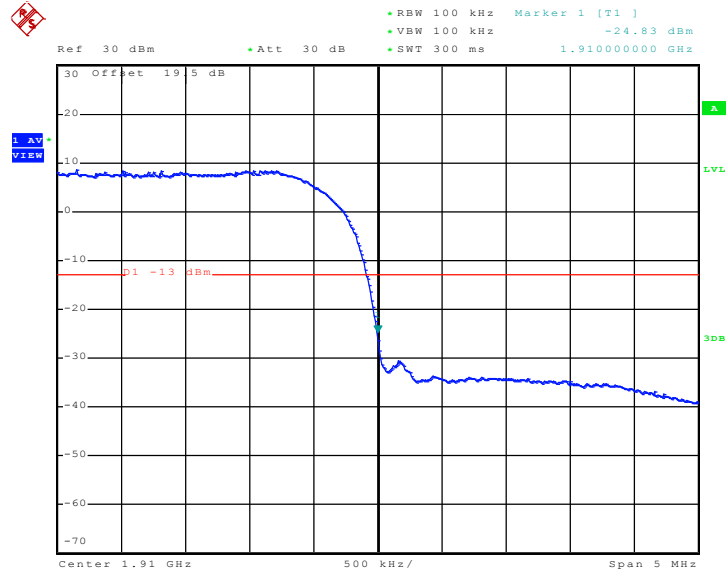

Date: 8.JUL.2010 11:15:19

## 3.5 Conducted Emission Measurement

### 3.5.1 Description of Conducted Emission Measurement

The power of any emission outside of the authorized operating frequency ranges must be lower than the transmitter power (P) by a factor of at least  $43 + 10 \log (P)$  dB.

It is measured by means of a calibrated spectrum analyzer and scanned from 30 MHz up to a frequency including its 10<sup>th</sup> harmonic.

### 3.5.2 Measuring Instruments

See list of measuring instruments of this test report.

### 3.5.3 Test Procedures

1. The EUT was connected to spectrum analyzer and base station via power divider.
2. The middle channel for the highest RF power within the transmitting frequency was measured.
3. The conducted spurious emission for the whole frequency range was taken.

### 3.5.4 Test Setup

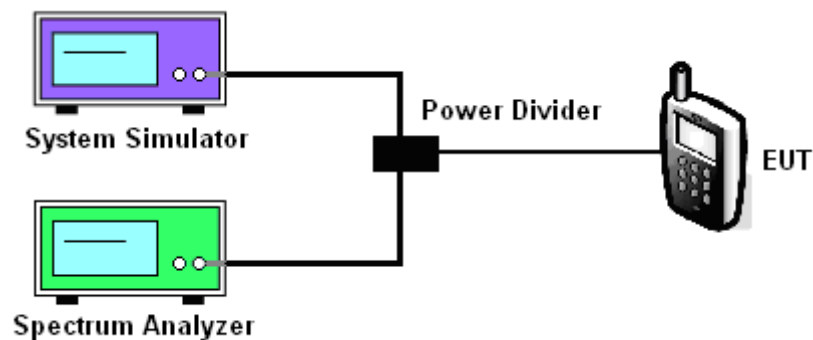



### 3.5.5 Test Result (Plots) of Conducted Emission

Band :	GSM850	Channel :	CH189
Test Mode :	GSM Link		

Conducted Emission Plot between 30MHz ~ 1GHz

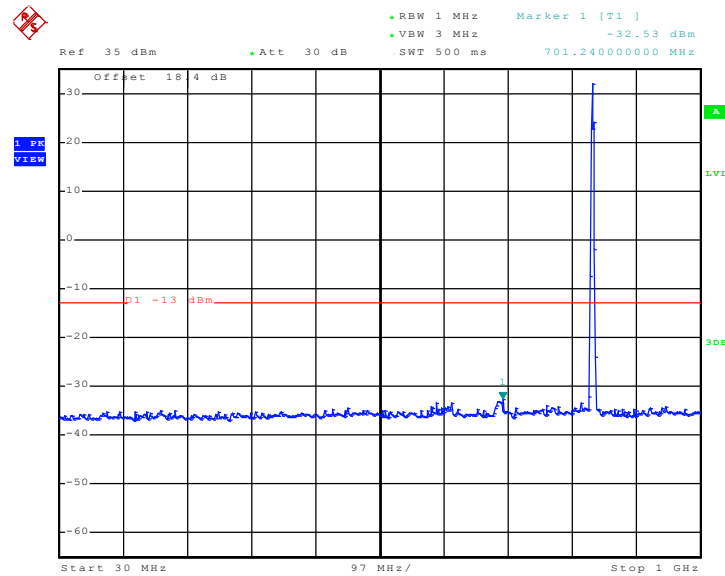

Date: 8.JUL.2010 15:34:43

Conducted Emission Plot between 1GHz ~ 3GHz

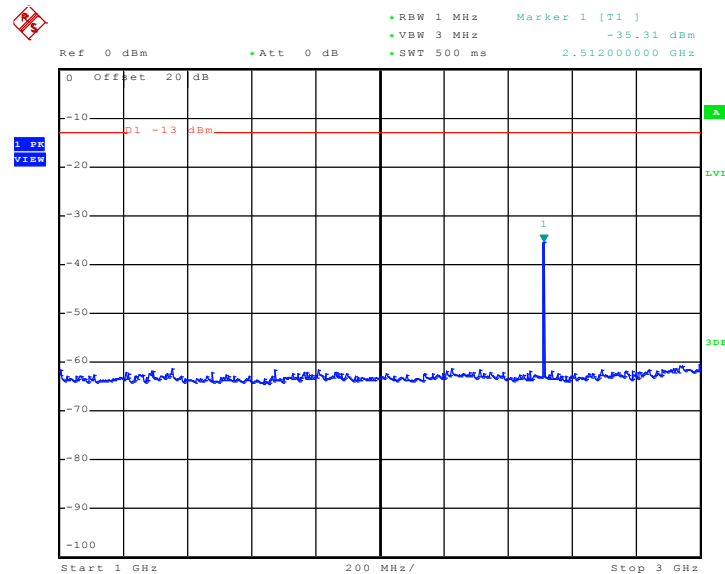

Date: 8.JUL.2010 15:33:09



### Conducted Emission Plot between 3GHz ~ 7GHz

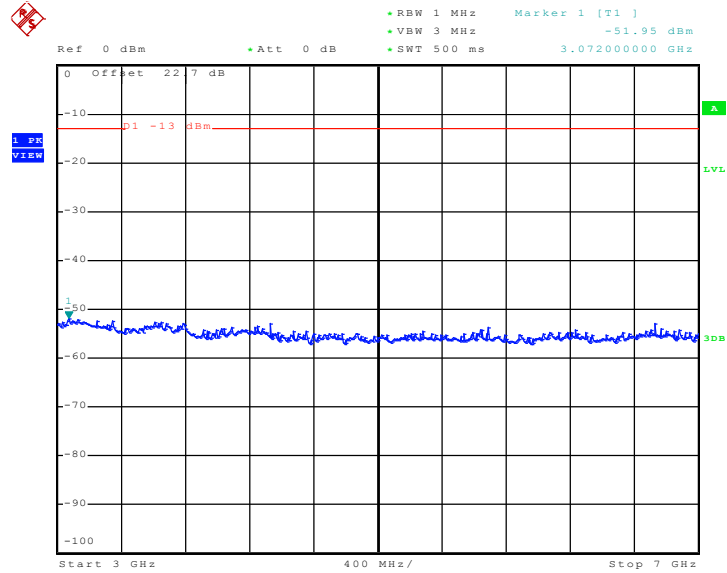

Date: 8.JUL.2010 15:32:04

### Conducted Emission Plot between 7GHz ~ 9GHz

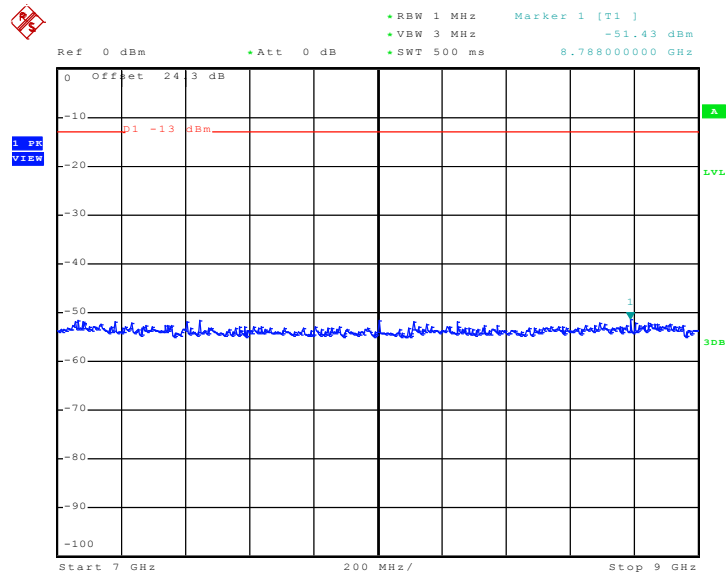

Date: 8.JUL.2010 15:31:38



Band :	GSM850	Channel :	CH189
Test Mode :	EDGE 8 Link		

Conducted Emission Plot between 30MHz ~ 1GHz

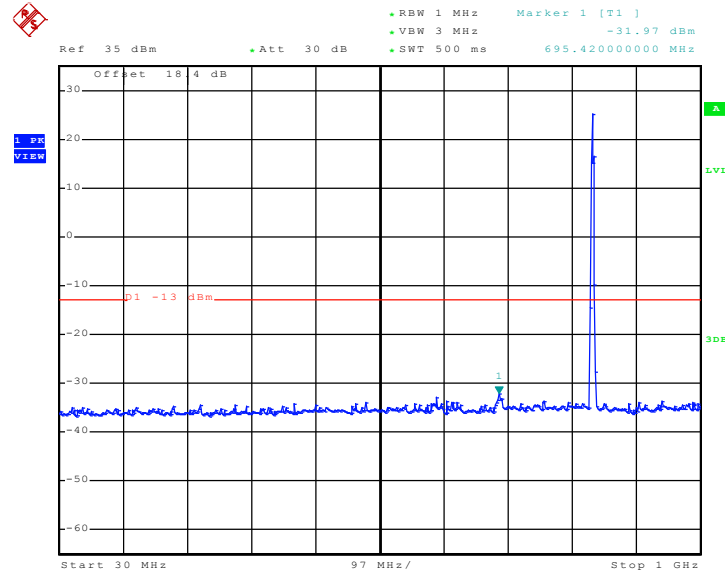

Date: 8.JUL.2010 15:23:56

Conducted Emission Plot between 1GHz ~ 3GHz

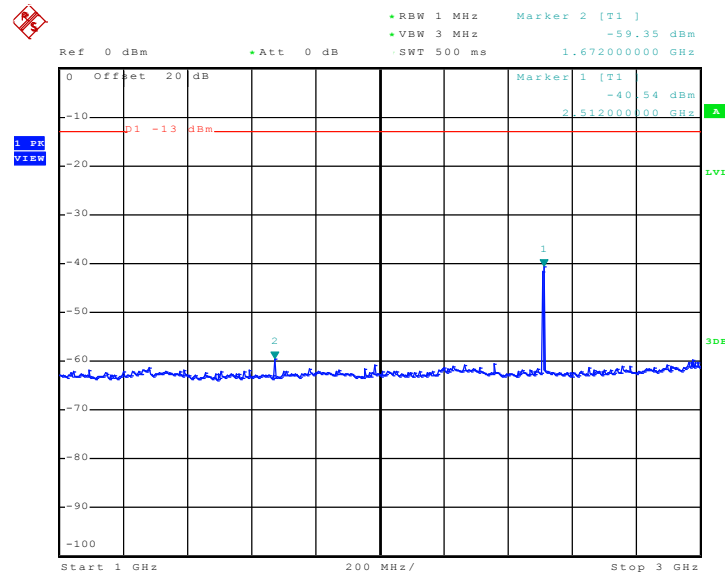

Date: 8.JUL.2010 15:26:25



### Conducted Emission Plot between 3GHz ~ 7GHz

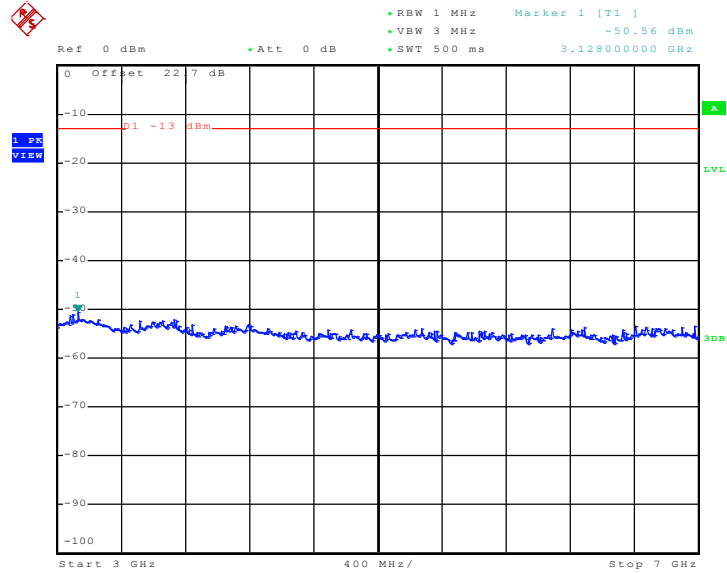

Date: 8.JUL.2010 15:26:57

### Conducted Emission Plot between 7GHz ~ 9GHz

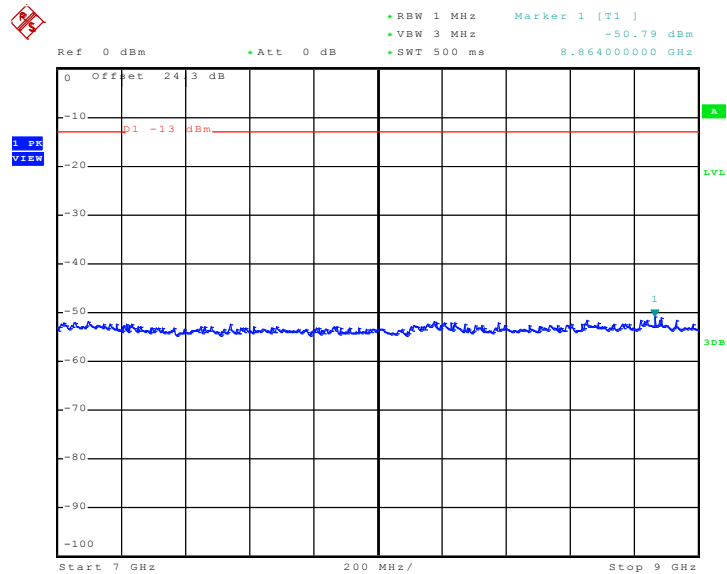

Date: 8.JUL.2010 15:27:42



Band :	GSM1900	Channel :	CH661
Test Mode :	GSM Link		

Conducted Emission Plot between 30MHz ~ 1GHz

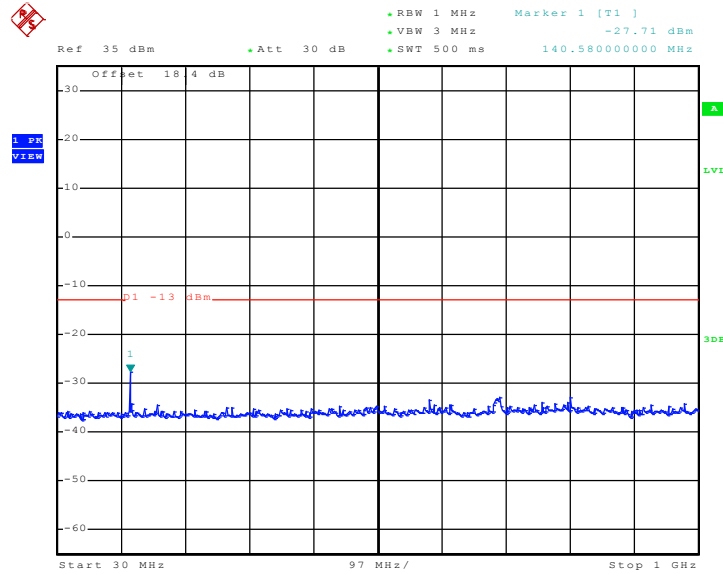

Date: 8.JUL.2010 15:05:37

Conducted Emission Plot between 1GHz ~ 3GHz

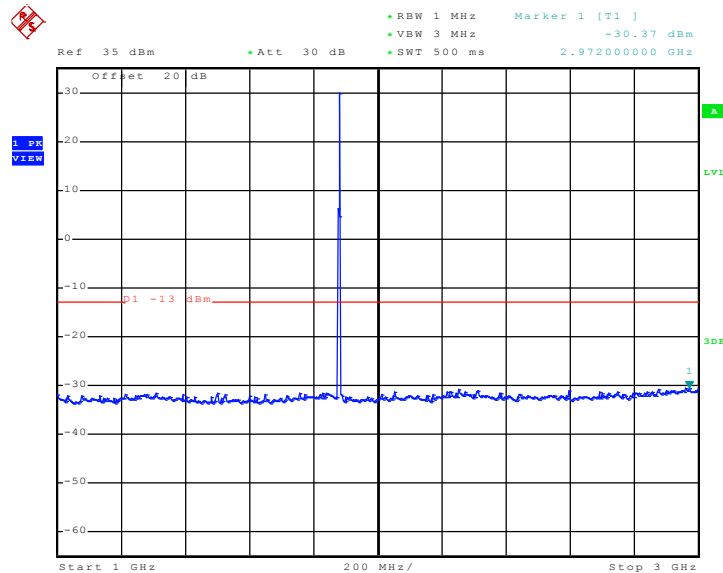

Date: 8.JUL.2010 15:07:42



### Conducted Emission Plot between 3GHz ~ 7GHz

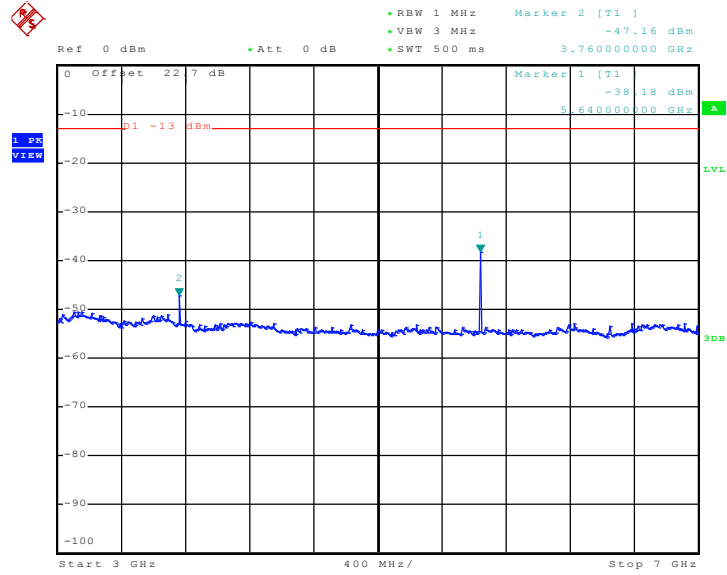

Date: 8.JUL.2010 15:10:41

### Conducted Emission Plot between 7GHz ~ 13.6GHz

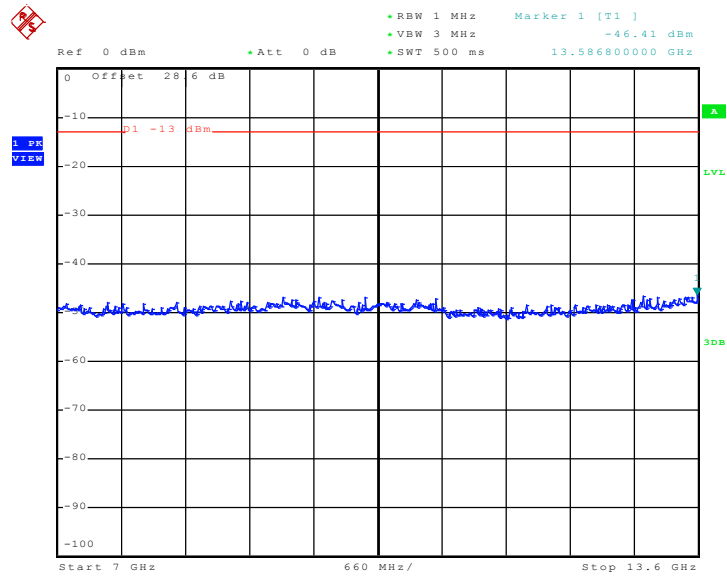

Date: 8.JUL.2010 15:16:58





Conducted Emission Plot between 13.6GHz ~ 19.1GHz

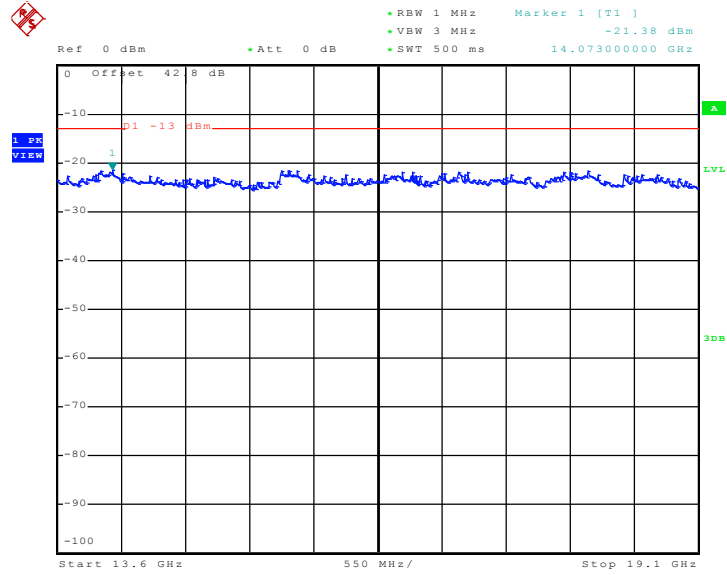

Date: 8.JUL.2010 15:17:31



Band :	GSM1900	Channel :	CH661
Test Mode :	EDGE 8 Link		

Conducted Emission Plot between 30MHz ~ 1GHz

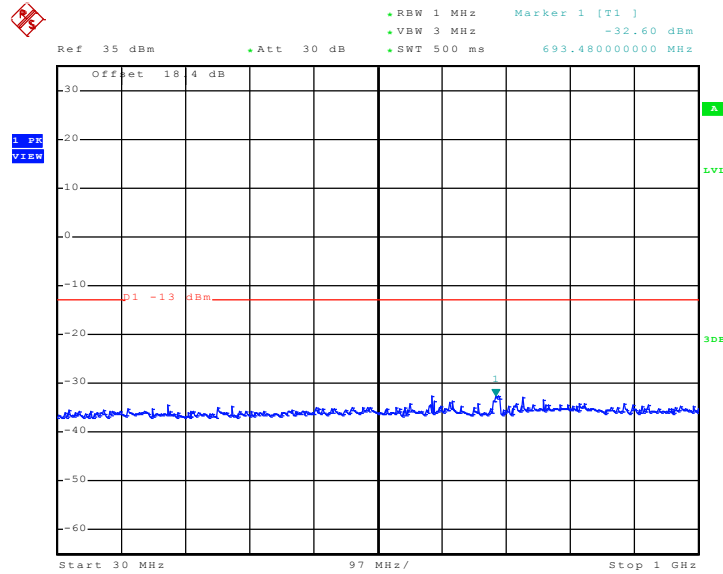

Date: 8.JUL.2010 15:01:54

Conducted Emission Plot between 1GHz ~ 3GHz

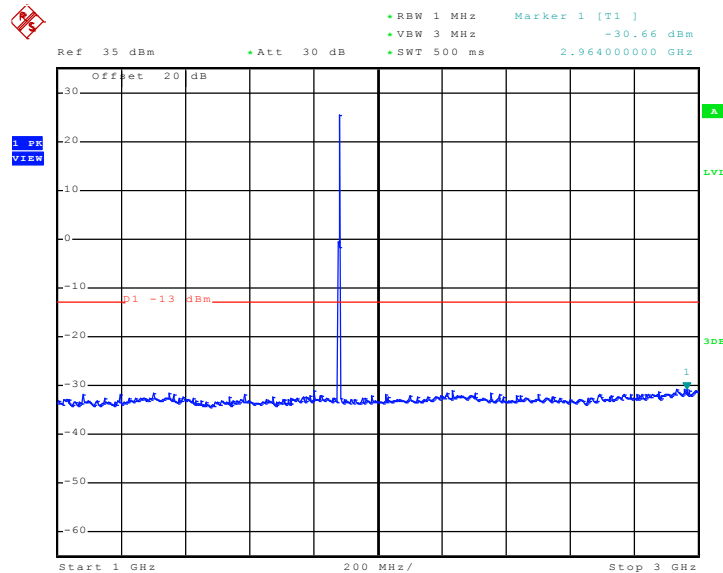

Date: 8.JUL.2010 15:01:17



### Conducted Emission Plot between 3GHz ~ 7GHz

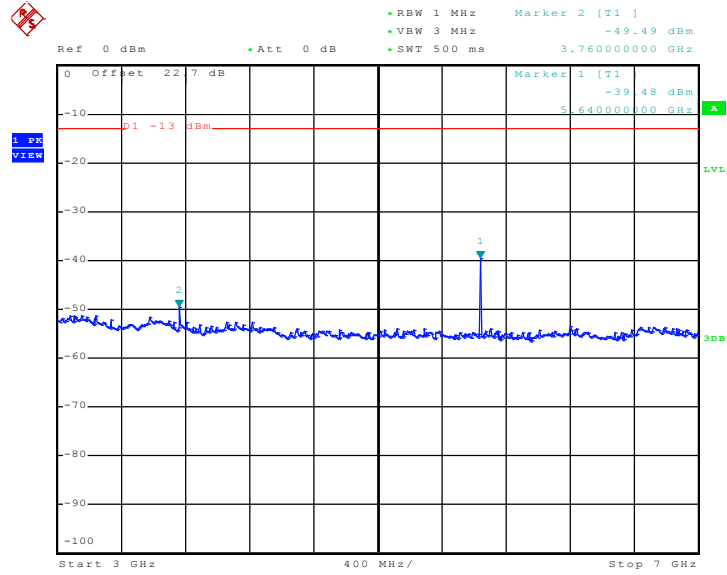

Date: 8.JUL.2010 14:58:41

### Conducted Emission Plot between 7GHz ~ 13.6GHz

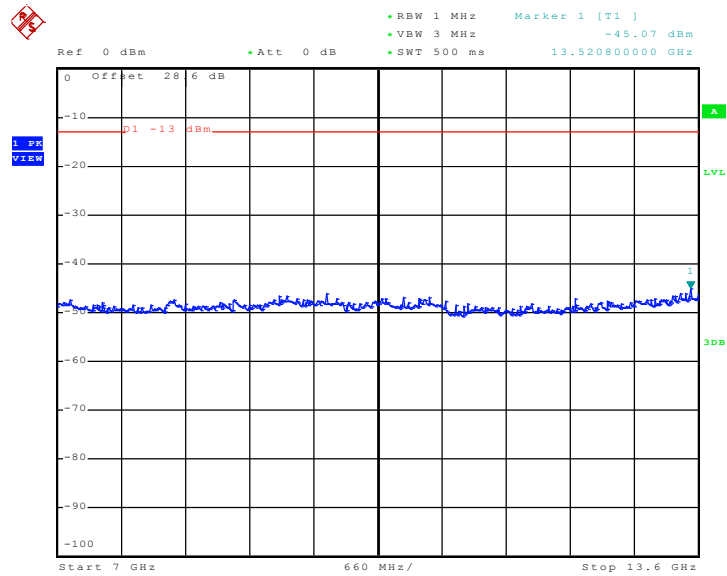

Date: 8.JUL.2010 14:57:35



Conducted Emission Plot between 13.6GHz ~ 19.1GHz

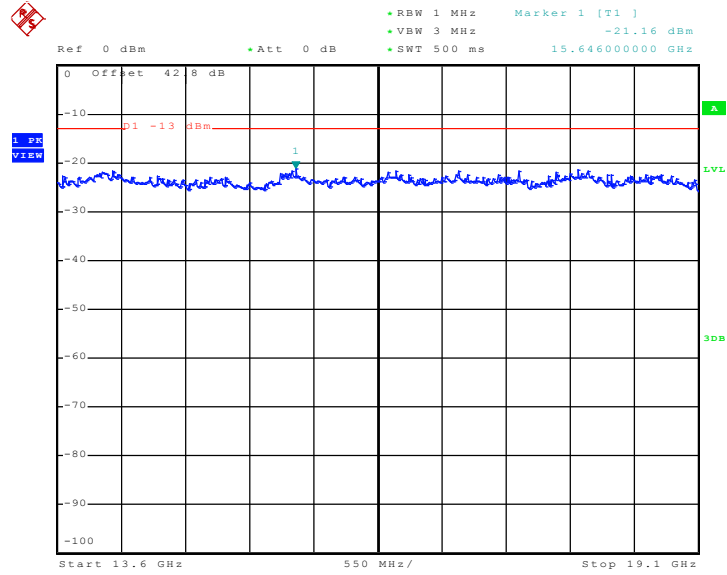

Date: 8.JUL.2010 14:56:39



Band :	WCDMA Band V	Channel :	CH4182
Test Mode :	RMC 12.2Kbps Link		

Conducted Emission Plot between 30MHz ~ 1GHz

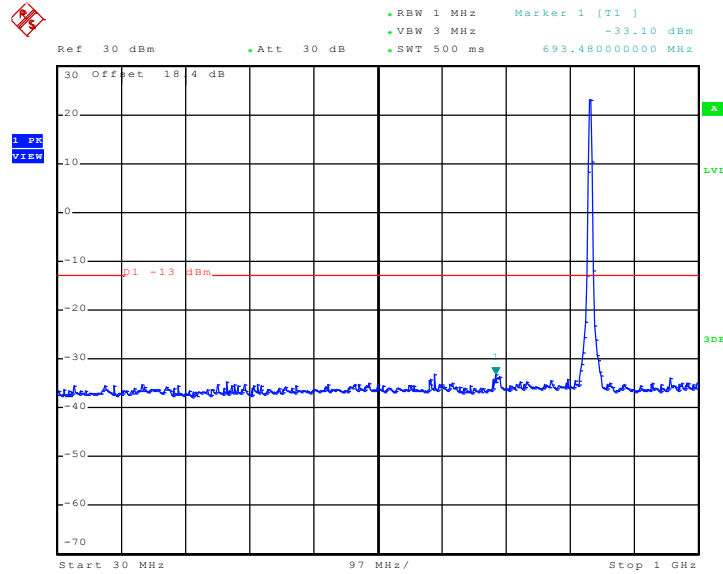

Date: 8.JUL.2010 14:45:12

Conducted Emission Plot between 1GHz ~ 3GHz

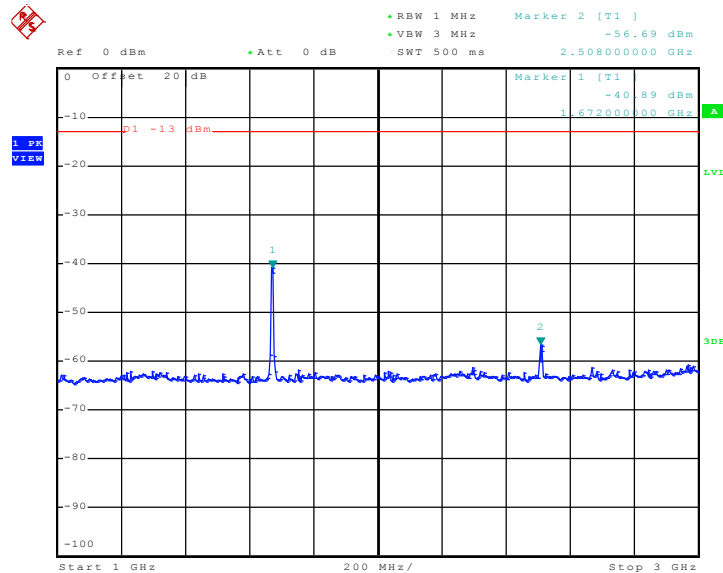

Date: 8.JUL.2010 14:46:19



### Conducted Emission Plot between 3GHz ~ 7GHz

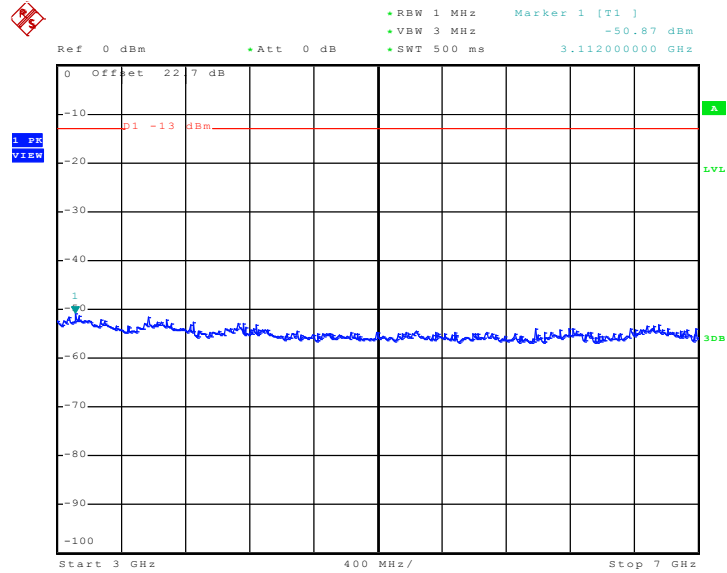

Date: 8.JUL.2010 14:46:53

### Conducted Emission Plot between 7GHz ~ 9GHz

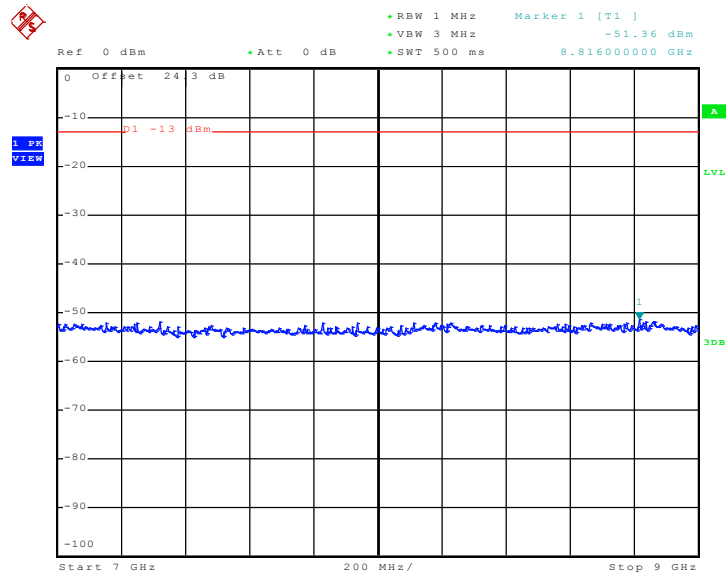

Date: 8.JUL.2010 14:47:45



Band :	WCDMA Band II	Channel :	CH9400
Test Mode :	HSDPA Link		

Conducted Emission Plot between 30MHz ~ 1GHz

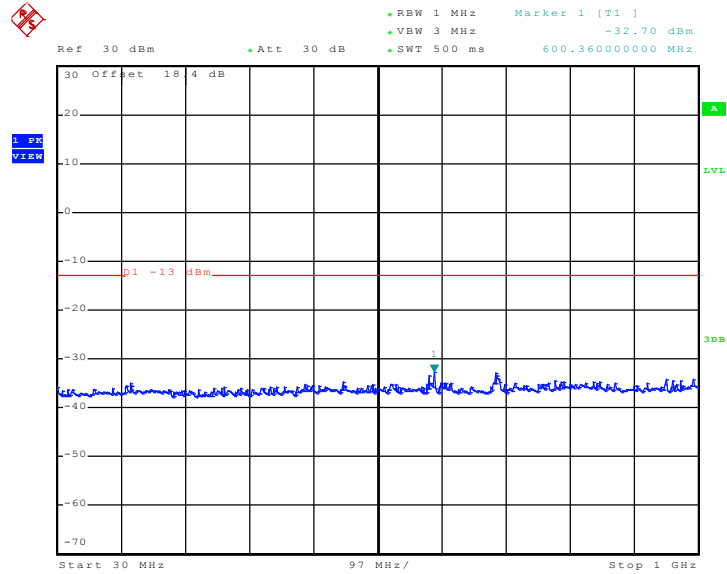

Date: 8.JUL.2010 14:50:22

Conducted Emission Plot between 1GHz ~ 3GHz

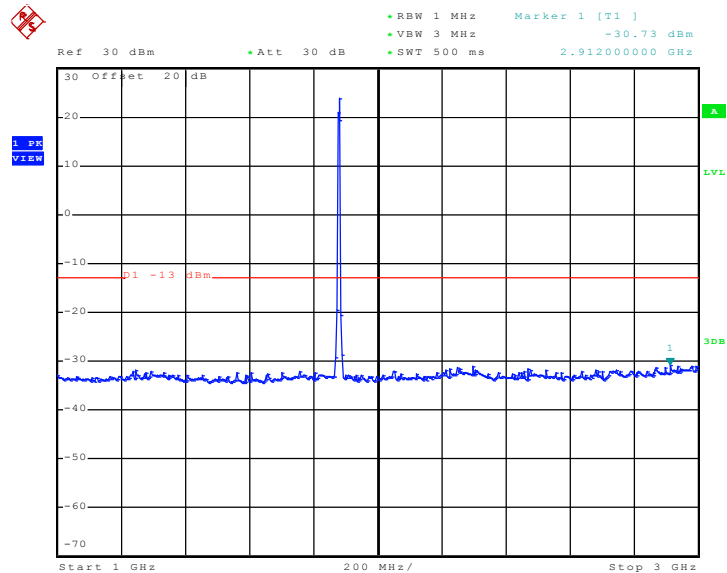

Date: 8.JUL.2010 14:51:16



### Conducted Emission Plot between 3GHz ~ 7GHz

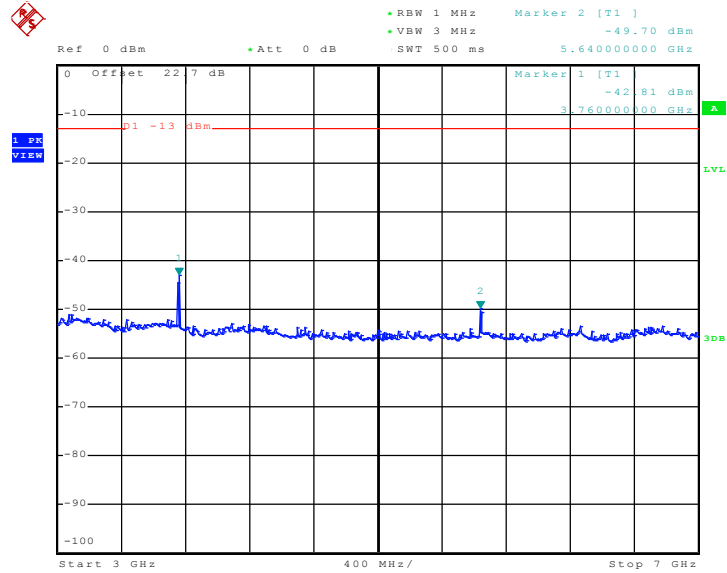

Date: 8.JUL.2010 14:52:10

### Conducted Emission Plot between 7GHz ~ 13.6GHz

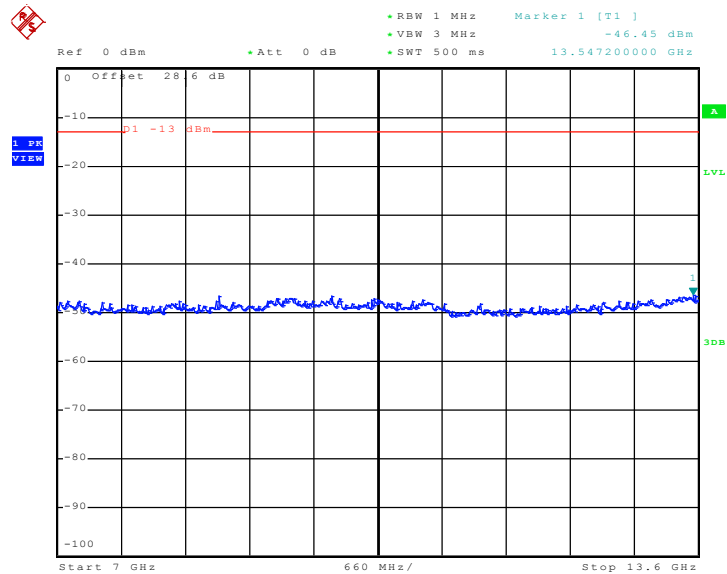

Date: 8.JUL.2010 14:53:02





Conducted Emission Plot between 13.6GHz ~ 19.1GHz

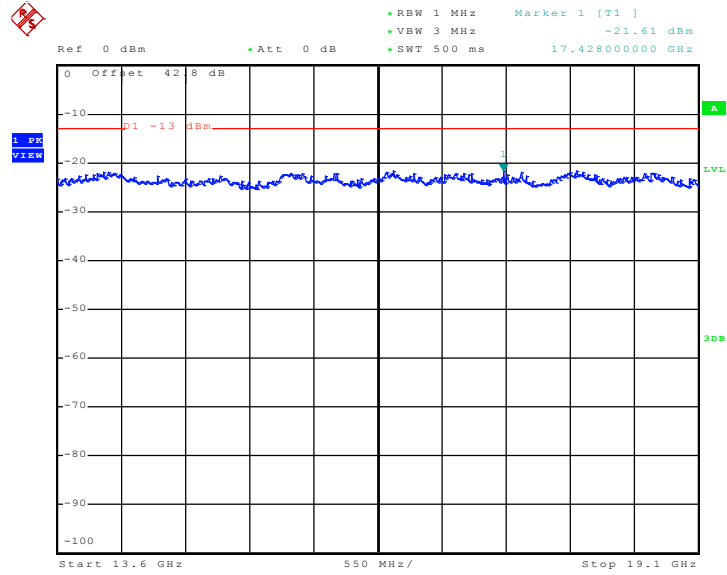

Date: 8.JUL.2010 14:53:37

## 3.6 Field Strength of Spurious Radiation Measurement

### 3.6.1 Description of Field Strength of Spurious Radiated Measurement

The radiated spurious emission was measured by substitution method according to ANSI / TIA / EIA-603-C-2004. The power of any emission outside of the authorized operating frequency ranges must be attenuated below the transmitter power (P) by a factor of at least  $43 + 10 \log (P)$  dB. The spectrum is scanned from 30 MHz up to a frequency including its 10th harmonic.

### 3.6.2 Measuring Instruments

See list of measuring instruments of this test report.

### 3.6.3 Test Procedures

1. The EUT was placed on a rotatable wooden table with 0.8 meter about ground.
2. The EUT was set 3 meters from the receiving antenna, which was mounted on the antenna tower.
3. The table was rotated 360 degrees to determine the position of the highest spurious emission.
4. The height of the receiving antenna is varied between one meter and four meters to search the maximum spurious emission for both horizontal and vertical polarizations.
5. Make the measurement with the spectrum analyzer's RBW = 1MHz, VBW = 3MHz, Sweep = 500ms, Taking the record of maximum spurious emission.
6. A horn antenna was substituted in place of the EUT and was driven by a signal generator.
7. Tune the output power of signal generator to the same emission level with EUT maximum spurious emission.
8. Taking the record of output power at antenna port.
9. Repeat step 7 to step 8 for another polarization.
10.  $EIRP \text{ (dBm)} = S.G. \text{ Power} - Tx \text{ Cable Loss} + Tx \text{ Antenna Gain}$
11.  $ERP \text{ (dBm)} = EIRP - 2.15$

### 3.6.4 Test Setup

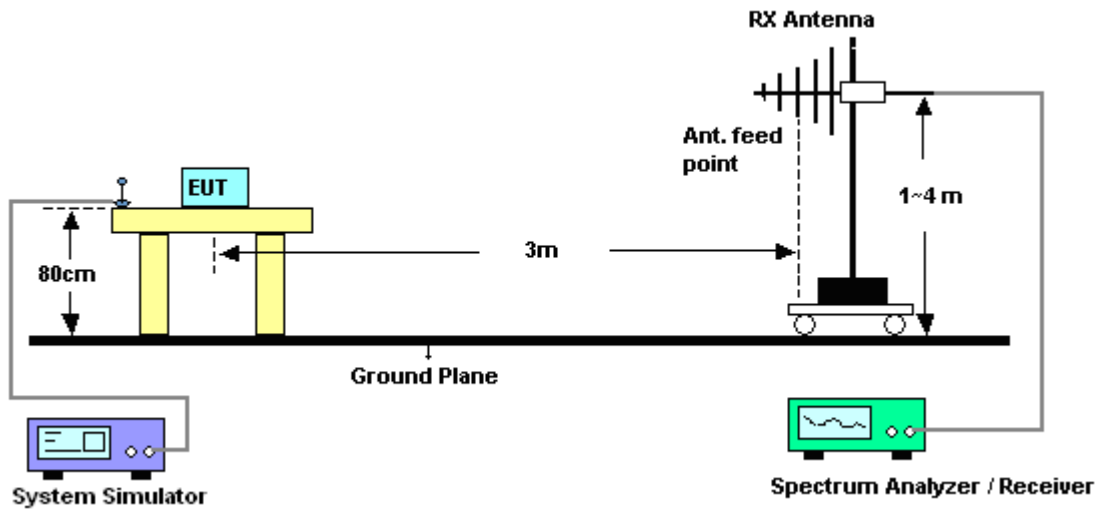



3.6.5 Test Result of Field Strength of Spurious Radiated

Band :	GSM850	Temperature :	25~26°C
Test Mode :	GSM Link for Phone 1	Relative Humidity :	43~44%
Test Engineer :	Kay Wu	Polarization :	Horizontal
Remark :	Spurious emissions within 30-1000MHz were found more than 20dB below limit line.		

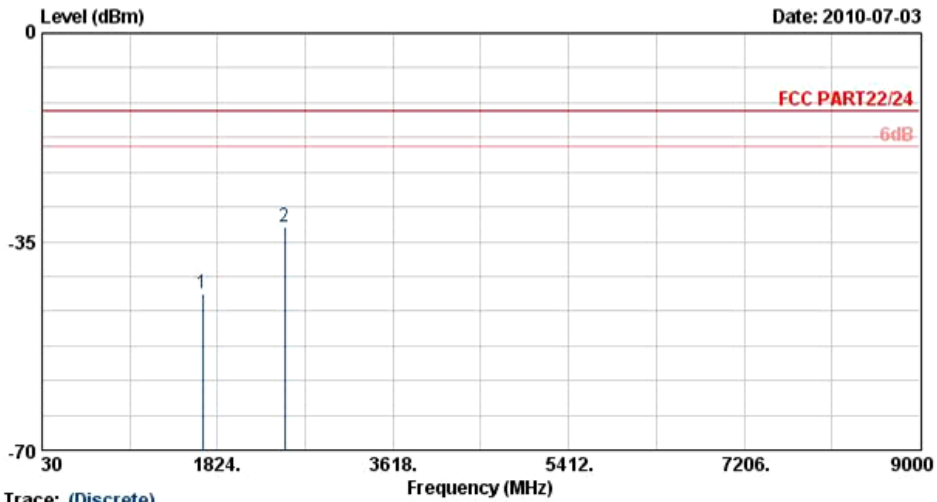

Trace: (Discrete)  
 Site : 03CH07-RY  
 Condition : FCC PART22/24 HF-ETRP(080306) HORIZONTAL  
 Project : FG 062328

Frequency ( MHz )	ERP ( dBm )	Limit ( dBm )	Over Limit ( dB )	SPA Reading ( dBm )	S.G. Power ( dBm )	TX Cable loss ( dB )	TX Antenna Gain ( dBi )	Polarization ( H/V )	Result
1669	-43.84	-13	-30.84	-53.4	-45.56	1.62	5.49	H	Pass
2509	-32.52	-13	-19.52	-46.78	-34.49	2.1	6.22	H	Pass



<b>Band :</b>	GSM850	<b>Temperature :</b>	25~26°C
<b>Test Mode :</b>	GSM Link for Phone 1	<b>Relative Humidity :</b>	43~44%
<b>Test Engineer :</b>	Kay Wu	<b>Polarization :</b>	Vertical
<b>Remark :</b>	Spurious emissions within 30-1000MHz were found more than 20dB below limit line.		

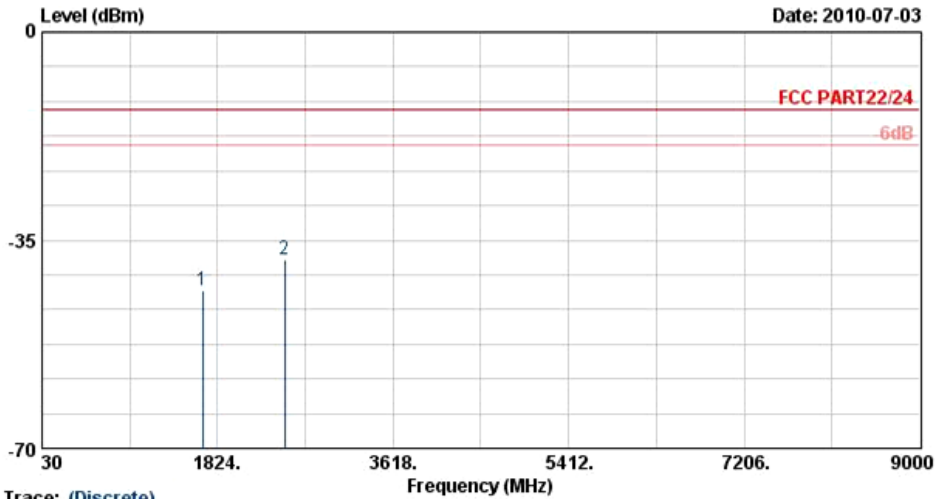

Trace: (Discrete)  
 Site : 03CH07-HY  
 Condition : FCC PART22/24 HF-ETRP(080306) VERTICAL  
 Project : FG 062328

Frequency ( MHz )	ERP ( dBm )	Limit ( dBm )	Over Limit ( dB )	SPA Reading ( dBm )	S.G. Power ( dBm )	TX Cable loss ( dB )	TX Antenna Gain ( dBi )	Polarization ( H/V )	Result
1669	-43.49	-13	-30.49	-55.28	-45.21	1.62	5.49	V	Pass
2509	-38.31	-13	-25.31	-53.02	-40.28	2.1	6.22	V	Pass



<b>Band :</b>	GSM850	<b>Temperature :</b>	25~26°C
<b>Test Mode :</b>	EDGE 8 Link for Phone 1	<b>Relative Humidity :</b>	43~44%
<b>Test Engineer :</b>	Kay Wu	<b>Polarization :</b>	Horizontal
<b>Remark :</b>	Spurious emissions within 30-1000MHz were found more than 20dB below limit line.		

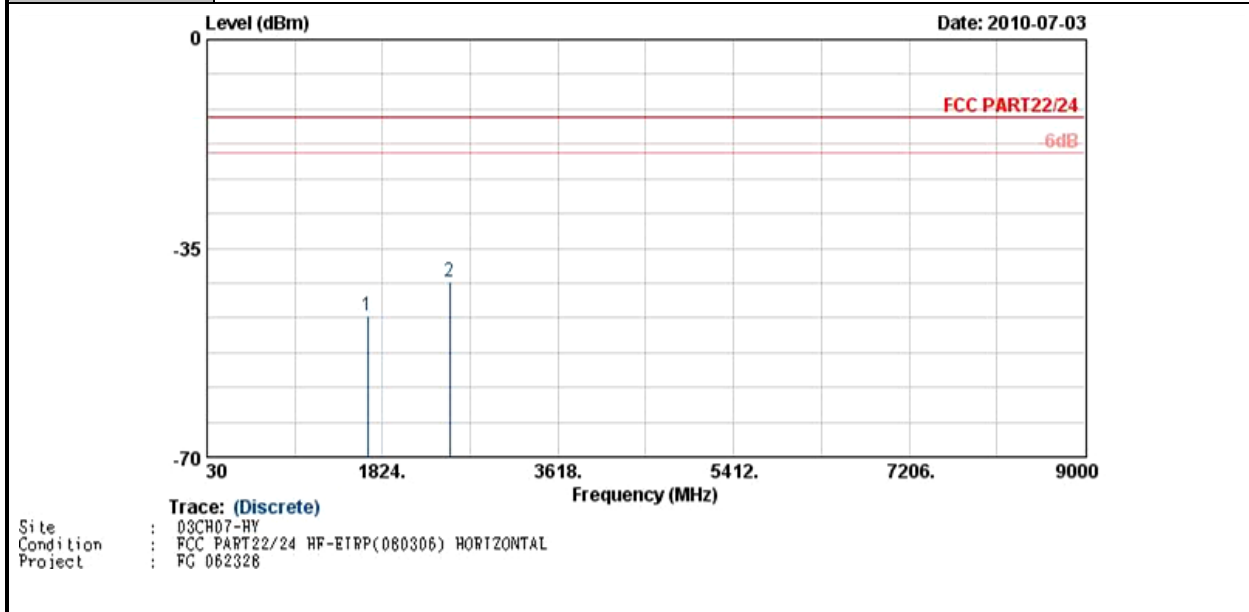

Frequency (MHz)	ERP (dBm)	Limit (dBm)	Over Limit (dB)	SPA Reading (dBm)	S.G. Power (dBm)	TX Cable loss (dB)	TX Antenna Gain (dBi)	Polarization (H/V)	Result
1669	-46.21	-13	-33.21	-55.76	-47.93	1.62	5.49	H	Pass
2509	-40.66	-13	-27.66	-54.92	-42.63	2.1	6.22	H	Pass



<b>Band :</b>	GSM850	<b>Temperature :</b>	25~26°C
<b>Test Mode :</b>	EDGE 8 Link for Phone 1	<b>Relative Humidity :</b>	43~44%
<b>Test Engineer :</b>	Kay Wu	<b>Polarization :</b>	Vertical
<b>Remark :</b>	Spurious emissions within 30-1000MHz were found more than 20dB below limit line.		

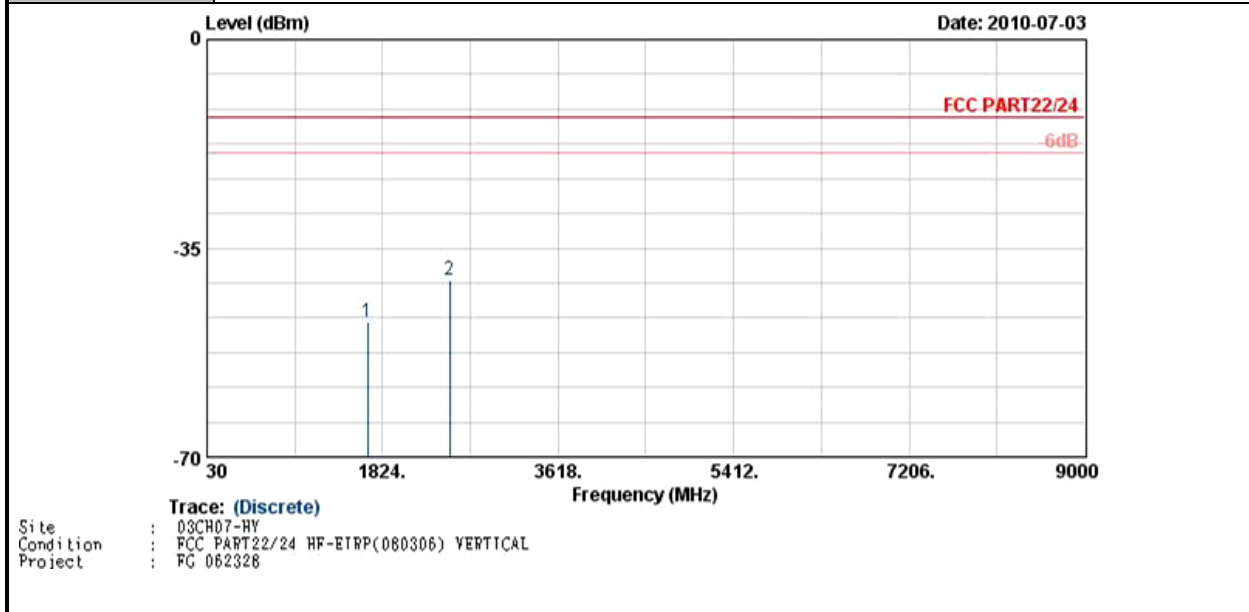

Frequency ( MHz )	ERP ( dBm )	Limit ( dBm )	Over Limit ( dB )	SPA Reading ( dBm )	S.G. Power ( dBm )	TX Cable loss ( dB )	TX Antenna Gain ( dBi )	Polarization ( H/V )	Result
1669	-47.46	-13	-34.46	-59.25	-49.18	1.62	5.49	V	Pass
2509	-40.34	-13	-27.34	-55.05	-42.31	2.1	6.22	V	Pass



<b>Band :</b>	GSM850	<b>Temperature :</b>	25~26°C
<b>Test Mode :</b>	GSM Link for Phone 2	<b>Relative Humidity :</b>	43~44%
<b>Test Engineer :</b>	Kay Wu	<b>Polarization :</b>	Horizontal
<b>Remark :</b>	Spurious emissions within 30-1000MHz were found more than 20dB below limit line.		

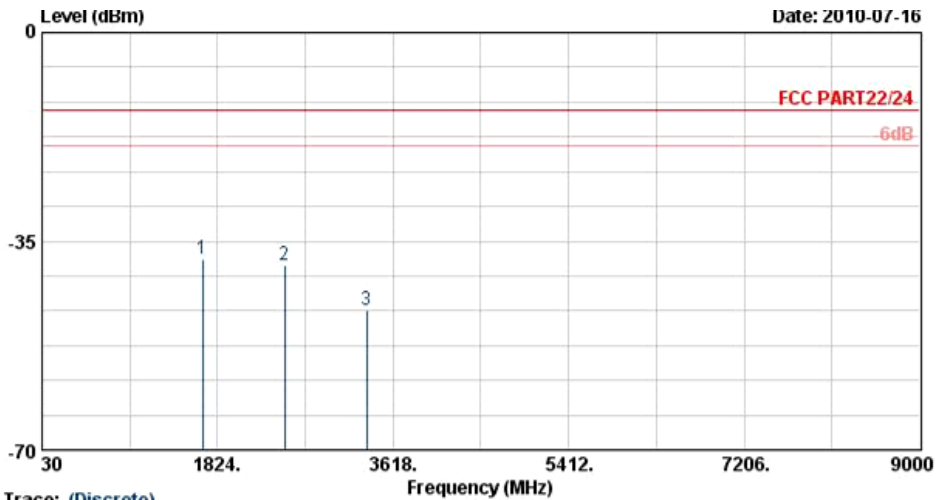

Trace: (Discrete)  
 Site : 03CH07-HY  
 Condition : FCC PART22/24 HF-ETRP(080306) HORIZONTAL  
 Project : FG 062328

Frequency ( MHz )	ERP ( dBm )	Limit ( dBm )	Over Limit ( dB )	SPA Reading ( dBm )	S.G. Power ( dBm )	TX Cable loss ( dB )	TX Antenna Gain ( dBi )	Polarization ( H/V )	Result
1669	-38.02	-13	-25.02	-47.21	-39.74	1.62	5.49	H	Pass
2509	-39.05	-13	-26.05	-52.82	-41.02	2.1	6.22	H	Pass
3345	-46.57	-13	-33.57	-60.84	-49.46	3.03	8.07	H	Pass





<b>Band :</b>	GSM850	<b>Temperature :</b>	25~26°C
<b>Test Mode :</b>	GSM Link for Phone 2	<b>Relative Humidity :</b>	43~44%
<b>Test Engineer :</b>	Kay Wu	<b>Polarization :</b>	Vertical
<b>Remark :</b>	Spurious emissions within 30-1000MHz were found more than 20dB below limit line.		

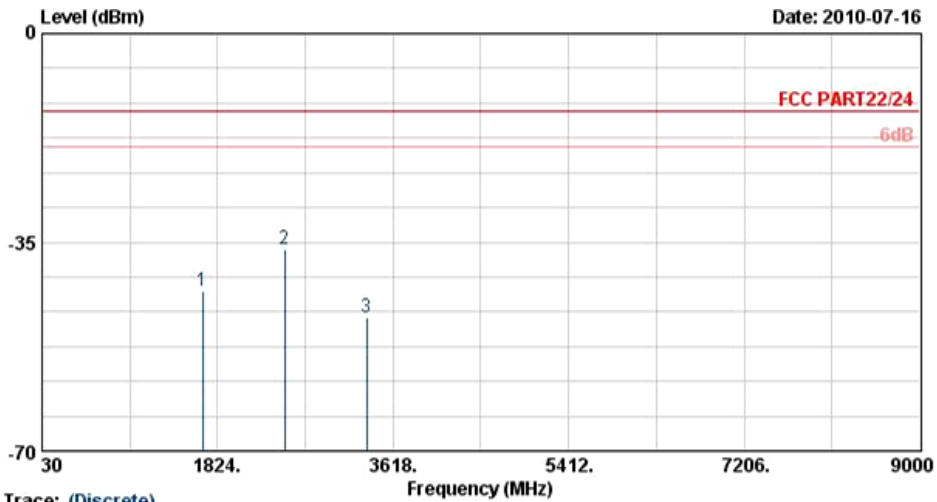

Trace: (Discrete)  
 Site : 08CH07-HY  
 Condition : FCC PART22/24 HF-ETRP(080306) VERTICAL  
 Project : FG 062328

Frequency ( MHz )	ERP ( dBm )	Limit ( dBm )	Over Limit ( dB )	SPA Reading ( dBm )	S.G. Power ( dBm )	TX Cable loss ( dB )	TX Antenna Gain ( dBi )	Polarization ( H/V )	Result
1669	-43.13	-13	-30.13	-54.71	-44.85	1.62	5.49	V	Pass
2509	-36.23	-13	-23.23	-51.94	-38.2	2.1	6.22	V	Pass
3345	-47.72	-13	-34.72	-63.04	-50.61	3.03	8.07	V	Pass



<b>Band :</b>	GSM1900	<b>Temperature :</b>	25~26°C
<b>Test Mode :</b>	GSM Link for Phone 1	<b>Relative Humidity :</b>	43~44%
<b>Test Engineer :</b>	Kay Wu	<b>Polarization :</b>	Horizontal
<b>Remark :</b>	Spurious emissions within 30-1000MHz were found more than 20dB below limit line.		

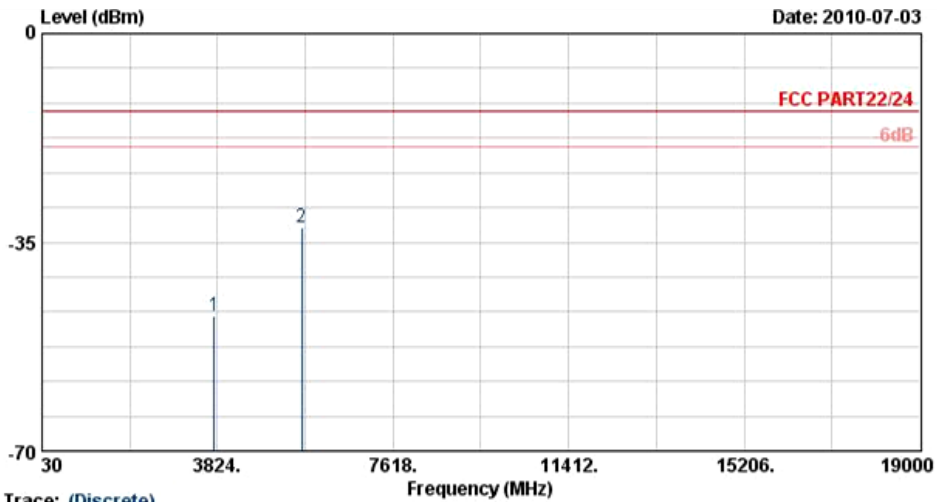

Trace: (Discrete)  
 Site : 08CH07-HY  
 Condition : FCC PART22/24 HF-ETRP(080306) HORIZONTAL  
 Project : FG 062328

Frequency (MHz)	EIRP (dBm)	Limit (dBm)	Over Limit (dB)	SPA Reading (dBm)	S.G. Power (dBm)	TX Cable loss (dB)	TX Antenna Gain (dBi)	Polarization (H/V)	Result
3760	-47.49	-13	-34.49	-63.14	-53.79	2.51	8.81	H	Pass
5636	-32.50	-13	-19.50	-51.83	-40.21	2.99	10.70	H	Pass



<b>Band :</b>	GSM1900	<b>Temperature :</b>	25~26°C
<b>Test Mode :</b>	GSM Link for Phone 1	<b>Relative Humidity :</b>	43~44%
<b>Test Engineer :</b>	Kay Wu	<b>Polarization :</b>	Vertical
<b>Remark :</b>	Spurious emissions within 30-1000MHz were found more than 20dB below limit line.		

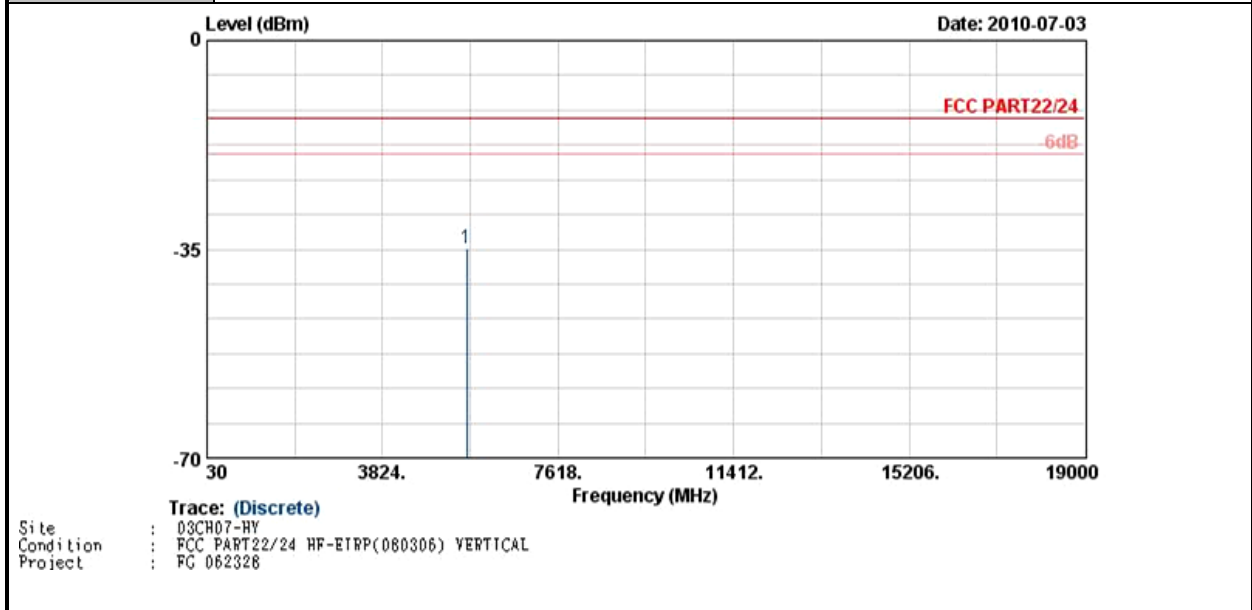

Frequency ( MHz )	EIRP ( dBm )	Limit ( dBm )	Over Limit ( dB )	SPA Reading ( dBm )	S.G. Power ( dBm )	TX Cable loss ( dB )	TX Antenna Gain ( dBi )	Polarization ( H/V )	Result
5636	-34.82	-13	-21.82	-53.09	-42.53	2.99	10.70	V	Pass



<b>Band :</b>	GSM1900	<b>Temperature :</b>	25~26°C
<b>Test Mode :</b>	EDGE 8 Link for Phone 1	<b>Relative Humidity :</b>	43~44%
<b>Test Engineer :</b>	Kay Wu	<b>Polarization :</b>	Horizontal
<b>Remark :</b>	Spurious emissions within 30-1000MHz were found more than 20dB below limit line.		

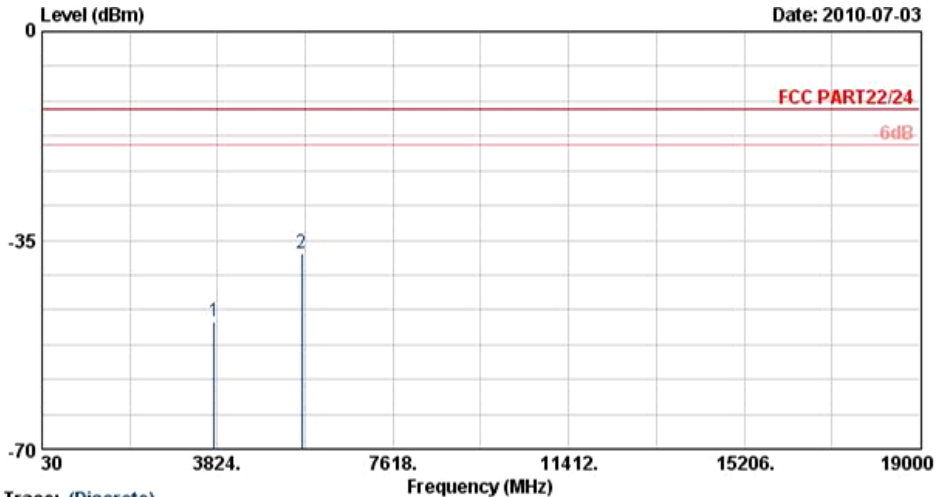

Trace: (Discrete)  
 Site : 03CH07-HY  
 Condition : FCC PART22/24 HF-ETRP(080306) HORIZONTAL  
 Project : FG 062328

Frequency ( MHz )	EIRP ( dBm )	Limit ( dBm )	Over Limit ( dB )	SPA Reading ( dBm )	S.G. Power ( dBm )	TX Cable loss ( dB )	TX Antenna Gain ( dBi )	Polarization ( H/V )	Result
3760	-48.68	-13	-35.68	-63.33	-54.98	2.51	8.81	H	Pass
5636	-37.29	-13	-24.29	-55.22	-45	2.99	10.70	H	Pass



<b>Band :</b>	GSM1900	<b>Temperature :</b>	25~26°C
<b>Test Mode :</b>	EDGE 8 Link for Phone 1	<b>Relative Humidity :</b>	43~44%
<b>Test Engineer :</b>	Kay Wu	<b>Polarization :</b>	Vertical
<b>Remark :</b>	Spurious emissions within 30-1000MHz were found more than 20dB below limit line.		

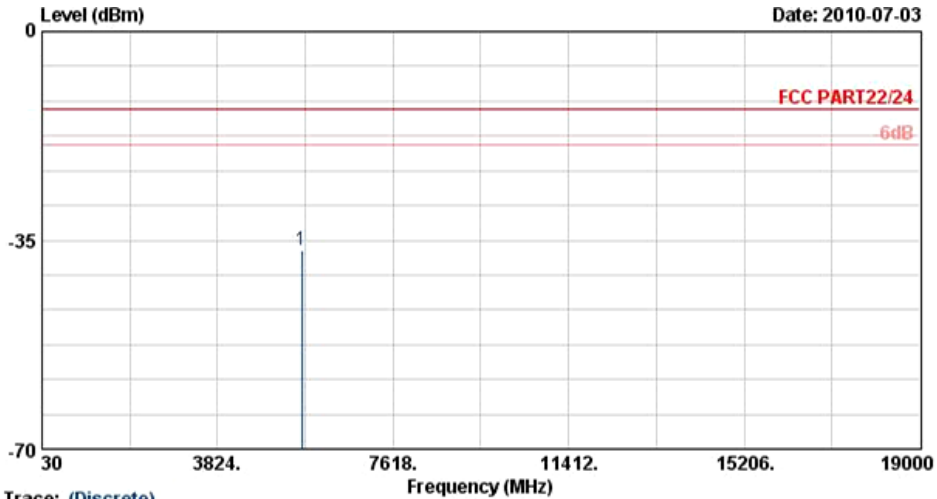

Trace: (Discrete)  
 Site : 03CH07-HY  
 Condition : FCC PART22/24 HF-ETRP(080306) VERTICAL  
 Project : FG 062328

Frequency ( MHz )	EIRP ( dBm )	Limit ( dBm )	Over Limit ( dB )	SPA Reading ( dBm )	S.G. Power ( dBm )	TX Cable loss ( dB )	TX Antenna Gain ( dBi )	Polarization ( H/V )	Result
5636	-36.77	-13	-23.77	-54.4	-44.48	2.99	10.70	V	Pass



<b>Band :</b>	GSM1900	<b>Temperature :</b>	25~26°C
<b>Test Mode :</b>	GSM Link for Phone 2	<b>Relative Humidity :</b>	43~44%
<b>Test Engineer :</b>	Kay Wu	<b>Polarization :</b>	Horizontal
<b>Remark :</b>	Spurious emissions within 30-1000MHz were found more than 20dB below limit line.		

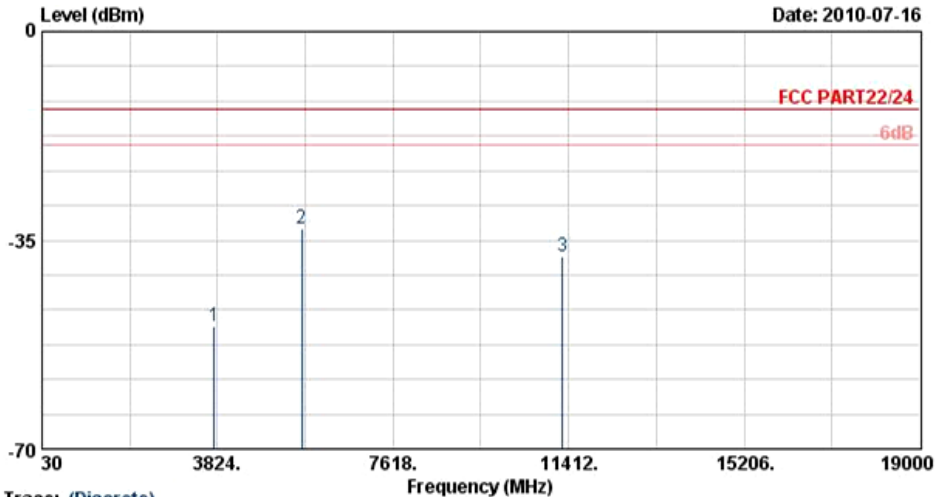

Trace: (Discrete)  
 Site : 08CH07-HY  
 Condition : FCC PART22/24 HF-ETRP(080306) HORIZONTAL  
 Project : FG 062328

Frequency ( MHz )	EIRP ( dBm )	Limit ( dBm )	Over Limit ( dB )	SPA Reading ( dBm )	S.G. Power ( dBm )	TX Cable loss ( dB )	TX Antenna Gain ( dBi )	Polarization ( H/V )	Result
3760	-49.33	-13	-36.33	-65.43	-55.63	2.51	8.81	H	Pass
5636	-32.98	-13	-19.98	-54.6	-40.69	2.99	10.70	H	Pass
11280	-37.73	-13	-24.73	-66.78	-46.77	4.27	13.31	H	Pass



<b>Band :</b>	GSM1900	<b>Temperature :</b>	25~26°C
<b>Test Mode :</b>	GSM Link for Phone 2	<b>Relative Humidity :</b>	43~44%
<b>Test Engineer :</b>	Kay Wu	<b>Polarization :</b>	Vertical
<b>Remark :</b>	Spurious emissions within 30-1000MHz were found more than 20dB below limit line.		

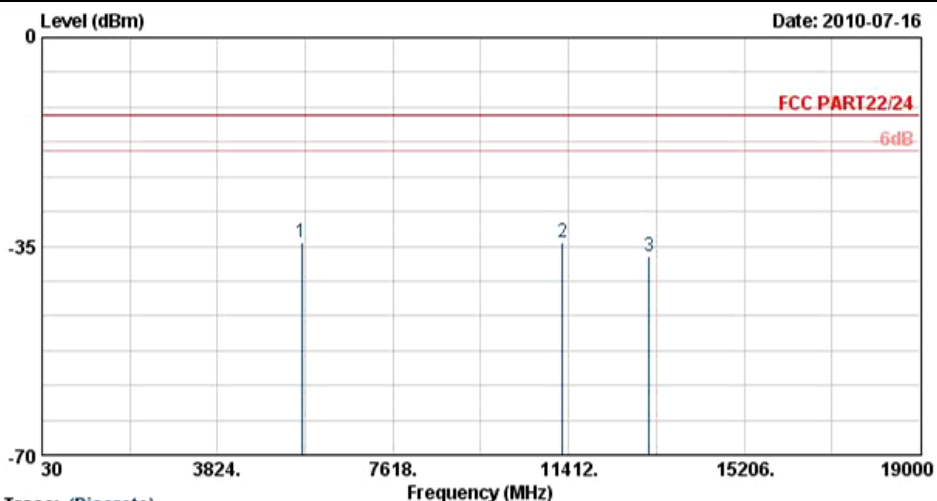

Trace: (Discrete)  
 Site : 08CH07-HY  
 Condition : FCC PART22/24 HF-ETRP(080306) VERTICAL  
 Project : FG 062328

Frequency ( MHz )	EIRP ( dBm )	Limit ( dBm )	Over Limit ( dB )	SPA Reading ( dBm )	S.G. Power ( dBm )	TX Cable loss ( dB )	TX Antenna Gain ( dBi )	Polarization ( H/V )	Result
5636	-34.43	-13	-21.43	-55.76	-42.14	2.99	10.70	V	Pass
11280	-34.37	-13	-21.37	-64.22	-43.41	4.27	13.31	V	Pass
13160	-36.73	-13	-23.73	-68.56	-46.25	4.27	13.79	V	Pass



<b>Band :</b>	WCDMA Band V	<b>Temperature :</b>	25~26°C
<b>Test Mode :</b>	RMC 12.2Kbps Link for Phone 1	<b>Relative Humidity :</b>	43~44%
<b>Test Engineer :</b>	Kay Wu	<b>Polarization :</b>	Horizontal
<b>Remark :</b>	Spurious emissions within 30-1000MHz were found more than 20dB below limit line.		

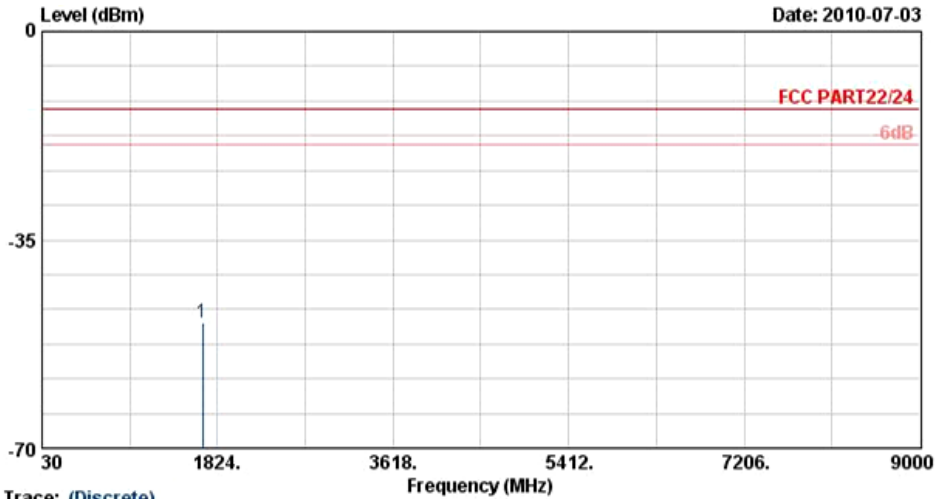

Trace: (Discrete)  
 Site : 08CH07-HY  
 Condition : FCC PART22/24 HF-ETRP(080306) HORIZONTAL  
 Project : FC 062328

Frequency (MHz)	ERP (dBm)	Limit (dBm)	Over Limit (dB)	SPA Reading (dBm)	S.G. Power (dBm)	TX Cable loss (dB)	TX Antenna Gain (dBi)	Polarization (H/V)	Result
1669	-48.99	-13	-35.99	-58.55	-50.71	1.62	5.49	H	Pass





<b>Band :</b>	WCDMA Band V	<b>Temperature :</b>	25~26°C
<b>Test Mode :</b>	RMC 12.2Kbps Link for Phone 1	<b>Relative Humidity :</b>	43~44%
<b>Test Engineer :</b>	Kay Wu	<b>Polarization :</b>	Vertical
<b>Remark :</b>	Spurious emissions within 30-1000MHz were found more than 20dB below limit line. Spurious emissions within 1000MHz ~ 10th harmonic were not found any signals.		

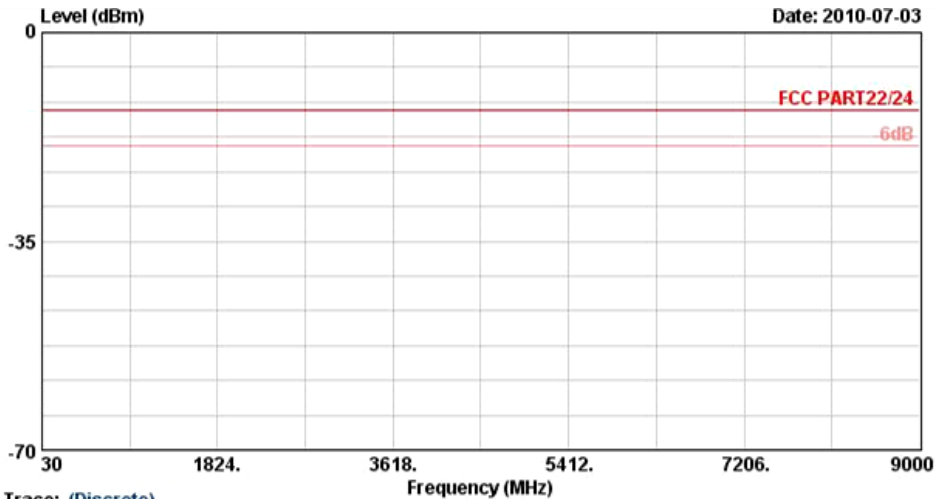

Trace: (Discrete)  
Site : 03CH07-HY  
Condition : FCC PART22/24 HF-ETRP(080306) VERTICAL  
Project : FG 062328



<b>Band :</b>	WCDMA Band II	<b>Temperature :</b>	25~26°C
<b>Test Mode :</b>	HSDPA Link for Phone 1	<b>Relative Humidity :</b>	43~44%
<b>Test Engineer :</b>	Kay Wu	<b>Polarization :</b>	Horizontal
<b>Remark :</b>	Spurious emissions within 30-1000MHz were found more than 20dB below limit line.		

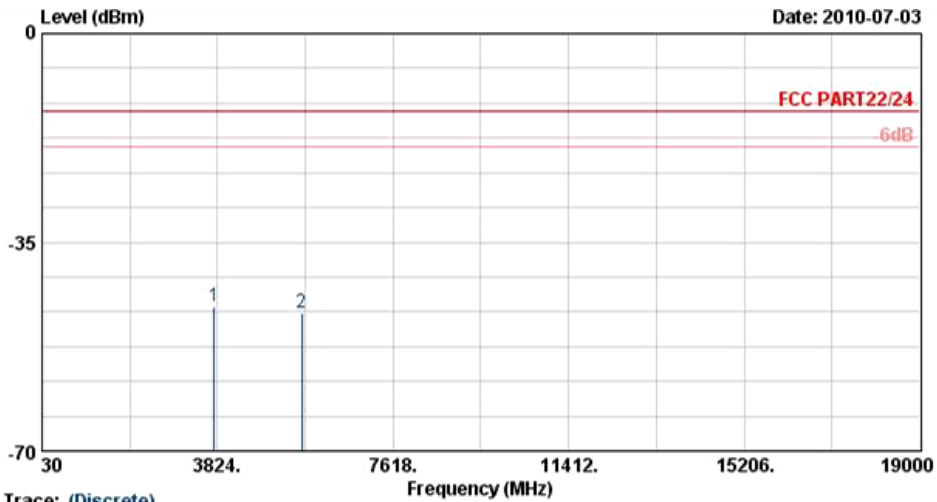

Trace: (Discrete)  
 Site : 08CH07-HY  
 Condition : FCC PART22/24 HF-ETRP(080306) HORIZONTAL  
 Project : FC 062328

Frequency ( MHz )	EIRP ( dBm )	Limit ( dBm )	Over Limit ( dB )	SPA Reading ( dBm )	S.G. Power ( dBm )	TX Cable loss ( dB )	TX Antenna Gain ( dBi )	Polarization ( H/V )	Result
3760	-45.81	-13	-32.81	-61.46	-52.11	2.51	8.81	H	Pass
5636	-46.86	-13	-33.86	-64.33	-54.57	2.99	10.70	H	Pass



<b>Band :</b>	WCDMA Band II	<b>Temperature :</b>	25~26°C
<b>Test Mode :</b>	HSDPA Link for Phone 1	<b>Relative Humidity :</b>	43~44%
<b>Test Engineer :</b>	Kay Wu	<b>Polarization :</b>	Vertical
<b>Remark :</b>	Spurious emissions within 30-1000MHz were found more than 20dB below limit line. Spurious emissions within 1000MHz ~ 10th harmonic were not found any signals.		

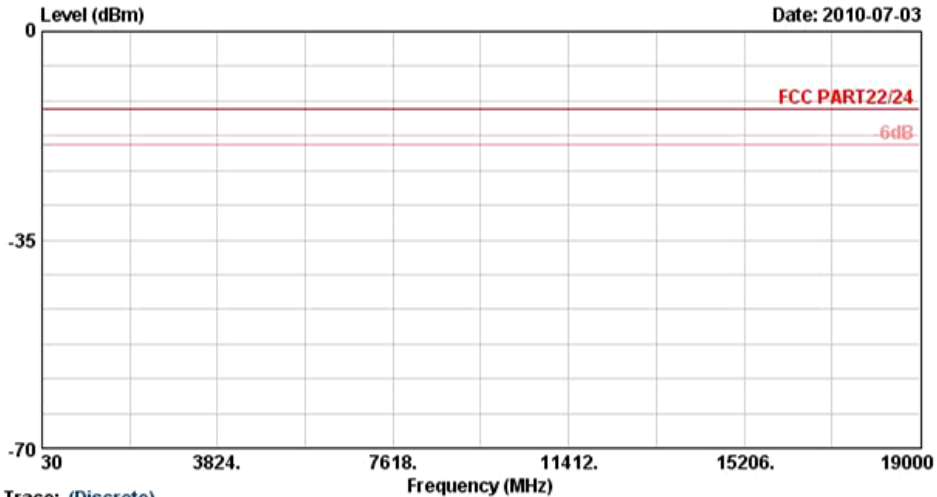

Trace: (Discrete)  
Site : 03CH07-HY  
Condition : FCC PART22/24 HF-ETRP(080306) VERTICAL  
Project : FG 062328

## 3.7 Frequency Stability Measurement

### 3.7.1 Description of Frequency Stability Measurement

The frequency stability shall be measured by variation of ambient temperature and variation of primary supply voltage to ensure that the fundamental emission stays within the authorized frequency block. The frequency stability of the transmitter shall be maintained within  $\pm 0.00025\%$  ( $\pm 2.5\text{ppm}$ ) of the center frequency.

### 3.7.2 Measuring Instruments

See list of measuring instruments of this test report.

### 3.7.3 Test Procedures for Temperature Variation

1. The EUT was set up in the thermal chamber and connected with the base station.
2. With power OFF, the temperature was decreased to  $-30^{\circ}\text{C}$  and the EUT was stabilized for three hours. Power was applied and the maximum change in frequency was recorded within one minute.
3. With power OFF, the temperature was raised in  $10^{\circ}\text{C}$  step up to  $50^{\circ}\text{C}$ . The EUT was stabilized at each step for at least half an hour. Power was applied and the maximum frequency change was recorded within one minute.
4. If the EUT can not be turned on at  $-30^{\circ}\text{C}$ , the testing lowest temperature will be raised in  $10^{\circ}\text{C}$  step until the EUT can be turned on.

### 3.7.4 Test Procedures for Voltage Variation

1. The EUT was placed in a temperature chamber at  $25\pm 5^{\circ}\text{C}$  and connected with the base station.
2. The power supply voltage to the EUT was varied from BEP to 115% of the nominal value measured at the input to the EUT.
3. The variation in frequency was measured for the worst case.

### 3.7.5 Test Setup

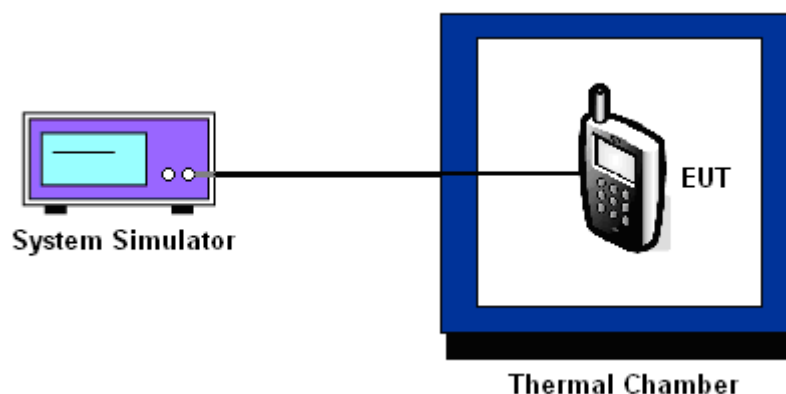



3.7.6 Test Result of Temperature Variation

Band :	GSM 850	Channel :	189
Limit (ppm) :	2.5		

Temperature (°C)	GSM		EDGE 8		Result
	Freq. Dev. (Hz)	Deviation (ppm)	Freq. Dev. (Hz)	Deviation (ppm)	
-30	-	-	-	-	PASS
-20	-	-	-	-	
-10	27	0.03	-15	-0.02	
0	-15	-0.02	-21	-0.02	
10	-13	-0.02	-23	-0.03	
20	-30	-0.04	-29	-0.03	
30	-24	-0.03	-28	-0.03	
40	-26	-0.03	-31	-0.04	
50	-29	-0.03	-34	-0.04	

Note:

1. The EUT stops transmitting at temperatures -20°C and -30°C.
2. The manufacturer declared that the EUT could work properly between temperatures -10°C~55°C.





Band :	GSM 1900	Channel :	661
Limit (ppm) :	2.5		

Temperature (°C)	GSM		EDGE 8		Result
	Freq. Dev. (Hz)	Deviation (ppm)	Freq. Dev. (Hz)	Deviation (ppm)	
-30	-	-	-	-	PASS
-20	-	-	-	-	
-10	-48	-0.03	-68	-0.04	
0	-50	-0.03	-71	-0.04	
10	-63	-0.03	-64	-0.03	
20	-60	-0.03	-36	-0.02	
30	-50	-0.03	-26	-0.01	
40	-55	-0.03	27	0.01	
50	-41	-0.02	34	0.02	

**Note:**

1. The EUT stops transmitting at temperatures -20°C and -30°C.
2. The manufacturer declared that the EUT could work properly between temperatures -10°C~55°C.



Band :	WCDMA Band V	Channel :	4182
Limit (ppm) :	2.5		

Temperature (°C)	RMC 12.2Kbps		Result
	Freq. Dev. (Hz)	Deviation (ppm)	
-30	-	-	PASS
-20	-	-	
-10	-21	-0.02	
0	-19	-0.02	
10	-13	-0.02	
20	-52	-0.06	
30	-39	-0.05	
40	-33	-0.04	
50	-21	-0.02	

**Note:**

1. The EUT stops transmitting at temperatures -20°C and -30°C.
2. The manufacturer declared that the EUT could work properly between temperatures -10°C~55°C.



Band :	WCDMA Band II	Channel :	9400
Limit (ppm) :	2.5		

Temperature (°C)	HSDPA		Result
	Freq. Dev. (Hz)	Deviation (ppm)	
-30	-	-	PASS
-20	-	-	
-10	31	0.02	
0	-14	-0.01	
10	-18	-0.01	
20	-32	-0.02	
30	23	0.01	
40	-37	-0.02	
50	-48	-0.03	

**Note:**

1. The EUT stops transmitting at temperatures -20°C and -30°C.
2. The manufacturer declared that the EUT could work properly between temperatures -10°C~55°C.





3.7.7 Test Result of Voltage Variation

Band & Channel	Mode	Voltage (Volt)	Freq. Dev. (Hz)	Deviation (ppm)	Limit (ppm)	Result
GSM 850 CH189	GSM	3.8	-25	-0.03	2.5	PASS
		BEP	-39	-0.05		
		4.2	-28	-0.03		
	EDGE 8	3.8	17	0.02		
		BEP	32	0.04		
		4.2	24	0.03		
GSM 1900 CH661	GSM	3.8	19	0.01		
		BEP	-27	-0.01		
		4.2	-36	-0.02		
	EDGE 8	3.8	46	0.02		
		BEP	-25	-0.01		
		4.2	49	0.03		
WCDMA Band V CH4182	RMC 12.2Kbps	3.8	-19	-0.02		
		BEP	-22	-0.03		
		4.2	-21	-0.02		
WCDMA Band II CH9400	HSDPA	3.8	-35	-0.02		
		BEP	-32	-0.02		
		4.2	-29	-0.02		

Note:

1. Normal Voltage = 3.8V.
2. Battery End Point (BEP) = 3.6 V.



## 4 List of Measuring Equipment

Instrument	Manufacturer	Model No.	Serial No.	Characteristics	Calibration Date	Due Date	Remark
System Simulator	R&S	CMU200	117995	N/A	Mar. 19, 2009	Mar. 18, 2011	Conducted (TH02-HY)
Spectrum Analyzer	R&S	FSP30	101329	9kHz~30GHz	Apr. 26, 2010	Apr. 25, 2011	Conducted (TH02-HY)
Thermal Chamber	TEN BILLION	TTH-D35P	TBN-930701	N/A	Jul. 29, 2009	Jul. 28, 2010	Conducted (TH02-HY)
Bilog Antenna	SCHAFFNER	CBL6111C	2726	30MHz ~ 1GHz	Oct. 31, 2009	Oct. 30, 2010	Radiation (03CH07-HY)
Spectrum Analyzer	R&S	FSP	101067	9KHz ~ 30GHz	Dec. 04, 2009	Dec. 03, 2010	Radiation (03CH07-HY)
Double Ridge Horn Antenna	ESCO	3117	00075962	1GHz ~ 18GHz	Aug. 20, 2009	Aug. 19, 2010	Radiation (03CH07-HY)
SHF-EHF Horn Antenna	SCHWARZBECK	BBHA 9170	BBHA9170251	15GHz- 40GHz	Oct. 14, 2009	Oct. 13, 2010	Radiation (03CH07-HY)
Pre Amplifier	Agilent	8449B	3008A02362	1GHz~ 26.5GHz	Dec.09,2009	Dec. 08, 2010	Radiation (03CH07-HY)
Pre Amplifier	COM-POWER	PA-103A	161241	10-1000MHz.32dB. GAIN	Mar. 27, 2010	Mar. 26, 2011	Radiation (03CH07-HY)
System Simulator	R&S	CMU200	117995	N/A	Mar. 19, 2009	Mar. 18, 2011	-

## 5 Uncertainty of Evaluation

### Uncertainty of Radiated Emission Measurement (30 MHz ~ 1000 MHz)

Contribution	Uncertainty of $X_i$		$u(X_i)$
	dB	Probability Distribution	
Receiver Reading	0.41	Normal (k=2)	0.21
Antenna Factor Calibration	0.83	Normal (k=2)	0.42
Cable Loss Calibration	0.25	Normal (k=2)	0.13
Pre-Amplifier Gain Calibration	0.27	Normal (k=2)	0.14
RCV/SPA Specification	2.50	Rectangular	0.72
Antenna Factor Interpolation for Frequency	1.00	Rectangular	0.29
Site Imperfection	1.43	Rectangular	0.83
Mismatch	+0.39 / -0.41	U-Shape	0.28
<b>Combined Standard Uncertainty <math>U_c(y)</math></b>	<b>1.27</b>		
<b>Measuring Uncertainty for a Level of Confidence of 95% (<math>U = 2U_c(y)</math>)</b>	<b>2.54</b>		

### Uncertainty of Radiated Emission Measurement (1 GHz ~ 40 GHz)

Contribution	Uncertainty of $X_i$		$u(X_i)$	$C_i$	$C_i * u(X_i)$
	dB	Probability Distribution			
Receiver Reading	$\pm 0.10$	Normal (k=2)	0.10	1	0.10
Antenna Factor Calibration	$\pm 1.70$	Normal (k=2)	0.85	1	0.85
Cable Loss Calibration	$\pm 0.50$	Normal (k=2)	0.25	1	0.25
Receiver Correction	$\pm 2.00$	Rectangular	1.15	1	1.15
Antenna Factor Directional	$\pm 1.50$	Rectangular	0.87	1	0.87
Site Imperfection	$\pm 2.80$	Triangular	1.14	1	1.14
Mismatch Receiver VSWR $\Gamma_1 = 0.197$ Antenna VSWR $\Gamma_2 = 0.194$ Uncertainty = $20\text{Log}(1-\Gamma_1*\Gamma_2)$	+0.34 / -0.35	U-Shape	0.244	1	0.244
<b>Combined Standard Uncertainty <math>U_c(y)</math></b>	<b>2.36</b>				
<b>Measuring Uncertainty for a Level of Confidence of 95% (<math>U = 2U_c(y)</math>)</b>	<b>4.72</b>				