



A Test Lab Techno Corp.

Changan Lab : No. 140 -1, Changan Street, Bade City, Taoyuan County, Taiwan R.O.C.
Tel : 886-3-271-0188 / Fax : 886-3-271-0190

HAC EVALUATION REPORT



Test Report No.	: 1001FS13-01
Applicant	: HTC Corporation
Trade Name	: HTC
Model Number	: PC70110
EUT Type	: Smartphone
FCC ID	: NM8PC70110
Dates of Test	: Jan. 11, 2010
Test Environment	: Ambient Temperature : 22 ± 2 °C Relative Humidity : 40 - 70 %
FCC Rule Part(s)	: FCC 47 CFR § 20.19.
HAC Standard	: ANSI C63.19-2007
C63.19 HAC Rated Category	: M3 (RF EMISSIONS)
Test Lab.	: Chang-An Lab

1. The test operations have to be performed with cautious behavior, the test results are as attached.
2. The test results are under chamber environment of A Test Lab Techno Corp. A Test Lab Techno Corp. does not assume responsibility for any conclusions and generalizations drawn from the test results with regard to other specimens or samples.
3. The measurement report has to be written approval of A Test Lab Techno Corp. It may only be reproduced or published in full. This report shall not be reproduced except in full, without the written approval of A Test Lab Techno Corp.
4. This document may be altered or revised by A Test Lab Techno. Corp. personnel only, and shall be noted in the revision section of the document.

Sam Chuang 20100127
Approve Signer

Alex Wu 20100127
Testing Engineer



Contents

1.	Description of Equipment Under Test (EUT)	3
2.	Introduction	4
3.	Test Equipment List	5
4.	Validation	6
5.	Probe Modulation Factor.....	8
6.	Test Results	11
6.1	HAC E-Field measurement results:	14
6.2	HAC H-Field measurement results:	16
6.3	Description of the Device under Test (DUT)	18



1. Description of Equipment Under Test (EUT)

Applicant :

HTC Corporation
No. 23, Xinghua Rd., Taoyuan City, Taoyuan County 330, Taiwan

Manufacturer : HTC Corporation
Manufacturer Address : No. 23, Xinghua Rd., Taoyuan City, Taoyuan County 330, Taiwan
EUT Type : Smartphone
Trade Name : HTC
Model Number : PC70110
FCC ID : NM8PC70110
Time-Avg Output Power : 0.260 W (24.15 dBm) GSM 850
0.131 W (21.17 dBm) PCS 1900
0.243 W (23.86 dBm) WCDMA Band V
0.226 W (23.54 dBm) WCDMA Band II
Tx Frequency : 824.2 - 848.8 MHz (GSM 850)
1850.2 - 1909.8 MHz (PCS 1900)
826.6 - 846.4 MHz (WCDMA Band V)
1852.6 - 1907.4 MHz (WCDMA Band II)
HW Version : NA
SW Version : NA
Antenna Gain : -1.2 dBi (GSM 850 / WCDMA Band V)
2.8 dBi (PCS 1900 / WCDMA Band II)
Antenna Type : PIFA
Test Device : Production Unit
Device Category : Portable

This wireless portable device has performed Hearing Aid Compatibility (HAC) measurements for the portable cellular phone. The measurements were performed to ensure compliance to the ANSI C63.19-2006 standards.



2. Introduction

The A Test Lab Techno Corp. has performed measurements of the maximum potential exposure to the user of **HTC Corporation Trade Name: HTC Model(s) : PC70110**. The test procedures, as described in ANSI C63.19-2006 standard were employed. A description of the product and operating configuration, detailed summary of the test results, methodology and procedures used in the equipment are included within this test report.



3. Test Equipment List

Manufacturer	Name of Equipment	Type/Model	Serial Number	Calibration	
				Last Cal.	Due Date
SPEAG	Dosimetric E-Filed Probe	ER3DV6	2256	Aug. 21, 2009	Aug. 21, 2010
SPEAG	Dosimetric H-Filed Probe	H3DV6	6076	Aug. 19, 2009	Aug. 19, 2010
SPEAG	835 MHz System Validation Kit	CD835V3	1017	Jul. 14, 2009	Jul. 14, 2010
SPEAG	1880 MHz System Validation Kit	CD1880V3	1036	Jul. 15, 2009	Jul. 15, 2010
SPEAG	Data Acquisition Electronics	DAE3	393	Aug. 24, 2009	Aug. 24, 2010
SPEAG	Device Holder	N/A	N/A	NCR	
SPEAG	Phantom	SAM V4.0	TP-1150	NCR	
SPEAG	Robot	Staubli TX90XL	F07/564ZA1/C/01	NCR	
SPEAG	Software	DASY5 V5.0 Build 91	N/A	NCR	
SPEAG	Software	SEMCAD X V12.4 Build 52	N/A	NCR	
SPEAG	Measurement Server	SE UMS 011 AA	1025	NCR	
Agilent	Wireless Communication Test Set	CMU200	109369	Jul. 29, 2009	Jul. 29, 2011
Agilent	Spectrum Analyzer(ESA-L)	E4408B	MY45107753	Jun. 23, 2009	Jun. 23, 2011
R&S	Spectrum Analyzer(FSL)	FSL6	100410	Mar. 25, 2009	Mar. 25, 2011
Agilent	Power Meter	E4418B	GB40206143	Jun. 18, 2009	Jun. 18, 2010
Agilent	Signal Generator	E8257D	MY44320425	NCR	
R&S	Power Sensor	8481H	3318A20779	Jun. 18, 2009	Jun. 18, 2010
Agilent	Dual Directional Coupler	778D	50334	NCR	
Mini-Circuits	Power Amplifier	ZVE-8G	D042005 671800514	NCR	
Mini-Circuits	Power Amplifier	ZHL-42W-SMA	D111103#5	NCR	

Table 1. Test Equipment List



4. Validation

Validations of the DASY5 v5.0 test system were performed using the measurement equipment listed in Section 3. All validations occur in free space using the DASY5 test arch. Note that the 10mm probe to dipole separation is measured from the top edge of the dipole to the calibration reference point of the probe. SPEAG uses the center point of the probe sensor(s) as the reference point when establishing targets for their dipoles. Therefore, because SPEAG's dipoles and targets are used, it is appropriate to measure the 10mm separation distance to the center of the sensors as they do. This reference point was used for validation only. Validations were performed at 835 MHz and/or 1880 MHz. These frequencies are within each operating band and are within 2MHz of the mid-band frequency of the test device.

Validations were performed to verify that measured E-field and H-field values are within +/- 25% from the target reference values provided by the manufacturer (Ref: Appendix D). Per Section 4.2.2.1 of the standard, "Values within +/-25% are acceptable, of which 12% is deviation and 13% is measurement uncertainty." Therefore, the E-Field and H-Field dipole verification results, shown in Table 2 & 3, are in accordance with the acceptable parameters defined by the standard.

Dipole	Freq. (MHz)	Protocol	Input Power (mW)	Target for Dipole (V/m)	E-Field Results (V/m)	Deviation	Date
SN:1017	835	CW	100	159.6	176.4	10.5%	Jan. 11, 2010
SN:1036	1880	CW	100	137.5	148.0	7.6 %	Jan. 11, 2010

Table 2. Dipole E-Field Measurement Summary

Dipole	Freq. (MHz)	Protocol	Input Power (mW)	Target for Dipole (A/m)	H-Field Results (A/m)	Deviation	Date
SN:1017	835	CW	100	0.457	0.459	0.4%	Jan. 11, 2010
SN:1036	1880	CW	100	0.474	0.461	-2.7%	Jan. 11, 2010

Table 3. Dipole H-Field Measurement Summary

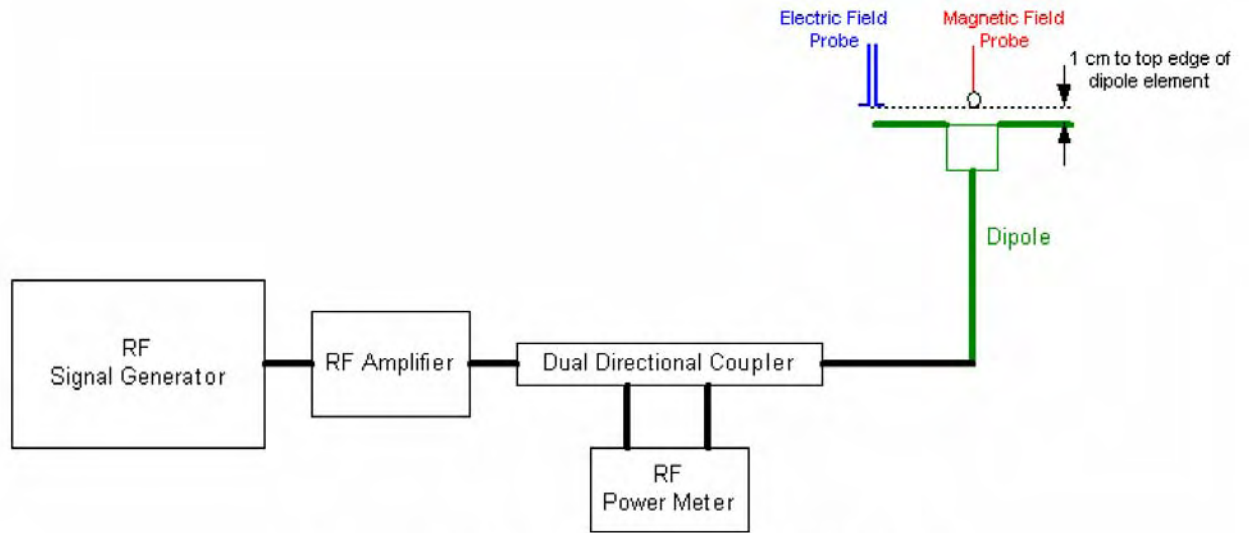

Figure 1. WD dipole calibration procedure

5. Probe Modulation Factor

After every probe calibration, the response of the probe to each applicable modulated signal (CDMA, GSM, WCDMA (UMTS), etc) must be assessed at both 835 MHz, 1880 MHz. The response of the probe system to a CW field at the frequency(s) of interest is compared to its response to a modulated signal with equal peak amplitude. For each PMF assessment, a Signal Generator was used to replace the original CW signal with the desired modulated signal. The PMF results are shown in Table 4. RF Field Probe Modulation Response was measured with the field probe and associated measurement equipment. The PMF was measured per ANSI C63.19-2007 using a signal generator as follows:

1. Illuminate a dipole with a CW signal at the intended measured frequency.
2. Fix the probe at a set location relative to the dipole; typically located at the field reference point.
3. Record the reading of the probe measurement system of the CW signal.
4. Substitute a modulated signal of the same amplitude, using the same modulation as that used by the intended WD for the CW signal.
5. Record the reading of the probe measurement system of the modulated signal.
6. The ratio of the CW to modulated signal reading is the probe modulation factor.
7. Spectrum analyzer settings:
 - Center Frequency: nominal center frequency of channel
 - Span: zero
 - Resolution bandwidth \geq emission bandwidth
 - Video bandwidth \geq 20 kHz.
 - Detection: RMS detection.
 - Trigger: Video or IF trigger, adjusted to give a stable display of the transmission.
 - Sweep rate: Set to show a complete transmission cycle.
 - Line max hold may be used temporarily to ease the peak reading.

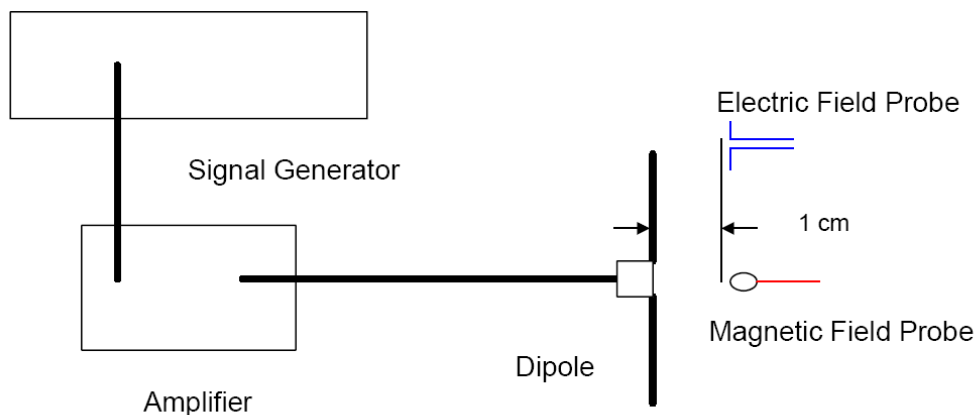

Figure 2. Dipole calibration procedure



Formula between PMF and test results

1. HAC test of device and determine the maximum value (M) of grids.
2. Determine the value (P) of PMF according to (M).
3. Find the maximum value (F) from the other data.

$$R = P * F$$

Example:

E-Field Maximum value (M) = 52, Maximum value (F) = 51.8, PMF (P) = 2.82

R = 51.8 * 2.82 = 146.076 V/m

Frequency (MHz)	Protocol	E-Field Probe SN:2256		H-Field Probe SN:6076	
		E-Field (V/m)	E-Field Modulation Factor	H-Field (A/m)	H-Field Modulation Factor
835.0	GSM	< 47	2.53	< 0.14	1.81
		47 - 63	2.54	0.14 - 0.19	2.12
		63 - 84	2.54	0.19 - 0.25	2.37
		84 - 112	2.55	0.25 - 0.34	2.57
		112 - 150	2.56	0.34 - 0.45	2.68
		150 - 200	2.56	0.45 - 0.60	2.71
		200- 266	2.57	0.60 - 0.80	2.64
		266 - 355	2.57	0.80 - 1.07	2.49
		355 - 473	2.58	1.07 - 1.43	2.26
		473 - 631	2.58	1.43 - 1.91	1.98
		631 - 841	2.59	1.91 - 2.54	1.67
		841 - 1122	2.60	2.54 - 3.39	1.36
1880.0	GSM	< 47	2.53	< 0.14	2.63
		47 - 63	2.52	0.14 - 0.19	2.59
		63 - 84	2.51	0.19 - 0.25	2.54
		84 - 112	2.50	0.25 - 0.34	2.44
		112 - 150	2.49	0.34 - 0.45	2.32
		150 - 200	2.48	0.45 - 0.60	2.18
		200- 266	2.47	0.60 - 0.80	2.02
		266 - 355	2.46	0.80 - 1.07	1.92
		355 - 473	2.45	1.07 - 1.43	1.73
		473 - 631	2.44	1.43 - 1.91	1.54
		631 - 841	2.43	1.91 - 2.54	1.36
		841 - 1122	2.42	2.54 - 3.39	1.17

Frequency (MHz)	Protocol	E-Field Probe SN:2256		H-Field Probe SN:6076	
		E-Field (V/m)	E-Field Modulation Factor	H-Field (A/m)	H-Field Modulation Factor
835.0	WCDMA	< 47	1.07	< 0.14	0.86
		47 - 63	1.04	0.14 - 0.19	0.86
		63 - 84	1.01	0.19 - 0.25	0.85
		84 - 112	0.98	0.25 - 0.34	0.83
		112 - 150	0.95	0.34 - 0.45	0.81
		150 - 200	0.92	0.45 - 0.60	0.78
		200 - 266	0.89	0.60 - 0.80	0.75
		266 - 355	0.87	0.80 - 1.07	0.72
		355 - 473	0.84	1.07 - 1.43	0.68
		473 - 631	0.82	1.43 - 1.91	0.64
		631 - 841	0.79	1.91 - 2.54	0.61
841 - 1122	0.77	2.54 - 3.39	0.56		
1880.0	WCDMA	< 47	0.90	< 0.14	0.81
		47 - 63	0.89	0.14 - 0.19	0.76
		63 - 84	0.89	0.19 - 0.25	0.71
		84 - 112	0.89	0.25 - 0.34	0.65
		112 - 150	0.89	0.34 - 0.45	0.59
		150 - 200	0.89	0.45 - 0.60	0.52
		200 - 266	0.89	0.60 - 0.80	0.46
		266 - 355	0.89	0.80 - 1.07	0.39
		355 - 473	0.89	1.07 - 1.43	0.33
		473 - 631	0.88	1.43 - 1.91	0.28
		631 - 841	0.88	1.91 - 2.54	0.23
841 - 1122	0.88	2.54 - 3.39	0.19		

Table 4. PMF Measurement Summary

Note: PMF measurements were verified at WD's power as an input to the dipole.



6. Test Results

The phone was tested in all normal configurations for the ear use. A DUT is mounted in the device holder equivalent as for classic dosimetric measurements. The acoustic output of the DUT shall coincide with the center point of the area formed by the dielectric wire and the middle bar of the arch's top frame. The DUT shall be moved vertically upwards until it touches the frame. The fine adjustment is possible by sliding the complete DUT holder on the yellow base plate of the Test Arch phantom. These test configurations are tested at the high, middle and low frequency channels of each applicable operating mode; for example, GSM, WCDMA (UMTS), CDMA and TDMA.

GSM Devices setup for HAC Measurement.

The values were assessed for the lowest, middle and highest channels defined by **GSM 850** and **PCS 1900** systems, Power level was set to its maximum, i.e., **GSM 850** nominal maximum output power class 4 (PCL 5, 33dBm) and **PCS 1900** nominal maximum output power class 1(PCL 0, 30dBm). These parameters will need to be replaced for the individual phone tested.

CDMA Devices setup for HAC Measurement.

The signal was setup by creating and maintaining an over the coaxial connection between the DUT and an R&S CMU200 Wireless Communications Test Set. The CDMA radio is available on CDMA 2000(1X) and IS-95. The test equipment was configured to use "all up bits" for RC1 / SO2 on J-STD-008 for CDMA 1900 and TSB-84 for CDMA 800 MHz. The Wideband and Zero Span spectrum analyzer plots are shown in Appendix A.

The DASY5 v5.0 measurement system specified in section 3.1 was utilized within the intended operations as set by the SPEAG™ setup. The default settings for the grid spacing of the scan were set to 5mm as shown in the Field plots included in Appendix B and C. The 5cm x 5cm area measurement grid is centered on the acoustic output of the device. The Test Arch provided by SPEAG is used to position the DUT. The WD reference plane is parallel to the device and contains the highest point on its contour in the area of the phone that normally rests against the user's ear. The measurement plane contains the nearest point on the probe sensor(s) relative to the WD. The pictures of the setup are included in 7.3.



WCDMA Devices setup for HAC Measurement.

The following procedures are applicable to WCDMA handsets operating under 3GPP Release 99 and Release 5. The default test configuration is to measure HAC with an established radio link between the DUT and a communication test set using a 12.2 kbps RMC (reference measurement channel) configured in Test Loop Mode 1. HAC is selectively confirmed for other physical channel configurations (DPCCH & DPDCH_n) according to output power, exposure conditions and device operating capabilities. Both uplink and downlink should be configured with the same RMC or AMR, when required. Maximum output power is verified according to 3GPP TS 34.121 and HAC must be measured according to these maximum output conditions.

HSDPA Devices setup for HAC Measurement.

Body HAC is not required for handsets with HSDPA capabilities when the maximum average output of each RF channel with HSDPA active is less than ¼ dB higher than that measured without HSDPA using 12.2 kbps RMC. Otherwise, HAC is measured for HSDPA, using FRC, with the body exposure configuration that results in the highest HAC in 12.2 RMC for that RF channel.

The device is positioned such that the WD reference plane is located 10mm from, and parallel to, the measurement plane. This is in accordance with section 4.3 of the standard, which states that “The WD reference plane is a plane parallel with the front "face" of the WD and containing the highest point on its contour in the area of the phone that normally rests against the user's ear.”

The following figure shows the position of the measurement grid with respect to a typical device under test.

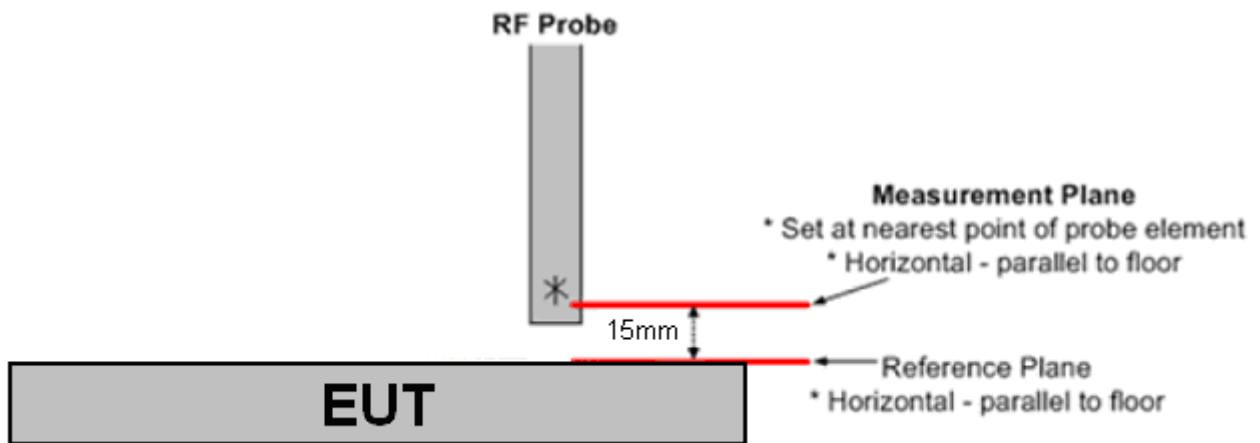

Figure 3. Clarification of Figure A-2 from the Standard

The HAC Rating results for E-Field and H-field are shown in 7.1 and 7.2. Also shown are the measured conducted output powers, the measured drifts, excluded areas, and the peak fields. PMF measurements are taken from Section 5. The worst-case test conditions are indicated with bold numbers in the tables and are detailed in Appendix C: HAC distribution plots for E-Field and H-Field.

Drift was measured using the typical DASY5 v5.0 measurement routines. The field is measured at the reference location (center of the ear piece) at the beginning of the test. Then after completion of the E or H field measurement, the probe returns to the same reference location and takes another measurement. The drift is the delta between these two values and is included in the test report scans.

The cellular phone model covered by this report has the following battery options:

Battery : BB00100 (3.7V 1300mAh)



6.1 HAC E-Field measurement results:

Band	Rating	E-Field
GSM 850	M3	149.6 to 266.1 V/m
	M4	< 149.6 V/m
PCS 1900	M3	47.3 to 84.1 V/m
	M4	< 47.3 V/m
WCDMA Band V	M3	199.5 to 354.8
	M4	< 199.5
WCDMA Band II	M3	63.1 to 112.2
	M4	< 63.1

Table 5. Emissions Limits

Open

Band	Channel	Conducted Power (dBm)	Measured PMF	Drift (dB)	Excluded Cells	Peak Field (V/m)	Rating
GSM 850	128	24.01	2.57	-0.058	4.7.8	188.8	M3
	190	24.15	2.57	0.019	4.7.8	190.9	M3
	251	24.10	2.57	-0.011	4.7.8	180.1	M3
PCS 1900	512	21.11	2.50	-0.050	7.8.9	70.0	M3
	661	21.17	2.50	-0.00322	7.8.9	68.3	M3
	810	21.03	2.50	-0.024	7.8.9	67.2	M3
WCDMA Band II	9262	23.69	0.90	0.032	7.8.9	32.9	M4
	9400	23.81	0.90	-0.128	7.8.9	33.0	M4
	9537	23.86	0.90	0.012	7.8.9	34.5	M4
WCDMA Band V	4132	23.17	1.01	-0.00452	7.8.9	68.6	M4
	4180	23.21	1.01	-0.018	7.8.9	63.6	M4
	4233	23.54	1.01	-0.031	4.7.8	60.8	M4

Note:

1. HAC E-Field measurement results for the portable cellular telephone at highest possible output power.



Close

Band	Channel	Conducted Power (dBm)	Measured PMF	Drift (dB)	Excluded Cells	Peak Field (V/m)	Rating
GSM 850	128	24.01	2.57	-0.015	2.3.6	203.8	M3
	190	24.15	2.57	-0.059	2.3.6	213.5	M3
	251	24.10	2.57	0.061	2.3.6	221.7	M3
PCS 1900	512	21.11	2.50	0.050	7.8.9	79.7	M3
	661	21.17	2.49	-0.00679	7.8.9	78.6	M3
	810	21.03	2.50	-0.00232	7.8.9	77.5	M3
WCDMA Band II	9262	23.69	0.90	0.057	7.8.9	38.7	M4
	9400	23.81	0.89	0.042	7.8.9	38.6	M4
	9537	23.86	0.90	-0.016	7.8.9	38.3	M4
WCDMA Band V	4132	23.17	0.98	0.030	2.3.6	84.5	M4
	4180	23.21	1.01	-0.058	2.3.6	77.9	M4
	4233	23.54	0.98	0.015	2.3.6	82.2	M4

Note:

HAC E-Field measurement results for the portable cellular telephone at highest possible output power.

Turn on Wi-Fi and Bluetooth Function

Band	EUT Mode	Channel	Wireless Mode	Peak Field (V/m)
GSM 850	Close	251	----	221.7
			Wi-Fi	221.6
			Bluetooth	221.7
PCS 1900	Close	512	----	79.7
			Wi-Fi	79.6
			Bluetooth	79.7
WCDMA Band II (RMC12.2K)	Close	9262	----	38.7
			Wi-Fi	38.7
			Bluetooth	38.5
WCDMA Band V (RMC12.2K)	Close	4132	----	84.5
			Wi-Fi	84.4
			Bluetooth	84.3



6.2 HAC H-Field measurement results:

Band	Rating	H-Field
GSM 850	M3	0.45 to 0.80 A/m
	M4	< 0.45 A/m
PCS 1900	M3	0.14 to 0.25 A/m
	M4	<0.14 A/m
WCDMA Band V	M3	0.60 to 1.07
	M4	< 0.60
WCDMA Band II	M3	0.19 to 0.34
	M4	< 0.19

Table 6. Emissions Limits

Open

Band	Channel	Conducted Power (dBm)	Measured PMF	Drift (dB)	Excluded Cells	Peak Field (A/m)	Rating
GSM 850	128	24.01	2.68	-0.152	1.2.4	0.251	M4
	190	24.15	2.57	0.015	1.2.4	0.235	M4
	251	24.10	2.57	0.100	1.2.4	0.226	M4
PCS 1900	512	21.11	2.54	-0.028	1.2.3	0.215	M3
	661	21.17	2.44	-0.068	1.2.3	0.203	M3
	810	21.03	2.54	0.029	1.2.3	0.217	M3
WCDMA Band II	9262	23.69	0.81	0.148	1.2.3	0.086	M4
	9400	23.81	0.81	-0.00873	1.2.3	0.085	M4
	9538	23.86	0.81	-0.000531	1.2.3	0.093	M4
WCDMA Band V	4132	23.17	0.86	-0.086	1.2.4	0.072	M4
	4180	23.21	0.86	-0.012	1.2.4	0.067	M4
	4233	23.54	0.86	-0.00217	1.2.4	0.063	M4

Note:

1. HAC H-Field measurement results for the portable cellular telephone at highest possible output power.



Close

Band	Channel	Conducted Power (dBm)	Measured PMF	Drift (dB)	Excluded Cells	Peak Field (A/m)	Rating
GSM 850	128	24.01	2.68	-0.011	1.4.7	0.271	M4
	190	24.15	2.68	-0.095	1.4.7	0.290	M4
	251	24.10	2.71	-0.042	1.4.7	0.309	M4
PCS 1900	512	21.11	2.44	-0.110	2.3.6	0.246	M3
	661	21.17	2.44	0.149	2.3.6	0.242	M3
	810	21.03	2.44	-0.018	2.3.6	0.247	M3
WCDMA Band II	9262	23.69	0.81	0.025	2.3.6	0.104	M4
	9400	23.81	0.81	0.00717	2.3.6	0.104	M4
	9537	23.86	0.81	0.00168	2.3.6	0.104	M4
WCDMA Band V	4132	23.17	0.86	0.043	1.4.7	0.092	M4
	4180	23.21	0.86	0.025	1.4.7	0.085	M4
	4233	23.54	0.86	0.030	1.4.7	0.093	M4

Note:

- HAC H-Field measurement results for the portable cellular telephone at highest possible output power.

Turn on Wi-Fi and Bluetooth Function

Band	EUT Mode	Channel	Wireless Mode	Peak Field (A/m)
GSM 850	Close	251	-----	0.309
			Wi-Fi	0.307
			Bluetooth	0.304
PCS 1900	Close	810	-----	0.247
			Wi-Fi	0.246
			Bluetooth	0.243
WCDMA Band II (RMC12.2K)	Close	9262	-----	0.104
			Wi-Fi	0.102
			Bluetooth	0.100
WCDMA Band V (RMC12.2K)	Close	4132	-----	0.093
			Wi-Fi	0.090
			Bluetooth	0.088



6.3 Description of the Device under Test (DUT)

Modes and Bands of Operation	GSM 850	PCS 1900	WCDMA Band V	WCDMA Band II
Modulation Mode	GMSK	GMSK	QPSK	QPSK
Duty Cycle	1/8.3	1/8.3	1/1	1/1
Transmitter Frequency Range (MHz)	824.2 - 848.8	1850.2 - 1909.8	826.6 - 846.4	1852.6 - 1907.4



Appendix A - Details of WD signal

GSM 835 MHz

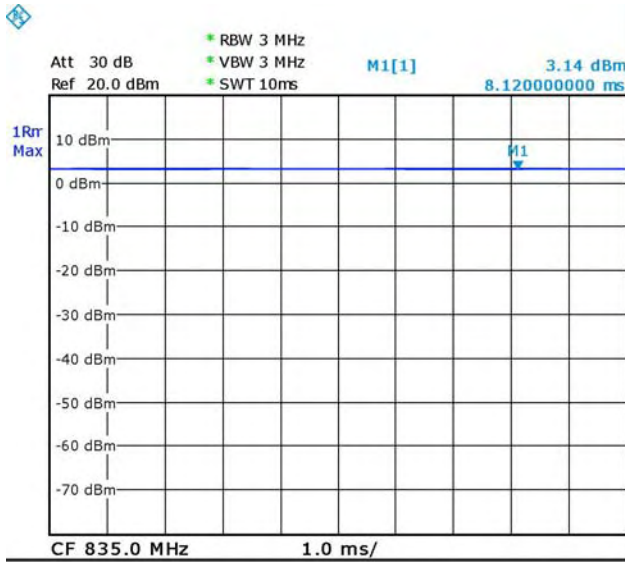

CW Signal

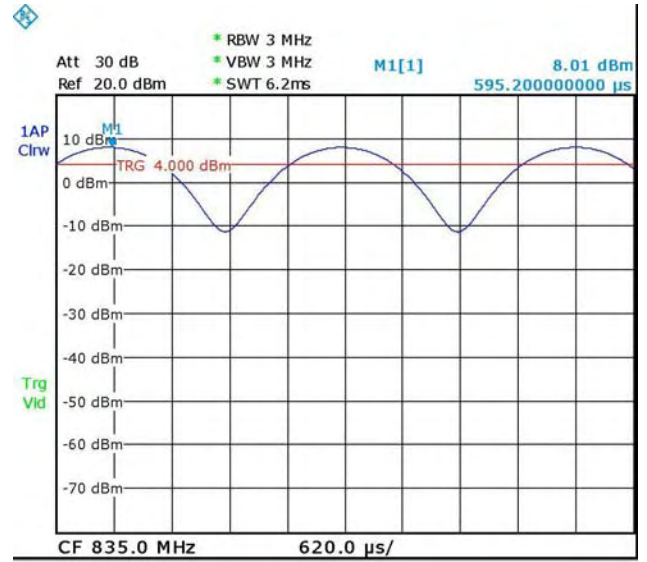

AM80%

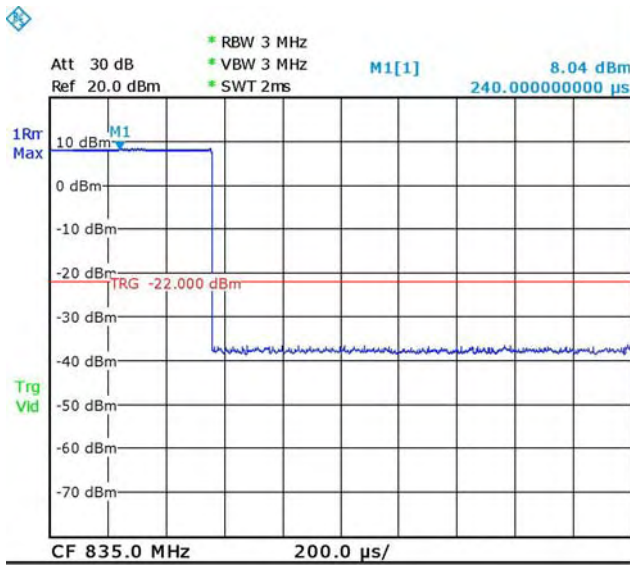

GSM Signal

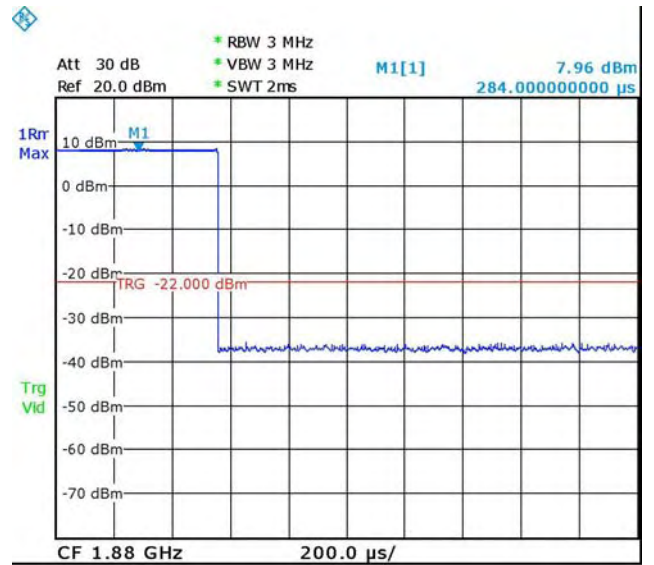

WCDMA Signal



1880 MHz

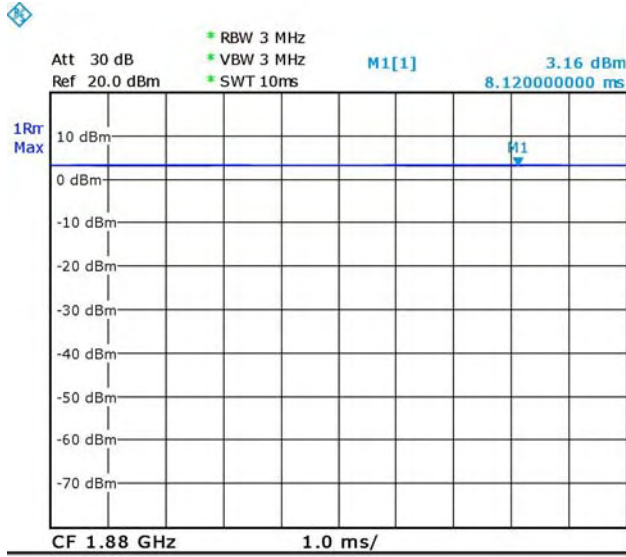

CW Signal

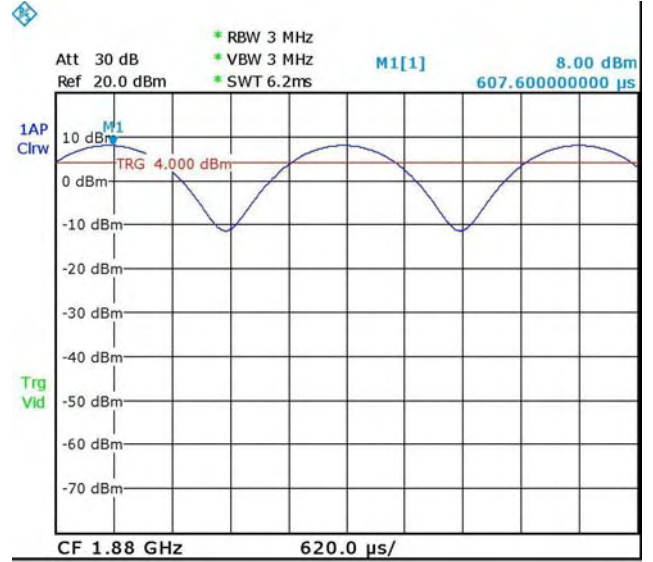

AM80%

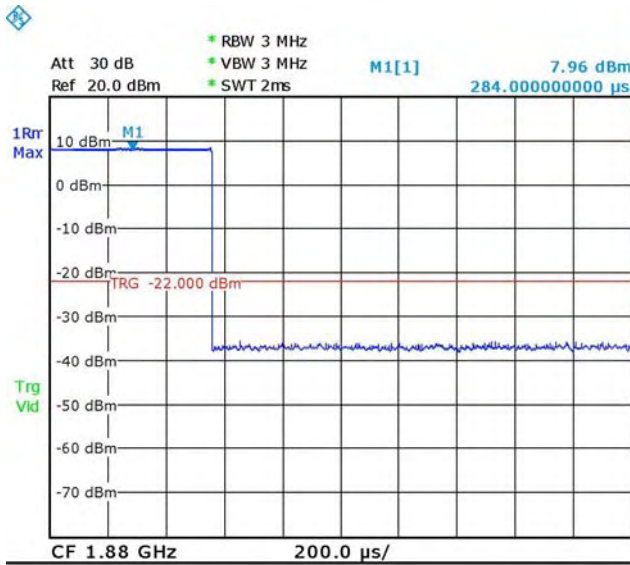

GSM Signal

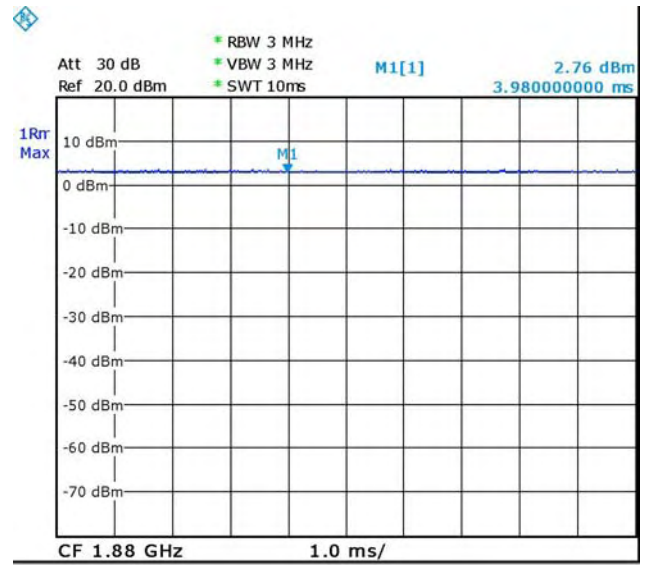

WCDMA Signal



Appendix B - Validation

See following Attached Pages for HAC distribution plots for E-Field and H-Field.



Test Laboratory: A Test Lab Techno Corp.

Date/Time: 1/11/2010 10:12:04 AM

HAC_System Performance Check at 835MHz_20100111_E

DUT: Dipole 835 MHz; Type: CD835V3; Serial: CD835V3 - SN:1017

Communication System: CW; Frequency: 835 MHz; Duty Cycle: 1:1

Medium parameters used: $\sigma = 0$ mho/m, $\epsilon_r = 1$; $\rho = 1000$ kg/m³

Phantom section: E Dipole Section

Measurement Standard: DASYS (IEEE/IEC)

DASY5 Configuration:

- Probe: ER3DV6 - SN2256; ConvF(1, 1, 1); Calibrated: 8/21/2009
- Sensor-Surface: (Fix Surface)
- Electronics: DAE3 Sn393; Calibrated: 8/24/2009
- Phantom: HAC Test Arch 4.6; Type: SD HAC P01 BA; Serial: 1038
- Measurement SW: DASYS, V5.0 Build 125; SEMCAD X Version 13.4 Build 125

E Scan - ER3DV6 - measurement distance from the probe sensor center to CD835

Dipole = 10mm/Hearing Aid Compatibility Test (41x361x1): Measurement grid:

dx=5mm, dy=5mm

Maximum value of peak Total field = 176.4 V/m

Probe Modulation Factor = 1

Device Reference Point: 0, 0, 354.7 mm

Reference Value = 124.1 V/m; Power Drift = 0.036 dB

Hearing Aid Near-Field Category: M4 (AWF 0 dB)

Peak E-field in V/m

Grid 1 175.9 M4	Grid 2 176.4 M4	Grid 3 161.4 M4
Grid 4 88.8 M4	Grid 5 89.6 M4	Grid 6 85.2 M4
Grid 7 165.1 M4	Grid 8 166.4 M4	Grid 9 156.7 M4

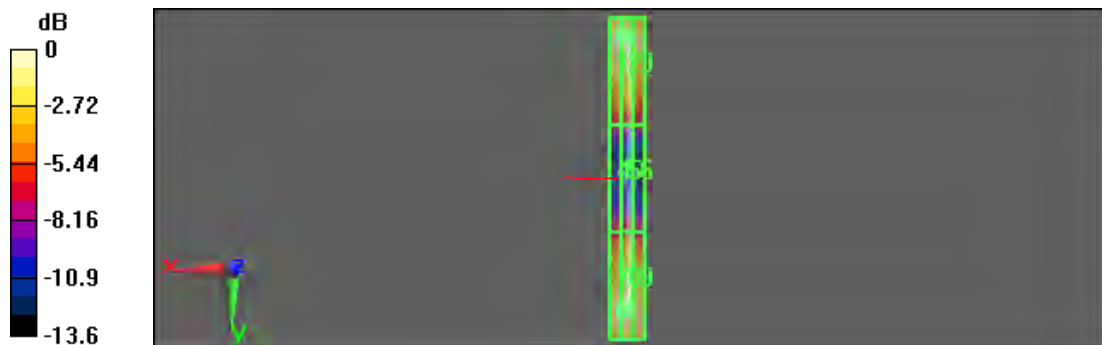

0 dB = 176.4V/m



Test Laboratory: A Test Lab Techno Corp.

Date/Time: 1/11/2010 10:37:44 AM

HAC_System Performance Check at 835MHz_20100111_H

DUT: Dipole 835 MHz; Type: CD835V3; Serial: CD835V3 - SN:1017

Communication System: CW; Frequency: 835 MHz; Duty Cycle: 1:1

Medium parameters used: $\sigma = 0$ mho/m, $\epsilon_r = 1$; $\rho = 1$ kg/m³

Phantom section: H Dipole Section

Measurement Standard: DASYS (IEEE/IEC)

DASY5 Configuration:

- Probe: H3DV6 - SN6076; ; Calibrated: 8/19/2009
- Sensor-Surface: (Fix Surface)
- Electronics: DAE3 Sn393; Calibrated: 8/24/2009
- Phantom: HAC Test Arch 4.6; Type: SD HAC P01 BA; Serial: 1038
- Measurement SW: DASYS, V5.0 Build 125; SEMCAD X Version 13.4 Build 125

H Scan - H3DV6 - measurement distance from the probe sensor center to CD835

Dipole = 10mm/Hearing Aid Compatibility Test (41x361x1): Measurement grid:

dx=5mm, dy=5mm

Maximum value of peak Total field = 0.459 A/m

Probe Modulation Factor = 1

Device Reference Point: 0, 0, 354.7 mm

Reference Value = 0.488 A/m; Power Drift = -0.010 dB

Hearing Aid Near-Field Category: M4 (AWF 0 dB)

Peak H-field in A/m

Grid 1	Grid 2	Grid 3
0.396 M4	0.409 M4	0.382 M4
Grid 4	Grid 5	Grid 6
0.444 M4	0.459 M4	0.432 M4
Grid 7	Grid 8	Grid 9
0.389 M4	0.405 M4	0.383 M4

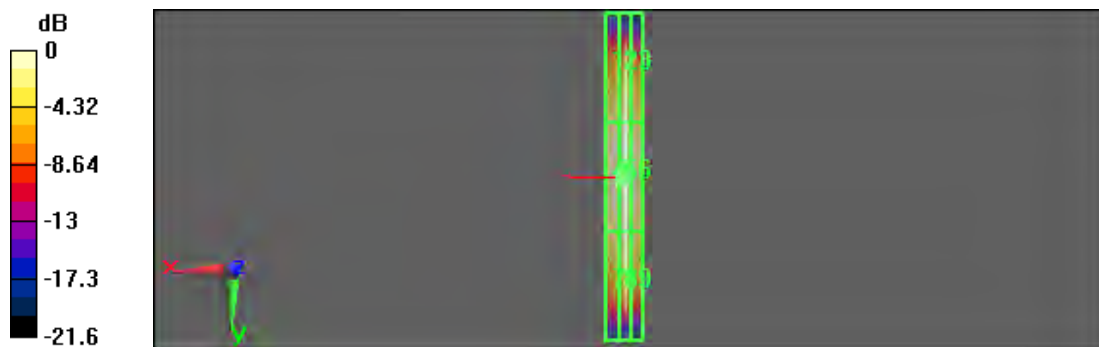

0 dB = 0.459A/m



Test Laboratory: A Test Lab Techno Corp.

Date/Time: 1/11/2010 11:45:26 AM

HAC_System Performance Check at 1880MHz_20100111_E

DUT: Dipole 1880 MHz; Type: CD1880V3; Serial: CD1880V3 - SN:1036

Communication System: CW; Frequency: 1880 MHz; Duty Cycle: 1:1

Medium parameters used: $\sigma = 0$ mho/m, $\epsilon_r = 1$; $\rho = 1000$ kg/m³

Phantom section: E Dipole Section

Measurement Standard: DASYS (IEEE/IEC)

DASY5 Configuration:

- Probe: ER3DV6 - SN2256; ConvF(1, 1, 1); Calibrated: 8/21/2009
- Sensor-Surface: (Fix Surface)
- Electronics: DAE3 Sn393; Calibrated: 8/24/2009
- Phantom: HAC Test Arch 4.6; Type: SD HAC P01 BA; Serial: 1038
- Measurement SW: DASYS, V5.0 Build 125; SEMCAD X Version 13.4 Build 125

E Scan - ER3DV6 - measurement distance from the probe sensor center to CD1880 Dipole = 10mm/Hearing Aid Compatibility Test (41x181x1): Measurement grid:

dx=5mm, dy=5mm

Maximum value of peak Total field = 148.0 V/m

Probe Modulation Factor = 1

Device Reference Point: 0, 0, 354.7 mm

Reference Value = 144.5 V/m; Power Drift = 0.033 dB

Hearing Aid Near-Field Category: M2 (AWF 0 dB)

Peak E-field in V/m

Grid 1 146.9 M2	Grid 2 148.0 M2	Grid 3 134.5 M2
Grid 4 91.2 M3	Grid 5 94.5 M3	Grid 6 90.5 M3
Grid 7 139.2 M2	Grid 8 141.5 M2	Grid 9 134.3 M2

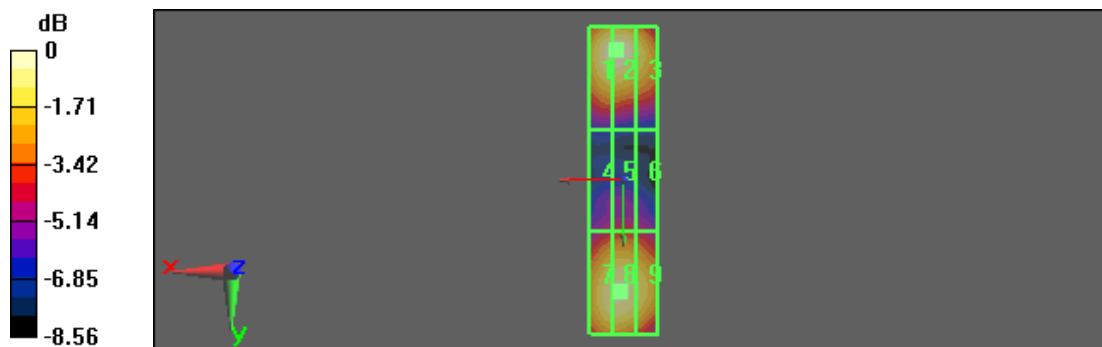

0 dB = 148.0V/m



Test Laboratory: A Test Lab Techno Corp.

Date/Time: 1/11/2010 11:24:34 AM

HAC_System Performance Check at 1880MHz_20100111_H

DUT: Dipole 1880 MHz; Type: CD1880V3; Serial: CD1880V3 - SN:1036

Communication System: CW; Frequency: 1880 MHz;Duty Cycle: 1:1

Medium parameters used: $\sigma = 0$ mho/m, $\epsilon_r = 1$; $\rho = 1$ kg/m³

Phantom section: H Dipole Section

Measurement Standard: DASYS (IEEE/IEC)

DASY5 Configuration:

- Probe: H3DV6 - SN6076; ; Calibrated: 8/19/2009
- Sensor-Surface: (Fix Surface)
- Electronics: DAE3 Sn393; Calibrated: 8/24/2009
- Phantom: HAC Test Arch 4.6; Type: SD HAC P01 BA; Serial: 1038
- Measurement SW: DASYS, V5.0 Build 125;SEMCAD X Version 13.4 Build 125

H Scan - H3DV6 - measurement distance from the probe sensor center to CD1880

Dipole = 10mm/Hearing Aid Compatibility Test (41x181x1): Measurement grid:

dx=5mm, dy=5mm

Maximum value of peak Total field = 0.461 A/m

Probe Modulation Factor = 1

Device Reference Point: 0, 0, 354.7 mm

Reference Value = 0.488 A/m; Power Drift = -0.011 dB

Hearing Aid Near-Field Category: M2 (AWF 0 dB)

Peak H-field in A/m

Grid 1	Grid 2	Grid 3
0.407 M2	0.421 M2	0.396 M2
Grid 4	Grid 5	Grid 6
0.445 M2	0.461 M2	0.437 M2
Grid 7	Grid 8	Grid 9
0.406 M2	0.422 M2	0.400 M2

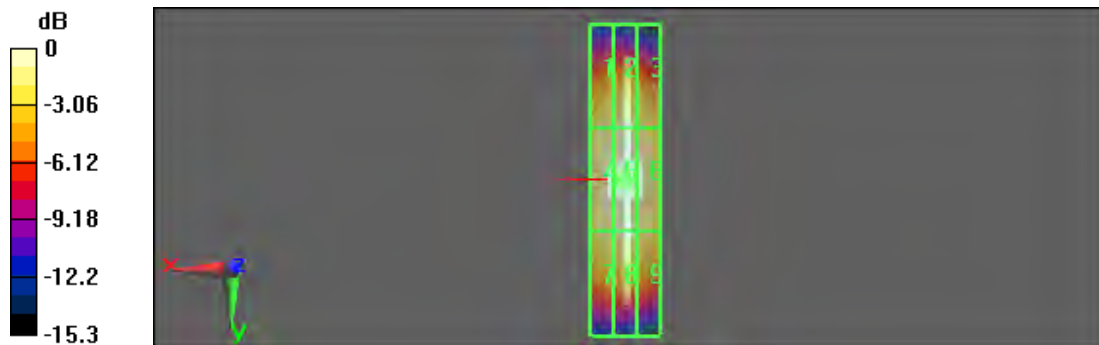

0 dB = 0.461A/m



Appendix C - HAC distribution plots for E-Field and H-Field

See following Attached Pages for HAC distribution plots for E-Field and H-Field.



Test Laboratory: A Test Lab Techno Corp.

Date/Time: 1/11/2010 4:21:24 PM

HAC_GSM850 CH128_E_Open

DUT: PC70110_Open; Type: Smartphone; FCC ID: NM8PC70110

Communication System: GSM850; Frequency: 824.2 MHz; Duty Cycle: 1:8.3

Medium parameters used: $\sigma = 0$ mho/m, $\epsilon_r = 1$; $\rho = 1000$ kg/m³

Phantom section: E Device Section

Measurement Standard: DASYS (IEEE/IEC)

DASY5 Configuration:

- Probe: ER3DV6 - SN2256; ConvF(1, 1, 1); Calibrated: 8/21/2009
- Sensor-Surface: (Fix Surface)
- Electronics: DAE3 Sn393; Calibrated: 8/24/2009
- Phantom: HAC Test Arch 4.6; Type: SD HAC P01 BA; Serial: 1038
- Measurement SW: DASYS, V5.0 Build 125; SEMCAD X Version 13.4 Build 125

E Scan - ER3DV6 - measurement distance from the probe sensor center to the Device = 15mm/Hearing Aid Compatibility Test (101x101x1): Measurement grid:

dx=5mm, dy=5mm

Maximum value of peak Total field = 188.8 V/m

Probe Modulation Factor = 2.57

Device Reference Point: 0, 0, 353.7 mm

Reference Value = 92.1 V/m; Power Drift = -0.058 dB

Hearing Aid Near-Field Category: M3 (AWF -5 dB)

Peak E-field in V/m

Grid 1 160.4 M3	Grid 2 169.0 M3	Grid 3 161.0 M3
Grid 4 183.2 M3	Grid 5 188.8 M3	Grid 6 177.7 M3
Grid 7 188.0 M3	Grid 8 190.5 M3	Grid 9 178.0 M3





Test Laboratory: A Test Lab Techno Corp.

Date/Time: 1/11/2010 4:28:53 PM

HAC_GSM850 CH190_E_Open

DUT: PC70110_Open; Type: Smartphone; FCC ID: NM8PC70110

Communication System: GSM850; Frequency: 836.6 MHz; Duty Cycle: 1:8.3

Medium parameters used: $\sigma = 0$ mho/m, $\epsilon_r = 1$; $\rho = 1000$ kg/m³

Phantom section: E Device Section

Measurement Standard: DASYS (IEEE/IEC)

DASY5 Configuration:

- Probe: ER3DV6 - SN2256; ConvF(1, 1, 1); Calibrated: 8/21/2009
- Sensor-Surface: (Fix Surface)
- Electronics: DAE3 Sn393; Calibrated: 8/24/2009
- Phantom: HAC Test Arch 4.6; Type: SD HAC P01 BA; Serial: 1038
- Measurement SW: DASY5, V5.0 Build 125; SEMCAD X Version 13.4 Build 125

E Scan - ER3DV6 - measurement distance from the probe sensor center to the Device = 15mm/Hearing Aid Compatibility Test (101x101x1): Measurement grid: dx=5mm, dy=5mm

Maximum value of peak Total field = 190.9 V/m

Probe Modulation Factor = 2.57

Device Reference Point: 0, 0, 353.7 mm

Reference Value = 92.7 V/m; Power Drift = 0.019 dB

Hearing Aid Near-Field Category: M3 (AWF -5 dB)

Peak E-field in V/m

Grid 1 161.3 M3	Grid 2 169.4 M3	Grid 3 162.0 M3
Grid 4 185.5 M3	Grid 5 190.9 M3	Grid 6 179.7 M3
Grid 7 191.0 M3	Grid 8 193.5 M3	Grid 9 180.2 M3



0 dB = 193.5V/m



Test Laboratory: A Test Lab Techno Corp.

Date/Time: 1/11/2010 4:35:17 PM

HAC_GSM850 CH251_E_Open

DUT: PC70110_Open; Type: Smartphone; FCC ID: NM8PC70110

Communication System: GSM850; Frequency: 848.8 MHz; Duty Cycle: 1:8.3

Medium parameters used: $\sigma = 0$ mho/m, $\epsilon_r = 1$; $\rho = 1000$ kg/m³

Phantom section: E Device Section

Measurement Standard: DASYS (IEEE/IEC)

DASY5 Configuration:

- Probe: ER3DV6 - SN2256; ConvF(1, 1, 1); Calibrated: 8/21/2009
- Sensor-Surface: (Fix Surface)
- Electronics: DAE3 Sn393; Calibrated: 8/24/2009
- Phantom: HAC Test Arch 4.6; Type: SD HAC P01 BA; Serial: 1038
- Measurement SW: DASY5, V5.0 Build 125; SEMCAD X Version 13.4 Build 125

E Scan - ER3DV6 - measurement distance from the probe sensor center to the Device = 15mm/Hearing Aid Compatibility Test (101x101x1): Measurement grid: dx=5mm, dy=5mm

Maximum value of peak Total field = 180.1 V/m

Probe Modulation Factor = 2.57

Device Reference Point: 0, 0, 353.7 mm

Reference Value = 87.4 V/m; Power Drift = -0.011 dB

Hearing Aid Near-Field Category: M3 (AWF -5 dB)

Peak E-field in V/m

Grid 1 151.4 M3	Grid 2 159.3 M3	Grid 3 152.7 M3
Grid 4 173.7 M3	Grid 5 180.1 M3	Grid 6 168.7 M3
Grid 7 179.9 M3	Grid 8 182.4 M3	Grid 9 169.1 M3



0 dB = 182.4V/m



Test Laboratory: A Test Lab Techno Corp.

Date/Time: 1/11/2010 3:46:56 PM

HAC_PCS CH512_E_Open

DUT: PC70110_Open; Type: Smartphone; FCC ID: NM8PC70110

Communication System: PCS; Frequency: 1850.2 MHz; Duty Cycle: 1:8.3

Medium parameters used: $\sigma = 0$ mho/m, $\epsilon_r = 1$; $\rho = 1000$ kg/m³

Phantom section: E Device Section

Measurement Standard: DASYS (IEEE/IEC)

DASY5 Configuration:

- Probe: ER3DV6 - SN2256; ConvF(1, 1, 1); Calibrated: 8/21/2009
- Sensor-Surface: (Fix Surface)
- Electronics: DAE3 Sn393; Calibrated: 8/24/2009
- Phantom: HAC Test Arch 4.6; Type: SD HAC P01 BA; Serial: 1038
- Measurement SW: DASY5, V5.0 Build 125; SEMCAD X Version 13.4 Build 125

E Scan - ER3DV6 - measurement distance from the probe sensor center to the Device = 15mm/Hearing Aid Compatibility Test (101x101x1): Measurement grid:

dx=5mm, dy=5mm

Maximum value of peak Total field = 70 V/m

Probe Modulation Factor = 2.5

Device Reference Point: 0, 0, 353.7 mm

Reference Value = 23.6 V/m; Power Drift = -0.050 dB

Hearing Aid Near-Field Category: M3 (AWF -5 dB)

Peak E-field in V/m

Grid 1	Grid 2	Grid 3
65.3 M3	59 M3	59 M3
Grid 4	Grid 5	Grid 6
52.7 M3	70 M3	70 M3
Grid 7	Grid 8	Grid 9
80 M3	84.6 M2	82.4 M3



0 dB = 84.6V/m



Test Laboratory: A Test Lab Techno Corp.

Date/Time: 1/11/2010 3:54:22 PM

HAC_PCS CH661_E_Open

DUT: PC70110_Open; Type: Smartphone; FCC ID: NM8PC70110

Communication System: PCS; Frequency: 1880 MHz; Duty Cycle: 1:8.3

Medium parameters used: $\sigma = 0$ mho/m, $\epsilon_r = 1$; $\rho = 1000$ kg/m³

Phantom section: E Device Section

Measurement Standard: DASYS (IEEE/IEC)

DASY5 Configuration:

- Probe: ER3DV6 - SN2256; ConvF(1, 1, 1); Calibrated: 8/21/2009
- Sensor-Surface: (Fix Surface)
- Electronics: DAE3 Sn393; Calibrated: 8/24/2009
- Phantom: HAC Test Arch 4.6; Type: SD HAC P01 BA; Serial: 1038
- Measurement SW: DASY5, V5.0 Build 125; SEMCAD X Version 13.4 Build 125

E Scan - ER3DV6 - measurement distance from the probe sensor center to the Device = 15mm/Hearing Aid Compatibility Test (101x101x1): Measurement grid: dx=5mm, dy=5mm

Maximum value of peak Total field = 68.3 V/m

Probe Modulation Factor = 2.5

Device Reference Point: 0, 0, 353.7 mm

Reference Value = 23.6 V/m; Power Drift = -0.00322 dB

Hearing Aid Near-Field Category: M3 (AWF -5 dB)

Peak E-field in V/m

Grid 1	Grid 2	Grid 3
59.5 M3	59.7 M3	59.7 M3
Grid 4	Grid 5	Grid 6
52.5 M3	68.3 M3	68.2 M3
Grid 7	Grid 8	Grid 9
79.4 M3	83.9 M3	80.5 M3



0 dB = 83.9V/m



Test Laboratory: A Test Lab Techno Corp.

Date/Time: 1/11/2010 4:01:50 PM

HAC_PCS CH810_E_Open

DUT: PC70110_Open; Type: Smartphone; FCC ID: NM8PC70110

Communication System: PCS; Frequency: 1909.8 MHz; Duty Cycle: 1:8.3

Medium parameters used: $\sigma = 0$ mho/m, $\epsilon_r = 1$; $\rho = 1000$ kg/m³

Phantom section: E Device Section

Measurement Standard: DASYS (IEEE/IEC)

DASY5 Configuration:

- Probe: ER3DV6 - SN2256; ConvF(1, 1, 1); Calibrated: 8/21/2009
- Sensor-Surface: (Fix Surface)
- Electronics: DAE3 Sn393; Calibrated: 8/24/2009
- Phantom: HAC Test Arch 4.6; Type: SD HAC P01 BA; Serial: 1038
- Measurement SW: DASY5, V5.0 Build 125; SEMCAD X Version 13.4 Build 125

E Scan - ER3DV6 - measurement distance from the probe sensor center to the Device = 15mm/Hearing Aid Compatibility Test (101x101x1): Measurement grid:

dx=5mm, dy=5mm

Maximum value of peak Total field = 67.2 V/m

Probe Modulation Factor = 2.5

Device Reference Point: 0, 0, 353.7 mm

Reference Value = 23.9 V/m; Power Drift = -0.024 dB

Hearing Aid Near-Field Category: M3 (AWF -5 dB)

Peak E-field in V/m

Grid 1	Grid 2	Grid 3
54.1 M3	59.5 M3	59.8 M3
Grid 4	Grid 5	Grid 6
51.8 M3	67.2 M3	67.1 M3
Grid 7	Grid 8	Grid 9
76.7 M3	80.9 M3	77.7 M3



0 dB = 80.9V/m

Test Laboratory: A Test Lab Techno Corp.

Date/Time: 1/11/2010 4:45:03 PM

HAC_WCDMA Band II CH9262_E_Open

DUT: PC70110_Open; Type: Smartphone; FCC ID: NM8PC70110

Communication System: WCDMA Band II; Frequency: 1852.4 MHz; Duty Cycle: 1:1

Medium parameters used: $\sigma = 0$ mho/m, $\epsilon_r = 1$; $\rho = 1000$ kg/m³

Phantom section: E Device Section

Measurement Standard: DASYS (IEEE/IEC)

DASY5 Configuration:

- Probe: ER3DV6 - SN2256; ConvF(1, 1, 1); Calibrated: 8/21/2009
- Sensor-Surface: (Fix Surface)
- Electronics: DAE3 Sn393; Calibrated: 8/24/2009
- Phantom: HAC Test Arch 4.6; Type: SD HAC P01 BA; Serial: 1038
- Measurement SW: DASY5, V5.0 Build 125; SEMCAD X Version 13.4 Build 125

E Scan - ER3DV6 - measurement distance from the probe sensor center to the Device = 15mm/Hearing Aid Compatibility Test (101x101x1): Measurement grid: dx=5mm, dy=5mm

Maximum value of peak Total field = 32.9 V/m

Probe Modulation Factor = 0.900

Device Reference Point: 0, 0, 353.7 mm

Reference Value = 30.6 V/m; Power Drift = 0.032 dB

Hearing Aid Near-Field Category: M4 (AWF 0 dB)

Peak E-field in V/m

Grid 1	Grid 2	Grid 3
30.8 M4	27.7 M4	27.5 M4
Grid 4	Grid 5	Grid 6
24.6 M4	32.9 M4	32.9 M4
Grid 7	Grid 8	Grid 9
37.6 M4	39.8 M4	38.7 M4

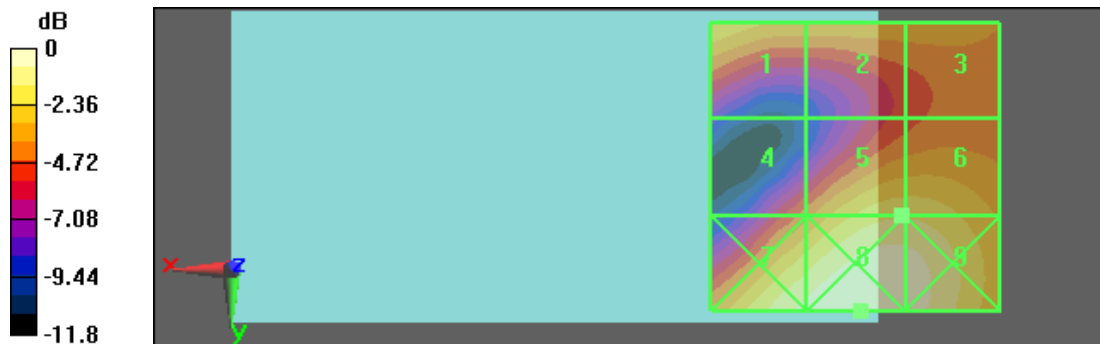

0 dB = 39.8V/m



Test Laboratory: A Test Lab Techno Corp.

Date/Time: 1/11/2010 4:51:07 PM

HAC_WCDMA Band II CH9400_E_Open

DUT: PC70110_Open; Type: Smartphone; FCC ID: NM8PC70110

Communication System: WCDMA Band II; Frequency: 1880 MHz; Duty Cycle: 1:1

Medium parameters used: $\sigma = 0$ mho/m, $\epsilon_r = 1$; $\rho = 1000$ kg/m³

Phantom section: E Device Section

Measurement Standard: DASYS (IEEE/IEC)

DASY5 Configuration:

- Probe: ER3DV6 - SN2256; ConvF(1, 1, 1); Calibrated: 8/21/2009
- Sensor-Surface: (Fix Surface)
- Electronics: DAE3 Sn393; Calibrated: 8/24/2009
- Phantom: HAC Test Arch 4.6; Type: SD HAC P01 BA; Serial: 1038
- Measurement SW: DASYS, V5.0 Build 125; SEMCAD X Version 13.4 Build 125

E Scan - ER3DV6 - measurement distance from the probe sensor center to the Device = 15mm/Hearing Aid Compatibility Test (101x101x1): Measurement grid: dx=5mm, dy=5mm

Maximum value of peak Total field = 33 V/m

Probe Modulation Factor = 0.900

Device Reference Point: 0, 0, 353.7 mm

Reference Value = 31.9 V/m; Power Drift = -0.128 dB

Hearing Aid Near-Field Category: M4 (AWF 0 dB)

Peak E-field in V/m

Grid 1	Grid 2	Grid 3
29 M4	28.6 M4	28.6 M4
Grid 4	Grid 5	Grid 6
25.3 M4	33 M4	32.9 M4
Grid 7	Grid 8	Grid 9
38.5 M4	40.7 M4	38.9 M4



0 dB = 40.7V/m



Test Laboratory: A Test Lab Techno Corp.

Date/Time: 1/11/2010 4:57:27 PM

HAC_WCDMA Band II CH9538_E_Open

DUT: PC70110_Open; Type: Smartphone; FCC ID: NM8PC70110

Communication System: WCDMA Band II; Frequency: 1907.6 MHz; Duty Cycle: 1:1

Medium parameters used: $\sigma = 0$ mho/m, $\epsilon_r = 1$; $\rho = 1000$ kg/m³

Phantom section: E Device Section

Measurement Standard: DASYS (IEEE/IEC)

DASY5 Configuration:

- Probe: ER3DV6 - SN2256; ConvF(1, 1, 1); Calibrated: 8/21/2009
- Sensor-Surface: (Fix Surface)
- Electronics: DAE3 Sn393; Calibrated: 8/24/2009
- Phantom: HAC Test Arch 4.6; Type: SD HAC P01 BA; Serial: 1038
- Measurement SW: DASY5, V5.0 Build 125; SEMCAD X Version 13.4 Build 125

E Scan - ER3DV6 - measurement distance from the probe sensor center to the Device = 15mm/Hearing Aid Compatibility Test (101x101x1): Measurement grid: dx=5mm, dy=5mm

Maximum value of peak Total field = 34.5 V/m

Probe Modulation Factor = 0.900

Device Reference Point: 0, 0, 353.7 mm

Reference Value = 33.7 V/m; Power Drift = 0.012 dB

Hearing Aid Near-Field Category: M4 (AWF 0 dB)

Peak E-field in V/m

Grid 1	Grid 2	Grid 3
28 M4	30.4 M4	30.6 M4
Grid 4	Grid 5	Grid 6
26.6 M4	34.5 M4	34.5 M4
Grid 7	Grid 8	Grid 9
39.6 M4	41.8 M4	40.2 M4



0 dB = 41.8V/m



Test Laboratory: A Test Lab Techno Corp.

Date/Time: 1/11/2010 5:03:50 PM

HAC_WCDMA Band V CH4132_E_Open

DUT: PC70110_Open; Type: Smartphone; FCC ID: NM8PC70110

Communication System: WCDMA Band V; Frequency: 826.4 MHz; Duty Cycle: 1:1

Medium parameters used: $\sigma = 0$ mho/m, $\epsilon_r = 1$; $\rho = 1000$ kg/m³

Phantom section: E Device Section

Measurement Standard: DASYS (IEEE/IEC)

DASY5 Configuration:

- Probe: ER3DV6 - SN2256; ConvF(1, 1, 1); Calibrated: 8/21/2009
- Sensor-Surface: (Fix Surface)
- Electronics: DAE3 Sn393; Calibrated: 8/24/2009
- Phantom: HAC Test Arch 4.6; Type: SD HAC P01 BA; Serial: 1038
- Measurement SW: DASYS, V5.0 Build 125; SEMCAD X Version 13.4 Build 125

E Scan - ER3DV6 - measurement distance from the probe sensor center to the Device = 15mm/Hearing Aid Compatibility Test (101x101x1): Measurement grid: dx=5mm, dy=5mm

Maximum value of peak Total field = 68.6 V/m

Probe Modulation Factor = 1.01

Device Reference Point: 0, 0, 353.7 mm

Reference Value = 85 V/m; Power Drift = -0.00452 dB

Hearing Aid Near-Field Category: M4 (AWF 0 dB)

Peak E-field in V/m

Grid 1	Grid 2	Grid 3
58.2 M4	61.2 M4	58.8 M4
Grid 4	Grid 5	Grid 6
66.5 M4	68.6 M4	64.6 M4
Grid 7	Grid 8	Grid 9
68.6 M4	69.5 M4	64.7 M4

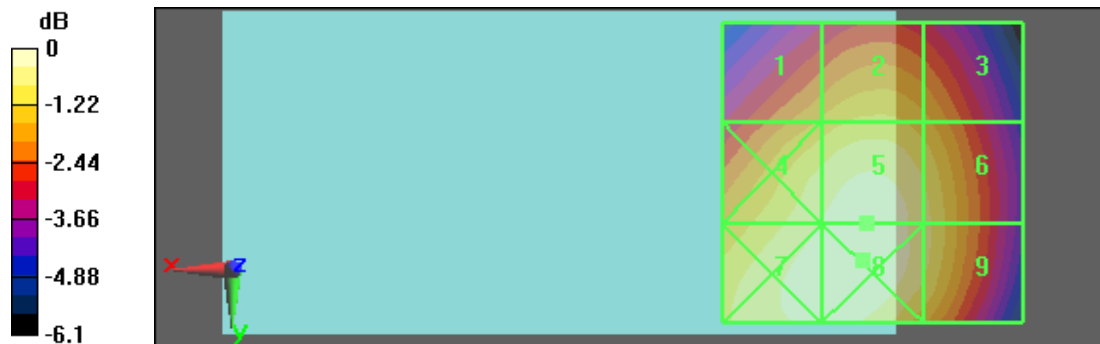

0 dB = 69.5V/m



Test Laboratory: A Test Lab Techno Corp.

Date/Time: 1/11/2010 5:12:21 PM

HAC_WCDMA Band V CH4183_E_Open

DUT: PC70110_Open; Type: Smartphone; FCC ID: NM8PC70110

Communication System: WCDMA Band V; Frequency: 836.6 MHz;Duty Cycle: 1:1

Medium parameters used: $\sigma = 0$ mho/m, $\epsilon_r = 1$; $\rho = 1000$ kg/m³

Phantom section: E Device Section

Measurement Standard: DASYS (IEEE/IEC)

DASY5 Configuration:

- Probe: ER3DV6 - SN2256; ConvF(1, 1, 1); Calibrated: 8/21/2009
- Sensor-Surface: (Fix Surface)
- Electronics: DAE3 Sn393; Calibrated: 8/24/2009
- Phantom: HAC Test Arch 4.6; Type: SD HAC P01 BA; Serial: 1038
- Measurement SW: DASY5, V5.0 Build 125;SEMCAD X Version 13.4 Build 125

E Scan - ER3DV6 - measurement distance from the probe sensor center to the Device = 15mm/Hearing Aid Compatibility Test (101x101x1): Measurement grid:

dx=5mm, dy=5mm

Maximum value of peak Total field = 63.6 V/m

Probe Modulation Factor = 1.01

Device Reference Point: 0, 0, 353.7 mm

Reference Value = 78.8 V/m; Power Drift = -0.018 dB

Hearing Aid Near-Field Category: M4 (AWF 0 dB)

Peak E-field in V/m

Grid 1	Grid 2	Grid 3
53.7 M4	56.5 M4	54.1 M4
Grid 4	Grid 5	Grid 6
61.6 M4	63.6 M4	59.8 M4
Grid 7	Grid 8	Grid 9
63.5 M4	64.5 M4	60 M4



0 dB = 64.5V/m



Test Laboratory: A Test Lab Techno Corp.

Date/Time: 1/11/2010 5:20:54 PM

HAC_WCDMA Band V CH4233_E_Open

DUT: PC70110_Open; Type: Smartphone; FCC ID: NM8PC70110

Communication System: WCDMA Band V; Frequency: 846.6 MHz; Duty Cycle: 1:1

Medium parameters used: $\sigma = 0$ mho/m, $\epsilon_r = 1$; $\rho = 1000$ kg/m³

Phantom section: E Device Section

Measurement Standard: DASYS (IEEE/IEC)

DASY5 Configuration:

- Probe: ER3DV6 - SN2256; ConvF(1, 1, 1); Calibrated: 8/21/2009
- Sensor-Surface: (Fix Surface)
- Electronics: DAE3 Sn393; Calibrated: 8/24/2009
- Phantom: HAC Test Arch 4.6; Type: SD HAC P01 BA; Serial: 1038
- Measurement SW: DASY5, V5.0 Build 125; SEMCAD X Version 13.4 Build 125

E Scan - ER3DV6 - measurement distance from the probe sensor center to the Device = 15mm/Hearing Aid Compatibility Test (101x101x1): Measurement grid: dx=5mm, dy=5mm

Maximum value of peak Total field = 60.8 V/m

Probe Modulation Factor = 1.01

Device Reference Point: 0, 0, 353.7 mm

Reference Value = 75 V/m; Power Drift = -0.031 dB

Hearing Aid Near-Field Category: M4 (AWF 0 dB)

Peak E-field in V/m

Grid 1	Grid 2	Grid 3
51.1 M4	53.9 M4	51.5 M4
Grid 4	Grid 5	Grid 6
58.7 M4	60.8 M4	57.1 M4
Grid 7	Grid 8	Grid 9
60.8 M4	61.6 M4	57.3 M4

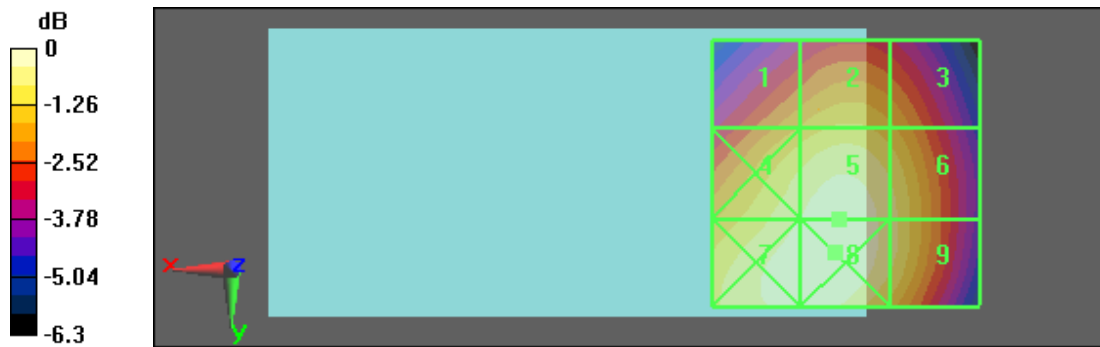

0 dB = 61.6V/m



Test Laboratory: A Test Lab Techno Corp.

Date/Time: 1/11/2010 1:52:53 PM

HAC_GSM850 CH128_E_Close

DUT: PC70110_Close; Type: Smartphone; FCC ID: NM8PC70110

Communication System: GSM850; Frequency: 824.2 MHz; Duty Cycle: 1:8.3

Medium parameters used: $\sigma = 0$ mho/m, $\epsilon_r = 1$; $\rho = 1000$ kg/m³

Phantom section: E Device Section

Measurement Standard: DASYS (IEEE/IEC)

DASY5 Configuration:

- Probe: ER3DV6 - SN2256; ConvF(1, 1, 1); Calibrated: 8/21/2009
- Sensor-Surface: (Fix Surface)
- Electronics: DAE3 Sn393; Calibrated: 8/24/2009
- Phantom: HAC Test Arch 4.6; Type: SD HAC P01 BA; Serial: 1038
- Measurement SW: DASY5, V5.0 Build 125; SEMCAD X Version 13.4 Build 125

E Scan - ER3DV6 - measurement distance from the probe sensor center to the Device = 15mm/Hearing Aid Compatibility Test (101x101x1): Measurement grid:

dx=5mm, dy=5mm

Maximum value of peak Total field = 203.8 V/m

Probe Modulation Factor = 2.57

Device Reference Point: 0, 0, 353.7 mm

Reference Value = 103.7 V/m; Power Drift = -0.015 dB

Hearing Aid Near-Field Category: M3 (AWF -5 dB)

Peak E-field in V/m

Grid 1 188.8 M3	Grid 2 200.2 M3	Grid 3 192.8 M3
Grid 4 192.2 M3	Grid 5 203.8 M3	Grid 6 197.3 M3
Grid 7 187.5 M3	Grid 8 198.9 M3	Grid 9 192.9 M3

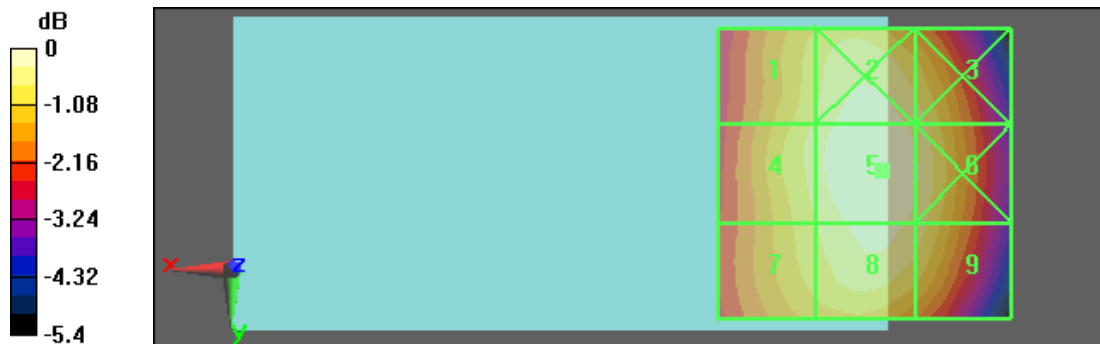

0 dB = 203.8V/m



Test Laboratory: A Test Lab Techno Corp.

Date/Time: 1/11/2010 2:02:49 PM

HAC_GSM850 CH190_E_Close

DUT: PC70110_Close; Type: Smartphone; FCC ID: NM8PC70110

Communication System: GSM850; Frequency: 836.6 MHz; Duty Cycle: 1:8.3

Medium parameters used: $\sigma = 0$ mho/m, $\epsilon_r = 1$; $\rho = 1000$ kg/m³

Phantom section: E Device Section

Measurement Standard: DASYS (IEEE/IEC)

DASY5 Configuration:

- Probe: ER3DV6 - SN2256; ConvF(1, 1, 1); Calibrated: 8/21/2009
- Sensor-Surface: (Fix Surface)
- Electronics: DAE3 Sn393; Calibrated: 8/24/2009
- Phantom: HAC Test Arch 4.6; Type: SD HAC P01 BA; Serial: 1038
- Measurement SW: DASY5, V5.0 Build 125; SEMCAD X Version 13.4 Build 125

E Scan - ER3DV6 - measurement distance from the probe sensor center to the Device = 15mm/Hearing Aid Compatibility Test (101x101x1): Measurement grid:

dx=5mm, dy=5mm

Maximum value of peak Total field = 213.5 V/m

Probe Modulation Factor = 2.57

Device Reference Point: 0, 0, 353.7 mm

Reference Value = 108.5 V/m; Power Drift = -0.059 dB

Hearing Aid Near-Field Category: M3 (AWF -5 dB)

Peak E-field in V/m

Grid 1 197.3 M3	Grid 2 209.9 M3	Grid 3 202.6 M3
Grid 4 201.0 M3	Grid 5 213.5 M3	Grid 6 206.9 M3
Grid 7 196.4 M3	Grid 8 208.5 M3	Grid 9 202.1 M3



0 dB = 213.5V/m



Test Laboratory: A Test Lab Techno Corp.

Date/Time: 1/11/2010 2:10:52 PM

HAC_GSM850 CH251_E_Close

DUT: PC70110_Close; Type: Smartphone; FCC ID: NM8PC70110

Communication System: GSM850; Frequency: 848.8 MHz; Duty Cycle: 1:8.3

Medium parameters used: $\sigma = 0$ mho/m, $\epsilon_r = 1$; $\rho = 1000$ kg/m³

Phantom section: E Device Section

Measurement Standard: DASYS (IEEE/IEC)

DASY5 Configuration:

- Probe: ER3DV6 - SN2256; ConvF(1, 1, 1); Calibrated: 8/21/2009
- Sensor-Surface: (Fix Surface)
- Electronics: DAE3 Sn393; Calibrated: 8/24/2009
- Phantom: HAC Test Arch 4.6; Type: SD HAC P01 BA; Serial: 1038
- Measurement SW: DASYS, V5.0 Build 125; SEMCAD X Version 13.4 Build 125

E Scan - ER3DV6 - measurement distance from the probe sensor center to the Device = 15mm/Hearing Aid Compatibility Test (101x101x1): Measurement grid: dx=5mm, dy=5mm

Maximum value of peak Total field = 221.7 V/m

Probe Modulation Factor = 2.57

Device Reference Point: 0, 0, 353.7 mm

Reference Value = 111.9 V/m; Power Drift = 0.061 dB

Hearing Aid Near-Field Category: M3 (AWF -5 dB)

Peak E-field in V/m

Grid 1 203.6 M3	Grid 2 217.6 M3	Grid 3 211.0 M3
Grid 4 207.5 M3	Grid 5 221.7 M3	Grid 6 214.4 M3
Grid 7 202.3 M3	Grid 8 215.9 M3	Grid 9 209.8 M3

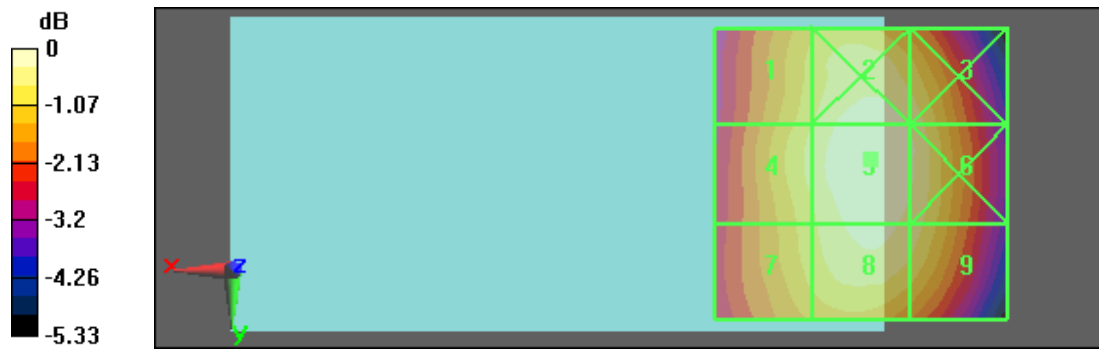

0 dB = 221.7V/m



Test Laboratory: A Test Lab Techno Corp.

Date/Time: 1/11/2010 1:23:38 PM

HAC_PCS CH512_E_Close

DUT: PC70110_Close; Type: Smartphone; FCC ID: NM8PC70110

Communication System: PCS; Frequency: 1850.2 MHz; Duty Cycle: 1:8.3

Medium parameters used: $\sigma = 0$ mho/m, $\epsilon_r = 1$; $\rho = 1000$ kg/m³

Phantom section: E Device Section

Measurement Standard: DASYS (IEEE/IEC)

DASY5 Configuration:

- Probe: ER3DV6 - SN2256; ConvF(1, 1, 1); Calibrated: 8/21/2009
- Sensor-Surface: (Fix Surface)
- Electronics: DAE3 Sn393; Calibrated: 8/24/2009
- Phantom: HAC Test Arch 4.6; Type: SD HAC P01 BA; Serial: 1038
- Measurement SW: DASY5, V5.0 Build 125; SEMCAD X Version 13.4 Build 125

E Scan - ER3DV6 - measurement distance from the probe sensor center to the Device = 15mm/Hearing Aid Compatibility Test (101x101x1): Measurement grid: dx=5mm, dy=5mm

Maximum value of peak Total field = 79.7 V/m

Probe Modulation Factor = 2.5

Device Reference Point: 0, 0, 353.7 mm

Reference Value = 26.8 V/m; Power Drift = 0.050 dB

Hearing Aid Near-Field Category: M3 (AWF -5 dB)

Peak E-field in V/m

Grid 1	Grid 2	Grid 3
79.7 M3	72 M3	60.8 M3
Grid 4	Grid 5	Grid 6
65.9 M3	77.5 M3	77.1 M3
Grid 7	Grid 8	Grid 9
91.6 M2	95.1 M2	89.5 M2

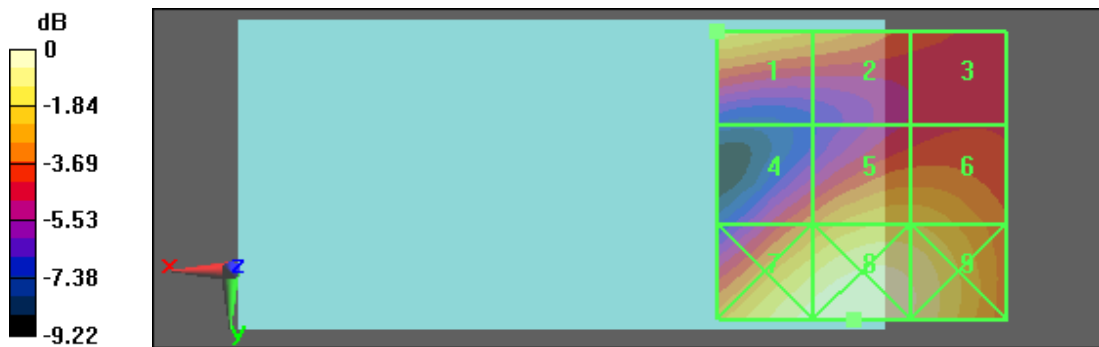

0 dB = 95.1V/m



Test Laboratory: A Test Lab Techno Corp.

Date/Time: 1/11/2010 1:30:40 PM

HAC_PCS CH661_E_Close

DUT: PC70110_Close; Type: Smartphone; FCC ID: NM8PC70110

Communication System: PCS; Frequency: 1880 MHz; Duty Cycle: 1:8.3

Medium parameters used: $\sigma = 0$ mho/m, $\epsilon_r = 1$; $\rho = 1000$ kg/m³

Phantom section: E Device Section

Measurement Standard: DASYS (IEEE/IEC)

DASY5 Configuration:

- Probe: ER3DV6 - SN2256; ConvF(1, 1, 1); Calibrated: 8/21/2009
- Sensor-Surface: (Fix Surface)
- Electronics: DAE3 Sn393; Calibrated: 8/24/2009
- Phantom: HAC Test Arch 4.6; Type: SD HAC P01 BA; Serial: 1038
- Measurement SW: DASYS, V5.0 Build 125; SEMCAD X Version 13.4 Build 125

E Scan - ER3DV6 - measurement distance from the probe sensor center to the Device = 15mm/Hearing Aid Compatibility Test (101x101x1): Measurement grid: dx=5mm, dy=5mm

Maximum value of peak Total field = 78.6 V/m

Probe Modulation Factor = 2.49

Device Reference Point: 0, 0, 353.7 mm

Reference Value = 27.8 V/m; Power Drift = -0.00679 dB

Hearing Aid Near-Field Category: M3 (AWF -5 dB)

Peak E-field in V/m

Grid 1	Grid 2	Grid 3
77.7 M3	72.3 M3	61.5 M3
Grid 4	Grid 5	Grid 6
66.9 M3	78.6 M3	78.1 M3
Grid 7	Grid 8	Grid 9
93 M2	96.4 M2	90.3 M2

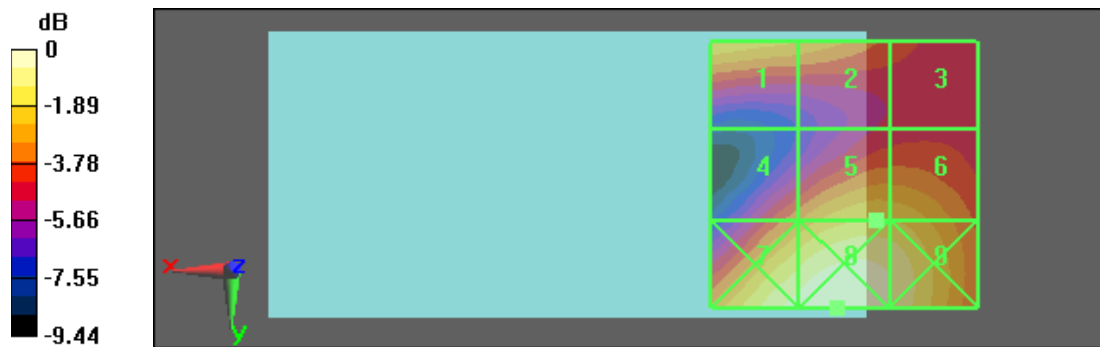

0 dB = 96.4V/m



Test Laboratory: A Test Lab Techno Corp.

Date/Time: 1/11/2010 1:40:33 PM

HAC_PCS CH810_E_Close

DUT: PC70110_Close; Type: Smartphone; FCC ID: NM8PC70110

Communication System: PCS; Frequency: 1909.8 MHz; Duty Cycle: 1:8.3

Medium parameters used: $\sigma = 0$ mho/m, $\epsilon_r = 1$; $\rho = 1000$ kg/m³

Phantom section: E Device Section

Measurement Standard: DASYS (IEEE/IEC)

DASY5 Configuration:

- Probe: ER3DV6 - SN2256; ConvF(1, 1, 1); Calibrated: 8/21/2009
- Sensor-Surface: (Fix Surface)
- Electronics: DAE3 Sn393; Calibrated: 8/24/2009
- Phantom: HAC Test Arch 4.6; Type: SD HAC P01 BA; Serial: 1038
- Measurement SW: DASY5, V5.0 Build 125; SEMCAD X Version 13.4 Build 125

E Scan - ER3DV6 - measurement distance from the probe sensor center to the Device = 15mm/Hearing Aid Compatibility Test (101x101x1): Measurement grid: dx=5mm, dy=5mm

Maximum value of peak Total field = 77.5 V/m

Probe Modulation Factor = 2.5

Device Reference Point: 0, 0, 353.7 mm

Reference Value = 27.4 V/m; Power Drift = -0.00232 dB

Hearing Aid Near-Field Category: M3 (AWF -5 dB)

Peak E-field in V/m

Grid 1	Grid 2	Grid 3
74.8 M3	69.4 M3	61 M3
Grid 4	Grid 5	Grid 6
65 M3	77.5 M3	77 M3
Grid 7	Grid 8	Grid 9
90.1 M2	93.7 M2	88.3 M2

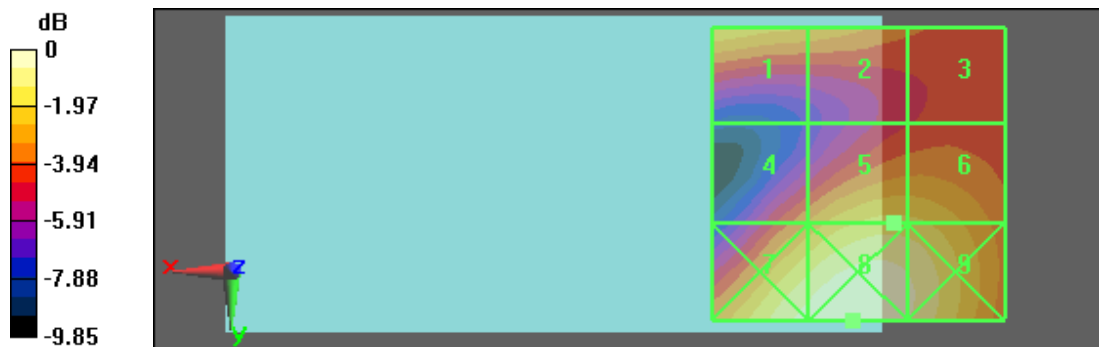

0 dB = 93.7V/m



Test Laboratory: A Test Lab Techno Corp.

Date/Time: 1/11/2010 2:19:09 PM

HAC_WCDMA Band II CH9262_E_Close

DUT: PC70110_Close; Type: Smartphone; FCC ID: NM8PC70110

Communication System: WCDMA Band II; Frequency: 1852.4 MHz; Duty Cycle: 1:1

Medium parameters used: $\sigma = 0$ mho/m, $\epsilon_r = 1$; $\rho = 1000$ kg/m³

Phantom section: E Device Section

Measurement Standard: DASYS (IEEE/IEC)

DASY5 Configuration:

- Probe: ER3DV6 - SN2256; ConvF(1, 1, 1); Calibrated: 8/21/2009
- Sensor-Surface: (Fix Surface)
- Electronics: DAE3 Sn393; Calibrated: 8/24/2009
- Phantom: HAC Test Arch 4.6; Type: SD HAC P01 BA; Serial: 1038
- Measurement SW: DASYS, V5.0 Build 125; SEMCAD X Version 13.4 Build 125

E Scan - ER3DV6 - measurement distance from the probe sensor center to the Device = 15mm/Hearing Aid Compatibility Test (101x101x1): Measurement grid:

dx=5mm, dy=5mm

Maximum value of peak Total field = 38.7 V/m

Probe Modulation Factor = 0.900

Device Reference Point: 0, 0, 353.7 mm

Reference Value = 35.9 V/m; Power Drift = 0.057 dB

Hearing Aid Near-Field Category: M4 (AWF 0 dB)

Peak E-field in V/m

Grid 1	Grid 2	Grid 3
38.7 M4	35 M4	29.6 M4
Grid 4	Grid 5	Grid 6
31.9 M4	37.7 M4	37.5 M4
Grid 7	Grid 8	Grid 9
44.7 M4	46.3 M4	43.5 M4

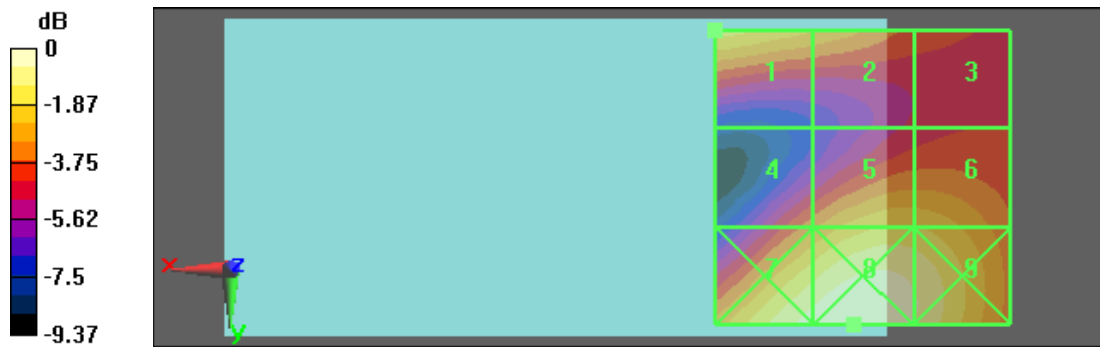

0 dB = 46.3V/m



Test Laboratory: A Test Lab Techno Corp.

Date/Time: 1/11/2010 2:27:38 PM

HAC_WCDMA Band II CH9400_E_Close

DUT: PC70110_Close; Type: Smartphone; FCC ID: NM8PC70110

Communication System: WCDMA Band II; Frequency: 1880 MHz; Duty Cycle: 1:1

Medium parameters used: $\sigma = 0$ mho/m, $\epsilon_r = 1$; $\rho = 1000$ kg/m³

Phantom section: E Device Section

Measurement Standard: DASYS (IEEE/IEC)

DASY5 Configuration:

- Probe: ER3DV6 - SN2256; ConvF(1, 1, 1); Calibrated: 8/21/2009
- Sensor-Surface: (Fix Surface)
- Electronics: DAE3 Sn393; Calibrated: 8/24/2009
- Phantom: HAC Test Arch 4.6; Type: SD HAC P01 BA; Serial: 1038
- Measurement SW: DASYS, V5.0 Build 125; SEMCAD X Version 13.4 Build 125

E Scan - ER3DV6 - measurement distance from the probe sensor center to the Device = 15mm/Hearing Aid Compatibility Test (101x101x1): Measurement grid:

dx=5mm, dy=5mm

Maximum value of peak Total field = 38.6 V/m

Probe Modulation Factor = 0.890

Device Reference Point: 0, 0, 353.7 mm

Reference Value = 37.7 V/m; Power Drift = 0.042 dB

Hearing Aid Near-Field Category: M4 (AWF 0 dB)

Peak E-field in V/m

Grid 1	Grid 2	Grid 3
37.6 M4	35.4 M4	30.3 M4
Grid 4	Grid 5	Grid 6
32.8 M4	38.6 M4	38.3 M4
Grid 7	Grid 8	Grid 9
45.5 M4	47.2 M4	44.3 M4

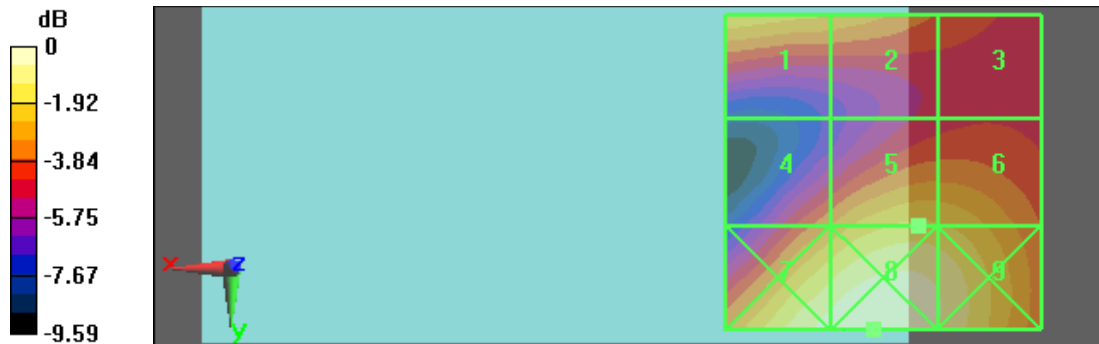

0 dB = 47.2V/m



Test Laboratory: A Test Lab Techno Corp.

Date/Time: 1/11/2010 2:34:03 PM

HAC_WCDMA Band II CH9538_E_Close

DUT: PC70110_Close; Type: Smartphone; FCC ID: NM8PC70110

Communication System: WCDMA Band II; Frequency: 1907.6 MHz; Duty Cycle: 1:1

Medium parameters used: $\sigma = 0$ mho/m, $\epsilon_r = 1$; $\rho = 1000$ kg/m³

Phantom section: E Device Section

Measurement Standard: DASYS (IEEE/IEC)

DASY5 Configuration:

- Probe: ER3DV6 - SN2256; ConvF(1, 1, 1); Calibrated: 8/21/2009
- Sensor-Surface: (Fix Surface)
- Electronics: DAE3 Sn393; Calibrated: 8/24/2009
- Phantom: HAC Test Arch 4.6; Type: SD HAC P01 BA; Serial: 1038
- Measurement SW: DASYS, V5.0 Build 125; SEMCAD X Version 13.4 Build 125

E Scan - ER3DV6 - measurement distance from the probe sensor center to the Device = 15mm/Hearing Aid Compatibility Test (101x101x1): Measurement grid: dx=5mm, dy=5mm

Maximum value of peak Total field = 38.3 V/m

Probe Modulation Factor = 0.900

Device Reference Point: 0, 0, 353.7 mm

Reference Value = 37.2 V/m; Power Drift = -0.016 dB

Hearing Aid Near-Field Category: M4 (AWF 0 dB)

Peak E-field in V/m

Grid 1	Grid 2	Grid 3
36.7 M4	34.1 M4	30.2 M4
Grid 4	Grid 5	Grid 6
32.1 M4	38.3 M4	38 M4
Grid 7	Grid 8	Grid 9
44.4 M4	46.3 M4	43.5 M4

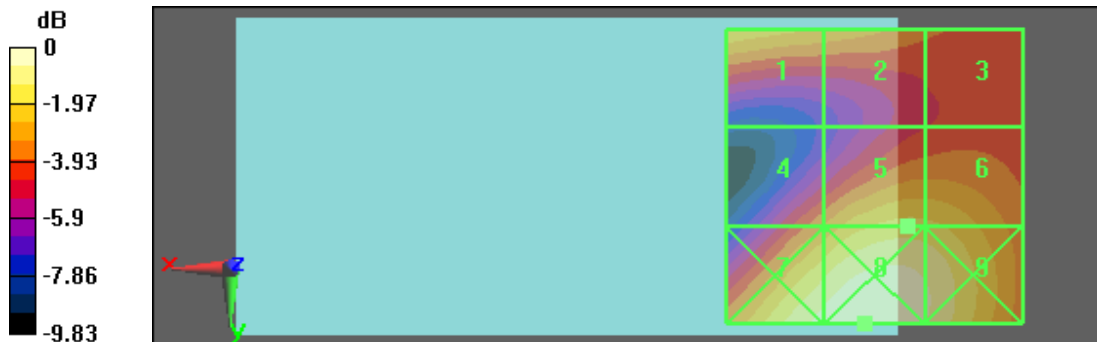

0 dB = 46.3V/m



Test Laboratory: A Test Lab Techno Corp.

Date/Time: 1/11/2010 2:49:48 PM

HAC_WCDMA Band V CH4132_E_Close

DUT: PC70110_Close; Type: Smartphone; FCC ID: NM8PC70110

Communication System: WCDMA Band V; Frequency: 826.4 MHz; Duty Cycle: 1:1

Medium parameters used: $\sigma = 0$ mho/m, $\epsilon_r = 1$; $\rho = 1000$ kg/m³

Phantom section: E Device Section

Measurement Standard: DASYS (IEEE/IEC)

DASY5 Configuration:

- Probe: ER3DV6 - SN2256; ConvF(1, 1, 1); Calibrated: 8/21/2009
- Sensor-Surface: (Fix Surface)
- Electronics: DAE3 Sn393; Calibrated: 8/24/2009
- Phantom: HAC Test Arch 4.6; Type: SD HAC P01 BA; Serial: 1038
- Measurement SW: DASY5, V5.0 Build 125; SEMCAD X Version 13.4 Build 125

E Scan - ER3DV6 - measurement distance from the probe sensor center to the Device = 15mm/Hearing Aid Compatibility Test (101x101x1): Measurement grid: dx=5mm, dy=5mm

Maximum value of peak Total field = 84.5 V/m

Probe Modulation Factor = 0.980

Device Reference Point: 0, 0, 353.7 mm

Reference Value = 111.7 V/m; Power Drift = -0.030 dB

Hearing Aid Near-Field Category: M4 (AWF 0 dB)

Peak E-field in V/m

Grid 1	Grid 2	Grid 3
78.2 M4	83 M4	80.1 M4
Grid 4	Grid 5	Grid 6
79.7 M4	84.5 M4	81.5 M4
Grid 7	Grid 8	Grid 9
77.8 M4	82.3 M4	79.6 M4

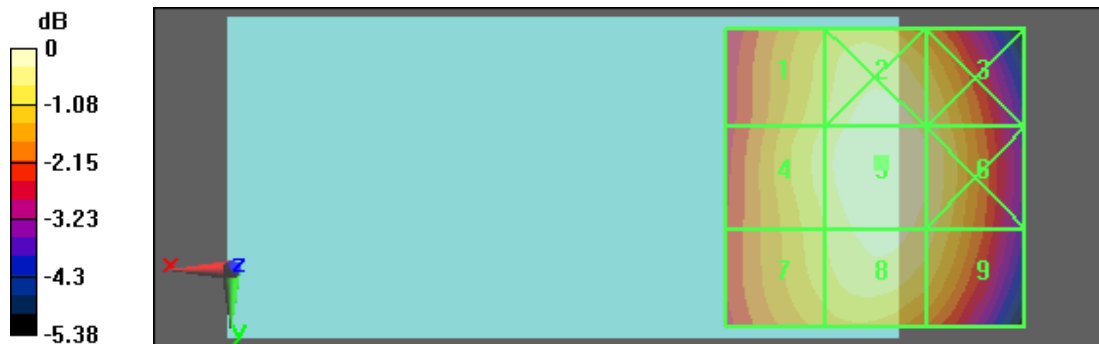

0 dB = 84.5V/m



Test Laboratory: A Test Lab Techno Corp.

Date/Time: 1/11/2010 2:56:41 PM

HAC_WCDMA Band V CH4183_E_Close

DUT: PC70110_Close; Type: Smartphone; FCC ID: NM8PC70110

Communication System: WCDMA Band V; Frequency: 836.6 MHz; Duty Cycle: 1:1

Medium parameters used: $\sigma = 0$ mho/m, $\epsilon_r = 1$; $\rho = 1000$ kg/m³

Phantom section: E Device Section

Measurement Standard: DASYS (IEEE/IEC)

DASY5 Configuration:

- Probe: ER3DV6 - SN2256; ConvF(1, 1, 1); Calibrated: 8/21/2009
- Sensor-Surface: (Fix Surface)
- Electronics: DAE3 Sn393; Calibrated: 8/24/2009
- Phantom: HAC Test Arch 4.6; Type: SD HAC P01 BA; Serial: 1038
- Measurement SW: DASY5, V5.0 Build 125; SEMCAD X Version 13.4 Build 125

E Scan - ER3DV6 - measurement distance from the probe sensor center to the Device = 15mm/Hearing Aid Compatibility Test (101x101x1): Measurement grid:

dx=5mm, dy=5mm

Maximum value of peak Total field = 77.9 V/m

Probe Modulation Factor = 1.01

Device Reference Point: 0, 0, 353.7 mm

Reference Value = 100.1 V/m; Power Drift = -0.058 dB

Hearing Aid Near-Field Category: M4 (AWF 0 dB)

Peak E-field in V/m

Grid 1	Grid 2	Grid 3
72.3 M4	76.7 M4	73.8 M4
Grid 4	Grid 5	Grid 6
73.6 M4	77.9 M4	75 M4
Grid 7	Grid 8	Grid 9
72 M4	76.2 M4	73.6 M4



0 dB = 77.9V/m



Test Laboratory: A Test Lab Techno Corp.

Date/Time: 1/11/2010 3:02:31 PM

HAC_WCDMA Band V CH4233_E_Close

DUT: PC70110_Close; Type: Smartphone; FCC ID: NM8PC70110

Communication System: WCDMA Band V; Frequency: 846.6 MHz; Duty Cycle: 1:1

Medium parameters used: $\sigma = 0$ mho/m, $\epsilon_r = 1$; $\rho = 1000$ kg/m³

Phantom section: E Device Section

Measurement Standard: DASYS (IEEE/IEC)

DASY5 Configuration:

- Probe: ER3DV6 - SN2256; ConvF(1, 1, 1); Calibrated: 8/21/2009
- Sensor-Surface: (Fix Surface)
- Electronics: DAE3 Sn393; Calibrated: 8/24/2009
- Phantom: HAC Test Arch 4.6; Type: SD HAC P01 BA; Serial: 1038
- Measurement SW: DASY5, V5.0 Build 125; SEMCAD X Version 13.4 Build 125

E Scan - ER3DV6 - measurement distance from the probe sensor center to the Device = 15mm/Hearing Aid Compatibility Test (101x101x1): Measurement grid: dx=5mm, dy=5mm

Maximum value of peak Total field = 82.2 V/m

Probe Modulation Factor = 0.980

Device Reference Point: 0, 0, 353.7 mm

Reference Value = 109.0 V/m; Power Drift = 0.015 dB

Hearing Aid Near-Field Category: M4 (AWF 0 dB)

Peak E-field in V/m

Grid 1	Grid 2	Grid 3
76 M4	80.9 M4	78.2 M4
Grid 4	Grid 5	Grid 6
77.4 M4	82.2 M4	79.8 M4
Grid 7	Grid 8	Grid 9
75.4 M4	80.1 M4	77.7 M4

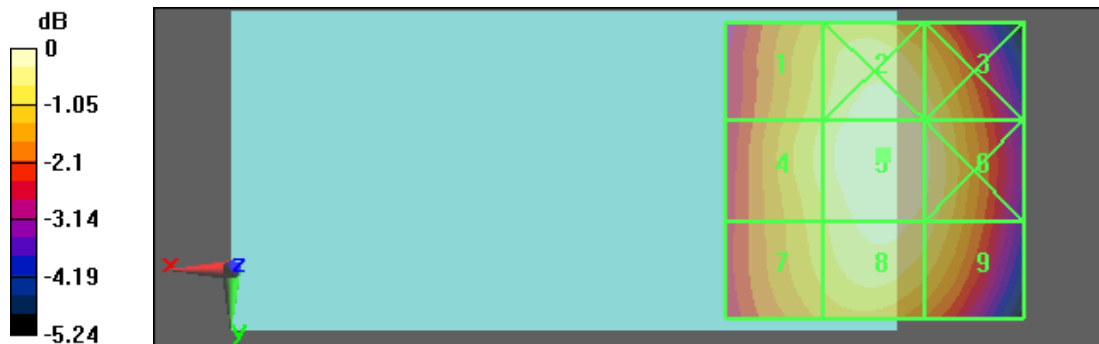

0 dB = 82.2V/m



Test Laboratory: A Test Lab Techno Corp.

Date/Time: 1/11/2010 9:28:30 PM

HAC_GSM850 CH128_H_Open

DUT: PC70110_Open; Type: Smartphone; FCC ID: NM8PC70110

Communication System: GSM850; Frequency: 824.2 MHz; Duty Cycle: 1:8.3

Medium parameters used: $\sigma = 0$ mho/m, $\epsilon_r = 1$; $\rho = 1$ kg/m³

Phantom section: H Device Section

Measurement Standard: DASYS (IEEE/IEC)

DASY5 Configuration:

- Probe: H3DV6 - SN6076; ; Calibrated: 8/19/2009
- Sensor-Surface: (Fix Surface)
- Electronics: DAE3 Sn393; Calibrated: 8/24/2009
- Phantom: HAC Test Arch 4.6; Type: SD HAC P01 BA; Serial: 1038
- Measurement SW: DASY5, V5.0 Build 125; SEMCAD X Version 13.4 Build 125

H Scan - H3DV6 - measurement distance from the probe sensor center to the Device = 15mm/Hearing Aid Compatibility Test (101x101x1): Measurement grid: dx=5mm, dy=5mm

Maximum value of peak Total field = 0.251 A/m

Probe Modulation Factor = 2.68

Device Reference Point: 0, 0, 353.7 mm

Reference Value = 0.073 A/m; Power Drift = -0.152 dB

Hearing Aid Near-Field Category: M4 (AWF -5 dB)

Peak H-field in A/m

Grid 1 0.323 M4	Grid 2 0.253 M4	Grid 3 0.192 M4
Grid 4 0.279 M4	Grid 5 0.221 M4	Grid 6 0.158 M4
Grid 7 0.251 M4	Grid 8 0.181 M4	Grid 9 0.107 M4

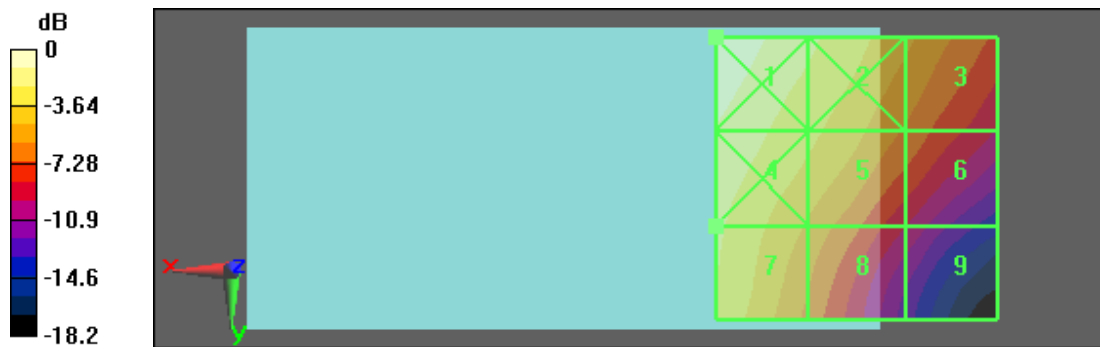

0 dB = 0.323A/m



Test Laboratory: A Test Lab Techno Corp.

Date/Time: 1/11/2010 9:35:17 PM

HAC_GSM850 CH190_H_Open

DUT: PC70110_Open; Type: Smartphone; FCC ID: NM8PC70110

Communication System: GSM850; Frequency: 836.6 MHz; Duty Cycle: 1:8.3

Medium parameters used: $\sigma = 0$ mho/m, $\epsilon_r = 1$; $\rho = 1$ kg/m³

Phantom section: H Device Section

Measurement Standard: DASYS (IEEE/IEC)

DASY5 Configuration:

- Probe: H3DV6 - SN6076; ; Calibrated: 8/19/2009
- Sensor-Surface: (Fix Surface)
- Electronics: DAE3 Sn393; Calibrated: 8/24/2009
- Phantom: HAC Test Arch 4.6; Type: SD HAC P01 BA; Serial: 1038
- Measurement SW: DASY5, V5.0 Build 125; SEMCAD X Version 13.4 Build 125

H Scan - H3DV6 - measurement distance from the probe sensor center to the Device = 15mm/Hearing Aid Compatibility Test (101x101x1): Measurement grid: dx=5mm, dy=5mm

Maximum value of peak Total field = 0.235 A/m

Probe Modulation Factor = 2.57

Device Reference Point: 0, 0, 353.7 mm

Reference Value = 0.071 A/m; Power Drift = 0.015 dB

Hearing Aid Near-Field Category: M4 (AWF -5 dB)

Peak H-field in A/m

Grid 1 0.306 M4	Grid 2 0.241 M4	Grid 3 0.185 M4
Grid 4 0.265 M4	Grid 5 0.210 M4	Grid 6 0.153 M4
Grid 7 0.235 M4	Grid 8 0.170 M4	Grid 9 0.100 M4



0 dB = 0.306A/m



Test Laboratory: A Test Lab Techno Corp.

Date/Time: 1/11/2010 9:42:44 PM

HAC_GSM850 CH251_H_Open

DUT: PC70110_Open; Type: Smartphone; FCC ID: NM8PC70110

Communication System: GSM850; Frequency: 836.6 MHz; Duty Cycle: 1:8.3

Medium parameters used: $\sigma = 0$ mho/m, $\epsilon_r = 1$; $\rho = 1$ kg/m³

Phantom section: H Device Section

Measurement Standard: DASYS (IEEE/IEC)

DASY5 Configuration:

- Probe: H3DV6 - SN6076; ; Calibrated: 8/19/2009
- Sensor-Surface: (Fix Surface)
- Electronics: DAE3 Sn393; Calibrated: 8/24/2009
- Phantom: HAC Test Arch 4.6; Type: SD HAC P01 BA; Serial: 1038
- Measurement SW: DASY5, V5.0 Build 125; SEMCAD X Version 13.4 Build 125

H Scan - H3DV6 - measurement distance from the probe sensor center to the Device = 15mm/Hearing Aid Compatibility Test (101x101x1): Measurement grid:

dx=5mm, dy=5mm

Maximum value of peak Total field = 0.226 A/m

Probe Modulation Factor = 2.57

Device Reference Point: 0, 0, 353.7 mm

Reference Value = 0.069 A/m; Power Drift = 0.100 dB

Hearing Aid Near-Field Category: M4 (AWF -5 dB)

Peak H-field in A/m

Grid 1 0.291 M4	Grid 2 0.231 M4	Grid 3 0.178 M4
Grid 4 0.253 M4	Grid 5 0.203 M4	Grid 6 0.149 M4
Grid 7 0.226 M4	Grid 8 0.163 M4	Grid 9 0.098 M4



0 dB = 0.291A/m



Test Laboratory: A Test Lab Techno Corp.

Date/Time: 1/11/2010 9:10:06 PM

HAC_PCS CH512_H_Open

DUT: PC70110_Open; Type: Smartphone; FCC ID: NM8PC70110

Communication System: PCS; Frequency: 1850.2 MHz; Duty Cycle: 1:8.3

Medium parameters used: $\sigma = 0$ mho/m, $\epsilon_r = 1$; $\rho = 1$ kg/m³

Phantom section: H Device Section

Measurement Standard: DASYS (IEEE/IEC)

DASY5 Configuration:

- Probe: H3DV6 - SN6076; ; Calibrated: 8/19/2009
- Sensor-Surface: (Fix Surface)
- Electronics: DAE3 Sn393; Calibrated: 8/24/2009
- Phantom: HAC Test Arch 4.6; Type: SD HAC P01 BA; Serial: 1038
- Measurement SW: DASY5, V5.0 Build 125; SEMCAD X Version 13.4 Build 125

H Scan - H3DV6 - measurement distance from the probe sensor center to the Device = 15mm/Hearing Aid Compatibility Test (101x101x1): Measurement grid: dx=5mm, dy=5mm

Maximum value of peak Total field = 0.215 A/m

Probe Modulation Factor = 2.54

Device Reference Point: 0, 0, 353.7 mm

Reference Value = 0.092 A/m; Power Drift = -0.028 dB

Hearing Aid Near-Field Category: M3 (AWF -5 dB)

Peak H-field in A/m

Grid 1 0.228 M3	Grid 2 0.220 M3	Grid 3 0.216 M3
Grid 4 0.199 M3	Grid 5 0.215 M3	Grid 6 0.212 M3
Grid 7 0.193 M3	Grid 8 0.174 M3	Grid 9 0.167 M3

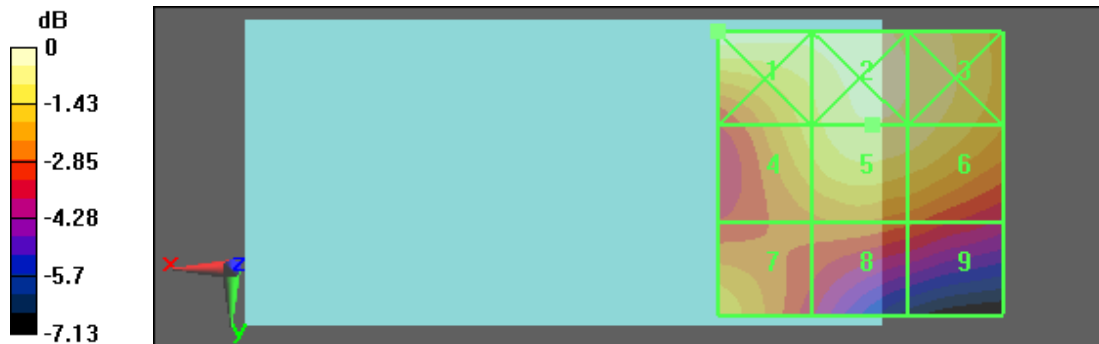

0 dB = 0.228A/m



Test Laboratory: A Test Lab Techno Corp.

Date/Time: 1/11/2010 9:15:45 PM

HAC_PCS CH661_H_Open

DUT: PC70110_Open; Type: Smartphone; FCC ID: NM8PC70110

Communication System: PCS; Frequency: 1880 MHz; Duty Cycle: 1:8.3

Medium parameters used: $\sigma = 0$ mho/m, $\epsilon_r = 1$; $\rho = 1$ kg/m³

Phantom section: H Device Section

Measurement Standard: DASYS (IEEE/IEC)

DASY5 Configuration:

- Probe: H3DV6 - SN6076; ; Calibrated: 8/19/2009
- Sensor-Surface: (Fix Surface)
- Electronics: DAE3 Sn393; Calibrated: 8/24/2009
- Phantom: HAC Test Arch 4.6; Type: SD HAC P01 BA; Serial: 1038
- Measurement SW: DASY5, V5.0 Build 125; SEMCAD X Version 13.4 Build 125

H Scan - H3DV6 - measurement distance from the probe sensor center to the Device = 15mm/Hearing Aid Compatibility Test (101x101x1): Measurement grid: dx=5mm, dy=5mm

Maximum value of peak Total field = 0.203 A/m

Probe Modulation Factor = 2.44

Device Reference Point: 0, 0, 353.7 mm

Reference Value = 0.089 A/m; Power Drift = -0.068 dB

Hearing Aid Near-Field Category: M3 (AWF -5 dB)

Peak H-field in A/m

Grid 1	Grid 2	Grid 3
0.220 M3	0.210 M3	0.205 M3
Grid 4	Grid 5	Grid 6
0.188 M3	0.203 M3	0.201 M3
Grid 7	Grid 8	Grid 9
0.189 M3	0.161 M3	0.158 M3



0 dB = 0.220A/m



Test Laboratory: A Test Lab Techno Corp.

Date/Time: 1/11/2010 9:21:29 PM

HAC_PCS CH810_H_Open

DUT: PC70110_Open; Type: Smartphone; FCC ID: NM8PC70110

Communication System: PCS; Frequency: 1909.8 MHz; Duty Cycle: 1:8.3

Medium parameters used: $\sigma = 0$ mho/m, $\epsilon_r = 1$; $\rho = 1$ kg/m³

Phantom section: H Device Section

Measurement Standard: DASYS (IEEE/IEC)

DASY5 Configuration:

- Probe: H3DV6 - SN6076; ; Calibrated: 8/19/2009
- Sensor-Surface: (Fix Surface)
- Electronics: DAE3 Sn393; Calibrated: 8/24/2009
- Phantom: HAC Test Arch 4.6; Type: SD HAC P01 BA; Serial: 1038
- Measurement SW: DASY5, V5.0 Build 125; SEMCAD X Version 13.4 Build 125

H Scan - H3DV6 - measurement distance from the probe sensor center to the Device = 15mm/Hearing Aid Compatibility Test (101x101x1): Measurement grid: dx=5mm, dy=5mm

Maximum value of peak Total field = 0.217 A/m

Probe Modulation Factor = 2.54

Device Reference Point: 0, 0, 353.7 mm

Reference Value = 0.090 A/m; Power Drift = 0.029 dB

Hearing Aid Near-Field Category: M3 (AWF -5 dB)

Peak H-field in A/m

Grid 1 0.227 M3	Grid 2 0.226 M3	Grid 3 0.221 M3
Grid 4 0.201 M3	Grid 5 0.217 M3	Grid 6 0.215 M3
Grid 7 0.200 M3	Grid 8 0.170 M3	Grid 9 0.165 M3

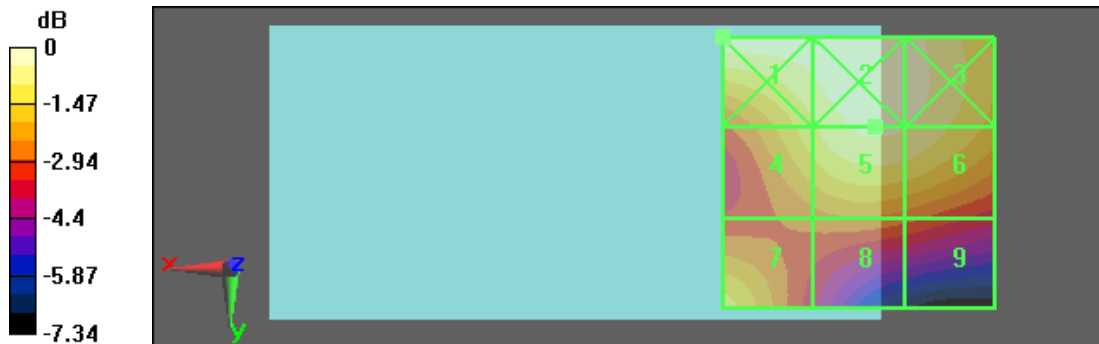

0 dB = 0.227A/m



Test Laboratory: A Test Lab Techno Corp.

Date/Time: 1/11/2010 9:51:09 PM

HAC_WCDMA Band II CH9262_H_Open

DUT: PC70110_Open; Type: Smartphone; FCC ID: NM8PC70110

Communication System: WCDMA Band II; Frequency: 1852.4 MHz; Duty Cycle: 1:1

Medium parameters used: $\sigma = 0$ mho/m, $\epsilon_r = 1$; $\rho = 1$ kg/m³

Phantom section: H Device Section

Measurement Standard: DASYS (IEEE/IEC)

DASY5 Configuration:

- Probe: H3DV6 - SN6076; ; Calibrated: 8/19/2009
- Sensor-Surface: (Fix Surface)
- Electronics: DAE3 Sn393; Calibrated: 8/24/2009
- Phantom: HAC Test Arch 4.6; Type: SD HAC P01 BA; Serial: 1038
- Measurement SW: DASY5, V5.0 Build 125; SEMCAD X Version 13.4 Build 125

H Scan - H3DV6 - measurement distance from the probe sensor center to the Device = 15mm/Hearing Aid Compatibility Test (101x101x1): Measurement grid: dx=5mm, dy=5mm

Maximum value of peak Total field = 0.086 A/m

Probe Modulation Factor = 0.810

Device Reference Point: 0, 0, 353.7 mm

Reference Value = 0.112 A/m; Power Drift = 0.148 dB

Hearing Aid Near-Field Category: M4 (AWF 0 dB)

Peak H-field in A/m

Grid 1	Grid 2	Grid 3
0.088 M4	0.087 M4	0.086 M4
Grid 4	Grid 5	Grid 6
0.078 M4	0.086 M4	0.084 M4
Grid 7	Grid 8	Grid 9
0.076 M4	0.069 M4	0.067 M4



0 dB = 0.088A/m



Test Laboratory: A Test Lab Techno Corp.

Date/Time: 1/11/2010 9:59:51 PM

HAC_WCDMA Band II CH9400_H_Open

DUT: PC70110_Open; Type: Smartphone; FCC ID: NM8PC70110

Communication System: WCDMA Band II; Frequency: 1880 MHz; Duty Cycle: 1:1

Medium parameters used: $\sigma = 0$ mho/m, $\epsilon_r = 1$; $\rho = 1$ kg/m³

Phantom section: H Device Section

Measurement Standard: DASYS (IEEE/IEC)

DASY5 Configuration:

- Probe: H3DV6 - SN6076; ; Calibrated: 8/19/2009
- Sensor-Surface: (Fix Surface)
- Electronics: DAE3 Sn393; Calibrated: 8/24/2009
- Phantom: HAC Test Arch 4.6; Type: SD HAC P01 BA; Serial: 1038
- Measurement SW: DASY5, V5.0 Build 125; SEMCAD X Version 13.4 Build 125

H Scan - H3DV6 - measurement distance from the probe sensor center to the Device = 15mm/Hearing Aid Compatibility Test (101x101x1): Measurement grid:

dx=5mm, dy=5mm

Maximum value of peak Total field = 0.085 A/m

Probe Modulation Factor = 0.810

Device Reference Point: 0, 0, 353.7 mm

Reference Value = 0.111 A/m; Power Drift = -0.00873 dB

Hearing Aid Near-Field Category: M4 (AWF 0 dB)

Peak H-field in A/m

Grid 1	Grid 2	Grid 3
0.092 M4	0.088 M4	0.085 M4
Grid 4	Grid 5	Grid 6
0.078 M4	0.085 M4	0.084 M4
Grid 7	Grid 8	Grid 9
0.079 M4	0.067 M4	0.066 M4

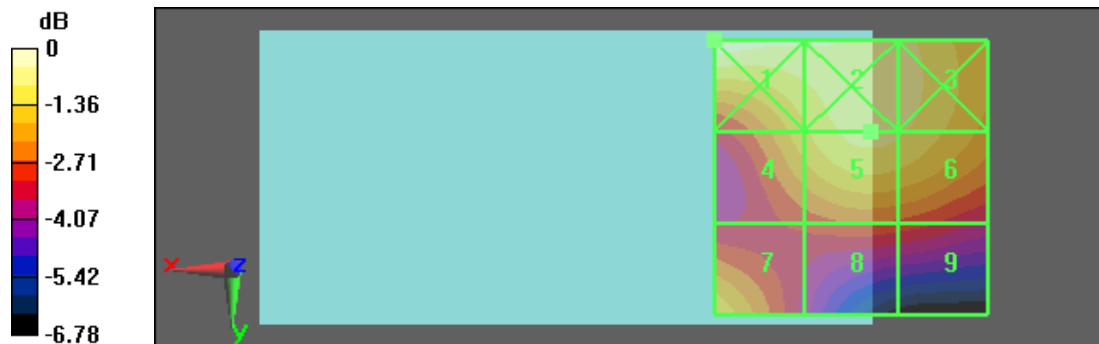

0 dB = 0.092A/m



Test Laboratory: A Test Lab Techno Corp.

Date/Time: 1/11/2010 10:07:14 PM

HAC_WCDMA Band II CH9538_H_Open

DUT: PC70110_Open; Type: Smartphone; FCC ID: NM8PC70110

Communication System: WCDMA Band II; Frequency: 1907.6 MHz; Duty Cycle: 1:1

Medium parameters used: $\sigma = 0$ mho/m, $\epsilon_r = 1$; $\rho = 1$ kg/m³

Phantom section: H Device Section

Measurement Standard: DASYS (IEEE/IEC)

DASY5 Configuration:

- Probe: H3DV6 - SN6076; ; Calibrated: 8/19/2009
- Sensor-Surface: (Fix Surface)
- Electronics: DAE3 Sn393; Calibrated: 8/24/2009
- Phantom: HAC Test Arch 4.6; Type: SD HAC P01 BA; Serial: 1038
- Measurement SW: DASY5, V5.0 Build 125; SEMCAD X Version 13.4 Build 125

H Scan - H3DV6 - measurement distance from the probe sensor center to the Device = 15mm/Hearing Aid Compatibility Test (101x101x1): Measurement grid: dx=5mm, dy=5mm

Maximum value of peak Total field = 0.093 A/m

Probe Modulation Factor = 0.810

Device Reference Point: 0, 0, 353.7 mm

Reference Value = 0.120 A/m; Power Drift = -0.000531 dB

Hearing Aid Near-Field Category: M4 (AWF 0 dB)

Peak H-field in A/m

Grid 1	Grid 2	Grid 3
0.097 M4	0.097 M4	0.094 M4
Grid 4	Grid 5	Grid 6
0.085 M4	0.093 M4	0.092 M4
Grid 7	Grid 8	Grid 9
0.085 M4	0.073 M4	0.072 M4



0 dB = 0.097A/m



Test Laboratory: A Test Lab Techno Corp.

Date/Time: 1/11/2010 10:14:25 PM

HAC_WCDMA Band V CH4132_H_Open

DUT: PC70110_Open; Type: Smartphone; FCC ID: NM8PC70110

Communication System: WCDMA Band V; Frequency: 826.4 MHz; Duty Cycle: 1:1

Medium parameters used: $\sigma = 0$ mho/m, $\epsilon_r = 1$; $\rho = 1$ kg/m³

Phantom section: H Device Section

Measurement Standard: DASYS (IEEE/IEC)

DASY5 Configuration:

- Probe: H3DV6 - SN6076; ; Calibrated: 8/19/2009
- Sensor-Surface: (Fix Surface)
- Electronics: DAE3 Sn393; Calibrated: 8/24/2009
- Phantom: HAC Test Arch 4.6; Type: SD HAC P01 BA; Serial: 1038
- Measurement SW: DASY5, V5.0 Build 125; SEMCAD X Version 13.4 Build 125

H Scan - H3DV6 - measurement distance from the probe sensor center to the Device = 15mm/Hearing Aid Compatibility Test (101x101x1): Measurement grid: dx=5mm, dy=5mm

Maximum value of peak Total field = 0.072 A/m

Probe Modulation Factor = 0.860

Device Reference Point: 0, 0, 353.7 mm

Reference Value = 0.065 A/m; Power Drift = -0.086 dB

Hearing Aid Near-Field Category: M4 (AWF 0 dB)

Peak H-field in A/m

Grid 1 0.090 M4	Grid 2 0.072 M4	Grid 3 0.056 M4
Grid 4 0.079 M4	Grid 5 0.064 M4	Grid 6 0.047 M4
Grid 7 0.072 M4	Grid 8 0.053 M4	Grid 9 0.032 M4

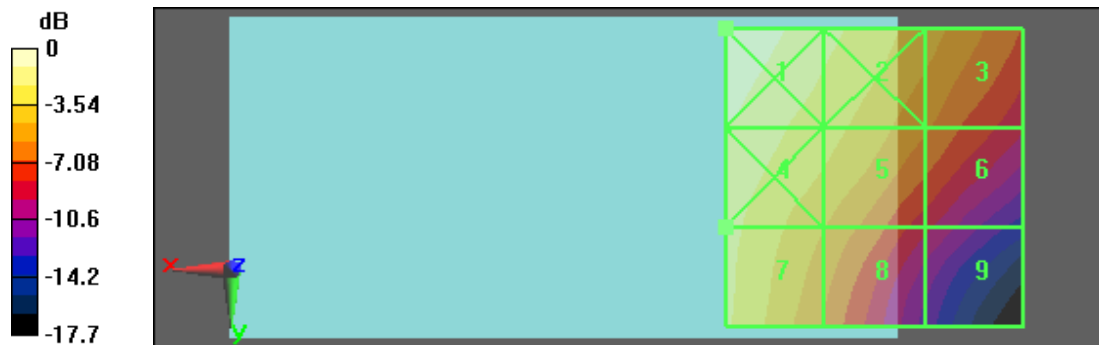

0 dB = 0.090A/m



Test Laboratory: A Test Lab Techno Corp.

Date/Time: 1/11/2010 10:22:13 PM

HAC_WCDMA Band V CH4183_H_Open

DUT: PC70110_Open; Type: Smartphone; FCC ID: NM8PC70110

Communication System: WCDMA Band V; Frequency: 836.6 MHz; Duty Cycle: 1:1

Medium parameters used: $\sigma = 0$ mho/m, $\epsilon_r = 1$; $\rho = 1$ kg/m³

Phantom section: H Device Section

Measurement Standard: DASYS (IEEE/IEC)

DASY5 Configuration:

- Probe: H3DV6 - SN6076; ; Calibrated: 8/19/2009
- Sensor-Surface: (Fix Surface)
- Electronics: DAE3 Sn393; Calibrated: 8/24/2009
- Phantom: HAC Test Arch 4.6; Type: SD HAC P01 BA; Serial: 1038
- Measurement SW: DASY5, V5.0 Build 125; SEMCAD X Version 13.4 Build 125

H Scan - H3DV6 - measurement distance from the probe sensor center to the Device = 15mm/Hearing Aid Compatibility Test (101x101x1): Measurement grid: dx=5mm, dy=5mm

Maximum value of peak Total field = 0.067 A/m

Probe Modulation Factor = 0.860

Device Reference Point: 0, 0, 353.7 mm

Reference Value = 0.061 A/m; Power Drift = -0.012 dB

Hearing Aid Near-Field Category: M4 (AWF 0 dB)

Peak H-field in A/m

Grid 1 0.085 M4	Grid 2 0.068 M4	Grid 3 0.053 M4
Grid 4 0.074 M4	Grid 5 0.059 M4	Grid 6 0.044 M4
Grid 7 0.067 M4	Grid 8 0.049 M4	Grid 9 0.029 M4



0 dB = 0.085A/m



Test Laboratory: A Test Lab Techno Corp.

Date/Time: 1/11/2010 10:28:03 PM

HAC_WCDMA Band V CH4233_H_Open

DUT: PC70110_Open; Type: Smartphone; FCC ID: NM8PC70110

Communication System: WCDMA Band V; Frequency: 846.6 MHz; Duty Cycle: 1:1

Medium parameters used: $\sigma = 0$ mho/m, $\epsilon_r = 1$; $\rho = 1$ kg/m³

Phantom section: H Device Section

Measurement Standard: DASYS (IEEE/IEC)

DASY5 Configuration:

- Probe: H3DV6 - SN6076; ; Calibrated: 8/19/2009
- Sensor-Surface: (Fix Surface)
- Electronics: DAE3 Sn393; Calibrated: 8/24/2009
- Phantom: HAC Test Arch 4.6; Type: SD HAC P01 BA; Serial: 1038
- Measurement SW: DASY5, V5.0 Build 125; SEMCAD X Version 13.4 Build 125

H Scan - H3DV6 - measurement distance from the probe sensor center to the Device = 15mm/Hearing Aid Compatibility Test (101x101x1): Measurement grid: dx=5mm, dy=5mm

Maximum value of peak Total field = 0.063 A/m

Probe Modulation Factor = 0.860

Device Reference Point: 0, 0, 353.7 mm

Reference Value = 0.058 A/m; Power Drift = -0.00217 dB

Hearing Aid Near-Field Category: M4 (AWF 0 dB)

Peak H-field in A/m

Grid 1	Grid 2	Grid 3
0.080 M4	0.064 M4	0.050 M4
Grid 4	Grid 5	Grid 6
0.070 M4	0.057 M4	0.042 M4
Grid 7	Grid 8	Grid 9
0.063 M4	0.046 M4	0.028 M4



0 dB = 0.080A/m



Test Laboratory: A Test Lab Techno Corp.

Date/Time: 1/11/2010 6:02:12 PM

HAC_GSM850 CH128_H_Close

DUT: PC70110_Close; Type: Smartphone; FCC ID: NM8PC70110

Communication System: GSM850; Frequency: 824.2 MHz; Duty Cycle: 1:8.3

Medium parameters used: $\sigma = 0$ mho/m, $\epsilon_r = 1$; $\rho = 1$ kg/m³

Phantom section: H Device Section

Measurement Standard: DASYS (IEEE/IEC)

DASY5 Configuration:

- Probe: H3DV6 - SN6076; ; Calibrated: 8/19/2009
- Sensor-Surface: (Fix Surface)
- Electronics: DAE3 Sn393; Calibrated: 8/24/2009
- Phantom: HAC Test Arch 4.6; Type: SD HAC P01 BA; Serial: 1038
- Measurement SW: DASYS, V5.0 Build 125; SEMCAD X Version 13.4 Build 125

H Scan - H3DV6 - measurement distance from the probe sensor center to the Device = 15mm/Hearing Aid Compatibility Test (101x101x1): Measurement grid: dx=5mm, dy=5mm

Maximum value of peak Total field = 0.271 A/m

Probe Modulation Factor = 2.68

Device Reference Point: 0, 0, 353.7 mm

Reference Value = 0.070 A/m; Power Drift = -0.011 dB

Hearing Aid Near-Field Category: M4 (AWF -5 dB)

Peak H-field in A/m

Grid 1 0.392 M4	Grid 2 0.271 M4	Grid 3 0.161 M4
Grid 4 0.359 M4	Grid 5 0.244 M4	Grid 6 0.139 M4
Grid 7 0.389 M4	Grid 8 0.269 M4	Grid 9 0.162 M4

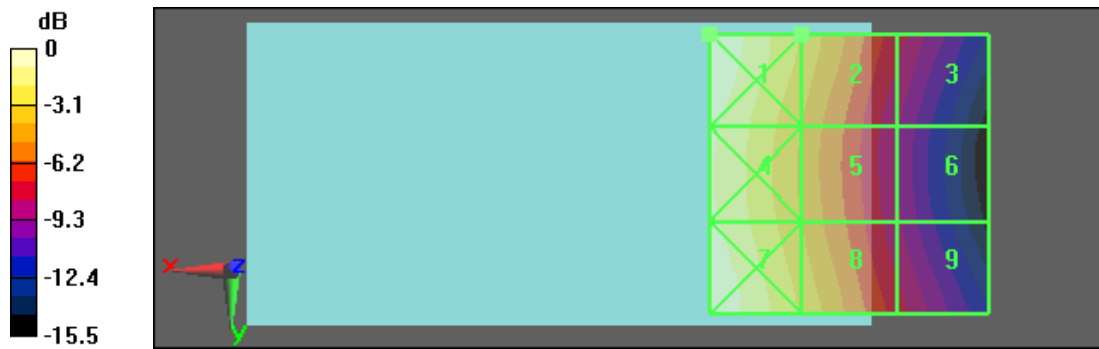

0 dB = 0.392A/m



Test Laboratory: A Test Lab Techno Corp.

Date/Time: 1/11/2010 6:07:54 PM

HAC_GSM850 CH190_H_Close

DUT: PC70110_Close; Type: Smartphone; FCC ID: NM8PC70110

Communication System: GSM850; Frequency: 836.6 MHz; Duty Cycle: 1:8.3

Medium parameters used: $\sigma = 0$ mho/m, $\epsilon_r = 1$; $\rho = 1$ kg/m³

Phantom section: H Device Section

Measurement Standard: DASYS (IEEE/IEC)

DASY5 Configuration:

- Probe: H3DV6 - SN6076; ; Calibrated: 8/19/2009
- Sensor-Surface: (Fix Surface)
- Electronics: DAE3 Sn393; Calibrated: 8/24/2009
- Phantom: HAC Test Arch 4.6; Type: SD HAC P01 BA; Serial: 1038
- Measurement SW: DASYS, V5.0 Build 125; SEMCAD X Version 13.4 Build 125

H Scan - H3DV6 - measurement distance from the probe sensor center to the Device = 15mm/Hearing Aid Compatibility Test (101x101x1): Measurement grid: dx=5mm, dy=5mm

Maximum value of peak Total field = 0.290 A/m

Probe Modulation Factor = 2.68

Device Reference Point: 0, 0, 353.7 mm

Reference Value = 0.074 A/m; Power Drift = -0.095 dB

Hearing Aid Near-Field Category: M4 (AWF -5 dB)

Peak H-field in A/m

Grid 1 0.417 M4	Grid 2 0.290 M4	Grid 3 0.171 M4
Grid 4 0.384 M4	Grid 5 0.260 M4	Grid 6 0.146 M4
Grid 7 0.416 M4	Grid 8 0.288 M4	Grid 9 0.172 M4



0 dB = 0.417A/m



Test Laboratory: A Test Lab Techno Corp.

Date/Time: 1/11/2010 6:13:42 PM

HAC_GSM850 CH251_H_Close

DUT: PC70110_Close; Type: Smartphone; FCC ID: NM8PC70110

Communication System: GSM850; Frequency: 848.8 MHz; Duty Cycle: 1:8.3

Medium parameters used: $\sigma = 0$ mho/m, $\epsilon_r = 1$; $\rho = 1$ kg/m³

Phantom section: H Device Section

Measurement Standard: DASYS (IEEE/IEC)

DASY5 Configuration:

- Probe: H3DV6 - SN6076; ; Calibrated: 8/19/2009
- Sensor-Surface: (Fix Surface)
- Electronics: DAE3 Sn393; Calibrated: 8/24/2009
- Phantom: HAC Test Arch 4.6; Type: SD HAC P01 BA; Serial: 1038
- Measurement SW: DASYS, V5.0 Build 125; SEMCAD X Version 13.4 Build 125

H Scan - H3DV6 - measurement distance from the probe sensor center to the Device = 15mm/Hearing Aid Compatibility Test (101x101x1): Measurement grid: dx=5mm, dy=5mm

Maximum value of peak Total field = 0.309 A/m

Probe Modulation Factor = 2.71

Device Reference Point: 0, 0, 353.7 mm

Reference Value = 0.078 A/m; Power Drift = -0.042 dB

Hearing Aid Near-Field Category: M4 (AWF -5 dB)

Peak H-field in A/m

Grid 1 0.444 M4	Grid 2 0.309 M4	Grid 3 0.182 M4
Grid 4 0.411 M4	Grid 5 0.279 M4	Grid 6 0.158 M4
Grid 7 0.444 M4	Grid 8 0.308 M4	Grid 9 0.184 M4



0 dB = 0.444A/m



Test Laboratory: A Test Lab Techno Corp.

Date/Time: 1/11/2010 5:42:05 PM

HAC_PCS CH512_H_Close

DUT: PC70110_Close; Type: Smartphone; FCC ID: NM8PC70110

Communication System: PCS; Frequency: 1850.2 MHz; Duty Cycle: 1:8.3

Medium parameters used: $\sigma = 0$ mho/m, $\epsilon_r = 1$; $\rho = 1$ kg/m³

Phantom section: H Device Section

Measurement Standard: DASYS (IEEE/IEC)

DASY5 Configuration:

- Probe: H3DV6 - SN6076; ; Calibrated: 8/19/2009
- Sensor-Surface: (Fix Surface)
- Electronics: DAE3 Sn393; Calibrated: 8/24/2009
- Phantom: HAC Test Arch 4.6; Type: SD HAC P01 BA; Serial: 1038
- Measurement SW: DASY5, V5.0 Build 125; SEMCAD X Version 13.4 Build 125

H Scan - H3DV6 - measurement distance from the probe sensor center to the Device = 15mm/Hearing Aid Compatibility Test (101x101x1): Measurement grid: dx=5mm, dy=5mm

Maximum value of peak Total field = 0.246 A/m

Probe Modulation Factor = 2.44

Device Reference Point: 0, 0, 353.7 mm

Reference Value = 0.113 A/m; Power Drift = -0.110 dB

Hearing Aid Near-Field Category: M3 (AWF -5 dB)

Peak H-field in A/m

Grid 1 0.228 M3	Grid 2 0.246 M3	Grid 3 0.243 M3
Grid 4 0.228 M3	Grid 5 0.246 M3	Grid 6 0.243 M3
Grid 7 0.235 M3	Grid 8 0.218 M3	Grid 9 0.205 M3



0 dB = 0.246A/m



Test Laboratory: A Test Lab Techno Corp.

Date/Time: 1/11/2010 5:49:30 PM

HAC_PCS CH661_H_Close

DUT: PC70110_Close; Type: Smartphone; FCC ID: NM8PC70110

Communication System: PCS; Frequency: 1880 MHz; Duty Cycle: 1:8.3

Medium parameters used: $\sigma = 0$ mho/m, $\epsilon_r = 1$; $\rho = 1$ kg/m³

Phantom section: H Device Section

Measurement Standard: DASYS (IEEE/IEC)

DASY5 Configuration:

- Probe: H3DV6 - SN6076; ; Calibrated: 8/19/2009
- Sensor-Surface: (Fix Surface)
- Electronics: DAE3 Sn393; Calibrated: 8/24/2009
- Phantom: HAC Test Arch 4.6; Type: SD HAC P01 BA; Serial: 1038
- Measurement SW: DASY5, V5.0 Build 125; SEMCAD X Version 13.4 Build 125

H Scan - H3DV6 - measurement distance from the probe sensor center to the Device = 15mm/Hearing Aid Compatibility Test (101x101x1): Measurement grid: dx=5mm, dy=5mm

Maximum value of peak Total field = 0.242 A/m

Probe Modulation Factor = 2.44

Device Reference Point: 0, 0, 353.7 mm

Reference Value = 0.108 A/m; Power Drift = 0.149 dB

Hearing Aid Near-Field Category: M3 (AWF -5 dB)

Peak H-field in A/m

Grid 1 0.224 M3	Grid 2 0.242 M3	Grid 3 0.241 M3
Grid 4 0.224 M3	Grid 5 0.242 M3	Grid 6 0.240 M3
Grid 7 0.240 M3	Grid 8 0.212 M3	Grid 9 0.200 M3

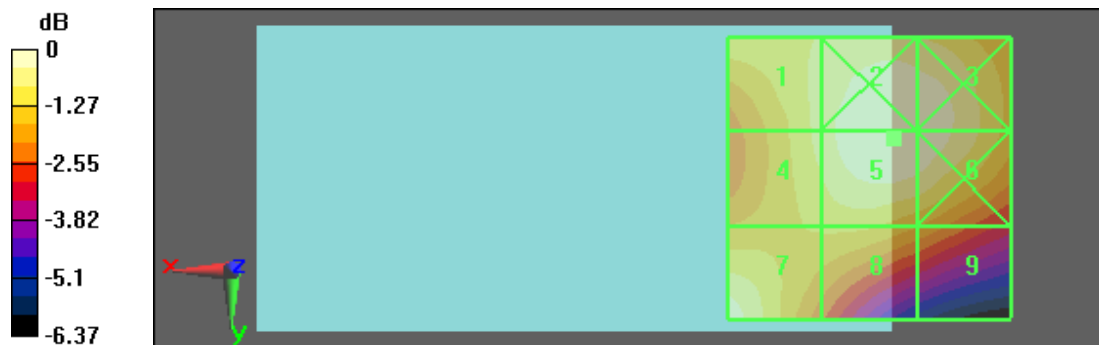

0 dB = 0.242A/m



Test Laboratory: A Test Lab Techno Corp.

Date/Time: 1/11/2010 5:55:31 PM

HAC_PCS CH810_H_Close

DUT: PC70110_Close; Type: Smartphone; FCC ID: NM8PC70110

Communication System: PCS; Frequency: 1909.8 MHz;Duty Cycle: 1:8.3

Medium parameters used: $\sigma = 0$ mho/m, $\epsilon_r = 1$; $\rho = 1$ kg/m³

Phantom section: H Device Section

Measurement Standard: DASYS (IEEE/IEC)

DASY5 Configuration:

- Probe: H3DV6 - SN6076; ; Calibrated: 8/19/2009
- Sensor-Surface: (Fix Surface)
- Electronics: DAE3 Sn393; Calibrated: 8/24/2009
- Phantom: HAC Test Arch 4.6; Type: SD HAC P01 BA; Serial: 1038
- Measurement SW: DASY5, V5.0 Build 125;SEMCAD X Version 13.4 Build 125

H Scan - H3DV6 - measurement distance from the probe sensor center to the Device = 15mm/Hearing Aid Compatibility Test (101x101x1): Measurement grid: dx=5mm, dy=5mm

Maximum value of peak Total field = 0.247 A/m

Probe Modulation Factor = 2.44

Device Reference Point: 0, 0, 353.7 mm

Reference Value = 0.112 A/m; Power Drift = -0.018 dB

Hearing Aid Near-Field Category: M3 (AWF -5 dB)

Peak H-field in A/m

Grid 1 0.229 M3	Grid 2 0.247 M3	Grid 3 0.244 M3
Grid 4 0.229 M3	Grid 5 0.247 M3	Grid 6 0.244 M3
Grid 7 0.244 M3	Grid 8 0.215 M3	Grid 9 0.202 M3



0 dB = 0.247A/m



Test Laboratory: A Test Lab Techno Corp.

Date/Time: 1/11/2010 6:20:19 PM

HAC_WCDMA Band II CH9262_H_Close

DUT: PC70110_Close; Type: Smartphone; FCC ID: NM8PC70110

Communication System: WCDMA Band II; Frequency: 1852.4 MHz; Duty Cycle: 1:1

Medium parameters used: $\sigma = 0$ mho/m, $\epsilon_r = 1$; $\rho = 1$ kg/m³

Phantom section: H Device Section

Measurement Standard: DASYS (IEEE/IEC)

DASY5 Configuration:

- Probe: H3DV6 - SN6076; ; Calibrated: 8/19/2009
- Sensor-Surface: (Fix Surface)
- Electronics: DAE3 Sn393; Calibrated: 8/24/2009
- Phantom: HAC Test Arch 4.6; Type: SD HAC P01 BA; Serial: 1038
- Measurement SW: DASY5, V5.0 Build 125; SEMCAD X Version 13.4 Build 125

H Scan - H3DV6 - measurement distance from the probe sensor center to the Device = 15mm/Hearing Aid Compatibility Test (101x101x1): Measurement grid:

dx=5mm, dy=5mm

Maximum value of peak Total field = 0.104 A/m

Probe Modulation Factor = 0.810

Device Reference Point: 0, 0, 353.7 mm

Reference Value = 0.142 A/m; Power Drift = 0.025 dB

Hearing Aid Near-Field Category: M4 (AWF 0 dB)

Peak H-field in A/m

Grid 1	Grid 2	Grid 3
0.095 M4	0.104 M4	0.103 M4
Grid 4	Grid 5	Grid 6
0.095 M4	0.104 M4	0.103 M4
Grid 7	Grid 8	Grid 9
0.099 M4	0.091 M4	0.088 M4



0 dB = 0.104A/m



Test Laboratory: A Test Lab Techno Corp.

Date/Time: 1/11/2010 6:26:04 PM

HAC_WCDMA Band II CH9400_H_Close

DUT: PC70110_Close; Type: Smartphone; FCC ID: NM8PC70110

Communication System: WCDMA Band II; Frequency: 1880 MHz;Duty Cycle: 1:1

Medium parameters used: $\sigma = 0$ mho/m, $\epsilon_r = 1$; $\rho = 1$ kg/m³

Phantom section: H Device Section

Measurement Standard: DASYS (IEEE/IEC)

DASY5 Configuration:

- Probe: H3DV6 - SN6076; ; Calibrated: 8/19/2009
- Sensor-Surface: (Fix Surface)
- Electronics: DAE3 Sn393; Calibrated: 8/24/2009
- Phantom: HAC Test Arch 4.6; Type: SD HAC P01 BA; Serial: 1038
- Measurement SW: DASY5, V5.0 Build 125;SEMCAD X Version 13.4 Build 125

H Scan - H3DV6 - measurement distance from the probe sensor center to the Device = 15mm/Hearing Aid Compatibility Test (101x101x1): Measurement grid: dx=5mm, dy=5mm

Maximum value of peak Total field = 0.104 A/m

Probe Modulation Factor = 0.810

Device Reference Point: 0, 0, 353.7 mm

Reference Value = 0.141 A/m; Power Drift = 0.00717 dB

Hearing Aid Near-Field Category: M4 (AWF 0 dB)

Peak H-field in A/m

Grid 1	Grid 2	Grid 3
0.096 M4	0.104 M4	0.103 M4
Grid 4	Grid 5	Grid 6
0.095 M4	0.104 M4	0.103 M4
Grid 7	Grid 8	Grid 9
0.103 M4	0.091 M4	0.087 M4



0 dB = 0.104A/m



Test Laboratory: A Test Lab Techno Corp.

Date/Time: 1/11/2010 6:32:02 PM

HAC_WCDMA Band II CH9538_H_Close

DUT: PC70110_Close; Type: Smartphone; FCC ID: NM8PC70110

Communication System: WCDMA Band II; Frequency: 1907.6 MHz; Duty Cycle: 1:1

Medium parameters used: $\sigma = 0$ mho/m, $\epsilon_r = 1$; $\rho = 1$ kg/m³

Phantom section: H Device Section

Measurement Standard: DASYS (IEEE/IEC)

DASY5 Configuration:

- Probe: H3DV6 - SN6076; ; Calibrated: 8/19/2009
- Sensor-Surface: (Fix Surface)
- Electronics: DAE3 Sn393; Calibrated: 8/24/2009
- Phantom: HAC Test Arch 4.6; Type: SD HAC P01 BA; Serial: 1038
- Measurement SW: DASY5, V5.0 Build 125; SEMCAD X Version 13.4 Build 125

H Scan - H3DV6 - measurement distance from the probe sensor center to the Device = 15mm/Hearing Aid Compatibility Test (101x101x1): Measurement grid: dx=5mm, dy=5mm

Maximum value of peak Total field = 0.104 A/m

Probe Modulation Factor = 0.810

Device Reference Point: 0, 0, 353.7 mm

Reference Value = 0.141 A/m; Power Drift = 0.00168 dB

Hearing Aid Near-Field Category: M4 (AWF 0 dB)

Peak H-field in A/m

Grid 1	Grid 2	Grid 3
0.096 M4	0.104 M4	0.103 M4
Grid 4	Grid 5	Grid 6
0.096 M4	0.104 M4	0.103 M4
Grid 7	Grid 8	Grid 9
0.103 M4	0.090 M4	0.087 M4



0 dB = 0.104A/m



Test Laboratory: A Test Lab Techno Corp.

Date/Time: 1/11/2010 6:39:28 PM

HAC_WCDMA Band V CH4132_H_Close

DUT: PC70110_Close; Type: Smartphone; FCC ID: NM8PC70110

Communication System: WCDMA Band V; Frequency: 826.4 MHz;Duty Cycle: 1:1

Medium parameters used: $\sigma = 0$ mho/m, $\epsilon_r = 1$; $\rho = 1$ kg/m³

Phantom section: H Device Section

Measurement Standard: DASYS (IEEE/IEC)

DASY5 Configuration:

- Probe: H3DV6 - SN6076; ; Calibrated: 8/19/2009
- Sensor-Surface: (Fix Surface)
- Electronics: DAE3 Sn393; Calibrated: 8/24/2009
- Phantom: HAC Test Arch 4.6; Type: SD HAC P01 BA; Serial: 1038
- Measurement SW: DASY5, V5.0 Build 125;SEMCAD X Version 13.4 Build 125

H Scan - H3DV6 - measurement distance from the probe sensor center to the Device = 15mm/Hearing Aid Compatibility Test (101x101x1): Measurement grid: dx=5mm, dy=5mm

Maximum value of peak Total field = 0.092 A/m

Probe Modulation Factor = 0.860

Device Reference Point: 0, 0, 353.7 mm

Reference Value = 0.073 A/m; Power Drift = 0.043 dB

Hearing Aid Near-Field Category: M4 (AWF 0 dB)

Peak H-field in A/m

Grid 1 0.132 M4	Grid 2 0.092 M4	Grid 3 0.055 M4
Grid 4 0.120 M4	Grid 5 0.082 M4	Grid 6 0.047 M4
Grid 7 0.130 M4	Grid 8 0.091 M4	Grid 9 0.055 M4

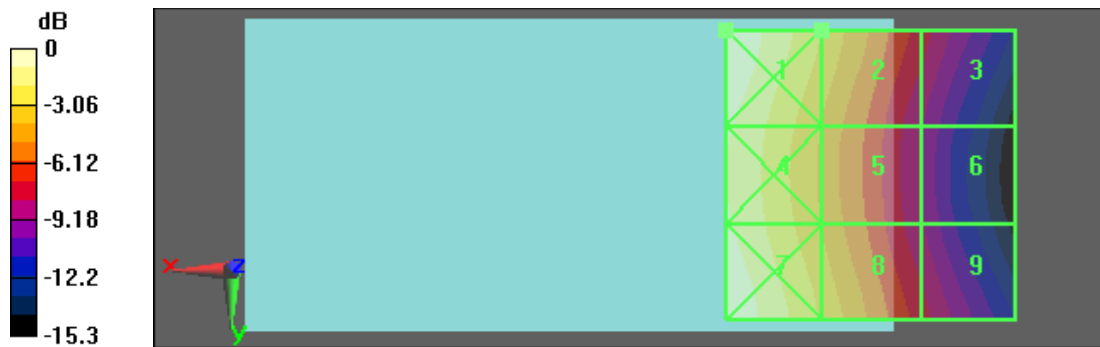

0 dB = 0.132A/m



Test Laboratory: A Test Lab Techno Corp.

Date/Time: 1/11/2010 6:45:51 PM

HAC_WCDMA Band V CH4183_H_Close

DUT: PC70110_Close; Type: Smartphone; FCC ID: NM8PC70110

Communication System: WCDMA Band V; Frequency: 836.6 MHz;Duty Cycle: 1:1

Medium parameters used: $\sigma = 0$ mho/m, $\epsilon_r = 1$; $\rho = 1$ kg/m³

Phantom section: H Device Section

Measurement Standard: DASYS (IEEE/IEC)

DASY5 Configuration:

- Probe: H3DV6 - SN6076; ; Calibrated: 8/19/2009
- Sensor-Surface: (Fix Surface)
- Electronics: DAE3 Sn393; Calibrated: 8/24/2009
- Phantom: HAC Test Arch 4.6; Type: SD HAC P01 BA; Serial: 1038
- Measurement SW: DASYS, V5.0 Build 125;SEMCAD X Version 13.4 Build 125

H Scan - H3DV6 - measurement distance from the probe sensor center to the Device = 15mm/Hearing Aid Compatibility Test (101x101x1): Measurement grid: dx=5mm, dy=5mm

Maximum value of peak Total field = 0.085 A/m

Probe Modulation Factor = 0.860

Device Reference Point: 0, 0, 353.7 mm

Reference Value = 0.067 A/m; Power Drift = 0.025 dB

Hearing Aid Near-Field Category: M4 (AWF 0 dB)

Peak H-field in A/m

Grid 1	Grid 2	Grid 3
0.120 M4	0.085 M4	0.051 M4
Grid 4	Grid 5	Grid 6
0.110 M4	0.076 M4	0.043 M4
Grid 7	Grid 8	Grid 9
0.120 M4	0.084 M4	0.051 M4

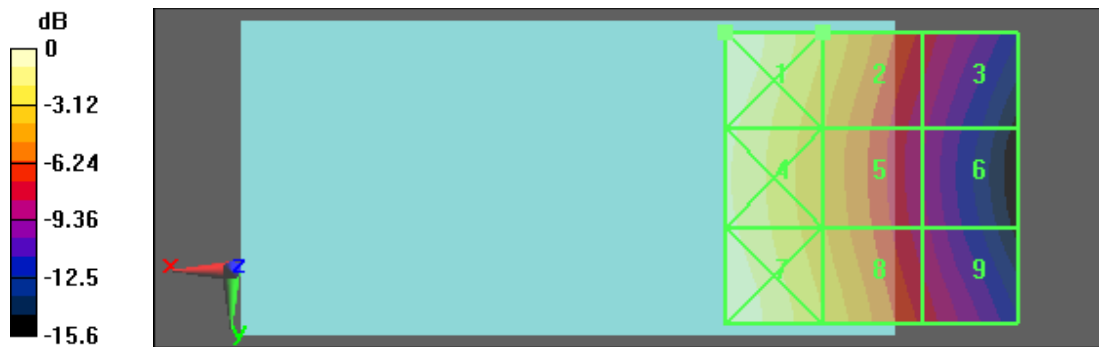

0 dB = 0.120A/m



Test Laboratory: A Test Lab Techno Corp.

Date/Time: 1/11/2010 6:52:21 PM

HAC_WCDMA Band V CH4233_H_Close

DUT: PC70110_Close; Type: Smartphone; FCC ID: NM8PC70110

Communication System: WCDMA Band V; Frequency: 846.6 MHz; Duty Cycle: 1:1

Medium parameters used: $\sigma = 0$ mho/m, $\epsilon_r = 1$; $\rho = 1$ kg/m³

Phantom section: H Device Section

Measurement Standard: DASYS (IEEE/IEC)

DASY5 Configuration:

- Probe: H3DV6 - SN6076; ; Calibrated: 8/19/2009
- Sensor-Surface: (Fix Surface)
- Electronics: DAE3 Sn393; Calibrated: 8/24/2009
- Phantom: HAC Test Arch 4.6; Type: SD HAC P01 BA; Serial: 1038
- Measurement SW: DASY5, V5.0 Build 125; SEMCAD X Version 13.4 Build 125

H Scan - H3DV6 - measurement distance from the probe sensor center to the Device = 15mm/Hearing Aid Compatibility Test (101x101x1): Measurement grid: dx=5mm, dy=5mm

Maximum value of peak Total field = 0.093 A/m

Probe Modulation Factor = 0.860

Device Reference Point: 0, 0, 353.7 mm

Reference Value = 0.075 A/m; Power Drift = 0.030 dB

Hearing Aid Near-Field Category: M4 (AWF 0 dB)

Peak H-field in A/m

Grid 1	Grid 2	Grid 3
0.133 M4	0.093 M4	0.056 M4
Grid 4	Grid 5	Grid 6
0.123 M4	0.084 M4	0.048 M4
Grid 7	Grid 8	Grid 9
0.133 M4	0.093 M4	0.056 M4

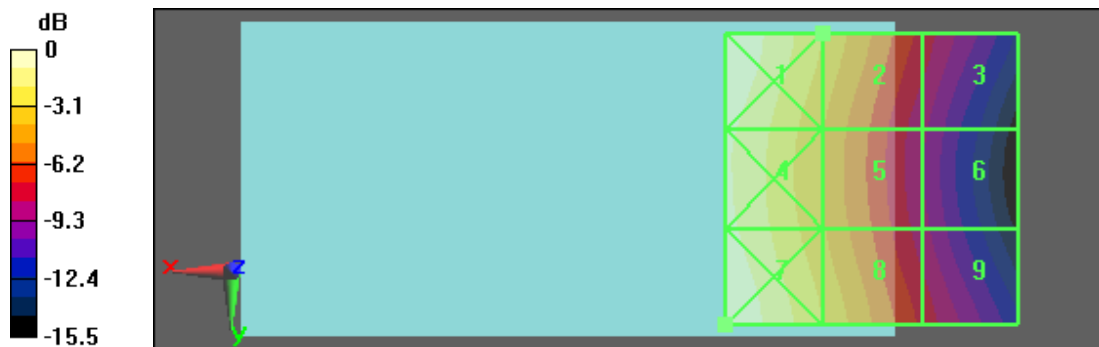

0 dB = 0.133A/m



Appendix D - Calibration

All of the instruments Calibration information are listed below.

- Dipole _ CD835V3 SN:1017 Calibration No.CD835V3-1017_Jul09
- Dipole _ CD1880V3 SN:1036 Calibration No.CD1880V3-1036_ Jul09
- Probe _ ER3DV6 SN: 2256 Calibration No. ER3-2256_Aug09
- Probe _ H3DV6 SN: 6076 Calibration No. H3-6076_ Aug09
- DAE _ DAE3 SN:393 Calibration No.DAE3-393_ Aug09



**Calibration Laboratory of
Schmid & Partner
Engineering AG**
Zeughausstrasse 43, 8004 Zurich, Switzerland



S Schweizerischer Kalibrierdienst
C Service suisse d'étalonnage
S Servizio svizzero di taratura
S Swiss Calibration Service

Accredited by the Swiss Accreditation Service (SAS)
The Swiss Accreditation Service is one of the signatories to the EA
Multilateral Agreement for the recognition of calibration certificates

Accreditation No.: **SCS 108**

Client **ATL (Auden)**

Certificate No: **CD835V3-1017_Jul09**

CALIBRATION CERTIFICATE

Object: **CD835V3 - SN: 1017**

Calibration procedure(s): **QA CAL-20.v4
Calibration procedure for dipoles in air**

Calibration date: **July 14, 2009**

Condition of the calibrated item: **In Tolerance**

This calibration certificate documents the traceability to national standards, which realize the physical units of measurements (SI).
All calibrations have been conducted in the closed laboratory facility: environment temperature (22 ± 3)°C and humidity < 70%.

Calibration Equipment used (M&TE critical for calibration)

Primary Standards	ID #	Cal Date (Certificate No.)	Scheduled Calibration
Power meter EPM-442A	GB37480704	08-Oct-08 (No. 217-00898)	Oct-09
Power sensor HP 8481A	US37292783	08-Oct-08 (No. 217-00898)	Oct-09
Probe ER3DV6	SN: 2336	22-Dec-08 (No. ER3-2336_Dec08)	Dec-09
Probe H3DV6	SN: 6065	22-Dec-08 (No. H3-6065_-Dec08)	Dec-09
DAE4	SN: 781	20-Feb-09 (No. DAE4-781_Feb09)	Feb-10

Secondary Standards	ID #	Check Date (in house)	Scheduled Check
Power meter R&S NRP	SN: 101748	23-Sep-08 (in house check Dec-08)	In house check: Dec-10
Power sensor R&S NRP-Z91	SN: 100711	25-Aug-08 (in house check Dec-08)	In house check: Dec-10
Power sensor R&S NRP-Z91	SN: 100712	25-Aug-08 (in house check Dec-08)	In house check: Dec-10
Network Analyzer HP 8753E	US37390585	18-Oct-01 (in house check Oct-08)	In house check: Oct-09
RF generator E4433B	MY 41310391	03-Nov-04 (in house check Oct-07)	In house check: Oct-09

Calibrated by:	Name Claudio Leubler	Function Laboratory Technician	Signature
Approved by:	Name Katja Pokovic	Function Technical Manager	Signature

Issued: July 15, 2009

This calibration certificate shall not be reproduced except in full without written approval of the laboratory.



Accredited by the Swiss Accreditation Service (SAS)
The Swiss Accreditation Service is one of the signatories to the EA
Multilateral Agreement for the recognition of calibration certificates

Accreditation No.: **SCS 108**

References

- [1] ANSI-C63.19-2006
American National Standard for Methods of Measurement of Compatibility between Wireless Communications Devices and Hearing Aids.
- [2] ANSI-C63.19-2007
American National Standard for Methods of Measurement of Compatibility between Wireless Communications Devices and Hearing Aids.

Methods Applied and Interpretation of Parameters:

- **Coordinate System:** y-axis is in the direction of the dipole arms. z-axis is from the basis of the antenna (mounted on the table) towards its feed point between the two dipole arms. x-axis is normal to the other axes. In coincidence with the standards [1, 2], the measurement planes (probe sensor center) are selected to be at a distance of 10 mm above the top edge of the dipole arms.
- **Measurement Conditions:** Further details are available from the hardcopies at the end of the certificate. All figures stated in the certificate are valid at the frequency indicated. The forward power to the dipole connector is set with a calibrated power meter connected and monitored with an auxiliary power meter connected to a directional coupler. While the dipole under test is connected, the forward power is adjusted to the same level.
- **Antenna Positioning:** The dipole is mounted on a HAC Test Arch phantom using the matching dipole positioner with the arms horizontal and the feeding cable coming from the floor. The measurements are performed in a shielded room with absorbers around the setup to reduce the reflections. It is verified before the mounting of the dipole under the Test Arch phantom, that its arms are perfectly in a line. It is installed on the HAC dipole positioner with its arms parallel below the dielectric reference wire and able to move elastically in vertical direction without changing its relative position to the top center of the Test Arch phantom. The vertical distance to the probe is adjusted after dipole mounting with a DASY4 Surface Check job. Before the measurement, the distance between phantom surface and probe tip is verified. The proper measurement distance is selected by choosing the matching section of the HAC Test Arch phantom with the proper device reference point (upper surface of the dipole) and the matching grid reference point (tip of the probe) considering the probe sensor offset. The vertical distance to the probe is essential for the accuracy.
- **Feed Point Impedance and Return Loss:** These parameters are measured using a HP 8753E Vector Network Analyzer. The impedance is specified at the SMA connector of the dipole. The influence of reflections was eliminating by applying the averaging function while moving the dipole in the air, at least 70cm away from any obstacles.
- **E-field distribution:** E field is measured in the x-y-plane with an isotropic ER3D-field probe with 100 mW forward power to the antenna feed point. In accordance with [1, 2], the scan area is 20mm wide, its length exceeds the dipole arm length (180 or 90mm). The sensor center is 10 mm (in z) above the top of the dipole arms. Two 3D maxima are available near the end of the dipole arms. Assuming the dipole arms are perfectly in one line, the average of these two maxima (in subgrid 2 and subgrid 8) is determined to compensate for any non-parallelity to the measurement plane as well as the sensor displacement. The E-field value stated as calibration value represents the maximum of the interpolated 3D-E-field, 10mm above the dipole surface.
- **H-field distribution:** H-field is measured with an isotropic H-field probe with 100mW forward power to the antenna feed point, in the x-y-plane. The scan area and sensor distance is equivalent to the E-field scan. The maximum of the field is available at the center (subgrid 5) above the feed point. The H-field value stated as calibration value represents the maximum of the interpolated H-field, 10mm above the dipole surface at the feed point.

1 Measurement Conditions

DASY system configuration, as far as not given on page 1.

DASY Version	DASY4	V4.7 B80
DASY PP Version	SEMCAD	V1.8 B186
Phantom	HAC Test Arch	SD HAC P01 BA, #1070
Distance Dipole Top - Probe Center	10 mm	
Scan resolution	dx, dy = 5 mm	area = 20 x 180 mm
Frequency	835 MHz ± 1 MHz	
Forward power at dipole connector	20.0 dBm = 100mW	
Input power drift	< 0.05 dB	

2 Maximum Field values

H-field 10 mm above dipole surface	condition	interpolated maximum
Maximum measured	100 mW forward power	0.457 A/m

Uncertainty for H-field measurement: 8.2% (k=2)

E-field 10 mm above dipole surface	condition	Interpolated maximum
Maximum measured above high end-	100 mW forward power	159.6 V/m
Maximum measured above low end	100 mW forward power	157.0 V/m
Averaged maximum above arm	100 mW forward power	158.3 V/m

Uncertainty for E-field measurement: 12.8% (k=2)

3 Appendix

3.1 Antenna Parameters

Frequency	Return Loss	Impedance
800 MHz	16.5 dB	(43.3 – j12.3) Ohm
835 MHz	28.4 dB	(49.2 + j3.7) Ohm
900 MHz	17.1 dB	(55.5 – j13.7) Ohm
950 MHz	20.7 dB	(45.5 + j7.6) Ohm
960 MHz	16.0 dB	(51.6 + j16.2) Ohm

3.2 Antenna Design and Handling

The calibration dipole has a symmetric geometry with a built-in two stub matching network, which leads to the enhanced bandwidth.

The dipole is built of standard semirigid coaxial cable. The internal matching line is open ended. The antenna is therefore open for DC signals.

Do not apply force to dipole arms, as they are liable to bend. The soldered connections near the feedpoint may be damaged. After excessive mechanical stress or overheating, check the impedance characteristics to ensure that the internal matching network is not affected.

After long term use with 40W radiated power, only a slight warming of the dipole near the feedpoint can be measured.



3.3 Measurement Sheets

3.3.1 Return Loss and Smith Chart

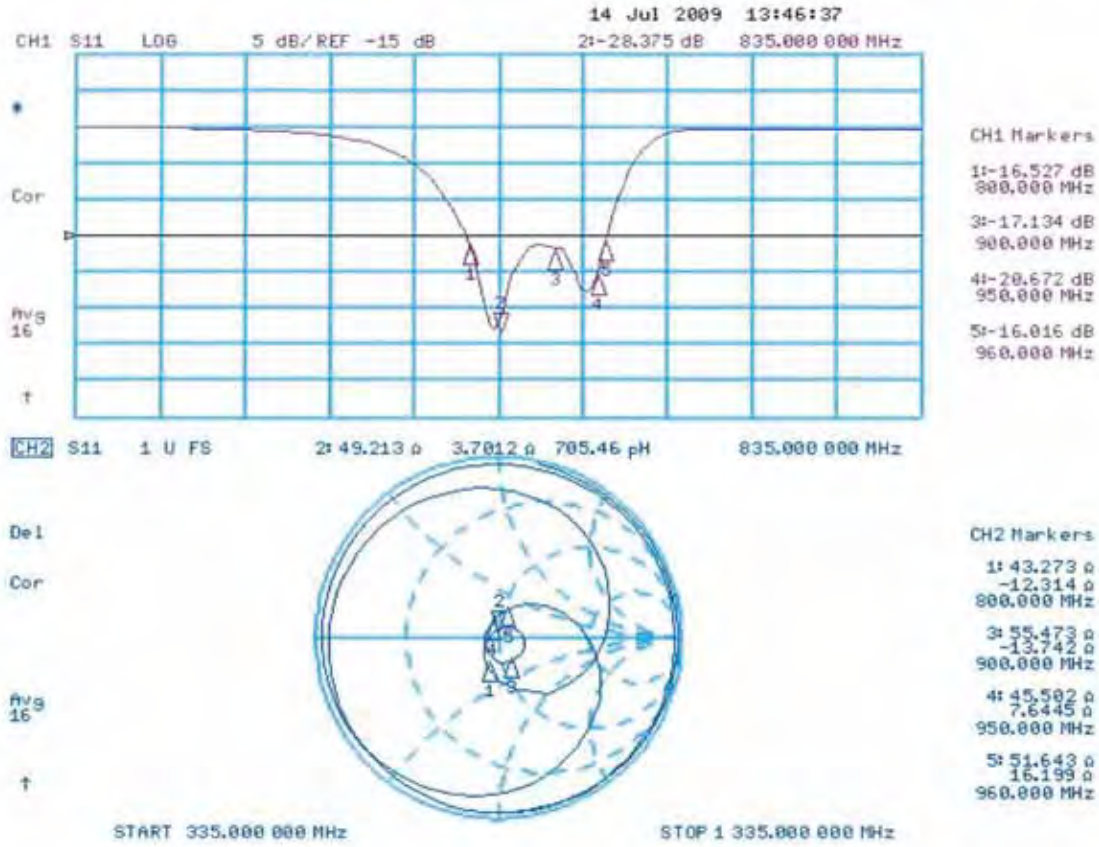

3.3.2 DASY4 H-field Result

Date/Time: 14.07.2009 11:05:09

Test Laboratory: SPEAG Lab 2

H_CD835_1017_090714

DUT: HAC-Dipole 835 MHz; Type: D835V3; Serial: 1017

Communication System: CW; Frequency: 835 MHz; Duty Cycle: 1:1

Medium parameters used: $\sigma = 0$ mho/m, $\epsilon_r = 1$; $\rho = 1$ kg/m³

Phantom section: RF Section

Measurement Standard: DASY4 (High Precision Assessment)

DASY4 Configuration:

- Probe: H3DV6 - SN6065; ; Calibrated: 22.12.2008
- Sensor-Surface: (Fix Surface)
- Electronics: DAE4 Sn781; Calibrated: 20.02.2009
- Phantom: HAC Test Arch with AMCC; Type: SD HAC P01 BA; Serial: 1070
- Measurement SW: DASY4, V4.7 Build 80; Postprocessing SW: SEMCAD, V1.8 Build 186

H Scan - measurement distance from the probe sensor center to CD835 Dipole =

10mm/Hearing Aid Compatibility Test (41x361x1): Measurement grid: dx=5mm, dy=5mm

Maximum value of peak Total field = 0.457 A/m

Probe Modulation Factor = 1.00

Device Reference Point: 0.000, 0.000, -6.30 mm

Reference Value = 0.489 A/m; Power Drift = -0.003 dB

Hearing Aid Near-Field Category: M4 (AWF 0 dB)

Peak H-field in A/m

Grid 1 0.374 M4	Grid 2 0.397 M4	Grid 3 0.374 M4
Grid 4 0.430 M4	Grid 5 0.457 M4	Grid 6 0.429 M4
Grid 7 0.379 M4	Grid 8 0.400 M4	Grid 9 0.371 M4



0 dB = 0.457A/m

3.3.3 DASy4 E-field Result

Date/Time: 14.07.2009 16:07:18

Test Laboratory: SPEAG Lab 2

E_CD835_1017_090714

DUT: HAC-Dipole 835 MHz; Type: D835V3; Serial: 1017

Communication System: CW; Frequency: 835 MHz; Duty Cycle: 1:1

Medium parameters used: $\sigma = 0$ mho/m, $\epsilon_r = 1$; $\rho = 1000$ kg/m³

Phantom section: RF Section

Measurement Standard: DASy4 (High Precision Assessment)

DASy4 Configuration:

- Probe: ER3DV6 - SN2336; ConvF(1, 1, 1); Calibrated: 22.12.2008
- Sensor-Surface: (Fix Surface)
- Electronics: DAE4 Sn781; Calibrated: 20.02.2009
- Phantom: HAC Test Arch with AMCC; Type: SD HAC P01 BA; Serial: 1070
- Measurement SW: DASy4, V4.7 Build 80; Postprocessing SW: SEMCAD, V1.8 Build 186

E Scan - measurement distance from the probe sensor center to CD835 Dipole = 10mm/Hearing Aid Compatibility Test (41x361x1):

Measurement grid: dx=5mm, dy=5mm

Maximum value of peak Total field = 159.6 V/m

Probe Modulation Factor = 1.00

Device Reference Point: 0.000, 0.000, -6.30 mm

Reference Value = 103.6 V/m; Power Drift = -0.032 dB

Hearing Aid Near-Field Category: M4 (AWF 0 dB)

Peak E-field in V/m

Grid 1 153.4 M4	Grid 2 157.0 M4	Grid 3 152.7 M4
Grid 4 85.7 M4	Grid 5 87.5 M4	Grid 6 84.0 M4
Grid 7 154.9 M4	Grid 8 159.6 M4	Grid 9 153.9 M4



0 dB = 159.6V/m



Calibration Laboratory of
Schmid & Partner
Engineering AG
 Zeughausstrasse 43, 8004 Zurich, Switzerland



S Schweizerischer Kalibrierdienst
C Service suisse d'étalonnage
S Servizio svizzero di taratura
S Swiss Calibration Service

Accredited by the Swiss Accreditation Service (SAS)
 The Swiss Accreditation Service is one of the signatories to the EA
 Multilateral Agreement for the recognition of calibration certificates

Accreditation No.: **SCS 108**

Client **ATL (Auden)**

Certificate No: **CD1880V3-1036_Jul09**

CALIBRATION CERTIFICATE

Object **CD1880V3 - SN: 1036**

Calibration procedure(s) **QA CAL-20.v4
 Calibration procedure for dipoles in air**

Calibration date: **July 15, 2009**

Condition of the calibrated item **In Tolerance**

This calibration certificate documents the traceability to national standards, which realize the physical units of measurements (SI).
 All calibrations have been conducted in the closed laboratory facility: environment temperature (22 ± 3)°C and humidity < 70%.

Calibration Equipment used (M&TE critical for calibration)

Primary Standards	ID #	Cal Date (Certificate No.)	Scheduled Calibration
Power meter EPM-442A	GB37480704	08-Oct-08 (No. 217-00898)	Oct-09
Power sensor HP 8481A	US37292783	08-Oct-08 (No. 217-00898)	Oct-09
Probe ER3DV6	SN: 2336	22-Dec-08 (No. ER3-2336_Dec08)	Dec-09
Probe H3DV6	SN: 6065	22-Dec-08 (No. H3-6065_-Dec08)	Dec-09
DAE4	SN 781	20-Feb-09 (No. DAE4-781_Feb09)	Feb-10

Secondary Standards	ID #	Check Date (in house)	Scheduled Check
Power meter R&S NRP	SN: 101748	23-Sep-08 (in house check Dec-08)	In house check: Dec-10
Power sensor R&S NRP-Z91	SN: 100711	25-Aug-08 (in house check Dec-08)	In house check: Dec-10
Power sensor R&S NRP-Z91	SN: 100712	25-Aug-08 (in house check Dec-08)	In house check: Dec-10
Network Analyzer HP 8753E	US37390585	18-Oct-01 (in house check Oct-08)	In house check: Oct-09
RF generator E4433B	MY 41310391	22-Nov-04 (in house check Oct-07)	In house check: Oct-09

Calibrated by: **Name: Mike Meili, Function: Laboratory Technician, Signature: [Signature]**

Approved by: **Name: Fin Bornholt, Function: Technical Director, Signature: [Signature]**

Issued: July 16, 2009

This calibration certificate shall not be reproduced except in full without written approval of the laboratory.



Accredited by the Swiss Accreditation Service (SAS)
The Swiss Accreditation Service is one of the signatories to the EA
Multilateral Agreement for the recognition of calibration certificates

Accreditation No.: **SCS 108**

References

- [1] ANSI-C63.19-2006
American National Standard for Methods of Measurement of Compatibility between Wireless Communications Devices and Hearing Aids.
- [2] ANSI-C63.19-2007
American National Standard for Methods of Measurement of Compatibility between Wireless Communications Devices and Hearing Aids.

Methods Applied and Interpretation of Parameters:

- *Coordinate System:* y-axis is in the direction of the dipole arms. z-axis is from the basis of the antenna (mounted on the table) towards its feed point between the two dipole arms. x-axis is normal to the other axes. In coincidence with the standards [1, 2], the measurement planes (probe sensor center) are selected to be at a distance of 10 mm above the top edge of the dipole arms.
- *Measurement Conditions:* Further details are available from the hardcopies at the end of the certificate. All figures stated in the certificate are valid at the frequency indicated. The forward power to the dipole connector is set with a calibrated power meter connected and monitored with an auxiliary power meter connected to a directional coupler. While the dipole under test is connected, the forward power is adjusted to the same level.
- *Antenna Positioning:* The dipole is mounted on a HAC Test Arch phantom using the matching dipole positioner with the arms horizontal and the feeding cable coming from the floor. The measurements are performed in a shielded room with absorbers around the setup to reduce the reflections. It is verified before the mounting of the dipole under the Test Arch phantom, that its arms are perfectly in a line. It is installed on the HAC dipole positioner with its arms parallel below the dielectric reference wire and able to move elastically in vertical direction without changing its relative position to the top center of the Test Arch phantom. The vertical distance to the probe is adjusted after dipole mounting with a DASY4 Surface Check job. Before the measurement, the distance between phantom surface and probe tip is verified. The proper measurement distance is selected by choosing the matching section of the HAC Test Arch phantom with the proper device reference point (upper surface of the dipole) and the matching grid reference point (tip of the probe) considering the probe sensor offset. The vertical distance to the probe is essential for the accuracy.
- *Feed Point Impedance and Return Loss:* These parameters are measured using a HP 8753E Vector Network Analyzer. The impedance is specified at the SMA connector of the dipole. The influence of reflections was eliminating by applying the averaging function while moving the dipole in the air, at least 70cm away from any obstacles.
- *E-field distribution:* E field is measured in the x-y-plane with an isotropic ER3D-field probe with 100 mW forward power to the antenna feed point. In accordance with [1, 2], the scan area is 20mm wide, its length exceeds the dipole arm length (180 or 90mm). The sensor center is 10 mm (in z) above the top of the dipole arms. Two 3D maxima are available near the end of the dipole arms. Assuming the dipole arms are perfectly in one line, the average of these two maxima (in subgrid 2 and subgrid 8) is determined to compensate for any non-parallelity to the measurement plane as well as the sensor displacement. The E-field value stated as calibration value represents the maximum of the interpolated 3D-E-field, 10mm above the dipole surface.
- *H-field distribution:* H-field is measured with an isotropic H-field probe with 100mW forward power to the antenna feed point, in the x-y-plane. The scan area and sensor distance is equivalent to the E-field scan. The maximum of the field is available at the center (subgrid 5) above the feed point. The H-field value stated as calibration value represents the maximum of the interpolated H-field, 10mm above the dipole surface at the feed point.



1. Measurement Conditions

DASY system configuration, as far as not given on page 1.

DASY Version	DASY4	V4.7 B80
DASY PP Version	SEMCAD	V1.8 B186
Phantom	HAC Test Arch	SD HAC P01 BA, #1070
Distance Dipole Top - Probe Center	10 mm	
Scan resolution	dx, dy = 5 mm	area = 20 x 90 mm
Frequency	1880 MHz ± 1 MHz	
Forward power at dipole connector	20.0 dBm = 100mW	
Input power drift	< 0.05 dB	

2. Maximum Field values

H-field 10 mm above dipole surface	condition	Interpolated maximum
Maximum measured	100 mW forward power	0.474 A/m

Uncertainty for H-field measurement: 8.2% (k=2)

E-field 10 mm above dipole surface	condition	Interpolated maximum
Maximum measured above high end	100 mW forward power	137.5 V/m
Maximum measured above low end	100 mW forward power	136.8 V/m
Averaged maximum above arm	100 mW forward power	137.2 V/m

Uncertainty for E-field measurement: 12.8% (k=2)

3. Appendix

3.1 Antenna Parameters

Frequency	Return Loss	Impedance
1710 MHz	20.0 dB	(50.0 + j10.1) Ohm
1880 MHz	22.0 dB	(52.5 + j7.8) Ohm
1900 MHz	22.1 dB	(54.9 + j6.6) Ohm
1950 MHz	32.1 dB	(52.4 - j0.8) Ohm
2000 MHz	20.3 dB	(41.4 + j2.1) Ohm

3.2 Antenna Design and Handling

The calibration dipole has a symmetric geometry with a built-in two stub matching network, which leads to the enhanced bandwidth.

The dipole is built of standard semirigid coaxial cable. The internal matching line is open ended. The antenna is therefore open for DC signals.

Do not apply force to dipole arms, as they are liable to bend. The soldered connections near the feedpoint may be damaged. After excessive mechanical stress or overheating, check the impedance characteristics to ensure that the internal matching network is not affected.

After long term use with 40W radiated power, only a slight warming of the dipole near the feedpoint can be measured.



3.3 Measurement Sheets

3.3.1 Return Loss and Smith Chart

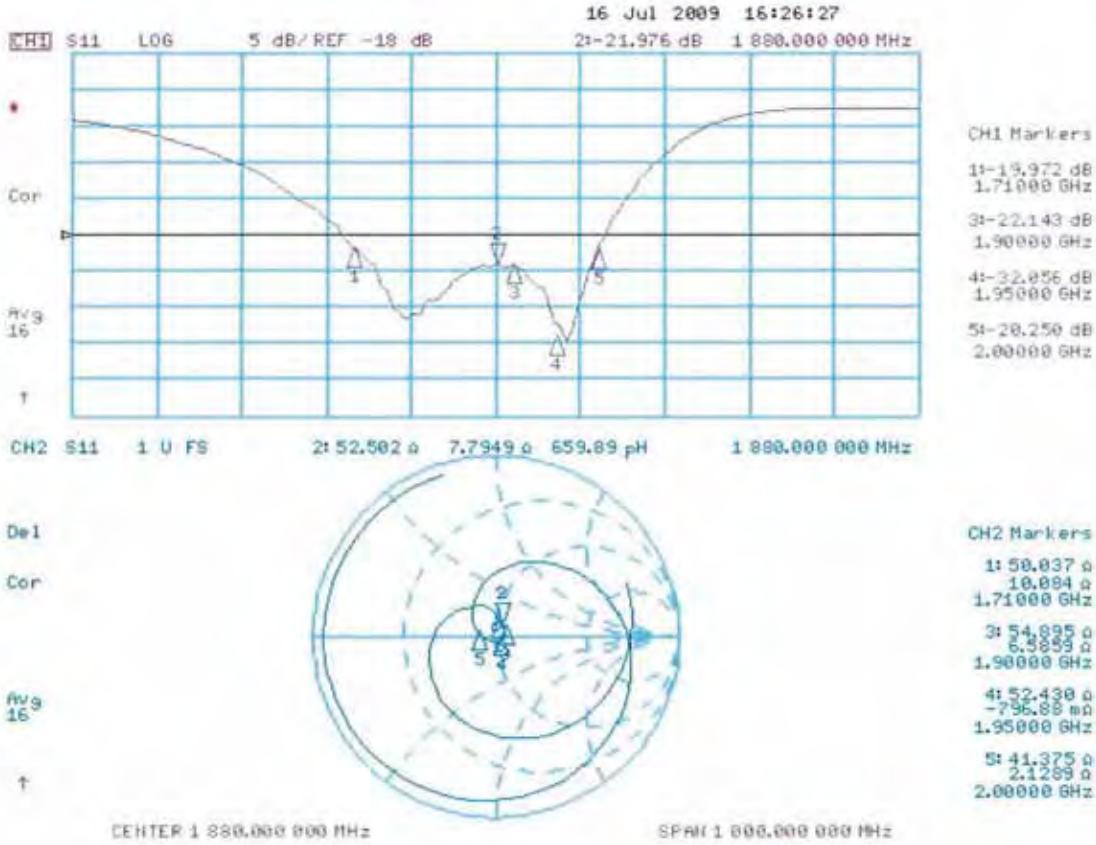

3.3.2 DASY4 H-Field Result

Date/Time: 15.07.2009 13:38:53

Test Laboratory: SPEAG Lab 2

DUT: HAC Dipole 1880 MHz; Type: CD1880V3; Serial: 1036

Communication System: CW; Frequency: 1880 MHz; Duty Cycle: 1:1

Medium parameters used: $\sigma = 0$ mho/m, $\epsilon_r = 1$; $\rho = 1$ kg/m³

Phantom section: RF Section

Measurement Standard: DASY4 (High Precision Assessment)

DASY4 Configuration:

- Probe: H3DV6 - SN6065; ; Calibrated: 22.12.2008
- Sensor-Surface: (Fix Surface)
- Electronics: DAE4 Sn781; Calibrated: 20.02.2009
- Phantom: HAC Test Arch with AMCC; Type: SD HAC P01 BA; Serial: 1070
- Measurement SW: DASY4, V4.7 Build 80; Postprocessing SW: SEMCAD, V1.8 Build 186

H Scan - measurement distance from the probe sensor center to CD1880 Dipole = 10mm/Hearing Aid Compatibility Test (41x181x1):

Measurement grid: dx=5mm, dy=5mm

Maximum value of peak Total field = 0.474 A/m

Probe Modulation Factor = 1.00

Device Reference Point: 0.000, 0.000, -6.30 mm

Reference Value = 0.503 A/m; Power Drift = -0.028 dB

Hearing Aid Near-Field Category: M2 (AWF 0 dB)

Peak H-field in A/m

Grid 1 0.417 M2	Grid 2 0.435 M2	Grid 3 0.410 M2
Grid 4 0.456 M2	Grid 5 0.474 M2	Grid 6 0.445 M2
Grid 7 0.417 M2	Grid 8 0.433 M2	Grid 9 0.401 M2

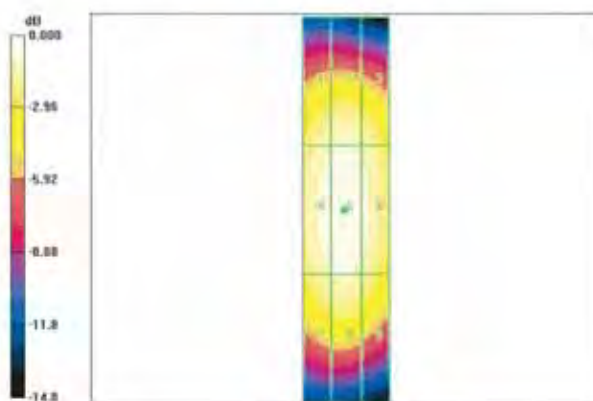

0 dB = 0.474A/m

3.3.3 DAS4 E-Field Result

Date/Time: 15.07.2009 11:02:06

Test Laboratory: SPEAG Lab 2

DUT: HAC Dipole 1880 MHz; Type: CD1880V3; Serial: 1036

Communication System: CW; Frequency: 1880 MHz; Duty Cycle: 1:1

Medium parameters used: $\sigma = 0$ mho/m, $\epsilon_r = 1$; $\rho = 1000$ kg/m³

Phantom section: RF Section

Measurement Standard: DAS4 (High Precision Assessment)

DASY4 Configuration:

- Probe: ER3DV6 - SN2336; ConvF(1, 1, 1); Calibrated: 22.12.2008
- Sensor-Surface: (Fix Surface)
- Electronics: DAE4 Sn781; Calibrated: 20.02.2009
- Phantom: HAC Test Arch with AMCC; Type: SD HAC P01 BA; Serial: 1070
- Measurement SW: DAS4, V4.7 Build 80; Postprocessing SW: SEMCAD, V1.8 Build 186

E Scan - measurement distance from the probe sensor center to CD1880 Dipole = 10mm/Hearing Aid Compatibility Test (41x181x1):

Measurement grid: dx=5mm, dy=5mm

Maximum value of peak Total field = 137.5 V/m

Probe Modulation Factor = 1.00

Device Reference Point: 0.000, 0.000, -6.30 mm

Reference Value = 154.7 V/m; Power Drift = -0.013 dB

Hearing Aid Near-Field Category: M2 (AWF 0 dB)

Peak E-field in V/m

Grid 1 133.3 M2	Grid 2 136.8 M2	Grid 3 131.9 M2
Grid 4 90.2 M3	Grid 5 91.9 M3	Grid 6 87.1 M3
Grid 7 132.6 M2	Grid 8 137.5 M2	Grid 9 131.3 M2

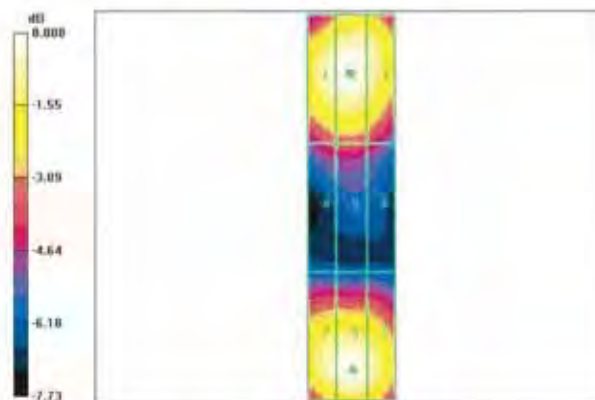

0 dB = 137.5V/m



**Calibration Laboratory of
Schmid & Partner
Engineering AG**
Zeughausstrasse 43, 8004 Zurich, Switzerland



S Schweizerischer Kalibrierdienst
C Service suisse d'étalonnage
S Servizio svizzero di taratura
S Swiss Calibration Service

Accredited by the Swiss Accreditation Service (SAS)
The Swiss Accreditation Service is one of the signatories to the EA
Multilateral Agreement for the recognition of calibration certificates

Accreditation No.: **SCS 108**

Client **ATL (Auden)**

Certificate No: **ER3-2256_Aug09**

CALIBRATION CERTIFICATE

Object **ER3DV6 - SN:2256**

Calibration procedure(s) **QA CAL-02.v5 and QA CAL-25.v2
Calibration procedure for E-field probes optimized for close near field
evaluations in air**

Calibration date: **August 21, 2009**

Condition of the calibrated item **In Tolerance**

This calibration certificate documents the traceability to national standards, which realize the physical units of measurements (SI).
The measurements and the uncertainties with confidence probability are given on the following pages and are part of the certificate.

All calibrations have been conducted in the closed laboratory facility: environment temperature (22 ± 3)°C and humidity < 70%.

Calibration Equipment used (M&TE critical for calibration)

Primary Standards	ID #	Cal Date (Certificate No.)	Scheduled Calibration
Power meter E4419B	GB41293874	1-Apr-09 (No. 217-01030)	Apr-10
Power sensor E4412A	MY41495277	1-Apr-09 (No. 217-01030)	Apr-10
Power sensor E4412A	MY41498087	1-Apr-09 (No. 217-01030)	Apr-10
Reference 3 dB Attenuator	SN: S5054 (3c)	31-Mar-09 (No. 217-01026)	Mar-10
Reference 20 dB Attenuator	SN: S5086 (20b)	31-Mar-09 (No. 217-01028)	Mar-10
Reference 30 dB Attenuator	SN: S5129 (30b)	31-Mar-09 (No. 217-01027)	Mar-10
Reference Probe ER3DV6	SN: 2328	1-Oct-08 (No. ER3-2328_Oct08)	Oct-09
DAE4	SN: 789	19-Dec-08 (No. DAE4-789_Dec08)	Dec-09

Secondary Standards	ID #	Check Date (in house)	Scheduled Check
RF generator HP 8648C	US3642U01700	4-Aug-99 (in house check Oct-07)	In house check: Oct-09
Network Analyzer HP 8753E	US37390585	18-Oct-01 (in house check Oct-08)	In house check: Oct-09

	Name	Function	Signature
Calibrated by:	Katja Pokovic	Technical Manager	
Approved by:	Niels Kuster	Quality Manager	

Issued: August 22, 2009

This calibration certificate shall not be reproduced except in full without written approval of the laboratory.

**Calibration Laboratory of
Schmid & Partner
Engineering AG**
Zeughausstrasse 43, 8004 Zurich, Switzerland



S Schweizerischer Kalibrierdienst
C Service suisse d'étalonnage
S Servizio svizzero di taratura
S Swiss Calibration Service

Accredited by the Swiss Accreditation Service (SAS)
The Swiss Accreditation Service is one of the signatories to the EA
Multilateral Agreement for the recognition of calibration certificates

Accreditation No.: **SCS 108**

Glossary:

NORM _{x,y,z}	sensitivity in free space
DCP	diode compression point
Polarization φ	φ rotation around probe axis
Polarization ϑ	ϑ rotation around an axis that is in the plane normal to probe axis (at measurement center), i.e., $\vartheta = 0$ is normal to probe axis
Connector Angle	information used in DASY system to align probe sensor X to the robot coordinate system

Calibration is Performed According to the Following Standards:

- a) IEEE Std 1309-2005, " IEEE Standard for calibration of electromagnetic field sensors and probes, excluding antennas, from 9 kHz to 40 GHz", December 2005.

Methods Applied and Interpretation of Parameters:

- *NORM_{x,y,z}*: Assessed for E-field polarization $\vartheta = 0$ for XY sensors and $\vartheta = 90$ for Z sensor ($f \leq 900$ MHz in TEM-cell; $f > 1800$ MHz: R22 waveguide).
- *NORM(f)_{x,y,z}* = *NORM_{x,y,z}* * *frequency_response* (see Frequency Response Chart).
- *DCP_{x,y,z}*: DCP are numerical linearization parameters assessed based on the data of power sweep (no uncertainty required). DCP does not depend on frequency.
- *Spherical isotropy (3D deviation from isotropy)*: in a locally homogeneous field realized using an open waveguide setup.
- *Sensor Offset*: The sensor offset corresponds to the offset of virtual measurement center from the probe tip (on probe axis). No tolerance required.
- *Connector Angle*: The angle is assessed using the information gained by determining the *NORM_x* (no uncertainty required).



ER3DV6 SN:2256

August 21, 2009

Probe ER3DV6

SN:2256

Manufactured:	March 15, 2001
Last calibrated:	August 22, 2008
Recalibrated:	August 21, 2009

Calibrated for DASY Systems

(Note: non-compatible with DASY2 system!)



ER3DV6 SN:2256

August 21, 2009

DASY - Parameters of Probe: ER3DV6 SN:2256

Sensitivity in Free Space [$\mu\text{V}/(\text{V}/\text{m})^2$]		Diode Compression ^A	
NormX	2.22 ± 10.1 % (k=2)	DCP X	94 mV
NormY	1.60 ± 10.1 % (k=2)	DCP Y	96 mV
NormZ	1.68 ± 10.1 % (k=2)	DCP Z	99 mV

Frequency Correction

X	0.0
Y	0.0
Z	0.0

Sensor Offset (Probe Tip to Sensor Center)

X	2.5 mm
Y	2.5 mm
Z	2.5 mm

Connector Angle -247 °

The reported uncertainty of measurement is stated as the standard uncertainty of measurement multiplied by the coverage factor k=2, which for a normal distribution corresponds to a coverage probability of approximately 95%.

^A numerical linearization parameter; uncertainty not required

Frequency Response of E-Field

(TEM-Cell:ifi110 EXX, Waveguide R22)

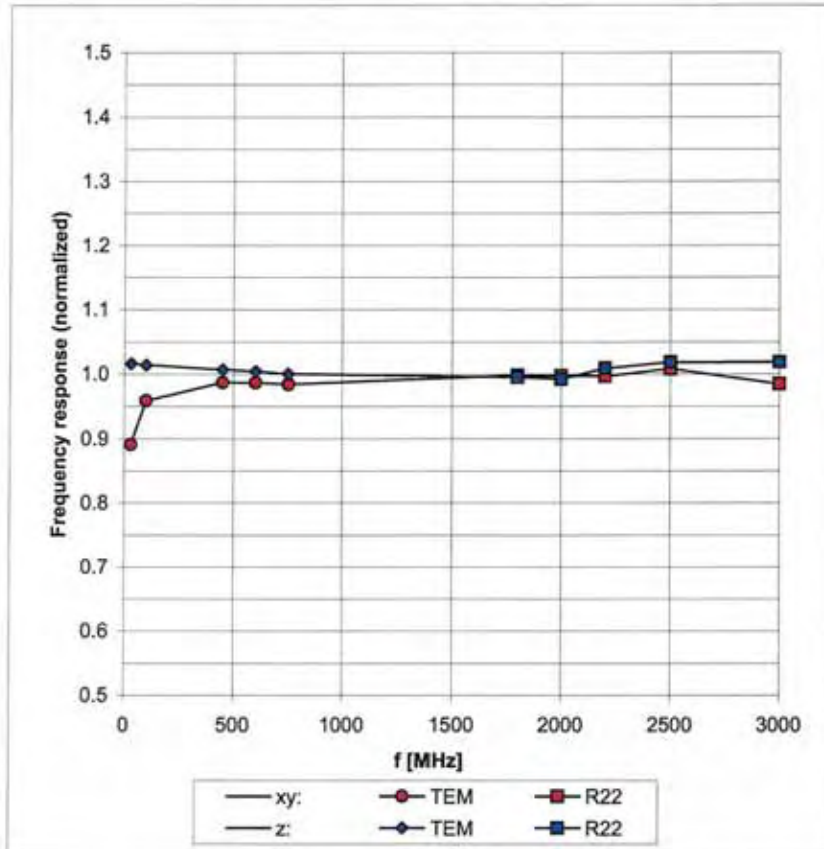

Uncertainty of Frequency Response of E-field: $\pm 6.3\%$ (k=2)

Receiving Pattern (ϕ), $\vartheta = 0^\circ$

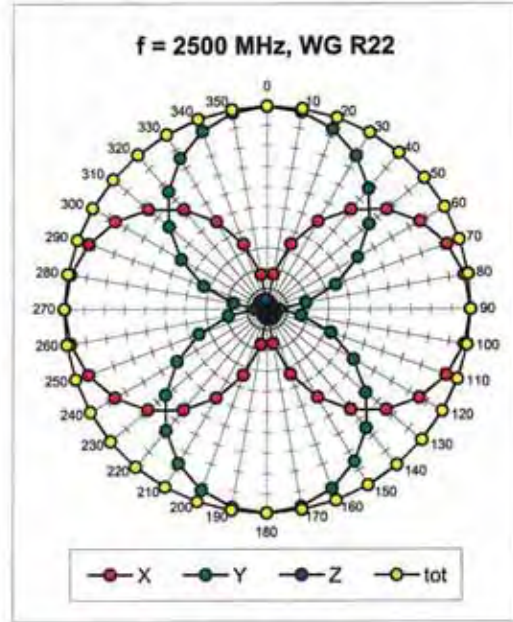
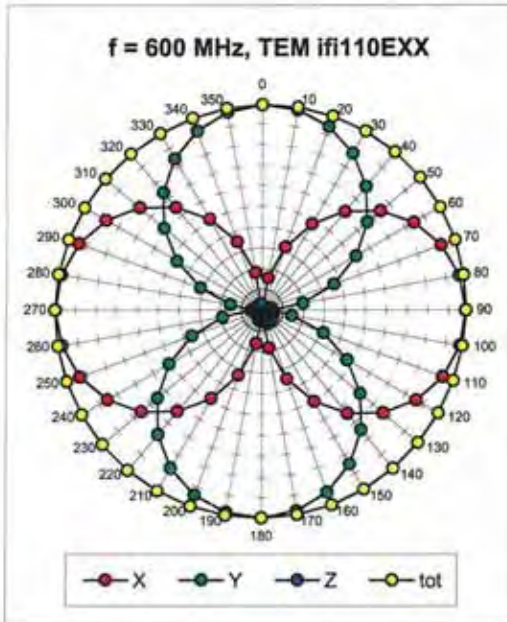

Receiving Pattern (ϕ), $\vartheta = 90^\circ$

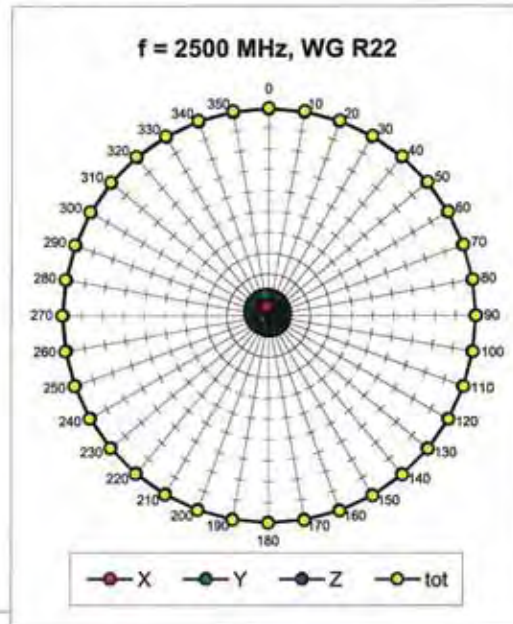
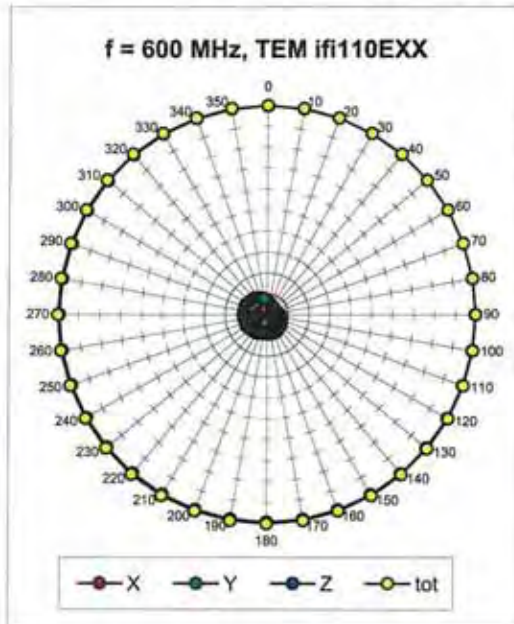

Receiving Pattern (ϕ), $\vartheta = 0^\circ$

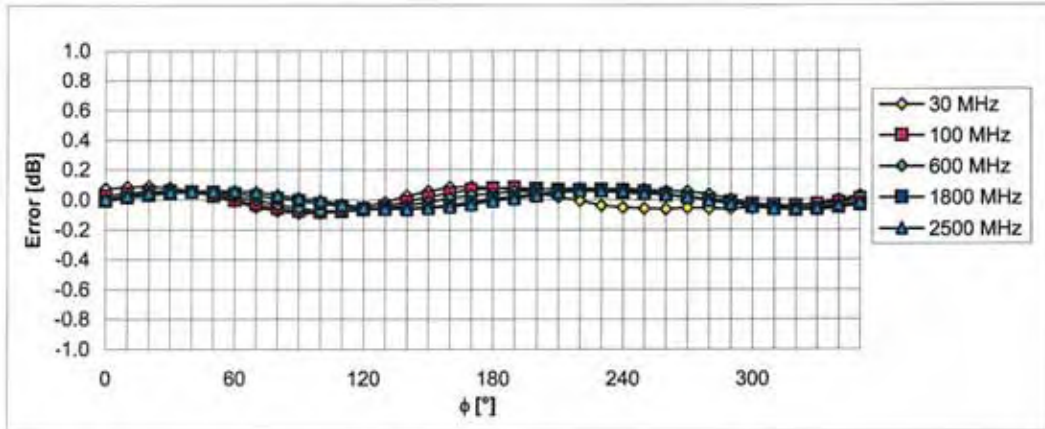

Uncertainty of Axial Isotropy Assessment: $\pm 0.5\%$ (k=2)

Receiving Pattern (ϕ), $\vartheta = 90^\circ$

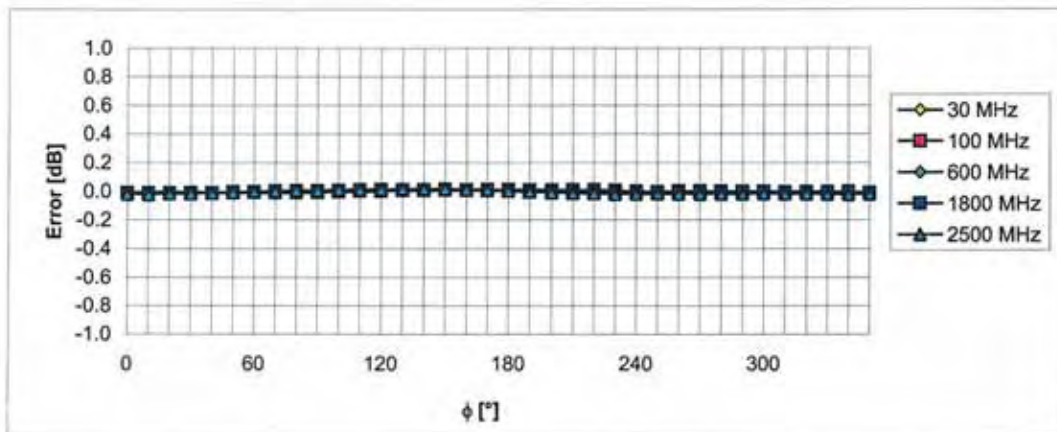

Uncertainty of Axial Isotropy Assessment: $\pm 0.5\%$ (k=2)

Dynamic Range f(E-field) (Waveguide R22, f = 1800 MHz)

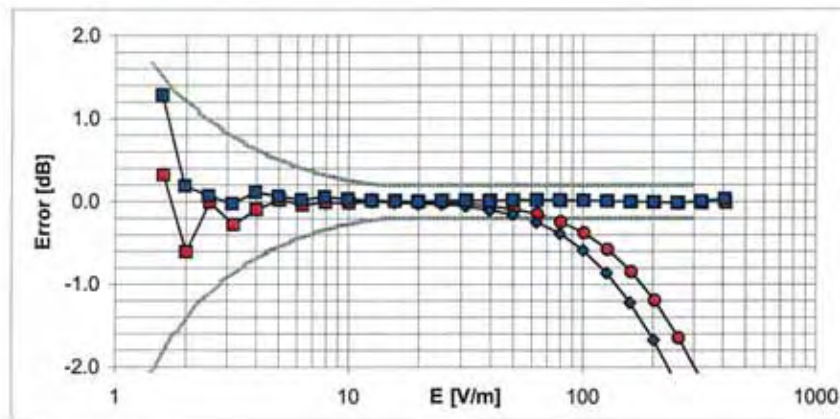
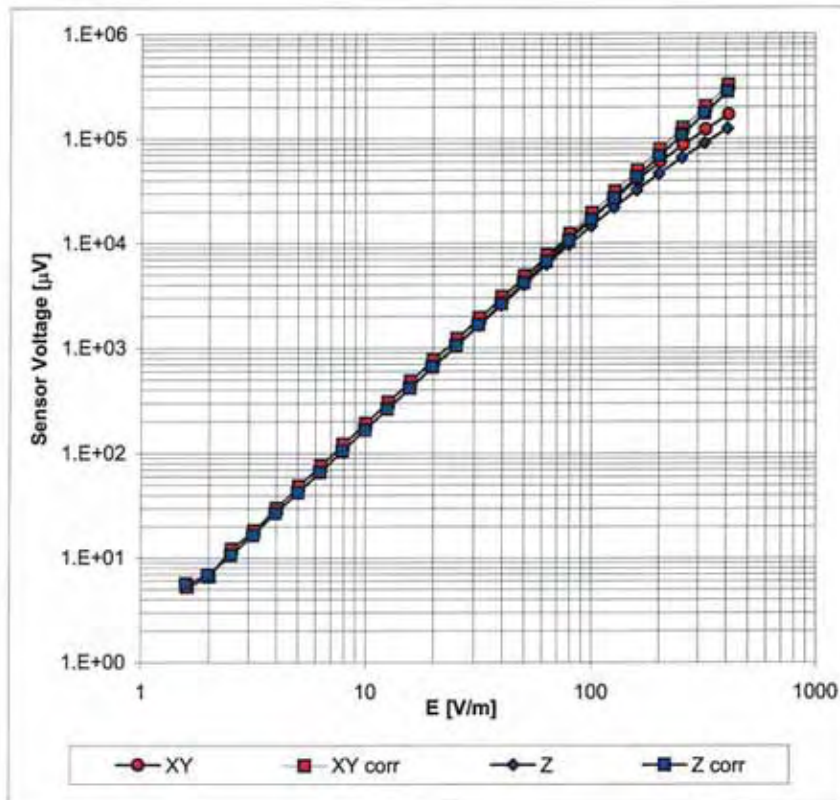

Uncertainty of Linearity Assessment: $\pm 0.6\%$ (k=2)

Deviation from Isotropy in Air Error (ϕ, θ) , $f = 900$ MHz

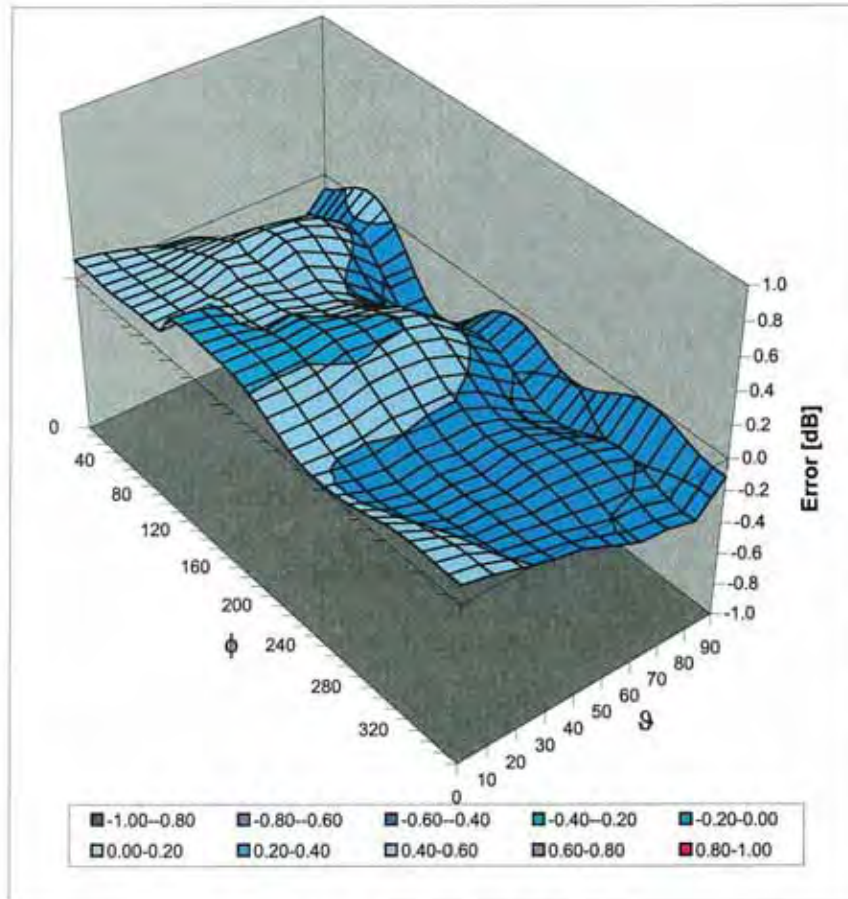

Uncertainty of Spherical Isotropy Assessment: $\pm 2.6\%$ (k=2)



**Calibration Laboratory of
Schmid & Partner
Engineering AG**
Zeughausstrasse 43, 8004 Zurich, Switzerland



S Schweizerischer Kalibrierdienst
C Service suisse d'étalonnage
S Servizio svizzero di taratura
S Swiss Calibration Service

Accredited by the Swiss Accreditation Service (SAS)
The Swiss Accreditation Service is one of the signatories to the EA
Multilateral Agreement for the recognition of calibration certificates

Accreditation No.: **SCS 108**

Client **ATL (Auden)**

Certificate No: **H3-6076_Aug09**

CALIBRATION CERTIFICATE

Object **H3DV6 - SN:6076**

Calibration procedure(s) **QA CAL-03.v5 and QA CAL-25.v2
Calibration procedure for H-field probes optimized for close near field
evaluations in air**

Calibration date: **August 19, 2009**

Condition of the calibrated item **In Tolerance**

This calibration certificate documents the traceability to national standards, which realize the physical units of measurements (SI).
The measurements and the uncertainties with confidence probability are given on the following pages and are part of the certificate.

All calibrations have been conducted in the closed laboratory facility: environment temperature (22 ± 3)°C and humidity < 70%.

Calibration Equipment used (M&TE critical for calibration)

Primary Standards	ID #	Cal Date (Certificate No.)	Scheduled Calibration
Power meter E4419B	GB41293874	1-Apr-09 (No. 217-01030)	Apr-10
Power sensor E4412A	MY41495277	1-Apr-09 (No. 217-01030)	Apr-10
Power sensor E4412A	MY41498087	1-Apr-09 (No. 217-01030)	Apr-10
Reference 3 dB Attenuator	SN: S5054 (3c)	31-Mar-09 (No. 217-01026)	Mar-10
Reference 20 dB Attenuator	SN: S5086 (20b)	31-Mar-09 (No. 217-01028)	Mar-10
Reference 30 dB Attenuator	SN: S5129 (30b)	31-Mar-09 (No. 217-01027)	Mar-10
Reference Probe H3DV6	SN: 6182	1-Oct-08 (No. H3-6182_Oct08)	Oct-09
DAE4	SN: 789	19-Dec-08 (No. DAE4-789_Dec08)	Dec-09

Secondary Standards	ID #	Check Date (in house)	Scheduled Check
RF generator HP 8648C	US3642U01700	4-Aug-99 (in house check Oct-07)	In house check: Oct-09
Network Analyzer HP 8753E	US37390585	18-Oct-01 (in house check Oct-08)	In house check: Oct-09

	Name	Function	Signature
Calibrated by:	Katja Pokovic	Technical Manager	
Approved by:	Niels Kuster	Quality Manager	

Issued: August 20, 2009

This calibration certificate shall not be reproduced except in full without written approval of the laboratory.

**Calibration Laboratory of
Schmid & Partner
Engineering AG**
Zeughausstrasse 43, 8004 Zurich, Switzerland



S Schweizerischer Kalibrierdienst
C Service suisse d'étalonnage
S Servizio svizzero di taratura
S Swiss Calibration Service

Accredited by the Swiss Accreditation Service (SAS)
The Swiss Accreditation Service is one of the signatories to the EA
Multilateral Agreement for the recognition of calibration certificates

Accreditation No.: **SCS 108**

Glossary:

NORM _{x,y,z}	sensitivity in free space
DCP	diode compression point
Polarization φ	φ rotation around probe axis
Polarization ϑ	ϑ rotation around an axis that is in the plane normal to probe axis (at measurement center), i.e., $\vartheta = 0$ is normal to probe axis
Connector Angle	information used in DASY system to align probe sensor X to the robot coordinate system

Calibration is Performed According to the Following Standards:

- a) IEEE Std 1309-2005, " IEEE Standard for calibration of electromagnetic field sensors and probes, excluding antennas, from 9 kHz to 40 GHz", December 2005.

Methods Applied and Interpretation of Parameters:

- X, Y, Z_{a0a1a2} : Assessed for E-field polarization $\vartheta = 90$ for XY sensors and $\vartheta = 0$ for Z sensor ($f \leq 900$ MHz in TEM-cell; $f > 1800$ MHz: R22 waveguide).
- $X, Y, Z(f)_{a0a1a2} = X, Y, Z_{a0a1a2} * frequency_response$ (see Frequency Response Chart).
- $DCP_{x,y,z}$: DCP are numerical linearization parameters assessed based on the data of power sweep (no uncertainty required). DCP does not depend on frequency.
- *Spherical isotropy (3D deviation from isotropy)*: in a locally homogeneous field realized using an open waveguide setup.
- *Sensor Offset*: The sensor offset corresponds to the offset of virtual measurement center from the probe tip (on probe axis). No tolerance required.
- *Connector Angle*: The angle is assessed using the information gained by determining the X_{a0a1a2} (no uncertainty required).



H3DV6 SN:6076

August 19, 2009

Probe H3DV6

SN:6076

Manufactured:	October 2, 2000
Last calibrated:	August 22, 2008
Recalibrated:	August 19, 2009

Calibrated for DASY Systems

(Note: non-compatible with DASY2 system!)



H3DV6 SN:6076

August 19, 2009

DASY - Parameters of Probe: H3DV6 SN:6076

Sensitivity in Free Space [A/m / $\sqrt{(\mu\text{V})}$]

	a0	a1	a2
X	2.949E-03	-2.301E-4	7.283E-5 ± 5.1 % (k=2)
Y	2.775E-03	-3.061E-4	3.202E-5 ± 5.1 % (k=2)
Z	3.090E-03	-7.826E-5	-1.605E-4 ± 5.1 % (k=2)

Diode Compression¹

DCP X	92 mV
DCP Y	83 mV
DCP Z	78 mV

Sensor Offset (Probe Tip to Sensor Center)

X	3.0 mm
Y	3.0 mm
Z	3.0 mm

Connector Angle -146 °

The reported uncertainty of measurement is stated as the standard uncertainty of measurement multiplied by the coverage factor k=2, which for a normal distribution corresponds to a coverage probability of approximately 95%.

¹ numerical linearization parameter: uncertainty not required

Frequency Response of H-Field

(TEM-Cell:ifi110 EXX, Waveguide R22)

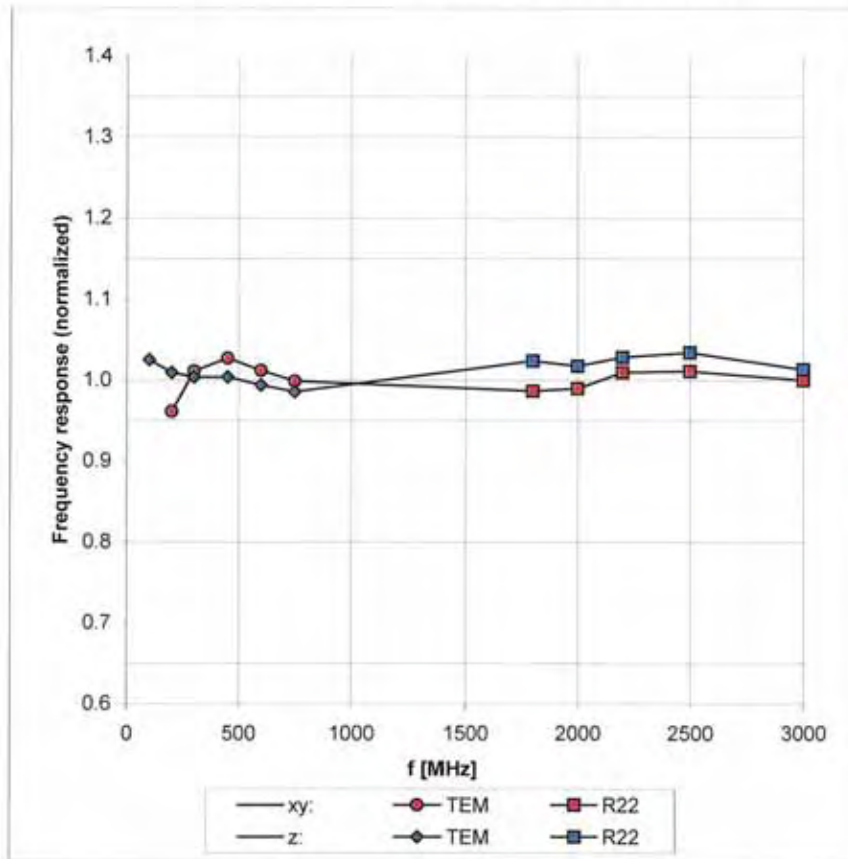

Uncertainty of Frequency Response of E-field: $\pm 6.3\%$ (k=2)

Receiving Pattern (ϕ), $\vartheta = 90^\circ$

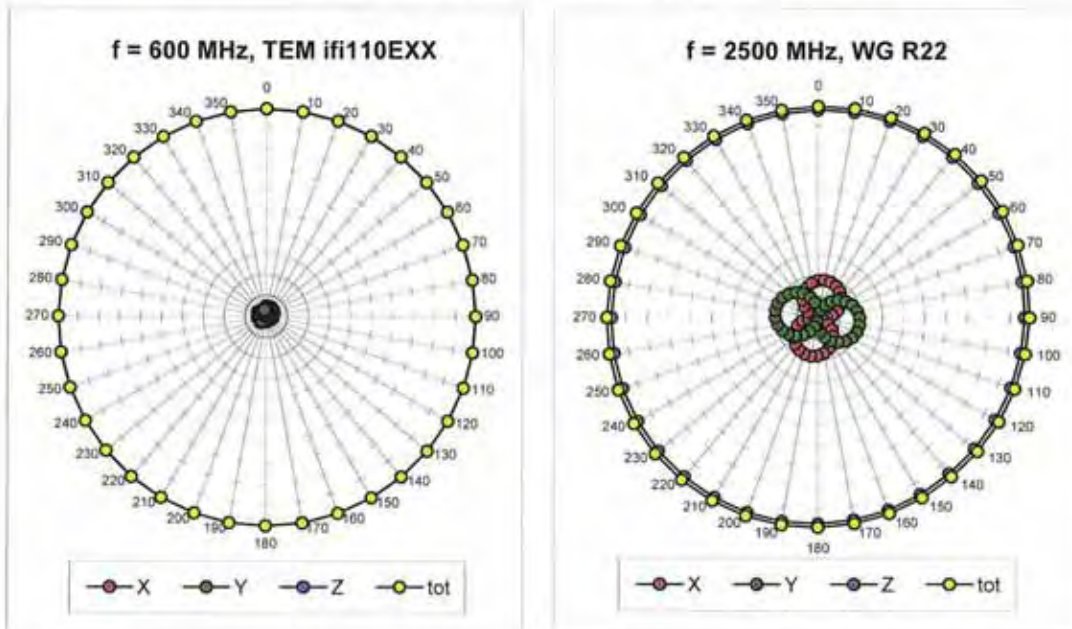

Receiving Pattern (ϕ), $\vartheta = 0^\circ$

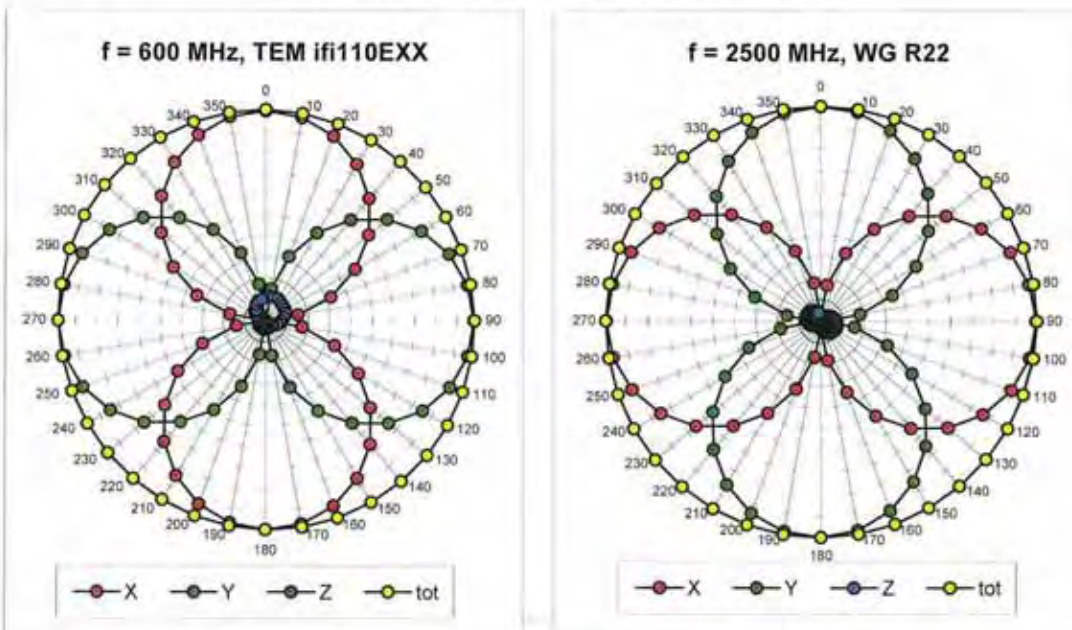

Receiving Pattern (ϕ), $\vartheta = 90^\circ$

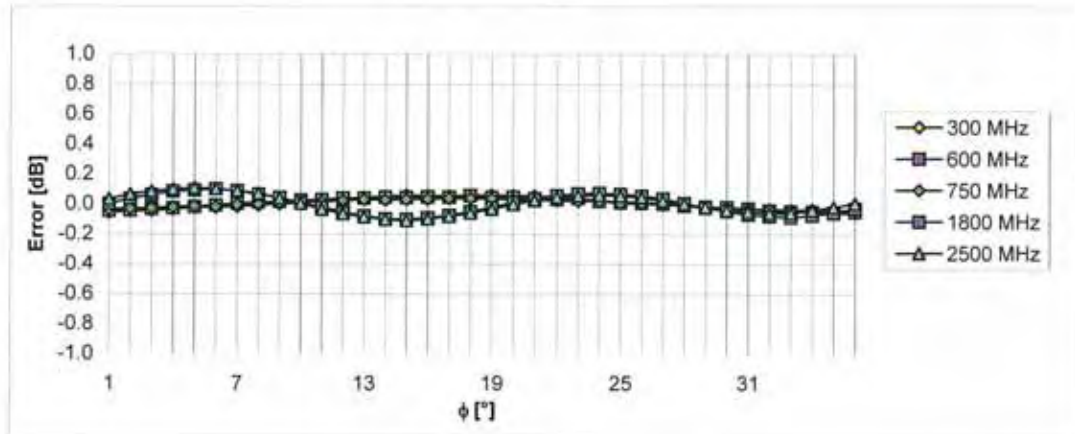

Uncertainty of Axial Isotropy Assessment: $\pm 0.5\%$ (k=2)

Receiving Pattern (ϕ), $\vartheta = 0^\circ$

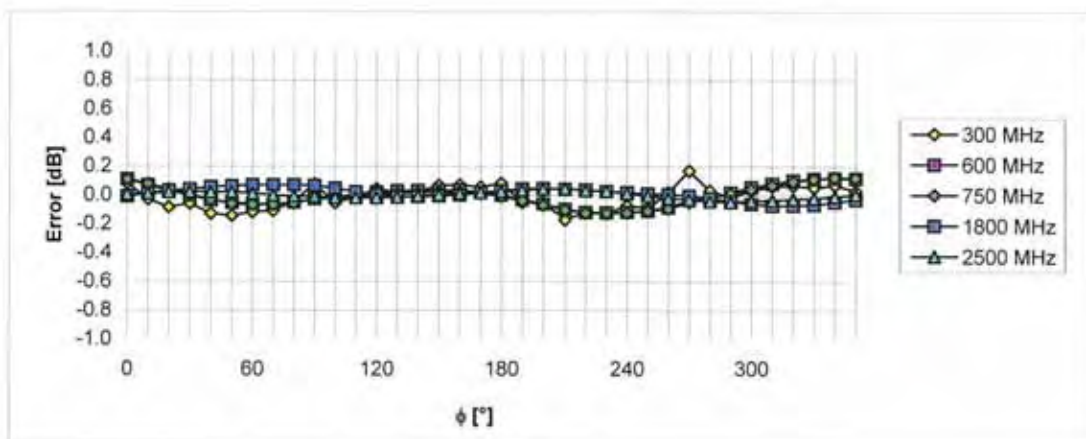

Uncertainty of Axial Isotropy Assessment: $\pm 0.5\%$ (k=2)

Dynamic Range f(H-field) (Waveguide R22, f = 1800 MHz)

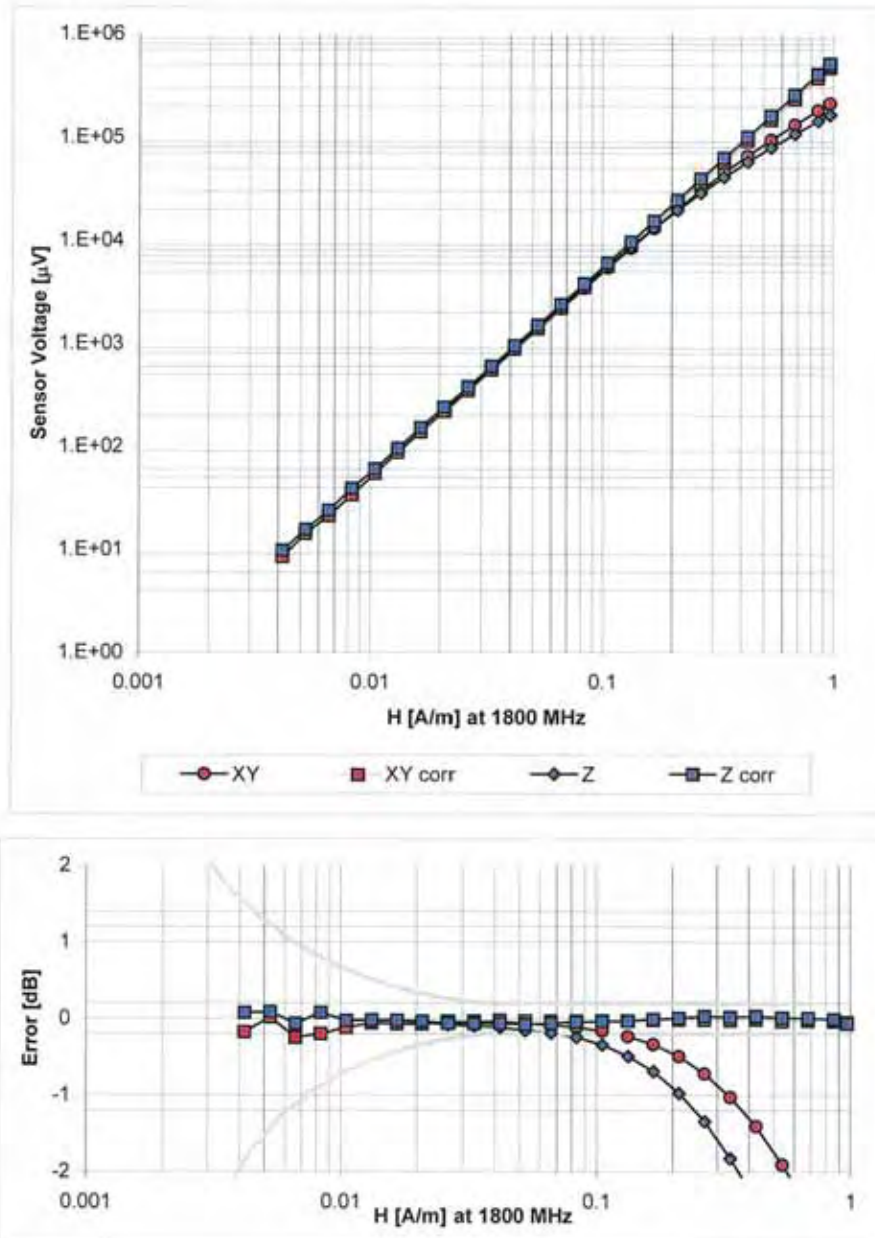

Uncertainty of Linearity Assessment: $\pm 0.6\%$ (k=2)

Deviation from Isotropy in Air Error (ϕ, θ), $f = 900$ MHz

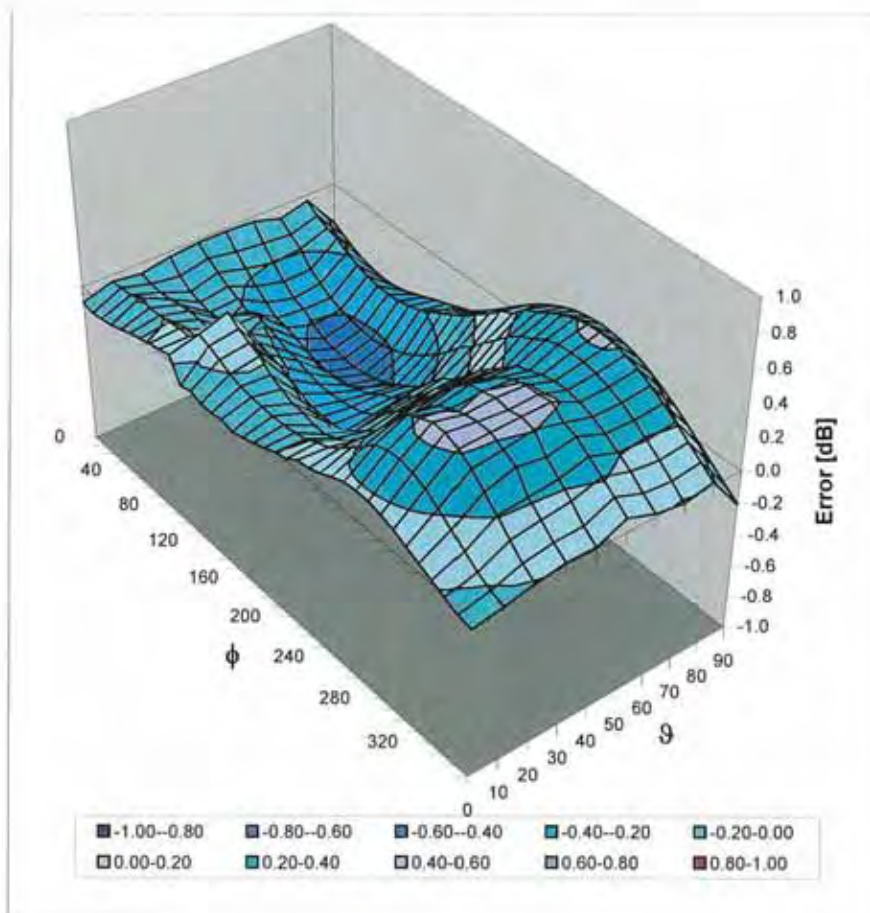

Uncertainty of Spherical Isotropy Assessment: $\pm 2.6\%$ ($k=2$)



**Calibration Laboratory of
Schmid & Partner
Engineering AG**
Zeughausstrasse 43, 8004 Zurich, Switzerland



S Schweizerischer Kalibrierdienst
C Service suisse d'étalonnage
S Servizio svizzero di taratura
S Swiss Calibration Service

Accredited by the Swiss Accreditation Service (SAS)
The Swiss Accreditation Service is one of the signatories to the EA
Multilateral Agreement for the recognition of calibration certificates

Accreditation No.: **SCS 108**

Client **ATL (Auden)**

Certificate No: **DAE3-393_Aug09**

CALIBRATION CERTIFICATE

Object **DAE3 - SD 000 D03 AA - SN: 393**

Calibration procedure(s) **QA CAL-06.v20
Calibration procedure for the data acquisition electronics (DAE)**

Calibration date: **August 24, 2009**

Condition of the calibrated item **In Tolerance**

This calibration certificate documents the traceability to national standards, which realize the physical units of measurements (SI).
The measurements and the uncertainties with confidence probability are given on the following pages and are part of the certificate.

All calibrations have been conducted in the closed laboratory facility: environment temperature (22 ± 3)°C and humidity < 70%.

Calibration Equipment used (M&TE critical for calibration)

Primary Standards	ID #	Cal Date (Certificate No.)	Scheduled Calibration
Keithley Multimeter Type 2001	SN: 0810278	30-Sep-08 (No: 7670)	Sep-09
Secondary Standards	ID #	Check Date (in house)	Scheduled Check
Calibrator Box V1.1	SE UMS 006 AB 1004	05-Jun-09 (in house check)	In house check: Jun-10

Calibrated by:

Name	Function	Signature
Andrea Guntli	Technician	

Approved by:

Name	Function	Signature
Fin Bomholt	R&D Director	

Issued: August 26, 2009

This calibration certificate shall not be reproduced except in full without written approval of the laboratory.



Glossary

DAE	data acquisition electronics
Connector angle	information used in DASY system to align probe sensor X to the robot coordinate system.

Methods Applied and Interpretation of Parameters

- *DC Voltage Measurement*: Calibration Factor assessed for use in DASY system by comparison with a calibrated instrument traceable to national standards. The figure given corresponds to the full scale range of the voltmeter in the respective range.
- *Connector angle*: The angle of the connector is assessed measuring the angle mechanically by a tool inserted. Uncertainty is not required.
- The following parameters as documented in the Appendix contain technical information as a result from the performance test and require no uncertainty.
 - *DC Voltage Measurement Linearity*: Verification of the Linearity at +10% and -10% of the nominal calibration voltage. Influence of offset voltage is included in this measurement.
 - *Common mode sensitivity*: Influence of a positive or negative common mode voltage on the differential measurement.
 - *Channel separation*: Influence of a voltage on the neighbor channels not subject to an input voltage.
 - *AD Converter Values with inputs shorted*: Values on the internal AD converter corresponding to zero input voltage
 - *Input Offset Measurement*: Output voltage and statistical results over a large number of zero voltage measurements.
 - *Input Offset Current*: Typical value for information; Maximum channel input offset current, not considering the input resistance.
 - *Input resistance*: DAE input resistance at the connector, during internal auto-zeroing and during measurement.
 - *Low Battery Alarm Voltage*: Typical value for information. Below this voltage, a battery alarm signal is generated.
 - *Power consumption*: Typical value for information. Supply currents in various operating modes.



DC Voltage Measurement

A/D - Converter Resolution nominal

High Range: 1LSB = 6.1 μ V, full range = -100...+300 mV

Low Range: 1LSB = 61nV, full range = -1.....+3mV

DASY measurement parameters: Auto Zero Time: 3 sec; Measuring time: 3 sec

Calibration Factors	X	Y	Z
High Range	403.906 \pm 0.1% (k=2)	404.156 \pm 0.1% (k=2)	404.066 \pm 0.1% (k=2)
Low Range	3.99061 \pm 0.7% (k=2)	3.96370 \pm 0.7% (k=2)	3.96389 \pm 0.7% (k=2)

Connector Angle

Connector Angle to be used in DASY system	303.5 $^{\circ}$ \pm 1 $^{\circ}$
---	-------------------------------------



Appendix

1. DC Voltage Linearity

High Range	Reading (μV)	Difference (μV)	Error (%)
Channel X + Input	200006.9	-2.85	-0.00
Channel X + Input	20003.94	4.04	0.02
Channel X - Input	-19994.54	5.36	-0.03
Channel Y + Input	200007.3	-1.44	-0.00
Channel Y + Input	19999.38	-0.52	-0.00
Channel Y - Input	-19996.11	3.79	-0.02
Channel Z + Input	200005.3	-2.72	-0.00
Channel Z + Input	19995.60	-4.30	-0.02
Channel Z - Input	-20007.61	0.04	0.04

Low Range	Reading (μV)	Difference (μV)	Error (%)
Channel X + Input	1999.8	-0.09	-0.00
Channel X + Input	199.02	-0.78	-0.39
Channel X - Input	-201.46	-1.36	0.68
Channel Y + Input	2000.1	-0.03	-0.00
Channel Y + Input	198.18	-1.72	-0.86
Channel Y - Input	-202.53	-2.43	1.21
Channel Z + Input	1999.9	-0.12	-0.01
Channel Z + Input	197.86	-2.14	-1.07
Channel Z - Input	-202.57	-2.37	1.18

2. Common mode sensitivity

DASY measurement parameters: Auto Zero Time: 3 sec; Measuring time: 3 sec

	Common mode Input Voltage (mV)	High Range Average Reading (μV)	Low Range Average Reading (μV)
Channel X	200	13.46	11.20
	-200	-9.35	-11.28
Channel Y	200	9.96	9.34
	-200	-10.98	-11.10
Channel Z	200	4.16	3.81
	-200	-5.83	-5.62

3. Channel separation

DASY measurement parameters: Auto Zero Time: 3 sec; Measuring time: 3 sec

	Input Voltage (mV)	Channel X (μV)	Channel Y (μV)	Channel Z (μV)
Channel X	200	-	3.58	0.25
Channel Y	200	2.49	-	5.70
Channel Z	200	3.07	-0.41	-



4. AD-Converter Values with inputs shorted

DASY measurement parameters: Auto Zero Time: 3 sec; Measuring time: 3 sec

	High Range (LSB)	Low Range (LSB)
Channel X	16158	17049
Channel Y	16025	16973
Channel Z	16453	17372

5. Input Offset Measurement

DASY measurement parameters: Auto Zero Time: 3 sec; Measuring time: 3 sec

Input 10M Ω

	Average (μ V)	min. Offset (μ V)	max. Offset (μ V)	Std. Deviation (μ V)
Channel X	0.30	-1.39	0.81	0.27
Channel Y	-0.46	-1.50	0.96	0.31
Channel Z	-0.14	-1.43	1.13	0.33

6. Input Offset Current

Nominal Input circuitry offset current on all channels: <25fA

7. Input Resistance

	Zeroing (MOhm)	Measuring (MOhm)
Channel X	0.2000	200.6
Channel Y	0.2000	200.4
Channel Z	0.2001	200.2

8. Low Battery Alarm Voltage (verified during pre test)

Typical values	Alarm Level (VDC)
Supply (+ Vcc)	+7.9
Supply (- Vcc)	-7.6

9. Power Consumption (verified during pre test)

Typical values	Switched off (mA)	Stand by (mA)	Transmitting (mA)
Supply (+ Vcc)	+0.0	+6	+14
Supply (- Vcc)	-0.01	-8	-9



Appendix E - Uncertainty

HAC Uncertainty Budget According to ANSI C63.19 [1], [2]							
Error Description	Uncertainty value	Prob. Dist.	Div.	(c_i) E	(c_i) H	Std. Unc. E	Std. Unc. H
Measurement System							
Probe Calibration	±5.1 %	N	1	1	1	±5.1 %	±5.1 %
Axial Isotropy	±4.7 %	R	$\sqrt{3}$	1	1	±2.7 %	±2.7 %
Sensor Displacement	±16.5 %	R	$\sqrt{3}$	1	0.145	±9.5 %	±1.4 %
Test Arch	±7.2 %	R	$\sqrt{3}$	1	0	±4.1 %	±0.0 %
Linearity	±4.7 %	R	$\sqrt{3}$	1	1	±2.7 %	±2.7 %
Scaling to Peak Envelope Power	±0.0 %	R	$\sqrt{3}$	1	1	±0.0 %	±0.0 %
System Detection Limit	±1.0 %	R	$\sqrt{3}$	1	1	±0.6 %	±0.6 %
Readout Electronics	±0.3 %	N	1	1	1	±0.3 %	±0.3 %
Response Time	±0.8 %	R	$\sqrt{3}$	1	1	±0.5 %	±0.5 %
Integration Time	±2.6 %	R	$\sqrt{3}$	1	1	±1.5 %	±1.5 %
RF Ambient Conditions	±3.0 %	R	$\sqrt{3}$	1	1	±1.7 %	±1.7 %
RF Reflections	±12.0 %	R	$\sqrt{3}$	1	1	±6.9 %	±6.9 %
Probe Positioner	±1.2 %	R	$\sqrt{3}$	1	0.67	±0.7 %	±0.5 %
Probe Positioning	±4.7 %	R	$\sqrt{3}$	1	0.67	±2.7 %	±1.8 %
Extrap. and Interpolation	±1.0 %	R	$\sqrt{3}$	1	1	±0.6 %	±0.6 %
Test Sample Related							
Device Positioning Vertical	±4.7 %	R	$\sqrt{3}$	1	0.67	±2.7 %	±1.8 %
Device Positioning Lateral	±1.0 %	R	$\sqrt{3}$	1	1	±0.6 %	±0.6 %
Device Holder and Phantom	±2.4 %	R	$\sqrt{3}$	1	1	±1.4 %	±1.4 %
Power Drift	±5.0 %	R	$\sqrt{3}$	1	1	±2.9 %	±2.9 %
Phantom and Setup Related							
Phantom Thickness	±2.4 %	R	$\sqrt{3}$	1	0.67	±1.4 %	±0.9 %
Combined Std. Uncertainty						±15.2 %	±10.8 %
Expanded Std. Uncertainty on Power						±30.4 %	±21.6 %
Expanded Std. Uncertainty on Field						±15.2 %	±10.8 %

Table 24.2: Worst-Case uncertainty budget for HAC free field assessment according to ANSI C63.19 [1], [2]. The budget is valid for the frequency range 800 MHz - 3 GHz and represents a worst-case analysis. For specific tests and configurations, the uncertainty could be considerably smaller. Some of the parameters are dependent on the user situations and need adjustment according to the actual laboratory conditions.