

FCC 47 CFR PART 15 SUBPART C

Product Type : Smartphone
Applicant : HTC Corporation
Address : No. 23, Xinghua Rd., Taoyuan City, Taoyuan County 330,
Taiwan
Trade Name : HTC
Model Number : PC10110
Test Specification : FCC 47 CFR PART 15 SUBPART C: Oct., 2009
Canada RSS-210 ISSUE 7: Jun., 2007
Canada RSS-Gen ISSUE 2: Jun., 2007
ANSI C63.4-2003
Issue Date : Sep. 13, 2010

Issue by

A Test Lab Techno Corp.
No. 140-1, Changan Street, Bade City,
Taoyuan County 334, Taiwan R.O.C.
Tel : +86-3-2710188 / Fax : +86-3-2710190



Taiwan Accreditation Foundation accreditation number: 1330

Note: This report shall not be reproduced except in full, without the written approval of A Test Lab Techno Corp. This document may be altered or revised by A Test Lab Techno Corp. personnel only, and shall be noted in the revision section of the document. The client should not use it to claim product endorsement by TAF, or any government agencies. The test results in the report only apply to the tested sample.

Revision History

Rev.	Issue Date	Revisions	Revised By
00	Aug. 30, 2010	Initial Issue	
01	Sep. 13. 2010	Re-test RF conducted output power	Joyce Liao

Verification

Issued Date: 2010/09/13

Product Type : Smartphone
Applicant : HTC Corporation
Address : No. 23, Xinghua Rd., Taoyuan City, Taoyuan County 330,
Taiwan
Trade Name : HTC
Model Number : PC10110
FCC ID : NM8PC10110
EUT Rated Voltage : DC 5.0V, 1.0A
Test Voltage : 120 Vac / 60 Hz
Applicable Standard : FCC 47 CFR PART 15 SUBPART C: Oct., 2009
Canada RSS-210 ISSUE 7: Jun., 2007
Canada RSS-Gen ISSUE 2: Jun., 2007
ANSI C63.4-2003

Test Result : Complied

Performing Lab. : A Test Lab Techno Corp.

No. 140-1, Changan Street, Bade City,
Taoyuan County 334, Taiwan R.O.C.

Tel : +86-3-2710188 / Fax : +86-3-2710190

Taiwan Accreditation Foundation accreditation number:
1330



<http://www.atl-lab.com.tw/e-index.htm>

The above equipment was tested by A Test Lab Techno Corp. The test data, data evaluation, test procedures, and equipment configurations shown in this report were made in accordance with the procedures given in ANSI C63.4: 2003 and the energy emitted by the sample tested as described in this report is in compliance with the requirements of FCC Rules Part 15.207, 15.209, 15.247 .

The test results of this report relate only to the tested sample identified in this report.

Approved By : 
(Manager) (Miller Lee)

Reviewed By : 
(Testing Engineer) (Gary Wu)

TABLE OF CONTENTS

1	General Information	6
2	EUT Description	7
3	Test Methodology.....	8
	3.1. Mode of Operation	8
	3.2. EUT Exercise Software.....	8
	3.3. Configuration of Test System Details	9
	3.4. Test Site Environment.....	9
4	Conducted Emission Measurement.....	10
	4.1. Limit.....	10
	4.2. Test Instruments	10
	4.3. Test Setup.....	10
	4.4. Test Procedure	11
	4.5. Test Result.....	12
5	Radiated Interference Measurement.....	16
	5.1. Limit.....	16
	5.2. Test Instruments	16
	5.3. Setup	17
	5.4. Test Procedure	17
	5.5. Test Result.....	19
6	Maximum Conducted Output Power Measurement.....	27
	6.1. Limit.....	27
	6.2. Test Setup.....	27
	6.3. Test Instruments	27
	6.4. Test Procedure	27
	6.5. Test Result.....	28
7	6dB RF Bandwidth Measurement	29
	7.1. Limit.....	29
	7.2. Test Setup.....	29
	7.3. Test Instruments	29
	7.4. Test Procedure	29
	7.5. Test Result.....	30
	7.6. Test Graphs	31

8	Maximum Power Density Measurement	34
8.1.	Limit.....	34
8.2.	Test Setup.....	34
8.3.	Test Instruments	34
8.4.	Test Procedure	34
8.5.	Test Result.....	35
8.6.	Test Graphs	36
9	Out of Band Conducted Emissions Measurement	39
9.1.	Limit.....	39
9.2.	Test Setup.....	39
9.3.	Test Instruments	39
9.4.	Test Procedure	39
9.5.	Test Graphs	40
10	Band Edges Measurement.....	43
10.1.	Limit.....	43
10.2.	Test Setup.....	43
10.3.	Test Instruments	43
10.4.	Test Procedure	44
10.5.	Test Result.....	45
11	99 % Occupied Bandwidth Measurement.....	57
11.1.	Limit.....	57
11.2.	Test Setup.....	57
11.3.	Test Instruments	57
11.4.	Test Procedure	57
11.5.	Test Result.....	58
11.6.	Test Graphs	59
12	Antenna Measurement	62
12.1.	Limit.....	62
12.2.	Antenna Connector Construction.....	62

1 General Information

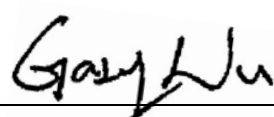
1.1 Summary of Test Result

Standard		Item	Result	Remark
15.247	RSS-GEN			
15.207	7.2.2	AC Power Conducted Emission	PASS	----
----	6	Receiver Radiated Emissions	PASS	----
Standard		Item	Result	Remark
15.247	RSS-210			
15.247(d)	A8.5	Transmitter Radiated Emissions	PASS	----
15.247(b)(3)	A8.4	Max. Output Power	PASS	----
15.247(a)(2)	A8.2 (a)	6dB RF Bandwidth	PASS	----
15.247(e)	A8.2 (b)	Power Spectral Density	PASS	----
15.247(c)	A8.5	Out of Band Conducted Spurious Emission	PASS	----
15.247(d)	A8.5	Band Edge Measurement	PASS	----
15.247(c)	A8.5	Occupied Bandwidth Measurement	PASS	----
15.203	-	Antenna Requirement	PASS	----

The test results of this report relate only to the tested sample(s) identified in this report. Manufacturer or whom it may concern should recognize the pass or fail of the test result.

1.2 Measurement Uncertainty

Conducted Emission

The measurement uncertainty is evaluated as ± 2.24 dB.

Radiated Emission

The measurement uncertainty of 30 MHz - 1GHz is evaluated as ± 3.072 dB.

2 EUT Description

Product	:	Smartphone
Trade Name	:	HTC
Model No.	:	PC10110
Applicant	:	HTC Corporation No. 23, Xinghua Rd., Taoyuan City, Taoyuan County 330, Taiwan
Manufacturer	:	HTC Corporation No. 23, Xinghua Rd., Taoyuan City, Taoyuan County 330, Taiwan
FCC ID	:	NM8PC10110
Frequency Range	:	2412 ~ 2462 MHz
Modulation Type	:	IEEE 802.11b:DSSS(CCK, DQPSK, DBPSK) IEEE 802.11g:DSSS(CCK, DQPSK, DBPSK)+ OFDM(QPSK, BPSK, 16-QAM, 64-QAM) draft 802.11n Standard-20MHz channel mode: OFDM(6.5,7.2, 13,14.4, 14.44, 19.5,217,26,28.89,28.9,39.43.3,43.33,52,57.78, 57.8, 58.5, 65.0, 72.2, 78, 86.67,104,115.56,117,130 and 144.44 Mbps)
Antenna Type	:	PIFA Type
Antenna Gain	:	1.69 dBi
RF Output Power	:	IEEE 802.11b: 0.097 W / 19.87 dBm IEEE 802.11g: 0.185 W / 22.68 dBm draft 802.11n Standard-20MHz: 0.180 W / 22.56 dBm

3 Test Methodology

3.1. Mode of Operation

Decision of Test ATL has verified the construction and function in typical operation. All the test modes were carried out with the EUT in normal operation, which was shown in this test report and defined as:

Test Mode
Mode 1: IDLE Mode
Mode 2: Normal Operation Mode
Mode 3: IEEE 802.11b Link Mode
Mode 4: IEEE 802.11g Link Mode
Mode 5: draft 802.11n Standard-20MHz Link Mode
Mode 6: Receiver Mode

Software used to control the EUT for staying in continuous transmitting mode was programmed.

After verification, all tests were carried out with the worst case test modes as shown below except radiated spurious emission below 1GHz and power line conducted emissions below 30MHz, which worst case was in normal link mode only.

IEEE 802.11b mode:

Channel Low (2412MHz), Channel Mid (2437MHz) and Channel High (2462MHz) with 11Mbps data rate were chosen for full testing.

IEEE 802.11g mode:

Channel Low (2412MHz), Channel Mid (2437MHz) and Channel High (2462MHz) with 6Mbps data rate were chosen for full testing.

draft 802.11n Standard-20 MHz Channel mode:

Channel Low (2412MHz), Channel Mid (2437MHz) and Channel High (2462MHz) with 6.5Mbps data rate were chosen for full testing.

3.2. EUT Exercise Software

1.	Setup the EUT shown on 3.3.
2.	Turn on the power of all equipment.
3.	Turn on Wi-Fi function link to AP.
4.	EUT run test program.

3.3. Configuration of Test System Details

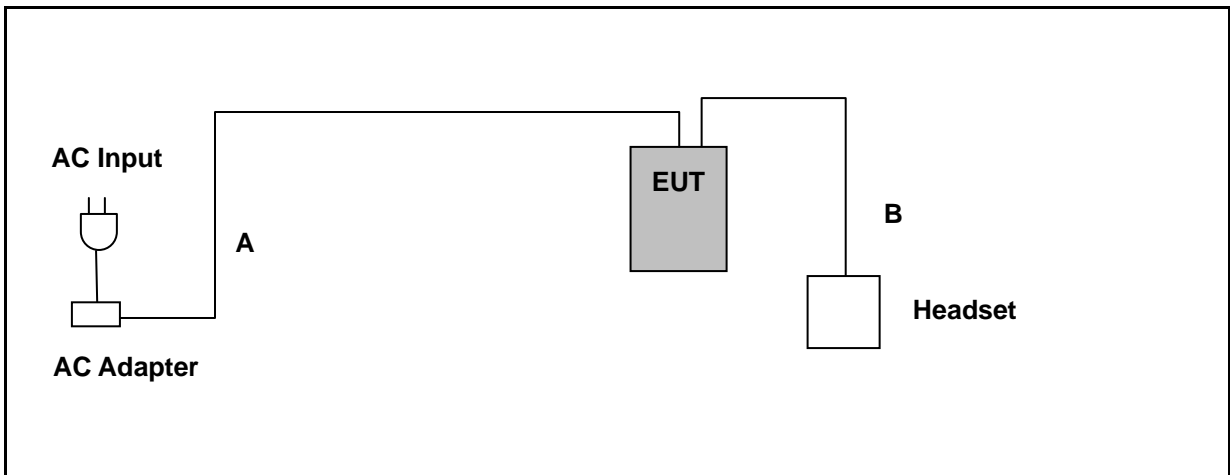

	Signal Cable Type	Signal Cable Description
A	Power Cable	Shielded, 1.2 m
B	Headset Cable	Non-Shielded, 1.25 m

Devices Description					
	Product	Manufacturer	Model Number	Serial Number	Power Cord
1.	-----	-----	-----	-----	-----

3.4. Test Site Environment

Items	Required (IEC 68-1)	Actual
Temperature (°C)	15-35	25
Humidity (%RH)	25-75	50
Barometric pressure (mbar)	860-1060	950

4 Conducted Emission Measurement

4.1. Limit

Frequency (MHz)	Quasi-peak	Average
0.15 - 0.5	66 to 56	56 to 46
0.50 - 5.0	56	46
5.0 - 30.0	60	50

4.2. Test Instruments

Describe	Manufacturer	Model Number	Serial Number	Cal. Date	Remark
Test Receiver	R&S	ESCI	100367	07/01/2010	(1)
LISN	R&S	ENV216	101040	03/02/2010	(1)
LISN	R&S	ENV216	101041	03/02/2010	(1)
Test Site	ATL	TE02	TE02	N.C.R.	----

Remark: (1) Calibration period 1 year. (2) Calibration period 2 years.

NOTE: N.C.R. = No Calibration Request.

4.3. Test Setup

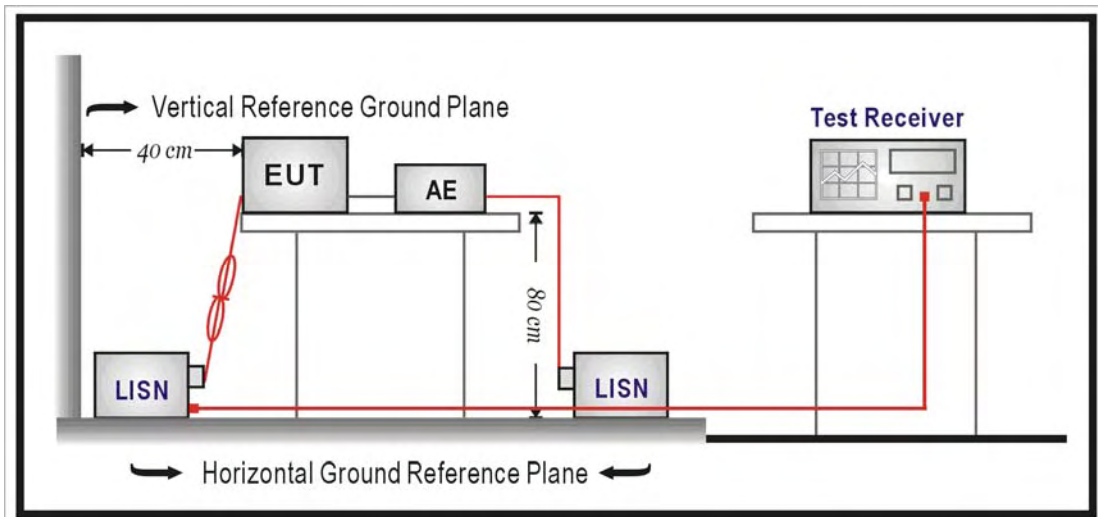

4.4. Test Procedure

The power line conducted emission measurements were performed in a shielded enclosure. The EUT was assembled on a wooden table which is 80 centimeters high, was placed 40 centimeters from the back wall and at least 1 meter from the sidewall.

Power was fed to the EUT from the public utility power grid through a line filter and EMCO Model 3162/2 SH Line Impedance Stabilization Networks (LISN). The LISN housing, measuring instrumentation case, ground plane, etc., were electrically bonded together at the same RF potential. The Spectrum analyzer was connected to the AC line through an isolation transformer. The 50-ohm output of the LISN was connected to the spectrum analyzer directly. Conducted emission levels were in the CISPR quasi-peak detection mode. The analyzer's 6 dB bandwidth was set to 9 KHz. No post-detector video filter was used.

The spectrum was scanned from 150 KHz to 30 MHz. The physical arrangement of the test system and associated cabling was varied (within the scope of arrangements likely to be encountered in actual use) to determine the effect on the unit's emanations in amplitude and frequency. All spurious emission frequencies were observed. The highest emission amplitudes relative to the appropriate limit were measured and have been recorded in paragraph 4.1.

4.5. Test Result

Standard:	FCC Part 15C	Line:	L1
Test item:	Conducted Emission	Power:	AC 120V/60Hz
Model Number:	PC10110	Temp.(°C)/Hum.(%RH):	26(°C)/60%RH
Mode:	Mode 1	Date:	2010/08/11
		Test By:	Gary Wu
Description:			

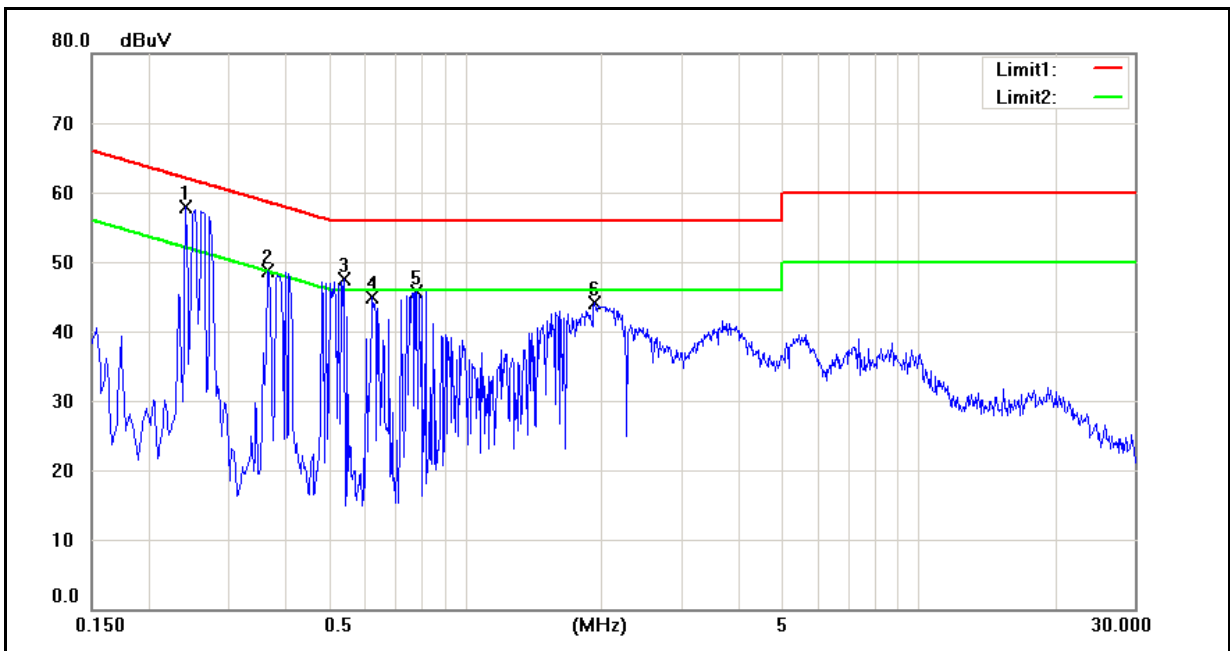

No.	Frequency (MHz)	QP reading (dBuV)	AVG reading (dBuV)	Correction factor (dB)	QP result (dBuV)	AVG result (dBuV)	QP limit (dBuV)	AVG limit (dBuV)	QP margin (dB)	AVG margin (dB)	Remark
1	0.2420	45.78	21.56	9.59	55.37	31.15	62.03	52.03	-6.66	-20.88	Pass
2	0.3660	36.39	14.03	9.59	45.98	23.62	58.59	48.59	-12.61	-24.97	Pass
3	0.5420	32.95	7.85	9.59	42.54	17.44	56.00	46.00	-13.46	-28.56	Pass
4	0.6220	30.70	7.10	9.59	40.29	16.69	56.00	46.00	-15.71	-29.31	Pass
5	0.7820	31.64	8.18	9.60	41.24	17.78	56.00	46.00	-14.76	-28.22	Pass
6	1.9300	27.60	8.69	9.61	37.21	18.30	56.00	46.00	-18.79	-27.70	Pass

Standard:	FCC Part 15C	Line:	N
Test item:	Conducted Emission	Power:	AC 120V/60Hz
Model Number:	PC10110	Temp.(°C)/Hum.(%RH):	26(°C)/60%RH
Mode:	Mode 1	Date:	2010/08/11
		Test By:	Gary Wu
Description:			

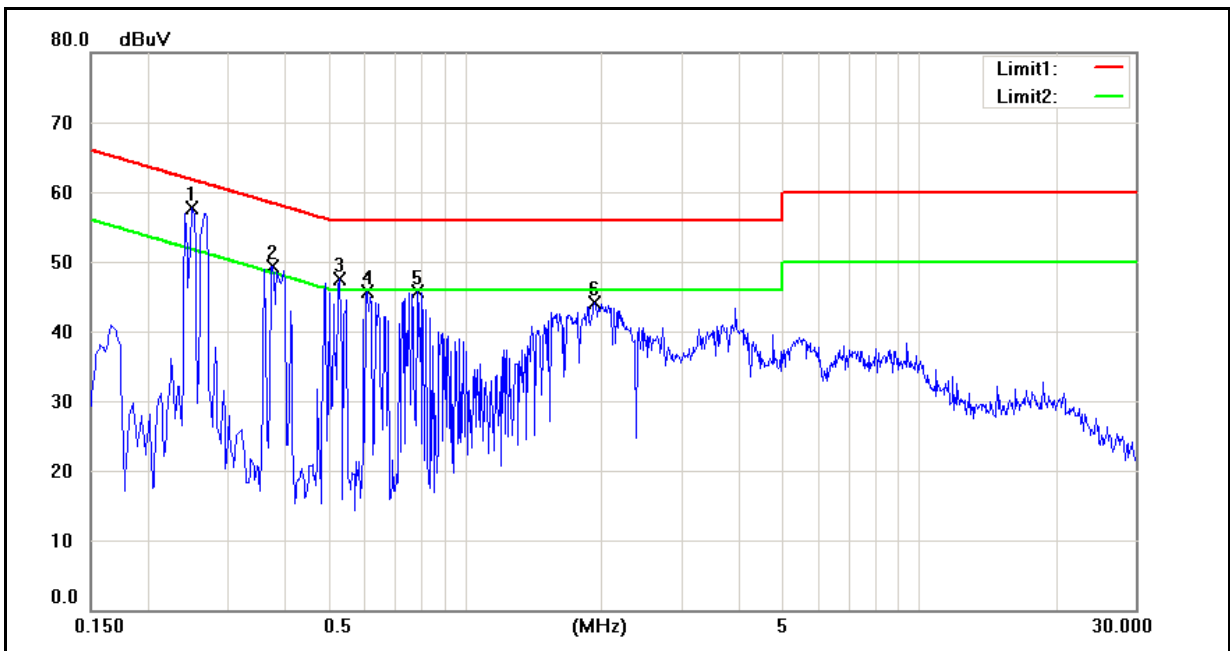

No.	Frequency (MHz)	QP reading (dBuV)	AVG reading (dBuV)	Correction factor (dB)	QP result (dBuV)	AVG result (dBuV)	QP limit (dBuV)	AVG limit (dBuV)	QP margin (dB)	AVG margin (dB)	Remark
1	0.2660	31.66	17.64	9.58	41.24	27.22	61.24	51.24	-20.00	-24.02	Pass
2	0.3900	34.59	15.48	9.59	44.18	25.07	58.06	48.06	-13.88	-22.99	Pass
3	1.1340	31.41	12.20	9.59	41.00	21.79	56.00	46.00	-15.00	-24.21	Pass
4	1.6660	31.62	10.74	9.60	41.22	20.34	56.00	46.00	-14.78	-25.66	Pass
5	3.3300	27.66	12.15	9.61	37.27	21.76	56.00	46.00	-18.73	-24.24	Pass
6	7.8500	22.39	12.17	9.68	32.07	21.85	60.00	50.00	-27.93	-28.15	Pass

Standard:	FCC Part 15C	Line:	L1
Test item:	Conducted Emission	Power:	AC 120V/60Hz
Model Number:	PC10110	Temp.(°C)/Hum.(%RH):	26(°C)/60%RH
Mode:	Mode 2	Date:	2010/08/11
		Test By:	Gary Wu
Description:			

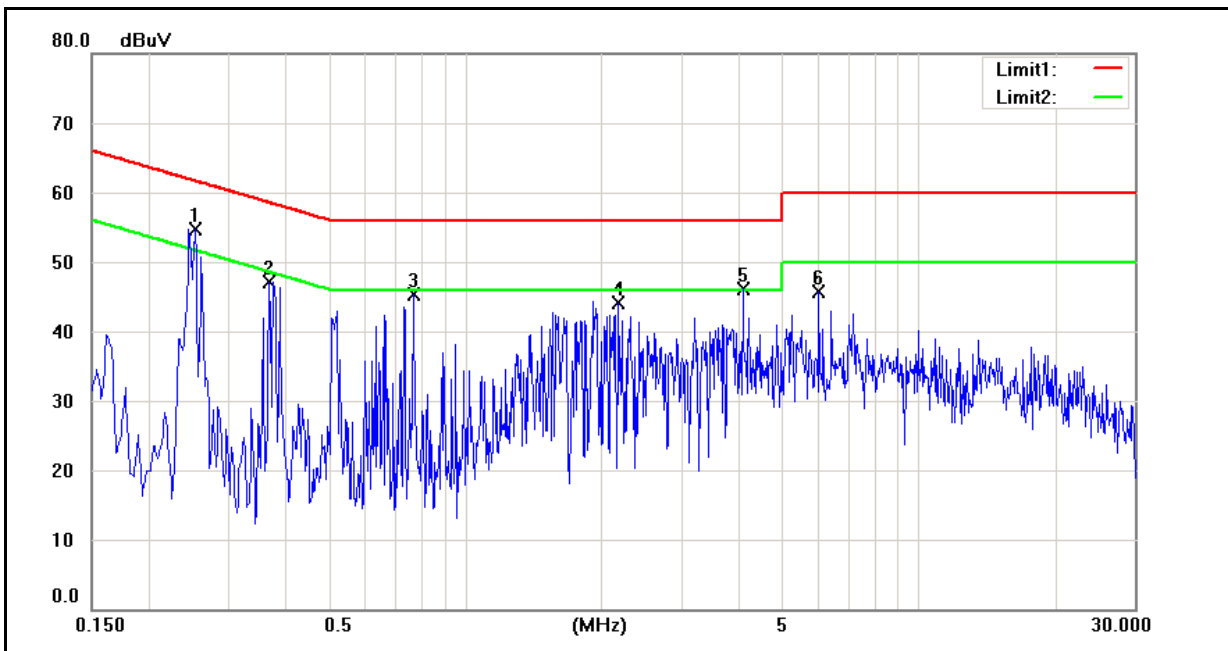

No.	Frequency (MHz)	QP reading (dBuV)	AVG reading (dBuV)	Correction factor (dB)	QP result (dBuV)	AVG result (dBuV)	QP limit (dBuV)	AVG limit (dBuV)	QP margin (dB)	AVG margin (dB)	Remark
1	0.2540	43.17	25.03	9.58	52.75	34.61	61.63	51.63	-8.88	-17.02	Pass
2	0.3700	32.78	10.28	9.59	42.37	19.87	58.50	48.50	-16.13	-28.63	Pass
3	0.7700	34.07	17.04	9.59	43.66	26.63	56.00	46.00	-12.34	-19.37	Pass
4	2.1820	31.43	13.02	9.60	41.03	22.62	56.00	46.00	-14.97	-23.38	Pass
5	4.1060	27.80	10.66	9.62	37.42	20.28	56.00	46.00	-18.58	-25.72	Pass
6	6.0300	25.08	7.97	9.65	34.73	17.62	60.00	50.00	-25.27	-32.38	Pass

Standard:	FCC Part 15C	Line:	N
Test item:	Conducted Emission	Power:	AC 120V/60Hz
Model Number:	PC10110	Temp.(°C)/Hum.(%RH):	26(°C)/60%RH
Mode:	Mode 2	Date:	2010/08/11
		Test By:	Gary Wu
Description:			

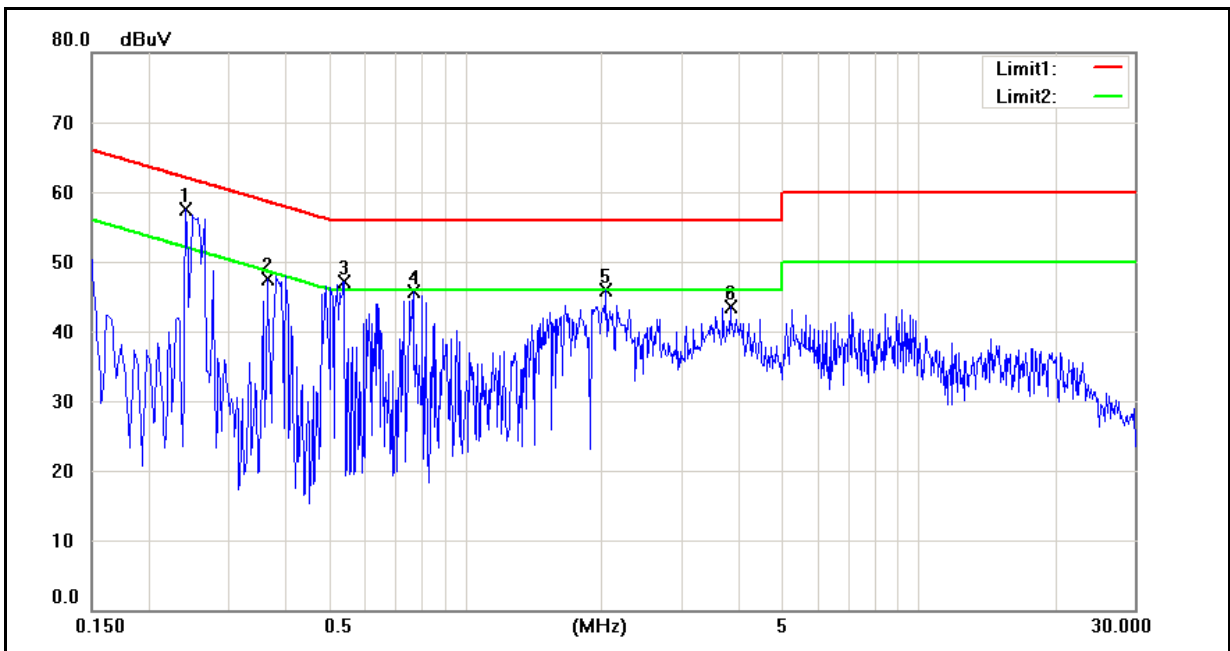

No.	Frequency (MHz)	QP reading (dBuV)	AVG reading (dBuV)	Correction factor (dB)	QP result (dBuV)	AVG result (dBuV)	QP limit (dBuV)	AVG limit (dBuV)	QP margin (dB)	AVG margin (dB)	Remark
1	0.2420	44.48	17.49	9.59	54.07	27.08	62.03	52.03	-7.96	-24.95	Pass
2	0.3660	34.41	10.91	9.59	44.00	20.50	58.59	48.59	-14.59	-28.09	Pass
3	0.5420	30.57	4.99	9.59	40.16	14.58	56.00	46.00	-15.84	-31.42	Pass
4	0.7700	34.58	17.15	9.60	44.18	26.75	56.00	46.00	-11.82	-19.25	Pass
5	2.0500	33.85	16.06	9.61	43.46	25.67	56.00	46.00	-12.54	-20.33	Pass
6	3.8460	30.68	11.16	9.63	40.31	20.79	56.00	46.00	-15.69	-25.21	Pass

5 Radiated Interference Measurement

5.1. Limit

Frequency Range (MHz)	Peak (dBuV)
30 to 88	40
88 to 216	43.5
216 to 960	46
Above 960	54

5.2. Test Instruments

3 Meter Chamber					
Equipment	Manufacturer	Model Number	Serial Number	Cal. Date	Remark
RF Pre-selector	Agilent	N9039A	MY46520256	01/07/2009	(2)
Spectrum Analyzer	Agilent	E4446A	MY46180578	02/24/2010	(1)
Pre Amplifier	Agilent	8449B	3008A02237	02/24/2010	(1)
Pre Amplifier	Agilent	8447D	2944A10961	02/24/2010	(1)
Bi-log Antenna	SCHWARZBECK MESS-ELEKTRONIK	VULB9163	9163-270	08/02/2010	(1)
Horn Antenna	SCHWARZBECK MESS-ELEKTRONIK	BBHA9120D	9120D-550	06/29/2010	(1)
Horn Antenna	SCHWARZBECK MESS-ELEKTRONIK	BBHA9170	9170-320	06/29/2010	(1)
Test Site	ATL	TE01	888001	07/30/2010	(1)

Remark: (1) Calibration period 1 year. (2) Calibration period 2 years.

NOTE: N.C.R. = No Calibration Request.

5.3. Setup

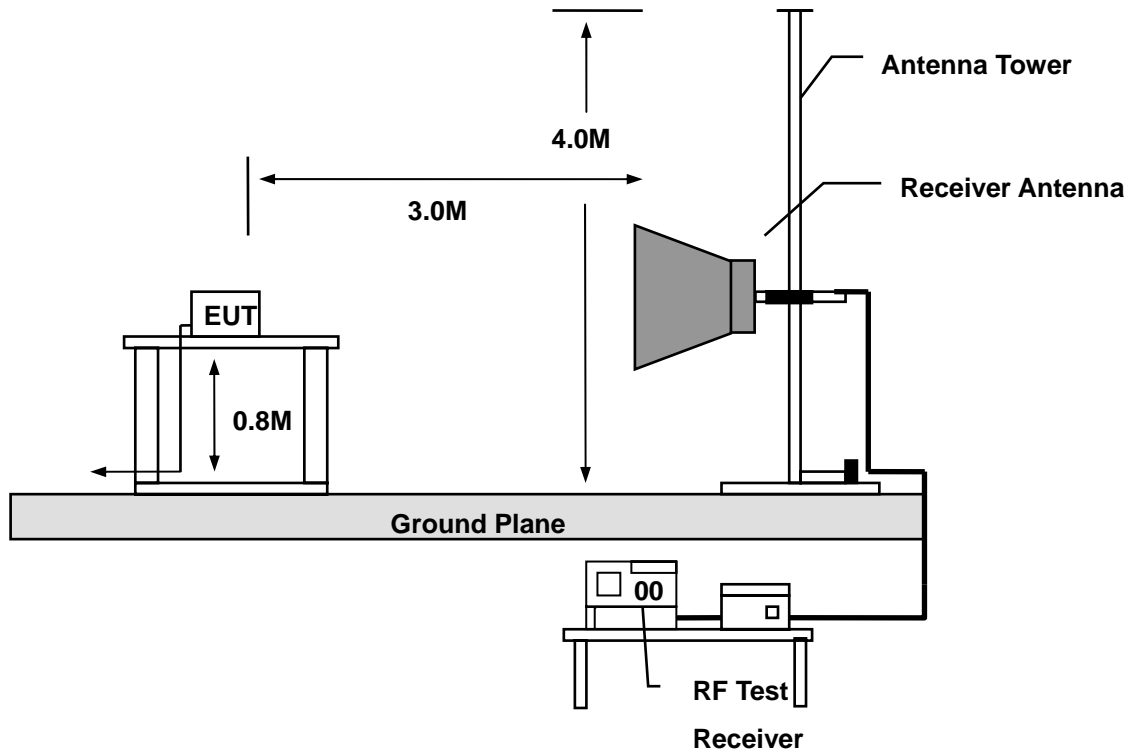

5.4. Test Procedure

Final radiation measurements were made on a three-meter, Semi Anechoic Chamber. The EUT system was placed on a nonconductive turntable which is 0.8 meters height, top surface 1.0 x 1.5 meter. The spectrum was examined from 250 MHz to 2.5 GHz in order to cover the whole spectrum below 10th harmonic which could generate from the EUT. During the test, EUT was set to transmit continuously & Measurements spectrum range from 30 MHz to 26.5 GHz is investigated.

For measurements below 1 GHz the resolution bandwidth is set to 100 kHz for peak detection measurements or 120 kHz for quasi-peak detection measurements. Peak detection is used unless otherwise noted as quasi-peak.

For measurements above 1 GHz the resolution bandwidth is set to 1 MHz, and then the video bandwidth is set to 1 MHz for peak measurements and 10 Hz for average measurements.

A nonconductive material surrounded the EUT to supporting the EUT for standing on three orthogonal planes. At each condition, the EUT was rotated 360 degrees, and the antenna was raised and lowered from one to four meters to find the maximum emission levels. Measurements were taken using both horizontal and vertical antenna polarization.

SCHWARZBECK MESS-ELEKTRONIK Biconilog Antenna (model VULB9163) at 3 Meter and the SCHWARZBECK Double Ridged Guide Antenna (model BBHA9120D&9170) was used in frequencies 1 – 26.5 GHz at a distance of 1 meter. All test results were extrapolated to equivalent signal at 3 meters utilizing an inverse linear distance extrapolation Factor (20dB/decade).

For testing above 1GHz, the emission level of the EUT in peak mode was 20dB lower than average limit (that means the emission level in peak mode also complies with the limit in average mode), then testing will be stopped and peak values of EUT will be reported, otherwise, the emissions will be measured in average mode again and reported.

Appropriate preamplifiers were used for improving sensitivity and precautions were taken to avoid overloading or desensitizing the spectrum analyzer. No post – detector video filters were used in the test.

The spectrum analyzer's 6 dB bandwidth was set to 1 MHz, and the analyzer was operated in the peak detection mode, for frequencies both below and up 1 GHz. The average levels were obtained by subtracting the duty cycle correction factor from the peak readings.

The following procedures were used to convert the emission levels measured in decibels referenced to 1 microvolt (dBuV) into field intensity in micro volts pre meter (uV/m).

The actual field intensity in decibels referenced to 1 microvolt in to field intensity in micro volts per meter (dBuV/m).

The actual field intensity in referenced to 1 microvolt per meter (dBuV/m) is determined by algebraically adding the measured reading in dBuV, the antenna factor (dB), and cable loss (dB) and Subtracting the gain of preamplifier (dB) is auto calculate in spectrum analyzer.

(1) $\text{Amplitude (dBuV/m)} = \text{FI (dBuV)} + \text{AF (dBuV)} + \text{CL (dBuV)} - \text{Gain (dB)}$

FI= Reading of the field intensity.

AF= Antenna factor.

CL= Cable loss.

P.S Amplitude is auto calculate in spectrum analyzer.

(2) $\text{Actual Amplitude (dBuV/m)} = \text{Amplitude (dBuV)} - \text{Dis (dB)}$

The FCC specified emission limits were calculated according the EUT operating frequency and by following linear interpolation equations:

(a) For fundamental frequency : Transmitter Output < +30dBm

(b) For spurious frequency : Spurious emission limits = fundamental emission limit /10

5.5. Test Result

Below 1GHz

Standard:	FCC Part 15C	Test Distance:	3m
Test item:	Radiated Emission	Power:	AC 120V/60Hz
Model Number:	PC10110	Temp.(°C)/Hum.(%RH):	26(°C)/60%RH
Mode:	Mode 2	Date:	2010/08/09
Ant.Polar.:	Horizontal	Test By:	Gary Wu

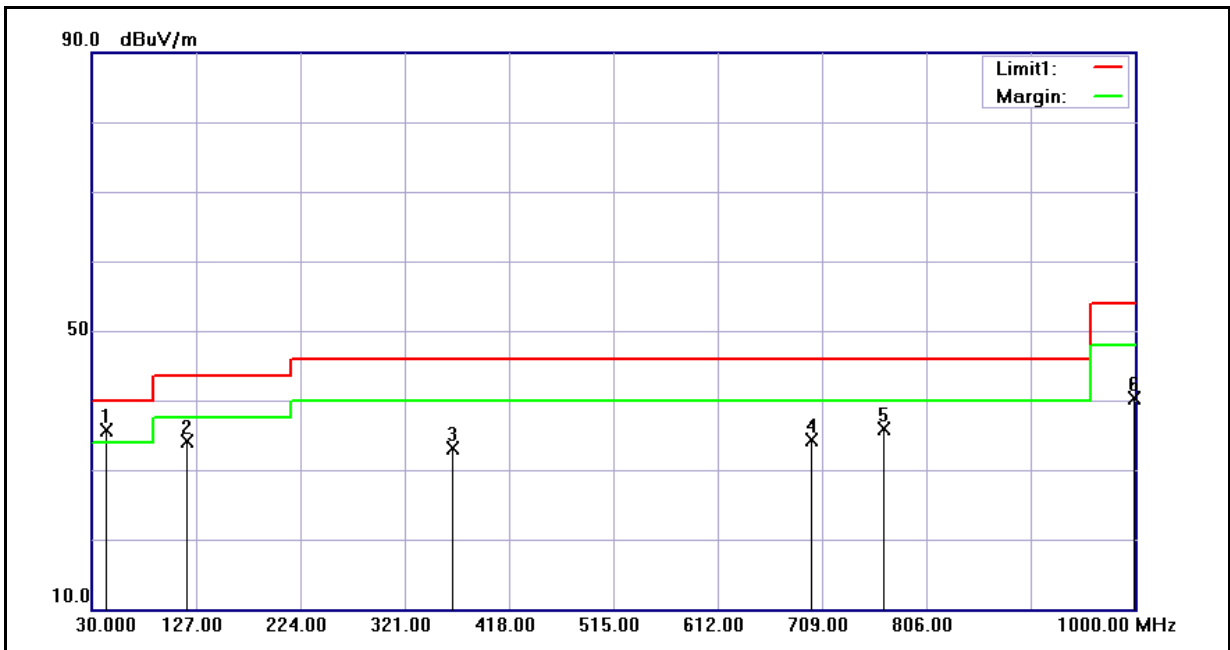

No.	Frequency (MHz)	Reading (dBuV)	Correct Factor(dB/m)	Result (dBuV/m)	Limit (dBuV/m)	Margin (dB)	Remark
1	44.0000	47.31	-11.62	35.69	40.00	-4.31	QP
2	119.0000	49.69	-15.68	34.01	43.50	-9.49	QP
3	366.5000	41.48	-8.46	33.02	46.00	-12.98	QP
4	700.0000	37.65	-3.39	34.26	46.00	-11.74	QP
5	766.5000	37.83	-1.90	35.93	46.00	-10.07	QP
6	999.5000	38.58	1.76	40.34	54.00	-13.66	QP

Standard:	FCC Part 15C	Test Distance:	3m
Test item:	Radiated Emission	Power:	AC 120V/60Hz
Model Number:	PC10110	Temp.(°C)/Hum.(%RH):	26(°C)/60%RH
Mode:	Mode 2	Date:	2010/08/09
Ant.Polar.:	Vertical	Test By:	Gary Wu

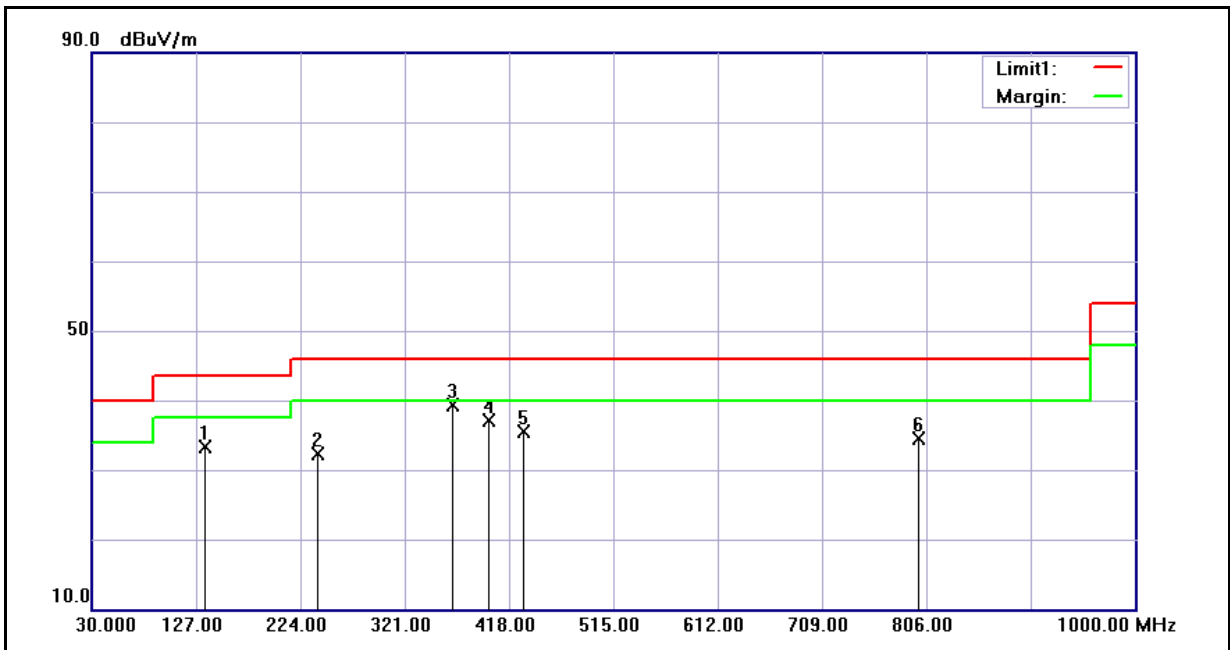

No.	Frequency (MHz)	Reading (dBuV)	Correct Factor(dB/m)	Result (dBuV/m)	Limit (dBuV/m)	Margin (dB)	Remark
1	135.0000	50.26	-16.95	33.31	43.50	-10.19	QP
2	240.0000	44.47	-12.15	32.32	46.00	-13.68	QP
3	366.5000	47.77	-8.46	39.31	46.00	-6.69	QP
4	400.0000	45.60	-8.50	37.10	46.00	-8.90	QP
5	432.0000	43.61	-8.16	35.45	46.00	-10.55	QP
6	800.0000	35.91	-1.35	34.56	46.00	-11.44	QP

Above 1GHz

Standard:	FCC Part 15C			Test Distance:	3m		
Test item:	Radiated Emission			Power:	AC 120V/60Hz		
Model Number:	PC10110			Temp.(°C)/Hum.(%RH):	26(°C)/60%RH		
Mode:	Mode 3			Date:	2010/08/09		
Frequency:	2412MHz			Test By:	Gary Wu		
Frequency (MHz)	Reading (dBuV)	Correct Factor(dB/m)	Result (dBuV/m)	Limit (dBuV/m)	Margin (dB)	Remark	Ant.Polar. H / V
1665.000	47.11	-2.97	44.14	74.00	-29.86	peak	H
2995.000	40.95	2.28	43.23	74.00	-30.77	peak	H
4824.000	37.83	7.92	45.75	74.00	-28.25	peak	H
7236.000	35.72	15.03	50.75	74.00	-23.25	peak	H
1665.000	48.25	-2.97	45.28	74.00	-28.72	peak	V
1994.000	48.91	-1.81	47.10	74.00	-26.90	peak	V
2988.000	46.09	2.25	48.34	74.00	-25.66	peak	V
4824.000	36.24	7.92	44.16	74.00	-29.84	peak	V
7236.000	35.96	15.03	50.99	74.00	-23.01	peak	V

Standard:	FCC Part 15C			Test Distance:	3m		
Test item:	Radiated Emission			Power:	AC 120V/60Hz		
Model Number:	PC10110			Temp.(°C)/Hum.(%RH):	26(°C)/60%RH		
Mode:	Mode 3			Date:	2010/08/09		
Frequency:	2437MHz			Test By:	Gary Wu		
Frequency (MHz)	Reading (dBuV)	Correct Factor(dB/m)	Result (dBuV/m)	Limit (dBuV/m)	Margin (dB)	Remark	Ant.Polar. H / V
1497.000	45.63	-3.58	42.05	74.00	-31.95	peak	H
1665.000	48.88	-2.97	45.91	74.00	-28.09	peak	H
4874.000	37.32	8.09	45.41	74.00	-28.59	peak	H
7311.000	33.77	15.23	49.00	74.00	-25.00	peak	H
1658.000	48.59	-3.00	45.59	74.00	-28.41	peak	V
1994.000	46.63	-1.81	44.82	74.00	-29.18	peak	V
2988.000	45.96	2.25	48.21	74.00	-25.79	peak	V
4874.000	37.32	8.09	45.41	74.00	-28.59	peak	V
7311.000	33.38	15.23	48.61	74.00	-25.39	peak	V

Standard:	FCC Part 15C			Test Distance:	3m		
Test item:	Radiated Emission			Power:	AC 120V/60Hz		
Model Number:	PC10110			Temp.(°C)/Hum.(%RH):	26(°C)/60%RH		
Mode:	Mode 3			Date:	2010/08/09		
Frequency:	2462MHz			Test By:	Gary Wu		
Frequency (MHz)	Reading (dBuV)	Correct Factor(dB/m)	Result (dBuV/m)	Limit (dBuV/m)	Margin (dB)	Remark	Ant.Polar. H / V
1497.000	45.45	-3.58	41.87	74.00	-32.13	peak	H
1665.000	48.47	-2.97	45.50	74.00	-28.50	peak	H
4924.000	36.45	8.25	44.70	74.00	-29.30	peak	H
7386.000	34.61	15.42	50.03	74.00	-23.97	peak	H
1665.000	50.00	-2.97	47.03	74.00	-26.97	peak	V
2001.000	50.02	-1.79	48.23	74.00	-25.77	peak	V
2988.000	46.18	2.25	48.43	74.00	-25.57	peak	V
4924.000	37.03	8.25	45.28	74.00	-28.72	peak	V
7386.000	34.62	15.42	50.04	74.00	-23.96	peak	V

Standard:	FCC Part 15C			Test Distance:	3m		
Test item:	Radiated Emission			Power:	AC 120V/60Hz		
Model Number:	PC10110			Temp.(°C)/Hum.(%RH):	26(°C)/60%RH		
Mode:	Mode 4			Date:	2010/08/09		
Frequency:	2412MHz			Test By:	Gary Wu		
Frequency (MHz)	Reading (dBuV)	Correct Factor(dB/m)	Result (dBuV/m)	Limit (dBuV/m)	Margin (dB)	Remark	Ant.Polar. H / V
1658.000	47.41	-3.00	44.41	74.00	-29.59	peak	H
4824.000	35.60	7.92	43.52	74.00	-30.48	peak	H
5550.000	37.65	10.07	47.72	74.00	-26.28	peak	H
7236.000	34.31	15.03	49.34	74.00	-24.66	peak	H
1665.000	47.98	-2.97	45.01	74.00	-28.99	peak	V
2988.000	46.17	2.25	48.42	74.00	-25.58	peak	V
3996.000	39.64	5.31	44.95	74.00	-29.05	peak	V
4824.000	37.55	7.92	45.47	74.00	-28.53	peak	V
4983.000	38.94	8.45	47.39	74.00	-26.61	peak	V
7236.000	35.78	15.03	50.81	74.00	-23.19	peak	V

Standard:	FCC Part 15C			Test Distance:	3m		
Test item:	Radiated Emission			Power:	AC 120V/60Hz		
Model Number:	PC10110			Temp.(°C)/Hum.(%RH):	26(°C)/60%RH		
Mode:	Mode 4			Date:	2010/08/09		
Frequency:	2437MHz			Test By:	Gary Wu		
Frequency (MHz)	Reading (dBuV)	Correct Factor(dB/m)	Result (dBuV/m)	Limit (dBuV/m)	Margin (dB)	Remark	Ant.Polar. H / V
1665.000	48.00	-2.97	45.03	74.00	-28.97	peak	H
4874.000	35.89	8.09	43.98	74.00	-30.02	peak	H
5060.000	38.16	8.68	46.84	74.00	-27.16	peak	H
7311.000	33.73	15.23	48.96	74.00	-25.04	peak	H
1546.000	50.45	-3.39	47.06	74.00	-26.94	peak	V
1994.000	48.63	-1.81	46.82	74.00	-27.18	peak	V
2995.000	45.05	2.28	47.33	74.00	-26.67	peak	V
4874.000	35.97	8.09	44.06	74.00	-29.94	peak	V
4990.000	38.69	8.47	47.16	74.00	-26.84	peak	V
7311.000	34.27	15.23	49.50	74.00	-24.50	peak	V

Standard:	FCC Part 15C			Test Distance:	3m		
Test item:	Radiated Emission			Power:	AC 120V/60Hz		
Model Number:	PC10110			Temp.(°C)/Hum.(%RH):	26(°C)/60%RH		
Mode:	Mode 4			Date:	2010/08/09		
Frequency:	2462MHz			Test By:	Gary Wu		
Frequency (MHz)	Reading (dBuV)	Correct Factor(dB/m)	Result (dBuV/m)	Limit (dBuV/m)	Margin (dB)	Remark	Ant.Polar. H / V
1665.000	45.76	-2.97	42.79	74.00	-31.21	peak	H
4924.000	35.56	8.25	43.81	74.00	-30.19	peak	H
7386.000	34.99	15.42	50.41	74.00	-23.59	peak	H
1658.000	48.80	-3.00	45.80	74.00	-28.20	peak	V
1987.000	46.56	-1.84	44.72	74.00	-29.28	peak	V
2988.000	45.51	2.25	47.76	74.00	-26.24	peak	V
3660.000	41.03	4.02	45.05	74.00	-28.95	peak	V
4924.000	35.69	8.25	43.94	74.00	-30.06	peak	V
7386.000	34.25	15.42	49.67	74.00	-24.33	peak	V

Standard:	FCC Part 15C			Test Distance:	3m		
Test item:	Radiated Emission			Power:	AC 120V/60Hz		
Model Number:	PC10110			Temp.(°C)/Hum.(%RH):	26(°C)/60%RH		
Mode:	Mode 5			Date:	2010/08/09		
Frequency:	2412MHz			Test By:	Gary Wu		
Frequency (MHz)	Reading (dBuV)	Correct Factor(dB/m)	Result (dBuV/m)	Limit (dBuV/m)	Margin (dB)	Remark	Ant.Polar. H / V
1497.000	45.85	-3.58	42.27	74.00	-31.73	peak	H
1658.000	46.89	-3.00	43.89	74.00	-30.11	peak	H
2043.000	44.24	-1.62	42.62	74.00	-31.38	peak	H
4824.000	36.73	7.92	44.65	74.00	-29.35	peak	H
7236.000	34.53	15.03	49.56	74.00	-24.44	peak	H
1665.000	47.56	-2.97	44.59	74.00	-29.41	peak	V
1994.000	47.08	-1.81	45.27	74.00	-28.73	peak	V
2988.000	45.74	2.25	47.99	74.00	-26.01	peak	V
4824.000	35.60	7.92	43.52	74.00	-30.48	peak	V
7236.000	35.39	15.03	50.42	74.00	-23.58	peak	V

Standard:	FCC Part 15C			Test Distance:	3m		
Test item:	Radiated Emission			Power:	AC 120V/60Hz		
Model Number:	PC10110			Temp.(°C)/Hum.(%RH):	26(°C)/60%RH		
Mode:	Mode 5			Date:	2010/08/09		
Frequency:	2437MHz			Test By:	Gary Wu		
Frequency (MHz)	Reading (dBuV)	Correct Factor(dB/m)	Result (dBuV/m)	Limit (dBuV/m)	Margin (dB)	Remark	Ant.Polar. H / V
1665.000	47.04	-2.97	44.07	74.00	-29.93	peak	H
4283.000	39.72	6.19	45.91	74.00	-28.09	peak	H
4874.000	36.24	8.09	44.33	74.00	-29.67	peak	H
7311.000	34.33	15.23	49.56	74.00	-24.44	peak	H
1665.000	48.96	-2.97	45.99	74.00	-28.01	peak	V
2001.000	48.80	-1.79	47.01	74.00	-26.99	peak	V
2995.000	46.31	2.28	48.59	74.00	-25.41	peak	V
3996.000	40.65	5.31	45.96	74.00	-28.04	peak	V
4874.000	36.33	8.09	44.42	74.00	-29.58	peak	V
7311.000	34.71	15.23	49.94	74.00	-24.06	peak	V

Standard:	FCC Part 15C			Test Distance:	3m		
Test item:	Radiated Emission			Power:	AC 120V/60Hz		
Model Number:	PC10110			Temp.(°C)/Hum.(%RH):	26(°C)/60%RH		
Mode:	Mode 5			Date:	2010/08/09		
Frequency:	2462MHz			Test By:	Gary Wu		
Frequency (MHz)	Reading (dBuV)	Correct Factor(dB/m)	Result (dBuV/m)	Limit (dBuV/m)	Margin (dB)	Remark	Ant.Polar. H / V
1665.000	47.00	-2.97	44.03	74.00	-29.97	peak	H
2995.000	41.21	2.28	43.49	74.00	-30.51	peak	H
4924.000	35.77	8.25	44.02	74.00	-29.98	peak	H
7386.000	34.34	15.42	49.76	74.00	-24.24	peak	H
1210.000	53.78	-5.18	48.60	74.00	-25.40	peak	V
1658.000	48.47	-3.00	45.47	74.00	-28.53	peak	V
2001.000	46.05	-1.79	44.26	74.00	-29.74	peak	V
3002.000	44.64	2.30	46.94	74.00	-27.06	peak	V
4924.000	36.25	8.25	44.50	74.00	-29.50	peak	V
7386.000	34.59	15.42	50.01	74.00	-23.99	peak	V

Standard:	FCC Part 15B			Test Distance:	3m			
Test item:	Radiated Emission			Power:	AC 120V/60Hz			
Model Number:	PC10110			Temp.(°C)/Hum.(%RH):	26(°C)/60%RH			
Mode:	Mode 6			Date:	2010/08/09			
Modulation Type :	draft 802.11n Standard-20MHz			Test By:	Gary Wu			
Frequency:	2437MHz							
Frequency (MHz)	Reading (dBuV)	Correct Factor(dB/m)	Result (dBuV/m)	Peak Limit (dBuV/m)	AVG. Limit (dBuV/m)	Margin (dB)	Remark	Ant.Polar. H / V
1665.000	48.17	-2.97	45.20	74.00	-28.80	-27.26	peak	H
1994.000	43.81	-1.81	42.00	74.00	-32.00	-30.12	peak	H
6887.000	36.53	14.06	50.59	74.00	-23.41	-23.87	peak	H
1203.000	50.70	-5.22	45.48	74.00	-28.52	-23.38	peak	V
1658.000	49.21	-3.00	46.21	74.00	-27.79	-27.02	peak	V
2995.000	46.36	2.28	48.64	74.00	-25.36	-26.94	peak	V

6 Maximum Conducted Output Power Measurement

6.1. Limit

For systems using digital modulation in the 2400-2483.5MHz, the limit for peak output power is 30dBm.

6.2. Test Setup

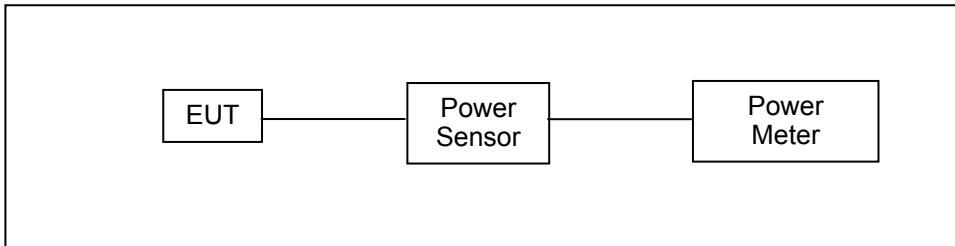

6.3. Test Instruments

Equipment	Manufacturer	Model Number	Serial Number	Cal. Date	Remark
Single Channel PK Power Sensor	Agilent	N1911A	MY45101619	07/19/2010	(1)
Wideband Power Meter	Agilent	N1921A	MY45241957	07/19/2010	(1)
Test Site	ATL	TE06	TE06	N.C.R.	-----

Remark: (1) Calibration period 1 year. (2) Calibration period 2 years.

NOTE: N.C.R. = No Calibration Request.

6.4. Test Procedure

The tests below are run with the EUT's transmitter set at high power in TX mode. The EUT is needed to force selection of output power level and channel number. While testing, EUT was set to transmit continuously. Remove the Subjective device's antenna and connect the RF output port to power sensor. The maximum peak output power shall not exceed 1 watt.

Use a direct connection between the antenna port of transmitter and the power sensor, for prevent the power sensor input attenuation 40-50 dB. Set the RBW Bandwidth of the emission or use a channel power meter mode.

For antennas with gains of 6 dBi or less, maximum allowed transmitter output is 1 watt (+30 dBm). For antennas with gains greater than 6 dBi, transmitter output level must be decreased by an amount equal to $(\text{GAIN} - 6)/3$ dBm.

The antenna port of the EUT was connected to the input of a power sensor. Power was read directly and cable loss correction was added to the reading to obtain power at the EUT antenna terminals.

6.5. Test Result

Model Number	PC10110					
Test Item	Maximum Conducted Output Power					
Test Mode	Mode 3: IEEE 802.11b Link Mode					
Date of Test	09/08/2010			Test Site	TE06	
Frequency (MHz)	Data Rate	Average Power		Peak Power		Limit (dBm)
		(dBm)	(W)	(dBm)	(W)	
2412	1 M	16.81	0.048	19.62	0.092	< 30
2437		16.67	0.046	19.71	0.094	< 30
2462		16.28	0.042	19.11	0.081	< 30
2412	11 M	16.66	0.046	19.87	0.097	< 30
2437		16.35	0.043	19.65	0.092	< 30
2462		16.12	0.041	19.31	0.085	< 30

Model Number	PC10110					
Test Item	Maximum Conducted Output Power					
Test Mode	Mode 4: IEEE 802.11g Link Mode					
Date of Test	09/08/2010			Test Site	TE06	
Frequency (MHz)	Data Rate	Average Power		Peak Power		Limit (dBm)
		(dBm)	(W)	(dBm)	(W)	
2412	6 M	12.31	0.017	22.56	0.180	< 30
2437		12.00	0.016	22.68	0.185	< 30
2462		11.69	0.015	22.30	0.170	< 30
2412	54 M	10.58	0.011	21.79	0.151	< 30
2437		10.72	0.012	22.32	0.171	< 30
2462		10.25	0.011	21.65	0.146	< 30

Model Number	PC10110					
Test Item	Maximum Conducted Output Power					
Test Mode	Mode 5: draft 802.11n Standard-20MHz Link Mode					
Date of Test	09/08/2010			Test Site	TE06	
Frequency (MHz)	Data Rate	Average Power		Peak Power		Limit (dBm)
		(dBm)	(W)	(dBm)	(W)	
2412	6.5 M	12.03	0.016	22.18	0.165	< 30
2437		11.87	0.015	22.56	0.180	< 30
2462		11.72	0.015	22.24	0.167	< 30
2412	65 M	10.45	0.011	21.86	0.153	< 30
2437		10.49	0.011	22.13	0.163	< 30
2462		10.17	0.010	21.75	0.150	< 30

7 6dB RF Bandwidth Measurement

7.1. Limit

Systems using digital modulation techniques may operate in the 2400–2483.5 MHz bands. The minimum 6 dB band-width shall be at least 500 kHz.

7.2. Test Setup

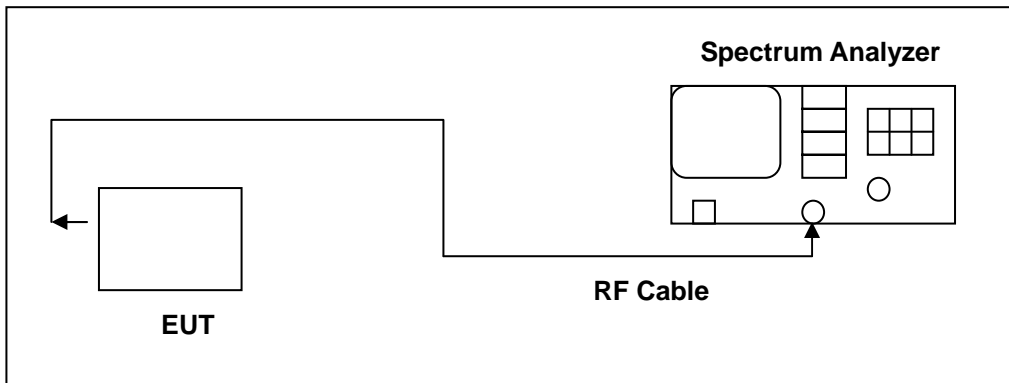

7.3. Test Instruments

Equipment	Manufacturer	Model Number	Serial Number	Cal. Date	Remark
Spectrum Analyzer	Agilent	E4445A	MY46181986	05/14/2009	(2)
Test Site	ATL	TE06	TE06	N.C.R.	-----

Remark: (1) Calibration period 1 year. (2) Calibration period 2 years.

NOTE: N.C.R. = No Calibration Request.

7.4. Test Procedure

The EUT was setup to ANSI C63.4, 2003; tested to DTS test procedure of Oct 2002 KDB558074 for compliance to FCC 47CFR 15.247 requirements.

The antenna port of the EUT was connected to the input of a spectrum analyzer. Analyzer RES BW was set to 100 kHz. For each RF output channel investigated, the spectrum analyzer center frequency was set to the channel carrier. A peak output reading was taken, a DISPLAY line was drawn 6 dB lower than peak level. The 6 dB bandwidth was determined from where the channel output spectrum intersected the display line.

The test was performed at 3 channels (Channel 1, 6, 11)

7.5. Test Result

Model Number	PC10110		
Test Item	6dB RF Bandwidth		
Test Mode	Mode 3: IEEE 802.11b Link Mode		
Date of Test	08/10/2010	Test Site	TE06
	Frequency (MHz)	Measurement (kHz)	Limit (kHz)
	2412	7000	> 500
	2437	7125	> 500
	2462	7625	> 500

Model Number	PC10110		
Test Item	6dB RF Bandwidth		
Test Mode	Mode 4: IEEE 802.11g Link Mode		
Date of Test	08/10/2010	Test Site	TE06
	Frequency (MHz)	Measurement (kHz)	Limit (kHz)
	2412	15650	> 500
	2437	15375	> 500
	2462	15625	> 500

Model Number	PC10110		
Test Item	6dB RF Bandwidth		
Test Mode	Mode 5: draft 802.11n Standard-20MHz Link Mode		
Date of Test	08/10/2010	Test Site	TE06
	Frequency (MHz)	Measurement (kHz)	Limit (kHz)
	2412	15500	> 500
	2437	15375	> 500
	2462	15625	> 500

7.6. Test Graphs

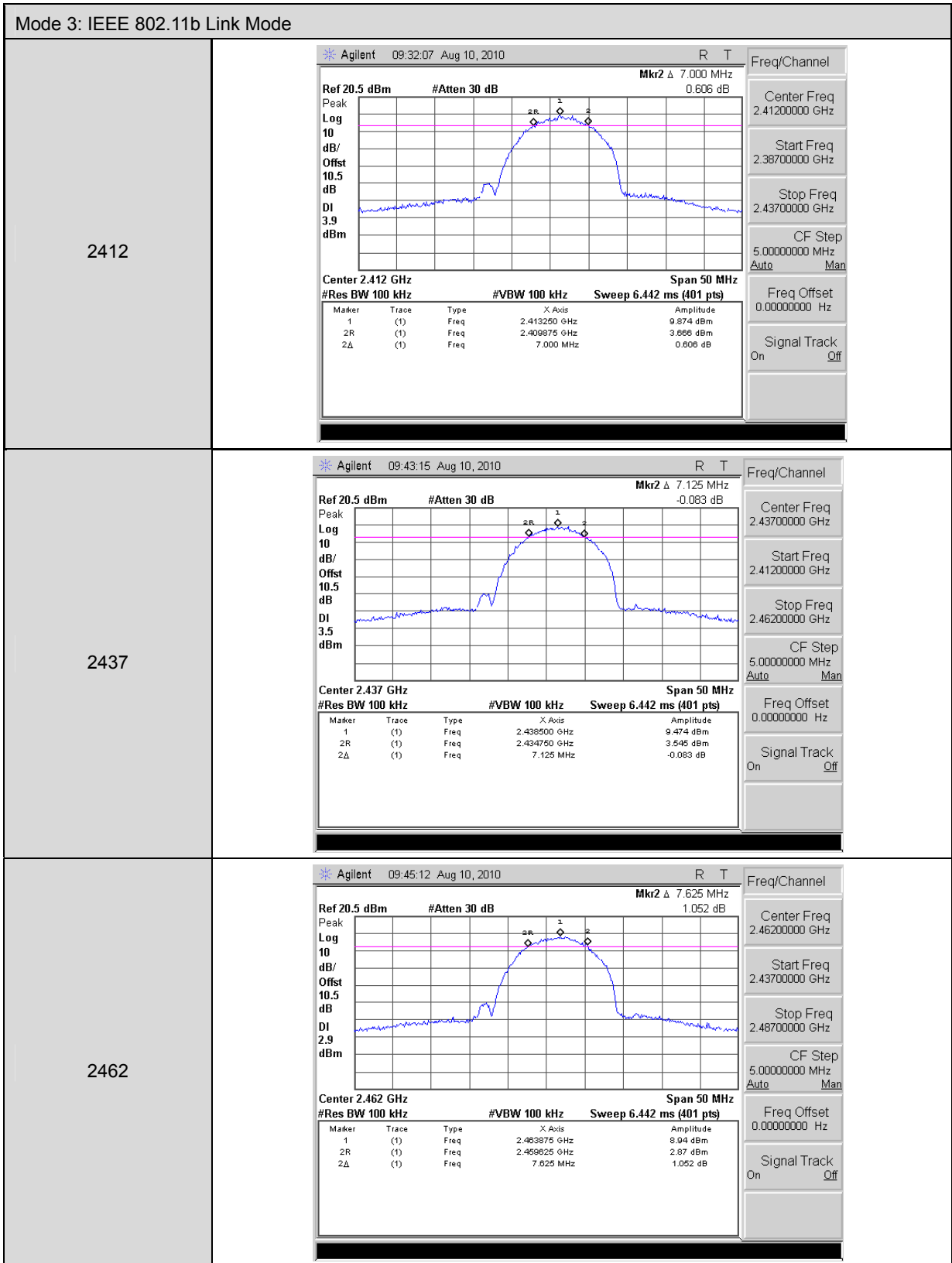

Mode 4: IEEE 802.11g Link Mode

<p>2412</p>	<p>Agilent 09:35:05 Aug 10, 2010</p> <p>Ref 20.5 dBm #Atten 30 dB Mkr2 Δ 15.625 MHz -0.094 dB</p> <p>Center 2.412 GHz Span 50 MHz</p> <table border="1"> <thead> <tr> <th>Marker</th> <th>Trace</th> <th>Type</th> <th>X Axis</th> <th>Amplitude</th> </tr> </thead> <tbody> <tr> <td>1</td> <td>(1)</td> <td>Freq</td> <td>2.413250 GHz</td> <td>2.176 dBm</td> </tr> <tr> <td>2R</td> <td>(1)</td> <td>Freq</td> <td>2.404250 GHz</td> <td>-4.249 dBm</td> </tr> <tr> <td>2Δ</td> <td>(1)</td> <td>Freq</td> <td>15.625 MHz</td> <td>-0.094 dB</td> </tr> </tbody> </table> <p>Center 2.412 GHz #Res BW 100 kHz #VBW 100 kHz Sweep 6.442 ms (401 pts)</p>	Marker	Trace	Type	X Axis	Amplitude	1	(1)	Freq	2.413250 GHz	2.176 dBm	2R	(1)	Freq	2.404250 GHz	-4.249 dBm	2Δ	(1)	Freq	15.625 MHz	-0.094 dB
Marker	Trace	Type	X Axis	Amplitude																	
1	(1)	Freq	2.413250 GHz	2.176 dBm																	
2R	(1)	Freq	2.404250 GHz	-4.249 dBm																	
2Δ	(1)	Freq	15.625 MHz	-0.094 dB																	
<p>2437</p>	<p>Agilent 09:41:52 Aug 10, 2010</p> <p>Ref 20.5 dBm #Atten 30 dB Mkr2 Δ 15.375 MHz -0.286 dB</p> <p>Center 2.437 GHz Span 50 MHz</p> <table border="1"> <thead> <tr> <th>Marker</th> <th>Trace</th> <th>Type</th> <th>X Axis</th> <th>Amplitude</th> </tr> </thead> <tbody> <tr> <td>1</td> <td>(1)</td> <td>Freq</td> <td>2.438250 GHz</td> <td>2.118 dBm</td> </tr> <tr> <td>2R</td> <td>(1)</td> <td>Freq</td> <td>2.429250 GHz</td> <td>-4.669 dBm</td> </tr> <tr> <td>2Δ</td> <td>(1)</td> <td>Freq</td> <td>15.375 MHz</td> <td>-0.286 dB</td> </tr> </tbody> </table> <p>Center 2.437 GHz #Res BW 100 kHz #VBW 100 kHz Sweep 6.442 ms (401 pts)</p>	Marker	Trace	Type	X Axis	Amplitude	1	(1)	Freq	2.438250 GHz	2.118 dBm	2R	(1)	Freq	2.429250 GHz	-4.669 dBm	2Δ	(1)	Freq	15.375 MHz	-0.286 dB
Marker	Trace	Type	X Axis	Amplitude																	
1	(1)	Freq	2.438250 GHz	2.118 dBm																	
2R	(1)	Freq	2.429250 GHz	-4.669 dBm																	
2Δ	(1)	Freq	15.375 MHz	-0.286 dB																	
<p>2462</p>	<p>Agilent 09:47:51 Aug 10, 2010</p> <p>Ref 20.5 dBm #Atten 30 dB Mkr2 Δ 15.625 MHz -0.437 dB</p> <p>Center 2.462 GHz Span 50 MHz</p> <table border="1"> <thead> <tr> <th>Marker</th> <th>Trace</th> <th>Type</th> <th>X Axis</th> <th>Amplitude</th> </tr> </thead> <tbody> <tr> <td>1</td> <td>(1)</td> <td>Freq</td> <td>2.460750 GHz</td> <td>1.748 dBm</td> </tr> <tr> <td>2R</td> <td>(1)</td> <td>Freq</td> <td>2.454250 GHz</td> <td>-4.465 dBm</td> </tr> <tr> <td>2Δ</td> <td>(1)</td> <td>Freq</td> <td>15.625 MHz</td> <td>-0.437 dB</td> </tr> </tbody> </table> <p>Center 2.462 GHz #Res BW 100 kHz #VBW 100 kHz Sweep 6.442 ms (401 pts)</p>	Marker	Trace	Type	X Axis	Amplitude	1	(1)	Freq	2.460750 GHz	1.748 dBm	2R	(1)	Freq	2.454250 GHz	-4.465 dBm	2Δ	(1)	Freq	15.625 MHz	-0.437 dB
Marker	Trace	Type	X Axis	Amplitude																	
1	(1)	Freq	2.460750 GHz	1.748 dBm																	
2R	(1)	Freq	2.454250 GHz	-4.465 dBm																	
2Δ	(1)	Freq	15.625 MHz	-0.437 dB																	

Mode 5: draft 802.11n Standard-20MHz Link Mode

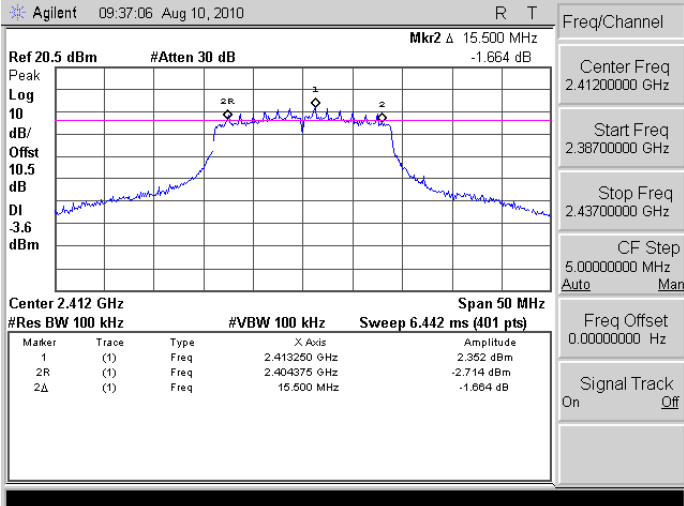
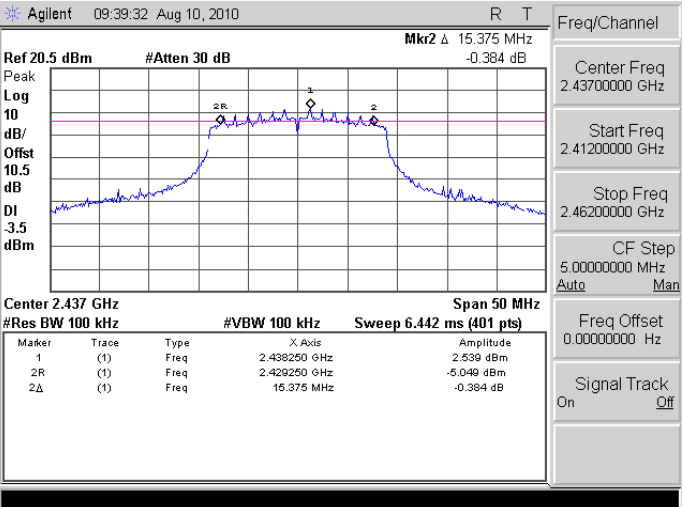
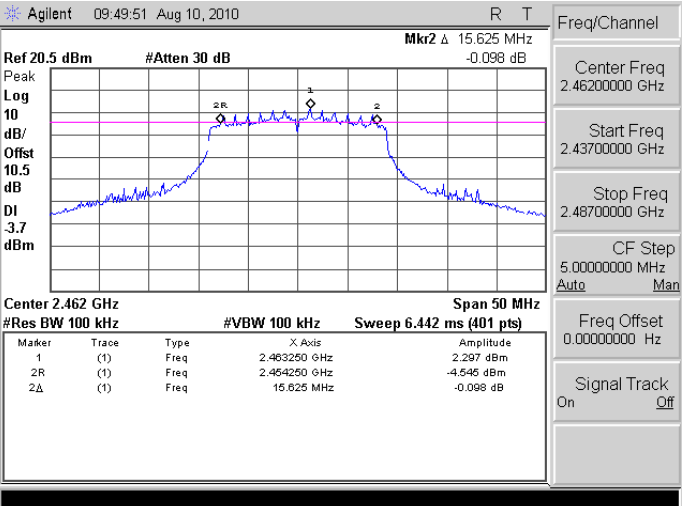
<p>2412</p>	
<p>2437</p>	
<p>2462</p>	

8 Maximum Power Density Measurement

8.1. Limit

For digitally modulated systems, the power spectral density conducted from the intentional radiator to the antenna shall not be greater than 8 dBm in any 3 kHz band during any time interval of continuous transmission.

8.2. Test Setup

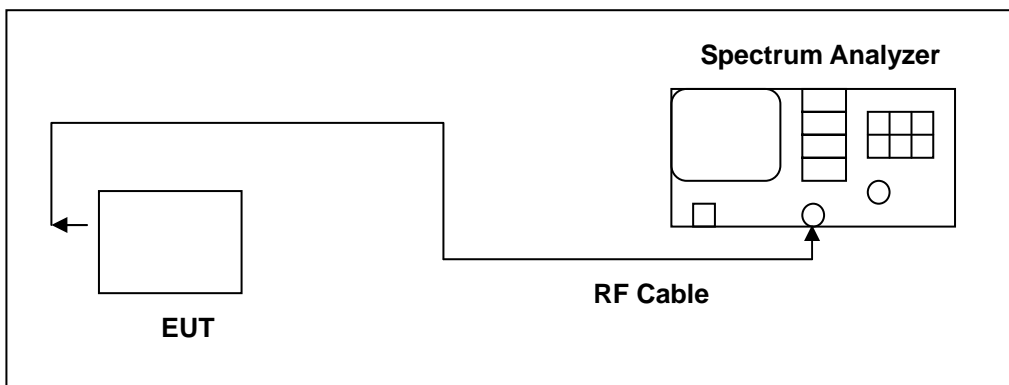

8.3. Test Instruments

Equipment	Manufacturer	Model Number	Serial Number	Cal. Date	Remark
Spectrum Analyzer	Agilent	E4445A	MY46181986	05/14/2009	(2)
Test Site	ATL	TE06	TE06	N.C.R.	-----

Remark: (1) Calibration period 1 year. (2) Calibration period 2 years.

NOTE: N.C.R. = No Calibration Request.

8.4. Test Procedure

The EUT was setup to ANSI C63.4, 2003; tested to DTS test procedure of Oct 2002 KDB558074 for compliance to FCC 47CFR 15.247 requirements.

The spectrum analyzer RES BW was set to 3 kHz. The START and STOP frequencies were set to the band edges of the maximum output pass band. If there is no clear maximum amplitude in any given portion of the band, it may be necessary to make measurements at a number of bands defined by several START and STOP frequency pairs. The specification calls for a 1 second interval at each 3 kHz bandwidth; total SWEEP TIME is calculated as follows:

$$\text{SWEEP TIME (SEC)} = (\text{Fstop, kHz} - \text{Fstart, kHz}) / 3 \text{ kHz}$$

Antenna output of the EUT was coupled directly to spectrum analyzer; if an external attenuator and/or cable was used, these losses are compensated for with the analyzer OFFSET function.

8.5. Test Result

Model Number	PC10110		
Test Item	Maximum Power Density		
Test Mode	Mode 3: IEEE 802.11b Link Mode		
Date of Test	08/10/2010	Test Site	TE06
	Frequency (MHz)	Measurement (dBm)	Limit (dBm)
	2412	-3.477	< 8
	2437	-3.256	< 8
	2462	-3.647	< 8

Model Number	PC10110		
Test Item	Maximum Power Density		
Test Mode	Mode 4: IEEE 802.11g Link Mode		
Date of Test	08/10/2010	Test Site	TE06
	Frequency (MHz)	Measurement (dBm)	Limit (dBm)
	2412	-11.03	< 8
	2437	-11.98	< 8
	2462	-11.64	< 8

Model Number	PC10110		
Test Item	Maximum Power Density		
Test Mode	Mode 5: draft 802.11n Standard-20MHz Link Mode		
Date of Test	08/10/2010	Test Site	TE06
	Frequency (MHz)	Measurement (dBm)	Limit (dBm)
	2412	-11.12	< 8
	2437	-11.90	< 8
	2462	-12.31	< 8

8.6. Test Graphs

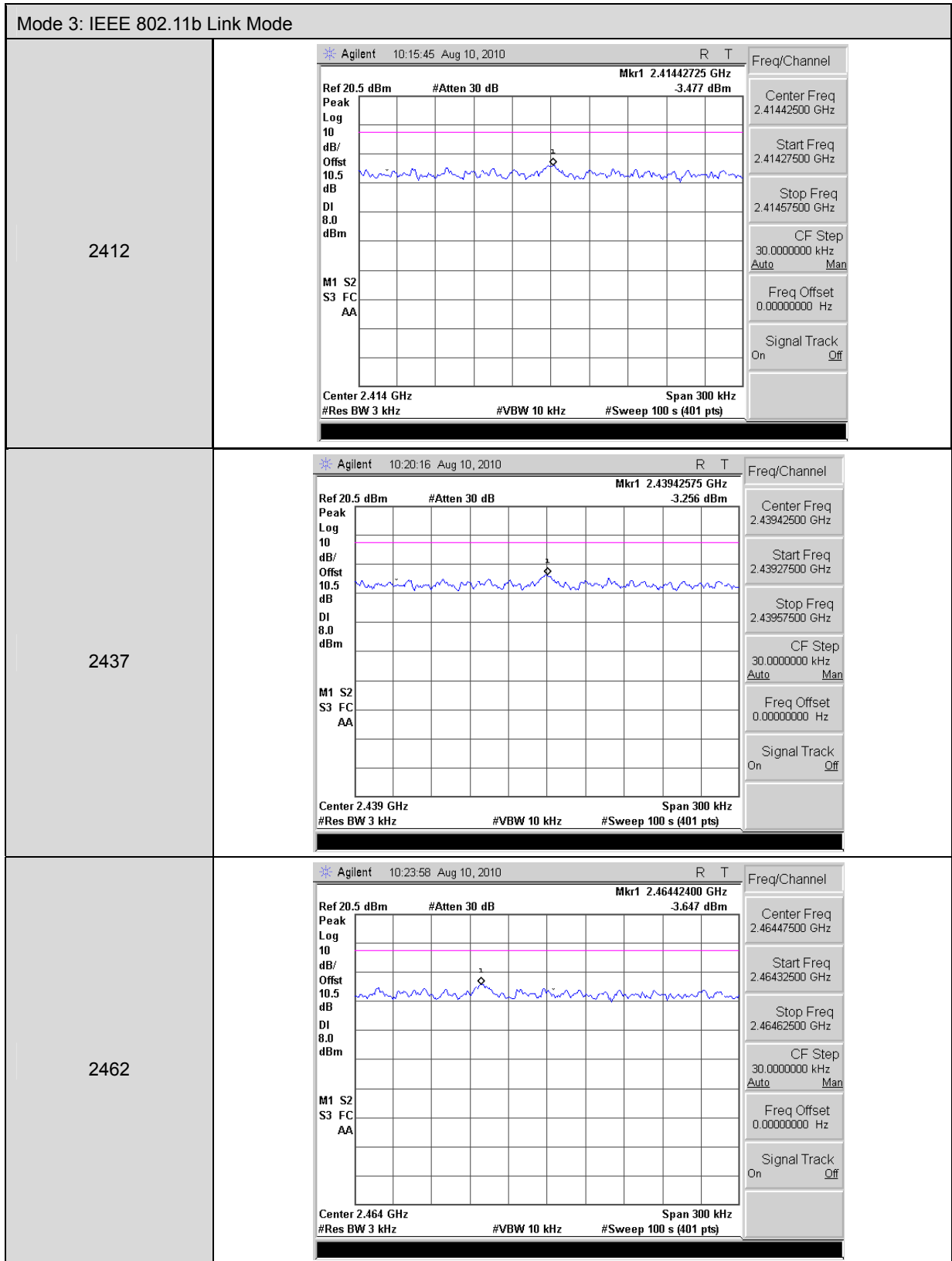

Mode 4: IEEE 802.11g Link Mode

2412	<p>Agilent 10:13:03 Aug 10, 2010 R T</p> <p>Ref 20.5 dBm #Atten 30 dB Mkr1 2.41385600 GHz -11.03 dBm</p> <p>Center 2.414 GHz Span 300 kHz #Res BW 3 kHz #VBW 10 kHz #Sweep 100 s (401 pts)</p>
2437	<p>Agilent 10:09:29 Aug 10, 2010 R T</p> <p>Ref 20.5 dBm #Atten 30 dB Mkr1 2.43510475 GHz -11.98 dBm</p> <p>Center 2.435 GHz Span 300 kHz #Res BW 3 kHz #VBW 10 kHz #Sweep 100 s (401 pts)</p>
2462	<p>Agilent 10:06:07 Aug 10, 2010 R T</p> <p>Ref 20.5 dBm #Atten 30 dB Mkr1 2.46321125 GHz -11.64 dBm</p> <p>Center 2.463 GHz Span 300 kHz #Res BW 3 kHz #VBW 10 kHz #Sweep 100 s (401 pts)</p>

Mode 5: draft 802.11n Standard-20MHz Link Mode

2412	<p>Agilent 09:56:23 Aug 10, 2010 R T</p> <p>Ref 20.5 dBm #Atten 30 dB Mkr1 2.41320375 GHz -11.12 dBm</p> <p>Peak Log 10 dB/Offst 10.5 dB DI 8.0 dBm</p> <p>M1 S2 S3 FC AA</p> <p>Center 2.413 GHz Span 300 kHz #Res BW 3 kHz #VBW 10 kHz #Sweep 100 s (401 pts)</p> <p>Freq/Channel: Center Freq 2.41324500 GHz, Start Freq 2.41309500 GHz, Stop Freq 2.41339500 GHz, CF Step 30.0000000 kHz, Freq Offset 0.00000000 Hz, Signal Track Off</p>
2437	<p>Agilent 10:00:25 Aug 10, 2010 R T</p> <p>Ref 20.5 dBm #Atten 30 dB Mkr1 2.43632900 GHz -11.9 dBm</p> <p>Peak Log 10 dB/Offst 10.5 dB DI 8.0 dBm</p> <p>M1 S2 S3 FC AA</p> <p>Center 2.436 GHz Span 300 kHz #Res BW 3 kHz #VBW 10 kHz #Sweep 100 s (401 pts)</p> <p>Freq/Channel: Center Freq 2.43635000 GHz, Start Freq 2.43620000 GHz, Stop Freq 2.43650000 GHz, CF Step 30.0000000 kHz, Freq Offset 0.00000000 Hz, Signal Track Off</p>
2462	<p>Agilent 10:03:06 Aug 10, 2010 R T</p> <p>Ref 20.5 dBm #Atten 30 dB Mkr1 2.46356875 GHz -12.31 dBm</p> <p>Peak Log 10 dB/Offst 10.5 dB DI 8.0 dBm</p> <p>M1 S2 S3 FC AA</p> <p>Center 2.464 GHz Span 300 kHz #Res BW 3 kHz #VBW 10 kHz #Sweep 100 s (401 pts)</p> <p>Freq/Channel: Center Freq 2.46355000 GHz, Start Freq 2.46340000 GHz, Stop Freq 2.46370000 GHz, CF Step 30.0000000 kHz, Freq Offset 0.00000000 Hz, Signal Track Off</p>

9 Out of Band Conducted Emissions Measurement

9.1. Limit

In any 100 kHz bandwidth outside the frequency band in which the spread spectrum or digitally modulated intentional radiator is operating, the radio frequency power that is produced by the intentional radiator shall be at least 20 dB below that in the 100 kHz bandwidth within the band that contains the highest level of the desired power

9.2. Test Setup

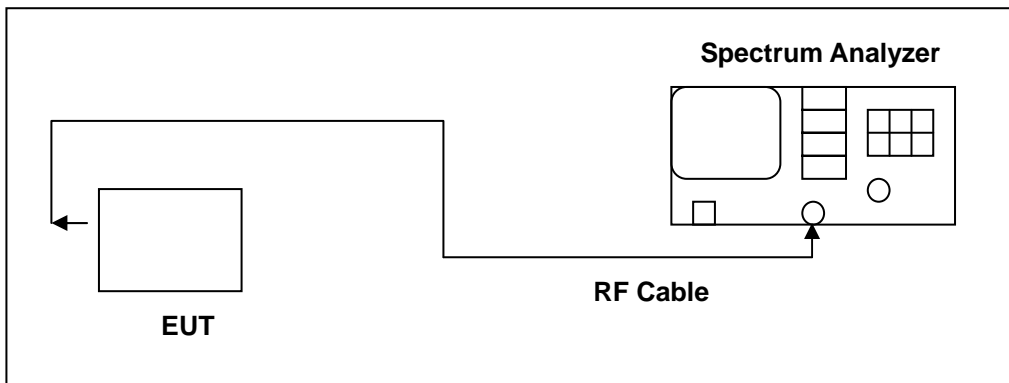

9.3. Test Instruments

Equipment	Manufacturer	Model Number	Serial Number	Cal. Date	Remark
Spectrum Analyzer	Agilent	E4445A	MY46181986	05/14/2009	(2)
Test Site	ATL	TE06	TE06	N.C.R.	-----

Remark: (1) Calibration period 1 year. (2) Calibration period 2 years.

NOTE: N.C.R. = No Calibration Request.

9.4. Test Procedure

In any 100 kHz bandwidth outside the EUT pass band, the RF power produced by the modulation products of the spreading sequence, the information sequence, and the carrier frequency shall be at least 20 dB below that of the maximum in-band 100 kHz emission, antenna output of the EUT was coupled directly to spectrum analyzer; if an external attenuator and/or cable was used, these losses are compensated for with the analyzer OFFSET function.

All other types of emissions from the EUT shall meet the general limits for radiated frequencies outside the pass band. The test was performed at 3 channels (Channel 1, 6, 11)

9.5. Test Graphs

Mode 3: IEEE 802.11b Link Mode	
2412	<p>Agilent 16:23:15 Aug 9, 2010 R T</p> <p>Ref 20.5 dBm #Atten 20 dB Mkr1 2.41 GHz 8.559 dBm</p> <p>#Peak 10</p> <p>Log dB/Offst 10.5 dB DI -11.4 dBm</p> <p>V1 S2 S3 FC AA</p> <p>Start 30 MHz Stop 26.5 GHz #Res BW 100 kHz #VBW 100 kHz Sweep 3.41 s (401 pts)</p> <p>Freq/Channel: Center Freq 13.2650000 GHz, Start Freq 30.0000000 MHz, Stop Freq 26.5000000 GHz, CF Step 2.64700000 GHz Auto Man, Freq Offset 0.00000000 Hz, Signal Track On Off</p>
2437	<p>Agilent 16:24:30 Aug 9, 2010 R T</p> <p>Ref 20.5 dBm #Atten 20 dB Mkr1 2.44 GHz 8.152 dBm</p> <p>#Peak 10</p> <p>Log dB/Offst 10.5 dB DI -11.8 dBm</p> <p>V1 S2 S3 FC AA</p> <p>Start 30 MHz Stop 26.5 GHz #Res BW 100 kHz #VBW 100 kHz Sweep 3.41 s (401 pts)</p> <p>Freq/Channel: Center Freq 13.2650000 GHz, Start Freq 30.0000000 MHz, Stop Freq 26.5000000 GHz, CF Step 2.64700000 GHz Auto Man, Freq Offset 0.00000000 Hz, Signal Track On Off</p>
2462	<p>Agilent 16:25:28 Aug 9, 2010 R T</p> <p>Ref 20.5 dBm #Atten 20 dB Mkr1 2.46 GHz 7.982 dBm</p> <p>#Peak 10</p> <p>Log dB/Offst 10.5 dB DI -12.0 dBm</p> <p>V1 S2 S3 FC AA</p> <p>Start 30 MHz Stop 26.5 GHz #Res BW 100 kHz #VBW 100 kHz Sweep 3.41 s (401 pts)</p> <p>Freq/Channel: Center Freq 13.2650000 GHz, Start Freq 30.0000000 MHz, Stop Freq 26.5000000 GHz, CF Step 2.64700000 GHz Auto Man, Freq Offset 0.00000000 Hz, Signal Track On Off</p>

Mode 4: IEEE 802.11g Link Mode	
2412	<p>Agilent 16:33:58 Aug 9, 2010 R T</p> <p>Ref 20.5 dBm #Atten 20 dB Mkr1 2.41 GHz -1.277 dBm</p> <p>#Peak Log 10 dB/Offst 10.5 dB DI -21.3 dBm V1 S2 S3 FC AA</p> <p>Start 30 MHz Stop 26.5 GHz #Res BW 100 kHz #VBW 100 kHz Sweep 3.41 s (401 pts)</p> <p>Freq/Channel: Center Freq 13.2650000 GHz, Start Freq 30.0000000 MHz, Stop Freq 26.5000000 GHz, CF Step 2.64700000 GHz Auto Man, Freq Offset 0.00000000 Hz, Signal Track On Off</p>
2437	<p>Agilent 16:32:20 Aug 9, 2010 R T</p> <p>Ref 20.5 dBm #Atten 20 dB Mkr1 2.44 GHz -1.694 dBm</p> <p>#Peak Log 10 dB/Offst 10.5 dB DI -21.7 dBm V1 S2 S3 FC AA</p> <p>Start 30 MHz Stop 26.5 GHz #Res BW 100 kHz #VBW 100 kHz Sweep 3.41 s (401 pts)</p> <p>Freq/Channel: Center Freq 13.2650000 GHz, Start Freq 30.0000000 MHz, Stop Freq 26.5000000 GHz, CF Step 2.64700000 GHz Auto Man, Freq Offset 0.00000000 Hz, Signal Track On Off</p>
2462	<p>Agilent 16:31:21 Aug 9, 2010 R T</p> <p>Ref 20.5 dBm #Atten 20 dB Mkr1 2.46 GHz -1.497 dBm</p> <p>#Peak Log 10 dB/Offst 10.5 dB DI -21.5 dBm V1 S2 S3 FC AA</p> <p>Start 30 MHz Stop 26.5 GHz #Res BW 100 kHz #VBW 100 kHz Sweep 3.41 s (401 pts)</p> <p>Freq/Channel: Center Freq 13.2650000 GHz, Start Freq 30.0000000 MHz, Stop Freq 26.5000000 GHz, CF Step 2.64700000 GHz Auto Man, Freq Offset 0.00000000 Hz, Signal Track On Off</p>

Mode 5: draft 802.11n Standard-20MHz Link Mode

<p>2412</p>	
<p>2437</p>	
<p>2462</p>	

10 Band Edges Measurement

10.1.Limit

In any 100 kHz bandwidth outside the intentional radiation frequency band, the radio frequency power shall be at least 20 dB below the highest level of the radiated power. In addition, radiated emissions which fall in the restricted bands must also comply with the radiated emission limits.

10.2.Test Setup

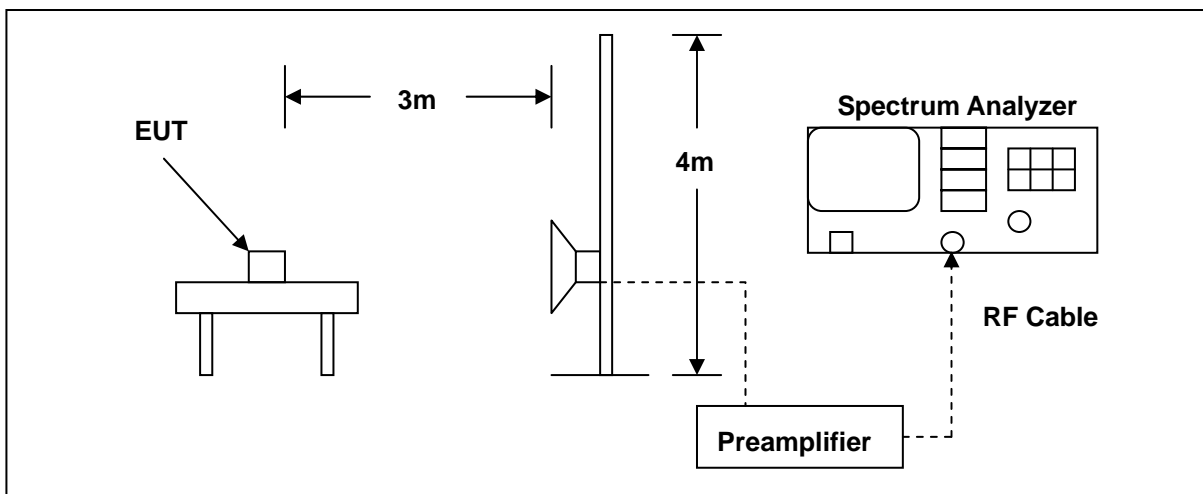

10.3.Test Instruments

Equipment	Manufacturer	Model Number	Serial Number	Cal. Date	Remark
Spectrum Analyzer	Agilent	E4408B	MY45107753	06/24/2010	(1)
Pre Amplifier	Agilent	8449B	3008A02237	02/24/2010	(1)
Horn Antenna	SCHWARZBECK MESS-ELEKTRONIK	9120D	9120D-550	06/29/2010	(1)
Test Site	ATL	TE06	TE06	N.C.R.	-----

Remark: (1) Calibration period 1 year. (2) Calibration period 2 years.

NOTE: N.C.R. = No Calibration Request.

10.4. Test Procedure

The EUT was setup to ANSI C63.4, 2003; tested to DTS test procedure of Oct 2002 KDB558074 for compliance to FCC 47CFR 15.247 requirements.

The emissions on the harmonics frequencies, the limits, and the margin of compliance are presented. These tests were made when the transmitter was in full radiated power. The additional test was performed to show compliance with the requirement at the band-edge frequency 2483.5 MHz and up to 2500 MHz and at 2390.0 MHz.

The transmitter was configured with the worst case antenna and setup to transmit at the highest channel. Then the field strength was measured at 2483.5 MHz.

The transmitter was then configured with the worst case antenna and setup to transmit at the lowest channel. Then the field strength was measured at 2390.0 MHz. These tests were performed at 4 different bit rates.

For measurements the resolution bandwidth is set to 1 MHz, and then the video bandwidth is set to 1 MHz for peak measurements and 10 Hz for average measurements.

10.5.Test Result

Standard:	FCC Part 15C	Test Distance:	3m
Test item:	Radiated Emission	Power:	AC 120V/60Hz
Model Number:	PC10110	Temp.(°C)/Hum.(%RH):	26(°C)/60%RH
Mode:	Mode 3	Date:	2010/08/09
Frequency:	2412 MHz	Test By:	Gary Wu
Ant.Polar.:	Horizontal		

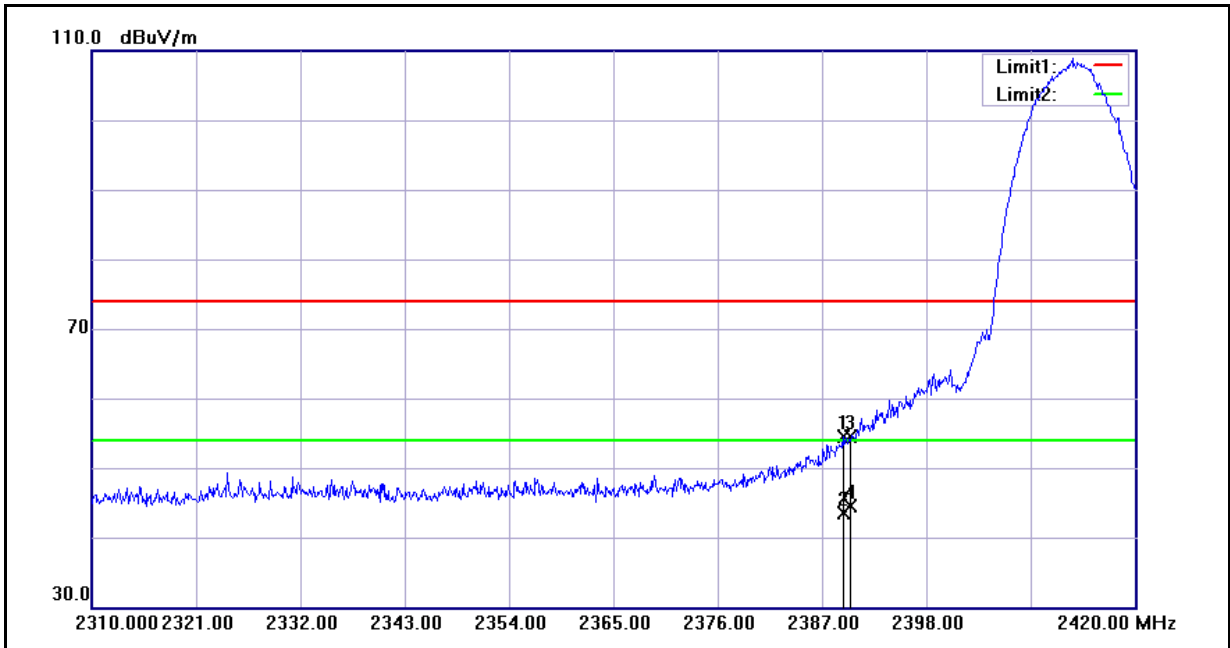

No.	Frequency (MHz)	Reading (dBuV)	Correct Factor(dB/m)	Result (dBuV/m)	Limit (dBuV/m)	Margin (dB)	Remark
1	2389.200	54.76	-0.22	54.54	74.00	-19.46	peak
2	2389.200	43.78	-0.22	43.56	54.00	-10.44	AVG
3	2390.000	54.70	-0.22	54.48	74.00	-19.52	peak
4	2390.000	44.68	-0.22	44.46	54.00	-9.54	AVG

Standard:	FCC Part 15C	Test Distance:	3m
Test item:	Radiated Emission	Power:	AC 120V/60Hz
Model Number:	PC10110	Temp.(°C)/Hum.(%RH):	26(°C)/60%RH
Mode:	Mode 3	Date:	2010/08/09
Frequency:	2412 MHz	Test By:	Gary Wu
Ant.Polar.:	Vertical		

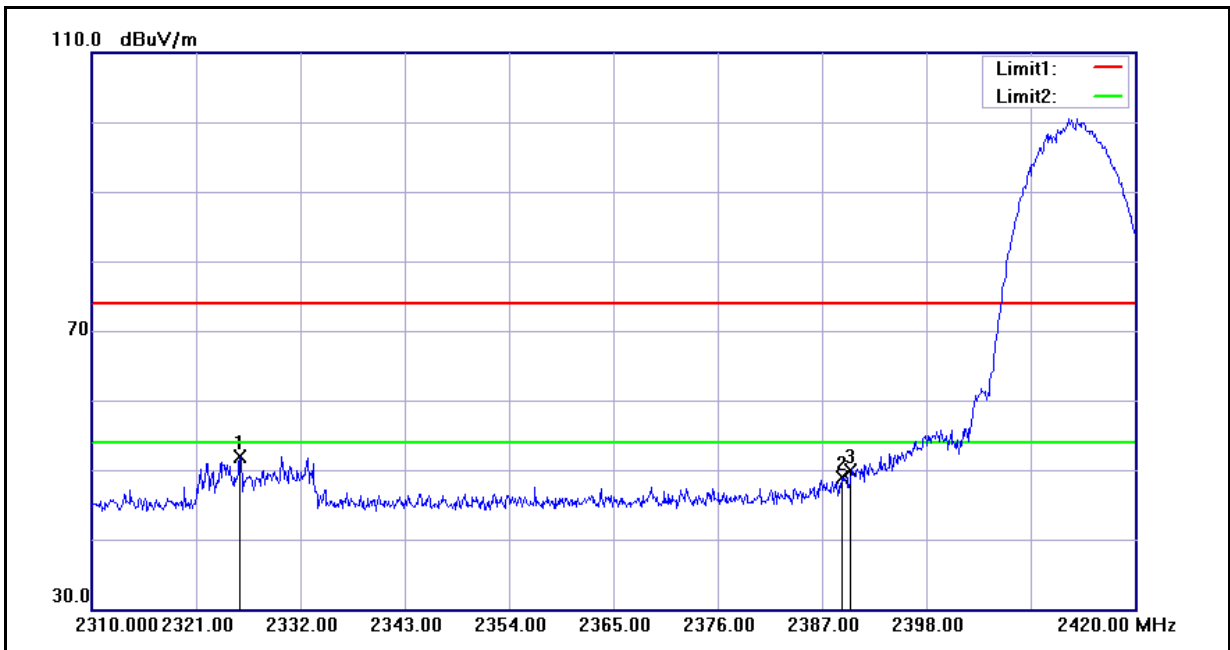

No.	Frequency (MHz)	Reading (dBuV)	Correct Factor(dB/m)	Result (dBuV/m)	Limit (dBuV/m)	Margin (dB)	Remark
1	2325.620	52.43	-0.47	51.96	74.00	-22.04	peak
2	2389.090	49.07	-0.22	48.85	74.00	-25.15	peak
3	2390.000	50.19	-0.22	49.97	74.00	-24.03	peak

Standard:	FCC Part 15C	Test Distance:	3m
Test item:	Radiated Emission	Power:	AC 120V/60Hz
Model Number:	PC10110	Temp.(°C)/Hum.(%RH):	26(°C)/60%RH
Mode:	Mode 3	Date:	2010/08/09
Frequency:	2462 MHz	Test By:	Gary Wu
Ant.Polar.:	Horizontal		

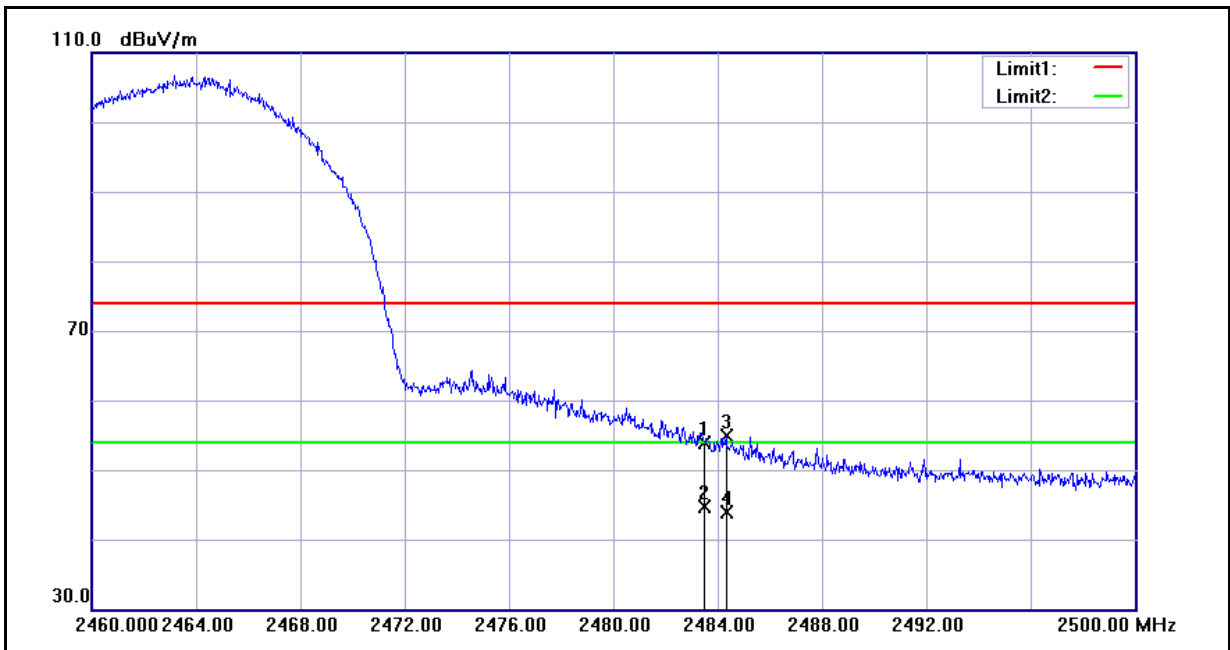

No.	Frequency (MHz)	Reading (dBuV)	Correct Factor(dB/m)	Result (dBuV/m)	Limit (dBuV/m)	Margin (dB)	Remark
1	2483.500	53.82	0.16	53.98	74.00	-20.02	peak
2	2483.500	44.46	0.16	44.62	54.00	-9.38	AVG
3	2484.320	54.76	0.16	54.92	74.00	-19.08	peak
4	2484.320	43.65	0.16	43.81	54.00	-10.19	AVG

Standard:	FCC Part 15C	Test Distance:	3m
Test item:	Radiated Emission	Power:	AC 120V/60Hz
Model Number:	PC10110	Temp.(°C)/Hum.(%RH):	26(°C)/60%RH
Mode:	Mode 3	Date:	2010/08/09
Frequency:	2462 MHz	Test By:	Gary Wu
Ant.Polar.:	Vertical		

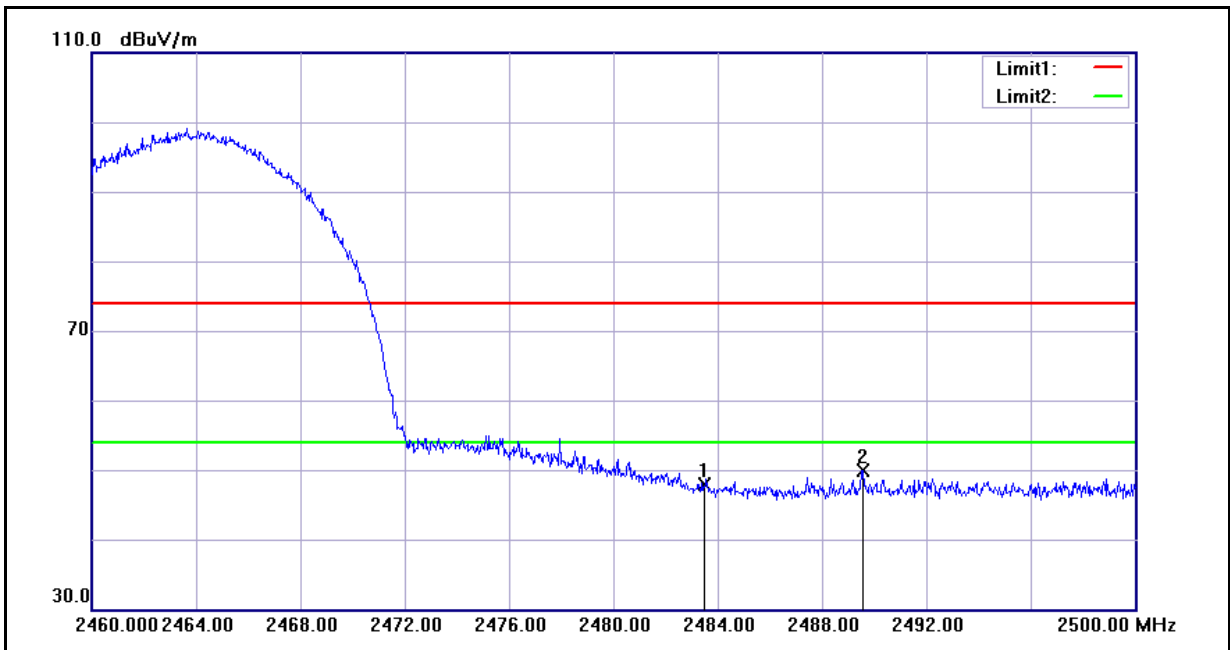

No.	Frequency (MHz)	Reading (dBuV)	Correct Factor(dB/m)	Result (dBuV/m)	Limit (dBuV/m)	Margin (dB)	Remark
1	2483.500	47.66	0.16	47.82	74.00	-26.18	peak
2	2489.560	49.79	0.18	49.97	74.00	-24.03	peak

Standard:	FCC Part 15C	Test Distance:	3m
Test item:	Radiated Emission	Power:	AC 120V/60Hz
Model Number:	PC10110	Temp.(°C)/Hum.(%RH):	26(°C)/60%RH
Mode:	Mode 4	Date:	2010/08/09
Frequency:	2412 MHz	Test By:	Gary Wu
Ant.Polar.:	Horizontal		

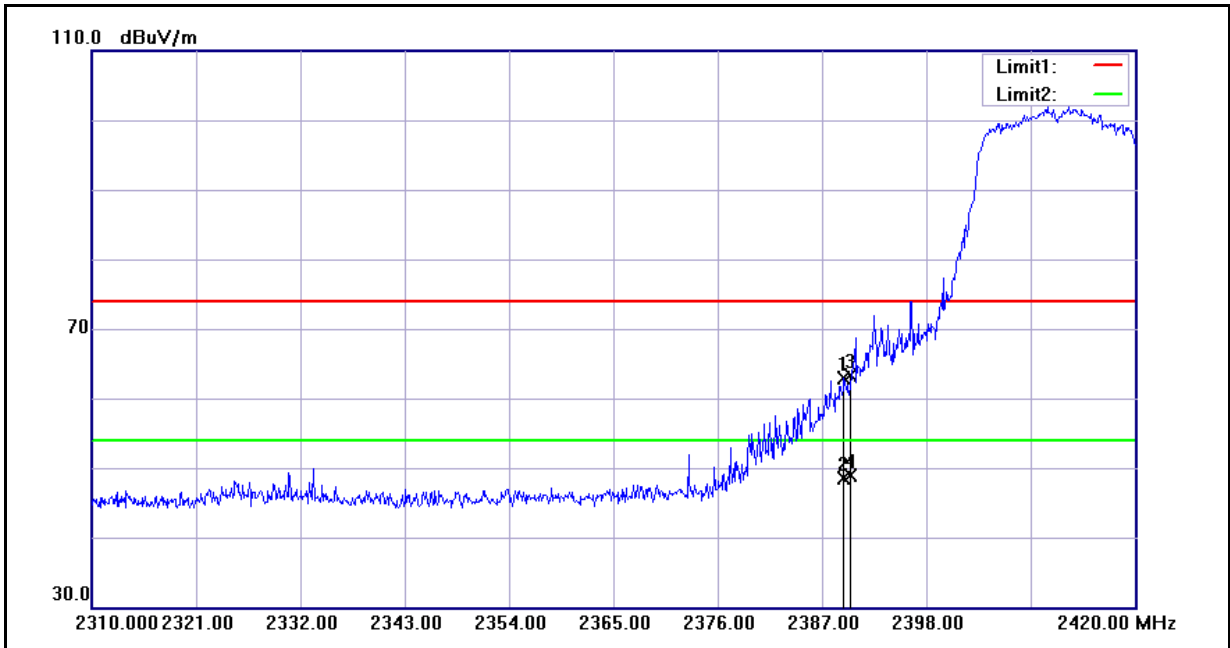

No.	Frequency (MHz)	Reading (dBuV)	Correct Factor(dB/m)	Result (dBuV/m)	Limit (dBuV/m)	Margin (dB)	Remark
1	2389.310	63.12	-0.22	62.90	74.00	-11.10	peak
2	2389.310	48.77	-0.22	48.55	54.00	-5.45	AVG
3	2390.000	63.43	-0.22	63.21	74.00	-10.79	peak
4	2390.000	49.09	-0.22	48.87	54.00	-5.13	AVG

Standard:	FCC Part 15C	Test Distance:	3m
Test item:	Radiated Emission	Power:	AC 120V/60Hz
Model Number:	PC10110	Temp.(°C)/Hum.(%RH):	26(°C)/60%RH
Mode:	Mode 4	Date:	2010/08/09
Frequency:	2412 MHz	Test By:	Gary Wu
Ant.Polar.:	Vertical		

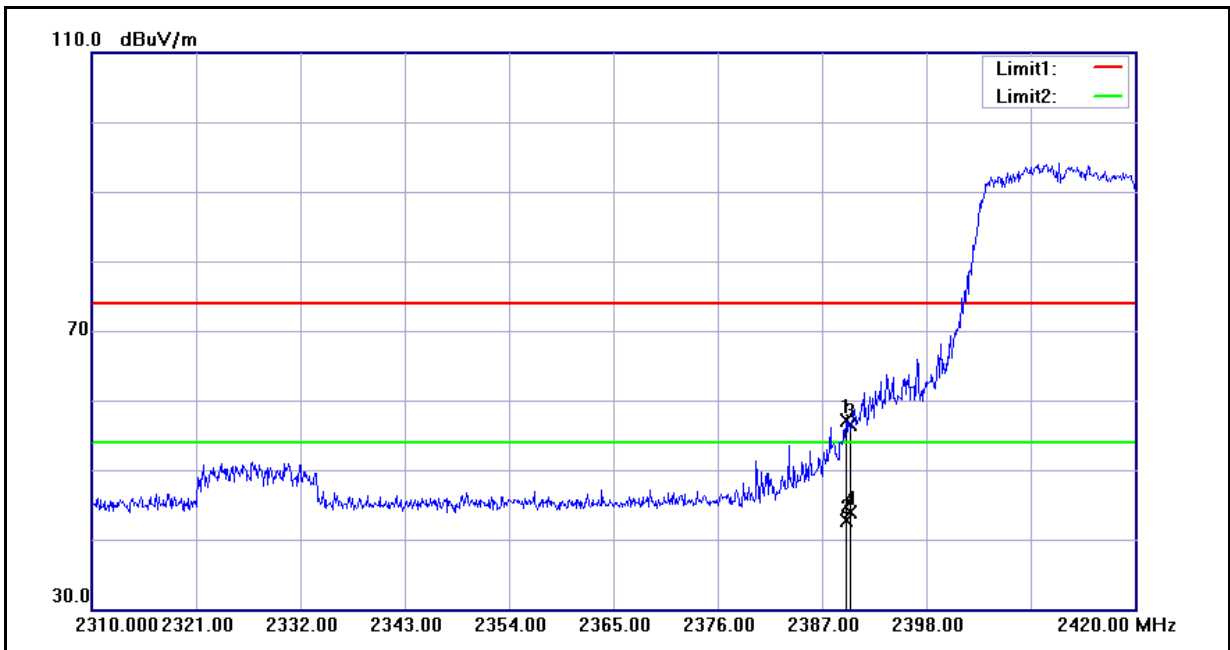

No.	Frequency (MHz)	Reading (dBuV)	Correct Factor(dB/m)	Result (dBuV/m)	Limit (dBuV/m)	Margin (dB)	Remark
1	2389.530	57.25	-0.22	57.03	74.00	-16.97	peak
2	2389.530	42.90	-0.22	42.68	54.00	-11.32	AVG
3	2390.000	56.64	-0.22	56.42	74.00	-17.58	peak
4	2390.000	44.16	-0.22	43.94	54.00	-10.06	AVG

Standard:	FCC Part 15C	Test Distance:	3m
Test item:	Radiated Emission	Power:	AC 120V/60Hz
Model Number:	PC10110	Temp.(°C)/Hum.(%RH):	26(°C)/60%RH
Mode:	Mode 4	Date:	2010/08/09
Frequency:	2462 MHz	Test By:	Gary Wu
Ant.Polar.:	Horizontal		

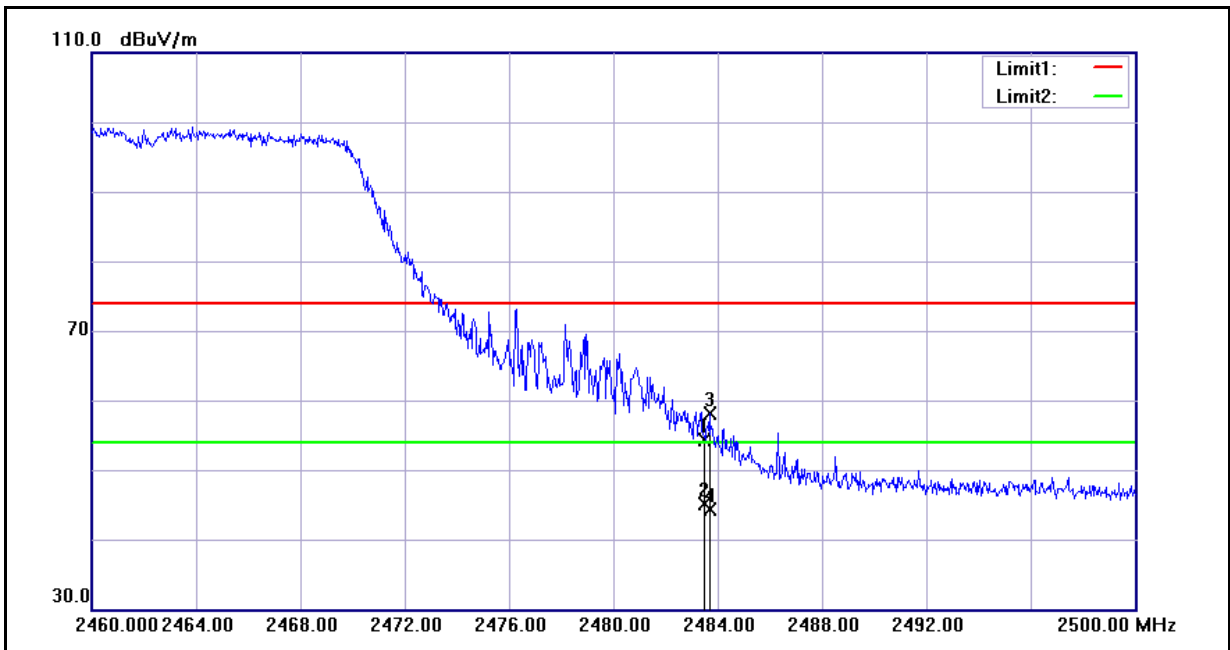

No.	Frequency (MHz)	Reading (dBuV)	Correct Factor(dB/m)	Result (dBuV/m)	Limit (dBuV/m)	Margin (dB)	Remark
1	2483.500	54.07	0.16	54.23	74.00	-19.77	peak
2	2483.500	44.94	0.16	45.10	54.00	-8.90	AVG
3	2483.680	58.00	0.16	58.16	74.00	-15.84	peak
4	2483.680	44.10	0.16	44.26	54.00	-9.74	AVG

Standard:	FCC Part 15C	Test Distance:	3m
Test item:	Radiated Emission	Power:	AC 120V/60Hz
Model Number:	PC10110	Temp.(°C)/Hum.(%RH):	26(°C)/60%RH
Mode:	Mode 4	Date:	2010/08/09
Frequency:	2462 MHz	Test By:	Gary Wu
Ant.Polar.:	Vertical		

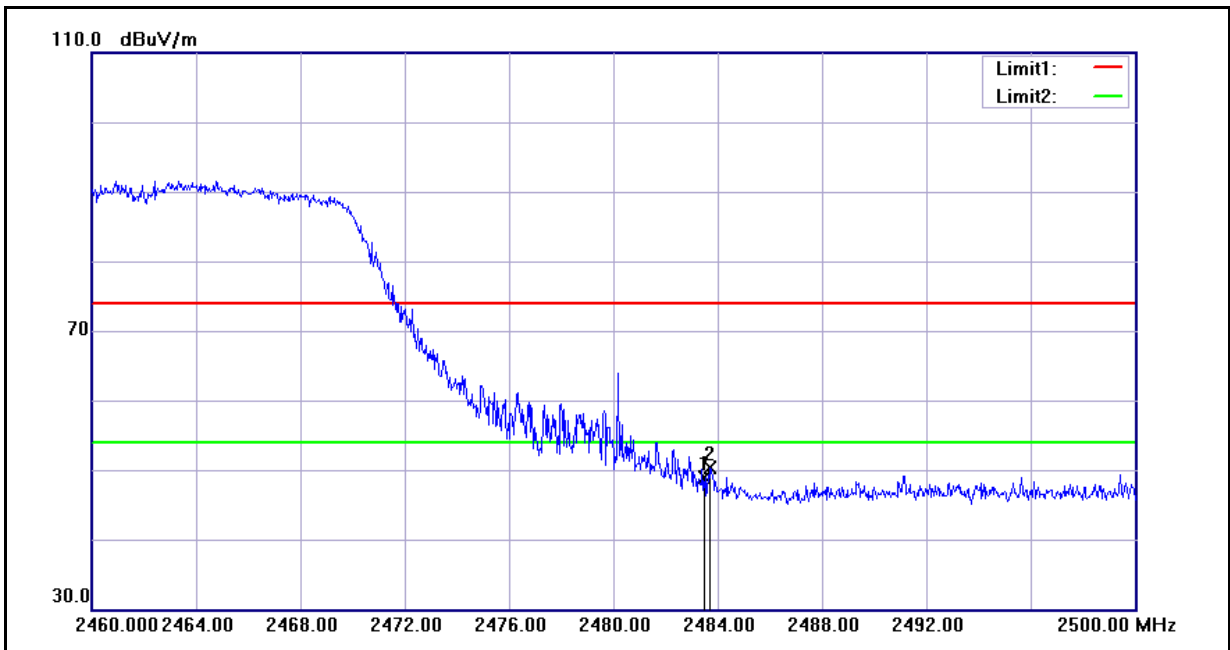

No.	Frequency (MHz)	Reading (dBuV)	Correct Factor(dB/m)	Result (dBuV/m)	Limit (dBuV/m)	Margin (dB)	Remark
1	2483.500	48.67	0.16	48.83	74.00	-25.17	peak
2	2483.720	50.15	0.16	50.31	74.00	-23.69	peak

Standard:	FCC Part 15C	Test Distance:	3m
Test item:	Radiated Emission	Power:	AC 120V/60Hz
Model Number:	PC10110	Temp.(°C)/Hum.(%RH):	26(°C)/60%RH
Mode:	Mode 5	Date:	2010/08/09
Frequency:	2412 MHz	Test By:	Gary Wu
Ant.Polar.:	Horizontal		

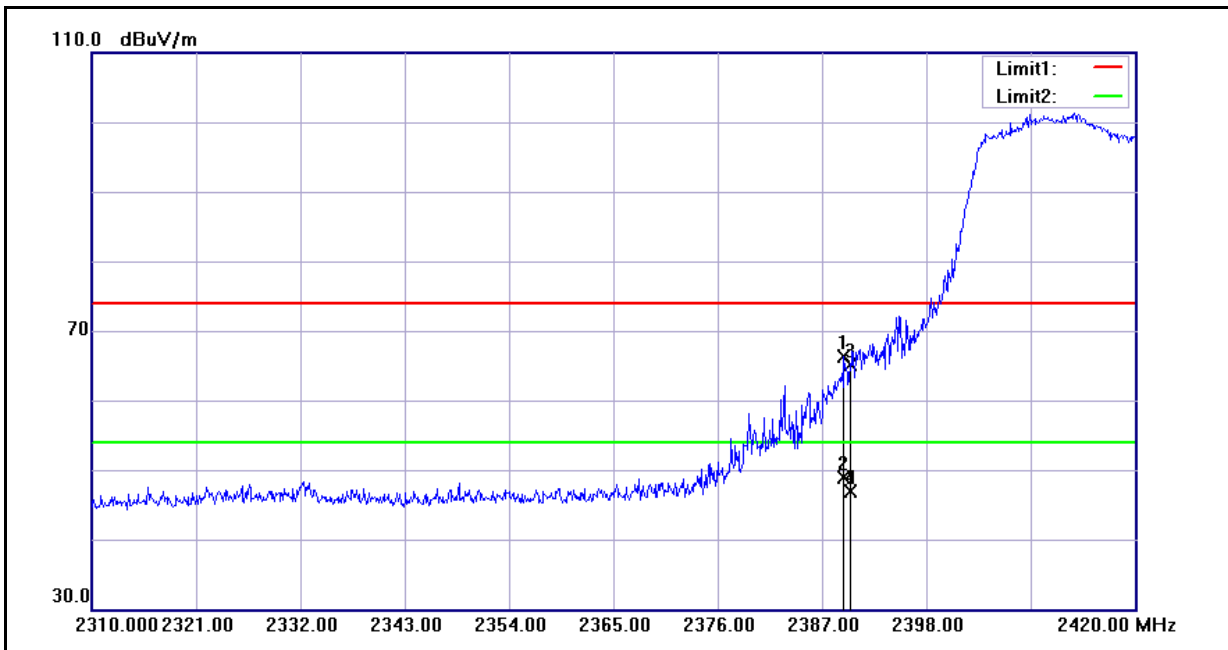

No.	Frequency (MHz)	Reading (dBuV)	Correct Factor(dB/m)	Result (dBuV/m)	Limit (dBuV/m)	Margin (dB)	Remark
1	2389.310	66.44	-0.22	66.22	74.00	-7.78	peak
2	2389.310	49.16	-0.22	48.94	54.00	-5.06	AVG
3	2390.000	65.38	-0.22	65.16	74.00	-8.84	peak
4	2390.000	47.08	-0.22	46.86	54.00	-7.14	AVG

Standard:	FCC Part 15C	Test Distance:	3m
Test item:	Radiated Emission	Power:	AC 120V/60Hz
Model Number:	PC10110	Temp.(°C)/Hum.(%RH):	26(°C)/60%RH
Mode:	Mode 5	Date:	2010/08/09
Frequency:	2412 MHz	Test By:	Gary Wu
Ant.Polar.:	Vertical		

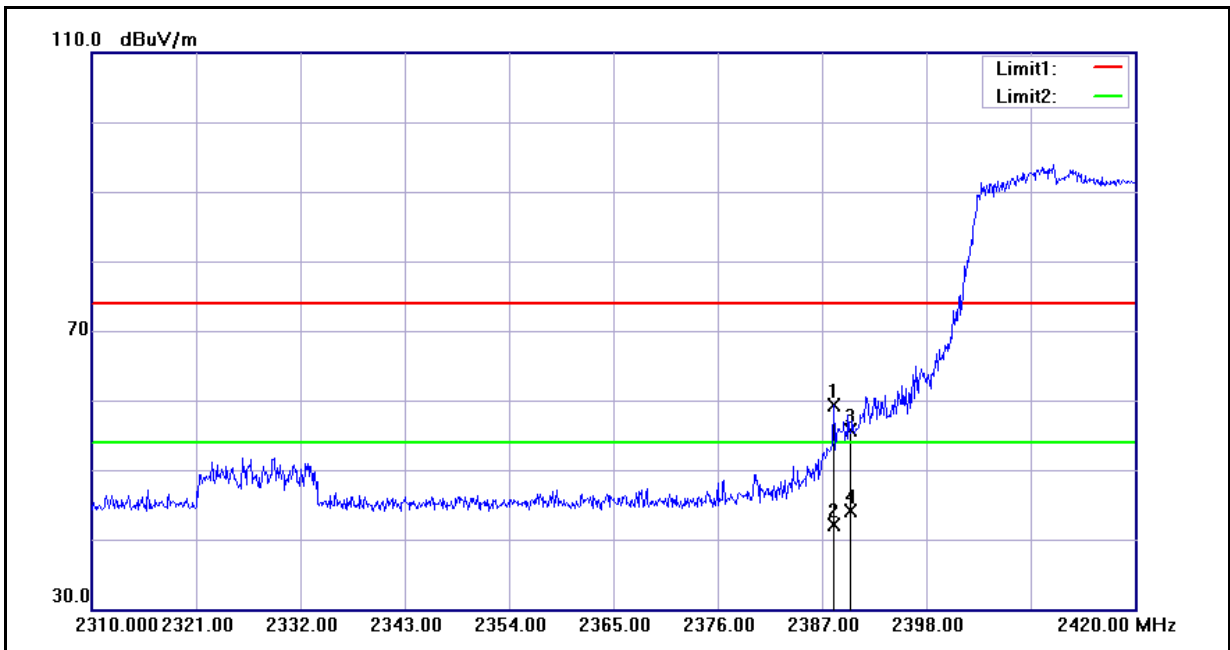

No.	Frequency (MHz)	Reading (dBuV)	Correct Factor(dB/m)	Result (dBuV/m)	Limit (dBuV/m)	Margin (dB)	Remark
1	2388.210	59.60	-0.22	59.38	74.00	-14.62	peak
2	2388.210	42.35	-0.22	42.13	54.00	-11.87	AVG
3	2390.000	55.97	-0.22	55.75	74.00	-18.25	peak
4	2390.000	44.35	-0.22	44.13	54.00	-9.87	AVG

Standard:	FCC Part 15C	Test Distance:	3m
Test item:	Radiated Emission	Power:	AC 120V/60Hz
Model Number:	PC10110	Temp.(°C)/Hum.(%RH):	26(°C)/60%RH
Mode:	Mode 5	Date:	2010/08/09
Frequency:	2462 MHz	Test By:	Gary Wu
Ant.Polar.:	Horizontal		

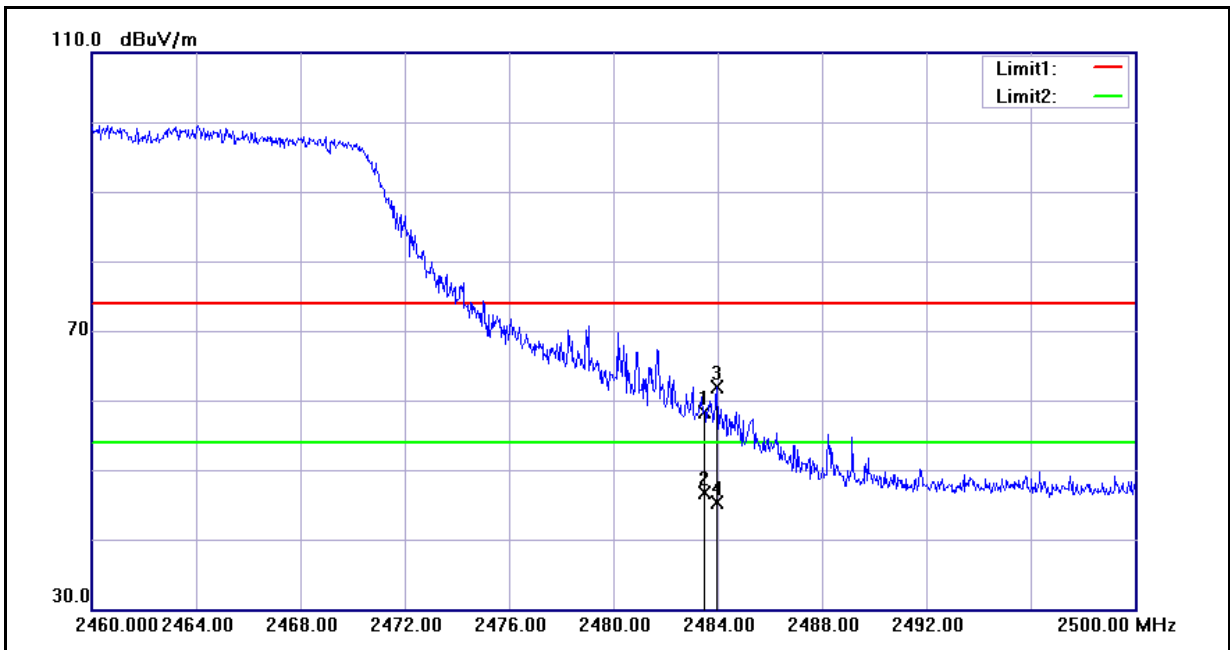

No.	Frequency (MHz)	Reading (dBuV)	Correct Factor(dB/m)	Result (dBuV/m)	Limit (dBuV/m)	Margin (dB)	Remark
1	2483.500	58.15	0.16	58.31	74.00	-15.69	peak
2	2483.500	46.60	0.16	46.76	54.00	-7.24	AVG
3	2483.960	61.69	0.16	61.85	74.00	-12.15	peak
4	2483.960	45.07	0.16	45.23	54.00	-8.77	AVG

Standard:	FCC Part 15C	Test Distance:	3m
Test item:	Radiated Emission	Power:	AC 120V/60Hz
Model Number:	PC10110	Temp.(°C)/Hum.(%RH):	26(°C)/60%RH
Mode:	Mode 5	Date:	2010/08/09
Frequency:	2462 MHz	Test By:	Gary Wu
Ant.Polar.:	Vertical		

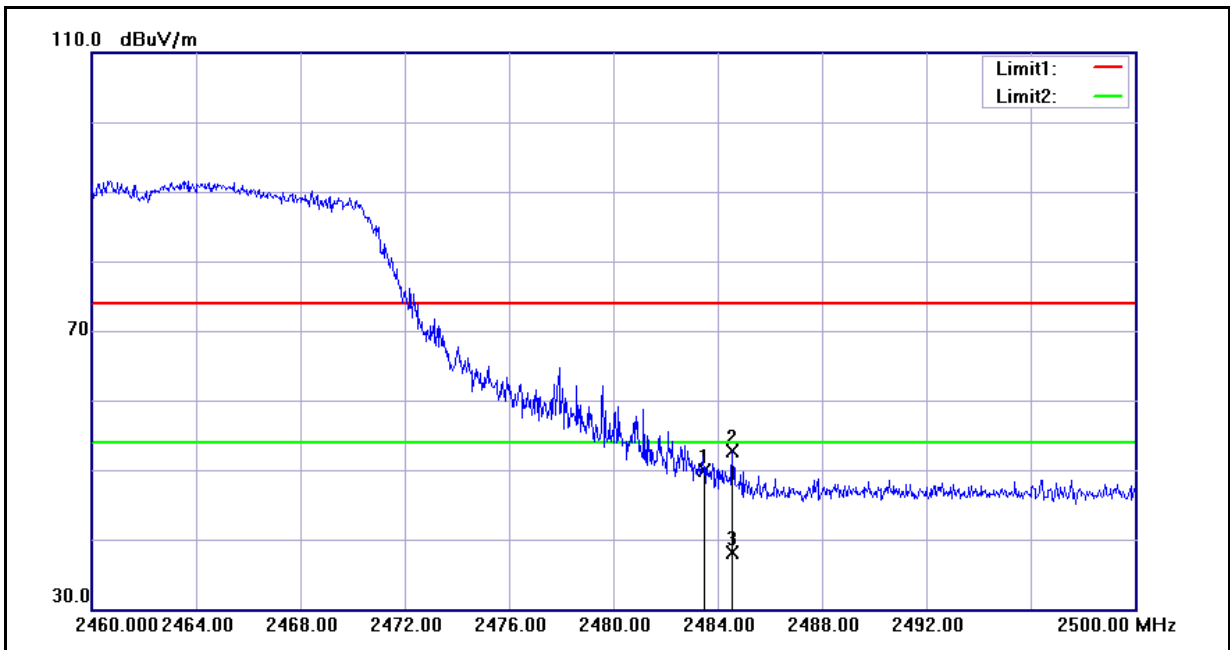

No.	Frequency (MHz)	Reading (dBuV)	Correct Factor(dB/m)	Result (dBuV/m)	Limit (dBuV/m)	Margin (dB)	Remark
1	2483.500	49.76	0.16	49.92	74.00	-24.08	peak
2	2484.560	52.59	0.16	52.75	74.00	-21.25	peak
3	2484.560	37.86	0.16	38.02	54.00	-15.98	AVG

11 99 % Occupied Bandwidth Measurement

11.1.Limit

N/A

11.2.Test Setup

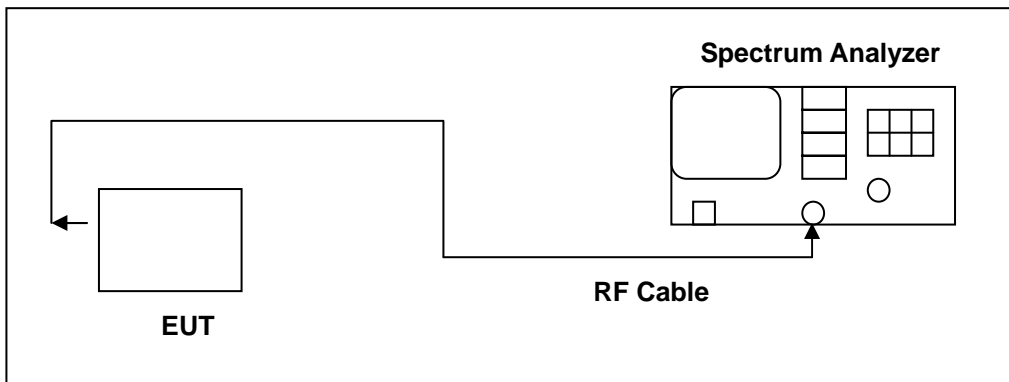

11.3.Test Instruments

Equipment	Manufacturer	Model Number	Serial Number	Cal. Date	Remark
Spectrum Analyzer	Agilent	E4445A	MY46181986	05/14/2009	(2)
Test Site	ATL	TE06	TE06	N.C.R.	-----

Remark: (1) Calibration period 1 year. (2) Calibration period 2 years.

NOTE: N.C.R. = No Calibration Request.

11.4.Test Procedure

The transmitter output is connected to the spectrum analyzer. The RBW is set to 1% to 3% of the 99 % bandwidth. The VBW is set to 3 times the RBW. The sweep time is coupled.

11.5.Test Result

Model Number	PC10110		
Test Item	99 % Occupied Bandwidth		
Test Mode	Mode 3: IEEE 802.11b Link Mode		
Date of Test	08/09/2010	Test Site	TE06
Frequency (MHz)	Measurement (kHz)	Limit (kHz)	
2412	11402.8	----	
2437	11274.3	----	
2462	11334.3	----	

Model Number	PC10110		
Test Item	99 % Occupied Bandwidth		
Test Mode	Mode 4: IEEE 802.11g Link Mode		
Date of Test	08/09/2010	Test Site	TE06
Frequency (MHz)	Measurement (kHz)	Limit (kHz)	
2412	16778.8	----	
2437	16740.9	----	
2462	16688.9	----	

Model Number	PC10110		
Test Item	99 % Occupied Bandwidth		
Test Mode	Mode 5: draft 802.11n Standard-20MHz Link Mode		
Date of Test	08/09/2010	Test Site	TE06
Frequency (MHz)	Measurement (kHz)	Limit (kHz)	
2412	17826.8	----	
2437	17788.2	----	
2462	17775.5	----	

11.6. Test Graphs

Mode 3: IEEE 802.11b Link Mode	
2412	<p>Agilent 16:45:36 Aug 9, 2010 R T</p> <p>Ch Freq 2.412 GHz Trig Free</p> <p>Occupied Bandwidth</p> <p>Ref 20.5 dBm #Atten 20 dB</p> <p>#Peak Log 10 dB/ Offst 10.5 dB</p> <p>Center 2.412 GHz Span 50 MHz #Res BW 300 kHz #VBW 1 MHz Sweep 4 ms (401 pts)</p> <p>Occupied Bandwidth Occ BW % Pwr 99.00 % 11.4028 MHz x dB -26.00 dB</p> <p>Transmit Freq Error 1.449 MHz x dB Bandwidth 14.457 MHz</p> <p>Freq/Channel Center Freq 2.41200000 GHz Start Freq 2.38700000 GHz Stop Freq 2.43700000 GHz CF Step 5.00000000 MHz Auto Man Freq Offset 0.00000000 Hz Signal Track On Off</p>
2437	<p>Agilent 16:46:45 Aug 9, 2010 R T</p> <p>Ch Freq 2.437 GHz Trig Free</p> <p>Occupied Bandwidth</p> <p>Ref 20.5 dBm #Atten 20 dB</p> <p>#Peak Log 10 dB/ Offst 10.5 dB</p> <p>Center 2.437 GHz Span 50 MHz #Res BW 300 kHz #VBW 1 MHz Sweep 4 ms (401 pts)</p> <p>Occupied Bandwidth Occ BW % Pwr 99.00 % 11.2743 MHz x dB -26.00 dB</p> <p>Transmit Freq Error 1.446 MHz x dB Bandwidth 14.258 MHz</p> <p>Freq/Channel Center Freq 2.43700000 GHz Start Freq 2.41200000 GHz Stop Freq 2.46200000 GHz CF Step 5.00000000 MHz Auto Man Freq Offset 0.00000000 Hz Signal Track On Off</p>
2462	<p>Agilent 16:51:32 Aug 9, 2010 R T</p> <p>Ch Freq 2.462 GHz Trig Free</p> <p>Occupied Bandwidth</p> <p>Ref 20.5 dBm #Atten 20 dB</p> <p>#Peak Log 10 dB/ Offst 10.5 dB</p> <p>Center 2.462 GHz Span 50 MHz #Res BW 300 kHz #VBW 1 MHz Sweep 4 ms (401 pts)</p> <p>Occupied Bandwidth Occ BW % Pwr 99.00 % 11.3343 MHz x dB -26.00 dB</p> <p>Transmit Freq Error 1.453 MHz x dB Bandwidth 14.372 MHz</p> <p>Freq/Channel Center Freq 2.46200000 GHz Start Freq 2.43700000 GHz Stop Freq 2.48700000 GHz CF Step 5.00000000 MHz Auto Man Freq Offset 0.00000000 Hz Signal Track On Off</p>

Mode 4: IEEE 802.11g Link Mode

<p>2412</p>	
<p>2437</p>	
<p>2462</p>	

Mode 5: draft 802.11n Standard-20MHz Link Mode

<p>2412</p>	<p>Agilent 16:41:53 Aug 9, 2010 R T</p> <p>Ch Freq 2.412 GHz Trig Free</p> <p>Occupied Bandwidth</p> <p>Ref 20.5 dBm #Atten 20 dB</p> <p>#Peak Log 10 dB/Offset 10.5 dB</p> <p>Center 2.412 GHz Span 50 MHz #Res BW 300 kHz #VBW 1 MHz Sweep 4 ms (401 pts)</p> <p>Occupied Bandwidth Occ BW % Pwr 99.00 % 17.8268 MHz x dB -26.00 dB</p> <p>Transmit Freq Error -5.715 kHz x dB Bandwidth 22.821 MHz</p> <p>Freq/Channel: Center Freq 2.41200000 GHz, Start Freq 2.38700000 GHz, Stop Freq 2.43700000 GHz, CF Step 5.00000000 MHz, Freq Offset 0.00000000 Hz, Signal Track On</p>
<p>2437</p>	<p>Agilent 16:47:48 Aug 9, 2010 R T</p> <p>Ch Freq 2.437 GHz Trig Free</p> <p>Occupied Bandwidth</p> <p>Ref 20.5 dBm #Atten 20 dB</p> <p>#Peak Log 10 dB/Offset 10.5 dB</p> <p>Center 2.437 GHz Span 50 MHz #Res BW 300 kHz #VBW 1 MHz Sweep 4 ms (401 pts)</p> <p>Occupied Bandwidth Occ BW % Pwr 99.00 % 17.7882 MHz x dB -26.00 dB</p> <p>Transmit Freq Error -2.025 kHz x dB Bandwidth 22.388 MHz</p> <p>Freq/Channel: Center Freq 2.43700000 GHz, Start Freq 2.41200000 GHz, Stop Freq 2.46200000 GHz, CF Step 5.00000000 MHz, Freq Offset 0.00000000 Hz, Signal Track On</p>
<p>2462</p>	<p>Agilent 16:53:06 Aug 9, 2010 R T</p> <p>Ch Freq 2.462 GHz Trig Free</p> <p>Occupied Bandwidth</p> <p>Ref 20.5 dBm #Atten 20 dB</p> <p>#Peak Log 10 dB/Offset 10.5 dB</p> <p>Center 2.462 GHz Span 50 MHz #Res BW 300 kHz #VBW 1 MHz Sweep 4 ms (401 pts)</p> <p>Occupied Bandwidth Occ BW % Pwr 99.00 % 17.7755 MHz x dB -26.00 dB</p> <p>Transmit Freq Error -7.864 kHz x dB Bandwidth 21.889 MHz</p> <p>Freq/Channel: Center Freq 2.46200000 GHz, Start Freq 2.43700000 GHz, Stop Freq 2.48700000 GHz, CF Step 5.00000000 MHz, Freq Offset 0.00000000 Hz, Signal Track On</p>

12 Antenna Measurement

12.1.Limit

For intentional device, according to 15.203, an intentional radiator shall be designed to ensure that no antenna other than that furnished by the responsible party shall be used with the device.

And According to 15.247 (b), if transmitting antennas of directional gain greater than 6 dBi are used, the power shall be reduced by the amount in dB that the directional gain of the antenna exceeds 6dBi.

12.2.Antenna Connector Construction

The antenna used in this product is **PIFA antenna**. And the maximum Gain of this antenna is only **1.69 dBi**.