

# Your HTC Desire Z User guide

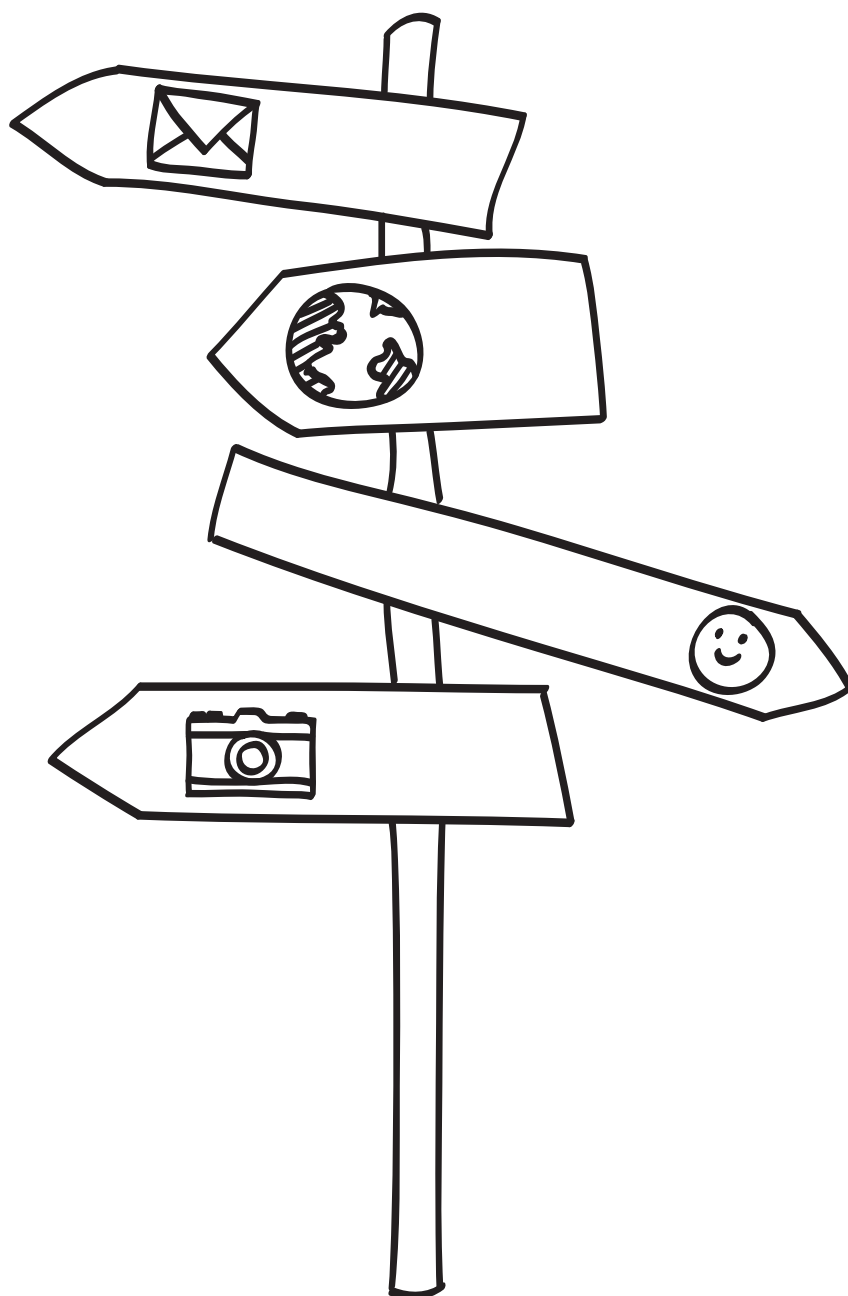

**htc**  
*quietly brilliant*

---

## Conventions used in this guide

---

In this user guide, we use the following symbols to indicate useful and important information:



This is a note. A note often gives additional information, such as what happens on your phone when you choose to do or not to do a certain action. A note also provides information that may only be applicable to some situations.



This is a tip. A tip gives you an alternative way to do a particular step or procedure, or lets you know of an option that you may find helpful.



This indicates that something is very important. Important information is something that you need to do in order to accomplish a certain task or to get a phone feature to work properly.



This provides safety precaution information, that is, information that you need to be careful about to prevent potential problems when using your phone.

# Contents

<b>Basics</b>	<b>7</b>
Inside the box	7
Your phone	7
Back cover	10
SIM card	11
Storage card	12
Battery	14
Switching your phone on or off	17
Entering your PIN	17
Finger gestures	17
Using the trackpad to interact with the touch screen	18
<b>Getting started</b>	<b>20</b>
Setting up your phone for the first time	20
Home screen	20
Status and notifications	22
Notifications panel	24
Connecting your phone to a computer	25
Searching your phone and the Web	27
Adjusting the volume	29
Sleep mode	30
<b>Personalizing</b>	<b>31</b>
Making your phone truly yours	31
Personalizing your phone with scenes	31
Changing your wallpaper	32
Applying a new skin	33
Personalizing your Home screen with widgets	33
Adding icons and other shortcuts on your Home screen	35
Adding folders on your Home screen	35
Rearranging or removing widgets and icons on your Home screen	36
Rearranging the Home screen	37
Changing your ringtones and alarms	38
Rearranging or hiding application tabs	40
<b>Phone calls</b>	<b>41</b>
Making calls	41
Receiving calls	44
HTC Caller ID	45
Using in-call options	45
Using Call history	48
Blocking callers	49
Call services	50
Turning Airplane mode on or off	50

<b>People</b>	<b>51</b>
About People	51
Setting up My contact card	52
Ways of getting contacts into your phone	52
Merging contact information	54
Your contacts list	56
Contact information and conversations	58
Contact groups	60
People widget	62
<b>Keyboard</b>	<b>63</b>
Using the slideout keyboard	63
Using the onscreen keyboard	64
Entering words with predictive text	66
Entering text by speaking	67
Copying and pasting text	68
Adjusting touch input settings	69
<b>Messages</b>	<b>71</b>
About Messages	71
Sending a text message (SMS)	72
Sending a multimedia message (MMS)	73
Resuming a draft message	74
Viewing and replying to a message	74
Managing message conversations	77
Setting message options	78
<b>Accounts and sync</b>	<b>80</b>
Synchronizing with online accounts	80
Synchronizing with your computer	83
<b>Social</b>	<b>90</b>
Facebook for HTC Sense	90
Facebook for Android	91
What's the difference between Facebook for Android and Facebook for HTC Sense?	92
Tweeting on your phone	92
Friend Stream	95
Chatting in Google Talk	98
<b>Email</b>	<b>100</b>
Using Gmail/Google Mail	100
Using Mail	105
<b>Calendar</b>	<b>113</b>
About Calendar	113
Creating calendar events	113
Changing calendar views	115
Managing calendar events	117
Calendar event reminders	118
Displaying and synchronizing calendars	119
Changing Calendar settings	120
About the Calendar widget	120

<b>Clock and Weather</b>	<b>121</b>
About the HTC Clock widget	121
About the Clock app	121
Using Desk Clock	122
Using World Clock	123
Setting the alarm clock	124
Checking weather	126
About the Weather widget	128
<b>Internet connections</b>	<b>129</b>
Data connection	129
Wi-Fi	130
Adding connection widgets	132
Connecting to a virtual private network (VPN)	132
Using your phone as a modem (tethering)	133
Connecting your phone to the Internet through a computer (Internet Pass-through)	134
Using your phone as a wireless router	134
<b>Web browser</b>	<b>135</b>
Using your phone's web browser	135
Copying text, looking up information, and sharing	138
Viewing bookmarks and previously visited pages	140
Setting browser options	141
<b>Bluetooth</b>	<b>142</b>
Bluetooth basics	142
Connecting a Bluetooth headset or car kit	142
Disconnecting or unpairing from a Bluetooth device	143
Sending information using Bluetooth	144
Receiving information using Bluetooth	145
<b>Camera</b>	<b>148</b>
Camera basics	148
Taking a photo	150
Recording video	151
Adding effects	152
After capturing	152
Changing camera settings	153
<b>Photos, videos, and music</b>	<b>154</b>
Browsing your Gallery	154
Listening to music	162
Sharing media on your home network	167
<b>HTCSense.com</b>	<b>169</b>
About HTCSense.com	169
Signing up for your HTCSense.com account	169
Using HTCSense.com	170
Dashboard	170
Footprints	172
People	174

Messages	175
HTC Hub	177
Signing out from or deleting your HTCSense.com account	177
<b>Maps and location</b>	<b>178</b>
Turning on location services	178
Locations	178
Google Maps	189
<b>More apps</b>	<b>197</b>
Watching videos on YouTube	197
Reading news feeds	198
Working on documents, spreadsheets, and presentations	201
Keeping track of your stocks	202
Listening to FM Radio	204
Recording your voice	205
Using Flashlight	206
Finding and installing apps from Android Market	207
Sharing games and apps	210
<b>Security</b>	<b>212</b>
Protecting your SIM card with a PIN	212
Protecting your phone with a screen lock	213
<b>Settings</b>	<b>214</b>
Settings on your phone	214
Changing display settings	215
Changing sound settings	217
Changing the phone language	218
Optimizing your phone's battery life	218
Managing memory	219
Checking information about your phone	220
<b>Update and reset</b>	<b>221</b>
Updating the phone software	221
Restarting or factory resetting your phone	222
<b>Trademarks and copyrights</b>	<b>223</b>
<b>Index</b>	<b>224</b>

# Basics

## Inside the box

You will find the following inside the box:

- Phone
- Battery (preinstalled)
- microSD™ card (preinstalled)
- USB cable
- 3.5mm stereo headset
- Power adapter
- Quick start guide
- Safety and regulatory guide

## Your phone

### Front panel (Keyboard opened)

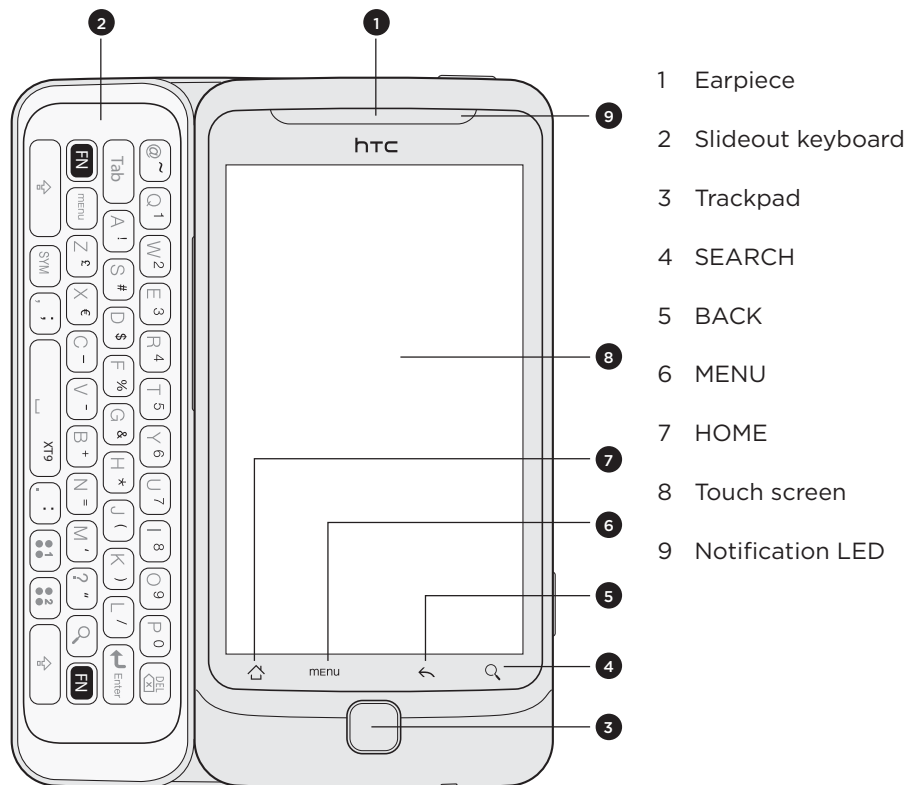

---

## Left and right panels

---

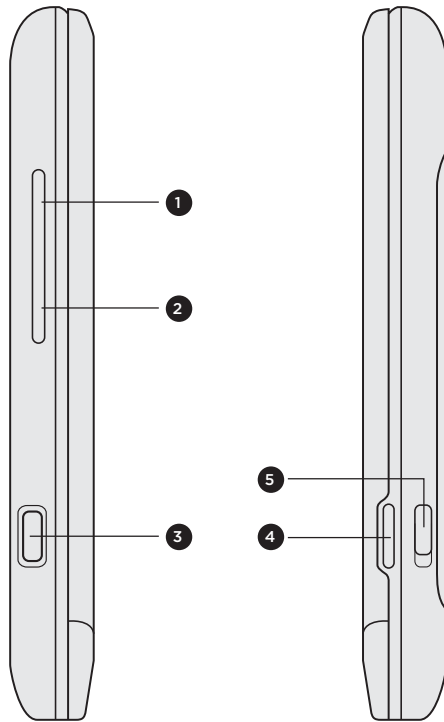

- 1 VOLUME UP
- 2 VOLUME DOWN
- 3 USB connector
- 4 CAMERA
- 5 Back cover lock

---

## Back panel

---

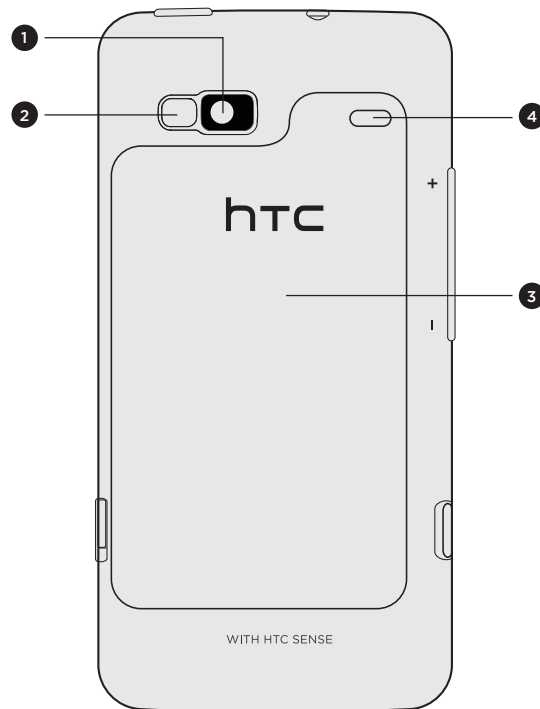

- 1 5 megapixel camera
- 2 LED flash
- 3 Back cover
- 4 Speaker



---

### Top panel

---

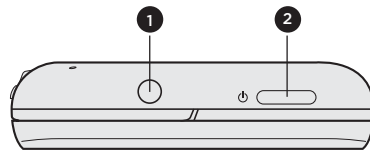

1 3.5mm headset jack

2 POWER

---

### Bottom panel

---

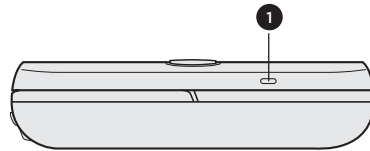

1 Microphone

## Back cover

---

### Removing the back cover

---

Remove the back cover to access the battery compartment, SIM card slot, and storage card slot.

1. With the phone switched off, hold your phone securely with the front facing down.
2. Slide down the back cover lock, and then lift the back cover to remove it.

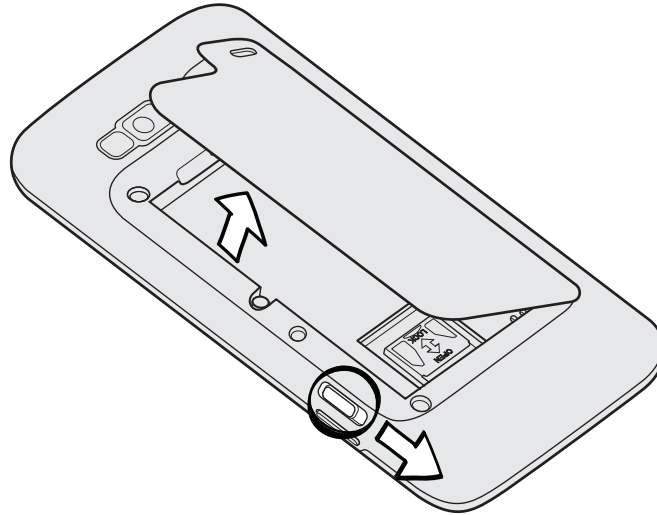

When you take your phone out from the box and remove the back cover for the first time, you'll find that the battery is inside the phone. See "Removing the battery."

---

### Replacing the back cover

---

1. Insert the back cover tabs to the openings located at the right side of your phone's back panel.
2. Press the back cover against the phone until the back cover lock clicks in place.

## SIM card

The SIM card contains your phone number, service details, and phonebook/message memory. Your phone supports both 1.8 V and 3 V SIM cards.



Some legacy SIM cards may not function with your phone. You should consult with your mobile operator for a replacement SIM card. There may be fees for this service.

---

### Inserting the SIM card

---

1. Take the back cover off.  
See “Removing the back cover.”
2. Remove the battery.  
See “Removing the battery.”
3. With the SIM card’s gold contacts facing down, insert the SIM card into the slot with its cut-off corner first.
4. Push the SIM card completely into the slot.

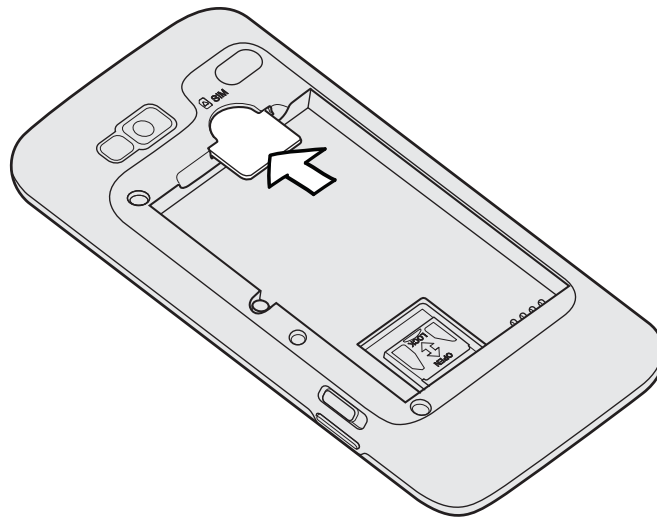

---

### Removing the SIM card

---

1. Take the back cover off.  
See “Removing the back cover.”
2. Remove the battery.  
See “Removing the battery.”
3. Slide the SIM card out from the SIM card slot using your thumb.

## Storage card

The phone uses a microSD card to store your photos, videos, and music.

 When you take your phone out from the box and remove the back cover and battery for the first time, you'll find that the microSD card is already installed on the phone.

---

### Inserting the storage card

---

1. Take the back cover off.  
See “Removing the back cover.”
2. Remove the battery.  
See “Removing the battery.”
3. Slide down the storage card holder towards the edge of the battery compartment, and then flip it up to open.

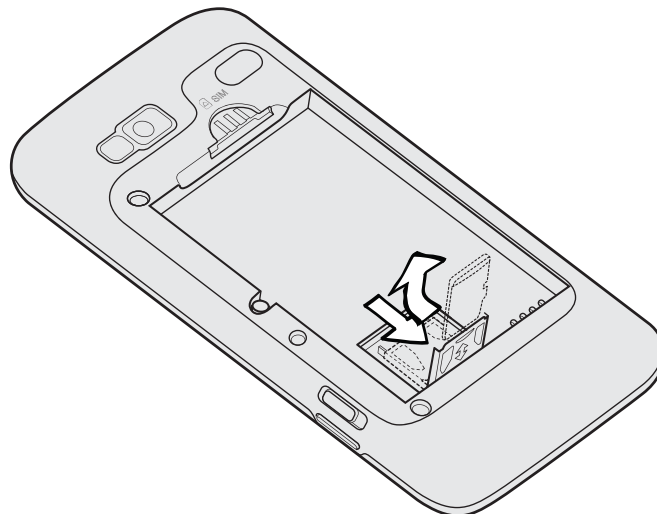

4. Insert the storage card to the holder with its gold contacts facing the connectors on the storage card slot.

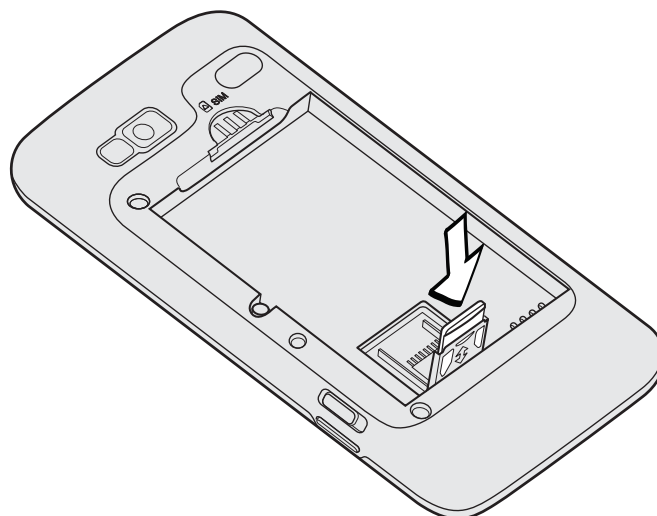

5. Flip down the storage card holder, and then slide it up to lock.

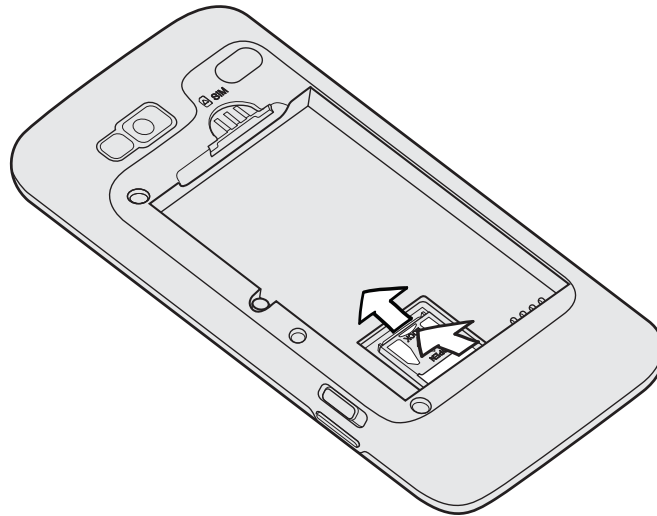

---

### Removing the storage card

---

1. Take the back cover off.  
See “Removing the back cover.”
2. Remove the battery.  
See “Removing the battery.”
3. Slide down the storage card holder towards the edge of the battery compartment, and then flip it up to open.
4. Pull out the storage card, and then close the storage card holder.

## Battery

Your phone uses a rechargeable battery. Please use only original batteries and accessories that came with your phone or replacements that we recommend.

How long the battery can last before it needs recharging depends on how you use your phone. Among these are the phone features and accessories you use (for example, leaving your Bluetooth connection always on uses more power). Long phone calls and frequent web browsing use up much battery. Also, consider your location: poor signal strength from your mobile network and extreme temperature make the battery work harder.



When you take your phone out from the box and remove the back cover for the first time, you'll find that the battery is already installed with a thin film. Pull the flap of the film to release the battery. Make sure to remove the film before you insert back the battery.

---

### Removing the battery

---

1. Take the back cover off.  
See "Removing the back cover."
2. Lift the battery from the groove at the top of the battery compartment.

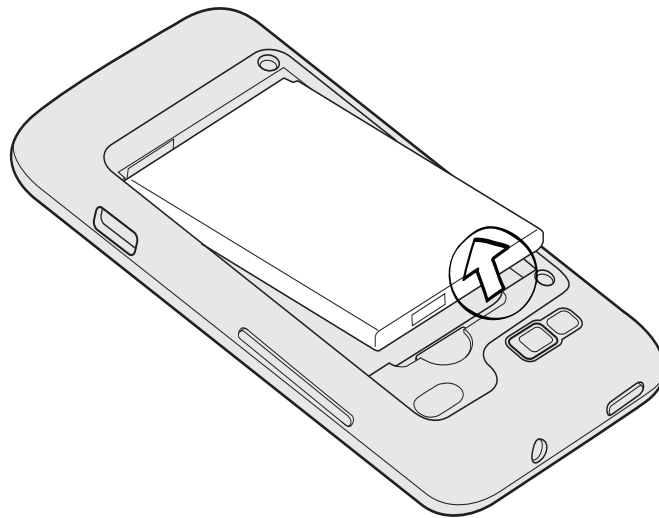

---

## Inserting the battery

---

1. Take the back cover off.  
See “Removing the back cover.”
2. Insert the battery (with its exposed copper contacts first) into the battery compartment.

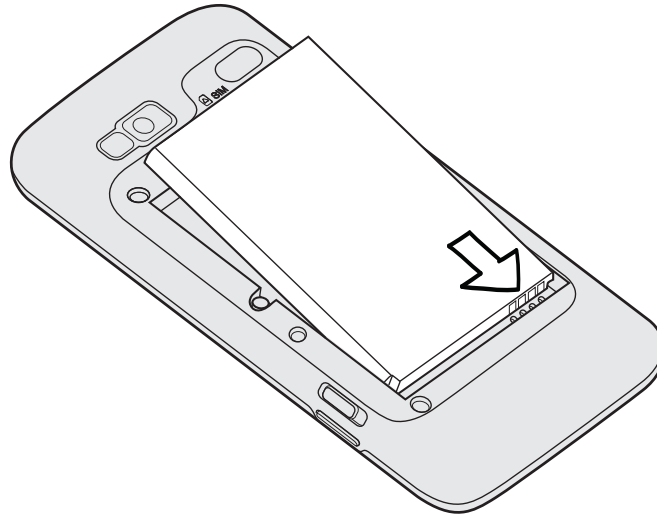

3. Replace the back cover.  
See “Replacing the back cover.”

## Charging the battery

The battery is partially charged when shipped. Before you turn on and start using your phone, it is recommended that you charge the battery. Some batteries perform best after several full charge/discharge cycles.

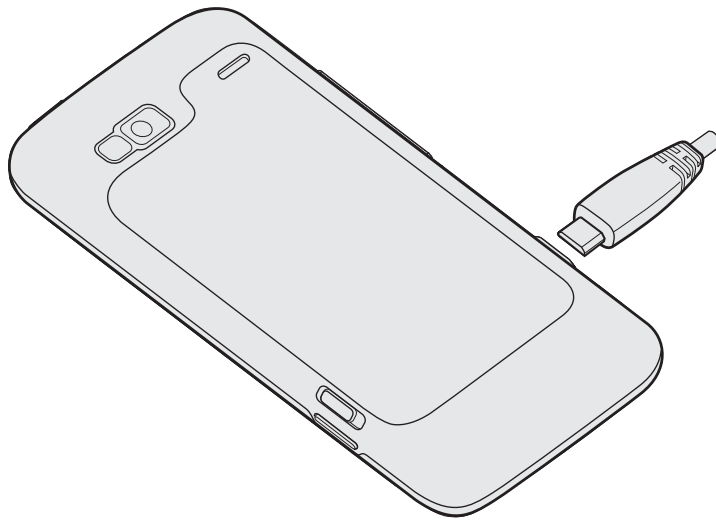

- When the phone is shipped, the battery is already installed on your phone. A thin film is inserted between the battery and the compartment. You need to remove this film before you can charge the battery. See “Removing the battery.”
- Only the power adapter and USB sync cable provided with your phone must be used to charge the battery.
- Do not remove the battery from the phone while you are charging it using the power or car adapter.

1. Plug the power adapter into the USB connector of your phone.



2. Plug in the power adapter to an electrical outlet to start charging the battery.

As the battery is being charged, the notification LED shows a solid red light. The light turns to solid green when the phone is fully charged.

When you charge the battery while the phone is on, the charging battery icon (  ) is displayed in your phone's status bar. After the battery has been fully charged, the charging battery icon turns to a full battery icon (  ).



As a safety precaution, the battery stops charging when it overheats.



## Switching your phone on or off

### Switching your phone on

Press the POWER button. Easy.



When you turn on the phone for the first time, you'll need to set it up. See the Getting started chapter for details.

### Switching your phone off

1. If the display is off, press the POWER button to turn it back on, then unlock the screen by sliding down the bar on the lock screen.  
See "Unlocking the screen" in the Getting started chapter for details.
2. Press and hold the POWER button for a few seconds.
3. When the Power options menu appears, tap **Power off**.

## Entering your PIN

Most SIM cards come with a PIN (personal identification number) set by your mobile operator. If you're asked for a PIN, enter it and then tap **OK**.

To find out how to enable, disable, or change the PIN, see "Protecting your SIM card with a PIN" in the Security chapter.



If you enter the wrong PIN three times, your SIM card is blocked. No problem. Just contact your mobile operator and ask for the PUK (PIN Unblocking Key).

## Finger gestures

Tap	When you want to type using the onscreen keyboard, select items onscreen such as application and settings icons, or press onscreen buttons, simply tap them with your finger.
Press and hold	To open the available options for an item (for example, a contact or link in a web page), simply press and hold the item.
Swipe or slide	To swipe or slide means to quickly drag your finger vertically or horizontally across the screen.
Drag	Press and hold your finger with some pressure before you start to drag. While dragging, do not release your finger until you have reached the target position.
Flick	Flicking the screen is similar to swiping, except that you need to swipe your finger in light, quicker strokes. This finger gesture is always in a vertical direction, such as when flicking the contacts or message list.
Rotate	For most screens, you can automatically change the screen orientation from portrait to landscape by turning the phone sideways. When entering text, you can turn the phone sideways to bring up a bigger keyboard.
Pinch	In some apps, like Gallery or the web browser, you can "pinch" the screen using two fingers (for example, thumb and index finger) to zoom in or zoom out when viewing a picture or a web page.

## Using the trackpad to interact with the touch screen

Besides using finger gestures, you can also use the trackpad to interact with your phone's touch screen.

Be sure to place your finger over the trackpad first (covering it completely), and then slide your finger across the trackpad.

---

### Navigating the Home screen

---

To go to the extended Home screen on the right, slide your finger to the right on the trackpad. Slide your finger to the left to go to the extended Home screen on the left.

---

### Selecting an item onscreen

---

For most screens, slide your finger to the left, right, up, or down, depending on the direction you want to go. For example, if you want to select (highlight) an item above, slide your finger upward. Press the trackpad to open the item.



---

## Selecting a tab

---

For screens that have tabs at the bottom, slide your finger to the left or right to go to a tab.



---

## Moving the cursor when entering text

---

To go back or forward one character in a word, slide your finger left or right. Slide your finger up or down to go up or down between lines of text.

---

## Selecting a link on a webpage

---

1. Slide your finger down to go to the next link on a webpage.
2. When a link is selected, press the trackpad to open the link.



# Getting started

## Setting up your phone for the first time

When you switch on your phone for the first time, you'll be asked to set up your phone. You can choose your language, how you want to connect to the Internet, and whether you want your current location to be automatically detected. If you still have personal contacts and calendar events stored on your old phone, you can easily transfer them to your new phone through Bluetooth as well.

Be sure to sign in to your Google Account so you can use Google apps like Gmail™/Google Mail. You can also set up your other email accounts, favorite social networks like Facebook® and Twitter™, and more.

Just follow the onscreen instructions and you'll be up and running with your phone in no time.



Some features that need to connect to the Internet such as location-based services and auto-sync of your online accounts may incur extra data fees from your mobile operator. Don't worry. You can enable or disable them in your phone's settings as you go along later on. To find out how, see the Settings chapter.

## Home screen

Your Home screen is where you make your phone your own. It comes with a weather clock widget that shows the time and weather in your current location. You can also add your favorite apps, shortcuts, folders and widgets so they're always just a tap away.



To find out how, see the Personalizing chapter.

---

## Extended Home screen

---

As you start to do more things with your phone, you might find that one Home screen is not enough. No problem. You can use up to six extra screens. It should be plenty.

Slide your finger horizontally to the left or right and you'll discover more space for adding icons, widgets, and more.

Press HOME to return to the main Home screen (that is, the center home screen).

---

## Using Leap view

---

To jump straight to the screen that you want, press HOME while on the main Home screen or pinch the screen to show the Leap view. It reveals all seven Home screens as thumbnails.

































Just tap the one you want and you'll leap right there.

## Status and notifications

### Status icons

You can tell a lot about your phone by checking the icons in its status bar. Here's what each one means:







































 Signal strength	 Battery is full
 GPRS connected	 Battery is charging
 GPRS in use	 Battery is low (20% remaining)
 EDGE connected	 Battery is very low (10% remaining)
 EDGE in use	 Silent mode
 3G connected	 Vibrate mode
 3G in use	 Phone microphone is mute
 HSDPA connected	 Speakerphone on
 HSDPA in use	 Wired microphone headset connected
 Roaming	 Wired headset connected
 No signal	 Bluetooth is on
 No SIM card installed	 Connected to a Bluetooth device
 Connected to a Wi-Fi network	 Airplane mode
 Data synchronizing	 GPS is on
 Network sharing is on	 Alarm is set

## Notification icons

A busy life means a busy phone. Notification icons on the status bar make it easy for you to keep on top of your messages, calendar events and alarms. Here's what each one means:



 New Gmail/Google Mail message	 Call in progress
 New Microsoft Exchange ActiveSync or POP3/IMAP email	 Missed call
 Problem with email delivery	 Call on hold
 New SMS/MMS	 Call forwarding on
 Problem with SMS/MMS delivery	 Message forwarding on
 New Google Talk instant message	 The phone is connected to a computer via USB cable
 New voicemail	 Wi-Fi is on and wireless networks are available
 Upcoming event	 Portable Wi-Fi Hotspot is on
 New updates from your social networks	 Uploading data (animated)
 New tweet	 Downloading data (animated)
 Matched contacts suggestion	 Waiting to upload
 New push message	 Downloaded Android Market app installed successfully
 Bluetooth pairing request	 Update available for an app downloaded from Android Market
 Phone software update available	 Storage card is safe to remove or storage card is being prepared
 TV out	 No storage card installed on the phone
 Song is playing	 Storage card is low on free space
 FM Radio app in use	 General notification
 Voice recording is on	 More (not displayed) notifications
 Compass needs orientation	

---

## Notification LED

---

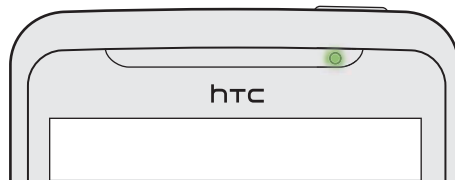

The notification LED shows a:

- Solid green light when the phone is connected to the power adapter or a computer and the battery is fully charged.
- Flashing green light when you have a pending notification.
- Solid red light when the battery is being charged.
- Flashing red light when the battery level reaches very low.

## Notifications panel

When you get a new notification, you can open the Notifications panel to see the message, reminder or event notification. The Notifications panel also lets you switch between recently-opened apps as quickly as possible.

---

### Opening the Notifications panel

---

Press and hold the status bar, then slide your finger downward to open the Notifications panel.



If you have several notifications, you can scroll down the screen to see them all.



You can also open the Notifications panel on the Home screen by pressing MENU and then tapping Notifications.



## Switching between recently-opened apps

On the Notifications panel, you can easily access up to eight apps you just recently opened.

1. Press and hold the status bar, then slide your finger downward to open the Notifications panel.
2. In the Recent apps section, slide your finger left or right to see recently-opened apps.



3. Tap an app to open it.



You can also go to the Recent apps screen when you press and hold HOME.

## Closing the Notifications panel

Press and hold the bottom bar of the Notifications panel, then slide your finger up the screen. Or just press BACK.

## Connecting your phone to a computer

Whenever you connect your phone to a computer using the USB cable, the Connect to PC screen opens and lets you choose the type of USB connection. Select one of the following choices, and then tap **Done**:

<b>Charge only</b>	Select this option if you only want to charge the battery while your phone is connected to your computer.
<b>HTC Sync</b>	Select this option to synchronize contacts, calendar, and other information between your computer and your phone. For more information, see “Synchronizing with your computer” in the Accounts and sync chapter.
<b>Disk drive</b>	This mode is available only when there's a microSD card on your phone. Select this mode when you want to copy files between your phone's storage card and your computer. For more information, see “Copying files to or from the storage card” in this chapter. When Disk drive mode is enabled while your phone is connected to the computer, you will not be able to use apps on your phone to access the storage card.
<b>USB tethering</b>	When you do not have Internet connection on your computer, you can select this mode to share your phone's mobile data connection with your computer. For more information, see “Using your phone as a modem (tethering)” in the Internet connections chapter.
<b>Internet pass-through</b>	If you don't have a data plan for your phone or you don't have access to a Wi-Fi network, you can select this mode to share your computer's Internet connection with your phone. For more information, see the Internet connections chapter.

You can also change the type of USB connection on-the-fly, without having to disconnect and reconnect your phone. Slide open the Notifications panel, and then tap the notification that says “Select to change USB connection type” to open the Connect to PC screen again.



To change the default connection type or choose between showing and hiding the Connect to PC screen, press MENU from the Home screen, and then tap **Settings > Connect to PC**.

---

## Copying files to or from the storage card

---

You can copy your music, photos, and other files to your phone’s storage card.



1. Connect your phone to your computer using the supplied USB cable.
2. On your phone’s Connect to PC screen, tap **Disk drive**, and then tap **Done**.  
On your computer, the connected phone is recognized as a removable disk.
3. Navigate to the removable disk and open it.
4. Do one of the following:
  - Copy the files from the computer to the phone’s storage card’s root folder.
  - Copy the files from the phone’s storage card to a folder in your computer.
5. After copying the files, unmount the removable disk (that is, the connected phone) as required by your computer’s operating system to safely remove your phone.
6. Do one of the following:
  - Disconnect the phone from the computer.
  - If you want to keep the phone connected to the computer but want the phone to be able to access the storage card, open the Notifications panel, tap **Disk drive**, select an option except **Disk drive**, and then tap **Done**.

## Searching your phone and the Web

Find all types of information on your phone and the Web. Search Anywhere sifts through different files, information, and apps on your phone. You can also choose to search the Web using your favorite web search service.

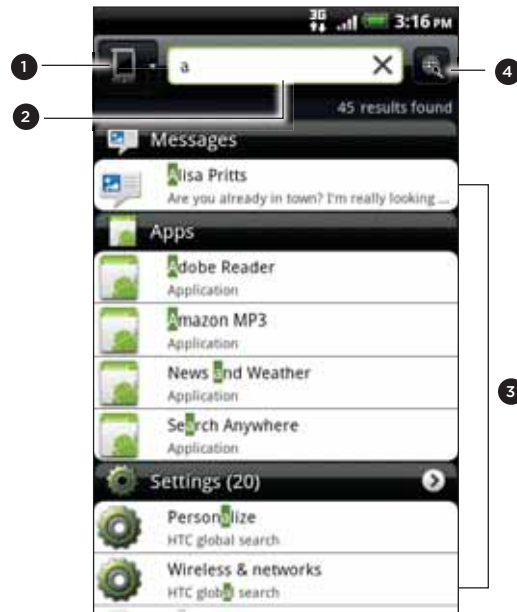
Simply press SEARCH from the Home screen. Then enter the first few letters of what you want to search for. Matching items will be shown as you type.



- 1 This icon (  ) indicates that your phone will search for all types of information. Tap it if you want to choose and search only for one type of item, for example, Mail.
- 2 Type in what you want to search for.
- 3 Matching search suggestions and results. You can:
  - Scroll down to see more search results.
  - Tap  to see more results for a particular category.
  - Tap a search result item to open its app.
- 4 After entering a word or phrase in the search box, tap to search the Web using your favorite search service. To find out how to select a search service to use, see “Setting your phone’s search options”.

### Setting your phone’s search options

1. From the Home screen, press SEARCH.
2. When the search box appears, press MENU, and then tap **Settings**.
3. Tap any of the following:

Web search engine	Choose a web search service you want to use.
Searchable items	Choose the types of items or apps to include in the search.

---

## Quickly looking up information on the Web

---

Quick Lookup helps you learn about something right on the spot. When you enter a new word or phrase, you can readily look it up in popular websites or search services such as Wikipedia, Google Search, YouTube, Google Translate, and Google Dictionary.

1. From the Home screen, tap  > Quick Lookup.
2. If the onscreen keyboard is open, press BACK to close it first so you'll see the bottom tabs.
3. Slide across the tabs to pick where you want to look up information. Then in the search box, enter what you want to search for.

If, for example, you've found the information you were looking for in one tab such as Wikipedia, you can switch to the other tabs to automatically search the same item in Google Search on the Web, watch related videos in YouTube, or look up translations and meanings in Google Translate and Google Dictionary.



---

## Translating words to other languages

---

1. From the Home screen, tap  > Quick Lookup.
2. Press BACK to hide the onscreen keyboard first, then slide to the **Google Translate** tab.
3. Under **From language**, choose the original language, then enter the word or phrase you want to translate.
4. Under **To language**, choose from the languages available for translation.
5. Tap Translate.



## Adjusting the volume

Adjusting the ringer volume changes the volume level of the phone ringtone, while adjusting the media volume changes the volume level of sound notifications and music or video playback.

---

### Adjusting the ringer volume

---

- Press the VOLUME UP or VOLUME DOWN button on the left panel of the phone to adjust the ringer volume to your desired level. The Ringer volume window appears on the screen to display the volume levels.
- While in the lowest ringer volume level (Silent mode), press VOLUME DOWN once to set your phone to Vibrate mode. The phone vibrates and the vibrate mode icon (  ) appears in the status bar.
- While in Vibrate mode, press VOLUME UP once to switch to silent mode. The speaker mute icon (  ) displays in the status bar.

---

### Adjusting the media volume

---

When playing music or watching video, press the VOLUME UP or VOLUME DOWN button on the left panel of the phone to adjust the media volume. The Media volume window appears on the screen to display the volume level.

---

### Adjusting the earpiece volume for phone calls

---

During a phone call, press the VOLUME UP or VOLUME DOWN button.

---

### Adjusting the volume via settings

---

1. From the Home screen, press MENU, and then tap **Settings > Sound > Volume**.
2. Drag the volume sliders to the left or right to adjust the volume levels of your phone's ringtone, media playback, alarms, and notifications.  
  
Your phone briefly plays a sample tone with the volume being adjusted as you drag a slider.
3. If you want the same volume for your ringtone and notifications, select **Use incoming call volume for notifications**.
4. When you're done, tap **OK**.

## Sleep mode

Sleep mode saves battery power by putting your phone into a low power state while the display is off. It also stops accidental button presses when the phone's in your bag or pocket. You'll still receive messages and calls though.



To change the delay before your screen turns off, see "Adjusting the time before the screen turns off" in the Settings chapter.

### Switching to Sleep mode

Quickly press the POWER button to turn off the display and switch your phone to Sleep mode. Your phone also automatically goes into Sleep mode when it's idle for a while.

### Waking up from Sleep mode

Your phone automatically wakes up when you have an incoming call. To wake it up manually, press the POWER button. You'll need to unlock the screen.

### Unlocking the screen

Press the bar on the lock screen and then slide your finger down to unlock the screen or answer an incoming call.



If you have set up a screen unlock pattern, pin, or password, you will be asked to draw the pattern on the screen or enter the PIN or password before it unlocks. See "Protecting your phone with a screen lock" in the Security chapter for details.

# Personalizing

## Making your phone truly yours

Make your phone look and sound just the way you want it. Personalize your phone with a different wallpaper, skin, ringtone, and notification sound for events such as incoming text, email, and calendar reminders.

Tap the **Personalize** button (  ) right on the Home screen to get started.

## Personalizing your phone with scenes

Your phone becomes multiple phones in one when you use scenes. Scenes are personalized Home screen layouts that you can quickly apply to your phone. By switching between scenes, you instantly turn your phone into your perfect weekend phone, travel phone, work phone, or pure play phone.



Everytime you add or modify something on the Home screen, your phone automatically saves your changes to the current scene selected.

### Using a preset scene

Your phone features preset scenes, each preconfigured with a different wallpaper and collection of widgets that reflect different moments in your life. You can choose a scene that is suitable for work, play, travel, or your social life.

1. From the Home screen, tap  > **Scene**.
2. Slide your finger on the screen from right to left to select the scene you want.



3. Tap **Apply**.



To download more scenes, tap **Get more**. To know more about downloading from HTC Hub, see the [HTCSense.com](http://HTCSense.com) chapter.

---

## Creating a new scene

---

You'll start with an empty Home screen when you create a new scene.

1. From the Home screen, tap  > **Scene**.
2. Press MENU, then tap **New**.
3. Enter a new scene name, then tap **Done**.
4. Personalize the scene by adding widgets and other elements, arranging the Home screen layout, and changing the skin or wallpaper. All of your changes will be automatically saved to this scene.

---

## Renaming a scene

---

1. From the Home screen, tap  > **Scene**.
2. Slide your finger on the screen from right to left to select the scene you want to rename.
3. Press and hold a scene thumbnail, then tap **Rename**.
4. Enter a new scene name, then tap **Done**.

---

## Deleting scenes

---

1. From the Home screen, tap  > **Scene**.
2. Press MENU, then tap **Delete**.
3. Slide your finger on the screen from right to left to browse through scenes, then tap one or more scenes you want to delete.
4. Tap **Delete**.

## Changing your wallpaper

Personalizing your wallpaper with your favorite photo is a quick and easy way to change the feel of your phone and give it a fresh look. Browse the collection of wallpapers included in your phone or choose from photos that you have taken with the camera. You can also change your Home screen to use an animated wallpaper.

1. From the Home screen, tap  > **Wallpaper**.
2. Tap one of the following:

HTC wallpapers	Choose a preset wallpaper, then tap <b>Preview</b> > <b>Apply</b> .
Live wallpapers	Choose from preset animated wallpapers. Tap <b>Preview</b> to view the animation, and then tap <b>Apply</b> .
Gallery	Choose a photo that you have taken using the camera or copied to your storage card. Crop the photo and then tap <b>Save</b> .



To download more wallpapers, tap **Wallpaper** > **HTC wallpapers** > **Get more**. To know more about downloading from HTC Hub, see the HTC Sense.com chapter.



## Applying a new skin

Personalize beyond the Home screen by applying a new skin. Skins are set to give a different look and feel to most of your phone's onscreen buttons, application screens, option menus, and other items.

1. From the Home screen, tap  > Skin.
2. Slide your finger on the screen from right to left to select the skin you want.
3. Tap Apply.



To download more skins, tap **Get more**. To know more about downloading from HTC Hub, see the [HTCSense.com](#) chapter.

## Personalizing your Home screen with widgets

Widgets put at-a-glance important information and media content up front on your Home screen. Some widgets are already added to your Home screen for your convenience. You can add more from the available selections of widgets, or download more widgets.

### Adding a widget

1. Go to a part of the Home screen where there's space to add a new widget.
2. Tap  > Widget.
3. Select a widget that you want.
4. Most HTC widgets are available in a variety of designs and sizes to suit your needs. Slide your finger on the screen from right to left to view the different styles, and then tap **Select** to choose one.



You can also add widgets that allow you to quickly switch on or off certain settings of your phone, such as Wi-Fi, Mobile Network, Bluetooth, and more. Scroll down the widgets list, tap **Settings**, and then tap the widget that you want.

---

## Changing the settings of a widget

---

Basic settings of some widgets (for example, the People and Mail widgets) can be modified from the Home screen.

1. Press and hold a widget on the Home screen.

The phone vibrates and you'll see a colored box around the widget. Don't lift your finger just yet.

2. Drag the widget to the **Edit** button (if it's enabled).



The relevant screen where you can change some settings for this widget then opens.

3. Customize the widget settings.

## Adding icons and other shortcuts on your Home screen

Place app icons on your Home screen to open apps quicker. You can also add shortcuts to settings and specific information such as a bookmarked webpage, someone's phone number, a music playlist, route directions, and many other items, to your Home screen.



The shortcuts available depend on the apps that are installed on your phone.

1. Go to a part of the Home screen where there's space to add a new icon or shortcut.
2. Tap , then do one of the following:
  - To add an app icon, tap **App** and then select one from the Add app shortcut list.
  - To add a shortcut to a setting or information, tap **Shortcut** and then select the type of information or setting.



To add an app icon on the Home screen, you can also press HOME, tap , and then press and hold an app icon. Without lifting your finger, drag the icon to an empty area on the Home screen, and then release it.

## Adding folders on your Home screen

Use folders to group related apps and other shortcuts to keep your Home screen tidy and organized. You can also add information folders that show up-to-date information such as Bluetooth received files, your Facebook phonebook, and more.

### Creating a new folder and adding items to it

1. Go to a part of the Home screen where there's space to add a new folder.
2. Tap  > **Folder**.
3. Tap **New Folder**.
4. Press and hold an app icon or a shortcut that you want to move to the folder. The phone then vibrates. Don't lift your finger just yet.
5. Drag the app icon or shortcut and drop it on top of the folder.

Simply tap the folder to open it so you can access the apps and shortcuts inside the folder.



---

### Renaming a folder

---

1. Tap the folder to open it.
2. Press and hold the folder window's title bar.
3. Enter a new folder name and then tap **OK**.

## Rearranging or removing widgets and icons on your Home screen

Rearrange the widgets and icons on your Home screen to give room for adding more items to the Home screen. You can also remove widgets and icons that you don't frequently use.

---

### Moving a widget or icon

---

1. Press and hold the widget or icon you want to move.

The phone vibrates and you'll see a colored box around the widget or icon. Don't lift your finger just yet.

2. Drag the widget or icon to a new location on the screen.



You can pause at the left or right edge of the screen to drag the widget or icon onto another Home screen panel.

3. When the widget or icon is where you want it, lift your finger.

---

### Removing a widget or icon

---

1. Press and hold the widget or icon you want to remove.

The phone vibrates and you'll see a colored box around the widget or icon. Don't lift your finger just yet.

2. Drag the widget or icon to the **Remove** button.
3. When the widget or icon also turns red, lift your finger.

## Rearranging the Home screen

Reorder your Home screen panels in any way that fits how you use the Home screen. For example, move the panels with frequently-used widgets, shortcuts, and folders closer to the main Home screen.

1. Pinch the Home screen to show the Leap view.
2. Press and hold the thumbnail of the home screen you want to move.  
The phone then vibrates. Don't lift your finger just yet.
3. Drag the thumbnail to its new position, and then lift your finger.



The center thumbnail in Leap view is always the main Home screen.

## Changing your ringtones and alarms

Select, create, and download sound sets (different collections of ringtone, notification sounds, and alarm) so that you can instantly change from subtle ringtone and notification sounds while you're in the office into something fun when you're out with friends.

### Choosing a preset sound set

1. From the Home screen, tap  > **Sound set**.
2. On the Sound sets screen, tap a sound set name.
3. You can tap **Details** to hear sample tones of the assigned ringtone, notification sounds, and alarm for that sound set.
4. Tap **Apply**.



To download more sound sets, tap **More sound sets** > **Browse HTC Hub**. To know more about downloading from HTC Hub, see the [HTCSense.com](http://HTCSense.com) chapter.

### Creating a sound set

1. From the Home screen, tap  > **Sound set**.
2. On the Sound sets screen, tap **More sound sets** > **Create new sound set**.
3. Enter a new sound set name, then tap **Done**.

The newly created sound set is then added to your phone's list of sound sets. To find out how to assign different tones to the sound set, see "Customizing a sound set".

### Customizing a sound set

You can customize a sound set by applying your personal choice of ringtone, notification sounds, and alarms that may be from your phone's preset selection or your storage card (except for notification sounds).

To find out how to copy files to your storage card, see the [Getting started](#) chapter.



Be sure to choose the correct sound set before changing the ringtone, notification sounds, and alarm since your phone automatically saves your changes to the current sound set selected.

### Changing the ringtone

1. From the Home screen, tap  > **Ringtone**.
2. Scroll through the available ringtones and tap the ringtone you want to use.  
The ringtone briefly plays when selected.
3. If the audio file is on your storage card, tap **More ringtones** > **Create new ringtone**, select the item you want to import to the Ringtones list, then tap **OK**.
4. Tap **Apply**.

### Changing the notification sounds

1. From the Home screen, tap  > Notification sound.
2. Choose the type of notification that you want to change.
3. Scroll through the available tones and tap the item you want to use.  
A sample tone briefly plays when selected.
4. Tap **Apply**.



Although you won't be able to import notification sounds from your storage card, you can tap **More notification sounds** to download more audio files from HTC Hub.

### Changing the alarm sound

1. From the Home screen, tap  > Alarm.
2. Scroll through the available tones and tap the item you want to use.  
A sample tone briefly plays when selected.
3. If the audio file is on your storage card, tap **More alarms** > **Create new alarm**, select the item you want to import to the Alarms list, then tap **OK**.
4. Tap **Apply**.

---

### Deleting sound sets

---

1. From the Home screen, tap  > Sound set.
2. Press **MENU**, and then tap **Delete**.
3. Tap one or more sound sets you want to delete.
4. Tap **Delete**.

## Rearranging or hiding application tabs

You can rearrange the tabs at the bottom of some of your phone's apps to prioritize the types of information you frequently use or remove the tabs you don't really need.

1. Open an app that has the usual tabs at the bottom of its screen (for example, the contact details screen in People).



2. Press and hold a tab. When you see the Drag to remove screen, lift your finger.
3. Do any of the following:

To	Do this
Move a tab	Press and hold the tab you want to move, and then drag it to its new position.
Remove a tab	Press and hold a tab you want to hide, then drag it up. When you see a colored box, lift your finger. You cannot hide the tab if it's grayed out.

4. When you're done, press BACK.

---

### Putting back the tabs you've removed

---

1. Open the app that you've previously removed some of its tabs.
2. Press and hold a tab. When you see the Drag to remove screen with the hidden tabs, lift your finger.
3. Press and hold the tab you want to show, then drag it down to where you want to position it again.

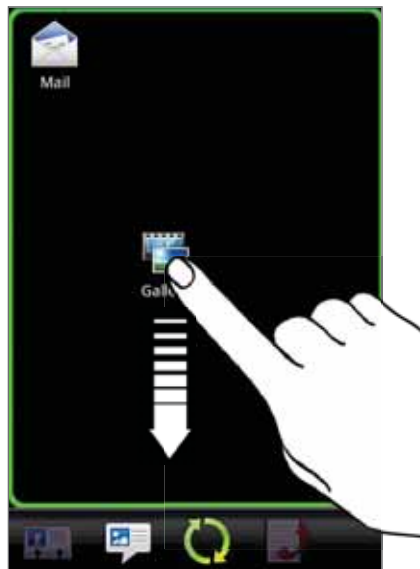

4. When you're done, press BACK.



# Phone calls

## Making calls



Most SIM cards come with a PIN (personal identification number) set by your mobile operator. If you're asked for a PIN, enter it and then tap **OK**.

If you enter the wrong PIN three times, your SIM card is blocked. To unlock your SIM card, see "Restoring a SIM card that has been locked out" in the Security chapter.

---

### Making a call on the Phone dialer screen



---

You can either dial a number directly, or use the Smart dial feature to search and call a stored contact or a number from your call history.

1. On the Home screen, tap **Phone**.
2. Begin entering the first few digits of a phone number or characters of a contact name on the phone keypad.

The Phone dialer screen then displays a list of matching numbers and names.

If you enter a wrong digit or letter, tap  to delete it. To erase the entire entry, press and hold .

3. Tap  to close the phone keypad and to see if there are more matching numbers or contacts. To browse through the filtered list, flick through the list or slide your finger up or down the list slowly.
4. To place a call, do one of the following:
  - Tap a phone number or contact from the list.
  - After entering a complete number, tap **Call**.
  - To call a different phone number associated with the contact, you can tap  at the right side of the contact name. On the contact details screen, tap the number you want to call.

While dialing or when the call is in progress, the status bar displays the Call in progress icon (  ) and its color changes to pulsing green.

## What is Smart dial?

The phone dialer's Smart Dial feature makes it quick and easy for you to place a call. Simply enter the phone number or first few letters of the person's name you want to call. Smart Dial automatically searches and filters your contacts list (stored on your phone, SIM card, and online accounts such as Google Account and Exchange ActiveSync) and the phone numbers from the call history.

---

## Using Speed dial

---

Use Speed dial to call a phone number with a single tap. For example, if you assign a contact's number to the number 2 key, you can simply press and hold this key on the Phone dialer keypad to dial that number.

### Assigning a speed dial key

1. On the Home screen, tap **Phone**.
2. Press MENU, and then tap **Speed dial > Add new**.
3. Enter the name of the contact you want to add. When the name comes up in the list, tap the name.
4. On the Speed dial screen, choose the phone number of the contact to use, and a speed dial key to assign.
5. Tap **Save**.

### Calling a speed dial number

1. On the Home screen, tap **Phone**.
2. On the phone keypad:
  - The number 1 key is generally reserved for your voicemail. Press and hold this key to call voicemail and retrieve your voicemail messages.
  - Press and hold the key that is associated with the contact you want to call.

---

## Calling a phone number in a text message

---

1. From the Home screen, tap  > **Messages**.
2. Tap the number or name of the person who sent you the text message.
3. Tap the phone number within the message.

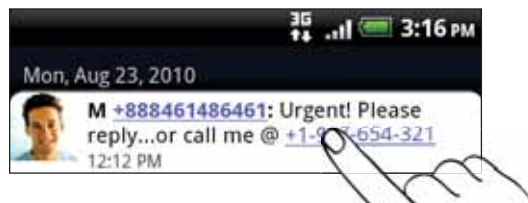

4. Edit the phone number if needed, and then tap **Call**.



To call the message sender, press and hold the sender or the received message, and then tap **Call** on the options menu.

To find out more about text messaging, see the Messages chapter.

---

## Calling a phone number in an email

---

1. From the Home screen, tap  > Mail.
2. In your email account's inbox, tap the email that contains the phone number to call.
3. In the email body, tap the phone number. A selection menu then pops up and the phone number is highlighted.

The phone will recognize a number as a phone number if the number has a minimum of 5 digits and have at least one of the following:

- Numbers starting with a plus sign (+). For example, +1-987-654-321 or +1987654321.
  - Numbers starting with an area or country code enclosed in a parenthesis. For example, (02)987654321 or (02)987-654-321.
  - Numbers separated by dashes. For example, (02)-987-654-321 or 0987-654-321.
4. Tap **Call**.
  5. When the phone dialer screen opens with the phone number already entered, tap **Call**.

To find out more about using email on your phone, see the Email chapter.

---

## Making an emergency call

---

You can make emergency calls from your phone even if you don't have a SIM card installed or your SIM card has been blocked.

1. From the Home screen, tap **Phone**.
2. Dial the international emergency number for your locale (for example, 000), and then tap **Call**.



Additional emergency numbers may be included in your SIM card. Contact your mobile operator for details.

If you enabled but forgotten your lock screen password, lock pattern, and/or the SIM lock, you can still make emergency calls by tapping **Emergency call** on the screen.

## Receiving calls

When you receive a phone call from a contact, the Incoming call screen appears and displays the caller ID icon, name, and phone number of the calling party.

When you receive a phone call from someone who is not stored in People, only the default caller ID icon and phone number appear on the Incoming call screen.



You can use your phone's polite ringer and pocket mode features for receiving calls. To find out how, see "Turning on or off automatic ring volume adjustment" in the Settings chapter.

## Answering or rejecting an incoming call



If	To answer the call	To reject the call
Display is on	Tap Answer.	Tap Decline.
Display is off	When the Lock screen appears, drag the bar that shows the caller name or number downward.	Drag the bar upward. Or, press MENU and then tap Decline.

You can also do one of the following to reject an incoming call:

- Press the POWER button twice.
- To reject the call and send a text message, press MENU, and then tap **Send message**.

### Changing the text message to send out for rejected calls

1. On the Phone dialer screen, press MENU.
2. Tap **Settings > Edit default message**.
3. Enter the new message, and then tap OK.

## Muting the ringing sound without rejecting the call

Do one of the following:

- Press the VOLUME DOWN or VOLUME UP button.
- Press the POWER button.
- Place the phone face down on a leveled surface.



If the phone is already facing down, the phone will still ring when there are subsequent incoming calls.

## HTC Caller ID

Everytime you make a call or your friend gives you a ring, you get to see your friend's latest status update from social networks like Facebook or Twitter right on the call screen.

You also won't miss people's birthdays. You'll see a birthday reminder, if your friend's birthday will occur sometime within the next seven days.



## Using in-call options

When a call is in progress, use the buttons onscreen to mute or unmute the microphone or to turn on or off the speakerphone. You can also press MENU and choose whether to add a call, place the call on hold, mute the microphone, and more.

---

### Putting a call on hold

---

Press MENU and then tap **Hold** to put the call on hold. When you put a call on hold, the status bar displays the Hold call icon (  ) and its color changes to pulsing red. Press MENU, and then tap **Unhold** to resume the call.

## Switching between calls

If you're already on a call and accept another call, you can choose to switch between the two calls.

1. When you receive another call, tap **Answer** to accept the second call, and to put the first call on hold.
2. To switch between the calls, tap the person you want to talk to on the screen.





3. To end the current call and return to the other call, tap **End call**.

## Setting up a conference call

Conference calling with your friends, family, or co-workers is easy. Make the first call (or accept a call), and then simply dial each subsequent call to add to the conference.



Make sure your SIM card is enabled with conference calling service. Contact your mobile operator for details.

1. Make a call to the first conference call participant.
2. When connected, press MENU, tap **Add call**, and then dial the number of the second participant. The first participant is put on hold when you dial the second participant.
3. When connected to the second participant, tap  (merge).
4. To add another participant to the conference call, tap  on the conference call screen, and then dial the number of the contact you want to invite to the conference call.
5. When connected, tap  to add the participant to the conference call.

When you want to talk to a person in the conference call in private, tap , and then select **Private call** on the options menu.

6. When finished, tap **End call**.

## Turning the speakerphone on or off during a call

To turn the speakerphone on, you can do any of the following:

- Flip your phone over during a call (be sure that **Flip for speaker** is selected in HOME > MENU > Settings > Sound).

- On the call screen, tap .



The speakerphone icon (  ) appears in the status bar when the speakerphone is on.

To turn the speakerphone off, just flip the phone over again, facing it up. Or tap  again.



To decrease potential damage to your hearing, do not hold your phone against your ear when the speakerphone is on.

## Muting the microphone during a call

On the call screen, tap  to toggle between turning the microphone on or off. When the microphone is turned off, the Mute icon (  ) appears in the status bar.

## Ending a call

Do one of the following to end the call:

- On the call screen, tap **End call**.



If the phone display is off, press POWER to turn on the screen so you can tap **End call**.

- Slide open the Notifications panel, then tap .
- If you are using the provided wired headset, press the button to end the call.

If the phone number of the person who called is not in your contacts list, you can choose to save the number to your contacts list after you hang up.

## Using Call history



Use the Call history to check missed calls, your dialed numbers and received calls.

### Checking a missed call

You will see the missed call icon  in the status bar when you miss a call.

1. Slide open the Notifications panel to check who the caller is.
2. To return the call, tap the missed call notification. Then tap the caller's name or number on the Call history screen.

### Checking calls in the call history

1. From the Home screen, tap  > **Call history**. You can also tap  on the Phone dialer screen.
2. On the Call history screen, you can:
  - Tap a name or number in the list to call.
  - Press and hold a name or number in the list to display the options menu where you can select to check the call history details, view contact information (if the number is stored in your contacts list), edit the number before you redial, send a text message, delete from call history, or block the caller.
  - Tap  to check only the call history of a particular contact.
  - Press MENU, then tap **View** to display just a particular type of calls such as Missed calls or Outgoing calls.



You can also access Call history from the People app. For details, see the People chapter.

### Adding a new phone number to your contacts from call history

1. On the Call history screen, press and hold a phone number that you want to save to your contacts, and then tap **Save to People**.
2. Choose whether to create a new contact or to save the number to an existing contact on your phone.
3. Do any of the following:
  - When creating a new contact, enter the contact name, contact type, and other information in the blank contact record that appears. The phone number is automatically added to the **Mobile** field in the Phone section. To store it as another type of number, for example a home number, tap the **Mobile** button.
  - When saving the number to an existing contact, tap a contact stored on your phone, and then select the number type.
4. Tap **Save**.



To find out how to add new contacts or edit the contact information, see the People chapter.



---

## Clearing the call history list

---

On the Call history screen, you can do the following:

- To remove one name or number from the list, press and hold the name or number, and then tap **Delete from call history**.
- To clear the entire list, press MENU, and then tap **Delete all**.

## Blocking callers

When you block a phone number or a contact from calling you, all blocked calls go directly to your voicemail.

---

### Blocking one or more contacts from calling

---

1. From the Home screen, tap  > **Blocked callers**.
2. On the All tab, tap **Add caller**.
3. Select the contacts you want to block, then tap **Save**.



You can also press and hold the name or phone number in People or Call history, then tap **Block caller**.

---

### Checking your blocked call history

---

1. From the Home screen, tap  > **Blocked callers**.
2. Slide to the **Blocked call history** tab.
3. Press and hold a name or number in the list to display the options menu where you can select to check the call history details, view the contact information (if the number is stored in your contacts list), edit the number before you calling, send a text message, or delete from call history.

---

### Unblocking callers

---

1. From the Home screen, tap  > **Blocked callers**.
2. On the All tab, press MENU, then tap **Remove callers**.
3. Select one or more contacts, then tap **Delete**.
4. When prompted, tap **OK**.

## Call services

Your phone can directly link to the mobile phone network, and enable you to access and change the settings of various phone services for your phone. Call services may include call forwarding, call waiting, voicemail, and more. Contact your mobile operator to find out about the availability of call services for your phone.

To open call services, press MENU from the Home screen, and then tap **Settings > Call**.

<b>Fixed Dialing Numbers</b>	Restrict outgoing calls to a fixed set of numbers. To enable this feature, you must know your SIM card's PIN2 code.
<b>Voicemail service</b>	Shows the current voicemail service being used.
<b>Voicemail settings</b>	Specify another voicemail number aside from the voice mail number on your SIM card.
<b>Clear voicemail notification</b>	If you have a notification of a new voicemail, you can clear the notification with this option.
<b>Phone settings</b>	Edit the call reject message, choose whether to open the message editor when you reject a call with a message, and choose whether to allow automatic saving of an unknown contact number when a call with that number ends.
<b>Cell broadcast</b>	Enable or disable receipt of cell broadcast messages from your service provider.
<b>Cell broadcast settings</b>	Configure channels and language for cell broadcast messages.
<b>Call forwarding</b>	Select how you want your phone to handle busy, unanswered, and unreachable calls. You can also set the call forwarding option for all incoming calls.
<b>Call barring settings</b>	Choose whether to block various categories of incoming and outgoing call.
<b>Additional call settings</b>	Enable or disable operator services such as caller ID and call waiting.

## Turning Airplane mode on or off

In many countries, you are required by law to turn off the phone while on board an aircraft. A way to turn off the phone function is to switch your phone to **Airplane mode**. When you enable Airplane mode, all wireless radios on your phone are turned off, including the call function, data services, Bluetooth, and Wi-Fi.

To turn Airplane mode on or off, you can:

- Press and hold POWER, and then tap **Airplane mode**.
- From the Home screen, press MENU. Tap **Settings > Wireless & networks**, and then select or clear the **Airplane mode** check box.

When enabled, the Airplane mode icon (  ) is displayed in the status bar.



When you disable Airplane mode, the call function is turned back on and the previous state of Bluetooth and Wi-Fi is restored.

# People

## About People

With the People app, you can sync your phone with contacts from your Google Account, computer, and Facebook. You can also sync with work contacts from the Exchange ActiveSync Server in your workplace. To find out how, see “Ways of getting contacts into your phone.”

Per contact, link the person’s information from all these different sources as one so you won’t have duplicated entries in your contacts list. To find out how to link, see “Merging contact information.”

And that’s not all. You can manage your communications with your contacts via phone, messaging, and email without the need to jump from one app to another. After you’ve linked contacts to their social network accounts like Facebook, Twitter, and Flickr, you’ll also see their updates and events from these accounts all in one place.

---

### People screen

---

The People screen has the following tabs:

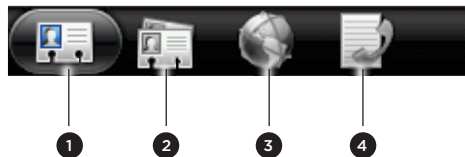

1 All tab	Gives you access to all contacts on your phone, including Google contacts, Exchange ActiveSync contacts, Phone contacts, contacts stored on your SIM card, and Facebook contacts. You can also use this tab to open or update My contact card. For more information, see “Setting up My contact card” in this chapter.
2 Groups tab	Lets you assign contacts to groups so you can easily send an SMS, MMS, or email message to a whole group. For more information, see “Contact groups” in this chapter.
3 Online directories tab	View your friends list in your social network accounts. You can also search for contacts in your Exchange ActiveSync account to copy to your phone.
4 Call history tab	Lists all your dialed numbers and received and missed calls. See “Using Call history” in the Phone calls chapter.

## Setting up My contact card

**My contact card** provides a convenient way to store your personal contact information so that you can easily send it via SMS, MMS, email, or Bluetooth.

1. From the Home screen, tap  > **People**.
2. On the **All** tab of the People screen, tap **Me**.



If you are logged in to your Facebook account through Facebook for HTC Sense, instead of **Me**, you will see the name you use in Facebook. Tap your name. Then press MENU and tap **Edit**.

3. Enter your name and contact details.
4. Tap **Save**.

## Ways of getting contacts into your phone

Gmail/Google Mail	Google contacts are imported to your phone after you sign in to your Google Account. You can also create more Google contacts right from your phone. To find out how, see “Adding a new contact” in this chapter.
Facebook	See “Adding a social network account” in the Accounts and sync chapter for details.
Phone contacts	See “Transferring contacts from your old phone” and “Adding a new contact” in this chapter.
SIM card	See “Importing contacts from your SIM card” in this chapter.
Exchange ActiveSync Server	See “Adding a Microsoft Exchange ActiveSync account” in the Email chapter.
Contacts on your computer	See “Synchronizing with your computer” in the Accounts and sync chapter.

### Transferring contacts from your old phone

Easily transfer contacts from your old phone to your new HTC phone through Bluetooth. Depending on your old phone’s model, you may also transfer other types of data such as calendar events and text messages to your phone.

1. From the Home screen, tap  > **Transfer Data**.
2. Tap **Next** to begin.
3. To check whether your old phone is supported, select a manufacturer name and phone model.
4. If supported, turn your old phone’s Bluetooth on and set it to discoverable mode, then tap **Next** to continue.

Your new HTC phone automatically turns Bluetooth on and searches for Bluetooth devices.

5. From the device list, select your old phone and then tap **Next**.

Your new HTC phone then tries to pair with your old phone. You'll then see a security passkey on the Transfer Data screen.

6. On your old phone, enter this passkey or simply confirm it.
7. Select the **Contacts** check box (and other supported types of data you want to import), and then tap **Next**.



8. When your new HTC phone finishes importing data, tap **Done**.

---

### Adding a new contact

---

1. From the Home screen, tap  > **People**.
2. On the **All** tab, tap **Add contact**.
3. Select the **Contact type**, for example **Google** or **Microsoft Exchange ActiveSync**. This determines which account the contact will sync with. For more information, see “Ways of getting contacts into your phone” in this chapter.



Some fields may not be supported when you're adding contacts to your SIM card.

4. In the **Name** field, enter the first and last name of the contact, then tap **OK**.
5. Enter the contact information in the fields provided.  
Press **BACK** if you want to close the onscreen keyboard first and easily scroll through the other fields.
6. Tap **Save**.

---

### Importing contacts from your SIM card

---

You can copy all your SIM contacts to your phone. You can import them as Phone contacts, Google contacts, or Exchange ActiveSync contacts, if you have set up the relevant accounts.

1. From the Home screen, tap  > **People**.
2. On the **All** tab, press **MENU**, and then tap **Import/Export** > **Import from SIM card**.
3. If you have Google or Exchange ActiveSync accounts set up on your phone, tap the type for the imported contacts.
4. Do one of the following:
  - To import all contacts, press **MENU**, and then tap **Select all**.
  - To import a contact, tap the contact.
5. Tap **Save**.



---

## Importing a contact from an Exchange ActiveSync account

---

You can search for a work contact from your Exchange ActiveSync account, and then copy it to your phone.

You need to have your Exchange ActiveSync account set up on your phone first. To find out how, see “Adding a Microsoft Exchange ActiveSync account” in the Email chapter.

1. From the Home screen, tap  > People.
2. On the Online directories tab, tap Company directory.
3. Enter the name, and then tap .
4. In the list, tap the name of the contact you want to copy to your phone.
5. Tap Save to People.

## Merging contact information

If you have stored contacts with the similar contact information such as name, email address, or mobile number in your phone and online accounts, your phone will try to link them as one automatically or create a list of matched contact suggestions. If it doesn't, you can manually link them so that you won't have duplicated entries in your contacts list.

Also link your contacts with other social network accounts such as Twitter and Flickr. You'll then see their updates and events from these accounts all in one place.

---

## Accepting matched contacts suggestions

---

When your phone finds contact information that can be merged, you'll see the Matched contact suggestions icon (  ) in the notification area of the status bar.

1. Slide down the Notifications panel, and then tap **Matched contacts suggestion**. Your phone displays all suggested contacts that you can merge.
2. Review the suggested links.



- When there are contacts you don't want to merge, tap  to break the contact information link.
- Tap OK.





If you don't want to merge any of your contacts, tap **Dismiss all**.

---

### Viewing a list of all your linked contacts





---

- From the Home screen, tap  > **People**.
- On the **All** tab, press MENU, then tap **More > Linked contacts**.  
The All linked contacts list then opens where you can check the account types and information merged. You can choose to tap  beside an account type to break the link.
- When you're done, tap **OK**.

---

### Manually merging contact information



---

- From the Home screen, tap  > **People**.
- On the **All** tab, tap the name of the contact (not the icon or photo) you want to link.
- On the upper-right corner of the screen, tap  or **Link**  (if there are suggested links).
- On the screen, you can:
  - Under **Suggest links**, tap  to link the contact to an account.
  - Under **Add contact**, tap one of the options to link to another contact.
- Tap **Done**.

---

### Breaking the contact information link between contacts

---

- From the Home screen, tap  > **People**.
- On the **All** tab, tap the name of the contact (not the icon or photo) whose contact information link you want to break.
- On the upper-right corner of the screen, tap .
- Under the **Linked contacts** section, tap  beside an account type to break the link.
- Tap **Done**.

## Your contacts list

The All tab of the People screen shows all your contacts, including Google contacts, Exchange ActiveSync contacts, Phone contacts, contacts stored on your SIM card, and Facebook contacts.



If you signed in to your Google Account and Facebook account when you first set up the phone, your contacts from those accounts will appear in the contacts list when you open People.



- 1 Create a new contact.
- 2 Tap to edit your My contact card.
- 3 This icon appears when the contact:
  - Has sent you a new text or email message, or tried to call you but you missed the call.
  - Has updated his or her Facebook profile or has added photos on Flickr or Facebook.
  - Has upcoming Facebook events or birthday.
- 4 SIM card contact
- 5 Online status of a contact whom you are friends with in Google Talk. Online status icons are displayed if you're signed in to Google Talk using your Google Account. For details, see "Chatting in Google Talk" in the Social chapter.
- 6 Tap to open the contact details screen for that contact.
- 7 Instant status update appears when you've linked the contact to his or her social network account.
- 8 Tap the photo or icon to open a menu where you can quickly choose how to communicate with the contact. Depending on the contact information stored, you can call, send a message or email, see the contact's Facebook profile, and map his/her address in Google Maps.



---

## Filtering your contacts list

---

You can choose to display contacts of a particular type only, for example Google contacts or Facebook contacts.

1. From the Home screen, tap  > People.
2. On the All tab, press MENU, then tap View.
3. Select the types of contacts you want to show in your contacts list.

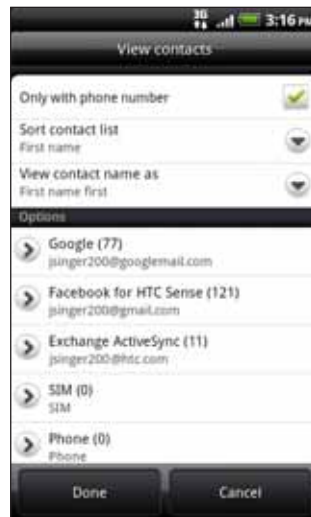

You can also choose how you want to display and sort your contacts.

4. Tap Done.

---

## Searching for a contact

---

1. From the Home screen, tap  > People.
2. Press SEARCH, then enter the first few letters of a contact's first or last name, email, or company name.

You can also type in the first few digits of your contact's phone number. Matching contacts are displayed.

3. Tap the contact to open his or her contact details screen. See "Contact information and conversations" in this chapter for details.

---

## Backing up your contacts to the storage card

---

1. From the Home screen, tap  > People.
2. Press MENU, and then tap Import/Export > Export to SD card.
3. Select an account or type of contacts to export, then tap OK.

## Importing contacts from the storage card

1. From the Home screen, tap  > People.
2. Press MENU, and then tap Import/Export > Import from SD card.



You can only import contacts that were exported to the storage card using the **Export to SD card** feature on the phone. See “Backing up your contacts to the storage card.”

3. If you have Google or Exchange ActiveSync accounts set up on your phone, tap the type for the imported contacts.

## Deleting contacts

1. From the Home screen, tap  > People.
2. On the All tab, press MENU, and then tap Delete.
3. Select the contacts you want to delete, and then tap Delete.
4. When prompted, tap OK.

## Contact information and conversations

When you tap a contact on the People screen, the contact details screen opens, showing you the information stored for that contact, exchanged messages and phone calls with that contact, updates and events from social networks, and more.

The contact details screen has the following tabs:

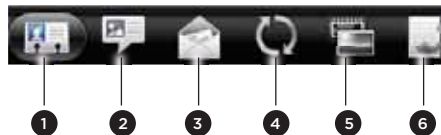

1	<b>Details tab</b>	Shows the information you have stored for the contact, and allows you to get in touch with the contact directly by tapping any of the displayed methods. For example, if the contact has a stored work phone number, tap <b>Call work</b> to call that number.
2	<b>Messages tab</b>	Shows your exchanged SMS messages with the contact. You can reply to the contact's message directly from this tab. To send a new message, press MENU, and then tap <b>New message</b> . See the Messages chapter for details.
3	<b>Mail tab</b>	Shows all the email you have received from the contact. Tap an email to view it. To send a new email, tap <b>New mail</b> . To find out more about sending email, see the Email chapter.
4	<b>Updates and events tab</b>	Shows the contact's updates and events from social network accounts like Facebook, Twitter, and Flickr. You'll be able to see updates such as posted status messages, uploads, and profile changes from all these accounts. To find out more about Facebook for HTC Sense, see the Social chapter.
5	<b>Gallery tab</b>	Shows the contact's Facebook and Flickr photo albums. Tap an album to look at the photos in the album. You need to be logged in to the same social networks on your phone to see the updates and events. If you are not logged in, tap the relevant link on the screen to sign in.
6	<b>Call history tab</b>	Lists all your incoming, outgoing, and missed calls to and from the contact. Tap a list item to call the contact using the displayed number.

---

## Editing a contact's information

---

1. From the Home screen, tap  > People.
2. On the All tab, press and hold the contact, and then tap **Edit contact**.



You cannot edit the contact information of a Facebook friend.

3. Enter the new information for the contact.
4. Tap **Save**.

---

## Sending contact information as a vCard

---

Share the contact information on your phone in different ways such as a text or multimedia message, email, and Bluetooth. To find out about how to send through Bluetooth, see the Bluetooth chapter.

### Sending someone's contact information

1. From the Home screen, tap  > People.
2. On the All tab, press and hold the name of the contact (not the icon or photo) whose contact information you want to send, and then tap **Send contact as vCard**.



You cannot send contact information that's from your Facebook account.

3. Choose how you want to send it.
4. Select the contact details you want to share, and then tap **Send**.

### Sending your contact information

1. From the Home screen, tap  > People.
2. On the All tab, tap [Your name] My contact card.
3. Press MENU, then tap **Send my contact info**.
4. Choose how you want to send it.
5. Select the contact details you want to share, and then tap **Send**.

## Contact groups

Assign contacts to groups so you can easily send a message or email to a whole group. You can also sync groups on your phone with the groups in your Google account, accessible via your computer's web browser.

We've also added the **Frequent** group as a special group type that automatically adds the contacts you frequently dial or get calls from as its members.

---

### Creating a group

---

1. From the Home screen, tap  > **People**.
2. On the **Groups** tab, tap **Add group**.
3. Enter a name for the group, and then tap **Add contact to group**.
4. Select the contacts you want to add to the group, and then tap **Save**.





If your contacts list is long, you can use the search bar to search for contacts quickly, or press **BACK** to hide the onscreen keyboard and scroll through the list.

5. Tap  to select a photo for the group.
6. Tap **Save**.

---

### Editing a contact group

---

1. From the Home screen, tap  > **People**.
2. On the **Groups** tab, press and hold the group, and then tap **Edit group**.
3. You can:
  - Tap the group name to change the name. You can only change the name for groups that you have created.
  - Tap the icon to the left of the group name to change or remove the group photo.
  - To add contacts to the group, tap **Add contact to group**, select the contacts you want to add, and then tap **Save**.
  - To remove a contact from the group, tap  at the right side of the contact name.
4. Tap **Save**.



## Sending a message or email to a group



You will be charged by your mobile provider for each message sent. For example, if you send a message to a group of five people, you will be charged for five messages.

1. From the Home screen, tap  > People.
2. On the **Groups** tab, tap the group you want to send a message or email to.
3. Go to the **Group action** tab, and then do one of the following:
  - Tap **Send group message** to send a message to the group. For information about composing and sending messages, see the Messages chapter.
  - Tap **Send group mail** to send an email to the group. For information on composing and sending email, see the Email chapter.



## Rearranging your contact groups

1. From the Home screen, tap  > People.
2. On the **Groups** tab, press MENU, and then tap **Rearrange**.
3. Press and hold  at the end of the group name you want to move. When the row is highlighted, drag it to its new position.



4. Tap **Save**.

## Rearranging the members of a contact group

1. From the Home screen, tap  > People.
2. On the **Groups** tab, tap the group to see its members.
3. Press MENU, and then tap **Rearrange**.
4. Press and hold  at the end of the contact's name you want to move. When the row is highlighted, drag it to its new position.
5. Tap **Save**.

## Deleting a group

1. From the Home screen, tap  > People.
2. On the **Groups** tab, press and hold the group you want to delete, and then tap **Delete group**.



You can only delete groups that you have created.

## People widget

Put the group of people you contact most right on the Home screen of your phone by adding them as the People widget. Using the People widget, you can instantly place a call, send a message, or view details of a favorite contact with a single tap.

---

### Adding People widgets

---

Stay in touch with different circles of friends or colleagues in your life. You can add several People widgets on the Home screen, with a different group of contacts on each widget.

1. From the Home screen, tap  > Widget > People.
2. Choose the widget style, and then tap **Select**.
3. Select the group you want to add as a widget.
4. Drag the widget to a blank space on a Home screen. When the widget is where you want it, lift your finger.
5. Repeat the above steps to add another People widget.

---

### Setting the default communication method

---

1. On the Home screen, go to the People widget.
2. Tap a contact on the widget.
3. On the Select default action screen, tap the communication method you want for the contact.

---

### Changing the default communication method

---

1. On the Home screen, go to the People widget.
2. Tap the name of a contact on the widget to open the person's contact card.
3. Press MENU, and then tap **More > Set widget action**.
4. On the Select default action screen, tap the communication method you want for the contact.

---

### Getting in touch with a contact

---

1. On the Home screen, go to the People widget.
2. Tap a contact (photo not the name) on the widget. The default communication method will be performed.

If you have not set a default communication method, you need to choose one first. See "Setting the default communication method."



Tap the name of the contact to open the contact details screen for that contact.

# Keyboard

## Using the slideout keyboard



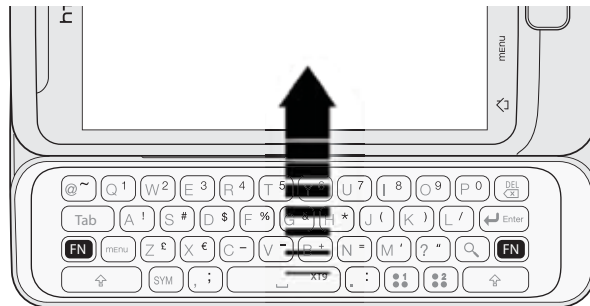

Open the slideout keyboard and type faster and more convenient with your fingers. The slideout keyboard also comes with special keys that let you quickly access menus, search your phone, or launch an app.

1. Hold the phone sideways, with the front panel buttons to your right
2. Push the screen panel up with your thumbs to reveal the slideout keyboard.





When the slideout keyboard is opened, the display stays in landscape and you will not be able to use the onscreen keyboard.

3. If you're entering text, start an app or select a field that requires text or numbers.
4. Press the letter keys to enter text. Or press these keys to enter uppercase letters, numbers, special characters, or symbols:



	<p><b>Shift key</b></p> <ul style="list-style-type: none"> <li>▪ Press once and then press a letter key to type that letter in uppercase.</li> <li>▪ Press twice to lock the key and type a series of uppercase letters. The cursor changes when you lock the Shift key: <b>Welcome to HTC</b></li> </ul> <p>To unlock the Shift key, press it once again.</p>
	<p><b>Function key</b></p> <ul style="list-style-type: none"> <li>▪ Press once to type the character shown beside the letter or punctuation keys. For example, if you need to type the dollar sign (\$), press the Function key, and then press the D key (FN, D).</li> <li>▪ Press twice to lock the key and type a series of numbers and characters. The cursor changes when you lock the Function key: <b>Jim's number is 0900</b></li> </ul> <p>To unlock the Function key, press it once again.</p>
	<p><b>Symbol key.</b> Press to open the symbols panel and insert a symbol or special character to your text. If <b>Symbol</b> and <b>Search</b> share a single key press  and then press  to open the symbols panel.</p>

5. Press these keys to perform other actions:

	<b>Menu key.</b> Instead of pressing the the MENU button, press this key to open the available menu options for the current screen.
	<b>Search key.</b> Instead of pressing the the SEARCH button, press this key to open the search box and type what you want to search. Press the Enter key to begin the search.
	<b>Quick keys.</b> These keys let you quickly open apps and other items such as bookmarks. See “Using the Quick keys” for more information.

## Using the quick keys

The slideout keyboard comes with quicks keys which you can assign to quickly open an app or an item when pressed.

1. From the Home screen, press MENU, and tap **Settings > Keyboard shortcuts**.
2. Tap **Shortcut key #1** to assign the first quick key (  ), or tap **Shortcut key #2** to assign the second quick key (  ).
3. Tap **Apps** or **Shortcuts**, and then tap the app or shortcut that you want to assign to the selected quick key. If you are assigning a shortcut to an item on your phone, follow the screen instructions to proceed.
4. Press BACK, and then open the slideout keyboard.
5. Press the quick key you’ve assigned. The app or item opens.





## Using the onscreen keyboard

When you start an app or select a field that requires text or numbers, and the slideout keyboard is closed, the onscreen keyboard becomes available.

After entering your text, you can tap  or press BACK to close the onscreen keyboard.

## Entering text

Use the following keys while entering text using the onscreen keyboard:

	Press and hold keys with gray characters at the top to enter numbers, symbols, or accented letters. The gray character displayed on the key is the character that will be inserted when you press and hold that key. Some keys have multiple characters or accents associated with them.
	<b>Shift key.</b> Tap to enter an uppercase letter. Tap twice to turn on caps lock.
	Tap to switch to the numeric and symbol keyboard.
	<b>Enter key.</b> Tap to create a new line.
	<b>Backspace key.</b> Tap to delete the previous character.





**Language** key. The key you see depends on the keyboard language you are currently using. Tap to switch to another keyboard language (see “Enabling multiple keyboard languages”) or access the onscreen keyboard settings.



Tap to toggle between Multitap and XT9 predictive modes when using the Compact QWERTY or Phone keypad layout. For more information, see “Entering words with predictive text.”



Tap to hide the onscreen keyboard.

## Selecting a keyboard layout

You can choose from three different keyboard layouts to suit your typing style.

1. From the Home screen, press MENU, and tap **Settings > Language & keyboard > Touch Input**.



If you’ve set the onscreen keyboard to support multiple languages, you can quickly access the Touch Input settings by tapping the Language key (  if you’re using the English onscreen keyboard), and then tapping **Settings**. See “Enabling multiple keyboard languages.”

2. Tap **Keyboard types**, and then select the keyboard layout that you want to use. Choose one from the following:

QWERTY	This layout is similar to a desktop computer keyboard. This is the default keyboard layout.
Phone Keypad	This layout resembles the traditional mobile phone keypad.
Compact QWERTY	This layout features two letters on each key. The key size is slightly bigger than on the full QWERTY layout.

## Enabling multiple keyboard languages

If there are multiple keyboard languages available on your phone, you can choose which languages to enable in the onscreen keyboard so that you can switch to these languages to enter text.

1. From the Home screen, press MENU, and tap **Settings > Language & keyboard > Touch Input**.
2. Tap **International keyboard**.
3. Choose the languages that you want.

Available languages depend on the region where you purchased the phone.

## Changing to the landscape onscreen keyboard

When entering text, you can choose to use the landscape orientation of the onscreen keyboard. Turn your phone sideways to use a larger keyboard for easy typing.



- The **Auto-rotate screen** check box in **HOME > MENU > Settings > Display** needs to be selected for the screen orientation to automatically change.
- The landscape onscreen keyboard is not supported in some apps.

## Entering words with predictive text

The onscreen keyboard has predictive text to help you type quickly and accurately. Predictive text input is enabled by default, and word suggestions are displayed as you type.



To enter a word in predictive mode, do any of the following:

- If you see the word you want highlighted in green or orange, you can simply tap the space bar to insert the word into your text.
- If you see the word you want shown in the suggestions before you have finished typing the entire word, tap the word to insert it into your text.
- If an arrow is shown to the right of the suggestion list, tap the arrow to see more suggestions.

---

### Enabling predictive text for a second language

---

Aside from the keyboard language you are currently using, you can set the predictive text to be bilingual. As you type, you'll get word suggestions in two languages that you've selected.

1. From the Home screen, press MENU, and tap **Settings > Language & keyboard > Touch Input**.



If you've set the onscreen keyboard to support multiple languages, you can quickly access the Touch Input settings by tapping the Language key (  if you're using the English onscreen keyboard), and then tapping **Settings**. See "Enabling multiple keyboard languages."

2. Tap **Bilingual prediction**, and then choose the language you want.

---

### Adding a word to the predictive text dictionary

---

Your phone comes with a list of words that it references for predictive text suggestions. Sometimes you may need to add a word to the predictive text dictionary, for example a name or a specialized technical word.

While entering text using the QWERTY keyboard layout, if you tap any word on the suggestion list, it is automatically added to the predictive text dictionary if it was not in the dictionary already.

You can also add a word to the list manually:

1. From the Home screen, press MENU, and then tap **Settings > Language & keyboard > Touch Input**.
2. Tap **Personal dictionary > Edit personal dictionary > Add new**.
3. Enter the word to add, and then tap **OK**.

---

## Editing or deleting a word in the predictive text dictionary

---

You can edit or remove words that you previously added to the predictive text dictionary.

1. From the Home screen, press MENU, and then tap **Settings > Language & keyboard > Touch Input**.
2. Tap **Personal dictionary > Edit personal dictionary**.
  - To edit a word, tap the word itself.
  - To delete words from the dictionary, press MENU and tap **Delete**. Then choose the words to remove and tap **OK**.

---

## Backing up your personal dictionary to your storage card

---

You can use your storage card to back up the new words you've added to the predictive text dictionary.

1. From the Home screen, press MENU, and then tap **Settings > Language & keyboard > Touch Input**.
2. Tap **Personal dictionary > Sync personal dictionary > Copy to storage card**.
3. When prompted, tap **OK**.

---

## Importing your personal dictionary from your storage card

---

1. From the Home screen, press MENU, and then tap **Settings > Language & keyboard > Touch Input**.
2. Tap **Personal dictionary > Sync personal dictionary > Restore from storage card**.
3. When prompted, tap **OK**.

## Entering text by speaking

No time to type? Try speaking the words to enter it in most text fields that let you use the onscreen keyboard.

Simply press and hold the **Language** key. When your phone cues you to "Speak now", tell your phone what you want to type.



- First make sure to select the language you'll be using in the **Voice input & output** settings. See "Setting the voice input language".
- Since your phone uses Google's speech-recognition service, you need to be connected to the Internet to enter text by speaking.

---

## Setting the voice input language

---

1. From the Home screen, press MENU, then tap **Settings > Voice input & output > Voice recognizer settings**.
2. Tap **Language**, then choose the language you want.

Available languages depend on the voice input languages supported by Google.

## Copying and pasting text

You can copy or cut text and then paste it in another text field within the app or in another app.



Some apps may offer their own way of selecting or copying text.

1. Press and hold the text field that contains the text you want to copy.
2. When the magnifier appears, drag your finger to move the text cursor to the beginning of the text you want to copy or cut. It's easy since the magnifier gives you a bigger view of the text.



3. After you've positioned the text cursor, lift your finger. The text selection menu pops up.
4. Do one of the following:
  - Tap **Select text**. When the word where you've placed the text cursor is highlighted, drag the start and end markers to select the text you want to copy or cut.

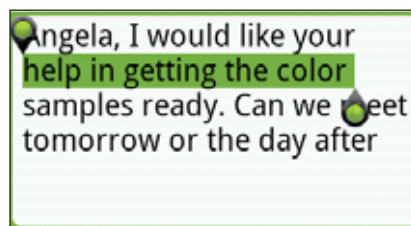

- Tap **Select all** to select everything in the text field.
5. Tap **Copy** to copy the text to the clipboard, or tap **Cut** to delete the text.
  6. On the same app or in another app, press and hold a text field where you want to paste the text.
  7. When the magnifier appears, drag your finger to move the text cursor where you want to paste the text.
  8. After you've positioned the text cursor, lift your finger. The text selection menu pops up.
  9. Tap **Paste**.

## Adjusting touch input settings

Open the Touch Input settings by doing one of the following:

- If you've enabled the onscreen keyboard's support for multiple languages, tap the **Language** key (  ), and then tap **Settings**.
- From the Home screen, press MENU and then tap **Settings** > **Language & keyboard** > **Touch Input**.

### Touch Input settings

Keyboard types	Select the onscreen keyboard layout to use. You can choose from QWERTY, Phone Keypad, or Compact QWERTY.
International keyboard	Select the languages that you want the onscreen keyboard to switch to when you tap the <b>Language</b> key.
Bilingual prediction	Select a second language for predictive text. See "Enabling predictive text for a second language."
Text input	Set text input options when entering text, calibrate the onscreen keyboard, and set a sound and/or vibration feedback whenever you tap a key. See "Text input" for details.
Tutorial	Learn how to use the onscreen keyboard with this interactive tutorial.
Personal dictionary	Add, edit or remove words in the predictive text dictionary. See "Entering words with predictive text."

### Text input

QWERTY	
Prediction	Select to enable the word prediction feature which provides a list of possible words that reflect the characters of the keys you have tapped as well as characters of nearby keys.
Spell correction	Select to correct typographical errors by selecting from a list of possible words that reflect the characters of the keys you have tapped as well as characters of nearby keys.
Hardware QWERTY	
Prediction	When using the slideout keyboard, select to enable the word prediction feature which provides a list of possible words that reflect the characters of the keys you have pressed as well as characters of nearby keys.
Spell correction	When using the slideout keyboard, select to correct typographical errors by selecting from a list of possible words that reflect the characters of the keys you have pressed as well as characters of nearby keys.

Phone keypad & compact QWERTY	
<b>Spell correction</b>	Select to correct typographical errors by selecting from a list of possible words that reflect the characters of the keys you have tapped as well as characters of nearby keys.
<b>Word completion</b>	When using the Compact QWERTY or Phone keypad, lets you select from a list of possible combinations based on the characters that appear on the keys that you tapped.
Other settings	
<b>Sound feedback</b>	Select to hear a clicking sound whenever you tap a key on the onscreen keyboard.
<b>Vibrate when typing</b>	Select to enable vibration feedback whenever you tap a key on the onscreen keyboard.
Finger touch precision	
<b>Calibration tool</b>	Tap to re-calibrate the onscreen keyboard touch accuracy. Re-calibrate the onscreen keyboard if you feel that the keys are not responding accurately to your taps.
<b>Reset calibration</b>	Tap to reset the calibration back to factory default.

# Messages

## About Messages

Keep in touch with important people in your life. Use the Messages app to compose and send text (SMS) and multimedia messages (MMS).

From the Home screen, tap  > Messages.

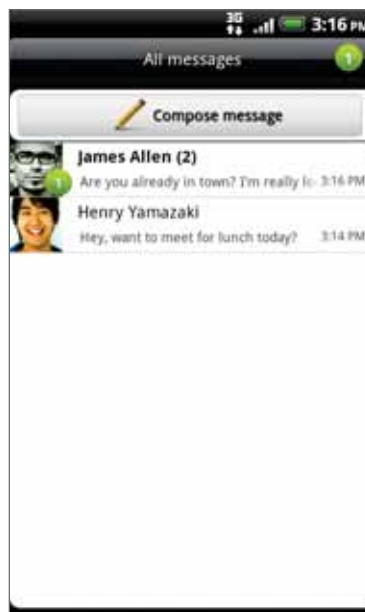

On the All messages screen, all your sent and received messages are neatly grouped into conversations, by contact name or phone number. You can:

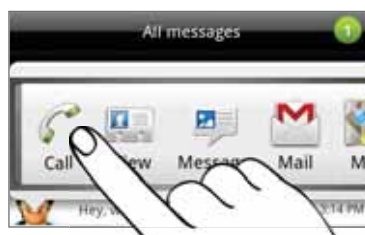

- Scroll up or down the list of conversations by swiping your finger on the screen.
- Tap a contact name or number to view the exchange of messages.
- Tap the photo or icon to open a menu where you can quickly choose how to communicate with the contact.



You can also view your messages on the Home screen with the Messages widget. If this widget is not there already, you can add it by following the steps in “Personalizing your Home screen with widgets” in the Personalizing chapter.

## Sending a text message (SMS)

If you exceed the limit on the number of characters for a single text message, your text message will be delivered as one but will be billed as more than one message.

1. From the Home screen, tap  > Messages.
2. On the All messages screen, tap **Compose message**.
3. Fill in one or more recipients. You can:
  - Enter the first few letters of a contact name or starting digits of a mobile number. As you type, matching names with phone numbers from your stored contacts are displayed. Tap a name or one of the contact's number.
  - Tap the  icon, and then select the phone numbers of the contacts to whom you want to send the message. You can also select contact groups as recipients.  
When you have selected all the message recipients, tap **OK**.
  - Enter the complete phone numbers directly in the **To** field.
4. Tap the box that says "Tap to add text", and then enter your message.



5. Tap **Send**.

Or press **BACK** to save it as a draft. To open and edit a draft message, see "Resuming a draft message."





Your text message automatically becomes a multimedia message when you enter an email address as the recipient, add a message subject, attach an item, or compose a very long message.





## Sending a multimedia message (MMS)

To compose a multimedia message, start by creating a new text message. Then choose the type of attachment to include in your message.

1. From the Home screen, tap  > **Messages**.
2. On the All messages screen, tap **Compose message**.
3. Fill in one or more recipients. You can:
  - Enter the first few letters of a contact name or starting digits of a mobile number. As you type, matching names with phone numbers and email addresses from your stored contacts are displayed. Tap a contact's number or email address.  
Email addresses will be displayed when **Show email address** is selected in Recipient list settings. To find out more about message settings, see "Setting message options".
  - Tap the  icon, and then select the phone numbers of the contacts to whom you want to send the message. You can also select contact groups as recipients.  
When you have selected all the message recipients, tap **OK**.
  - Enter the complete phone numbers or email address directly in the **To** field.
4. To add a subject line, press **MENU** and then tap **More > Add subject**.
5. Tap the box that says "Tap to add text", and then enter your message.
6. Tap  and then choose the type of attachment.

<b>Picture</b>	Select <b>Camera</b> to take a photo and attach it, or <b>Gallery</b> to attach a photo from your storage card.
<b>Video</b>	Select <b>Camcorder</b> to capture a video and attach it, or <b>Videos</b> to attach a video from your storage card.
<b>Audio</b>	Select <b>Voice Recorder</b> to make a voice recording and attach it, or <b>Music &amp; sounds</b> to attach a music file or voice recording from your storage card.
<b>App recommendation</b>	Choose an app you've installed from Android Market that you want to share with others. The URL from which the app can be downloaded will be inserted to your message.
<b>Location</b>	Add your current location (requires GPS to be turned on), or a location you pick on a map to your message. See the Maps and location chapter for more details.
<b>Contact (vCard)</b>	Select a contact, and then select the information to attach.
<b>Appointment (vCalendar)</b>	Select the calendar event you want to attach.
<b>Slideshow</b>	See "Creating a slideshow" for details.

7. To make changes to your attachment, tap  or  (depending on the type of file you've attached).

You can also press **MENU**, then tap **Remove** to start over.



8. Tap **Send**.

Or press **BACK** to save it as a draft. To open and edit a draft message, see "Resuming a draft message."

## Creating a slideshow

In a multimedia message, you can add slides, each containing a photo, video, or audio.

1. In the multimedia message you're composing, tap  > **Slideshow**.
2. On the Edit slideshow screen, tap **Add slide**.
3. Tap **Slide 1**.
4. To compose your slideshow, do any of the following:

Add a picture	Tap <b>Insert picture</b> .
Add a video	Press <b>MENU</b> , and then tap <b>Add video</b> (you cannot add both a picture and a video on the same slide).
Add music or a voice recording	Press <b>MENU</b> , and then tap <b>Add audio</b> .
Add a caption	Tap the box that says "Tap to add text".
Add a new slide	Tap <b>Add slide</b> .
View the next or previous slide	Tap  or  .
Preview your slideshow	Press <b>MENU</b> , and then tap <b>Preview</b> .

For more options, press **MENU**, and then tap **More**.

5. When finished, tap **Done** to attach the slideshow to your message.
6. Tap **Send**.

Or press **BACK** to save it as a draft. To open and edit a draft message, see "Resuming a draft message."

## Resuming a draft message

1. On the All messages screen, press **MENU**, and then tap **Drafts**.
2. Tap the message to resume editing it.
3. When you finish editing the message, tap **Send**.

## Viewing and replying to a message

Depending on your notification settings, the phone plays a ringtone, vibrates, or displays the message briefly in the status bar when you receive a new message. A new message icon  is also displayed in the status bar.



You can change the notification for new messages. See "Setting message options."

## Viewing a message

To open and read your received messages, you can:

- Press and hold the status bar, and then slide your finger down to open the Notifications panel. Then tap the new message notification.
- Open the Messages app to access and read the message.

While reading the message, you can:

Call or save a phone number contained in the message	Tap the phone number. Then choose whether to dial the number or add it to your contacts.
Open a link in the message	Tap the link to open it in the web browser.
Send to or save an email address contained in the message	Tap the email address. Then choose whether to send an email, send a multimedia message, or save the email address to your contacts.
Forward a message	Press and hold the message to open the options menu, and then tap <b>Forward</b> .
Check message details	Press and hold the message to open the options menu, and then tap <b>View message details</b> .

## Replying to a message

1. On the All messages screen, tap a contact (or phone number) to display the exchange of messages with that contact.
2. To reply to the message, tap the text box at the bottom of the screen, then enter your reply message.

You can also reply with a multimedia message. See “Sending a multimedia message (MMS)” for details.

3. Tap **Send**.

## Replying to another phone number of the contact

When a contact has multiple phone numbers stored on your phone, you’ll see the particular phone number used within the message. There’s also a bold letter before the phone number to indicate the number type (for example, **M** stands for **Mobile**).

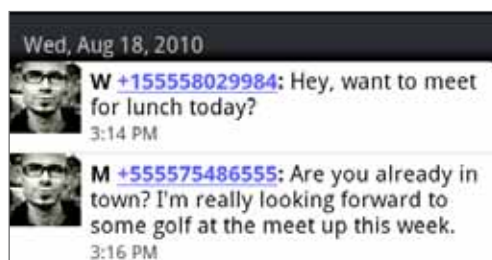

Keep in mind that your response will be sent to the phone number of the latest message you’ve received from this contact.

If you want to change the phone number before you send out your reply, press **MENU**, then tap **More > Recipient phone number**. Select another phone number of this contact, and then tap **OK**.

## Viewing and saving an attachment from a multimedia message

If you are concerned about the size of your data downloads, check the multimedia message size first before you download it.



When **Auto-retrieve** in MMS settings is disabled, only the message header is downloaded. To download the entire message, tap the **Download** button at the right side of the message. To find out more about message settings, see “Setting message options.”

- If there’s a media attachment such as a photo or video in a received message, tap it to view the content.
- If the attachment is a contact (vCard), tap it to view the contact information, then tap **Save** to add to your contacts.  
Open the People app to view the contact. See the People chapter.
- If the attachment is an appointment or event (vCalendar), tap it and then choose the calendar where to save it. Tap **Import**.  
Open the Calendar app to view the appointment or event. See the Calendar chapter.
- To save the attachment to your storage card, press and hold the multimedia message, and then tap **Save [attachment type]** on the options menu.

## Viewing push messages

Push messages contain a web link. Often, the link will be to download a file that you have requested, for example a ringtone.

When you receive a push message, a notification icon  is displayed in the status bar.

### Opening and reading a new push message

1. Press and hold the status bar, and then slide the status bar down to open the Notifications panel.
2. Tap the new message.
3. Tap **Visit website**.

### Viewing all your push messages

1. From the Home screen, tap  > Messages.
2. Press **MENU**, and then tap **Push messages**.

## Managing message conversations

---

### Protecting a message from deletion

---

You can lock a message so that it will not be deleted even if you delete the other messages in the conversation.

1. On the All messages screen, tap a contact (or phone number) to display the exchange of messages with that contact.
2. Press and hold the message that you want to lock.
3. Tap **Lock message** on the options menu.

A lock icon (  ) is displayed at the right hand side of the message.

---

### Copying a message to your SIM card

---

1. On the All messages screen, tap a contact (or phone number) to display the exchange of messages with that contact.
2. Press and hold a message, and then tap **Copy to SIM**.

A SIM card icon (  ) is displayed at the right hand side of the message.

---

### Deleting a single message

---

1. On the All messages screen, tap a contact (or phone number) to display the exchange of messages with that contact.
2. Press and hold the message that you want to delete.
3. If the message is locked, tap **Unlock message** on the options menu, and then press and hold the message to display the options menu again.
4. Tap **Delete message** on the options menu.
5. When prompted to confirm, tap **OK**.

---

### Deleting several messages within a conversation

---

1. On the All messages screen, tap a contact (or phone number) to display the exchange of messages with that contact.
2. Press **MENU** and then tap **More > Delete**.
3. Tap **Delete by selection**.



You can also tap **Delete by phone number** if the contact used multiple phone numbers throughout the conversation and you want to delete the messages sent from a particular number.

4. Select the messages you want to delete and then tap **Delete**.

---

## Deleting a conversation

---

1. On the All messages screen, press and hold a contact (or phone number) whose messages you want to delete, and then tap **Delete**.

While looking at the exchange of messages in a conversation, you can also press MENU and then tap **More > Delete > Delete thread**.

Any locked messages in the conversation thread will not be deleted unless you select the **Delete locked messages** check box.

2. When prompted to confirm, tap **OK** to delete the entire thread.
- 

## Deleting several conversations

---

1. On the All messages screen, press MENU, and then tap **Delete**.
2. Select the conversation threads you want to delete.
3. Tap **Delete**.

Any locked messages will not be deleted.

## Setting message options

On the All messages screen, press MENU and then tap **Settings**. You'll find several groups of settings.

### Storage settings

Delete old messages	Automatically delete older messages, except for locked messages, when the set limits are reached.
Text message limit	Choose the maximum number of text messages to store in each conversation thread (this does not include locked messages).
Multimedia message limit	Choose the maximum number of MMS messages to store in each conversation thread (this does not include locked messages).

### Recipient list settings

Show email address	Search and display the email addresses of stored contacts when you're adding message recipients.
--------------------	--

### Message forwarding

Forward to phone number	Forward the text and multimedia messages you'll receive to another phone number (this may incur extra fees from your mobile operator).
Forward to email address	Forward the text and multimedia messages you'll receive to an email address (this may incur extra fees from your mobile operator).

## SMS settings

Delivery reports	Receive a report on the delivery status of your message.
Service center	Displays the message service center number used. Tap to change the number. It is recommended that you do not change the number here for it may cause problems in receiving and sending messages.
Manage SIM card messages	View text messages stored on your SIM card. You can also delete or copy these messages to your phone's memory.

## MMS settings

Delivery reports	Receive a report on the delivery status of your message.
Read reports	Receive a report whether each recipient has read the message or deleted it without reading.
Auto-retrieve	Automatically retrieve all your MMS messages completely. When selected, the MMS message header plus the message body and attachments will automatically download to your phone. If you clear this check box, only the MMS message header will be retrieved and shown on the All messages screen.
Roaming auto-retrieve	Automatically retrieve all your MMS messages completely when roaming. This may incur significant phone charges.
Priority setting	Set the message priority of MMS messages sent.
Maximum message size	Set the maximum file size of an MMS message. The MMS message will not be sent out if it exceeds the file size set here.

## Received messages

Received notification	Receive a notification in the status bar when a new message arrives.
Play notification sound	Set your phone to play a sound when a new message arrives.
Notification sound	Choose a sound that will play when you receive a message.
Vibrate	Set your phone to vibrate when a new message arrives.

## Sent messages

Sent notification	Receive a notification in the status bar when a message is sent successfully.
Failure notification	Receive a notification in the status bar when a message is not sent successfully.
Play notification sound	Set your phone to play a sound when a sent or failure notification is received.
Notification sound	Choose a sound that will play when there's a sent or failure notification.
Vibrate	Set your phone to vibrate when a new message arrives.
Display message on screen	Set your phone to show pop-up notifications (not just in the status bar) when your messages are sent successfully or not. You can also select <b>None</b> to disable this option.

# Accounts and sync

## Synchronizing with online accounts

---

### About online accounts

---

These are some of the types of information your phone can sync with your online accounts:

- Gmail™/Google™ Mail and Exchange ActiveSync email.
- Google and Exchange ActiveSync contacts, as well as your friends' contact information in Facebook® and their Twitter™ profiles. For information on contacts, see the People chapter.
- Calendar events from your primary Google Account, from Exchange ActiveSync, and from your Facebook account. For information on using Calendar, see the Calendar chapter.
- Status updates and links shared by your friends and yourself on social networks such as Facebook and Twitter. For details, see the Social chapter.
- Flickr™ and Facebook photo uploads. For information on viewing photos, see the Photos, videos, and music chapter.



You can set up an Exchange ActiveSync account on your phone either in the Mail app or the Accounts & sync setting.

To set it up in the Mail app, see “Adding a Microsoft Exchange ActiveSync account” in the Email chapter.

---

### Synchronizing with a Google Account

---

Signing in to your Google Account lets you sync Gmail/Google Mail and your Google contacts and calendars between your phone and the Web. You also need to sign in to a Google Account to use Google apps such as Google Talk™ and Android Market™.



If you skipped signing in to a Google Account when you first set up your phone, you may encounter problems when using some Google apps. If these problems persist, you may need to factory reset your phone and enter your Google Account details when you set up the phone again. To factory reset your phone, see “Restarting or factory resetting your phone” in the Update and reset chapter.



## Adding more Google Accounts

You can add more than one Google Account on your phone. However, subsequent Google Accounts can only sync contacts, emails, and calendar events. Other Google services use the first Google Account you added.

1. From the Home screen, press MENU, and then tap **Settings > Accounts & sync**.
2. Tap **Add account > Google**.
3. Follow the onscreen instructions to sign in to an account or create a new account.

## Forgot your Google Account password?

You need your Google Account password to sync Google Mail (Gmail), Calendar, and Google contacts to your phone. You also need this password to use Google Talk and download apps from Android Market.

If you have forgotten your Google Account password, you can try to recover it by going to the Google website.

1. On your phone or computer, open your web browser and go to <https://www.google.com/accounts/ForgotPasswd>.
2. Enter the email address or username that you use to sign in to your Google Account.
3. Complete the word verification process. Enter the characters that you see onscreen and click **Submit**.

An email will be sent to the alternate email address you provided when you created your Google Account. Follow the instructions in the email to reset your password.

If you don't have an alternate email address or cannot access the email account you used to create your Google Account, you can reset your Google Account after 24 hours by answering the security question for password recovery.

---

## Adding a social network account

---

If you skipped setting up your social network account (such as Facebook, Twitter, or Flickr) when you first turned on and set up your phone, you can still sign in to these accounts through your phone's settings.

1. From the Home screen, press MENU, and then tap **Settings > Accounts & sync**.
2. Tap **Add account**, and then tap the account type you want to add.
3. Follow the onscreen instructions to enter your account information.

Your social network account will be added to the list on the Accounts & sync screen. Depending on how you set up the account, the new information may start synchronizing with your phone.

## Managing your online accounts

### Changing general sync settings

1. From the Home screen, press MENU, and then tap **Settings > Accounts & sync**.
2. Select or clear the following:

<b>Background data</b>	If this is selected, apps can send and receive online account information even if you are not currently using them.
<b>Auto-sync</b>	If this is selected, apps can use the sync schedule defined in the account settings. If this is cleared, you will need to sync accounts manually. For instructions on doing this, see “Synchronizing an account manually”.

### Synchronizing an account manually

1. From the Home screen, press MENU, and then tap **Settings > Accounts & sync**.
2. Tap the account that you want to sync.
3. Tap **Sync now**.

### Changing account settings

You can change settings such as the sync frequency and the types of information synchronized, the kinds of notification you receive, and the way that account information is displayed.

1. On the Accounts & sync screen, tap the account that you want to edit.
2. Tap the type of information you want to sync or select an item to edit its settings.

### Removing an account

You can remove an account to delete it and all information associated with it from your phone, for example messages, contacts, or settings. Removing an account does not delete information from the online service itself.



You cannot remove some accounts, such as the first Google Account you signed into on the phone, except by deleting all personal information from your phone with a hard reset. For instructions on doing this, see “Restarting or factory resetting your phone” in the Update and reset chapter.

1. From the Home screen, press MENU, and then tap **Settings > Accounts & sync**.
2. Tap the account that you want to remove.
3. Tap **Remove account**, and then confirm that you want to remove the account.

## Synchronizing with your computer

You have your new vacation photos on your phone while your business calendar is on your computer. Why not make these types of files and information available on both devices? With HTC Sync™, you can:

- Sync your contacts between your Microsoft® Outlook®, Outlook® Express or Windows Contacts on your computer and your phone.
- Sync your calendar events between the Outlook or Windows Calendar on your computer and your phone.
- Bring your photos, videos, documents, songs, and playlists from your computer to your phone and enjoy them on the go.
- Easily import your captured photos and videos from your phone to your computer.
- Sync bookmarks inside the “HTC Bookmarks” favorites folder on your computer and all bookmarks stored on your phone’s web browser.
- Download maps and useful add-on services for your phone’s Locations app to your computer first, and then sync them to your phone.
- Install third-party mobile phone apps (not downloaded from Android Market) from your computer.



You need a microSD card inserted into your phone to be able to sync multimedia files, maps, and documents.

### Installing HTC Sync that came with the microSD card

Make sure the microSD card is inserted to your phone. Copy the HTC Sync installer from the microSD card to your computer and use it to install.



- The HTC Sync version in the microSD card that came with your phone can be installed on a computer running Windows 7, Windows Vista, or Windows XP.
- HTC Sync requires USB 2.0 on your computer to connect and sync with your phone.
- For trouble-free installation, first quit all running programs and temporarily exit from your anti-virus program before you start installing HTC Sync.

1. Connect your phone to your computer using the supplied USB cable.
2. On your phone’s Connect to PC screen, tap **Disk drive**, and then tap **Done**.  
On your computer, the connected phone is recognized as a removable disk.
3. Navigate to the removable disk and open it.
4. Copy **HTCSync.exe** to your computer.
5. After copying, unmount the removable disk (that is, the connected phone) as required by your computer’s operating system to safely remove your phone.
6. On your computer, double-click **HTCSync.exe** and follow the onscreen instructions to install HTC Sync.

After installing HTC Sync, the HTC Sync icon (  ) is added to your computer’s system tray (check the bottom-right side of your computer screen). You can double-click this icon to open HTC Sync.

## Setting up HTC Sync to recognize your phone

After installing, set up HTC Sync to recognize your phone.

1. Connect your phone to your computer using the supplied USB cable.
2. On your phone's Connect to PC screen, tap **HTC Sync**, and then tap **Done**.  
On your computer, wait for HTC Sync to recognize your phone.
3. When the Device setup screen opens, enter a name for your phone, and then click **Save**.

The Device panel then opens.

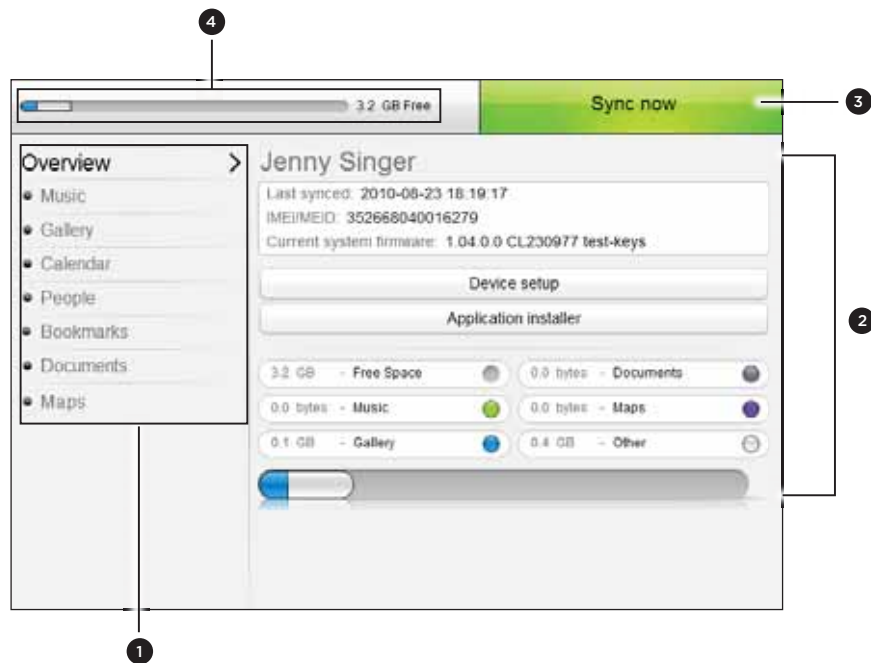

- |   |  |
|---|--|
| 1 | Click a category of items to see its sync options on the right section of the Device panel. Click <b>Overview</b> to see your phone's basic software information and storage card usage, change the phone name, or install third-party apps to your phone. |
| 2 | Shows the available sync options for the category you've selected.   |
| 3 | Click to start synchronization.  |
| 4 | <b>Estimated storage usage bar.</b> When there are new items to be synchronized and added to your phone, this bar shows the estimated storage card space that will be used.  |

## Setting the Music sync options

Bring the music tracks and songs you play on your computer to your phone. If you have playlists created in iTunes® or Windows Media® Player, you can sync these too and enjoy them on the go.



You can sync audio files in these formats:

\*.aac, \*.amr, \*.m4a, \*.mid, \*.midi, \*.mp3, \*.wav, and \*.wma.

1. On the Device panel, click **Music**, and then click the **On** button.

Turning Music sync on means you want this category included every time you sync your computer and phone.

2. Select **Sync music files from**, and then click **Add**.

3. Choose the folder that contains your audio files, and then click **OK**.

All supported audio files added to this folder will also be copied to your phone's storage card during synchronization.

4. Select **Sync music files from iTunes and Windows Media Player** if you're using any of these apps on your computer. Then, choose one of the following:

<b>All songs and playlists</b>	Choose to sync all songs and playlists from iTunes and Windows Media Player.
--------------------------------	--

<b>Selected playlists</b>	Choose to select only your favorite playlist titles.
---------------------------	--

## Setting the Gallery sync options

You can choose to automatically copy your phone camera shots to your computer. At the same time, when you select a folder from your computer, the photos and videos stored in it are also synchronized on your phone's storage card.



You can sync photos and videos in these formats:

- Photos: \*.bmp, \*.gif, \*.jpeg, \*.jpg, and \*.png.
- Videos: \*.3gp, \*.3g2, \*.mp4, and \*.wmv.

1. On the Device panel, click **Gallery**, and then click the **On** button.

Turning Gallery sync on means you want this category included every time you sync your computer and phone.

2. To automatically import your camera shots to your computer during synchronization, select **Copy device Camera Shots to PC**.

Photos and videos from your storage card will be saved to the **\My Photos\Device Camera Shots** folder on your computer.

3. Select **Sync PC photos & videos from**, and then click **Add**.

4. Choose the folder on your computer that contains your multimedia files, and then click **OK**.

All supported image and video files added to this folder will also be copied to your phone's storage card during synchronization.

---

## Setting Calendar sync options

---

Your phone can sync appointments and events with your calendar in Outlook (Outlook XP, Outlook 2003 or Outlook 2007) or Windows Calendar (for Windows Vista).

1. On the Device panel, click **Calendar**, and then click the **On** button.  
Turning Calendar sync on means you want this category included every time you sync your computer and phone.
2. Select the app you want to sync calendar events with.
3. Choose the number of days of calendar events to sync. You can choose **One week ago**, **Two weeks ago**, or **One month ago**.
4. In cases when conflicting information are found on both the phone and computer, choose which information you want to keep.



You can only sync the following calendar event details: Event name, Event date, Start time, End time, Event location, Description, Reminder, and Repetition.

---

## Setting People sync options

---

Sync your phone contacts with your Outlook (Outlook XP, Outlook 2003 or Outlook 2007), Outlook Express, or Windows Contacts (for Windows Vista).

If you have contacts to sync from your SIM card, you have to import these first to your phone storage.

1. On the Device panel, click **People**, and then click the **On** button.  
Turning People sync on means you want this category included every time you sync your computer and phone.
2. Choose the app you want to sync your contacts with.
3. In cases when conflicting information are found on both the phone and computer, choose which information you want to keep.



Only the contact fields supported on your phone will be synchronized.

---

## Setting Bookmarks sync options

---

Sync the bookmarks inside the “HTC Bookmarks” favorites folder in your computer’s web browser with the bookmarks stored on your phone’s web browser.

1. On the Device panel, click **Bookmarks**, and then click the **On** button.  
Turning Bookmarks sync on means you want this category included every time you sync your computer and phone.
2. Choose the web browser that stores the bookmarks to sync with your phone.



- Only the web page title and URL information are synchronized.
- If you are using Firefox® and have selected it to sync with your phone, make sure to close all Firefox browser windows before you begin synchronization.
- When conflicting information are found on both the phone and computer, HTC Sync keeps the information from your computer.

---

## Setting Documents sync options

---

You can sync files and documents from your computer to your phone. Make sure that your phone has the app needed to open or view such files and documents.

Usually, your phone can open and view these file types: Microsoft Office 2003 and 2007 Word (.doc), Excel (.xls), and PowerPoint (.ppt), PDF files (.pdf), Text files (.txt).

You can also sync email attachments that you stored on your phone's storage card to your computer.



To sync email attachments stored on your phone's storage card to your computer, you must set up an Exchange ActiveSync or POP3/IMAP email account on your phone using Mail. For more information on how to do this, see the Email chapter.

1. On the Device panel, click **Documents**, and then click the **On** button.

Turning Documents sync on means you want this category included every time you sync your computer and phone.

2. To sync email attachments that you've stored on your phone's storage card, select **Copy all download Mail documents to PC**.

When you sync the phone with your computer, email attachments will be saved to the `\My Documents\Device documents\` folder on your computer.

3. To sync files and documents from your computer to your phone's storage card, select **Sync PC documents from**, and then click **Add**.

4. Choose a folder that contains the files you want to sync with your phone, and then click **OK**.

When you sync the phone with your computer, the files and documents from your computer will be saved to the `\My Documents\Documents\` folder on your phone's storage card.

---

## Setting Maps sync options

---

Before going on a trip to another city or country, you can download the maps you need using HTC Sync on your computer, then sync it to your phone. Aside from different maps, you can also purchase licenses for other useful data such as driving and walking navigation, safety camera map views, and more.

To find out how you can use the downloaded content on your phone, see the Maps and location chapter for more information.

1. On the Device panel, click **Maps**, and then click the **On** button.

Turning Maps sync on means you want this category included every time you sync your computer and phone.

2. Choose one of the following:

<b>All Maps and Licenses</b>	Choose to sync all maps and licenses between your computer and your phone.
<b>Select Maps and Licenses</b>	Choose to sync only the maps and licenses you want.

3. If you want to purchase and download more maps and other data, click **Get more Maps and Licenses**.



The Maps feature will be available in the next release of HTC Sync. You can use it to download maps, voices, and add-on services for your phone's Locations app to your computer first, and then sync them to your phone. Visit our support website ([www.htc.com/support](http://www.htc.com/support)) from time to time to check for updates and more information.

## Synchronizing your phone

When you are done setting up synchronization for your selected categories, click the **Sync now** button.

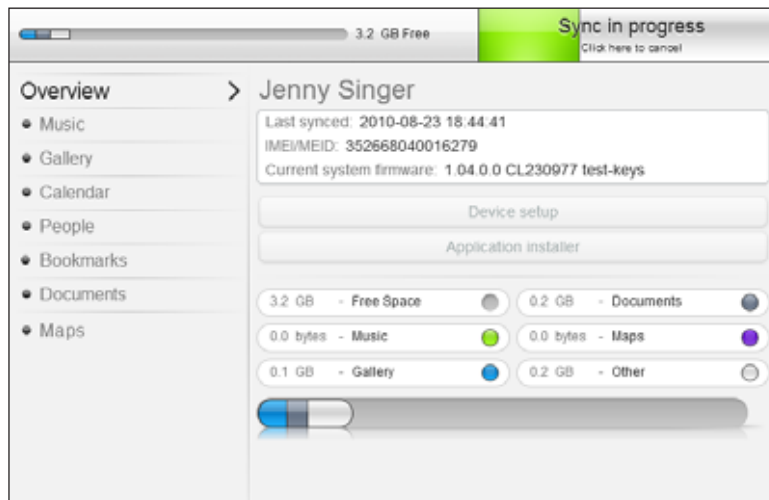

After synchronization is complete, click **Disconnect** and safely remove your phone as required by your computer's operating system. The next time you connect your phone to your computer, synchronization automatically begins based on your sync options.



Always check the estimated file size of new items that you want to synchronize with your phone. You will see a warning icon beside the estimated storage usage bar when there isn't enough space left on your storage card.

## Installing apps from your computer to your phone

If you have app (\*.apk files) on your computer, you can use HTC Sync to install them to your phone. We strongly recommend that you install only app that you trust.

Before you begin, make sure that your phone is set to allow app from your computer to be installed to your phone. To do this, press MENU from the Home screen, tap **Settings > Applications**, and then select the **Unknown sources** check box.

1. Connect your phone to the computer with the supplied USB cable.
2. On your phone's Connect to PC screen, tap **HTC Sync** and then tap **Done**.  
HTC Sync automatically starts on your computer.
3. On the Device panel of HTC Sync, click **Application installer**.
4. Locate the app on your computer, and then click **Open**.
5. Click **Done**. The installation process starts on your phone.



6. Check your phone's screen to see if there are additional instructions to complete the installation.
7. After installation is complete, you can click **Disconnect** and safely remove your phone as required by your computer's operating system.

---

### Synchronizing another phone with your computer

---

HTC Sync can synchronize up to three phones with your computer, making your favorite music, videos, photos, and files always available to you.



Make sure that all the phones you connect with your computer and synchronize using HTC Sync are running on Android 2.1 or later.

1. Connect the other phone to your computer using the supplied USB cable.
2. On the phone's Connect to PC screen, tap **HTC Sync**, and then tap **Done**.
3. On your computer, wait for HTC Sync to recognize the other phone. When the Device setup screen opens, enter a name for the phone, and then click **Save**.
4. You can separately customize your sync settings for this phone.

To switch between the connected phones, click **Devices** on the top left corner of the Device panel, and then click the phone's name or image.

# Social

## Facebook for HTC Sense

If you signed in to your Facebook account when you turned on and set up your phone for the first time, that means your Facebook account is linked to Facebook for HTC Sense on your phone. (If you did not do this, see the Accounts and sync chapter to find out how to sign in to Facebook for HTC Sense.)

With Facebook for HTC Sense, you can:

- See all your Facebook contacts and their instant status updates in People.

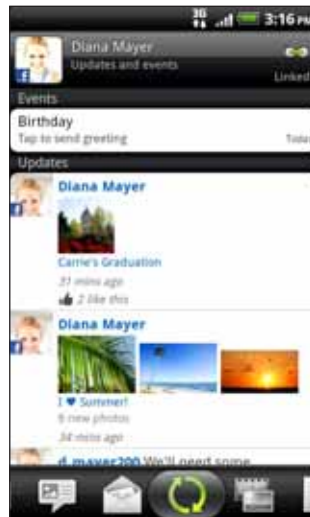

When you tap a contact on the People screen, slide to the **Updates and events** tab to see updates such as posted status messages, uploads, and profile changes.

When there is a notification of the contact's birthday, you can tap the notification to call the contact directly or send a message greeting.

- See Facebook photos right on the Gallery app.



You can also upload one or more photos from your storage card to Facebook, then tag and add captions that go with it.

When you're viewing the albums of a Facebook friend, you can also share a link to a particular album, or comment on the album photos.

To know more about viewing Facebook photos, see the Photos, videos, and music chapter.

- Check your friends' Facebook status updates in Friend Stream. See "Friend Stream" to find out the things you can do on the Friend Stream app.
- Add your Facebook events and your friends' birthdays to the Calendar app. See the Calendar chapter for details.

## Facebook for Android

The Facebook app on your phone lets you keep up and stay close with your friends in Facebook. It offers most of the features that you are familiar with when using Facebook on your computer.

With the Facebook app, you can:

- Share your thoughts and check other people's status updates.
- View your friends list and write on someone's wall.
- Comment on and like a friend's post.
- View someone's personal information, including photo albums.
- Check your Facebook notifications.
- Take a photo and upload it straight to your Facebook account.

---

### Using the Facebook app

---

1. Press HOME, and then tap  > Facebook.
2. If this is your first time to use Facebook, follow the onscreen instructions to sign in to your Facebook account.
3. On the News Feed screen, press MENU, and then tap **Home** to access the other functions.



- While on the Facebook home screen, press MENU, and then tap **Settings** to set refresh and notification options.
- On some Facebook screens, you can press and hold an item to open an options menu.

---

### Adding the Facebook widget

---

Add the Facebook widget to the Home screen by following the steps in "Personalizing your Home screen with widgets" in the Personalizing chapter.



The widget will only link to the Facebook account that you logged into on the Facebook app.

## What's the difference between Facebook for Android and Facebook for HTC Sense?

- Facebook for HTC Sense is not a standalone app. It is integrated in People, Friend Stream, Gallery, and Calendar to give you up-to-date information about your Facebook contacts (their status updates, shared links, and photos) in these apps.
- Facebook for Android is a standalone app. Use this app to do most of the things that you would do when you're using your computer's web browser to access your Facebook account, such as adding a friend and sending Facebook messages.
- The two do not share the same login credentials. Signing in to Facebook for HTC Sense does not sign you in to the Facebook for Android app and vice versa. If you want to use the same Facebook account for both, you'll have to sign in to both using the same login credentials.



If you have more than one Facebook account, you may sign in to the Facebook app using your second account, since the Facebook app does not share the same login credentials as Facebook for HTC Sense.

## Tweeting on your phone

You can post and read tweets, send and receive direct messages, search for new Twitter users to follow using the Peep app. Peep is a Twitter client that lets you enjoy "tweeting" on your phone.

You can also link your contacts in People to their Twitter profiles (if you're following them). To find out how, see "Merging contact information" in the People chapter.

If you did not sign in to your Twitter account when you first turned on the phone, you can do one of the following:

- Sign in to your Twitter account from Peep. From the Home screen, tap  > Peep, then follow the onscreen instructions.
- Add the **Twitter for HTC Sense** account in **Settings > Accounts & sync**. To find out how, see "Adding a social network account" in the Accounts and sync chapter.



Twitter for HTC Sense and Peep share the same login credentials. This means that when you use Peep on your phone for tweeting, you can also link your contacts to their Twitter profiles via Twitter for HTC Sense.

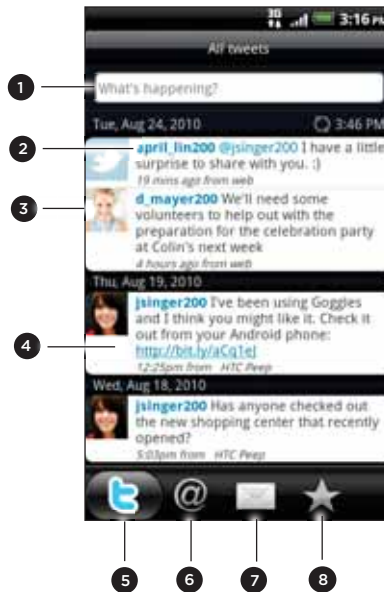

## Using Peep

From the Home screen, tap  > Peep. Peep opens in the All tweets tab.



- |   |  |
|---|--|
| 1 | Tap in this area to compose and send a tweet.  |
| 2 | Tap a person's name to check profile details and all of his or her tweets.   |
| 3 | If you have linked the contact in People, tap the photo or icon to open a menu where you can quickly choose how to communicate with the contact. |
| 4 | Press and hold a tweet to open an options menu to reply, send a direct message, retweet, and more.   |
| 5 | <b>All tweets tab.</b> View all the tweets from people you follow and tweets that you have posted.   |
| 6 | <b>Mentions tab.</b> View all tweets that mention your username using the "@[your username]" convention.   |
| 7 | <b>Direct message tab.</b> View all private/direct messages that you have received or sent.  |
| 8 | <b>Favorites tab.</b> View tweets that you have marked as favorites.   |



## Sending a tweet

- On the **All tweets** tab, tap the box that says "What's happening?".
- Type your tweet.
- Add a picture or location to your tweet.
  - Tap  to post a picture from Gallery or Camera to your default photo hosting site and add the link to the picture in your tweet.
  - Tap  to insert your location into the tweet. You can choose to add a map link, insert your location name, or insert your position coordinates.
- Tap **Update**.

---

## Searching for Twitter users to follow

---

1. On the Peep screen, press the SEARCH button.
2. Type a Twitter name in the search box.  
You can also narrow down the search when you tap  > Users.
3. Tap .
4. In the list of search results, tap the Twitter user you want to follow.
5. Press MENU, and then tap Follow.

## Unfollowing a Twitter user

1. On the Peep screen, tap the name of the Twitter user you want to stop following.
2. Press MENU, and then tap Unfollow.

---

## Sending a direct message

---

You can only send a direct message to someone who is following you.

1. On the Peep screen, press MENU, and then tap **New message**.
2. Tap the **To** field, and then enter the name. As you enter characters, the names of the Twitter users that match the characters you enter will appear. Tap the name when you see it.
3. Enter your message, and then tap **Update**.

You can also send a direct message when you press and hold a tweet of the person you want to send the direct message to, and then tap **Send direct message** on the options menu.

---

## Setting Peep options

---

On the Peep screen, press MENU, and then tap **More > Settings**. You can set these options:

<b>Account settings</b>	Sign out of your Twitter account.
<b>General settings</b>	Choose whether to show the screen name or the real name of the people you follow.
<b>Send &amp; receive</b>	Set the frequency to check for new tweets and set the number of tweets to download.
<b>Services</b>	Set your photo hosting site, photo quality, location options, and URL shortening host.
<b>Notification settings</b>	Select when and how you want to be notified.

---

## About the Twitter widget

---

Use the Twitter widget to send and follow your tweets right on your Home screen.

To find out how to add a widget to the Home screen, see “Personalizing your Home screen with widgets” in the Personalizing chapter.

## Friend Stream

Friend Stream connects you to your social networks. Share and get updates from friends in popular networks like Facebook and Twitter in a single feed. With Friend Stream, you can easily track your friends' status messages, photo uploads, notifications, and more — or comment and post your own.

- You must be signed in to at least one social network account to use Friend Stream. To find out how, see “Adding a social network account” in the Accounts and sync chapter.
- To use your Facebook account on Friend Stream, you need to be signed in via Facebook for HTC Sense. See “Facebook for HTC Sense” in this chapter.

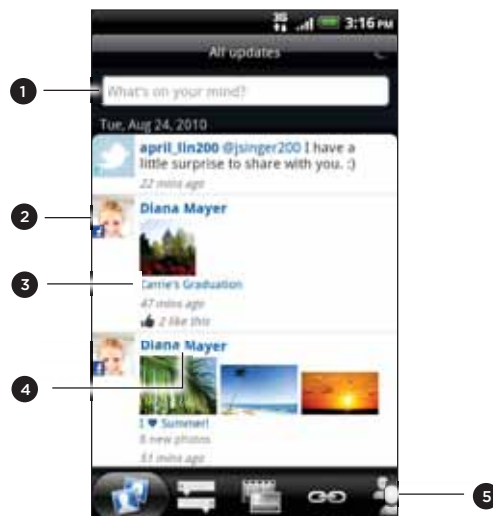

- |   |   |
|---|---|
| 1 | Tap in this area to compose and send a status update.   |
| 2 | If you have linked the contact in People, tap the photo or icon to open a menu where you can quickly choose how to communicate with the contact.  |
| 3 | When you tap someone's status update, you can: <ul style="list-style-type: none"> <li>▪ Open Peep and view all tweets. See “Tweeting on your phone” in this chapter.</li> <li>▪ Write a comment. Like or unlike someone's Facebook posts.</li> <li>▪ Look at someone's album photos.</li> </ul> |
| 4 | When you tap someone's name, you can: <ul style="list-style-type: none"> <li>▪ Check the person's profile details.</li> <li>▪ Look at the person's Facebook wall.</li> <li>▪ Check the person's posted tweets.</li> </ul>   |
| 5 | Slide to the other tabs to view social network updates grouped as status updates only, photo uploads, links, updates from members of your Facebook list, or social network notifications.   |

### Updating your status

You can update your status simultaneously on all the social network accounts you are signed in to.

1. From the Home screen, tap  > Friend Stream.
2. On the All updates tab, tap the box that says “What's on your mind?”.

3. Enter your status update.



4. If you do not want to send the status update to all your social network accounts, tap and clear the check boxes of the social networks to exclude.
5. Tap and then choose what you want to attach to your tweet or status update.

App recommendation	Choose an app you've installed from Android Market that you want to share with others. The URL from which the app can be downloaded will be inserted to your status. To find out more about sharing app, see "Sharing games and apps" in the More apps chapter.
Picture	Select <b>From Camera</b> to take a photo and attach it or <b>From Gallery</b> to attach a photo from your storage card.
Location	Add your current location or a location you pick on a map. See the Maps and location chapter for details.

6. Tap Share.

### Commenting on and liking Facebook posts

After tapping someone's status update on the **All updates** tab, you can do the following:



- 1 Tap a photo or the album name shown in the status update to view and comment on the album photos using the Gallery app. See the Photos, videos, and music chapter.
- 2 Type what you think about the person's status update.
- 3 Like or unlike the person's status update.



---

## Checking notifications from your social networks

---

Slide to the Notifications tab to easily see a single feed of your notifications from different social networks. It can be a comment on your Facebook post, a mention or direct message in Twitter, a tagged photo of you, and more.

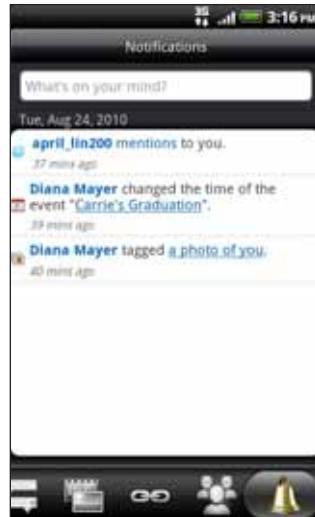

---

## About the Friend Stream widget

---

Use the Friend Stream widget so you can easily update your status and view other people's status updates right on the Home screen.

If you don't have this widget on your Home screen, see "Personalizing your Home screen with widgets" in the Personalizing chapter to find out how to add it to the Home screen.

## Chatting in Google Talk

Google Talk is Google's instant messaging program. It lets you communicate with other people that also use Google Talk.

If you signed in to your Google Account when you first set up the phone, you are already signed in to Google Talk.

---

### Chatting with friends

---

1. From the Home screen, tap  > Talk.
2. Tap a friend in the Friends list.
3. Enter your message in the text box. You can also insert a smiley by pressing MENU, and then tapping **More > Insert smiley**.
4. Tap **Send**.
5. While chatting, press MENU and then tap any of these options:

<b>Chat off record</b>	Your Google Talk messages are stored in the Chats folder of your Gmail account. Tap this option if you don't want to store your chat messages.
<b>Switch chats</b>	If you have more than one chat going, tap this to switch chat with another friend.
<b>Friends list</b>	Return to the Friends list.
<b>Add chat</b>	Add another friend to your chat. The friend you invited and the friend you currently chatting with receive an invitation to a group chat. Each one who accepts the invitation joins the group chat.
<b>End chat</b>	End your current chat.
<b>More</b>	Clear the chat history, insert a smiley or view your friend's contact details.

---

### Accepting chat invitations

---

When a friend sends you a Google Talk message, you receive a notification. Their entry in the Friends list turns white and displays the message.

Do one of the following:

- In the Friends list, tap the friend who sent you the invitation to chat.
- Open the Notifications panel, and then tap the chat notification. See "Opening the Notifications panel" in the Getting started chapter.

---

### Changing your online status and picture

---

1. From the Home screen, tap  > Talk.
2. In the Friends list, tap your name to open the Set Status screen.
3. Enter your new status message, or press BACK to choose a custom status from the list.
4. Tap the online status beside your picture, and then select the status you want on the menu.

5. Tap your picture, and then tap **Remove** to remove your photo, or **Change** to select another picture on the storage card. Note that if you've selected a big picture, you will be asked to crop it.
6. Tap **Done**.

Your online status, message, and picture appear in your contact's Friends lists and in other apps where your Google Talk status are displayed.

---

## Adding and managing friends

---

The Friends list is where you add and manage your friends in Google Talk.

1. From the Home screen, tap  > **Talk**.
2. In the Friends list, do any of the following.

<b>Invite a friend</b>	<ol style="list-style-type: none"> <li>1. Press <b>MENU</b>, and then tap <b>Add friend</b>.</li> <li>2. Enter the Google Talk instant messaging ID or Gmail address of the friend you want to add.</li> <li>3. Tap <b>Send invitation</b>.</li> </ol>
<b>View all friends</b>	Initially, only those friends that you often chat with — the most popular — are shown in the Friends list. To view all your friends, press <b>MENU</b> , and then tap <b>All friends</b> . To view only friends that you often chat with, press <b>MENU</b> , and then tap <b>Most popular</b> .
<b>Make a friend popular</b>	<ol style="list-style-type: none"> <li>1. Press <b>MENU</b>, and then tap <b>All friends</b>.</li> <li>2. Press and hold a friend's name, and then tap <b>Always show friend</b>.</li> </ol>
<b>Block a friend</b>	<p>You can block a friend from sending you messages. When blocked, your friend is removed from the Friends list and is added to the blocked friends list.</p> <ol style="list-style-type: none"> <li>1. Press <b>MENU</b>, and then tap <b>All friends</b>.</li> <li>2. Press and hold a friend's name, and then tap <b>Block friend</b>.</li> </ol>
<b>Unblock a friend</b>	<ol style="list-style-type: none"> <li>1. Press <b>MENU</b>, and then tap <b>More &gt; Blocked</b>.</li> <li>2. Tap the name of the blocked friend, and then tap <b>OK</b>.</li> </ol>
<b>View all invited friends</b>	Press <b>MENU</b> , and then tap <b>More &gt; Invites</b> . Friends who have not yet accepted your invitation are listed in the screen.

---

## Changing the settings and signing out

---

1. From the Home screen, tap  > **Talk**.
2. In the Friends list, press **MENU** and then tap:
  - **Settings** to change the app and notification settings.
  - **Sign out** to sign out from Google Talk.

# Email

## Using Gmail/Google Mail

Gmail/Google Mail is Google's web-based email service. When you first set up your phone, make sure you sign into your Google Account so you can send and receive Gmail/Google Mail messages. If you didn't do so, go to the **Accounts & sync** setting to sign in.

You can also set up more than one Google Account on your phone, and then switch between accounts in Gmail/Google Mail. To find out how to set up several Google Accounts, see "Adding more Google Accounts" in the Accounts and sync chapter.

### Viewing your Gmail/Google Mail Inbox

The Inbox conversations list is your default Gmail/Google Mail view. All your received emails are delivered to your Inbox.

Gmail/Google Mail groups each message you send with all the responses you receive. This conversation list continues to grow as new replies arrive, so you can always see your messages in context. A new message or a change to the subject of a current message will begin a new conversation.

1. From the Home screen, tap  > Gmail/Google Mail.  
Your inbox appears.

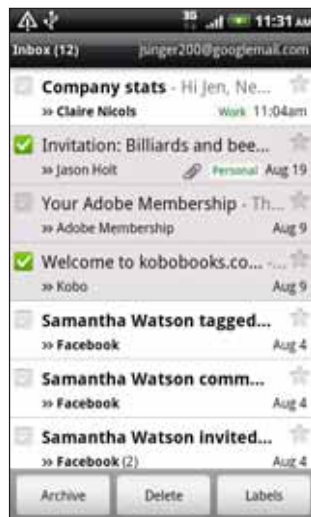

2. Do any of the following:

View more email messages	If the Inbox is full, swipe your finger up the screen to view more messages and conversations.
Read a new email message	Tap the unread message or the conversation with an unread message (just arrived items display in bold). For more information, see "Reading your messages."

Select messages and conversations	Tap the box (  ) before the email or conversation.
View the Inbox of your other Gmail/Google Mail account	Press MENU, tap <b>Accounts</b> , and then tap the account you want to view.
Refresh the Inbox	Press MENU, and then tap <b>Refresh</b> .

## Sending a new message

1. From the Home screen, tap  > Gmail/Google Mail.
2. In the Inbox, press MENU and then tap **Compose**.
3. Enter the message recipient's email address in the **To** field. If you are sending the email to several recipients, separate the email addresses with a comma. As you enter email addresses, any matching addresses from your contacts list are displayed. Tap a match to enter that address directly.



If you want to send a carbon copy (Cc) or a blind carbon copy (Bcc) of the email to other recipients, press MENU and then tap **Add Cc/Bcc**.

4. Enter the email subject, and then compose your email.
5. If you want to attach a picture, press MENU and then tap **Attach**. Locate and then tap the picture you want to attach.
6. After composing your message, tap **Send**.





- While composing the message, tap **Save as draft** or press the **BACK** button to save it as a draft. To view your draft email messages, in the Inbox, press MENU and then tap **Go to labels > Drafts**.
- To view your sent messages, in the Inbox, press MENU and then tap **Go to labels > Sent**.

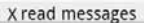

## Reading your messages

Depending on your notification settings, the phone plays a ringtone or vibrates when you receive a new email. A new email icon (  ) also appears on the notifications area of the status bar to tell you that you have a new email. For more information on email notification settings, refer to “Changing Gmail/Google Mail settings” later in this chapter.

1. Press and hold the status bar, and then slide down your finger on the screen to open the Notifications panel.
2. Tap the new email.
3. In the Inbox, tap the unread email or the conversation with the unread email to view it.
4. On the email message or conversation, do any of the following:
  - Scroll through the messages in the conversation by swiping your finger up or down the screen.
  - If you have two or more email messages in the conversation, tap  to expand all message headers in the conversation.

- Tap the star (  ) to star the message. See “Searching and organizing your emails” for more information.
- If the sender is a friend in Google Talk, check the button (  ) before the star in the message header to know your friend’s online status.
- Tap **Archive** to remove the conversation from your Inbox and transfer it to the All mail folder in your Google Account.
- Tap **Delete** to delete the conversation from your Inbox.



- If you’ve archived or deleted a conversation by accident, tap **Undo** at the top of the conversations list. The conversation is returned to your Inbox.
- To view your archived or deleted messages, in the Inbox, press MENU and then tap **Go to labels > All Mail** (for archived messages) or **Trash (for deleted messages)**.
  - Tap  or  to see the previous or next conversation in your Inbox.
  - Press MENU to see more options.

---

## Replying to or forwarding an email message

---

1. From the Home screen, tap  > **Gmail/Google Mail**.
2. In the Inbox, tap the email message or conversation.  
If the email message is long, swipe your finger up the screen.
3. Tap **Reply**, **Reply to all**, or **Forward**.
4. Do one of the following:
  - If you selected **Reply** or **Reply to all**, enter your reply message.
  - If you selected **Forward**, specify the message recipients.
5. Tap **Send**.



---

## Searching and organizing your emails

---

### Searching for messages



You can search for messages that contain one or more words in their contents or in their addresses, subjects, labels, and so on. When you search for messages, all of the messages in your Gmail/Google Mail account on the web are included (except those labeled **Trash** or **Spam**), not just those that you’ve synchronized onto your phone.

1. From the Home screen, tap  > **Gmail/Google Mail**.
2. In the Inbox, press SEARCH.
3. Enter the word or words to search for.
4. Tap , or tap the Enter key on the onscreen keyboard.

A conversation list opens, displaying all of the conversations with messages that contain the words you searched for. The words you searched for are displayed below the status bar. You work with the conversations in this list just as you would with the conversations in your Inbox or any other conversation list.

## Starring an email message or conversation

You can star an important message or a conversation so that you can easily find it again. To view just starred messages or conversations with starred messages, see “Filtering conversations” in this chapter.

1. From the Home screen, tap  > Gmail/Google Mail.
2. Do one of the following:
  - In the Inbox, tap the star (  ) to the right of the conversation subject to star the latest message in the conversation. Conversations with starred messages are displayed with a star in your Inbox and in other conversation lists.
  - In the inbox, tap a conversation and then go to the message that you want to star. Touch the star (  ) in the message header.

To unstar a message or conversation, touch its star again. You can also tap a star in a conversation list to unstar all messages in that conversation.

## Labeling a conversation

You can organize conversations by labeling them. Gmail/Google Mail has several preset labels you can use, and you can also add your own labels, using Gmail/Google Mail on the web.

1. From the Home screen, tap  > Gmail/Google Mail.
2. Tap a conversation to view the messages in it.
3. Press MENU and then tap **Change labels**.
4. Select the labels that you want to assign to the conversation, and then tap **OK**.

## Filtering conversations

You can choose to display conversations that have the same label or only those that are starred.

1. From the Home screen, tap  > Gmail/Google Mail.
2. In the Inbox or in another conversation list, press MENU, and then tap **Go to labels**.
3. Tap a label to view a list of conversations bearing that label.

The conversation list resembles your Inbox, but the label replaces “Inbox” below the status bar. You work with labeled conversations lists in the same way as with your Inbox.

## Cleaning up your Inbox

You can clean up your Inbox by archiving, deleting, or muting conversations. You can also report a conversation as spam to stop receiving any future messages from that sender.

1. From the Home screen, tap  > Gmail/Google Mail.
2. In the Inbox, tap the box (  ) before the conversations you want to work on, and then do any of the following:

<b>Delete</b>	Tap <b>Delete</b> . If you've deleted the conversation by accident, tap <b>Undo</b> at the top of the screen to move the conversation back to the Inbox.
<b>Archive</b>	Tap <b>Archive</b> . If you've archived the conversation by accident, tap <b>Undo</b> at the top of the screen to move the conversation back to the Inbox.
<b>Mute</b>	Press MENU, and then tap <b>Mute</b> . If you 'mute' a conversation, you will not receive any future messages for that conversation.
<b>Report as spam</b>	Press MENU, and then tap <b>Report spam</b> . The Gmail/Google Mail webmail service works hard to prevent spam (unwanted and unsolicited "junk" mail) from reaching your Inbox. But when spam makes it through, you can help improve the service by reporting the conversation as spam.

---

### Changing Gmail/Google Mail settings

---

1. From the Home screen, tap  > Gmail/Google Mail.
2. In the Inbox, press MENU and then tap **More > Settings**.
3. Set the following options:

<b>Signature</b>	Enter a signature that automatically appears at the end of your email messages.
<b>Confirm actions</b>	Show a confirmation box when you archive, delete or send a conversation.
<b>Auto-advance</b>	Select which conversation to display after you delete or archive a conversation.
<b>Message text size</b>	Adjust the size of text in your email messages.
<b>Batch operations</b>	When selected, this adds a check box to the left of each conversation so you can add it to a batch.
<b>Clear search history</b>	Remove the searches you have performed.
<b>Labels</b>	Set how many days and which Gmail/Google Mail labels to synchronize. See "Changing Gmail/Google Mail synchronization settings" in this chapter.
<b>Email notifications</b>	Show a notification icon on the status bar when you receive a new email.
<b>Select ringtone</b>	Choose a notification sound for new email messages.
<b>Vibrate</b>	Make your phone vibrate when you receive a new email message.
<b>Notify once</b>	When cleared, you are notified every time you receive a new email message.



## Changing Gmail/Google Mail synchronization settings

1. From the Home screen, tap  > Gmail/Google Mail.
2. In the Inbox, press MENU, and then tap **More > Settings > Labels**.
3. To set the number of days to synchronize, tap **Number of days to sync**.
4. To set synchronization for a particular message label, tap the label, and then select whether you want messages bearing that label to sync according to the default number of days you selected earlier, sync all, or sync none of them.

## Using Mail

Use the Mail app to add your webmail and other POP3 or IMAP email accounts. You can also set up and use your Exchange ActiveSync email on your phone.

---

### Adding a POP3/IMAP email account

---

1. From the Home screen, tap  > Mail.
2. Do one of the following:
  - If this is your first time to add an email account in Mail, tap **Other (POP3/IMAP)** on the Choose a mail provider screen.
  - If you've already added an email account in Mail, press MENU, and then tap **More > New account**. If the Choose a mail provider screen is displayed, tap **Other (POP3/IMAP)**.
3. Enter the email address and password for your email account and then tap **Next**.
4. If the account type you want to set up is not in the phone database, you'll be asked to enter more details.
5. Enter the account name and your name and then tap **Finish setup**.

---

### Adding a Microsoft Exchange ActiveSync account

---

You can add one or more Microsoft Exchange ActiveSync accounts on your phone. You can sync with Microsoft Exchange Server 2003 Service Pack 2 (SP2) or later.



You can add up to 15 Exchange ActiveSync accounts on your phone.

1. From the Home screen, tap  > Mail.
2. Do one of the following:
  - If this is your first time to add an email account in Mail, tap **Exchange ActiveSync** on the Choose a mail provider screen.
  - If you've already added an email account in Mail, press MENU, and then tap **More > New account**. If the Choose a mail provider screen is displayed, tap **Exchange ActiveSync**.

3. Enter the Exchange ActiveSync account details, and then tap **Next**. Your corporate Exchange Server must support auto-detect for the phone to automatically set up the Exchange ActiveSync account. If your corporate Exchange Server does not support auto-detect, you'll need to enter your Exchange Server settings after you tap **Next**. Ask your Exchange Server administrator for details.
4. Choose the types of information you want to sync, and then tap **Finish setup**.

---

### Checking your Mail inbox

---

When you open the Mail app, it displays the inbox of one of your email accounts that you've set up on your phone. To switch between email accounts, tap the bar that shows the current email account, and then tap another account.

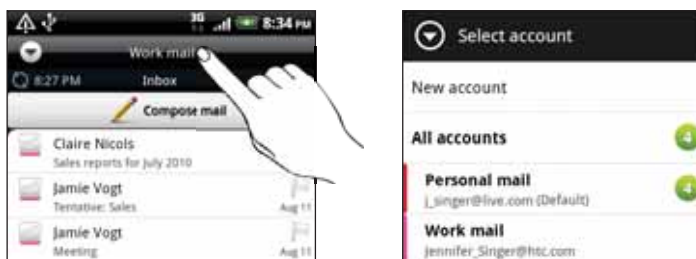

### Viewing the unified inbox of all your email accounts

You can view email from all your accounts just in one place without having to switch to different accounts.



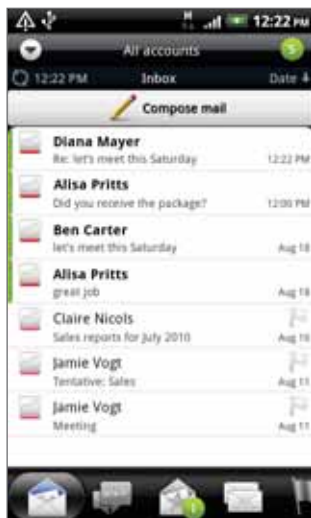



Just tap the bar that shows the current email account, and then tap **All accounts**.



Up to 15 email accounts can be shown in the unified inbox.

## Different views of your inbox

If you have lots of email messages, it may take you some time to browse through the long list and find a single email or related email messages. To skim through your email messages easier, tap one of the following tabs to change the view of your inbox:

	<b>Received.</b> Displays email messages as individual items.
	<b>Conversations.</b> Displays email messages as conversations, grouped according to the subject line. Tap a subject in the list to show the email conversation.
	<b>Group.</b> Displays all email messages from a contact group. To choose which contact group to display, press MENU, tap <b>View</b> , and then select a group. To find out more about working with contact groups, see “Contact groups” in the People chapter.
	<b>Unread.</b> Displays unread messages.
	<b>Marked</b> (Exchange ActiveSync only). Displays all flagged messages.
	<b>Meeting invitations</b> (Exchange ActiveSync only). Displays meeting invitations which you have not yet accepted or declined.
	<b>Attachments.</b> Displays all messages that have attachments.



You can rearrange the tabs to the order that you want. To find out how, see “Rearranging or hiding application tabs” in the Personalizing chapter.

## Refreshing your email account

Whatever your automatic synchronization settings are, you can also synchronize your sent and received emails manually at any time.

- While in the account you want to sync, press MENU, and then tap **Refresh**.
- If you have several email accounts, you can refresh them all at the same time. Go to the unified inbox first. Then press MENU and tap **Refresh**.

To find out how to display the unified inbox, see “Viewing the unified inbox of all your email accounts.”

## Sorting email messages

You can sort email messages by date received, priority, subject, sender, or size.

On the inbox, press MENU, tap **Sort**, and select from the sorting options.

## Quickly browsing your inbox

If you have a long list of email messages in your inbox, it may not be easy to browse the list and find an email that you want.

You can quickly browse through your inbox by using finger gestures.

1. Choose a sorting order for displaying your email messages. See “Sorting email messages.”
2. Press and hold your two fingers on any email message, and then slightly drag downward without lifting your fingers.



Your screen then jumps to the next or previous set of email messages based on your chosen sorting order. For instance:

- If your email messages are arranged by date, your screen jumps to the email messages received on the previous or next date, depending on your sorting order.
- If your email messages are arranged alphabetically by sender name or subject, your screen jumps to the previous or next sender or subject, depending on what's your sorting order.

---

## Managing email messages

---

### Deleting an email message

1. On the inbox, press and hold the message you want to delete.
2. On the options menu, tap **Delete**.

### Selecting several email messages

1. Tap the check boxes of email messages to select them.
2. Choose what you want to do with the selected messages: **Mark unread**, **Delete**, or **Move to** another folder.



You cannot move email messages when you're in the unified (**All accounts**) inbox.

### Moving several email messages to another folder

1. Switch to the email account you want to use.
2. Go to the **Received** tab or any other tab (except for the **Conversations** tab).
3. Tap the check boxes of email messages you want to move.
4. Tap **Move to**, and then tap the folder where to move the email messages.

## Moving an email message after reading

In the open message, press MENU, and then tap **More > Move to**.

## Deleting all messages

1. First tap the check box of any email message.
2. Press MENU, and then tap **Select all**.
3. Tap **Delete**.

---

## Switching to other mail folders



---

1. Press MENU, and then tap **Folders**.
2. Tap the mail folder whose messages you want to view.

---

## Sending an email message

---

1. From the Home screen, tap  > **Mail**.
2. Switch to the email account that you want to use for sending email.
3. On the email account inbox, tap **Compose mail**.
4. Fill in one or more recipients. You can:
  - Enter email addresses directly in the **To** field, separating them with a comma. As you enter email addresses, any matching addresses from your contacts list are displayed. Tap a match to enter that address directly.
  - Tap the  icon, and then choose the contacts to whom you want to send the message. You can also select contact groups as recipients, or add contacts from the company directory if you have set up an Exchange ActiveSync account on your phone. When you have selected all the message recipients, tap **OK**.



If you want to send a carbon copy (Cc) or a blind carbon copy (Bcc) of the email to other recipients, press MENU, and then tap **Show Cc/Bcc**.

4. Enter the subject, and then compose your message.
5. To add an attachment, press MENU, tap **Attach**, and choose from the following options:

Picture	Select <b>Camera</b> to take a photo and attach it, or <b>Gallery</b> to attach a photo from your storage card.
Video	Select <b>Camcorder</b> to capture a video and attach it, or <b>Videos</b> to attach a video from your storage card.
Audio	Select <b>Voice Recorder</b> to make a voice recording and attach it, or <b>Files</b> to attach a music file or voice recording from your storage card.
App recommendation	Choose an app you've installed from Android Market that you want to tell other people about. The URL from which the app can be downloaded will be inserted in your email. See "Sharing games and apps" in the More apps chapter.

Location	You can attach location information. Send your current location (requires GPS to be turned on) or a location you pick on a map. For more information, see the Maps and location chapter.
Document	Attach a PDF file or an Office document such as a text file or a spreadsheet.
Contact (vCard)	Attach someone's contact information.
Appointment (vCalendar)	Attach a calendar event.
File	Attach any file from your storage card.

6. Tap **Send** to send the message immediately, or tap **Save as draft** to send it later.



If there's no Wi-Fi or data connection available or Airplane mode is on when you send your email, the email will be saved to the Outbox folder. Once there's Wi-Fi or data connection available, the saved email will be sent automatically next time your phone syncs.

### Resuming a draft email message

1. In the email account inbox, press MENU, and then tap **Folders > Drafts**.
2. Tap the message.
3. When you finish editing the message, tap **Send**.

### Reading and replying to an email message

1. From the Home screen, tap  > Mail.
2. Switch to the email account you want to use.
3. On the email account inbox, tap the email you want to read.
4. Do any of the following:

Reply to the message	Tap <b>Reply</b> or <b>Reply all</b> .
Forward the message	Press MENU, and then tap <b>More &gt; Forward</b> .
Delete the message	Press MENU, and then tap <b>Delete</b> .
Mark the message as unread	Press MENU, and then tap <b>Mark unread</b> .

### Setting the priority for an email message

You can set the priority for an email message that you send.

1. While composing the message, press MENU.
2. Tap **Set priority**.
3. Select the priority for the message.

If you selected High or Low priority, the priority appears below the subject line of the message.

---



## Working with Exchange ActiveSync email

---

If you sync your phone with your work Exchange ActiveSync account, you can read, reply, send, and manage email in the same easy way as with a POP3/IMAP account. In addition, you can also use some powerful Exchange features.

To find out how you can set up your Exchange ActiveSync account, see “Adding a Microsoft Exchange ActiveSync account” in this chapter.

### Flagging an email

While viewing the inbox, tap the white flag icon  that appears on the right of an email message. The icon turns red  after you flagged the email.

While reading an email, you can also tap the flag icon in the email.

### Setting out of the office status

You can set your out of office status and auto-reply message right from your phone.

1. Switch to your Exchange ActiveSync account.
2. Press MENU and then tap **More > Out of the office**.
3. Tap the box, and then select **Out of the office**.
4. Set the dates and times for the period when you will be out of the office.
5. Enter the auto-reply message.
6. Tap **Save**.

### Sending a meeting request

1. Switch to your Exchange ActiveSync account.
2. Go to the **Meeting invitations** tab, and then tap **New meeting invitation**.
3. Enter the meeting details,
4. Tap **Send**.

---

## Changing email account settings

---

1. Switch to the email account whose settings you want to change.
2. Press MENU and then tap **More > Settings**.
3. Select from the following:

<b>Account settings</b>	Change the email account settings such as the name, email address, password, and description.
<b>General settings</b>	Set the font size when reading emails, enable, disable or set the signature, set the account as the default email account, and set where to save email attachments.
<b>Send &amp; Receive</b>	Set the maximum email file size limit when receiving and frequency to check for new emails and how many to check for. You can also set to have emails that you send bcc'd to yourself.
<b>Notification settings</b>	Set email notification settings.
<b>Delete account</b>	Tap to delete the email account.

4. Press BACK to save your changes.

### Deleting an email account

1. Switch to the email account you want to delete.
2. Press MENU, and then tap **More > Settings > Delete account**.



# Calendar

## About Calendar

Never miss an important date again. Use your phone's Calendar to schedule your events, meetings, and appointments.

You can set up your phone to stay in sync with the following types of calendars:

- On your phone, sign in to your Google Account so you'll be able to sync your phone's Calendar with your Google Calendar online. You can add multiple Google accounts. If you have not signed in to your Google Account yet, see the Accounts and sync chapter to find out how to sign in.
- If you're using Microsoft Outlook on your computer, you can set up HTC Sync on your computer to sync Outlook Calendar with your phone's Calendar. See "Synchronizing with your computer" in the Accounts and sync chapter.
- If you have a Microsoft Exchange ActiveSync account and you have added it on your phone, you can sync your phone's Calendar with your Exchange ActiveSync calendar events. See the Email and Accounts and sync chapters for details.

If you've signed in to your social network accounts such as Facebook, birthdays and events of friends from your social networks will appear in Calendar. To find out how to sign in to your social networks, see "Adding a social network account" in the Accounts and sync chapter.

## Creating calendar events

You can create events that appear on your phone only, as well as events that sync with your Google Calendar, your computer's Outlook Calendar, or Exchange ActiveSync calendar.

1. From the Home screen, tap , and then tap **Calendar**.
2. On any Calendar view, press **MENU** and then tap **New event**.



When you are in the Month or Agenda view, you can also tap  at the bottom-right of the screen to create a new event.

3. If you have more than one calendar, select a calendar in which to add the event:
  - Select **My Calendar** to create an event that will appear only on your phone.
  - Select your Google Account to create a Google Calendar event. If you have several Google Calendars on the Web, select one in which to add your event.

- Select **PC Sync** to create an Outlook Calendar event to sync with your computer.
  - Select your Exchange ActiveSync account to create an Exchange ActiveSync calendar event.
4. Enter a name for the event.
  5. To specify the date and time of the event, do one of the following:
    - If there is a time frame for the event, tap the **From** and **To** date and time to set them.
    - If it is a special occasion such as a birthday or a whole-day event, set the **From** and **To** date, then select the **All day** check box.
  6. Enter the event location and description.
  7. Set the reminder time.



You can add another reminder time in a Google Calendar event. Press **MENU** and then tap **Add reminder**.

8. If the event occurs on a regular basis, tap the **Repetition** box and then choose how often the event occurs.
9. Scroll to the bottom of the screen and then tap **Save**.

---

### Inviting guests to your event (Google Account only)

---

If you want to invite guests to your event, you need to create and add the event in your Google Calendar. An invitation email will be sent to your guests using your Google Account.

1. Open Calendar and create a new event. Tap the **Calendar** field and then select your Google Account (or one of your other Google Calendars). For the steps, see “Creating calendar events”.
2. Add details about the event, such as date and time, location, and more.
3. In the **Guests** field, enter the email addresses of everyone you want to invite to the event. Separate multiple addresses with commas ( , ).

If the people to whom you send invitations use Google Calendar, they'll receive an invitation in Calendar and by email.

4. Tap **Save** to add the event to your Google Calendar.

---

## Sending a meeting request using Calendar (Exchange ActiveSync only)

---

If you have an Exchange ActiveSync account set up on your phone, you can use Calendar to create a meeting appointment and send a meeting request email to the people you want to invite to your meeting.

1. Open Calendar and create a new event. Tap the **Calendar** field and then select your Exchange ActiveSync account. For the steps, see “Creating calendar events”.
2. Add details about the meeting, such as date and time, location, and more.
3. Press MENU and then tap **Meeting Invitation**.
4. Tap  and choose attendees from your contacts or Company directory.
5. Enter your message and then tap **Send**.

## Changing calendar views

When you open Calendar, it displays the Month view by default. You can also display the Calendar in Agenda, Day, or Week view. To change between calendar views, press MENU, and then choose the type of view that you want.

---



### Month view

---

In Month view, you'll see markers on days that have events.



When in Month view:

- Tap  on the bottom left of the screen to switch to Agenda view. Tap  on the bottom right to create a new event.
- Tap a day to view the events of that day.
- Press and hold a day to open an options menu from which you can also choose to create an event or switch to either Day or Agenda view.
- Slide your finger up or down the screen to view earlier or later months.

## Day and Agenda views

Day view displays a list of the events of one day and also shows weather information at the bottom of the screen when you're viewing events of the current day. Agenda view shows a list of all your events in chronological order.

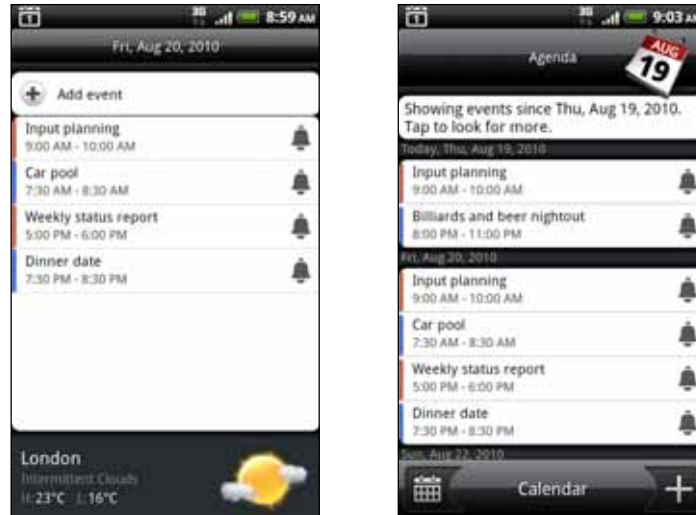

The color bars on the left side of the events indicate the type of calendar in which the event is part of. To find out what each color represents, press MENU and then tap More > Calendars.

When in Day view, slide left or right across the screen to view earlier or later days.



- In Day view, the weather information appears only if the event is within the five-day forecast of the Weather app.
- Weather information does not appear in Day view when you change Day view to display as a time list. See “Changing Calendar settings” for details.

## Week view

Week view displays a chart of the events of one week.

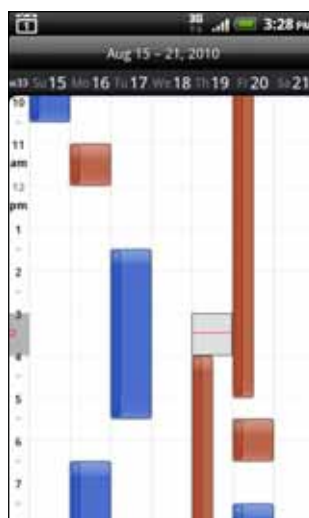

When in Week view:

- You can press and hold on a time slot to create a new event at that time.
- Tap an event to view its details.
- Slide left or right across the screen to view earlier or later weeks.

## Managing calendar events

You can view, edit, delete, or share events that you created. You can also view and share event invitations that other people sent to you.

---

### Viewing an event

---

1. From the Home screen, tap , and then tap **Calendar**.
2. In Month view, tap the day when the event takes place, and then tap the event to open it.

The Event details screen then opens and shows the summary of the event.

3. When viewing the event summary, you can do the following:
  - Find the event's location in **Maps**.
  - Call any phone number included in the event location or description.
  - Check the participants of the event you sent or are invited to.
  - Respond whether you'll attend the event you're invited to.
  - If it's an Exchange ActiveSync calendar event, reply by email to the organizer or to all the guests. Press **MENU**, and then either tap **Reply** or **Reply all**.
  - Select any text and look it up on the web. To learn more, see "Quickly looking up information on the Web" in the Getting started chapter.
  - Tap the reminder time to change it. Press **BACK** to save changes.

---

### Editing an event

---

1. While viewing an event, press **MENU**, and then tap **Edit event**.
2. Make your changes to the event.
3. When you're done editing, tap **Save**.

---

### Deleting an event

---

There are a number of ways to delete an event.

- While viewing the summary of an event on the Event details screen, press **MENU** and then tap **Delete event**.
- In Day, Agenda or Week view, press and hold an event and then tap **Delete event**.
- When editing an event, scroll down to the bottom of screen and then tap **Delete**.

If the event repeats, you'll be asked whether you want to delete just that occurrence, this and all future occurrences, or all past and future occurrences in your Calendar.

---

### Sharing an event (vCalendar)

---

You can share a calendar event as a vCalendar to someone's phone using Bluetooth or by sending it as a file attachment with your email or message.

1. While viewing an event, press MENU, and then tap **Share**.
2. Do one of the following:
  - Tap **Bluetooth**. you'll be asked to turn on Bluetooth on your phone and connect to the receiving Bluetooth device. Follow the steps in "Sending information using Bluetooth" in the Bluetooth chapter.
  - Tap **Email**. A new message window opens and automatically includes the vCalendar as an attachment. Your default email account that's selected in the Mail app will be used to send. For more information, see the Email chapter.
  - Tap **Message**. A new message window opens and automatically includes the vCalendar as a multimedia attachment. For more information, see the Messages chapter.

## Calendar event reminders

If you have set at least one reminder for an event, the upcoming event icon  will appear in the notifications area of the status bar to remind you of the upcoming event.

---

### Dismissing or snoozing event reminders

---

1. Tap the status bar, then slide your finger down the screen to open the Notifications panel.
2. Do one of the following:
  - Tap **Clear** to dismiss event reminders and all other notifications. Other types of notifications such as new messages and missed calls will also be deleted.
  - After sliding open the Notifications panel, tap the calendar event reminder. You'll then see a list of all pending event reminders. Tap **Snooze all** to snooze all event reminders for five minutes, or tap **Dismiss all** to dismiss all event reminders.
  - Press BACK to keep the reminders pending in the notifications area of the status bar.

## Displaying and synchronizing calendars

You can select which calendars to show or hide on your phone's Calendar, and which ones to keep synchronized.

---

### Showing or hiding calendars

---

In any Calendar view, press MENU , tap **More > Calendars**, and then select or clear a calendar to show or hide it. Tap **All calendars** to display all calendars.

The calendars are kept synchronized on your phone, whether or not you hide them.

---

### Choosing which Google Calendars are synchronized on your phone

---

You can choose which Google Calendars to keep synchronized on your phone or which ones to stop synchronizing.

#### Stop synchronizing a Google Calendar

1. In any Calendar view, press MENU and then tap **More > Calendars**.
2. Press MENU again and then tap **Remove calendars**.
3. Select a Google Calendar to remove from your calendars list, and then tap **OK**.
4. Press BACK to update Calendar with the new changes and return to the Calendar view you were viewing.

The calendars that you remove from your calendars list will no longer be synchronized on your phone, but you remain subscribed to them and can work with them in Google Calendar on the Web.

#### Adding a Google Calendar to sync with

Only the calendars that you've created or subscribed to on the Web, but previously removed from your calendars list, are shown in the list of calendars that you can add.

1. In any Calendar view, press MENU and then tap **More > Calendars**.
2. Press MENU again and then tap **Add calendars**.
3. Select a Google Calendar to add to your calendars list, and then tap **OK**.
4. Press BACK to update Calendar with the new changes and return to the Calendar view you were viewing.

## Changing Calendar settings

You can change Calendar settings to specify how it displays events and how it notifies you of upcoming events. In any Calendar view, press MENU and then tap **More > Settings** to access Calendar's settings.

### Reminder settings

Choose how you want Calendar to issue event reminders when there are upcoming events.

All calendars	Select this check box to use the same event reminder settings for all types of calendars. If you clear this check box, you can set different reminder settings for each calendar.
Set alerts & notifications	Configure event reminders to open an alert, send you a notification, or turn off event notifications on your phone.
Default reminder time	Choose how soon before an event you want to be notified.
Select ringtone	Choose a ringtone to sound when you receive an event reminder.
Vibrate	Choose whether you want your phone to vibrate when you receive an event notification.
Hide declined events	Choose whether to show or hide events to which you've declined invitations.

### Calendar view settings

Choose what appears in Calendar when opened and what's shown in Day, Week, and Month views.

Start in	Choose the default Calendar view that is displayed when you open Calendar.
Day views	Choose whether to display Day view in the form of an event list or time list.
First day of week	Set the Month and Week views to start on a Sunday or Monday.
Include weather	Make sure this check box is selected so that weather information is shown in Day view's event list.
City	By default, Day view displays your current location's weather. You can change it to display the weather of another city.

## About the Calendar widget

There's a Calendar widget available that you can add to your Home screen, and it comes in different calendar views. Tapping a day or event on the widget brings you to the Calendar app. To find out how you can add a widget, see "Personalizing your Home screen with widgets" in the Personalizing chapter.



# Clock and Weather

## About the HTC Clock widget

Use the HTC Clock widget to see your current date, time, and location. It's added by default on your Home screen. Tap the weather image to open the Weather app and check for more weather forecasts. See "Checking weather" for details.

If you want to show the time of another city, just add another clock widget to the extended Home screen. Select from a variety of looks and designs. To find out how you can add a widget, see "Personalizing your Home screen with widgets" in the Personalizing chapter.



## About the Clock app

Get more from the Clock app than just the regular date and time. Use your phone as a desk clock complete with weather information. Or let it serve as a night clock or a screensaver. As a world clock, see what time it is in several cities across the globe. You could also use it as an alarm clock, stopwatch, and countdown timer.

To open the Clock app, you can:

- Tap the HTC Clock widget on the Home screen.
- From the Home screen, tap  and then tap Clock.

Tap the tabs at the bottom row or slide your finger across the tabs to switch between the different functions of the Clock app.



- 1 Desk Clock tab
- 2 World Clock tab
- 3 Alarm Clock tab
- 4 Stopwatch tab
- 5 Timer tab

## Using Desk Clock

Opening the Clock app brings you directly to the Desk Clock screen.

The Desk Clock displays the current date, time, and weather. It also has an alarm clock indicator and a battery charging indicator. You can dim the screen to show only the time and date on the Desk Clock.



- 1 Shows whether the alarm clock is on or off. To find out how to turn on and set the alarm clock, see “Setting the alarm clock.”
- 2 Shows the weather information of your current location. Tapping it brings you to the Weather app where you can see weather forecasts of the next few days. See “Checking weather” for more information about the Weather app.
- 3 Shows the battery charge level. You’ll see it only when your phone is plugged with the power adapter or connected to your computer.
- 4 Tap to dim the screen and display only the time and date on the Desk Clock. To light up the screen again, tap anywhere on the screen or press the BACK button on your phone.
- 5 Tap to dim the screen and go into screensaver mode. When in screensaver mode, the time and date will change position on the screen after every few minutes. To light up the screen again, tap anywhere on the screen or press the BACK button on your phone.

You can change the Desk Clock screen to display the date and time of another time zone. To find out how to select a different time zone, see “Setting the time zone, date, and time.”

## Using World Clock

Use the Clock app’s World Clock screen to check the current time in several places around the globe simultaneously. You can also set your home city, add more cities to the world clock list, and manually set your time zone, date, and time.

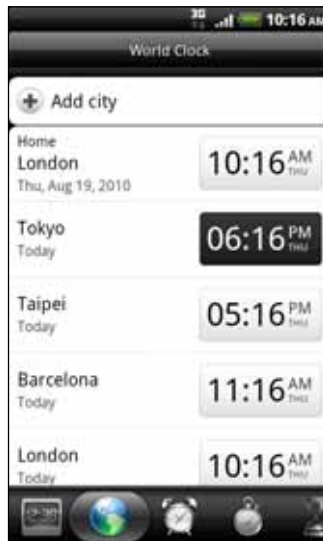

### Setting your home city

1. Tap the HTC Clock widget on the Home screen.
2. Tap the **World Clock** tab.
3. Press MENU and then tap **Home settings**.
4. Enter your home city’s name. As you enter letters, the list is filtered to show matching cities and countries.
5. Scroll through the list and tap your home city.

### Setting the time zone, date, and time

To set the time zone, date, and time on your phone manually, you need to turn off auto time synchronization first.

1. Tap the HTC Clock widget on the Home screen.
2. Tap the **World Clock** tab.
3. Press MENU and then tap **Local time settings** to open the Date & time settings screen.
4. Clear the **Automatic** check box.
5. Tap **Select time zone**. Scroll through the list and then tap the time zone that you want.

6. To change the date, tap **Set date**. Adjust the date by rolling the day, month, and year scroll wheels onscreen and then tap **OK**.
7. To change the time, tap **Set time**. Adjust the time by rolling the hour and minute scroll wheels onscreen and then tap **OK**.
8. Tap the **Use 24-hour format** check box to toggle between using a 12-hour or a 24-hour time format.
9. Tap **Select date format** then select how you want dates to be displayed. (The selected date format also applies to the date displayed in the alarm clock.)



From the Home screen, you can also press MENU and then tap **Settings > Date & time** to open the Date & time settings screen.

### Adding a city to the World Clock screen

Add more cities to the World Clock screen so you can instantly check the date and time in these cities. In addition to the current and home cities, the World Clock screen can display up to 15 cities.

1. Tap the HTC Clock widget on the Home screen.
2. Tap the **World Clock** tab.
3. Tap **Add city**. Enter the city name you want to add. As you enter letters, the list is filtered to show matching cities and countries.
4. Scroll through the matching list and tap the city that you want to add.

## Setting the alarm clock

You can use the Clock app's Alarms screen to set up one or more wake-up alarms.

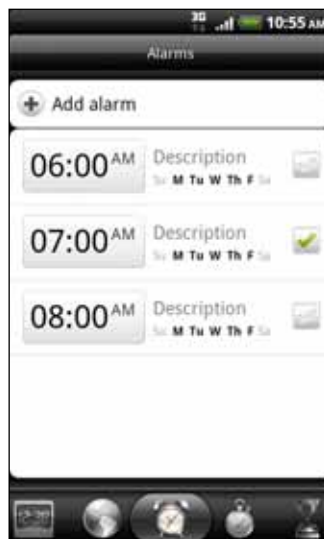

## Setting an alarm

1. Tap the HTC Clock widget on the Home screen.
2. Tap the **Alarms** tab.
3. Select the check box of an alarm. and then tap that alarm.
4. On the Set alarm screen, drag your finger up or down to roll the time scroll wheels and set the alarm time.
5. Scroll through the Set alarms screen to see all the available alarm options. You can:
  - Enter the alarm **Description** and choose the **Alarm sound** to use.
  - Tap **Repeat**. Select what days of the week to sound the alarm and then tap **OK**.
  - Select the **Vibrate** check box if you want your phone to also vibrate when the alarm goes off.
6. When you've finished setting the alarm, tap **Done**.



- To turn off an alarm, tap (clear) the check box of that alarm.
- If you need to set more than three alarms, press MENU while you're on the Alarms screen and then tap **Add alarm**.

## Deleting an alarm

1. Tap the HTC Clock widget on the Home screen.
2. Tap the **Alarms** tab.
3. On the **Alarms** screen, press MENU and then tap **Delete**.
4. Select the alarms you want to delete and then tap **Delete**.

## Changing alarm sound settings

If you've set one or more alarms, you can change their settings such as the alarm volume, how long to snooze the alarm, and more.

1. Tap the HTC Clock widget on the Home screen.
2. Tap the **Alarms** tab.
3. On the **Alarms** screen, press MENU and then tap **Settings**. You can change the following settings:

<b>Alarm in silent mode</b>	Selected by default, this option allows the alarm to sound even when your phone's volume is set to silent mode. Clear this check box if you want to silence the alarm when the volume is in silent mode.
<b>Alarm volume</b>	Set the volume level that you want for the alarm.
<b>Snooze duration</b>	Set how long to snooze between alarms.

**Side button behavior**

Choose what happens to the alarm when pressing the side button (VOLUME UP/DOWN) of your phone. You can set the button to snooze, dismiss the alarm, or disable the button.

The side button works only when the phone's screen is not locked. While on the lock screen, tap the onscreen **Snooze** button to snooze, or slide down the screen to dismiss the alarm.

## Checking weather

If you consented to turn location service on when you were setting up your phone for the first time, you'll see the weather of your current location right on the HTC Clock widget of your Home screen.

You can also check the current weather and weather forecasts for the next four days of the week. In addition to your current location's weather, this app also displays the weather forecasts of other cities around the globe.



If you declined to turn location service on during first-time setup of your phone, turn location service on in your phone's settings so that you'll be able to check your current location's weather on the HTC Clock widget, Weather app, and the Weather widget. From the Home screen, press MENU, tap **Settings** > **Location**, and then select the **Use wireless networks** check box.

1. Connect to the Internet using your phone's Wi-Fi or data connection. To find out how, see the Internet connections chapter.
2. From the Home screen, tap , and then tap **Weather**.
3. On the Weather screen, you'll first see your current location's weather. To check the weather in other cities, swipe your finger up or down the screen.



4. The Weather app automatically downloads and displays the latest weather updates. Tap  to update the information anytime.
5. To see more weather details on the Web, tap **Weather** at the bottom center of the Weather screen.

---

### Adding a city to the Weather screen

---

Add more cities to the Weather screen so you can instantly check the weather forecasts in these cities. In addition to your current location, the Weather screen can display up to 15 cities.

1. On the Weather screen, tap .
2. Enter the location you want to add. As you type, the list is filtered to show the possible locations based on the letters you entered.
3. Tap the desired city to select it.

---

### Changing the order of cities on the Weather screen

---

1. On the Weather screen, press MENU and then tap **Rearrange**.
2. Press and hold  at the end of the item you want to move. When the row is highlighted in green, drag it to its new position, then release.
3. Tap **Done**.

---

### Deleting cities from the Weather screen

---

1. On the **Weather** screen, press MENU and then tap **Delete**.
2. Select the cities you want to remove and then tap **Delete**.

---

### Changing weather options

---

1. On the **Weather** screen, press MENU and then tap **Settings**.
2. You can change the following weather settings:

<b>Update automatically</b>	Select this check box to automatically download weather updates.
<b>Update schedule</b>	Set an auto update schedule.
<b>Temperature scale</b>	Choose whether to display weather in Celsius or Fahrenheit.

## About the Weather widget

Use the Weather widget to instantly check weather forecasts of your current location and other cities without having to open the Weather app. The Weather widget comes in different looks and styles. You can add this widget to the Home screen, if it's not yet added. To find out how you can add a widget, see “Personalizing your Home screen with widgets” in the Personalizing chapter.



# Internet connections

## Data connection

Your phone will be automatically set up to use your mobile operator's data connection when you turn on your phone (if the SIM card is inserted) for the first time.

---

### Checking the data connection you are using

---

1. From the Home screen, press MENU, and then tap **Settings**
2. Tap **Wireless & networks > Mobile networks > Network operators or Access Point Names**.

---

### Turning the data connection on or off

---

Turning your data connection off can help save battery life and save money on data charges. However, if you don't have data connection turned on and you're also not connected to a Wi-Fi network, you won't receive automatic updates to your email, social network accounts, and other synchronized information.

1. From the Home screen, press MENU, and then tap **Settings**.
2. Tap **Wireless & networks**.
3. Select the **Mobile network** check box to turn on the data connection; clear the check box to turn off the data connection.

---

### Creating a new access point

---

Before you add another data connection on your phone, have the access point name and settings (including username and password if required) from your mobile operator ready.

1. From the Home screen, press MENU, and then tap **Settings**.
2. Tap **Wireless & networks > Mobile networks > Access Point Names**.
3. On the APNs screen, press MENU and then tap **New APN**.
4. On the Edit access point screen, enter the APN settings. Tap the APN setting item to edit it.
5. Press MENU and then tap **Save**.

## Enabling data roaming

Connect to your mobile operator's partner networks and access data services when you're out of your mobile operator's coverage area.



Using data services while roaming will be costly. Check with your mobile operator for data roaming rates before you use data roaming.

1. From the Home screen, press MENU, and then tap **Settings**.
2. Tap **Wireless & networks > Mobile networks**, and then select the **Data roaming** check box.

Select the **Data roaming sound** check box if you'd like your phone to play a sound so you'll know when it's connecting to a roaming network.

## Wi-Fi

To use Wi-Fi on your phone, you need access to a wireless access point or "hotspot". The availability and strength of the Wi-Fi signal will vary depending on objects, such as buildings or simply a wall between rooms, the Wi-Fi signal has to pass through.

### Turning Wi-Fi on and connecting to a wireless network

1. From the Home screen, press MENU, and then tap **Settings**.
2. Tap **Wireless & networks**, and then select the **Wi-Fi** check box to turn Wi-Fi on. The phone then scans for available wireless networks.
3. Tap **Wi-Fi settings**. The network names and security settings of detected Wi-Fi networks are displayed in the Wi-Fi networks section.
4. If the wireless network you want to connect to is not in the list of detected networks, scroll down the screen, and then tap **Add Wi-Fi network**. Enter the wireless network settings, and then tap **Save**.
5. Tap the Wi-Fi network you want to connect to.
  - If you selected an open network, you'll be automatically connected to the network.
  - If you selected a network that is secured with WEP, enter the key and then tap **Connect**.



Depending on the network type and its security settings, you may also need to enter more information or choose a security certificate.

When your phone is connected to a wireless network, the Wi-Fi icon  appears in the status bar and tells you the approximate signal strength (number of bands that light up).

The next time your phone connects to a previously accessed secured wireless network, you won't be asked to enter the key or other security information again, unless you reset your phone to its factory default settings.

---

## Connecting to a Wi-Fi network with EAP-TLS security

---

You may need to install a network certificate (\*.p12) to your phone before you can connect to a Wi-Fi network with EAP-TLS authentication protocol.

1. Save the certificate file to the root folder of the storage card.
2. From the Home screen, press MENU, and then tap **Settings**.
3. Tap **Security > Install from SD card**.
4. Select the network certificate needed to connect to the EAP-TLS network.
5. Follow the steps in the previous section to connect to the Wi-Fi network.

---

## Checking the wireless network status

---

1. From the Home screen, press MENU, and then tap **Settings**.
2. Tap **Wireless & networks**.
3. On the Wireless & networks screen, tap **Wi-Fi settings**, and then tap the wireless network that the phone is currently connected to.

A message box is then displayed showing the Wi-Fi network name, status, speed, signal strength, and more.



If you want to remove the wireless network settings on your phone, tap **Forget**. You'll need to enter the settings again if you want to connect to this wireless network.

---

## Connecting to another Wi-Fi network

---

1. From the Home screen, press MENU, and then tap **Settings**.
2. Tap **Wireless & networks > Wi-Fi settings**. Detected Wi-Fi networks are displayed in the Wi-Fi networks section.
3. To manually scan for available Wi-Fi networks, on the Wi-Fi settings screen, press MENU and then tap **Scan**.
4. Tap another Wi-Fi network to connect to it.

## Adding connection widgets

Add the Mobile Network and Wi-Fi widgets or the Data dashboard widget to the Home screen to make it faster for you to turn on or off these connections. Tap the widget or icon on the dashboard to turn on or off the connection.



To find out how to add widgets, see “Adding a widget” in the Personalizing chapter.

## Connecting to a virtual private network (VPN)

Add, set up, and manage virtual private networks (VPNs) so you can connect and access resources inside a secured local network, such as your corporate network.

Depending on the type of VPN you’re using at work, you may be asked to enter your login credentials and install security certificates before you can connect to your company’s local network. You can get this information from your network administrator.

Also, your phone must first establish a Wi-Fi or data connection before you can start a VPN connection. For information about setting up and using these connections on your phone, see “Data connection” and “Wi-Fi” in this chapter.

---

### Setting up secure credential storage

---

If your network administrator tells you to download and install security certificates, you must first set up the phone’s secure credential storage.

1. From the Home screen, press MENU, and then tap **Settings**.
2. Tap **Security > Set password**.
3. Enter a new password for the credential storage.
4. Scroll down and confirm the password, and then tap **OK**.
5. Select the **Use secure credentials** check box.

You can then download and install the certificates needed to access your local network. Your network administrator can tell you how to do this.

---

## Adding a VPN connection

---

1. From the Home screen, press MENU, and then tap **Settings**.
2. Tap **Wireless & networks > VPN settings**.
3. Tap **Add VPN**, and then tap the type of VPN you want to add.
4. Tap the VPN settings and set them up according to the security details your network administrator gave you.
5. Press MENU, and then tap **Save**.

The VPN is then added to the VPNs section of the VPN settings screen.

---

## Connecting to a VPN

---

1. From the Home screen, press MENU, and then tap **Settings**.
2. Tap **Wireless & networks > VPN settings**.
3. In the VPNs section, tap the VPN that you want to connect to.
4. When asked, enter your log in credentials, and then tap **Connect**.  
When you're connected, the VPN connected icon  appears in the notification area of the title bar.

You can then open the web browser to access resources such as your corporate network intranet.

---

## Disconnecting from a VPN

---

1. Press and hold the title bar, and then slide down your finger to open the Notifications panel.
2. Tap the VPN connection to return to the VPN settings screen, and then tap the VPN connection to disconnect from it.

When your phone has disconnected from the VPN, the VPN disconnected icon  is displayed in the notification area of the title bar.

## Using your phone as a modem (tethering)

No Internet connection available for your computer? No problem. Use your phone's data connection to connect to the Internet using your computer.

You need your SIM card inserted on your phone to use the data connection. To find out how to set up and use the data connection, see "Data connection" earlier in this chapter.

Before you can use your phone as a modem, be sure to install HTC Sync on your computer first. To find out how to install HTC Sync, see "Synchronizing with your computer" in the Accounts and sync chapter.

1. Make sure your phone's data connection is turned on. See "Turning the data connection on or off" earlier in this chapter to find out how to turn on the phone's data connection.

2. Connect the phone to the computer using the provided USB cable.
3. On the Connect to PC screen, select **Mobile network sharing**, and then tap **Done**.

## Connecting your phone to the Internet through a computer (Internet Pass-through)

If you don't have a data plan for your phone or you don't have access to a Wi-Fi network, you can still go online on your phone by using your computer's Internet connection.

Before you can use your computer as a modem, be sure to install HTC Sync on your computer first. To find out how to install HTC Sync, see "Synchronizing with your computer" in the Accounts and sync chapter.

1. Make sure your computer is connected to the Internet.



Two things to check for your computer's Internet connection. One, we recommend that you turn off your local network's firewall. Two, if your computer connects to the Internet via PPP (e.g. Dial UP, xDSL, or VPN), Internet Pass-through will only support TCP protocol.

2. Connect the phone to the computer using the provided USB cable.
3. On the Connect to PC screen, select **Internet Pass-through**, and then tap **Done**.
4. On the message window, tap **OK**.

## Using your phone as a wireless router

Share your data connection with other devices by turning your phone into a wireless router. Make sure your phone's data connection is turned on before you use it as a wireless router. To find out how to turn on your phone's data connection, see "Data connection" earlier in this chapter.

1. From the Home screen, press **MENU**, and then tap **Settings**.
2. Tap **Wireless & networks > Portable Wi-Fi hotspot settings**.



The first time you open Portable Wi-Fi hotspot, a brief introduction describing the application is displayed. Tap **OK**.

3. Enter a name in **Router name (SSID)**, or use the default router name.
4. Choose the type of **Security** and set the **Password (key)** for your wireless router. If you selected **None** in Security, you don't need to enter a password.

The password is the key other people need to enter on their device so they can connect and use your phone as a wireless router.

5. Select the **Portable Wi-Fi Hotspot** check box to turn on your phone's wireless router.

Your phone is ready to be used as a wireless router when you see  on the status bar. Only two devices can connect to your phone's wireless router at one time so if a third device tries to connect to your phone, it won't be able to.

# Web browser

## Using your phone's web browser



You must have an active data connection or Wi-Fi connection to access the Internet.

Do one of the following to open the web browser and start surfing the Web:

- On the Home screen, tap **Internet**.
- From the Home screen, tap  > **Internet**.

### Going to a webpage

1. On the browser screen, press MENU and then tap the URL field on top of the screen.
2. Enter the webpage address using the keyboard. As you enter the address, matching webpage addresses will appear on the screen. Tap an address to go directly to that webpage or continue entering the webpage address.

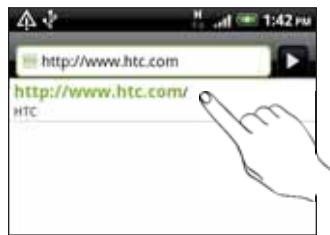

3. Tap the Enter key  on the onscreen keyboard.

### Setting your home page

1. From the browser screen, press MENU, and then tap **More > Settings > Set home page**.
2. On the Set home page screen, select the home page you want to use.

### Changing the screen orientation

The phone automatically changes the screen orientation depending on how you're holding your phone.

Turn your phone sideways to display the web browser in landscape orientation.



If the screen orientation doesn't change automatically, please switch automatic screen orientation on. From the Home screen, press MENU, tap **Settings > Display**, and then select the **Auto-rotate screen** check box.

## Browsing full versions of all websites

Some websites display a mobile version of their pages on phone web browsers. You can choose to view the full version of all pages, even for these sites.

From the browser screen, press MENU, tap **More > Settings**, and then clear the **Mobile view** check box.

## Choosing when to show Flash content

Choose which Flash® content you want to see by switching to **On demand**. By switching to **On demand**, you decide when Flash content appear on a webpage.

1. From the browser screen, press MENU, and then tap **More > Settings > Enable plugins**.
2. Tap **On demand**.

After switching to **On demand**, you can show the Flash content by tapping  on the web page.

## Navigating on a webpage

You can swipe your finger on the screen to navigate and view other areas of the webpage.

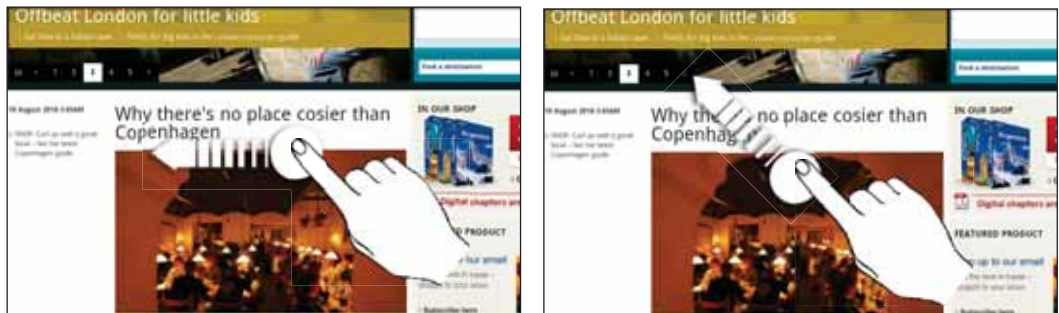

## Zooming in or out on a webpage

Tap the screen twice quickly to zoom in, then tap the screen twice quickly again to zoom out. You can also use your fingers to spread or pinch the screen to zoom in and out.

## Selecting a link in a webpage

You can tap a link with your finger to open it, or press and hold a link for more options.

Link	What to do
Webpage address (URLs)	<ul style="list-style-type: none"> <li>▪ Tap the link to open the webpage.</li> <li>▪ Press and hold the link to open a menu that allows you to open, bookmark, copy to the clipboard, or share the link via email or your social networks.</li> </ul>
Email address	<ul style="list-style-type: none"> <li>▪ Tap to send an email message to the email address.</li> <li>▪ Press and hold, then tap <b>Copy</b> on the menu to copy the email address to the clipboard. You can paste the email address later when creating a new contact or sending a new email message.</li> </ul>



## Selecting an address or phone number in a webpage

You can map an address or call a phone number on a webpage.

Link	What to do
Location address	Tap the address to copy it or map it using Google Maps™.
Phone number	Tap the phone number to copy, call, send a text message to that number, or save the number to a contact in People.

## Opening a new browser window

Open multiple browser windows to make it easier for you to switch from one website to another. You can open up to 4 browser windows.

1. While viewing a webpage, press MENU and then tap **Windows**.
2. Tap .

A new browser window opens and goes to the home page that is set.

## Switching between browser windows

1. While viewing a web page, do one of the following:
  - Press MENU and then tap **Windows**.
  - Pinch the screen (zoom out) until you see the other browser windows.
2. Select the browser window you want to view by sliding your finger on the screen from right to left.



You can also do the following:



- 1 Tap a webpage to display it in full screen.
- 2 Tap  to close a webpage.

## Downloading applications from the web



All downloaded applications are saved to the storage card. Before you download an application from the web, make sure that you have installed a storage card on your phone. For information on how to install a storage card, refer to the Basics chapter.

Before you can download applications from the web, you must first enable downloading from the phone settings.

1. From the Home screen, press MENU, and then tap **Settings**.
2. Tap **Applications**, and then select the **Unknown sources** check box.
3. When the Attention dialog box opens, tap **OK**.



Applications downloaded from the web can be from unknown sources. To protect your phone and personal data, download applications only from trusted sources such as Android Market. Refer to “Finding and installing apps from Android Market” in the More apps chapter for details.

### Viewing your downloads

While viewing a webpage, press MENU and then tap **More > Downloads**.

## Copying text, looking up information, and sharing

You can select text and then:

- Copy it.
- Search it using Google Search.
- Look it up on Wikipedia, YouTube, or Google Dictionary.
- Get a translation of the text from Google Translate.
- Share the text in a new email, text, or multimedia message or in your status update on a social network.

### Finding text within a webpage

1. While viewing a webpage, press MENU and then tap **More > Find on page**.
2. Enter what you want to search for. As you enter characters, matching characters will be highlighted. Tap the left or right arrow to go to the previous or next matching item.



## Selecting text

1. Press and hold on a word.
2. Drag the start and end markers to highlight the surrounding text you want to select.



- 1 Start and end markers. Drag to increase or decrease the text selection area.









To select text in a link, press and hold the link, and then tap **Copy link URL**.

## Copying and pasting text

1. After you have selected the text you want to copy, tap . The selected text is then copied to the clipboard.
2. In a text entry field (for example while composing a message), press and hold at the point where you want to paste the text.
3. Tap **Paste**.

## Searching or translating text

1. After you have selected the text you want to search or translate, tap .
2. Tap one of the following tabs:

	<b>Wikipedia.</b> Look for related information on Wikipedia, based on the text that you selected.
	<b>Google Search.</b> Look for related information using Google Search, based on the text that you selected.
	<b>YouTube.</b> Look for videos on YouTube, based on the text that you selected.
	<b>Google Translate.</b> Translate the text to another language.
	<b>Google Dictionary.</b> Look up the selected text in the dictionary.

## Pasting text in a new message or social network status update

1. After you have selected the text you want to share, tap .
2. Select an option to paste the selected text in a new email, text or multimedia message or in your status update on a social network such as Twitter. See the Email, Messages, and Social chapters for more information on using these features.

## Viewing bookmarks and previously visited pages

You can store as many bookmarks as you want on your phone. You can also access a convenient History list of the sites you have visited, or quickly view the pages that you access most often.

---

### Bookmarking a webpage

---

1. While viewing a webpage, press MENU, and then tap **Add bookmark**.
2. Edit the bookmark name if needed, and then tap **Add**.

---

### Opening a bookmark

---

1. While viewing a webpage, press MENU, and then tap **Bookmarks**.
2. On the Bookmarks tab , navigate to the bookmark you want to open, and then tap it.

---

### Editing a bookmark

---

1. While viewing a webpage, press MENU, and then tap **Bookmarks**.
2. On the Bookmarks tab , press MENU and then tap **Edit**.
3. Tap the bookmark you want to edit.
4. Enter your changes, and then tap **Add**.

---

### Viewing a previously visited page

---

1. While viewing a webpage, press MENU, and then tap **Bookmarks**.
2. On the History tab , navigate to the page you want to view and then tap the page.

---

### Clearing the list of previously visited pages

---

1. While viewing a webpage, press MENU, and then tap **Bookmarks**.
2. On the History tab , press MENU, and then tap **Clear history**.

---

### Viewing a page that you often visit

---

1. While viewing a webpage, press MENU, and then tap **Bookmarks**.
2. On the Most visited tab , navigate to the page you want to view, and then tap the page.

---

### Clearing the list of most visited pages



---

1. While viewing a webpage, press MENU, and then tap **Bookmarks**.
2. On the Most visited tab , press MENU, and then tap **Clear all**.

---

## Changing the view of bookmarks or most visited pages

---

1. While viewing a webpage, press MENU, and then tap **Bookmarks**.
2. On the Bookmarks tab  or the Most visited tab , press MENU, and then tap **Thumbnails**, **List**, or **Grid** to change the view. For example, if you are in Thumbnails view and you want to view bookmarks in a grid, press MENU > **List**, and then press MENU > **Grid**.

## Setting browser options

Customize the web browser to suit your browsing lifestyle. Set display, privacy, and security options when using the web browser.

From the browser screen, press MENU, and then tap **More > Settings**.

# Bluetooth

## Bluetooth basics

---

### Turning Bluetooth on or off

---

1. From the Home screen, press MENU, and then tap **Settings > Wireless & networks**.
2. Select or clear the **Bluetooth** check box.

An even easier way to turn Bluetooth on or off is with the Bluetooth widget or Bluetooth setting shortcut on the Home screen. To find out how to add widgets and shortcuts to the Home screen, see the Personalizing chapter.



Turn off Bluetooth when not in use to save battery power, or in places where using a wireless device is prohibited, such as on board an aircraft and in hospitals.

---

### Changing the phone name

---

The phone name identifies your phone to other devices.

1. From the Home screen, press MENU, and then tap **Settings > Wireless & networks > Bluetooth settings**.
2. If the **Bluetooth** check box is not selected, select it to turn Bluetooth on.
3. Tap **Device name**.
4. Enter the name for your phone in the dialog box, and then tap **OK**.

## Connecting a Bluetooth headset or car kit

You can listen to music over a Bluetooth stereo headset, or have hands-free conversations using a compatible Bluetooth headset or car kit. It's the same procedure to set up stereo audio and hands-free.

- For you to listen to music with your headset or car kit, the headset or car kit must support the A2DP Bluetooth profile.
  - Before you connect your headset, you need to make it discoverable so your phone can find it. You can find out how to do this by referring to your headset manual.
1. From the Home screen, press MENU, and then tap **Settings > Wireless & networks > Bluetooth settings**.
  2. If the **Bluetooth** check box is not selected, select it to turn Bluetooth on.
  3. Make sure that the headset is discoverable.

4. Tap **Scan for devices**. Your phone will start to scan for Bluetooth devices within range.
5. When you see the name of your headset displayed in the Bluetooth devices section, tap the name. Your phone then automatically tries to pair with the headset.
6. If automatic pairing fails, enter the passcode supplied with your headset.

The pairing and connection status is displayed below the hands-free headset or car kit name in the Bluetooth devices section. When the Bluetooth headset or car kit is connected to your phone, the Bluetooth connected icon  is displayed in the status bar. Depending on the type of headset or car kit you have connected, you can then start using the headset or car kit to listen to music and/or make and receive phone calls.

---

### Reconnecting a headset or car kit

---

Normally, you can easily reconnect your headset by switching on Bluetooth on your phone, and then turning on the headset. However, you might have to connect manually if your headset has been used with another Bluetooth device.

1. From the Home screen, press MENU, and then tap **Settings > Wireless & networks > Bluetooth settings**.
2. If the **Bluetooth** check box is not selected, select it to turn Bluetooth on..
3. Make sure that the headset is discoverable.
4. Tap the headset's name in the Bluetooth devices section.
5. If prompted to enter a passcode, try 0000 or 1234, or consult the headset/car kit documentation to find the passcode.

If you still cannot reconnect to the headset or car kit, follow the instructions in "Unpairing from a Bluetooth device", and then follow the steps under "Connecting a Bluetooth headset or car kit."

## Disconnecting or unpairing from a Bluetooth device

---

### Disconnecting a Bluetooth device

---

1. From the Home screen, press MENU, and then tap **Settings > Wireless & networks > Bluetooth settings**.
2. In the Bluetooth devices section, press and hold the device to disconnect.
3. Tap **Disconnect**.

---

### Unpairing from a Bluetooth device

---

You can make your phone forget its pairing connection with another Bluetooth device. To connect to the other device again, you may need to enter or confirm a passcode again.

1. From the Home screen, press MENU, and then tap **Settings > Wireless & networks > Bluetooth settings**.
2. In the Bluetooth devices section, press and hold the device to unpair.
3. Tap **Disconnect & unpair**.

Or, tap **Unpair** if the Bluetooth device is currently not connected to your phone.

## Sending information using Bluetooth







You can use Bluetooth to send information from your phone to another Bluetooth enabled device such as a phone or notebook computer. You can send the following types of information, depending on the device you are sending to:

- Photos and videos
- Calendar events
- Contacts
- Audio files

Before you begin, set the receiving device to discoverable mode. You may also need to set it to “Receive Beams” or “Receive Files”. Refer to the device’s documentation for instructions on receiving information over Bluetooth.

The first time you transfer information between your phone and another device, you need to enter or confirm a security passcode. After that, your phone and the other device are paired, and you will not need to exchange passcodes to transfer information in the future.

1. On your phone, open the app that contains the information or file you want to send.
2. Follow the steps for the type of item you want to send:

Captured photo or video	After capturing, on the Camera preview screen, tap the <b>Share</b> button  and then tap <b>Bluetooth</b> .
Photos or videos	<ol style="list-style-type: none"> <li>1. On the <b>Albums</b> tab  of the Gallery app, choose an album.</li> <li>2. Tap the <b>Share</b> button , and then tap <b>Bluetooth</b>.</li> <li>3. Choose the photos and videos you want to share, and then tap <b>Next</b>.</li> </ol>
Contact	<ol style="list-style-type: none"> <li>1. On the <b>All</b> tab  of the People app, press and hold a contact, and then tap <b>Send contact as vCard</b>.</li> <li>2. Tap the down arrow icon, and then select <b>Bluetooth</b> from the displayed list.</li> </ol> <div style="text-align: center; margin-top: 10px;">  </div>
Calendar event	In Day view, Agenda view, or Week view, press and hold the event, and then tap <b>Share &gt; Bluetooth</b> .
Music track	With the track displayed on the Music app’s Now playing screen, press MENU, and then tap <b>Share &gt; Bluetooth</b> .
Voice recording	On the main Voice Recorder screen, tap the <b>Share</b> button  , and then tap <b>Bluetooth</b> .



3. Turn on Bluetooth if you're asked to do so.
4. If you haven't paired with the receiving device before, tap **Scan for devices**.
5. Tap the name of the receiving device.
6. If prompted, accept the pairing request on your phone and the receiving device.

Also enter the same passcode on both your phone and the other device, or confirm the auto-generated passcode.

7. On the receiving device, accept the file.

---

### Where sent information is saved

---

When you send information from your phone using Bluetooth, the location where it's saved depends on the type of information and the receiving device.

If you send a calendar event or contact, it is normally added directly to the corresponding app on the receiving device. For example, if you send a calendar event to a compatible phone, the event is shown in that phone's calendar app.

If you send another file type to a Windows computer, it is normally saved in the Bluetooth Exchange folder within your personal document folders.

- On Windows XP, the path may be:  
C:\Documents and Settings\[your username]\My Documents\Bluetooth Exchange
- On Windows Vista, the path may be:  
C:\Users\[your username]\Documents
- On Windows 7, the path may be:  
C:\Users\[your username]\My Documents\Bluetooth Exchange Folder

If you send a file to another device, the saved location may depend on the file type. For example, if you send an image file to another mobile phone, it may be saved in a folder named "Images."

## Receiving information using Bluetooth

Your phone is capable of receiving a wide variety of file types with Bluetooth, including photos, music tracks, and documents such as PDFs.

The first time you transfer information between your phone and another device, you need to enter or confirm a security passcode. After that, your phone and the other device are paired, and you will not need to exchange passcodes to transfer information in the future.

To receive files using Bluetooth, you need to have a microSD card on your phone.

1. From the Home screen, press MENU, and then tap **Settings > Wireless & networks > Bluetooth settings**.
2. If the **Bluetooth** check box is not selected, select it to turn Bluetooth on.
3. Select the **Discoverable** check box.

4. On the sending device, send one or more files to your phone. Refer to the device's documentation for instructions on sending information over Bluetooth.
5. If prompted, accept the pairing request on your phone and the receiving device.

Also enter the same passcode on both your phone and the other device, or confirm the auto-generated passcode.

A Bluetooth authorization request is then displayed on your phone.

6. If you want to automatically receive files from the sending device in the future, select the **Always** check box.
7. Tap **Accept** or **OK**.
8. When your phone receives a file transfer request notification, slide down the Notifications panel, tap the incoming file notification, and then tap **Accept**.

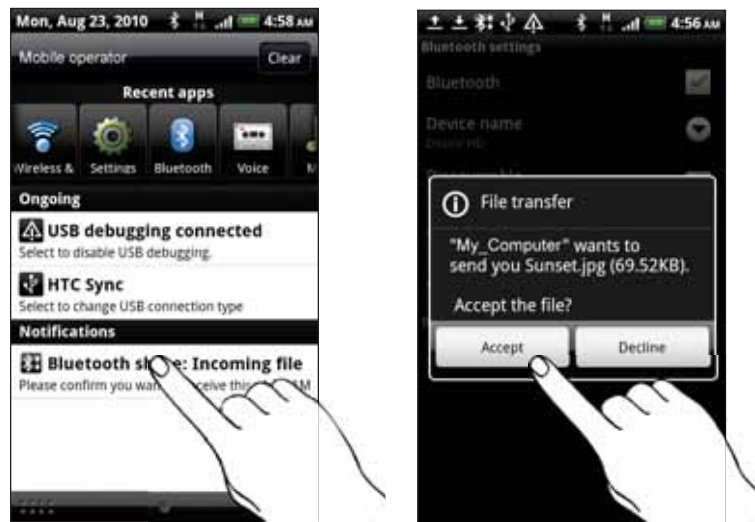

9. When a file is transferred, a notification is displayed. To open the file immediately, slide down the Notifications panel, and then tap the relevant notification.

When you open a received file, what happens next depends on the file type:

- Media files and documents are usually opened directly in a compatible app. For example, if you open a music track, it starts playing in the Music app.
- For a vCalendar file, choose the calendar where you want to save the event, and then tap **Import**. The vCalendar is added to your Calendar events. For information on using Calendar, see the Calendar chapter.
- For a vCard contact file, if there are multiple vCard files on your storage card, you can choose to import one, several, or all of those contacts to your contacts list.

---

## Adding the Bluetooth received folder to the Home screen

---

You can add a folder to the Home screen that shows all files you have received with Bluetooth.

1. From the Home screen, tap .
2. On the Personalize screen, tap **Folder > Bluetooth received**.
3. Press and hold the Bluetooth received folder icon, and drag it to the Home screen position you want.

To view the folder contents, tap the folder icon. To open a file, tap the file name.

# Camera



## Camera basics

Whether traveling for business or fun, enjoy taking photos and videos of your trip and encounters with your phone's camera.



Be sure to plug in your microSD card before you use your phone's camera. Photos and videos captured with the camera will be stored onto your microSD card.

If you have not yet inserted your microSD card to your phone, follow the steps in "Inserting the storage card" in the Basics chapter to insert it.

- To open the camera in photo mode and take photos, tap  from the Home screen, and then tap **Camera**.
- To open the camera directly in video mode so you can immediately start capturing videos, tap  from the Home screen, and then tap **Camcorder**.

### Viewfinder screen

When you're in photo mode and you turn your phone left or right, the camera onscreen controls automatically rotate to how you hold the phone. You'll find the following onscreen controls on the Viewfinder screen:

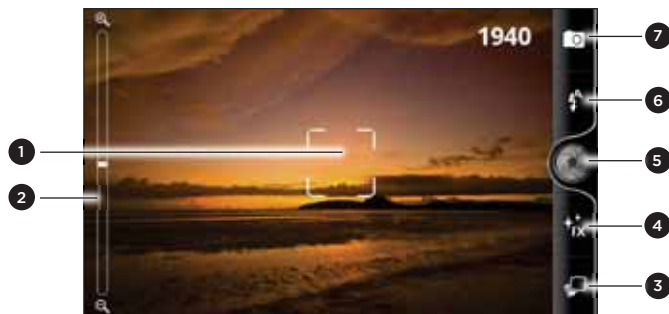

1	Auto focus indicator	See "Auto focusing."
2	Zoom bar	See "Zooming."
3	Gallery button	See the "Photos, videos, and music" chapter.
4	Effects button	See "Adding effects."
5	Shutter release/Record button	Tap to take a photo or start capturing video.
6	Flash button	See "Taking a photo" and "Recording video."
7	Mode button	Tap to switch between photo and video modes.

---

## Using the trackpad for taking photos and videos

---

You can either use the onscreen shutter release/record button or the trackpad for taking photos and videos.

When using the trackpad, press it to take a photo or begin capturing video. Press it again to stop capturing video.

---

## Zooming

---

Before taking a photo or video, you can first use the onscreen zoom bar to zoom in or out of your subject.

Simply slide your finger across the zoom bar to zoom in or out.





When you're recording video, the zoom bar is always shown onscreen. You can freely zoom in or out while recording.





If you choose 720p HD resolution for video recording, there's no zooming available.

## Taking a photo

1. From the Home screen, tap  > Camera.
2. Before taking the photo, you can zoom in or out first on your subject. To find out how, see “Zooming”.
3. Tap the **Flash** button repeatedly to choose a flash mode depending on your lighting conditions.
 

 Auto flash

 Flash on

 Flash off
4. Choose the resolution and other camera settings you want to use. See “Changing camera settings” for details.
5. You can choose an effect to apply to your photo. See “Adding effects” for details.
6. Point the camera and focus on your subject. See “Auto focusing” for details. Then tap  to take the photo.  
 You can also set the camera to automatically take a photo without the need for you to tap the shutter release button. See “Auto capturing” for details.
7. Choose what you want to do with the photo you’ve just taken. See “After capturing” for details.

---

### Auto focusing

---

Whenever you point the camera at a different subject or location, it shows the auto focus indicator at the center of the Viewfinder screen.

Let the camera auto focus on the center of the screen. Or you can tap another area on the screen that you want to focus on.

### Face detection

If you turn **Face detection** on in the camera settings, the camera will automatically recognize faces and adjust the focus when you’re taking photos of people. When you see boxes on people’s faces, tap  to take the photo.



## Auto capturing



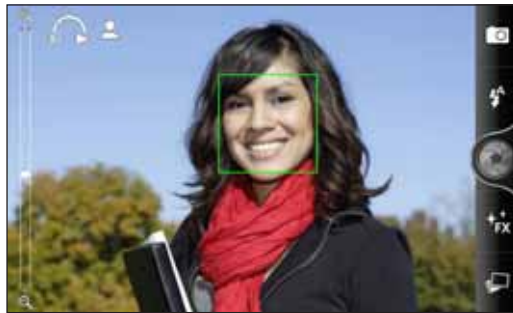

If you set the camera to use face detection, self-timer, or both to automatically capture, you won't need to tap the shutter release button when taking photos.

1. Open the settings menu panel. To find out how, see "Changing camera settings."
2. Tap **Auto capture**.
3. Choose whether you want the camera to identify 1 or 2 faces of people in the shot.
4. To set a time delay before the camera takes the shot, set the timer to 2 or 10 seconds.
5. Press MENU to close the settings menu panel.
6. Point the camera at your subjects. Use the onscreen zoom bar if you need to zoom in or out. See "Zooming" for details.

The camera focuses and automatically takes the photo.



## Recording video

1. From the Home screen, tap  > Camcorder.
2. Choose the video quality and other camera settings you want to use. See "Changing camera settings" for details.  
To record video in HD, set video quality to **HD 720P**. Or for sharing on the Web, select **Online (HD)**.
3. You can choose an effect to apply to your video. See "Adding effects" for details.
4. Frame your subject on the Viewfinder screen.
5. Tap  to start recording.
6. You can freely zoom in or out while recording video. To find out how, see "Zooming".
7. You can change focus to a different subject or area by just tapping it on the Viewfinder screen.
8. Tap the **Flash** button to switch the camera light on or off during recording.  
 Light on       Light off
9. To stop recording, tap  again.
10. Choose what you want to do with the video you've just recorded. See "After capturing" for details.

### Camera flash doesn't turn on?

The camera flash uses much battery power. To save battery power, the camera disables it (even when it's set on) when one of the following occurs:

#### You have an incoming call

The camera flash will be disabled temporarily when you have an incoming call. After the call ends, you'll be able to use it again.

If you have set the flash to **Auto flash** or **Flash on** in photo mode or **Light on** in video mode, it turns back on after you answer and end the call.

#### Your phone's battery level reaches 15% or lower

Recharge the battery so that the camera can have enough battery power to use the flash.

#### Cold weather may lower battery performance which affects the flash

To make sure the camera has enough battery life to power up the flash, keep your phone warm. When not in use, put the phone inside your jacket to keep it warm, and try to avoid sudden temperature changes that may affect battery performance.

## Adding effects

Want to make your photos look more interesting? Easy. Use the available camera effects to make your photos look like they've been taken through special lenses and filters. You can also add certain effects to videos.

Choose an effect first before you start taking a photo or video. Just tap . Then scroll through the available effects and tap one that you like.

When you choose certain photo effects such as depth of field, distortion, or vignette, drag the bar that appears on the right side of the screen to adjust the intensity of the effect.

## After capturing

After capturing a photo or video, the Review screen will display the photo or the starting image of the video that you have just captured. Tap the onscreen buttons to choose what you want to do next.



**Camera.** Return to the Viewfinder screen.



**Delete.** Delete the photo or video.



**Share.** Send the photo or video to another phone or your computer using Bluetooth, send it by email, or select a social network where you want to upload it to.



**Set as.** Set the photo as a contact picture or your wallpaper.



**Play.** Watch the video.



## Changing camera settings

Open the menu panel to access and change camera settings. To open it, just press MENU.

Scroll through the menu panel and choose the settings that you want.

Image adjustments	Slide your finger across each of the slider bars to adjust the exposure, contrast, saturation, and sharpness.
White balance	White balance enables the camera to capture colors more accurately by adjusting to your current lighting environment. White balance settings include: Auto, Incandescent, Fluorescent, Daylight, and Cloudy.
Auto capture (photo mode only)	Set the camera to use face detection, self-timer, or both to automatically take photos without the need for you to tap the shutter release button.
Resolution/Video quality	Choose a photo or video resolution to use.
ISO (photo mode only)	You can choose an ISO level or set it back to Auto. Higher ISO numbers are better for taking pictures in low light conditions.
Review duration	Set the time for a captured photo or video to be displayed on the Review screen before the camera changes back to the Viewfinder screen.
Widescreen (photo mode only)	When this check box is selected (default), photo resolutions available for selection are in 5:3 ratio and you can use the entire Viewfinder screen to frame your subject. When not selected, photo resolutions available for selection are in standard 4:3 ratio.
Geo-tag photos (photo mode only)	Select this check box when you want to store GPS location in your captured photos.
Auto focus	This option enables or disables centered auto focus. Auto focus is enabled by default.
Face detection (photo mode only)	This option allows the camera to automatically recognize faces and adjust the focus when you take people photos. Face detection will be turned off if you disable auto focus.
Shutter sound	Select or clear this check box, depending on whether you want the camera to play a sound when you press the shutter release or record button.
Grid (photo mode only)	Select this check box when you want to display a grid on the Viewfinder screen so you can easily frame and center your subject before taking the photo.
Record with audio (video mode only)	Select or clear the check box, depending on whether you want to record audio when capturing videos.
Reset to default	Change the camera back to default settings.

# Photos, videos, and music

## Browsing your Gallery

### About the Gallery app

Relive the fun while viewing photos and videos of your latest travels or your pet's newest tricks. Get an audience by tagging your Facebook and Flickr friends. You can even play your media on a TV screen.



To start using Gallery, check first if you have photos or videos copied on your storage card. To find out how to copy files, see “Copying files to or from the storage card” in the Getting started chapter.

What's more, you can edit and add effects to your photos. You can also easily turn a photo as your contact icon, location icon, or wallpaper.

### Selecting an album

From the Home screen, tap  and then tap **Gallery**.

The Gallery app opens in the Albums screen where your photos and videos are organized by albums for easy viewing.

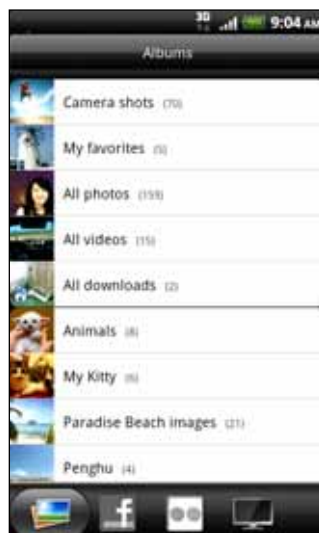

The following are preset albums:

- **Camera shots** lets you view photos and videos that are stored in the camera's folder.
- Photos and videos that you set as your favorites will be grouped under **My favorites**.
- **All photos** lets you view all photos that are stored in all the folders on the storage card.

- **All videos** lets you view all videos that are stored in all the folders on the storage card.
- **All downloads** lets you view photos and videos that you downloaded.

Folders in your storage card that contain photos and videos will also be treated as albums and will be listed below the preset albums. The actual folder names will be used as the album names.

Simply tap an album to view the photos and/or videos in that album.



If there are photos or videos under the root path of your storage card (that are not contained in folders), they will be grouped under the **Other** album.

## Viewing photos

After you've selected an album, you can browse through your photos and videos. Depending on how you hold your phone, the screen automatically switches to either grid view or filmstrip view:

- While in grid view, slide your finger up or down to scroll through the thumbnails. Tap a photo or video to view it in full screen.

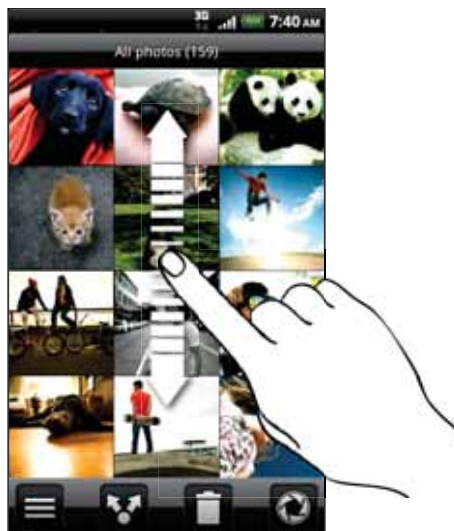

- While in filmstrip view (when you turn your phone sideways), slide your finger left or right across the screen to go through your photos and videos. Tap a photo or video to view it in full screen.



## Zooming in or out on a photo

There are two ways you can zoom in or out of a photo:

- Tap the screen twice quickly to zoom in, then tap the screen twice quickly again to zoom out.
- You can also use pinch zooming. Press your thumb and index finger on the screen and then spread your fingers apart to zoom in. Pinch your fingers together to zoom out.

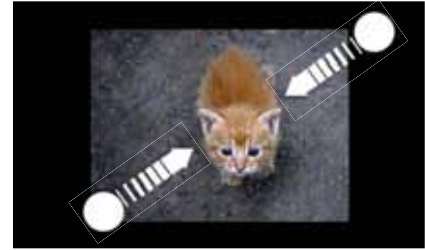

## Viewing videos

Video is always displayed in landscape mode when you play it. Use the onscreen controls to play, pause, or stop the video. Tap  to toggle between full and best-fit screens.



Another way to easily get to your videos is to tap  from the Homescreen, and then tap Videos.

## Editing your photos

Do basic editing tasks on your photos such as rotate and crop. You can also enhance your photos by applying effects such as high contrast, vintage, and more.

### Rotating a photo

1. On the Gallery app's Albums screen, tap an album.
2. Press and hold on the photo that you want to rotate.
3. In the menu that opens, tap **Edit**, and then tap either **Rotate left** or **Rotate right**.

### Cropping a photo

1. On the Gallery app's Albums screen, tap an album.
2. Press and hold on the photo that you want to crop.

3. In the menu that opens, tap **Edit**, and then tap **Crop**. You'll see a crop box around the photo.



4. To adjust the crop box size, press and hold the edge of the box. When directional arrows appear, drag your finger inward to or outward to resize the crop box.
5. To move the crop box to the part of the photo that you want to crop, drag the crop box to the desired position.
6. Tap **Save** to keep the changes.

The cropped photo is saved in the storage card as a copy. The original photo remains unedited.

### Adding effects

1. On the Gallery app's Albums screen, tap an album.
2. Press and hold on the photo that you want to add effects to.
3. In the menu that opens, tap **Edit**, and then tap **Effects**. You'll see options available to you on the top panel.
4. Tap an effect to apply on the photo.
5. Tap **Save** to keep the changes.

The enhanced photo is saved in the storage card as a copy. The original photo remains unedited.

---



### Sending your photos and videos

---

Send photos and videos via email or MMS. You can also send them to another phone or your computer using Bluetooth.

#### Sending photos or videos by email



You can send several photos, videos, or both in an email message. They are added as file attachments in your email.

1. From the Home screen, tap , and then tap **Gallery**.
2. Tap the album where the photos or videos you want to share are in.
3. Tap , and then tap **Gmail** or **Mail**.
4. Select the photos or videos you want to share and then tap **Next**.
5. Compose your message and then tap **Send**.



If you selected **Mail** and you have multiple email accounts, the default email account will be used.

### Sending a photo or video by MMS



1. From the Home screen, tap , and then tap **Gallery**.
2. Tap the album where the photo or video you want to share is in.
3. Tap , and then tap **Messages**.
4. Tap the photo or video you want to send.
5. The photo or video is automatically added into the MMS message.

If you want to add more photos to your slideshow attachment, tap **Add slide**, and then tap **Insert picture**. When finished, tap **Done**.

6. Compose your message and then tap **Send**.

### Sending photos or videos using Bluetooth

You can select several photos, videos, or both and send them to someone's phone or your computer using Bluetooth.

1. From the Home screen, tap , and then tap **Gallery**.
2. Tap the album where the photos or videos you want to share are in.
3. Tap , and then tap **Bluetooth**.
4. Select the photos or videos you want to share and then tap **Next**.
5. In the next few steps, you'll be asked to turn on Bluetooth on your phone and connect to the receiving Bluetooth device so the files can be sent. Follow the steps in "Sending information using Bluetooth" in the Bluetooth chapter

---

### Sharing your photos and videos on the Web



---

Using the Gallery app, you can share photos and videos on your social networks, as well as post videos on YouTube.

You can also use the Camera or Camcorder app to share a photo or video right after you've captured it. See the Camera chapter.

### Sharing photos or videos on Facebook

You need to be logged in to your Facebook account to be able to upload photos or videos.

1. From the Home screen, tap , and then tap **Gallery**.
2. Tap the album where the photos or videos you want to share are in.
3. Tap , and then tap **Facebook for HTC Sense**.
4. Select the photos or videos you want to share and then tap **Next**.
5. Enter a different caption on each photo or video.

You can also tag friends on your photos. Tap **Tag this photo**, and then tap the part where your friend is. From the list that shows, select who you want to tag.



6. Slide to the left to go to the next photo or video.



7. Tap Upload.
8. Select which album to upload to and set privacy settings for the uploaded photos or videos.
9. Tap Done.

### Sharing photos or videos on Flickr

You need to be logged in to your Flickr account to be able to upload photos or videos.

1. From the Home screen, tap , and then tap **Gallery**.
2. Tap the album where the photos or videos you want to share are in.
3. Tap , and then tap Flickr.
4. Select the photos or videos you want to share and then tap **Next**.
5. Enter a different title and description on each photo or video.

You can also tag friends on your photos. Tap **Tag this photo**, and then tap the part where your friend is. From the list that shows, select who you want to tag.



6. Slide to the left to go to the next photo or video.



7. Tap **Upload**.
8. Select which album to upload to and set privacy settings for the uploaded photos or videos.
9. Tap **Done**.

### Sharing photos on Picasa



You need to be signed in to a Google Account to be able to upload photos to the Picasa™ photo organizing service.

1. From the Home screen, tap , and then tap **Gallery**.
2. Tap the album where the photos you want to share are in.
3. Tap , and then tap **Picasa**.
4. Select the photos you want to share and then tap **Next**.
5. Enter a caption for the photos you're uploading.
6. Select the online album where you want to upload the photos, or tap  to create a new album.
7. Tap **Upload**.

You can view the photos online at <http://picasaweb.google.com>.

### Sharing videos on YouTube

You can share your videos by uploading them to YouTube™. Please sign in to your YouTube or Google Account, if you're asked to do so.

1. From the Home screen, tap , and then tap **Gallery**.
2. Tap the album where the videos you want to share are in.
3. Tap , and then tap **YouTube**.
4. Select the videos you want to share and then tap **Next**.
5. Enter a title for the videos you're uploading.
6. Tap **More details** and enter the prompted information, such as description and tags, and select a privacy option.
7. Tap **Upload**.



---

## Viewing photos in your social networks

---

Right on the Gallery app, check what you and your friends have uploaded to your social networks (Facebook and Flickr only).

### Viewing photos on Facebook

You need to be logged in to your Facebook account to view Facebook photos.

1. From the Home screen, tap , and then tap **Gallery**.
2. Tap the **Facebook** tab.
3. Tap your account name or your friend's account on the list to view the photos in the account.

You can view photos in your online albums the same way as how you view photos in your storage card.

### Viewing photos on Flickr

You need to be logged in to your Flickr account to view Flickr photos.

1. From the Home screen, tap , and then tap **Gallery**.
2. Tap the **Flickr** tab.  
  
You may be asked to give authorization for the app to connect to the Flickr website. If this happens, you need to give authorization to access your Flickr account.
3. Tap your account name or your friend's account on the list to view the photos in the account.

You can view photos in your online albums the same way as how you view photos in your storage card.

### Commenting photos in your social networks

Add comments to your uploaded photos as well as your friends'.

1. Do one of the following:
  - While browsing online albums, press and hold a photo and then tap **Add comment**.
  - While viewing a photo in full screen, tap anywhere on the screen, and then tap .
2. Tap the box that says "Write a comment."
3. Enter your text, and then tap **Comment**.

## Listening to music

Enjoy listening to songs and music on your phone using the Music app.



You need to copy music files to your storage card first to use the Music app to play music. To find out how to copy files, see “Copying files to or from the storage card” in the Getting started chapter.

From the Home screen, tap , and then tap **Music**.

The Music app opens in the Playback screen. Tap the onscreen icons to control music playback, select a song to play, repeat songs, and more.



- |    |   |
|----|---|
| 1  | Turn shuffle on or off.<br>(Shuffle is off when button is gray.)  |
| 2  | Press and drag your finger across the progress bar to jump to any part of the song.                               |
| 3  | Tap to check out featured albums from HTC Sense.com. (Availability depends on your country.)                      |
| 4  | Go to the Library.  |
| 5  | Go to the previous song in the Now playing list.  |
| 6  | Play, pause, or resume playing the song.  |
| 7  | Go to the next song in the Now playing list.  |
| 8  | Switch between showing the Now playing list and Playback screen. You can rearrange songs in the Now playing list. |
| 9  | Buy songs from the Amazon music store. (Availability depends on your country.)                                    |
| 10 | Cycle through the repeat modes: <b>Repeat all songs</b> , <b>Repeat current song</b> , and <b>Don't repeat</b> .  |

Swipe your finger left or right across the screen to go to the next or previous music album.

When you're listening to music and the screen turns off, press POWER to turn the screen back on and control the music playback directly on the Lock screen.

If you don't see the playback controls on the Lock screen, tap anywhere on the screen to display them.

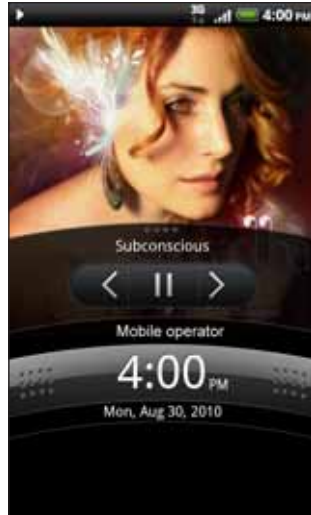

You can also pause music playback right from the Notifications panel. To find out how to open the Notifications panel, see the Getting started chapter.

## Browsing music in the Library

Tap  on the Music app's Playback screen or Now playing list to go to the Library.

In the Library, your music is organized by categories such as **Artists** and **Albums**. Choose a category by tapping one of the tabs at the bottom of the screen.



When you tap a song in a category to play it, the Now playing list is updated with the song list from your selected category.



You can add, remove, or rearrange the tabs in the Library. To find out how, see "Rearranging or hiding application tabs" in the Personalizing chapter.

## Creating a playlist

Personalize your music experience by creating music playlists. Make a playlist containing just your favorite songs or create one to match your mood for the day. You can make as many playlists as you like.

1. From the Home screen, tap , and then tap **Music**.
2. Tap  to go to the Library.
3. In the Library, tap or slide your finger on the bottom row to go to the **Playlists** category.
4. Tap **Add playlist**.
5. Enter a playlist name, and then tap **Add songs to playlist**.

6. Choose a category. If you go to the **Songs** category, you can see a complete list of songs on your storage card.
7. Select the check boxes of songs you want to add to the playlist and then tap **Add**.
8. Tap **Save**.

### Playing the songs in a playlist

1. In the Library, tap or slide your finger on the bottom row to go to the **Playlists** category.
2. Tap a playlist to open it.
3. Tap the first song or any song in the playlist.

When you tap a song in the list to play it, the Now playing list is updated with the songs from your playlist.

### Managing playlists

After creating a playlist, you can add more songs to it, rearrange their order, and more.

1. In the Library, tap or slide your finger on the bottom row to go to the **Playlists** category.
2. Tap a playlist to open it.
3. Press MENU, and then choose what you want to do:



Add more songs to a playlist	<ol style="list-style-type: none"> <li>1. Tap <b>Add songs</b>.</li> <li>2. Go to the <b>Songs</b> category or any other category.</li> <li>3. Select the songs you want to add to the playlist and then tap <b>Add</b>.</li> </ol>
Rearrange songs	<ol style="list-style-type: none"> <li>1. Tap <b>Change order</b>.</li> <li>2. Press and hold  at the end of the song title you want to move. When the row is highlighted, drag it to its new position, then release.</li> <li>3. Tap <b>Done</b>.</li> </ol>
Delete songs from a playlist	<ol style="list-style-type: none"> <li>1. Tap <b>Remove songs</b>.</li> <li>2. Select the songs you want to delete and then tap <b>Remove</b>.</li> </ol>
Change playlist name	Tap <b>Rename playlist</b> .

### Deleting playlists

1. In the Library, tap or slide your finger on the bottom row to go to the **Playlists** category.
2. Press MENU and then tap **Delete playlists**.
3. Select the playlists to delete and then tap **Delete**.

## Setting a song as ringtone

You can choose a song from the Music app's Library and set it as your phone's ringtone or a ringtone for a certain contact.

1. From the Home screen, tap , and then tap **Music**.
2. Tap  to go to the Library.
3. In the Library, choose the song that you want to use as ringtone and then play it back.
4. On the Playback screen, press MENU and then tap **Set as ringtone**.
5. If you chose an MP3 song, you can trim it first and set the part that you trimmed as the ringtone. See "Trimming an MP3 ringtone."
6. In the Set as ringtone options menu, tap **Phone ringtone** or **Contact ringtone**.

If you select **Contact ringtone**, you need to choose the contacts you want to associate the song with in the next screen.

### Trimming an MP3 ringtone

The Music app has a built-in ringtone trimmer. You can trim an MP3 song and set a part of it as your ringtone.

1. On the Playback screen, press MENU, and then tap **Set as ringtone > Trim the ringtone**.
2. Use the onscreen controls to trim your ringtone.



- |   |   |
|---|---|
| 1 | Trim sliders  |
| 2 | Left button   |
| 3 | Right button  |
| 4 | Play/Pause button   |
| 5 | Markers. (These show where the ringtone starts and ends.) |

To trim, you can:

- First drag the two trim sliders approximately to the part where you want the ringtone to begin and end.
  - Then tap the right and left arrow buttons to more precisely set the start and end points of the ringtone.
3. After you've finished trimming, tap **Set as**. Then choose whether to set the trimmed song as your **Phone ringtone** or **Contact ringtone**.

### Checking if the song was added as a ringtone



1. From the Home screen, press MENU and then tap **Settings**.
2. On the Settings screen, tap **Sound > Phone ringtone**. The song should be in the ringtone list and selected.

---

### Sharing music using Bluetooth

---

You can choose a song from the Music app's Library and send it to someone's phone or your computer using Bluetooth.

1. From the Home screen, tap , and then tap **Music**.
2. Tap  to go to the Library.
3. In the Library, tap the song that you want to share.
4. On the Playback screen, press MENU and then tap **Share > Bluetooth**.
5. In the next few steps, you'll be asked to turn on Bluetooth on your phone and connect to the receiving Bluetooth device so the music can be sent. Follow the steps in "Sending information using Bluetooth" in the Bluetooth chapter.

---

### Finding music videos in YouTube

---

You can find music videos of the song you're listening to in YouTube.

It's simple. On the Playback screen, just press MENU and then tap **Find videos**.

---

### About the Music widget

---

You can use the Music widget to play music right from your Home screen. To find out how you can add this widget to your Home screen, see "Personalizing your Home screen with widgets" in the Personalizing chapter.

## Sharing media on your home network









Sharing photos, videos, and music with a bigger circle of friends is easy on your home network. Simply connect your phone to the network and instantly show your captured photos and videos on a big TV, or start streaming your favorite music tracks on hi-fi speakers — all via DLNA™. For more information about DLNA, visit [www.dlna.org](http://www.dlna.org).



Before you share media through the network:

- Connect your phone to the network via Wi-Fi. To find out how to connect to a Wi-Fi network, see the Internet chapter.
- Connect the TV or speakers to the network. Check the documentation that came with your TV or speakers to know how.



1. Open the Gallery or Music app.
2. Locate the media that you want to share, and then tap it.
3. While viewing the photo or playing the video or music, press MENU, and then tap **Select player**.
4. Choose the device on your network where you want to play the media.
5. Once connected to the other device, your phone opens up the Controller screen where you can tap:

Controls	To
	Play the media on the other device.
	Pause the music or video playback.
	Play the previous photo or music track.
	Play the next photo or music track.
	Shuffle your music playlist.
	Select a repeat mode for photos or music tracks.
	Show available media that you can share.
	View the media information such as the file name, title, and duration.

Controls	To
	Connect to another device on the network.`
 / 	Adjust the volume of the video or music you're playing on the other device. You can also drag the volume slider to adjust the volume.



While playing a media on another device, you can press BACK and do other things on your phone. To return to the Controller screen, slide open the Notifications panel, and then tap the device you're connected to.

6. To stop sharing your media, tap  to disconnect your phone from the other device.



Until you disconnect the phone from the other device, other media that you open from the Gallery or Music app are shared on the other device.



# HTCSense.com

## About HTCSense.com

The HTC Sense experience has now extended from the phone to the Web. Without physically connecting the phone to the computer, you can communicate with your phone through the computer's web browser. Go to HTCSense.com to personalize your phone, manage contacts, read, send, and search text and MMS messages, create and share Footprints, and safeguard your phone — all from the computer's web browser.



Your phone must be turned on and have an active mobile data connection for HTCSense.com to communicate with your phone.

## Signing up for your HTCSense.com account

You can sign up for your HTCSense.com account through your phone or your computer's web browser.

---

### Signing up from your phone

---

If you skipped signing up to your HTCSense.com account when you first turned on and set up your phone, you can still sign up by:

1. Do one of the following:
  - From the Home screen, tap  > HTC Hub.
  - From the Home screen, press MENU, and then tap Settings > Accounts & sync > Add account > HTC Sense.
2. Follow the onscreen instructions to sign up for your HTCSense.com account.

---

### Signing up from your computer

---

Make sure you have your phone close by, you'll need your phone to complete the sign-up process.

1. On your computer, open your web browser.
2. Go to [www.htcsense.com](http://www.htcsense.com).
3. Follow the onscreen instructions to sign up for your HTCSense.com account.

After signing up to HTCSense.com on the Web, you have to sign in using the same account credentials on your phone. Follow the steps in "Signing up from your phone" to sign in on your phone.

---

## Updating your HTCSense.com account details

---

1. On your computer, open your web browser and sign in to your HTCSense.com account.
2. On the upper-right corner, click **Account**.
3. Update your account details, and then click **Save Changes**.

## Using HTCSense.com

Click one of the available services to get you started with HTCSense.com.

<b>Dashboard</b>	Take action if you lose or forget your phone. See “Dashboard” in this chapter for details.
<b>Footprints</b>	Find destinations on your PC ... grab and go on your phone. See “Footprints” in this chapter for details.
<b>People</b>	Manage your phone contacts. See “People” in this chapter for details.
<b>Messages</b>	Read, create, send, and search text and MMS messages. See “Messages” in this chapter for details.
<b>HTC Hub</b>	Load up your phone with content from us. See “HTC Hub” in this chapter for details.

## Dashboard

Forgot your phone at home or you can't find it? Or worse, it slipped out of your pocket while riding the train. Use Dashboard to communicate with your phone so you can forward calls and messages to a different number, make your phone ring, lock your phone, and even erase the contents of your phone.

---

### Turning on Phone finder

---

Most features of Dashboard require that the Phone finder option on your phone is selected.

1. On your phone, from the Home screen, press **MENU**, and then tap **Settings**.
2. Tap **Location**.
3. Select the **Phone finder** check box.

---

### Forwarding calls and messages

---

You can forward calls and messages to another phone if you don't have your phone with you.

1. On your computer, open your web browser and sign in to your HTCSense.com account.
2. Click **Dashboard**.
3. Click the **Forward calls** and/or **Forward messages** On/Off switch.

4. Enter the phone number where you want your calls and/or messages to be forwarded to.



You can also forward messages to an email account.

### Making your phone ring

You know your phone is somewhere in your home but you just can't find it. Make your phone ring, even if it's on mute, so you can find it. Hopefully, it's just buried under some clothes in the hamper.

1. On your computer, open your web browser and sign in to your HTCSense.com account.
2. Click **Dashboard**.
3. Click **Ring**.

### Locating your phone

Left your phone somewhere while doing your errands? You can use the Dashboard to find the approximate location of your phone.



You must have the **Phone finder** option selected on your phone for this feature to work. Refer to "Turning on Phone finder" earlier in this chapter to find out how to turn on Phone finder.

1. On your computer, open your web browser and sign in to your HTCSense.com account.
2. Click **Dashboard**.
3. Check the map to see where your phone is. Click **Refresh location** above the map to refresh the map.

### Locking your phone

Lost your phone? Lock your phone and show a message onscreen so if somebody finds it, they can contact you.

1. On your computer, open your web browser and sign in to your HTCSense.com account.
2. Click **Dashboard**.
3. Click **Lock Phone**.
4. Enter a PIN, an alternate phone number to call if somebody finds your phone, and a short message to show onscreen.



The alternate number is shown on your phone's screen. If somebody happens to find your phone, that person can simply tap it to call that number using your phone.

5. Click **Save**.

## Erasing your phone contents

If there's no chance of getting your phone back, you can erase the contents of the phone and the installed storage card so no one sees sensitive information on your phone.



There's no way to recover your phone and storage card data after you erase the contents so be absolutely sure before you proceed.

1. On your computer, open your web browser and sign in to your HTCSense.com account.
2. Click **Dashboard**.
3. Click **Erase Phone**.
4. When asked to confirm, click **Erase Phone**.

## Footprints

### Creating a footprint

When you create a footprint in HTCSense.com, that footprint is also automatically added as a footprint in your phone as well. Cool. See what you can do with footprints on your phone by referring to "Locations" in the Maps and location chapter.

#### Creating a footprint by doing a search

1. On your computer, open your web browser and sign in to your HTCSense.com account.
2. Click **Footprints**.
3. Near the upper-right corner, click the search box.
4. Enter the place you're looking for, and then click  to select the search scope. You can choose to search existing footprints only, points of interest from Google only, or both.
5. On the map, click the location markers to check if that's the location you're looking for. When you see the location you want to create a footprint for, click **Add footprint** on the location's balloon.
6. Enter the details for the footprint, and then click **Save**.



- Set the category for the footprint so you can use the categories on the left panel to search your footprints.
- Select the **Private** check box if you don't want the footprint to show on your HTCSense.com friends' maps. Check "HTCSense.com Community" in this chapter for more information.

#### Creating a footprint from scratch

1. On your computer, open your web browser and sign in to your HTCSense.com account.
2. Click **Footprints**.
3. On the left panel, click **Add footprint**.
4. Enter the details for the footprint, and then click **Save**.

---

## Editing a footprint

---

1. On your computer, open your web browser and sign in to your HTCSense.com account.
2. Click **Footprints**.
3. In the left panel, select the category where the footprint you want to edit is in.
4. In the thumbnail strip above the map, click the footprint that you want to edit.
5. On the map, click **Edit** on the footprint's information window.
6. Update the information, and then click **Save**.

---

## Sharing a footprint

---

Share your footprint with a friend by sending it through MMS.

1. On your computer, open your web browser and sign in to your HTCSense.com account.
2. Click **Footprints**.
3. In the left panel, select the category where the footprint you want to share is in.
4. In the thumbnail strip above the map, click the footprint that you want to send to a friend.
5. On the map, click **Share** on the footprint's information window.
6. Enter the recipient's phone number, enter your message, and then click **Send**.

---

## Deleting a footprint

---

1. On your computer, open your web browser and sign in to your HTCSense.com account.
2. Click **Footprints > List view**.
3. In the left panel, select the category where the footprint you want to delete is in.
4. Mouseover the footprint that you want to delete, and then click **options** on the upper-right corner of the footprint box.
5. Click **Delete**.
6. When asked to confirm, click **Delete**.

---

## Getting directions to or from a footprint

---

1. On your computer, open your web browser and sign in to your HTCSense.com account.
2. Click **Footprints > List view**.
3. In the left panel, select the category where the footprint you want to get directions to is in.
4. Mouseover the footprint that you want to get directions to, and then click **options** on the upper-right corner of the footprint box.

5. Click **Directions**.
6. Select if you want to get directions from or to the footprint, and then click **Google Maps**.

## People

Manage your contacts. Chances are that most of your friends or family photos are on your computer. While creating or editing a contact in People, use photos on your computer for your contacts' picture.



If you synchronized your phone with your Google Account and Exchange ActiveSync account, you'll also see the contacts and groups in those accounts as well.

---

### Creating a new contact

---

1. On your computer, open your web browser and sign in to your HTCSense.com account.
2. Click **People**.
3. On the left panel, click **Add contact**.
4. Enter the contact details, and then click **Save**.

---

### Creating a new group

---

1. On your computer, open your web browser and sign in to your HTCSense.com account.
2. Click **People**.
3. On the left panel, click **Add group**.
4. Enter the group name, and then click **Create Group**.

---

### Editing a contact

---

1. On your computer, open your web browser and sign in to your HTCSense.com account.
2. Click **People**.
3. Mouseover the contact that you want to edit, and then click **options** on the upper-right corner of the contact box.
4. Click **Edit**.
5. Update the contact information, and then click **Save**.

---

### Deleting a contact

---

1. On your computer, open your web browser and sign in to your HTCSense.com account.
2. Click **People**.

3. Mouseover the contact that you want to delete, and then click **options** on the upper-right corner of the contact box.
4. Click **Delete**.
5. When you're asked to confirm, click **Delete**.

---

### Adding a contact to a group

---

1. On your computer, open your web browser and sign in to your HTCSense.com account.
2. Click **People**.
3. Mouseover the contact that you want to add to a group, and then click and hold the  on the lower-left corner of the contact box.
4. Drag the contact to the group you want to add it to on the left panel.

---

### HTCSense.com Community

---

You'll notice there's a group named **Community** at the bottom of the left panel of People. You can check this to see who among your contacts are already your HTCSense.com friends, contacts that also have registered for an HTCSense.com account, and contacts that have requested you to become an HTCSense.com friend.

Sharing becomes so much faster and easier when you and your contact are HTCSense.com friends. HTCSense.com friends can see each others footprints (if they are not marked as Private) and quickly add them to their own footprints and also share their recommended apps much faster.

You can see your HTCSense.com friends in the People application on the phone. To see your HTCSense.com friends on your phone, open the People application, go to the Online directories tab, and then tap **HTC Sense**.

## Messages

See your conversations online as you see them on your phone. Read, create and send text and MMS messages using your computer. Messages also acts as a mirror for your messages on the phone, so if you're looking for that message that had the name and contact info of that awesome restaurant from like months ago, you can easily search for it here.

---

### Searching for messages

---

1. On your computer, open your web browser and sign in to your HTCSense.com account.
2. Click **Messages**.
3. On the upper-right corner, enter what you want to search for in the search box, and then press ENTER on the keyboard.

---

## Creating a new message

---

Type even faster by using your computer's keyboard to compose your messages.



Unfortunately, you'll still be charged by your mobile operator when you send messages from your computer.

1. On your computer, open your web browser and sign in to your HTCSense.com account.
2. Click **Messages**.
3. On the upper-left corner of the screen, tap **New Message**.
4. Compose your message, and then click **Send**.



Adding a subject line or adding an attachment converts the message into an MMS message.

---

## Replying to messages

---

1. On your computer, open your web browser and sign in to your HTCSense.com account.
2. Click **Messages**.
3. Mouseover the message you want to reply to, and then click **view thread** on the upper-right corner of the message box.
4. Enter your reply in the **Compose message** box, and then click **Send**.

---

## Deleting an entire message thread

---

1. On your computer, open your web browser and sign in to your HTCSense.com account.
2. Click **Messages**.
3. Mouseover the message thread you want to delete, and then click **view thread** on the upper-right corner of the message box.
4. Click **Delete message thread**.

---

## Deleting a message in a message thread

---

1. On your computer, open your web browser and sign in to your HTCSense.com account.
2. Click **Messages**.
3. Mouseover the message thread where the message you want to delete is in, and then click **view thread** on the upper-right corner of the message box.
4. In the message thread, mouseover the message you want to delete, and then click **Delete Message** on the upper-right corner of the message box.



## HTC Hub

Use the HTC Hub service to add more content for your phone. Browse apps, music, ringtones, wallpapers, and a whole lot of other cool stuff and send them to your phone.



You know, you can also browse and download content right from your phone using HTC Hub on your phone. To open HTC Hub on your phone, from the Home screen, tap  > **HTC Hub**.

---

### Adding content to your phone



---

Make sure you have your phone close by, you'll need your phone to complete the download process.

1. On your computer, open your web browser and sign in to your HTCSense.com account.
2. Click **HTC Hub**.
3. Browse through the HTC recommended items and check if you see something you like or click **More** to see more items for that category.



You can also click the drop-down menu near the upper-left corner to select a category from where to choose items to add to your phone.

4. Select the item you want, and then click **Send to phone**.
5. On your phone, tap  on the Home screen, and then tap **HTC Hub**.
6. Slide to the My downloads tab , and then tap the item that you've just sent from your computer.

## Signing out from or deleting your HTCSense.com account

---

### Signing out of your HTCSense.com account

---

If you want to stop syncing your phone with your HTCSense.com account, sign out of HTCSense.com from the phone.

1. From the Home screen, press MENU, and then tap **Settings**.
2. Tap **Accounts & sync > HTC Sense > Remove account**.

Rest assured that your contacts, footprints, and messages on the phone won't be deleted when you sign out from your HTCSense.com account.

---

### Deleting your HTCSense.com account

---

1. On your computer, open your web browser and sign in to your HTCSense.com account.
2. On the upper-right corner, click **Account**.
3. Click **Click here to delete your HTCSense account**.

Deleting your HTCSense.com account will also delete your data on HTCSense.com servers.

# Maps and location

## Turning on location services

In order to find your location on your phone, you need to enable location sources.

1. From the Home screen, press MENU, and then tap **Settings > Location**.
2. Select one or both of the following:

Use wireless networks	Uses Wi-Fi or your mobile data connection to find your approximate location.
Use GPS satellites	Finds your exact GPS location. This requires a clear view of the sky and more battery power.

## Locations

Search for places of interest, get directions to places you want to go to, and drive using turn-by-turn GPS navigation with Locations. Locations is also your perfect travel companion, whether you're at home or when you're in a different country. With Locations, you can download maps to your phone beforehand so you don't have to worry about having an Internet connection while on the road or costly data roaming charges when abroad. Have your map ready before you start your journey.



If you are in an area where there are a lot of surrounding buildings, Locations may have a hard time pinpointing your location.

Your phone comes with a map installed. The map on your phone will depend on the country where you bought your phone. Don't worry, you can download other maps when you need them. Refer to "Downloading maps or purchasing services" in this chapter to find out how.

## Finding your location and what's around you

1. From the Home screen, tap  > **Locations**.
2. You can see your current location right below the tab name.

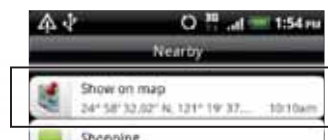

Press MENU, and then tap **My location** to update your current location or tap **Map** to show your current location on the map.

3. Select a category that you're interested in to see the places that are close by. The places are listed according to the distance from your current location.

## Searching for a place of interest or an address

### Searching for a place of interest

You can search using a name of an establishment, street, or city.

As you enter the place to look for, suggested matches from the database, footprints, and previously searched items are displayed.

1. From the Home screen, tap  > Locations.
2. Press the SEARCH button.
3. Enter the place you want to search in the search box. Matching establishments are shown sorted by the distance from your current location. If you don't see what you are looking for, keep entering characters to narrow down the search.



- Search is done in your current country. If you want to do a search on a different country on your phone, tap **Current search region**. To find out how to download other maps, see “Downloading maps or purchasing services” in this chapter.
- Tap  if you don't see any suggestions or if you don't see the place you are looking for in the list.

4. Tap an establishment to get directions, call them, add it as a footprint, and more.



### Searching for an address

To find an address, you don't need to enter the complete address. You can just enter the street or city name and we'll show you a list of suggestions that will guide you to what you are looking for.

For example, to find “321, Church Street, London, UK”, just enter “Church” or “London” to start your search.



- You can also search by entering a zip code. To search using a zip code, enter the zip code, and then tap .

## Viewing maps

In Locations, press MENU, and then tap **Map**.



- |   |  |
|---|--|
| 1 | Tap to switch between 2D and 3D views.   |
| 2 | Point of interest. Tap to see details, call, get directions, or share. See “Choosing which places of interest to show on the map” to find out how to show or hide places of interests. |
| 3 | Your current location.   |
| 4 | Tap to use or not use the compass.   |

### Using the compass

Should I turn left or right? By using the compass, the map adjusts depending on where you're facing so you know where to go.

### Moving around the map

Swipe your finger on the screen to view other areas of the map.

### Zooming in or out of a map

Do one of the following:

- Spread your thumb and index finger across the map to zoom in.
- Pinch your thumb and index finger on the map to zoom out.
- Double-tap a location on the map to zoom in to that location.

### Choosing which places of interest to show on the map

1. While viewing a map, press MENU, and then tap **View**.
2. Choose the points of interest you want or don't want to see when you're viewing a map.



You can also choose to show or not show footprints and 3D buildings on the map.

3. Tap **Done**.

## Pinning a location on the map

Pin a favorite location on the map and add it as a footprint, get directions to it, or share it with friends. Sharing is a great way to let your friends know about that little place you found that has the best sandwiches in town.

1. While viewing a map, press and hold an area on the map that you want to pin.
2. Tap  and then choose if you want to add the location as a footprint, get directions to it, or share it.



To remove all the pins on the map, while viewing a map, press MENU, and then tap **More > Clear pin.**

## Changing the language of street names and places of interest

1. From the Home screen, tap  > **Locations.**
2. On the Nearby tab, press MENU, and then tap **Settings > Map language.**
3. Choose one of the following.
  - **Use native map language** if you want to use the local language of the map. For example, if you are looking at a map of Japan, it will use Japanese characters.
  - **Use language that fits best** if you want to use the language of your phone. This may not be available for all maps.

---



## Footprints

---

A footprint consists of a photo of a location such as a restaurant, a sightseeing destination, etc., stored together with a precise GPS position and other information about that location such as the street address and phone number.

The next time you want to visit the same place, simply access the footprint. You can then dial the phone number or view the location in the map.

## Adding a location as a footprint

1. In Locations, search for the destination you want to go to. See “Searching for a place of interest” earlier in this chapter to find out how.
2. Tap **Save to Footprints.**
3. You can:
  - Tap  to take a picture and add it as a photo for the footprint.
  - Tap  to fine tune the position of the footprint on the map.
4. Tap **Done.**



Before pressing **Done**, tap the photo to change the name, category, or address of the footprint, enter the phone and website, and add a voice memo to the footprint.

## Setting a footprint as your home location

Save your home address as a footprint to make it easier to set it as your destination.

1. While at your home location, open Locations, and then go to the Footprints tab.
2. Tap **Save to Footprints**.



The address shown should be your current location. If it doesn't show your home address, press MENU, and then tap **My location**.

3. Tap **Done**.
4. Tap **My home**, select your home address from the list, and then tap **Done**.



Tap  to change your home address.

## Revisiting a footprint

1. On the Footprints tab, tap a category.
2. Tap the footprint you want to revisit.
3. Tap the information fields to get directions, share the footprint, call a stored phone number, and more.

## Editing or deleting a footprint

1. On the Footprints tab, tap a category.
2. Press and hold the footprint you want to edit or delete.
3. Tap **Edit** or **Delete** on the options menu.

## Sharing your footprints

1. Create a footprint. See “Adding a location as a footprint” earlier in this chapter to find out how.
2. On the Footprints tab, tap the footprint that you have just created.
3. Tap **Share**, and then choose how you want to share the footprint.

## Deleting multiple footprints

1. On the Footprints tab, tap a category.
2. Press MENU, and then tap **Delete**.
3. Select the footprints you want to delete, and then tap **Delete**.

## Exporting your footprints

Back up footprints by exporting them to the storage card. You can also open exported footprints files in other applications such as Google Earth on your PC. To transfer files from your storage card to your computer, see “Copying files to or from the storage card” in the Getting started chapter.

1. On the Footprints tab, tap a category.
2. Press MENU, and then tap **Export**.
3. Select the footprints you want to export, and then tap **Export**.



Press MENU and then tap **Unmark all** to deselect all the footprints.

Exported footprints are saved as .kmz files in the Footprints folder on your storage card. If you exported multiple footprints at one time, they are saved together in one .kmz file.

### Importing footprints

Bring back footprints you previously backed up to the storage card to your phone. You can also import .kmz files that you saved in other applications, or use a photo as a footprint.

1. On the Footprints tab, press MENU, and then tap Import.
2. Do one of the following:
  - To import a saved footprint or another .kmz file from the storage card, tap **Footprints data**, and then tap the file you want to import. If a footprint on your phone is the same as the one you want to import, you're asked whether you want to overwrite it.
  - To import a photo, tap **Photos**, navigate to the photo you want to import, and then tap the photo. You can then add Footprints information such as location and category.

---

### Getting directions

---

Get detailed driving or walking text instructions on how to get to your destination.

#### Getting directions from your current location

1. In Locations, search for the destination you want to go to. See “Searching for a place of interest” earlier in this chapter to find out how.



You have footprints saved? You can also set a footprint as your destination. Just go to the Footprints tab, and then choose a footprint.

2. Tap **Directions**.
3. Choose how you want to get to your destination. The map opens showing the route to your destination.
4. Do one of the following:
  - At the bottom of the screen, tap **<** or **>** to follow the route to your destination.
  - Slide up the directions bar, and then tap the instructions to follow the route to your destination.



If you have turn-by-turn navigation for that country, press MENU, and then tap **Navigate** to start turn-by-turn navigation.

### Getting directions by setting a start and end location

1. While viewing the map, press MENU, and then tap **Direction**.
2. Tap the **My Location** text box, and then search for the starting location you want.
3. Tap the **End point** text box, and then search for the destination you want.
4. Tap **Driving** or **Walking** depending on how you want to get to your destination.
5. Do one of the following:
  - At the bottom of the screen, tap **<** or **>** to follow the route to your destination.
  - Slide up the directions bar, and then tap the instructions to follow the route to your destination.



If you have turn-by-turn navigation for that country, press MENU, and then tap **Navigate** to start turn-by-turn navigation.

### Using turn-by-turn navigation



- To use turn-by-turn navigation, the **Use GPS satellites** option in Location sources needs to be selected. To find out how to turn it on, see “Turning on location services” in this chapter.
- Check if you have the turn-by-turn navigation for the map you’re using. To find out if the phone has turn-by-turn navigation for the map, see “Managing Locations services.”

### Using your phone with the car kit

If you purchased the dedicated car kit for your phone, you can use the included in-car holder to mount your phone securely inside your car and use your phone on the road. Refer to the car kit guide for instructions on how to install the in-car holder and properly mount your phone to the holder.

When you mount your phone on the car kit, the Car Panel automatically opens. To find out more about the Car Panel, refer to “Using Car Panel” earlier in this chapter.



## Setting a destination

1. In Locations, search for the destination you want to go to. See “Searching for a place of interest” earlier in this chapter to find out how.



You have footprints stored? You can also set a footprint as your destination. Just go to the Footprints tab, and then choose a footprint.

2. Tap Premium navigation.

You might need to wait a few seconds for the GPS satellites to find your current location. Once your location is found, you can start driving to your destination by following the turn-by-turn instructions. If you prefer a different voice to guide you, you can download a different voice. To find out how to download new voices, see “Downloading maps or purchasing services” in this chapter.



While driving, you can tap the screen to see what other options are available.

Exit/Stop	<ul style="list-style-type: none"> <li>▪ When not en route to a destination, tap to exit turn-by-turn navigation.</li> <li>▪ When en route to a destination, tap to stop turn-by-turn navigation.</li> </ul>
Preview	Check the route you'll be taking by going on a “virtual helicopter ride” from your current position to your destination.
Phone	Make a call.
Back	Close the panel.
2D/3D	Switch to 2D or 3D view of the map.
Itinerary	View the route turn list.
Mute	Turn on or off the voice instructions for turn-by-turn navigation.
More	Open the Car Panel. See “Using Car Panel” in this chapter for details.

## Using Car Panel

Easily access footprints, points of interest, and places nearby with Car Panel, and then start navigation to show you how to get there.

Open the Car Panel by doing one of the following:

- Mount your phone on the in-car holder. See “Using your phone with the car kit” in this chapter for details.
- From the Home screen, tap  > Car Panel.
- While in turn-by-turn navigation, tap the screen, and then tap **More**.



When your phone is in the holder and is not connected to a Bluetooth car kit or headset, the phone's speakerphone is automatically turned on when you make or answer a phone call.



Destination	Search for a destination to go to.
Footprints	Select a footprint to set as a destination.
History	Check the places you've search before, and then choose one to set as your destination.
Phone	Make a phone call.
Nearby	Check places of interest that are close to your current location, and then choose one to set as your destination.
Settings	Set Car Panel options.

### Car Panel keeps opening by itself when you're using a mini-to-micro USB converter?

If you connect a mini-USB power adapter or car charger to your phone through a mini-to-micro USB converter, your phone may misinterpret this to be a car kit connection (due to the different connector PIN assignment on the mini-USB power adapter or car charger) and automatically display the Car Panel.

You can prevent Car Panel from automatically opening by:

1. In Car Panel, tap **Settings** > **Car kit**.
2. Clear the **Automatically launch** check box.

## Setting navigation preferences

Choose how you want Locations to map your route. You can tell Locations to avoid highways or toll roads, show lane information, choose your route preference, and more.

1. While using turn-by-turn navigation, tap the screen.
2. Tap **More > Settings > Navigator**.
3. Set your preferences by selecting or tapping an item.

## Turning off speed and safety camera alerts

If you have the safety camera service, you can choose to turn this service off temporarily.

1. While using turn-by-turn navigation, tap the screen.
2. Tap **More > Settings > Warnings**.
3. Clear the **Speed warning** and **Safety camera warning** check boxes.

## Automatically connecting to a Bluetooth car kit or headset

You can set your phone to connect to your Bluetooth car kit or Bluetooth headset automatically, if one is paired with your phone, whenever you mount the phone on the in-car holder.



If you don't have a Bluetooth car kit or headset paired with your phone, refer to the Bluetooth chapter to find out how to pair a Bluetooth device with your phone.

1. In Car Panel, tap **Settings > Car kit**.
2. Select the **Auto-connect** check box.
3. If you have more than one Bluetooth car kit or headset paired with your phone, tap **Default device** to choose the Bluetooth car kit or headset to use.

Before mounting your phone on the in-car holder, make sure that Bluetooth on your phone and the paired Bluetooth car kit or headset is turned on.

## Answering a call while using navigation

When a call comes in, the whole map nudges up a bit so you can see the incoming call and answer it. Don't worry, you'll still be able to use navigation as we made sure that the call screen just occupies as little space as possible at the bottom of the screen.

---

## Managing Locations services

---

Check the maps, navigation, safety camera information, and voices for turn-by-turn voice instructions that are already on your phone.

1. From the Home screen, tap  > **Locations**.
2. Press MENU, and then tap **Upgrade**.
3. In the Manage licenses & content tab, you'll see a list of services that are already on your phone.

---

## Downloading maps or purchasing services

---

Going to a different country for vacation? You can download the map of the country you're going to for free. You can also download or purchase additional services such as navigation, safety camera, and turn-by-turn voice instructions.



You need a data or Wi-Fi connection to download or purchase maps and services.

1. From the Home screen, tap  > Locations.
2. Press MENU, and then tap **Upgrade**.
3. Slide to the tab of the item or service that you want to download.
4. Tap what you want to download.
5. Depending on what you selected, tap **Download** or **Purchase**.

Depending on the country where you bought your phone, you may only need to enter a voucher code to activate turn-by-turn navigation. If you have a voucher code, enter it by tapping **Voucher code** at the top of the Purchase navigation tab.

---

## Adding Locations widgets

---

Add a favorite destination and places of interest that are nearby as widgets on your Home screen. Add the Navigate widget to start turn-by-turn navigation to your favorite destination. Add the Nearby widget to let you browse places of interest right on the Home screen.

To find out how to add widgets, refer to “Adding a widget” in the Personalizing chapter.

## Google Maps

### About Google Maps

Google Maps lets you track your current location, view real-time traffic situations, and receive detailed directions to your destination. It also provides a search tool where you can locate places of interest or an address on a map, or view locations at street level.





- You need an active mobile data or Wi-Fi connection to use Google Maps.
- To find your location with Google Maps, you need to enable location sources. To learn how, see “Turning on location services” in this chapter.
- The Google Maps application does not cover every country or city.

### Getting around maps

When you open Google Maps, you can easily find your location on the map or check out nearby places by panning and zooming in and out on the map.

To find your location with Google Maps, you need to enable location sources. See “Turning on location services” in this chapter to learn how.

1. From the Home screen, tap  > Maps.
2. Do any of the following on the map:

Show your location	Press MENU and then tap <b>My Location</b> . The blue marker (  ) shows your location on the map and points north for your reference.
Move around	Swipe your finger to any direction on the screen to view nearby places on the map.
Zoom in	<ul style="list-style-type: none"> <li>▪ Place your thumb and index fingers on top of the area that you want to zoom in, and then spread your fingers across the map.</li> <li>▪ Tap .</li> <li>▪ Double-tap the area on the map that you want to zoom in.</li> </ul>
Zoom out	<ul style="list-style-type: none"> <li>▪ Pinch your thumb and index finger on the map to zoom out.</li> <li>▪ Tap .</li> </ul>
View information for a random location	<ol style="list-style-type: none"> <li>1. Press and hold a location on the map. A balloon opens over the location, with the address and a thumbnail from street view (if available).</li> <li>2. Tap the balloon to see more information. You can get directions to the location, check for nearby places of interest, and more.</li> </ol>

### Looking at a location in Street View

Street View mode (available only in selected areas) provides a street-level view of the location.

1. From the Home screen, tap  > Maps.
2. Do one of the following:
  - Press and hold a location on the map, and then tap the balloon that appears.

- Search for the place you want to view in Street View. See “Searching for a location” and “Searching for a place of interest near you” in this chapter for details. When you find the place, tap its balloon.
3. On the location details screen, tap the **Street view** button  .



4. To navigate in Street View, do any of the following:

<b>View surrounding areas</b>	<ul style="list-style-type: none"> <li>▪ Swipe your finger on the screen to pan up or down or to look in other directions.</li> <li>▪ Press MENU and then tap <b>Compass mode</b> to turn Compass mode on. Tilt, pan, or turn your phone to view the area around the location.</li> </ul>
<b>Step forward or backward</b>	<ul style="list-style-type: none"> <li>▪ Tap the onscreen arrow to move towards the direction it is pointing.</li> <li>▪ Press MENU and then tap <b>Step forward</b> or <b>Step backward</b>.</li> </ul>
<b>Zoom in or out</b>	<ul style="list-style-type: none"> <li>▪ Tap .</li> <li>▪ Press MENU, and then tap <b>Zoom</b>.</li> </ul>

4. To return to the street map, press MENU and then tap **Go to map**.

### Viewing map layers

Initially, Google Maps opens with a street map. You can view additional map layers, such as satellite images, traffic information, your Google Latitude friends' locations, and Wikipedia information on locations. You can also view maps that you and other people have created in Google Maps on the web. You can view multiple layers at the same time.



Not all locations have information to support all Map layers or all zoom levels. To learn more about layers, visit Google Maps on the web: <http://maps.google.com/>

1. From the Home screen, tap  > **Maps**.
2. Press MENU, and then tap **Layers**.
3. Select any of the following:

<b>Traffic</b>	(Available only in selected areas.) Real-time traffic conditions are displayed over roads as color-coded lines. Each color represents how fast the traffic is moving.
----------------	---





<b>Satellite</b>	Google Maps uses the same satellite data as Google Earth™. Satellite images are not real-time. Google Earth acquires the best imagery available, most of which is approximately one to three years old.
<b>Terrain</b>	Shows the elevation of the map you're viewing. Elevation is limited to natural geographic features, like mountains and canyons, and does not apply to buildings.
<b>Buzz</b>	See photos and information about places shared by other people, or post your own.
<b>Latitude</b>	When you have joined Latitude, you can view your friends' locations as a layer on the map. For information, see "Finding your friends with Google Latitude (available by country)" in this chapter.
<b>Clear Map</b>	Clear layers and view only the street map.
<b>More Layers</b>	Select more layers such as transit lines or maps that you have created in Google Maps on the web.

---

## Searching for a location

---

In Google Maps, you can search for a location, such as an address or a type of business or establishment (for example, museums).

1. From the Home screen, tap  > Maps.
2. While viewing a map, press SEARCH.
3. Enter the place you want to search in the search box.  
As you enter the location to look for, suggested matches from your contacts, the web, and previously searched items are displayed.
4. Tap  to search for the location you entered or tap a suggested search item.  
The search results are displayed as markers on the map.
5. Do any of the following:
  - If the first search result (  ) is what you're looking for, tap the balloon.  
Otherwise, tap  to go to the next search result until you find the location you're searching for, and then tap its balloon.
  - Tap  to show the search results as a list, and then tap the location.

Details about the selected location displays on the screen.

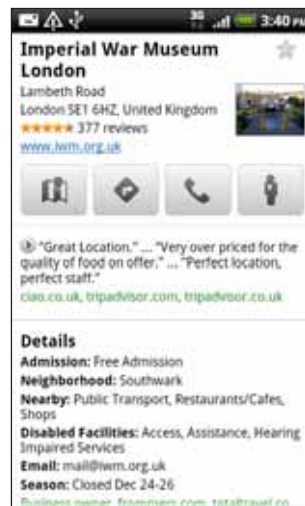

5. Do any of the following:

- Tap the onscreen buttons to view the location on a map, get directions, view the location in Street View, if available, and more. Scroll down the screen to view more options.
- Swipe left or right across the screen to view the information for the next or previous search result.

### Clearing the map

After you've search on a map, you can clear away the various markers drawn on it by pressing MENU, and then tapping **More > Clear Map**.

---

### Searching for a place of interest near you

---

Use **Places** to find places of interest near your current location. Places uses Google Maps to search common places that you would want to find, such as the nearest gas station or ATM kiosk.

Before you use Places, you need to enable location sources. See "Turning on location services" in this chapter to learn how.

1. From the Home screen, tap  > Places.
2. Tap the place you want to search.



3. Do any of the following:

- When one or two places of interest are found, the search results are displayed as markers on the map. You can tap the marker, and then tap the balloon to view more information about the place.
- When several places are found, the search results display in a list. Tap a place to show its location on a map, and then tap its balloon to view more information about the place.

See “Searching for a location” in this chapter to learn what you can do on the location information screen.

### Adding a place to search

In Places, you can add other places of interest that you frequently search for, such as a church or a pizza restaurant.



1. From the Home screen, tap  > Places.
2. Tap Add.
3. Enter the place you want to add to Places’ search items, and then tap Add. The place is added as a button on the Places’ screen.

---

### Getting directions

---

Get detailed directions to your destination. Google Maps can provide directions for travel by foot, public transportation, or car.

1. From the Home screen, tap  > Maps.
2. While viewing a map, press MENU, and then tap **Directions**.
3. Use your current location as the starting point, or enter a location from where to start in the first text box. Then enter your destination in the second text box.  
Or tap  to select an address from your contacts or a point that you tap on a map.



3. Choose how you want to get to your destination by tapping the car, public transit, or walk button.
4. Tap **Go**.
5. If the place you’ve set as your destination has several locations available, choose which one to go to.

The next screen displays the directions to your destination in a list.

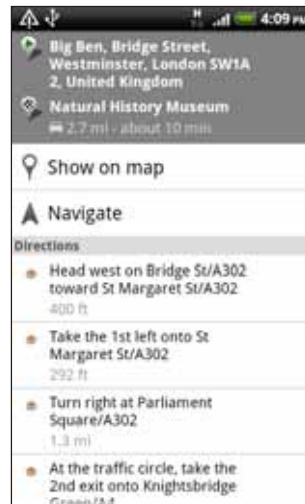

6. Tap **Show on map** to view the directions on the map.
7. Tap the arrow buttons on the map to follow the directions.

When you're finished viewing or following the directions, press **MENU** and then tap **More > Clear Map** to reset the map. Your destination is automatically saved in the Google Maps history.

---



### Finding your friends with Google Latitude (available by country)

---

Google Latitude™ user location service lets you and your friends share locations and status messages with each other. It also lets you send text and email messages, make phone calls, and get directions to your friends' locations.

Your location is not shared automatically. You must join Latitude, and then invite your friends to view your location or accept their invitations. Only friends that you have explicitly invited or accepted can see your location.

#### Opening and joining Latitude

1. From the Home screen, tap  > **Maps**.
2. While viewing a map, press **MENU** and then tap **Join Latitude**.
3. After you've joined Latitude and closed the application, you can do any of the following to open it from the Home screen:
  - Tap  > **Latitude**.
  - Tap  > **Maps**, press **MENU**, and then tap **Latitude**.

## Inviting friends to share their locations

1. From the Home screen, tap  > Latitude.
2. Press MENU, and then tap **Add friends**.
3. Choose how to add friends:

Select from Contacts	Select any number of friends from your Contacts.
Add via email address	Enter one or more email addresses.

4. Tap **Add friends**.
5. When asked to confirm, tap **Yes**.

If your friends already use Latitude, they receive an email request and a notification on Latitude. If they have not yet joined Latitude, they receive an email request that tells them to sign in to Latitude with their Google Account.

## Responding to an invitation

When you get a sharing request from a friend, you can:

Accept and share back	You and your friend can see each other's locations.
Accept, but hide my location	You can see your friend's location, but they can't see yours.
Don't accept	No location information is shared between you and your friend.

## Viewing your friends' locations

You can view your friends' locations on a map or in a list.



When you open Maps, your friends' locations are shown. Each friend is represented by their picture (from Contacts) with an arrow pointing to their approximate location. If a friend has chosen to share city-level locations, their picture does not have an arrow and appears in the middle of the city.

To see a friend's profile and connect, tap the photo. Your friend's name appears in a balloon. Tap the balloon to open a screen with details about your friend and many connection options.

When you open Latitude you see a list of your Latitude friends, with a summary of their last known locations, status, and so on. Tap a friend in the list to open a screen with details about the friend and many connection options.

## Connecting with and managing friends

Tap a friend's contact details balloon in map view or tap a friend in list view to open your friend's profile. Tap any of the following buttons or options on the profile screen:

	Shows your friend's location on the map.
	Gets directions to your friend's location.
	View your friend's location in Street View.
Your friend's photo	Opens Quick contact and lets you view your friend's contact details, send your friend an email, and more.

<b>Sharing options</b>	<p>Select from the following:</p> <ul style="list-style-type: none"> <li>▪ <b>Best available location.</b> Share your precise location information.</li> <li>▪ <b>Share only city level location.</b> Share only the city you're in, not the street-level location. Your friend can see your photo icon in the middle of the city you're in. To share more precise location again, tap <b>Best available location.</b></li> <li>▪ <b>Hide from this friend.</b> Stop sharing your location with this friend, in a list or on a map.</li> </ul>
<b>Remove this friend</b>	Remove the friend from your list and stop sharing locations with him or her altogether.

### Changing privacy settings

You have control over how and when you can be found by your friends. Only the last location sent to Latitude is stored with your Google Account. If you turn off Latitude or are hiding, no location is stored.

1. From the Home screen, tap  > Latitude.
2. Tap your own name, and then tap **Edit privacy settings**.
3. Set the following options to your preferences:

<b>Turn off Latitude</b>	Disable Latitude and stop sharing your location or status. You can always join Latitude again.
<b>Detect your location</b>	Let Latitude detect and update your location as you move. The update frequency is determined by several factors, such as how recently your location has changed.
<b>Set your location</b>	Choose from several options to manually select your location.
<b>Hide your location</b>	Hide your location from all your friends.

# More apps

## Watching videos on YouTube

Use the YouTube app to check out what's popular on the online video-sharing website. Videos are conveniently categorized into Most viewed, Most discussed, and Top rated.



- You need an active Wi-Fi or data connection to access YouTube.
- The first time you use certain YouTube functions such as video sharing, sign in using your YouTube or Google Account, if you're asked to do so.

1. From the Home screen, tap  > YouTube.
2. Scroll through the list of videos, and then tap a video to watch it. The screen automatically switches to landscape view when you play a video.
3. While watching a video, you can:
  - Tap the screen to display the playback controls. When the playback controls are displayed, you can pause, skip forward or backward, or drag the slider to the point in the video you want to watch.
  - Press MENU to rank, comment on, share, flag as inappropriate, and interact with the video in other ways.
4. Press BACK to stop playback, and return to the video list.

---

### Searching for videos

---

1. On the YouTube main screen, press SEARCH.
2. Enter a search keyword, and then tap .
3. The number of search results appears below the status bar. Scroll through the results and tap a video to watch it.

### Clearing the search history

1. On the YouTube main screen, press MENU, and then tap **Settings**.
2. Tap **Clear search history**, and then tap **OK** when prompted.

---





### Sharing a video link

---

Share a video by sending its link to your contacts.

1. While watching a video, press MENU, and then tap **Share**.
2. Choose how you want to share the video link from the available options.

## Capturing a video and sharing it on YouTube

1. From the Home screen, tap  > YouTube.
2. Tap .
3. Press  to start capturing video. When you are done capturing, press  again. Tap Done.
4. Enter a title, description, and tags for your video.
5. Set the privacy level.
6. Tap Upload.

## Reading news feeds

Don't get left behind with yesterday's stories. Use the News app to subscribe to news feeds that cover breaking news, sports, top blogs, and more. You can also get updates based on specific keywords you want.

From the Home screen, tap  > News.



- 1 **Subscriptions** tab. Tap to list the channels you've subscribed to. To find out how to subscribe, see "Subscribing to news channels."
- 2 **My Items** tab. Tap to show links to your starred items and added keywords. See "Starring a story" and "Adding a keyword".

## Subscribing to news channels





1. From the Home screen, tap  > News.
2. On the **Subscriptions** tab, tap **Add feeds**.
3. Do one of the following:

Tap	To
Any category (such as <b>Blogs</b> , <b>Entertainment</b> , <b>Sports</b> , and more)	Choose from popular news feeds.
<b>Search more</b>	Enter a keyword to search the Web for related news feeds or enter the complete URL of a news feed to subscribe to.

4. After selecting the channel or channels to subscribe to, tap **Add**.

## Reading a story

1. From the Home screen, tap  > News.
2. On the **Subscriptions** tab, tap a channel.
3. Tap a story to read it. While reading the story, you can:

Tap	To
	Star the story as a favorite.
	Share a link to the story from the available options.
	Go to the web page where the story is published.
	Go to the next or previous story in the channel.

4. If you want to read the whole story, tap **Read full article**. This opens the story in the web browser. See “Using your phone’s web browser” in the Web browser chapter to learn how to navigate the web page.



## Manually checking for new stories

On the **Subscriptions** tab, press **MENU**, and then tap **Refresh**.

## Starring a story

Star your favorite stories to read them again later. Starred stories are displayed on the **Starred** tab.

Do one of the following:

- On a list of stories, tap  next to a story.
- While reading a story, tap  near the top-right corner of the screen.

You can remove the star from a story by tapping the star icon again.

## Adding a keyword

Easily find stories that interest you by entering a search keyword. Stories that contain the keyword are grouped together on the **Keywords** tab.

1. From the Home screen, tap  > News.
2. On the My items tab, tap **Keywords** > Add keywords.
3. Enter the keyword, and then tap **Add**.

Your new keyword is displayed on the **Keywords** tab. Tap the keyword to show the stories that contain that keyword.

## Changing update schedule and font settings

In the News app, press MENU, tap **Settings**, and then do the following:

Tap	To
<b>Accounts &amp; sync</b>	Manage sync options and general News settings.
<b>Update when opened</b>	Update the content of the channels you've subscribed to every time you open the News app.
<b>Update schedule</b>	Choose a time interval when the channels you've subscribed to are updated. Select <b>Manual</b> to refresh the content only when you like.
<b>News content</b>	Choose how to read news stories by default: whether as a summary or as a full web page article.

## Adding the News widget

Read snippets of stories that you have subscribed to right on the Home screen. To find out how to add this widget to your Home screen, see “Personalizing your Home screen with widgets” in the Personalizing chapter.



## Working on documents, spreadsheets, and presentations

Need to tweak a report while you're on the go? Use Quickoffice to easily view, edit, or even create Microsoft Office Word (.doc) and Microsoft Office Excel (.xls) files. You can also use it to view Microsoft PowerPoint (.ppt) presentations and text (.txt) files on your phone.

From the Home screen, tap  > Quickoffice.

If you have a long file list, press MENU and then tap **Sort** to arrange your files by name or date. Press **SEARCH** to look for specific filenames.

---

### Viewing a document, spreadsheet, or presentation

---

1. On the Quickoffice main screen, tap the file you want to open.
2. While viewing a file, you can:
  - Slide your finger on the screen to pan or go through the pages of the file.
  - Turn your phone left sideways to view the file in landscape mode.
  - To zoom in, spread your thumb and index finger across the screen. To zoom out, pinch your thumb and index finger on the screen.



After you zoomed in on a PowerPoint slide, double-tap the slide to make it fit with the screen's width.

- Press MENU and then tap **Worksheet** to view other worksheets in an Excel file.
- Tap a URL link in a Word or PowerPoint file to open the web page in the web browser.
- When you open Word documents, Quickoffice reformats the text to make it fit the screen's width. Press MENU, and then tap **View** to switch between normal and reformatted modes.



Quickoffice does not reflow text in tables.

---

### Editing a document or worksheet

---

1. While viewing a document or worksheet, press MENU, and then tap **Edit**.
2. Make your changes on the file.
3. When done, press **MENU > More**, and then tap **Save** or **Save as** to keep your changes.

## Creating a new document or worksheet

1. On the Quickoffice main screen, press MENU, and then tap New.
2. Choose a file type to create:
  - Word 97- 2003 document
  - Excel 97 - 2003 workbook
3. Press MENU, and then tap Edit to start entering text.
4. When done, press MENU > More, and then tap Save as to keep your changes.

## Keeping track of your stocks

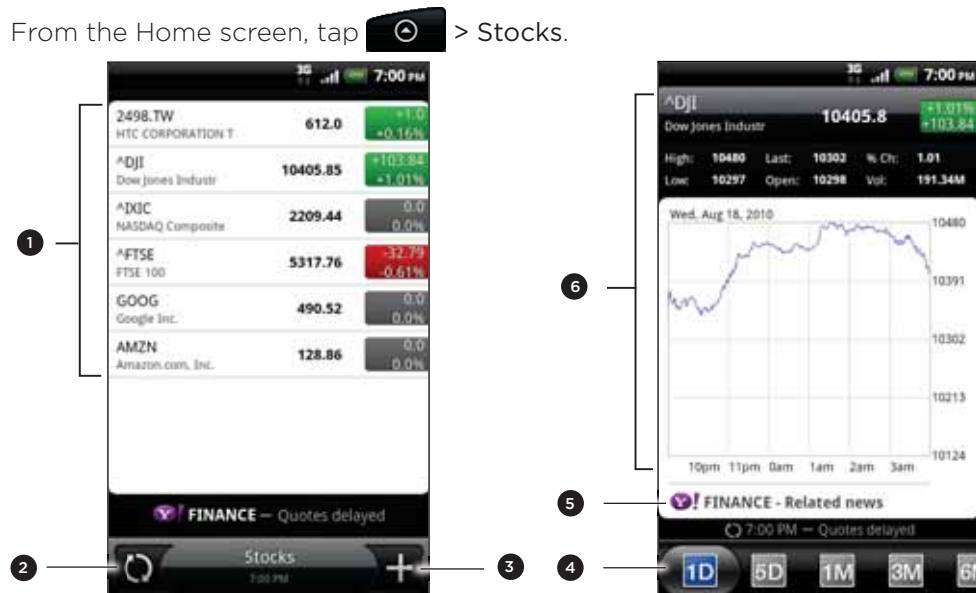

Use the Stocks app to get the latest stock updates for stock quotes and market indices you follow.

From the Home screen, tap  > Stocks.



- 1 Tap an item to view from the list of stock quotes and market indices.
- 2 Tap to update the stock information.
- 3 Tap to add a stock quote or stock market index.
- 4 Slide to other tabs to view up to two years of an item's past trade information.
- 5 Tap to view related news for a selected item.
- 6 View an item's trade information, and as well as its price chart for a specific period.

## Adding a stock quote or stock market index

1. On the Stocks main screen, tap .
2. Enter the stock quote or stock market index on the text field, and then tap .
3. On the results list, tap the stock quote or stock market index you want to add.

### Changing the stock list order

1. On the Stocks main screen, press MENU, and then tap **Rearrange**.
2. Press and hold  at the end of the item you want to move. When the row is highlighted in green, drag it to its new position, and then release.
3. Tap **Done**.

### Deleting stock quotes and indices

1. On the Stocks main screen, press MENU, and then tap **Delete**.
2. Select the items you want to delete, and then tap **Delete**.

### Manually updating stock information

On the Stocks main screen, press MENU, and then tap **Update**.

### Changing update schedule and color settings



Downloading stock information automatically may incur additional fees from your mobile operator.

In the Stocks app, press MENU, tap **Settings**, and then do the following:

Tap	To
Update when opened	Update the stock information every time you open the Stocks app.
Scheduled sync	Set automatic downloads of stock information.
Update schedule	Choose a time interval for checking updates.
Set color for price raise	Change the color for displaying stock price increases to either red or green, depending on what's being used in your country.

### About the Stocks widget

Use the Stocks widget to instantly check stock updates right on your Home screen. It comes in different looks and styles. To find out how to add this widget to your Home screen, see “Personalizing your Home screen with widgets” in the Personalizing chapter.

## Listening to FM Radio

Tune in and listen to chart-topping pop songs using your phone's FM Radio app.



You need to connect a headset first to the audio jack of your phone to use FM Radio. FM Radio uses the stereo headset as the FM radio antenna.

From the Home screen, tap  > FM Radio.



The first time you open FM Radio, it automatically scans for available FM stations, saves them as presets, and plays the first FM station found.



- |   |   |
|---|---|
| 1 | Drag to tune in to a frequency on the FM band.                    |
| 2 | Tap to fine tune the radio frequency by -0.1 MHz.                 |
| 3 | View the All presets list.  |
| 4 | Tap to search the FM band for the previous FM station.”           |
| 5 | Tap to search the FM band for the next FM station.                |
| 6 | Tap to change the name of the current station you are tuned into. |
| 7 | Tap to fine tune the radio frequency by +0.1 MHz.                 |
| 8 | Switch off and close FM Radio.                                    |

### Tuning in to an FM station

There are several things you can do while you're on the FM Radio screen:

- Tap  and then select a station you want to listen to.
- Tap  to go to the previous available FM station, or  to go to the next available FM station.
- Press the VOLUME UP and VOLUME DOWN buttons on the side of the phone to adjust the volume.
- To repeat scanning and saving of FM stations, press MENU, and then tap Scan & Save. Press BACK to stop the auto-scan.

- Press MENU to mute the sound or to change the sound output to **Mono** or **Stereo**.

You can also switch the sound output between the **Speaker** and **Headset**.

---

### Closing or turning off FM Radio

---

To close the FM Radio screen:

- Press BACK. FM Radio continues to run in the background, and you can still listen to the radio while using other apps on your phone.

To go back to the FM Radio screen, slide open the Notifications panel, and then tap **FM Radio**.

To turn off completely and close FM Radio:

- Tap  on the upper-right corner of the FM Radio screen.

---

### Adding the FM Radio widget

---



Use the FM Radio widget to listen to your favorite FM stations right on your Home screen. To find out how to add this widget to your Home screen, see “Personalizing your Home screen with widgets” in the Personalizing chapter.

## Recording your voice

Don't just think out loud. Use Voice Recorder to quickly capture your thoughts. You can also record your voice and set it as a ringtone.





You need to have a microSD card on your phone to use Voice Recorder.

1. From the Home screen, tap  > **Voice Recorder**.
2. Hold the phone's microphone near your mouth.
3. Tap  to start recording a voice clip.



Voice Recorder can run on the background while you do other things on your phone, except when you open other apps that also use audio functions. To go back to the Voice Recorder screen, slide open the Notifications panel, and then tap **Voice Recorder**.

4. Tap  to stop recording.
5. Type a name for the voice clip and tap **Save**.
6. To play back the voice clip, tap .
7. To show options for sharing, deleting, or renaming the voice clip, press MENU.

---

### Sharing a voice clip

---

1. On the Voice Recorder screen, tap .
2. Press and hold the voice clip you want to share, and then tap **Share**.
3. From the available options, choose how you want to share the voice clip.

---

## Setting a voice clip as a ringtone

---

1. On the Voice Recorder screen, tap .
2. Press and hold the voice clip you want to set as a ringtone, and then tap **Set as ringtone**.

---

## Renaming a voice clip

---

1. On the Voice Recorder screen, tap .
2. Press and hold the voice clip you want to rename, and then tap **Rename**.
3. Enter the name, and then tap **Save**.

## Using Flashlight

Never get caught in the dark again. Use the Flashlight app to turn on your phone's LED flashlight to shine a light wherever you need it.

On the Home screen, tap  > **Flashlight**.

The app then plays a short animation to show you how to adjust brightness and turn the light on or off.



- To adjust the brightness of the light, simply tap the onscreen power button on the flashlight handle.
- To close the flashlight, press **BACK**.

## Finding and installing apps from Android Market

Android Market™ is the place to go to find new apps for your phone. Choose from a wide variety of free and paid apps ranging from productivity apps, entertainment, to games. When you find an app you want, you can easily download and install it on your phone with just a few taps of your finger.

To access Android Market, you must first connect to the Internet using your phone's Wi-Fi or data connection and sign in to your Google Account.



Paid apps are currently only available in certain countries.

### Finding and installing an app

When you install apps from Android Market and use them on your phone, they may require access to your personal information (such as your location, contact data, and more) or access to certain functions or settings of your phone. Download and install only apps that you trust.





- You need a Google Checkout account to purchase items on Android Market. See “Creating a Google Checkout account” to set up a Google Checkout account if you do not have one.
- Be cautious when downloading apps that have access to your phone's functions or a significant amount of your data. You're responsible for the results of using downloaded apps on your phone.

1. From the Home screen, tap  > Market.

When you open Android Market for the first time, the Terms of Service window will appear. Tap **Accept** to continue.

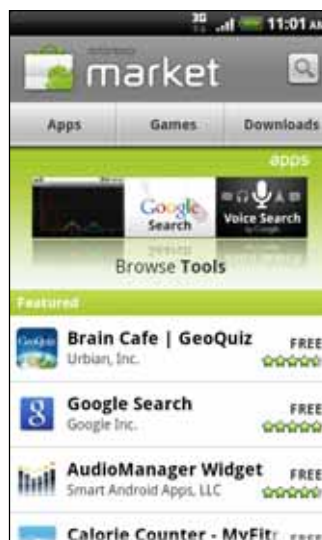
2. Do any of the following to find an app:



To	Do this
Browse featured apps	Scroll through the list of featured apps.
Browse apps by categories	Tap <b>Apps</b> or <b>Games</b> , and then tap a category. Under a category, you can filter the apps by <b>Top paid</b> , <b>Top free</b> or <b>Just in</b> .
Search for an app	Tap  on the Android Market home screen, enter the name or type of app you're looking for, and then tap  to the right of the search box.

- When you find the app that you like, tap it and read its description and user comments.
- Tap **Install** (for free apps) or **Buy** (for paid apps).

The subsequent screen notifies you whether the app will require access to your personal information or access to certain functions or settings of your phone.

- If you agree to the conditions, tap **OK** to begin downloading and installing the app.

If you selected a paid app, after tapping **OK**, you will be redirected to the Google Checkout screen to pay for the app before it's downloaded to your phone.

### Creating a Google Checkout account

You must have a Google Checkout account associated with your Google Account to purchase items from Android Market.

To create a Google Checkout account, do one of the following:

- On your computer, go to <http://checkout.google.com>.
- The first time you use your phone to buy an app from Android Market, follow the prompts onscreen to enter your billing information.



When you've used Google Checkout once to purchase an app from Android Market, the phone remembers your password, so you don't need to enter it the next time. For this reason, you should secure your phone to prevent others from using it without your permission. See the Security chapter to learn how to secure your phone.

### Requesting a refund for a paid app

If you are not satisfied with an app, you can ask for a refund within 24 hours of the purchase. Your credit card will not be charged and the app will be removed from your phone.

If you change your mind, you can install the app again, but you can't request a refund a second time.

- From the Home screen, tap  > **Market** > **Downloads**.
- Tap the app you want to uninstall for a refund. The details screen for the app opens.
- Tap **Uninstall & refund**. Your app is uninstalled and the charge is cancelled.
- Choose the reason for removing the app, and then tap **OK**.





---

## Opening an installed app

---

Do one of the following:

- If you see this icon (  ) on the status bar, open the Notifications panel, and then tap the app. See “Opening the Notifications panel” in the Getting started chapter.
- From the Home screen, tap  > Market > Downloads. On the Downloads screen, tap the app and then tap Open.
- From the Home screen, tap  . On the All apps screen, locate the app, and then tap it.

---

## Uninstalling an app

---

You can uninstall any app that you have downloaded and installed from Android Market.

1. From the Home screen, tap  > Market > Downloads.
2. Tap the app you want to uninstall, and then tap **Uninstall**.
3. When asked, tap **OK**.
4. Choose the reason for removing the app, and then tap **OK**.

---

## Getting help

---

If you need help or have questions about Android Market, press MENU, and then tap **Help**. The web browser will take you to the Android Market Help web page

## Sharing games and apps

Having fun with a game or app that you've downloaded from Android Market? Share it instantly with your circle of friends.



For your friends to link to the app and download it from Android Market, they must be using an Android phone.

1. From the Home screen, tap .
2. Press MENU, and then tap **Share**.

You'll then see the list of games and apps that you downloaded and installed from Android Market.



3. Tap an app, and then choose how to share it:

Bluetooth	Send the link using Bluetooth. See the Bluetooth chapter.
Facebook	Post the link to Facebook. See the Social chapter.
Friend Stream	Post the link to Facebook and Twitter. See the Social chapter.
Gmail	Send the link using your Gmail account. See the Email chapter.
Mail	Send the link using your POP3/IMAP or Exchange ActiveSync email account. See the Email chapter.
Message	Send the link in a text message. See the Messages chapter.
Peep	Share the link in Twitter. See the Social chapter.

When your friends see the link in your sent message, email, or status update, they can simply tap the link to go directly to the game or app in Android Market to download it.



- While entering your status update in Friend Stream, you can also tap  to choose from games or apps that you want to share in your social networks.
- If you've already created a new text or email message, press MENU and then tap **Attach > App recommendation** to choose from your list of installed games and apps.

# Security

## Protecting your SIM card with a PIN

Add another layer of security for your phone by assigning a PIN (personal identification number).

Make sure you have the default SIM PIN provided by your mobile operator before continuing.

1. From the Home screen, press MENU, and then tap **Settings > Security**.
2. Tap **Set up SIM card lock**, then select **Lock SIM card**.
3. Enter the default SIM card PIN, and then tap **OK**.
4. To change the SIM card PIN, tap **Change SIM PIN**.



Emergency calls can be placed at any time without requiring a PIN. See “Making an emergency call” in the Phone calls chapter for more details.

---

### Restoring a SIM card that has been locked out

---

If you enter the wrong PIN more times than the maximum number of attempts allowed, your SIM card will become “PUK-locked.” You need a PUK code to restore access to the phone. This code may have been provided by your mobile operator when you received your SIM card.

1. On the Phone dialer screen, enter the PUK code, and then tap **Next**.
2. Enter the new PIN you want to use, and then tap **Next**.
3. Enter the new PIN again, and then tap **Next**.

## Protecting your phone with a screen lock

Protect your personal information and prevent others from using your phone without your permission by setting a screen lock password, a PIN, or a lock pattern.

Your screen lock will be asked every time your phone is turned on or when it's idle for a certain period of time.

1. From the Home screen, press MENU, and then tap **Settings > Security**.
2. Tap **Set up screen lock**.
3. Tap one of the following:

<b>None</b>	Disable the screen lock you've previously created.
<b>Pattern</b>	Set a screen lock pattern by following the onscreen instructions.
<b>PIN</b>	Set a numeric password of at least four digits.
<b>Password</b>	Set an alpha-numeric password.

4. On the Security screen, tap **Lock phone after**, then specify the idle time you can allow before the screen is locked.



You can also clear the **Use visible pattern** on the Security screen if you don't want your screen lock pattern to display as you draw it onscreen.

---

### Changing your screen lock

---

1. From the Home screen, press MENU, and then tap **Settings > Security**.
2. Tap **Change screen lock**.
3. Enter your current screen lock to confirm that you want to change it.
4. Choose a different screen lock type, then enter your new pattern, PIN, or password.

Or tap **None** if you don't want to use a screen lock.

---

### Forgot your screen lock pattern?

---

If you've forgotten your screen lock pattern, you have up to five attempts to try and unlock your phone. If this fails, you can unlock your phone by entering your Google Account user name and password.

1. On the unlock screen, enter your lock pattern.
2. After the fifth attempt and you're asked to wait for 30 seconds, tap **OK**.
3. If the display goes off, press the **POWER** button to turn the display back on, and then press the bar on the lock screen and slide your finger down to unlock the screen.
4. Tap the **Forgot pattern** button in the lower right corner when it appears.
5. Enter your Google Account name and password, and then tap **Sign in**.

You'll then be asked to create a new screen lock pattern. If you no longer want to do so, tap **Cancel**.

# Settings

## Settings on your phone

Control and customize phone settings on the Settings screen.

From the Home screen, press MENU, and then tap **Settings**.

Personalize	Choose a scene, set the Home screen or Lockscreen wallpaper to use, apply a skin, and set sound options. You can also rename or delete a custom scene by pressing and holding a scene in Scenes.
Wireless & networks	Set up your phone's wireless connections, such as Wi-Fi and Bluetooth, enable the Airplane mode, or set the options for mobile networks, roaming, Wi-Fi hotspot, Virtual Private Networks, and more.
Call	Set up call services such as voicemail, call forwarding, call waiting, and caller ID.
Sound	<ul style="list-style-type: none"> <li>▪ Choose sounds to use for your phone ringtone and notifications.</li> <li>▪ Adjust media playback volume. See “Adjusting the volume” in the Getting started chapter.</li> <li>▪ Set to lower the ring volume when you move the phone when it's ringing, make the phone ring louder when inside a bag or pocket, and turn on the speakerphone when you flip over the phone.</li> <li>▪ Turn on or off sound and vibrate features such as <b>Audible touch tones</b>, <b>Quiet ring on pickup</b>, <b>Pocket mode</b>, and more.</li> </ul>
Display	Set up display settings such as automatic screen orientation, brightness, screen timeout, and more.
Keyboard shortcuts	Assign an app or shortcut to the two shortcut keys on the slideout keyboard. To find out how to assign shortcuts, see “Using the Quick keys” in the Keyboard chapter.
Accounts & sync	Log in or out of your social network accounts, Google Account, Exchange ActiveSync account, and HTCsense.com account. You can also manage synchronization and other settings for your accounts. See the Accounts and sync chapter for details.
Location	Select the sources to use when determining your location. Select <b>Phone finder</b> so you can use HTCsense.com to locate your phone.
Search	Select items to include when you do a search on your phone and set Google search options.
Privacy	Choose to automatically back up some settings on the phone (e.g. Wi-Fi passwords or Bookmarks) to Google servers using your Google Account so you can restore them when needed.

Connect to PC	<ul style="list-style-type: none"> <li>Set the default USB connection type to use whenever you connect your phone to your computer.</li> <li>Or, select the <b>Ask me</b> check box to set your phone to always display the screen for selecting the USB connection type. To find out more, see “Connecting your phone to a computer” in the Getting started chapter.</li> </ul>
Security	Set a screen lock, enable the SIM card lock, or manage the phone’s credential storage. See the Security chapter for details.
Power saver	Turn on power saver to automatically switch to power saving mode when the battery level goes down to the level that you set. See “Optimizing your phone’s battery life” in this chapter for details.
Applications	Manage running applications, move applications to or from the storage card, and install or uninstall programs.
SD & phone storage	<ul style="list-style-type: none"> <li>Check the available storage card and phone memory.</li> <li>From this screen, be sure to unmount your microSD card before you remove it from your phone.</li> <li>You can also do a factory reset. See the Update and reset chapter for more details.</li> </ul>
Date & time	Set the date and time, time zone, and date or time format. To turn off auto time synchronization and be able to manually change time zone settings, see “Setting the time zone, date, and time” in the Clock and Weather chapter.
Language & keyboard	Set the operating system language and region. You can also set onscreen keyboard options.
Accessibility	This option appears only after you’ve downloaded and installed an accessibility tool, such as a screen reader that provides voice feedback. You can turn accessibility functions or services on or off.
Voice input & output	Set up the voice input options of your phone. Also, if you’ve installed a text-to-speech (voice data) application, use this to set the text-to-speech settings.
About phone	<ul style="list-style-type: none"> <li>Turn on or off scheduled checks for system software updates, or manually check for updates.</li> <li>View different information about your phone, such as the mobile network type, signal strength, battery level, battery use of individual applications, software version of your phone, and more. See “Checking information about your phone” in this chapter.</li> </ul>

## Changing display settings

### Adjusting the screen brightness manually

- From the Home screen, press MENU, and then tap **Settings**.
- Tap **Display > Brightness**.
- Clear the **Automatic brightness** check box.
- Drag the brightness slider to the left to decrease or to the right to increase the screen brightness. Tap **OK**.

---

### Adjusting the time before the screen turns off

---

After a period of inactivity, the phone screen turns off to conserve battery power. You can set the idle time before the screen turns off.

1. From the Home screen, press MENU, and then tap **Settings**.
2. Tap **Display > Screen timeout**.
3. Tap the time before the screen turns off.

---

### Turning automatic screen rotation off

---

By default, the screen orientation automatically adjusts depending on how you hold the phone.



Automatic rotation is not supported in all application screens.

1. From the Home screen, press MENU, and then tap **Settings**.
2. Tap **Display**, and then clear the **Auto-rotate screen** check box.

---

### Recalibrating the G-sensor

---

Recalibrate the screen if you feel that the screen orientation does not respond properly to the way you hold the phone.

1. From the Home screen, press MENU, and then tap **Settings**.
2. Tap **Display > G-Sensor calibration**.
3. Place the phone on a flat and level surface, and then tap **Calibrate**.
4. After the recalibration process, tap **OK**.

---

### Keeping the screen on while charging the phone

---

You can keep the phone screen from turning off while you're charging the phone.

1. From the Home screen, press MENU, and then tap **Settings**.
2. Tap **Applications > Development**.
3. Select the **Stay awake** check box.

---

### Switching animation effects on or off

---

You can turn off the animation or enable only some animations when switching between screens.

1. From the Home screen, press MENU, and then tap **Settings**.
2. Tap **Display > Animation**.
3. On the options menu, select the animation setting you want.



## Changing sound settings

---

### Switching between silent, vibration, and normal modes

---

- To change back from silent to normal mode, simply press the VOLUME UP button.
- To change back from vibration to normal mode, press the VOLUME UP button twice.
- From the Home screen, press MENU, and then tap **Settings > Sound > Sound profile**.
- You can also add the Profile widget to your Home screen. To find out how to add a widget, see “Personalizing your Home screen with widgets” in the Personalizing chapter.

---

### Enabling or disabling audible selection

---

You can choose to play a sound when you’re selecting items onscreen.

1. From the Home screen, press MENU, and then tap **Settings**.
2. Tap **Sound**, and then select the **Audible selection** check box.

---

### Choosing the notification sound

---

You can choose a default sound for your phone to play whenever there are new notifications.

1. From the Home screen, press MENU, and then tap **Settings**.
2. Tap **Sound > Notification sound**.
3. Select your preferred notification sound in the list, and then tap **OK**.

To use different sounds for different types of notifications, set the notification sounds in the respective applications. For example, to set different sounds for received and sent text messages, open the Messages application, then press MENU and tap **Settings**.

---

### Turning on or off automatic ring volume adjustment

---

#### Quiet ring on pickup

Your phone has a quiet ring feature that automatically lowers the ring volume when you move your phone.

1. From the Home screen, press MENU, and then tap **Settings**.
2. Tap **Sound**, and then select or clear the **Quiet ring on pickup** check box.

### Turning on Pocket mode

To help avoid missing incoming calls when your phone is in your pocket or bag, the pocket mode feature gradually increases the ring volume and vibrates when you receive a call. When not in your pocket or bag, the phone will ring at the normal volume you set.

1. From the Home screen, press MENU, and then tap **Settings**.
2. Tap **Sound**, and then select or clear the **Pocket mode** check box.

---

### Switching to speakerphone automatically

---

You can switch to speakerphone by simply flipping over your phone.

1. From the Home screen, press MENU, and then tap **Settings**.
2. Tap **Sound**, and then select or clear the **Flip for speaker** check box.

## Changing the phone language

When you turn your phone on for the first time, you're asked to choose the language you want to use for your phone. If you want, you can still change the phone language after you set up your phone. Changing the language adjusts the keyboard layout, date and time formatting, and more.

The languages available to choose from may depend on the version of phone you have.

1. From the Home screen, press MENU, and then tap **Settings**.
2. Tap **Language & keyboard > Select language**.
3. Tap the language and corresponding region you want to use.
4. Press HOME to return to the Home screen. You may need to wait a few seconds for the new language to be applied.

## Optimizing your phone's battery life

You can set the phone to automatically switch to power saving mode when the battery level reaches a certain level.

1. From the Home screen, press MENU, and then tap **Settings**.
2. Tap **Power saver**.
3. Select the **Enable power saver** check box.
4. Tap **Turn power saver on at**, and then select when to switch to power saver mode.
5. In the **Power saver settings** section, set and select the phone behavior when the phone switches to power saving mode.

---

### Using the GSM network of your mobile operator

---

Switch to using the GSM network of your mobile operator if you're not using a data connection to connect to the Internet. Connecting to your mobile operator's GSM network consumes less battery power.

1. From the Home screen, press MENU, and then tap **Settings**.
2. Tap **Wireless & networks > Mobile networks > Network mode**.
3. Tap **GSM only**.

---

### Checking the power usage of applications

---

1. From the Home screen, press MENU, and then tap **Settings**.
2. Tap **About phone > Battery > Battery use**.

## Managing memory

---

### Checking how much phone memory is available for use

---

1. From the Home screen, press MENU, and then tap **Settings**.
2. Tap **SD & phone storage**. The available phone memory is displayed in the Internal phone storage section.

---

### Checking the available storage card space

---

1. From the Home screen, press MENU, and then tap **Settings**.
2. Tap **SD & phone storage**. The total and available storage card space is displayed in the SD card section.

---

### Clearing application cache and data

---

1. From the Home screen, press MENU, and then tap **Settings**.
2. Tap **Applications > Manage applications**.
3. On the Manage applications screen, switch to the **Running** tab, and then tap the application whose cache and/or data you want to delete.
4. In the Application info screen, tap **Clear data** and/or **Clear cache**.

---

### Uninstalling third-party applications

---

You cannot uninstall applications that are preinstalled on the phone.

1. From the Home screen, press MENU, and then tap **Settings**.
2. Tap **Applications > Manage applications**.
3. On the **Downloaded** tab, tap the application you want to uninstall.
4. On the Application info screen, tap **Uninstall**.

## Moving applications to or from the storage card

Move applications that you've downloaded to the phone to the storage card if your phone's memory is getting low. Or, if your storage card is getting full, you can also move applications that are on your storage card to the phone.



You can only move applications that are not preinstalled on your phone.

1. From the Home screen, press MENU, and then tap **Settings**.
2. Tap **Applications > Manage applications**.
3. On the **Downloaded** tab, tap the application you want to move.
4. On the Application info screen, tap **Move to SD card** or **Move to phone**.

## Checking information about your phone

1. From the Home screen, press MENU, and then tap **Settings**.
2. Tap **About phone**.
3. Select one of the following:

<b>System software updates</b>	Enable or disable the automatic check feature for software updates for your phone. You can also tap <b>Check now</b> to manually check for software updates.
<b>Network</b>	Check information about your mobile operator and its service status.
<b>Phone identity</b>	Check information about your phone and the SIM card you're using.
<b>Battery</b>	Check information about the battery such as its current battery level, status, and what programs are using the battery.
<b>Hardware information</b>	Check the Wi-Fi MAC and Bluetooth addresses.
<b>Software information</b>	Check the version and other information about the Android platform being used by the phone. You can also check the version of the web browser.
<b>Legal information</b>	Read legal information from HTC and Google, and licenses used by the phone.

# Update and reset

## Updating the phone software

From time to time, software updates for your phone may be available. Your phone can check and then notify you if there's a new update. You can then download and install the software update using your phone's Wi-Fi or data connection.



- Checking and downloading phone software updates may incur additional data transfer fees from your mobile operator.
- Make sure your phone has a microSD card inserted. The update will be downloaded to the microSD card.

Depending on the type of update, the update may erase all your personal data and customized settings, and also remove any applications you've installed. Make sure that you've backed up the information and files you want to keep.

- When there is an update available, the Install system software update dialog box will appear onscreen. Select **Install now** and then tap **OK**.
- If you're in the middle of a call and there's an update available, you'll receive an update notification. After you end the call, slide open the Notifications panel (see "Opening the Notifications panel" in the Getting started chapter). Then tap the update notification to download and install the software update.

Wait for the update process to finish. When the update is finished, the phone will automatically reset.

---

### Checking for phone system software updates manually

---

1. From the Home screen, press MENU, and then tap **Settings**.
2. Tap **About phone > System software updates**.
3. On the System software update screen, tap **Check now**.

## Restarting or factory resetting your phone

### Restarting your phone (soft reset)

If your phone is running slower than normal, an application is not performing properly, or your phone becomes unresponsive, try restarting your phone and see if that helps solve the problem.

1. If the display is off, press the POWER button to turn it back on.
2. Unlock your phone if the Lock screen is displayed. See “Unlocking the screen” in the Getting started chapter.
3. Press and hold the POWER button, and then tap **Restart**.
4. When asked to confirm, tap **Restart**.

If you can't restart the phone following the above steps, remove the battery, wait for a few seconds, reinsert the battery, and then turn the phone on.

### Performing a factory reset (hard reset)

If you're passing your phone on to someone else or your phone has a persistent problem that cannot be solved, you can do a factory reset (also called a hard reset). This returns your phone to the state it was in before the first time you turned it on.



Factory reset will not erase the data and files that are on the storage card.

Factory reset is not a step to be taken lightly. It'll permanently delete all your data and customized settings, and will remove any applications you've downloaded and installed. Be sure to back up any data and files you want to keep before you do a factory reset.

#### Performing a factory reset via settings

1. From the Home screen, press MENU, and then tap **Settings**.
2. Tap **SD & phone storage > Factory data reset**.
3. On the Factory data reset screen, tap **Reset phone**, and then tap **Erase everything**.

#### Performing a factory reset using phone buttons

If you can't turn on your phone or access the phone settings, you can still perform a factory reset by using the buttons on the phone.

1. With the phone turned off, press and hold the VOLUME DOWN button, and then briefly press the POWER button.
2. Wait for the screen with the three Android images to appear, and then release the VOLUME DOWN button.
3. Press VOLUME DOWN to select **FACTORY RESET**, and then press the POWER button.

# Trademarks and copyrights

Copyright © 2010 HTC Corporation. All Rights Reserved.

The HTC logo, the HTC quietly brilliant logo, HTC Desire Z, HTC Sense, HTC Hub, Footprints, Locations, HTC Sync, and HTC Care are trademarks and/or service marks of HTC Corporation.

Copyright © 2010 Google Inc. Used with permission.

Google, the Google logo, Android, Google Search, Google Maps, Gmail, Google Mail, YouTube, Android Market, and Google Talk are trademarks of Google Inc.

Google, the Google logo and Google Maps are trademarks of Google, Inc. TeleAtlas® Map Data ©2010. Street View Images ©2010 Google.

Microsoft, Windows, Windows XP, Windows Vista, ActiveSync, and Outlook are either registered trademarks or trademarks of Microsoft Corporation in the United States and/or other countries.

Bluetooth and the Bluetooth logo are trademarks owned by Bluetooth SIG, Inc.

Wi-Fi is a registered trademark of the Wireless Fidelity Alliance, Inc.

microSD is a trademark of SD Card Association.

Copyright © 2010 Adobe Systems Incorporated. All Rights Reserved.

Java, J2ME and all other Java-based marks are trademarks or registered trademarks of Sun Microsystems, Inc. in the United States and other countries.

Facebook is a trademark of Facebook, Inc.

Twitter is a trademark of Twitter, Inc., and is used under license.

Flickr is a trademark of Yahoo! Inc.

DLNA is a registered trademark, DLNA disc logo is a service mark, and DLNA Certified is a trademark of the Digital Living Network Alliance.

All other company, product and service names mentioned herein are trademarks, registered trademarks or service marks of their respective owners.

HTC shall not be liable for technical or editorial errors or omissions contained herein, nor for incidental or consequential damages resulting from furnishing this material. The information is provided "as is" without warranty of any kind and is subject to change without notice. HTC also reserves the right to revise the content of this document at any time without prior notice.

No part of this document may be reproduced or transmitted in any form or by any means, electronic or mechanical, including photocopying, recording or storing in a retrieval system, or translated into any language in any form without prior written permission of HTC.

# Index

## Symbols

---

3G 129

## A

---

Access point 129  
 Adding a city to the Weather screen 127  
 Adding a city to the World Clock screen 124  
 Airplane mode 50  
 Alarm clock 124  
 Alarms  
 - changing the alarm sound 39  
 Album (Gallery app) 154  
 Android Market 207  
 Answering an incoming call 44  
 Apps  
 - adding icons from the Home screen 35  
 - rearranging or hiding tabs 40  
 - switching between recently-opened apps 25  
 App Sharing 210  
 Attachments  
 - types of message attachments 73  
 - viewing and saving message attachments 76  
 Auto capture 151, 153  
 Auto focus 150, 153

## B

---

Back cover 10  
 - removing 10  
 - replacing 10  
 Battery 14  
 - charging 16  
 - inserting 15  
 - optimizing 218  
 - removing 14  
 Blocking callers 49  
 Bluetooth  
 - Bluetooth received folder 147  
 - changing phone name 142  
 - connecting headset or car kit 142

- receiving information 145  
 - sending information 144  
 - sending photo/video 152  
 - sending photos or videos 158  
 - sharing music 166  
 - turning on or off 142

Bookmarks 140

Browser 135

## C

---

Calendar 113  
 - widget 120  
 Calendar events  
 - creating 113  
 - deleting 117  
 - editing 117  
 - inviting guests to a Google calendar event 114  
 - sending an Exchange ActiveSync meeting request 115  
 - sharing a vCalendar 118  
 - viewing 117  
 Caller ID 44, 45  
 Call history 48  
 Calls  
 - answering a call 44  
 - ending a call 47  
 - making a call 41  
 - putting a call on hold 45  
 - rejecting a call 44  
 - switching between calls 46  
 Call services 50  
 Camera 148  
 Car kit 184  
 Car Panel 186  
 Charging the battery 16  
 Chat invitations  
 - accepting 98  
 - inviting a friend in Google Talk 99  
 Chatting in Google Talk 98  
 Checking information about your phone 220  
 Checking notifications from social networks 97



Checking weather 126  
 Clock 121  
 Clock widget (HTC) 121  
 Conference call 46  
 Connected media 167  
 Connecting your phone to a computer 25  
 Connect to PC 25  
 Contact groups 60
 

- creating 60
- deleting a group 61
- editing a contact group 60
- rearranging your contact groups 61
- Sending a message or email to a group 61

 Contact information
 

- editing 59
- merging 54
- sending 59

 Contacts
 

- adding a new contact 53
- backing up your contacts to the storage card 57
- importing from an Exchange ActiveSync account 54
- importing from your SIM card 53
- transferring contacts from your old phone 52

 Contacts list 56
 

- filtering 57

 Conversations 58, 77  
 Copying files to or from the storage card 26  
 Copying text 138

## D

---

Data connection 129  
 Date and time 123  
 Desk Clock 122

## E

---

Effects (camera) 152  
 Email
 

- sending photo/video 152
- sending photos or videos 157

 Emergency call 43  
 Event reminders 118  
 Exchange ActiveSync 105, 111  
 Extended Home screen 21

## F

---

Facebook
 

- commenting photos 161
- Facebook for Android 91, 92
- Facebook for HTC Sense 90, 92
- sharing photos 158
- view photos 161

 Facebook for HTC Sense
 

- sharing photo/video 152

 Face detection
 

- auto capturing 151
- manual capturing 150

 Factory reset 222  
 Finger gestures 17  
 Flashlight 206  
 Flash settings (camera)
 

- photo mode 150
- video mode 151

 Flickr
 

- commenting photos 161
- sharing photos 159
- viewing photos 161

 FM Radio 204  
 Folders 35
 

- creating a new folder 35
- renaming a folder 36

 Footprints 181  
 Friend Stream 95
 

- checking notifications 97
- commenting on and liking Facebook posts 96
- Friend Stream widget 97

## G

---

G-sensor 216  
 Gallery 154  
 Gmail/Google Mail
 

- about 100
- adding a signature 104
- changing the settings 104
- labeling a conversation 103
- muting a conversation 104
- reading emails 101
- replying/forwarding emails 102
- searching emails 102
- sending an email 101
- spam 104
- star an email 103

- using batch operations 104
- viewing the Inbox 100
- Google Accounts 80
- Google Dictionary 139
- Google Latitude 194
- Google Maps 189
- Google Talk 98
- Google Translate 139
- Groups 60

## H

---

- Home city 123
- Home page 135
- Home screen 20
  - adding folders 35
  - adding icons and shortcuts 35
  - adding widgets 33
  - changing the wallpaper 32
  - extended Home screen 21
  - personalizing with scenes 31
  - rearranging Home screen items 36
  - rearranging the home panels 37
- HTC Caller ID 45
- HTC Clock widget 121
- HTCSense.com 169
  - Dashboard 170
  - deleting 177
  - Footprints 172
  - HTC Hub 177
  - Messages 175
  - People 174
  - services 170
  - signing out 177
  - signing up 169
  - unpairing your phone 177
- HTC Sync 83

## I

---

- Internet connections 129
- Internet pass-through 25

## K

---

- Keyboard 63
  - adjusting touch input settings 69
  - changing to the landscape onscreen keyboard 65
  - enabling multiple keyboard languages 65

## L

---

- Latitude 194
- Leap view 21
- Library (Music) 163
- Linking contact information 54
- Live wallpapers 32
- Locations 178
  - Car Panel 186
  - downloading or purchasing services 188
  - Footprints 181
  - getting directions 183
  - searching 179
  - sharing a location 181
  - turn-by-turn navigation 184
  - viewing maps 180
  - widgets 188
- Location services 178
- Lock message 77
- Lock screen 30

## M

---

- Mail app
  - about 105
  - all accounts 106
  - checking email 106
  - deleting conversation 102
  - deleting email 108, 109
  - different views of inbox 107
  - Exchange ActiveSync 105, 111
  - marking unread 108
  - moving 108, 109
  - POP3/IMAP account 105
  - quick browsing 107
  - reading and replying 110
  - selecting email messages 108
  - sending 109
  - setting priority 110
  - settings 112
  - sorting 107
  - switching folders 109
  - unified inbox 106
- Making calls 41
- Managing memory 219
- Maps 189
- Matched contacts suggestions 54
- Media volume 29
- Meeting request 111

Memory 219  
 Merging contact information 54  
 Messages 71
 

- about the Messages app 71
- deleting a message 77
- protecting a message 77
- replying to a message 75
- resuming a draft message 74
- sending a multimedia message 73
- sending a text message 72
- settings 78
- viewing a message 75

 microSD card 12  
 Microsoft Exchange ActiveSync 105  
 Missed call 48  
 MMS 73
 

- attaching files and information 73
- creating a slideshow 74
- settings 79

 Mobile network connection 129  
 Modem 133  
 MP3 165  
 Music 162
 

- creating a playlist 163
- sharing 166

 Muting the microphone 47  
 My contact card
 

- creating 52
- sending your contact information 59

## N

---

Navigation 178, 184  
 News feeds 198  
 Notification icons 23  
 Notification sound 217  
 Notification sounds 39  
 Notifications panel 24

## O

---

Online accounts 80  
 Onscreen keyboard 64
 

- changing the layout 65

 Optimizing your phone's battery life 218

## P

---

Peep 92  
 People
 

- about 51
- contact information and conversations 58
- People screen 51
- People widget 62

 Personalizing 31  
 Phone
 

- front, top, left, and back panels 7
- phone dialer 41

 Photo
 

- sharing 152
- taking a photo 150

 Photo editing 156
 

- adding effects 157
- cropping 156
- rotating 156

 Photos
 

- commenting in your social networks 161
- editing 156
- sending by Bluetooth 158
- sending by email 157
- sending by MMS 158
- sharing on Facebook 158
- sharing on Flickr 159
- sharing on Picasa 160
- viewing 155
- viewing albums in social networks 161
- zooming in or out 156

 Pinch 17  
 Pocket mode 218  
 POP3/IMAP 105  
 Predictive text 66
 

- bilingual 66
- Personal dictionary 66

 PUK 212  
 Push messages 76

## Q

---

Quick keys 64  
 Quick Lookup 28  
 Quickoffice 201  
 Quiet ring on pickup 217

## R

---

- Recalibrating the G-sensor 216
- Recent apps 25
- Recording
  - video 151
- Recording your voice 205
- Rejecting an incoming call 44
- Restarting 222
- Ringer volume 29
- Ringtone 38, 165
  - trimming 165

## S

---

- Scenes 31
  - creating 32
  - deleting 32
  - renaming 32
- Screen lock
  - changing your screen lock 213
  - lock password 213
  - lock pattern 213
  - PIN 213
- Screen unlock pattern 213
- Search Anywhere 27
  - searching your phone and the Web 27
  - setting search options 27
- Searching for a contact 57
- Security 212
- Selecting text 139
- Self-timer (camera) 151
- Settings 214
  - alarm sound 125
  - calendar 120
  - camera 153
  - date and time 123
  - weather 127
- Setting up My contact card 52
- Setting up your phone for the first time 20
- Sharing
  - photo 152
  - video 152
  - YouTube 198
- Shortcuts 35
- SIM card 11
  - copying a message to 77
  - entering PIN 17
  - inserting 11

- removing 11
- restoring a SIM card that has been locked out 212
- SIM PIN 212
- SIM card PIN 17
- Skins 33
- Sleep mode 30
- Slideout keyboard 63
- Slideshow 74
- SMS
  - composing and sending 72
  - settings 79
- Social network accounts 81
- Social networks
  - sharing photo/video 152
- Sound sets
  - choosing a preset sound set 38
  - creating 38
  - customizing 38
  - deleting 39
- Speakerphone 47
- Speed dial 42
- Status icons 22
- Stocks 202
- Stopwatch 121
- Storage 219
- Storage card 12
  - copying files to or from 26
  - inserting 12
  - removing 13
- Street view 189
- Switching between calls 46
- Switching your phone on or off 17

## T

---

- Talk 98
- Tethering 133
- Text
  - copying 68
  - entering text by speaking 67
  - entering text using the onscreen keyboard 64
  - using predictive text input 66
- Timer 121
- Time zone 123
- Touch input settings 69
- Trackpad 18, 149
- Transfer Data 52

- Translating words 28
- Turning your phone on or off 17
- Tweeting on your phone 93
- Twitter 93
  - Twitter for HTC Sense 92
  - Twitter widget 94

## U

---

- Unblocking callers 49
- Uninstalling third-party applications 219
- Unlocking the screen 30
- Updating the phone software 221
- USB tethering 25
- Using your phone as a modem 133

## V

---

- vCalendar 118
- vCard 59
- Vibrate mode 29
- Video
  - capturing/recording 151
  - sharing 152
- Videos 197
  - sending by Bluetooth 158
  - sending by email 157
  - sending by MMS 158
  - sharing on Facebook 158
  - sharing on Flickr 159
  - sharing on YouTube 160
  - viewing 156
- Voice Recorder 205
- Volume
  - adjusting the earpiece volume for calls 29
  - adjusting the media volume 29
  - adjusting the ringer volume 29
  - adjusting via settings 29
- VPN 132

## W

---

- Wallpaper 32, 152
- Weather 126
- Weather widget 128
- Web browser 135
- Wi-Fi 130

- Widgets 33, 200, 203, 205
  - adding 33
  - changing the widget settings 34
- World Clock 123

## Y

---

- YouTube 160, 197
  - sharing video 152

## Z

---

- Zooming (camera) 149