

FCC RF Test Report

APPLICANT : HTC Corporation
EQUIPMENT : Pocket PC Phone
MODEL NAME : PB81120
FCC ID : NM8PB81120
STANDARD : FCC 47 CFR Part 2, 22(H), 24(E), 27(L)
CLASSIFICATION : PCS Licensed Transmitter Held to Ear (PCE)
Tx/Rx FREQUENCY RANGE : GSM850 : 824.2 ~ 848.8 MHz /
869.2 ~ 893.8 MHz
GSM1900 : 1850.2 ~ 1909.8 MHz /
1930.2 ~ 1989.8 MHz
WCDMA Band IV : 1712.4 MHz ~ 1752.6 MHz
2112.4 MHz ~ 2152.6 MHz
MAX. ERP/EIRP POWER : <Pocket PC Phone 1>
GSM850 (GSM) : 0.37 W
GSM850 (EDGE 8) : 0.16 W
GSM1900 (GSM) : 0.88 W
GSM1900 (EDGE 12) : 0.67 W
WCDMA Band IV (HSDPA) : 0.22 W
<Pocket PC Phone 2>
GSM850 (GSM) : 0.44 W
GSM850 (EDGE 8) : 0.22 W
GSM1900 (GSM) : 0.64 W
GSM1900 (EDGE 12) : 0.51 W
WCDMA Band IV (HSDPA) : 0.39 W
EMISSION DESIGNATOR : GMSK : 248KGXW
8PSK : 246KG7W
QPSK : 4M18F9W

The product was received on Nov. 20, 2009 and completely tested on Dec. 14, 2009. We, SPORTON INTERNATIONAL INC., would like to declare that the tested sample has been evaluated in accordance with the procedures given in ANSI / TIA / EIA-603-C-2004 and shown compliance with the applicable technical standards.

The test results in this report apply exclusively to the tested model / sample. Without written approval of SPORTON INTERNATIONAL INC., the test report shall not be reproduced except in full.

Reviewed by:

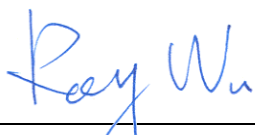

Roy Wu / Manager



SPORTON INTERNATIONAL INC.

No. 52, Hwa Ya 1st Rd., Hwa Ya Technology Park, Kwei-Shan Hsiang, Tao Yuan Hsien, Taiwan, R.O.C.

SPORTON INTERNATIONAL INC.

TEL : 886-3-327-3456

FAX : 886-3-328-4978

FCC ID : NM8PB81120

Page Number : 1 of 70

Report Issued Date : Jan. 05, 2010

Report Version : Rev. 01



TABLE OF CONTENTS

REVISION HISTORY..... 3
SUMMARY OF TEST RESULT 4
1 GENERAL DESCRIPTION 5
1.1 Applicant..... 5
1.2 Manufacturer 5
1.3 Feature of Equipment Under Test..... 6
1.4 Testing Site..... 7
1.5 Applied Standards 7
1.6 Ancillary Equipment List 7
2 TEST CONFIGURATION OF EQUIPMENT UNDER TEST 8
2.1 Test Mode..... 8
2.2 Connection Diagram of Test System 10
3 TEST RESULT 11
3.1 Conducted Output Power Measurement 11
3.2 Effective Radiated Power and Effective Isotropic Radiated Power Measurement 13
3.3 Occupied Bandwidth Measurement 20
3.4 Band Edge Measurement..... 26
3.5 Conducted Emission Measurement 32
3.6 Field Strength of Spurious Radiation Measurement 46
3.7 Frequency Stability Measurement..... 64
4 LIST OF MEASURING EQUIPMENTS..... 68
5 UNCERTAINTY OF EVALUATION 69
6 CERTIFICATION OF TAF ACCREDITATION 70
APPENDIX A. PHOTOGRAPHS OF EUT
APPENDIX B. SETUP PHOTOGRAPHS



SUMMARY OF TEST RESULT

Report Section	FCC Rule	IC Rule	Description	Limit	Result	Remark
3.1	§2.1046	N/A	Conducted Output Power	N/A	PASS	
3.2	§22.913(a)(2)	RSS-132(4.4) SRSP-503(5.1.3)	Effective Radiated Power	< 7 Watts	PASS	-
3.2	§24.232(c)	RSS-133 (6.4) SRSP-510(5.1.2)	Equivalent Isotropic Radiated Power	< 2 Watts	PASS	-
3.2	§27.50(d)(2)	RSS-139 (6.4) SRSP-513(5.1.2)	Equivalent Isotropic Radiated Power	< 1 Watts	PASS	-
3.3	§2.1049 §22.917(a) §24.238(a) §27.53(g)	N/A	Occupied Bandwidth	N/A	PASS	-
3.4	§2.1051 §22.917(a) §24.238(a) §27.53(g)	RSS-132 (4.5.1) RSS-133 (6.5.1) RSS-139 (6.5)	Band Edge Measurement	< 43+10log ₁₀ (P[Watts])	PASS	-
3.5	§2.1051 §22.917(a) §24.238(a) §27.53(g)	RSS-132 (4.5.1) RSS-133 (6.5.1) RSS-139 (6.5)	Conducted Emission	< 43+10log ₁₀ (P[Watts])	PASS	-
3.6	§2.1053 §22.917(a) §24.238(a) §27.53(g)	RSS-132 (4.5.1) RSS-133 (6.5.1) RSS-139 (6.5)	Field Strength of Spurious Radiation	< 43+10log ₁₀ (P[Watts])	PASS	Under limit 20.61 dB at 13156 MHz
3.7	§2.1055 §22.355 §24.235 §27.54	RSS-132 (4.3) RSS-133 (6.3) RSS-139 (6.3)	Frequency Stability for Temperature & Voltage	< 2.5 ppm	PASS	-



1 General Description

1.1 Applicant

HTC Corporation

No. 23, Xinghua Rd., Taoyuan 330, Taiwan

1.2 Manufacturer

HTC Corporation

No. 23, Xinghua Rd., Taoyuan 330, Taiwan

1.3 Feature of Equipment Under Test

Product Feature & Specification	
Equipment	Pocket PC Phone
Model Name	PB81120
FCC ID	NM8PB81120
Pocket PC Phone 1	EUT with LCD Panel 1 + Camera 1
Pocket PC Phone 2	EUT with LCD Panel 2 + Camera 2
Tx Frequency	GSM850 : 824 MHz ~ 849 MHz GSM1900 : 1850 MHz ~ 1910 MHz WCDMA Band IV : 1710 MHz ~ 1755 MHz
Rx Frequency	GSM850 : 869 MHz ~ 894 MHz GSM1900 : 1930 MHz ~ 1990 MHz WCDMA Band IV : 2110 MHz ~ 2155 MHz
Maximum Output Power to Antenna	GSM850 : 32.80 dBm GSM1900 : 29.71 dBm WCDMA Band IV : 22.78 dBm
Maximum ERP/EIRP	<p><Pocket PC Phone 1> GSM850 (GSM) : 0.37 W (25.68 dBm) GSM850 (EDGE 8) : 0.16 W (22.17 dBm) GSM1900 (GSM) : 0.88 W (29.46 dBm) GSM1900 (EDGE 12) : 0.67 W (28.25 dBm) WCDMA Band IV (HSDPA) : 0.22 W (23.38 dBm)</p> <p><Pocket PC Phone 2> GSM850 (GSM) : 0.44 W (26.45 dBm) GSM850 (EDGE 8) : 0.22 W (23.42 dBm) GSM1900 (GSM) : 0.64 W (28.04 dBm) GSM1900 (EDGE 12) : 0.51 W (27.11 dBm) WCDMA Band IV (HSDPA) : 0.39 W (25.89 dBm)</p>
Antenna Type	Fixed Internal Antenna
Type of Modulation	GSM / GPRS : GMSK EDGE : 8PSK WCDMA : QPSK HSDPA : QPSK / 16QAM HSUPA : BPSK
Type of Emission	GMSK : 248KGXW 8PSK : 246KG7W QPSK : 4M18F9W
EUT Stage	Identical Prototype

1.4 Testing Site

Test Site	SPORTON INTERNATIONAL INC.		
Test Site Location	No. 52, Hwa Ya 1 st Rd., Hwa Ya Technology Park, Kwei-Shan Hsiang, Tao Yuan Hsien, Taiwan, R.O.C. TEL: +886-3-327-3456 FAX: +886-3-328-4978		
Test Site No.	Sporton Site No.		FCC/IC Registration No.
	TH02-HY	03CH07-HY	TW1022/4086B-1

1.5 Applied Standards

According to the specifications of the manufacturer, the EUT must comply with the requirements of the following standards:

- ♦ Preliminary Guidance for Receiving Applications for Certification of 3G Device. May 9, 2006.
- ♦ 47 CFR Part 2, 22(H), 24(E), 27(L)
- ♦ ANSI / TIA / EIA-603-C-2004
- ♦ IC RSS-132 Issue 2
- ♦ IC RSS-133 Issue 5
- ♦ IC RSS-139 Issue 2

Remark:

1. All test items were verified and recorded according to the standards and without any deviation during the test.
2. This EUT has also been tested and complied with the requirements of FCC Part 15, Subpart B (DoC), recorded in a separate test report.

1.6 Ancillary Equipment List

Item	Equipment	Trade Name	Model No.	FCC ID	Data Cable	Power Cord
1.	System Simulator	R&S	CMU200	N/A	N/A	Unshielded, 1.8 m

2 Test Configuration of Equipment Under Test

2.1 Test Mode

During all testing, EUT is in link mode with base station emulator at maximum power level. The spurious emission measurements were carried out in semi-anechoic chamber with 3-meter test range, and EUT is rotated on three test planes to find out the worst emission.

Frequency range investigated for radiated emission is as follows:

1. 30 MHz to 9000 MHz for GSM850.
2. 30 MHz to 18000 MHz for WCDMA Band IV.
3. 30 MHz to 19000 MHz for GSM1900.

Test Modes		
Band	Radiated TCs	Conducted TCs
GSM 850	<ul style="list-style-type: none"> ■ GSM Link for Pocket PC Phone 1 ■ GSM Link for Pocket PC Phone 2 ■ EDGE 8 Link for Pocket PC Phone 1 	<ul style="list-style-type: none"> ■ GSM Link ■ EDGE 8 Link
GSM 1900	<ul style="list-style-type: none"> ■ GSM Link for Pocket PC Phone 1 ■ GSM Link for Pocket PC Phone 2 ■ EDGE 12 Link for Pocket PC Phone 1 	<ul style="list-style-type: none"> ■ GSM Link ■ EDGE 12 Link
WCDMA Band IV	<ul style="list-style-type: none"> ■ HSDPA Link for Pocket PC Phone 1 ■ HSDPA Link for Pocket PC Phone 2 	<ul style="list-style-type: none"> ■ HSDPA Link

Note:

1. The maximum power levels are GSM mode for GMSK link, EDGE multi-slot class 8 mode for 8PSK link for GSM850, EDGE multi-slot class 12 mode for 8PSK link for GSM1900, and HSDPA mode for WCDMA band IV, only these modes were used for all tests.
2. Because there are individual antennas for each WWAN and WLAN, the co-location test modes are not required.



The conducted power tables are as follows:

Conducted Power (*Unit: dBm)						
Band	GSM850			GSM1900		
Channel	128	189	251	512	661	810
Frequency	824.2	836.4	848.8	1850.2	1880	1909.8
GSM	32.64	32.73	32.80	29.71	29.60	29.53
GPRS 8	32.58	32.67	32.74	29.71	29.60	29.53
GPRS 10	32.52	32.60	32.63	29.68	29.55	29.48
GPRS 12	30.95	31.01	31.06	28.05	27.95	27.87
EGPRS 8	26.41	26.48	26.53	24.44	24.30	24.22
EGPRS 10	25.35	25.20	25.25	24.25	24.10	24.01
EGPRS 12	25.31	25.37	25.67	25.51	25.38	25.31

Conducted Power (*Unit: dBm)			
Band	WCDMA Band IV		
Tx Channel	1312	1413	1513
Rx Channel	1537	1638	1738
Frequency	1712.4	1732.6	1752.6
RMC 12.2K	22.43	22.31	22.76
HSDPA Subtest-1	22.27	22.03	22.71
HSDPA Subtest-2	22.21	22.03	22.78
HSDPA Subtest-3	21.10	20.95	21.58
HSDPA Subtest-4	21.16	21.00	21.57
HSUPA Subtest-1	22.01	22.02	22.18
HSUPA Subtest-2	19.90	20.35	20.43
HSUPA Subtest-3	20.86	20.55	21.21
HSUPA Subtest-4	20.80	20.86	21.40
HSUPA Subtest-5	22.22	22.05	22.27

2.2 Connection Diagram of Test System

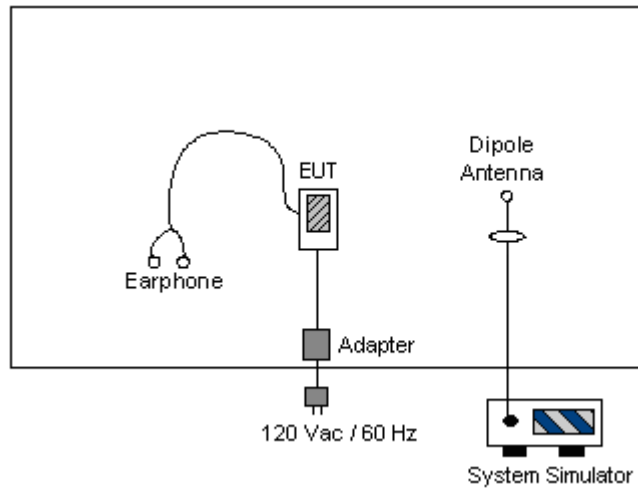

3 Test Result

3.1 Conducted Output Power Measurement

3.1.1 Description of the Conducted Output Power Measurement

A base station simulator was used to establish communication with the EUT. Its parameters were set to transmit the maximum power on the EUT. The measured power in the radio frequency on the transmitter output terminals shall be reported.

3.1.2 Measuring Instruments

See list of measuring instruments of this test report.

3.1.3 Test Procedures

1. The transmitter output port was connected to base station.
2. Set EUT at maximum power through base station.
3. Select lowest, middle, and highest channels for each band and different modulation.

3.1.4 Test Setup

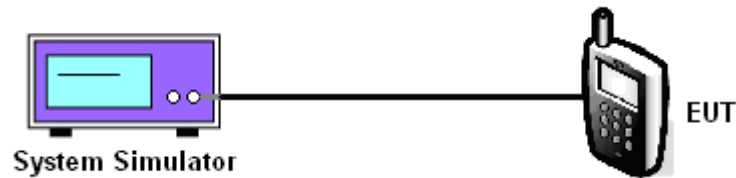



3.1.5 Test Result of Conducted Output Power

Cellular Band				
Modes	Channel	Frequency (MHz)	Conducted Power (dBm)	Conducted Power (Watts)
GSM850 (GSM)	128 (Low)	824.2	32.64	1.84
	189 (Mid)	836.4	32.73	1.87
	251 (High)	848.8	32.80	1.91
GSM820 (EDGE 8)	128 (Low)	824.2	26.41	0.44
	189 (Mid)	836.4	26.48	0.44
	251 (High)	848.8	26.53	0.45

PCS Band				
Modes	Channel	Frequency (MHz)	Conducted Power (dBm)	Conducted Power (Watts)
GSM1900 (GSM)	512 (Low)	1850.2	29.71	0.94
	661 (Mid)	1880.0	29.60	0.91
	810 (High)	1909.8	29.53	0.90
GSM1900 (EDGE 12)	512 (Low)	1850.2	25.51	0.36
	661 (Mid)	1880.0	25.38	0.35
	810 (High)	1909.8	25.31	0.34

AWS Band				
Modes	Channel	Frequency (MHz)	Conducted Power (dBm)	Conducted Power (Watts)
WCDMA Band IV (HSDPA)	1312 (Low)	1712.4	22.21	0.17
	1413 (Mid)	1732.6	22.03	0.16
	1513 (High)	1752.6	22.78	0.19

3.2 Effective Radiated Power and Effective Isotropic Radiated Power Measurement

3.2.1 Description of the ERP/EIRP Measurement

ERP/EIRP is measured by substitution method according to ANSI / TIA / EIA-603-C-2004. The ERP of mobile transmitters must not exceed 7 Watts. The EIRP of mobile transmitters are limited to 2 Watts for 1850~1910 MHz and 1 watt for 1710~1755 MHz.

3.2.2 Measuring Instruments

See list of measuring instruments of this test report.

3.2.3 Test Procedures

1. The EUT was placed on an non-conductive rotating platform with 0.8 meter height in a semi-anechoic chamber. The radiated emission at the fundamental frequency was measured at 3 m with a test antenna and a spectrum analyzer with RBW= 3MHz,VBW= 3MHz, and peak detector settings.
2. During the measurement, the EUT was enforced in maximum power and linked with a base station. The highest emission was recorded from analyzer power level (LVL) from the 360 degrees rotation of the turntable and the test antenna raised and lowered over a range from 1 to 4 meters in both horizontally and vertically polarized orientations.
3. Effective Isotropic Radiated Power (EIRP) was measured by substitution method according to TIA/EIA-603-C. The EUT was replaced by dipole antenna (substitution antenna) at same location, and then a known power from S.G. was applied into the dipole antenna through a Tx cable, and then recorded the maximum Analyzer reading through raised and lowered the test antenna. The correction factor (in dB) = S.G. - Tx Cable loss + Substitution antenna gain - Analyzer reading. Then the EUT's EIRP was calculated with the correction factor, $EIRP = LVL + \text{Correction factor}$ and $ERP = EIRP - 2.15$.

3.2.4 Test Setup

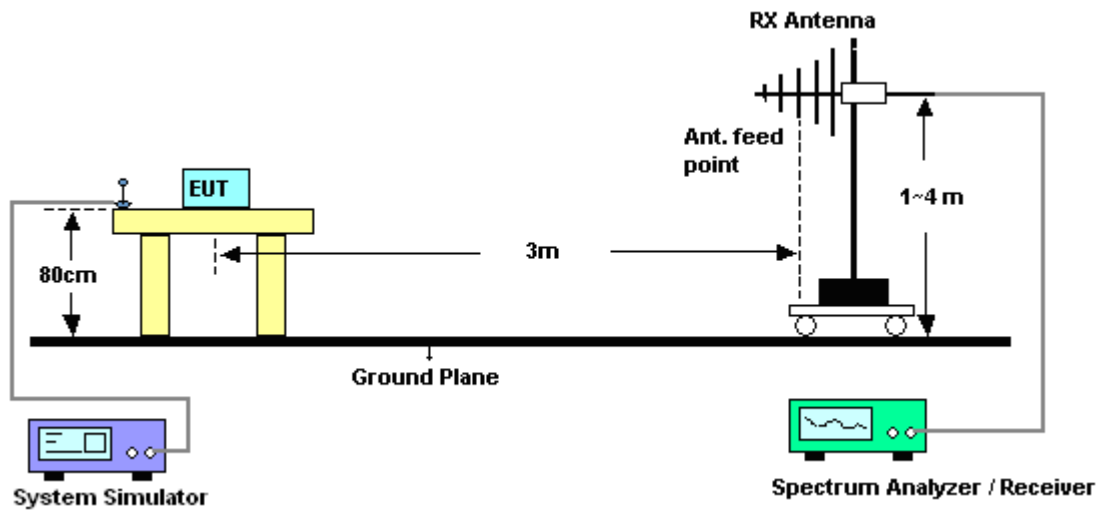

3.2.5 Test Result of ERP

GSM850 (GSM) Radiated Power ERP for Pocket PC Phone 1				
Horizontal Polarization				
Frequency (MHz)	LVL (dBm)	Correction Factor (dB)	ERP (dBm)	ERP (W)
824.2	-4.59	32.04	25.30	0.34
836.4	-5.08	32.91	25.68	0.37
848.8	-5.52	32.84	25.17	0.33
Vertical Polarization				
Frequency (MHz)	LVL (dBm)	Correction Factor (dB)	ERP (dBm)	ERP (W)
824.2	-10.49	36.10	23.46	0.22
836.4	-10.61	34.41	21.65	0.15
848.8	-10.95	34.65	21.55	0.14

* ERP = LVL (dBm) + Correction Factor (dB) – 2.15

GSM850 (EDGE 8) Radiated Power ERP for Pocket PC Phone 1				
Horizontal Polarization				
Frequency (MHz)	LVL (dBm)	Correction Factor (dB)	ERP (dBm)	ERP (W)
824.2	-7.81	32.04	22.08	0.16
836.4	-8.59	32.91	22.17	0.16
848.8	-8.93	32.84	21.76	0.15
Vertical Polarization				
Frequency (MHz)	LVL (dBm)	Correction Factor (dB)	ERP (dBm)	ERP (W)
824.2	-13.96	36.10	19.99	0.10
836.4	-14.22	34.41	18.04	0.06
848.8	-14.48	34.65	18.02	0.06

* ERP = LVL (dBm) + Correction Factor (dB) – 2.15



GSM850 (GSM) Radiated Power ERP for Pocket PC Phone 2				
Horizontal Polarization				
Frequency (MHz)	LVL (dBm)	Correction Factor (dB)	ERP (dBm)	ERP (W)
824.2	-3.44	32.04	26.45	0.44
836.4	-4.43	32.91	26.33	0.43
848.8	-5.28	32.84	25.41	0.35
Vertical Polarization				
Frequency (MHz)	LVL (dBm)	Correction Factor (dB)	ERP (dBm)	ERP (W)
824.2	-10.30	36.10	23.65	0.23
836.4	-9.84	34.41	22.42	0.17
848.8	-10.13	34.65	22.37	0.17

* ERP = LVL (dBm) + Correction Factor (dB) – 2.15

GSM850 (EDGE 8) Radiated Power ERP for Pocket PC Phone 2				
Horizontal Polarization				
Frequency (MHz)	LVL (dBm)	Correction Factor (dB)	ERP (dBm)	ERP (W)
824.2	-7.11	32.04	22.78	0.19
836.4	-7.34	32.91	23.42	0.22
848.8	-8.21	32.84	22.48	0.18
Vertical Polarization				
Frequency (MHz)	LVL (dBm)	Correction Factor (dB)	ERP (dBm)	ERP (W)
824.2	-13.66	36.10	20.29	0.11
836.4	-13.22	34.41	19.04	0.08
848.8	-13.93	34.65	18.57	0.07

* ERP = LVL (dBm) + Correction Factor (dB) – 2.15



3.2.6 Test Result of EIRP

GSM1900 (GSM) Radiated Power EIRP for Pocket PC Phone 1				
Horizontal Polarization				
Frequency (MHz)	LVL (dBm)	Correction Factor (dB)	EIRP (dBm)	EIRP (W)
1850.2	-13.59	41.24	27.65	0.58
1880.0	-15.61	41.46	25.85	0.38
1909.8	-16.06	41.21	25.15	0.33
Vertical Polarization				
Frequency (MHz)	LVL (dBm)	Correction Factor (dB)	EIRP (dBm)	EIRP (W)
1850.2	-12.06	41.52	29.46	0.88
1880.0	-13.92	43.10	29.18	0.83
1909.8	-15.24	42.73	27.49	0.56

* EIRP = LVL (dBm) + Correction Factor (dB)

GSM1900 (EDGE 12) Radiated Power EIRP for Pocket PC Phone 1				
Horizontal Polarization				
Frequency (MHz)	LVL (dBm)	Correction Factor (dB)	EIRP (dBm)	EIRP (W)
1850.2	-14.54	41.24	26.70	0.47
1880.0	-16.65	41.46	24.81	0.30
1909.8	-16.92	41.21	24.29	0.27
Vertical Polarization				
Frequency (MHz)	LVL (dBm)	Correction Factor (dB)	EIRP (dBm)	EIRP (W)
1850.2	-13.27	41.52	28.25	0.67
1880.0	-15.30	43.10	27.80	0.60
1909.8	-16.31	42.73	26.42	0.44

* EIRP = LVL (dBm) + Correction Factor (dB)



GSM1900 (GSM) Radiated Power EIRP for Pocket PC Phone 2				
Horizontal Polarization				
Frequency (MHz)	LVL (dBm)	Correction Factor (dB)	EIRP (dBm)	EIRP (W)
1850.2	-14.11	41.24	27.13	0.52
1880.0	-15.29	41.46	26.17	0.41
1909.8	-15.41	41.21	25.80	0.38
Vertical Polarization				
Frequency (MHz)	LVL (dBm)	Correction Factor (dB)	EIRP (dBm)	EIRP (W)
1850.2	-13.48	41.52	28.04	0.64
1880.0	-16.06	43.10	27.04	0.51
1909.8	-15.68	42.73	27.05	0.51

* EIRP = LVL (dBm) + Correction Factor (dB)

GSM1900 (EDGE 12) Radiated Power EIRP for Pocket PC Phone 2				
Horizontal Polarization				
Frequency (MHz)	LVL (dBm)	Correction Factor (dB)	EIRP (dBm)	EIRP (W)
1850.2	-14.18	41.24	27.06	0.51
1880.0	-15.72	41.46	25.74	0.37
1909.8	-16.41	41.21	24.80	0.30
Vertical Polarization				
Frequency (MHz)	LVL (dBm)	Correction Factor (dB)	EIRP (dBm)	EIRP (W)
1850.2	-14.41	41.52	27.11	0.51
1880.0	-16.90	43.10	26.20	0.42
1909.8	-17.26	42.73	25.47	0.35

* EIRP = LVL (dBm) + Correction Factor (dB)



WCDMA Band IV (HSDPA) Radiated Power EIRP for Pocket PC Phone 1				
Horizontal Polarization				
Frequency (MHz)	LVL (dBm)	Correction Factor (dB)	EIRP (dBm)	EIRP (W)
1712.4	-19.61	39.24	19.63	0.09
1732.6	-18.70	40.25	21.55	0.14
1752.6	-21.04	40.31	19.27	0.08
Vertical Polarization				
Frequency (MHz)	LVL (dBm)	Correction Factor (dB)	EIRP (dBm)	EIRP (W)
1712.4	-20.73	44.11	23.38	0.22
1732.6	-20.22	42.66	22.44	0.18
1752.6	-19.02	41.70	22.68	0.19

* EIRP = LVL (dBm) + Correction Factor (dB)

WCDMA Band IV (HSDPA) Radiated Power EIRP for Pocket PC Phone 2				
Horizontal Polarization				
Frequency (MHz)	LVL (dBm)	Correction Factor (dB)	EIRP (dBm)	EIRP (W)
1712.4	-23.44	39.24	15.80	0.04
1732.6	-24.66	40.25	15.59	0.04
1752.6	-20.67	40.31	19.64	0.09
Vertical Polarization				
Frequency (MHz)	LVL (dBm)	Correction Factor (dB)	EIRP (dBm)	EIRP (W)
1712.4	-18.22	44.11	25.89	0.39
1732.6	-17.52	42.66	25.14	0.33
1752.6	-16.79	41.70	24.91	0.31

* EIRP = LVL (dBm) + Correction Factor (dB)

3.3 Occupied Bandwidth Measurement

3.3.1 Description of Occupied Bandwidth Measurement

The emission bandwidth is defined as the width of the signal between two points, located at the 2 sides of the carrier frequency, outside of which all emissions are attenuated at least 26 dB below the transmitter power.

3.3.2 Measuring Instruments

See list of measuring instruments of this test report.

3.3.3 Test Procedures

1. The EUT was connected to Spectrum Analyzer and Base Station via power divider.
2. The 99% and 26 dB occupied bandwidth (BW) of the middle channel for the highest RF powers were measured.

3.3.4 Test Setup

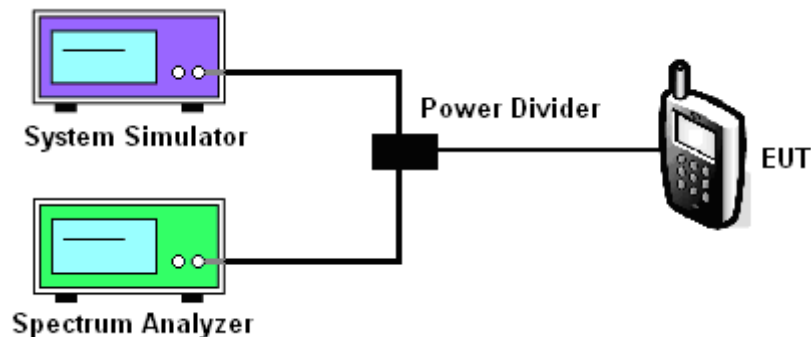

3.3.5 Test Result (Plots) of Occupied Bandwidth

Band :	GSM 850	Power Stage :	High
Test Mode :	GSM Link		

99% Occupied Bandwidth Plot on Channel 189

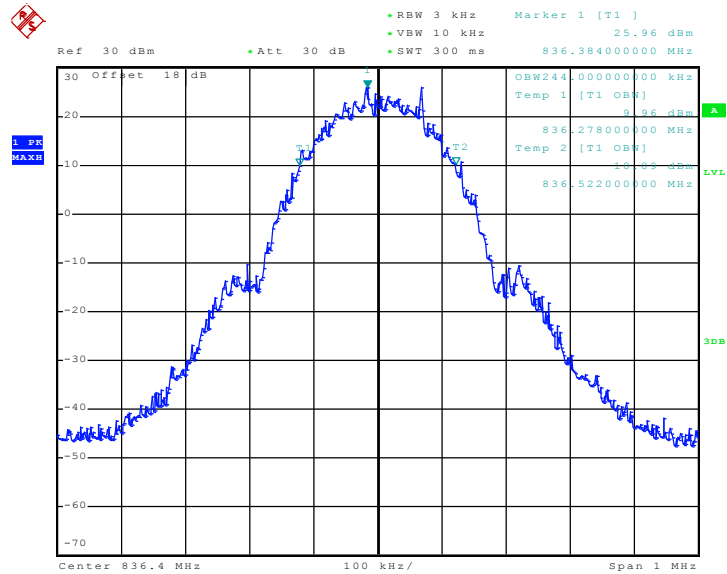

Date: 26.NOV.2009 08:36:05

26dB Bandwidth Plot on Channel 189

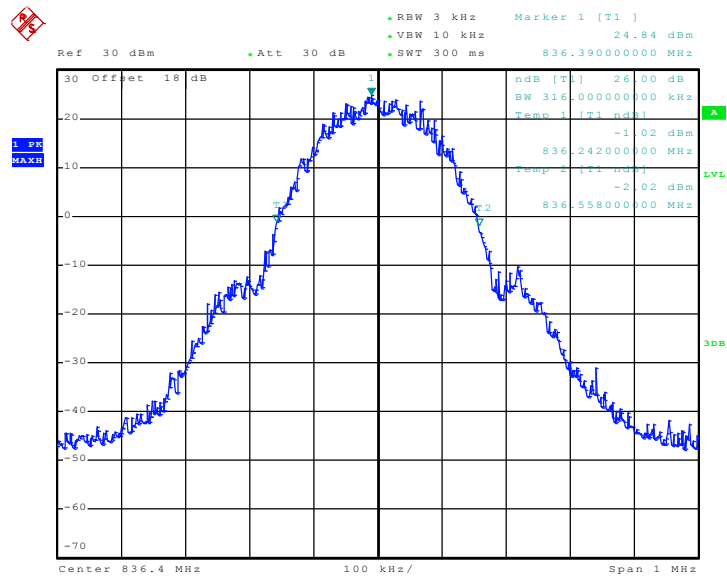

Date: 26.NOV.2009 08:33:09



Band :	GSM 850	Power Stage :	High
Test Mode :	EDGE 8 Link		

99% Occupied Bandwidth Plot on Channel 189

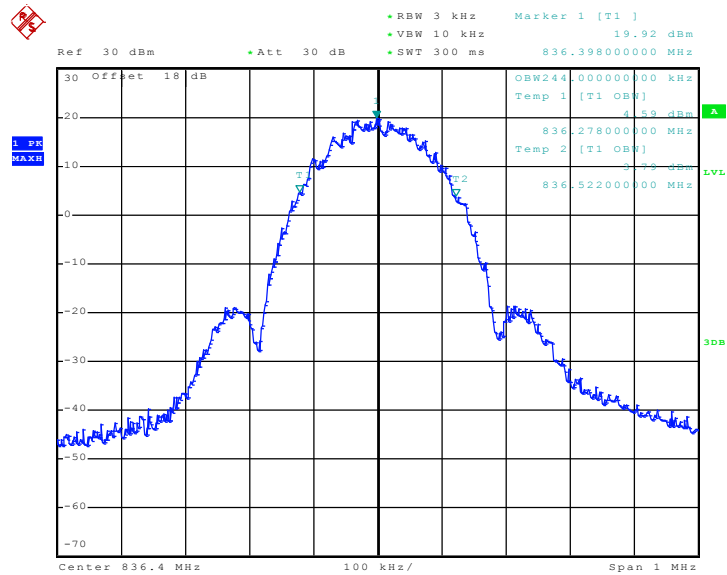

Date: 26.NOV.2009 09:00:59

26dB Bandwidth Plot on Channel 189

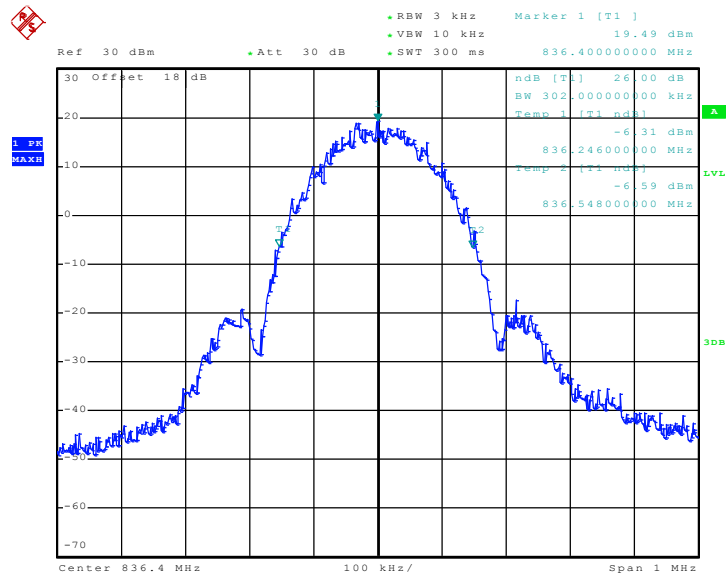

Date: 26.NOV.2009 08:50:41



Band :	GSM 1900	Power Stage :	High
Test Mode :	GSM Link		

99% Occupied Bandwidth Plot on Channel 661

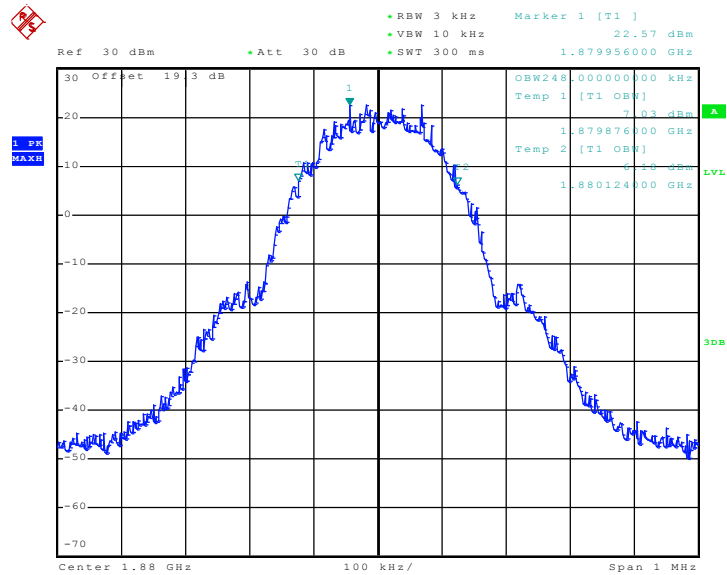

Date: 26.NOV.2009 10:05:10

26dB Bandwidth Plot on Channel 661

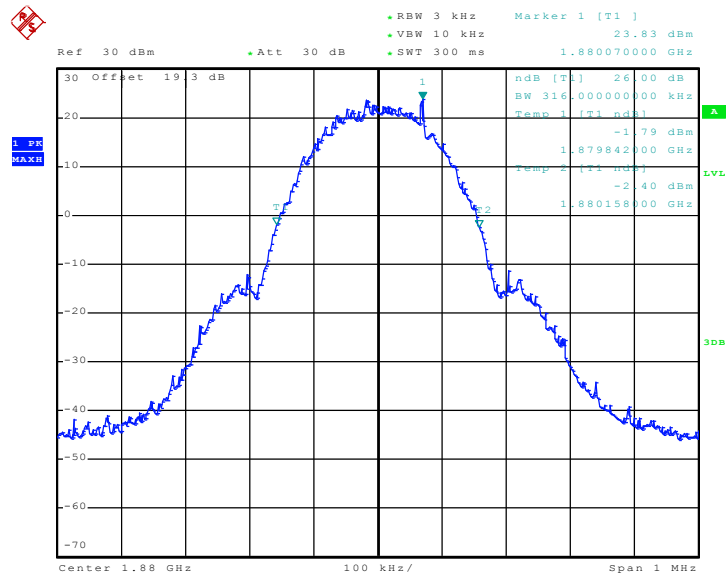

Date: 26.NOV.2009 09:56:18



Band :	GSM 1900	Power Stage :	High
Test Mode :	EDGE 12 Link		

99% Occupied Bandwidth Plot on Channel 661

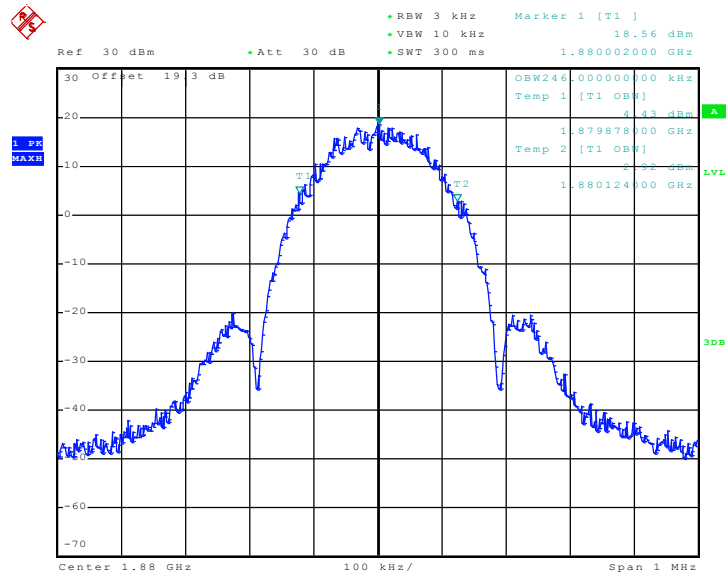

Date: 26.NOV.2009 10:35:03

26dB Bandwidth Plot on Channel 661

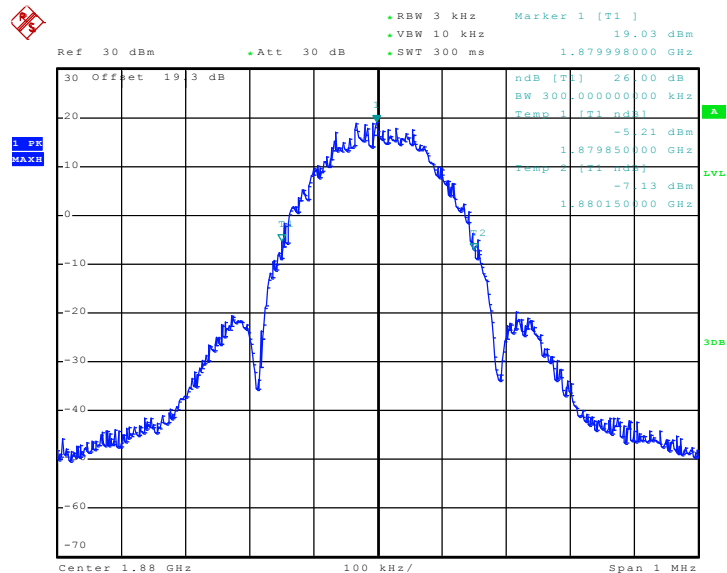

Date: 26.NOV.2009 10:31:51



Band :	WCDMA Band IV	Power Stage :	High
Test Mode :	HSDPA Link		

99% Occupied Bandwidth Plot on Channel 1413

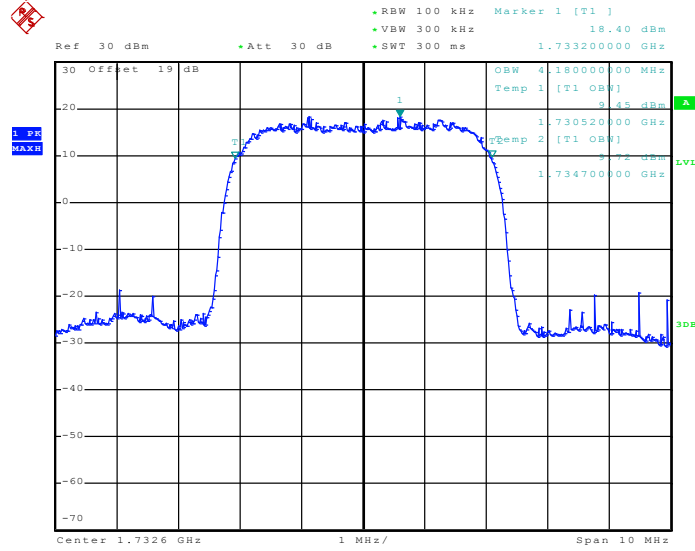

Date: 26.NOV.2009 11:07:18

26dB Bandwidth Plot on Channel 1413

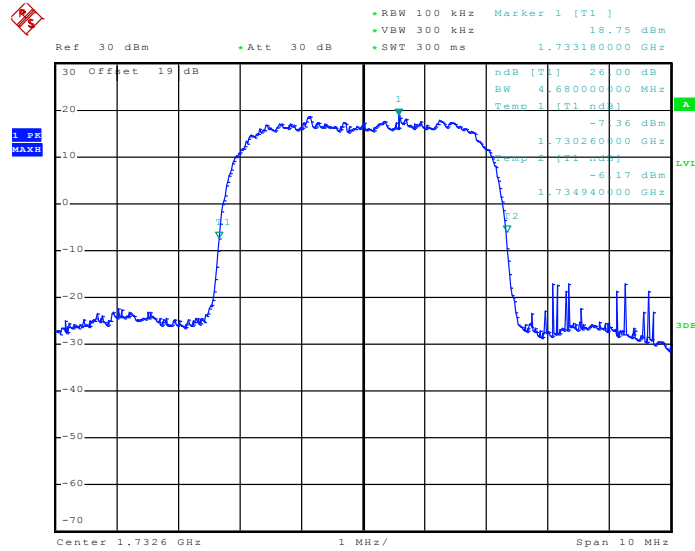

Date: 26.NOV.2009 12:47:57

3.4 Band Edge Measurement

3.4.1 Description of Band Edge Measurement

The power of any emission outside of the authorized operating frequency ranges must be lower than the transmitter power (P) by a factor of at least $43 + 10 \log (P)$ dB.

3.4.2 Measuring Instruments

See list of measuring instruments of this test report.

3.4.3 Test Procedures

1. The EUT was connected to Spectrum Analyzer and Base Station via power divider.
2. The band edges of low and high channels for the highest RF powers were measured. Setting RBW as roughly BW/100.

3.4.4 Test Setup

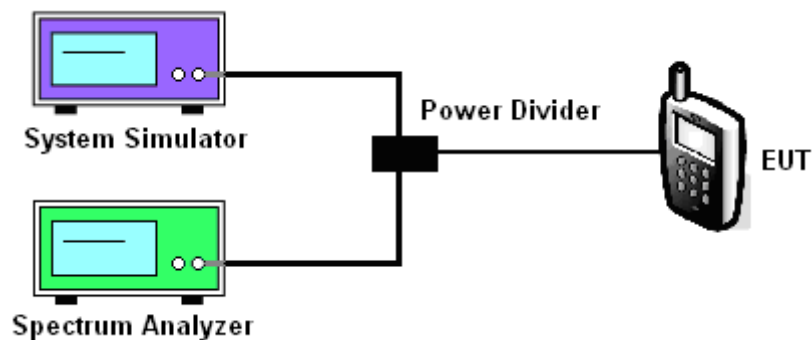



3.4.5 Test Result (Plots) of Conducted Band Edge

Band :	GSM850	Power Stage :	High
Test Mode :	GSM Link		

Lower Band Edge Plot on Channel 128

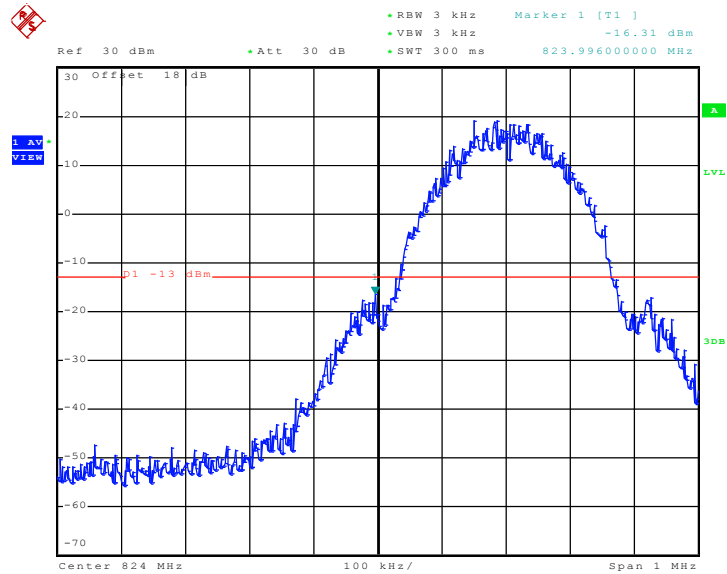

Date: 26.NOV.2009 08:39:00

Higher Band Edge Plot on Channel 251

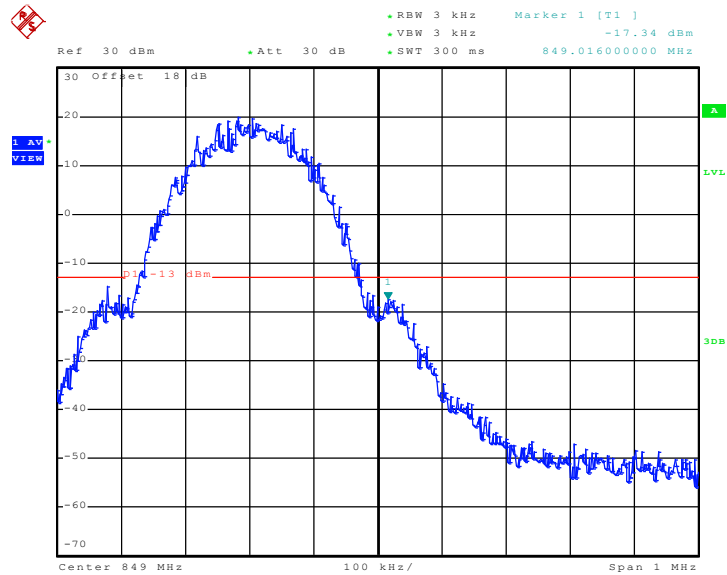

Date: 26.NOV.2009 08:42:03



Band :	GSM850	Power Stage :	High
Test Mode :	EDGE 8 Link		

Lower Band Edge Plot on Channel 128

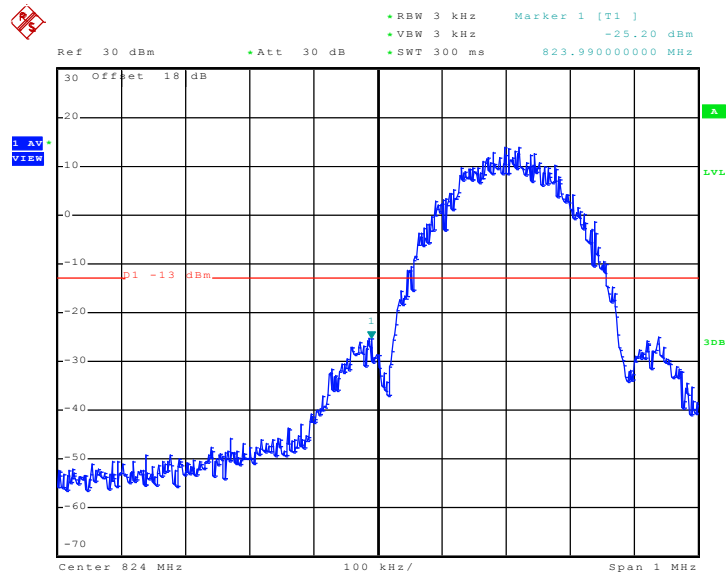

Date: 26.NOV.2009 08:49:13

Higher Band Edge Plot on Channel 251

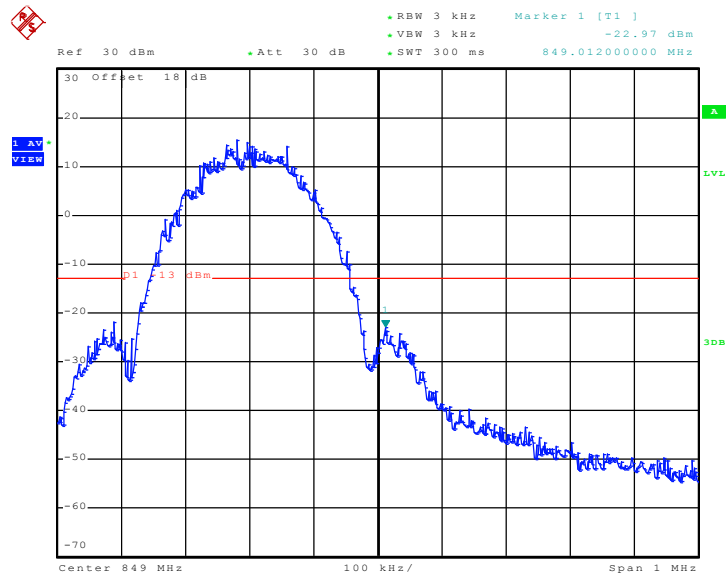

Date: 26.NOV.2009 08:45:29



Band :	GSM1900	Power Stage :	High
Test Mode :	GSM Link		

Lower Band Edge Plot on Channel 512

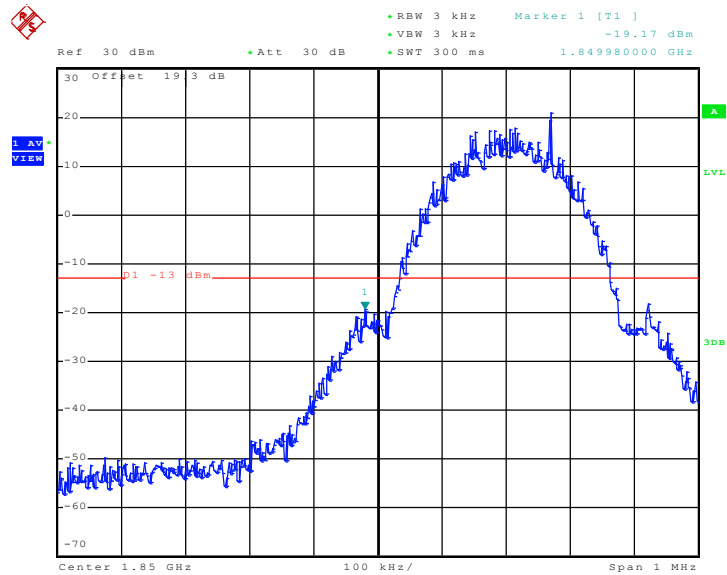

Date: 26.NOV.2009 10:07:13

Higher Band Edge Plot on Channel 810

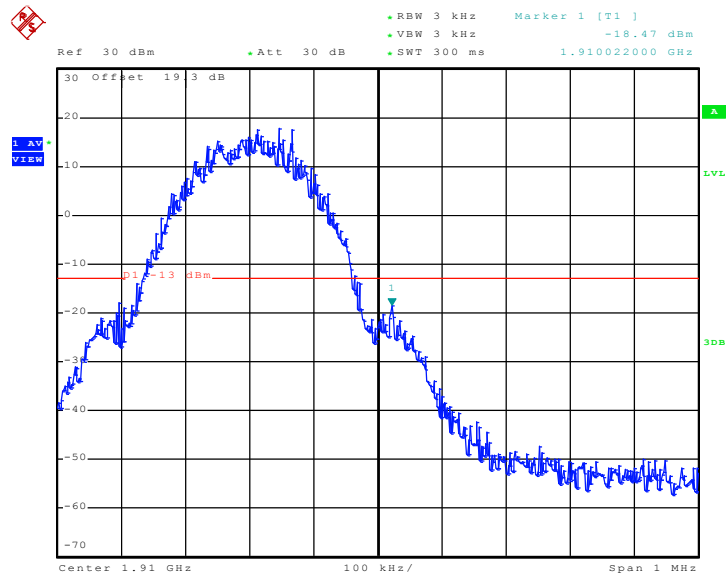

Date: 26.NOV.2009 10:14:48



Band :	GSM1900	Power Stage :	High
Test Mode :	EDGE 12 Link		

Lower Band Edge Plot on Channel 512

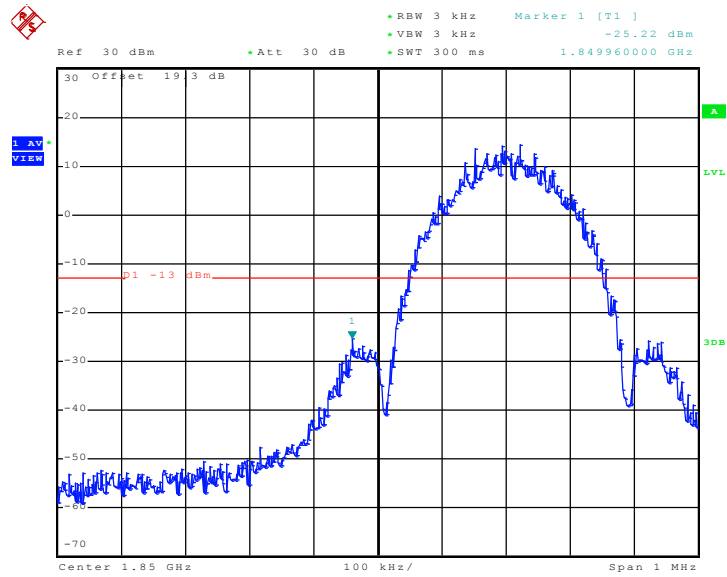

Date: 26.NOV.2009 10:25:03

Higher Band Edge Plot on Channel 810

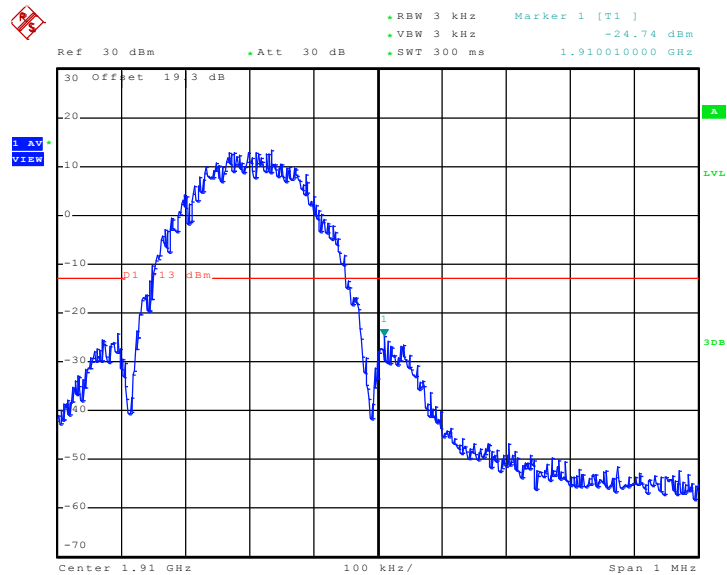

Date: 26.NOV.2009 10:22:52



Band :	WCDMA Band IV	Power Stage :	High
Test Mode :	HSDPA Link		

Lower Band Edge Plot on Channel 1312

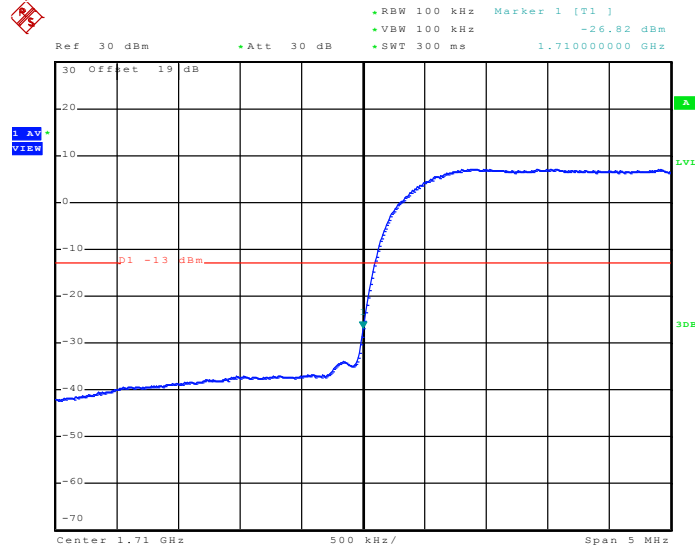

Date: 26.NOV.2009 12:50:06

Higher Band Edge Plot on Channel 1513

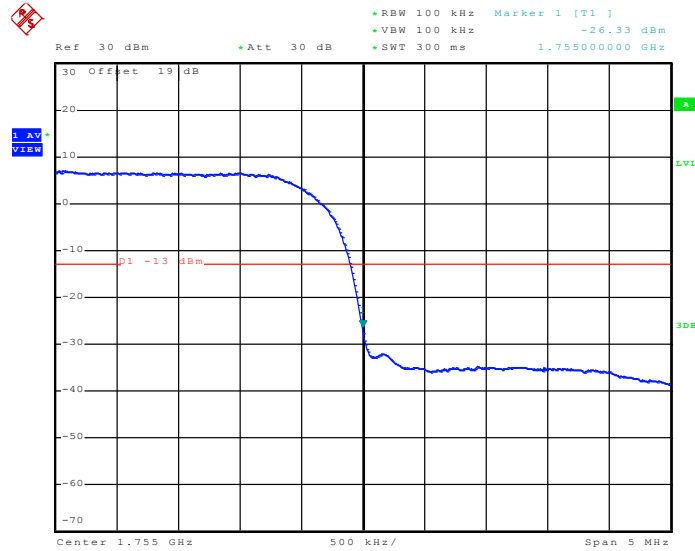

Date: 26.NOV.2009 12:52:04

3.5 Conducted Emission Measurement

3.5.1 Description of Conducted Emission Measurement

The power of any emission outside of the authorized operating frequency ranges must be lower than the transmitter power (P) by a factor of at least $43 + 10 \log (P)$ dB.

It is measured by means of a calibrated spectrum analyzer and scanned from 30 MHz up to a frequency including its 10th harmonic.

3.5.2 Measuring Instruments

See list of measuring instruments of this test report.

3.5.3 Test Procedures

3. The EUT was connected to spectrum analyzer and base station via power divider.
4. The middle channel for the highest RF power within the transmitting frequency was measured.
5. The conducted spurious emission for the whole frequency range was taken.

3.5.4 Test Setup

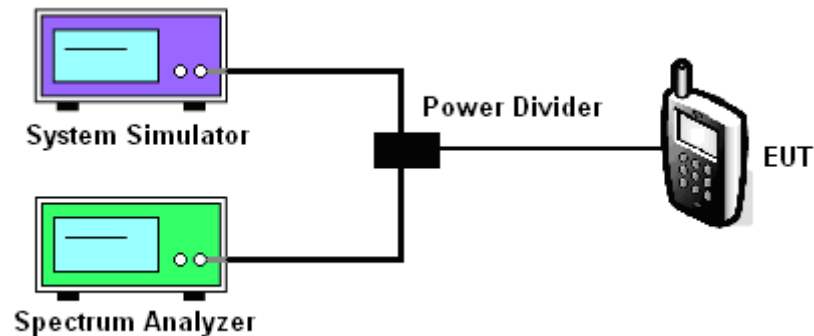



3.5.5 Test Result (Plots) of Conducted Emission

Band :	GSM850	Channel :	CH189
Test Mode :	GSM Link		

Conducted Emission Plot between 30MHz ~ 1GHz

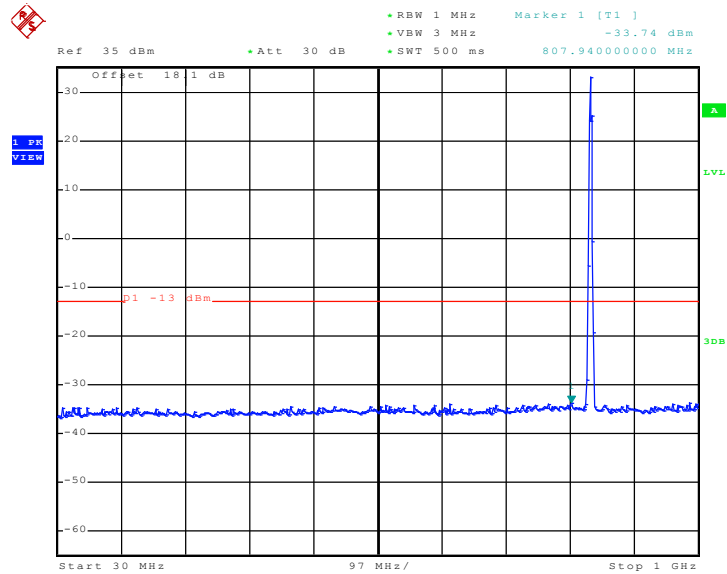

Date: 26.NOV.2009 09:11:23

Conducted Emission Plot between 1GHz ~ 3GHz

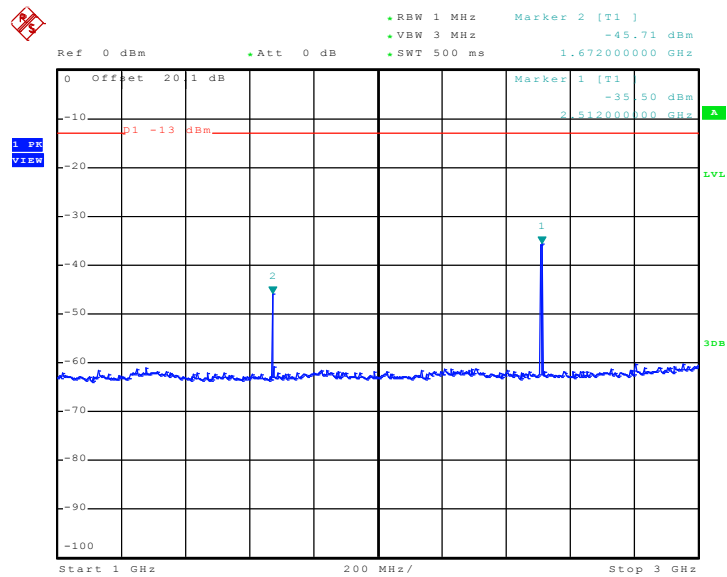

Date: 26.NOV.2009 09:15:34



Conducted Emission Plot between 3GHz ~ 7GHz

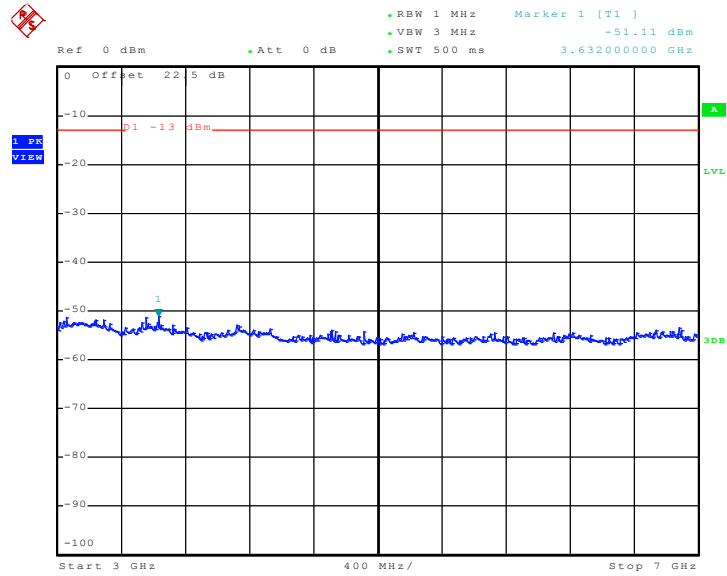

Date: 26.NOV.2009 09:16:21

Conducted Emission Plot between 7GHz ~ 9GHz

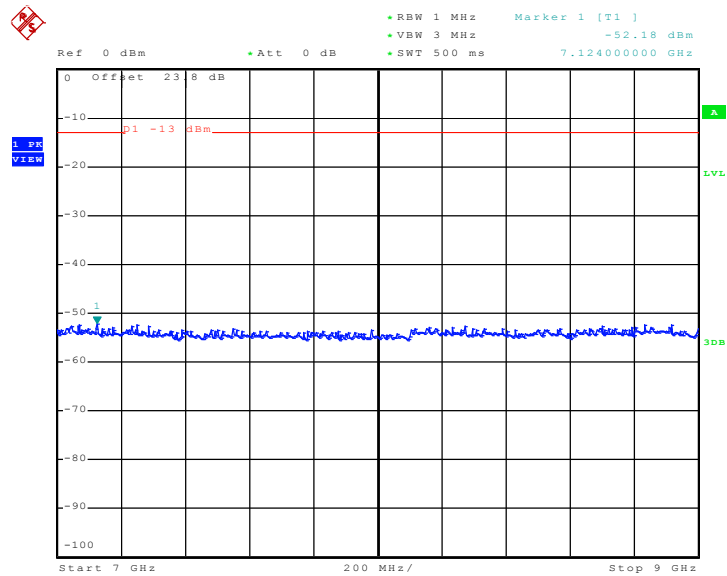

Date: 26.NOV.2009 09:17:58



Band :	GSM850	Channel :	CH189
Test Mode :	EDGE 8 Link		

Conducted Emission Plot between 30MHz ~ 1GHz

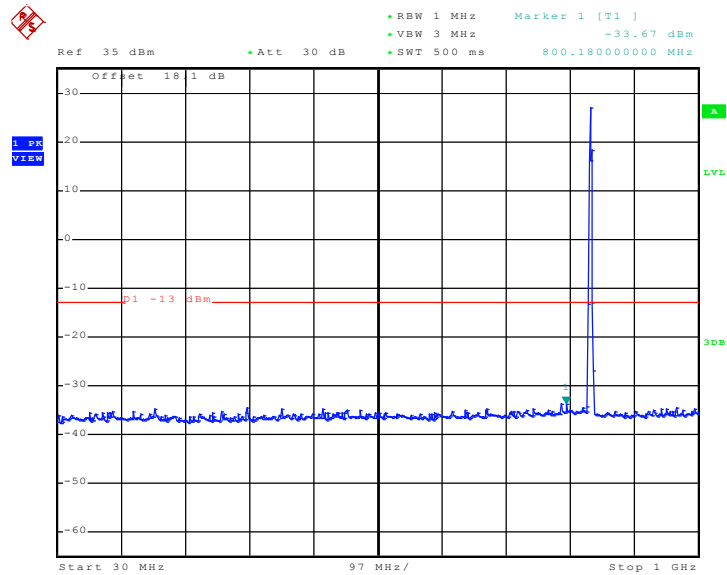

Date: 26.NOV.2009 09:12:01

Conducted Emission Plot between 1GHz ~ 3GHz

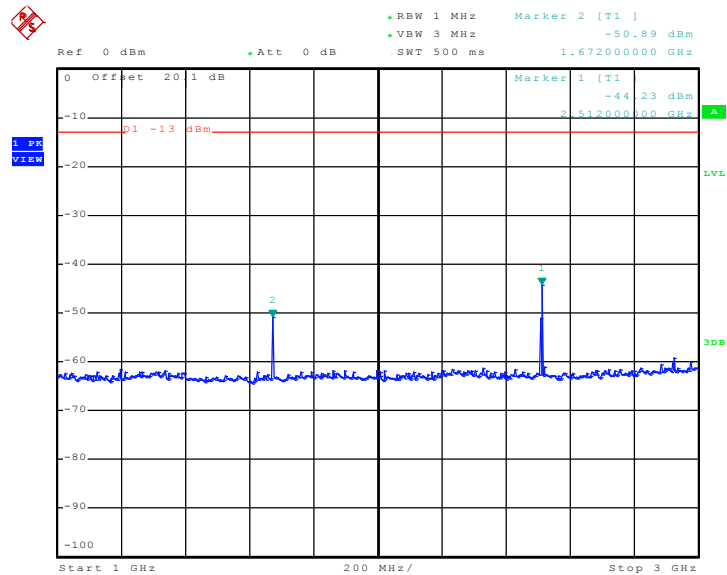

Date: 26.NOV.2009 09:13:57



Conducted Emission Plot between 3GHz ~ 7GHz

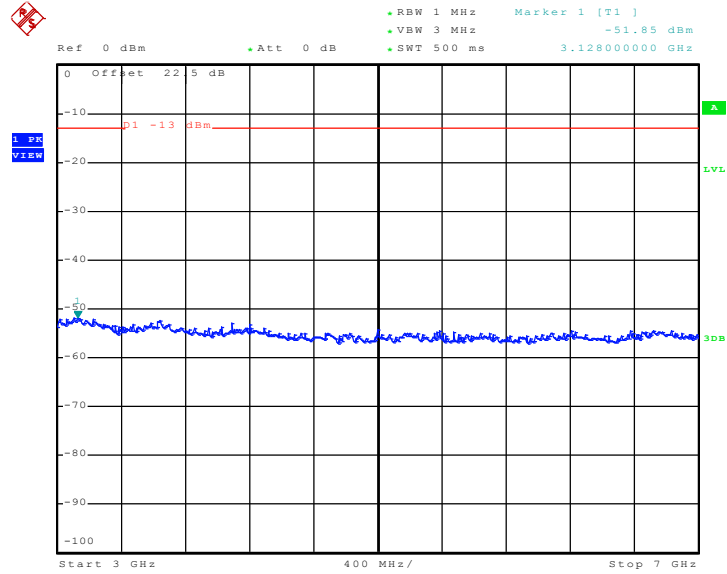

Date: 26.NOV.2009 09:16:56

Conducted Emission Plot between 7GHz ~ 9GHz

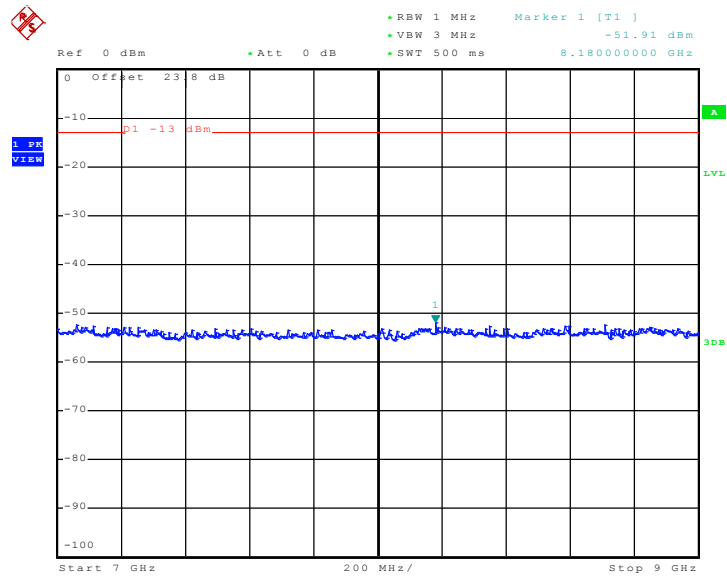

Date: 26.NOV.2009 09:17:25



Band :	GSM1900	Channel :	CH661
Test Mode :	GSM Link		

Conducted Emission Plot between 30MHz ~ 1GHz

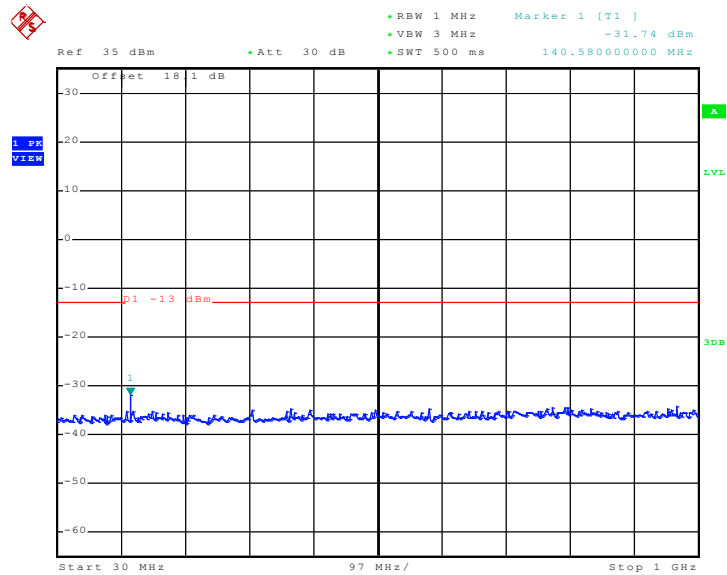

Date: 26.NOV.2009 09:41:24

Conducted Emission Plot between 1GHz ~ 3GHz

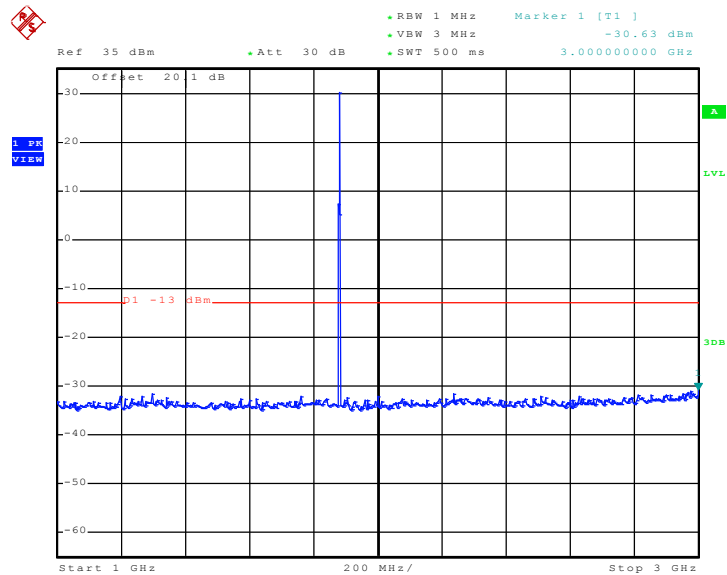

Date: 26.NOV.2009 09:38:42



Conducted Emission Plot between 3GHz ~ 7GHz

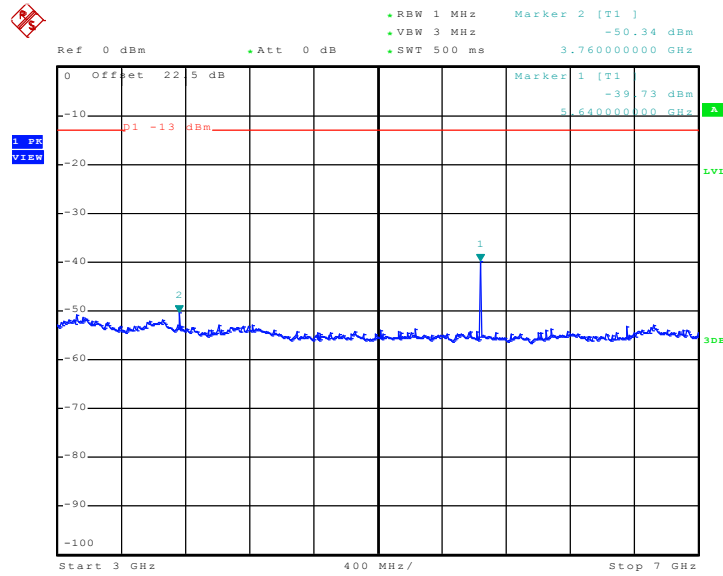

Date: 26.NOV.2009 09:34:32

Conducted Emission Plot between 7GHz ~ 13.6G

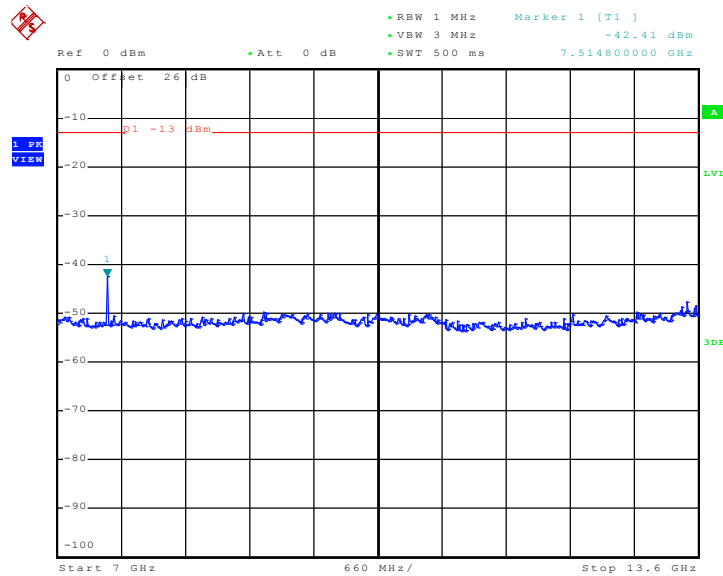

Date: 26.NOV.2009 09:30:26



Conducted Emission Plot between 13.6GHz ~ 19.1GHz

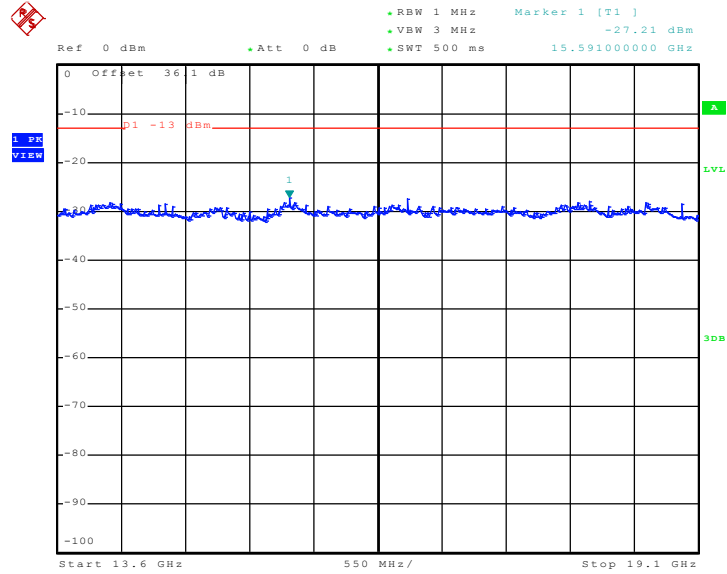

Date: 26.NOV.2009 09:24:25



Band :	GSM1900	Channel :	CH661
Test Mode :	EDGE 12 Link		

Conducted Emission Plot between 30MHz ~ 1GHz

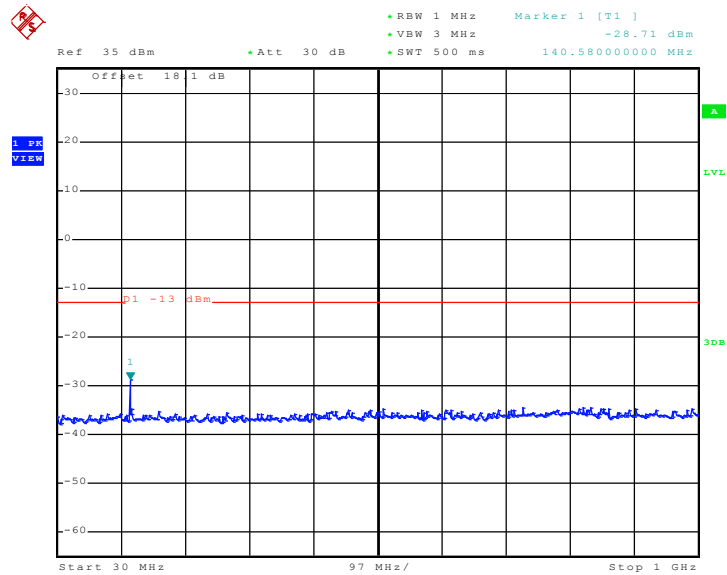

Date: 26.NOV.2009 09:40:47

Conducted Emission Plot between 1GHz ~ 3GHz

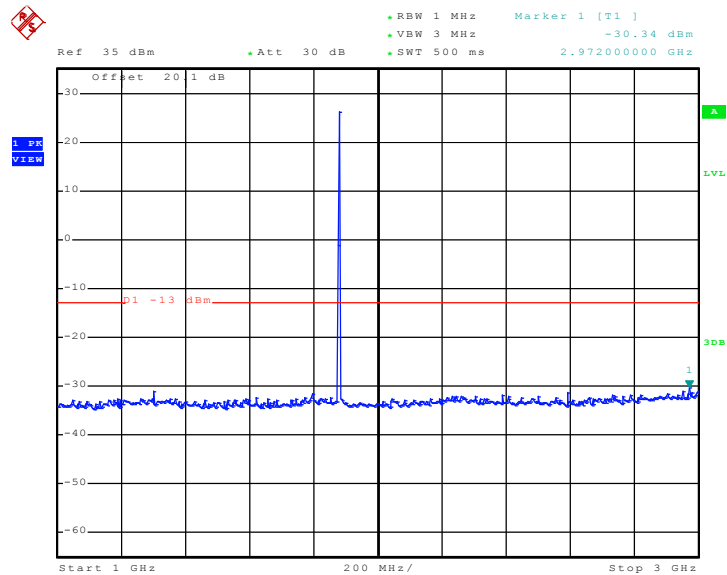

Date: 26.NOV.2009 09:39:39



Conducted Emission Plot between 3GHz ~ 7GHz

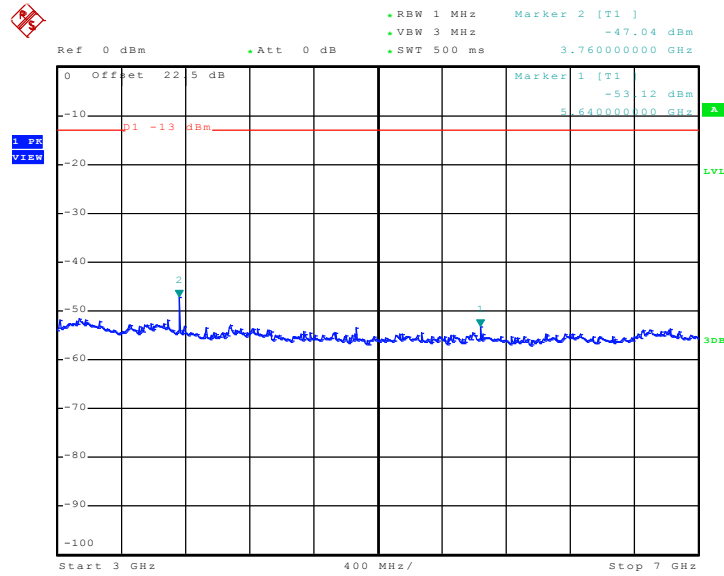

Date: 26.NOV.2009 09:33:34

Conducted Emission Plot between 7GHz ~ 13.6GHz

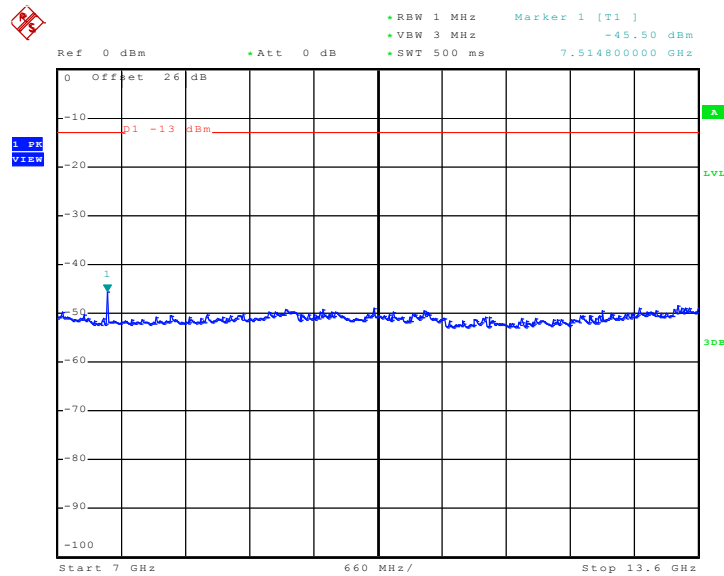

Date: 26.NOV.2009 09:29:57



Conducted Emission Plot between 13.6GHz ~ 19.1GHz

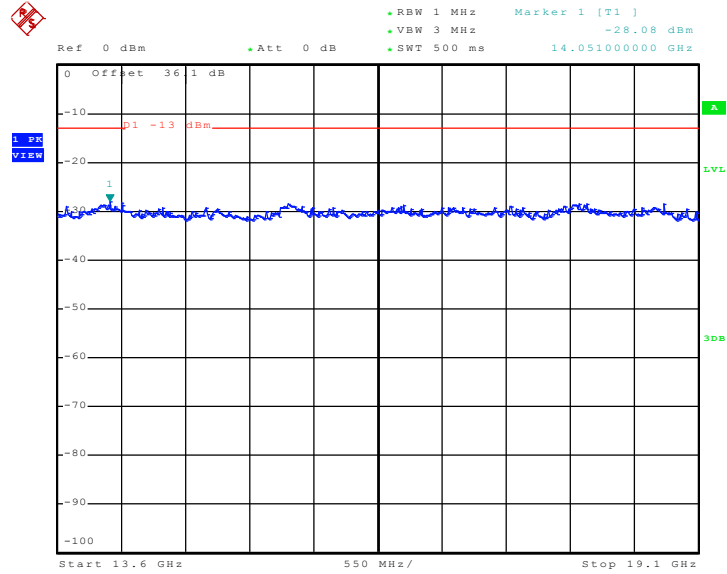

Date: 26.NOV.2009 09:28:33



Band :	WCDMA Band IV	Channel :	CH1413
Test Mode :	HSDPA Link		

Conducted Emission Plot between 30MHz ~ 1GHz

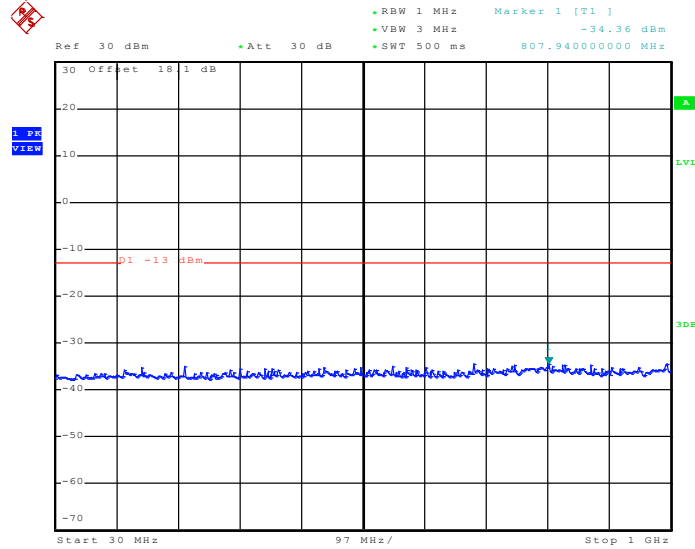

Date: 26.NOV.2009 12:59:55

Conducted Emission Plot between 1GHz ~ 3GHz

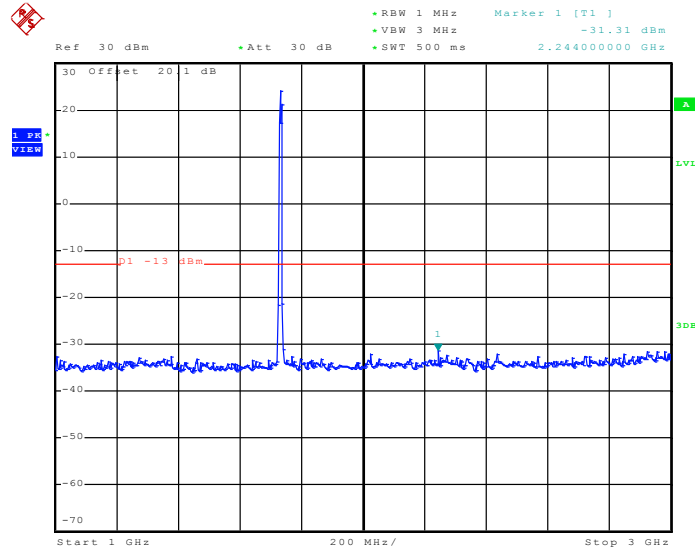

Date: 26.NOV.2009 13:00:56



Conducted Emission Plot between 3GHz ~ 7GHz

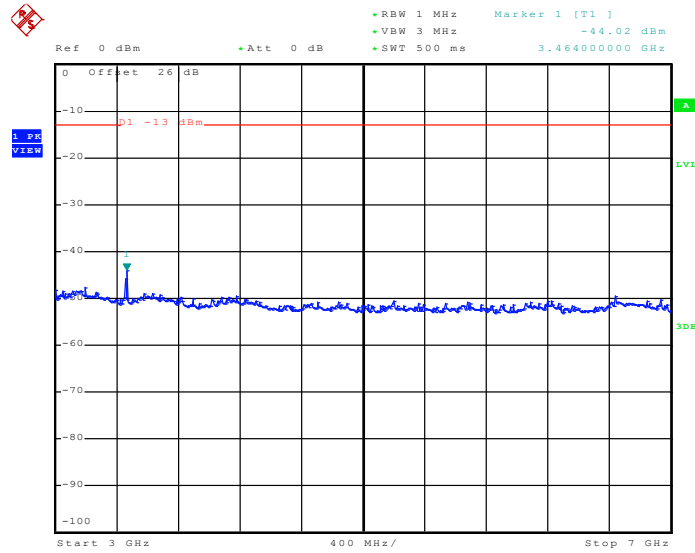

Date: 26.NOV.2009 13:03:21

Conducted Emission Plot between 7GHz ~ 13.6GHz

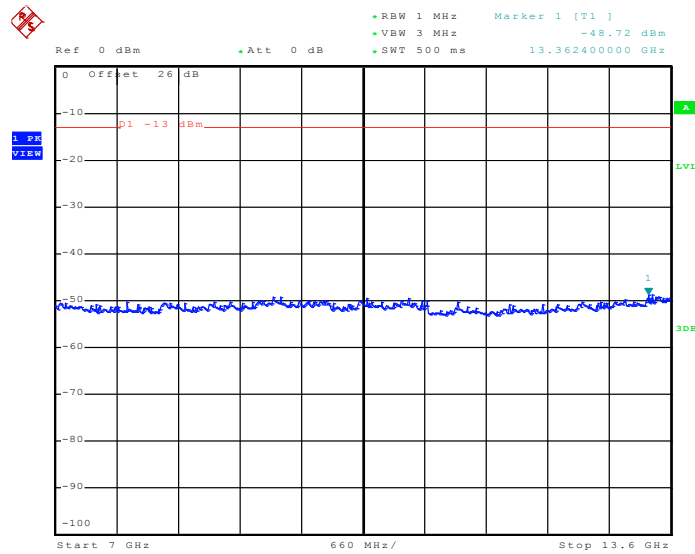

Date: 26.NOV.2009 13:04:46



Conducted Emission Plot between 13.6GHz ~ 18GHz

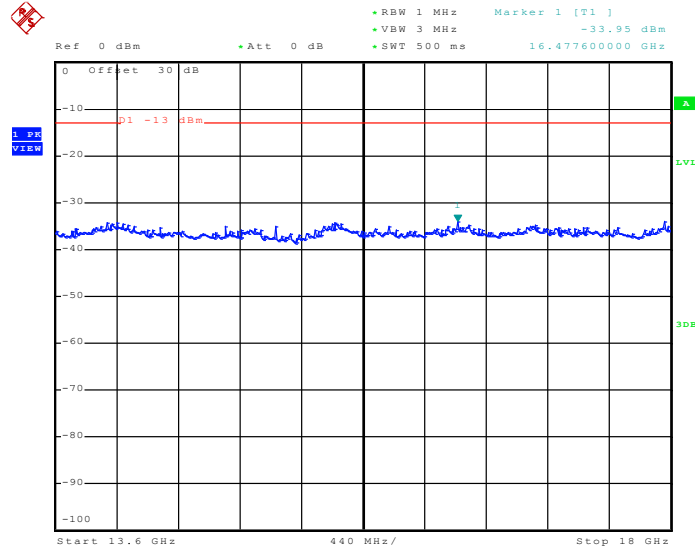

Date: 26.NOV.2009 13:09:12



3.6 Field Strength of Spurious Radiation Measurement

3.6.1 Description of Field Strength of Spurious Radiated Measurement

The radiated spurious emission was measured by substitution method according to ANSI / TIA / EIA-603-C-2004. The power of any emission outside of the authorized operating frequency ranges must be attenuated below the transmitter power (P) by a factor of at least $43 + 10 \log (P)$ dB. The spectrum is scanned from 30 MHz up to a frequency including its 10th harmonic.

3.6.2 Measuring Instruments

See list of measuring instruments of this test report.

3.6.3 Test Procedures

1. The EUT was placed on a rotatable wooden table with 0.8 meter about ground.
2. The EUT was set 3 meters from the receiving antenna, which was mounted on the antenna tower.
3. The table was rotated 360 degrees to determine the position of the highest spurious emission.
4. The height of the receiving antenna is varied between one meter and four meters to search the maximum spurious emission for both horizontal and vertical polarizations.
5. Taking the record of maximum spurious emission.
6. A horn antenna was substituted in place of the EUT and was driven by a signal generator.
7. Tune the output power of signal generator to the same emission level with EUT maximum spurious emission.
8. Taking the record of output power at antenna port.
9. Repeat step 7 to step 8 for another polarization.
10. $EIRP \text{ (dBm)} = S.G. \text{ Power} - Tx \text{ Cable Loss} + Tx \text{ Antenna Gain}$
11. $ERP \text{ (dBm)} = EIRP - 2.15$

3.6.4 Test Setup

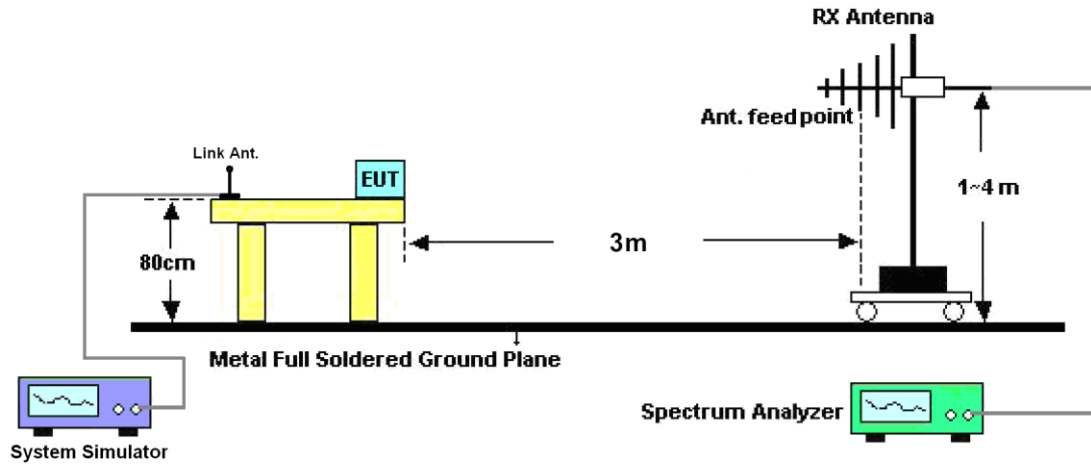



3.6.5 Test Result of Field Strength of Spurious Radiated

Band :	GSM850	Temperature :	23~25°C
Test Mode :	GSM Link for Pocket PC Phone 1	Relative Humidity :	50~54%
Test Engineer :	Cona Huang	Polarization :	Horizontal
Remark :	Spurious emissions within 30-1000MHz were found more than 20dB below limit line.		

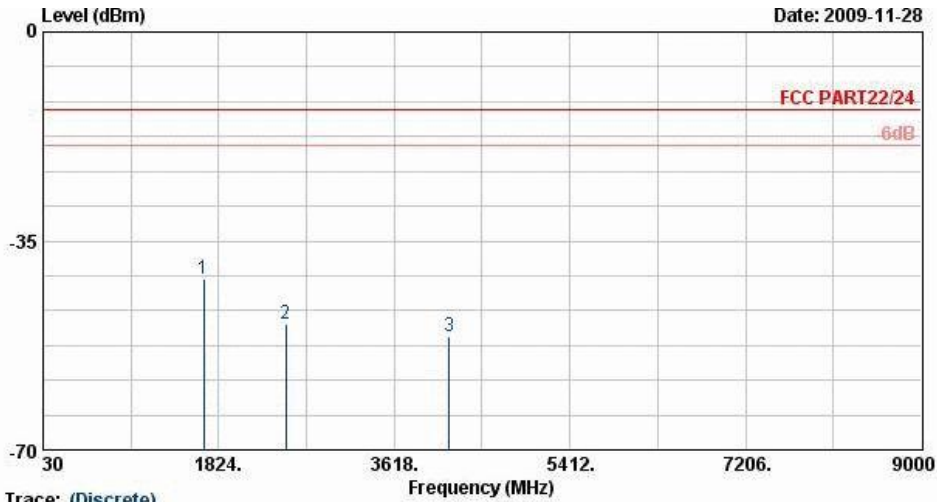

Trace: (Discrete)
 Site : 03CH07-HY
 Condition : FCC PART22/24 HF-ETRP(080306) HORIZONTAL
 Project : RC 961306-05

Frequency (MHz)	ERP (dBm)	Limit (dBm)	Over Limit (dB)	SPA Reading (dBm)	S.G. Power (dBm)	TX Cable loss (dB)	TX Antenna Gain (dBi)	Polarization (H/V)	Result
1669	-41.48	-13	-28.48	-50.07	-41.33	3.39	5.39	H	Pass
2509	-48.92	-13	-35.92	-59.06	-49.18	3.71	6.12	H	Pass
4175	-51.06	-13	-38.06	-64.16	-54.9	3.01	9.00	H	Pass



Band :	GSM850	Temperature :	23~25°C
Test Mode :	GSM Link for Pocket PC Phone 1	Relative Humidity :	50~54%
Test Engineer :	Cona Huang	Polarization :	Vertical
Remark :	Spurious emissions within 30-1000MHz were found more than 20dB below limit line.		

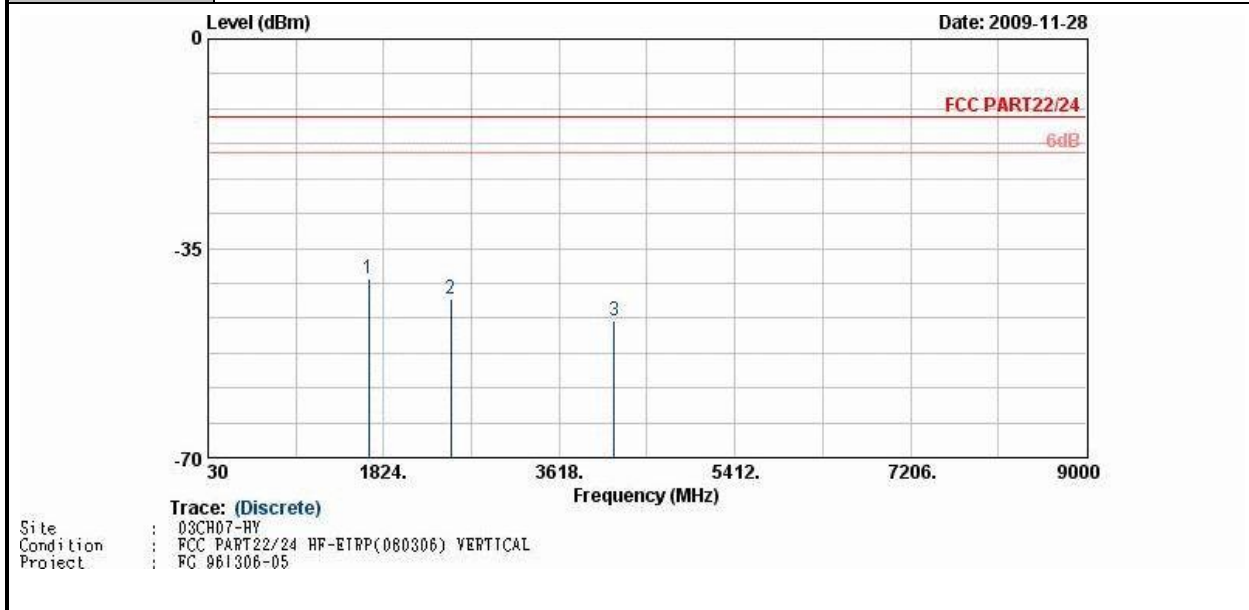

Frequency (MHz)	ERP (dBm)	Limit (dBm)	Over Limit (dB)	SPA Reading (dBm)	S.G. Power (dBm)	TX Cable loss (dB)	TX Antenna Gain (dBi)	Polarization (H/V)	Result
1669	-39.98	-13	-26.98	-48.8	-39.83	3.39	5.39	V	Pass
2509	-43.40	-13	-30.40	-54.27	-43.66	3.71	6.12	V	Pass
4175	-47.22	-13	-34.22	-61.15	-51.06	3.01	9.00	V	Pass



Band :	GSM850	Temperature :	23~25°C
Test Mode :	GSM Link for Pocket PC Phone 2	Relative Humidity :	50~54%
Test Engineer :	Cona Huang	Polarization :	Horizontal
Remark :	Spurious emissions within 30-1000MHz were found more than 20dB below limit line.		

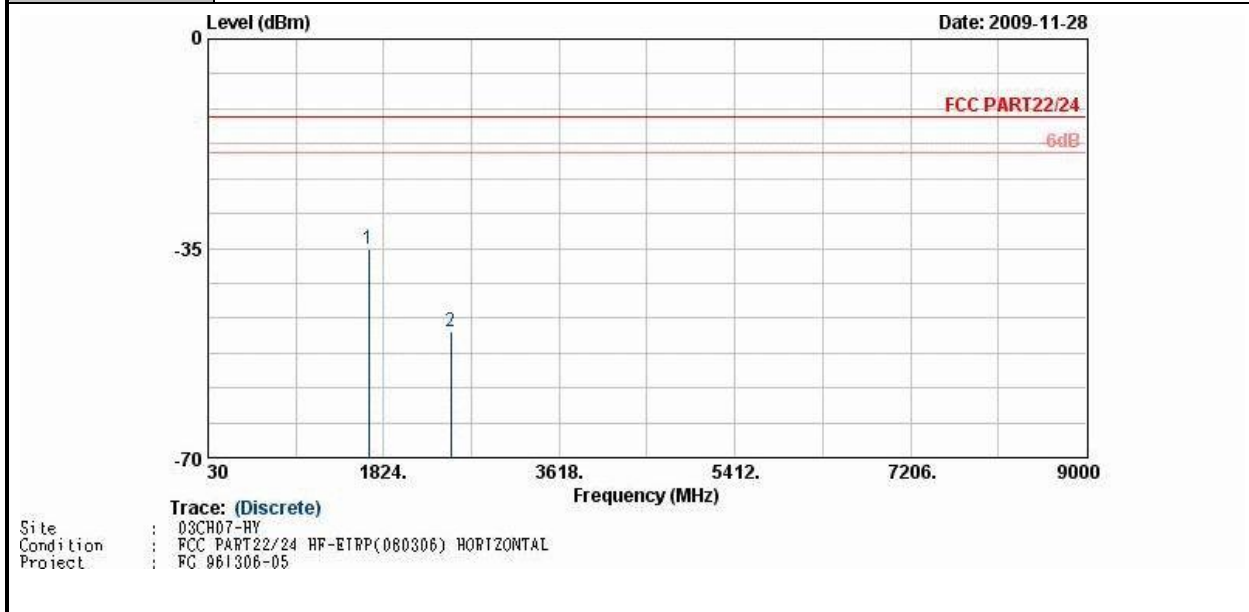

Frequency (MHz)	ERP (dBm)	Limit (dBm)	Over Limit (dB)	SPA Reading (dBm)	S.G. Power (dBm)	TX Cable loss (dB)	TX Antenna Gain (dBi)	Polarization (H/V)	Result
1669	-35.08	-13	-22.08	-44.2	-34.93	3.39	5.39	H	Pass
2509	-48.99	-13	-35.99	-55.93	-49.25	3.71	6.12	H	Pass



Band :	GSM850	Temperature :	23~25°C
Test Mode :	GSM Link for Pocket PC Phone 2	Relative Humidity :	50~54%
Test Engineer :	Cona Huang	Polarization :	Vertical
Remark :	Spurious emissions within 30-1000MHz were found more than 20dB below limit line.		

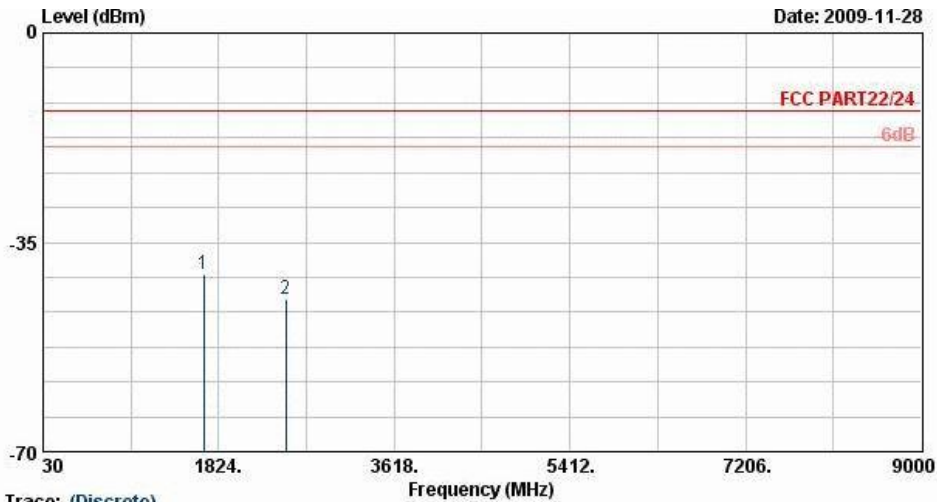

Trace: (Discrete)
 Site : 08CH07-HY
 Condition : FCC PART22/24 HF-ETRP(080306) VERTICAL
 Project : FC 961306-05

Frequency (MHz)	ERP (dBm)	Limit (dBm)	Over Limit (dB)	SPA Reading (dBm)	S.G. Power (dBm)	TX Cable loss (dB)	TX Antenna Gain (dBi)	Polarization (H/V)	Result
1669	-40.39	-13	-27.39	-49	-40.24	3.39	5.39	V	Pass
2509	-44.42	-13	-31.42	-55.04	-44.68	3.71	6.12	V	Pass



Band :	GSM850	Temperature :	23~25°C
Test Mode :	EDGE 8 Link for Pocket PC Phone 1	Relative Humidity :	50~54%
Test Engineer :	Cona Huang	Polarization :	Horizontal
Remark :	Spurious emissions within 30-1000MHz were found more than 20dB below limit line.		

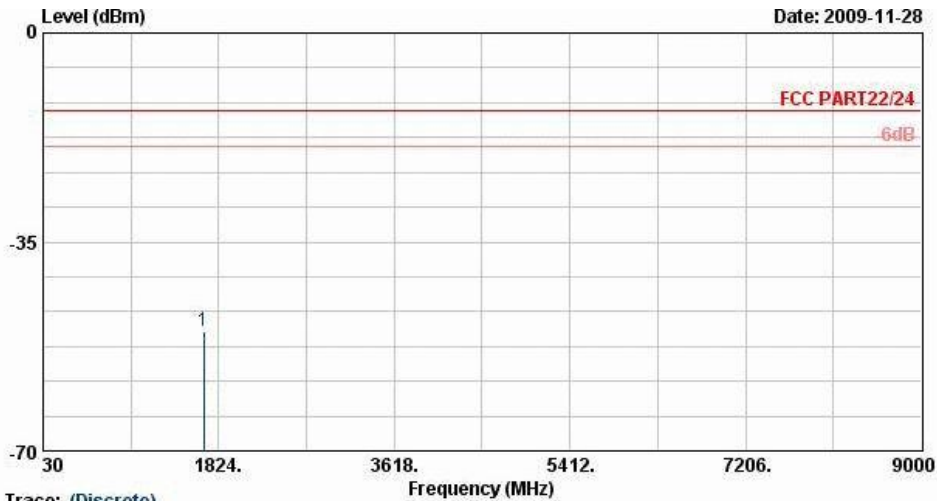

Trace: (Discrete)
 Site : 03CH07-HY
 Condition : FCC PART22/24 HF-ETRP(080306) HORIZONTAL
 Project : RC 961306-05

Frequency (MHz)	ERP (dBm)	Limit (dBm)	Over Limit (dB)	SPA Reading (dBm)	S.G. Power (dBm)	TX Cable loss (dB)	TX Antenna Gain (dBi)	Polarization (H/V)	Result
1669	-50.00	-13	-37.00	-57.09	-49.85	3.39	5.39	H	Pass



Band :	GSM850	Temperature :	23~25°C
Test Mode :	EDGE 8 Link for Pocket PC Phone 1	Relative Humidity :	50~54%
Test Engineer :	Cona Huang	Polarization :	Vertical
Remark :	Spurious emissions within 30-1000MHz were found more than 20dB below limit line.		

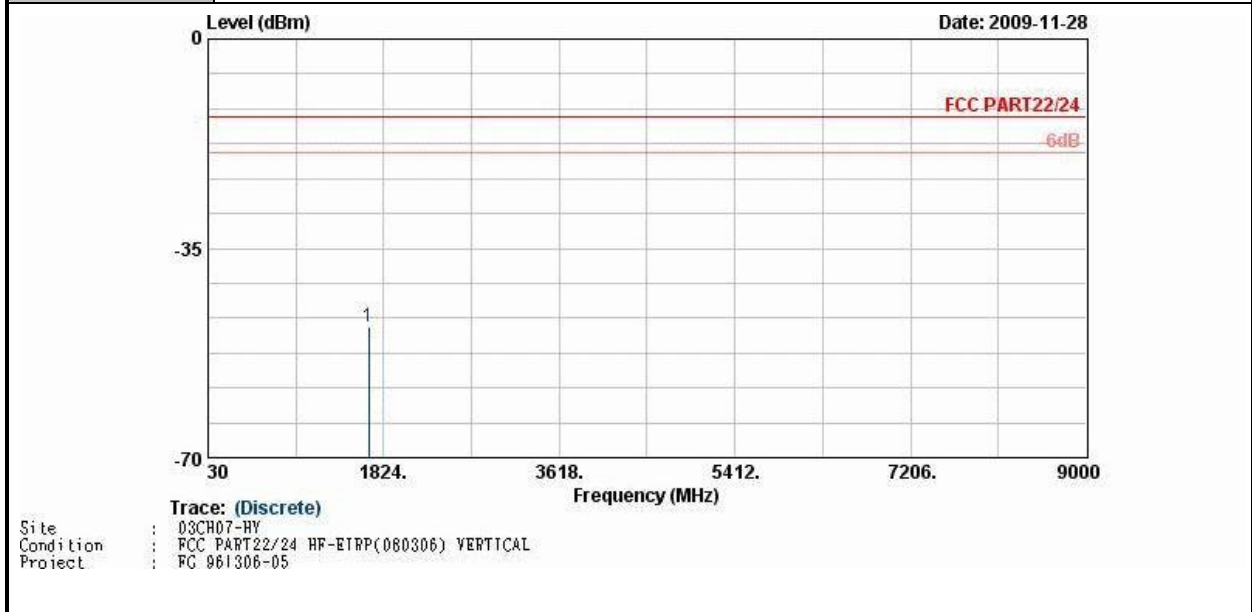

Frequency (MHz)	ERP (dBm)	Limit (dBm)	Over Limit (dB)	SPA Reading (dBm)	S.G. Power (dBm)	TX Cable loss (dB)	TX Antenna Gain (dBi)	Polarization (H/V)	Result
1669	-48.10	-13	-35.10	-55.65	-47.95	3.39	5.39	V	Pass



Band :	GSM1900	Temperature :	23~25°C
Test Mode :	GSM Link for Pocket PC Phone 1	Relative Humidity :	50~54%
Test Engineer :	Cona Huang	Polarization :	Horizontal
Remark :	Spurious emissions within 30-1000MHz were found more than 20dB below limit line.		

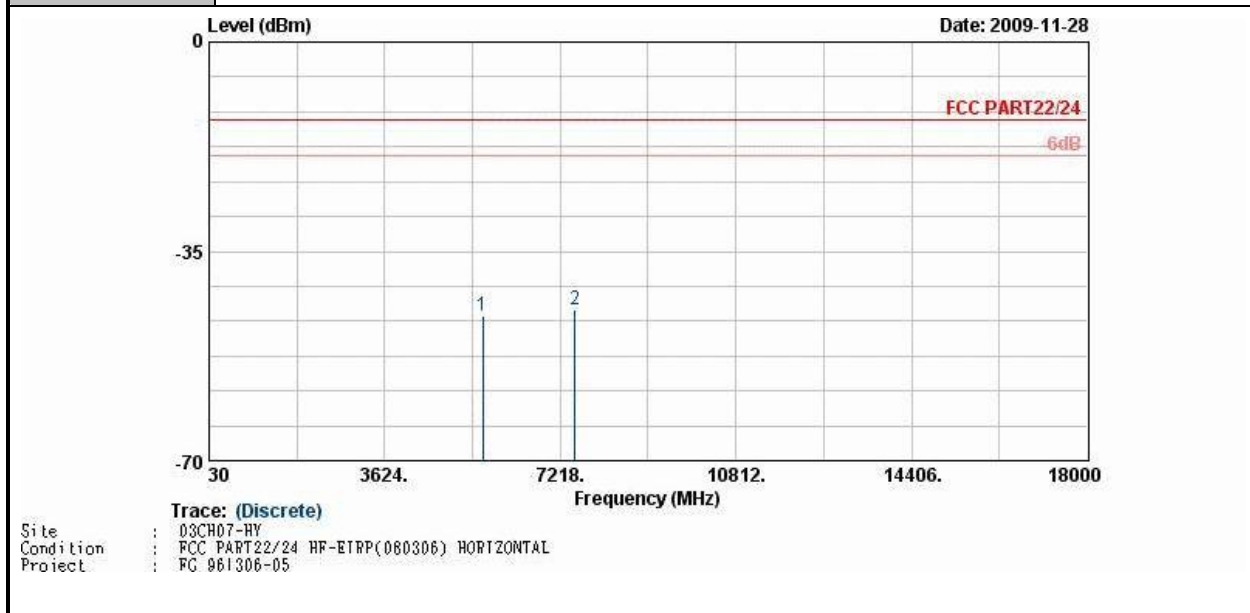

Frequency (MHz)	EIRP (dBm)	Limit (dBm)	Over Limit (dB)	SPA Reading (dBm)	S.G. Power (dBm)	TX Cable loss (dB)	TX Antenna Gain (dBi)	Polarization (H/V)	Result
5636	-45.70	-13	-32.70	-62.94	-48.96	5.55	8.81	H	Pass
7520	-44.69	-13	-31.69	-64.79	-47.76	6.64	9.71	H	Pass



Band :	GSM1900	Temperature :	23~25°C
Test Mode :	GSM Link for Pocket PC Phone 1	Relative Humidity :	50~54%
Test Engineer :	Cona Huang	Polarization :	Vertical
Remark :	Spurious emissions within 30-1000MHz were found more than 20dB below limit line.		

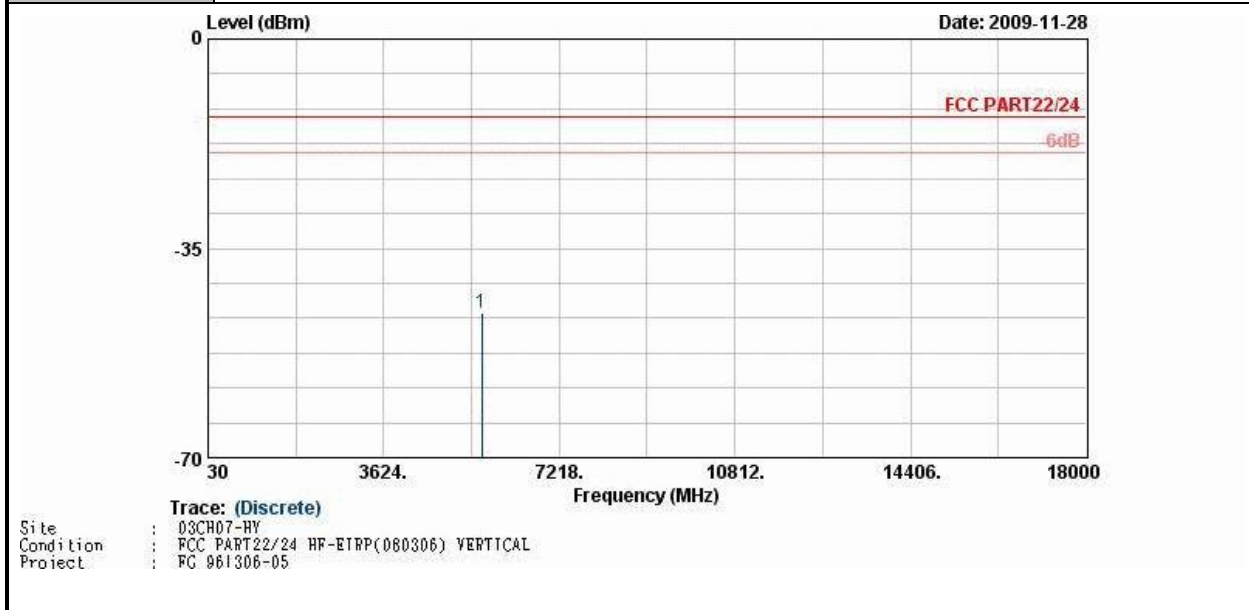

Frequency (MHz)	EIRP (dBm)	Limit (dBm)	Over Limit (dB)	SPA Reading (dBm)	S.G. Power (dBm)	TX Cable loss (dB)	TX Antenna Gain (dBi)	Polarization (H/V)	Result
5636	-45.91	-13	-32.91	-64.56	-50.13	5.55	9.77	V	Pass



Band :	GSM1900	Temperature :	23~25°C
Test Mode :	GSM Link for Pocket PC Phone 2	Relative Humidity :	50~54%
Test Engineer :	Cona Huang	Polarization :	Horizontal
Remark :	Spurious emissions within 30-1000MHz were found more than 20dB below limit line.		

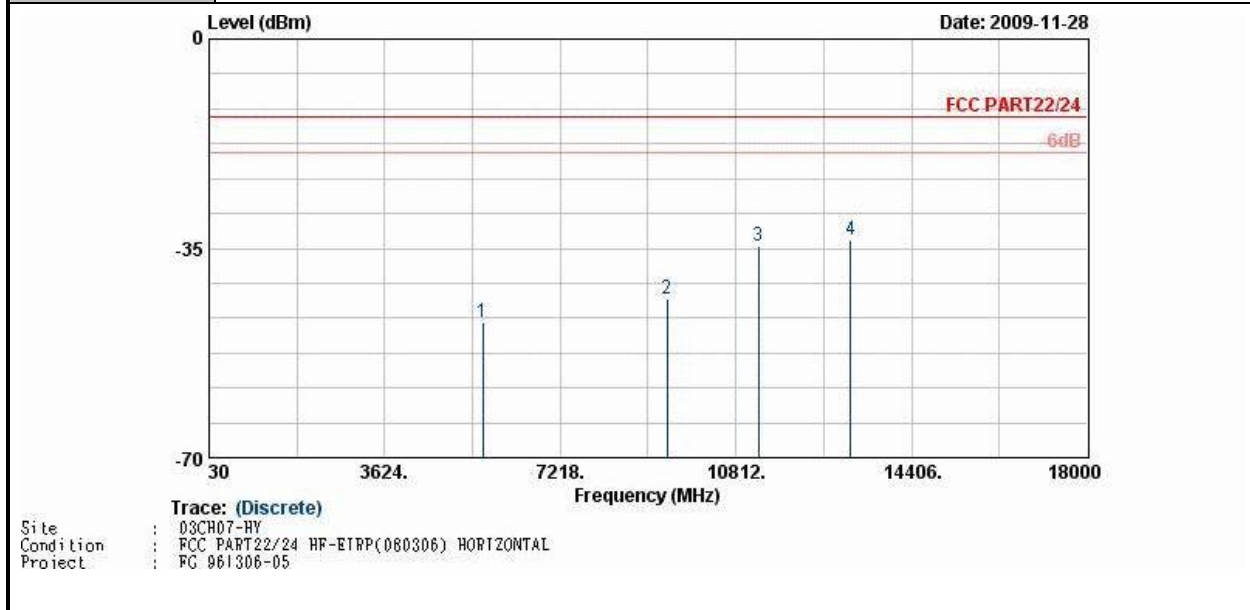

Frequency (MHz)	EIRP (dBm)	Limit (dBm)	Over Limit (dB)	SPA Reading (dBm)	S.G. Power (dBm)	TX Cable loss (dB)	TX Antenna Gain (dBi)	Polarization (H/V)	Result
5636	-47.47	-13	-34.47	-64.92	-50.73	5.55	8.81	H	Pass
9396	-43.39	-13	-30.39	-64.88	-47.2	6.91	10.72	H	Pass
11280	-34.60	-13	-21.60	-66.77	-38.13	7.23	10.76	H	Pass
13156	-33.61	-13	-20.61	-66.04	-35.84	8.8	11.03	H	Pass



Band :	GSM1900	Temperature :	23~25°C
Test Mode :	GSM Link for Pocket PC Phone 2	Relative Humidity :	50~54%
Test Engineer :	Cona Huang	Polarization :	Vertical
Remark :	Spurious emissions within 30-1000MHz were found more than 20dB below limit line.		

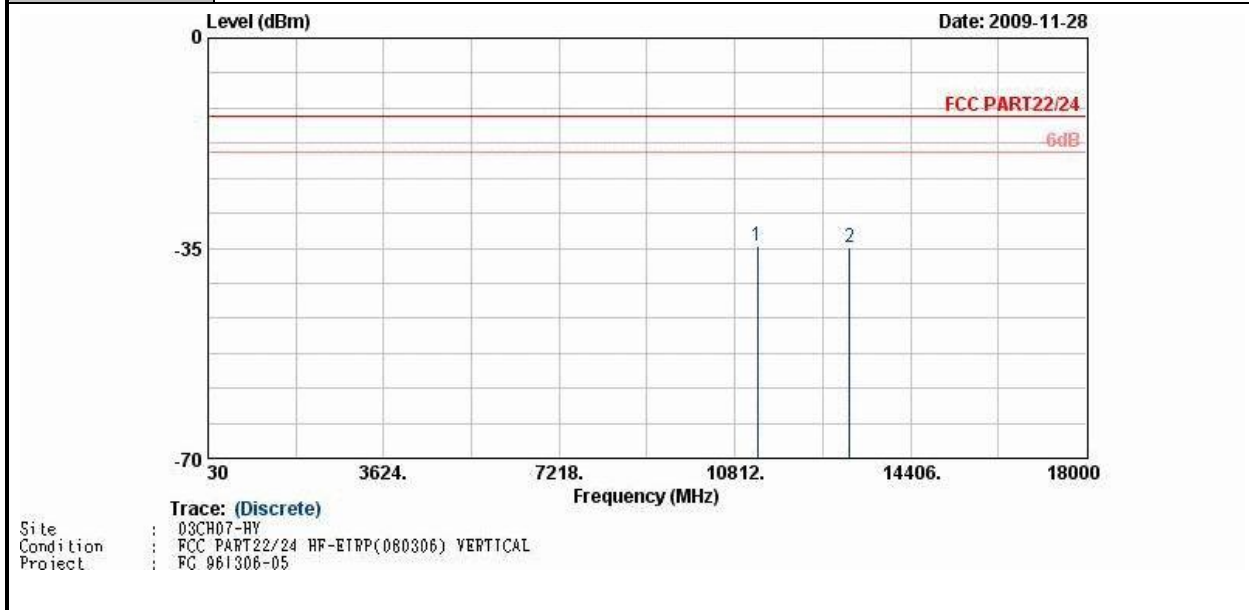

Frequency (MHz)	EIRP (dBm)	Limit (dBm)	Over Limit (dB)	SPA Reading (dBm)	S.G. Power (dBm)	TX Cable loss (dB)	TX Antenna Gain (dBi)	Polarization (H/V)	Result
11280	-34.48	-13	-21.48	-67.27	-38.61	7.23	11.36	V	Pass
13156	-34.89	-13	-21.89	-65.34	-38.25	8.8	12.16	V	Pass



Band :	GSM1900	Temperature :	23~25°C
Test Mode :	EDGE 12 Link for Pocket PC Phone 1	Relative Humidity :	50~54%
Test Engineer :	Cona Huang	Polarization :	Horizontal
Remark :	1. Spurious emissions within 30-1000MHz were found more than 20dB below limit line. 2. Spurious emissions within 1000MHz ~ 10th harmonic were not found any signals.		

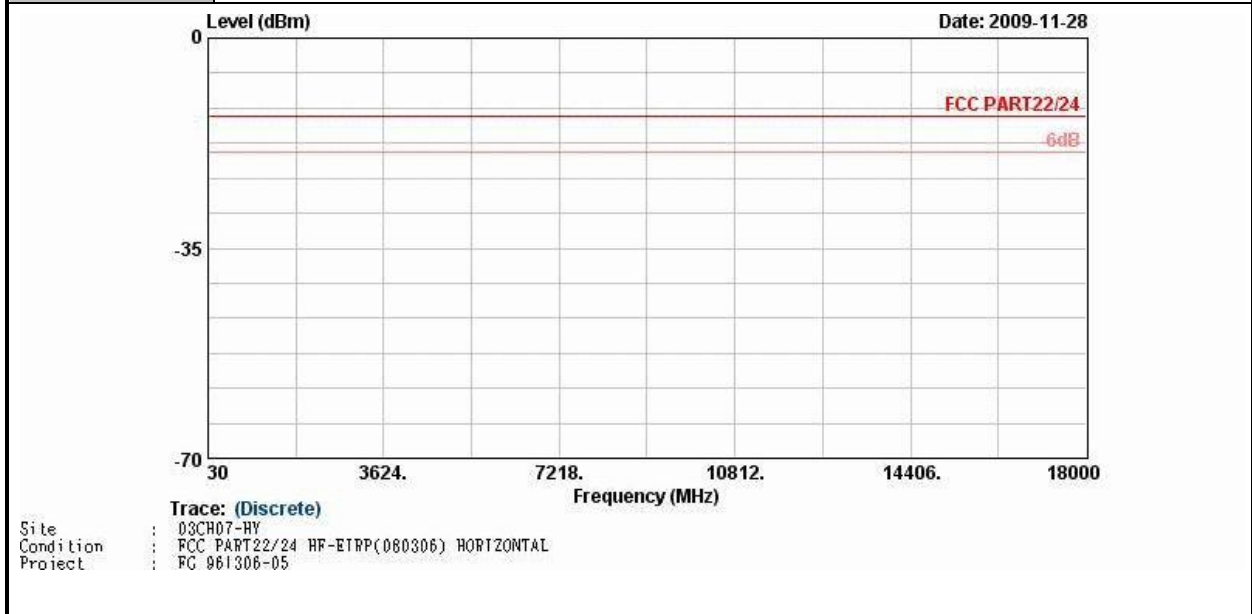



Band :	GSM1900	Temperature :	23~25°C
Test Mode :	EDGE 12 Link for Pocket PC Phone 1	Relative Humidity :	50~54%
Test Engineer :	Cona Huang	Polarization :	Vertical
Remark :	1. Spurious emissions within 30-1000MHz were found more than 20dB below limit line. 2. Spurious emissions within 1000MHz ~ 10th harmonic were not found any signals.		

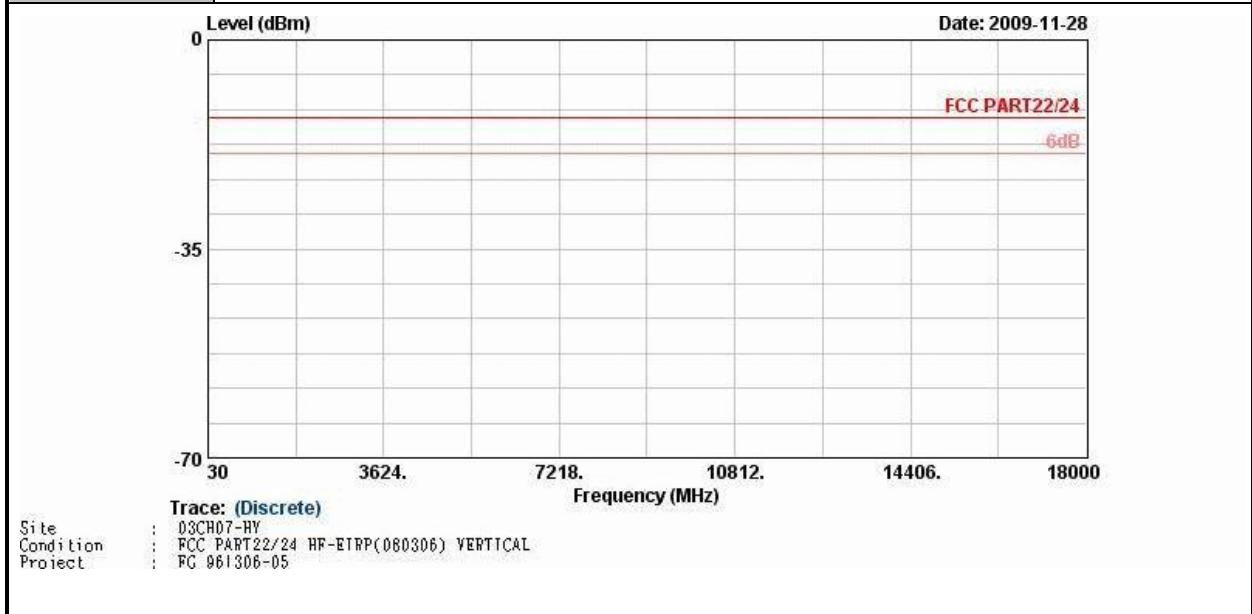



Band :	WCDMA Band IV	Temperature :	23~25°C
Test Mode :	HSDPA Link for Pocket PC Phone 1	Relative Humidity :	50~54%
Test Engineer :	Cona Huang	Polarization :	Horizontal
Remark :	1. Spurious emissions within 30-1000MHz were found more than 20dB below limit line. 2. Spurious emissions within 1000MHz ~ 10th harmonic were not found any signals.		

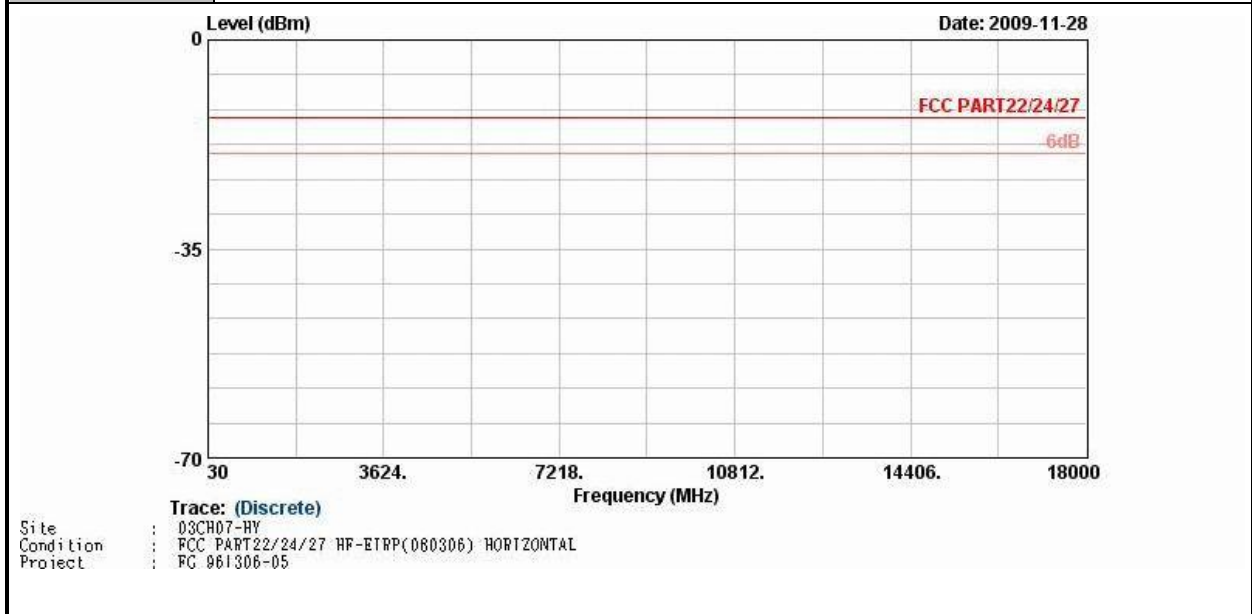



Band :	WCDMA Band IV	Temperature :	23~25°C
Test Mode :	HSDPA Link for Pocket PC Phone 1	Relative Humidity :	50~54%
Test Engineer :	Cona Huang	Polarization :	Vertical
Remark :	1. Spurious emissions within 30-1000MHz were found more than 20dB below limit line. 2. Spurious emissions within 1000MHz ~ 10th harmonic were not found any signals.		

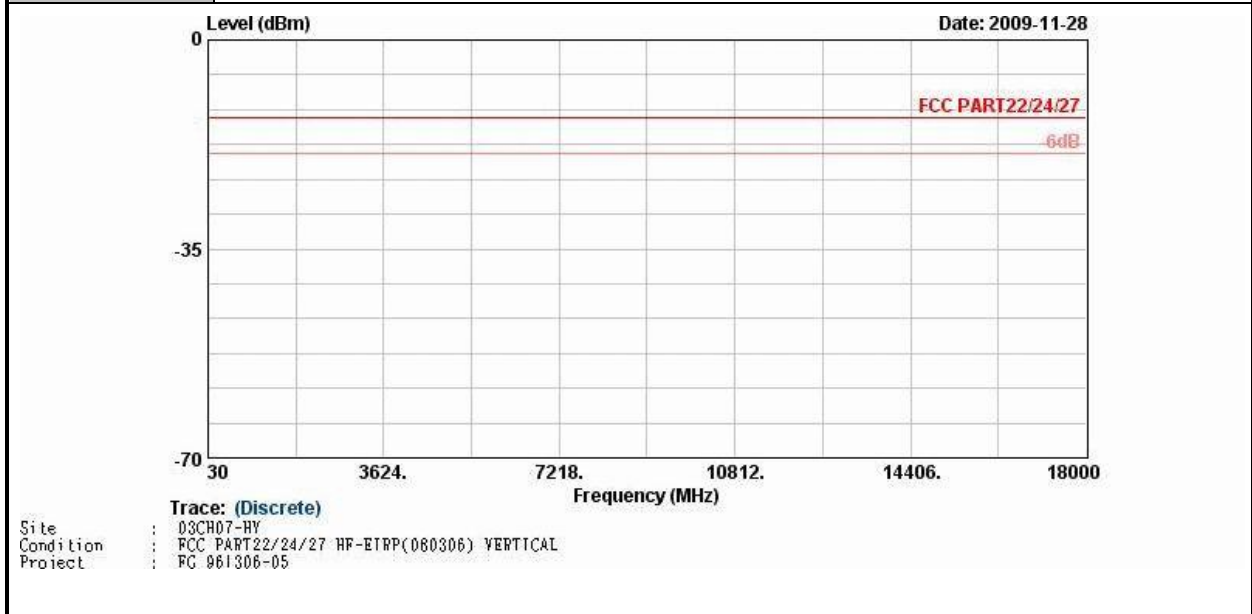



Band :	WCDMA Band IV	Temperature :	23~25°C
Test Mode :	HSDPA Link for Pocket PC Phone 2	Relative Humidity :	50~54%
Test Engineer :	Cona Huang	Polarization :	Horizontal
Remark :	1. Spurious emissions within 30-1000MHz were found more than 20dB below limit line. 2. Spurious emissions within 1000MHz ~ 10th harmonic were not found any signals.		

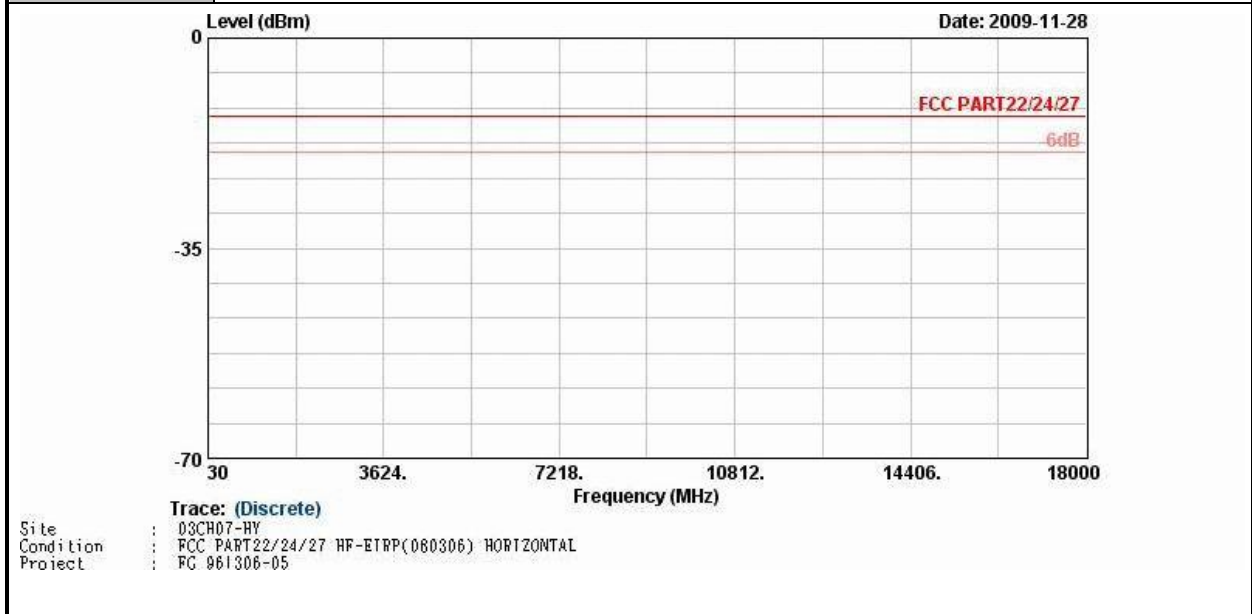



Band :	WCDMA Band IV	Temperature :	23~25°C
Test Mode :	HSDPA Link for Pocket PC Phone 2	Relative Humidity :	50~54%
Test Engineer :	Cona Huang	Polarization :	Vertical
Remark :	1. Spurious emissions within 30-1000MHz were found more than 20dB below limit line. 2. Spurious emissions within 1000MHz ~ 10th harmonic were not found any signals.		

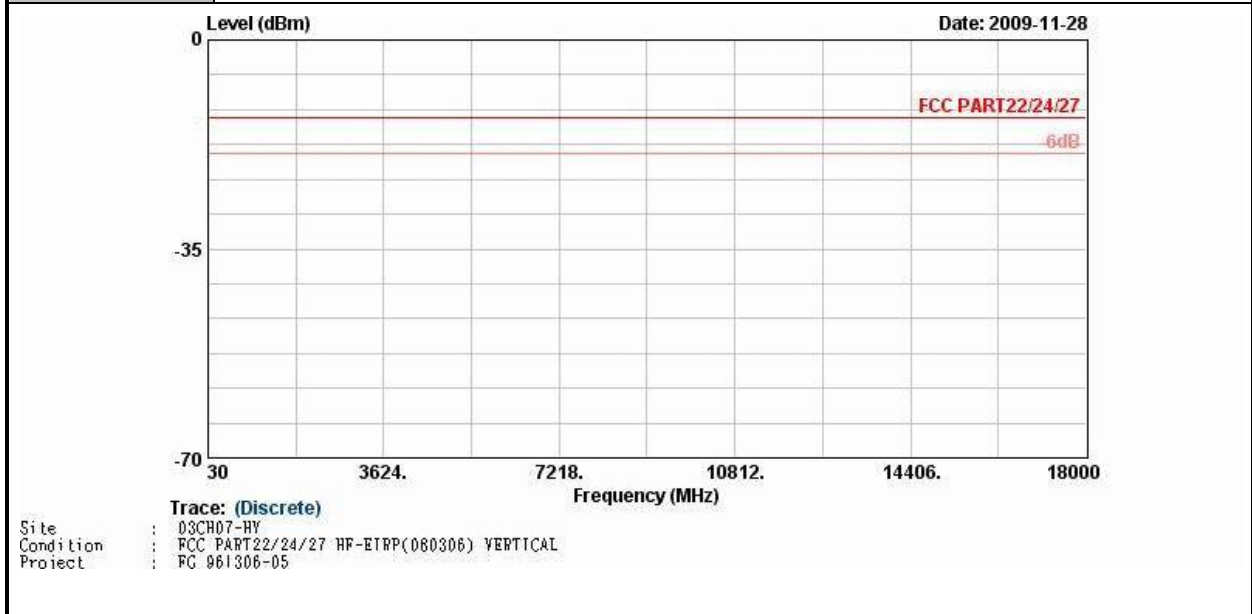

3.7 Frequency Stability Measurement

3.7.1 Description of Frequency Stability Measurement

The frequency stability shall be measured by variation of ambient temperature and variation of primary supply voltage to ensure that the fundamental emission stays within the authorized frequency block. The frequency stability of the transmitter shall be maintained within $\pm 0.00025\%$ ($\pm 2.5\text{ppm}$) of the center frequency.

3.7.2 Measuring Instruments

See list of measuring instruments of this test report.

3.7.3 Test Procedures for Temperature Variation

1. The EUT was set up in the thermal chamber and connected with the base station.
2. With power OFF, the temperature was decreased to -30°C and the EUT was stabilized for three hours. Power was applied and the maximum change in frequency was recorded within one minute.
3. With power OFF, the temperature was raised in 10°C step up to 50°C . The EUT was stabilized at each step for at least half an hour. Power was applied and the maximum frequency change was recorded within one minute.
4. If the EUT can not be turned on at -30°C , the testing lowest temperature will be raised in 10°C step until the EUT can be turned on.

3.7.4 Test Procedures for Voltage Variation

1. The EUT was placed in a temperature chamber at $25\pm 5^{\circ}\text{C}$ and connected with the base station.
2. The power supply voltage to the EUT was varied from BEP to 115% of the nominal value measured at the input to the EUT.
3. The variation in frequency was measured for the worst case.

3.7.5 Test Setup

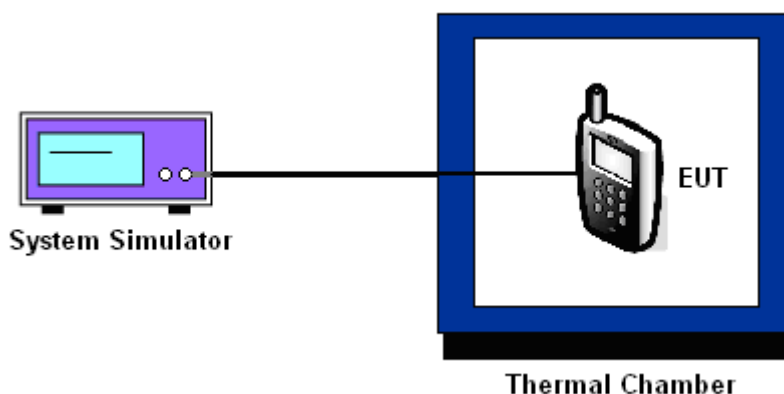



3.7.6 Test Result of Temperature Variation

Band :	GSM 850	Channel :	189
Limit (ppm) :	2.5		

Temperature (°C)	GSM		EDGE 8		Result
	Freq. Dev. (Hz)	Deviation (ppm)	Freq. Dev. (Hz)	Deviation (ppm)	
-30	21	0.02	15	0.02	PASS
-20	29	0.03	-12	-0.01	
-10	14	0.02	-20	-0.02	
0	18	0.02	-13	-0.02	
10	21	0.02	17	0.02	
20	-44	-0.05	10	0.01	
30	-19	-0.02	-13	-0.02	
40	-24	-0.03	-9	-0.01	
50	-18	-0.02	-11	-0.01	

Band :	GSM 1900	Channel :	661
Limit (ppm) :	2.5		

Temperature (°C)	GSM		EDGE 12		Result
	Freq. Dev. (Hz)	Deviation (ppm)	Freq. Dev. (Hz)	Deviation (ppm)	
-30	44	0.02	27	0.01	PASS
-20	37	0.02	25	0.01	
-10	-25	-0.01	-27	-0.01	
0	-22	-0.01	-33	-0.02	
10	-24	-0.01	-29	-0.02	
20	-24	-0.01	31	0.02	
30	18	0.01	38	0.02	
40	21	0.01	42	0.02	
50	24	0.01	46	0.02	



Band :	WCDMA Band IV	Channel :	1413
Limit (ppm) :	2.5		

Temperature (°C)	HSDPA		Result
	Freq. Dev. (Hz)	Deviation (ppm)	
-30	24	0.01	PASS
-20	21	0.01	
-10	20	0.01	
0	26	0.02	
10	-27	-0.02	
20	19	0.01	
30	11	0.01	
40	24	0.01	
50	-22	-0.01	



3.7.7 Test Result of Voltage Variation

Band & Channel	Mode	Voltage (Volt)	Freq. Dev. (Hz)	Deviation (ppm)	Limit (ppm)	Result
GSM 850 CH189	GSM	3.8	-35	-0.04	2.5	PASS
		BEP	-186	-0.22		
		4.2	-27	-0.03		
	EDGE 8	3.8	28	0.03		
		BEP	23	0.03		
		4.2	27	0.03		
GSM 1900 CH661	GSM	3.8	-44	-0.02		
		BEP	-57	-0.03		
		4.2	-46	-0.02		
	EDGE 12	3.8	20	0.01		
		BEP	18	0.01		
		4.2	26	0.01		
WCDMA Band IV CH1413	HSDPA	3.8	35	0.02		
		BEP	36	0.02		
		4.2	38	0.02		

Note:

1. Normal Voltage = 3.8V.
2. Battery End Point (BEP) = 3.6 V.

4 List of Measuring Equipments

Instrument	Manufacturer	Model No.	Serial No.	Characteristics	Calibration Date	Due Date	Remark
System Simulator	R&S	CMU200	116456	N/A	Jun. 05, 2008	Jun. 04, 2010	Conducted (TH02-HY)
Spectrum Analyzer	R&S	FSP40	100055	9kHz~40GHz	Jun. 23, 2009	Jun. 22, 2010	Conducted (TH02-HY)
Thermal Chamber	TEN BILLION	TTH-D35P	TBN-930701	N/A	Jul. 29, 2009	Jul. 28, 2010	Conducted (TH02-HY)
Bilog Antenna	SCHAFFNER	CBL6111C	2726	30MHz ~ 1GHz	Oct. 31, 2009	Oct. 30, 2010	Radiation (03CH07-HY)
Spectrum Analyzer	R&S	FSP	101067	9KHz ~ 30GHz	Dec. 04, 2009	Dec. 03, 2010	Radiation (03CH07-HY)
Double Ridge Horn Antenna	ESCO	3117	00075962	1GHz ~ 18GHz	Aug. 20, 2009	Aug. 19, 2010	Radiation (03CH07-HY)
SHF-EHF Horn Antenna	SCHWARZBECK	BBHA 9170	BBHA917025 1	15GHz- 40GHz	Oct. 14, 2009	Oct. 13, 2010	Radiation (03CH07-HY)
Pre Amplifier	Agilent	8449B	3008A02362	1GHz~ 26.5GHz	Dec.09,2009	Dec. 08, 2010	Radiation (03CH07-HY)
Pre Amplifier	COM-POWER	PA-103A	161241	10-1000MHz.32dB. GAIN	Mar. 27, 2009	Mar. 26, 2010	Radiation (03CH07-HY)
Loop Antenna	R&S	HFH2-Z2	860004/001	9 KHz~30 MHz	May 22, 2008	May 21, 2010	Radiation (03CH07-HY)
System Simulator	R&S	CMU200	117997	N/A	May 14, 2009	May 13, 2011	Radiation (03CH07-HY)

5 Uncertainty of Evaluation

Uncertainty of Radiated Emission Measurement (30 MHz ~ 1000 MHz)

Contribution	Uncertainty of X_i		$u(X_i)$
	dB	Probability Distribution	
Receiver Reading	0.41	Normal (k=2)	0.21
Antenna Factor Calibration	0.83	Normal (k=2)	0.42
Cable Loss Calibration	0.25	Normal (k=2)	0.13
Pre-Amplifier Gain Calibration	0.27	Normal (k=2)	0.14
RCV/SPA Specification	2.50	Rectangular	0.72
Antenna Factor Interpolation for Frequency	1.00	Rectangular	0.29
Site Imperfection	1.43	Rectangular	0.83
Mismatch	+0.39 / -0.41	U-Shape	0.28
Combined Standard Uncertainty $Uc(y)$	1.27		
Measuring Uncertainty for a Level of Confidence of 95% ($U = 2Uc(y)$)	2.54		

Uncertainty of Radiated Emission Measurement (1 GHz ~ 40 GHz)

Contribution	Uncertainty of X_i		$u(X_i)$	C_i	$C_i * u(X_i)$
	dB	Probability Distribution			
Receiver Reading	± 0.10	Normal (k=2)	0.10	1	0.10
Antenna Factor Calibration	± 1.70	Normal (k=2)	0.85	1	0.85
Cable Loss Calibration	± 0.50	Normal (k=2)	0.25	1	0.25
Receiver Correction	± 2.00	Rectangular	1.15	1	1.15
Antenna Factor Directional	± 1.50	Rectangular	0.87	1	0.87
Site Imperfection	± 2.80	Triangular	1.14	1	1.14
Mismatch Receiver VSWR $\Gamma_1 = 0.197$ Antenna VSWR $\Gamma_2 = 0.194$ Uncertainty = $20\text{Log}(1-\Gamma_1*\Gamma_2)$	+0.34 / -0.35	U-Shape	0.244	1	0.244
Combined Standard Uncertainty $Uc(y)$	2.36				
Measuring Uncertainty for a Level of Confidence of 95% ($U = 2Uc(y)$)	4.72				

6 Certification of TAF Accreditation



Certificate No. : L1190-090318

財團法人全國認證基金會
Taiwan Accreditation Foundation

Certificate of Accreditation

This is to certify that

Sporton International Inc.

EMC & Wireless Communications Laboratory

No.52, Hwa Ya 1st Rd., Hwa Ya Technology Park, Kwei-Shan Hsiang, Tao Yuan Hsien,
Taiwan, R.O.C.

is accredited in respect of laboratory

Accreditation Criteria : ISO/IEC 17025:2005
Accreditation Number : 1190
Originally Accredited : December 15, 2003
Effective Period : January 10, 2007 to January 09, 2010
Accredited Scope : Testing Field, see described in the Appendix
Specific Accreditation Program : Accreditation Program for Designated Testing Laboratory for Commodities Inspection
Accreditation Program for Telecommunication Equipment Testing Laboratory
Accreditation Program for BSMI Mutual Recognition Arrangement with Foreign Authorities



Jay-San Chen
President, Taiwan Accreditation Foundation
Date : March 18, 2009

PI, total 19 pages

The Appendix forms an integral part of this Certificate, which shall be invalid when use without the Appendix



Appendix A. Photographs of EUT

Please refer to Sporton report number EP961306-05 as below.