



FCC RF Test Report

APPLICANT : HTC Corporation
EQUIPMENT : PDA Phone
MODEL NAME : PB00100
FCC ID : NM8PB00100
STANDARD : FCC Part 15 Subpart C §15.247
CLASSIFICATION : Digital Transmission System (DTS)

The product was received on Jul. 14, 2009 and completely tested on Aug. 16, 2009. We, SPORTON INTERNATIONAL INC., would like to declare that the tested sample has been evaluated in accordance with the procedures given in ANSI C63.4-2003 and shown the compliance with the applicable technical standards.

The test results in this report apply exclusively to the tested model / sample. Without written approval of SPORTON INTERNATIONAL INC., the test report shall not be reproduced except in full.

Reviewed by:

Roy Wu / Manager



SPORTON INTERNATIONAL INC.

No. 52, Hwa Ya 1st Rd., Hwa Ya Technology Park, Kwei-Shan Hsiang, Tao Yuan Hsien, Taiwan, R.O.C.



TABLE OF CONTENTS

REVISION HISTORY.....3

SUMMARY OF TEST RESULT4

1 GENERAL DESCRIPTION.....5

 1.1 Applicant.....5

 1.2 Manufacturer.....5

 1.3 Feature of Equipment Under Test5

 1.4 Testing Site.....6

 1.5 Applied Standards6

 1.6 Ancillary Equipment List7

2 TEST CONFIGURATION OF EQUIPMENT UNDER TEST.....8

 2.1 Pre-Scanned RF Power.....8

 2.2 Test Mode.....9

 2.3 Connection Diagram of Test System.....10

 2.4 RF Utility11

3 TEST RESULT.....12

 3.1 6dB Bandwidth Measurement12

 3.2 Output Power Measurement.....17

 3.3 Band Edges Measurement22

 3.4 Spurious Emission Measurement.....27

 3.5 Power Spectral Density Measurement34

 3.6 AC Conducted Emission Measurement.....39

 3.7 Radiated Emission Measurement.....43

 3.8 Antenna Requirements.....60

4 LIST OF MEASURING EQUIPMENT61

5 UNCERTAINTY OF EVALUATION.....62

6 CERTIFICATION OF TAF ACCREDITATION64

APPENDIX A. PHOTOGRAPHS OF EUT

APPENDIX B. SETUP PHOTOGRAPHS



REVISION HISTORY

REPORT NO.	VERSION	DESCRIPTION	ISSUED DATE
FR971401B	Rev. 01	Initial issue of report	Sep. 09, 2009



SUMMARY OF TEST RESULT

Report Section	FCC Rule	IC Rule	Description	Limit	Result	Remark
3.1	15.247(a)(2)	A8.2(a)	6dB Bandwidth	$\geq 0.5\text{MHz}$	Pass	-
3.2	15.247(b)	A8.4	Power Output	$\leq 30\text{dBm}$	Pass	-
3.3	15.247(d)	A8.5	Frequency Band Edges	$\leq 20\text{dBc}$	Pass	-
3.4	15.247(d)	A8.5	Spurious Emission	$< 20\text{ dBc}$	Pass	-
3.5	15.247(e)	A8.2(b)	Power Spectral Density	$\leq 8\text{dBm}$	Pass	-
3.6	15.207	Gen 7.2.2	AC Conducted Emission	15.207(a)	Pass	Under limit 5.3 dB at 0.310 MHz
3.7	15.247(d)	A8.5	Transmitter Radiated Emission	15.209(a) & 15.247(d)	Pass	Under limit 1.45 dB at 2389.99 MHz
3.8	15.203 & 15.247(b)	A8.4	Antenna Requirement	N/A	Pass	-



1 General Description

1.1 Applicant

HTC Corporation

No. 23, Xinghua Rd., Taoyuan City, Taiwan

1.2 Manufacturer

HTC Corporation

1F., No. 6-3, Baoqiang Rd., Sindian City, Taipei, Taiwan

1.3 Feature of Equipment Under Test

Product Feature & Specification	
Equipment	PDA Phone
PDA Phone 1	EUT with LCM-Main
PDA Phone 2	EUT with LCM-2nd
Model Name	PB00100
FCC ID	NM8PB00100
Tx/Rx Frequency Range	2400 MHz ~ 2483.5 MHz
Number of Channels	11
Carrier Frequency of Each Channel	$2412+(n-1)*5$ MHz; n=1~11
Channel Spacing	5 MHz
Maximum Output Power to Antenna	802.11b: 17.87 dBm (61.24 mW) 802.11g : 15.76 dBm (37.67 mW)
Antenna Type	PIFA Antenna with gain 0 dBi
Type of Modulation	802.11b : DSSS (BPSK / QPSK / CCK) 802.11g : OFDM (BPSK / QPSK / 16QAM / 64QAM)
EUT Stage	Production Unit

Remark:

1. For other wireless features of this EUT, test report will be issued separately.
2. This test report recorded only product characteristics and test results of Digital Transmission System (DTS).



1.4 Testing Site

Test Site	SPORTON INTERNATIONAL INC.		
Test Site Location	No. 52, Hwa Ya 1 st Rd., Hwa Ya Technology Park, Kwei-Shan Hsiang, Tao Yuan Hsien, Taiwan, R.O.C. TEL: +886-3-3273456 / FAX: +886-3-3284978		
Test Site No.	Sporton Site No.		FCC/IC Registration No.
	CO05-HY	03CH06-HY	TW1022/4086B-1

1.5 Applied Standards

According to the specifications of the manufacturer, the EUT must comply with the requirements of the following standards:

- ♦ FCC Part 15 Subpart C §15.247
- ♦ FCC KDB Publication No. 558074 (Measurement Guidelines of DTS)
- ♦ ANSI C63.4-2003
- ♦ IC RSS-210 Issue 7

Remark:

1. All test items were verified and recorded according to the standards and without any deviation during the test.
2. This EUT has also been tested and complied with the requirements of FCC Part 15, Subpart B (DoC), recorded in a separate test report.



1.6 Ancillary Equipment List

Item	Equipment	Trade Name	Model Name	FCC ID	Data Cable	Power Cord
1.	System Simulator	R&S	CMU 200	N/A	N/A	Unshielded, 1.8 m
2.	GPS Base Station	T&E	GS-50	N/A	N/A	Unshielded, 1.8 m
3.	WLAN AP	D-Link	DIR-628	KA2DIR628A2	N/A	Unshielded, 1.8 m
4.	Notebook	DELL	Vostro 1510	FCC DoC	N/A	AC I/P: Unshielded, 1.2 m DC O/P: Shielded, 1.8 m
5.	LCD Monitor	Lenovo	6135-AB1	FCC DoC	Shielded, 1.6 m	Unshielded, 1.8 m
6.	Bluetooth Earphone	Nokia	BH-100	PYA1YH	N/A	N/A
7.	iPod	Apple	A1285	FCC DoC	Shielded, 1.0 m	N/A

2 Test Configuration of Equipment Under Test

2.1 Pre-Scanned RF Power

Preliminary tests were performed in different data rate and recorded the RF power output in the following table:

802.11b Pre-Scanned RF Power (dBm)					
Channel	Frequency (MHz)	Data Rate			
		1 Mbps	2 Mbps	5.5 Mbps	11 Mbps
CH 01	2412 MHz	15.74	15.76	15.80	15.75
CH 06	2437 MHz	16.05	16.07	16.11	16.18
CH 11	2462 MHz	16.38	16.32	16.33	16.31

802.11g Pre-Scanned RF Power (dBm)									
Channel	Frequency (MHz)	Data Rate							
		6 Mbps	9 Mbps	12 Mbps	18 Mbps	24 Mbps	36 Mbps	48 Mbps	54 Mbps
CH 01	2412 MHz	12.15	12.08	11.27	11.31	11.87	12.09	11.57	11.48
CH 06	2437 MHz	12.63	12.57	11.57	11.52	12.25	12.22	11.85	11.84
CH 11	2462 MHz	12.64	12.62	11.70	11.74	12.37	12.33	11.95	11.94

Remark:

1. For WLAN RF power, the pre-scanned RF power was measured by power meter.
2. The 802.11b data rates were set in 1 Mbps and 802.11g data rates were set in 6 Mbps for all the test cases, due to the highest RF output power.
3. The EUT is programmed to transmit signals continuously for all testing.



2.2 Test Mode

The EUT has been associated with peripherals pursuant to ANSI C63.4-2003 and configuration operated in a manner tended to maximize its emission characteristics in a typical application. Frequency range investigated: conducted emission (150 kHz to 30 MHz), radiated emission (30 MHz to the 10th harmonic of the highest fundamental frequency or to 40 GHz, whichever is lower). Pre-scanned tests were conducted to determine the final configuration from all possible combinations. The following tables are showing the test modes as the worst cases and recorded in this report.

Test Cases		
Test Item	802.11b	802.11g
Conducted TCs	Mode 1 : CH01_2412 MHz Mode 2 : CH06_2437 MHz Mode 3 : CH11_2462 MHz	Mode 4 : CH01_2412 MHz Mode 5 : CH06_2437 MHz Mode 6 : CH11_2462 MHz
Radiated TCs	Mode 1 : CH01_2412 MHz + Adapter 1 + Battery 1 + USB Cable 1 for PDA Phone 1 Mode 2 : CH06_2437 MHz + Adapter 1 + Battery 1 + USB Cable 1 for PDA Phone 1 Mode 3 : CH11_2462 MHz + Adapter 1 + Battery 1 + USB Cable 1 for PDA Phone 1	Mode 4 : CH01_2412 MHz + Adapter 1 + Battery 1 + USB Cable 1 for PDA Phone 1 Mode 5 : CH06_2437 MHz + Adapter 1 + Battery 1 + USB Cable 1 for PDA Phone 1 Mode 6 : CH11_2462 MHz + Adapter 1 + Battery 1 + USB Cable 1 for PDA Phone 1 Mode 7 : CH01_2412 MHz + Adapter 1 + Battery 1 + USB Cable 1 for PDA Phone 2
AC Conducted Emission	Mode 1 : PDA Phone 1 + CDMA2000 BC0 (1xRTT) Idle + WLAN Link + Bluetooth Link + Camera + GPS Rx + Battery 1 + Adapter 1 Mode 2 : PDA Phone 1 + CDMA2000 BC1 (1xRTT) Idle + WLAN Link + Bluetooth Link + MPEG4 + GPS Rx + Battery 2 + Adapter 2 Mode 3 : PDA Phone 1 + CDMA2000 BC0 (1xRTT) Idle + WLAN Link + Bluetooth Link + Camera + GPS Rx + Battery 2 + USB Cable 1 (Link with Notebook) Mode 4 : PDA Phone 1 + CDMA2000 BC1 (1xRTT) Idle + WLAN Link + Bluetooth Link + Camera + GPS Rx + Battery 1 + USB Cable 2 (Link with Notebook) Mode 5 : PDA Phone 2 + CDMA2000 BC1 (1xRTT) Idle + WLAN Link + Bluetooth Link + Camera + GPS Rx + Battery 1 + USB Cable 2 (Link with Notebook)	
Remark: The worst case of conducted emission is mode 4; only the test data of it was reported.		

2.3 Connection Diagram of Test System

<Conducted Emission>
EUT with Adapter Mode

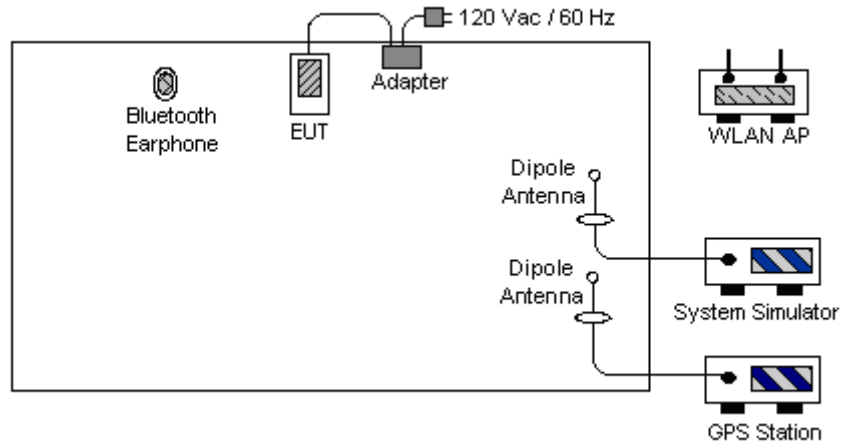

EUT with USB Link Mode

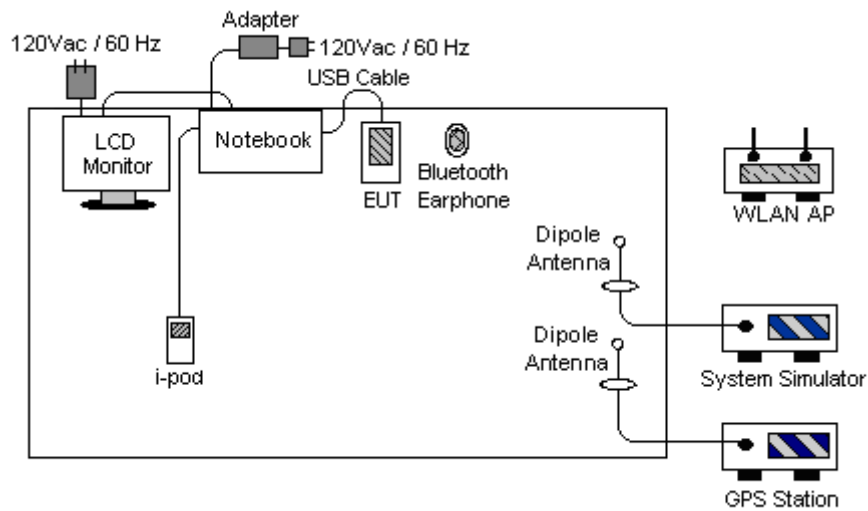

<Radiated Emission>

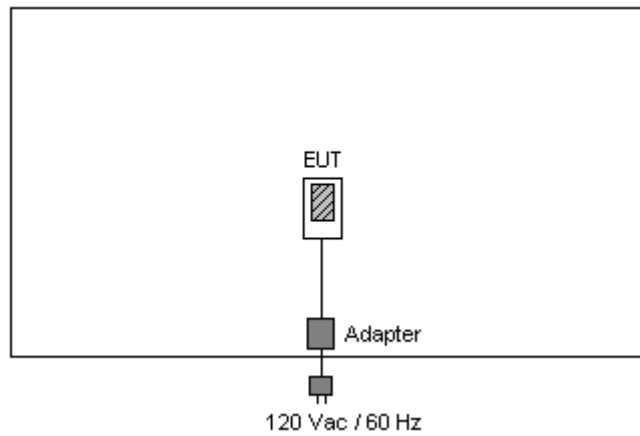

2.4 RF Utility

The programmed RF utility, "RadioScope_422_Router" is installed in EUT to provide channel selection, power level, data rate and the application type. RF Utility can send transmitting signal for all testing. The RF output power selection is for the setting of RF output power expected by the customer and is going to be fixed on the firmware of the final end product.

3 Test Result

3.1 6dB Bandwidth Measurement

3.1.1 Limit of 6dB Bandwidth

The minimum 6 dB bandwidth shall be at least 500 kHz.

3.1.2 Measuring Instruments

See list of measuring instruments of this test report.

3.1.3 Test Procedures

1. The testing follows FCC KDB Publication No. 558074 (Measurement Guidelines of DTS).
2. The RF output of EUT was connected to the spectrum analyzer by a low loss cable.
3. Make the measurement with the spectrum analyzer's resolution bandwidth (RBW) = 100 kHz.
In order to make an accurate measurement, set the span greater than RBW. The 6 dB bandwidth must be greater than 500 kHz.
4. The marker-delta reading at this point is the 6 dB bandwidth of the emission.

3.1.4 Test Setup

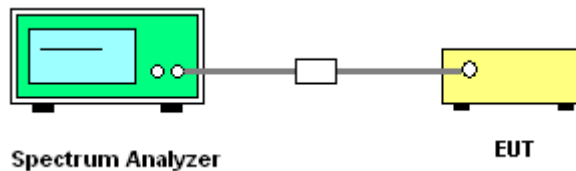



3.1.5 Test Result of 6dB Bandwidth

Test Mode :	Mode 1, 2, 3	Temperature :	23~24°C
Test Engineer :	Eric Huang	Relative Humidity :	42~43%

Channel	Frequency (MHz)	802.11b 6dB Bandwidth (MHz)	6dB Bandwidth Min. Limit (MHz)	Pass/Fail
01	2412	10.08	0.5	Pass
06	2437	10.08	0.5	Pass
11	2462	10.08	0.5	Pass

Mode 1 : 6 dB Bandwidth Plot on 802.11b Channel 01

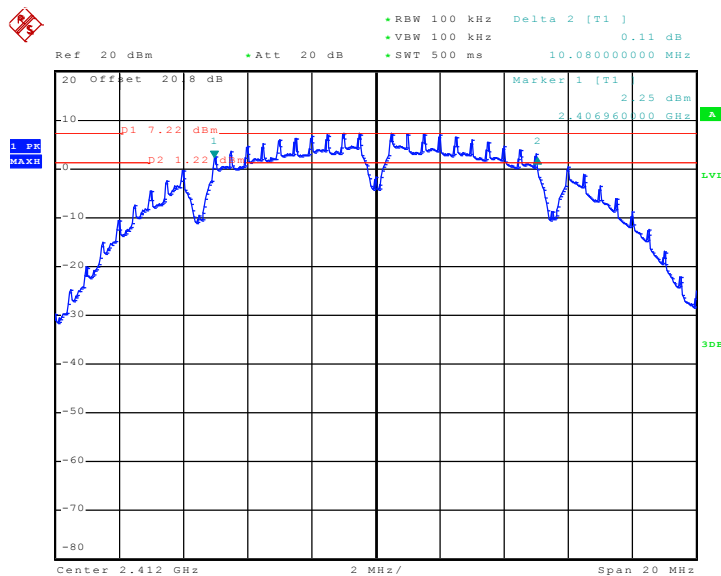

Date: 12.AUG.2009 22:06:55



Mode 2 : 6 dB Bandwidth Plot on 802.11b Channel 06

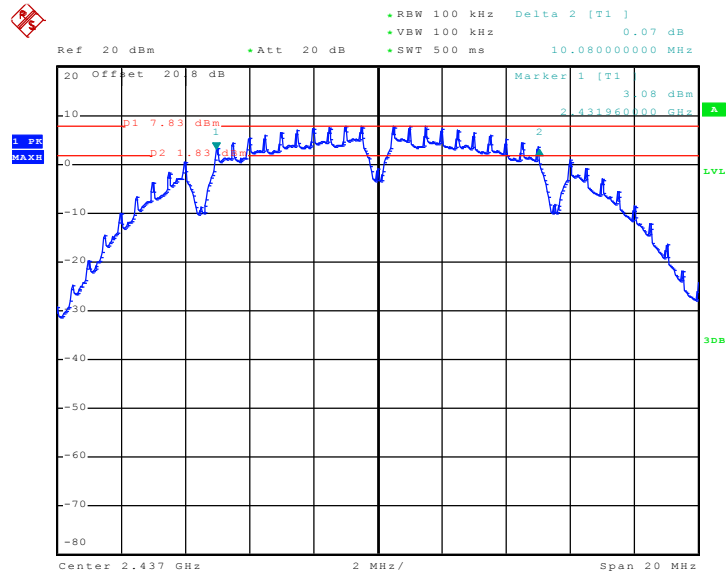

Date: 12.AUG.2009 20:31:01

Mode 3 : 6 dB Bandwidth Plot on 802.11b Channel 11

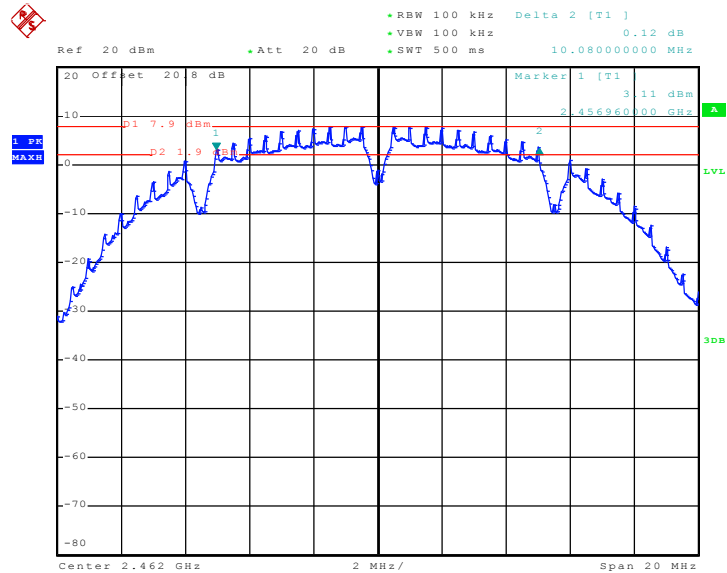

Date: 12.AUG.2009 20:31:53



Test Mode :	Mode 4, 5, 6	Temperature :	23~24°C
Test Engineer :	Eric Huang	Relative Humidity :	42~43%

Channel	Frequency (MHz)	802.11g 6dB Bandwidth (MHz)	6dB Bandwidth Min. Limit (MHz)	Pass/Fail
01	2412	16.32	0.5	Pass
06	2437	16.36	0.5	Pass
11	2462	16.32	0.5	Pass

Mode 4 : 6 dB Bandwidth Plot on 802.11g Channel 01

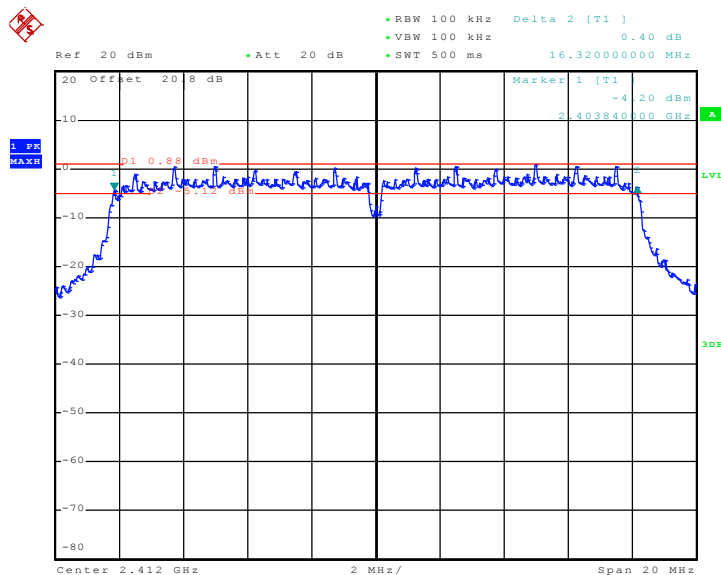

Date: 12.AUG.2009 20:38:21



Mode 5 : 6 dB Bandwidth Plot on 802.11g Channel 06

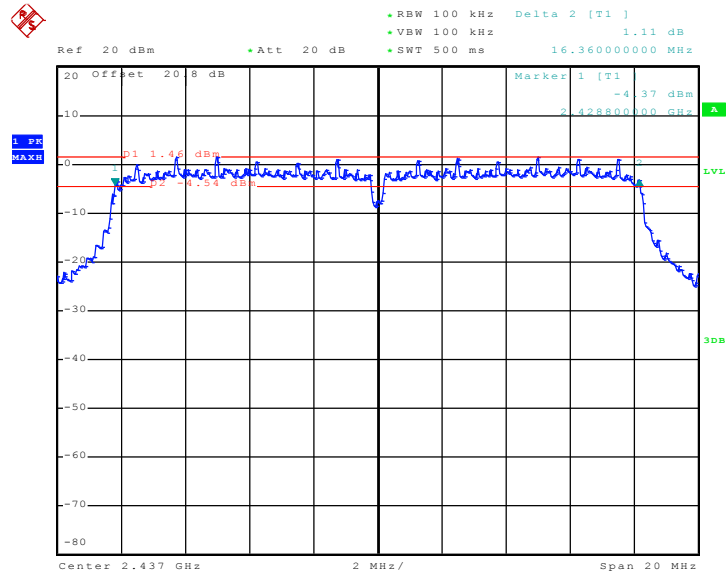

Date: 12.AUG.2009 20:37:21

Mode 6 : 6 dB Bandwidth Plot on 802.11g Channel 11

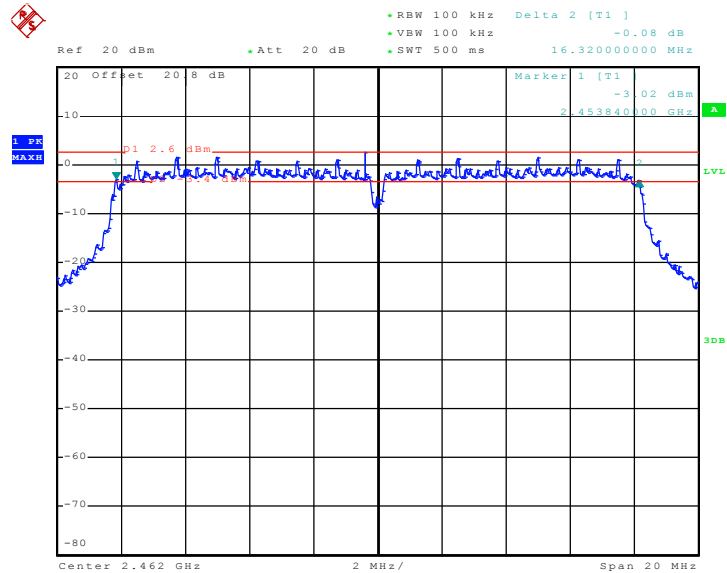

Date: 12.AUG.2009 20:35:05

3.2 Output Power Measurement

3.2.1 Limit of Output Power

For systems using digital modulation in the 2400-2483.5MHz, the limit for peak output power is 30dBm. If transmitting antenna of directional gain greater than 6dBi are used the peak output power from the intentional radiator shall be reduced below the above stated value by the amount in dB that the directional gain of the antenna exceeds 6 dBi. In case of point-to-point operation, the limit has to be reduced by 1dB for every 3dB that the directional gain of the antenna exceeds 6dBi.

3.2.2 Measuring Instruments

See list of measuring instruments of this test report.

3.2.3 Test Procedures

1. The testing follows FCC KDB Publication No. 558074 (Measurement Guidelines of DTS).
2. The RF output of EUT was connected to the spectrum analyzer by a low loss cable.
3. Measure the power by spectrum analyzer.

3.2.4 Test Setup

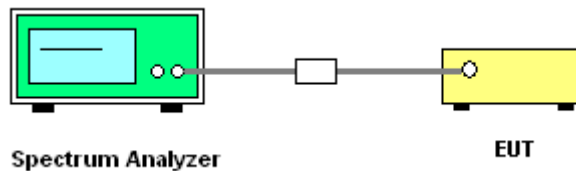



3.2.5 Test Result of Output Power

Test Mode :	Mode 1, 2, 3	Temperature :	23~24°C
Test Engineer :	Eric Huang	Relative Humidity :	42~43%

Channel	Frequency (MHz)	802.11b Measured Output Power (dBm)	Max. Limits (dBm)	Pass/Fail
01	2412	17.31	30	Pass
06	2437	17.78	30	Pass
11	2462	17.87	30	Pass

Mode 1 : Output Power Plot on 802.11b Channel 01

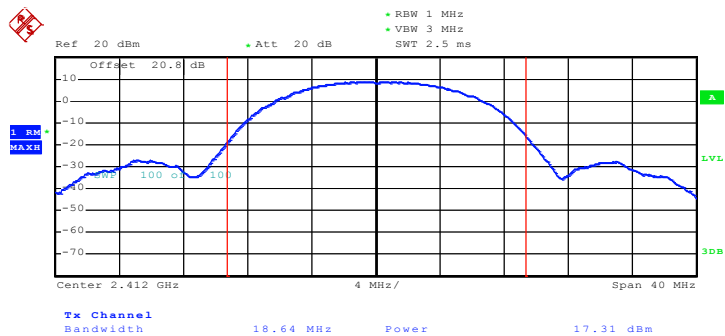

Date: 10.AUG.2009 20:13:20



Mode 2 : Output Power Plot on 802.11b Channel 06

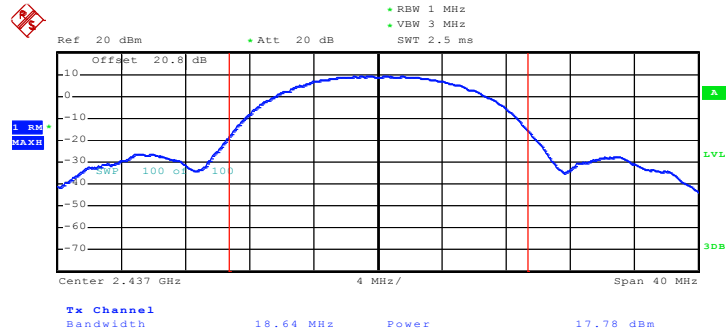

Date: 10.AUG.2009 20:13:52

Mode 3 : Output Power Plot on 802.11b Channel 11

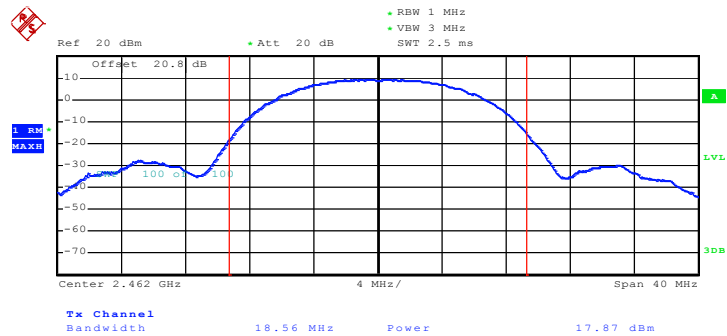

Date: 10.AUG.2009 20:14:22



Test Mode :	Mode 4, 5, 6	Temperature :	23~24°C
Test Engineer :	Eric Huang	Relative Humidity :	42~43%

Channel	Frequency (MHz)	802.11g Measured Output Power (dBm)	Max. Limits (dBm)	Pass/Fail
01	2412	15.15	30	Pass
06	2437	15.56	30	Pass
11	2462	15.76	30	Pass

Mode 4 : Output Power Plot on 802.11g Channel 01

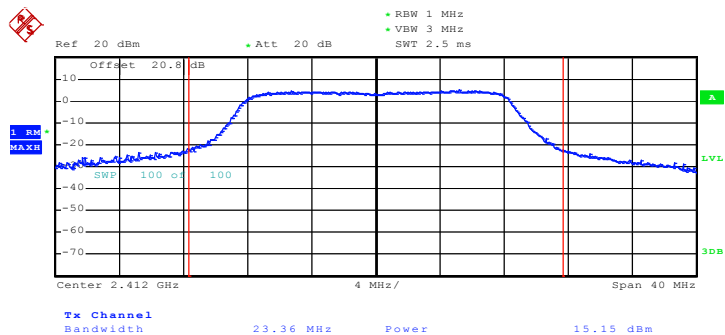

Date: 10.AUG.2009 20:16:51



Mode 5 : Output Power Plot on 802.11g Channel 06

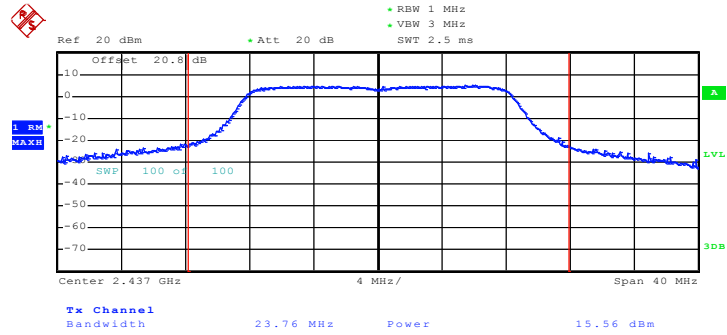

Date: 10.AUG.2009 20:17:47

Mode 6 : Output Power Plot on 802.11g Channel 11

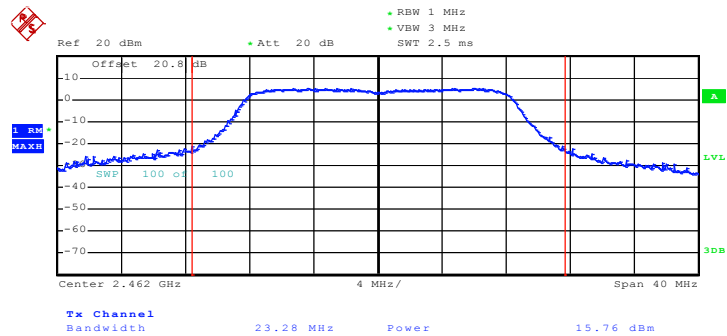

Date: 10.AUG.2009 20:18:41

3.3 Band Edges Measurement

3.3.1 Limit of Band Edges

In any 100 kHz bandwidth outside the intentional radiation frequency band, the radio frequency power shall be at least 20 dB below the highest level of the radiated power. If the output power of this device was measured by spectrum analyzer, the attenuation under this paragraph shall be 30 dB instead of 20 dB.

3.3.2 Measuring Instruments

See list of measuring instruments of this test report.

3.3.3 Test Procedures

1. The testing follows the guidelines in ANSI C63.4-2003 and FCC KDB Publication No. 558074 (Measurement Guidelines of DTS).
2. Conducted emission test: Set RBW = 100 kHz, Video bandwidth (VBW) > RBW, scan up through 10th harmonic. Band edge emissions must be at least 20 dB below the highest emission level within the authorized band as measured with a 100 kHz RBW. Note: If the output power of this device was measured by power meter, the attenuation under this paragraph shall be 30 dB instead of 20 dB.
3. Radiated emission test: Apply to band edge emissions that fall in the restricted bands listed in FCC Section 15.205. The maximum permitted average field strength is listed in FCC Section 15.209. A pre-amp is necessary for this measurement. For measurements above 1 GHz, set RBW = 1MHz, VBW = 10 Hz, Sweep=Auto. If the emission is pulsed, modify the unit for continuous operation; use the settings shown above, then correct the reading by subtracting the peak-average correction factor, derived from the appropriate duty cycle calculation as in FCC Section 15.35(b) and (c).

3.3.4 Test Setup

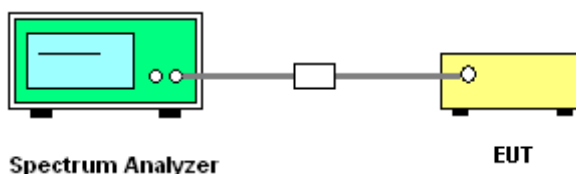



3.3.5 Test Result of Radiated Band Edges

Test Mode :	Mode 1	Temperature :	25~27°C
Test Band :	802.11b	Relative Humidity :	46~51%
Test Channel :	01	Test Engineer :	Kai Wang

ANTENNA POLARITY : HORIZONTAL										
Frequency (MHz)	Level (dBuV/m)	Over Limit (dB)	Limit Line (dBuV/m)	Read Level (dBuV)	Antenna Factor (dB)	Cable Loss (dB)	Preamp Factor (dB)	Ant Pos (cm)	Table Pos (deg)	Remark
2385.65	53.14	-20.86	74.00	53.52	31.98	3.92	36.28	200	162	Peak
2385.65	42.70	-11.30	54.00	43.08	31.98	3.92	36.28	200	162	Average

ANTENNA POLARITY : VERTICAL										
Frequency (MHz)	Level (dBuV/m)	Over Limit (dB)	Limit Line (dBuV/m)	Read Level (dBuV)	Antenna Factor (dB)	Cable Loss (dB)	Preamp Factor (dB)	Ant Pos (cm)	Table Pos (deg)	Remark
2387.33	48.42	-25.58	74.00	48.80	31.98	3.92	36.28	100	311	Peak
2387.33	36.56	-17.44	54.00	36.94	31.98	3.92	36.28	100	311	Average

Test Mode :	Mode 3	Temperature :	25~27°C
Test Band :	802.11b	Relative Humidity :	46~51%
Test Channel :	11	Test Engineer :	Kai Wang

ANTENNA POLARITY : HORIZONTAL										
Frequency (MHz)	Level (dBuV/m)	Over Limit (dB)	Limit Line (dBuV/m)	Read Level (dBuV)	Antenna Factor (dB)	Cable Loss (dB)	Preamp Factor (dB)	Ant Pos (cm)	Table Pos (deg)	Remark
2483.50	50.09	-23.91	74.00	50.26	32.08	4.05	36.30	167	166	Peak
2483.50	37.85	-16.15	54.00	38.02	32.08	4.05	36.30	167	166	Average

ANTENNA POLARITY : VERTICAL										
Frequency (MHz)	Level (dBuV/m)	Over Limit (dB)	Limit Line (dBuV/m)	Read Level (dBuV)	Antenna Factor (dB)	Cable Loss (dB)	Preamp Factor (dB)	Ant Pos (cm)	Table Pos (deg)	Remark
2485.37	47.98	-26.02	74.00	48.15	32.08	4.05	36.30	100	310	Peak
2485.37	35.02	-18.98	54.00	35.19	32.08	4.05	36.30	100	310	Average



Test Mode :	Mode 5	Temperature :	25~27°C
Test Band :	802.11g	Relative Humidity :	46~51%
Test Channel :	01	Test Engineer :	Kai Wang

ANTENNA POLARITY : HORIZONTAL										
Frequency (MHz)	Level (dBuV/m)	Over Limit (dB)	Limit Line (dBuV/m)	Read Level (dBuV)	Antenna Factor (dB)	Cable Loss (dB)	Preamp Factor (dB)	Ant Pos (cm)	Table Pos (deg)	Remark
2389.99	72.55	-1.45	74.00	72.93	31.98	3.92	36.28	200	131	Peak
2389.99	48.51	-5.49	54.00	48.89	31.98	3.92	36.28	200	131	Average

ANTENNA POLARITY : VERTICAL										
Frequency (MHz)	Level (dBuV/m)	Over Limit (dB)	Limit Line (dBuV/m)	Read Level (dBuV)	Antenna Factor (dB)	Cable Loss (dB)	Preamp Factor (dB)	Ant Pos (cm)	Table Pos (deg)	Remark
2389.99	62.16	-11.84	74.00	62.54	31.98	3.92	36.28	133	191	Peak
2389.99	40.21	-13.79	54.00	40.59	31.98	3.92	36.28	133	191	Average

Test Mode :	Mode 7	Temperature :	25~27°C
Test Band :	802.11g	Relative Humidity :	46~51%
Test Channel :	11	Test Engineer :	Kai Wang

ANTENNA POLARITY : HORIZONTAL										
Frequency (MHz)	Level (dBuV/m)	Over Limit (dB)	Limit Line (dBuV/m)	Read Level (dBuV)	Antenna Factor (dB)	Cable Loss (dB)	Preamp Factor (dB)	Ant Pos (cm)	Table Pos (deg)	Remark
2483.50	60.22	-13.78	74.00	60.38	32.08	4.05	36.30	200	169	Peak
2483.50	39.84	-14.16	54.00	40.01	32.08	4.05	36.30	200	169	Average

ANTENNA POLARITY : VERTICAL										
Frequency (MHz)	Level (dBuV/m)	Over Limit (dB)	Limit Line (dBuV/m)	Read Level (dBuV)	Antenna Factor (dB)	Cable Loss (dB)	Preamp Factor (dB)	Ant Pos (cm)	Table Pos (deg)	Remark
2483.50	56.40	-17.60	74.00	56.57	32.08	4.05	36.30	131	190	Peak
2483.50	35.28	-18.72	54.00	35.45	32.08	4.05	36.30	131	190	Average



3.3.6 Test Plots of Conducted Band Edges

Test Mode :	Mode 1 and 3	Temperature :	23~24°C
Test Band :	802.11b	Relative Humidity :	42~43%
Test Channel :	01 and 11	Test Engineer :	Eric Huang

Low Band Edge Plot on 802.11b Channel 01

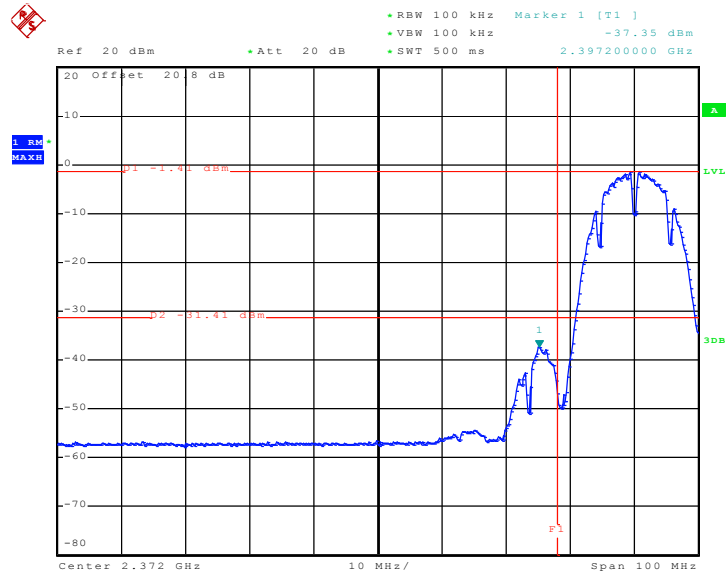

Date: 12.AUG.2009 20:26:54

High Band Edge Plot on 802.11b Channel 11

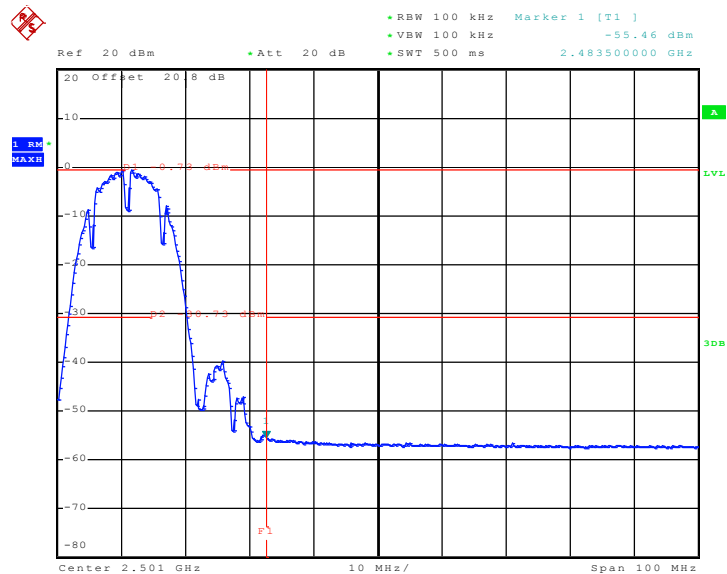

Date: 12.AUG.2009 20:27:59



Test Mode :	Mode 4 and 6	Temperature :	23~24°C
Test Band :	802.11g	Relative Humidity :	42~43%
Test Channel :	01 and 11	Test Engineer :	Eric Huang

Low Band Edge Plot on 802.11g Channel 01

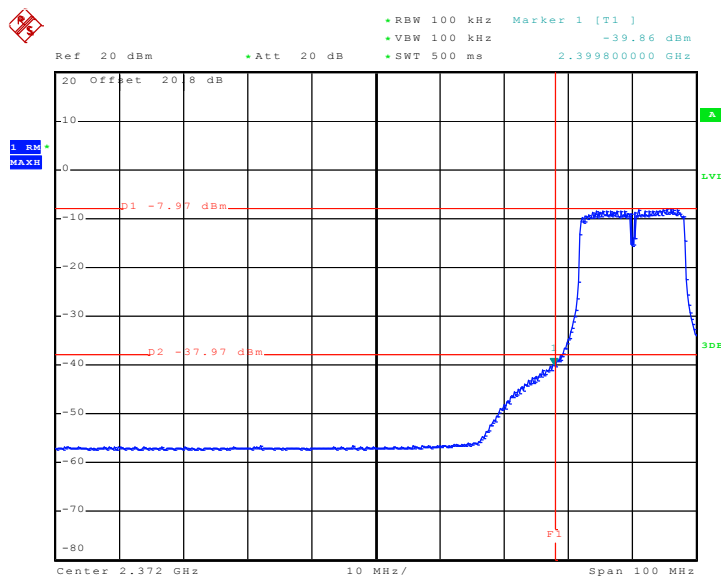

Date: 12.AUG.2009 20:25:56

High Band Edge Plot on 802.11g Channel 11

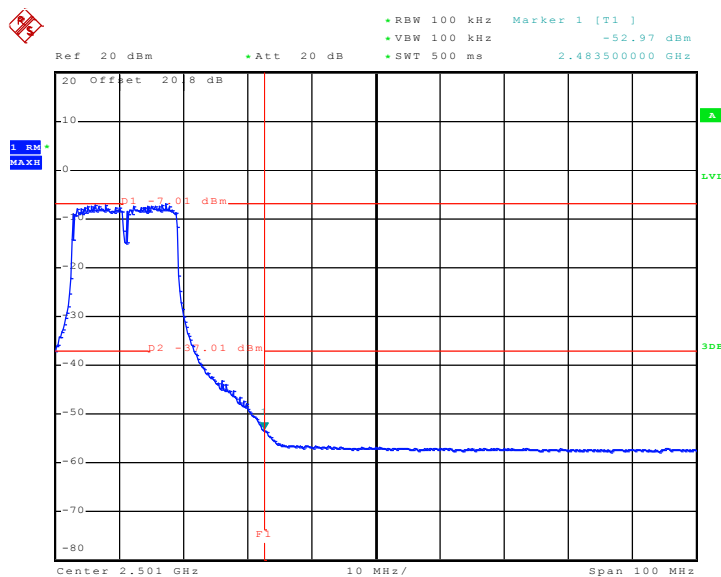

Date: 12.AUG.2009 20:28:36

3.4 Spurious Emission Measurement

3.4.1 Limit of Spurious Emission Measurement

All harmonics/spurs must be at least 20 dB down from the highest emission level within the authorized band.

3.4.2 Measuring Instruments

See list of measuring instruments of this test report.

3.4.3 Test Procedure

1. The transmitter output was connected to the spectrum analyzer via a low lose cable.
2. Set RBW = 100 kHz, Video bandwidth (VBW) \geq RBW, scan up through 10th harmonic. All harmonics/spurs must be at least 20 dB down from the highest emission level within the authorized band as measured with a 100 kHz RBW.

3.4.4 Test Setup

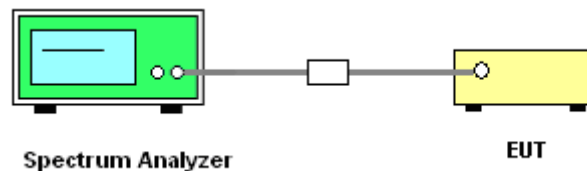



3.4.5 Test Plots of Spurious Emission

Test Mode :	Mode 1	Temperature :	23~24°C
Test Channel :	01	Relative Humidity :	42~43%
		Test Engineer :	Eric Huang

Conducted Spurious Emission Plot between 9 kHz ~ 3 GHz

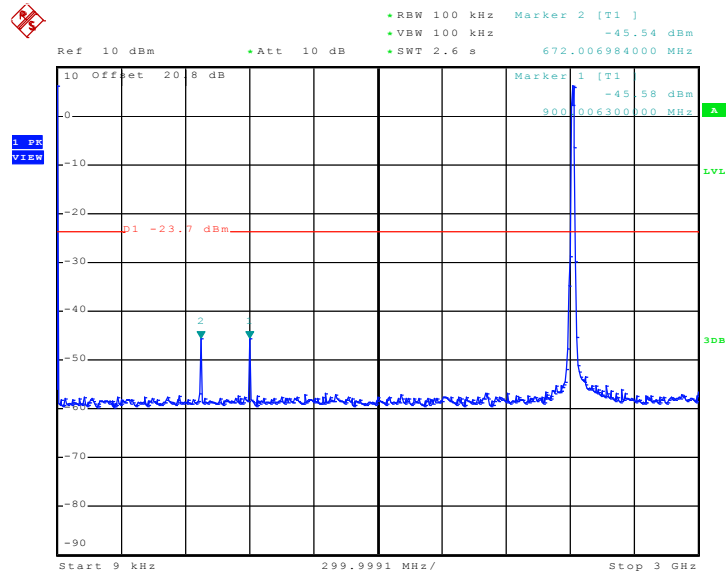

Date: 12.AUG.2009 21:01:48

Conducted Spurious Emission Plot between 1GHz ~ 25 GHz

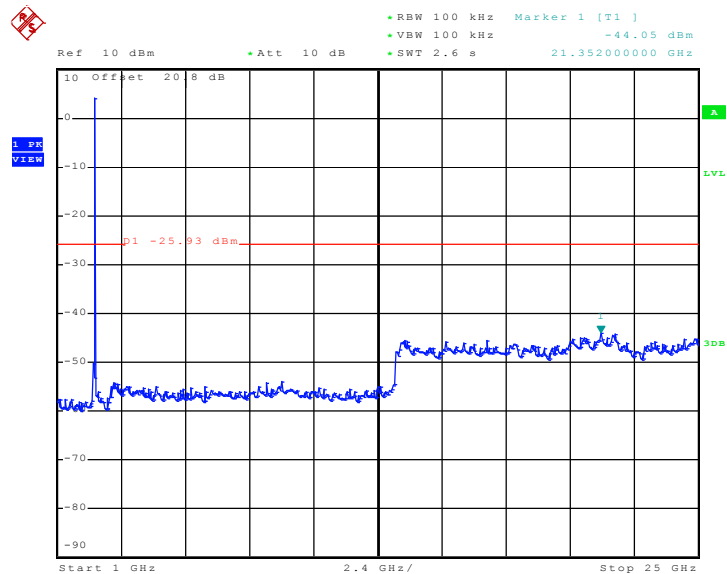

Date: 12.AUG.2009 20:52:13



Test Mode :	Mode 2	Temperature :	23~24°C
Test Channel :	06	Relative Humidity :	42~43%
		Test Engineer :	Eric Huang

Conducted Spurious Emission Plot between 9 kHz ~ 3 GHz

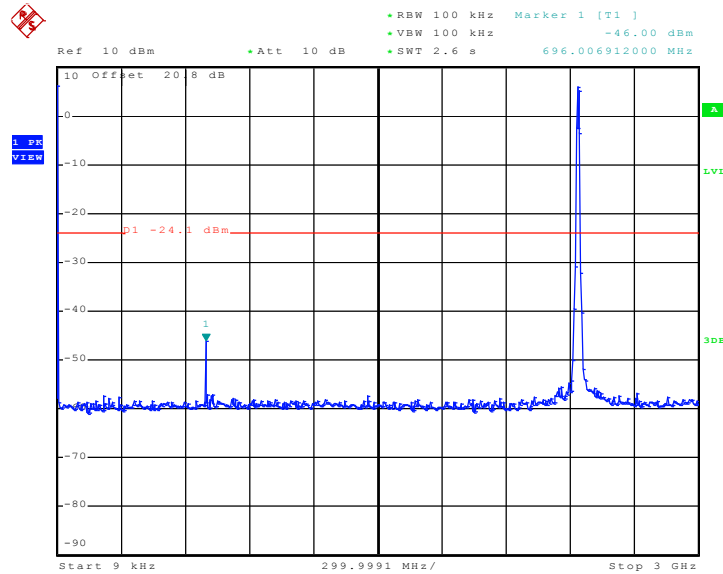

Date: 12.AUG.2009 21:08:55

Conducted Spurious Emission Plot between 1GHz ~ 25 GHz

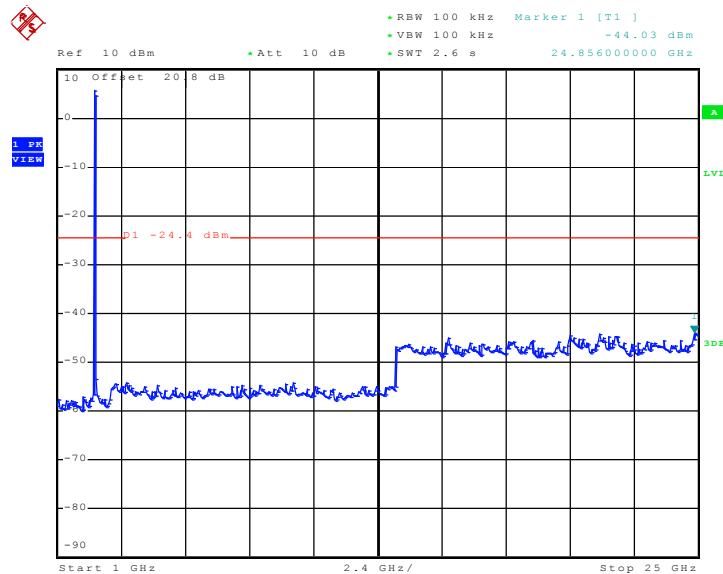

Date: 12.AUG.2009 20:52:58



Test Mode :	Mode 3	Temperature :	23~24°C
Test Channel :	11	Relative Humidity :	42~43%
		Test Engineer :	Eric Huang

Conducted Spurious Emission Plot between 9 kHz ~ 3 GHz

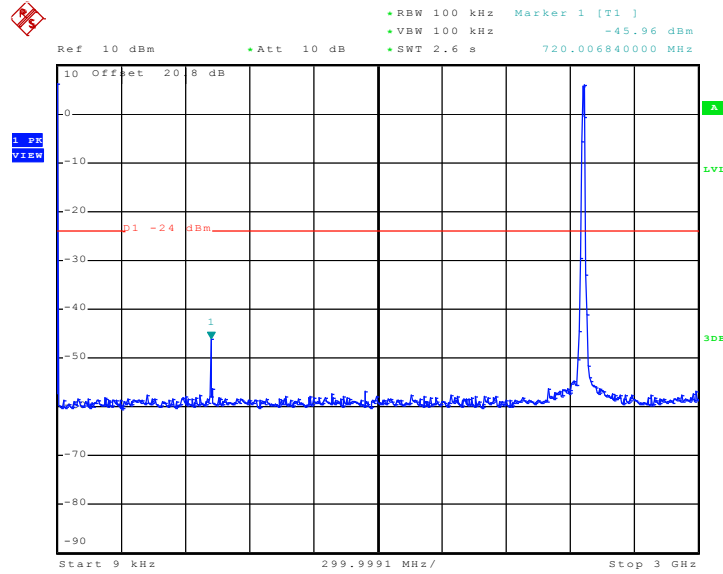

Date: 12.AUG.2009 21:09:25

Conducted Spurious Emission Plot between 1GHz ~ 25 GHz

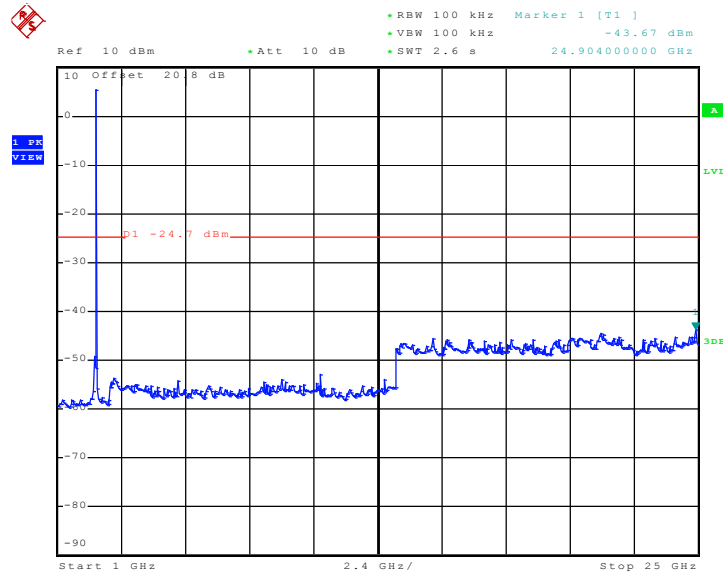

Date: 12.AUG.2009 20:53:39



Test Mode :	Mode 4	Temperature :	23~24°C
Test Channel :	01	Relative Humidity :	42~43%
		Test Engineer :	Eric Huang

Conducted Spurious Emission Plot between 9 kHz ~ 3 GHz

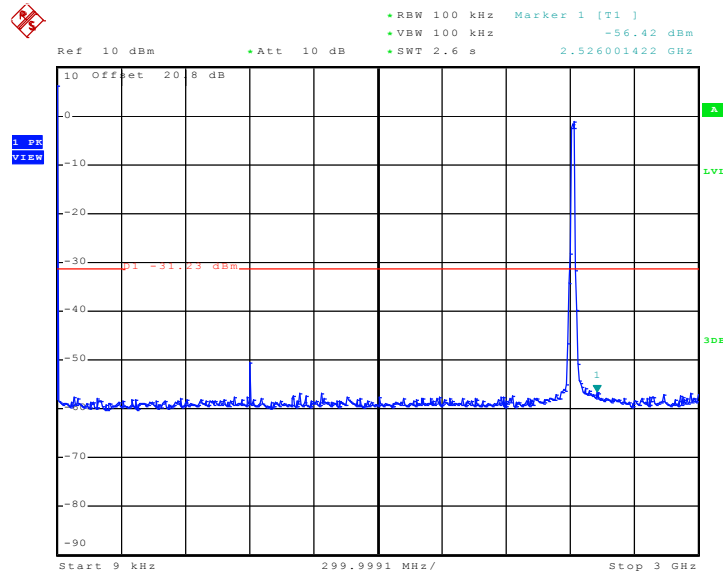

Date: 12.AUG.2009 20:54:09

Conducted Spurious Emission Plot between 1GHz ~ 25 GHz

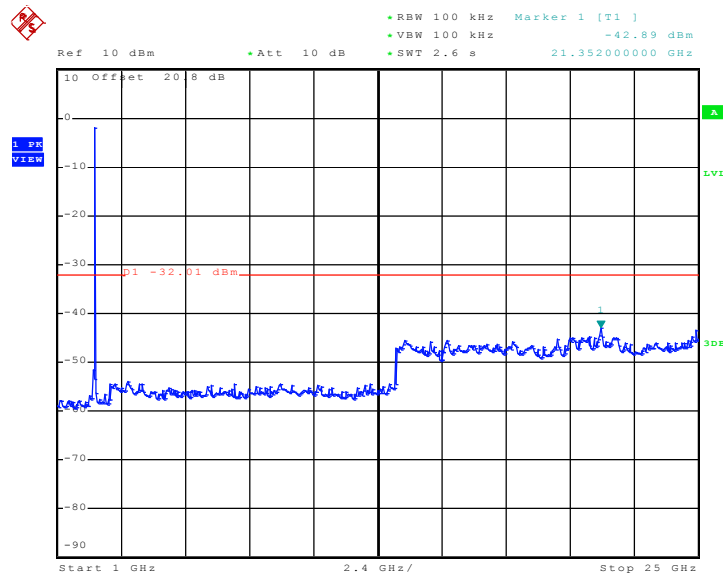

Date: 12.AUG.2009 20:54:31



Test Mode :	Mode 5	Temperature :	23~24°C
Test Channel :	06	Relative Humidity :	42~43%
		Test Engineer :	Eric Huang

Conducted Spurious Emission Plot between 9 kHz ~ 3 GHz

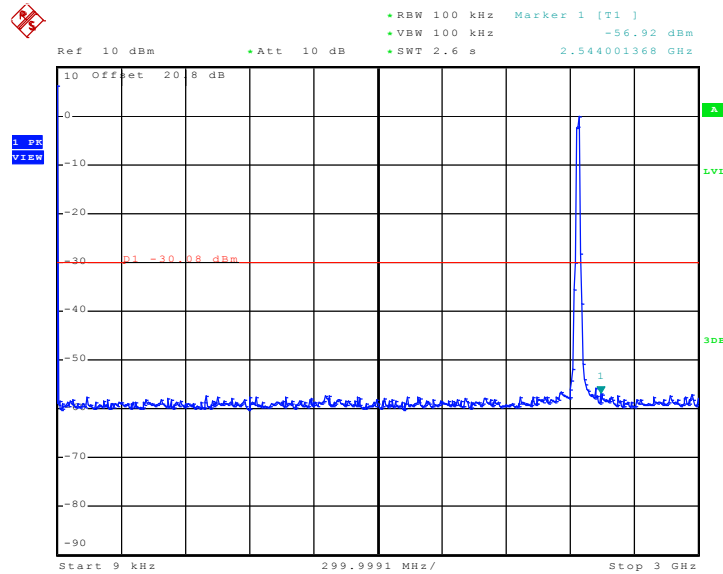

Date: 12.AUG.2009 20:54:54

Conducted Spurious Emission Plot between 1GHz ~ 25 GHz

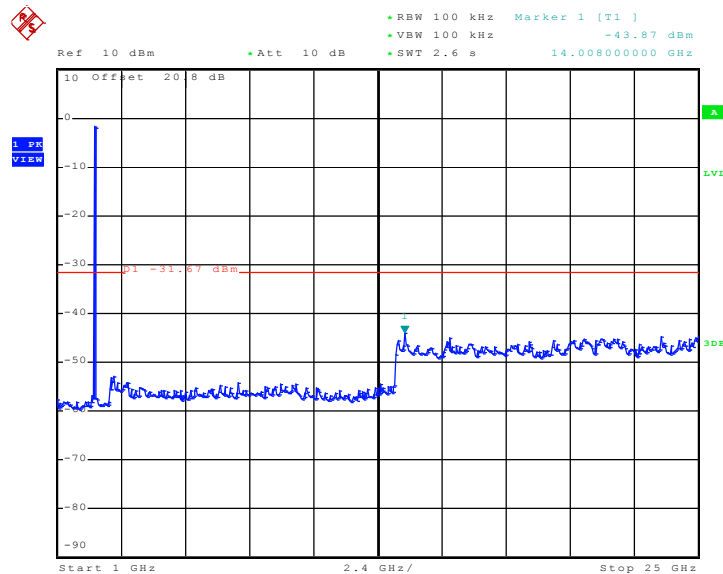

Date: 12.AUG.2009 20:55:09



Test Mode :	Mode 6	Temperature :	23~24°C
Test Channel :	11	Relative Humidity :	42~43%
		Test Engineer :	Eric Huang

Conducted Spurious Emission Plot between 9 kHz ~ 3 GHz

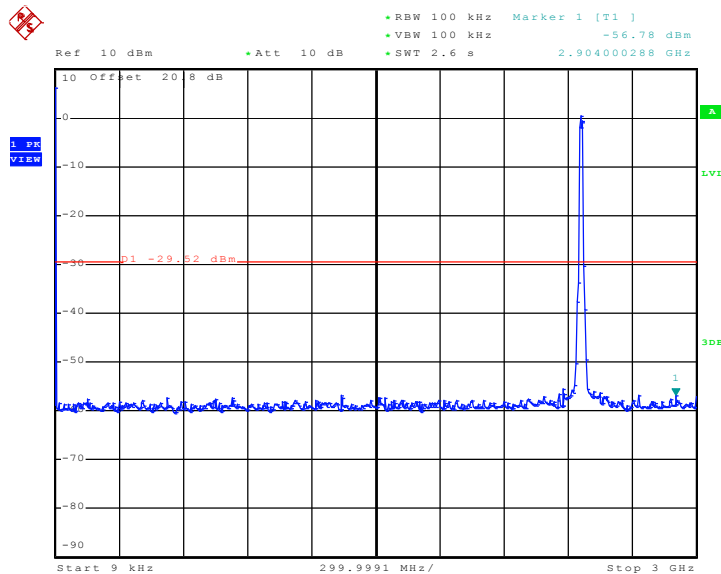

Date: 12.AUG.2009 20:55:31

Conducted Spurious Emission Plot between 1GHz ~ 25 GHz

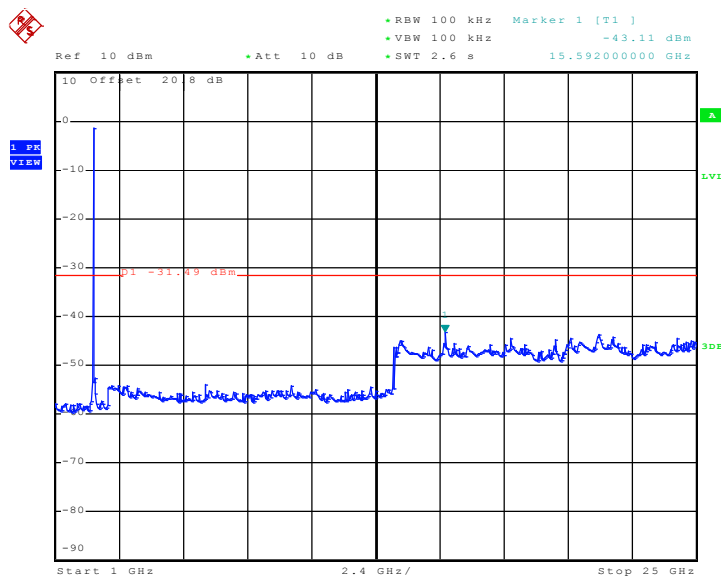

Date: 12.AUG.2009 20:55:48

3.5 Power Spectral Density Measurement

3.5.1 Limit of Power Spectral Density

The peak power spectral density shall not be greater than 8dBm in any 3kHz band at any time interval of continuous transmission.

3.5.2 Measuring Instruments

See list of measuring instruments of this test report.

3.5.3 Test Procedures

1. The test follows FCC KDB Publication No. 558074 (Measurement Guidelines of DTS).
2. The RF output of EUT was connected to the spectrum analyzer by a low loss cable.
3. Take the measured data from spectrum analyzer.

3.5.4 Test Setup

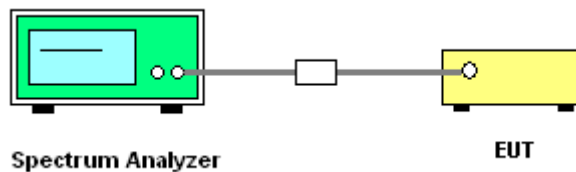



3.5.5 Test Result of Power Spectral Density

Test Mode :	Mode 1, 2, 3	Temperature :	23~24°C
Test Engineer :	Eric Huang	Relative Humidity :	42~43%

Channel	Frequency (MHz)	802.11b Measured PSD (dBm)	Max. Limits (dBm)	Pass/Fail
01	2412	-6.49	8	Pass
06	2437	-5.77	8	Pass
11	2462	-5.76	8	Pass

Mode 1 : PSD Plot on 802.11b Channel 01

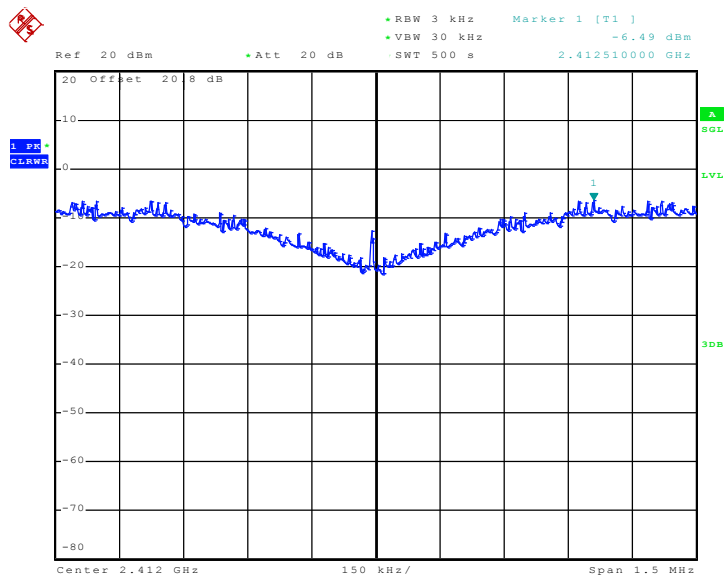

Date: 12.AUG.2009 21:19:22



Mode 2 : PSD Plot on 802.11b Channel 06

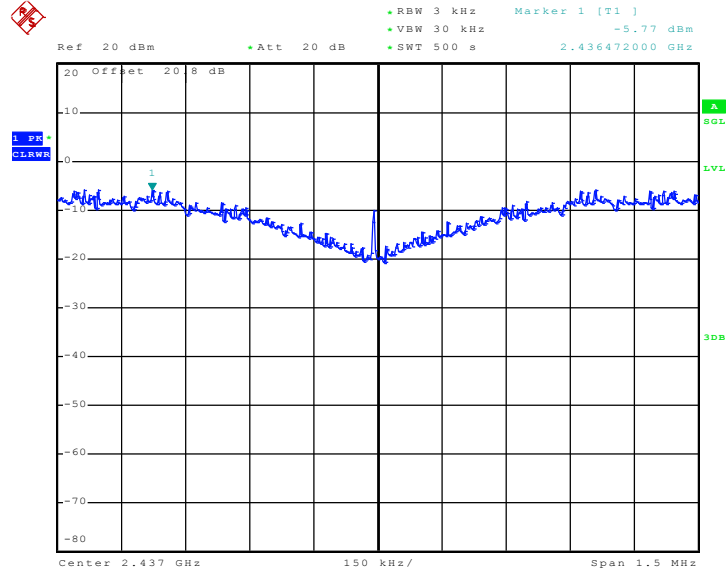

Date: 12.AUG.2009 21:28:02

Mode 3 : PSD Plot on 802.11b Channel 11

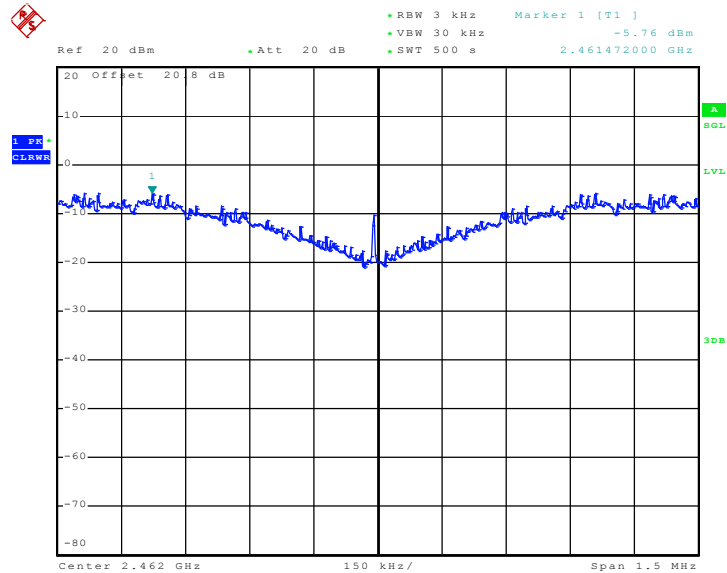

Date: 12.AUG.2009 21:36:51



Test Mode :	Mode 4, 5, 6	Temperature :	23~24°C
Test Engineer :	Eric Huang	Relative Humidity :	42~43%

Channel	Frequency (MHz)	802.11g Measured PSD (dBm)	Max. Limits (dBm)	Pass/Fail
01	2412	-11.90	8	Pass
06	2437	-10.83	8	Pass
11	2462	-11.07	8	Pass

Mode 4 : PSD Plot on 802.11g Channel 01

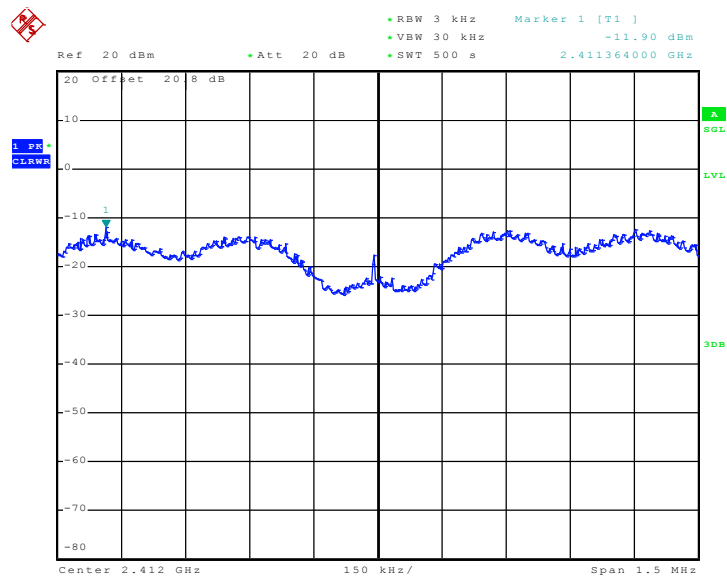

Date: 12.AUG.2009 21:47:37



Mode 5 : PSD Plot on 802.11g Channel 06

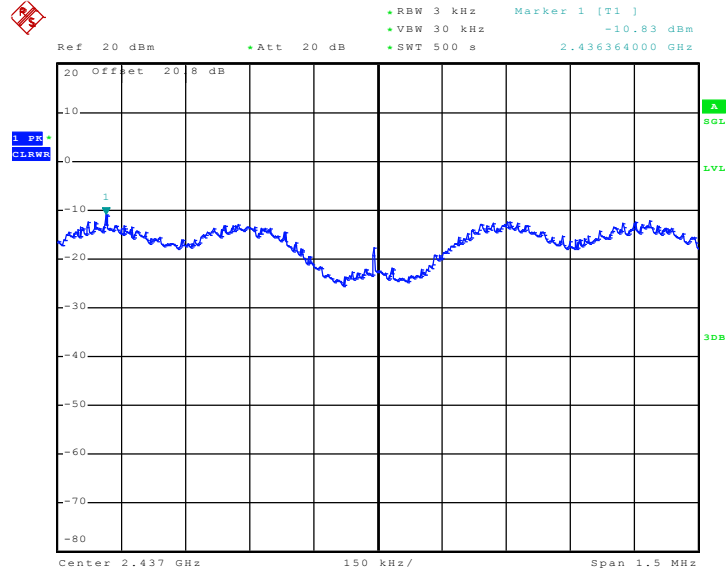

Date: 12.AUG.2009 21:57:05

Mode 6 : PSD Plot on 802.11g Channel 11

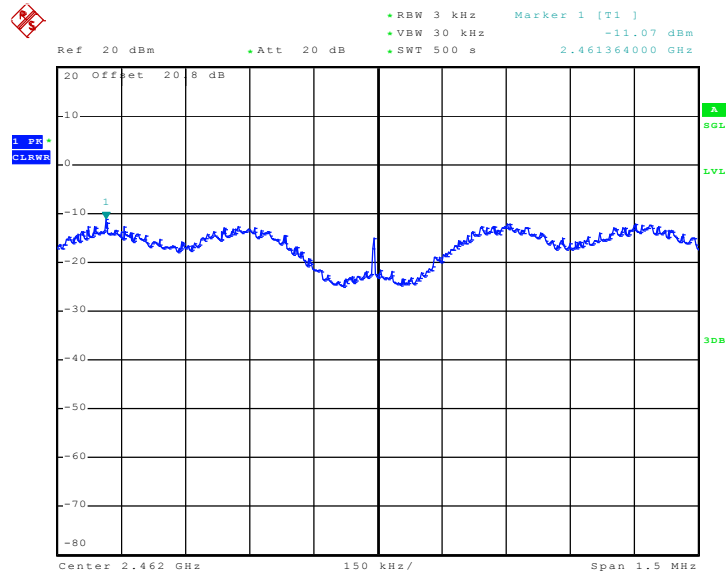

Date: 12.AUG.2009 22:05:48



3.6 AC Conducted Emission Measurement

3.6.1 Limit of AC Conducted Emission

For equipment that is designed to be connected to the public utility (AC) power line, the radio frequency voltage that is conducted back onto the AC power line on any frequency or frequencies within the band 150 kHz to 30 MHz shall not exceed the limits in the following table.

Frequency of Emission (MHz)	Conducted Limit (dBuV)	
	Quasi-Peak	Average
0.15-0.5	66 to 56*	56 to 46*
0.5-5	56	46
5-30	60	50

*Decreases with the logarithm of the frequency.

3.6.2 Measuring Instruments

See list of measuring instruments of this test report.

3.6.3 Test Procedures

1. The testing follows the guidelines in ANSI C63.4-2003.
2. The EUT was placed 0.4 meter from the conducting wall of the shielding room, and it was kept at least 80 centimeters from any other grounded conducting surface.
3. Connect EUT to the power mains through a line impedance stabilization network (LISN).
4. All the support units are connecting to the other LISN.
5. The LISN provides 50 ohm coupling impedance for the measuring instrument.
6. The FCC states that a 50 ohm, 50 microhenry LISN should be used.
7. Both sides of AC line were checked for maximum conducted interference.
8. The frequency range from 150 kHz to 30 MHz was searched.
9. Set the test-receiver system to Peak Detect Function and specified bandwidth with Maximum Hold Mode.

3.6.4 Test Setup

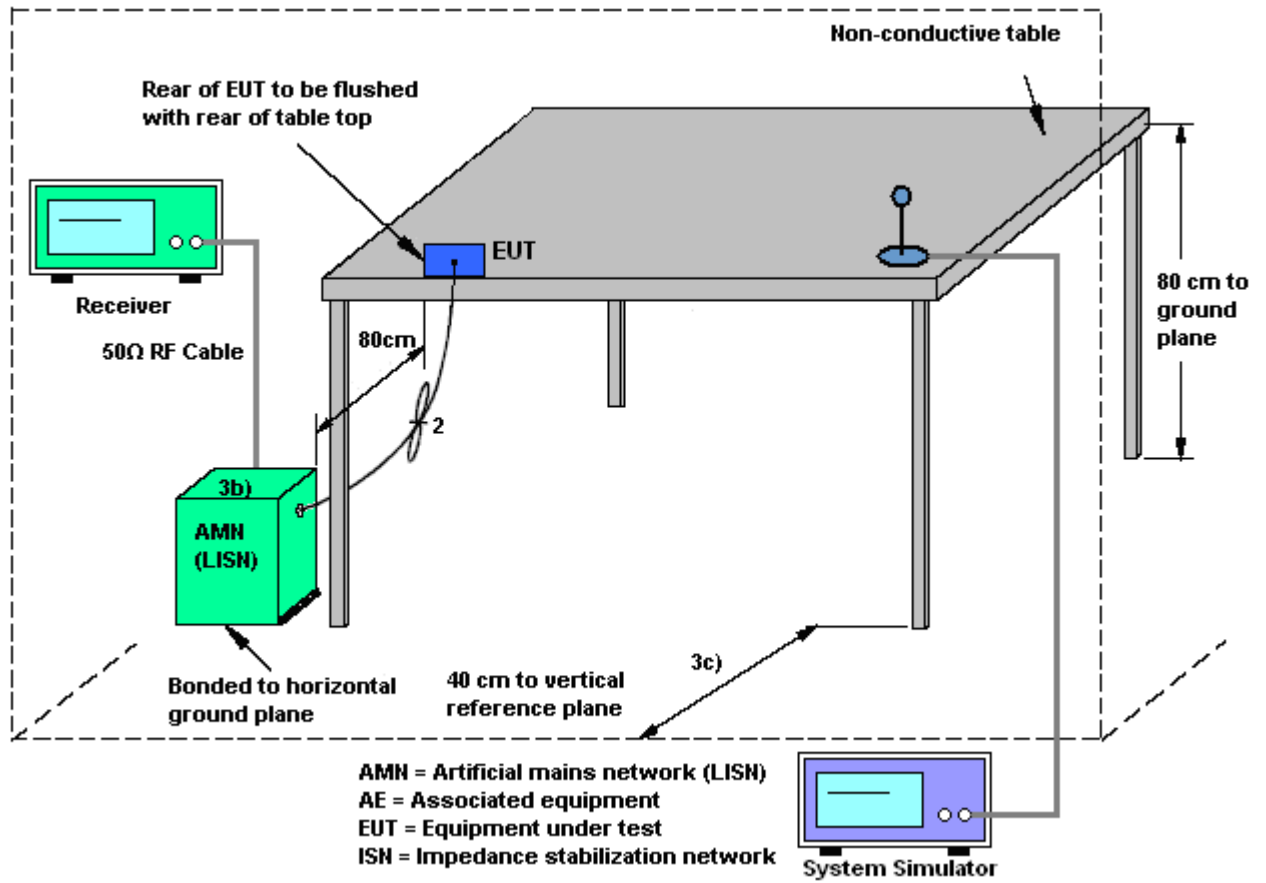



3.6.5 Test Result of AC Conducted Emission

Test Mode :	Mode 4	Temperature :	23~24°C
Test Engineer :	Cona Huang	Relative Humidity :	42~43%
Test Voltage :	120Vac / 60Hz	Phase :	Line
Function Type :	PDA Phone 1 + CDMA2000 BC1 (1xRTT) Idle + WLAN Link + Bluetooth Link + Camera + GPS Rx + Battery 1 + USB Cable 2 (Link with Notebook)		
Remark :	All emissions not reported here are more than 10 dB below the prescribed limit.		

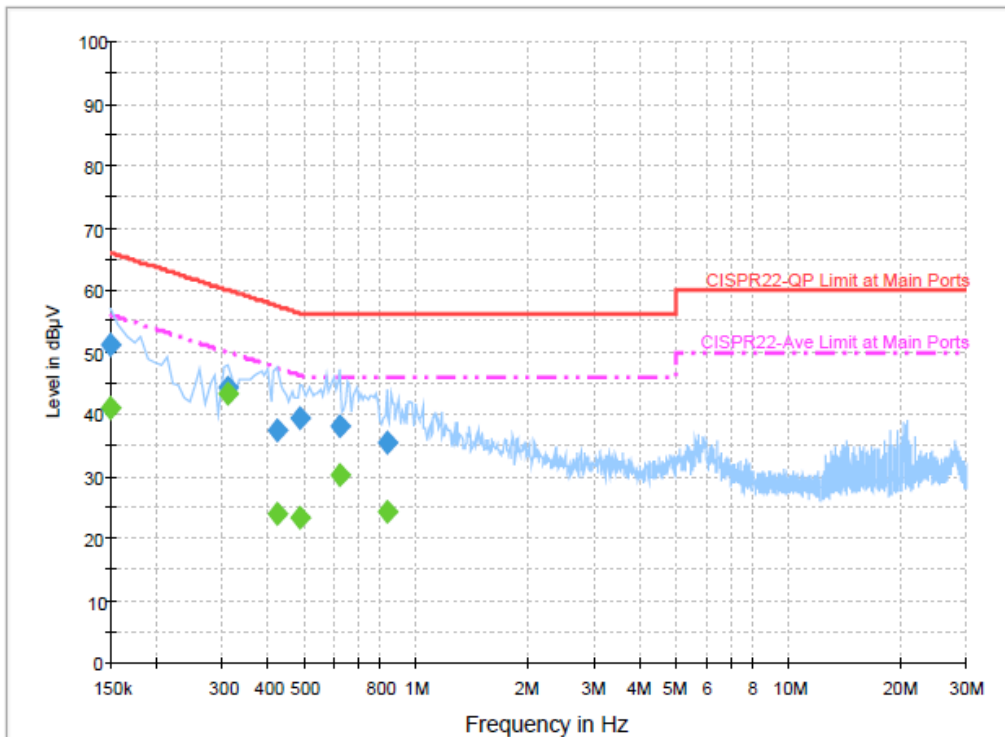

Final Result 1

Frequency (MHz)	QuasiPeak (dBµV)	Filter	Line	Corr. (dB)	Margin (dB)	Limit (dBµV)
0.150000	51.1	Off	L1	19.5	14.9	66.0
0.310000	44.2	Off	L1	19.4	15.8	60.0
0.422000	37.3	Off	L1	19.4	20.1	57.4
0.486000	39.5	Off	L1	19.4	16.7	56.2
0.622000	38.1	Off	L1	19.4	17.9	56.0
0.830000	35.6	Off	L1	19.5	20.4	56.0

Final Result 2

Frequency (MHz)	Average (dBµV)	Filter	Line	Corr. (dB)	Margin (dB)	Limit (dBµV)
0.150000	41.0	Off	L1	19.5	15.0	56.0
0.310000	43.2	Off	L1	19.4	6.8	50.0
0.422000	24.1	Off	L1	19.4	23.3	47.4
0.486000	23.3	Off	L1	19.4	22.9	46.2
0.622000	30.1	Off	L1	19.4	15.9	46.0
0.830000	24.2	Off	L1	19.5	21.8	46.0



Test Mode :	Mode 4	Temperature :	23~24°C
Test Engineer :	Cona Huang	Relative Humidity :	42~43%
Test Voltage :	120Vac / 60Hz	Phase :	Neutral
Function Type :	PDA Phone 1 + CDMA2000 BC1 (1xRTT) Idle + WLAN Link + Bluetooth Link + Camera + GPS Rx + Battery 1 + USB Cable 2 (Link with Notebook)		
Remark :	All emissions not reported here are more than 10 dB below the prescribed limit.		

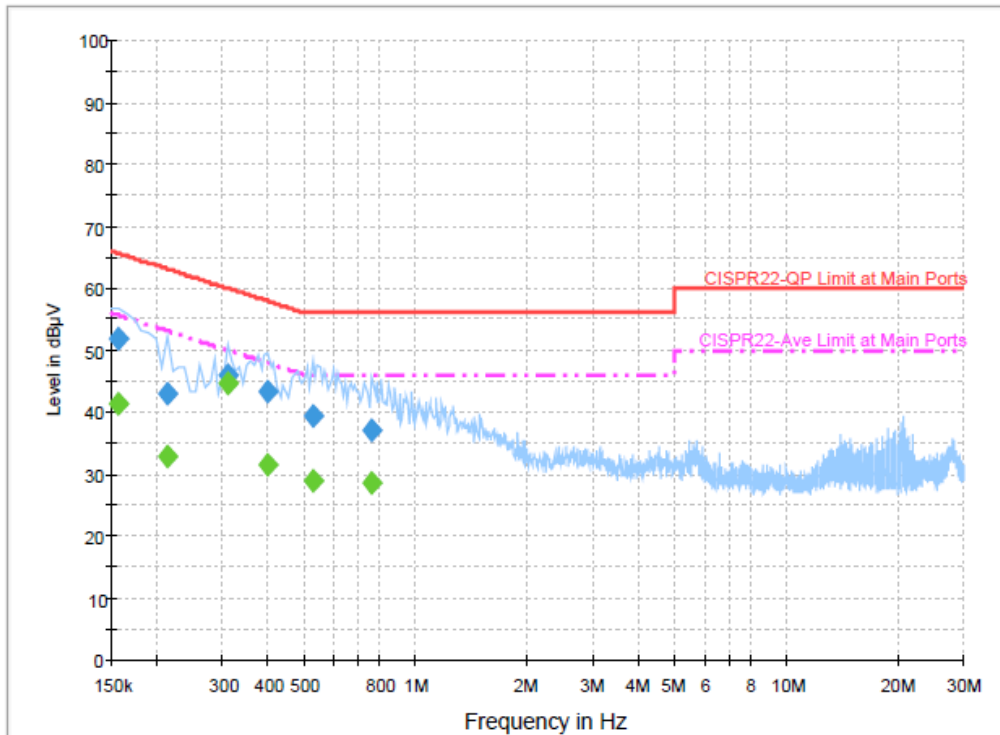

Final Result 1

Frequency (MHz)	QuasiPeak (dBµV)	Filter	Line	Corr. (dB)	Margin (dB)	Limit (dBµV)
0.158000	51.7	Off	N	19.5	13.9	65.6
0.214000	43.0	Off	N	19.5	20.0	63.0
0.310000	45.9	Off	N	19.4	14.1	60.0
0.398000	43.3	Off	N	19.5	14.6	57.9
0.526000	39.4	Off	N	19.5	16.6	56.0
0.758000	36.9	Off	N	19.5	19.1	56.0

Final Result 2

Frequency (MHz)	Average (dBµV)	Filter	Line	Corr. (dB)	Margin (dB)	Limit (dBµV)
0.158000	41.5	Off	N	19.5	14.1	55.6
0.214000	32.9	Off	N	19.5	20.1	53.0
0.310000	44.7	Off	N	19.4	5.3	50.0
0.398000	31.6	Off	N	19.5	16.3	47.9
0.526000	29.0	Off	N	19.5	17.0	46.0
0.758000	28.4	Off	N	19.5	17.6	46.0

3.7 Radiated Emission Measurement

3.7.1 Limit of Radiated Emission

In any 100 kHz bandwidth outside the intentional radiator frequency band, all harmonics/spurious must be at least 20 dB below the highest emission level within the authorized band. If the output power of this device was measured by spectrum analyzer, the attenuation under this paragraph shall be 30 dB instead of 20 dB. In addition, radiated emissions which fall in the restricted bands must also comply with the FCC section 15.209 limits as below.

Frequency (MHz)	Field Strength (microvolts/meter)	Measurement Distance (meters)
0.009 – 0.490	2400/F(kHz)	300
0.490 – 1.705	24000/F(kHz)	30
1.705 – 30.0	30	30
30 – 88	100	3
88 – 216	150	3
216 - 960	200	3
Above 960	500	3

3.7.2 Measuring Instruments

See list of measuring instruments of this test report.

3.7.3 Test Procedures

1. The testing follows the guidelines in FCC KDB Publication No. 558074 (Measurement Guidelines of DTS).
2. Use the following spectrum analyzer settings:
Span = wide enough to fully capture the emission being measured; RBW = 1 MHz for $f \geq 1$ GHz, 100 kHz for $f < 1$ GHz; VBW \geq RBW; Sweep = auto; Detector function = peak; Trace = max hold.
3. Follow the guidelines in **ANSI C63.4-2003** with respect to maximizing the emission by rotating the EUT, measuring the emission for three EUT orthogonal planes, and adjusting the measurement antenna height and polarization. A pre-amp and a high pass filter are used for this test in order to get the good signal level.

3.7.4 Test Setup

For radiated emissions below 30MHz

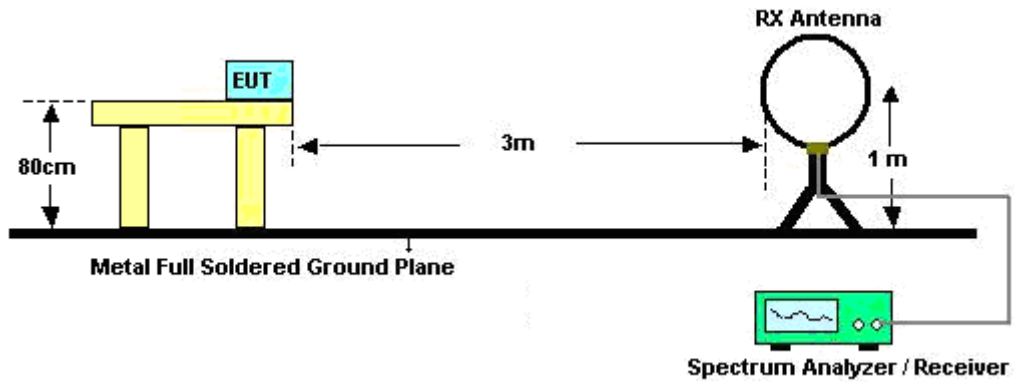

For radiated emissions above 30MHz

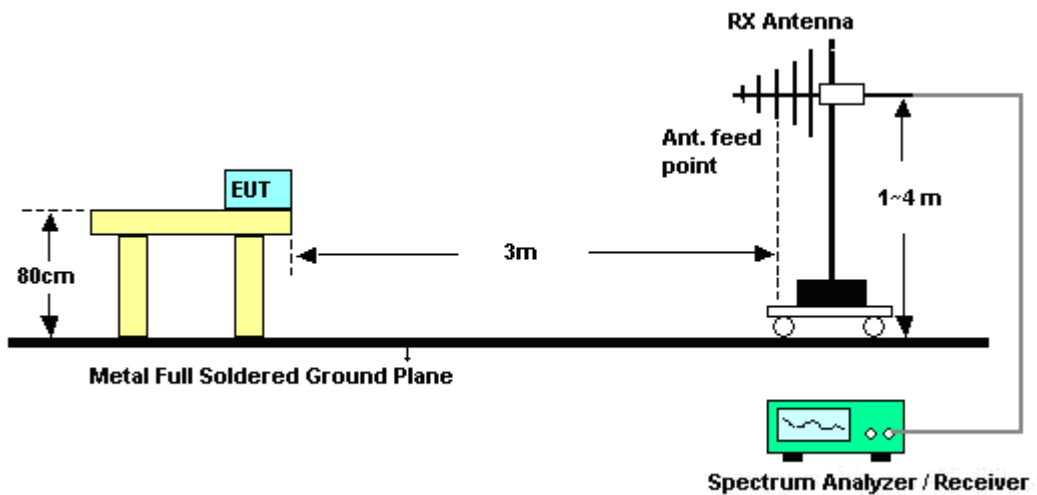



3.7.5 Test Results of Radiated Emissions (9 kHz ~ 30 MHz)

Test Engineer :	Kai Wang	Temperature :	25~27°C	
		Relative Humidity :	46~51%	
Frequency (MHz)	Level (dBuV)	Over Limit (dB)	Limit Line (dBuV)	Remark
-	-	-	-	See Note

Note:

The amplitude of spurious emissions that are attenuated by more than 20dB below the permissible value has no need to be reported.

Distance extrapolation factor = $40 \log(\text{specific distance} / \text{test distance})$ (dB);

Limit line = specific limits (dBuV) + distance extrapolation factor.



3.7.6 Test Result of Radiated Emission (30 MHz ~ 10th Harmonic)

Test Mode :	Mode 1	Temperature :	25~27°C
Test Channel :	01	Relative Humidity :	46~51%
Test Engineer :	Kai Wang	Polarization :	Horizontal
Remark :	#9 and #10 are Fundamental Signals which can be ignored.		

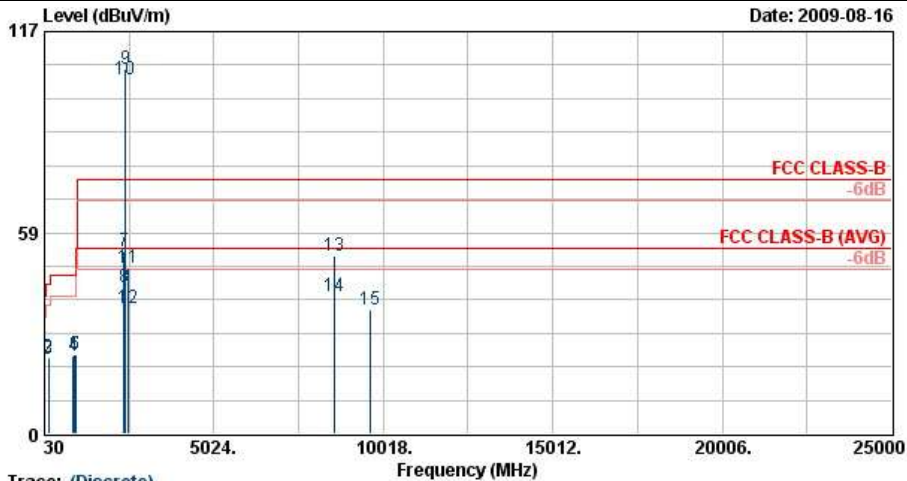

Trace: (Discrete)
 Site : 03CH06-HY
 Condition : FCC CLASS-B 3m SHF-EHF HORN HORIZONTAL
 Project : FR 971401

	Freq	Level	Over	Limit	Read	Antenna	Cable	Preamp	Ant	Table	Remark
	MHz	dBuV/m	dB	dBuV/m	dBuV	dB/m	dB	dB	cm	deg	
1	30.54	19.03	-20.97	40.00	31.04	19.30	0.30	31.61	100	257	Peak
2	154.74	22.20	-21.30	43.50	42.46	10.95	0.60	31.81	---	---	Peak
3	161.49	21.63	-21.87	43.50	42.33	10.62	0.60	31.92	---	---	Peak
4	885.90	22.81	-23.19	46.00	31.77	21.61	1.30	31.88	---	---	Peak
5	920.90	23.17	-22.83	46.00	31.68	21.86	1.20	31.57	---	---	Peak
6	952.40	23.25	-22.75	46.00	31.30	22.11	1.23	31.39	---	---	Peak
7	2385.65	53.14	-20.86	74.00	53.52	31.98	3.92	36.28	200	162	Peak
8	2385.65	42.70	-11.30	54.00	43.08	31.98	3.92	36.28	200	162	Average
9 X	2412.00	106.16			106.49	32.00	3.95	36.28	200	162	Peak
10 @	2412.00	102.88			103.21	32.00	3.95	36.28	200	162	Average
11	2494.00	48.46	-25.54	74.00	48.61	32.10	4.05	36.30	200	162	Peak
12	2494.00	36.36	-17.64	54.00	36.51	32.10	4.05	36.30	200	162	Average
13	8586.00	51.95	-22.05	74.00	45.60	35.78	7.30	36.73	100	218	Peak
14	8586.00	39.80	-14.20	54.00	33.45	35.78	7.30	36.73	100	218	Average
15	9648.00	36.11	-37.89	74.00	75.49	-10.27	7.94	37.06	100	0	Peak



Test Mode :	Mode 1	Temperature :	25~27°C
Test Channel :	01	Relative Humidity :	46~51%
Test Engineer :	Kai Wang	Polarization :	Vertical
Remark :	#9 and #10 are Fundamental Signals which can be ignored.		

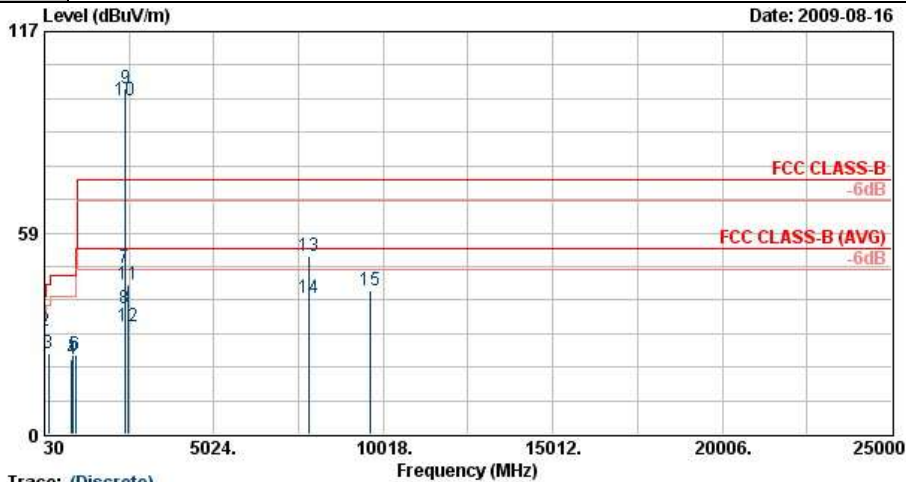

Trace: (Discrete)

Site : 03CH06-HY
 Condition : FCC CLASS-B 3m SHF-EHF HORN VERTICAL
 Project : FR 971401

	Freq	Level	Over Limit	Limit Line	ReadAntenna	Cable	Preamp	Ant	Table	Remark
	MHz	dBuV/m	dB	dBuV/m	dBuV	dB/m	dB	cm	deg	
1	31.89	26.86	-13.14	40.00	39.53	18.70	0.30	31.67	---	Peak
2	45.93	30.21	-9.79	40.00	51.01	10.67	0.30	31.77	100	278 Peak
3	154.74	23.44	-20.06	43.50	43.69	10.95	0.60	31.81	---	Peak
4	840.40	21.90	-24.10	46.00	31.78	21.28	1.20	32.36	---	Peak
5	878.90	23.05	-22.95	46.00	32.16	21.57	1.30	31.98	---	Peak
6	943.30	23.22	-22.78	46.00	31.43	22.05	1.20	31.46	---	Peak
7	2387.33	48.42	-25.58	74.00	48.80	31.98	3.92	36.28	100	311 Peak
8	2387.33	36.56	-17.44	54.00	36.94	31.98	3.92	36.28	100	311 Average
9 X	2412.00	100.58	---	---	100.91	32.00	3.95	36.28	100	311 Peak
10 @	2412.00	96.92	---	---	97.25	32.00	3.95	36.28	100	311 Average
11	2500.00	43.48	-30.52	74.00	43.63	32.10	4.05	36.30	100	311 Peak
12	2500.00	31.27	-22.73	54.00	31.42	32.10	4.05	36.30	100	311 Average
13	7812.00	51.94	-22.06	74.00	45.55	35.63	7.42	36.66	100	281 Peak
14	7812.00	39.54	-14.46	54.00	33.15	35.63	7.42	36.66	100	281 Average
15	9648.00	41.70	-32.30	74.00	81.11	-10.29	7.94	37.06	100	0 Peak



Test Mode :	Mode 2	Temperature :	25~27°C
Test Channel :	06	Relative Humidity :	46~51%
Test Engineer :	Kai Wang	Polarization :	Horizontal
Remark :	#9 and #10 are Fundamental Signals which can be ignored.		

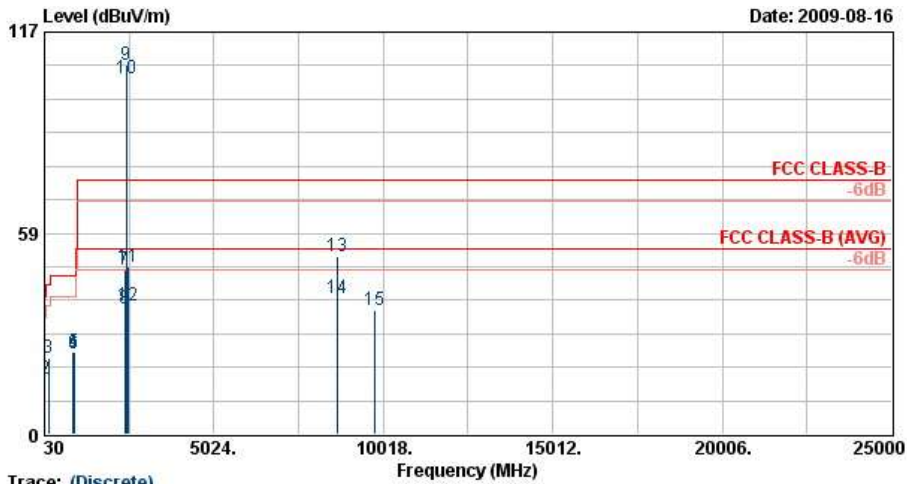

Trace: (Discrete)
 Site : 03CH06-HY
 Condition : FCC CLASS-B 3m SHF-EHF HORN HORIZONTAL
 Project : FR 971401

	Freq	Level	Over	Limit	Read	Antenna	Cable	Preamp	Ant	Table	Remark
	MHz	dBuV/m	dB	dBuV/m	dBuV	dB/m	dB	dB	cm	deg	
1	30.54	19.87	-20.13	40.00	31.88	19.30	0.30	31.61	100	197	Peak
2	47.28	16.12	-23.88	40.00	37.69	10.00	0.30	31.87	---	---	Peak
3	154.74	22.36	-21.14	43.50	42.62	10.95	0.60	31.81	---	---	Peak
4	868.40	23.77	-22.23	46.00	33.12	21.51	1.28	32.13	---	---	Peak
5	892.90	23.95	-22.05	46.00	32.76	21.66	1.30	31.77	---	---	Peak
6	904.80	23.62	-22.38	46.00	32.22	21.74	1.30	31.65	---	---	Peak
7	2390.00	47.66	-26.34	74.00	48.04	31.98	3.92	36.28	194	152	Peak
8	2390.00	36.54	-17.46	54.00	36.92	31.98	3.92	36.28	194	152	Average
9 X	2437.00	107.49			107.76	32.04	3.99	36.29	194	152	Peak
10 @	2437.00	103.72			103.98	32.04	3.99	36.29	194	152	Average
11	2486.00	48.90	-25.10	74.00	49.07	32.08	4.05	36.30	194	152	Peak
12	2486.00	37.39	-16.61	54.00	37.56	32.08	4.05	36.30	194	152	Average
13	8661.00	51.72	-22.28	74.00	45.23	35.87	7.39	36.76	100	171	Peak
14	8661.00	39.58	-14.42	54.00	33.09	35.87	7.39	36.76	100	171	Average
15	9748.00	35.91	-38.09	74.00	75.04	-10.02	7.98	37.10	100	0	Peak



Test Mode :	Mode 2	Temperature :	25~27°C
Test Channel :	06	Relative Humidity :	46~51%
Test Engineer :	Kai Wang	Polarization :	Vertical
Remark :	#9 and #10 are Fundamental Signals which can be ignored.		

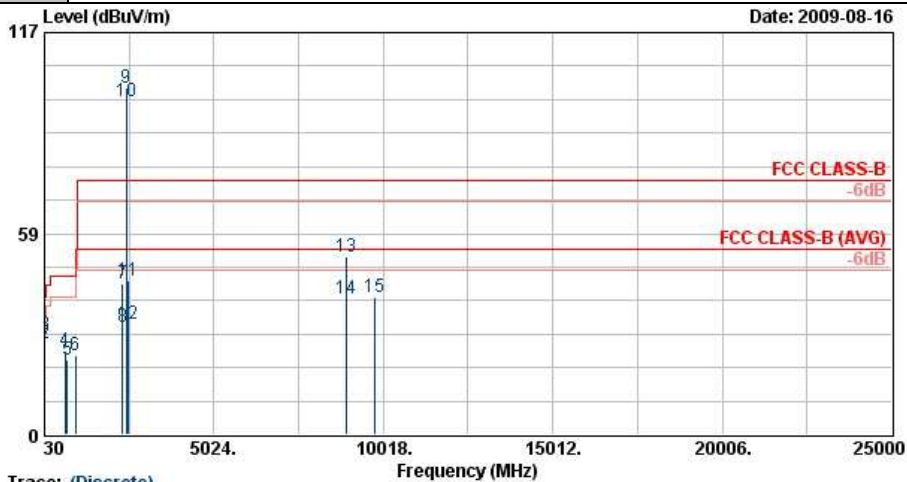

Trace: (Discrete)
 Site : 03CH06-HY
 Condition : FCC CLASS-B 3m SHF-EHF HORN VERTICAL
 Project : FR 971401

	Freq	Level	Over	Limit	ReadAntenna	Cable	Preamp	Ant	Table	Remark
	MHz	dBuV/m	dB	dBuV/m	dBuV	dB	dB	cm	deg	
1	30.00	27.35	-12.65	40.00	38.71	19.90	0.30	31.56	---	Peak
2	37.29	26.75	-13.25	40.00	43.09	15.10	0.30	31.75	---	Peak
3	46.20	29.07	-10.93	40.00	50.25	10.33	0.30	31.82	100	117 Peak
4	638.80	24.15	-21.85	46.00	35.59	19.41	1.09	31.94	---	Peak
5	703.90	21.85	-24.15	46.00	33.41	19.75	1.14	32.45	---	Peak
6	953.80	22.90	-23.10	46.00	30.93	22.11	1.24	31.38	---	Peak
7	2342.00	44.00	-30.00	74.00	44.50	31.91	3.86	36.27	100	311 Peak
8	2342.00	31.43	-22.57	54.00	31.93	31.91	3.86	36.27	100	311 Average
9 X	2437.00	100.91			101.18	32.04	3.99	36.29	100	311 Peak
10 @	2437.00	97.10			97.36	32.04	3.99	36.29	100	311 Average
11	2484.00	44.61	-29.39	74.00	44.78	32.08	4.05	36.30	100	311 Peak
12	2484.00	31.99	-22.01	54.00	32.16	32.08	4.05	36.30	100	311 Average
13	8916.00	51.92	-22.08	74.00	44.95	36.12	7.71	36.86	100	272 Peak
14	8916.00	39.48	-14.52	54.00	32.51	36.12	7.71	36.86	100	272 Average
15	9748.00	39.98	-34.02	74.00	79.11	-10.02	7.98	37.10	100	0 Peak



Test Mode :	Mode 3	Temperature :	25~27°C
Test Channel :	11	Relative Humidity :	46~51%
Test Engineer :	Kai Wang	Polarization :	Horizontal
Remark :	#9 and #10 are Fundamental Signals which can be ignored.		



Trace: (Discrete)
 Site : D3CH06-HY
 Condition : FCC CLASS-B 3m SHF-EHF HORN HORIZONTAL
 Project : FR 971401

	Freq	Level	Over	Limit	ReadAntenna	Cable	Preamp	Ant	Table	Remark
	MHz	dBuV/m	dB	dBuV/m	dBuV	dB/m	dB	cm	deg	
1	30.00	18.88	-21.12	40.00	30.24	19.90	0.30	31.56	---	Peak
2	155.28	23.25	-20.25	43.50	43.50	10.95	0.60	31.81	100	292 Peak
3	160.68	22.36	-21.14	43.50	43.03	10.66	0.60	31.93	---	Peak
4	859.30	22.41	-23.59	46.00	32.01	21.46	1.20	32.26	---	Peak
5	880.30	22.66	-23.34	46.00	31.73	21.58	1.30	31.95	---	Peak
6	952.40	23.54	-22.46	46.00	31.60	22.11	1.23	31.39	---	Peak
7	2382.00	48.48	-25.52	74.00	48.88	31.96	3.92	36.28	167	166 Peak
8	2382.00	35.40	-18.60	54.00	35.80	31.96	3.92	36.28	167	166 Average
9 X	2462.00	104.91			105.12	32.06	4.02	36.29	167	166 Peak
10 @	2462.00	102.00			102.21	32.06	4.02	36.29	167	166 Average
11	2483.50	50.09	-23.91	74.00	50.26	32.08	4.05	36.30	167	166 Peak
12	2483.50	37.85	-16.15	54.00	38.02	32.08	4.05	36.30	167	166 Average
13	7161.00	52.54	-21.46	74.00	46.23	35.64	7.15	36.47	100	281 Peak
14	7161.00	40.43	-13.57	54.00	34.11	35.64	7.15	36.47	100	281 Average
15	9848.00	37.71	-36.29	74.00	76.57	-9.77	8.04	37.14	100	0 Peak



Test Mode :	Mode 3	Temperature :	25~27°C
Test Channel :	11	Relative Humidity :	46~51%
Test Engineer :	Kai Wang	Polarization :	Vertical
Remark :	#9 and #10 are Fundamental Signals which can be ignored.		



Trace: (Discrete)
 Site : 03CH06-HY
 Condition : FCC CLASS-B 3m SHF-EHF HORN VERTICAL
 Project : FR 971401

	Freq	Level	Over	Limit	Read	Antenna	Cable	Preamp	Ant	Table	Remark
	MHz	dBuV/m	Limit	dB	dBuV/m	Level	Loss	Factor	Pos	Pos	
						Factor			cm	deg	
1	30.00	28.51	-11.49	40.00	39.87	19.90	0.30	31.56	---	---	Peak
2	45.93	28.63	-11.37	40.00	49.43	10.67	0.30	31.77	100	158	Peak
3	155.28	23.37	-20.13	43.50	43.62	10.95	0.60	31.81	---	---	Peak
4	638.80	24.40	-21.60	46.00	35.84	19.41	1.09	31.94	---	---	Peak
5	887.30	22.80	-23.20	46.00	31.73	21.63	1.30	31.85	---	---	Peak
6	943.30	23.21	-22.79	46.00	31.41	22.05	1.20	31.46	---	---	Peak
7	2382.00	43.52	-30.48	74.00	43.92	31.96	3.92	36.28	100	310	Peak
8	2382.00	31.74	-22.26	54.00	32.14	31.96	3.92	36.28	100	310	Average
9 X	2462.00	99.56			99.77	32.06	4.02	36.29	100	310	Peak
10 @	2462.00	96.37			96.58	32.06	4.02	36.29	100	310	Average
11	2485.37	47.98	-26.02	74.00	48.15	32.08	4.05	36.30	100	310	Peak
12	2485.37	35.02	-18.98	54.00	35.19	32.08	4.05	36.30	100	310	Average
13	8706.00	51.43	-22.57	74.00	44.87	35.90	7.45	36.78	100	318	Peak
14	8706.00	39.03	-14.97	54.00	32.46	35.90	7.45	36.78	100	318	Average
15	9848.00	41.47	-32.53	74.00	80.34	-9.77	8.04	37.14	100	0	Peak



Test Mode :	Mode 4	Temperature :	25~27°C
Test Channel :	01	Relative Humidity :	46~51%
Test Engineer :	Kai Wang	Polarization :	Horizontal
Remark :	#9 and #10 are Fundamental Signals which can be ignored.		

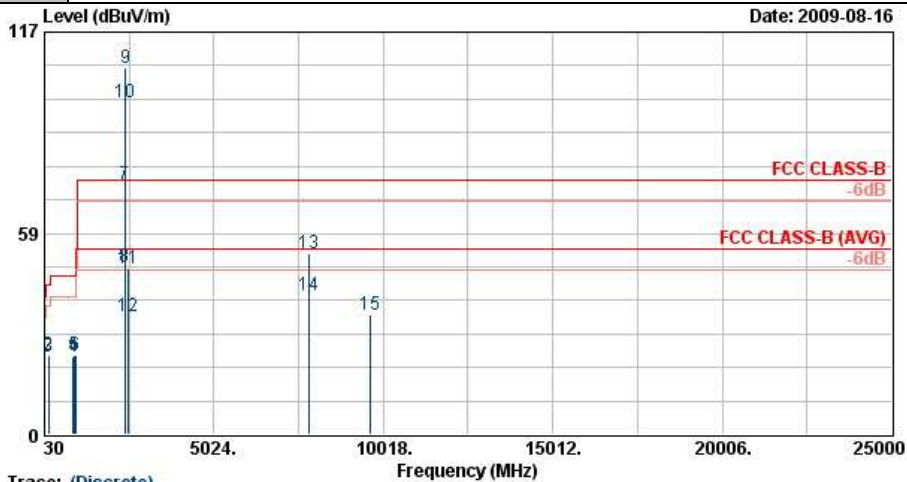

Trace: (Discrete)
 Site : 03CH06-HY
 Condition : FCC CLASS-B 3m SHF-EHF HORN HORIZONTAL
 Project : FR 971401

	Freq	Level	Over	Limit	ReadAntenna	Cable	Preamp	Ant	Table	Remark
	MHz	dBuV/m	Limit	Line	Level	Loss	Factor	Pos	Pos	
			dB	dBuV/m	dBuV	dB	dB	cm	deg	
1	30.00	19.88	-20.12	40.00	31.24	19.90	0.30	31.56	217	Peak
2	154.74	23.05	-20.45	43.50	43.30	10.95	0.60	31.81	---	Peak
3	161.49	22.57	-20.93	43.50	43.27	10.62	0.60	31.92	---	Peak
4	875.40	22.48	-23.52	46.00	31.65	21.56	1.30	32.02	---	Peak
5	899.90	22.94	-23.06	46.00	31.61	21.70	1.30	31.67	---	Peak
6	934.90	22.96	-23.04	46.00	31.28	21.98	1.20	31.50	---	Peak
7 !	2389.99	72.55	-1.45	74.00	72.93	31.98	3.92	36.28	200	131 Peak
8 !	2389.99	48.51	-5.49	54.00	48.89	31.98	3.92	36.28	200	131 Average
9 X	2412.00	106.66			106.99	32.00	3.95	36.28	200	131 Peak
10 @	2412.00	96.75			97.08	32.00	3.95	36.28	200	131 Average
11	2484.00	48.28	-25.72	74.00	48.44	32.08	4.05	36.30	200	131 Peak
12	2484.00	34.19	-19.81	54.00	34.36	32.08	4.05	36.30	200	131 Average
13	7842.00	52.65	-21.35	74.00	46.25	35.63	7.44	36.67	100	287 Peak
14	7842.00	40.42	-13.59	54.00	34.01	35.63	7.44	36.67	100	287 Average
15	9648.00	34.93	-39.07	74.00	74.34	-10.29	7.94	37.06	100	0 Peak



Test Mode :	Mode 4	Temperature :	25~27°C
Test Channel :	01	Relative Humidity :	46~51%
Test Engineer :	Kai Wang	Polarization :	Vertical
Remark :	#9 and #10 are Fundamental Signals which can be ignored.		

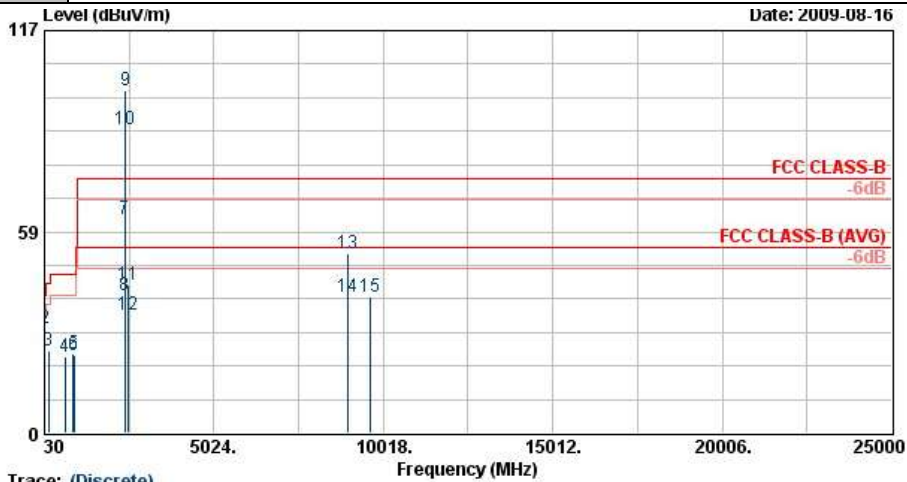

Site : 03CH06-HY
 Condition : FCC CLASS-B 3m SHF-EHF HORN VERTICAL
 Project : FR 971401

	Freq	Level	Over	Limit	ReadAntenna	Cable	Preamp	Ant	Table	Remark	
	MHz	dBuV/m	dB	dBuV/m	dBuV	dB/m	dB	dB	cm	deg	
1	30.00	27.36	-12.64	40.00	38.72	19.90	0.30	31.56	---	---	Peak
2	44.04	30.45	-9.55	40.00	50.28	11.58	0.30	31.71	100	292	Peak
3	153.93	23.84	-19.66	43.50	44.02	11.00	0.60	31.78	---	---	Peak
4	638.80	22.04	-23.96	46.00	33.48	19.41	1.09	31.94	---	---	Peak
5	876.80	23.09	-22.91	46.00	32.24	21.56	1.30	32.01	---	---	Peak
6	903.40	22.66	-23.34	46.00	31.29	21.72	1.30	31.66	---	---	Peak
7	2389.99	62.16	-11.84	74.00	62.54	31.98	3.92	36.28	133	191	Peak
8	2389.99	40.21	-13.79	54.00	40.59	31.98	3.92	36.28	133	191	Average
9 X	2412.00	99.55			99.88	32.00	3.95	36.28	133	191	Peak
10 @	2412.00	88.35			88.68	32.00	3.95	36.28	133	191	Average
11	2500.00	42.89	-31.11	74.00	43.04	32.10	4.05	36.30	133	191	Peak
12	2500.00	34.32	-19.68	54.00	34.47	32.10	4.05	36.30	133	191	Average
13	8967.00	52.10	-21.90	74.00	45.04	36.17	7.77	36.88	100	209	Peak
14	8967.00	39.48	-14.52	54.00	32.42	36.17	7.77	36.88	100	209	Average
15	9648.00	39.48	-34.52	74.00	78.88	-10.29	7.94	37.06	100	0	Peak



Test Mode :	Mode 5	Temperature :	25~27°C
Test Channel :	06	Relative Humidity :	46~51%
Test Engineer :	Kai Wang	Polarization :	Horizontal
Remark :	#9 and #10 are Fundamental Signals which can be ignored.		



Trace: (Discrete)
 Site : 03CH06-HY
 Condition : FCC CLASS-B 3m SHF-EHF HORN HORIZONTAL
 Project : FR 971401

	Freq	Level	Over	Limit	ReadAntenna	Cable	Preamp	Ant	Table	Remark
	MHz	dBUV/m	dB	dBUV/m	dBuV	dB/m	dB	cm	deg	
1	30.00	19.14	-20.86	40.00	30.50	19.90	0.30	31.56	---	Peak
2	154.74	22.70	-20.80	43.50	42.96	10.95	0.60	31.81	100	47 Peak
3	162.03	22.13	-21.37	43.50	42.83	10.62	0.60	31.92	---	Peak
4	778.80	23.88	-22.12	46.00	34.23	20.59	1.19	32.13	---	Peak
5	917.40	23.07	-22.93	46.00	31.59	21.84	1.23	31.59	---	Peak
6	932.80	22.99	-23.01	46.00	31.34	21.97	1.20	31.51	---	Peak
7	2390.00	46.67	-27.33	74.00	47.05	31.98	3.92	36.28	196	151 Peak
8	2390.00	33.66	-20.34	54.00	34.04	31.98	3.92	36.28	196	151 Average
9 X	2437.00	104.83			105.10	32.04	3.99	36.29	196	151 Peak
10 @	2437.00	94.67			94.93	32.04	3.99	36.29	196	151 Average
11	2484.00	46.63	-27.37	74.00	46.80	32.08	4.05	36.30	196	151 Peak
12	2484.00	34.12	-19.88	54.00	34.29	32.08	4.05	36.30	196	151 Average
13	8952.00	52.49	-21.51	74.00	45.48	36.15	7.74	36.88	100	219 Peak
14	8952.00	39.60	-14.40	54.00	32.59	36.15	7.74	36.88	100	219 Average
15	9748.00	36.09	-37.91	74.00	75.22	-10.02	7.98	37.10	100	0 Peak



Test Mode :	Mode 5	Temperature :	25~27°C
Test Channel :	06	Relative Humidity :	46~51%
Test Engineer :	Kai Wang	Polarization :	Vertical
Remark :	#9 and #10 are Fundamental Signals which can be ignored.		

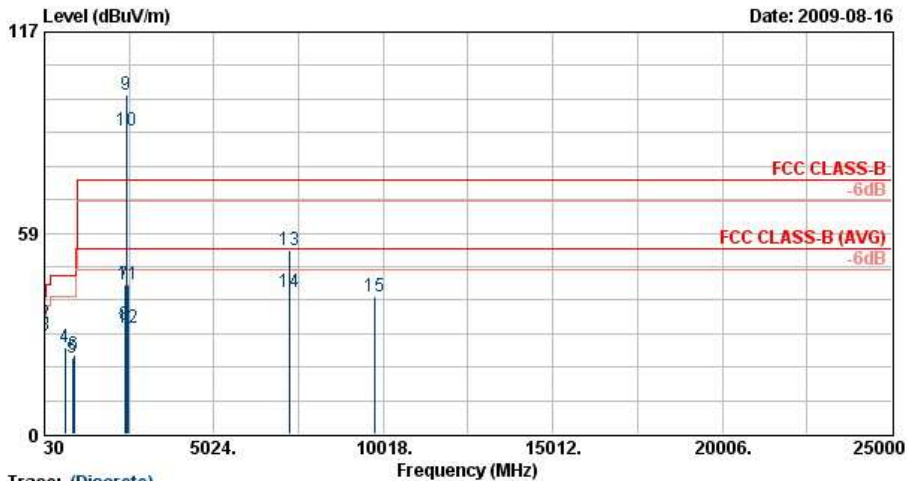

Trace: (Discrete)
 Site : 03CR06-HY
 Condition : FCC CLASS-B 3m SHF-EHF HORN VERTICAL
 Project : FR 971401

	Freq	Level	Over	Limit	Read	Antenna	Cable	Preamp	Ant	Table	Remark
	MHz	dBuV/m	dB	dBuV/m	dBuV	dB/m	dB	dB	cm	deg	
1	30.54	29.32	-10.68	40.00	41.33	19.30	0.30	31.61	---	---	Peak
2	39.99	32.32	-7.68	40.00	49.81	13.90	0.30	31.69	100	303	Peak
3	46.74	28.90	-11.10	40.00	50.09	10.33	0.30	31.82	---	---	Peak
4	638.80	25.40	-20.60	46.00	36.84	19.41	1.09	31.94	---	---	Peak
5	850.90	22.05	-23.95	46.00	31.83	21.41	1.20	32.39	---	---	Peak
6	906.90	23.05	-22.95	46.00	31.64	21.75	1.30	31.64	---	---	Peak
7	2390.00	43.48	-30.52	74.00	43.86	31.98	3.92	36.28	100	181	Peak
8	2390.00	31.92	-22.08	54.00	32.30	31.98	3.92	36.28	100	181	Average
9 X	2437.00	98.60			98.88	32.02	3.99	36.29	100	181	Peak
10 @	2437.00	88.17			88.43	32.04	3.99	36.29	100	181	Average
11	2500.00	43.40	-30.60	74.00	43.55	32.10	4.05	36.30	100	181	Peak
12	2500.00	31.03	-22.97	54.00	31.18	32.10	4.05	36.30	100	181	Average
13	7266.00	53.49	-20.51	74.00	47.22	35.59	7.18	36.51	100	76	Peak
14	7266.00	41.15	-12.85	54.00	34.89	35.59	7.18	36.51	100	76	Average
15	9748.00	40.19	-33.81	74.00	79.32	-10.02	7.98	37.10	100	0	Peak



Test Mode :	Mode 6	Temperature :	25~27°C
Test Channel :	11	Relative Humidity :	46~51%
Test Engineer :	Kai Wang	Polarization :	Horizontal
Remark :	#9 and #10 are Fundamental Signals which can be ignored.		

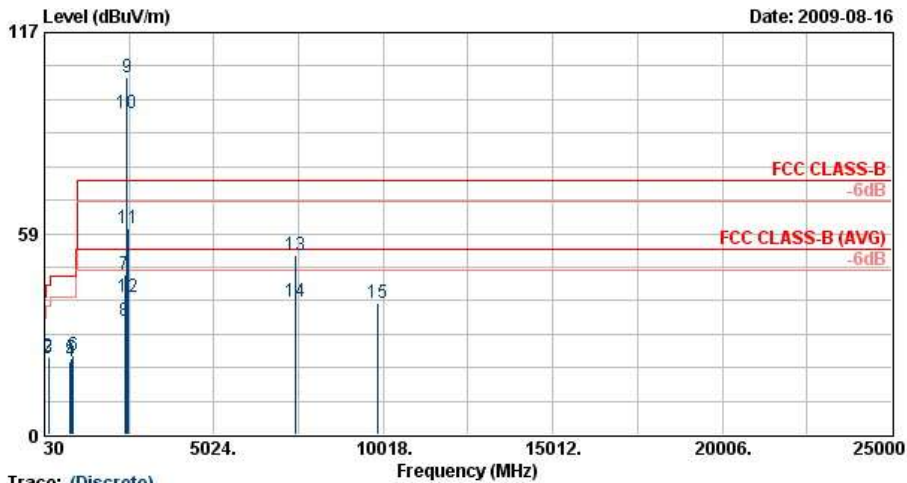

Trace: (Discrete)
 Site : 03CH06-HY
 Condition : FCC CLASS-B 3m SHF-EHF HORN HORIZONTAL
 Project : FR 971401

	Freq	Level	Over	Limit	Read	Antenna	Cable	Preamp	Ant	Table	Remark
	MHz	dBuV/m	dB	dBuV/m	dBuV	dB/m	dB	dB	cm	deg	
1	30.00	18.73	-21.27	40.00	30.09	19.90	0.30	31.56	---	---	Peak
2	153.93	22.73	-20.77	43.50	42.91	11.00	0.60	31.78	100	332	Peak
3	160.68	22.06	-21.44	43.50	42.72	10.66	0.60	31.93	---	---	Peak
4	778.80	21.20	-24.80	46.00	31.55	20.59	1.19	32.13	---	---	Peak
5	820.80	21.99	-24.01	46.00	32.01	21.05	1.20	32.27	---	---	Peak
6	880.30	22.87	-23.13	46.00	31.94	21.58	1.30	31.95	---	---	Peak
7	2388.00	46.45	-27.55	74.00	46.83	31.98	3.92	36.28	200	169	Peak
8	2388.00	32.91	-21.09	54.00	33.29	31.98	3.92	36.28	200	169	Average
9 X	2462.00	104.11			104.32	32.06	4.02	36.29	200	169	Peak
10 @	2462.00	93.34			93.55	32.06	4.02	36.29	200	169	Average
11	2483.50	60.22	-13.78	74.00	60.39	32.08	4.05	36.30	200	169	Peak
12	2483.50	39.84	-14.16	54.00	40.01	32.08	4.05	36.30	200	169	Average
13	7422.00	52.11	-21.89	74.00	45.90	35.53	7.24	36.57	100	348	Peak
14	7422.00	38.81	-15.19	54.00	32.61	35.53	7.24	36.57	100	348	Average
15	9848.00	38.22	-35.78	74.00	77.09	-9.77	8.04	37.14	100	0	Peak



Test Mode :	Mode 6	Temperature :	25~27°C
Test Channel :	11	Relative Humidity :	46~51%
Test Engineer :	Kai Wang	Polarization :	Vertical
Remark :	#9 and #10 are Fundamental Signals which can be ignored.		

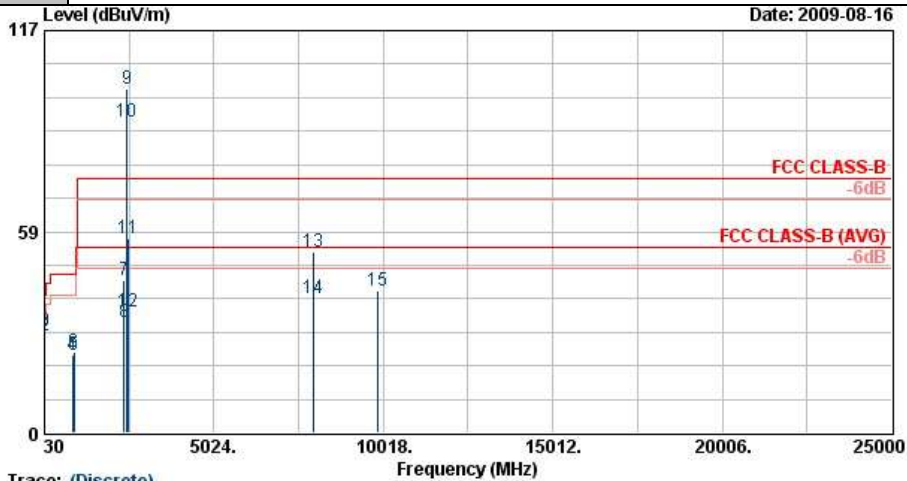

Trace: (Discrete)
 Site : 03CH06-HY
 Condition : FCC CLASS-B 3m SHF-EHF HORN VERTICAL
 Project : FR 971401

	Freq	Level	Over	Limit	Read	Antenna	Cable	Preamp	Ant	Table	Remark
	MHz	dBuV/m	dB	dBuV/m	dBuV	dB/m	dB	dB	cm	deg	
1	30.00	28.27	-11.73	40.00	39.63	19.90	0.30	31.56	---	---	Peak
2	37.83	28.25	-11.75	40.00	44.59	15.10	0.30	31.75	---	---	Peak
3	45.93	29.37	-10.63	40.00	50.17	10.67	0.30	31.77	100	178	Peak
4	857.90	22.48	-23.52	46.00	32.11	21.45	1.20	32.27	---	---	Peak
5	880.30	22.81	-23.19	46.00	31.87	21.58	1.30	31.95	---	---	Peak
6	894.30	23.69	-22.31	46.00	32.48	21.67	1.30	31.75	---	---	Peak
7	2382.00	44.46	-29.54	74.00	44.86	31.96	3.92	36.28	131	190	Peak
8	2382.00	32.21	-21.79	54.00	32.61	31.96	3.92	36.28	131	190	Average
9 X	2462.00	99.86			100.07	32.06	4.02	36.29	131	190	Peak
10 X	2462.00	90.41			90.62	32.06	4.02	36.29	131	190	Average
11	2483.50	56.40	-17.60	74.00	56.57	32.08	4.05	36.30	131	190	Peak
12	2483.50	35.28	-18.72	54.00	35.45	32.08	4.05	36.30	131	190	Average
13	7977.00	52.44	-21.56	74.00	45.94	35.69	7.51	36.70	100	139	Peak
14	7977.00	39.25	-14.75	54.00	32.75	35.69	7.51	36.70	100	139	Average
15	9848.00	41.12	-32.88	74.00	79.99	-9.77	8.04	37.14	100	0	Peak



Test Mode :	Mode 7	Temperature :	25~27°C
Test Channel :	01	Relative Humidity :	46~51%
Test Engineer :	Kai Wang	Polarization :	Horizontal
Remark :	#9 and #10 are Fundamental Signals which can be ignored.		

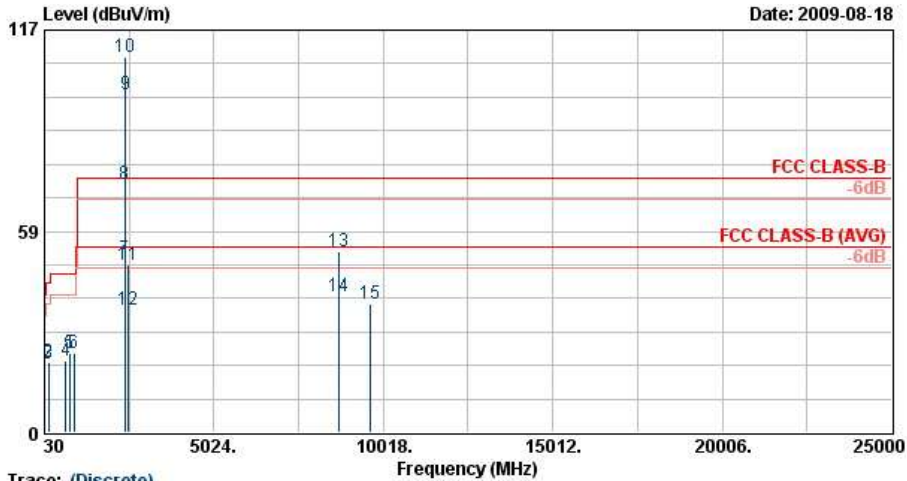

Trace: (Discrete)
 Site : 03CR06-HY
 Condition : FCC CLASS-B 3m SHF-EHF HORN HORIZONTAL
 Project : FR 971401
 Memo : Mode 10

	Freq	Level	Over Limit	Limit Line	ReadAntenna	Cable	Preamp	Ant	Table	Remark	
	MHz	dBuV/m	dB	dBuV/m	dBuV	dB/m	dB	dB	cm	deg	
1	30.00	19.43	-20.57	40.00	30.79	19.90	0.30	31.56	100	109 Peak	
2	154.74	20.43	-23.07	43.50	40.68	10.95	0.60	31.81	---	---	Peak
3	162.03	19.91	-23.59	43.50	40.62	10.62	0.60	31.92	---	---	Peak
4	654.90	20.76	-25.24	46.00	32.08	19.52	1.10	31.94	---	---	Peak
5	766.90	23.06	-22.94	46.00	33.59	20.47	1.10	32.10	---	---	Peak
6	903.40	23.20	-22.80	46.00	31.84	21.72	1.30	31.66	---	---	Peak
7 !	2389.99	50.64	-3.36	54.00	51.14	31.86	3.92	36.28	165	172 Average	
8 !	2389.99	72.07	-1.93	74.00	72.57	31.86	3.92	36.28	165	172 Peak	
9 @	2412.00	98.16			98.61	31.88	3.95	36.28	165	172 Average	
10 X	2412.00	109.08			109.53	31.88	3.95	36.28	165	172 Peak	
11	2500.00	48.68	-25.32	74.00	48.93	32.00	4.05	36.30	165	172 Peak	
12	2500.00	35.56	-18.44	54.00	35.81	32.00	4.05	36.30	165	172 Average	
13	8697.00	52.46	-21.54	74.00	45.90	35.90	7.45	36.78	100	138 Peak	
14	8697.00	39.64	-14.36	54.00	33.07	35.90	7.45	36.78	100	138 Average	
15	9648.00	37.28	-36.72	74.00	76.69	-10.29	7.94	37.06	100	0 Peak	



Test Mode :	Mode 7	Temperature :	25~27°C
Test Channel :	01	Relative Humidity :	46~51%
Test Engineer :	Kai Wang	Polarization :	Vertical
Remark :	#9 and #10 are Fundamental Signals which can be ignored.		

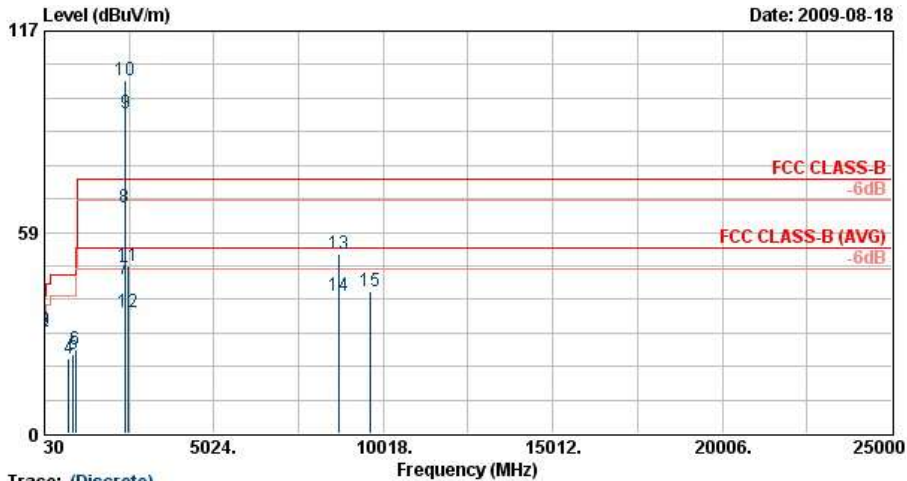

Trace: (Discrete)
 Site : 03CH06-HY
 Condition : FCC CLASS-B 3m SHF-EHF HORN VERTICAL
 Project : FR 971401

	Freq	Level	Over	Limit	Read	Antenna	Cable	Preamp	Ant	Table	Remark
	MHz	dBuV/m	dB	dBuV/m	dBuV	dB/m	dB	dB	cm	deg	
1	30.54	26.96	-13.04	40.00	38.98	19.30	0.30	31.61	---	---	Peak
2	35.13	29.65	-10.35	40.00	44.28	16.90	0.30	31.83	---	---	Peak
3	44.58	29.83	-10.17	40.00	50.25	11.00	0.30	31.72	100	139	Peak
4	754.30	21.87	-24.13	46.00	32.49	20.35	1.10	32.07	---	---	Peak
5	871.90	23.12	-22.88	46.00	32.37	21.53	1.30	32.08	---	---	Peak
6	943.30	24.56	-21.44	46.00	32.76	22.05	1.20	31.46	---	---	Peak
7	2389.99	44.59	-9.41	54.00	45.09	31.86	3.92	36.28	100	212	Average
8	2389.99	65.63	-8.37	74.00	66.13	31.86	3.92	36.28	100	212	Peak
9 @	2412.00	93.09			93.54	31.88	3.95	36.28	100	212	Average
10 X	2412.00	102.69			103.14	31.88	3.95	36.28	100	212	Peak
11	2486.00	48.56	-25.44	74.00	48.83	31.98	4.05	36.30	100	212	Peak
12	2486.00	35.07	-18.93	54.00	35.34	31.98	4.05	36.30	100	212	Average
13	8721.00	52.14	-21.86	74.00	45.54	35.92	7.48	36.79	100	107	Peak
14	8721.00	39.91	-14.09	54.00	33.31	35.92	7.48	36.79	100	107	Average
15	9648.00	41.23	-32.77	74.00	80.61	-10.27	7.94	37.06	100	0	Peak



3.8 Antenna Requirements

3.8.1 Standard Applicable

If directional gain of transmitting antennas is greater than 6dBi, the power shall be reduced by the same level in dB comparing to gain minus 6dBi. For the fixed point-to-point operation, the power shall be reduced by one dB for every 3 dB that the directional gain of the antenna exceeds 6 dBi. The use of a permanently attached antenna or of an antenna that uses a unique coupling to the intentional radiator shall be considered sufficient to comply with the FCC rule.

3.8.2 Antenna Connected Construction

The antennas type used in this product is PIFA Antenna without connector and it is considered to meet antenna requirement.

3.8.3 Antenna Gain

The antenna peak gain of EUT is less than 6 dBi. Therefore, it is not necessary to reduce maximum peak output power limit.



4 List of Measuring Equipment

Instrument	Manufacturer	Model No.	Serial No.	Characteristics	Calibration Date	Due Date	Remark
Spectrum Analyzer	R&S	FSP40	100055	9kHz~40GHz	Jun. 23, 2009	Jun. 22, 2010	Conducted (TH02-HY)
Power Meter	Agilent	E4416A	GB41292344	N/A	Feb. 19, 2009	Feb. 18, 2010	Conducted (TH02-HY)
Power Sensor	Agilent	E9327A	US40441548	N/A	Feb. 19, 2009	Feb. 18, 2010	Conducted (TH02-HY)
EMI Test Receive	R&S	ESCS 30	100356	9KHz – 2.75GHz	Aug. 05, 2009	Aug. 04, 2010	Conduction (CO05-HY)
Two-LISN	R&S	ENV216	11-100081	9kHz~30MHz	Nov. 26, 2008	Nov. 25, 2009	Conduction (CO05-HY)
Two-LISN	R&S	ENV216	11-100080	9kHz~30MHz	Nov. 26, 2008	Nov. 25, 2009	Conduction (CO05-HY)
AC Power Source	APC	APC-1000W	N/A	N/A	N/A	N/A	Conduction (CO05-HY)
System Simulator	R&S	CMU200	105934	N/A	Nov. 11, 2008	Nov. 10, 2010	Conduction (CO05-HY)
GPS Base Station	T&E	GS-50	N/A	N/A	N/A	N/A	Conduction (CO05-HY)
Spectrum Analyzer	Agilent	E4408B	MY44211030	9kHz~26.5GHz	Oct. 24, 2008	Oct. 23, 2009	Radiation (03CH06-HY)
Spectrum Analyzer	R&S	FSP40	100057	9kHz~40GHz	Oct. 16, 2008	Oct. 15, 2009	Radiation (03CH06-HY)
EMI Test Receiver	R&S	ESVS10	834468/003	20MHz~1000M Hz	Apr. 28, 2009	Apr. 27, 2010	Radiation (03CH06-HY)
Bilog Antenna	SCHAFFNER	CBL6112B	2885	30MHz~2GHz	Nov. 12, 2008	Nov. 11, 2009	Radiation (03CH06-HY)
Double Ridge Horn Antenna	EMCO	3117	00066583	1G~18GHz	Aug. 18, 2009	Aug. 17, 2010	Radiation (03CH06-HY)
Double Ridge Horn Antenna	Training Research	AF-0801	95119	8G~18G	Oct. 28, 2008	Oct. 27, 2009	Radiation (03CH06-HY)
SHF-EHF Horn	SCHWARZBECK	BBHA 9170	BBHA9170251	15G~40GHz	Oct. 16, 2008	Oct. 15, 2009	Radiation (03CH06-HY)
Pre Amplifier	Agilent	8449B	3008A01917	1G~26.5GHz	Nov. 11, 2008	Nov. 10, 2009	Radiation (03CH06-HY)
Pre Amplifier	Agilent	310N	186713	9kHz~1GHz	Apr. 20, 2009	Apr. 19, 2010	Radiation (03CH06-HY)
Loop Antenna	R&S	HFH2-Z2	860004/001	9 kHz~30 MHz	May 22, 2008	May 21, 2010	Radiation (03CH06-HY)

5 Uncertainty of Evaluation

Uncertainty of Conducted Emission Measurement (150 kHz ~ 30 MHz)

Contribution	Uncertainty of x_i		$u(x_i)$
	dB	Probability Distribution	
Receiver reading	0.10	Normal(k=2)	0.05
Cable loss	0.10	Normal(k=2)	0.05
AMN insertion loss	2.50	Rectangular	0.63
Receiver Spec	1.50	Rectangular	0.43
Site imperfection	1.39	Rectangular	0.80
Mismatch	+0.34/-0.35	U-shape	0.24
Combined standard uncertainty Uc(y)	1.13		
Measuring uncertainty for a level of confidence of 95% U=2Uc(y)	2.26		

Uncertainty of Radiated Emission Measurement (30 MHz ~ 1000 MHz)

Contribution	Uncertainty of x_i		$u(x_i)$
	dB	Probability Distribution	
Receiver reading	0.41	Normal(k=2)	0.21
Antenna factor calibration	0.83	Normal(k=2)	0.42
Cable loss calibration	0.25	Normal(k=2)	0.13
Pre Amplifier Gain calibration	0.27	Normal(k=2)	0.14
RCV/SPA specification	2.50	Rectangular	0.72
Antenna Factor Interpolation for Frequency	1.00	Rectangular	0.29
Site imperfection	1.43	Rectangular	0.83
Mismatch	+0.39/-0.41	U-shaped	0.28
Combined standard uncertainty Uc(y)	1.27		
Measuring uncertainty for a level of confidence of 95% U=2Uc(y)	2.54		



Uncertainty of Radiated Emission Measurement (1 GHz ~ 40 GHz)

Contribution	Uncertainty of x_i		$u(x_i)$	C_i	$C_i * u(x_i)$
	dB	Probability Distribution			
Receiver reading	±0.10	Normal(k=1)	0.10	1	0.10
Antenna factor calibration	±1.70	Normal(k=2)	0.85	1	0.85
Cable loss calibration	±0.50	Normal(k=2)	0.25	1	0.25
Receiver Correction	±2.00	Rectangular	1.15	1	1.15
Antenna Factor Directional	±1.50	Rectangular	0.87	1	0.87
Site imperfection	±2.80	Triangular	1.14	1	1.14
Mismatch Receiver VSWR $\Gamma_1 = 0.197$ Antenna VSWR $\Gamma_2 = 0.194$ Uncertainty = $20 \log(1 - \Gamma_1 * \Gamma_2)$	+0.34/-0.35	U-shaped	0.244	1	0.244
Combined standard uncertainty $U_c(y)$	2.36				
Measuring uncertainty for a level of confidence of 95% $U = 2U_c(y)$	4.72				

6 Certification of TAF Accreditation



Certificate No. : L1190-090417

財團法人全國認證基金會
Taiwan Accreditation Foundation

Certificate of Accreditation

This is to certify that

Sporton International Inc.
EMC & Wireless Communications Laboratory
No.52, Hwa Ya 1st Rd., Hwa Ya Technology Park, Kwei-Shan Hsiang, Tao Yuan Hsien,
Taiwan, R.O.C.

is accredited in respect of laboratory

Accreditation Criteria	: ISO/IEC 17025:2005
Accreditation Number	: 1190
Originally Accredited	: December 15, 2003
Effective Period	: January 10, 2007 to January 09, 2010
Accredited Scope	: Testing Field, see described in the Appendix
Specific Accreditation Program	: Accreditation Program for Designated Testing Laboratory for Commodities Inspection Accreditation Program for Telecommunication Equipment Testing Laboratory Accreditation Program for BSMI Mutual Recognition Arrangement with Foreign Authorities

Jay-San Chen
President, Taiwan Accreditation Foundation
Date : April 17, 2009

Pl, total 20 pages

The Appendix forms an integral part of this Certificate, which shall be invalid when use without the Appendix



Appendix A. Photographs of EUT

Please refer to Sporton report number EP971401 as below.