



FCC 47 CFR PART 22 SUBPART H AND PART 24 SUBPART E

TEST REPORT

For

PHOE100

Model: PHOE100

Trade Name: N/A

Issued to

**High Tech Computer Corp.
No. 23, Xinghua Rd., Taoyuan 330, Taiwan**

Issued by

**Compliance Certification Services Inc.
No. 81-1, Lane 210, Bade Rd. 2, Luchu Hsiang,
Taoyuan Hsien, (338) Taiwan, R.O.C.
<http://www.ccsemc.com.tw>
service@tw.ccsemc.com**



***Note:** This report shall not be reproduced except in full, without the written approval of Compliance Certification Services Inc. This document may be altered or revised by Compliance Certification Services Inc. personnel only, and shall be noted in the revision section of the document.*



TABLE OF CONTENTS

- 1. TEST RESULT CERTIFICATION..... 3**
- 2. EUT DESCRIPTION 4**
- 3. TEST METHODOLOGY 5**
 - 3.1 EUT CONFIGURATION 5
 - 3.2 EUT EXERCISE 5
 - 3.3 GENERAL TEST PROCEDURES 5
 - 3.4 DESCRIPTION OF TEST MODES 6
- 4. INSTRUMENT CALIBRATION..... 7**
 - 4.1 MEASURING INSTRUMENT CALIBRATION 7
 - 4.2 MEASUREMENT EQUIPMENT USED 7
- 5. FACILITIES AND ACCREDITATIONS 9**
 - 5.1 FACILITIES 9
 - 5.2 EQUIPMENT 9
 - 5.3 TABLE OF ACCREDITATIONS AND LISTINGS 10
- 6. SETUP OF EQUIPMENT UNDER TEST 11**
 - 6.1 SETUP CONFIGURATION OF EUT 11
 - 6.2 SUPPORT EQUIPMENT 11
- 7. FCC PART 22 & 24 REQUIREMENTS 12**
 - 7.1 AVERAGE POWER 12
 - 7.2 ERP & EIRP MEASUREMENT 14
 - 7.3 OCCUPIED BANDWIDTH MEASUREMENT 22
 - 7.4 OUT OF BAND EMISSION AT ANTENNA TERMINALS 30
 - 7.5 FIELD STRENGTH OF SPURIOUS RADIATION MEASUREMENT 42
 - 7.6 FREQUENCY STABILITY V.S. TEMPERATURE MEASUREMENT 80
 - 7.7 FREQUENCY STABILITY V.S. VOLTAGE MEASUREMENT 82
 - 7.8 POWERLINE CONDUCTED EMISSIONS 84



1. TEST RESULT CERTIFICATION

Applicant: High Tech Computer Corp.
 No. 23, Xinghua Rd., Taoyuan 330, Taiwan

Equipment Under Test: PHOE100

Trade Name: N/A

Model Number: PHOE100

Date of Test: July 5 ~ 25, 2007

APPLICABLE STANDARDS	
STANDARD	TEST RESULT
FCC 47 CFR PART 22 SUBPART H AND PART 24 SUBPART E	No non-compliance noted

We hereby certify that:

The above equipment was tested by Compliance Certification Services Inc. The test data, data evaluation, test procedures, and equipment configurations shown in this report were made in accordance with the procedures given in ANSI/TIA/EIA-603-A-2001 and the energy emitted by the sample EUT tested as described in this report is in compliance with conducted and radiated emission limits of FCC Rule FCC PART 22 Subpart H and PART 24 Subpart E.

The test results of this report relate only to the tested sample identified in this report.

Approved by:

Reviewed by:

Johnny Liu
 Section Manager
 Compliance Certification Services Inc.

Amanda Wu
 Section Manager
 Compliance Certification Services Inc.



2. EUT DESCRIPTION

Product	PHOE100
Trade Name	N/A
Model Number	PHOE100
Model Discrepancy	N/A
Power Supply	<p>Power Adapter:</p> <p>1. Trade Name / Model Number: DELTA / ADP-5FH B I/P: AC 100-240V, 50/60Hz, 0.2A O/P: DC 5V, 1A</p> <p>2. Trade Name / Model Number: PHIHONG / PSAA05A-050 I/P: AC 100-240V, 200mA, 50/60Hz, 13-20VA O/P: DC 5V, 1A</p> <p>Rechargeable Battery: Trade Name: TWS, SAMSUNG Model: KII0160 Rating: 3.7VDC, 920mAh</p>
Accessories	<ul style="list-style-type: none"> ● Holster: NEWTECH (model name: HTC552) ● Earphone: COTRON (model name: CHM-311STV08002), Unshielded, 1.3m ● Earphone: MEC (model name: G-EP-A404), Unshielded, 1.2m ● USB cable: MEC (model name: 60-4251-100), Unshielded, 1.0m
Frequency Range	<p>TX: 824 ~ 849 MHz / 1850 ~ 1910 MHz</p> <p>RX: 869 ~ 894 MHz / 1930 ~ 1989.8 MHz</p>
Transmit Power (ERP & EIRP Power)	<p>GSM 850: 30.78dBm</p> <p>GPRS 850: 29.95dBm</p> <p>EGPRS 850: 29.86dBm</p> <p>GSM 1900: 24.18 dBm</p> <p>GPRS 1900: 23.82 dBm</p> <p>EGPRS 1900: 20.06 dBm</p>
Cellular Phone Protocol	<p>GSM 850, GSM1900: Class B</p> <p>GPRS 850, GPRS1900: Class 10</p> <p>EGPRS 850, EGPRS 1900: Class 10</p>
Type of Emission	249KGXW---
Antenna Gain	<p>850 MHz: -4.5 dBi</p> <p>1900 MHz: -2.5 dBi</p>
Antenna Type	PIFA Antenna

Remark:

1. The sample selected for test was engineering sample that approximated to production product and was provided by manufacturer.
2. This submittal(s) (test report) is intended for FCC ID: **NM8PB** filing to comply with Part 22 and Part 24 of the FCC 47 CFR Rules.



3. TEST METHODOLOGY

Both conducted and radiated testing were performed according to the procedures document on chapter 13 of ANSI C63.4 and FCC CFR 47, 2.1046, 2.1047, 2.1049, 2.1051, 2.1053, 2.1055 and 2.1057.

3.1 EUT CONFIGURATION

The EUT configuration for testing is installed on RF field strength measurement to meet the Commissions requirement and operating in a manner that intends to maximize its emission characteristics in a continuous normal application.

3.2 EUT EXERCISE

The EUT was operated in the engineering mode to fix the TX frequency that was for the purpose of the measurements.

3.3 GENERAL TEST PROCEDURES

Conducted Emissions

The EUT is placed on the turntable, which is 0.8 m above ground plane. According to the requirements in Section 13.1.4.1 of ANSI C63.4. Conducted emissions from the EUT measured in the frequency range between 0.15 MHz and 30MHz using CISPR Quasi-peak and average detector modes.

Radiated Emissions

The EUT is placed on a turn table, which is 0.8 m above ground plane. The turntable shall rotate 360 degrees to determine the position of maximum emission level. EUT is set 3m away from the receiving antenna, which varied from 1m to 4m to find out the highest emission. And also, each emission was to be maximized by changing the polarization of receiving antenna both horizontal and vertical. In order to find out the maximum emissions, exploratory radiated emission measurements were made according to the requirements in Section 13.1.4.1 of ANSI C63.4.



3.4 DESCRIPTION OF TEST MODES

The EUT (model: PHOE100) had been tested under operating condition.

EUT staying in continuous transmitting mode was programmed.

GSM850, GPRS 850: Channel Low (CH128), Channel Mid (CH190) and Channel High (CH251) were chosen for full testing.

GSM1900, GPRS 1900: Channel Low (CH512), Channel Mid (CH661) and Channel High (CH810) were chosen for full testing.

After verification, all tests were carried out with the worst case test modes as shown below except radiated spurious emission below 1GHz and power line conducted emissions below 30MHz, which worst case was in normal link mode only.

The field strength of spurious emission was measured in the following position: EUT stand-up position (Z axis), lie-down position (X, Y axis). The worst emission were found in lie-down (X axis), in stand-up (Z axis) and the worst case were recorded.

The field strength of spurious emission was measured in the following position: EUT stand-up position (Z axis), lie-down position (X, Y axis).

The worst emission were found:

in lie-down (X axis) for cellular close mode,

and in stand-up (Z axis) for cellular close mode, and the worst case were recorded.



4. INSTRUMENT CALIBRATION

4.1 MEASURING INSTRUMENT CALIBRATION

The measuring equipment, which was utilized in performing the tests documented herein, has been calibrated in accordance with the manufacturer's recommendations for utilizing calibration equipment, which is traceable to recognized national standards.

4.2 MEASUREMENT EQUIPMENT USED

Equipment Used for Emissions Measurement

Remark: Each piece of equipment is scheduled for calibration once a year.

Conducted Emissions Test Site				
Name of Equipment	Manufacturer	Model	Serial Number	Calibration Due
Spectrum Analyzer	Agilent	E4446A	MY43360131	01/30/2008
Power Meter	Agilent	E4416A	GB41291611	03/20/2008
Power Sensor	Agilent	E9327A	US40441097	05/23/2008
Temp. / Humidity Chamber	Terchy	MHG-150LF	930619	08/08/2008
DC Power Source	Agilent	E3640A	MY40001774	01/11/2008

3M Semi Anechoic Chamber				
Name of Equipment	Manufacturer	Model	Serial Number	Calibration Due
Spectrum Analyzer	Agilent	E4446A	US42510252	08/01/2008
Test Receiver	Rohde & Schwarz	ESCI	100064	11/12/2008
Switch Controller	TRC	Switch Controller	SC94050010	05/03/2008
4 Port Switch	TRC	4 Port Switch	SC94050020	05/03/2008
Horn-Antenna	TRC	HA-0502	06	05/31/2008
Horn-Antenna	TRC	HA-0801	04	05/03/2008
Bilog- Antenna	Sunol Sciences	JB3	A030205	03/29/2008
Turn Table	Max-Full	MFT-120S	T120S940302	N.C.R.
Antenna Tower	Max-Full	MFA-430	A440940302	N.C.R.
Controller	Max-Full	MF-CM886	CC-C-1F-13	N.C.R.
Site NSA	N/A	FCC: 965860 IC: IC 6106	09/25/2008	09/25/2008
Reject Filter	Micro-Tronics	HPM13194	003	04/25/2008
S.G.	HP	83630B	3844A01022	04/08/2008
Substituted Dipole	Schwazbeck	VHAP/UHAP	998 +999/ 981+982	06/10/2008
Substituted Horn	EMCO	3115	00022257	12/18/2007
Test S/W	LABVIEW (V 6.1)			

Remark: The measurement uncertainty is less than +/-2.0065dB (30MHz ~ 1GHz), +/-3.0958dB (Above 1GHz) which is evaluated as per the NAMAS NIS 81 and CISPR/A/291/CDV.



Powerline Conducted Emissions Test Site				
Name of Equipment	Manufacturer	Model	Serial Number	Calibration Due
EMI Test Receiver 9kHz-30MHz	Rohde & Schwarz	ESHS30	828144/003	10/31/2007
Two-Line V-Network 9kHz-30MHz	Schaffner	NNB41	03/10013	06/12/2008
LISN 10kHz-100MHz	EMCO	3825/2	9106-1809	04/01/2008
Test S/W	LABVIEW (V 6.1)			

Remark: The measurement uncertainty is less than +/- 2.81dB, which is evaluated as per the NAMAS NIS 81 and CISPR/A/291/CDV.



5. FACILITIES AND ACCREDITATIONS

5.1 FACILITIES

No.199, Chunghsen Road, Hsintien City, Taipei Hsien, Taiwan, R.O.C.

Tel: 886-2-2217-0894 / Fax: 886-2-2217-1029

No.11, Wugong 6th Rd., Wugu Industrial Park, Taipei Hsien 248, Taiwan

Tel: 886-2-2299-9720 / Fax: 886-2-2298-4045

No.81-1, Lane 210, Bade 2nd Rd., Luchu Hsiang, Taoyuan Hsien 338, Taiwan

Tel: 886-3-324-0332 / Fax: 886-3-324-5235

The sites are constructed in conformance with the requirements of ANSI C63.7, ANSI C63.4 and CISPR Publication 22.

5.2 EQUIPMENT







Radiated emissions are measured with one or more of the following types of linearly polarized antennas: tuned dipole, biconical, log periodic, bi-log, and/or ridged waveguide, horn. Spectrum analyzers with pre-selectors and quasi-peak detectors are used to perform radiated measurements.

Conducted emissions are measured with Line Impedance Stabilization Networks and EMI Test Receivers.

Calibrated wideband preamplifiers, coaxial cables, and coaxial attenuators are also used for making measurements.

All receiving equipment conforms to CISPR Publication 16-1, "Radio Interference Measuring Apparatus and Measurement Methods."

5.3 TABLE OF ACCREDITATIONS AND LISTINGS

Country	Agency	Scope of Accreditation	Logo
USA	A2LA	EN 55011, EN 55014-1/2, CISPR 11, CISPR 14-1/2, EN 55022, EN 55015, CISPR 22, CISPR 15, AS/NZS 3548, VCCI V3 (2001), CFR 47, FCC Part 15/18, CNS 13783-1, CNS 13439, CNS 13438, CNS 13803, CNS 14115, EN 55024, IEC 801-2, IEC 801-3, IEC 801-4, IEC/EN 61000-3-2, IEC/EN 61000-3-3, IEC/EN 61000-4-2/3/4/5/6/8/11, EN 50081-1/ EN 61000-6-3, EN 50081-2/EN 61000-6-4, EN 50081-2/EN 61000-6-1: 2001	 0824-01
USA	FCC	3/10 meter Open Area Test Sites (93105, 90471) / 3M Semi Anechoic Chamber (965860) to perform FCC Part 15/18 measurements	 93105, 90471 965860
Japan	VCCI	3/10 meter Open Area Test Sites to perform conducted/radiated measurements	 R-393/1066/725/879 C-402/747/912
Norway	NEMKO	EN 50081-1/2, EN 50082-1/2, IEC 61000-6-1/2, EN 50091-2, EN 50130-4, EN 55011, EN 55013, EN 55014-1/2, EN 55015, EN 55022, EN 55024, EN 61000-3-2/3, EN 61326-1, IEC 61000-4-2/3/4/5/6/8/11, EN 60601-1-2, EN 300 328, EN 300 422-2, EN 301 419-1, EN 301 489-01/03/07/08/09/17, EN 301 419-2/3, EN 300 454-2, EN 301 357-2	 ELA 124a ELA 124b ELA 124c
Taiwan	TAF	EN 300 328, EN 300 220-1, EN 300 220-2, EN 300 220-3, 47 CFR FCC Part 15 Subpart C, EN 61000-3-2, EN 61000-3-3, CNS 13439, CNS 13783-1, CNS 14115, CNS 13438, AS/NZS CISPR 22, CNS 13022-1, IEC 61000-4-2/3/4/5/6/8/11, CNS 13022-2/3	 Testing Laboratory 0363
Taiwan	BSMI	CNS 13438, CNS 13783-1, CNS 13439, CNS 14115	 SL2-IS-E-0014 SL2-IN-E-0014 SL2-A1-E-0014 SL2-R1-E-0014 SL2-R2-E-0014 SL2-L1-E-0014
Canada	Industry Canada	3/10 meter Open Area Test Sites (IC 2324C-3, IC 2324C-5) / 3M Semi Anechoic Chamber (IC 6106)	 IC 2324C-3 IC 2324C-5 IC 6106

* No part of this report may be used to claim or imply product endorsement by A2LA or any agency of the US Government.



6. SETUP OF EQUIPMENT UNDER TEST

6.1 SETUP CONFIGURATION OF EUT

See test photographs attached in Appendix 1 for the actual connections between EUT and support equipment.

6.2 SUPPORT EQUIPMENT

No.	Device Type	Brand	Model	FCC ID	Series No.	Data Cable	Power Cord
1.	Bluetooth Headset (Remote)	COREGA	CG-BTHS01-10	CG-BTHS01-10	10T90020500124	N/A	N/A
2.	Universal Radio Communication Tester (Remote)	R&S	CMU200	1100.000.8.02	N/A	N/A	Unshielded, 1.8m

Remark:

- 1. All the equipment/cables were placed in the worst-case configuration to maximize the emission during the test.*
- 2. Grounding was established in accordance with the manufacturer's requirements and conditions for the intended use.*



7. FCC PART 22 & 24 REQUIREMENTS

7.1 AVERAGE POWER

LIMIT

According to FCC §2.1046.

Test Configuration

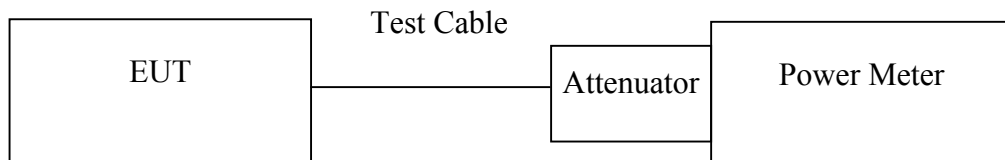

Remark: Measurement setup for testing on Antenna connector

TEST PROCEDURE

The transmitter output was connected to a calibrated attenuator, the other end of which was connected to a power meter. Transmitter output was read off the power meter in dBm. The power output at the transmitter antenna port was determined by adding the value of the attenuator to the power meter reading.



TEST RESULTS

No non-compliance noted.

Test Data

Test Mode	CH	Frequency (MHz)	Power Meter Reading (dBm)	Attenuator (dB)	Average Power (dBm)
GSM 850 (Class B)	128	824.20	-4.69	36.3	31.61
	190	836.60	-3.48		32.82
	251	848.80	-4.80		31.50
GPRS 850 (Class 10)	128	824.20	-4.90		31.40
	190	836.60	-3.69		32.61
	251	848.80	-4.91		31.39
EGPRS 850 (Class 10)	128	824.20	-9.34		26.96
	190	836.60	-9.51		26.79
	251	848.80	-9.46		26.84

Remark: The value of factor includes both the loss of cable and external attenuator

Test Mode	CH	Frequency (MHz)	Power Meter Reading (dBm)	Attenuator (dB)	Average Power (dBm)
GSM 1900 (Class B)	512	1850.20	-5.89	36.3	30.41
	661	1880.00	-6.18		30.12
	810	1910.00	-5.59		30.71
GPRS 1900 (Class 10)	512	1850.20	-6.66		29.64
	661	1880.00	-6.72		29.58
	810	1910.00	-6.09		30.21
EGPRS 1900 (Class 10)	512	1850.20	-10.47		25.83
	661	1880.00	-10.59		25.71
	810	1910.00	-10.96		25.34

Remark: The value of factor includes both the loss of cable and external attenuator

7.2 ERP & EIRP MEASUREMENT

LIMIT

According to FCC §2.1046

FCC 22.913(b): The Effective Radiated Power (ERP) of mobile transmitters must not exceed 7 Watts.

FCC 24.232(b): The equivalent Isotropic Radiated Power (EIRP) must not exceed 2 Watts.

TEST CONFIGURATION

Below 1 GHz

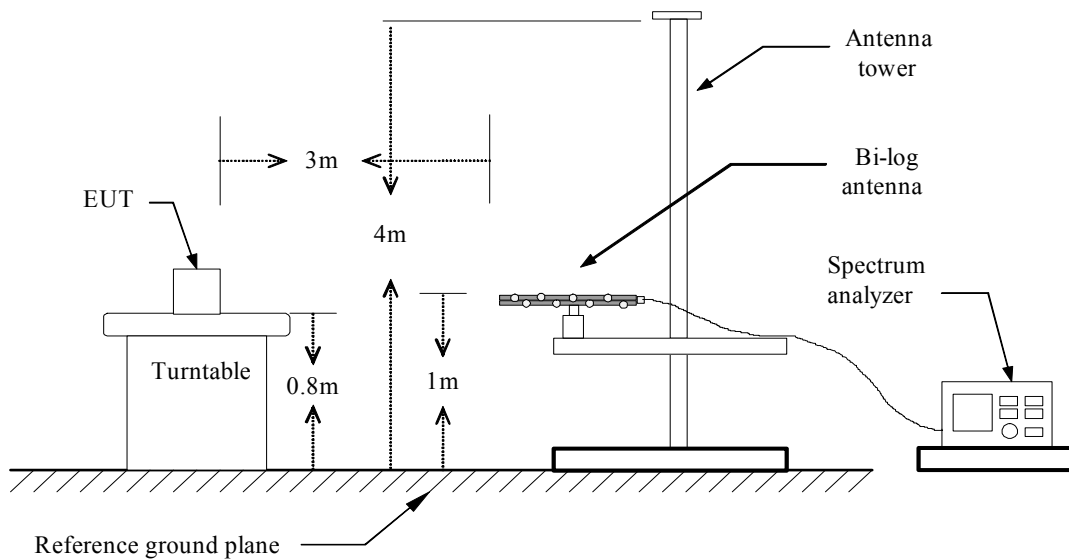

Above 1 GHz

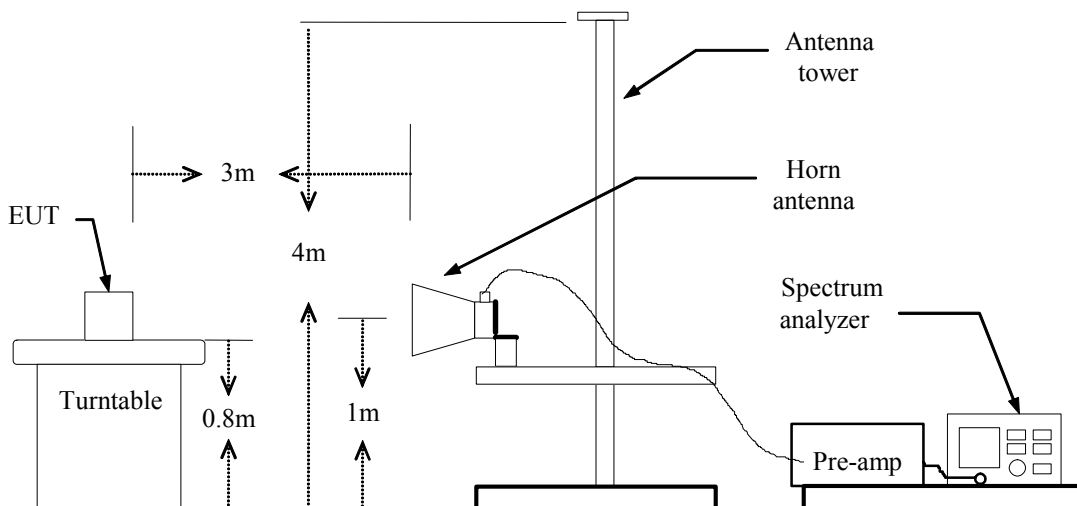

For Substituted Method Test Set-UP

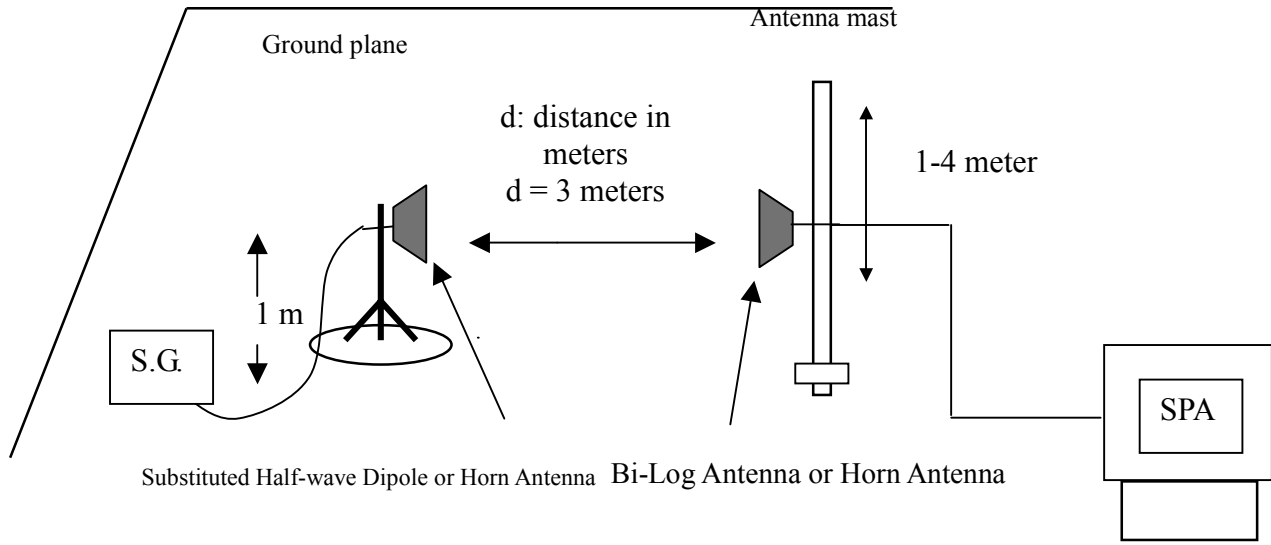

TEST PROCEDURE

The EUT was placed on an non-conductive turntable using a non-conductive support. The radiated emission at the fundamental frequency was measured at 3 m with a test antenna and EMI spectrum analyzer.

During the measurement of the EUT, the resolution bandwidth was set to 3MHz and the average bandwidth was set to 3MHz. The highest emission was recorded with the rotation of the turntable and the lowering of the test antenna. The reading was recorded and the field strength (E in dBuV/m) was calculated.

ERP in frequency band 824-849MHz, and EIRP in frequency band 1851.25 –1910MHz were measured using a substitution method. The EUT was replaced by half-wave dipole (824-849MHz) or horn antenna (1851.25-1910MHz) connected to a signal generator. The spectrum analyzer reading was recorded and ERP/EIRP was calculated as follows:

$$ERP = \text{S.G. output (dBm)} + \text{Antenna Gain (dBd)} - \text{Cable (dB)}$$

$$EIRP = \text{S.G. output (dBm)} + \text{Antenna Gain (dBi)} - \text{Cable (dB)}$$

**TEST RESULTS***No non-compliance noted.***GSM 850 Test Data (Class B) Closed Mode**

EUT Pol.	Channel	Frequency (MHz)	Antenna Pol.	Reading level (dBuV)	Correction Factor (dB)	Emission level (dBm)	Limit (dBm)	Margin (dB)
X	128	824.18	V	-20.76	40.26	19.50	38.50	-19.00
		824.18	H	-11.88	40.22	28.34	38.50	-10.16
	190	836.54	V	-19.06	40.11	21.05	38.50	-17.45
		836.54	H	-11.04	40.06	29.02	38.50	-9.48
	251	848.66	V	-17.94	39.78	21.85	38.50	-16.65
		848.66	H	-10.84	39.71	28.87	38.50	-9.63
Y	128	824.24	V	-22.78	40.26	17.48	38.50	-21.02
		824.24	H	-12.86	40.22	27.35	38.50	-11.15
	190	836.6	V	-22.58	40.12	17.54	38.50	-20.96
		836.6	H	-11.54	40.06	28.53	38.50	-9.97
	251	848.84	V	-20.98	39.79	18.81	38.50	-19.69
		848.84	H	-10.29	39.71	29.42	38.50	-9.08
Z	128	824.3	V	-12.38	40.26	27.88	38.50	-10.62
		824.3	H	-20.42	40.22	19.80	38.50	-18.70
	190	836.54	V	-10.59	40.12	29.53	38.50	-8.97
		836.54	H	-19.19	40.06	20.87	38.50	-17.63
	251	848.78	V	-9.00	39.78	*30.78	38.50	-7.72
		848.78	H	-18.03	39.71	21.68	38.50	-16.82

GPRS 850 Test Data (Class 10) Closed Mode

EUT Pol.	Channel	Frequency (MHz)	Antenna Pol.	Reading level (dBuV)	Correction Factor (dB)	Emission level (dBm)	Limit (dBm)	Margin (dB)
X	128	824.18	V	-18.81	40.26	21.45	38.50	-17.05
		824.18	H	-12.79	40.22	27.43	38.50	-11.07
	190	836.54	V	-17.88	40.12	22.24	38.50	-16.26
		836.54	H	-12.80	40.06	27.26	38.50	-11.24
	251	848.84	V	-17.30	39.78	22.48	38.50	-16.02
		848.84	H	-11.73	39.71	27.98	38.50	-10.52
Y	128	824.24	V	-24.48	40.26	15.78	38.50	-22.72
		824.24	H	-16.52	40.22	23.70	38.50	-14.80
	190	836.6	V	-23.34	40.12	16.78	38.50	-21.72
		836.6	H	-12.89	40.07	27.18	38.50	-11.32
	251	848.84	V	-21.08	39.79	18.70	38.50	-19.80
		848.84	H	-11.22	39.71	28.49	38.50	-10.01
Z	128	824.24	V	-13.51	40.26	26.75	38.50	-11.75
		824.24	H	-21.50	40.22	18.72	38.50	-19.78
	190	836.48	V	-11.06	40.12	29.06	38.50	-9.44
		836.48	H	-20.27	40.06	19.79	38.50	-18.71
	251	848.84	V	-9.84	39.78	*29.95	38.50	-8.55
		848.84	H	-19.13	39.72	20.59	38.50	-17.91

**EGPRS 850 Test Data (Class 10) Closed Mode**

EUT Pol.	Channel	Frequency (MHz)	Antenna Pol.	Reading level (dBuV)	Correction Factor (dB)	Emission level (dBm)	Limit (dBm)	Margin (dB)
X	128	824.30	V	-20.41	40.26	19.85	38.50	-18.65
		824.30	H	-13.60	40.22	26.62	38.50	-11.88
	190	836.54	V	-19.37	40.12	20.75	38.50	-17.75
		836.78	H	-13.01	40.06	27.05	38.50	-11.45
	251	849.08	V	-18.29	39.79	21.50	38.50	-17.00
		848.96	H	-11.78	39.70	27.92	38.50	-10.58
Y	128	824.18	V	-24.35	40.26	15.91	38.50	-22.59
		824.48	H	-13.84	40.22	26.38	38.50	-12.12
	190	836.54	V	-22.14	40.12	17.98	38.50	-20.52
		836.54	H	-12.45	40.06	27.61	38.50	-10.89
	251	848.84	V	-20.67	39.78	19.11	38.50	-19.39
		848.84	H	-11.15	39.71	28.56	38.50	-9.94
Z	128	824.24	V	-12.97	40.26	27.29	38.50	-11.21
		824.30	H	-21.39	40.22	18.82	38.50	-19.68
	190	836.54	V	-11.16	40.12	28.96	38.50	-9.54
		836.54	H	-19.63	40.06	20.43	38.50	-18.07
	251	848.84	V	-9.92	39.78	*29.86	38.50	-8.64
		848.84	H	-18.73	39.70	20.97	38.50	-17.53

GSM 850 Test Data (Class B) Slide Mode

EUT Pol.	Channel	Frequency (MHz)	Antenna Pol.	Reading level (dBuV)	Correction Factor (dB)	Emission level (dBm)	Limit (dBm)	Margin (dB)
X	128	824.18	V	-21.35	40.26	18.91	38.50	-19.59
		824.18	H	-17.07	40.22	23.15	38.50	-15.35
	190	836.54	V	-20.13	40.12	19.99	38.50	-18.51
		836.54	H	-15.93	40.06	24.14	38.50	-14.36
	251	848.78	V	-18.57	39.78	21.22	38.50	-17.28
		848.78	H	-14.82	39.70	24.88	38.50	-13.62
Y	128	824.18	V	-25.27	40.26	14.99	38.50	-23.51
		824.18	H	-17.85	40.22	22.37	38.50	-16.13
	190	836.54	V	-24.03	40.12	16.08	38.50	-22.42
		836.54	H	-16.52	40.06	23.55	38.50	-14.95
	251	848.78	V	-23.29	39.78	16.49	38.50	-22.01
		848.78	H	-14.47	39.71	25.24	38.50	-13.26
Z	128	824.18	V	-16.73	40.26	23.53	38.50	-14.97
		824.18	H	-22.74	40.22	17.48	38.50	-21.02
	190	836.54	V	-15.65	40.12	24.47	38.50	-14.03
		836.54	H	-21.56	40.06	18.50	38.50	-20.00
	251	848.78	V	-13.87	39.79	25.91	38.50	-12.59
		848.78	H	-20.17	39.71	19.54	38.50	-18.96

**GPRS 850 Test Data (Class 10) Slide Mode**

EUT Pol.	Channel	Frequency (MHz)	Antenna Pol.	Reading level (dBuV)	Correction Factor (dB)	Emission level (dBm)	Limit (dBm)	Margin (dB)
X	128	824.18	V	-21.93	40.26	18.33	38.50	-20.17
		824.18	H	-18.77	40.22	21.44	38.50	-17.06
	190	836.66	V	-20.98	40.12	19.14	38.50	-19.36
		836.66	H	-17.46	40.06	22.61	38.50	-15.89
	251	848.84	V	-19.24	39.79	20.54	38.50	-17.96
		848.84	H	-16.44	39.71	23.28	38.50	-15.22
Y	128	824.3	V	-27.97	40.26	12.30	38.50	-26.20
		824.3	H	-19.84	40.22	20.38	38.50	-18.12
	190	836.6	V	-27.75	40.12	12.37	38.50	-26.13
		836.60	H	-18.55	40.06	21.51	38.50	-16.99
	251	848.84	V	-26.35	39.79	13.44	38.50	-25.06
		848.84	H	-17.37	39.72	22.35	38.50	-16.15
Z	128	824.3	V	-18.09	40.26	22.17	38.50	-16.33
		824.30	H	-25.15	40.22	15.07	38.50	-23.43
	190	836.54	V	-16.32	40.12	23.80	38.50	-14.70
		836.54	H	-23.93	40.06	16.13	38.50	-22.37
	251	848.84	V	-14.86	39.78	24.93	38.50	-13.57
		848.84	H	-22.62	39.71	17.09	38.50	-21.41

EGPRS 850 Test Data (Class 10) Slide Mode

EUT Pol.	Channel	Frequency (MHz)	Antenna Pol.	Reading level (dBuV)	Correction Factor (dB)	Emission level (dBm)	Limit (dBm)	Margin (dB)
X	128	824.30	V	-24.12	40.26	16.14	38.50	-22.36
		824.30	H	-19.24	40.21	20.97	38.50	-17.53
	190	836.48	V	-21.81	40.12	18.31	38.50	-20.19
		836.66	H	-17.27	40.06	22.79	38.50	-15.71
	251	848.96	V	-20.65	39.78	19.13	38.50	-19.37
		848.96	H	-16.31	39.71	23.41	38.50	-15.09
Y	128	824.24	V	-30.12	40.26	10.14	38.50	-28.36
		824.24	H	-19.80	40.21	20.41	38.50	-18.09
	190	836.66	V	-29.20	40.12	10.92	38.50	-27.58
		836.66	H	-17.82	40.06	22.24	38.50	-16.26
	251	848.84	V	-27.44	39.78	12.34	38.50	-26.16
		848.84	H	-16.93	39.70	22.77	38.50	-15.73
Z	128	824.30	V	-17.19	40.26	23.07	38.50	-15.43
		824.30	H	-24.75	40.22	15.47	38.50	-23.03
	190	836.66	V	-15.61	40.12	24.51	38.50	-13.99
		836.66	H	-22.62	40.06	17.44	38.50	-21.06
	251	848.84	V	-14.42	39.78	25.36	38.50	-13.14
		848.84	H	-21.81	39.70	17.89	38.50	-20.61

**GSM 1900 Test Data (Class B) Closed Mode**

EUT Pol.	Channel	Frequency (MHz)	Antenna Pol.	Reading level (dBuV)	Correction Factor (dB)	Emission level (dBm)	Limit (dBm)	Margin (dB)
X	512	1850.4	V	-26.25	38.75	12.49	33.00	-20.51
		1850.1	H	-19.12	38.79	19.67	33.00	-13.33
	661	1880.1	V	-24.61	38.76	14.15	33.00	-18.85
		1880.1	H	-16.73	38.80	22.07	33.00	-10.93
	810	1909.8	V	-22.84	38.77	15.93	33.00	-17.07
		1909.8	H	-14.64	38.81	*24.18	33.00	-8.82
Y	512	1850.2	V	-18.95	38.75	19.79	33.00	-13.21
		1850.2	H	-25.96	38.79	12.83	33.00	-20.17
	661	1880	V	-16.77	38.76	21.98	33.00	-11.02
		1880	H	-22.85	38.80	15.96	33.00	-17.04
	810	1909.80	V	-15.24	38.77	23.52	33.00	-9.48
		1909.8	H	-20.77	38.81	18.04	33.00	-14.96
Z	512	1850.2	V	-23.81	38.75	14.93	33.00	-18.07
		1850.2	H	-22.55	38.79	16.25	33.00	-16.75
	661	1880	V	-21.29	38.76	17.47	33.00	-15.53
		1880	H	-20.33	38.80	18.47	33.00	-14.53
	810	1909.8	V	-20.01	38.77	18.76	33.00	-14.24
		1909.8	H	-17.54	38.81	21.27	33.00	-11.73

GPRS 1900 Test Data (Class 10) Closed Mode

EUT Pol.	Channel	Frequency (MHz)	Antenna Pol.	Reading level (dBuV)	Correction Factor (dB)	Emission level (dBm)	Limit (dBm)	Margin (dB)
X	512	1850.1	V	-26.80	38.75	11.95	33.00	-21.05
		1850.10	H	-19.26	38.79	19.54	33.00	-13.46
	661	1880.1	V	-24.92	38.76	13.83	33.00	-19.17
		1880.1	H	-17.15	38.80	21.65	33.00	-11.35
	810	1909.7	V	-22.82	38.77	15.95	33.00	-17.05
		1909.7	H	-14.99	38.81	*23.82	33.00	-9.18
Y	512	1850.4	V	-18.54	38.75	20.20	33.00	-12.80
		1850.4	H	-27.63	38.79	11.17	33.00	-21.83
	661	1880.3	V	-16.84	38.76	21.92	33.00	-11.08
		1880.3	H	-25.09	38.80	13.71	33.00	-19.29
	810	1909.7	V	-15.58	38.77	23.19	33.00	-9.81
		1909.7	H	-22.22	38.81	16.59	33.00	-16.41
Z	512	1850.4	V	-23.54	38.75	15.21	33.00	-17.79
		1850.4	H	-22.34	38.79	16.45	33.00	-16.55
	661	1880.1	V	-21.21	38.76	17.55	33.00	-15.45
		1880.1	H	-21.53	38.80	17.27	33.00	-15.73
	810	1909.70	V	-19.87	38.77	18.90	33.00	-14.10
		1909.7	H	-19.15	38.81	19.66	33.00	-13.34

**EGPRS 1900 Test Data (Class 10) Closed Mode**

EUT Pol.	Channel	Frequency (MHz)	Antenna Pol.	Reading level (dBuV)	Correction Factor (dB)	Emission level (dBm)	Limit (dBm)	Margin (dB)
X	512	1850.20	V	-28.07	38.75	10.67	33.00	-22.33
		1850.20	H	-22.14	38.79	16.65	33.00	-16.35
	661	1880.50	V	-26.24	38.76	12.52	33.00	-20.48
		1879.80	H	-21.57	38.80	17.23	33.00	-15.77
	810	1909.90	V	-25.49	38.77	13.27	33.00	-19.73
		1909.90	H	-18.75	38.81	*20.06	33.00	-12.94
Y	512	1850.20	V	-22.13	38.75	16.61	33.00	-16.39
		1850.20	H	-27.76	38.79	11.04	33.00	-21.96
	661	1880.30	V	-21.28	38.76	17.48	33.00	-15.52
		1880.30	H	-25.27	38.80	13.54	33.00	-19.46
	810	1909.70	V	-19.57	38.77	19.20	33.00	-13.80
		1909.70	H	-23.89	38.81	14.92	33.00	-18.08
Z	512	1850.10	V	-27.26	38.75	11.49	33.00	-21.51
		1850.10	H	-26.33	38.79	12.47	33.00	-20.53
	661	1880.10	V	-25.53	38.76	13.23	33.00	-19.77
		1880.10	H	-24.64	38.80	14.16	33.00	-18.84
	810	1909.70	V	-22.73	38.77	16.03	33.00	-16.97
		1909.70	H	-22.91	38.81	15.90	33.00	-17.10

GSM 1900 Test Data (Class B) Slide Mode

EUT Pol.	Channel	Frequency (MHz)	Antenna Pol.	Reading level (dBuV)	Correction Factor (dB)	Emission level (dBm)	Limit (dBm)	Margin (dB)
X	512	1850.2	V	-31.94	38.75	6.81	33.00	-26.19
		1850.2	H	-23.82	38.79	14.98	33.00	-18.02
	661	1880	V	-28.79	38.76	9.97	33.00	-23.03
		1880	H	-20.69	38.80	18.11	33.00	-14.89
	810	1909.9	V	-24.57	38.77	14.20	33.00	-18.80
		1909.9	H	-18.49	38.81	20.32	33.00	-12.68
Y	512	1850.2	V	-22.44	38.75	16.31	33.00	-16.69
		1850.2	H	-25.39	38.79	13.40	33.00	-19.60
	661	1880	V	-19.67	38.76	19.09	33.00	-13.91
		1880	H	-22.18	38.80	16.62	33.00	-16.38
	810	1909.9	V	-17.19	38.77	21.58	33.00	-11.42
		1909.9	H	-18.46	38.81	20.35	33.00	-12.65
Z	512	1850.2	V	-26.24	38.75	12.51	33.00	-20.49
		1850.2	H	-23.84	38.79	14.95	33.00	-18.05
	661	1880.1	V	-23.11	38.76	15.65	33.00	-17.35
		1880.1	H	-19.94	38.80	18.86	33.00	-14.14
	810	1909.9	V	-20.77	38.77	17.99	33.00	-15.01
		1909.9	H	-17.38	38.81	21.43	33.00	-11.57

**GPRS 1900 Test Data (Class 10) Slide Mode**

EUT Pol.	Channel	Frequency (MHz)	Antenna Pol.	Reading level (dBuV)	Correction Factor (dB)	Emission level (dBm)	Limit (dBm)	Margin (dB)
X	512	1850.2	V	-32.89	38.75	5.86	33.00	-27.14
		1850.2	H	-23.49	38.79	15.30	33.00	-17.70
	661	1880	V	-28.66	38.76	10.09	33.00	-22.91
		1880.00	H	-20.58	38.80	18.22	33.00	-14.78
	810	1909.8	V	-24.15	38.77	14.62	33.00	-18.38
		1909.8	H	-18.82	38.81	19.99	33.00	-13.01
Y	512	1850.2	V	-23.99	38.75	14.75	33.00	-18.25
		1850.2	H	-26.77	38.79	12.02	33.00	-20.98
	661	1880.1	V	-21.14	38.76	17.62	33.00	-15.38
		1880.1	H	-23.05	38.80	15.75	33.00	-17.25
	810	1909.8	V	-18.64	38.77	20.13	33.00	-12.87
		1909.80	H	-20.27	38.81	18.55	33.00	-14.45
Z	512	1850.2	V	-28.23	38.75	10.52	33.00	-22.48
		1850.2	H	-25.45	38.79	13.34	33.00	-19.66
	661	1880	V	-24.54	38.76	14.21	33.00	-18.79
		1880	H	-21.09	38.80	17.71	33.00	-15.29
	810	1909.7	V	-21.82	38.77	16.94	33.00	-16.06
		1909.7	H	-18.49	38.81	20.32	33.00	-12.68

EGPRS 1900 Test Data (Class 10) Slide Mode

EUT Pol.	Channel	Frequency (MHz)	Antenna Pol.	Reading level (dBuV)	Correction Factor (dB)	Emission level (dBm)	Limit (dBm)	Margin (dB)
X	512	1850.40	V	-33.03	38.75	5.71	33.00	-27.29
		1850.40	H	-26.50	38.79	12.30	33.00	-20.70
	661	1880.30	V	-28.55	38.76	10.21	33.00	-22.79
		1880.30	H	-24.98	38.80	13.82	33.00	-19.18
	810	1909.60	V	-26.05	38.77	12.71	33.00	-20.29
		1909.60	H	-22.83	38.81	15.98	33.00	-17.02
Y	512	1850.10	V	-27.79	38.75	10.96	33.00	-22.04
		1850.20	H	-28.13	38.79	10.66	33.00	-22.34
	661	1880.00	V	-24.06	38.76	14.70	33.00	-18.30
		1880.00	H	-25.66	38.80	13.15	33.00	-19.85
	810	1910.20	V	-22.12	38.77	16.65	33.00	-16.35
		1909.90	H	-22.52	38.81	16.29	33.00	-16.71
Z	512	1850.10	V	-31.39	38.75	7.36	33.00	-25.64
		1850.10	H	-28.28	38.79	10.51	33.00	-22.49
	661	1879.80	V	-27.54	38.76	11.22	33.00	-21.78
		1880.00	H	-24.03	38.80	14.77	33.00	-18.23
	810	1909.90	V	-24.61	38.77	14.15	33.00	-18.85
		1909.70	H	-21.31	38.81	17.51	33.00	-15.49

7.3 OCCUPIED BANDWIDTH MEASUREMENT

LIMIT

According to §FCC 2.1049.

Test Configuration

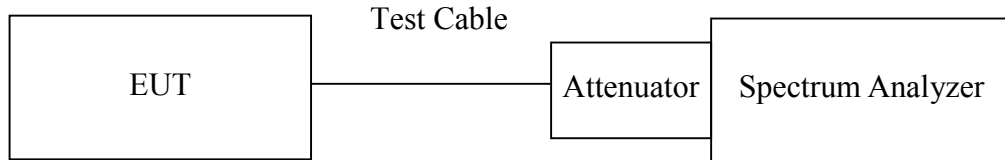

Remark: Measurement setup for testing on Antenna connector

TEST PROCEDURE

The EUT's output RF connector was connected with a short cable to the spectrum analyzer, RBW was set to about 1% of emission BW, VBW is set to 3 times the RBW, -26dBc display line was placed on the screen (or 99% bandwidth), the occupied bandwidth is the delta frequency between the two points where the display line intersects the signal trace.



TEST RESULTS

No non-compliance noted

Test Data

Test Mode	CH	Frequency (MHz)	99% Bandwidth (kHz)
GSM 850 (Class B)	128	824.20	243.8117
	190	836.60	247.8627
	251	848.80	237.3942
GPRS 850 (Class 10)	128	824.20	234.9164
	190	836.60	234.9996
	251	848.80	230.8498

Test Mode	CH	Frequency (MHz)	99% Bandwidth (kHz)
GSM 1900 (Class B)	512	1850.20	249.0116
	661	1880.00	245.1086
	810	1909.80	244.9819
GPRS 1900 (Class 10)	512	1850.20	247.4579
	661	1880.00	239.1360
	810	1909.80	240.4704



Test Plot

GSM 850 (CH Low)

Agilent 11:28:45 Jul 5, 2007

R T

Mkr1 824.205 MHz

26.04 dBm

Ref 36.3 dBm

#Atten 20 dB

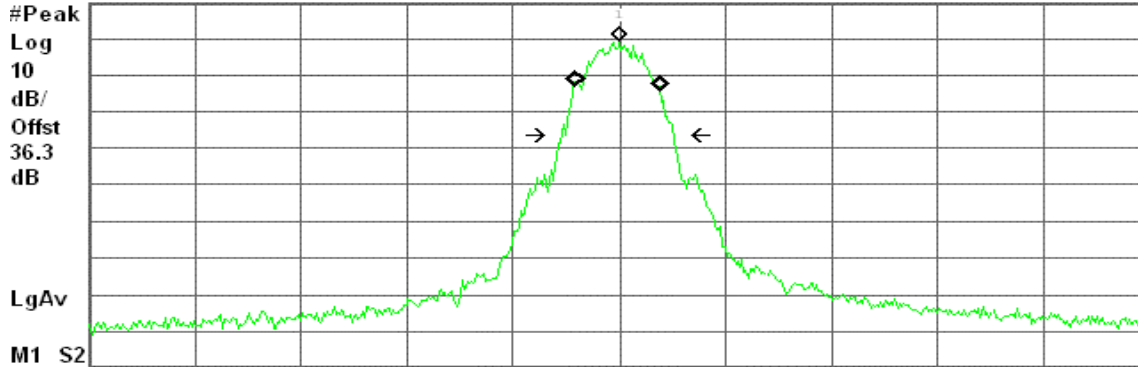

Center 824.205 MHz

Span 3 MHz

#Res BW 3 kHz

#VBW 10 kHz

Sweep 316.3 ms (601 pts)

Occupied Bandwidth
243.8117 kHz

Occ BW % Pwr 99.00 %
x dB -26.00 dB

Transmit Freq Error -5.440 kHz
x dB Bandwidth 315.219 kHz

GSM 850 (CH Mid)

Agilent 11:29:12 Jul 5, 2007

R T

Mkr1 836.585 MHz

27.16 dBm

Ref 36.3 dBm

#Atten 20 dB

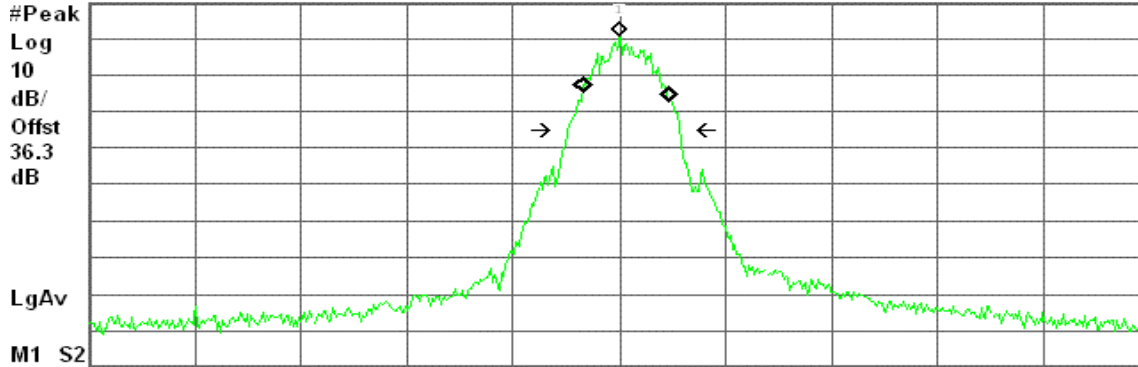

Center 836.585 MHz

Span 3 MHz

#Res BW 3 kHz

#VBW 10 kHz

Sweep 316.3 ms (601 pts)

Occupied Bandwidth
247.8627 kHz

Occ BW % Pwr 99.00 %
x dB -26.00 dB

Transmit Freq Error 16.896 kHz
x dB Bandwidth 316.533 kHz



GSM 850 (CH High)

Agilent 11:29:40 Jul 5, 2007

R T

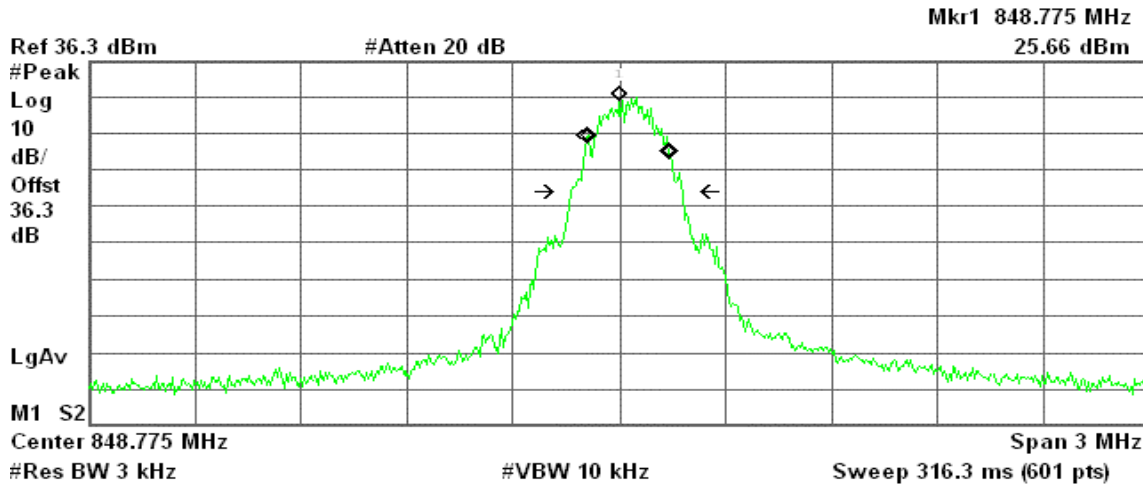

Occupied Bandwidth
237.3942 kHz

Occ BW % Pwr 99.00 %
x dB -26.00 dB

Transmit Freq Error 21.560 kHz
x dB Bandwidth 314.794 kHz

GPRS 850 (CH Low)

Agilent 20:29:59 Jul 6, 2007

R T

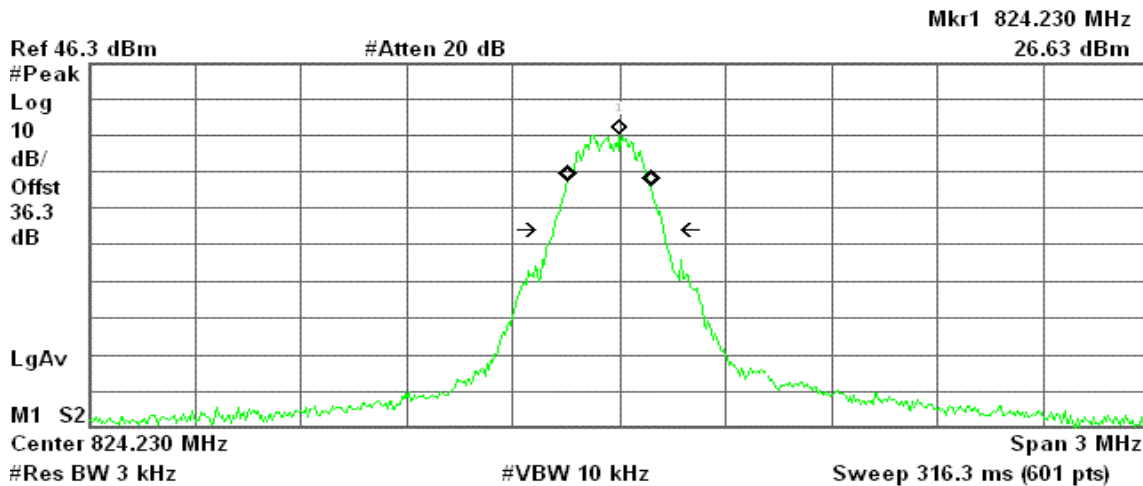

Occupied Bandwidth
234.9164 kHz

Occ BW % Pwr 99.00 %
x dB -26.00 dB

Transmit Freq Error -29.321 kHz
x dB Bandwidth 309.514 kHz



GPRS 850 (CH Mid)

Agilent 20:34:00 Jul 6, 2007

R T

Mkr1 836.550 MHz
27.21 dBm

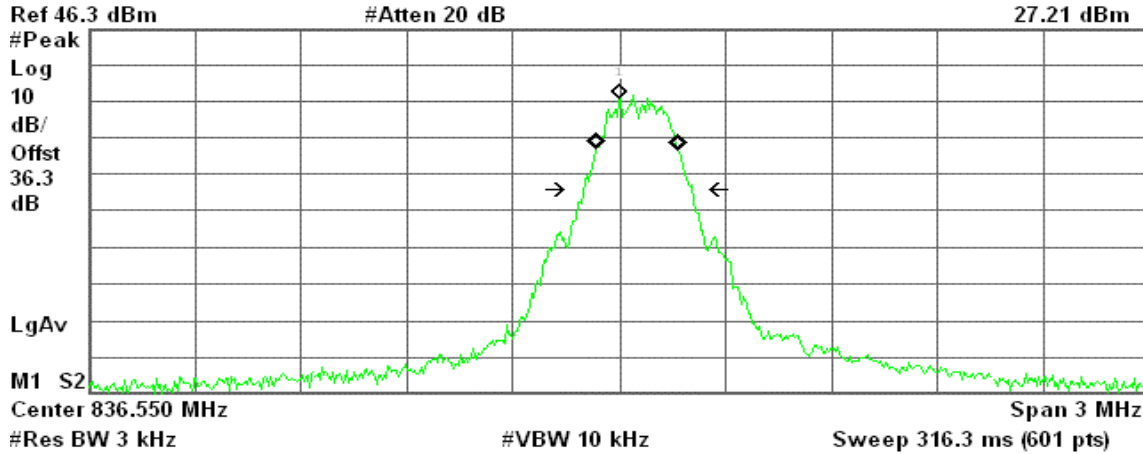

Occupied Bandwidth
234.9996 kHz

Occ BW % Pwr 99.00 %
x dB -26.00 dB

Transmit Freq Error 49.721 kHz
x dB Bandwidth 310.716 kHz

GPRS 850(CH High)

Agilent 20:34:23 Jul 6, 2007

R T

Mkr1 848.850 MHz
25.85 dBm

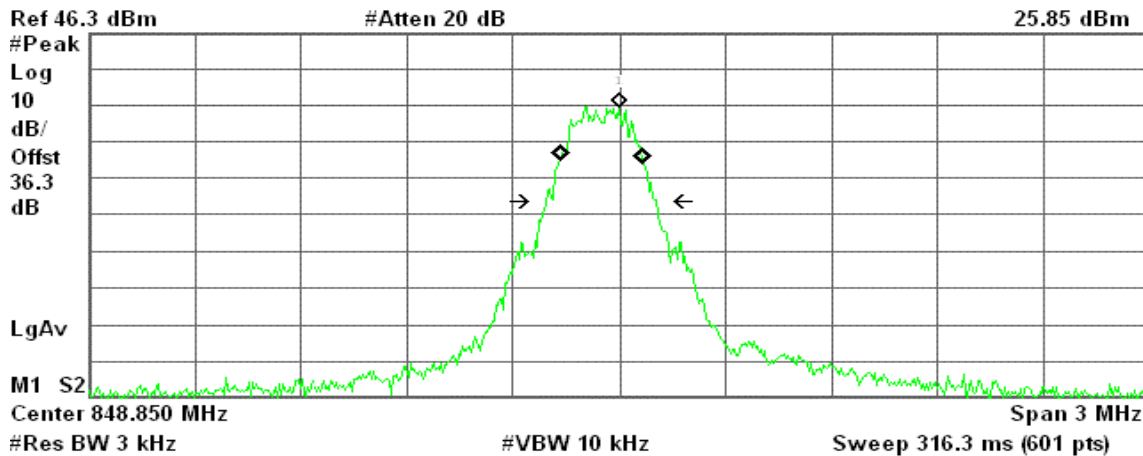

Occupied Bandwidth
230.8498 kHz

Occ BW % Pwr 99.00 %
x dB -26.00 dB

Transmit Freq Error -49.905 kHz
x dB Bandwidth 309.476 kHz



GSM 1900 (CH Low)

Agilent 13:17:09 Jul 5, 2007

R T

Mkr1 1.850 190 GHz
20.82 dBm

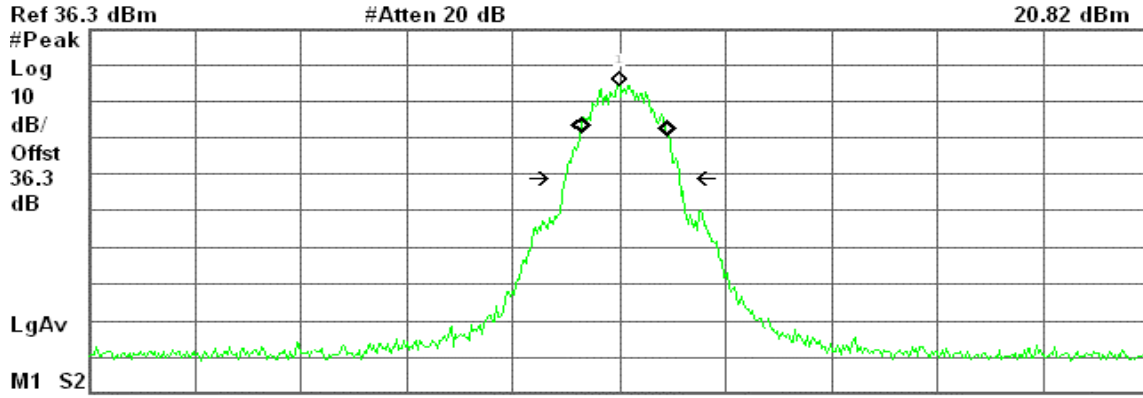

Ref 36.3 dBm #Atten 20 dB
Center 1.850 190 GHz Span 3 MHz
#Res BW 3 kHz #VBW 10 kHz Sweep 316.3 ms (601 pts)

Occupied Bandwidth
249.0116 kHz

Occ BW % Pwr 99.00 %
x dB -26.00 dB

Transmit Freq Error 12.704 kHz
x dB Bandwidth 321.091 kHz

GSM 1900 (CH Mid)

Agilent 13:18:04 Jul 5, 2007

R T

Mkr1 1.879 990 GHz
21.26 dBm

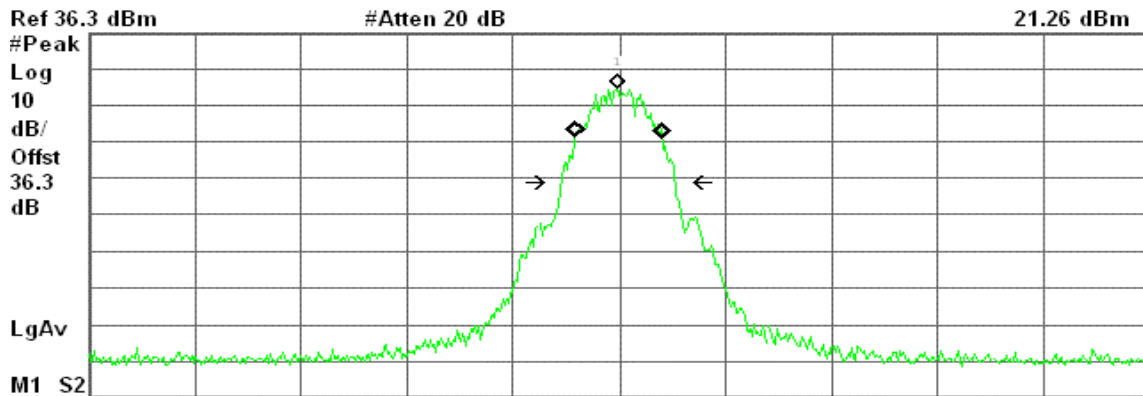

Ref 36.3 dBm #Atten 20 dB
Center 1.880 000 GHz Span 3 MHz
#Res BW 3 kHz #VBW 10 kHz Sweep 316.3 ms (601 pts)

Occupied Bandwidth
245.1086 kHz

Occ BW % Pwr 99.00 %
x dB -26.00 dB

Transmit Freq Error -280.940 Hz
x dB Bandwidth 320.880 kHz



GSM 1900 (CH High)

Agilent 13:18:33 Jul 5, 2007

R T

Mkr1 1.909 780 GHz
21.27 dBm

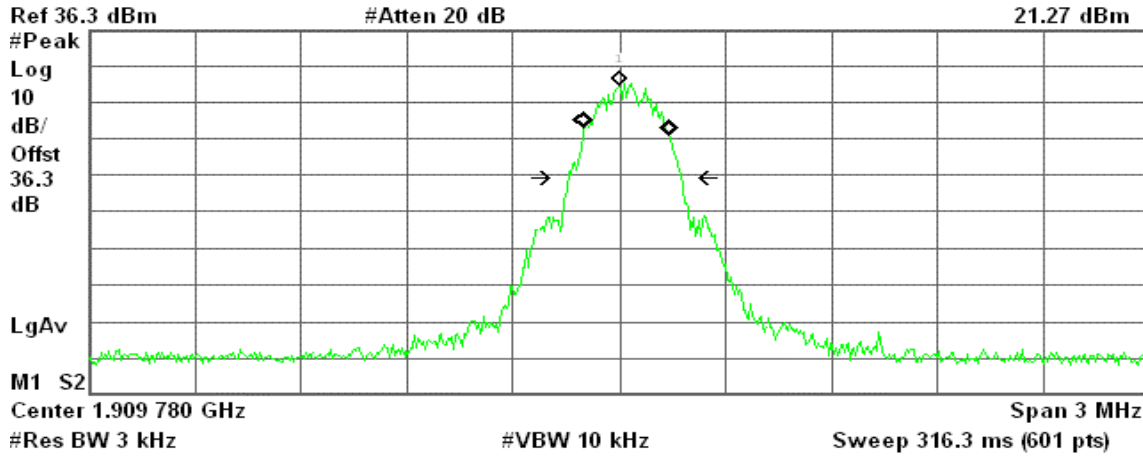

Occupied Bandwidth
244.9819 kHz

Occ BW % Pwr 99.00 %
x dB -26.00 dB

Transmit Freq Error 19.982 kHz
x dB Bandwidth 319.845 kHz

GPRS 1900 (CH Low)

Agilent 20:26:29 Jul 6, 2007

R T

Mkr1 1.850 135 GHz
29.69 dBm

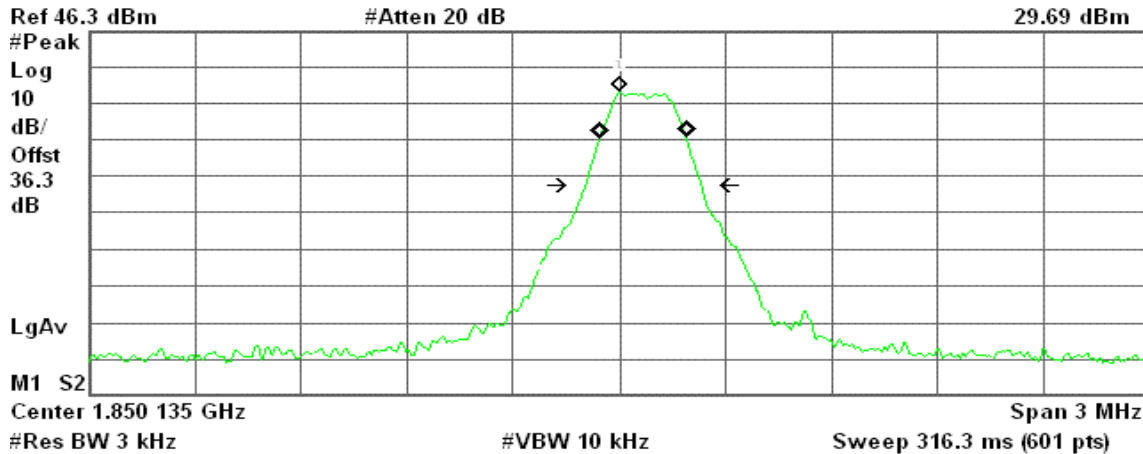

Occupied Bandwidth
247.4579 kHz

Occ BW % Pwr 99.00 %
x dB -26.00 dB

Transmit Freq Error 65.156 kHz
x dB Bandwidth 331.715 kHz



GPRS 1900 (CH Mid)

Agilent 20:27:52 Jul 6, 2007

R T

Mkr1 1.879 980 GHz
19.97 dBm

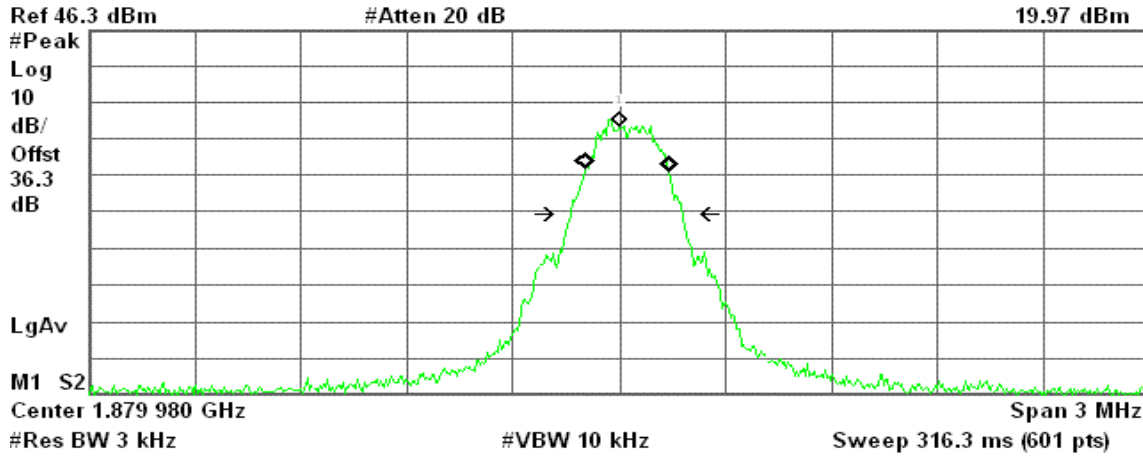

Occupied Bandwidth
239.1360 kHz

Occ BW % Pwr 99.00 %
x dB -26.00 dB

Transmit Freq Error 19.589 kHz
x dB Bandwidth 313.977 kHz

GPRS 1900 (CH High)

Agilent 20:28:16 Jul 6, 2007

R T

Mkr1 1.909 755 GHz
21.14 dBm

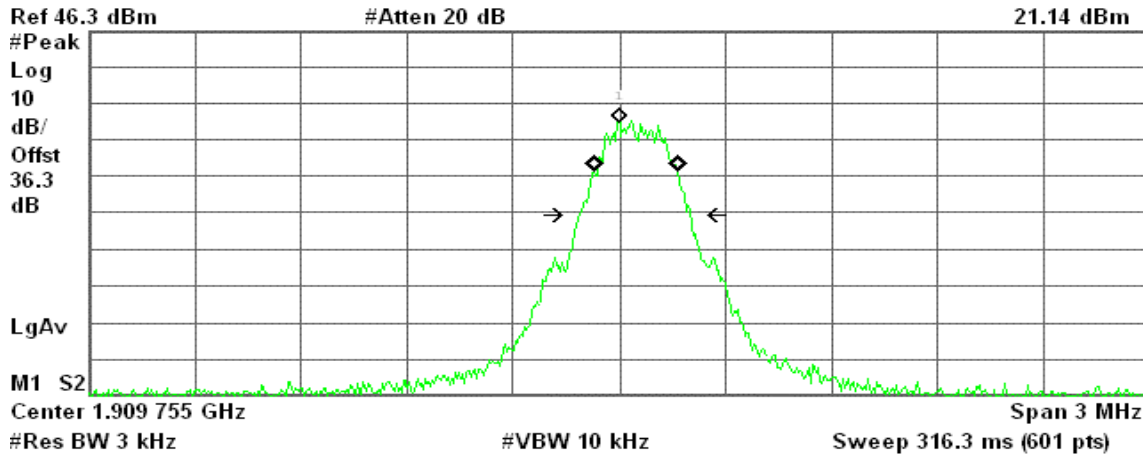

Occupied Bandwidth
240.4704 kHz

Occ BW % Pwr 99.00 %
x dB -26.00 dB

Transmit Freq Error 43.678 kHz
x dB Bandwidth 314.612 kHz



7.4 OUT OF BAND EMISSION AT ANTENNA TERMINALS

LIMIT

According to FCC §2.1051, FCC §22.917, FCC §24.238(a).

Out of Band Emissions: The mean power of emission must be attenuated below the mean power of the non-modulated carrier (P) on any frequency twice or more than twice the fundamental frequency by at least $43 + 10 \log P$ dB.

Mobile Emissions in Base Frequency Range: The mean power of any emissions appearing in the base station frequency range from cellular mobile transmitters operated must be attenuated to a level not exceed -80 dBm at the transmit antenna connector.

Band Edge Requirements: In the 1MHz bands immediately outside and adjacent to the frequency block, a resolution bandwidth of at least 1% of the emission bandwidth of the fundamental emission of the transmitter may be employed to measure the Out of band Emission

TEST CONFIGURATION

Out of band emission at antenna terminals:

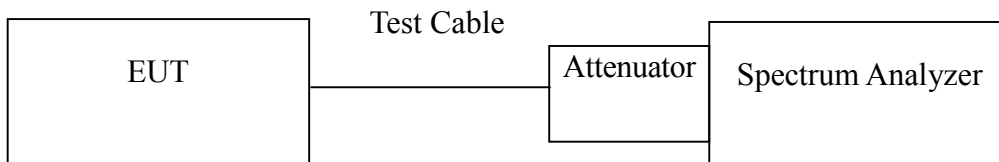

TEST PROCEDURE

The RF output of the transceiver was connected to a spectrum analyzer through appropriate attenuation. The resolution bandwidth of the spectrum analyzer was set at 1MHz, sufficient scans were taken to show the out of band Emissions if any up to 10th harmonic.

For the out of band: Set the RBW, VBW = 1MHz, Start=30MHz, Stop= 10 th harmonic. Limit = -13dBm

Band Edge Requirements (824 MHz and 849 MHz /1850MHz and 1910MHz): In the 1 MHz bands immediately outside and adjacent to the frequency block, a resolution bandwidth of at least 1 percent of the emission bandwidth of the fundamental emission of the transmitter may be employed to measure the out of band Emissions. Limit, -13dBm.



TEST RESULTS

No non-compliance noted.

Test Data

Mode	CH	Location	Description
GSM 850 (Class B)	128	Figure 7-1	Conducted spurious emissions, 30MHz - 20GHz
	190	Figure 7-2	Conducted spurious emissions, 30MHz - 20GHz
	251	Figure 7-3	Conducted spurious emissions, 30MHz - 20GHz
GPRS 850 (Class 10)	128	Figure 7-4	Conducted spurious emissions, 30MHz - 20GHz
	190	Figure 7-5	Conducted spurious emissions, 30MHz - 20GHz
	251	Figure 7-6	Conducted spurious emissions, 30MHz - 20GHz

Mode	CH	Location	Description
GSM 1900 (Class B)	512	Figure 8-1	Conducted spurious emissions, 30MHz - 20GHz
	661	Figure 8-2	Conducted spurious emissions, 30MHz - 20GHz
	810	Figure 8-3	Conducted spurious emissions, 30MHz - 20GHz
GPRS 1900 (Class 10)	512	Figure 8-4	Conducted spurious emissions, 30MHz - 20GHz
	661	Figure 8-5	Conducted spurious emissions, 30MHz - 20GHz
	810	Figure 8-6	Conducted spurious emissions, 30MHz - 20GHz

Mode	CH	Location	Description
GSM 850 (Class B)	128	Figure 9-1	Band Edge emissions
	251	Figure 9-2	Band Edge emissions
GPRS 850 (Class 10)	128	Figure 9-3	Band Edge emissions
	251	Figure 9-4	Band Edge emissions

Mode	CH	Location	Description
GSM 1900 (Class B)	512	Figure 10-1	Band Edge emissions
	810	Figure 10-2	Band Edge emissions
GPRS 1900 (Class 10)	512	Figure 10-3	Band Edge emissions
	810	Figure 10-4	Band Edge emissions



Test Plot

GSM 850

Figure 7-1: Out of Band emission at antenna terminals – GSM CH Low

Agilent 14:29:55 Jul 5, 2007

R T

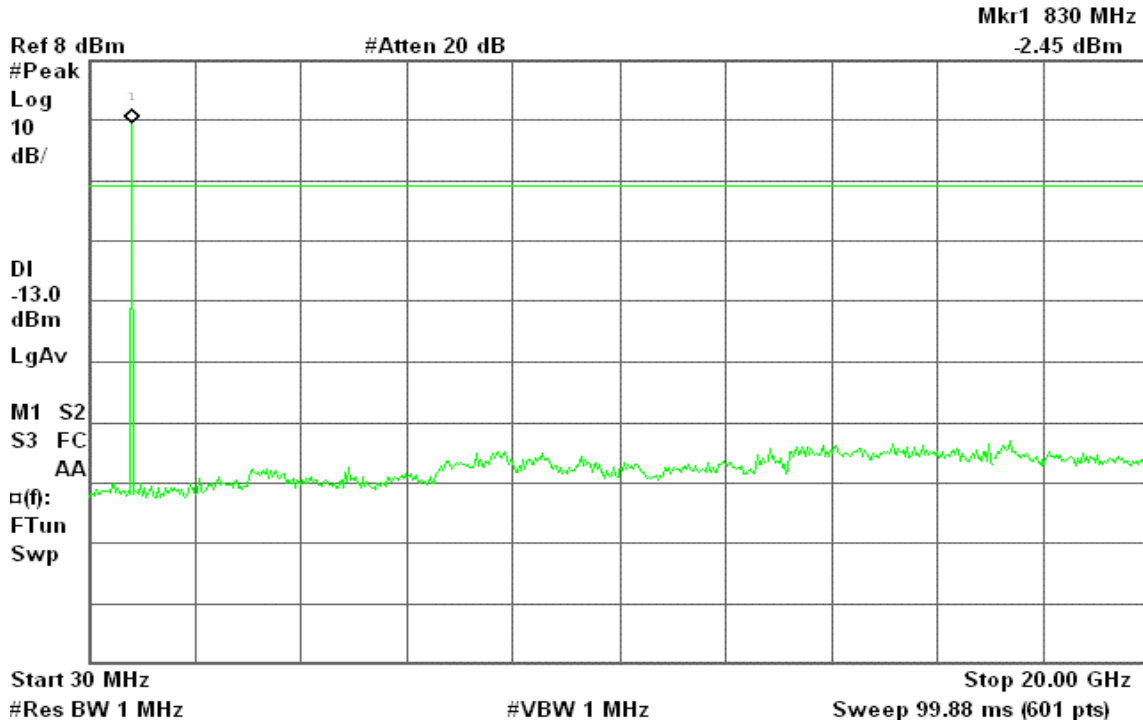

Figure 7-2: Out of Band emission at antenna terminals – GSM CH Mid

Agilent 14:30:26 Jul 5, 2007

R T

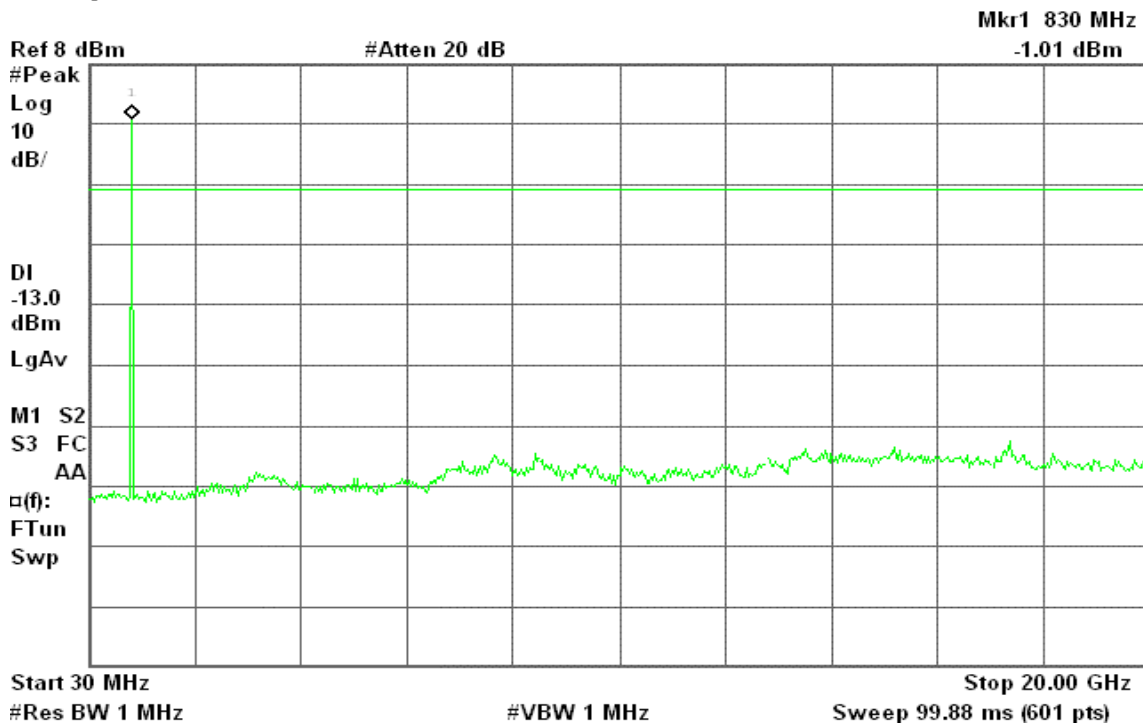
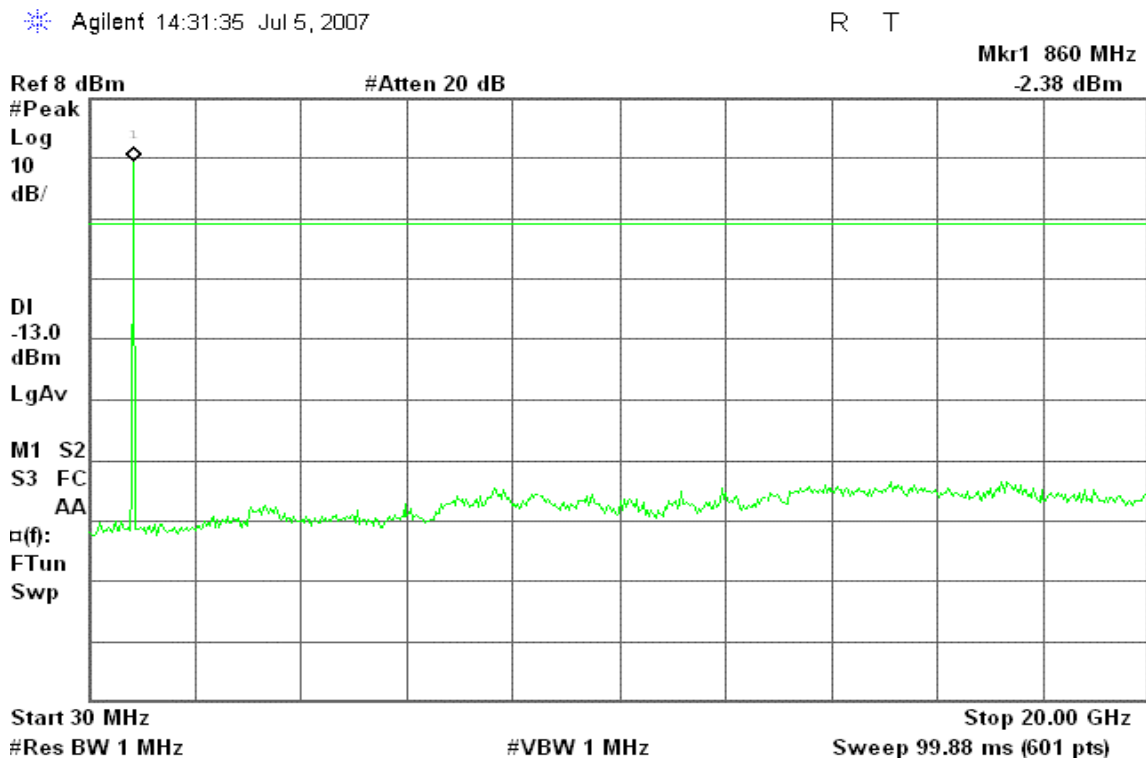



Figure 7-3: Out of Band emission at antenna terminals – GSM CH High



GPRS 850

Figure 7-4: Out of Band emission at antenna terminals – GPRS CH Low

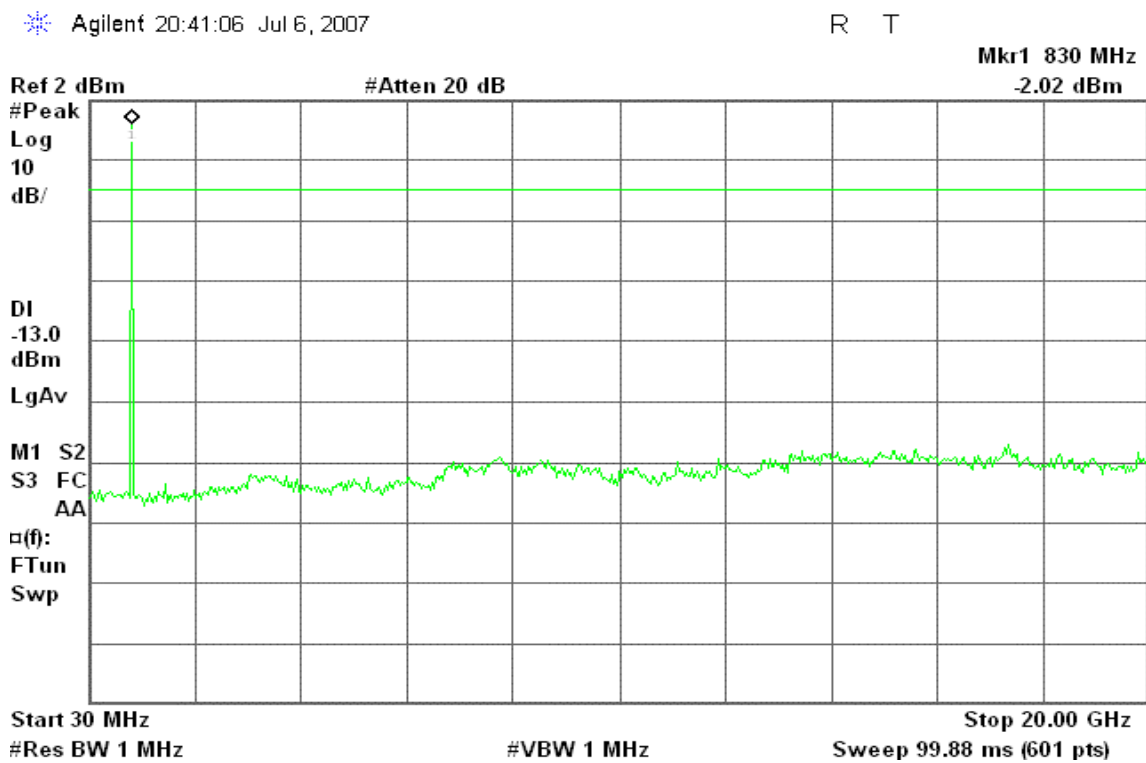



Figure 7-5: Out of Band emission at antenna terminals – GPRS CH Mid

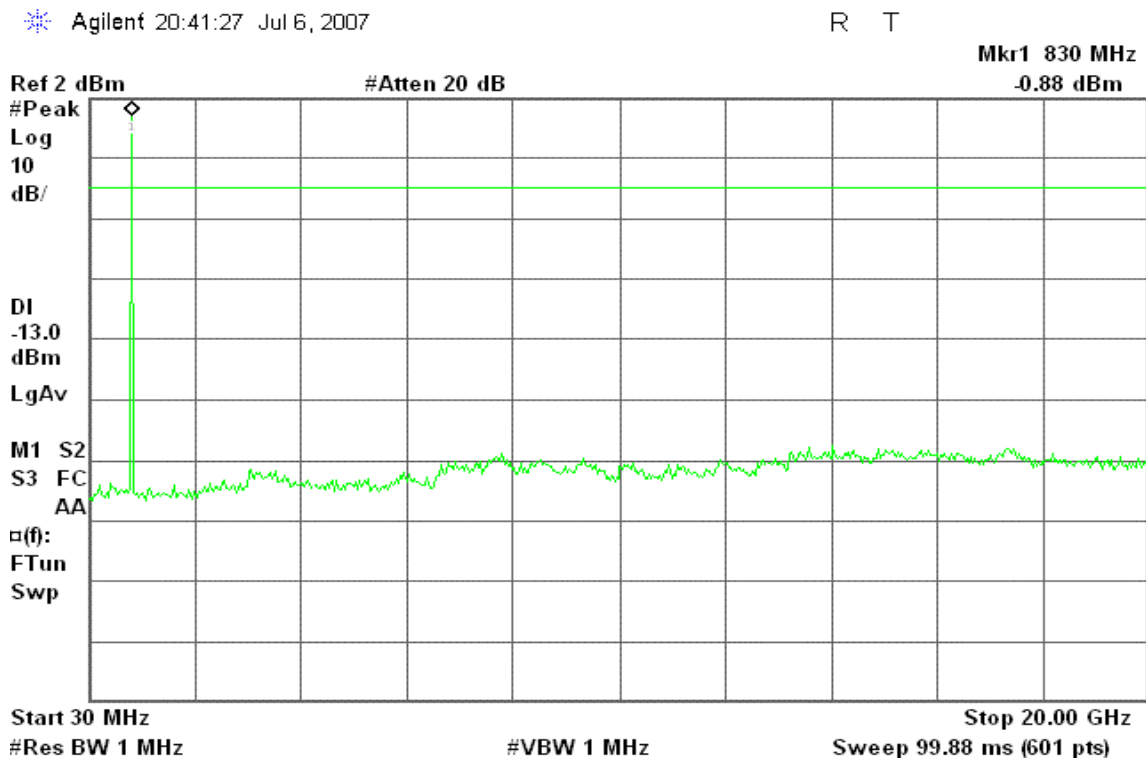
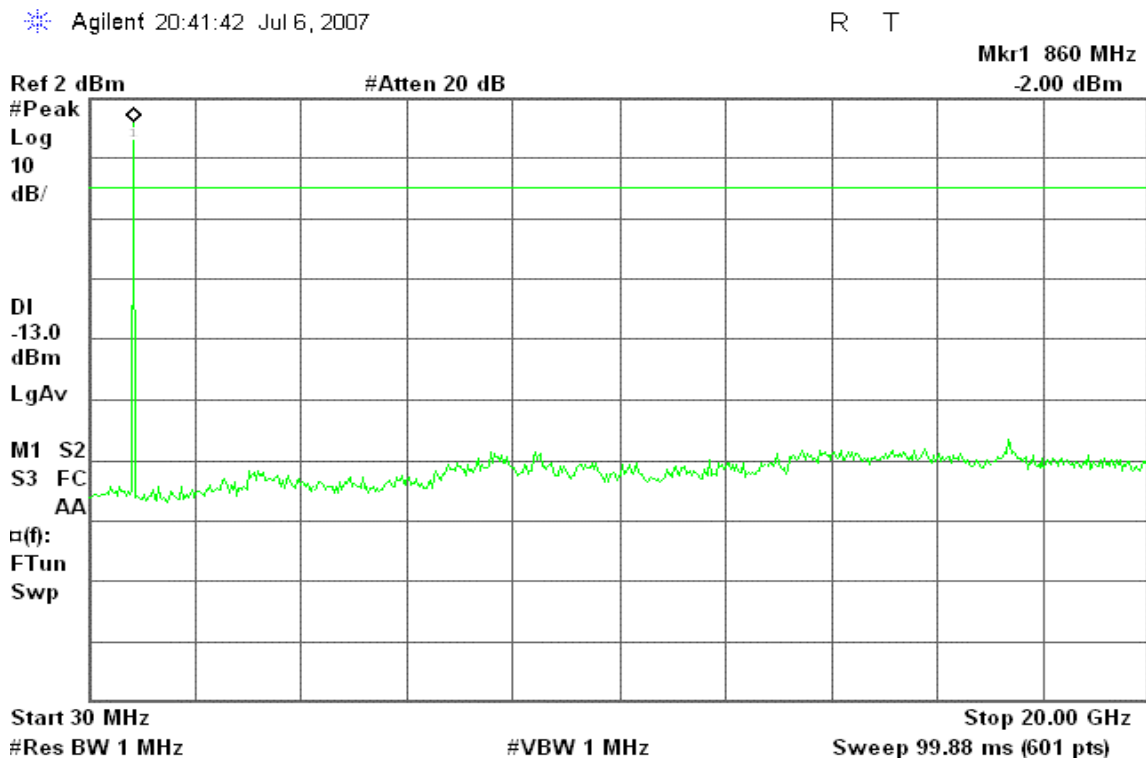

Figure 7-6: Out of Band emission at antenna terminals – GPRS CH High





GSM 1900

Figure 8-1: Out of Band emission at antenna terminals – GSM CH Low

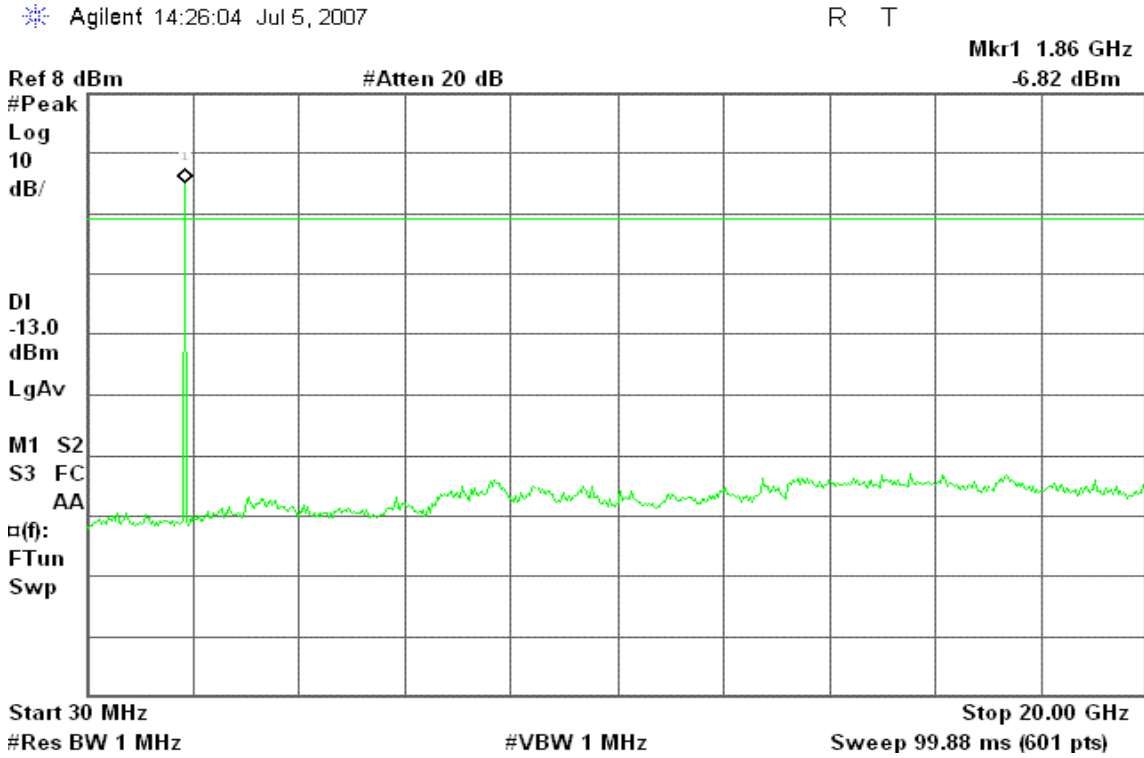

Figure 8-2: Out of Band emission at antenna terminals – GSM CH Mid

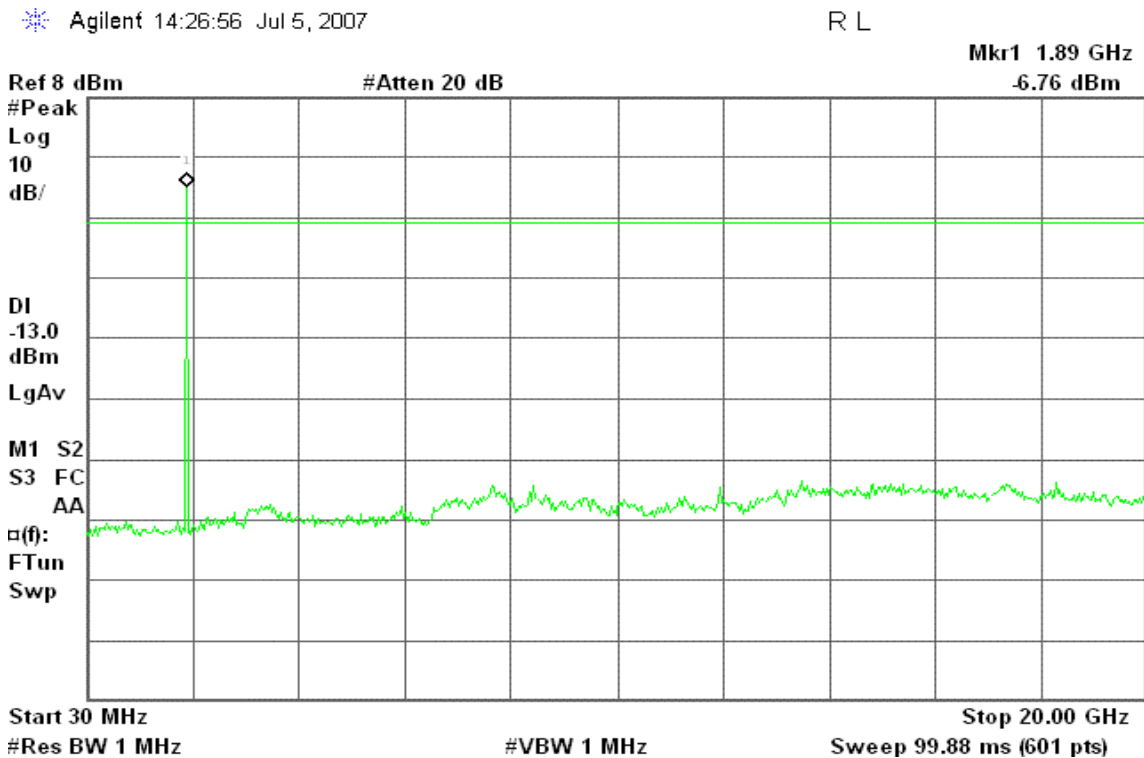
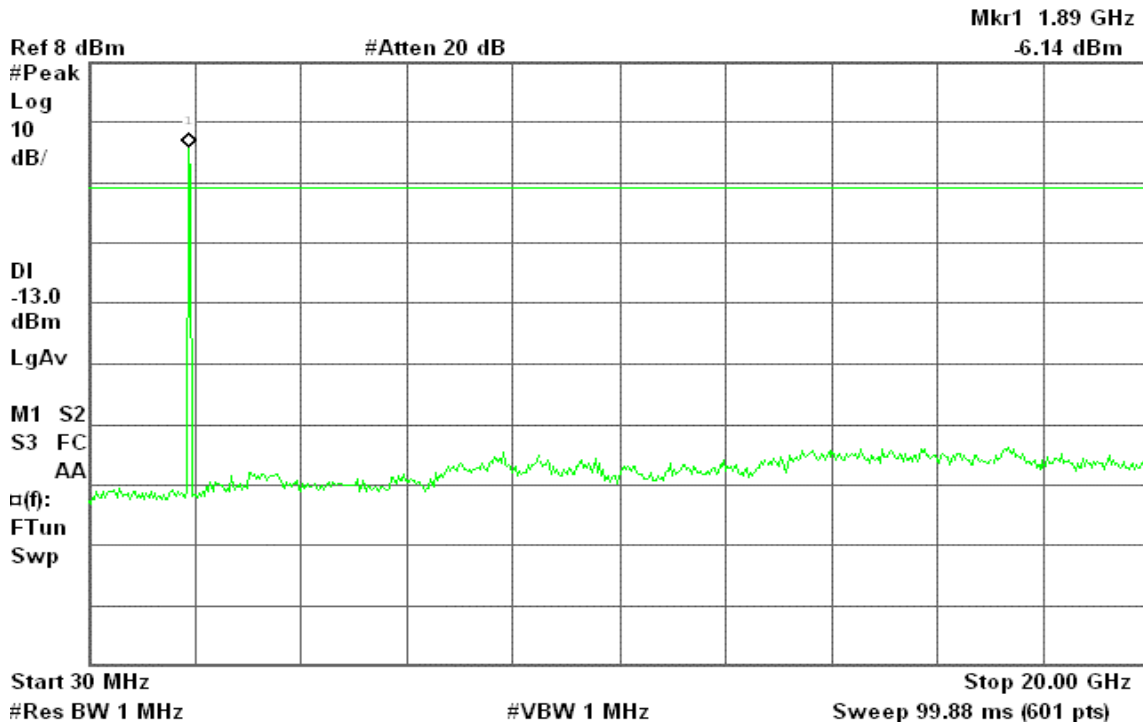



Figure 8-3: Out of Band emission at antenna terminals – GSM CH High

Agilent 14:27:16 Jul 5, 2007

R T



GPRS 1900

Figure 8-4: Out of Band emission at antenna terminals – GPRS CH Low

Agilent 20:40:14 Jul 6, 2007

R T

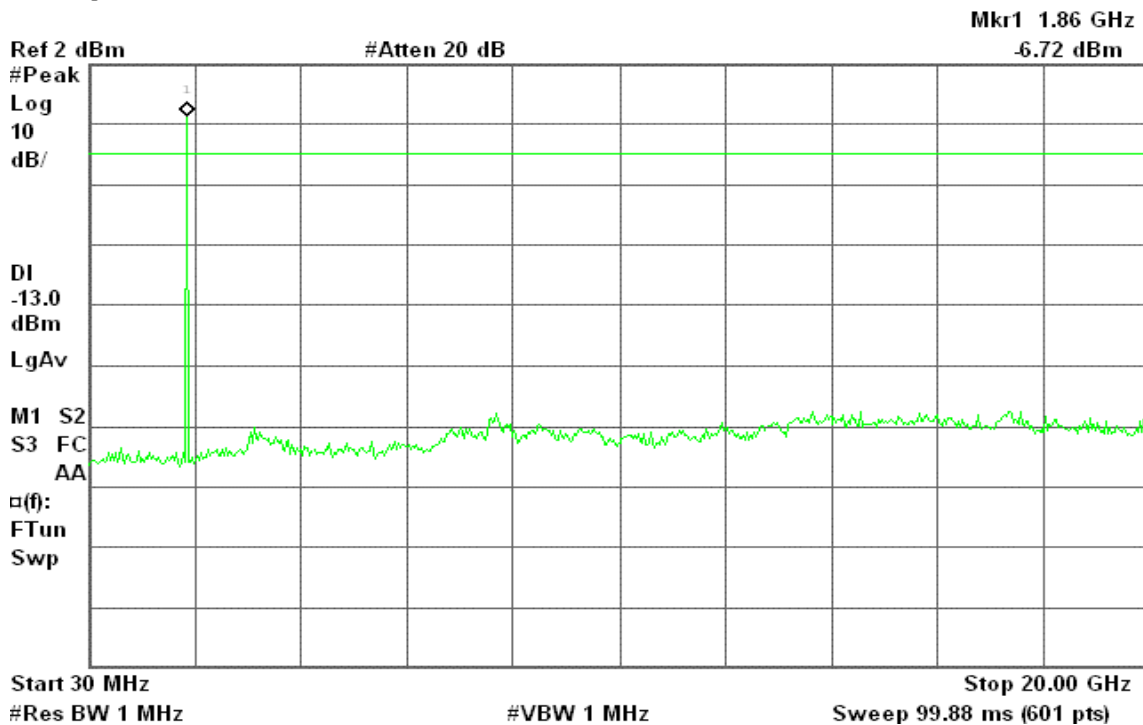



Figure 8-5: Out of Band emission at antenna terminals – GPRS CH Mid

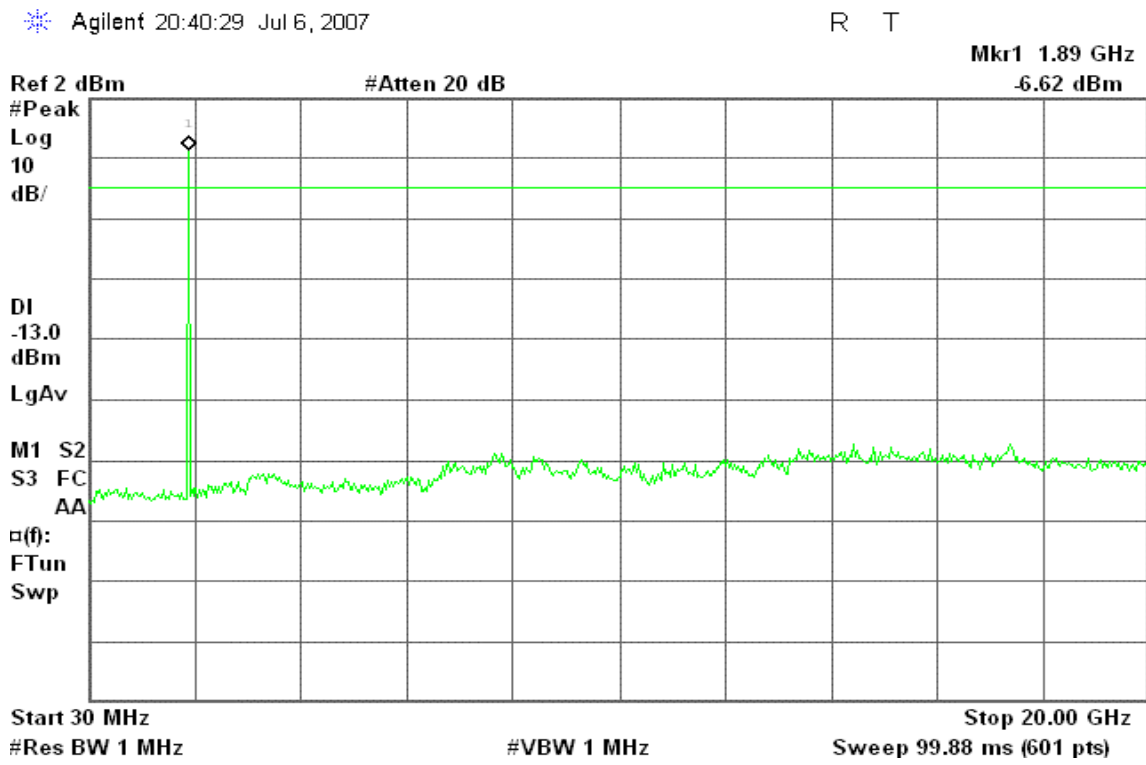
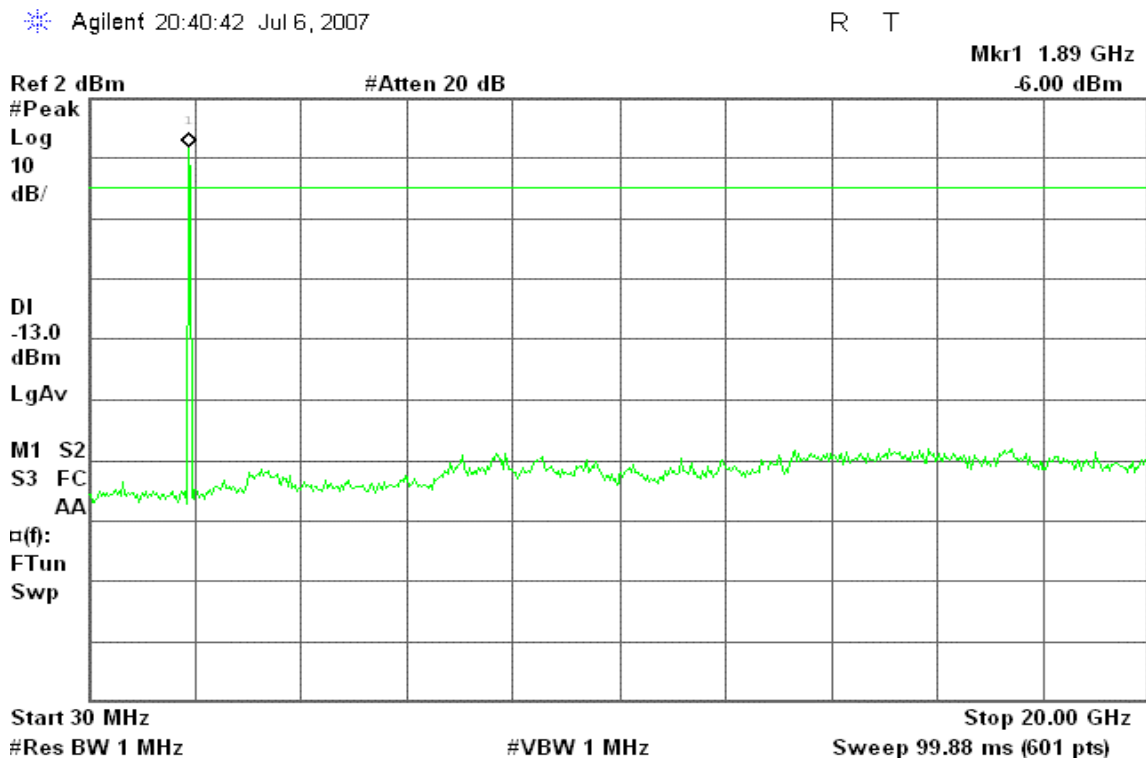

Figure 8-6: Out of Band emission at antenna terminals – GPRS CH High





GSM 850

Figure 9-1: Band Edge emissions – GSM CH Low

Agilent 14:18:32 Jul 5, 2007

R T

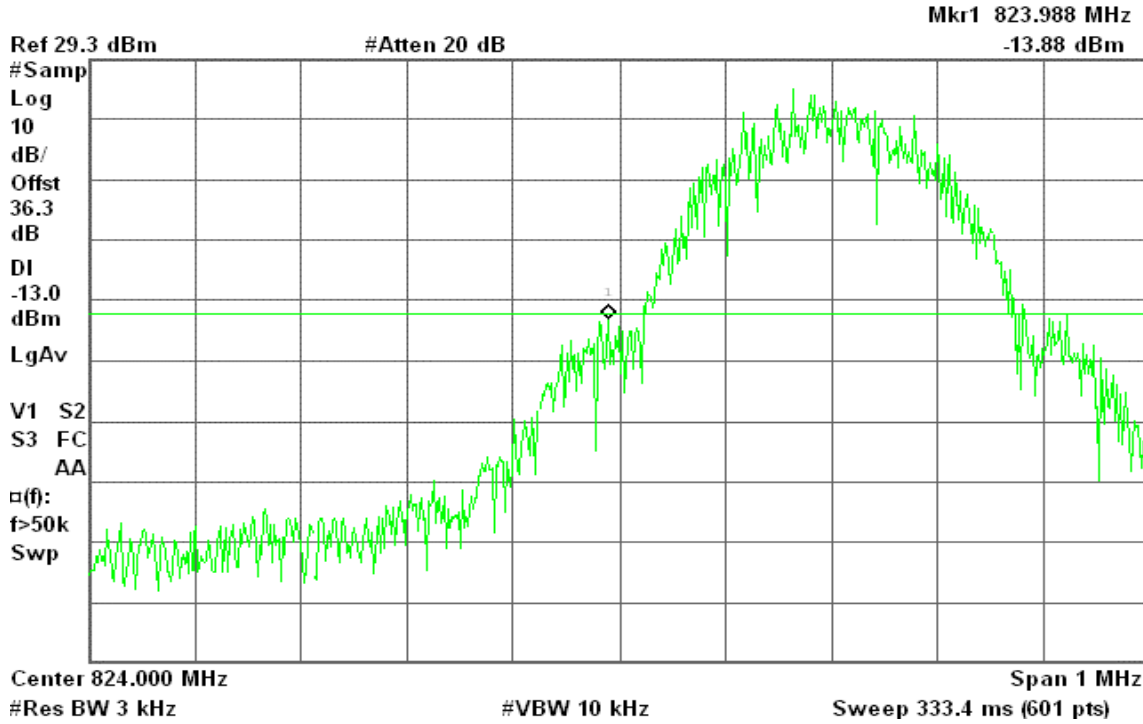
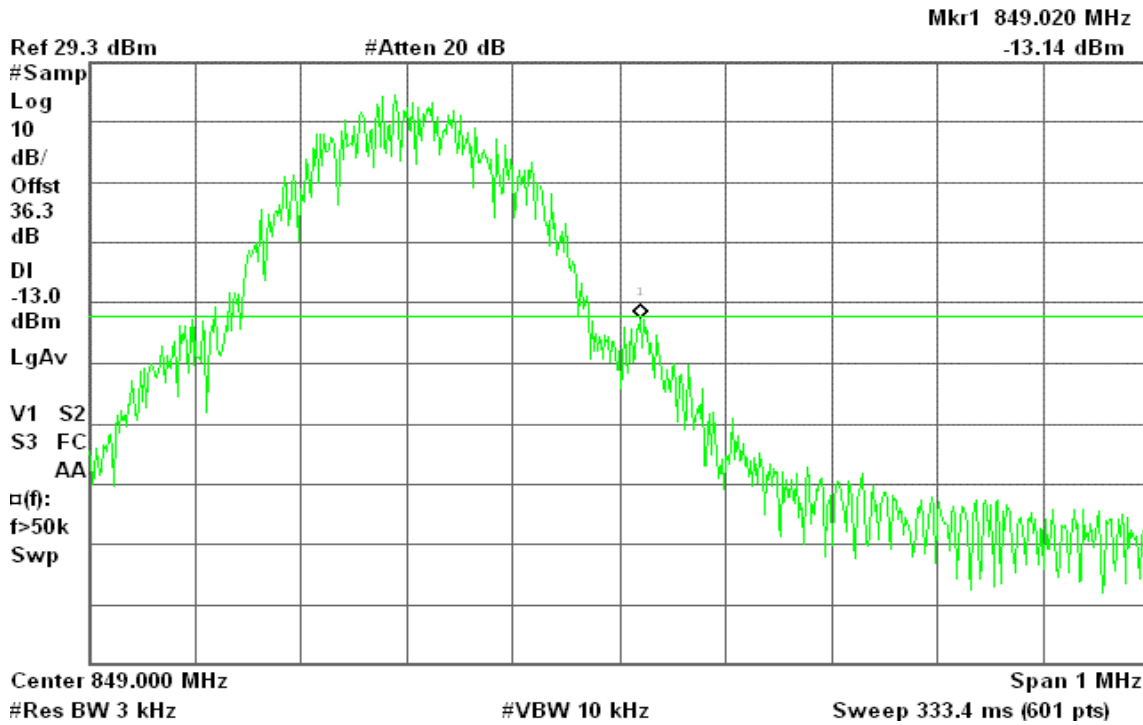

Figure 9-2: Band Edge emissions – GSM CH High

Agilent 14:11:51 Jul 5, 2007

R T





GPRS 850

Figure 9-3: Band Edge emissions – GPRS CH Low

Agilent 20:37:30 Jul 6, 2007

R T

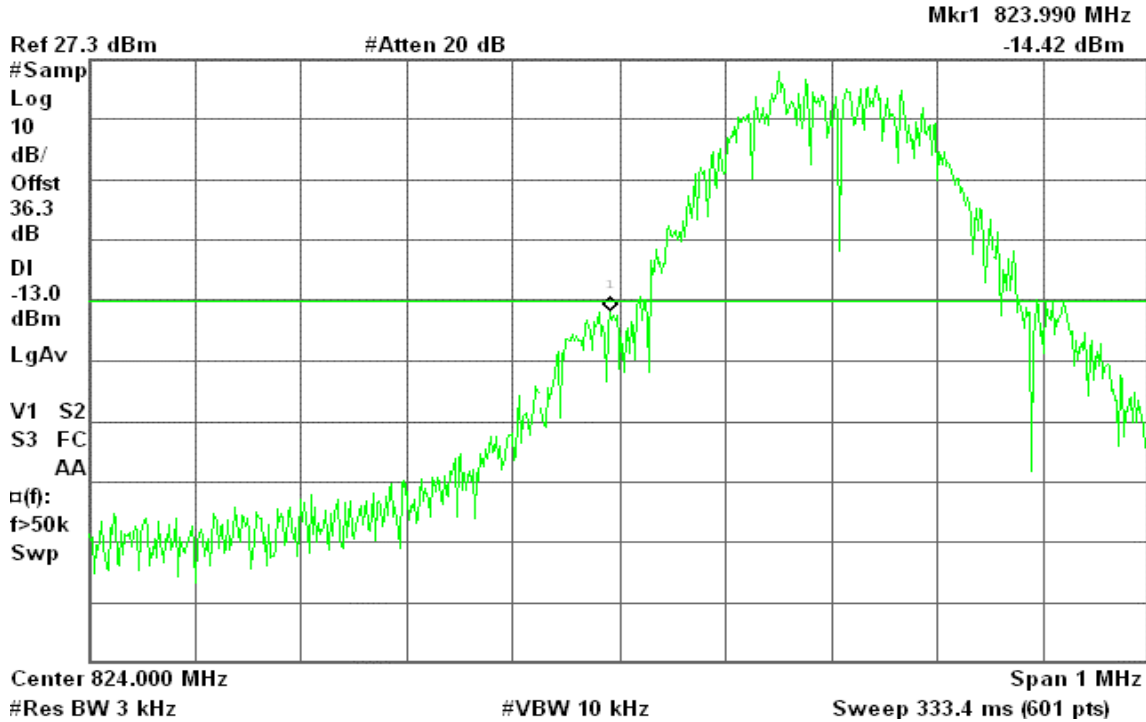
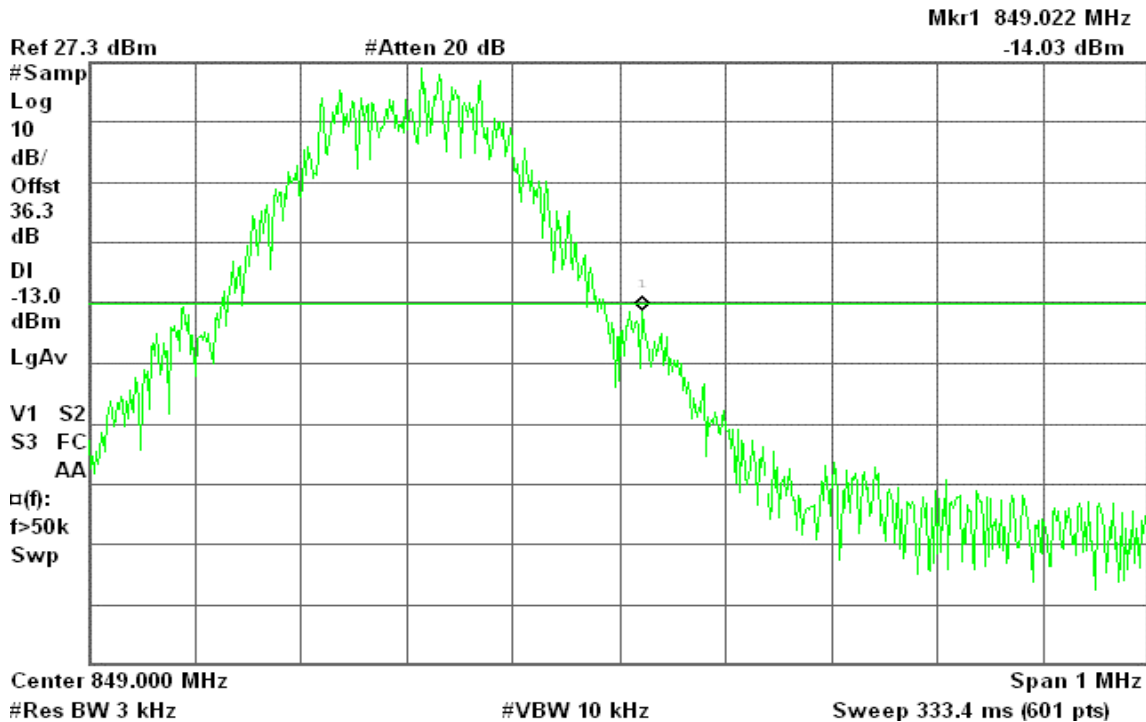

Figure 9-4: Band Edge emissions –GPRS CH High

Agilent 20:36:49 Jul 6, 2007

R T





GSM 1900

Figure 10-1: Band Edge emissions – GSM CH Low

Agilent 14:20:28 Jul 5, 2007

R T

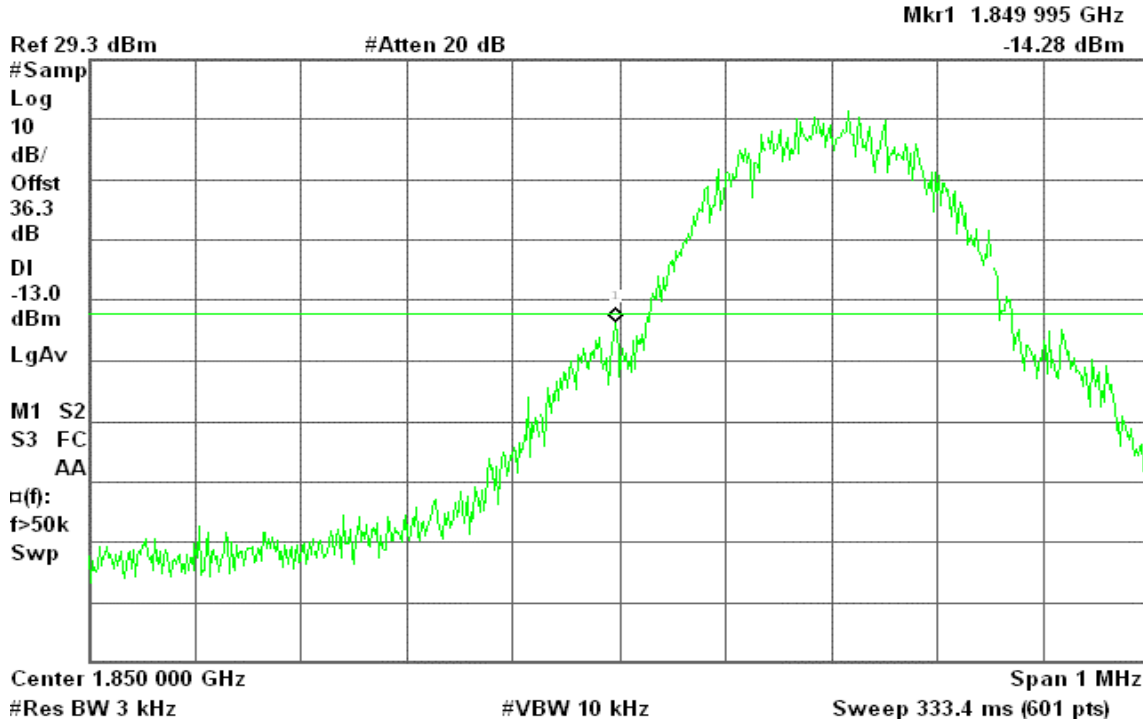
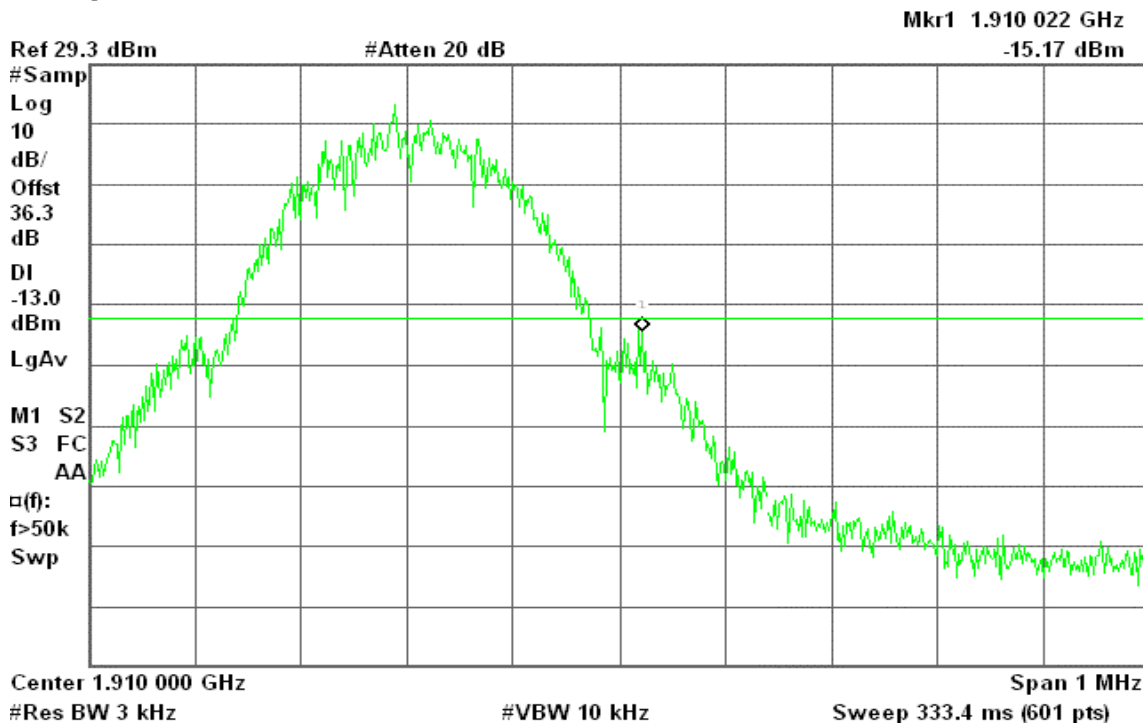

Figure 10-2: Band Edge emissions – GSM CH High

Agilent 14:22:24 Jul 5, 2007

R T





GPRS 1900

Figure 10-3: Band Edge emissions – GPRS CH Low

Agilent 20:38:27 Jul 6, 2007

R T

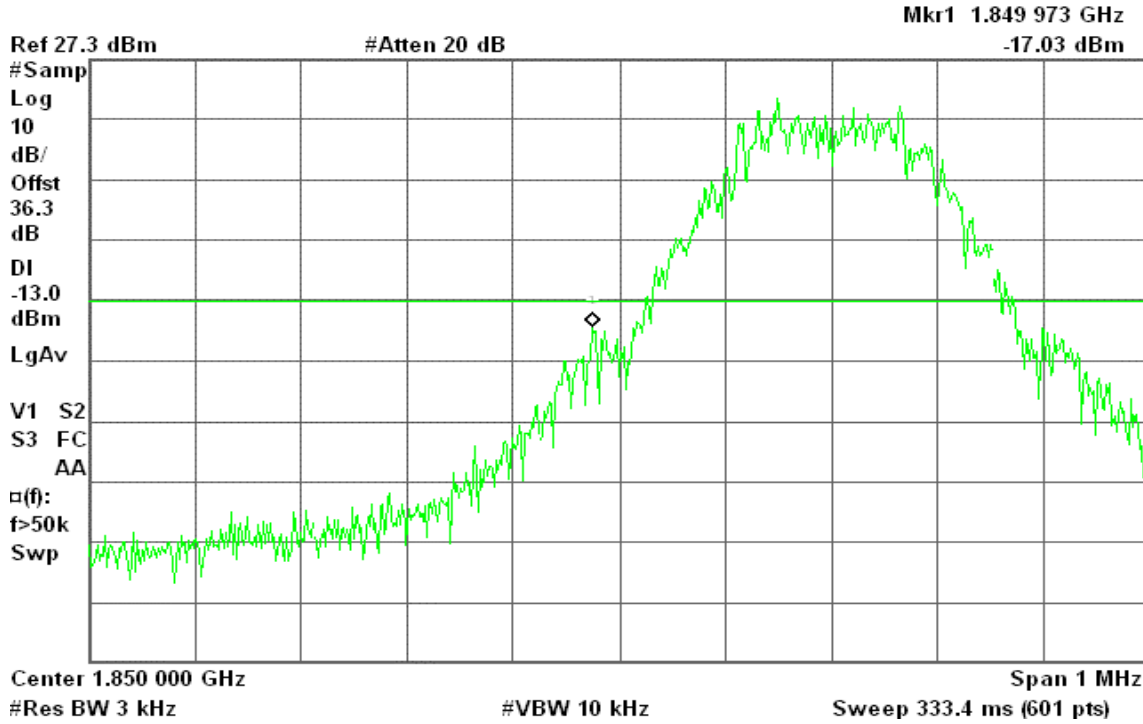
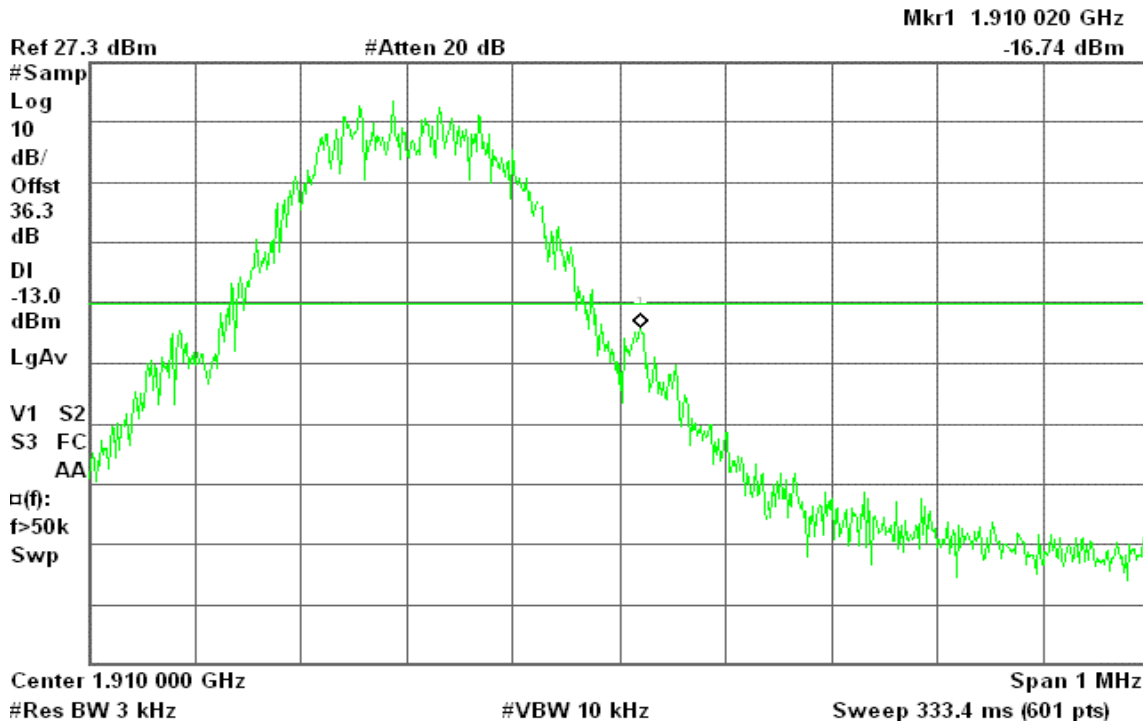

Figure 10-4: Band Edge emissions – GPRS CH High

Agilent 20:39:07 Jul 6, 2007

R T



7.5 FIELD STRENGTH OF SPURIOUS RADIATION MEASUREMENT

LIMIT

According to FCC §2.1053

Test Configuration

Below 1 GHz

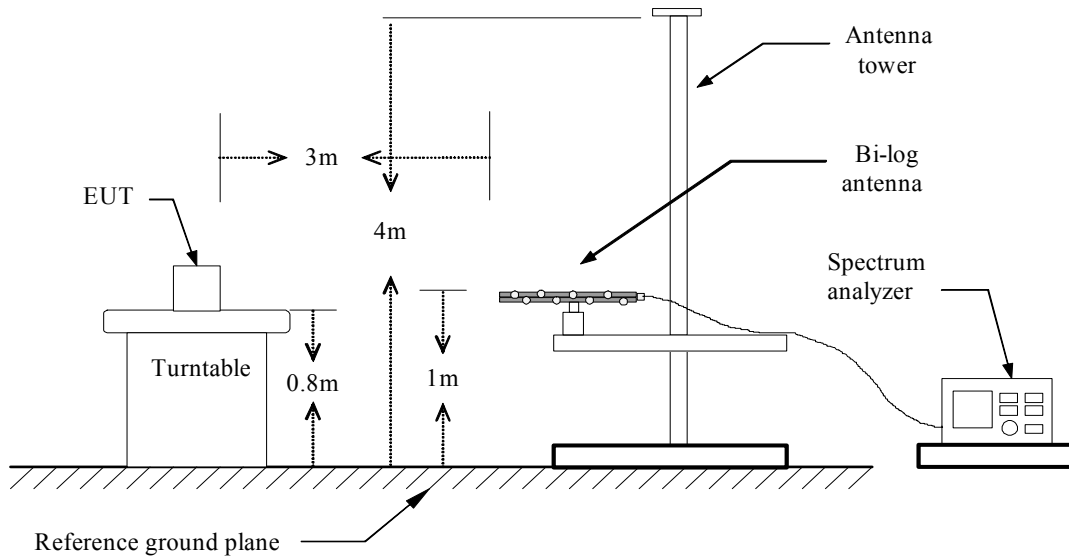

Above 1 GHz

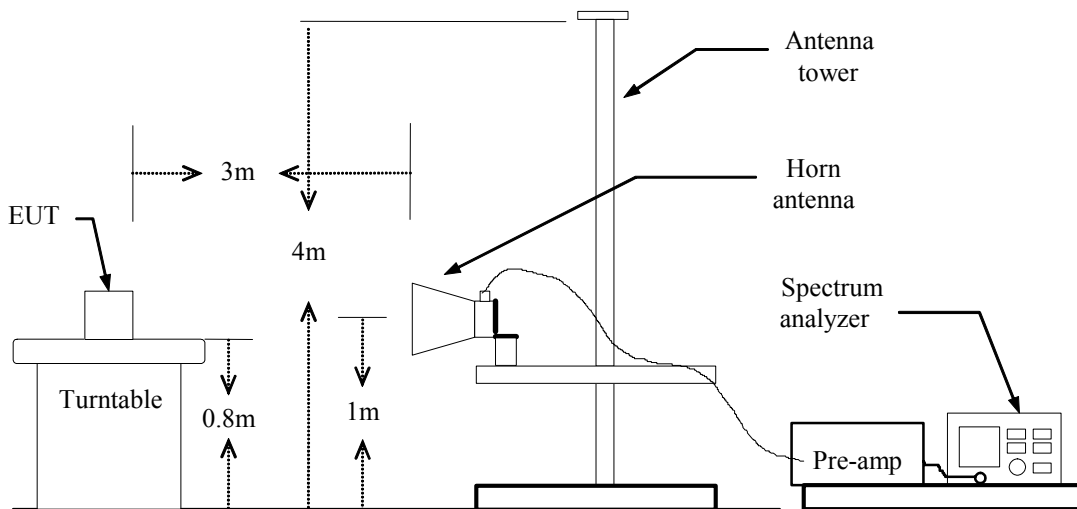

Substituted Method Test Set-up

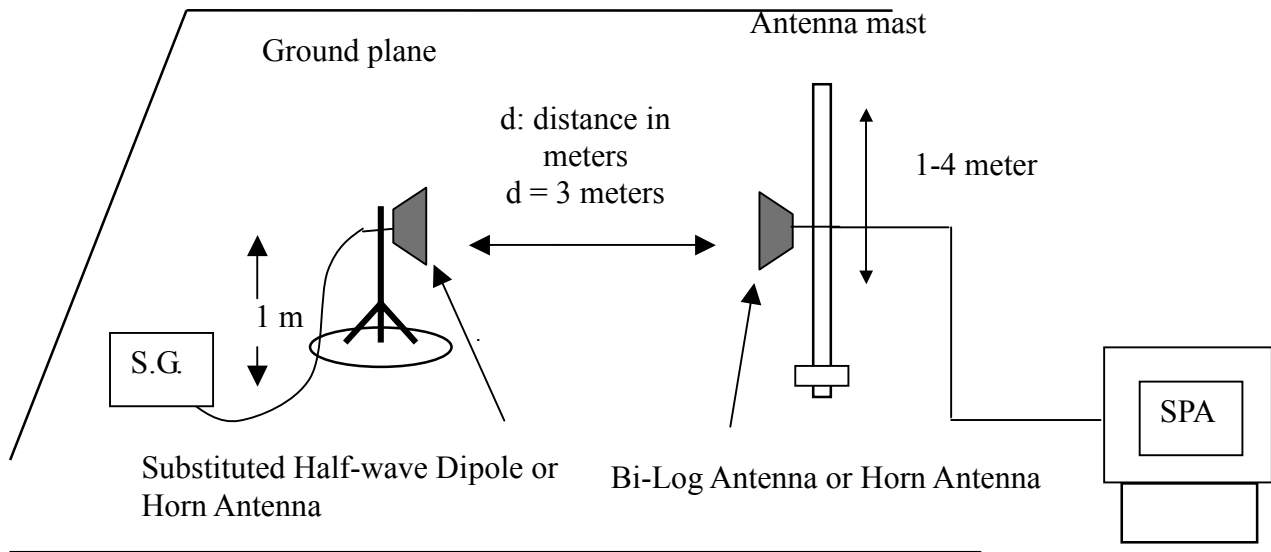

TEST PROCEDURE

The EUT was placed on a non-conductive, the measurement antenna was placed at a distance of 3 meters from the EUT. During the tests, the antenna height and the EUT azimuth were varied in order to identify the maximum level of emissions from the EUT. This maximization process was repeated with the EUT positioned in each of its three orthogonal orientations.

The frequency range up to tenth harmonic was investigated for each of three fundamental frequency (low, middle and high channels). Once spurious emission were identified, the power of the emission was determined using the substitution method.

The spurious emissions attenuation was calculated as the difference between radiated power at the fundamental frequency and the spurious emissions frequency.

$$ERP = \text{S.G. output (dBm)} + \text{Antenna Gain (dBd)} - \text{Cable (dB)}$$

$$EIRP = \text{S.G. output (dBm)} + \text{Antenna Gain (dBi)} - \text{Cable (dB)}$$

TEST RESULTS

Refer to the attached tabular data sheets.



Radiated Spurious Emission Measurement Result

Below 1GHz

Operation Mode: GSM 850 Closed Mode / TX / CH 128

Test Date: July 24, 2007

Temperature: 25°C

Tested by: Ryan Chen

Humidity: 50 % RH

Polarity: Ver. / Hor.

Frequency (MHz)	Antenna Polarization (V/H)	Reading (dBm)	Correction Factor (dB)	Emission level (dBm)	Limit (dBm)	Margin (dB)
99.84	V	-46.85	-19.62	-66.46	-13.00	-53.46
398.60	V	-55.64	-11.60	-67.24	-13.00	-54.24
408.30	V	-54.65	-11.21	-65.86	-13.00	-52.86
512.09	V	-62.11	-8.57	-70.68	-13.00	-57.68
681.84	V	-61.21	-6.32	-67.53	-13.00	-54.53
923.37	V	-67.30	-3.57	-70.88	-13.00	-57.88
45.52	H	-65.10	-4.33	-69.43	-13.00	-56.43
90.14	H	-54.96	-18.55	-73.51	-13.00	-60.51
99.84	H	-53.80	-19.63	-73.43	-13.00	-60.43
138.64	H	-55.26	-18.25	-73.51	-13.00	-60.51
196.84	H	-59.32	-16.34	-75.66	-13.00	-62.66
512.09	H	-61.41	-8.83	-70.24	-13.00	-57.24

Remark:

1. *The emission behaviour belongs to narrowband spurious emission.*
2. *Measurements above show only up to 6 maximum emissions noted, or would be lesser; with " N/A " remark, if no specific emissions from the EUT are recorded (ie: margin>20dB from the applicable limit) and considered that's already beyond the background noise floor.*



Operation Mode: GSM 850 Closed Mode / TX / CH 190

Test Date: July 24, 2007

Temperature: 25°C

Tested by: Ryan Chen

Humidity: 50 % RH

Polarity: Ver. / Hor.

Frequency (MHz)	Antenna Polarization (V/H)	Reading (dBm)	Correction Factor (dB)	Emission level (dBm)	Limit (dBm)	Margin (dB)
52.31	V	-65.50	-5.72	-71.22	-13.00	-58.22
130.88	V	-48.39	-19.26	-67.66	-13.00	-54.66
198.78	V	-59.82	-17.01	-76.83	-13.00	-63.83
453.89	V	-59.16	-9.96	-69.12	-13.00	-56.12
523.73	V	-62.45	-8.47	-70.91	-13.00	-57.91
967.99	V	-62.15	-3.00	-65.16	-13.00	-52.16
45.52	H	-65.42	-4.33	-69.75	-13.00	-56.75
90.14	H	-53.04	-18.55	-71.58	-13.00	-58.58
132.82	H	-52.20	-20.35	-72.55	-13.00	-59.55
201.69	H	-56.54	-16.08	-72.62	-13.00	-59.62
242.43	H	-61.18	-14.38	-75.55	-13.00	-62.55
385.02	H	-66.50	-11.40	-77.90	-13.00	-64.90

Remark:

1. The emission behaviour belongs to narrowband spurious emission.
2. Measurements above show only up to 6 maximum emissions noted, or would be lesser, with " N/A " remark, if no specific emissions from the EUT are recorded (ie: margin > 20dB from the applicable limit) and considered that's already beyond the background noise floor.



Operation Mode: GSM 850 Closed Mode / TX / CH 251

Test Date: July 24, 2007

Temperature: 25°C

Tested by: Ryan Chen

Humidity: 50 % RH

Polarity: Ver. / Hor.

Frequency (MHz)	Antenna Polarization (V/H)	Reading (dBm)	Correction Factor (dB)	Emission level (dBm)	Limit (dBm)	Margin (dB)
50.37	V	-65.67	-5.31	-70.97	-13.00	-57.97
79.47	V	-59.99	-13.74	-73.73	-13.00	-60.73
138.64	V	-56.76	-17.53	-74.29	-13.00	-61.29
196.84	V	-59.15	-17.05	-76.20	-13.00	-63.20
262.80	V	-62.30	-15.19	-77.49	-13.00	-64.49
342.34	V	-64.26	-13.36	-77.62	-13.00	-64.62
44.55	H	-65.37	-4.21	-69.58	-13.00	-56.58
89.17	H	-54.16	-18.28	-72.44	-13.00	-59.44
132.82	H	-53.36	-20.35	-73.71	-13.00	-60.71
199.75	H	-58.53	-16.28	-74.81	-13.00	-61.81
241.46	H	-62.34	-14.41	-76.75	-13.00	-63.75
403.45	H	-65.33	-11.06	-76.39	-13.00	-63.39

Remark:

1. The emission behaviour belongs to narrowband spurious emission.
2. Measurements above show only up to 6 maximum emissions noted, or would be lesser, with " N/A " remark, if no specific emissions from the EUT are recorded (ie: margin > 20dB from the applicable limit) and considered that's already beyond the background noise floor.



Operation Mode: GPRS 850 Closed Mode / TX / CH 128 Test Date: July 25, 2007

Temperature: 25°C Tested by: Ryan Chen

Humidity: 50 % RH Polarity: Ver. / Hor.

Frequency (MHz)	Antenna Polarization (V/H)	Reading (dBm)	Correction Factor (dB)	Emission level (dBm)	Limit (dBm)	Margin (dB)
63.95	V	-62.03	-8.27	-70.31	-13.00	-57.31
99.84	V	-47.49	-19.62	-67.10	-13.00	-54.10
196.84	V	-59.52	-17.05	-76.56	-13.00	-63.56
407.33	V	-54.62	-11.25	-65.87	-13.00	-52.87
512.09	V	-62.77	-8.57	-71.34	-13.00	-58.34
682.81	V	-61.34	-6.30	-67.63	-13.00	-54.63
45.52	H	-65.57	-4.33	-69.89	-13.00	-56.89
99.84	H	-49.66	-19.63	-69.29	-13.00	-56.29
136.70	H	-53.15	-18.95	-72.10	-13.00	-59.10
195.87	H	-57.92	-16.36	-74.28	-13.00	-61.28
408.30	H	-61.02	-11.01	-72.02	-13.00	-59.02
512.09	H	-60.95	-8.83	-69.78	-13.00	-56.78

Remark:

1. The emission behaviour belongs to narrowband spurious emission.
2. Measurements above show only up to 6 maximum emissions noted, or would be lesser, with " N/A " remark, if no specific emissions from the EUT are recorded (ie: margin > 20dB from the applicable limit) and considered that's already beyond the background noise floor.



Operation Mode: GPRS 850 Closed Mode / TX / CH 190 Test Date: July 25, 2007

Temperature: 25°C Tested by: Ryan Chen

Humidity: 50 % RH Polarity: Ver. / Hor.

Frequency (MHz)	Antenna Polarization (V/H)	Reading (dBm)	Correction Factor (dB)	Emission level (dBm)	Limit (dBm)	Margin (dB)
63.95	V	-61.39	-8.27	-69.66	-13.00	-56.66
130.88	V	-47.75	-19.26	-67.01	-13.00	-54.01
452.92	V	-59.62	-10.00	-69.62	-13.00	-56.62
522.76	V	-61.11	-8.49	-69.61	-13.00	-56.61
548.95	V	-66.79	-7.93	-74.73	-13.00	-61.73
967.02	V	-61.41	-3.02	-64.44	-13.00	-51.44
46.49	H	-65.19	-4.76	-69.94	-13.00	-56.94
90.14	H	-55.86	-18.55	-74.41	-13.00	-61.41
135.73	H	-53.39	-19.30	-72.69	-13.00	-59.69
196.84	H	-58.92	-16.34	-75.26	-13.00	-62.26
343.31	H	-64.86	-13.68	-78.55	-13.00	-65.55
389.87	H	-65.83	-11.30	-77.13	-13.00	-64.13

Remark:

1. The emission behaviour belongs to narrowband spurious emission.
2. Measurements above show only up to 6 maximum emissions noted, or would be lesser, with " N/A " remark, if no specific emissions from the EUT are recorded (ie: margin > 20dB from the applicable limit) and considered that's already beyond the background noise floor.



Operation Mode: GPRS 850 Closed Mode / TX / CH 251 Test Date: July 25, 2007

Temperature: 25°C Tested by: Ryan Chen

Humidity: 50 % RH Polarity: Ver. / Hor.

Frequency (MHz)	Antenna Polarization (V/H)	Reading (dBm)	Correction Factor (dB)	Emission level (dBm)	Limit (dBm)	Margin (dB)
32.91	V	-54.94	-13.64	-68.57	-13.00	-55.57
63.95	V	-61.05	-8.27	-69.32	-13.00	-56.32
140.58	V	-60.52	-17.23	-77.75	-13.00	-64.75
201.69	V	-58.58	-16.89	-75.47	-13.00	-62.47
277.35	V	-63.01	-15.13	-78.14	-13.00	-65.14
343.31	V	-65.45	-13.36	-78.81	-13.00	-65.81
44.55	H	-66.03	-4.21	-70.24	-13.00	-57.24
90.14	H	-59.74	-18.55	-78.28	-13.00	-65.28
139.61	H	-57.64	-17.90	-75.54	-13.00	-62.54
201.69	H	-58.86	-16.08	-74.94	-13.00	-61.94
240.49	H	-62.78	-14.45	-77.23	-13.00	-64.23
348.16	H	-66.11	-13.51	-79.62	-13.00	-66.62

Remark:

1. The emission behaviour belongs to narrowband spurious emission.
2. Measurements above show only up to 6 maximum emissions noted, or would be lesser, with " N/A " remark, if no specific emissions from the EUT are recorded (ie: margin > 20dB from the applicable limit) and considered that's already beyond the background noise floor.



Operation Mode: EGPRS 850 Closed Mode / TX / CH 128 Test Date: July 25, 2007

Temperature: 25°C Tested by: Ryan Chen

Humidity: 50 % RH Polarity: Ver. / Hor.

Frequency (MHz)	Antenna Polarization (V/H)	Reading (dBm)	Correction Factor (dB)	Emission level (dBm)	Limit (dBm)	Margin (dB)
57.16	V	-64.16	-6.73	-70.89	-13.00	-57.89
99.84	V	-47.46	-19.62	-67.07	-13.00	-54.07
398.60	V	-56.56	-11.60	-68.16	-13.00	-55.16
408.30	V	-56.12	-11.21	-67.33	-13.00	-54.33
512.09	V	-62.52	-8.57	-71.09	-13.00	-58.09
681.84	V	-62.23	-6.32	-68.55	-13.00	-55.55
44.55	H	-66.39	-4.21	-70.60	-13.00	-57.60
99.84	H	-54.03	-19.63	-73.66	-13.00	-60.66
126.03	H	-51.77	-21.09	-72.86	-13.00	-59.86
201.69	H	-60.62	-16.08	-76.70	-13.00	-63.70
252.13	H	-60.11	-14.31	-74.42	-13.00	-61.42
512.09	H	-62.15	-8.83	-70.98	-13.00	-57.98

Remark:

- 1. The emission behaviour belongs to narrowband spurious emission.*
- 2. Measurements above show only up to 6 maximum emissions noted, or would be lesser, with " N/A " remark, if no specific emissions from the EUT are recorded (ie: margin>20dB from the applicable limit) and considered that's already beyond the background noise floor.*



Operation Mode: EGPRS 850 Closed Mode / TX / CH 190 Test Date: July 25, 2007

Temperature: 25°C Tested by: Ryan Chen

Humidity: 50 % RH Polarity: Ver. / Hor.

Frequency (MHz)	Antenna Polarization (V/H)	Reading (dBm)	Correction Factor (dB)	Emission level (dBm)	Limit (dBm)	Margin (dB)
57.16	V	-64.23	-6.73	-70.97	-13.00	-57.97
130.88	V	-49.02	-19.26	-68.28	-13.00	-55.28
240.49	V	-62.46	-15.55	-78.01	-13.00	-65.01
452.92	V	-60.25	-10.00	-70.25	-13.00	-57.25
522.76	V	-64.32	-8.49	-72.81	-13.00	-59.81
967.99	V	-61.08	-3.00	-64.08	-13.00	-51.08
46.49	H	-65.99	-4.76	-70.74	-13.00	-57.74
89.17	H	-60.51	-18.28	-78.79	-13.00	-65.79
131.85	H	-56.55	-20.70	-77.26	-13.00	-64.26
200.72	H	-58.54	-16.19	-74.73	-13.00	-61.73
239.52	H	-60.66	-14.51	-75.17	-13.00	-62.17
404.42	H	-67.27	-11.05	-78.32	-13.00	-65.32

Remark:

- 1. The emission behaviour belongs to narrowband spurious emission.*
- 2. Measurements above show only up to 6 maximum emissions noted, or would be lesser, with " N/A " remark, if no specific emissions from the EUT are recorded (ie: margin>20dB from the applicable limit) and considered that's already beyond the background noise floor.*



Operation Mode: EGPRS 850 Closed Mode / TX / CH 251 Test Date: July 24, 2007

Temperature: 25°C Tested by: Ryan Chen

Humidity: 50 % RH Polarity: Ver. / Hor.

Frequency (MHz)	Antenna Polarization (V/H)	Reading (dBm)	Correction Factor (dB)	Emission level (dBm)	Limit (dBm)	Margin (dB)
59.10	V	-62.23	-7.14	-69.37	-13.00	-56.37
89.17	V	-60.09	-18.31	-78.40	-13.00	-65.40
203.63	V	-62.69	-16.78	-79.48	-13.00	-66.48
243.40	V	-63.19	-15.35	-78.53	-13.00	-65.53
284.14	V	-65.21	-14.60	-79.81	-13.00	-66.81
348.16	V	-67.06	-13.32	-80.38	-13.00	-67.38
45.52	H	-66.04	-4.33	-70.37	-13.00	-57.37
89.17	H	-60.96	-18.28	-79.24	-13.00	-66.24
128.94	H	-55.97	-21.29	-77.26	-13.00	-64.26
199.75	H	-59.20	-16.28	-75.48	-13.00	-62.48
243.40	H	-59.17	-14.34	-73.52	-13.00	-60.52
283.17	H	-64.35	-15.69	-80.04	-13.00	-67.04

Remark:

1. The emission behaviour belongs to narrowband spurious emission.
2. Measurements above show only up to 6 maximum emissions noted, or would be lesser, with " N/A " remark, if no specific emissions from the EUT are recorded (ie: margin>20dB from the applicable limit) and considered that's already beyond the background noise floor.



Above 1GHz

Operation Mode: GSM 850 Closed Mode / TX / CH 128

Test Date: July 24, 2007

Temperature: 25°C

Tested by: Ryan Chen

Humidity: 50 % RH

Polarity: Ver. / Hor.

Frequency (MHz)	Antenna Polarization	Reading level (dBuV)	Correction Factor (dB)	Emission level (dBm)	Limit (dBm)	Margin (dB)
1651.00	V	-57.65	1.78	-55.87	-13.00	-42.87
2470.00	V	-57.71	4.10	-53.61	-13.00	-40.61
4122.00	V	-56.80	6.37	-50.43	-13.00	-37.43
6593.00	V	-60.26	10.51	-49.75	-13.00	-36.75
N/A						
1651.00	H	-52.34	2.97	-49.36	-13.00	-36.36
2470.00	H	-53.94	4.56	-49.38	-13.00	-36.38
4122.00	H	-56.60	6.97	-49.63	-13.00	-36.63
4948.00	H	-57.31	8.47	-48.85	-13.00	-35.85
5767.00	H	-56.49	8.01	-48.48	-13.00	-35.48
6593.00	H	-58.09	10.47	-47.62	-13.00	-34.62

Remark:

1. Measuring frequencies from 1 GHz to the 10th harmonic of highest fundamental frequency.
2. Measurements above show only up to 6 maximum emissions noted, or would be lesser, with " N/A " remark, if no specific emissions from the EUT are recorded (ie: margin > 20dB from the applicable limit) and considered that's already beyond the background noise floor.



Operation Mode: GSM 850 Closed Mode / TX / CH 190

Test Date: July 24, 2007

Temperature: 25°C

Tested by: Ryan Chen

Humidity: 50 % RH

Polarity: Ver. / Hor.

Frequency (MHz)	Antenna Polarization	Reading level (dBuV)	Correction Factor (dB)	Emission level (dBm)	Limit (dBm)	Margin (dB)
1672.00	V	-57.21	1.79	-55.43	-13.00	-42.43
2512.00	V	-40.89	4.28	-36.61	-13.00	-23.61
4185.00	V	-53.96	6.40	-47.56	-13.00	-34.56
5018.00	V	-57.04	7.63	-49.41	-13.00	-36.41
5858.00	V	-59.17	7.96	-51.21	-13.00	-38.21
6691.00	V	-58.59	10.87	-47.72	-13.00	-34.72
2512.00	H	-43.91	4.71	-39.19	-13.00	-26.19
4185.00	H	-53.50	7.02	-46.49	-13.00	-33.49
5018.00	H	-55.31	8.59	-46.72	-13.00	-33.72
5858.00	H	-53.67	8.01	-45.67	-13.00	-32.67
6691.00	H	-56.21	10.81	-45.40	-13.00	-32.40
7531.00	H	-60.31	14.42	-45.90	-13.00	-32.90

Remark:

1. Measuring frequencies from 1 GHz to the 10th harmonic of highest fundamental frequency.
2. Measurements above show only up to 6 maximum emissions noted, or would be lesser, with " N/A " remark, if no specific emissions from the EUT are recorded (ie: margin > 20dB from the applicable limit) and considered that's already beyond the background noise floor.



Operation Mode: GSM 850 Closed Mode / TX / CH 251

Test Date: July 24, 2007

Temperature: 25°C

Tested by: Ryan Chen

Humidity: 50 % RH

Polarity: Ver. / Hor.

Frequency (MHz)	Antenna Polarization	Reading level (dBuV)	Correction Factor (dB)	Emission level (dBm)	Limit (dBm)	Margin (dB)
1700.00	V	-53.09	1.80	-51.30	-13.00	-38.30
2547.00	V	-50.80	4.39	-46.41	-13.00	-33.41
3394.00	V	-59.87	5.60	-54.26	-13.00	-41.26
4248.00	V	-53.85	6.43	-47.41	-13.00	-34.41
5095.00	V	-54.55	7.61	-46.94	-13.00	-33.94
7643.00	V	-60.15	14.13	-46.03	-13.00	-33.03
2547.00	H	-41.34	4.80	-36.54	-13.00	-23.54
4241.00	H	-54.09	7.05	-47.03	-13.00	-34.03
5095.00	H	-55.22	8.50	-46.72	-13.00	-33.72
5942.00	H	-52.74	8.00	-44.74	-13.00	-31.74
6789.00	H	-55.25	11.14	-44.11	-13.00	-31.11
7643.00	H	-58.87	14.80	-44.07	-13.00	-31.07

Remark:

1. Measuring frequencies from 1 GHz to the 10th harmonic of highest fundamental frequency.
2. Measurements above show only up to 6 maximum emissions noted, or would be lesser, with " N/A " remark, if no specific emissions from the EUT are recorded (ie: margin > 20dB from the applicable limit) and considered that's already beyond the background noise floor.



Operation Mode: GPRS 850 Closed Mode / TX / CH 128

Test Date: July 24, 2007

Temperature: 25°C

Tested by: Ryan Chen

Humidity: 50 % RH

Polarity: Ver. / Hor.

Frequency (MHz)	Antenna Polarization	Reading level (dBuV)	Correction Factor (dB)	Emission level (dBm)	Limit (dBm)	Margin (dB)
1651.00	V	-53.48	1.78	-51.70	-13.00	-38.70
2470.00	V	-55.06	4.10	-50.96	-13.00	-37.96
3296.00	V	-57.35	5.67	-51.69	-13.00	-38.69
4122.00	V	-58.77	6.37	-52.40	-13.00	-39.40
4948.00	V	-58.87	7.52	-51.35	-13.00	-38.35
N/A						
1651.00	H	-50.38	2.97	-47.41	-13.00	-34.41
2470.00	H	-46.47	4.56	-41.91	-13.00	-28.91
3296.00	H	-54.68	5.88	-48.80	-13.00	-35.80
4948.00	H	-56.75	8.47	-48.28	-13.00	-35.28
5767.00	H	-54.51	8.01	-46.50	-13.00	-33.50
6593.00	H	-56.64	10.47	-46.17	-13.00	-33.17

Remark:

1. Measuring frequencies from 1 GHz to the 10th harmonic of highest fundamental frequency.
2. Measurements above show only up to 6 maximum emissions noted, or would be lesser, with " N/A " remark, if no specific emissions from the EUT are recorded (ie: margin > 20dB from the applicable limit) and considered that's already beyond the background noise floor.



Operation Mode: GPRS 850 Closed Mode / TX / CH 190

Test Date: July 24, 2007

Temperature: 25°C

Tested by: Ryan Chen

Humidity: 50 % RH

Polarity: Ver. / Hor.

Frequency (MHz)	Antenna Polarization	Reading level (dBuV)	Correction Factor (dB)	Emission level (dBm)	Limit (dBm)	Margin (dB)
1672.00	V	-55.98	1.79	-54.20	-13.00	-41.20
2512.00	V	-43.06	4.28	-38.78	-13.00	-25.78
5858.00	V	-56.48	7.96	-48.53	-13.00	-35.53
N/A						
1672.00	H	-53.47	2.95	-50.52	-13.00	-37.52
2512.00	H	-51.08	4.71	-46.36	-13.00	-33.36
3345.00	H	-58.45	5.87	-52.58	-13.00	-39.58
5018.00	H	-54.34	8.59	-45.75	-13.00	-32.75
5858.00	H	-55.01	8.01	-47.00	-13.00	-34.00
6691.00	H	-56.92	10.81	-46.11	-13.00	-33.11

Remark:

1. Measuring frequencies from 1 GHz to the 10th harmonic of highest fundamental frequency.
2. Measurements above show only up to 6 maximum emissions noted, or would be lesser, with " N/A " remark, if no specific emissions from the EUT are recorded (ie: margin > 20dB from the applicable limit) and considered that's already beyond the background noise floor.



Operation Mode: GPRS 850 Closed Mode / TX / CH 251

Test Date: July 24, 2007

Temperature: 25°C

Tested by: Ryan Chen

Humidity: 50 % RH

Polarity: Ver. / Hor.

Frequency (MHz)	Antenna Polarization	Reading level (dBuV)	Correction Factor (dB)	Emission level (dBm)	Limit (dBm)	Margin (dB)
1700.00	V	-55.47	1.80	-53.67	-13.00	-40.67
2547.00	V	-39.85	4.39	-35.45	-13.00	-22.45
5095.00	V	-55.22	7.61	-47.60	-13.00	-34.60
5942.00	V	-58.08	8.05	-50.03	-13.00	-37.03
N/A						
1700.00	H	-52.24	2.93	-49.32	-13.00	-36.32
2547.00	H	-48.58	4.80	-43.79	-13.00	-30.79
5095.00	H	-56.14	8.50	-47.64	-13.00	-34.64
5942.00	H	-56.13	8.00	-48.13	-13.00	-35.13
6789.00	H	-54.68	11.14	-43.54	-13.00	-30.54
N/A						

Remark:

1. Measuring frequencies from 1 GHz to the 10th harmonic of highest fundamental frequency.
2. Measurements above show only up to 6 maximum emissions noted, or would be lesser, with " N/A " remark, if no specific emissions from the EUT are recorded (ie: margin > 20dB from the applicable limit) and considered that's already beyond the background noise floor.



Operation Mode: EGPRS 850 Closed Mode / TX / CH 128

Test Date: July 25, 2007

Temperature: 25°C

Tested by: Ryan Chen

Humidity: 50 % RH

Polarity: Ver. / Hor.

Frequency (MHz)	Antenna Polarization	Reading level (dBuV)	Correction Factor (dB)	Emission level (dBm)	Limit (dBm)	Margin (dB)
1651.00	V	-58.69	1.78	-56.91	-13.00	-43.91
2470.00	V	-55.77	4.10	-51.67	-13.00	-38.67
3359.00	V	-61.23	5.63	-55.60	-13.00	-42.60
N/A						
1651.00	H	-54.14	2.97	-51.17	-13.00	-38.17
2470.00	H	-51.42	4.56	-46.87	-13.00	-33.87
3296.00	H	-59.36	5.88	-53.48	-13.00	-40.48
4948.00	H	-57.67	8.47	-49.20	-13.00	-36.20
5767.00	H	-57.80	8.01	-49.78	-13.00	-36.78
N/A						

Remark:

1. Measuring frequencies from 1 GHz to the 10th harmonic of highest fundamental frequency.
2. Measurements above show only up to 6 maximum emissions noted, or would be lesser, with " N/A " remark, if no specific emissions from the EUT are recorded (ie: margin > 20dB from the applicable limit) and considered that's already beyond the background noise floor.



Operation Mode: EGPRS 850 Closed Mode / TX / CH 190

Test Date: July 25, 2007

Temperature: 25°C

Tested by: Ryan Chen

Humidity: 50 % RH

Polarity: Ver. / Hor.

Frequency (MHz)	Antenna Polarization	Reading level (dBuV)	Correction Factor (dB)	Emission level (dBm)	Limit (dBm)	Margin (dB)
1672.00	V	-58.98	1.79	-57.19	-13.00	-44.19
2512.00	V	-55.32	4.28	-51.04	-13.00	-38.04
3345.00	V	-61.03	5.64	-55.39	-13.00	-42.39
5018.00	V	-59.10	7.63	-51.48	-13.00	-38.48
N/A						
1672.00	H	-56.51	2.95	-53.56	-13.00	-40.56
2512.00	H	-50.92	4.71	-46.21	-13.00	-33.21
5018.00	H	-56.73	8.59	-48.14	-13.00	-35.14
5858.00	H	-54.81	8.01	-46.81	-13.00	-33.81
6691.00	H	-59.80	10.81	-48.99	-13.00	-35.99
7531.00	H	-61.15	14.42	-46.74	-13.00	-33.74

Remark:

1. Measuring frequencies from 1 GHz to the 10th harmonic of highest fundamental frequency.
2. Measurements above show only up to 6 maximum emissions noted, or would be lesser, with " N/A " remark, if no specific emissions from the EUT are recorded (ie: margin > 20dB from the applicable limit) and considered that's already beyond the background noise floor.



Operation Mode: EGPRS 850 Closed Mode / TX / CH 251

Test Date: July 25, 2007

Temperature: 25°C

Tested by: Ryan Chen

Humidity: 50 % RH

Polarity: Ver. / Hor.

Frequency (MHz)	Antenna Polarization	Reading level (dBuV)	Correction Factor (dB)	Emission level (dBm)	Limit (dBm)	Margin (dB)
1700.00	V	-57.44	1.80	-55.65	-13.00	-42.65
2547.00	V	-54.87	4.39	-50.48	-13.00	-37.48
5095.00	V	-57.58	7.61	-49.96	-13.00	-36.96
5942.00	V	-60.36	8.05	-52.31	-13.00	-39.31
6789.00	V	-58.80	11.22	-47.58	-13.00	-34.58
N/A						
1700.00	H	-56.50	2.93	-53.57	-13.00	-40.57
2547.00	H	-50.03	4.80	-45.23	-13.00	-32.23
5095.00	H	-57.14	8.50	-48.64	-13.00	-35.64
5942.00	H	-55.42	8.00	-47.41	-13.00	-34.41
6789.00	H	-56.62	11.14	-45.48	-13.00	-32.48
N/A						

Remark:

1. Measuring frequencies from 1 GHz to the 10th harmonic of highest fundamental frequency.
2. Measurements above show only up to 6 maximum emissions noted, or would be lesser, with " N/A " remark, if no specific emissions from the EUT are recorded (ie: margin>20dB from the applicable limit) and considered that's already beyond the background noise floor.

**Below 1GHz****Operation Mode:** GSM 1900 Closed Mode / TX / CH 512 **Test Date:** July 24, 2007**Temperature:** 25°C**Tested by:** Ryan Chen**Humidity:** 50 % RH**Polarity:** Ver. / Hor.

Frequency (MHz)	Antenna Polarization (V/H)	Reading (dBm)	Correction Factor (dB)	Emission level (dBm)	Limit (dBm)	Margin (dB)
53.28	V	-65.28	-5.92	-71.20	-13.00	-58.20
67.83	V	-63.57	-9.20	-72.77	-13.00	-59.77
135.73	V	-56.54	-18.18	-74.73	-13.00	-61.73
200.72	V	-61.22	-16.94	-78.16	-13.00	-65.16
262.80	V	-62.35	-15.19	-77.54	-13.00	-64.54
416.06	V	-65.79	-10.92	-76.71	-13.00	-63.71
43.58	H	-65.93	-4.44	-70.37	-13.00	-57.37
61.04	H	-64.07	-8.85	-72.92	-13.00	-59.92
127.00	H	-51.98	-21.16	-73.14	-13.00	-60.14
207.51	H	-59.45	-15.41	-74.87	-13.00	-61.87
252.13	H	-64.20	-14.31	-78.51	-13.00	-65.51
382.11	H	-65.22	-11.46	-76.67	-13.00	-63.67

Remark:

1. *Measuring frequencies from 1 GHz to the 10th harmonic of highest fundamental frequency.*
2. *Measurements above show only up to 6 maximum emissions noted, or would be lesser; with " N/A " remark, if no specific emissions from the EUT are recorded (ie: margin > 20dB from the applicable limit) and considered that's already beyond the background noise floor.*



Operation Mode: GSM 1900 Closed Mode / TX / CH 661 Test Date: July 24, 2007

Temperature: 25°C Tested by: Ryan Chen

Humidity: 50 % RH Polarity: Ver. / Hor.

Frequency (MHz)	Antenna Polarization (V/H)	Reading (dBm)	Correction Factor (dB)	Emission level (dBm)	Limit (dBm)	Margin (dB)
51.34	V	-65.36	-5.51	-70.87	-13.00	-57.87
89.17	V	-60.04	-18.31	-78.34	-13.00	-65.34
136.70	V	-57.68	-17.97	-75.64	-13.00	-62.64
201.69	V	-59.73	-16.89	-76.62	-13.00	-63.62
252.13	V	-61.85	-14.96	-76.81	-13.00	-63.81
335.55	V	-64.39	-13.42	-77.81	-13.00	-64.81
41.64	H	-65.40	-4.90	-70.30	-13.00	-57.30
66.86	H	-63.56	-10.06	-73.61	-13.00	-60.61
126.03	H	-53.70	-21.09	-74.78	-13.00	-61.78
138.64	H	-55.11	-18.25	-73.36	-13.00	-60.36
201.69	H	-59.36	-16.08	-75.43	-13.00	-62.43
350.10	H	-63.94	-13.45	-77.39	-13.00	-64.39

Remark:

1. Measuring frequencies from 1 GHz to the 10th harmonic of highest fundamental frequency.
2. Measurements above show only up to 6 maximum emissions noted, or would be lesser; with " N/A " remark, if no specific emissions from the EUT are recorded (ie: margin > 20dB from the applicable limit) and considered that's already beyond the background noise floor.



Operation Mode: GSM 1900 Closed Mode / TX / CH 810 Test Date: July 24, 2007

Temperature: 25°C Tested by: Ryan Chen

Humidity: 50 % RH Polarity: Ver. / Hor.

Frequency (MHz)	Antenna Polarization (V/H)	Reading (dBm)	Correction Factor (dB)	Emission level (dBm)	Limit (dBm)	Margin (dB)
48.43	V	-64.93	-5.53	-70.46	-13.00	-57.46
127.00	V	-55.79	-19.46	-75.25	-13.00	-62.25
135.73	V	-56.64	-18.18	-74.83	-13.00	-61.83
199.75	V	-60.67	-16.99	-77.65	-13.00	-64.65
262.80	V	-62.67	-15.19	-77.86	-13.00	-64.86
336.52	V	-64.99	-13.41	-78.40	-13.00	-65.40
43.58	H	-65.53	-4.44	-69.97	-13.00	-56.97
65.89	H	-63.52	-9.86	-73.38	-13.00	-60.38
131.85	H	-52.17	-20.70	-72.87	-13.00	-59.87
201.69	H	-55.67	-16.08	-71.75	-13.00	-58.75
218.18	H	-62.12	-15.16	-77.28	-13.00	-64.28
339.43	H	-65.06	-13.82	-78.88	-13.00	-65.88

Remark:

1. Measuring frequencies from 1 GHz to the 10th harmonic of highest fundamental frequency.
2. Measurements above show only up to 6 maximum emissions noted, or would be lesser, with " N/A " remark, if no specific emissions from the EUT are recorded (ie: margin > 20dB from the applicable limit) and considered that's already beyond the background noise floor.



Operation Mode: GPRS 1900 Closed Mode / TX / CH 512 Test Date: July 25, 2007

Temperature: 25°C Tested by: Ryan Chen

Humidity: 50 % RH Polarity: Ver. / Hor.

Frequency (MHz)	Antenna Polarization (V/H)	Reading (dBm)	Correction Factor (dB)	Emission level (dBm)	Limit (dBm)	Margin (dB)
32.91	V	-41.46	-13.64	-55.09	-13.00	-42.09
122.15	V	-36.03	-19.45	-55.49	-13.00	-42.49
228.85	V	-41.98	-16.24	-58.22	-13.00	-45.22
253.10	V	-41.66	-14.99	-56.65	-13.00	-43.65
345.25	V	-47.65	-13.34	-60.99	-13.00	-47.99
416.06	V	-51.14	-10.92	-62.06	-13.00	-49.06
32.91	H	-46.35	-12.56	-58.92	-13.00	-45.92
131.85	H	-29.57	-20.70	-50.27	-13.00	-37.27
187.14	H	-41.44	-16.77	-58.21	-13.00	-45.21
229.82	H	-39.96	-15.30	-55.26	-13.00	-42.26
246.31	H	-40.33	-14.23	-54.56	-13.00	-41.56
393.75	H	-50.75	-11.23	-61.97	-13.00	-48.97

Remark:

1. Measuring frequencies from 1 GHz to the 10th harmonic of highest fundamental frequency.
2. Measurements above show only up to 6 maximum emissions noted, or would be lesser, with " N/A " remark, if no specific emissions from the EUT are recorded (ie: margin > 20dB from the applicable limit) and considered that's already beyond the background noise floor.



Operation Mode: GPRS 1900 Closed Mode / TX / CH 661 **Test Date:** July 25, 2007
Temperature: 25°C **Tested by:** Ryan Chen
Humidity: 50 % RH **Polarity:** Ver. / Hor.

Frequency (MHz)	Antenna Polarization (V/H)	Reading (dBm)	Correction Factor (dB)	Emission level (dBm)	Limit (dBm)	Margin (dB)
64.92	V	-50.70	-8.51	-59.20	-13.00	-46.20
134.76	V	-35.68	-18.40	-54.08	-13.00	-41.08
181.32	V	-41.92	-17.72	-59.64	-13.00	-46.64
221.09	V	-42.76	-16.49	-59.24	-13.00	-46.24
239.52	V	-43.29	-15.61	-58.90	-13.00	-45.90
351.07	V	-49.43	-13.30	-62.73	-13.00	-49.73
44.55	H	-56.49	-4.21	-60.70	-13.00	-47.70
127.97	H	-30.90	-21.23	-52.12	-13.00	-39.12
188.11	H	-41.51	-16.67	-58.18	-13.00	-45.18
200.72	H	-41.34	-16.19	-57.52	-13.00	-44.52
239.52	H	-42.91	-14.51	-57.42	-13.00	-44.42
255.04	H	-44.02	-14.61	-58.63	-13.00	-45.63

Remark:

1. *Measuring frequencies from 1 GHz to the 10th harmonic of highest fundamental frequency.*
2. *Measurements above show only up to 6 maximum emissions noted, or would be lesser, with " N/A " remark, if no specific emissions from the EUT are recorded (ie: margin > 20dB from the applicable limit) and considered that's already beyond the background noise floor.*



Operation Mode: GPRS 1900 Closed Mode / TX / CH 810 Test Date: July 25, 2007

Temperature: 25°C Tested by: Ryan Chen

Humidity: 50 % RH Polarity: Ver. / Hor.

Frequency (MHz)	Antenna Polarization (V/H)	Reading (dBm)	Correction Factor (dB)	Emission level (dBm)	Limit (dBm)	Margin (dB)
32.91	V	-40.40	-13.64	-54.03	-13.00	-41.03
133.79	V	-38.20	-18.61	-56.82	-13.00	-43.82
145.43	V	-41.07	-17.25	-58.32	-13.00	-45.32
242.43	V	-44.28	-15.41	-59.69	-13.00	-46.69
256.98	V	-44.03	-15.10	-59.13	-13.00	-46.13
349.13	V	-49.01	-13.32	-62.32	-13.00	-49.32
44.55	H	-56.98	-4.21	-61.19	-13.00	-48.19
122.15	H	-33.47	-20.81	-54.28	-13.00	-41.28
134.76	H	-35.26	-19.65	-54.91	-13.00	-41.91
178.41	H	-42.78	-17.53	-60.32	-13.00	-47.32
220.12	H	-42.62	-15.17	-57.79	-13.00	-44.79
253.10	H	-44.38	-14.41	-58.79	-13.00	-45.79

Remark:

1. Measuring frequencies from 1 GHz to the 10th harmonic of highest fundamental frequency.
2. Measurements above show only up to 6 maximum emissions noted, or would be lesser, with " N/A " remark, if no specific emissions from the EUT are recorded (ie: margin>20dB from the applicable limit) and considered that's already beyond the background noise floor.



Operation Mode: EGPRS 1900 Closed Mode / TX / CH 512 Test Date: July 25, 2007

Temperature: 25°C Tested by: Ryan Chen

Humidity: 50 % RH Polarity: Ver. / Hor.

Frequency (MHz)	Antenna Polarization (V/H)	Reading (dBm)	Correction Factor (dB)	Emission level (dBm)	Limit (dBm)	Margin (dB)
57.16	V	-47.87	-6.73	-54.61	-13.00	-41.61
127.97	V	-37.26	-19.46	-56.72	-13.00	-43.72
194.90	V	-45.12	-17.09	-62.21	-13.00	-49.21
231.76	V	-43.62	-16.09	-59.71	-13.00	-46.71
245.34	V	-44.17	-15.22	-59.38	-13.00	-46.38
344.28	V	-51.42	-13.35	-64.77	-13.00	-51.77
39.70	H	-54.69	-5.55	-60.24	-13.00	-47.24
116.33	H	-36.74	-20.25	-56.99	-13.00	-43.99
196.84	H	-45.57	-16.34	-61.91	-13.00	-48.91
243.40	H	-42.15	-14.34	-56.49	-13.00	-43.49
259.89	H	-42.18	-15.11	-57.29	-13.00	-44.29
347.19	H	-52.82	-13.55	-66.37	-13.00	-53.37

Remark:

1. Measuring frequencies from 1 GHz to the 10th harmonic of highest fundamental frequency.
2. Measurements above show only up to 6 maximum emissions noted, or would be lesser, with " N/A " remark, if no specific emissions from the EUT are recorded (ie: margin > 20dB from the applicable limit) and considered that's already beyond the background noise floor.



Operation Mode: EGPRS 1900 Closed Mode / TX / CH 661 Test Date: July 25, 2007

Temperature: 25°C Tested by: Ryan Chen

Humidity: 50 % RH Polarity: Ver. / Hor.

Frequency (MHz)	Antenna Polarization (V/H)	Reading (dBm)	Correction Factor (dB)	Emission level (dBm)	Limit (dBm)	Margin (dB)
57.16	V	-50.31	-6.73	-57.04	-13.00	-44.04
125.06	V	-36.30	-19.46	-55.75	-13.00	-42.75
172.59	V	-43.62	-18.30	-61.92	-13.00	-48.92
197.81	V	-43.69	-17.03	-60.72	-13.00	-47.72
251.16	V	-46.17	-14.93	-61.10	-13.00	-48.10
264.74	V	-46.71	-15.19	-61.90	-13.00	-48.90
33.88	H	-47.32	-11.20	-58.52	-13.00	-45.52
128.94	H	-34.32	-21.29	-55.61	-13.00	-42.61
223.03	H	-44.28	-15.21	-59.49	-13.00	-46.49
251.16	H	-38.49	-14.21	-52.70	-13.00	-39.70
266.68	H	-40.96	-15.63	-56.60	-13.00	-43.60
407.33	H	-55.13	-11.02	-66.15	-13.00	-53.15

Remark:

1. Measuring frequencies from 1 GHz to the 10th harmonic of highest fundamental frequency.
2. Measurements above show only up to 6 maximum emissions noted, or would be lesser, with " N/A " remark, if no specific emissions from the EUT are recorded (ie: margin > 20dB from the applicable limit) and considered that's already beyond the background noise floor.



Operation Mode: EGPRS 1900 Closed Mode / TX / CH 810 Test Date: July 25, 2007

Temperature: 25°C Tested by: Ryan Chen

Humidity: 50 % RH Polarity: Ver. / Hor.

Frequency (MHz)	Antenna Polarization (V/H)	Reading (dBm)	Correction Factor (dB)	Emission level (dBm)	Limit (dBm)	Margin (dB)
57.16	V	-49.01	-6.73	-55.74	-13.00	-42.74
126.03	V	-36.94	-19.46	-56.40	-13.00	-43.40
192.96	V	-45.20	-17.13	-62.33	-13.00	-49.33
225.94	V	-43.94	-16.33	-60.27	-13.00	-47.27
238.55	V	-44.41	-15.67	-60.08	-13.00	-47.08
253.10	V	-45.70	-14.99	-60.69	-13.00	-47.69
43.58	H	-57.34	-4.44	-61.78	-13.00	-48.78
127.00	H	-32.30	-21.16	-53.46	-13.00	-40.46
185.20	H	-45.64	-16.96	-62.60	-13.00	-49.60
222.06	H	-45.53	-15.20	-60.73	-13.00	-47.73
242.43	H	-43.88	-14.38	-58.26	-13.00	-45.26
263.77	H	-44.56	-15.41	-59.97	-13.00	-46.97

Remark:

1. Measuring frequencies from 1 GHz to the 10th harmonic of highest fundamental frequency.
2. Measurements above show only up to 6 maximum emissions noted, or would be lesser, with " N/A " remark, if no specific emissions from the EUT are recorded (ie: margin>20dB from the applicable limit) and considered that's already beyond the background noise floor.



Above 1GHz

Operation Mode: GSM 1900 Closed Mode / TX / CH 512

Test Date: July 24, 2007

Temperature: 25°C

Tested by: Ryan Chen

Humidity: 50 % RH

Polarity: Ver. / Hor.

Frequency (MHz)	Antenna Polarization	Reading level (dBuV)	Correction Factor (dB)	Emission level (dBm)	Limit (dBm)	Margin (dB)
3702.00	V	-59.95	5.84	-54.11	-13.00	-41.11
5550.00	V	-56.93	7.60	-49.33	-13.00	-36.33
7398.00	V	-58.85	13.41	-45.44	-13.00	-32.44
N/A						
3702.00	H	-53.89	6.26	-47.63	-13.00	-34.63
5550.00	H	-58.63	8.03	-50.60	-13.00	-37.60
7398.00	H	-60.25	13.81	-46.44	-13.00	-33.44
N/A						

Remark:

1. Measuring frequencies from 1 GHz to the 10th harmonic of highest fundamental frequency.
2. Measurements above show only up to 6 maximum emissions noted, or would be lesser, with " N/A " remark, if no specific emissions from the EUT are recorded (ie: margin > 20dB from the applicable limit) and considered that's already beyond the background noise floor.



Operation Mode: GSM 1900 Closed Mode / TX / CH 661

Test Date: July 24, 2007

Temperature: 25°C

Tested by: Ryan Chen

Humidity: 50 % RH

Polarity: Ver. / Hor.

Frequency (MHz)	Antenna Polarization	Reading level (dBuV)	Correction Factor (dB)	Emission level (dBm)	Limit (dBm)	Margin (dB)
3758.00	V	-60.03	5.93	-54.11	-13.00	-41.11
5641.00	V	-59.55	7.70	-51.85	-13.00	-38.85
7517.00	V	-56.44	13.82	-42.62	-13.00	-29.62
N/A						
3758.00	H	-56.08	6.38	-49.70	-13.00	-36.70
5641.00	H	-59.34	8.02	-51.32	-13.00	-38.32
7524.00	H	-55.01	14.39	-40.62	-13.00	-27.62
N/A						

Remark:

1. Measuring frequencies from 1 GHz to the 10th harmonic of highest fundamental frequency.
2. Measurements above show only up to 6 maximum emissions noted, or would be lesser, with " N/A " remark, if no specific emissions from the EUT are recorded (ie: margin > 20dB from the applicable limit) and considered that's already beyond the background noise floor.



Operation Mode: GSM 1900 Closed Mode / TX / CH 810

Test Date: July 24, 2007

Temperature: 25°C

Tested by: Ryan Chen

Humidity: 50 % RH

Polarity: Ver. / Hor.

Frequency (MHz)	Antenna Polarization	Reading level (dBuV)	Correction Factor (dB)	Emission level (dBm)	Limit (dBm)	Margin (dB)
5732.00	V	-56.66	7.81	-48.85	-13.00	-35.85
7643.00	V	-51.56	14.13	-37.44	-13.00	-24.44
N/A						
3821.00	H	-57.92	6.51	-51.41	-13.00	-38.41
5732.00	H	-56.64	8.02	-48.62	-13.00	-35.62
7636.00	H	-54.20	14.77	-39.42	-13.00	-26.42
N/A						

Remark:

1. Measuring frequencies from 1 GHz to the 10th harmonic of highest fundamental frequency.
2. Measurements above show only up to 6 maximum emissions noted, or would be lesser, with " N/A " remark, if no specific emissions from the EUT are recorded (ie: margin > 20dB from the applicable limit) and considered that's already beyond the background noise floor.



Operation Mode: GPRS 1900 Closed Mode / TX / CH 512

Test Date: July 24, 2007

Temperature: 25°C

Tested by: Ryan Chen

Humidity: 50 % RH

Polarity: Ver. / Hor.

Frequency (MHz)	Antenna Polarization	Reading level (dBuV)	Correction Factor (dB)	Emission level (dBm)	Limit (dBm)	Margin (dB)
1854.00	V	-41.41	1.85	-39.55	-13.00	-26.55
3702.00	V	-51.74	5.84	-45.90	-13.00	-32.90
5550.00	V	-37.61	7.60	-30.01	-13.00	-17.01
7405.00	V	-54.42	13.44	-40.98	-13.00	-27.98
N/A						
1854.00	H	-43.18	2.80	-40.39	-13.00	-27.39
3702.00	H	-45.81	6.26	-39.54	-13.00	-26.54
5550.00	H	-36.42	8.03	-28.39	-13.00	-15.39
7405.00	H	-56.30	13.85	-42.46	-13.00	-29.46
N/A						

Remark:

1. Measuring frequencies from 1 GHz to the 10th harmonic of highest fundamental frequency.
2. Measurements above show only up to 6 maximum emissions noted, or would be lesser, with " N/A " remark, if no specific emissions from the EUT are recorded (ie: margin > 20dB from the applicable limit) and considered that's already beyond the background noise floor.



Operation Mode: GPRS 1900 Closed Mode / TX / CH 661

Test Date: July 24, 2007

Temperature: 25°C

Tested by: Ryan Chen

Humidity: 50 % RH

Polarity: Ver. / Hor.

Frequency (MHz)	Antenna Polarization	Reading level (dBuV)	Correction Factor (dB)	Emission level (dBm)	Limit (dBm)	Margin (dB)
1882.00	V	-44.38	1.87	-42.51	-13.00	-29.51
3758.00	V	-55.41	5.93	-49.49	-13.00	-36.49
5641.00	V	-36.78	7.70	-29.08	-13.00	-16.08
7517.00	V	-51.12	13.82	-37.30	-13.00	-24.30
N/A						
1882.00	H	-42.70	2.77	-39.93	-13.00	-26.93
3758.00	H	-49.66	6.38	-43.28	-13.00	-30.28
5641.00	H	-33.90	8.02	-25.87	-13.00	-12.87
7524.00	H	-51.64	14.39	-37.25	-13.00	-24.25
N/A						

Remark:

1. Measuring frequencies from 1 GHz to the 10th harmonic of highest fundamental frequency.
2. Measurements above show only up to 6 maximum emissions noted, or would be lesser, with " N/A " remark, if no specific emissions from the EUT are recorded (ie: margin > 20dB from the applicable limit) and considered that's already beyond the background noise floor.



Operation Mode: GPRS 1900 Closed Mode / TX / CH 810

Test Date: July 24, 2007

Temperature: 25°C

Tested by: Ryan Chen

Humidity: 50 % RH

Polarity: Ver. / Hor.

Frequency (MHz)	Antenna Polarization	Reading level (dBuV)	Correction Factor (dB)	Emission level (dBm)	Limit (dBm)	Margin (dB)
1910.00	V	-41.35	1.88	-39.48	-13.00	-26.48
3821.00	V	-57.26	6.02	-51.24	-13.00	-38.24
5732.00	V	-54.12	7.81	-46.31	-13.00	-33.31
7643.00	V	-50.02	14.13	-35.89	-13.00	-22.89
N/A						
1910.00	H	-43.13	2.75	-40.38	-13.00	-27.38
3821.00	H	-53.73	6.51	-47.22	-13.00	-34.22
5732.00	H	-54.14	8.02	-46.13	-13.00	-33.13
7643.00	H	-50.00	14.80	-35.20	-13.00	-22.20
N/A						

Remark:

1. Measuring frequencies from 1 GHz to the 10th harmonic of highest fundamental frequency.
2. Measurements above show only up to 6 maximum emissions noted, or would be lesser, with " N/A " remark, if no specific emissions from the EUT are recorded (ie: margin > 20dB from the applicable limit) and considered that's already beyond the background noise floor.



Operation Mode: EGPRS 1900 Closed Mode / TX / CH 512

Test Date: July 25, 2007

Temperature: 25°C

Tested by: Ryan Chen

Humidity: 50 % RH

Polarity: Ver. / Hor.

Frequency (MHz)	Antenna Polarization	Reading level (dBuV)	Correction Factor (dB)	Emission level (dBm)	Limit (dBm)	Margin (dB)
3702.00	V	-52.89	5.84	-47.05	-13.00	-34.05
5550.00	V	-42.50	7.60	-34.90	-13.00	-21.90
7405.00	V	-60.24	13.44	-46.80	-13.00	-33.80
N/A						
1854.00	H	-55.25	2.80	-52.45	-13.00	-39.45
3702.00	H	-54.08	6.26	-47.81	-13.00	-34.81
5550.00	H	-40.99	8.03	-32.96	-13.00	-19.96
7398.00	H	-58.23	13.81	-44.42	-13.00	-31.42
N/A						

Remark:

1. Measuring frequencies from 1 GHz to the 10th harmonic of highest fundamental frequency.
2. Measurements above show only up to 6 maximum emissions noted, or would be lesser, with " N/A " remark, if no specific emissions from the EUT are recorded (ie: margin > 20dB from the applicable limit) and considered that's already beyond the background noise floor.



Operation Mode: EGPRS 1900 Closed Mode / TX / CH 661

Test Date: July 25, 2007

Temperature: 25°C

Tested by: Ryan Chen

Humidity: 50 % RH

Polarity: Ver. / Hor.

Frequency (MHz)	Antenna Polarization	Reading level (dBuV)	Correction Factor (dB)	Emission level (dBm)	Limit (dBm)	Margin (dB)
3758.00	V	-59.96	5.93	-54.03	-13.00	-41.03
5641.00	V	-47.18	7.70	-39.48	-13.00	-26.48
7524.00	V	-56.39	13.84	-42.55	-13.00	-29.55
N/A						
1882.00	H	-55.83	2.77	-53.06	-13.00	-40.06
3758.00	H	-60.24	6.38	-53.86	-13.00	-40.86
5641.00	H	-57.13	8.02	-49.11	-13.00	-36.11
7517.00	H	-54.08	14.37	-39.71	-13.00	-26.71
N/A						

Remark:

1. Measuring frequencies from 1 GHz to the 10th harmonic of highest fundamental frequency.
2. Measurements above show only up to 6 maximum emissions noted, or would be lesser, with " N/A " remark, if no specific emissions from the EUT are recorded (ie: margin > 20dB from the applicable limit) and considered that's already beyond the background noise floor.



Operation Mode: EGPRS 1900 Closed Mode / TX / CH 810

Test Date: July 25, 2007

Temperature: 25°C

Tested by: Ryan Chen

Humidity: 50 % RH

Polarity: Ver. / Hor.

Frequency (MHz)	Antenna Polarization	Reading level (dBuV)	Correction Factor (dB)	Emission level (dBm)	Limit (dBm)	Margin (dB)
3821.00	V	-60.95	6.02	-54.92	-13.00	-41.92
5732.00	V	-54.74	7.81	-46.93	-13.00	-33.93
7643.00	V	-53.70	14.13	-39.57	-13.00	-26.57
N/A						
3821.00	H	-57.30	6.51	-50.79	-13.00	-37.79
5732.00	H	-56.24	8.02	-48.23	-13.00	-35.23
7643.00	H	-54.01	14.80	-39.22	-13.00	-26.22
N/A						

Remark:

1. Measuring frequencies from 1 GHz to the 10th harmonic of highest fundamental frequency.
2. Measurements above show only up to 6 maximum emissions noted, or would be lesser, with " N/A " remark, if no specific emissions from the EUT are recorded (ie: margin > 20dB from the applicable limit) and considered that's already beyond the background noise floor.

7.6 FREQUENCY STABILITY V.S. TEMPERATURE MEASUREMENT

LIMIT

According to FCC §2.1055, FCC §24.235.

Frequency Tolerance: 2.5 ppm

Test Configuration

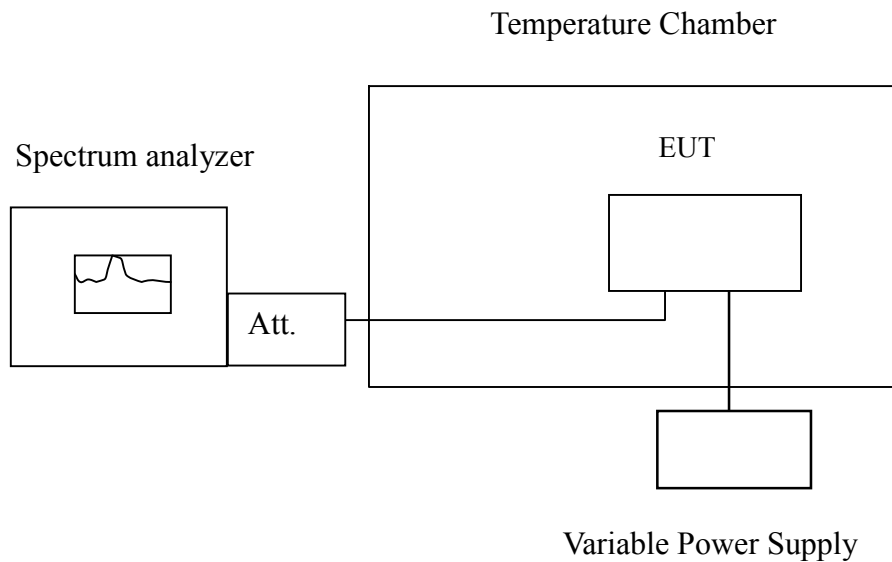

Remark: Measurement setup for testing on Antenna connector



TEST PROCEDURE

The equipment under test was connected to an external AC or DC power supply and input rated voltage. RF output was connected to a frequency counter or spectrum analyzer via feed through attenuators. The EUT was placed inside the temperature chamber. Set the spectrum analyzer RBW low enough to obtain the desired frequency resolution and measure EUT 20°C operating frequency as reference frequency. Turn EUT off and set the chamber temperature to -30°C. After the temperature stabilized for approximately 30 minutes recorded the frequency. Repeat step measure with 10°C increased per stage until the highest temperature of +50°C reached.

TEST RESULTS

No non-compliance noted.

Reference Frequency: GSM Mid Channel 836.6 MHz @ 20°C				
Limit: +/- 2.5 ppm = 2090 Hz				
Power Supply Vdc	Environment Temperature (°C)	Frequency (Hz)	Delta (Hz)	Limit (Hz)
3.7	50	83599997.64	0	2090
	40	83599998.80	1	
	30	83600001.25	3	
	20	83599998.00	0	
	10	83600001.25	3	
	0	83599998.64	1	
	-10	83600000.65	3	
	-20	83600000.25	2	
	-30	83599998.44	0	

Reference Frequency: GSM Mid Channel 1880 MHz @ 20°C				
Limit: ± 2.5 ppm = 4700 Hz				
Power Supply Vdc	Environment Temperature (°C)	Frequency (Hz)	Delta (Hz)	Limit (Hz)
3.7	50	1880000016	32	4700
	40	1880000024	40	
	30	1880000018	34	
	20	1879999984	0	
	10	1880000005	21	
	0	1880000007	23	
	-10	1880000008	24	
	-20	1880000005	21	
	-30	1880000003	19	

7.7 FREQUENCY STABILITY V.S. VOLTAGE MEASUREMENT

LIMIT

According to FCC §2.1055, FCC §24.235,

Frequency Tolerance: 2.5 ppm.

Test Configuration

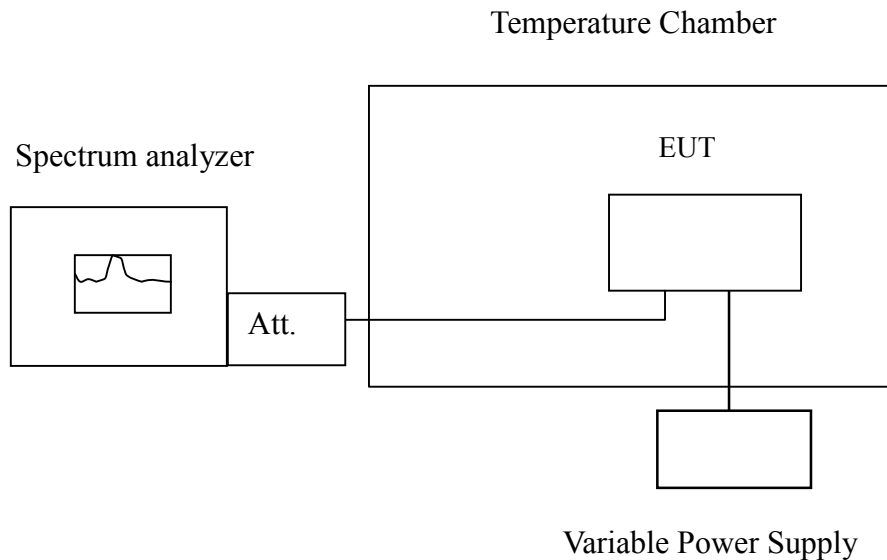

Remark: Measurement setup for testing on Antenna connector.



TEST PROCEDURE

Set chamber temperature to 20°C. Use a variable AC power supply / DC power source to power the EUT and set the voltage to rated voltage. Set the spectrum analyzer RBW low enough to obtain the desired frequency resolution and recorded the frequency.

Reduce the input voltage to specify extreme voltage variation (± 15%) and endpoint, record the maximum frequency change.

TEST RESULTS

No non-compliance noted.

Reference Frequency: GSM Mid Channel 836.6 MHz @ 20°C				
Limit: ± 2.5 ppm = 2090Hz				
Power Supply Vdc	Environment Temperature (°C)	Frequency (Hz)	Delta (Hz)	Limit (Hz)
4	20	83599995	-3	2090
3.7		83599998	0	
3.2		83600002	4	
2.9END		83599884	-118	

Reference Frequency: GSM Mid Channel 1880 MHz @ 20°C				
Limit: ± 2.5 ppm = 4700 Hz				
Power Supply Vdc	Environment Temperature (°C)	Frequency (Hz)	Delta (Hz)	Limit (Hz)
4	20	1879999988	4	4700
3.7		1879999984	0	
3.2		1879999998	14	
3.1 END		1879999916	-68	



7.8 POWERLINE CONDUCTED EMISSIONS

LIMIT

For an intentional radiator which is designed to be connected to the public utility (AC) power line, the radio frequency voltage that is conducted back onto the AC power line on any frequency or frequencies within the band 150 kHz to 30 MHz shall not exceed 250 microvolts (The limit decreases linearly with the logarithm of the frequency in the range 0.15 MHz to 0.50 MHz). The limits at specific frequency range is listed as follows:

Frequency Range (MHz)	Limits (dB μ V)	
	Quasi-peak	Average
0.15 to 0.50	66 to 56	56 to 46
0.50 to 5	56	46
5 to 30	60	50

Compliance with this provision shall be based on the measurement of the radio frequency voltage between each power line (LINE and NEUTRAL) and ground at the power terminals.

Test Configuration

See test photographs attached in Appendix I for the actual connections between EUT and support equipment.

TEST PROCEDURE

1. The EUT was placed on a table, which is 0.8m above ground plane.
2. Maximum procedure was performed on the six highest emissions to ensure EUT compliance.
3. Repeat above procedures until all frequency measured were complete..



TEST RESULTS

The initial step in collecting conducted data is a spectrum analyzer peak scan of the measurement range. Significant peaks are then marked as shown on the following data page, and these signals are then quasi-peaked.

Operation Mode: TX + RX mode **Test Date:** July 24, 2007
Temperature: 25°C **Tested by:** Ryan Chen
Humidity: 55% RH

Freq. (MHz)	QP Reading (dBuV)	AV Reading (dBuV)	Corr. factor (dB)	QP Result (dBuV)	AV Result (dBuV)	QP Limit (dBuV)	AV Limit (dBuV)	QP Margin (dB)	AV Margin (dB)	Note
0.302	31.710	28.480	0.100	31.810	28.580	60.188	50.188	-28.378	-21.608	L1
0.429	31.470	26.300	0.100	31.570	26.400	57.272	47.272	-25.702	-20.872	L1
0.666	29.730	25.090	0.100	29.830	25.190	56.000	46.000	-26.170	-20.810	L1
2.325	28.120	20.660	0.100	28.220	20.760	56.000	46.000	-27.780	-25.240	L1
6.449	17.940	17.610	0.345	18.285	17.955	60.000	50.000	-41.715	-32.045	L1
15.994	25.580	24.890	0.880	26.460	25.770	60.000	50.000	-33.540	-24.230	L1
0.182	28.390	24.250	0.136	28.526	24.386	64.394	54.394	-35.868	-30.008	L2
0.242	27.860	23.090	0.100	27.960	23.190	62.027	52.027	-34.067	-28.837	L2
0.727	24.030	18.740	0.100	24.130	18.840	56.000	46.000	-31.870	-27.160	L2
1.704	25.450	18.430	0.100	25.550	18.530	56.000	46.000	-30.450	-27.470	L2
2.253	30.620	22.340	0.100	30.720	22.440	56.000	46.000	-25.280	-23.560	L2
6.148	23.390	21.570	0.315	23.705	21.885	60.000	50.000	-36.295	-28.115	L2

Remark:

1. Measuring frequencies from 0.15 MHz to 30MHz.
2. The emissions measured in frequency range from 0.15 MHz to 30MHz were made with an instrument using Quasi-peak detector and average detector.
3. The IF bandwidth of SPA between 0.15MHz to 30MHz was 10kHz; the IF bandwidth of Test Receiver between 0.15MHz to 30MHz was 9kHz;
4. L1 = Line One (Live Line) / L2 = Line Two (Neutral Line)



Test Plots

Conducted emissions (Line 1)

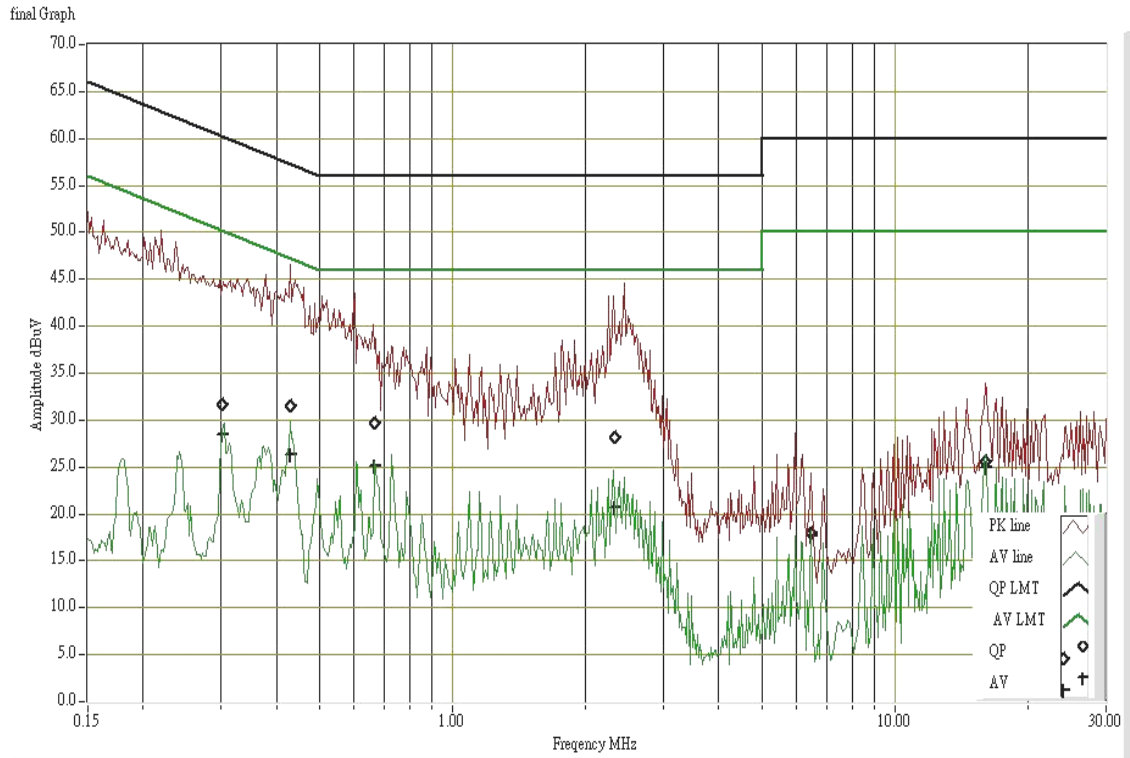

Conducted emissions (Line 2)

