



ANSI C63.19
FCC HAC TEST REPORT

For

PDA phone

Model: PA10A

Trade Name: N/A

Issued to

High Tech Computer Corp.
1F, 6-3, Bau Chian Road, Hsin-Tien,
Taipei, 231, Taiwan

Issued by

Compliance Certification Services Inc.
No. 11, Wu-Kung 6 Rd, Wu-Ku Hsiang,
Wu-Ku Industrial District, Taipei Hsien, (248) Taiwan.
TEL: 886-2-2299-9720
FAX: 886-2-2299-9721



Note: This report shall not be reproduced except in full, without the written approval of Compliance Certification Services Inc. This document may be altered or revised by Compliance Certification Services Inc. personnel only, and shall be noted in the revision section of the document.



TABLE OF CONTENTS

1.	EQUIPMENT UNDER TEST DESCRIPTION AND TEST SUMMARY	4
2.	REQUIREMENTS FOR COMPLIANCE TESTING DEFINED BY THE FCC	5
3.	SYSTEM DESCRIPTION	6
3.1	MEASUREMENT SYSTEM DIAGRAM	6
4.	SYSTEM COMPONENTS	7
4.1	DASY4 MEASUREMENT SERVER.....	7
4.2	DATA ACQUISITION ELECTRONICS (DAE)	7
4.3	ER3DV6 ISOTROPIC E-FIELD PROBE FOR GENERAL NEAR-FILED MEASUREMENTS.....	7
4.4	H3DV6 ISOTROPIC E-FIELD PROBE FOR GENERAL NEAR-FILED MEASUREMENTS.....	8
4.5	LIGHT BEAM UNIT	8
4.6	TEST ARCH	8
4.7	PHONE POSITIONER	9
4.8	SYSTEM VALIDATION KITS.....	9
4.9	SOFTWARE HAC V4.5	9
5.	EVALUATION PROCEDURES	10
6.	MEASUREMENT UNCERTAINTY	12
7.	TEST PROCEDURES	13
8.	PERFORMANCE	16
8.1	ARTICULATION WEIGHTING FACTOR (AWF)	16
8.2	TELEPHONE N-FILED CATEGORY	16
9.	MEASUREMENT RESULTS	17
9.1	SYSTEM CHECK.....	17
9.2	DIPOLE VALIDATION.....	17
9.3	EUT TUNE-UP PROCEDURES	25
9.4	HAC MEASUREMENT RESULTS.....	26
10.	EUT PHOTOS.....	34
11.	EQUIPMENT LIST & CALIBRATION STATUS.....	35
12.	LOCATION OF TEST SITE.....	36
13.	ATTACHMENTS	36



HEARING AID COMPATIBILITY CERTIFICATE

APPLICATION TYPE:	Original Grant
FCC RULE PART(s):	47 CFR PART §20.19(b)
APPLICANT:	High Tech Computer Corp.
ADDRESS:	1F, 6-3, Bau Chian Road, Hsin-Tien, Taipei, 231, Taiwan
MODEL:	PA10A
Trade Name:	N/A
SERIAL NUMBER:	528E600708
TEST SAMPLE TYPE:	Dual Band CDMA PDA Phone with with WiFi 802.11b and Bluetooth
Date of Test:	July 27 ~ 28, 2005; November 03~04,2005

APPLICABLE STANDARDS	
STANDARD	TEST RESULT
ANSI C63.19 - 2001	No non-compliance noted
HAC RATE CATEGORY	
M3 (RF EMISSION)	

The device was tested by Compliance Certification Services Inc. in accordance with the measurement methods and procedures specified in ANSI C63.19. The test results in this report apply only to the tested sample of the stated device/equipment. Other similar device/equipment will not necessarily produce the same results due to production tolerance and measurement uncertainties.

Approved by:

Harris W. Lai
 Executive Vice President
 Compliance Certification Services Inc.

Reviewed by:

Chris Hsieh
 Section Manager
 Compliance Certification Services Inc.



1. EQUIPMENT UNDER TEST DESCRIPTION AND TEST SUMMARY

PDA Phone (Dual Band CDMA Transceiver with WiFi 802.11b and Bluetooth)	
Model Number	PA10A
Model Discrepancy	N/A
Serial number	528E600708
Normal operation:	Held to ear for close slide cover and open slide cover mode
Radio modules:	<ul style="list-style-type: none"> ● CDMA: Manufacture by Maxim, model number: Max22422820 ● WiFi(802.11b)- Manufacture by TI, model number: TNETW1100B ● Bluetooth- Manufacture by TI, model number: BRF6250CZSL1R
Duty cycle of Transmitter	100% for CDMA, WiFi(802.11b) and bluetooth
Power supply	Rechargeable Li-ion Polymer Battery – Manufacture by: CexpertEnergy Co., Ltd. Model number: PA16A, rating: 3.7Vdc, 1350mA/h (only one type of battery to be used in the EUT)
Accessories	<ul style="list-style-type: none"> ● Holster with belt clip (Pouch) –New Tech, P/N: HTC-125B-1 ● Headset – Merry, P/N: EMC 147-012-01 ● Mini USB cable – MEC, P/N: 60-4008-201A ● Cradle – HTC, Model number:PA15A
Frequency Range	CDMA Cellular band: 824.7 MHz to 848.31 MHz CDMA PCS band: 1851.25 MHz to 1908.85 MHz WiFi(802.11b): 2412MHz to 2462MHz Bluetooth: 2402MHz to 2480MHz
Transmit Power	CDMA Cellular Band: 24.35 dBm CDMA PCS band: 24.30 dBm WiFi(802.11b): 14.35 dBm Bluetooth: 0.47 dBm
Test Result	CDMA Cellular band: E-Field: 39.94 dB V/m -M3 Phone H-Field: -12.57 dB A/m-M3 Phone CDMA PCS band: E-Field: 35.13 dB V/m-M4 Phone H-Field: -14.88 dB A/m-M4 Phone 2.4GHz band: E-Field: 19.13 dB V/m-M4 Phone H-Field: -31.64 dB A/m-M4 Phone
Modulation Technique	DSSS, FHSS
Antenna Specification	CDMA (Cellular and PCS band): Monopole WiFi(802.11b): Monopole Bluetooth: Monopole FPC



2. REQUIREMENTS FOR COMPLIANCE TESTING DEFINED BY THE FCC

In July 2003, the Federal Communications Commission (FCC) modified the exemption for wireless phones under the Hearing Aid Compatibility Act of 1988 to require that wireless phone manufacturers and wireless phone service providers make digital wireless phones accessible to individuals who use hearing aids.

Since 2003, more people have come to rely on wireless phones for safety, business, and personal uses. For these reasons, it is vital for individuals with a hearing impairment have access to digital wireless phones. The FCC has taken steps to increase access to wireless telephones by requiring wireless carriers and equipment manufacturers to make more digital wireless phones hearing aid-compatible.

In June 2005, the FCC reaffirmed the timetable for the development and sale of digital wireless phones that are compatible with hearing aids. Specifically, the rules are as follows:

- By **September 16, 2005**, the five largest wireless carriers (Sprint, Nextel, Verizon Wireless, Cingular and T-Mobile) must:
 - either make **four** hearing aid-compatible handset models available for each air interface (an air interface the standard operating system of a wireless network that selects which radio channels are employed during a call) or
 - ensure that 25% of their handset models are hearing compatible.
- By **September 16, 2006**, the five largest wireless carriers must, per air interface, make **five** hearing aid-compatible handset models available for each air interface.
- **All** wireless carriers must ensure that 50% of their handset models are hearing aid-compatible by **February 18, 2008**.
- Hearing aid-compatible wireless phones must have prominent exterior labeling indicating the handset's technical rating and have more detailed information included inside the package. This information will allow you to quickly and easily determine which wireless phones are compatible with your hearing aid.
- All carrier owned and operated retail outlets must make live, in-store testing available to consumers. Carriers are encouraged to include hearing aid-compatible information on "call-out cards" as part of the handset display.
- Wireless service providers are encouraged to provide a 30-day trial period or adopt a flexible return policy. This allows individuals with hearing aids sufficient time to choose suitable wireless phones and become comfortable with them.

Note: Wireless carriers, service providers, and handset manufacturers are exempt from these rules if they only offer **two or fewer digital handset models** on a particular air interface.

The FCC also encourages digital wireless phone manufacturers and service providers to offer at least one compliant handset that is a lower-priced model and one that has higher-end features and encourages hearing-aid manufacturers to label their pre-customization products according to the ANSI standard.

3. SYSTEM DESCRIPTION

3.1 MEASUREMENT SYSTEM DIAGRAM

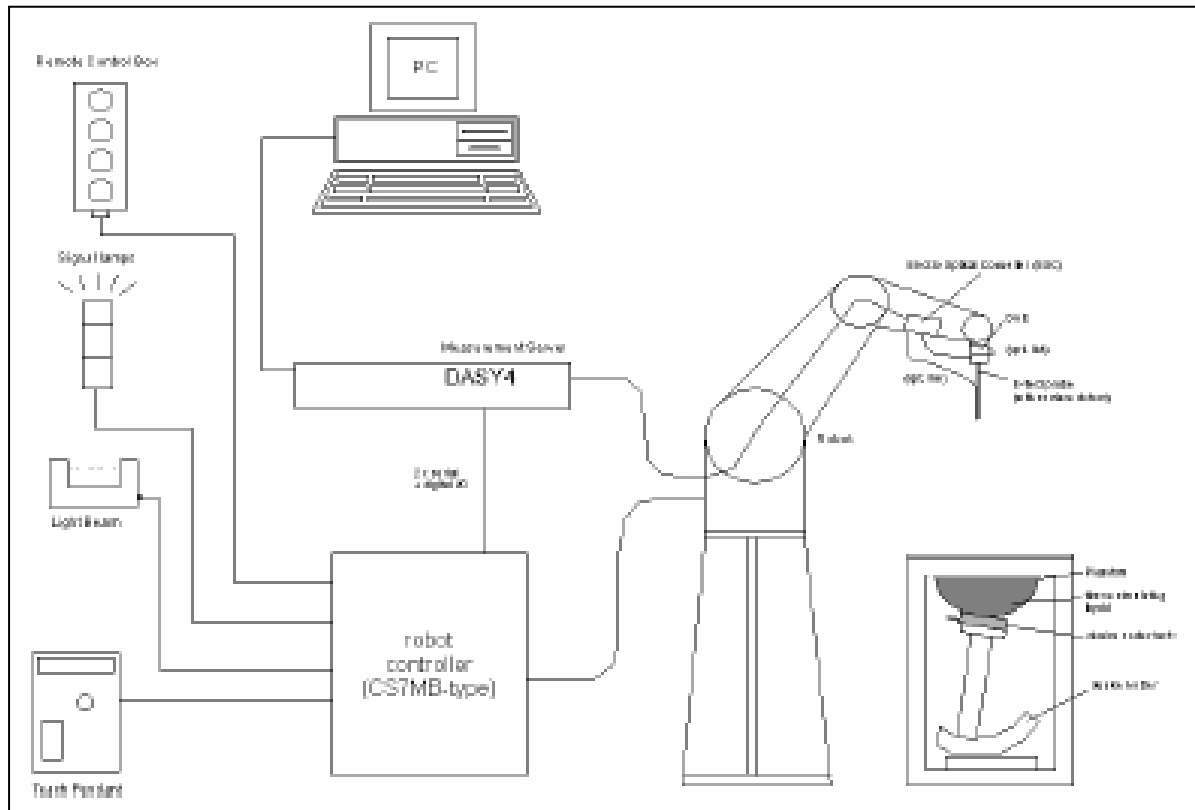

Figure 1: Measurement System diagram

The DASY4 system for performing compliance tests consists of the following items:

- A standard high precision 6-axis robot (Stäubli RX family) with controller, teach pendant and software. An arm extension for accommodating the data acquisition electronics (DAE).
- A dosimetric probe, i.e., an isotropic E-field probe optimized and calibrated for usage in tissue simulating liquid. The probe is equipped with an optical surface detector system.
- A data acquisition electronics (DAE) which performs the signal amplification, signal multiplexing, AD-conversion, offset measurements, mechanical surface detection, collision detection, etc. The unit is battery powered with standard or rechargeable batteries. The signal is optically transmitted to the EOC.
- The Electro-optical converter (EOC) performs the conversion between optical and electrical of the signals for the digital communication to the DAE and for the analog signal from the optical surface detection. The EOC is connected to the measurement server.
- The function of the measurement server is to perform the time critical tasks such as signal filtering, control of the robot operation and fast movement interrupts.
- A probe alignment unit which improves the (absolute) accuracy of the probe positioning.
- A computer operating Windows 2000 or Windows XP.
- DASY4 software.
- Remote control with teach pendant and additional circuitry for robot safety such as warning lamps, etc.
- The SAM twin phantom enabling testing left-hand and right-hand usage.
- Validation dipole kits allowing validating the proper functioning of the system.

4. SYSTEM COMPONENTS

4.1 DASY4 MEASUREMENT SERVER



Figure 2:DASY4 Server

The DASY4 measurement server is based on a PC/104 CPU board with a 166MHz low-power Pentium, 32MB chip disk and 64MB RAM. The necessary circuits for communication with either the DAE3 electronic box as well as the 16-bit AD-converter system for optical detection and digital I/O interface are contained on the DASY4 I/O-board, which is directly connected to the PC/104 bus of the CPU board.

The measurement server performs all real-time data evaluation for field measurements and surface detection, controls robot movements and handles safety operation. The PC-operating system cannot interfere with these time critical processes. All connections are supervised by a watchdog, and disconnection of any of the cables to the measurement server will automatically disarm the robot and disable all program-controlled robot movements. Furthermore, the measurement server is equipped with two expansion slots which are reserved for future applications. Please note that the expansion slots do not have a standardized pinout and therefore only the expansion cards provided by SPEAG can be inserted. Expansion cards from any other supplier could seriously damage the measurement server. Calibration: No calibration required.

4.2 DATA ACQUISITION ELECTRONICS (DAE)

The data acquisition electronics (DAE3) consists of a highly sensitive electrometer grade preamplifier with auto-zeroing, a channel and gain-switching multiplexer, a fast 16 bit AD converter and a command decoder and control logic unit. Transmission to the measurement server is accomplished through an optical downlink for data and status information as well as an optical uplink for commands and the clock. The mechanical probe mounting device includes two different sensor systems for frontal and sideways probe contacts. They are used for mechanical surface detection and probe collision detection. The input impedance of the DAE3 box is 200M Ω ; the inputs are symmetrical and floating. Common mode rejection is above 80 dB.



Figure 3: DAE

4.3 ER3DV6 ISOTROPIC E-FIELD PROBE FOR GENERAL NEAR-FIELD MEASUREMENTS

- Construction:** One dipole parallel, two dipoles normal to probe axis
 Built-in shielding against static charges
 PEEK enclosure material (resistant to organic solvents, e.g., glycolether)
- Calibration:** In air from 100 MHz to 3.0 GHz (absolute accuracy $\pm 6.0\%$, $k=2$)
- Frequency:** 100 MHz to > 6 GHz; Linearity: ± 0.2 dB (100 MHz to 3 GHz)
- Directivity:** ± 0.2 dB in air (rotation around probe axis)
 ± 0.4 dB in air (rotation normal to probe axis)
- Dynamic Range:** 2 V/m to > 1000 V/m; Linearity: ± 0.2 dB
- Dimensions:** Overall length: 330 mm (Tip: 16 mm)
 Tip diameter: 8 mm (Body: 12 mm)
 Distance from probe tip to dipole centers: 2.5 mm
 The closest part of the sensor element is 1.1 mm closer to the tip
- Application:** General near-field measurements up to 6 GHz
 Field component measurements
 Fast automatic scanning in phantoms



Figure 4 and 5: ER3DV6 E-Field Probe

4.4 H3DV6 ISOTROPIC H-FIELD PROBE FOR GENERAL NEAR-FILED MEASUREMENTS

- Construction:** Three concentric loop sensors with 3.8 mm loop diameters resistively loaded detector diodes for linear response
Built-in shielding against static charges
PEEK enclosure material (resistant to organic solvents, e.g., glycoether)
- Frequency:** 200 MHz to 3 GHz (absolute accuracy $\pm 6.0\%$, $k=2$); Output linearized
- Directivity:** ± 0.25 dB (spherical isotropy error)
- Dynamic Range:** 10 mA/m to 2 A/m at 1 GHz
- E-Field Interference:** $< 10\%$ at 3 GHz (for plane wave)
- Dimensions:** Overall length: 330 mm (Tip: 40 mm)
Tip diameter: 6 mm (Body: 12 mm)
Distance from probe tip to dipole centers: 3 mm
The closest part of the sensor element is 1.9 mm closer to the tip
- Application:** General magnetic near-field measurements up to 3 GHz
Field component measurements
Surface current measurements
Measurements in air or liquids
Low interaction with the measured field



Figure 6 and 7: H3DV6 H-Field Probe

4.5 LIGHT BEAM UNIT

The light beam switch allows automatic "tooling" of the probe. During the process, the actual position of the probe tip with respect to the robot arm is measured, as well as the probe length and the horizontal probe offset. The software then corrects all movements, so that the robot coordinates are valid for the probe tip. The repeatability of this process is better than 0.1 mm. If a position has been taught with an aligned probe, the same position will be reached with another aligned probe within 0.1 mm, even if the other probe has different dimensions. During probe rotations, the probe tip will keep its actual position.



Figure 8: Light Beam Unit

4.6 TEST ARCH

- Construction:** Enables easy and well defined positioning of the phone and validation dipoles as well as simple teaching of the robot.
- Dimensions:** 370 x 370 x 370mm

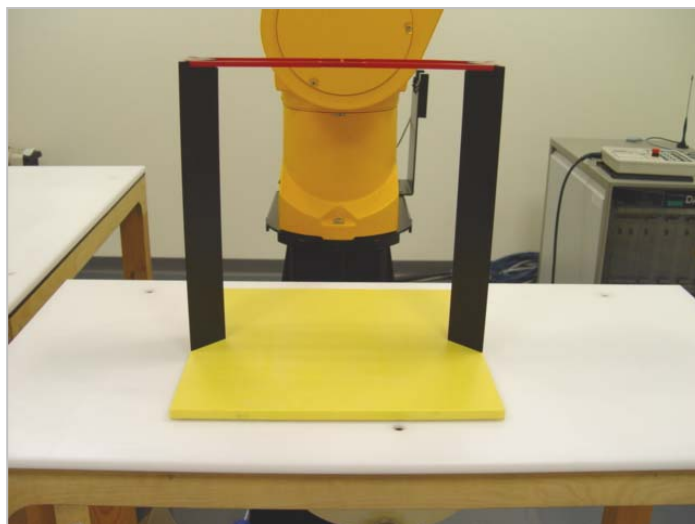

Figure 9: Test Arch

4.7 PHONE POSITIONER

Construction: Supports accurate and reliable positioning of any phone effect on near field <+/- 0.5dB

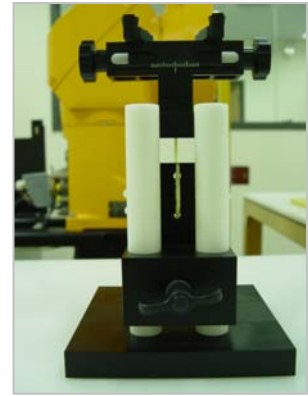

Figure 10: Phone positioner

4.8 SYSTEM VALIDATION KITS

Construction: Symmetrical dipole with built-in two step matching network and balun
CD835V3

Frequency Band: 800 - 960 MHz (free space)

Return Loss: > 15 dB

Calibrated at: 835MHz

Power Capability: 50W continuous

Length & Height: 166 x 330 mm

CD1880V3

Frequency Band: 1710 - 2000 MHz (free space)

Return Loss: > 18 dB

Calibrated at: 1880MHz

Power Capability: 50W continuous

Length & Height: 80.8 x 330 mm

CD2450V3

Frequency Band: 2250 - 2650 MHz (free space)

Return Loss: > 18 dB over frequency band in free space

Calibrated at: 2450MHz

Power Capability: 50W continuous

Length & Height: 59.9 x 330 mm

Dipole Holder: Tripod holder with adapter

Regular: Hight Range 205 - 300 mm

Shortened: Hight Range 160 - 210 mm

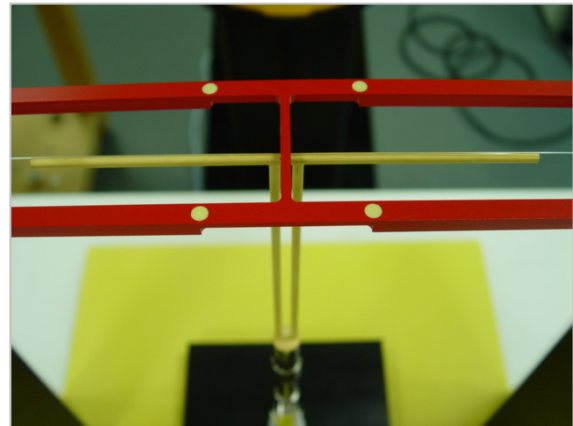

Figure 10: Dipole with Test Arch

4.9 SOFTWARE HAC V4.5

Easy teaching of predefined ANSI C63.19 measurement area

Evaluation incorporates automatic exclusion of high-level areas

Documentation ready for inclusion into compliance report.

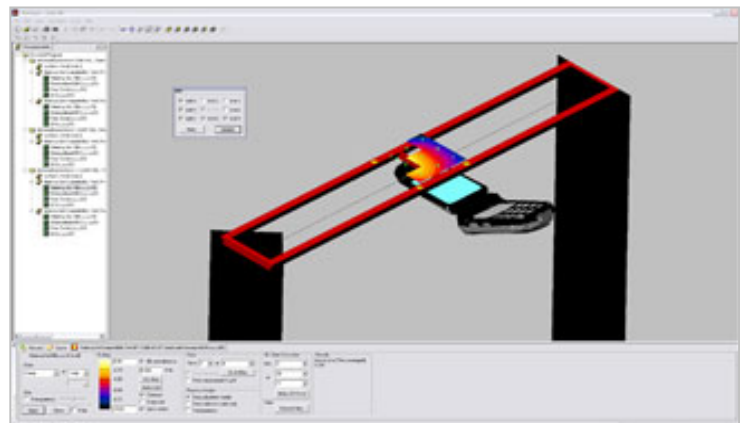

Figure 11: DASY4 software



5. EVALUATION PROCEDURES

DATA EVALUATION

The DASY4 post processing software (SEMCAD) automatically executes the following procedures to calculate the field units from the microvolt readings at the probe connector. The parameters used in the evaluation are stored in the configuration modules of the software:

Probe parameters:	- Sensitivity	$Norm_i, a_{i0}, a_{i1}, a_{i2}$
	- Conversion factor	$ConvF_i$
	- Diode compression point	dcp_i
Device parameters:	- Frequency	f
	- Crest factor	cf
Media parameters:	- Conductivity	σ
	- Density	ρ

These parameters must be set correctly in the software. They can be found in the component documents or be imported into the software from the configuration files issued for the DASY components. In the direct measuring mode of the multi-meter option, the parameters of the actual system setup are used. In the scan visualization and export modes, the parameters stored in the corresponding document files are used.

The first step of the evaluation is a linearization of the filtered input signal to account for the compression characteristics of the detector diode. The compensation depends on the input signal, the diode type and the DC-transmission factor from the diode to the evaluation electronics. If the exciting field is pulsed, the crest factor of the signal must be known to correctly compensate for peak power. The formula for each channel can be given as:

$$V_i = U_i + U_i^2 \cdot \frac{cf}{dcp_i}$$

with	V_i	= Compensated signal of channel i	(i = x, y, z)
	U_i	= Input signal of channel i	(i = x, y, z)
	cf	= Crest factor of exciting field	(DASY parameter)
	dcp_i	= Diode compression point	(DASY parameter)

From the compensated input signals the primary field data for each channel can be evaluated:

E-field probes:
$$E_i = \sqrt{\frac{V_i}{Norm_i \cdot ConvF}}$$

H-field probes:
$$H_i = \sqrt{V_i} \cdot \frac{a_{i10} + a_{i11}f + a_{i12}f^2}{f}$$

with	V_i	= Compensated signal of channel i	(i = x, y, z)
	$Norm_i$	= Sensor sensitivity of channel i	(i = x, y, z)
		$\mu V/(V/m)^2$ for E0field Probes	
	$ConvF$	= Sensitivity enhancement in solution	
	aij	= Sensor sensitivity factors for H-field probes	
	f	= Carrier frequency (GHz)	
	E_i	= Electric field strength of channel i in V/m	
	H_i	= Magnetic field strength of channel i in A/m	

The RSS value of the field components gives the total field strength (Hermitian magnitude):

$$E_{tot} = \sqrt{E_x^2 + E_y^2 + E_z^2}$$

The primary field data are used to calculate the derived field units.



$$SAR = E_{tot}^2 \cdot \frac{\sigma}{\rho \cdot 1000}$$

- with SAR = local specific absorption rate in mW/g
 E_{tot} = total field strength in V/m
 σ = conductivity in [mho/m] or [Siemens/m]
 ρ = equivalent tissue density in g/cm³

Note that the density is normally set to 1 (or 1.06), to account for actual brain density rather than the density of the simulation liquid.

The power flow density is calculated assuming the excitation field as a free space field.

$$P_{pwe} = \frac{E_{tot}^2}{3770} \quad \text{or} \quad P_{pwe} = H_{tot}^2 \cdot 37.7$$

- with P_{pwe} = Equivalent power density of a plane wave in mW/cm²
 E_{tot} = total electric field strength in V/m
 H_{tot} = total magnetic field strength in A/m



6. MEASUREMENT UNCERTAINTY

HAC UNCERTAINTY BUDGET ACCORDING TO ANSI C63.19[1]							
Error Description	Uncertainty Value	Probability distribution	Divisor	(C _i) E	(C _i) H	Std. Unc. E	Std. Unc. H
Measurement System							
Probe calibration	±5.1%	Normal	1	1	1	±5.1%	±5.1%
Axial isotropy	±4.7%	Rectangular	√3	1	1	±2.7%	±2.7%
Sensor Displacement	±16.5%	Rectangular	√3	1	0.145	±9.5%	±1.4%
Boundary Effects	±2.4%	Rectangular	√3	1	1	±1.4%	±1.4%
Linearity	±4.7%	Rectangular	√3	1	1	±2.7%	±2.7%
Scaling to Peak Envelope Power	±2.0%	Rectangular	√3	1	1	±1.2%	±1.2%
System Detection Limit	±1.0%	Rectangular	√3	1	1	±0.6%	±0.6%
Readout Electronics	±0.3%	Rectangular	√3	1	1	±0.3%	±0.3%
Response Time	±0.8%	Rectangular	√3	1	1	±0.5%	±0.5%
Integration Time	±2.6%	Rectangular	√3	1	1	±1.5%	±1.5%
RF Ambient Condition	±3.0%	Rectangular	√3	1	1	±1.7%	±1.7%
RF Reflections	±12.0%	Rectangular	√3	1	1	±6.9%	±6.9%
Probe Positioner	±1.2%	Rectangular	√3	1	0.67	±0.7%	±0.5%
Probe Positioning	±4.7%	Rectangular	√3	1	0.67	±2.7%	±1.8%
Extrap. And Interpolation	±1.0%	Rectangular	√3	1	1	±0.6%	±0.6%
Test Sample Related							
Device Positioning Vertical	±4.7%	Rectangular	√3	1	0.67	±2.7%	±1.8%
Device Positioning Lateral	±1.0%	Rectangular	√3	1	1	±0.6%	±0.6%
Device Holder and Phantom	±2.4%	Rectangular	√3	1	1	±1.4%	±1.4%
Power Drift	±5.0%	Rectangular	√3	1	1	±2.9%	±2.9%
Phantom and Setup Related							
Phantom Thickness	±2.4%	Rectangular	√3	1	0.67	±1.4%	±0.9%
Combined Std. Uncertainty						±14.7%	±10.9%
Expanded Std. Uncertainty on Power						±29.4%	±21.8%
Expanded Std. Uncertainty on Field						±14.7%	±10.9%

Table: Worst-case uncertainty budget for HAC free field assessment according to ANSI C63.19 [1]. The budget is valid for the frequency range 800 MHz – 3GHz and represents a worst-case analysis. For specific tests and configurations, the uncertainty could be considerably smaller.

7. TEST PROCEDURES

The following are RF emission step-by-step test procedures:

Test Instructions

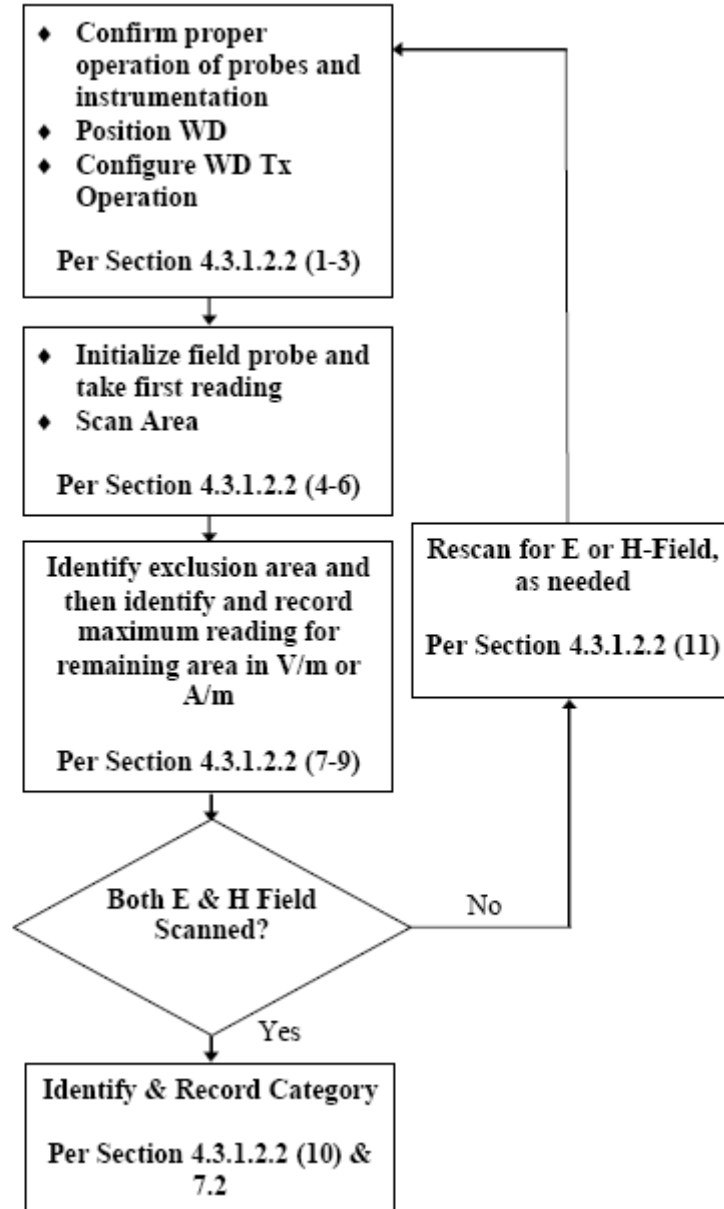

Figure 12: Near-field emission automated test flowchart

RF EMISSION TEST SETUP:

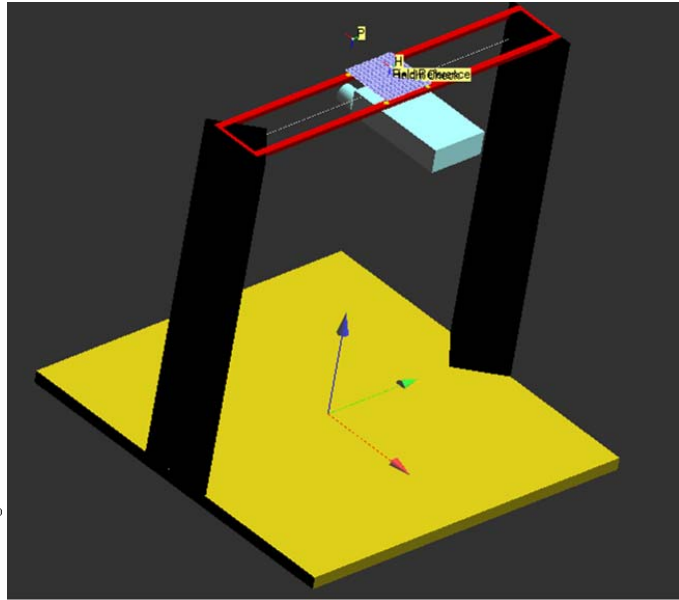
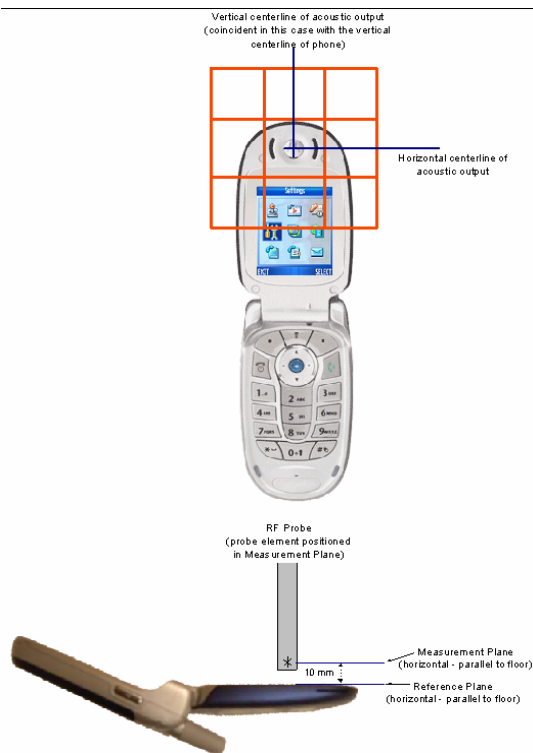

Figure 13: WD near-field emission test setup

Figure 14: HAC test arch with WD setup

The following are measurement RF near field emission:

1. Confirm proper operation of the field probe, probe measurement system and other instrumentation and the positioning system.
2. Position the WD in its intended test position. The WD's acoustic output point perpendicular to the field probe with test arch (see the figure 13 and figure 14).
3. Configure the WD normal operation for maximum rated RF output power, at the desired channel and other operating parameters, (e.g. test mode) as intended for the test. The fully charge battery was used for each test.
4. The center sub-grid was centered on the center of the WD output (acoustic or T-Coil output), as appropriate. The field probe at the initial test position in the 5 x 5 cm grid with a 5mm step size.
5. The field probe was aligned in the light beam. The phantom adjustment and verification procedure (1. surface check; 2. Verify Height 0.5mm above Center; 3. Verify Height 0.5mm above Center; 4. Verify Height for Scan) was performed before each setup change.
6. The measurement system was tested 5 x 5 cm grid with a 5mm step size. The probe was rotated 360° about the azimuth axis at the maximum interpolated position. The reading was recorded at each measurement procedure.
7. The power drift was measurement for each test. Power drift shall be below 5% or 0.25dB. If the power drift was higher than 5% or 0.25dB, the measurement was re-test.
8. Around the center sub-grid, five contiguous sub-grids around the center sub-grid with lowest maximum field strength reading. A maximum of five blocks can be excluded for both E- and H-field measurements for the WD output was measured.
9. The highest field strength reading was converted to peak V/m or A/m, as appropriate. This conversion was done using the appropriate probe modulation factor.
10. Repeat steps 1-9 for both the E- and H-field measurements.
11. The peak reading was according to the categories define in the C63.19 using the appropriate AWF.
12. The DASY4 software will control the DASY4 system to carry out the follow procedure for each mode testing:



- (1) Phantom Adjustment and Verification:
 - a. Surface Check
 - b. Verify Height 0.5mm above Center
 - c. Delay
 - d. Verify Height for scan
- (2) E(or H) field Scan :
 - a. Power Reference Measurement
 - b. Hearing Aid Compatibility Test: The E-field probe need to offset Z position:-1.1 for probe element above WD 10mm. The H-field probe need to offset Z position:-1.9 for probe element above WD 10mm.(See section 4.3 and 4.4).
 - c. Robot Command
 - d. Rotation
 - e. Z Scan
 - f. Power Drift Measurement



8. PERFORMANCE

8.1 ARTICULATION WEIGHTING FACTOR (AWF)

The following AWF factors shall be used for the standard transmission protocols:

Standard	Technology	AWF (dB)
TIA/EIA/IS-2000	CDMA	0
TIA/EIA-136	TDMA (50 Hz)	0
J-STD-007	GSM (217)	-5
T1/T1P1/3GPP	UMTS (WCDMA)	0
iDENTM	TDMA (22 and 11 Hz)	0

Table 8.1 Articulation Weighting Factor (AWF)

8.2 TELEPHONE N-FILED CATEGORY

The following shows the M-rating for wireless telephone:

Category	Telephone RF Parameters					
	Near Field	AWF	E-Field Emissions (Peak)		H-Field Emissions (Peak)	
Category M1		0	199.5 – 354.8	V/m	0.60 – 1.07	A/m
		-5	149.6 – 266.1	V/m	0.45 – 0.80	A/m
Category M2		0	112.2 – 199.5	V/m	0.34 – 0.60	A/m
		-5	84.1 – 149.6	V/m	0.25 – 0.45	A/m
Category M3		0	63.1 – 112.2	V/m	0.19 – 0.34	A/m
		-5	47.3 – 84.1	V/m	0.14 – 0.25	A/m
Category M4		0	<63.1	V/m	<0.19	A/m
		-5	<47.3	V/m	<0.14	A/m

Table 8.2 Telephone near-field categories in linear units

Category	Telephone RF Parameters					
	Near Field	AWF	E-Field Emissions (Peak)		H-Field Emissions (Peak)	
Category M1		0	46 – 51	dB (V/m)	-4.4 – 0.6	dB (A/m)
		-5	43.5 – 48.5	dB (V/m)	-6.9 – -1.9	dB (A/m)
Category M2		0	41 – 46	dB (V/m)	-9.4 – -4.4	dB (A/m)
		-5	38.5 – 43.5	dB (V/m)	-11.9 – -6.9	dB (A/m)
Category M3		0	36 – 41	dB (V/m)	-14.4 – -9.4	dB (A/m)
		-5	33.5 – 38.5	dB (V/m)	-16.9 – -11.9	dB (A/m)
Category M4		0	<36	dB (V/m)	<-14.4	dB (A/m)
		-5	<33.5	dB (V/m)	<-16.9	dB (A/m)

Table 8.3 Telephone near-field categories in logarithmic units

NOTE
The WD must be performed in the category M3

9. MEASUREMENT RESULTS

9.1 SYSTEM CHECK

The test setup should be validated when first configured and verified periodically thereafter to ensure proper function. The procedure consists of two parts: dipole validation and determination of probe modulation factor.

9.2 DIPOLE VALIDATION

The HAC validation dipole antenna serves as a known source for an electrical and magnetic RF output. Figure 2 shows the setup used for the dipole validation.

1. The dipole antenna was placed in the position normally occupied by the WD.
2. The dipole was energized with a 20 dBm un-modulated continuous-wave signal.
3. The length of the dipole was scanned with both E-field and H-field probes and the maximum value for each scan was recorded.
4. The readings were compared with the values provided by the probe manufacturer and were found to agree within the allowed tolerance of 10%. Figure 2: Dipole Validation Procedure

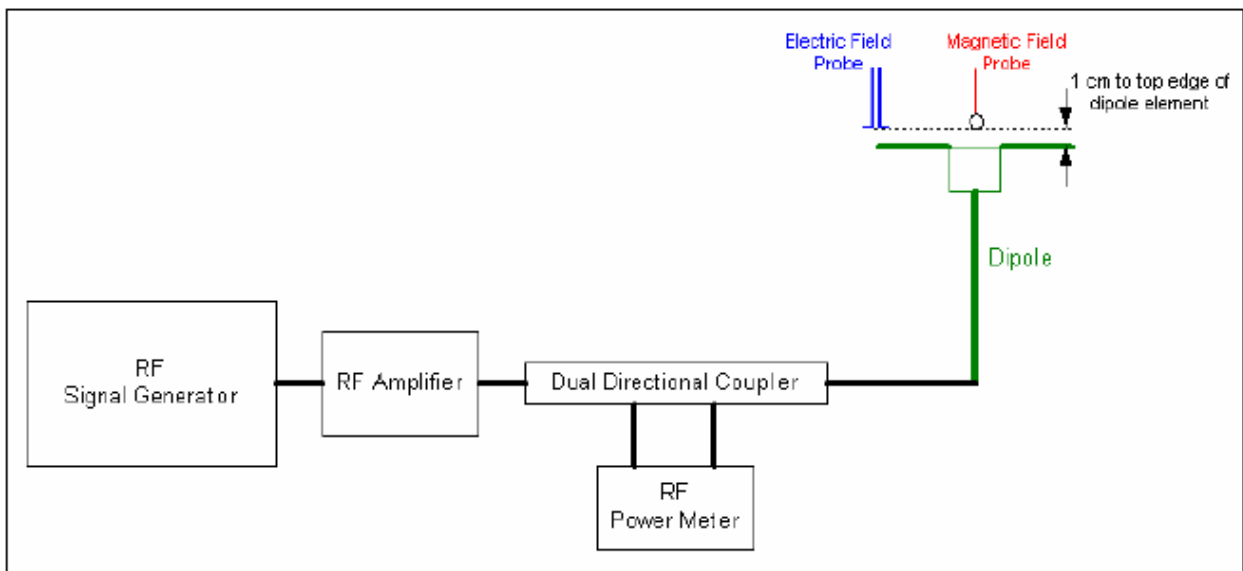

Figure 15: WD dipole calibration procedure

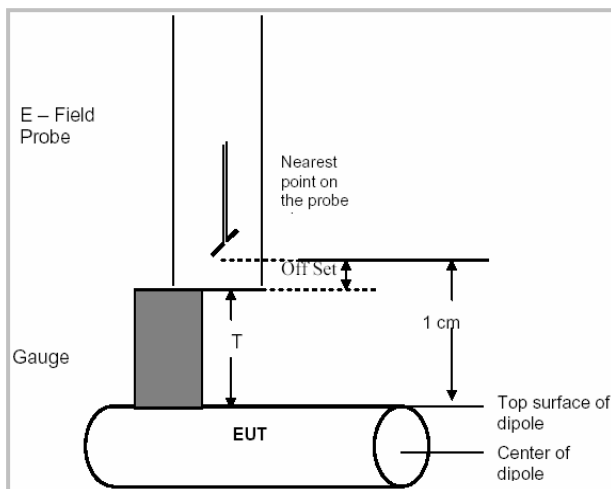

Figure 16

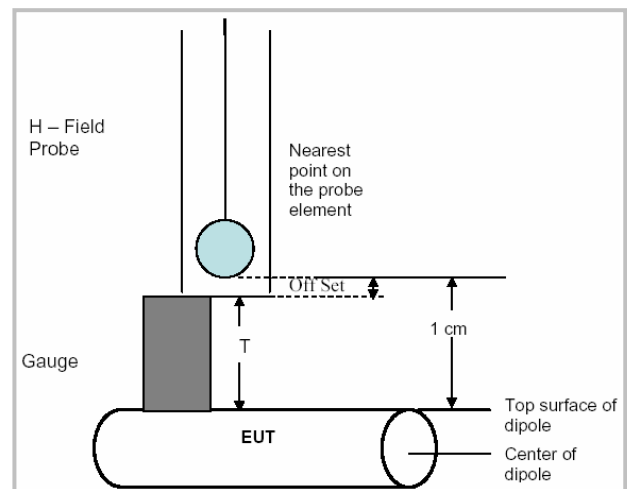

Figure 17

The probe is positioned over the illuminated dipole at 10 mm distance from the nearest point on the probe sensor element to the top surface (edge) of the dipole element.



9.1.1 Probe Modulation Factor

In addition, a calibration shall be made of the modulation response of the probe and its instrumentation chain. This calibration shall be performed with the field probe, attached to the instrumentation that is to be used with it during the measurement. The response of the probe system to a CW field at the frequency(s) of interest is compared to its response to a modulated signal with equal peak amplitude. The field level of the test signals shall be more than 10 dB above the ambient level and the noise floor of the instrumentation being used. The ratio of the CW reading to that taken with a modulated field shall be applied to the readings taken of modulated fields of the specified type. This was done using the following procedure:

- 1. Fixing the probe in a set location relative to a field generating device, such as a reference dipole antenna, as illustrated in Figure 15.
2. Illuminate the probe with a CW signal at the intended measurement frequency.
3. Record the reading of the probe measurement system of the CW signal.
4. Determine the level of the CW signal being used to drive the field generating device.
5. Substitute a signal using the same modulation as that used by the intended WD for the CW signal.
6. Set the amplitude during transmission of the modulated signal to equal the amplitude of the CW signal.
7. Record the reading of the probe measurement system of the modulated signal.
8. The ratio of the CW to modulated signal reading is the modulation factor

9.1.2 Measurement Power

- 1. 835MHz:

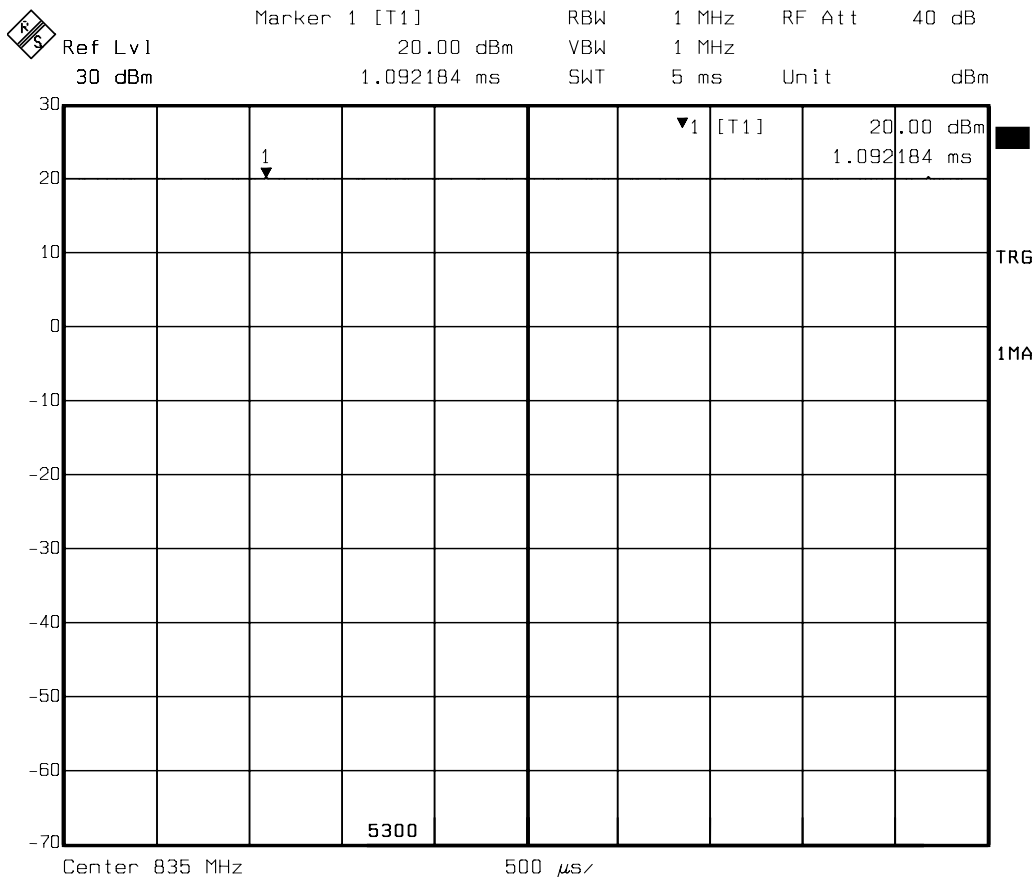

Date: 03.NOV.2005 16:39:55

CW Signal Peak Power

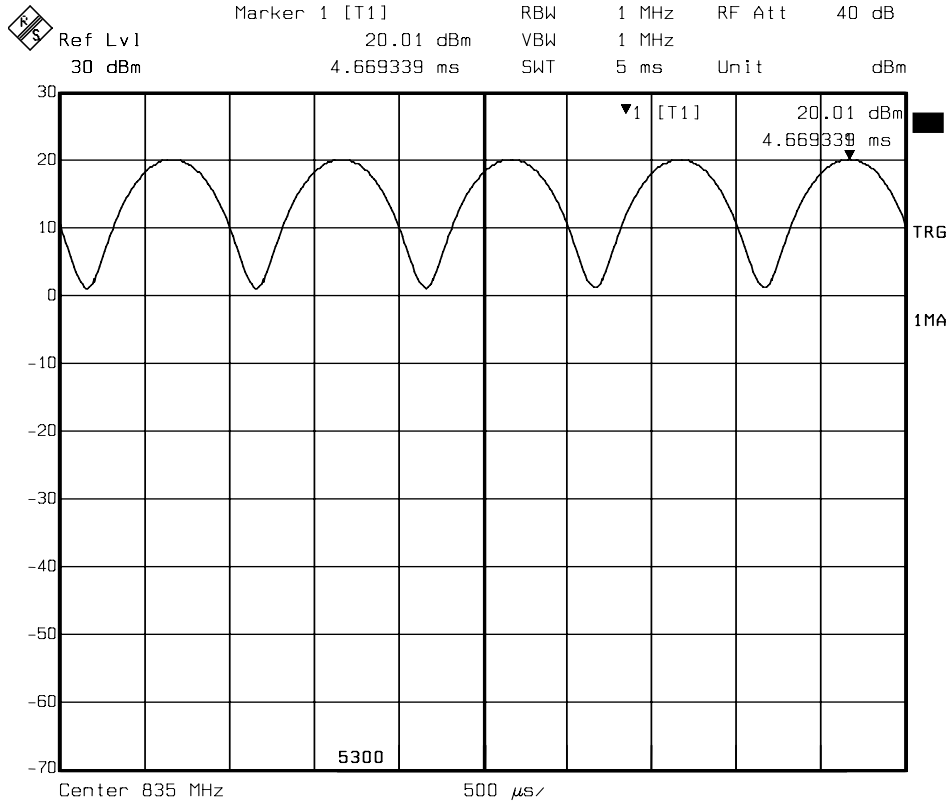

Date: 03.NOV.2005 17:00:56

AM 80% Signal Peak Power

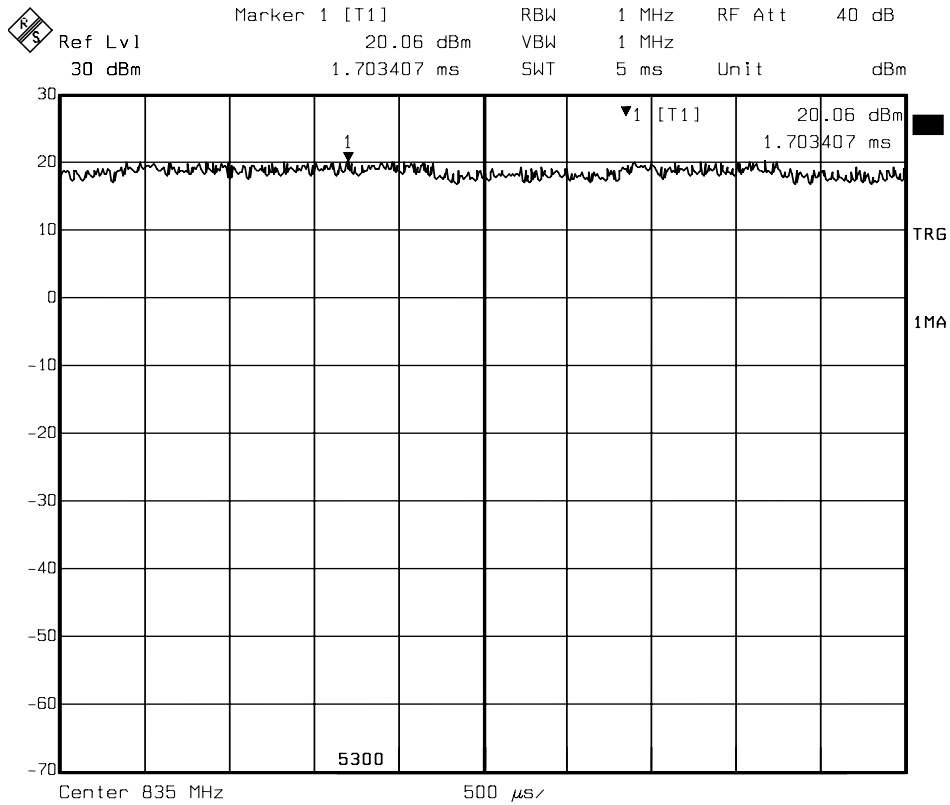

Date: 03.NOV.2005 16:57:34

CDMA Signal Peak Power



2. 1880MHz:

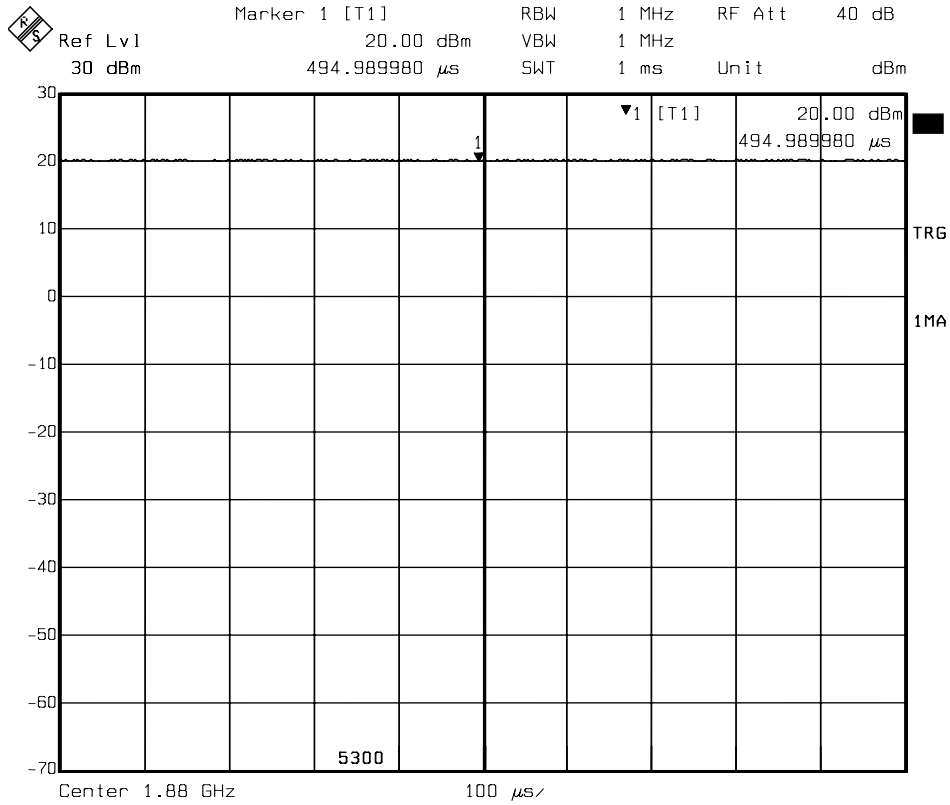

Date: 03.NOV.2005 19:04:48

CW Signal Peak Power

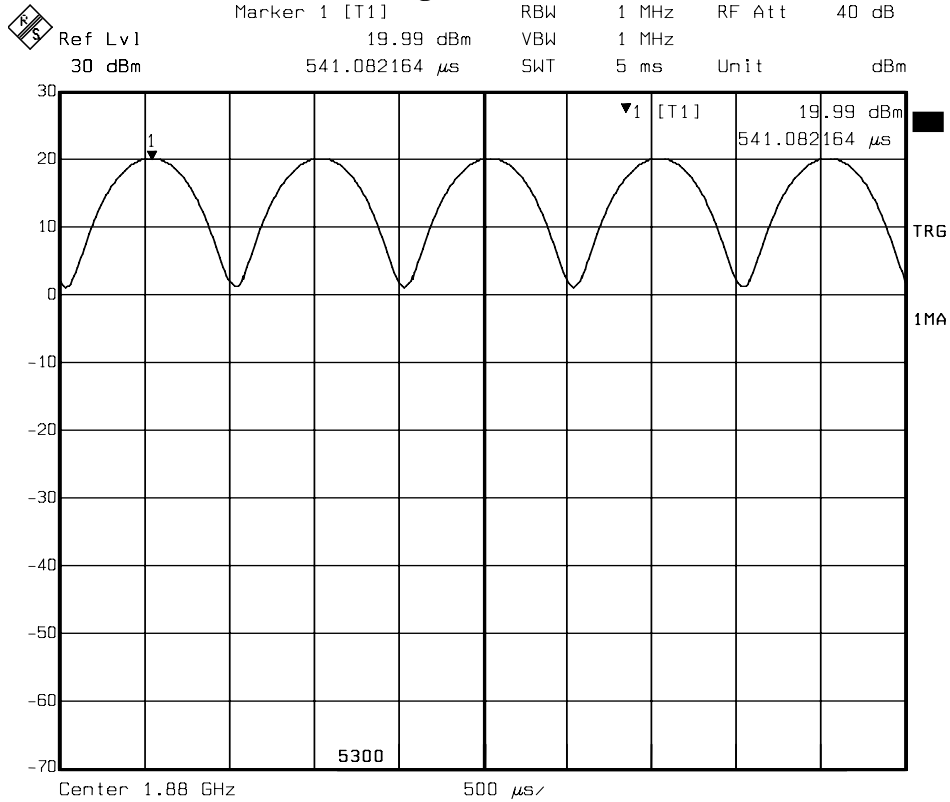

Date: 03.NOV.2005 19:08:03

AM 80% Signal Peak Power

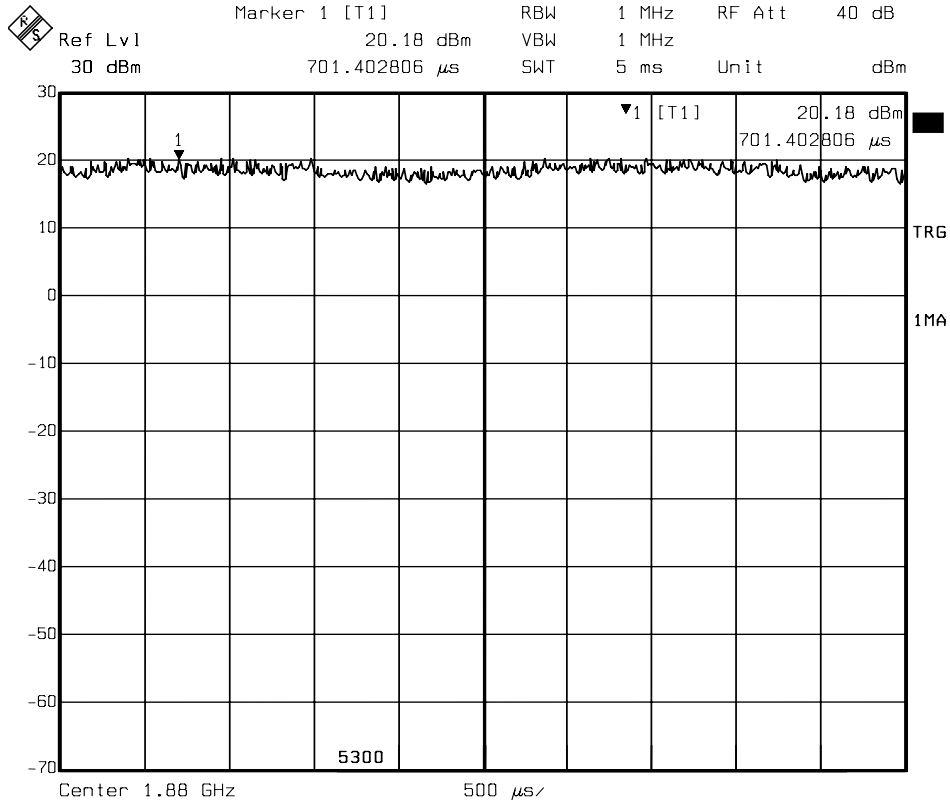

Date: 03.NOV.2005 19:11:34

CDMA Signal Peak Power

3. 2450MHz

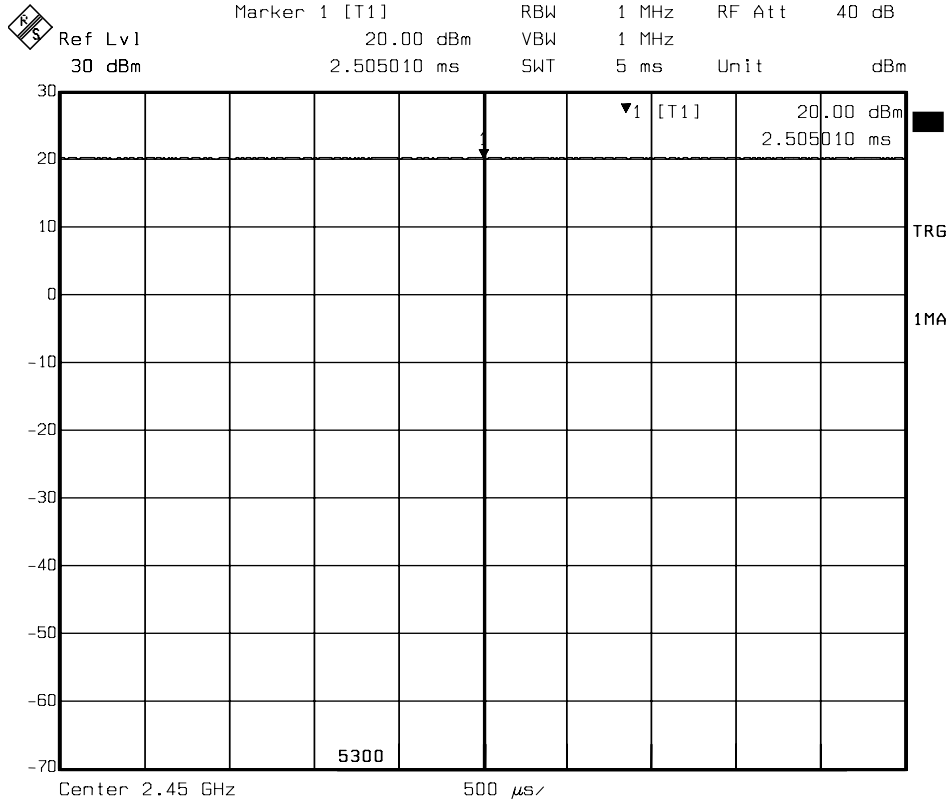

Date: 03.NOV.2005 21:36:54

CW Signal Peak Power

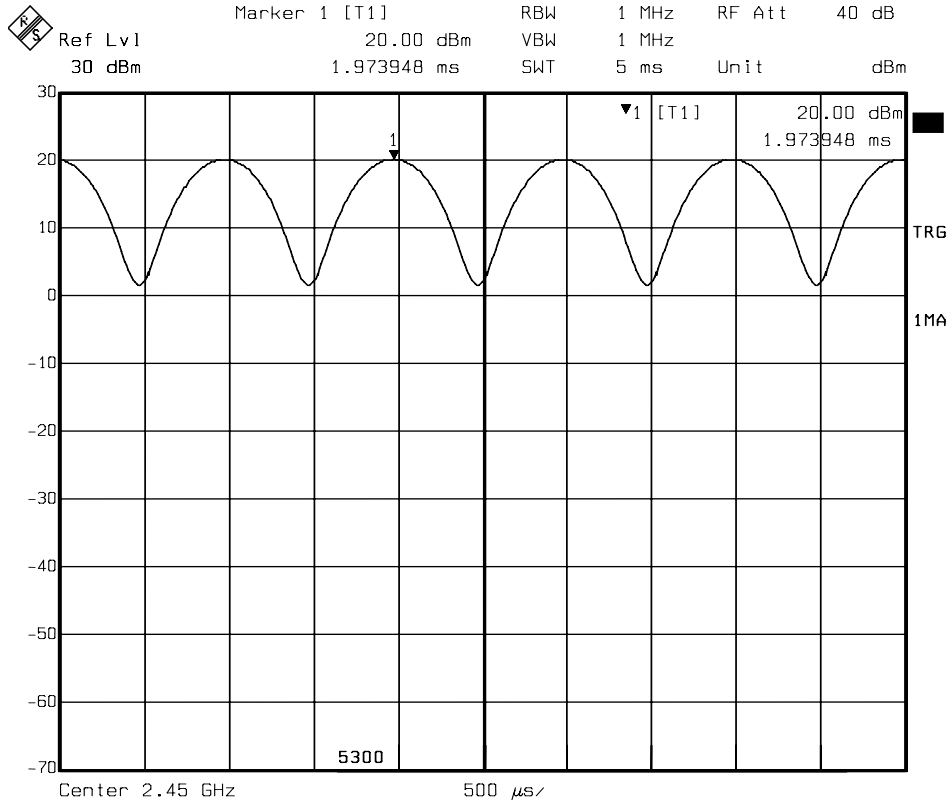

Date: 03.NOV.2005 21:41:27

AM 80% Signal Peak Power

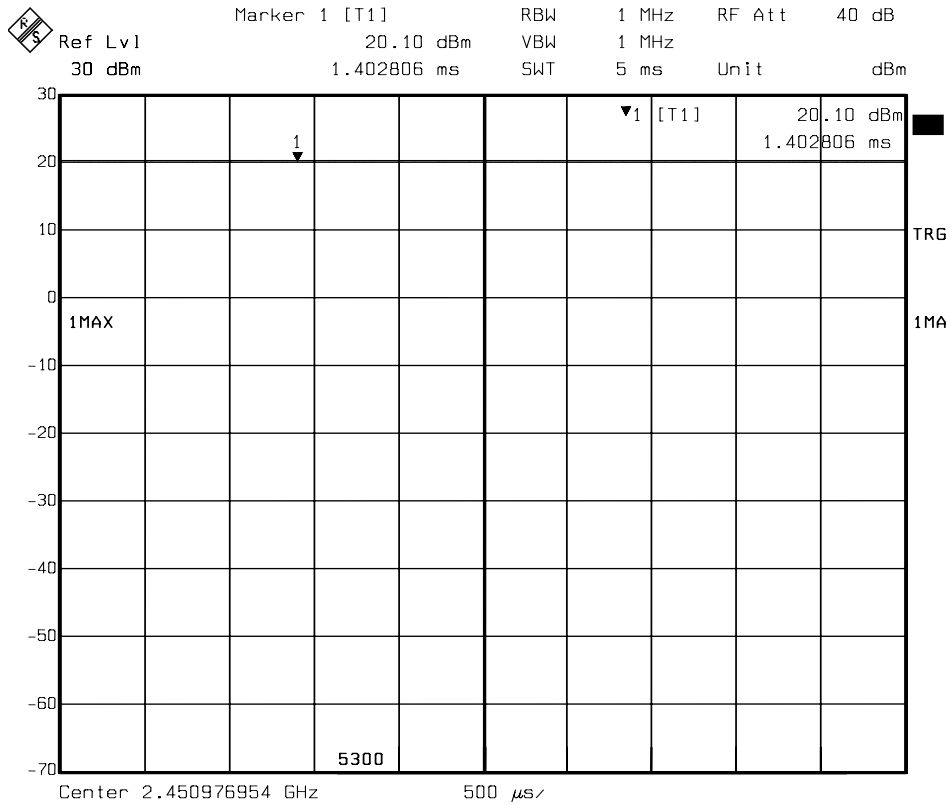

Date: 03.NOV.2005 22:02:40

DSSS Signal Peak Power



9.1.3 Validation and Modulation Factor

Date of test: July 28, 2005

f(MHz)	Signal Type	Pulse Average Power (dBm)	Measurement E-field (V/m)	Target E-Field (V/m)	Deviation %	Mod. Factor Ration
835.00	CW	20.00	165.80	162.50	2.03	–
835.00	AM80%	20.00	103.10	–	–	1.61
835.00	CDMA	20.00	164.40	–	–	1.01
1880.00	CW	20.00	139.90	138.50	1.01	–
1880.00	AM80%	20.00	87.20	–	–	1.60
1880.00	CDMA	20.00	139.20	–	–	1.01
2450.00	CW	20.00	144.40	131.80	9.56	–
2450.00	AM80%	20.00	89.30	–	–	1.62

f(MHz)	Signal Type	Pulse Average Power (dBm)	Measurement H-field (A/m)	Target H-Field (A/m)	Deviation %	Mod. Factor Ration
835.00	CW	20.00	0.409	0.451	-9.31	–
835.00	AM80%	20.00	0.266	–	–	1.54
835.00	CDMA	20.00	0.406	–	–	1.01
1880.00	CW	20.00	0.441	0.455	-3.08	–
1880.00	AM80%	20.00	0.293	–	–	1.51
1880.00	CDMA	20.00	0.437	–	–	1.01
2450.00	CW	20.00	0.458	0.469	-2.35	–
2450.00	AM80%	20.00	0.327	–	–	1.40

Note:

1. Modulation Factor = Measured E/H Field (CW) / Measured E/H Field (Modulation)
2. The HAC measurement of peak V/m or A/m should be calculation by formula or insert crest factor in the day4 software.
3. Peak(dB V/m or dB A/m) = 20 x log(Reading [time averaging V/m or A/m] x Probe Modulation Factor)



Date of test: November 03, 2005

f(MHz)	Signal Type	Pulse Average Power (dBm)	Measurement E-field (V/m)	Target E-Field (V/m)	Deviation %	Mod. Factor Ration
835.00	CW	20.00	171.20	162.50	5.35	–
835.00	AM80%	20.00	106.60	–	–	1.61
835.00	CDMA	20.00	169.40	–	–	1.01
1880.00	CW	20.00	144.00	138.50	3.97	–
1880.00	AM80%	20.00	91.10	–	–	1.58
1880.00	CDMA	20.00	141.90	–	–	1.01
2450.00	CW	20.00	143.00	131.80	8.50	–
2450.00	AM80%	20.00	89.80	–	–	1.59
2450.00	DSSS	20.00	322.80	–	–	0.44

f(MHz)	Signal Type	Pulse Average Power (dBm)	Measurement H-field (A/m)	Target H-Field (A/m)	Deviation %	Mod. Factor Ration
835.00	CW	20.00	0.464	0.451	2.88	–
835.00	AM80%	20.00	0.300	–	–	1.55
835.00	CDMA	20.00	0.460	–	–	1.01
1880.00	CW	20.00	0.464	0.455	1.98	–
1880.00	AM80%	20.00	0.291	–	–	1.59
1880.00	CDMA	20.00	0.462	–	–	1.00
2450.00	CW	20.00	0.486	0.469	3.62	–
2450.00	AM80%	20.00	0.342	–	–	1.42
2450.00	DSSS	20.00	1.080	–	–	0.45

Note:

1. Modulation Factor = Measured E/H Field (CW) / Measured E/H Field (Modulation)
2. The HAC measurement of peak V/m or A/m should be calculation by formula or insert crest factor in the day4 software.
3. Peak(dB V/m or dB A/m) = 20 x log(Reading [time averaging V/m or A/m] x Probe Modulation Factor)



9.3 EUT TUNE-UP PROCEDURES

The following procedures had been used to prepare the EUT for the SAR test.

- To setup the desire channel frequency and the maximum output power. A Radio Communication Tester “Agilent, model: E5515C (8960 SERIES 10)” was used to program the EUT.

Operation Mode: Active Cell

System Mode: IS-2000

Call Parm	Cell band	
	US Cellular	US PCS
Channel	1013 / 384 / 777	25 / 600 / 1175
Protocol Rev	6 (IS-2000-0)	6 (IS-2000-0)
Radio Config	(Fwd3, Rvs3), S055 (Loopback)	(Fwd3, Rvs3), S055 (Loopback)
Rvs Power Ctrl	All Up Bits	All Up Bits
Power Ctrl Size	1.0 dBm	1.0 dBm
Call Drop Timer	Off	Off
Call Limit Mode	Off	Off
Traffic Dada Rate	Full	Full
Revr Power Ctrl	Manual	Manual
Meas Frequency	Auto	Auto
Voice SO Mode	Voice Echo	Voice Echo
Echo Delay	Medium	Medium

Measurement Conducted output power:

Channel	f(MHz)	Average Power(dBm)
1013	824.70	24.35
384	836.52	24.25
777	848.31	24.30

Measurement Conducted output power:

Channel	f(MHz)	Average Power(dBm)
25	1851.25	24.20
600	1880.00	24.12
1175	1908.75	24.30

The following procedures has been used to prepare the Wifi(802.11b) and Bluetooth for the HAC collocation test.

- The client supplied a special driving program to control the EUT to continually transmit the specified maximum power/

WiFi (802.11b):

Measurement Conducted output power:

Channel	f(MHz)	Average Power(dBm)
1	2412	14.12
6	2437	14.35
11	2462	14.20

Bluetooth:

Measurement Conducted output power:

Channel	f(MHz)	Average Power(dBm)
0	2402	0.35
39	2441	0.45
78	2480	0.47

- Maximum conducted power was measured by replacing the antenna with an adapter for conductive measurements, before and after the SAR measurements was done.



9.4 HAC MEASUREMENT RESULTS

1. Cellular phone E-Field Emission (Close slide cover mode):

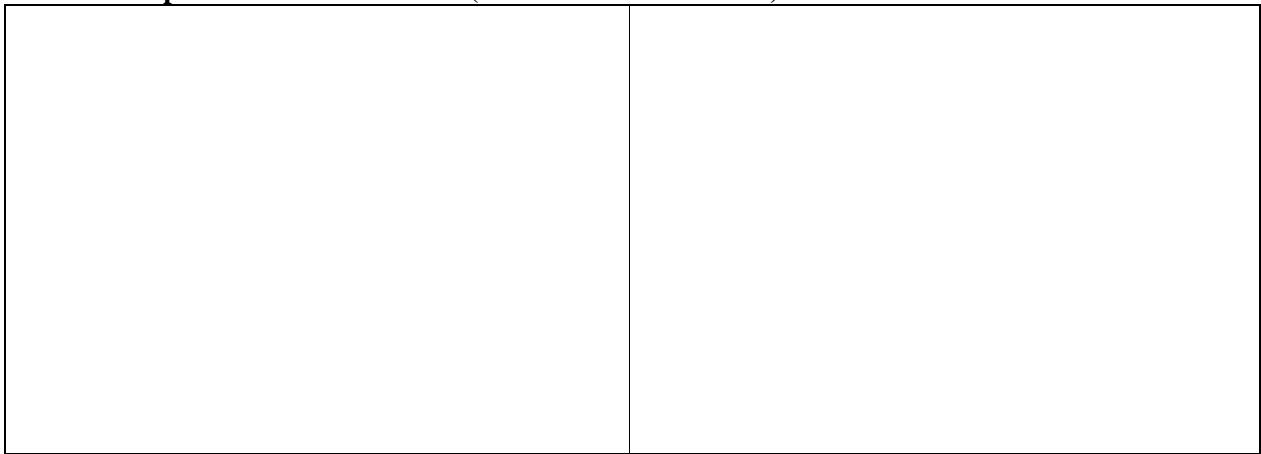

Note: Setup photo on this page have been extracted under a separate file.

CDMA Cellular Band Duty cycle:100%

Mode	Channel 1	Antenna	Backlight	Peak Field (V/m)	Peak Filed (dB V/m)	Power drift (dB)	Extrapolate Field (dB V/m)	Limit (dB V/m)	Margin (dB)	M-Rating Category Result
CDMA	1013	Fixed	OFF	84.5	38.54	0.062	38.60	41	-2.40	M3
CDMA	384	Fixed	OFF	87.6	38.85	0.079	38.93	41	-2.07	M3
CDMA	777	Fixed	OFF	87.3	38.82	0.110	38.93	41	-2.07	M3

CDMA Cellular Band with WiFi and Bluetooth(colocation test) Duty cycle:100%

Mode	Channel 1	Antenna	Backlight	Peak Field (V/m)	Peak Filed (dB V/m)	Power drift (dB)	Extrapolate Field (dB V/m)	Limit (dB V/m)	Margin (dB)	M-Rating Category Result
CDMA	1013	Fixed	OFF	86.2	38.71	0.130	38.84	41	-2.16	M3
CDMA	384	Fixed	OFF	89.7	39.06	0.180	39.24	41	-1.76	M3
CDMA	777	Fixed	OFF	87.5	38.84	0.108	38.95	41	-2.05	M3

CDMA PCS Band Duty cycle:100%

Mode	Channel 1	Antenna	Backlight	Peak Field (V/m)	Peak Filed (dB V/m)	Power drift (dB)	Extrapolate Field (dB V/m)	Limit (dB V/m)	Margin (dB)	M-Rating Category Result
CDMA	25	Fixed	OFF	56.9	35.10	0.031	35.13	41	-5.87	M4
CDMA	600	Fixed	OFF	53.7	34.60	0.002	34.60	41	-6.40	M4
CDMA	1175	Fixed	OFF	52.9	34.47	0.020	34.49	41	-6.51	M4

CDMA PCS Band with WiFi and Bluetooth(colocation test) Duty cycle:100%

Mode	Channel 1	Antenna	Backlight	Peak Field (V/m)	Peak Filed (dB V/m)	Power drift (dB)	Extrapolate Field (dB V/m)	Limit (dB V/m)	Margin (dB)	M-Rating Category Result
CDMA	25	Fixed	OFF	55.8	34.93	0.150	35.08	41	-5.92	M4
CDMA	600	Fixed	OFF	56.1	34.98	0.069	35.05	41	-5.95	M4
CDMA	1175	Fixed	OFF	54.8	34.78	0.052	34.83	41	-6.17	M4

Note:

- The extrapolate field value have including power drift value for worst case HAC test result.



2. Cellular phone E-Field Emission(Open slide cover mode):

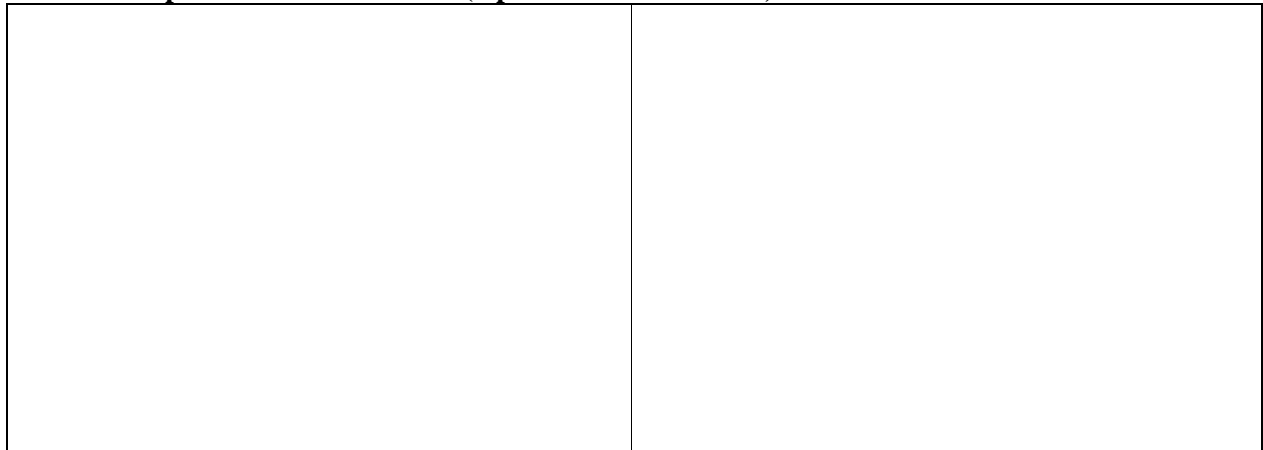

Note: Setup photo on this page have been extracted under a separate file.

CDMA Cellular Band Duty cycle:100%

Mode	Channel	Antenna	Backlight	Peak Field (V/m)	Peak Filed (dB V/m)	Power drift (dB)	Extrapolate Field (dB V/m)	Limit (dB V/m)	Margin (dB)	M-Rating Category Result
CDMA	1013	Fixed	OFF	94.9	39.55	0.038	39.58	41	-1.42	M3
CDMA	384	Fixed	OFF	93.3	39.40	0.081	39.48	41	-1.52	M3
CDMA	777	Fixed	OFF	92.1	39.29	0.043	39.33	41	-1.67	M3

CDMA Cellular Band with WiFi and Bluetooth(colocation test) Duty cycle:100%

Mode	Channel	Antenna	Backlight	Peak Field (V/m)	Peak Filed (dB V/m)	Power drift (dB)	Extrapolate Field (dB V/m)	Limit (dB V/m)	Margin (dB)	M-Rating Category Result
CDMA	1013	Fixed	OFF	97.0	39.74	0.140	39.88	41	-1.12	M3
CDMA	384	Fixed	OFF	96.4	39.68	0.013	39.69	41	-1.31	M3
CDMA	777	Fixed	OFF	98.4	39.86	0.079	39.94	41	-1.06	M3
CDMA	777	Fixed	ON	94.1	39.47	0.220	39.69	41	-1.31	M3

CDMA PCS Band Duty cycle:100%

Mode	Channel	Antenna	Backlight	Peak Field (V/m)	Peak Filed (dB V/m)	Power drift (dB)	Extrapolate Field (dB V/m)	Limit (dB V/m)	Margin (dB)	M-Rating Category Result
CDMA	25	Fixed	OFF	34.5	30.76	0.015	30.77	41	-10.23	M4
CDMA	600	Fixed	OFF	35.9	31.10	0.200	31.30	41	-9.70	M4
CDMA	1175	Fixed	OFF	36.8	31.32	0.159	31.48	41	-9.52	M4

CDMA PCS Band with WiFi and Bluetooth(colocation test) Duty cycle:100%

Mode	Channel	Antenna	Backlight	Peak Field (V/m)	Peak Filed (dB V/m)	Power drift (dB)	Extrapolate Field (dB V/m)	Limit (dB V/m)	Margin (dB)	M-Rating Category Result
CDMA	25	Fixed	OFF	36.7	31.29	0.108	31.40	41	-9.60	M4
CDMA	600	Fixed	OFF	36.7	31.29	0.194	31.49	41	-9.51	M4

Note:

- The extrapolate field value have including power drift value for worst case HAC test result.



3. Pocket PC phone E-Field Emission(Close slide cover mode):

--	--

Note: Setup photo on this page have been extracted under a separate file.

2.4GHz DSSS Duty cycle:100%

Rate (Mbps)	Channel	Antenna	Backlight	Peak Field (V/m)	Peak Filed (dB V/m)	Power drift (dB)	Extrapolate Field (dB V/m)	Limit (dB V/m)	Margin (dB)	M-Rating Category Result
1	1	Fixed	OFF	7.75	17.79	0.145	17.93	41	-23.07	M4
1	6	Fixed	OFF	8.53	18.62	0.124	18.74	41	-22.26	M4
1	11	Fixed	OFF	8.83	18.92	0.033	18.95	41	-22.05	M4

2.4GHz DSSS with Bluetooth(colocation test) Duty cycle:100%

Rate	Channel	Antenna	Backlight	Peak Field (V/m)	Peak Filed (dB V/m)	Power drift (dB)	Extrapolate Field (dB V/m)	Limit (dB V/m)	Margin (dB)	M-Rating Category Result
1	11	Fixed	OFF	8.67	18.76	0.140	18.90	41	-22.10	M4

Note:

1. The extrapolate field value have including power drift value for worst case HAC test result.



4. Pocket PC phone E-Field Emission(Open slide cover mode):

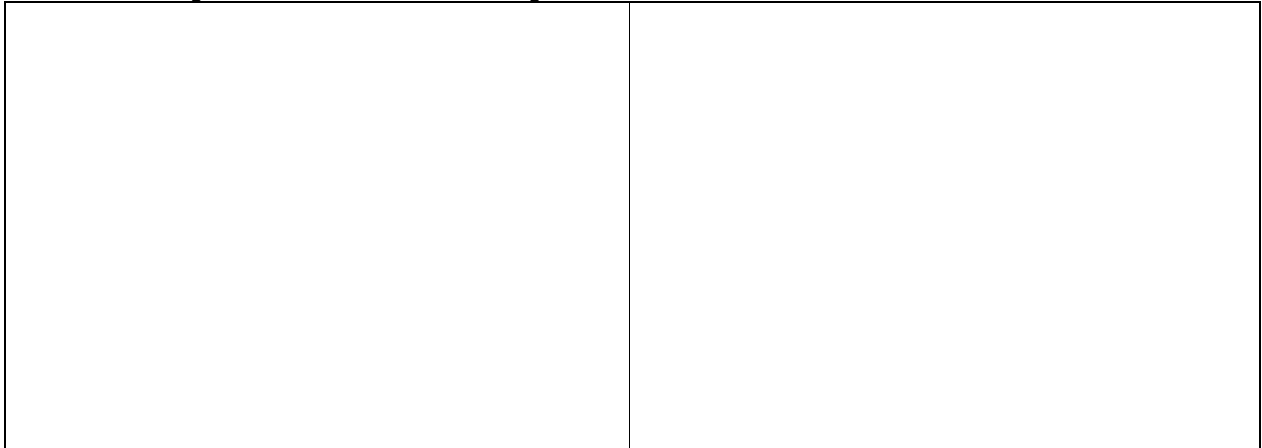

Note: Setup photo on this page have been extracted under a separate file.

2.4GHz DSSS Duty cycle:100%

Rate (Mbps)	Channel	Antenna	Backlight	Peak Field (V/m)	Peak Filed (dB V/m)	Power drift (dB)	Extrapolate Field (dB V/m)	Limit (dB V/m)	Margin (dB)	M-Rating Category Result
1	1	Fixed	OFF	7.67	17.70	0.006	17.70	41	-23.30	M4
1	6	Fixed	OFF	8.39	18.48	0.009	18.48	41	-22.52	M4
1	11	Fixed	OFF	8.94	19.03	0.008	19.03	41	-21.97	M4

2.4GHz DSSS with Bluetooth(colocation test) Duty cycle:100%

Rate	Channel	Antenna	Backlight	Peak Field (V/m)	Peak Filed (dB V/m)	Power drift (dB)	Extrapolate Field (dB V/m)	Limit (dB V/m)	Margin (dB)	M-Rating Category Result
1	11	Fixed	OFF	8.96	19.05	0.087	19.13	41	-21.87	M4
1	11	Fixed	ON	8.94	19.03	0.031	19.06	41	-21.94	M4

Note:

1. The extrapolate field value have including power drift value for worst case HAC test result.



5. Cellular phone H-Field Emissions (Close slide cover mode):

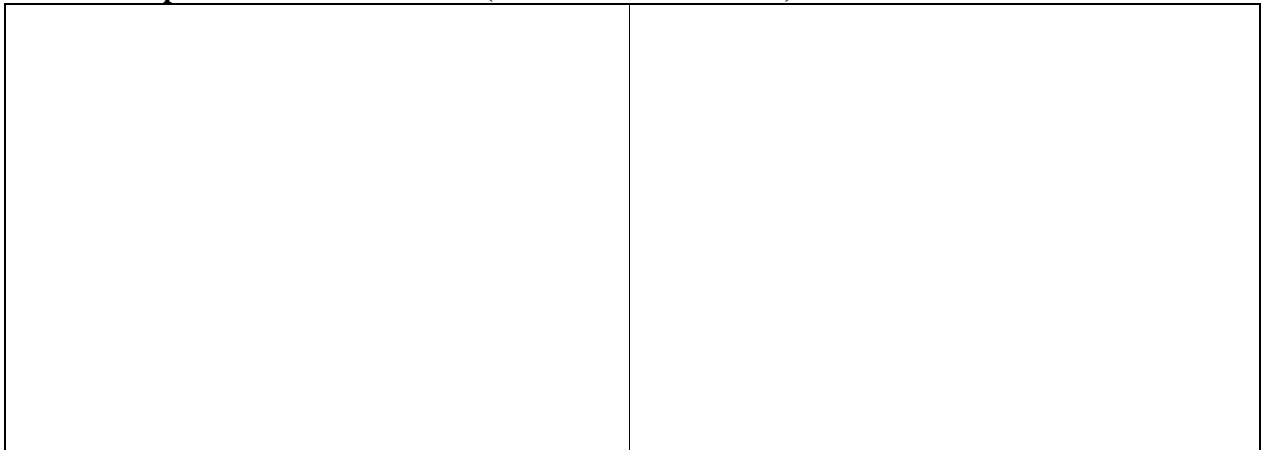

Note: Setup photo on this page have been extracted under a separate file.

CDMA Cellular Band Duty cycle:100%

Mode	Channel	Antenna	Backlight	Peak Field (A/m)	Peak Filed (dB A/m)	Power drift (dB)	Extrapolate Field (dB A/m)	Limit (dB A/m)	Margin (dB)	M-Rating Category Result
CDMA	1013	Fixed	OFF	0.165	-15.65	0.153	-15.50	-9.4	-6.10	M4
CDMA	384	Fixed	OFF	0.166	-15.60	0.085	-15.51	-9.4	-6.11	M4
CDMA	777	Fixed	OFF	0.163	-15.76	0.041	-15.72	-9.4	-6.32	M4

CDMA Cellular Band with WiFi and Bluetooth(colocation test) Duty cycle:100%

Mode	Channel	Antenna	Backlight	Peak Field (A/m)	Peak Filed (dB A/m)	Power drift (dB)	Extrapolate Field (dB A/m)	Limit (dB A/m)	Margin (dB)	M-Rating Category Result
CDMA	1013	Fixed	OFF	0.216	-13.31	0.100	-13.21	-9.4	-3.81	M3
CDMA	384	Fixed	OFF	0.218	-13.23	0.037	-13.19	-9.4	-3.79	M3
CDMA	777	Fixed	OFF	0.214	-13.39	0.098	-13.29	-9.4	-3.89	M3

CDMA PCS Band Duty cycle:100%

Mode	Channel	Antenna	Backlight	Peak Field (A/m)	Peak Filed (dB A/m)	Power drift (dB)	Extrapolate Field (dB A/m)	Limit (dB A/m)	Margin (dB)	M-Rating Category Result
CDMA	25	Fixed	OFF	0.176	-15.09	0.165	-14.92	-9.4	-5.52	M4
CDMA	600	Fixed	OFF	0.156	-16.14	0.138	-16.00	-9.4	-6.60	M4
CDMA	1175	Fixed	OFF	0.155	-16.19	0.082	-16.11	-9.4	-6.71	M4

CDMA PCS Band with WiFi and Bluetooth(colocation test) Duty cycle:100%

Mode	Channel	Antenna	Backlight	Peak Field (A/m)	Peak Filed (dB A/m)	Power drift (dB)	Extrapolate Field (dB A/m)	Limit (dB A/m)	Margin (dB)	M-Rating Category Result
CDMA	25	Fixed	OFF	0.179	-14.94	0.062	-14.88	-9.4	-5.48	M4
CDMA	600	Fixed	OFF	0.168	-15.49	0.107	-15.39	-9.4	-5.99	M4
CDMA	1175	Fixed	OFF	0.169	-15.44	0.065	-15.38	-9.4	-5.98	M4

Note:

- The extrapolate field value have including power drift value for worst case HAC test result.



6. Cellular phone H-Field Emissions (Open slide cover mode):

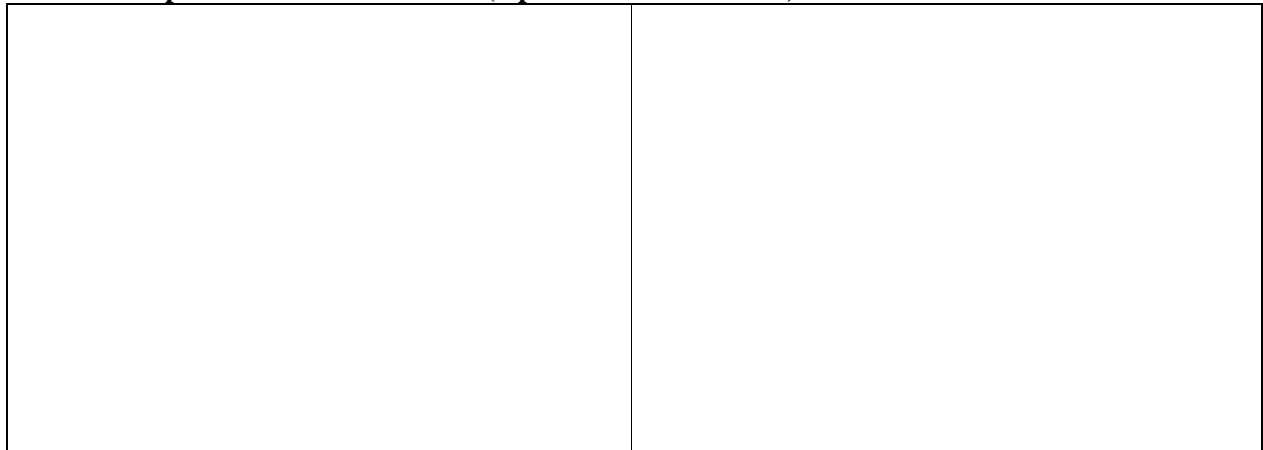

Note: Setup photo on this page have been extracted under a separate file.

CDMA Cellular Band Duty cycle:100%

Mode	Channel	Antenna	Backlight	Peak Field (A/m)	Peak Filed (dB A/m)	Power drift (dB)	Extrapolate Field (dB A/m)	Limit (dB A/m)	Margin (dB)	M-Rating Category Result
CDMA	1013	Fixed	OFF	0.159	-15.97	0.003	-15.97	-9.4	-6.57	M4
CDMA	384	Fixed	OFF	0.160	-15.92	0.166	-15.75	-9.4	-6.35	M4
CDMA	777	Fixed	OFF	0.154	-16.25	0.231	-16.02	-9.4	-6.62	M4

CDMA Cellular Band with WiFi and Bluetooth(colocation test) Duty cycle:100%

Mode	Channel	Antenna	Backlight	Peak Field (A/m)	Peak Filed (dB A/m)	Power drift (dB)	Extrapolate Field (dB A/m)	Limit (dB A/m)	Margin (dB)	M-Rating Category Result
CDMA	1013	Fixed	OFF	0.232	-12.69	0.125	-12.57	-9.4	-3.17	M3
CDMA	384	Fixed	OFF	0.229	-12.80	0.048	-12.76	-9.4	-3.36	M3
CDMA	777	Fixed	OFF	0.224	-13.00	0.074	-12.92	-9.4	-3.52	M3

CDMA PCS Band Duty cycle:100%

Mode	Channel	Antenna	Backlight	Peak Field (A/m)	Peak Filed (dB A/m)	Power drift (dB)	Extrapolate Field (dB A/m)	Limit (dB A/m)	Margin (dB)	M-Rating Category Result
CDMA	25	Fixed	OFF	0.110	-19.17	0.219	-18.95	-9.4	-9.55	M4
CDMA	600	Fixed	OFF	0.107	-19.41	0.209	-19.20	-9.4	-9.80	M4
CDMA	1175	Fixed	OFF	0.098	-20.18	0.155	-20.02	-9.4	-10.62	M4

CDMA PCS Band with WiFi and Bluetooth(colocation test) Duty cycle:100%

Mode	Channel	Antenna	Backlight	Peak Field (A/m)	Peak Filed (dB A/m)	Power drift (dB)	Extrapolate Field (dB A/m)	Limit (dB A/m)	Margin (dB)	M-Rating Category Result
CDMA	25	Fixed	OFF	0.129	-17.79	0.047	-17.74	-9.4	-8.34	M4
CDMA	600	Fixed	OFF	0.130	-17.72	0.011	-17.71	-9.4	-8.31	M4
CDMA	1175	Fixed	OFF	0.133	-17.52	0.071	-17.45	-9.4	-8.05	M4

Note:

1. The extrapolate field value have including power drift value for worst case HAC test result.



7. Pocket PC phone H-Field Emissions (Close slide cover mode):

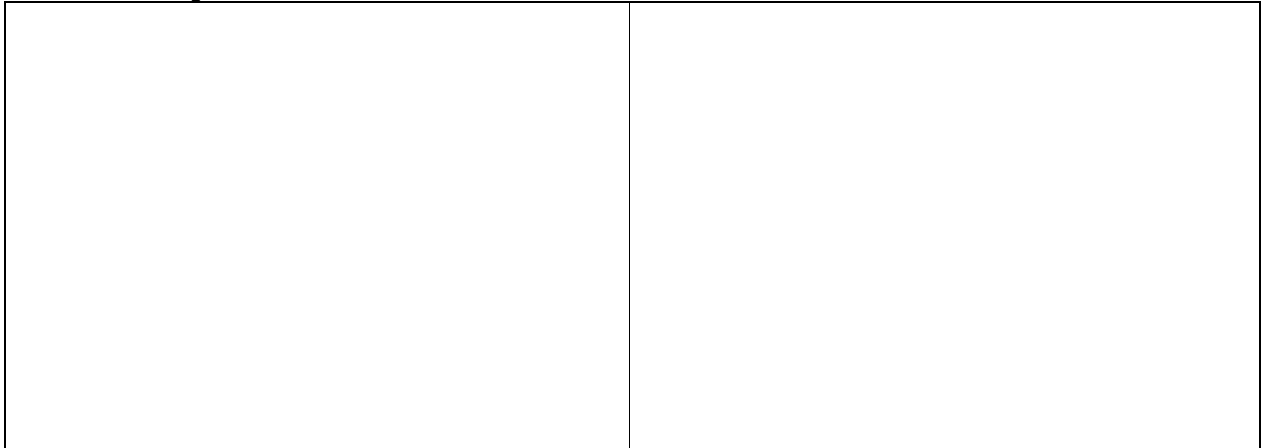

Note: Setup photo on this page have been extracted under a separate file.

2.4GHz DSSS Duty cycle:100%

Rate (Mbps)	Channel	Antenna	Backlight	Peak Field (A/m)	Peak Filed (dB A/m)	Power drift (dB)	Extrapolate Field (dB A/m)	Limit (dB A/m)	Margin (dB)	M-Rating Category Result
1	1	Fixed	OFF	0.019	-34.42	0.078	-34.35	-9.4	-24.95	M4
1	6	Fixed	OFF	0.019	-34.42	0.129	-34.30	-9.4	-24.90	M4
1	11	Fixed	OFF	0.020	-33.98	0.054	-33.93	-9.4	-24.53	M4

2.4GHz DSSS with Bluetooth(colocation test) Duty cycle:100%

Rate	Channel	Antenna	Backlight	Peak Field (A/m)	Peak Filed (dB A/m)	Power drift (dB)	Extrapolate Field (dB A/m)	Limit (dB A/m)	Margin (dB)	M-Rating Category Result
1	11	Fixed	OFF	0.02	-34.42	0.175	-34.25	-9.4	-24.85	M4

Note:

- The extrapolate field value have including power drift value for worst case HAC test result.



8. Pocket PC phone H-Field Emissions (Open slide cover mode):

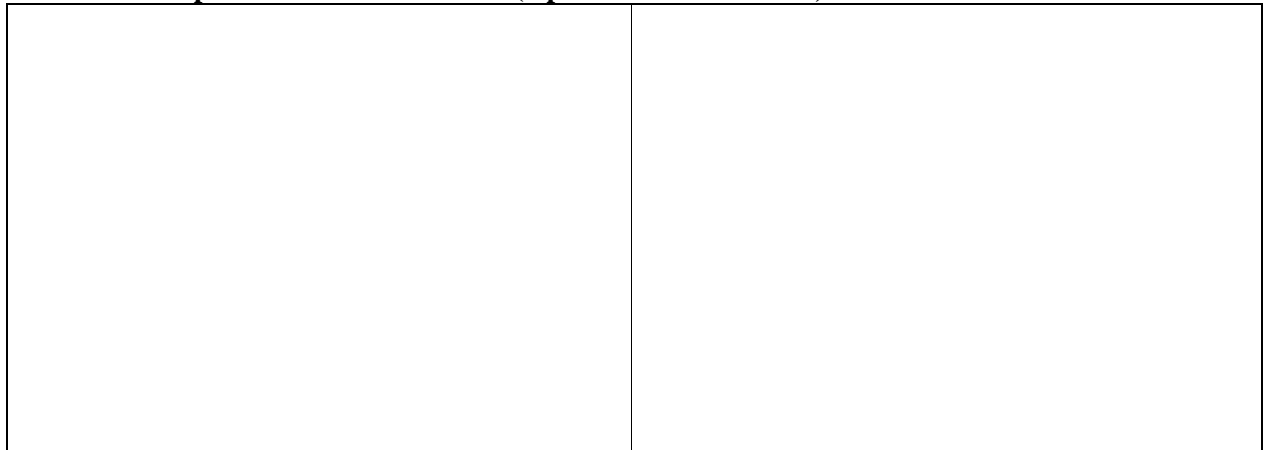

Note: Setup photo on this page have been extracted under a separate file.

2.4GHz DSSS Duty cycle:100%

Rate (Mbps)	Channel	Antenna	Backlight	Peak Field (A/m)	Peak Filed (dB A/m)	Power drift (dB)	Extrapolate Field (dB A/m)	Limit (dB A/m)	Margin (dB)	M-Rating Category Result
1	1	Fixed	OFF	0.022	-33.15	0.012	-33.14	-9.4	-23.74	M4
1	6	Fixed	OFF	0.024	-32.40	0.007	-32.39	-9.4	-22.99	M4
1	11	Fixed	OFF	0.026	-31.70	0.023	-31.68	-9.4	-22.28	M4

2.4GHz DSSS with Bluetooth(colocation test) Duty cycle:100%

Rate	Channel	Antenna	Backlight	Peak Field (A/m)	Peak Filed (dB A/m)	Power drift (dB)	Extrapolate Field (dB A/m)	Limit (dB A/m)	Margin (dB)	M-Rating Category Result
1	11	Fixed	OFF	0.03	-31.70	0.065	-31.64	-9.4	-22.24	M4

Note:

1. The extrapolate field value have including power drift value for worst case HAC test result.



10.EUT PHOTOS

Note: EUT photo on this page have been extracted under a separate file.



11.EQUIPMENT LIST & CALIBRATION STATUS

Name of Equipment	Manufacturer	Type/Model	Serial Number	Calibration Cycle(days)	Calibration Due
Power Meter	Agilent	E4416A	GB41291611	365	24/05/06
Power Sensor	Agilent	E9327A	US40441097	365	24/05/06
Thermometer	Amarell	4046	25060	3650	10/02/14
Thermometer	Amarell	4046	25058	3650	10/02/14
Wireless Communication Test Set	Agilent	E5515C	GB44051665	365	05/24/06
Universal Radio Communication Tester	Rohde & Schwarz	CMU 200	1100.0008.02	N/A	N/A
Signal Generator	Agilent	83630B	3844A01022	365	01/14/06
Signal Generator	Agilent	E8257C	US42340383	365	08/01/06
Spectrum Analyzer	Agilent	E4446A	US42510268	365	09/19/05
Spectrum Analyzer	Rohde & Schwarz	FSEK30	1088.3494.35	365	02/15/06
Amplifier	Mini-Circuit	ZVE-8G	N/A	N/A	N/A
Amplifier	Mini-Circuit	ZHL-1724HLN	N/A	N/A	N/A
DC Power generator	ABM	8301HD	N/A	N/A	N/A
Data Acquisition Electronics (DAE)	SPEAG	DAE3	558	365	08/24/05
Data Acquisition Electronics (DAE)	SPEAG	DAE3	427	365	09/22/06
E-Field Probe	SPEAG	ER3DV6	2345	365	06/03/06
H-Field Probe	SPEAG	H3DV6	6163	365	04/27/06
835 MHz System Validation Dipole	SPEAG	CD835V3	1031	730	04/27/06
1880 MHz System Validation Dipole	SPEAG	CD1880V3	1024	730	06/02/06
2450 MHz System Validation Dipole	SPEAG	CD2450V3	1026	730	04/29/06
Probe Alignment Unit	SPEAG	LB (V2)	348	N/A	N/A
Robot	Staubli	RX90B L	F02/5T69A1/A/01	N/A	N/A
HAC Test Arch	SPEAG	SD HAC P01 BA	1027	N/A	N/A
Devices Holder	SPEAG	N/A	N/A	N/A	N/A



12.LOCATION OF TEST SITE

All measurement facilities used to collect the measurement data are located at

- No. 81-1, Lane 210, Bade Rd. 2, Luchu Hsiang, Taoyuan Hsien, Taiwan, R.O.C.
- No. 11, Wu-Kung 6 Rd, Wu-Ku Hsiang, Wu-Ku Industrial District, Taipei Hsien, (248) Taiwan.
- No. 199, Chunghsen Road, Hsintien City, Taipei Hsien, Taiwan, R.O.C.

13.ATTACHMENTS

No.	Contents	No. of page (s)
1	System Check Plot	32
2	HAC Test Plot	101
3	Certificate of E-filed Probe ER3DV6 SN:2345	9
4	Certificate of H-filed Probe H3DV6 SN:6163	8
5	Certificate of System Validation Dipole CD835V3 SN:1031	6
6	Certificate of System Validation Dipole CD1880V3 SN:1024	6
7	Certificate of System Validation Dipole CD2450V3 SN:1026	6

END OF REPORT