



FCC TEST REPORT (WIRELESS LAN)

REPORT NO.: RF960503L06-2

MODEL NO.: IRIS100

RECEIVED: May 03, 2007

TESTED: May 03 ~ May 11, 2007

ISSUED: May 22, 2007

APPLICANT: High Tech Computer Corp.

ADDRESS: 23, Hsin-Hua Rd., Taoyuan, 330, Taiwan, R.O.C.

ISSUED BY: Advance Data Technology Corporation

LAB ADDRESS: No. 47, 14th Ling, Chia Pau Tsuen, Lin Kou Hsiang
244, Taipei Hsien, Taiwan, R.O.C.

TEST LOCATION: No. 19, Hwa Ya 2nd Rd., Wen Hwa Tsuen, Kwei
Shan Hsiang, Taoyuan Hsien 333, Taiwan, R.O.C.

This test report consists of 73 pages in total. It may be duplicated completely for legal use with the approval of the applicant. It should not be reproduced except in full, without the written approval of our laboratory. The client should not use it to claim product endorsement by CNLA, A2LA or any government agencies. The test results in the report only apply to the tested sample.





TABLE OF CONTENTS

1.	CERTIFICATION	4
2.	SUMMARY OF TEST RESULTS.....	5
2.1	MEASUREMENT UNCERTAINTY	5
3.	GENERAL INFORMATION	6
3.1	GENERAL DESCRIPTION OF EUT	6
3.2	DESCRIPTION OF TEST MODES	8
3.2.1	CONFIGURATION OF SYSTEM UNDER TEST	8
3.2.2	TEST MODE APPLICABILITY AND TESTED CHANNEL DETAIL	9
3.3.3	GENERAL DESCRIPTION OF APPLIED STANDARDS	11
3.3.4	DESCRIPTION OF SUPPORT UNITS.....	11
4.	TEST TYPES AND RESULTS.....	12
4.1	CONDUCTED EMISSION MEASUREMENT.....	12
4.1.1	LIMITS OF CONDUCTED EMISSION MEASUREMENT	12
4.1.2	TEST INSTRUMENTS	12
4.1.3	TEST PROCEDURES	13
4.1.4	DEVIATION FROM TEST STANDARD	13
4.1.5	TEST SETUP	14
4.1.6	EUT OPERATING CONDITIONS.....	14
4.1.7	TEST RESULTS	15
4.2	RADIATED EMISSION MEASUREMENT.....	33
4.2.1	LIMITS OF RADIATED EMISSION MEASUREMENT	33
4.2.2	TEST INSTRUMENTS	34
4.2.3	TEST PROCEDURES	35
4.2.4	DEVIATION FROM TEST STANDARD	35
4.2.5	TEST SETUP	36
4.2.6	EUT OPERATING CONDITIONS.....	36
4.2.7	TEST RESULTS	37
4.3	6dB BANDWIDTH MEASUREMENT	46
4.3.1	LIMITS OF 6dB BANDWIDTH MEASUREMENT	46
4.3.2	TEST INSTRUMENTS	46
4.3.3	TEST PROCEDURE	46
4.3.4	DEVIATION FROM TEST STANDARD	46
4.3.5	TEST SETUP	47
4.3.6	EUT OPERATING CONDITIONS.....	47
4.3.7	TEST RESULTS	48
4.4	MAXIMUM PEAK OUTPUT POWER.....	52
4.4.1	LIMITS OF MAXIMUM PEAK OUTPUT POWER MEASUREMENT	52
4.4.2	TEST INSTRUMENTS	52
4.4.3	TEST PROCEDURES	53
4.4.4	DEVIATION FROM TEST STANDARD	53
4.4.5	TEST SETUP	53
4.4.6	EUT OPERATING CONDITIONS.....	53
4.4.7	TEST RESULTS	54
4.5	POWER SPECTRAL DENSITY MEASUREMENT	55



4.5.1	LIMITS OF POWER SPECTRAL DENSITY MEASUREMENT	55
4.5.2	TEST INSTRUMENTS	55
4.5.3	TEST PROCEDURE	55
4.5.4	DEVIATION FROM TEST STANDARD	55
4.5.5	TEST SETUP	56
4.5.6	EUT OPERATING CONDITION	56
4.5.7	TEST RESULTS	57
4.6	BAND EDGES MEASUREMENT.....	61
4.6.1	LIMITS OF BAND EDGES MEASUREMENT	61
4.6.2	TEST INSTRUMENTS	61
4.6.3	TEST PROCEDURE	61
4.6.4	DEVIATION FROM TEST STANDARD	61
4.6.5	EUT OPERATING CONDITION	61
4.6.6	TEST RESULTS	62
4.7	ANTENNA REQUIREMENT	70
4.7.1	STANDARD APPLICABLE	70
4.7.2	ANTENNA CONNECTED CONSTRUCTION	70
5.	PHOTOGRAPHS OF THE TEST CONFIGURATION	71
6.	INFORMATION ON THE TESTING LABORATORIES	72
	APPENDIX-A.....	A-1



1. CERTIFICATION

PRODUCT: Smart Phone

MODEL: IRIS100

APPLICANT: High Tech Computer Corp.

TESTED: May 03 ~ May 11, 2007

TEST SAMPLE: ENGINEERING SAMPLE

STANDARDS: FCC Part 15, Subpart C (Section 15.247)

ANSI C63.4-2003

The above equipment (model: IRIS100) have been tested by **Advance Data Technology Corporation**, and found compliance with the requirement of the above standards. The test record, data evaluation & Equipment Under Test (EUT) configurations represented herein are true and accurate accounts of the measurements of the sample's EMC characteristics under the conditions specified in this report.

PREPARED BY : Wendy Liao , **DATE:** May 22, 2007
(Wendy Liao)

TECHNICAL ACCEPTANCE : Long Chen , **DATE:** May 22, 2007
Responsible for RF (Long Chen)

APPROVED BY : Gary Chang , **DATE:** May 22, 2007
(Gary Chang / Supervisor)

2. SUMMARY OF TEST RESULTS

The EUT has been tested according to the following specifications:

APPLIED STANDARD: FCC Part 15, Subpart C			
STANDARD SECTION	TEST TYPE AND LIMIT	RESULT	REMARK
15.207	AC Power Conducted Emission	PASS	Meet the requirement of limit. Minimum passing margin is -12.55dB at 2.316MHz.
15.247(a)(2)	Spectrum Bandwidth of a Direct Sequence Spread Spectrum System Limit: min. 500kHz	PASS	Meet the requirement of limit
15.247(b)	Maximum Peak Output Power Limit: max. 30dBm	PASS	Meet the requirement of limit
15.247(d)	Radiated Emissions Limit: Table 15.209	PASS	Meet the requirement of limit. Minimum passing margin is -1.22dB at 2390.00MHz.
15.247(e)	Power Spectral Density Limit: max. 8dBm	PASS	Meet the requirement of limit
15.247(d)	Band Edge Measurement Limit: 20dB less than the peak value of fundamental frequency	PASS	Meet the requirement of limit

2.1 MEASUREMENT UNCERTAINTY

Where relevant, the following measurement uncertainty levels have been estimated for tests performed on the EUT as specified in CISPR 16-4-2:

MEASUREMENT	FREQUENCY	UNCERTAINTY
Conducted emissions	9kHz~30MHz	2.44 dB
Radiated emissions	30MHz ~ 200MHz	3.62 dB
	200MHz ~1000MHz	3.64 dB
	1GHz ~ 18GHz	2.26 dB
	18GHz ~ 40GHz	1.94 dB

This uncertainty represents an expanded uncertainty expressed at approximately the 95% confidence level using a coverage factor of k=2.



3. GENERAL INFORMATION

3.1 GENERAL DESCRIPTION OF EUT

PRODUCT	Smart Phone
MODEL NO.	IRIS100
FCC ID	NM8IRIS100
POWER SUPPLY	3.7Vdc from rechargeable lithium battery 5.0Vdc from power adapter 5.0Vdc from host equipment
MODULATION TYPE	CCK, DQPSK, DBPSK for DSSS 64QAM, 16QAM, QPSK, BPSK for OFDM Bluetooth: GFSK for FHSS
MODULATION TECHNOLOGY	DSSS, OFDM, FHSS
TRANSFER RATE	Wireless LAN: 802.11b:11/5.5/2/1Mbps 802.11g: 54/48/36/24/18/12/9/6Mbps Bluetooth: 1Mbps
FREQUENCY RANGE	Wireless LAN: 802.11b & 802.11g: 2.412 ~ 2.462GHz Bluetooth: 2.402 ~ 2.480GHz
NUMBER OF CHANNEL	Wireless LAN: 802.11b & 802.11g: 11 Bluetooth: 79
OUTPUT POWER	Wireless LAN: 79.799mW Bluetooth: 0.836mW
ANTENNA TYPE	PIFA antenna with 1dBi gain
DATA CABLE	1.8m USB shielded cable without core
I/O PORTS	Refer to user's manual
ASSOCIATED DEVICES	Adapter*2, Battery*2, Headset (USB connector and another is Audio connector)(1.7m), Pouch

NOTE:

1. The EUT is a CDMA850/CDMA1900/EVDO Smart Phone with wireless LAN and Bluetooth functions. This report is only covered the functions of wireless LAN. The Bluetooth and mobile phone function is covered in another three test reports, which standards used are FCC 15.247, FCC Part 22 and FCC Part 24 (Report No.: RF960503L06-3, RF960503L06 and RF960503L06-1).
2. The EUT have two lithium batteries listed as below:

STANDARD BATTERY 1:	
MANUFACTURER:	Dynapack International Technology Corporation
MODEL:	IRIS160
RATING:	3.7Vdc, 1200mAh

STANDARD BATTERY 2:	
MANUFACTURER:	Simplo Technology Co., Ltd.
MODEL:	IRIS160
RATING:	3.7Vdc, 1200mAh

**Battery 1 was the worst case for final test.

3. The EUT were operated with following power adapters:

ADAPTER 1:	
BRAND:	DELTA ELECTRONICS, INC.
MODEL:	ADP-5FH B
INPUT:	100-240Vac, 50-60Hz, 0.2A
OUTPUT:	5Vdc, 1A
POWER LINE:	1.8m non-shielded cable without core

ADAPTER 2:	
BRAND:	PHIHONG
MODEL:	PSAA05A-050
INPUT:	100-240Vac, 50-60Hz, 200mA
OUTPUT:	5.0Vdc, 1A
POWER LINE:	1.8m non-shielded cable without core

4. The EUT, operates in the 2.4GHz frequency range, lets you connect IEEE 802.11g or IEEE 802.11b devices to the network. With its high-speed data transmissions of up to 54Mbps.
5. The above EUT information was declared by manufacturer and for more detailed features description, please refer to the manufacturer's specifications or User's Manual.

3.2 DESCRIPTION OF TEST MODES

11 channels are provided to the EUT for wireless LAN function:

CHANNEL	FREQUENCY	CHANNEL	FREQUENCY
1	2412 MHz	7	2442 MHz
2	2417 MHz	8	2447 MHz
3	2422 MHz	9	2452 MHz
4	2427 MHz	10	2457 MHz
5	2432 MHz	11	2462 MHz
6	2437 MHz		

3.2.1 CONFIGURATION OF SYSTEM UNDER TEST

TEST MODE A & B

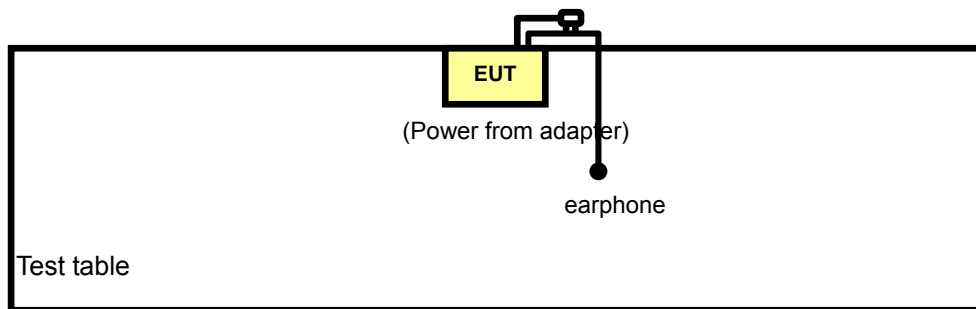

TEST MODE C

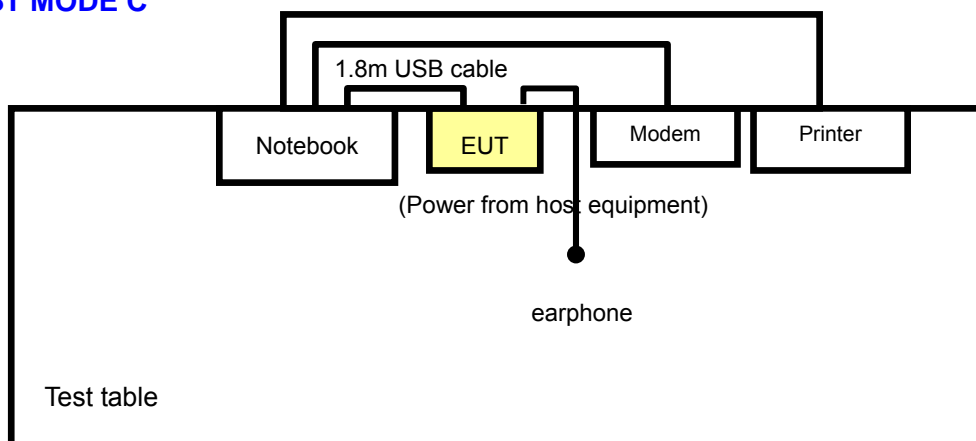

3.2.2 TEST MODE APPLICABILITY AND TESTED CHANNEL DETAIL

EUT CONFIGURE MODE	APPLICABLE TO				DESCRIPTION
	PLC	RE<1G	RE≥1G	APCM	
A	√	√	-	-	The EUT was powered by the adapter 1
B	√	√	-	-	The EUT was powered by the adapter 2
C	√	√	√	√	The EUT was powered from host equipment.

Where **PLC**: Power Line Conducted Emission

RE<1G: Radiated Emission below 1GHz

RE≥1G: Radiated Emission above 1GHz

APCM: Antenna Port Conducted Measurement

NOTE: “-“ means no effect.

POWER LINE CONDUCTED EMISSION TEST:

- Pre-Scan has been conducted to determine the worst-case mode from all possible combinations between available modulations, data rates and antenna ports (if EUT with antenna diversity architecture).
- Following channel(s) was (were) selected for the final test as listed below.

EUT CONFIGURE MODE	AVAILABLE CHANNEL	TESTED CHANNEL	MODULATION TECHNOLOGY	MODULATION TYPE	DATA RATE (Mbps)
A	1 to 11	1, 6, 11	OFDM	BPSK	6
B	1 to 11	1, 6, 11	OFDM	BPSK	6
C	1 to 11	1, 6, 11	OFDM	BPSK	6

RADIATED EMISSION TEST (BELOW 1 GHz):

- Pre-Scan has been conducted to determine the worst-case mode from all possible combinations between available modulations, data rates, antenna ports (if EUT with antenna diversity architecture) and X, Y and Z Axis.
- Following channel(s) was (were) selected for the final test as listed below.

EUT CONFIGURE MODE	AVAILABLE CHANNEL	TESTED CHANNEL	MODULATION TECHNOLOGY	MODULATION TYPE	DATA RATE (Mbps)	AXIS
A	1 to 11	11	OFDM	BPSK	6	X
B	1 to 11	11	OFDM	BPSK	6	X
C	1 to 11	11	OFDM	BPSK	6	X

RADIATED EMISSION TEST (ABOVE 1 GHz):

- Pre-Scan has been conducted to determine the worst-case mode from all possible combinations between available modulations, data rates, antenna ports (if EUT with antenna diversity architecture) and X, Y and Z Axis.
- Following channel(s) was (were) selected for the final test as listed below.

EUT CONFIGURE MODE	AVAILABLE CHANNEL	TESTED CHANNEL	MODULATION TECHNOLOGY	MODULATION TYPE	DATA RATE (Mbps)	AXIS
C	1 to 11	1, 6, 11	DSSS	DBPSK	1	X
C	1 to 11	1, 6, 11	OFDM	BPSK	6	X

BANDEDGE MEASUREMENT:

- Pre-Scan has been conducted to determine the worst-case mode from all possible combinations between available modulations, data rates and antenna ports (if EUT with antenna diversity architecture).
- Following channel(s) was (were) selected for the final test as listed below.

EUT CONFIGURE MODE	AVAILABLE CHANNEL	TESTED CHANNEL	MODULATION TECHNOLOGY	MODULATION TYPE	DATA RATE (Mbps)
C	1 to 11	1, 11	DSSS	DBPSK	1
C	1 to 11	1, 11	OFDM	BPSK	6

ANTENNA PORT CONDUCTED MEASUREMENT:

- Pre-Scan has been conducted to determine the worst-case mode from all possible combinations between available modulations, data rates and antenna ports (if EUT with antenna diversity architecture).
- Following channel(s) was (were) selected for the final test as listed below.

EUT CONFIGURE MODE	AVAILABLE CHANNEL	TESTED CHANNEL	MODULATION TECHNOLOGY	MODULATION TYPE	DATA RATE (Mbps)
C	1 to 11	1, 6, 11	DSSS	DBPSK	1
C	1 to 11	1, 6, 11	OFDM	BPSK	6



3.3.3 GENERAL DESCRIPTION OF APPLIED STANDARDS

The EUT is a RF Product. According to the specifications of the manufacturer, it must comply with the requirements of the following standards:

FCC Part 15, Subpart C. (15.247)

ANSI C63.4- 2003

All test items have been performed and recorded as per the above standards.

NOTE: The EUT is also considered as a kind of computer peripheral, because the connection to computer is necessary for typical use. It has been verified to comply with the requirements of FCC Part 15, Subpart B, Class B (DoC). The test report has been issued separately.

3.3.4 DESCRIPTION OF SUPPORT UNITS

The EUT has been tested as an independent unit together with other necessary accessories or support units. The following support units or accessories were used to form a representative test configuration during the tests.

NO.	PRODUCT	BRAND	MODEL NO.	SERIAL NO.	FCC ID
1	NOTEBOOK COMPUTER	DELL	PP05L	16484462992	E2K24CLNS
2	MODEM	ACEEX	1414V/3	0401008253	IFAXDM1414
3	PRINTER	EPSON	LQ-300+	DCGY054011	FCC DoC Approved

NO.	SIGNAL CABLE DESCRIPTION OF THE ABOVE SUPPORT UNITS
1	NA
2	1.2 m shielded cable
3	1.2m shielded cable

NOTE: All power cords of the above support units are non shielded (1.8m).

4. TEST TYPES AND RESULTS

4.1 CONDUCTED EMISSION MEASUREMENT

4.1.1 LIMITS OF CONDUCTED EMISSION MEASUREMENT

FREQUENCY OF EMISSION (MHz)	CONDUCTED LIMIT (dB μ V)	
	Quasi-peak	Average
0.15 ~ 0.5	66 to 56	56 to 46
0.5 ~ 5	56	46
5 ~ 30	60	50

- NOTE:**
1. The lower limit shall apply at the transition frequencies.
 2. The limit decreases in line with the logarithm of the frequency in the range of 0.15 to 0.50 MHz.
 3. All emanations from a class A/B digital device or system, including any network of conductors and apparatus connected thereto, shall not exceed the level of field strengths specified above.

4.1.2 TEST INSTRUMENTS

DESCRIPTION & MANUFACTURER	MODEL NO.	SERIAL NO.	CALIBRATED UNTIL
Test Receiver ROHDE & SCHWARZ	ESCS30	100288	Sep. 25, 2007
RF signal cable Woken	5D-FB	Cable-HYCO3-01	Jan. 06, 2008
LISN ROHDE & SCHWARZ	ESH2-Z5	100100	Jan. 08, 2008
LISN ROHDE & SCHWARZ	ESH3-Z5	100311	Jan. 16, 2008
Software ADT	ADT_Cond_V3	NA	NA

- NOTE:**
1. The calibration interval of the above test instruments is 12 months and the calibrations are traceable to NML/ROC and NIST/USA.
 2. The test was performed in HwaYa Shielded Room 2.
 3. The VCCI Site Registration No. is C-2047.

4.1.3 TEST PROCEDURES

- a. The EUT was placed 0.4 meters from the conducting wall of the shielded room with EUT being connected to the power mains through a line impedance stabilization network (LISN). Other support units were connected to the power mains through another LISN. The two LISNs provide 50 ohm/ 50uH of coupling impedance for the measuring instrument.
- b. Both lines of the power mains connected to the EUT were checked for maximum conducted interference.
- c. The frequency range from 150kHz to 30MHz was searched. Emission levels under (Limit - 20dB) was not recorded.

4.1.4 DEVIATION FROM TEST STANDARD

No deviation

4.1.5 TEST SETUP

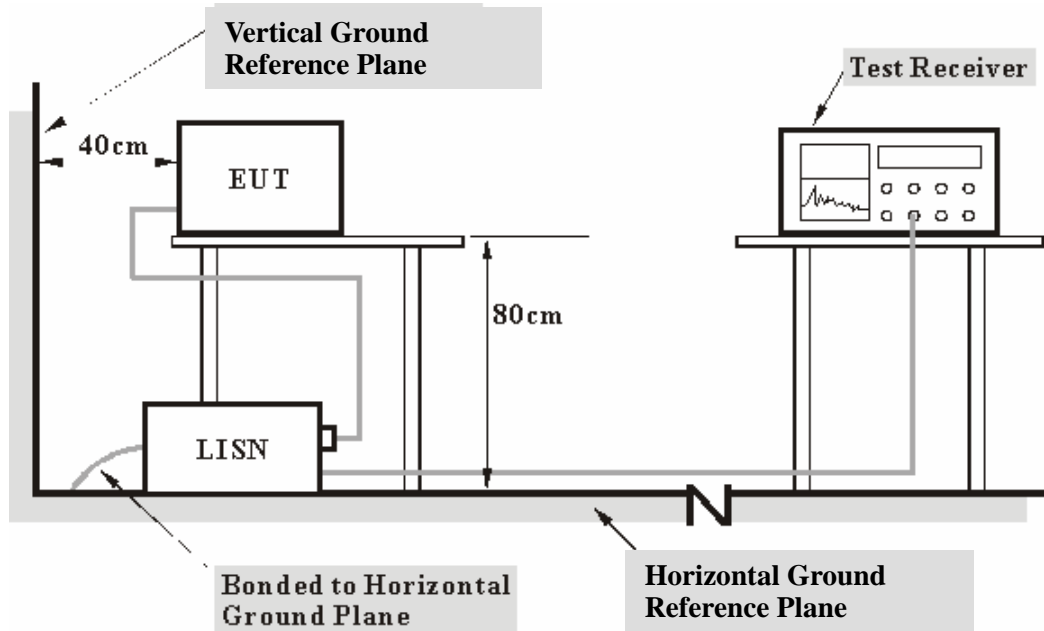

- Note:** 1. Support units were connected to second LISN.
 2. Both of LISNs (AMN) 80 cm from EUT and at the least 80 cm from other units and other metal planes support units.

For the actual test configuration, please refer to the attached file (Test Setup Photo).

4.1.6 EUT OPERATING CONDITIONS

TEST MODE A, B:

- Placed the EUT on a testing table.
- Set the EUT under transmission condition continuously at specific channel frequency.

TEST MODE C:

- Connected the EUT to notebook via USB cable and placed on a testing table.
- The notebook ran a test program (provided by manufacturer) to enable EUT under transmission condition continuously at specific channel frequency.
- The necessary accessories enable the system in full functions.

4.1.7 TEST RESULTS

CONDUCTED WORST CASE DATA FOR TEST MODE A

EUT TEST CONDITION		MEASUREMENT DETAIL	
CHANNEL	Channel 1	PHASE	Line 1
MODULATION TYPE	BPSK	6dB BANDWIDTH	9 kHz
ENVIRONMENTAL CONDITIONS	20deg. C, 60%RH, 991hPa	INPUT POWER (SYSTEM)	120Vac, 60 Hz
TRANSFER RATE	6Mbps	TESTED BY	Match Tsui

No	Freq. [MHz]	Corr. Factor [dB]	Reading Value [dB (uV)]		Emission Level [dB (uV)]		Limit [dB (uV)]		Margin (dB)	
			Q.P.	AV.	Q.P.	AV.	Q.P.	AV.	Q.P.	AV.
1	0.181	0.10	32.41	-	32.51	-	64.43	54.43	-31.92	-
2	0.486	0.10	30.60	-	30.70	-	56.24	46.24	-25.54	-
3	0.974	0.11	31.45	-	31.56	-	56.00	46.00	-24.44	-
4	2.563	0.24	33.46	-	33.70	-	56.00	46.00	-22.30	-
5	10.609	0.35	30.20	-	30.55	-	60.00	50.00	-29.45	-
6	18.352	0.54	31.79	-	32.33	-	60.00	50.00	-27.67	-

- REMARKS:**
1. Q.P. and AV. are abbreviations of quasi-peak and average individually.
 2. "-": The Quasi-peak reading value also meets average limit and measurement with the average detector is unnecessary.
 3. The emission levels of other frequencies were very low against the limit.
 4. Margin value = Emission level - Limit value
 5. Correction factor = Insertion loss + Cable loss
 6. Emission Level = Correction Factor + Reading Value.

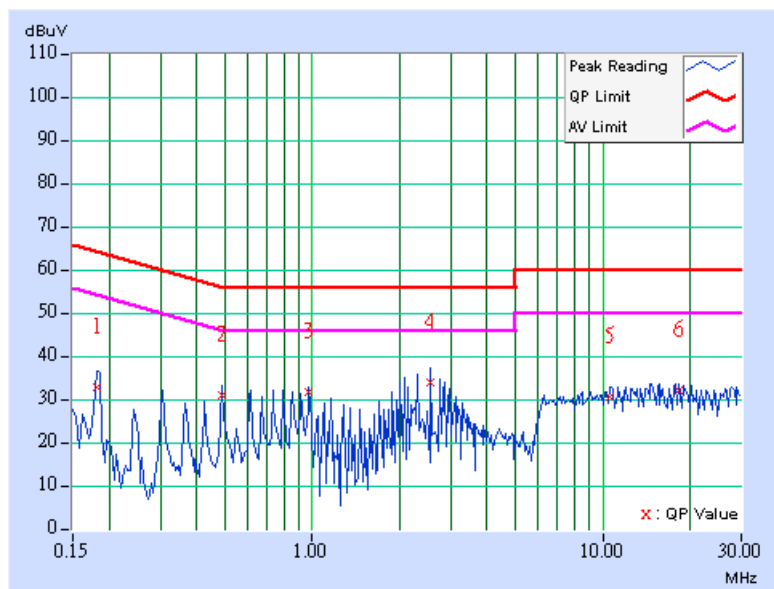

EUT TEST CONDITION		MEASUREMENT DETAIL	
CHANNEL	Channel 1	PHASE	Line 2
MODULATION TYPE	BPSK	6dB BANDWIDTH	9 kHz
ENVIRONMENTAL CONDITIONS	20deg. C, 60%RH, 991hPa	INPUT POWER (SYSTEM)	120Vac, 60 Hz
TRANSFER RATE	6Mbps	TESTED BY	Match Tsui

No	Freq.	Corr.	Reading Value		Emission Level		Limit		Margin	
	[MHz]	(dB)	[dB (uV)]		[dB (uV)]		[dB (uV)]		(dB)	
			Q.P.	AV.	Q.P.	AV.	Q.P.	AV.	Q.P.	AV.
1	0.184	0.10	31.62	-	31.72	-	64.31	54.31	-32.59	-
2	0.490	0.12	31.31	-	31.43	-	56.17	46.17	-24.74	-
3	0.853	0.18	32.56	-	32.74	-	56.00	46.00	-23.26	-
4	2.197	0.23	34.82	-	35.05	-	56.00	46.00	-20.95	-
5	9.636	0.42	30.51	-	30.93	-	60.00	50.00	-29.07	-
6	15.185	0.48	31.70	-	32.18	-	60.00	50.00	-27.82	-

- REMARKS:**
1. Q.P. and AV. are abbreviations of quasi-peak and average individually.
 2. "-": The Quasi-peak reading value also meets average limit and measurement with the average detector is unnecessary.
 3. The emission levels of other frequencies were very low against the limit.
 4. Margin value = Emission level - Limit value
 5. Correction factor = Insertion loss + Cable loss
 6. Emission Level = Correction Factor + Reading Value.

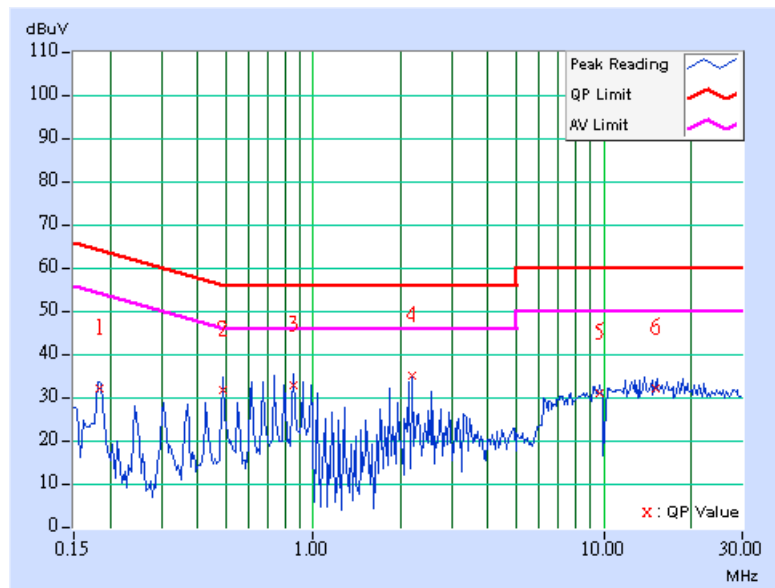

EUT TEST CONDITION		MEASUREMENT DETAIL	
CHANNEL	Channel 6	PHASE	Line 1
MODULATION TYPE	BPSK	6dB BANDWIDTH	9 kHz
ENVIRONMENTAL CONDITIONS	20deg. C, 60%RH, 991hPa	INPUT POWER (SYSTEM)	120Vac, 60 Hz
TRANSFER RATE	6Mbps	TESTED BY	Match Tsui

No	Freq. [MHz]	Corr. Factor [dB]	Reading Value [dB (uV)]		Emission Level [dB (uV)]		Limit [dB (uV)]		Margin (dB)	
			Q.P.	AV.	Q.P.	AV.	Q.P.	AV.	Q.P.	AV.
1	0.184	0.10	33.48	-	33.58	-	64.31	54.31	-30.73	-
2	0.490	0.10	30.51	-	30.61	-	56.17	46.17	-25.56	-
3	0.916	0.11	29.31	-	29.42	-	56.00	46.00	-26.58	-
4	2.258	0.23	36.28	-	36.51	-	56.00	46.00	-19.49	-
5	12.207	0.40	28.24	-	28.64	-	60.00	50.00	-31.36	-
6	19.223	0.56	29.24	-	29.80	-	60.00	50.00	-30.20	-

- REMARKS:**
1. Q.P. and AV. are abbreviations of quasi-peak and average individually.
 2. "-": The Quasi-peak reading value also meets average limit and measurement with the average detector is unnecessary.
 3. The emission levels of other frequencies were very low against the limit.
 4. Margin value = Emission level - Limit value
 5. Correction factor = Insertion loss + Cable loss
 6. Emission Level = Correction Factor + Reading Value.

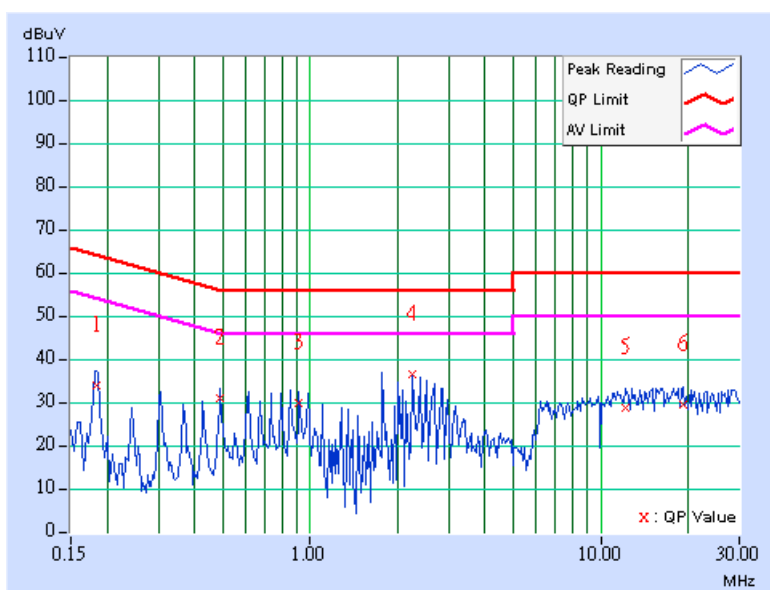

EUT TEST CONDITION		MEASUREMENT DETAIL	
CHANNEL	Channel 6	PHASE	Line 2
MODULATION TYPE	BPSK	6dB BANDWIDTH	9 kHz
ENVIRONMENTAL CONDITIONS	20deg. C, 60%RH, 991hPa	INPUT POWER (SYSTEM)	120Vac, 60 Hz
TRANSFER RATE	6Mbps	TESTED BY	Match Tsui

No	Freq.	Corr.	Reading Value		Emission Level		Limit		Margin	
	[MHz]	Factor	[dB (uV)]		[dB (uV)]		[dB (uV)]		(dB)	
		(dB)	Q.P.	AV.	Q.P.	AV.	Q.P.	AV.	Q.P.	AV.
1	0.184	0.10	30.82	-	30.92	-	64.31	54.31	-33.39	-
2	0.486	0.12	31.68	-	31.80	-	56.24	46.24	-24.44	-
3	0.853	0.18	31.44	-	31.62	-	56.00	46.00	-24.38	-
4	2.137	0.22	37.30	-	37.52	-	56.00	46.00	-18.48	-
5	11.721	0.45	30.48	-	30.93	-	60.00	50.00	-29.07	-
6	18.557	0.54	30.85	-	31.39	-	60.00	50.00	-28.61	-

- REMARKS:**
1. Q.P. and AV. are abbreviations of quasi-peak and average individually.
 2. "-": The Quasi-peak reading value also meets average limit and measurement with the average detector is unnecessary.
 3. The emission levels of other frequencies were very low against the limit.
 4. Margin value = Emission level - Limit value
 5. Correction factor = Insertion loss + Cable loss
 6. Emission Level = Correction Factor + Reading Value.

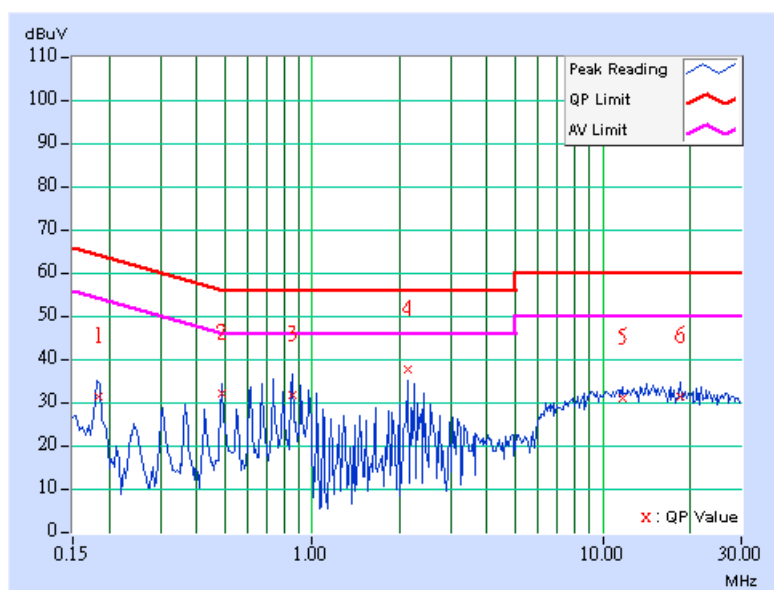

EUT TEST CONDITION		MEASUREMENT DETAIL	
CHANNEL	Channel 11	PHASE	Line 1
MODULATION TYPE	BPSK	6dB BANDWIDTH	9 kHz
ENVIRONMENTAL CONDITIONS	20deg. C, 60%RH, 991hPa	INPUT POWER (SYSTEM)	120Vac, 60 Hz
TRANSFER RATE	6Mbps	TESTED BY	Match Tsui

No	Freq. [MHz]	Corr. Factor (dB)	Reading Value [dB (uV)]		Emission Level [dB (uV)]		Limit [dB (uV)]		Margin (dB)	
			Q.P.	AV.	Q.P.	AV.	Q.P.	AV.	Q.P.	AV.
1	0.185	0.10	32.33	-	32.43	-	64.25	54.25	-31.82	-
2	0.488	0.10	30.92	-	31.02	-	56.19	46.19	-25.17	-
3	0.974	0.11	31.35	-	31.46	-	56.00	46.00	-24.54	-
4	2.258	0.23	36.30	-	36.53	-	56.00	46.00	-19.47	-
5	11.648	0.38	30.14	-	30.52	-	60.00	50.00	-29.48	-
6	19.332	0.56	31.19	-	31.75	-	60.00	50.00	-28.25	-

- REMARKS:**
1. Q.P. and AV. are abbreviations of quasi-peak and average individually.
 2. "-": The Quasi-peak reading value also meets average limit and measurement with the average detector is unnecessary.
 3. The emission levels of other frequencies were very low against the limit.
 4. Margin value = Emission level - Limit value
 5. Correction factor = Insertion loss + Cable loss
 6. Emission Level = Correction Factor + Reading Value.

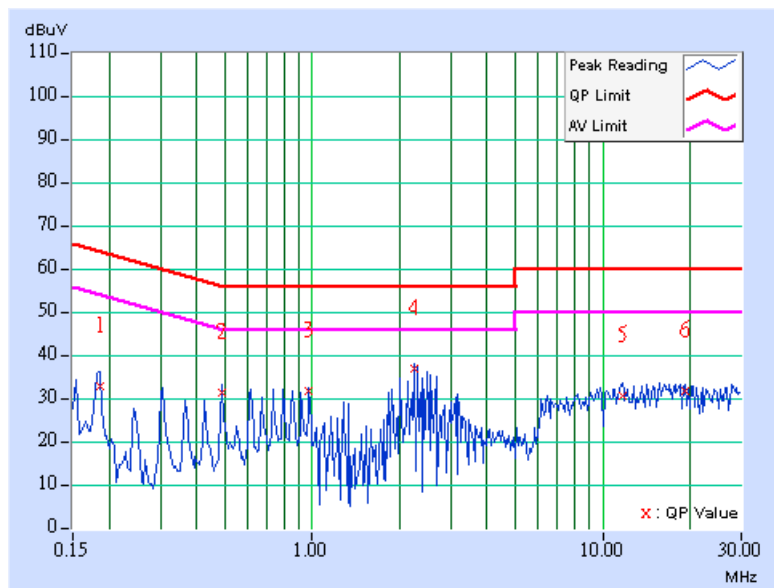

EUT TEST CONDITION		MEASUREMENT DETAIL	
CHANNEL	Channel 11	PHASE	Line 2
MODULATION TYPE	BPSK	6dB BANDWIDTH	9 kHz
ENVIRONMENTAL CONDITIONS	20deg. C, 60%RH, 991hPa	INPUT POWER (SYSTEM)	120Vac, 60 Hz
TRANSFER RATE	6Mbps	TESTED BY	Match Tsui

No	Freq.	Corr.	Reading Value		Emission Level		Limit		Margin	
	[MHz]	Factor	[dB (uV)]		[dB (uV)]		[dB (uV)]		(dB)	
		(dB)	Q.P.	AV.	Q.P.	AV.	Q.P.	AV.	Q.P.	AV.
1	0.185	0.10	31.00	-	31.10	-	64.25	54.25	-33.15	-
2	0.486	0.12	31.22	-	31.34	-	56.24	46.24	-24.90	-
3	0.857	0.18	30.75	-	30.93	-	56.00	46.00	-25.07	-
4	2.258	0.23	34.81	-	35.04	-	56.00	46.00	-20.96	-
5	12.445	0.45	30.86	-	31.31	-	60.00	50.00	-28.69	-
6	19.887	0.57	29.63	-	30.20	-	60.00	50.00	-29.80	-

- REMARKS:**
1. Q.P. and AV. are abbreviations of quasi-peak and average individually.
 2. "-": The Quasi-peak reading value also meets average limit and measurement with the average detector is unnecessary.
 3. The emission levels of other frequencies were very low against the limit.
 4. Margin value = Emission level - Limit value
 5. Correction factor = Insertion loss + Cable loss
 6. Emission Level = Correction Factor + Reading Value.

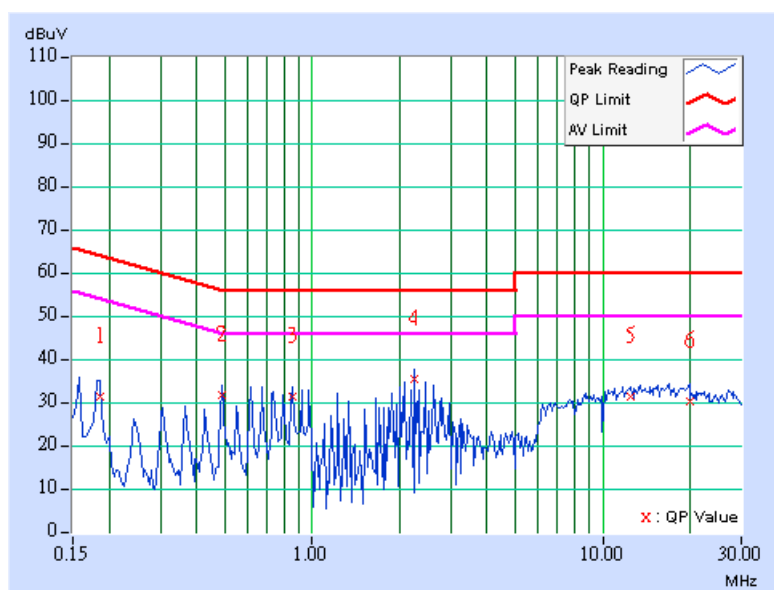

FOR TEST MODE B

EUT TEST CONDITION		MEASUREMENT DETAIL	
CHANNEL	Channel 1	PHASE	Line 1
MODULATION TYPE	BPSK	6dB BANDWIDTH	9 kHz
ENVIRONMENTAL CONDITIONS	20deg. C, 60%RH, 991hPa	INPUT POWER (SYSTEM)	120Vac, 60 Hz
TRANSFER RATE	6Mbps	TESTED BY	Match Tsui

No	Freq. [MHz]	Corr. Factor (dB)	Reading Value [dB (uV)]		Emission Level [dB (uV)]		Limit [dB (uV)]		Margin (dB)	
			Q.P.	AV.	Q.P.	AV.	Q.P.	AV.	Q.P.	AV.
1	0.181	0.10	39.93	-	40.03	-	64.43	54.43	-24.40	-
2	0.537	0.10	38.66	-	38.76	-	56.00	46.00	-17.24	-
3	0.884	0.11	36.41	-	36.52	-	56.00	46.00	-19.48	-
4	1.762	0.19	35.75	-	35.94	-	56.00	46.00	-20.06	-
5	2.348	0.23	42.56	-	42.79	-	56.00	46.00	-13.21	-
6	8.137	0.31	38.79	-	39.10	-	60.00	50.00	-20.90	-

- REMARKS:**
1. Q.P. and AV. are abbreviations of quasi-peak and average individually.
 2. "-": The Quasi-peak reading value also meets average limit and measurement with the average detector is unnecessary.
 3. The emission levels of other frequencies were very low against the limit.
 4. Margin value = Emission level - Limit value
 5. Correction factor = Insertion loss + Cable loss
 6. Emission Level = Correction Factor + Reading Value.

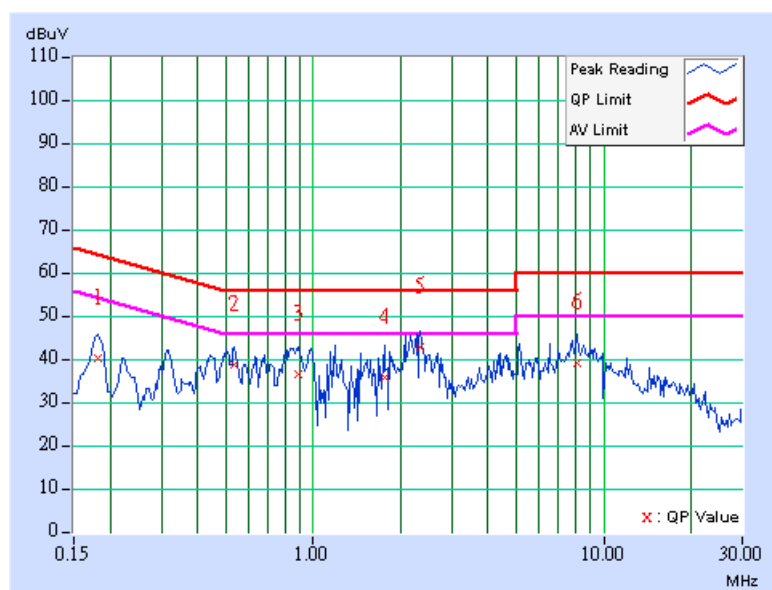

EUT TEST CONDITION		MEASUREMENT DETAIL	
CHANNEL	Channel 1	PHASE	Line 2
MODULATION TYPE	BPSK	6dB BANDWIDTH	9 kHz
ENVIRONMENTAL CONDITIONS	20deg. C, 60%RH, 991hPa	INPUT POWER (SYSTEM)	120Vac, 60 Hz
TRANSFER RATE	6Mbps	TESTED BY	Match Tsui

No	Freq. [MHz]	Corr. Factor (dB)	Reading Value [dB (uV)]		Emission Level [dB (uV)]		Limit [dB (uV)]		Margin (dB)	
			Q.P.	AV.	Q.P.	AV.	Q.P.	AV.	Q.P.	AV.
1	0.181	0.10	37.83	-	37.93	-	64.43	54.43	-26.50	-
2	0.365	0.10	34.43	-	34.53	-	58.62	48.62	-24.09	-
3	0.857	0.18	32.56	-	32.74	-	56.00	46.00	-23.26	-
4	1.664	0.22	36.13	-	36.35	-	56.00	46.00	-19.65	-
5	2.164	0.22	41.41	-	41.63	-	56.00	46.00	-14.37	-
6	8.551	0.39	35.72	-	36.11	-	60.00	50.00	-23.89	-

- REMARKS:**
1. Q.P. and AV. are abbreviations of quasi-peak and average individually.
 2. "-": The Quasi-peak reading value also meets average limit and measurement with the average detector is unnecessary.
 3. The emission levels of other frequencies were very low against the limit.
 4. Margin value = Emission level - Limit value
 5. Correction factor = Insertion loss + Cable loss
 6. Emission Level = Correction Factor + Reading Value.

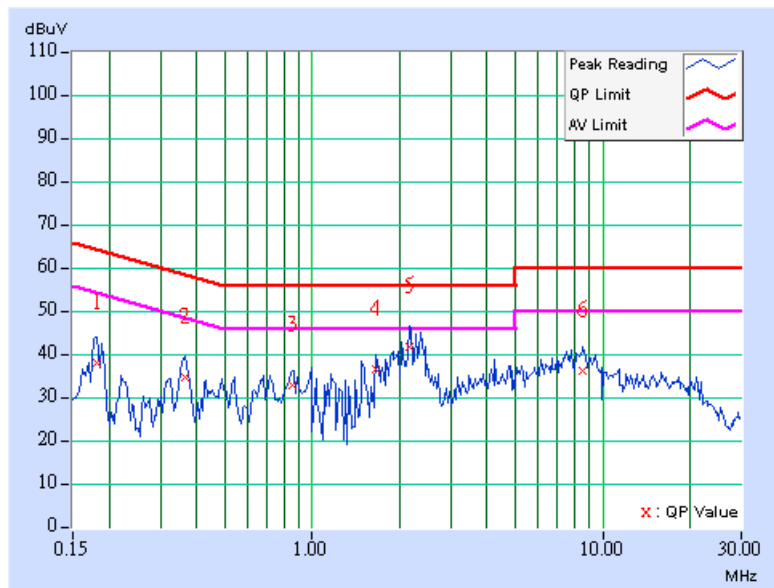

EUT TEST CONDITION		MEASUREMENT DETAIL	
CHANNEL	Channel 6	PHASE	Line 1
MODULATION TYPE	BPSK	6dB BANDWIDTH	9 kHz
ENVIRONMENTAL CONDITIONS	20deg. C, 60%RH, 991hPa	INPUT POWER (SYSTEM)	120Vac, 60 Hz
TRANSFER RATE	6Mbps	TESTED BY	Match Tsui

No	Freq. [MHz]	Corr. Factor [dB]	Reading Value [dB (uV)]		Emission Level [dB (uV)]		Limit [dB (uV)]		Margin (dB)	
			Q.P.	AV.	Q.P.	AV.	Q.P.	AV.	Q.P.	AV.
1	0.181	0.10	39.75	-	39.85	-	64.43	54.43	-24.58	-
2	0.525	0.10	37.15	-	37.25	-	56.00	46.00	-18.75	-
3	0.861	0.11	38.81	-	38.92	-	56.00	46.00	-17.08	-
4	1.859	0.20	37.09	-	37.29	-	56.00	46.00	-18.71	-
5	2.316	0.23	43.22	-	43.45	-	56.00	46.00	-12.55	-
6	8.434	0.32	38.54	-	38.86	-	60.00	50.00	-21.14	-

- REMARKS:**
1. Q.P. and AV. are abbreviations of quasi-peak and average individually.
 2. "-": The Quasi-peak reading value also meets average limit and measurement with the average detector is unnecessary.
 3. The emission levels of other frequencies were very low against the limit.
 4. Margin value = Emission level - Limit value
 5. Correction factor = Insertion loss + Cable loss
 6. Emission Level = Correction Factor + Reading Value.

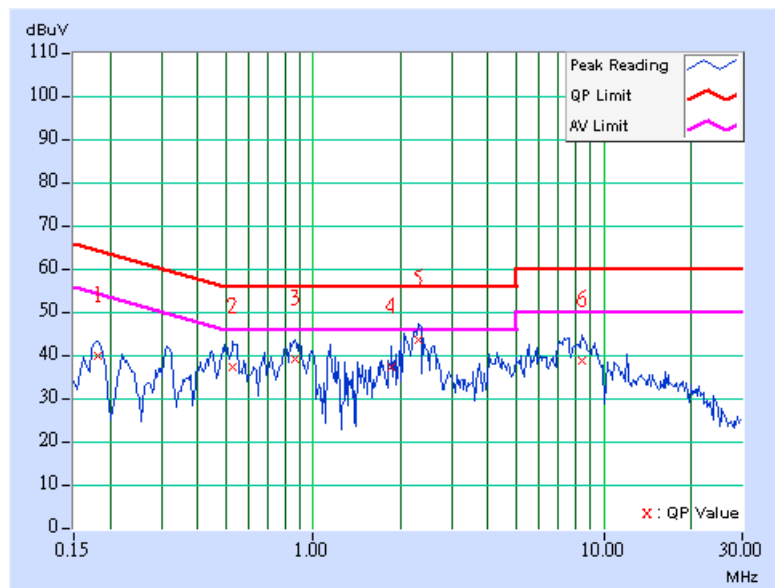

EUT TEST CONDITION		MEASUREMENT DETAIL	
CHANNEL	Channel 6	PHASE	Line 2
MODULATION TYPE	BPSK	6dB BANDWIDTH	9 kHz
ENVIRONMENTAL CONDITIONS	20deg. C, 60%RH, 991hPa	INPUT POWER (SYSTEM)	120Vac, 60 Hz
TRANSFER RATE	6Mbps	TESTED BY	Match Tsui

No	Freq. [MHz]	Corr. Factor (dB)	Reading Value [dB (uV)]		Emission Level [dB (uV)]		Limit [dB (uV)]		Margin (dB)	
			Q.P.	AV.	Q.P.	AV.	Q.P.	AV.	Q.P.	AV.
1	0.185	0.10	35.23	-	35.33	-	64.25	54.25	-28.92	-
2	0.360	0.10	34.97	-	35.07	-	58.74	48.74	-23.67	-
3	1.000	0.21	31.00	-	31.21	-	56.00	46.00	-24.79	-
4	1.496	0.21	33.52	-	33.73	-	56.00	46.00	-22.27	-
5	2.313	0.23	40.54	-	40.77	-	56.00	46.00	-15.23	-
6	8.172	0.38	34.75	-	35.13	-	60.00	50.00	-24.87	-

- REMARKS:**
1. Q.P. and AV. are abbreviations of quasi-peak and average individually.
 2. "-": The Quasi-peak reading value also meets average limit and measurement with the average detector is unnecessary.
 3. The emission levels of other frequencies were very low against the limit.
 4. Margin value = Emission level - Limit value
 5. Correction factor = Insertion loss + Cable loss
 6. Emission Level = Correction Factor + Reading Value.

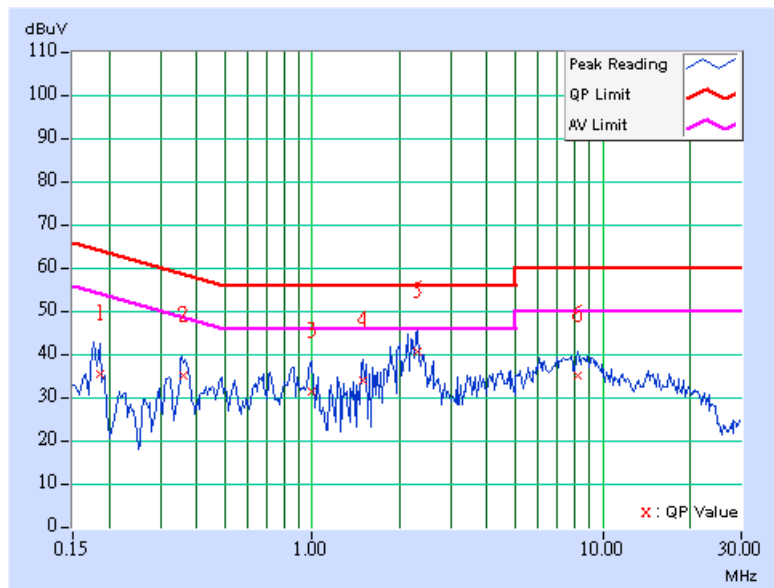

EUT TEST CONDITION		MEASUREMENT DETAIL	
CHANNEL	Channel 11	PHASE	Line 1
MODULATION TYPE	BPSK	6dB BANDWIDTH	9 kHz
ENVIRONMENTAL CONDITIONS	20deg. C, 60%RH, 991hPa	INPUT POWER (SYSTEM)	120Vac, 60 Hz
TRANSFER RATE	6Mbps	TESTED BY	Match Tsui

No	Freq. [MHz]	Corr. Factor [dB]	Reading Value [dB (uV)]		Emission Level [dB (uV)]		Limit [dB (uV)]		Margin (dB)	
			Q.P.	AV.	Q.P.	AV.	Q.P.	AV.	Q.P.	AV.
1	0.181	0.10	39.81	-	39.91	-	64.43	54.43	-24.52	-
2	0.498	0.10	39.11	-	39.21	-	56.04	46.04	-16.83	-
3	0.861	0.11	39.15	-	39.26	-	56.00	46.00	-16.74	-
4	1.852	0.20	38.33	-	38.53	-	56.00	46.00	-17.47	-
5	2.219	0.23	42.93	-	43.16	-	56.00	46.00	-12.84	-
6	7.699	0.31	37.69	-	38.00	-	60.00	50.00	-22.00	-

- REMARKS:**
1. Q.P. and AV. are abbreviations of quasi-peak and average individually.
 2. "-": The Quasi-peak reading value also meets average limit and measurement with the average detector is unnecessary.
 3. The emission levels of other frequencies were very low against the limit.
 4. Margin value = Emission level - Limit value
 5. Correction factor = Insertion loss + Cable loss
 6. Emission Level = Correction Factor + Reading Value.

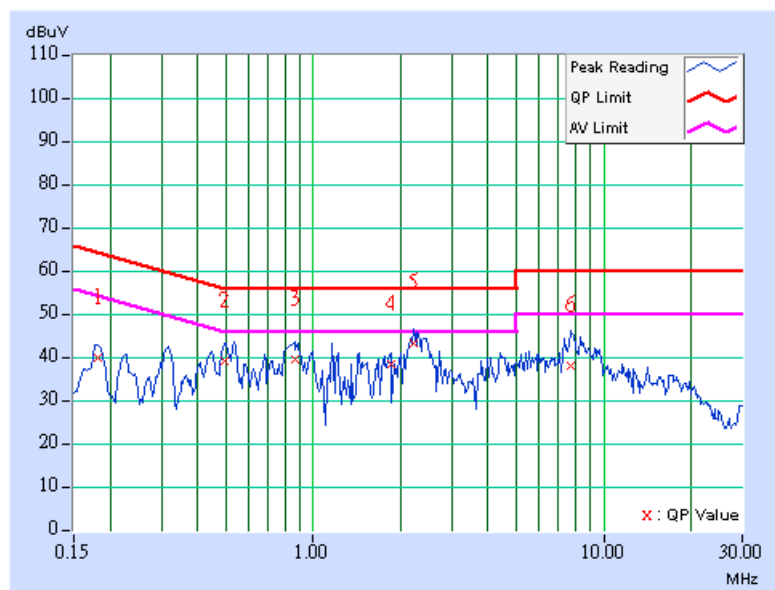

EUT TEST CONDITION		MEASUREMENT DETAIL	
CHANNEL	Channel 11	PHASE	Line 2
MODULATION TYPE	BPSK	6dB BANDWIDTH	9 kHz
ENVIRONMENTAL CONDITIONS	20deg. C, 60%RH, 991hPa	INPUT POWER (SYSTEM)	120Vac, 60 Hz
TRANSFER RATE	6Mbps	TESTED BY	Match Tsui

No	Freq. [MHz]	Corr. Factor [dB]	Reading Value [dB (uV)]		Emission Level [dB (uV)]		Limit [dB (uV)]		Margin (dB)	
			Q.P.	AV.	Q.P.	AV.	Q.P.	AV.	Q.P.	AV.
			1	0.181	0.10	36.90	-	37.00	-	64.43
2	0.361	0.10	35.65	-	35.75	-	58.71	48.71	-22.96	-
3	0.994	0.21	31.35	-	31.56	-	56.00	46.00	-24.44	-
4	1.715	0.22	37.43	-	37.65	-	56.00	46.00	-18.35	-
5	2.039	0.22	40.34	-	40.56	-	56.00	46.00	-15.44	-
6	8.527	0.39	35.11	-	35.50	-	60.00	50.00	-24.50	-

- REMARKS:**
1. Q.P. and AV. are abbreviations of quasi-peak and average individually.
 2. "-": The Quasi-peak reading value also meets average limit and measurement with the average detector is unnecessary.
 3. The emission levels of other frequencies were very low against the limit.
 4. Margin value = Emission level - Limit value
 5. Correction factor = Insertion loss + Cable loss
 6. Emission Level = Correction Factor + Reading Value.

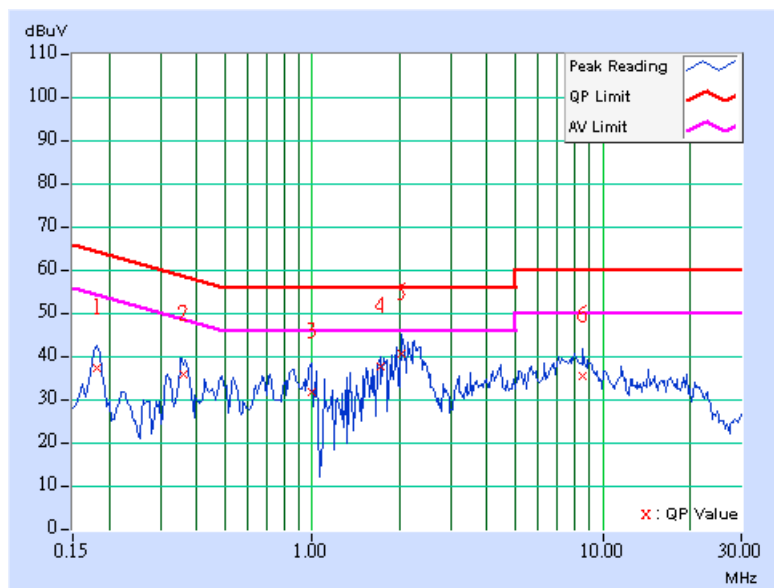

FOR TEST MODE C

EUT TEST CONDITION		MEASUREMENT DETAIL	
CHANNEL	Channel 1	PHASE	Line 1
MODULATION TYPE	BPSK	6dB BANDWIDTH	9 kHz
ENVIRONMENTAL CONDITIONS	25deg. C, 68%RH, 991hPa	INPUT POWER (SYSTEM)	120Vac, 60 Hz
TRANSFER RATE	6Mbps	TESTED BY	Match Tsui

No	Freq. [MHz]	Corr. Factor (dB)	Reading Value [dB (uV)]		Emission Level [dB (uV)]		Limit [dB (uV)]		Margin (dB)	
			Q.P.	AV.	Q.P.	AV.	Q.P.	AV.	Q.P.	AV.
1	0.170	0.10	50.91	-	51.01	-	64.98	54.98	-13.97	-
2	0.224	0.10	43.62	-	43.72	-	62.66	52.66	-18.94	-
3	0.283	0.10	39.29	-	39.39	-	60.73	50.73	-21.34	-
4	0.341	0.10	34.00	-	34.10	-	59.17	49.17	-25.07	-
5	0.396	0.10	31.94	-	32.04	-	57.93	47.93	-25.89	-
6	3.688	0.27	36.51	-	36.78	-	56.00	46.00	-19.22	-

- REMARKS:**
1. Q.P. and AV. are abbreviations of quasi-peak and average individually.
 2. "-": The Quasi-peak reading value also meets average limit and measurement with the average detector is unnecessary.
 3. The emission levels of other frequencies were very low against the limit.
 4. Margin value = Emission level - Limit value
 5. Correction factor = Insertion loss + Cable loss
 6. Emission Level = Correction Factor + Reading Value.

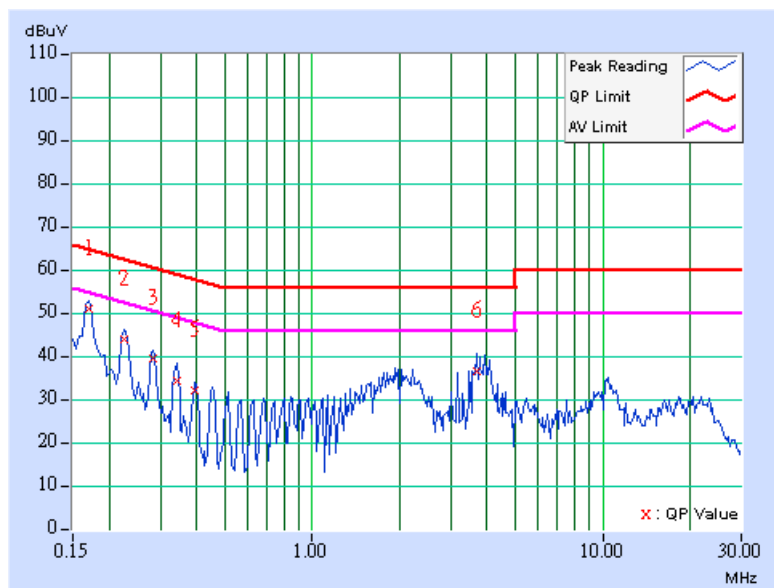

EUT TEST CONDITION		MEASUREMENT DETAIL	
CHANNEL	Channel 1	PHASE	Line 2
MODULATION TYPE	BPSK	6dB BANDWIDTH	9 kHz
ENVIRONMENTAL CONDITIONS	25deg. C, 68%RH, 991hPa	INPUT POWER (SYSTEM)	120Vac, 60 Hz
TRANSFER RATE	6Mbps	TESTED BY	Match Tsui

No	Freq. [MHz]	Corr. Factor (dB)	Reading Value [dB (uV)]		Emission Level [dB (uV)]		Limit [dB (uV)]		Margin (dB)	
			Q.P.	AV.	Q.P.	AV.	Q.P.	AV.	Q.P.	AV.
1	0.173	0.10	49.67	-	49.77	-	64.79	54.79	-15.02	-
2	0.228	0.10	42.81	-	42.91	-	62.52	52.52	-19.61	-
3	0.283	0.10	40.78	-	40.88	-	60.73	50.73	-19.85	-
4	0.341	0.10	34.76	-	34.86	-	59.17	49.17	-24.31	-
5	0.392	0.10	31.07	-	31.17	-	58.02	48.02	-26.85	-
6	3.914	0.28	39.74	-	40.02	-	56.00	46.00	-15.98	-

- REMARKS:**
1. Q.P. and AV. are abbreviations of quasi-peak and average individually.
 2. "-": The Quasi-peak reading value also meets average limit and measurement with the average detector is unnecessary.
 3. The emission levels of other frequencies were very low against the limit.
 4. Margin value = Emission level - Limit value
 5. Correction factor = Insertion loss + Cable loss
 6. Emission Level = Correction Factor + Reading Value.

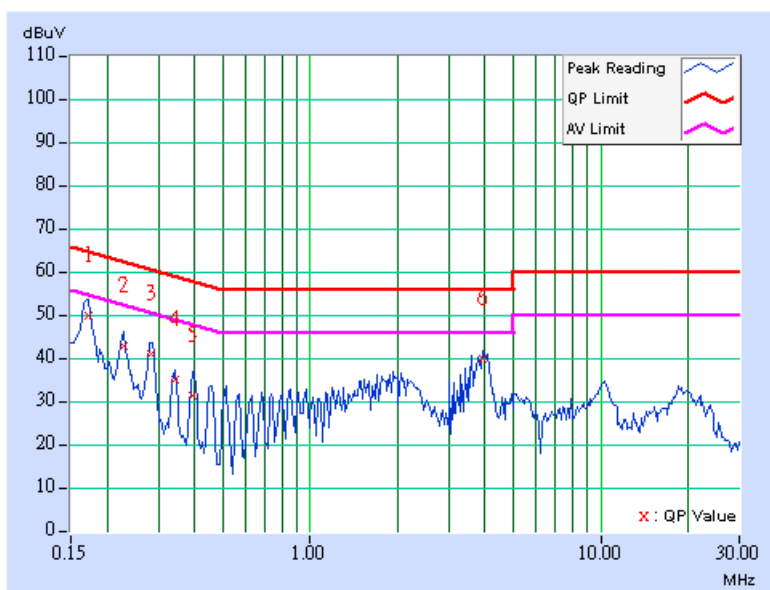

EUT TEST CONDITION		MEASUREMENT DETAIL	
CHANNEL	Channel 6	PHASE	Line 1
MODULATION TYPE	BPSK	6dB BANDWIDTH	9 kHz
ENVIRONMENTAL CONDITIONS	25deg. C, 68%RH, 991hPa	INPUT POWER (SYSTEM)	120Vac, 60 Hz
TRANSFER RATE	6Mbps	TESTED BY	Match Tsui

No	Freq. [MHz]	Corr. Factor [dB]	Reading Value [dB (uV)]		Emission Level [dB (uV)]		Limit [dB (uV)]		Margin (dB)	
			Q.P.	AV.	Q.P.	AV.	Q.P.	AV.	Q.P.	AV.
1	0.170	0.10	50.85	-	50.95	-	64.98	54.98	-14.03	-
2	0.224	0.10	43.62	-	43.72	-	62.66	52.66	-18.94	-
3	0.283	0.10	39.29	-	39.39	-	60.73	50.73	-21.34	-
4	0.341	0.10	33.92	-	34.02	-	59.17	49.17	-25.15	-
5	0.392	0.10	28.46	-	28.56	-	58.02	48.02	-29.46	-
6	3.742	0.27	37.86	-	38.13	-	56.00	46.00	-17.87	-

- REMARKS:**
1. Q.P. and AV. are abbreviations of quasi-peak and average individually.
 2. "-": The Quasi-peak reading value also meets average limit and measurement with the average detector is unnecessary.
 3. The emission levels of other frequencies were very low against the limit.
 4. Margin value = Emission level - Limit value
 5. Correction factor = Insertion loss + Cable loss
 6. Emission Level = Correction Factor + Reading Value.

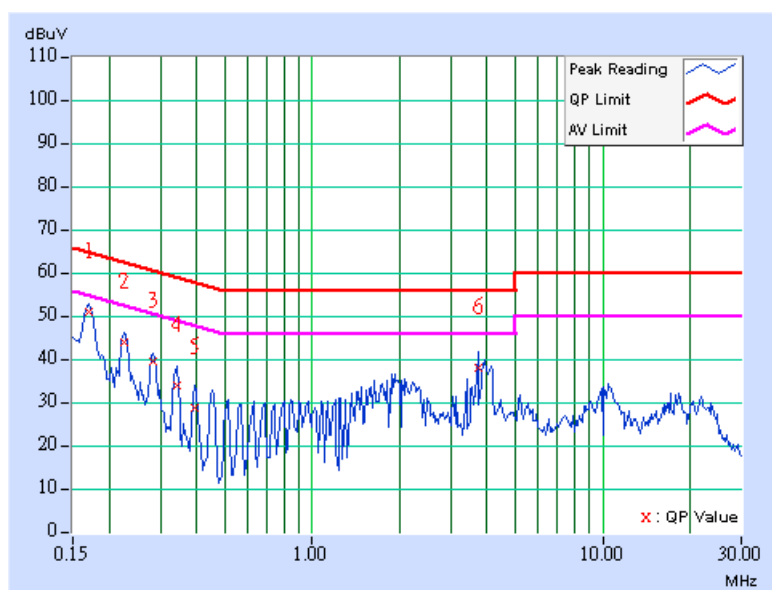

EUT TEST CONDITION		MEASUREMENT DETAIL	
CHANNEL	Channel 6	PHASE	Line 2
MODULATION TYPE	BPSK	6dB BANDWIDTH	9 kHz
ENVIRONMENTAL CONDITIONS	25deg. C, 68%RH, 991hPa	INPUT POWER (SYSTEM)	120Vac, 60 Hz
TRANSFER RATE	6Mbps	TESTED BY	Match Tsui

No	Freq. [MHz]	Corr. Factor (dB)	Reading Value [dB (uV)]		Emission Level [dB (uV)]		Limit [dB (uV)]		Margin (dB)	
			Q.P.	AV.	Q.P.	AV.	Q.P.	AV.	Q.P.	AV.
1	0.173	0.10	49.97	-	50.07	-	64.80	54.80	-14.73	-
2	0.228	0.10	42.91	-	43.01	-	62.52	52.52	-19.51	-
3	0.283	0.10	40.98	-	41.08	-	60.73	50.73	-19.65	-
4	0.341	0.10	34.96	-	35.06	-	59.17	49.17	-24.11	-
5	0.392	0.10	31.87	-	31.97	-	58.02	48.02	-26.05	-
6	3.914	0.28	39.94	-	40.22	-	56.00	46.00	-15.78	-

- REMARKS:**
1. Q.P. and AV. are abbreviations of quasi-peak and average individually.
 2. "-": The Quasi-peak reading value also meets average limit and measurement with the average detector is unnecessary.
 3. The emission levels of other frequencies were very low against the limit.
 4. Margin value = Emission level - Limit value
 5. Correction factor = Insertion loss + Cable loss
 6. Emission Level = Correction Factor + Reading Value.

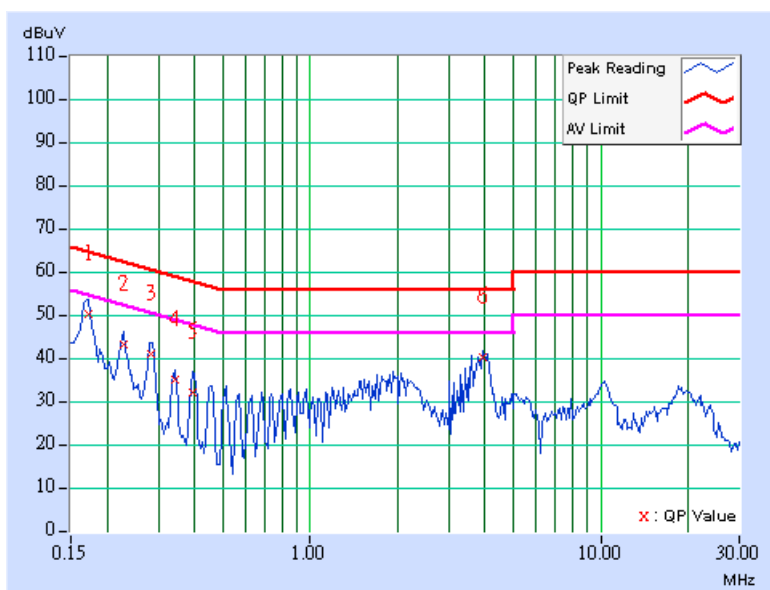

EUT TEST CONDITION		MEASUREMENT DETAIL	
CHANNEL	Channel 11	PHASE	Line 1
MODULATION TYPE	BPSK	6dB BANDWIDTH	9 kHz
ENVIRONMENTAL CONDITIONS	25deg. C, 68%RH, 991hPa	INPUT POWER (SYSTEM)	120Vac, 60 Hz
TRANSFER RATE	6Mbps	TESTED BY	Match Tsui

No	Freq. [MHz]	Corr. Factor [dB]	Reading Value [dB (uV)]		Emission Level [dB (uV)]		Limit [dB (uV)]		Margin (dB)	
			Q.P.	AV.	Q.P.	AV.	Q.P.	AV.	Q.P.	AV.
1	0.170	0.10	50.56	-	50.66	-	64.98	54.98	-14.32	-
2	0.224	0.10	43.62	-	43.72	-	62.66	52.66	-18.94	-
3	0.283	0.10	39.12	-	39.22	-	60.73	50.73	-21.51	-
4	0.338	0.10	34.32	-	34.42	-	59.26	49.26	-24.84	-
5	0.396	0.10	32.00	-	32.10	-	57.93	47.93	-25.83	-
6	3.797	0.27	36.58	-	36.85	-	56.00	46.00	-19.15	-

- REMARKS:**
1. Q.P. and AV. are abbreviations of quasi-peak and average individually.
 2. "-": The Quasi-peak reading value also meets average limit and measurement with the average detector is unnecessary.
 3. The emission levels of other frequencies were very low against the limit.
 4. Margin value = Emission level - Limit value
 5. Correction factor = Insertion loss + Cable loss
 6. Emission Level = Correction Factor + Reading Value.

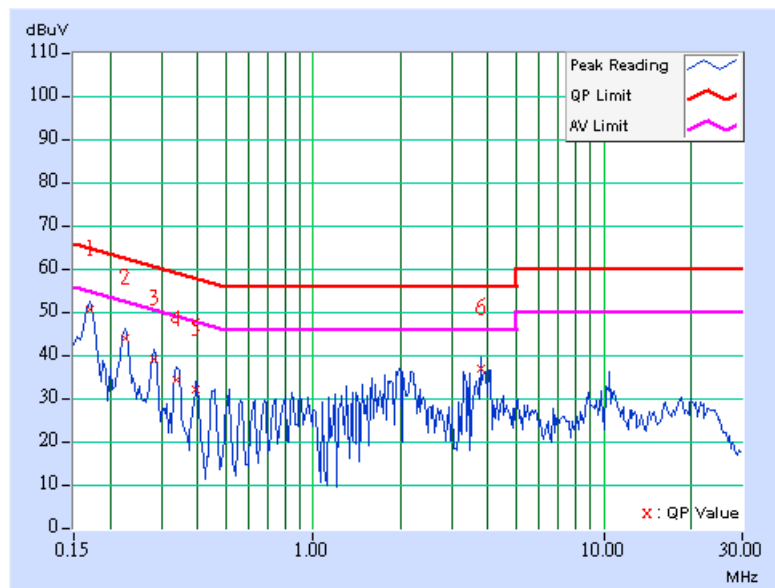

EUT TEST CONDITION		MEASUREMENT DETAIL	
CHANNEL	Channel 11	PHASE	Line 2
MODULATION TYPE	BPSK	6dB BANDWIDTH	9 kHz
ENVIRONMENTAL CONDITIONS	25deg. C, 68%RH, 991hPa	INPUT POWER (SYSTEM)	120Vac, 60 Hz
TRANSFER RATE	6Mbps	TESTED BY	Match Tsui

No	Freq. [MHz]	Corr. Factor [dB]	Reading Value [dB (uV)]		Emission Level [dB (uV)]		Limit [dB (uV)]		Margin (dB)	
			Q.P.	AV.	Q.P.	AV.	Q.P.	AV.	Q.P.	AV.
1	0.173	0.10	48.96	-	49.06	-	64.79	54.79	-15.73	-
2	0.228	0.10	42.51	-	42.61	-	62.52	52.52	-19.91	-
3	0.341	0.10	34.57	-	34.67	-	59.17	49.17	-24.50	-
4	0.400	0.10	32.72	-	32.82	-	57.85	47.85	-25.03	-
5	0.455	0.11	31.32	-	31.43	-	56.79	46.79	-25.36	-
6	3.906	0.28	38.85	-	39.13	-	56.00	46.00	-16.87	-

- REMARKS:**
1. Q.P. and AV. are abbreviations of quasi-peak and average individually.
 2. "-": The Quasi-peak reading value also meets average limit and measurement with the average detector is unnecessary.
 3. The emission levels of other frequencies were very low against the limit.
 4. Margin value = Emission level - Limit value
 5. Correction factor = Insertion loss + Cable loss
 6. Emission Level = Correction Factor + Reading Value.

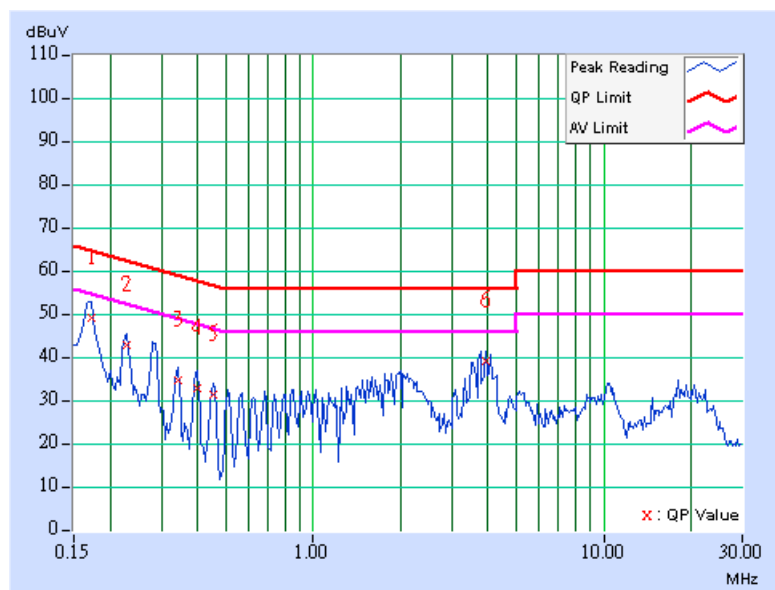

4.2 RADIATED EMISSION MEASUREMENT

4.2.1 LIMITS OF RADIATED EMISSION MEASUREMENT

Emissions radiated outside of the specified bands, shall be according to the general radiated limits in 15.209 as following:

FREQUENCIES (MHz)	FIELD STRENGTH (microvolts/meter)	MEASUREMENT DISTANCE (meters)
0.009 ~ 0.490	2400/F(kHz)	300
0.490 ~ 1.705	24000/F(kHz)	30
1.705 ~ 30.0	30	30
30 ~ 88	100	3
88 ~ 216	150	3
216 ~ 960	200	3
Above 960	500	3

NOTE:

1. The lower limit shall apply at the transition frequencies.
2. Emission level (dBuV/m) = 20 log Emission level (uV/m).
3. As shown in 15.35(b), for frequencies above 1000MHz, the field strength limits are based on average detector, however, the peak field strength of any emission shall not exceed the maximum permitted average limits, specified above by more than 20dB under any condition of modulation.



4.2.2 TEST INSTRUMENTS

DESCRIPTION & MANUFACTURER	MODEL NO.	SERIAL NO.	CALIBRATED UNTIL
Test Receiver ROHDE & SCHWARZ	ESI7	838496/016	Dec. 29, 2007
Spectrum Analyzer ROHDE & SCHWARZ	FSP40	100039	Dec. 01, 2007
BILOG Antenna SCHWARZBECK	VULB9168	9168-155	Jan. 04, 2008
HORN Antenna SCHWARZBECK	BBHA 9120D	9120D-405	Dec. 18, 2007
HORN Antenna SCHWARZBECK	BBHA 9170	BBHA9170242	Jan. 16, 2008
Preamplifier Agilent	8449B	3008A1960	Oct. 30, 2007
Preamplifier Agilent	8447D	2944A10631	Oct. 30, 2007
RF signal cable HUBER+SUHNNER	SUCOFLEX 104	230128/4	Nov. 14, 2007
RF signal cable HUBER+SUHNNER	SUCOFLEX 104	233233/4	Nov. 14, 2007
Software ADT.	ADT_Radiated_V7.6	NA	NA
Antenna Tower inn-co GmbH	MA 4000	010303	NA
Antenna Tower Controller inn-co GmbH	CO2000	019303	NA
Turn Table ADT.	TT100.	TT93021704	NA
Turn Table Controller ADT.	SC100.	SC93021704	NA

NOTE: 1. The calibration interval of the above test instruments is 12 months and the calibrations are traceable to NML/ROC and NIST/USA.

2. The test was performed in HwaYa Chamber 4.

3. The horn antenna and HP preamplifier (model: 8449B) are used only for the measurement of emission frequency above 1GHz if tested.

4. The IC Site Registration No. is IC3789B-4.

4.2.3 TEST PROCEDURES

- a. The EUT was placed on the top of a rotating table 0.8 meters above the ground at a 3 meter semi-anechoic chamber. The table was rotated 360 degrees to determine the position of the highest radiation.
- b. The EUT was set 3 meters away from the interference-receiving antenna, which was mounted on the top of a variable-height antenna tower.
- c. The antenna is a broadband antenna, and its height is varied from one meter to four meters above the ground to determine the maximum value of the field strength. Both horizontal and vertical polarizations of the antenna are set to make the measurement.
- d. For each suspected emission, the EUT was arranged to its worst case and then the antenna was tuned to heights from 1 meter to 4 meters and the rotatable table was turned from 0 degrees to 360 degrees to find the maximum reading.
- e. The test-receiver system was set to Peak Detect Function and Specified Bandwidth with Maximum Hold Mode.
- f. If the emission level of the EUT in peak mode was lower than the limit specified, then testing could be stopped and the peak values of the EUT would be reported. Otherwise the emissions would be re-tested one by one using the peak, quasi-peak or average method as specified and then reported in a data sheet.

NOTE:

1. The resolution bandwidth and video bandwidth of test receiver/spectrum analyzer is 120kHz for Quasi-peak detection at frequency below 1GHz.
2. The resolution bandwidth of test receiver/spectrum analyzer is 1 MHz and video bandwidth is 3MHz for Peak detection at frequency above 1GHz.
3. The resolution bandwidth of test receiver/spectrum analyzer is 1 MHz and the video bandwidth is 10Hz for Average detection (AV) at frequency above 1GHz.

4.2.4 DEVIATION FROM TEST STANDARD

No deviation

4.2.5 TEST SETUP

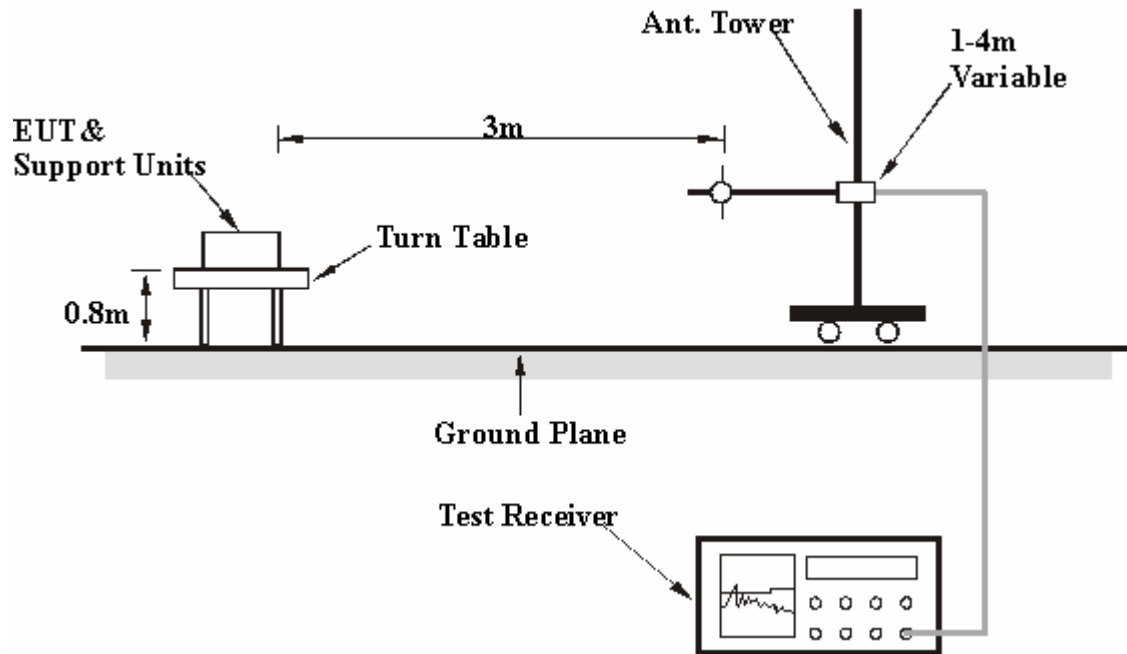

For the actual test configuration, please refer to the attached file (Test Setup Photo).

4.2.6 EUT OPERATING CONDITIONS

Same as 4.1.6

4.2.7 TEST RESULTS

RADIATED BELOW 1GHz TEST DATA FOR TEST MODE A

EUT TEST CONDITION		MEASUREMENT DETAIL	
CHANNEL	Channel 11	FREQUENCY RANGE	Below 1000MHz
MODULATION TYPE	BPSK	DETECTOR FUNCTION	Quasi-Peak
TRANSFER RATE	6Mbps	INPUT POWER (SYSTEM)	120Vac, 60 Hz
ENVIRONMENTAL CONDITIONS	24deg. C, 68%RH, 991hPa	TESTED BY	Match Tsui

ANTENNA POLARITY & TEST DISTANCE: HORIZONTAL AT 3 M								
No.	Freq. (MHz)	Emission Level (dBuV/m)	Limit (dBuV/m)	Margin (dB)	Antenna Height (m)	Table Angle (Degree)	Raw Value (dBuV)	Correction Factor (dB/m)
1	59.06	25.00 QP	40.00	-15.00	1.50 H	253	11.08	13.92
2	76.56	22.76 QP	40.00	-17.24	2.00 H	325	11.28	11.48
3	127.11	26.49 QP	43.50	-17.01	2.00 H	325	13.84	12.65
4	129.06	24.76 QP	43.50	-18.74	2.00 H	322	12.00	12.77
5	175.72	25.60 QP	43.50	-17.90	2.00 H	334	12.20	13.41
6	885.39	27.33 QP	46.00	-18.67	1.00 H	301	-0.39	27.72
7	928.16	28.25 QP	46.00	-17.75	1.00 H	322	-0.02	28.27

ANTENNA POLARITY & TEST DISTANCE: VERTICAL AT 3 M								
No.	Freq. (MHz)	Emission Level (dBuV/m)	Limit (dBuV/m)	Margin (dB)	Antenna Height (m)	Table Angle (Degree)	Raw Value (dBuV)	Correction Factor (dB/m)
1	51.29	36.14 QP	40.00	-3.86	1.50 V	274	21.89	14.25
2	64.90	37.28 QP	40.00	-2.72	1.00 V	319	24.25	13.03
3	152.39	27.52 QP	43.50	-15.98	2.50 V	166	12.77	14.74
4	286.55	27.48 QP	46.00	-18.52	1.50 V	10	13.02	14.46
5	862.06	27.19 QP	46.00	-18.81	2.00 V	283	-0.15	27.35
6	885.39	27.61 QP	46.00	-18.39	2.00 V	73	-0.11	27.72
7	916.50	28.39 QP	46.00	-17.61	1.00 V	136	0.25	28.14
8	959.27	28.58 QP	46.00	-17.42	1.00 V	130	-0.06	28.64

- REMARKS:**
1. Emission level(dBuV/m)=Raw Value(dBuV) + Correction Factor(dB/m)
 2. Correction Factor(dB/m) = Antenna Factor (dB/m) + Cable Factor (dB)
 3. The other emission levels were very low against the limit.
 4. Margin value = Emission level – Limit value.

FOR TEST MODE B

EUT TEST CONDITION		MEASUREMENT DETAIL	
CHANNEL	Channel 11	FREQUENCY RANGE	Below 1000MHz
MODULATION TYPE	BPSK	DETECTOR FUNCTION	Quasi-Peak
TRANSFER RATE	6Mbps	INPUT POWER (SYSTEM)	120Vac, 60 Hz
ENVIRONMENTAL CONDITIONS	24deg. C, 68%RH, 991hPa	TESTED BY	Match Tsui

ANTENNA POLARITY & TEST DISTANCE: HORIZONTAL AT 3 M								
No.	Freq. (MHz)	Emission Level (dBuV/m)	Limit (dBuV/m)	Margin (dB)	Antenna Height (m)	Table Angle (Degree)	Raw Value (dBuV)	Correction Factor (dB/m)
1	31.84	33.85 QP	40.00	-6.15	1.50 H	181	21.32	12.53
2	80.45	31.07 QP	40.00	-8.93	1.00 H	301	20.05	11.02
3	129.06	36.86 QP	43.50	-6.64	1.50 H	58	24.09	12.77
4	214.61	32.04 QP	43.50	-11.46	1.00 H	136	20.02	12.03
5	243.77	34.31 QP	46.00	-11.69	1.00 H	136	20.90	13.41
6	836.78	26.69 QP	46.00	-19.31	1.50 H	235	-0.27	26.96
7	871.78	26.50 QP	46.00	-19.50	1.00 H	10	-1.00	27.50
8	918.44	27.81 QP	46.00	-18.19	1.00 H	169	-0.35	28.16
9	957.33	28.63 QP	46.00	-17.37	1.50 H	319	0.01	28.62

ANTENNA POLARITY & TEST DISTANCE: VERTICAL AT 3 M								
No.	Freq. (MHz)	Emission Level (dBuV/m)	Limit (dBuV/m)	Margin (dB)	Antenna Height (m)	Table Angle (Degree)	Raw Value (dBuV)	Correction Factor (dB/m)
1	55.18	36.81 QP	40.00	-3.19	1.50 V	136	22.73	14.08
2	94.06	31.73 QP	43.50	-11.77	1.50 V	298	22.46	9.27
3	125.17	40.93 QP	43.50	-2.57	2.00 V	163	28.40	12.53
4	189.33	38.96 QP	43.50	-4.54	1.50 V	334	26.89	12.07
5	251.55	32.68 QP	46.00	-13.32	1.50 V	295	18.94	13.74
6	815.39	26.47 QP	46.00	-19.53	1.50 V	262	-0.19	26.65
7	877.61	27.37 QP	46.00	-18.63	1.00 V	184	-0.23	27.60
8	910.66	27.84 QP	46.00	-18.16	1.50 V	46	-0.23	28.07

- REMARKS:**
1. Emission level(dBuV/m)=Raw Value(dBuV) + Correction Factor(dB/m)
 2. Correction Factor(dB/m) = Antenna Factor (dB/m) + Cable Factor (dB)
 3. The other emission levels were very low against the limit.
 4. Margin value = Emission level – Limit value.

FOR TEST MODE C

EUT TEST CONDITION		MEASUREMENT DETAIL	
CHANNEL	Channel 11	FREQUENCY RANGE	Below 1000MHz
MODULATION TYPE	BPSK	DETECTOR FUNCTION	Quasi-Peak
TRANSFER RATE	6Mbps	INPUT POWER (SYSTEM)	120Vac, 60 Hz
ENVIRONMENTAL CONDITIONS	24deg. C, 68%RH, 991hPa	TESTED BY	Match Tsui

ANTENNA POLARITY & TEST DISTANCE: HORIZONTAL AT 3 M								
No.	Freq. (MHz)	Emission Level (dBuV/m)	Limit (dBuV/m)	Margin (dB)	Antenna Height (m)	Table Angle (Degree)	Raw Value (dBuV)	Correction Factor (dB/m)
1	51.29	33.62 QP	40.00	-6.38	1.50 H	58	19.38	14.25
2	64.90	29.65 QP	40.00	-10.35	1.50 H	67	16.62	13.03
3	119.34	39.08 QP	43.50	-4.42	2.50 H	196	26.93	12.15
4	175.72	38.83 QP	43.50	-4.67	2.50 H	67	25.42	13.41
5	232.11	34.63 QP	46.00	-11.37	1.50 H	73	21.77	12.86
6	465.42	34.01 QP	46.00	-11.99	1.50 H	292	14.60	19.40
7	599.58	33.68 QP	46.00	-12.32	1.50 H	340	10.55	23.13
8	731.79	32.59 QP	46.00	-13.41	1.00 H	349	6.97	25.62
9	953.44	31.79 QP	46.00	-14.21	1.50 H	67	3.23	28.56

ANTENNA POLARITY & TEST DISTANCE: VERTICAL AT 3 M								
No.	Freq. (MHz)	Emission Level (dBuV/m)	Limit (dBuV/m)	Margin (dB)	Antenna Height (m)	Table Angle (Degree)	Raw Value (dBuV)	Correction Factor (dB/m)
1	64.90	38.34 QP	40.00	-1.66	1.50 V	103	25.31	13.03
2	109.62	34.94 QP	43.50	-8.56	1.00 V	223	23.82	11.12
3	177.67	40.78 QP	43.50	-2.72	1.00 V	61	27.69	13.09
4	216.55	33.03 QP	46.00	-12.97	1.50 V	103	20.91	12.12
5	230.16	33.98 QP	46.00	-12.02	2.00 V	58	21.22	12.77
6	356.54	34.58 QP	46.00	-11.42	2.00 V	142	18.36	16.22
7	451.81	39.99 QP	46.00	-6.01	1.00 V	10	21.03	18.96
8	599.58	34.47 QP	46.00	-11.53	1.00 V	286	11.34	23.13

- REMARKS:**
1. Emission level(dBuV/m)=Raw Value(dBuV) + Correction Factor(dB/m)
 2. Correction Factor(dB/m) = Antenna Factor (dB/m) + Cable Factor (dB)
 3. The other emission levels were very low against the limit.
 4. Margin value = Emission level – Limit value.

RADIATED ABOVE 1GHz WORST-CASE DATA
802.11b DSSS MODULATION

EUT TEST CONDITION		MEASUREMENT DETAIL	
CHANNEL	Channel 1	FREQUENCY RANGE	1 ~ 25GHz
MODULATION TYPE	DBPSK	DETECTOR FUNCTION	Peak (PK) Average (AV)
TRANSFER RATE	1Mbps	ENVIRONMENTAL CONDITIONS	25deg. C, 65%RH, 991hPa
INPUT POWER (SYSTEM)	120Vac, 60 Hz	TESTED BY	Dean Wang

ANTENNA POLARITY & TEST DISTANCE: HORIZONTAL AT 3 M								
No.	Freq. (MHz)	Emission Level (dBuV/m)	Limit (dBuV/m)	Margin (dB)	Antenna Height (m)	Table Angle (Degree)	Raw Value (dBuV)	Correction Factor (dB/m)
1	2390.00	59.68 PK	74.00	-14.32	1.00 H	320	27.35	32.33
2	2390.00	49.18 AV	54.00	-4.82	1.00 H	320	16.85	32.33
3	*2412.00	106.97 PK			1.00 H	327	74.54	32.43
4	*2412.00	102.52 AV			1.00 H	327	70.09	32.43
5	4824.00	51.04 PK	74.00	-22.96	1.00 H	126	12.28	38.76
6	4824.00	38.30 AV	54.00	-15.70	1.00 H	126	-0.46	38.76

ANTENNA POLARITY & TEST DISTANCE: VERTICAL AT 3 M								
No.	Freq. (MHz)	Emission Level (dBuV/m)	Limit (dBuV/m)	Margin (dB)	Antenna Height (m)	Table Angle (Degree)	Raw Value (dBuV)	Correction Factor (dB/m)
1	2390.00	58.58 PK	74.00	-15.42	1.12 V	12	26.25	32.33
2	2390.00	47.95 AV	54.00	-6.05	1.12 V	12	15.62	32.33
3	*2412.00	104.69 PK			1.12 V	10	72.26	32.43
4	*2412.00	100.11 AV			1.12 V	10	67.68	32.43
5	4824.00	50.11 PK	74.00	-23.89	1.00 V	105	11.35	38.76
6	4824.00	37.47 AV	54.00	-16.53	1.00 V	105	-1.29	38.76

- REMARKS:**
1. Emission level (dBuV/m) = Raw Value (dBuV) + Correction Factor (dB/m).
 2. Correction Factor (dB/m) = Antenna Factor (dB/m) + Cable Factor (dB).
 3. The other emission levels were very low against the limit.
 4. Margin value = Emission level – Limit value.
 5. “ * “: Fundamental frequency.

EUT TEST CONDITION		MEASUREMENT DETAIL	
CHANNEL	Channel 6	FREQUENCY RANGE	1 ~ 25GHz
MODULATION TYPE	DBPSK	DETECTOR FUNCTION	Peak (PK) Average (AV)
TRANSFER RATE	1Mbps	ENVIRONMENTAL CONDITIONS	25deg. C, 65%RH, 991hPa
INPUT POWER (SYSTEM)	120Vac, 60 Hz	TESTED BY	Dean Wang

ANTENNA POLARITY & TEST DISTANCE: HORIZONTAL AT 3 M								
No.	Freq. (MHz)	Emission Level (dBuV/m)	Limit (dBuV/m)	Margin (dB)	Antenna Height (m)	Table Angle (Degree)	Raw Value (dBuV)	Correction Factor (dB/m)
1	*2437.00	104.84 PK			1.00 H	338	72.30	32.54
2	*2437.00	100.50 AV			1.00 H	338	67.96	32.54
3	4874.00	50.59 PK	74.00	-23.41	1.05 H	221	11.67	38.92
4	4874.00	38.01 AV	54.00	-15.99	1.05 H	221	-0.91	38.92

ANTENNA POLARITY & TEST DISTANCE: VERTICAL AT 3 M								
No.	Freq. (MHz)	Emission Level (dBuV/m)	Limit (dBuV/m)	Margin (dB)	Antenna Height (m)	Table Angle (Degree)	Raw Value (dBuV)	Correction Factor (dB/m)
1	*2437.00	101.46 PK			1.07 V	10	68.92	32.54
2	*2437.00	96.96 AV			1.07 V	10	64.42	32.54
3	4874.00	50.23 PK	74.00	-23.77	1.05 V	26	11.31	38.92
4	4874.00	38.01 AV	54.00	-15.99	1.05 V	26	-0.91	38.92

- REMARKS:**
1. Emission level (dBuV/m) = Raw Value (dBuV) + Correction Factor (dB/m).
 2. Correction Factor (dB/m) = Antenna Factor (dB/m) + Cable Factor (dB).
 3. The other emission levels were very low against the limit.
 4. Margin value = Emission level – Limit value.
 5. “ * “: Fundamental frequency.

EUT TEST CONDITION		MEASUREMENT DETAIL	
CHANNEL	Channel 11	FREQUENCY RANGE	1 ~ 25GHz
MODULATION TYPE	DBPSK	DETECTOR FUNCTION	Peak (PK) Average (AV)
TRANSFER RATE	1Mbps	ENVIRONMENTAL CONDITIONS	25deg. C, 65%RH, 991hPa
INPUT POWER (SYSTEM)	120Vac, 60 Hz	TESTED BY	Dean Wang

ANTENNA POLARITY & TEST DISTANCE: HORIZONTAL AT 3 M								
No.	Freq. (MHz)	Emission Level (dBuV/m)	Limit (dBuV/m)	Margin (dB)	Antenna Height (m)	Table Angle (Degree)	Raw Value (dBuV)	Correction Factor (dB/m)
1	*2462.00	102.49 PK			1.19 H	331	69.83	32.66
2	*2462.00	98.17 AV			1.19 H	331	65.51	32.66
3	2483.50	59.13 PK	74.00	-14.87	1.16 H	330	26.38	32.75
4	2483.50	48.11 AV	54.00	-5.89	1.16 H	330	15.36	32.75
5	4924.00	51.08 PK	74.00	-22.92	1.21 H	62	12.02	39.06
6	4924.00	37.81 AV	54.00	-16.19	1.21 H	62	-1.25	39.06

ANTENNA POLARITY & TEST DISTANCE: VERTICAL AT 3 M								
No.	Freq. (MHz)	Emission Level (dBuV/m)	Limit (dBuV/m)	Margin (dB)	Antenna Height (m)	Table Angle (Degree)	Raw Value (dBuV)	Correction Factor (dB/m)
1	*2462.00	98.41 PK			1.05 V	1	65.75	32.66
2	*2462.00	94.30 AV			1.05 V	1	61.64	32.66
3	2483.50	57.44 PK	74.00	-16.56	1.03 V	3	24.69	32.75
4	2483.50	47.33 AV	54.00	-6.67	1.03 V	3	14.58	32.75
5	4924.00	50.39 PK	74.00	-23.61	1.00 V	126	11.33	39.06
6	4924.00	37.70 AV	54.00	-16.30	1.00 V	126	-1.36	39.06

- REMARKS:**
1. Emission level (dBuV/m) = Raw Value (dBuV) + Correction Factor (dB/m).
 2. Correction Factor (dB/m) = Antenna Factor (dB/m) + Cable Factor (dB).
 3. The other emission levels were very low against the limit.
 4. Margin value = Emission level – Limit value.
 5. “ * “: Fundamental frequency.

802.11g OFDM MODULATION

EUT TEST CONDITION		MEASUREMENT DETAIL	
CHANNEL	Channel 1	FREQUENCY RANGE	1 ~ 25GHz
MODULATION TYPE	BPSK	DETECTOR FUNCTION	Peak (PK) Average (AV)
TRANSFER RATE	6Mbps	ENVIRONMENTAL CONDITIONS	27deg. C, 65%RH, 991hPa
INPUT POWER (SYSTEM)	120Vac, 60 Hz	TESTED BY	Dean Wang

ANTENNA POLARITY & TEST DISTANCE: HORIZONTAL AT 3 M								
No.	Freq. (MHz)	Emission Level (dBuV/m)	Limit (dBuV/m)	Margin (dB)	Antenna Height (m)	Table Angle (Degree)	Raw Value (dBuV)	Correction Factor (dB/m)
1	2390.00	67.05 PK	74.00	-6.95	1.00 H	331	34.72	32.33
2	2390.00	52.78 AV	54.00	-1.22	1.00 H	331	20.45	32.33
3	*2412.00	108.06 PK			1.00 H	326	75.63	32.43
4	*2412.00	97.70 AV			1.00 H	326	65.27	32.43
5	4824.00	52.64 PK	74.00	-21.36	1.00 H	63	13.88	38.76
6	4824.00	38.81 AV	54.00	-15.19	1.00 H	63	0.05	38.76

ANTENNA POLARITY & TEST DISTANCE: VERTICAL AT 3 M								
No.	Freq. (MHz)	Emission Level (dBuV/m)	Limit (dBuV/m)	Margin (dB)	Antenna Height (m)	Table Angle (Degree)	Raw Value (dBuV)	Correction Factor (dB/m)
1	2390.00	65.24 PK	74.00	-8.76	1.08 V	10	32.91	32.33
2	2390.00	52.04 AV	54.00	-1.96	1.08 V	10	19.71	32.33
3	*2412.00	106.72 PK			1.08 V	9	74.29	32.43
4	*2412.00	97.03 AV			1.08 V	9	64.60	32.43
5	4824.00	51.64 PK	74.00	-22.36	1.00 V	63	12.88	38.76
6	4824.00	38.41 AV	54.00	-15.59	1.00 V	63	-0.35	38.76

- REMARKS:**
1. Emission level (dBuV/m) = Raw Value (dBuV) + Correction Factor (dB/m).
 2. Correction Factor (dB/m) = Antenna Factor (dB/m) + Cable Factor (dB).
 3. The other emission levels were very low against the limit.
 4. Margin value = Emission level – Limit value.
 5. " * ": Fundamental frequency.

EUT TEST CONDITION		MEASUREMENT DETAIL	
CHANNEL	Channel 6	FREQUENCY RANGE	1 ~ 25GHz
MODULATION TYPE	BPSK	DETECTOR FUNCTION	Peak (PK) Average (AV)
TRANSFER RATE	6Mbps	ENVIRONMENTAL CONDITIONS	27deg. C, 65%RH, 991hPa
INPUT POWER (SYSTEM)	120Vac, 60 Hz	TESTED BY	Dean Wang

ANTENNA POLARITY & TEST DISTANCE: HORIZONTAL AT 3 M								
No.	Freq. (MHz)	Emission Level (dBuV/m)	Limit (dBuV/m)	Margin (dB)	Antenna Height (m)	Table Angle (Degree)	Raw Value (dBuV)	Correction Factor (dB/m)
1	*2437.00	106.85 PK			1.00 H	326	74.31	32.54
2	*2437.00	96.52 AV			1.00 H	326	63.98	32.54
3	4874.00	52.83 PK	74.00	-21.17	1.00 H	58	13.91	38.92
4	4874.00	38.91 AV	54.00	-15.09	1.00 H	58	-0.01	38.92

ANTENNA POLARITY & TEST DISTANCE: VERTICAL AT 3 M								
No.	Freq. (MHz)	Emission Level (dBuV/m)	Limit (dBuV/m)	Margin (dB)	Antenna Height (m)	Table Angle (Degree)	Raw Value (dBuV)	Correction Factor (dB/m)
1	*2437.00	105.68 PK			1.05 V	23	73.14	32.54
2	*2437.00	95.47 AV			1.05 V	23	62.93	32.54
3	4874.00	51.96 PK	74.00	-22.04	1.02 V	26	13.04	38.92
4	4874.00	38.09 AV	54.00	-15.91	1.02 V	26	-0.83	38.92

- REMARKS:**
1. Emission level (dBuV/m) = Raw Value (dBuV) + Correction Factor (dB/m).
 2. Correction Factor (dB/m) = Antenna Factor (dB/m) + Cable Factor (dB).
 3. The other emission levels were very low against the limit.
 4. Margin value = Emission level – Limit value.
 5. “ * “: Fundamental frequency.

EUT TEST CONDITION		MEASUREMENT DETAIL	
CHANNEL	Channel 11	FREQUENCY RANGE	1 ~ 25GHz
MODULATION TYPE	BPSK	DETECTOR FUNCTION	Peak (PK) Average (AV)
TRANSFER RATE	6Mbps	ENVIRONMENTAL CONDITIONS	27deg. C, 65%RH, 991hPa
INPUT POWER (SYSTEM)	120Vac, 60 Hz	TESTED BY	Dean Wang

ANTENNA POLARITY & TEST DISTANCE: HORIZONTAL AT 3 M								
No.	Freq. (MHz)	Emission Level (dBuV/m)	Limit (dBuV/m)	Margin (dB)	Antenna Height (m)	Table Angle (Degree)	Raw Value (dBuV)	Correction Factor (dB/m)
1	*2462.00	105.11 PK			1.22 H	324	72.45	32.66
2	*2462.00	95.66 AV			1.22 H	324	63.00	32.66
3	2483.50	65.40 PK	74.00	-8.60	1.22 H	323	32.65	32.75
4	2483.50	50.60 AV	54.00	-3.40	1.22 H	323	17.85	32.75
5	4924.00	51.34 PK	74.00	-22.66	1.00 H	123	12.28	39.06
6	4924.00	38.38 AV	54.00	-15.62	1.00 H	123	-0.68	39.06

ANTENNA POLARITY & TEST DISTANCE: VERTICAL AT 3 M								
No.	Freq. (MHz)	Emission Level (dBuV/m)	Limit (dBuV/m)	Margin (dB)	Antenna Height (m)	Table Angle (Degree)	Raw Value (dBuV)	Correction Factor (dB/m)
1	*2462.00	104.71 PK			1.10 V	23	72.05	32.66
2	*2462.00	94.57 AV			1.10 V	23	61.91	32.66
3	2483.50	61.07 PK	74.00	-12.93	1.10 V	22	28.32	32.75
4	2483.50	49.70 AV	54.00	-4.30	1.10 V	22	16.95	32.75
5	4924.00	51.38 PK	74.00	-22.62	1.00 V	21	12.32	39.06
6	4924.00	38.78 AV	54.00	-15.22	1.00 V	21	-0.28	39.06

- REMARKS:**
1. Emission level (dBuV/m) = Raw Value (dBuV) + Correction Factor (dB/m).
 2. Correction Factor (dB/m) = Antenna Factor (dB/m) + Cable Factor (dB).
 3. The other emission levels were very low against the limit.
 4. Margin value = Emission level – Limit value.
 5. “ * “: Fundamental frequency.



4.3 6dB BANDWIDTH MEASUREMENT

4.3.1 LIMITS OF 6dB BANDWIDTH MEASUREMENT

The minimum of 6dB Bandwidth Measurement is 0.5 MHz.

4.3.2 TEST INSTRUMENTS

DESCRIPTION & MANUFACTURER	MODEL NO.	SERIAL NO.	CALIBRATED UNTIL
SPECTRUM ANALYZER	FSP40	100040	Jun. 07, 2007

NOTE: The calibration interval of the above test instruments is 12 months and the calibrations are traceable to NML/ROC and NIST/USA.

4.3.3 TEST PROCEDURE

The transmitter output was connected to the spectrum analyzer through an attenuator. The bandwidth of the fundamental frequency was measured by spectrum analyzer with 100kHz RBW and 100kHz VBW. The 6dB bandwidth is defined as the total spectrum the power of which is higher than peak power minus 6dB.

4.3.4 DEVIATION FROM TEST STANDARD

No deviation

4.3.5 TEST SETUP

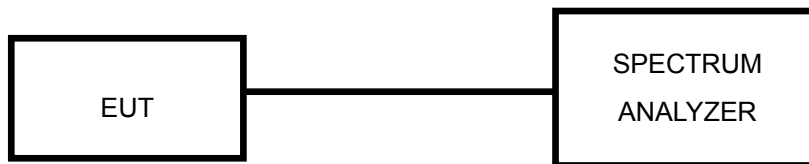

4.3.6 EUT OPERATING CONDITIONS

The software provided by client to enable the EUT under transmission condition continuously at lowest, middle and highest channel frequencies individually.

4.3.7 TEST RESULTS

802.11b DSSS MODULATION

MODULATION TYPE	DBPSK	TRANSFER RATE	1Mbps
INPUT POWER (SYSTEM)	120Vac, 60 Hz	ENVIRONMENTAL CONDITIONS	25deg. C, 68%RH, 991hPa
TESTED BY	Morgan Chen		

CHANNEL	CHANNEL FREQUENCY (MHz)	6dB BANDWIDTH (MHz)	MINIMUM LIMIT (MHz)	PASS/FAIL
1	2412	10.04	0.5	PASS
6	2437	10.08	0.5	PASS
11	2462	10.16	0.5	PASS

CH 1

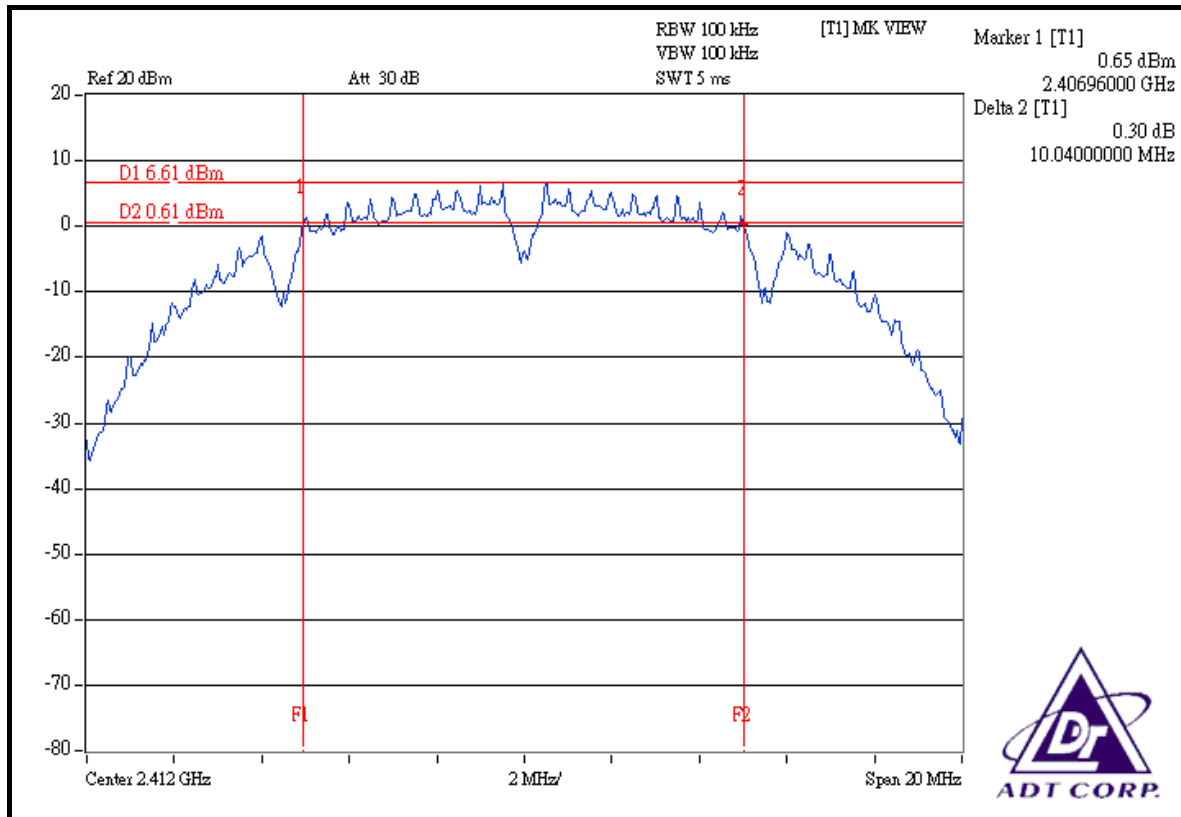



CH 6

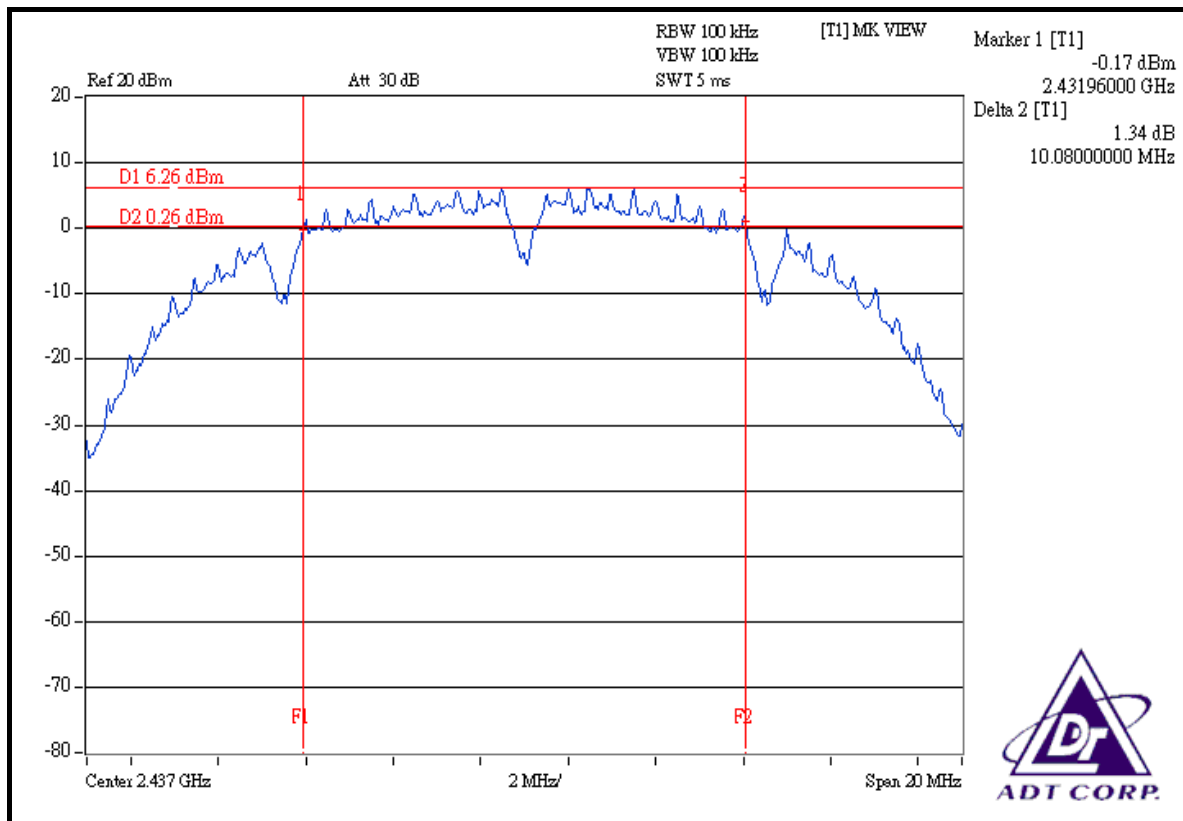

CH 11

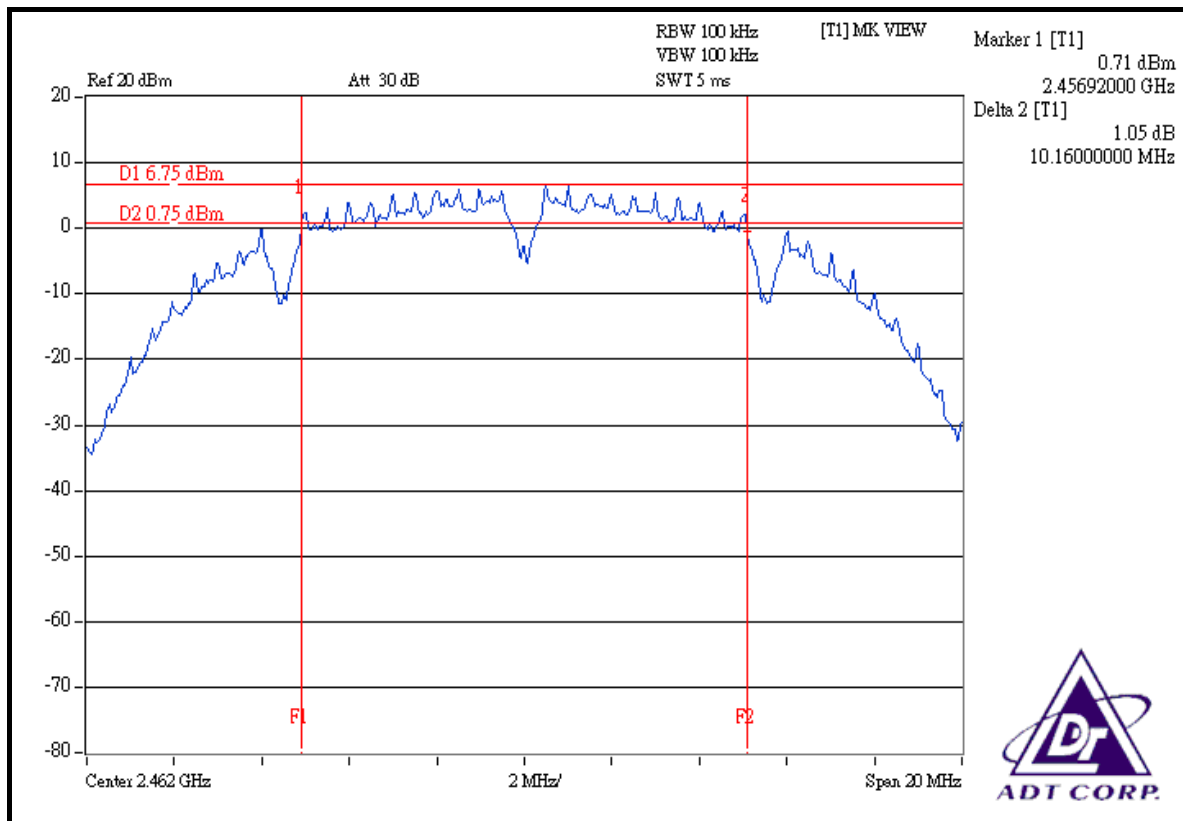



802.11g OFDM MODULATION

MODULATION TYPE	BPSK	TRANSFER RATE	6Mbps
INPUT POWER (SYSTEM)	120Vac, 60 Hz	ENVIRONMENTAL CONDITIONS	25deg. C, 68%RH, 991hPa
TESTED BY	Morgan Chen		

CHANNEL	CHANNEL FREQUENCY (MHz)	6dB BANDWIDTH (MHz)	MINIMUM LIMIT (MHz)	PASS/FAIL
1	2412	16.40	0.5	PASS
6	2437	16.40	0.5	PASS
11	2462	16.40	0.5	PASS

CH 1

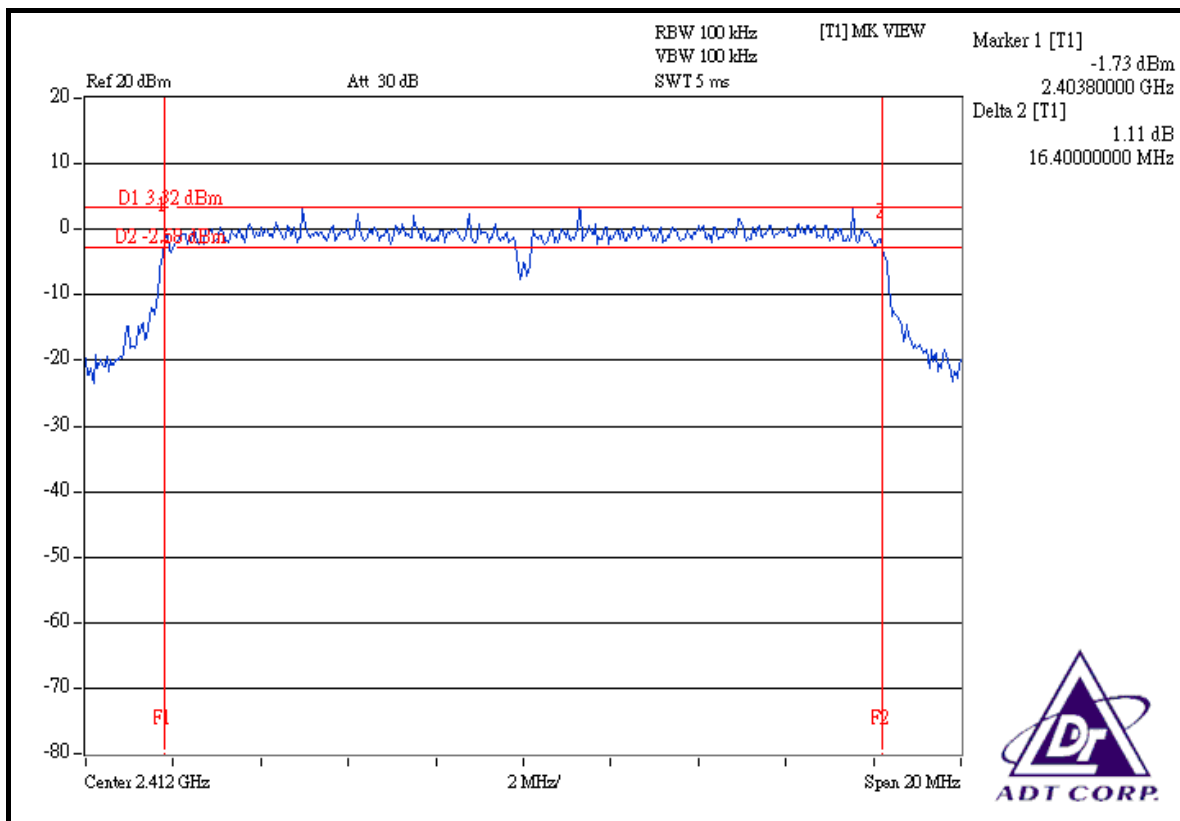



CH 6

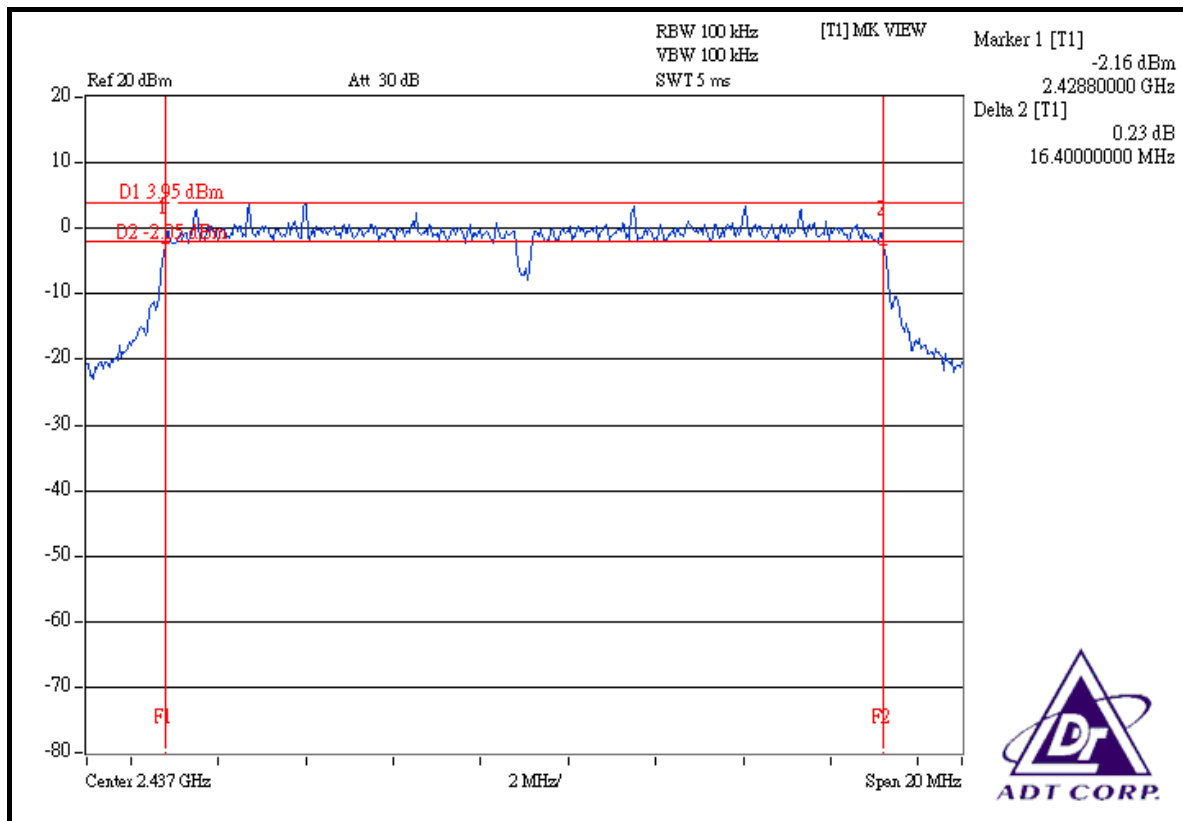

CH 11

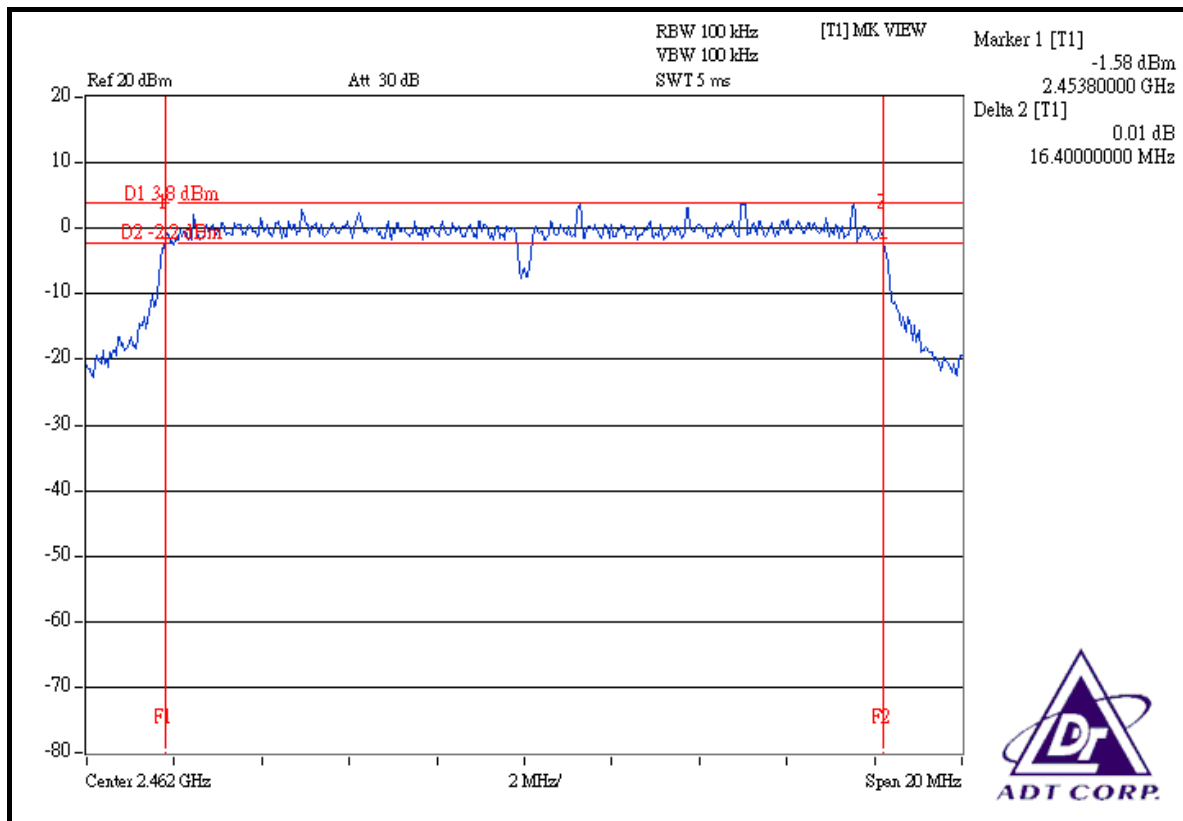



4.4 MAXIMUM PEAK OUTPUT POWER

4.4.1 LIMITS OF MAXIMUM PEAK OUTPUT POWER MEASUREMENT

The Maximum Peak Output Power Measurement is 30dBm.

4.4.2 TEST INSTRUMENTS

DESCRIPTION & MANUFACTURER	MODEL NO.	SERIAL NO.	CALIBRATED UNTIL
R&S SPECTRUM ANALYZER	FSP40	100040	Jun. 07, 2007
R&S SIGNAL GENERATOR	SML03	102843	Aug. 31, 2007
DIGITAL RT OSCILLOSCOPE	TDS1012	C037299	Nov. 27, 2007
NARDA DETECTOR	4503A	FSCM99899	NA

NOTE: The calibration interval of the above test instruments is 12 months and the calibrations are traceable to NML/ROC and NIST/USA.

4.4.3 TEST PROCEDURES

- a. A detector was used on the output port of the EUT. An oscilloscope was used to read the response of the detector.
- b. Replaced the EUT by the signal generator. The center frequency of the S.G was adjusted to the center frequency of the measured channel.
- c. Adjusted the power to have the same reading on oscilloscope. Record the power level.

4.4.4 DEVIATION FROM TEST STANDARD

No deviation

4.4.5 TEST SETUP



4.4.6 EUT OPERATING CONDITIONS

Same as Item 4.3.6

4.4.7 TEST RESULTS

802.11b DSSS MODULATION

MODULATION TYPE	DBPSK	TRANSFER RATE	1Mbps
INPUT POWER (SYSTEM)	120Vac, 60 Hz	ENVIRONMENTAL CONDITIONS	25deg. C, 68%RH, 991hPa
TESTED BY	Morgan Chen		

CHANNEL	CHANNEL FREQUENCY (MHz)	PEAK POWER OUTPUT (mW)	PEAK POWER OUTPUT (dBm)	PEAK POWER LIMIT (dBm)	PASS/FAIL
1	2412	64.269	18.08	30	PASS
6	2437	63.387	18.02	30	PASS
11	2462	63.096	18.00	30	PASS

802.11g OFDM MODULATION

MODULATION TYPE	BPSK	TRANSFER RATE	6Mbps
INPUT POWER (SYSTEM)	120Vac, 60 Hz	ENVIRONMENTAL CONDITIONS	25deg. C, 68%RH, 991hPa
TESTED BY	Morgan Chen		

CHANNEL	CHANNEL FREQUENCY (MHz)	PEAK POWER OUTPUT (mW)	PEAK POWER OUTPUT (dBm)	PEAK POWER LIMIT (dBm)	PASS/FAIL
1	2412	72.444	18.60	30	PASS
6	2437	79.799	19.02	30	PASS
11	2462	79.616	19.01	30	PASS



4.5 POWER SPECTRAL DENSITY MEASUREMENT

4.5.1 LIMITS OF POWER SPECTRAL DENSITY MEASUREMENT

The Maximum of Power Spectral Density Measurement is 8dBm.

4.5.2 TEST INSTRUMENTS

DESCRIPTION & MANUFACTURER	MODEL NO.	SERIAL NO.	CALIBRATED UNTIL
R&S SPECTRUM ANALYZER	FSP40	100040	Jun. 07, 2007

NOTE: The calibration interval of the above test instruments is 12 months and the calibrations are traceable to NML/ROC and NIST/USA.

4.5.3 TEST PROCEDURE

The transmitter output was connected to the spectrum analyzer through an attenuator, the bandwidth of the fundamental frequency was measured with the spectrum analyzer using 3kHz RBW and 30kHz VBW, set sweep time = span/3kHz. The power spectral density was measured and recorded.

The sweep time is allowed to be longer than span/3kHz for a full response of the mixer in the spectrum analyzer.

4.5.4 DEVIATION FROM TEST STANDARD

No deviation

4.5.5 TEST SETUP

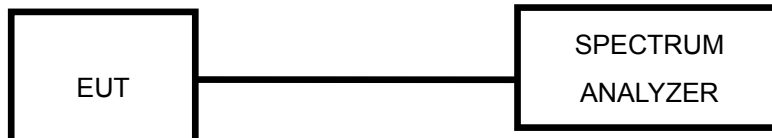

4.5.6 EUT OPERATING CONDITION

Same as Item 4.3.6



4.5.7 TEST RESULTS

802.11b DSSS MODULATION

MODULATION TYPE	DBPSK	TRANSFER RATE	1Mbps
INPUT POWER (SYSTEM)	120Vac, 60 Hz	ENVIRONMENTAL CONDITIONS	25deg. C, 68%RH, 991hPa
TESTED BY	Morgan Chen		

CHANNEL	CHANNEL FREQUENCY (MHz)	RF POWER LEVEL IN 3kHz BW (dBm)	MAXIMUM LIMIT (dBm)	PASS/FAIL
1	2412	-8.27	8	PASS
6	2437	-8.19	8	PASS
11	2462	-8.18	8	PASS

CH 1

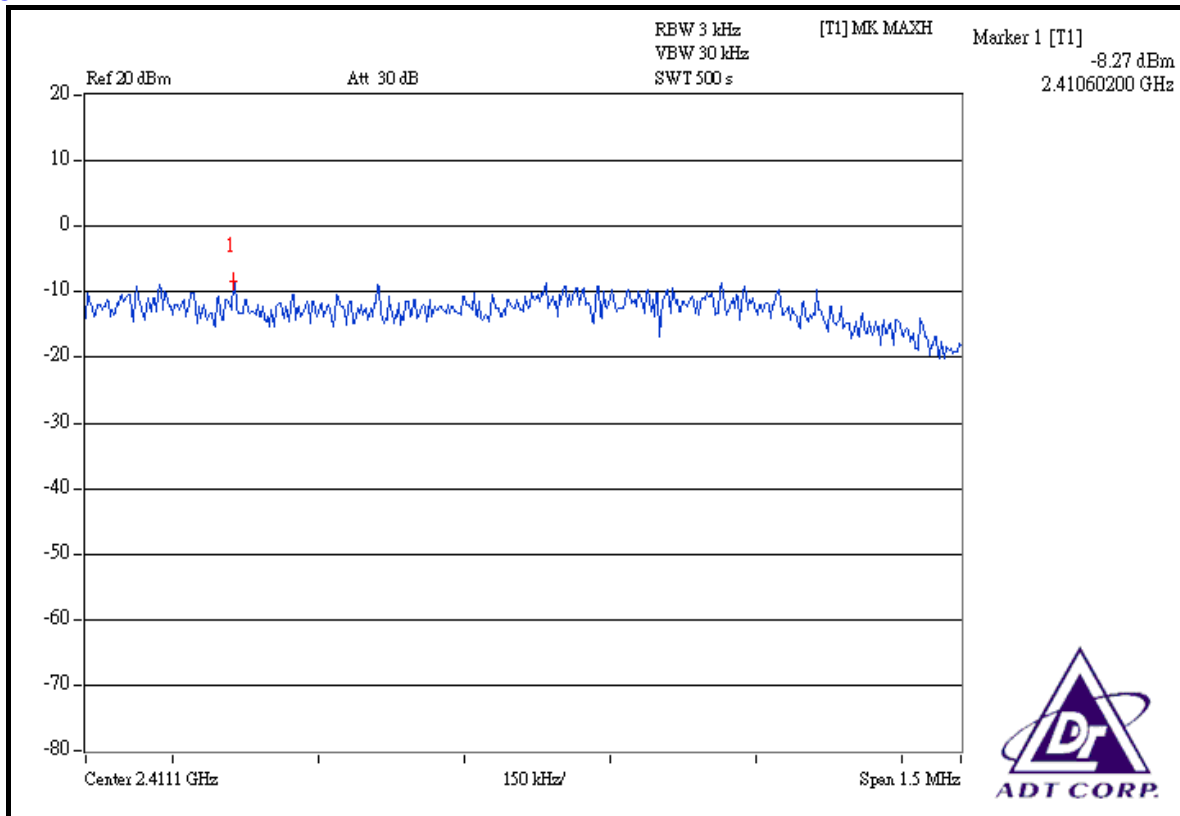



CH 6

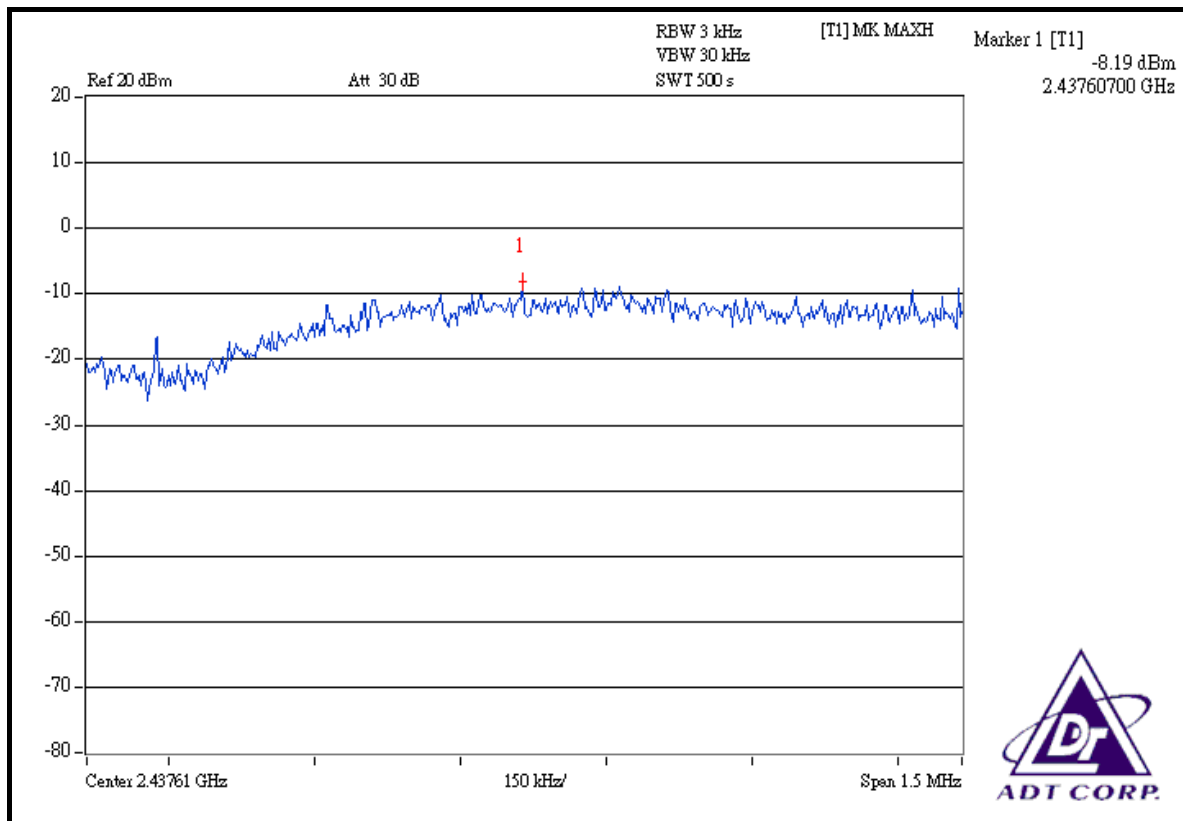

CH 11

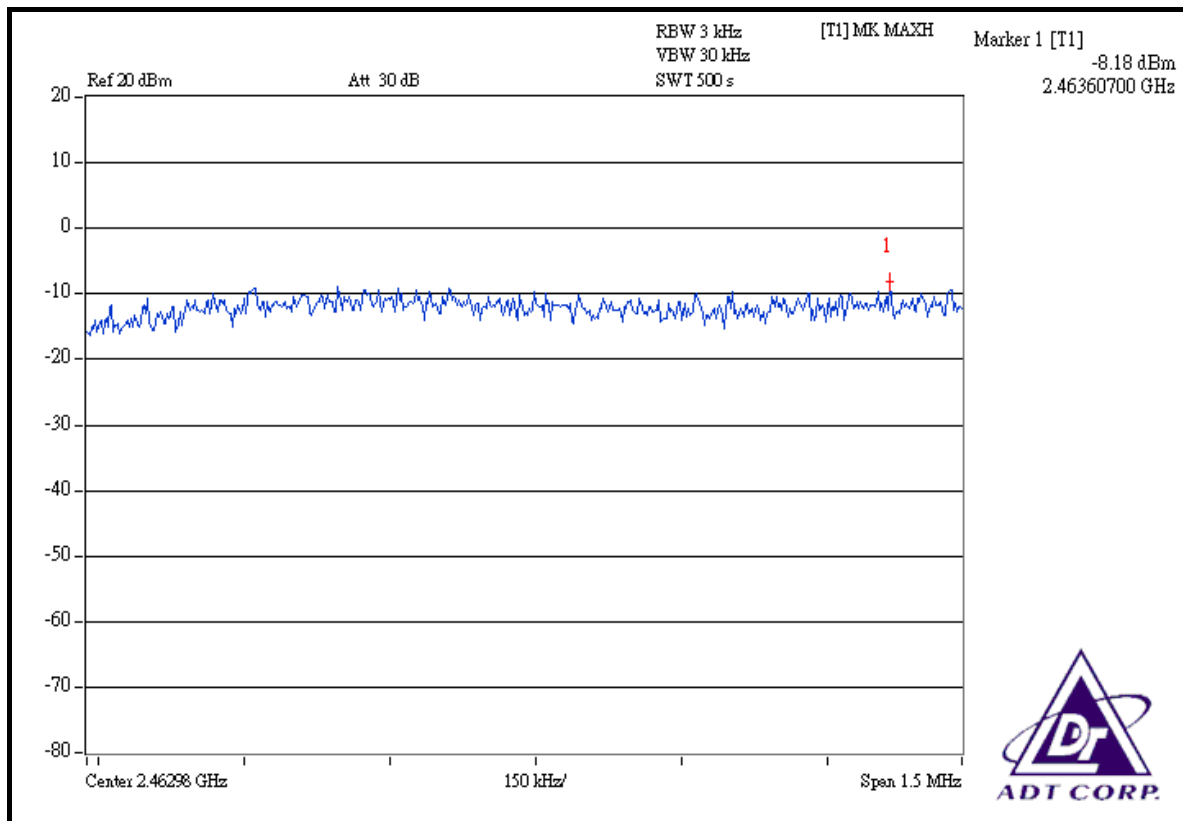



802.11g OFDM MODULATION

MODULATION TYPE	BPSK	TRANSFER RATE	6Mbps
INPUT POWER (SYSTEM)	120Vac, 60 Hz	ENVIRONMENTAL CONDITIONS	25deg. C, 68%RH, 991hPa
TESTED BY	Morgan Chen		

CHANNEL	CHANNEL FREQUENCY (MHz)	RF POWER LEVEL IN 3kHz BW (dBm)	MAXIMUM LIMIT (dBm)	PASS/FAIL
1	2412	-9.86	8	PASS
6	2437	-9.26	8	PASS
11	2462	-9.18	8	PASS

CH 1

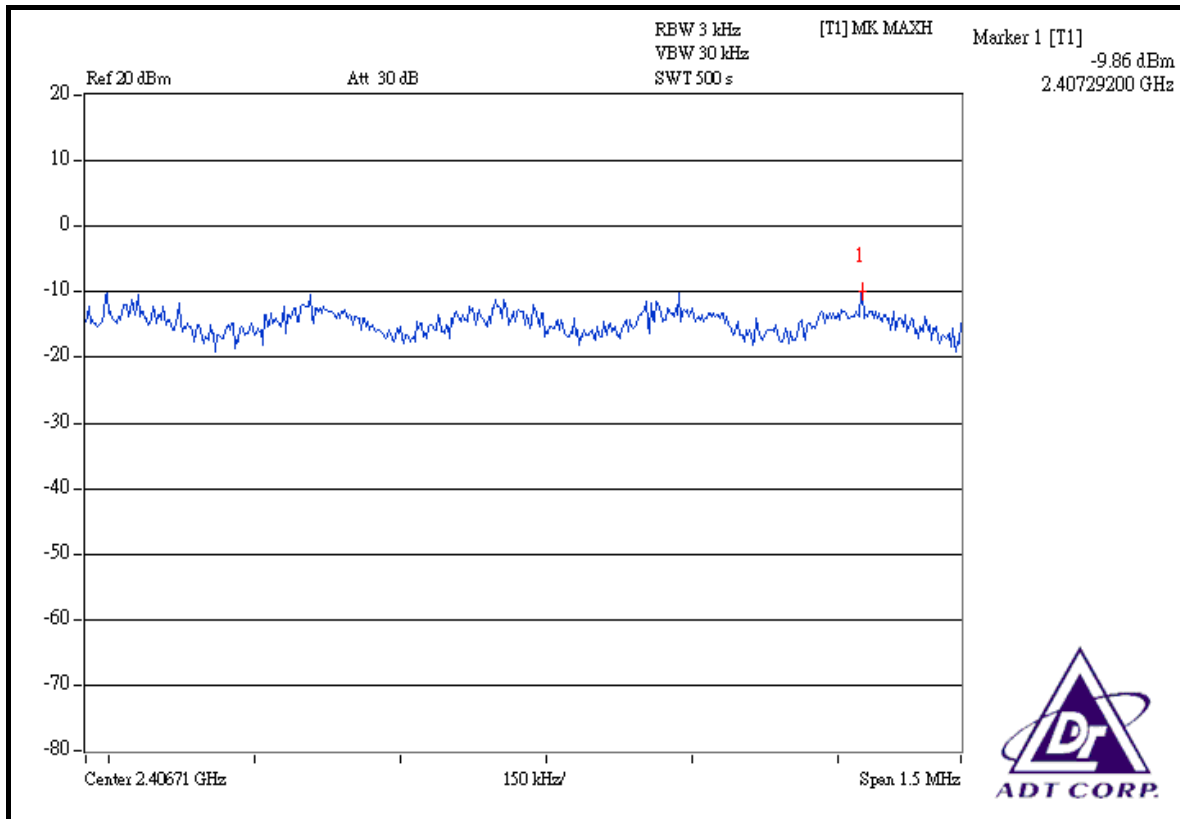



CH 6

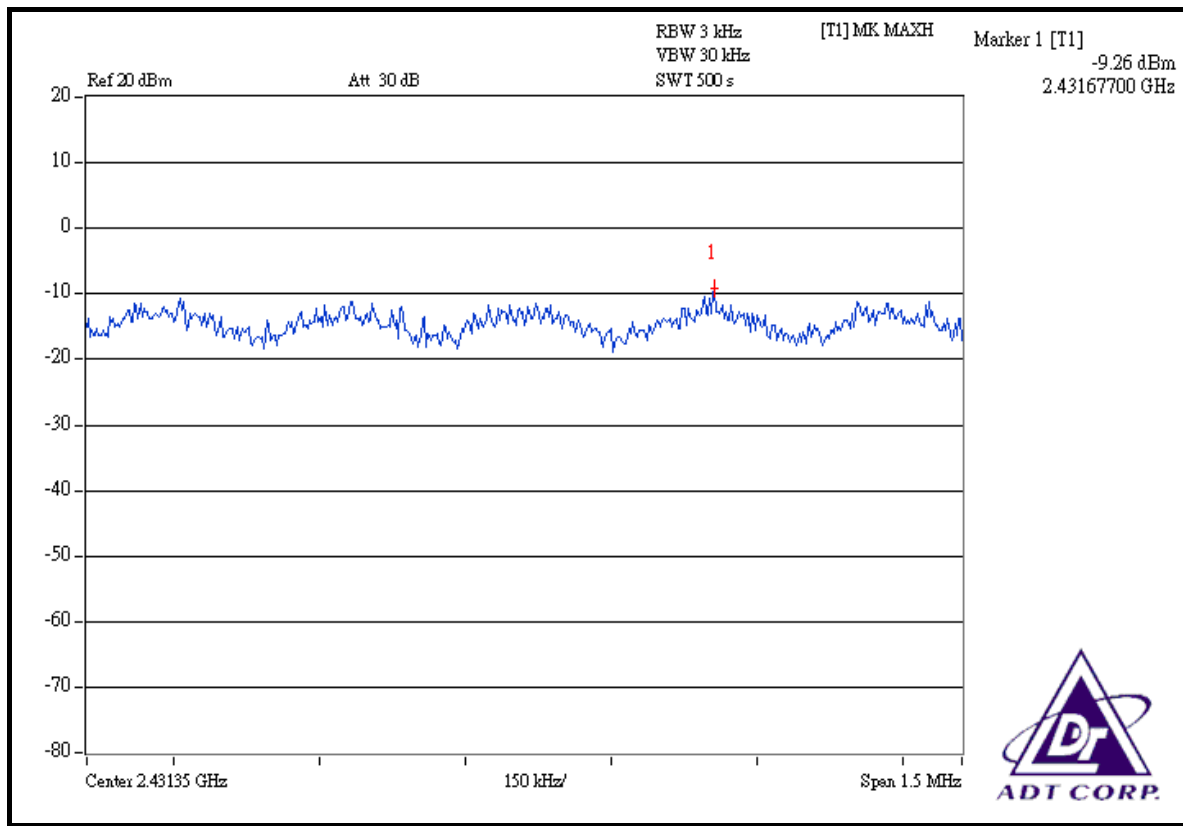

CH 11

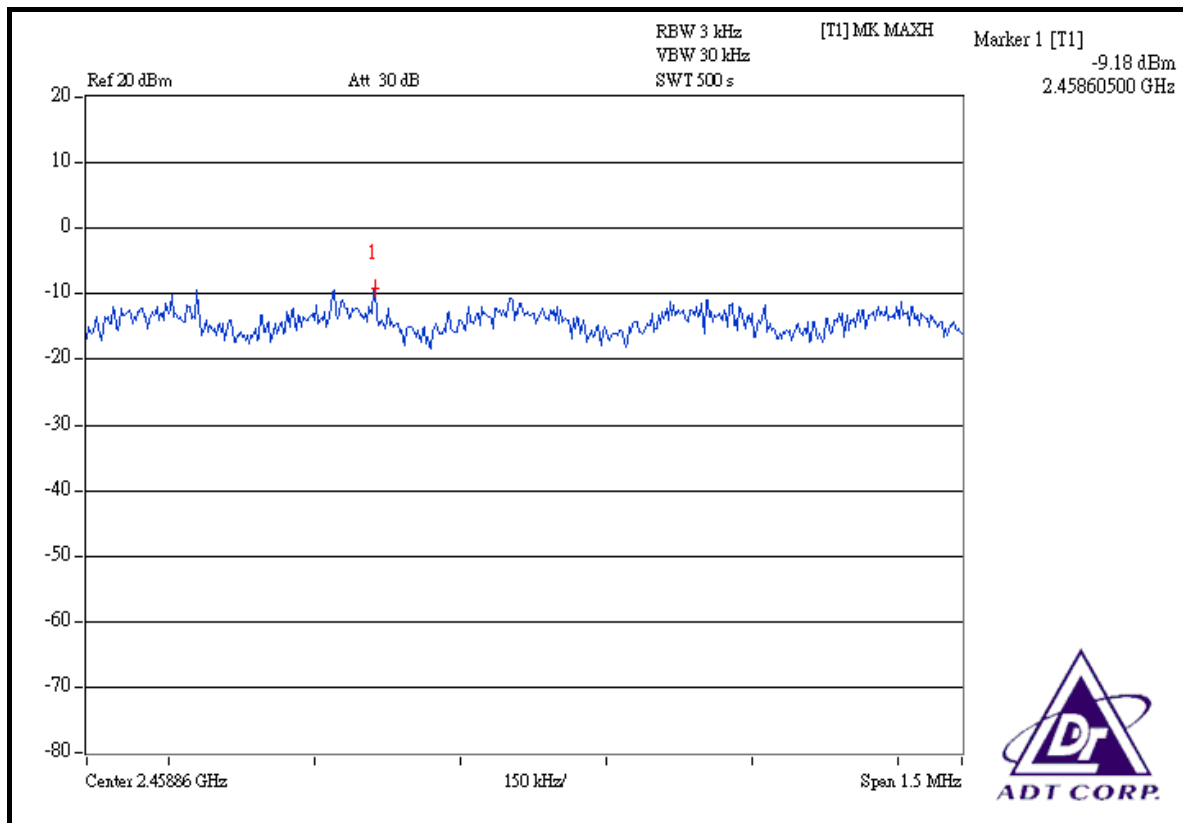



4.6 BAND EDGES MEASUREMENT

4.6.1 LIMITS OF BAND EDGES MEASUREMENT

Below -20dB of the highest emission level of operating band (in 100kHz Resolution Bandwidth).

4.6.2 TEST INSTRUMENTS

DESCRIPTION &	MODEL NO.	SERIAL NO.	CALIBRATED UNTIL
R&S SPECTRUM ANALYZER	FSP40	100040	Jun. 07, 2007

NOTE: The calibration interval of the above test instruments is 12 months and the calibrations are traceable to NML/ROC and NIST/USA.

4.6.3 TEST PROCEDURE

The transmitter output was connected to the spectrum analyzer via a low lose cable. Set both RBW and VBW of spectrum analyzer to 100 kHz and 100 kHz with suitable frequency span including 100 MHz bandwidth from band edge. The band edges was measured and recorded.

The spectrum plots (Peak RBW=VBW=100kHz; Average RBW=1MHz, VBW=10Hz) are attached on the following pages.

4.6.4 DEVIATION FROM TEST STANDARD

No deviation

4.6.5 EUT OPERATING CONDITION

Same as Item 4.3.6



4.6.6 TEST RESULTS

The spectrum plots are attached on the following 12 images. D1 line indicates the highest level, and D2 line indicates the 20dB offset below D1. It shows compliance with the requirement in part 15.247(d).

802.11b DSSS MODULATION

NOTE 1: The band edge emission plot on the next page shows 54.06dBc between carrier maximum power and local maximum emission in restrict band (2.3900GHz). The emission of carrier strength list in the test result of channel 1 at the item 4.2.7 is 106.97dBuV/m (Peak), so the maximum field strength in restrict band is $106.97 - 54.06 = 52.91$ dBuV/m which is under 74dBuV/m limit.

The band edge emission plot of on the next page shows 61.55dBc between carrier maximum power and local maximum emission in restrict band (2.3900GHz). The emission of carrier strength list in the test result of channel 1 at the item 4.2.7 is 102.52dBuV/m (Average), so the maximum field strength in restrict band is $102.52 - 61.55 = 40.97$ dBuV/m which is under 54dBuV/m limit.

NOTE 2: The band edge emission plot on the next second page shows 54.36dBc between carrier maximum power and local maximum emission in restrict band (2.4862GHz). The emission of carrier strength list in the test result of channel 11 at the item 4.2.7 is 102.49dBuV/m (Peak), so the maximum field strength in restrict band is $102.49 - 54.36 = 48.13$ dBuV/m which is under 74dBuV/m limit.

The band edge emission plot on the next third page shows 62.25dBc between carrier maximum power and local maximum emission in restrict band (2.4835GHz). The emission of carrier strength list in the test result of channel 11 at the item 4.2.7 is 98.17dBuV/m (Average), so the maximum field strength in restrict band is $98.17 - 62.25 = 35.92$ dBuV/m which is under 54dBuV/m limit.

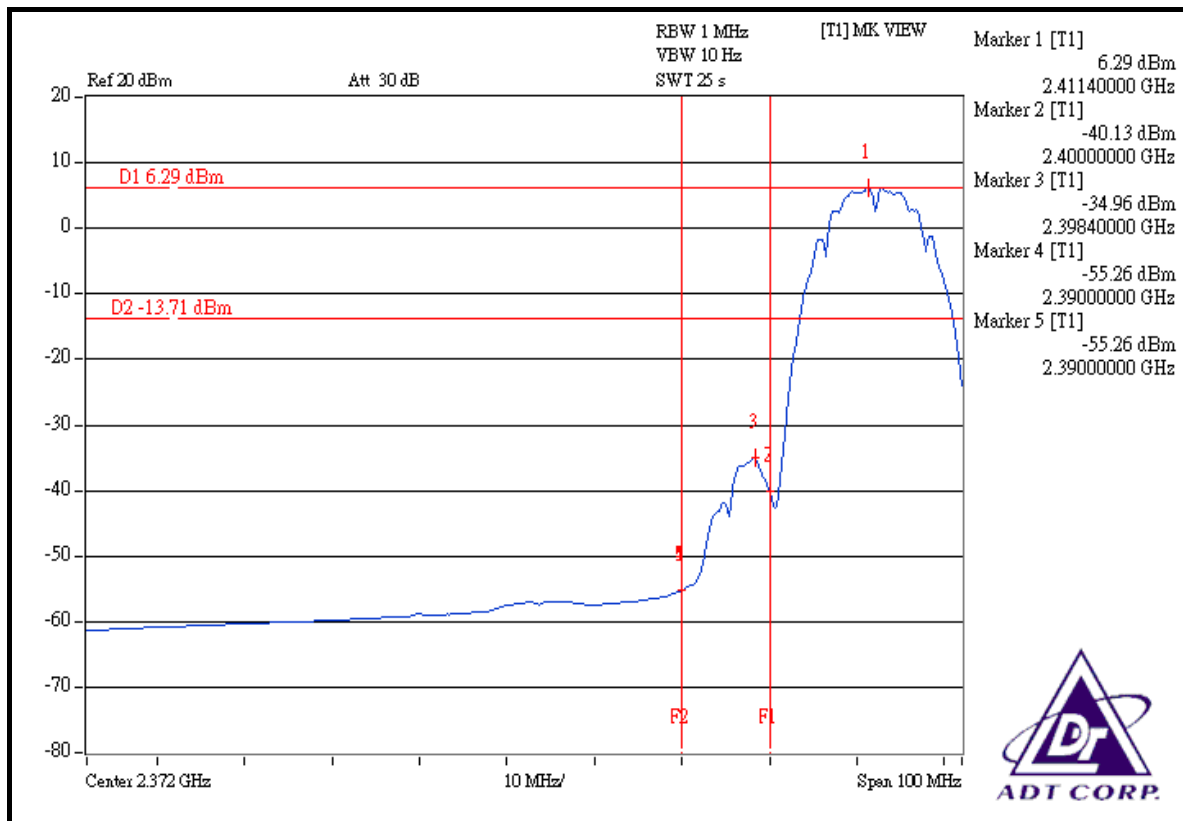
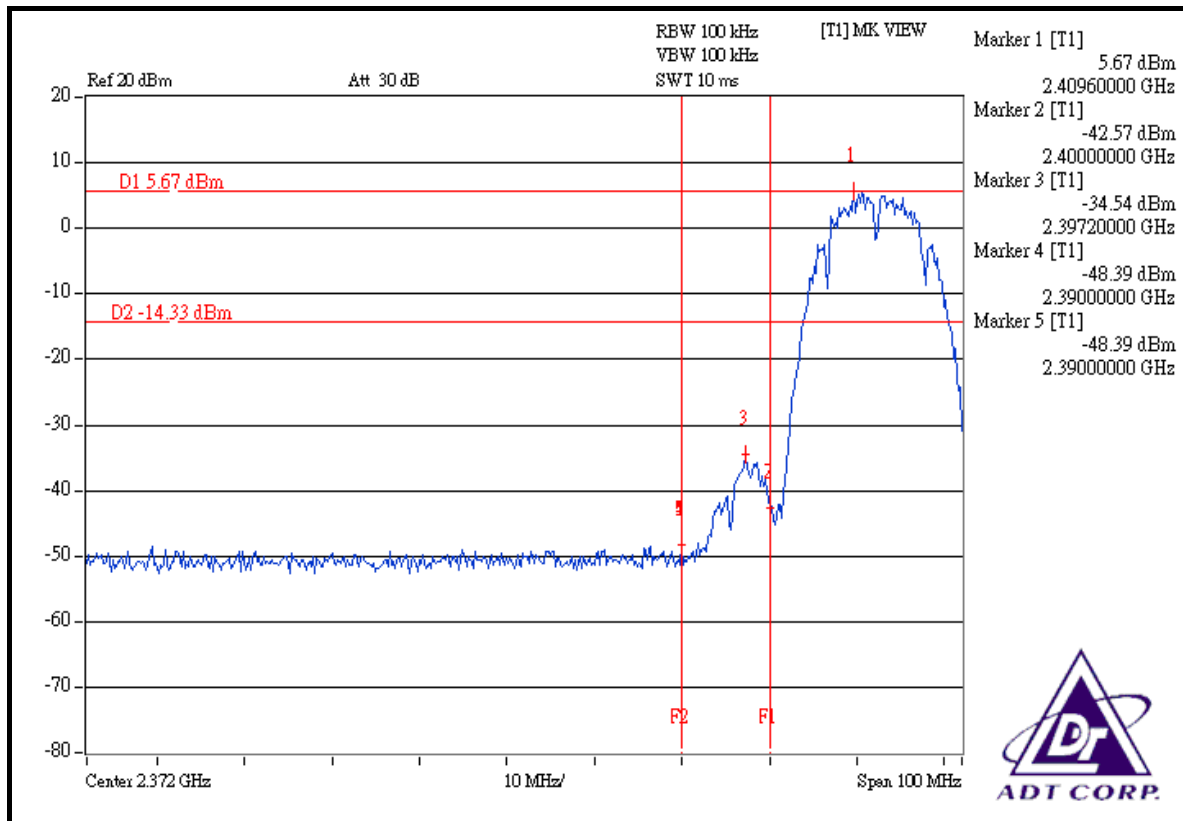

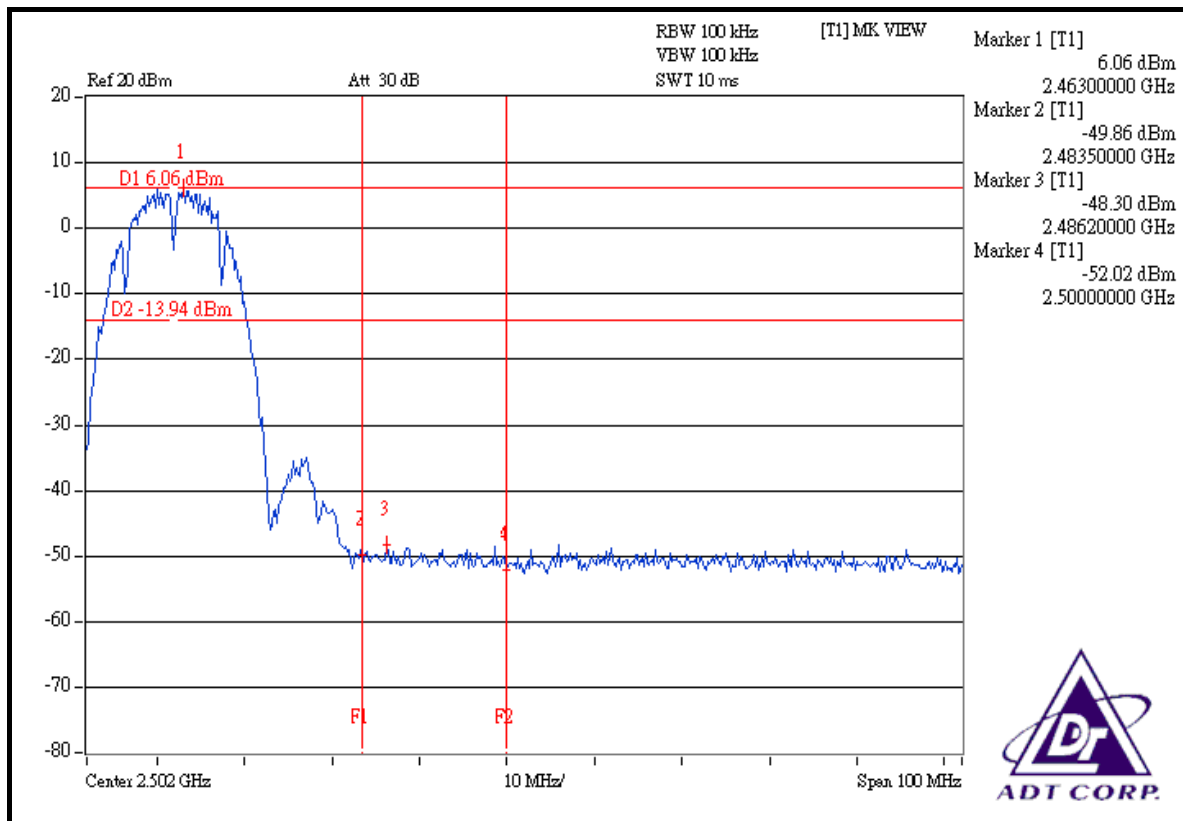
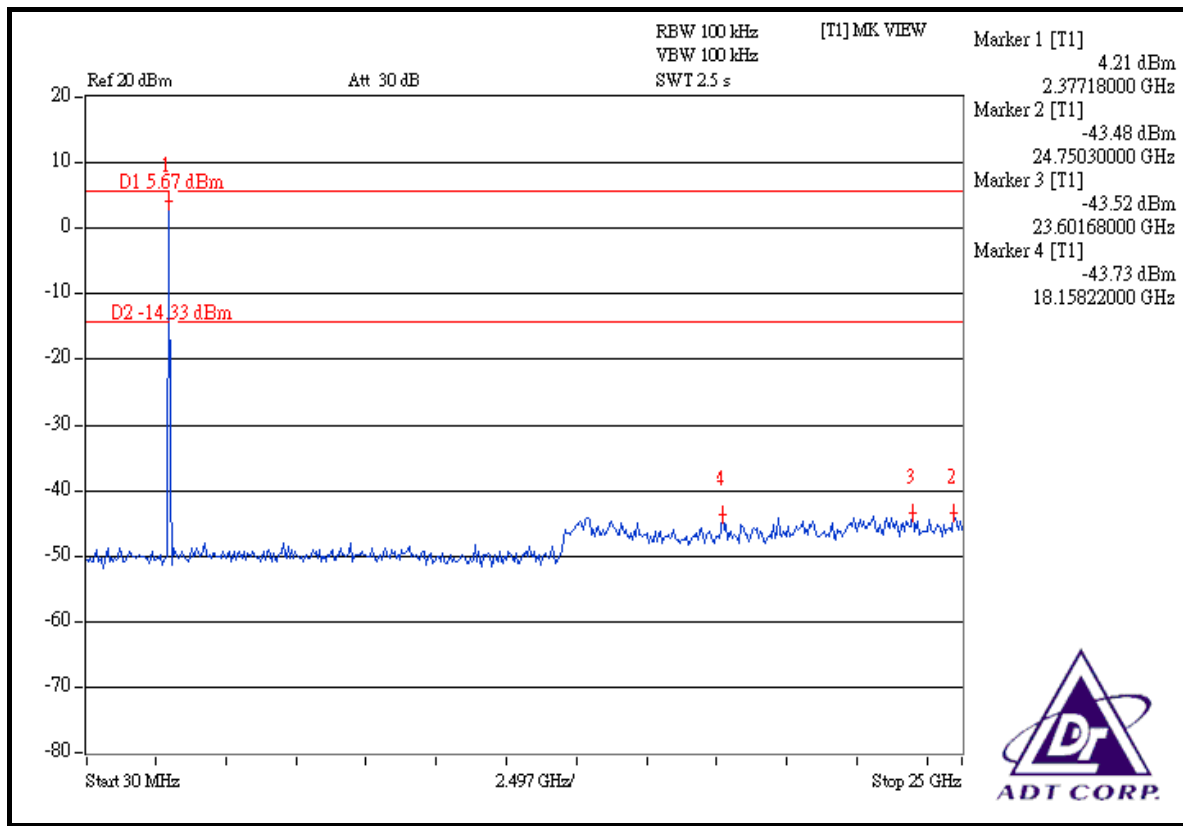

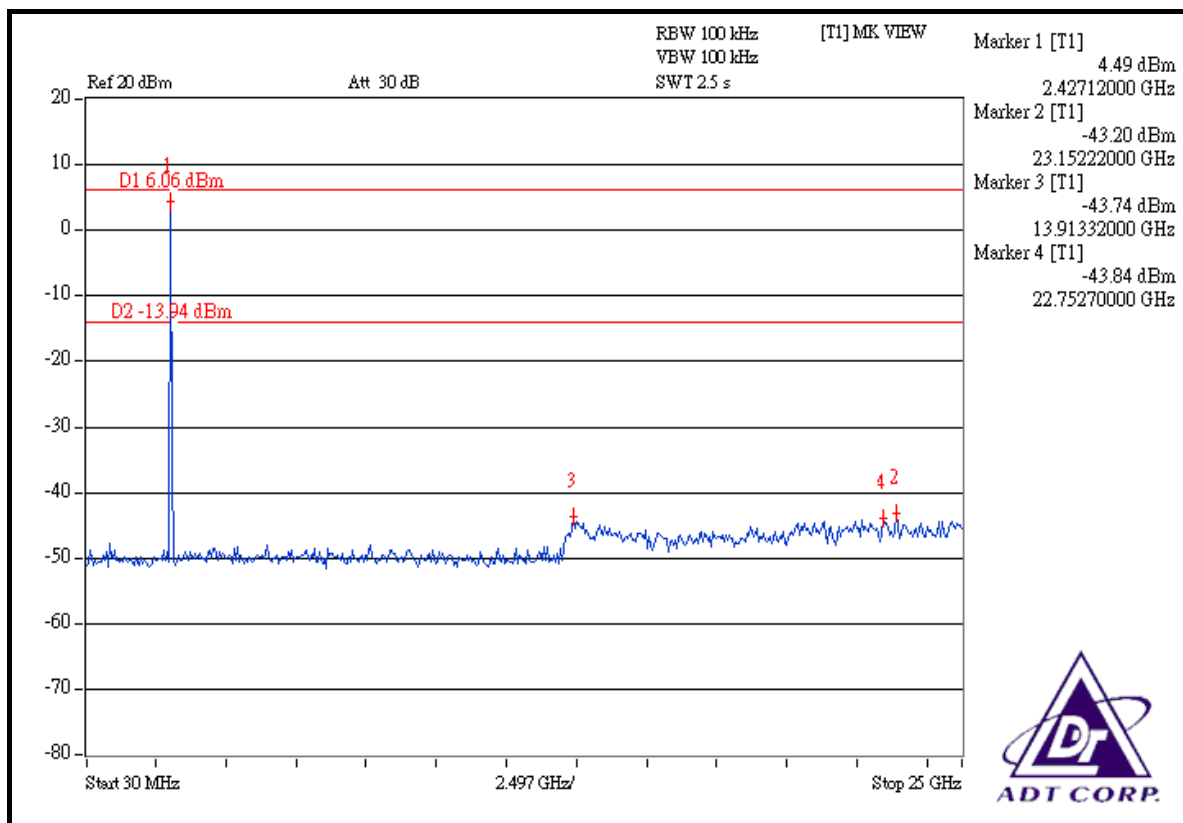
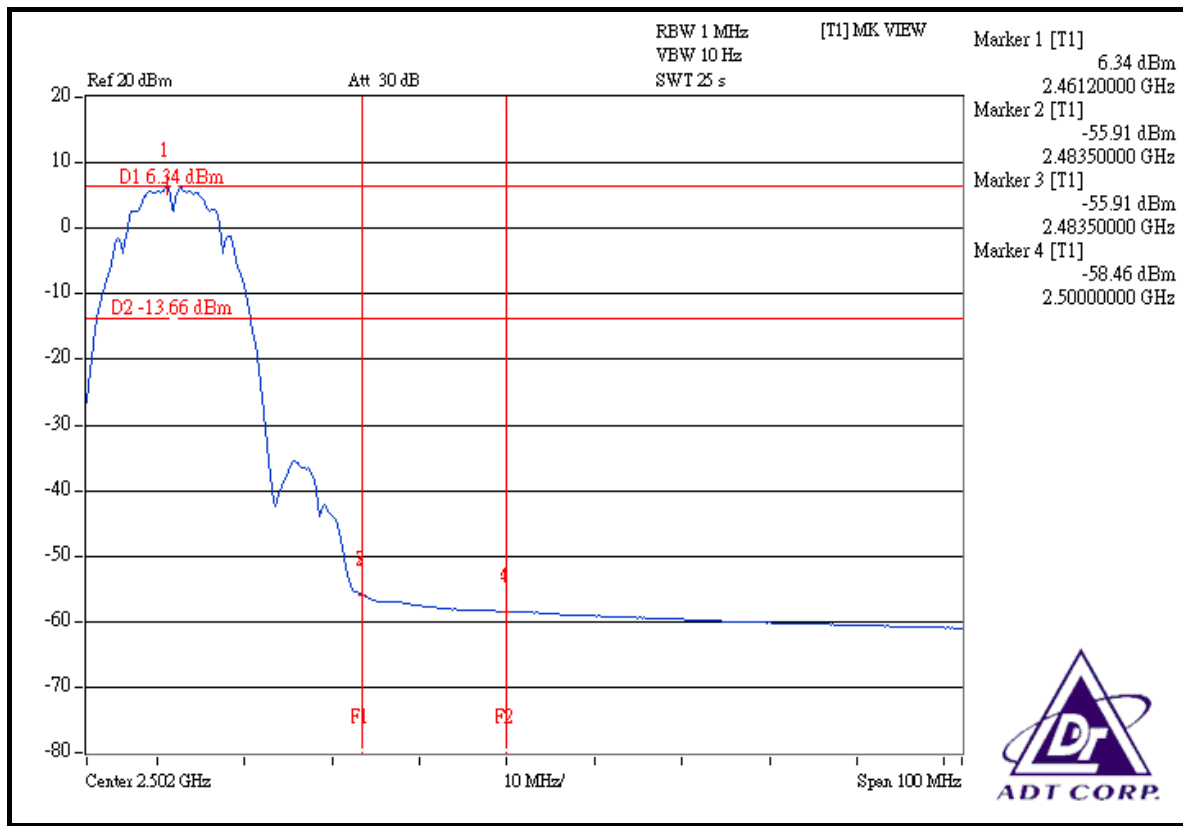



802.11g OFDM MODULATION

NOTE 1: The band edge emission plot on the next page shows 40.09dBc between carrier maximum power and local maximum emission in restrict band (2.3896GHz). The emission of carrier strength list in the test result of channel 1 at the item 4.2.7 is 108.06dBuV/m (Peak), so the maximum field strength in restrict band is $108.06 - 40.09 = 67.97$ dBuV/m which is under 74dBuV/m limit.

The band edge emission plot of on the next page shows 45.47dBc between carrier maximum power and local maximum emission in restrict band (2.3900GHz). The emission of carrier strength list in the test result of channel 1 at the item 4.2.7 is 97.70dBuV/m (Average), so the maximum field strength in restrict band is $97.70 - 45.47 = 52.23$ dBuV/m which is under 54dBuV/m limit.

NOTE 2: The band edge emission plot on the next second page shows 39.38dBc between carrier maximum power and local maximum emission in restrict band (2.4836GHz). The emission of carrier strength list in the test result of channel 11 at the item 4.2.7 is 105.11dBuV/m (Peak), so the maximum field strength in restrict band is $105.11 - 39.38 = 65.73$ dBuV/m which is under 74dBuV/m limit.

The band edge emission plot on the next third page shows 42.73dBc between carrier maximum power and local maximum emission in restrict band (2.4835GHz). The emission of carrier strength list in the test result of channel 11 at the item 4.2.7 is 95.66dBuV/m (Average), so the maximum field strength in restrict band is $95.66 - 42.73 = 52.93$ dBuV/m which is under 54dBuV/m limit.

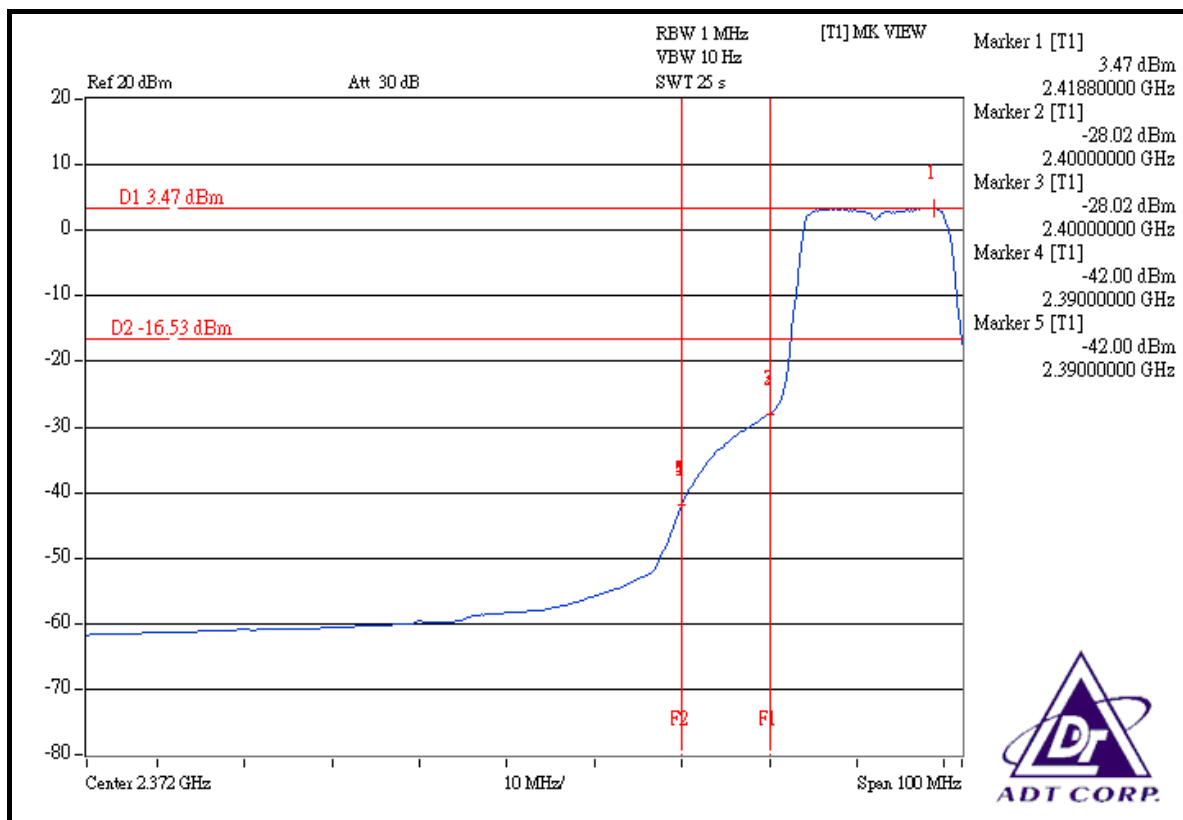
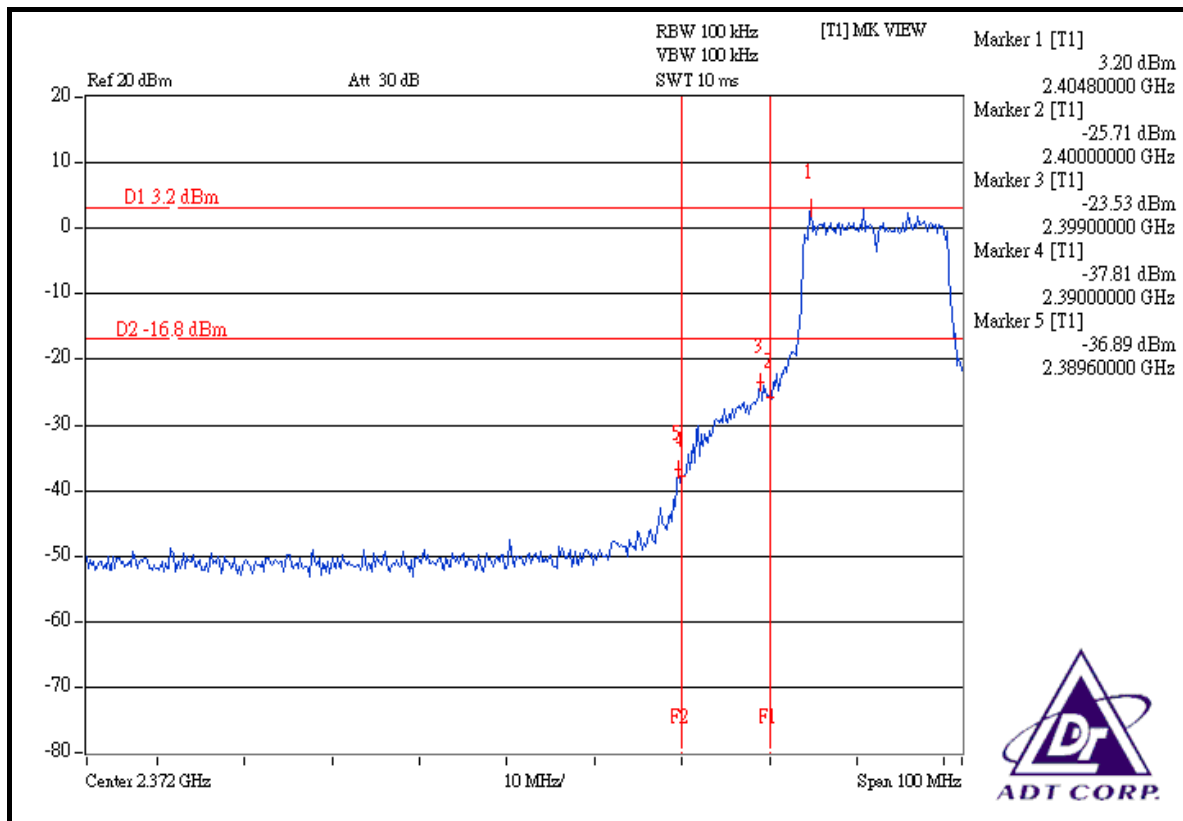

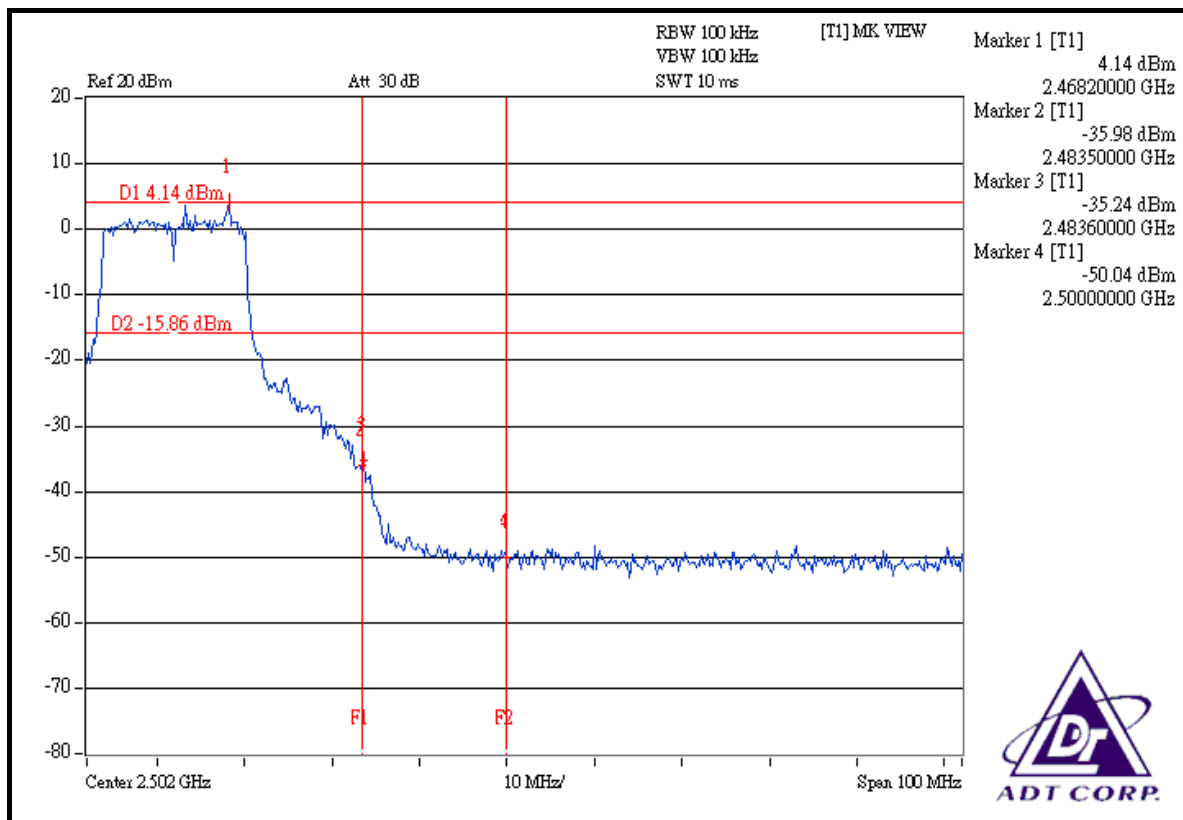
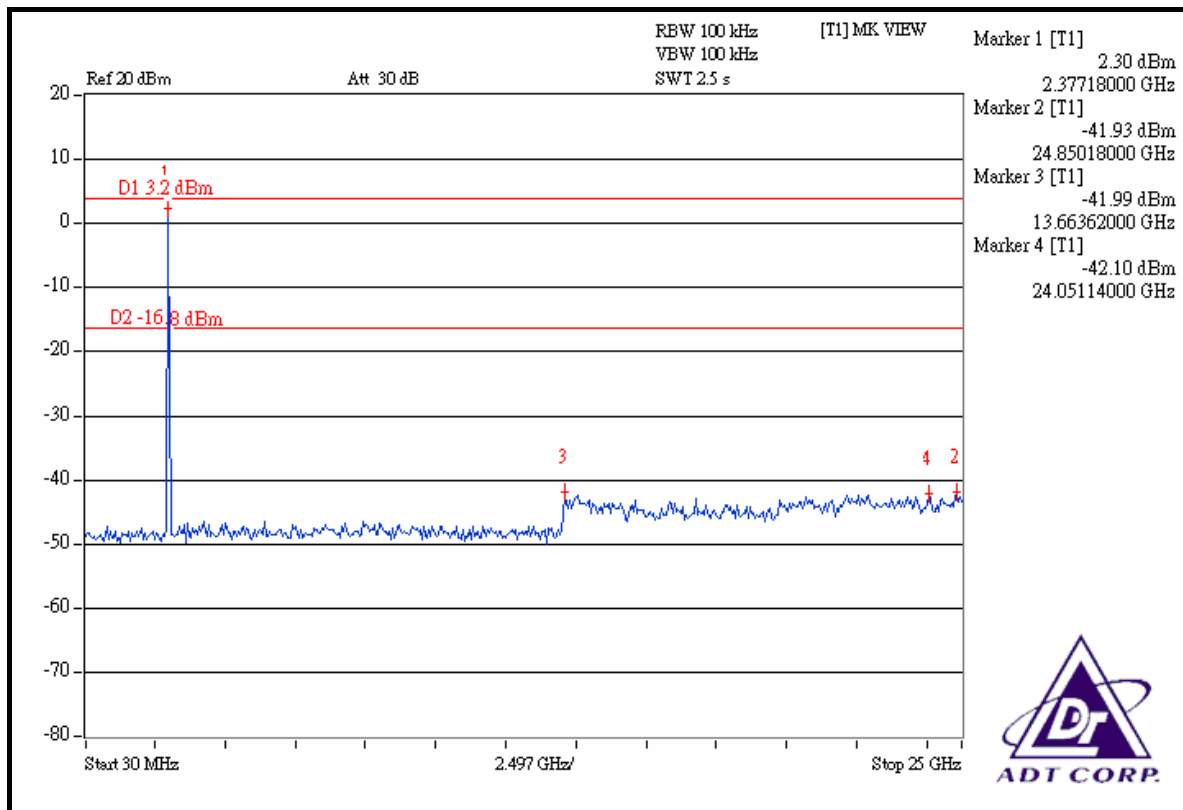

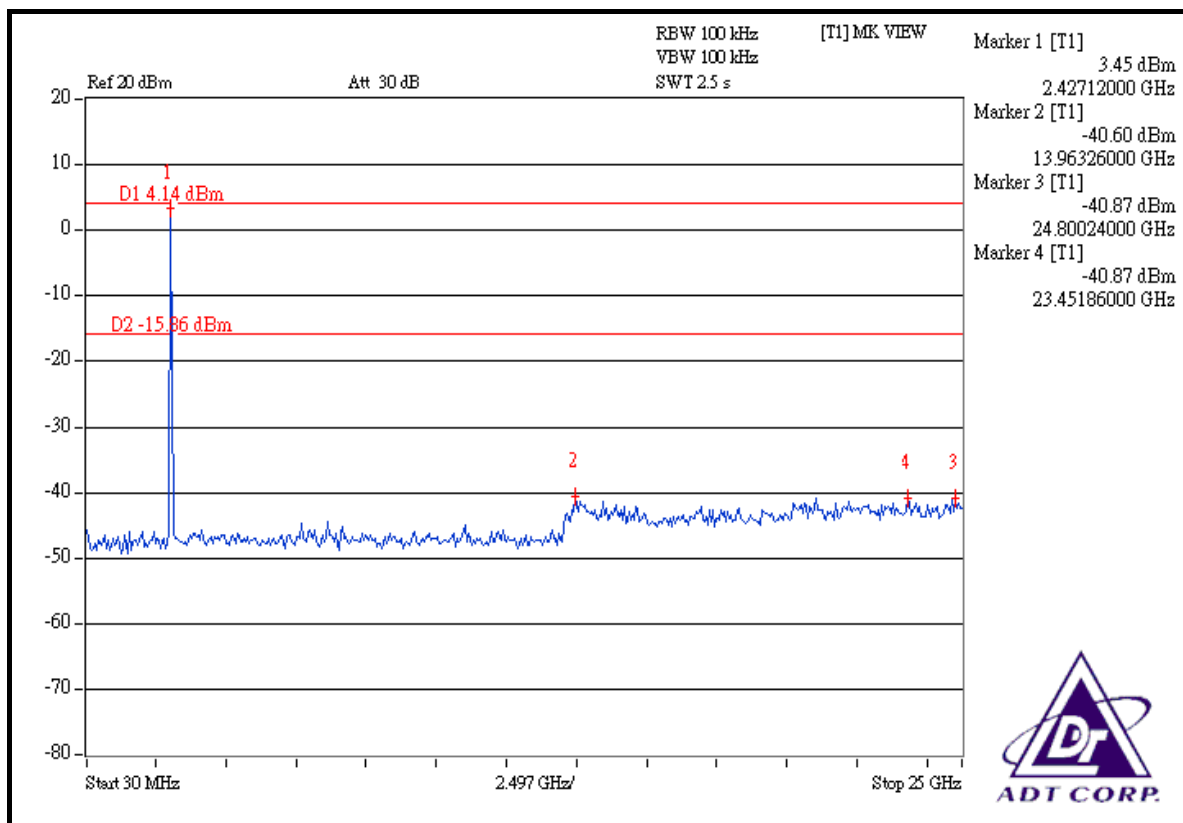
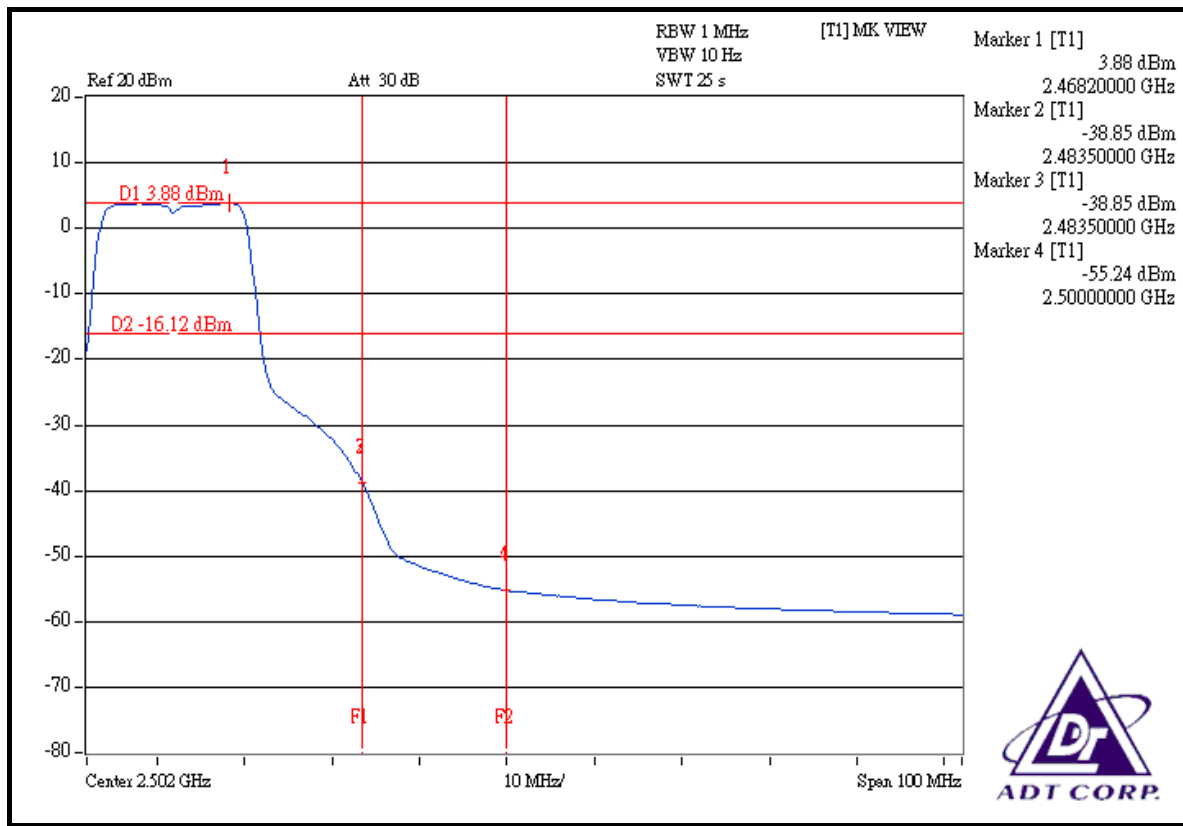



4.7 ANTENNA REQUIREMENT

4.7.1 STANDARD APPLICABLE

For intentional device, according to FCC 47 CFR Section 15.203, an intentional radiator shall be designed to ensure that no antenna other than that furnished by the responsible party shall be used with the device. And according to FCC 47 CFR Section 15.247 (b), if transmitting antennas of directional gain greater than 6dBi are used, the power shall be reduced by the amount in dB that the directional gain of the antenna exceeds 6dBi.

4.7.2 ANTENNA CONNECTED CONSTRUCTION

The antenna used in this product is PIFA antenna without antenna connector. The maximum gain of this antenna is 1dBi.



5. PHOTOGRAPHS OF THE TEST CONFIGURATION

Please refer to the attached file (Test Setup Photo).



6. INFORMATION ON THE TESTING LABORATORIES

We, ADT Corp., were founded in 1988 to provide our best service in EMC, Radio, Telecom and Safety consultation. Our laboratories are accredited and approved by the following approval agencies according to ISO/IEC 17025.

USA	FCC, UL, A2LA
GERMANY	TUV Rheinland
JAPAN	VCCI
NORWAY	NEMKO
CANADA	INDUSTRY CANADA , CSA
R.O.C.	CNLA, BSMI, NCC
NETHERLANDS	Telefication
SINGAPORE	PSB , GOST-ASIA (MOU)
RUSSIA	CERTIS (MOU)

Copies of accreditation certificates of our laboratories obtained from approval agencies can be downloaded from our web site: www.adt.com.tw/index.5/phtml.
If you have any comments, please feel free to contact us at the following:

Linko EMC/RF Lab:
Tel: 886-2-26052180
Fax: 886-2-26051924

Hsin Chu EMC/RF Lab:
Tel: 886-3-5935343
Fax: 886-3-5935342

Hwa Ya EMC/RF/Safety Telecom Lab:
Tel: 886-3-3183232
Fax: 886-3-3185050

Web Site: www.adt.com.tw

The address and road map of all our labs can be found in our web site also.



APPENDIX-A

MODIFICATIONS RECORDERS FOR ENGINEERING CHANGES TO THE EUT BY THE LAB

No any modifications are made to the EUT by the lab during the test