

## FCC Test Report

### (PART 22)

**Report No.:** RF170220C11E-6

**FCC ID:** NM8HTV33

**Test Model:** HTV33

**Received Date:** Feb. 20, 2017

**Test Date:** Mar. 14, 2017 ~ Mar. 18, 2017

**Issued Date:** May 08, 2017

**Applicant:** HTC Corporation

**Address:** 1F, 6-3 Baoqiang Road, Xindian District, New Taipei City, Taiwan 231

**Issued By:** Bureau Veritas Consumer Products Services (H.K.) Ltd., Taoyuan Branch

**Lab Address:** No. 47-2, 14th Ling, Chia Pau Vil., Lin Kou Dist., New Taipei City, Taiwan  
( R.O.C )

**Test Location:** No. 19, Hwa Ya 2nd Rd, Wen Hwa Tsuen, Kwei Shan Hsiang, Taoyuan  
Hsien 333, Taiwan, R.O.C.



This report is for your exclusive use. Any copying or replication of this report to or for any other person or entity, or use of our name or trademark, is permitted only with our prior written permission. This report sets forth our findings solely with respect to the test samples identified herein. The results set forth in this report are not indicative or representative of the quality or characteristics of the lot from which a test sample was taken or any similar or identical product unless specifically and expressly noted. Our report includes all of the tests requested by you and the results thereof based upon the information that you provided to us. You have 60 days from date of issuance of this report to notify us of any material error or omission caused by our negligence, provided, however, that such notice shall be in writing and shall specifically address the issue you wish to raise. A failure to raise such issue within the prescribed time shall constitute your unqualified acceptance of the completeness of this report, the tests conducted and the correctness of the report contents. Unless specific mention, the uncertainty of measurement has been explicitly taken into account to declare the compliance or non-compliance to the specification. The report must not be used by the client to claim product certification, approval, or endorsement by TAF or any government agencies

## Table of Contents

<b>Release Control Record</b> .....	<b>3</b>
<b>1 Certificate of Conformity</b> .....	<b>4</b>
<b>2 Summary of Test Results</b> .....	<b>5</b>
2.1 Measurement Uncertainty .....	5
2.2 Test Site and Instruments .....	6
<b>3 General Information</b> .....	<b>7</b>
3.1 General Description of EUT .....	7
3.2 Configuration of System under Test.....	9
3.2.1 Description of Support Units .....	9
3.3 Test Mode Applicability and Tested Channel Detail .....	10
3.4 EUT Operating Conditions .....	13
3.5 General Description of Applied Standards.....	13
<b>4 Test Types and Results</b> .....	<b>14</b>
4.1 Output Power Measurement .....	14
4.1.1 Limits of Output Power Measurement .....	14
4.1.2 Test Procedures.....	14
4.1.3 Test Setup .....	15
4.1.4 Test Results .....	16
4.2 Frequency Stability Measurement .....	25
4.2.1 Limits of Frequency Stability Measurement.....	25
4.2.2 Test Procedure .....	25
4.2.3 Test Setup .....	25
4.2.4 Test Results .....	26
4.3 Occupied Bandwidth Measurement.....	38
4.3.1 Test Procedure .....	38
4.3.2 Test Setup .....	38
4.3.3 Test Result .....	39
4.4 Band Edge Measurement .....	45
4.4.1 Limits of Band Edge Measurement .....	45
4.4.2 Test Setup .....	45
4.4.3 Test Procedures.....	45
4.4.4 Test Results .....	46
4.5 Peak to Average Ratio .....	56
4.5.1 Limits of Peak to Average Ratio Measurement .....	56
4.5.2 Test Setup .....	56
4.5.3 Test Procedures.....	56
4.5.4 Test Results .....	57
4.6 Conducted Spurious Emissions .....	63
4.6.1 Limits of Conducted Spurious Emissions Measurement.....	63
4.6.2 Test Setup .....	63
4.6.3 Test Procedure .....	63
4.6.4 Test Results .....	64
4.7 Radiated Emission Measurement.....	76
4.7.1 Limits of Radiated Emission Measurement .....	76
4.7.2 Test Procedure .....	76
4.7.3 Deviation from Test Standard .....	76
4.7.4 Test Setup .....	76
4.7.5 Test Results .....	77
<b>5 Pictures of Test Arrangements</b> .....	<b>107</b>
<b>Appendix – Information on the Testing Laboratories</b> .....	<b>108</b>

### Release Control Record

Issue No.	Description	Date Issued
RF170220C11E-6	Original Release	May 08, 2017

## 1 Certificate of Conformity

**Product:** Smartphone  
**Brand:** HTC  
**Test Model:** HTV33  
**Sample Status:** Production Unit  
**Applicant:** HTC Corporation  
**Test Date:** Mar. 14, 2017 ~ Mar. 18, 2017  
**Standards:** FCC Part 22, Subpart H

The above equipment has been tested by **Bureau Veritas Consumer Products Services (H.K.) Ltd., Taoyuan Branch**, and found compliance with the requirement of the above standards. The test record, data evaluation & Equipment Under Test (EUT) configurations represented herein are true and accurate accounts of the measurements of the sample's EMC characteristics under the conditions specified in this report.

**Prepared by :**  , **Date:** May 08, 2017  
Gina Liu / Specialist

**Approved by :**  , **Date:** May 08, 2017  
David Huang / Project Engineer

## 2 Summary of Test Results

Applied Standard: FCC Part 22 & Part 2			
FCC Clause	Test Item	Result	Remarks
2.1046 22.913 (a)	Effective Radiated Power	Pass	Meet the requirement of limit.
---	Peak to Average Ratio	Pass	Meet the requirement of limit.
2.1055 22.355	Frequency Stability	Pass	Meet the requirement of limit.
2.1049	Occupied Bandwidth	Pass	Meet the requirement of limit.
22.917	Band Edge Measurements	Pass	Meet the requirement of limit.
2.1051 22.917	Conducted Spurious Emissions	Pass	Meet the requirement of limit.
2.1053 22.917	Radiated Spurious Emissions	Pass	Meet the requirement of limit. Minimum passing margin is -26.87 dB at 2472.60 MHz.

### 2.1 Measurement Uncertainty

Where relevant, the following measurement uncertainty levels have been estimated for tests performed on the EUT as specified in CISPR 16-4-2:

Measurement	Frequency	Expanded Uncertainty (k=2) (±)
Conducted Emissions at mains ports	150 kHz ~ 30 MHz	2.44 dB
Radiated Emissions up to 1 GHz	30 MHz ~ 200 MHz	2.93 dB
	200 MHz ~ 1000 MHz	2.95 dB
Radiated Emissions above 1 GHz	1 GHz ~ 18 GHz	2.26 dB
	18 GHz ~ 40 GHz	1.94 dB

## 2.2 Test Site and Instruments

Description & Manufacturer	Model No.	Serial No.	Date of Calibration	Due Date of Calibration
Test Receiver Agilent	N9038A	MY51210203	Feb. 17, 2017	Feb. 16, 2018
Spectrum Analyzer Agilent	N9010A	MY52220314	Dec. 16, 2016	Dec. 15, 2017
Spectrum Analyzer ROHDE & SCHWARZ	FSU43	101261	Dec. 13, 2016	Dec. 12, 2017
BILOG Antenna SCHWARZBECK	VULB9168	9168-472	Dec. 26, 2016	Dec. 27, 2017
HORN Antenna SCHWARZBECK	BBHA 9120 D	9120D-969	Dec. 12, 2016	Dec. 13, 2017
Double Ridge Guide Horn Antenna EMCO	3115	5619	Dec. 15, 2016	Dec. 14, 2017
BILOG Antenna SCHWARZBECK	VULB 9168	9168-153	Dec. 13, 2016	Dec. 12, 2017
Agilent Communications Tester-Wireless	8960 Series 10	MY53201073	Jul. 03, 2015	Jul. 02, 2017
Preamplifier EMCI	EMC 012645	980115	Oct. 21, 2016	Oct. 20, 2017
Preamplifier EMCI	EMC 184045	980116	Oct. 21, 2016	Oct. 20, 2017
Preamplifier EMCI	EMC 330H	980112	Oct. 21, 2016	Oct. 20, 2017
Power Meter Anritsu	ML2495A	1232002	Sep. 08, 2016	Sep. 07, 2017
Power Sensor Anritsu	MA2411B	1207325	Sep. 08, 2016	Sep. 07, 2017
RF signal cable HUBER+SUHNNER	SUCOFLEX 104	309219/4 2950114	Oct. 21, 2016	Oct. 20, 2017
RF signal cable HUBER+SUHNNER	SUCOFLEX 104	250130/4	Oct. 21, 2016	Oct. 20, 2017
RF Coaxial Cable Worken	8D-FB	Cable-Ch10-01	Oct. 21, 2016	Oct. 20, 2017
Software BV ADT	E3 6.120103	NA	NA	NA
Antenna Tower MF	MFA-440H	NA	NA	NA
Turn Table MF	MFT-201SS	NA	NA	NA
Antenna Tower & Turn Table Controller MF	MF-7802	NA	NA	NA
Radio Communication Analyzer	MT8820C	6201300640	Aug. 10, 2015	Aug. 09, 2017
Temperature & Humidity Chamber	GTH-120-40-CP-AR	MAA1306-019	Sep. 02, 2016	Sep. 01, 2017
DC Power Supply Topward	33010D	807748	Oct. 25, 2016	Oct. 24, 2018
Digital Multimeter Fluke	87-III	70360742	Jul. 01, 2016	Jun. 30, 2017

- Note:
1. The calibration interval of the above test instruments is 12 / 24 months and the calibrations are traceable to NML/ROC and NIST/USA.
  2. The test was performed in HwaYa Chamber 10.
  3. The horn antenna and preamplifier (model: EMC 184045) are used only for the measurement of emission frequency above 1 GHz if tested.
  4. The FCC Site Registration No. is 690701.
  5. The IC Site Registration No. is IC7450F-10.

### 3 General Information

#### 3.1 General Description of EUT

<b>Product</b>	Smartphone	
<b>Brand</b>	HTC	
<b>Test Model</b>	HTV33	
<b>Status of EUT</b>	Production Unit	
<b>Power Supply Rating</b>	3.85 Vdc (Battery) 5 or 9 or 12 Vdc (Adapter or host equipment) 5 Vdc (Host equipment)	
<b>Modulation Type</b>	GSM/GPRS	GMSK
	EDGE	GMSK, 8PSK
	WCDMA	BPSK
	LTE	QPSK, 16QAM
<b>Frequency Range</b>	GSM/GPRS/EDGE	824.2 ~ 848.8 MHz
	WCDMA	826.4 ~ 846.6 MHz
	LTE 5 (Channel Bandwidth: 1.4 MHz)	824.7 ~ 848.3 MHz
	LTE 5 (Channel Bandwidth: 3 MHz)	825.5 ~ 847.5 MHz
	LTE 5 (Channel Bandwidth: 5 MHz)	826.5 ~ 846.5 MHz
	LTE 5 (Channel Bandwidth: 10 MHz)	829 ~ 844 MHz
	LTE 26 (Channel Bandwidth: 1.4 MHz)	824.7 ~ 848.3 MHz
	LTE 26 (Channel Bandwidth: 3 MHz)	825.5 ~ 847.5 MHz
	LTE 26 (Channel Bandwidth: 5 MHz)	826.5 ~ 846.5 MHz
	LTE 26 (Channel Bandwidth: 10 MHz)	829 ~ 844 MHz
<b>Max. ERP Power</b>	LTE 26 (Channel Bandwidth: 15 MHz)	831.5 ~ 841.5 MHz
	GSM/GPRS	676.08 mW
	EDGE	139.70 mW
	WCDMA	93.97 mW
	LTE 5 (Channel Bandwidth: 1.4 MHz)	76.24 mW
	LTE 5 (Channel Bandwidth: 3 MHz)	74.61 mW
	LTE 5 (Channel Bandwidth: 5 MHz)	70.50 mW
	LTE 5 (Channel Bandwidth: 10 MHz)	70.93 mW
	LTE 26 (Channel Bandwidth: 1.4 MHz)	69.06 mW
	LTE 26 (Channel Bandwidth: 3 MHz)	72.24 mW
	LTE 26 (Channel Bandwidth: 5 MHz)	72.31 mW
	LTE 26 (Channel Bandwidth: 10 MHz)	71.12 mW
LTE 26 (Channel Bandwidth: 15 MHz)	73.11 mW	

<b>Emission Designator</b>	GSM/GPRS	245KGXW
	EDGE	245KG7W
	WCDMA	4M14F9W
	LTE 5 (Channel Bandwidth: 1.4 MHz)	1M09W7D
	LTE 5 (Channel Bandwidth: 3 MHz)	2M70G7D
	LTE 5 (Channel Bandwidth: 5 MHz)	4M49W7D
	LTE 5 (Channel Bandwidth: 10 MHz)	8M97W7D
	LTE 26 (Channel Bandwidth: 1.4 MHz)	1M09W7D
	LTE 26 (Channel Bandwidth: 3 MHz)	2M70G7D
	LTE 26 (Channel Bandwidth: 5 MHz)	4M49W7D
	LTE 26 (Channel Bandwidth: 10 MHz)	8M97G7D
	LTE 26 (Channel Bandwidth: 15 MHz)	13M4G7D
<b>Antenna Type</b>	Fixed Internal Antenna	
<b>Accessory Device</b>	Refer to Note as below	
<b>Data Cable Supplied</b>	Refer to Note as below	

Note:

1. The EUT's accessories list refers to Ext. Pho.
2. The above EUT information is declared by manufacturer and for more detailed features description, please refer to the manufacturer's specifications or user's manual.



### 3.2 Configuration of System under Test

#### <Radiated Emission Test>

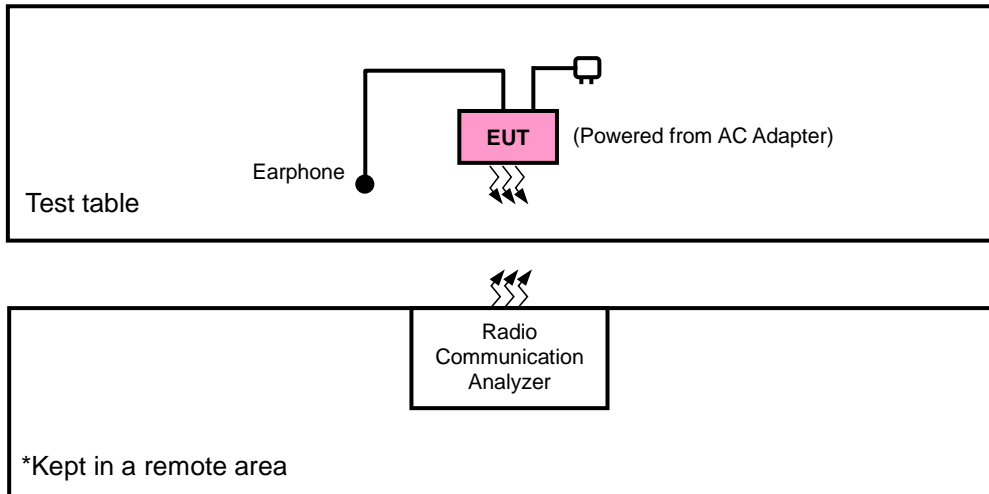

#### <E.R.P. Test>

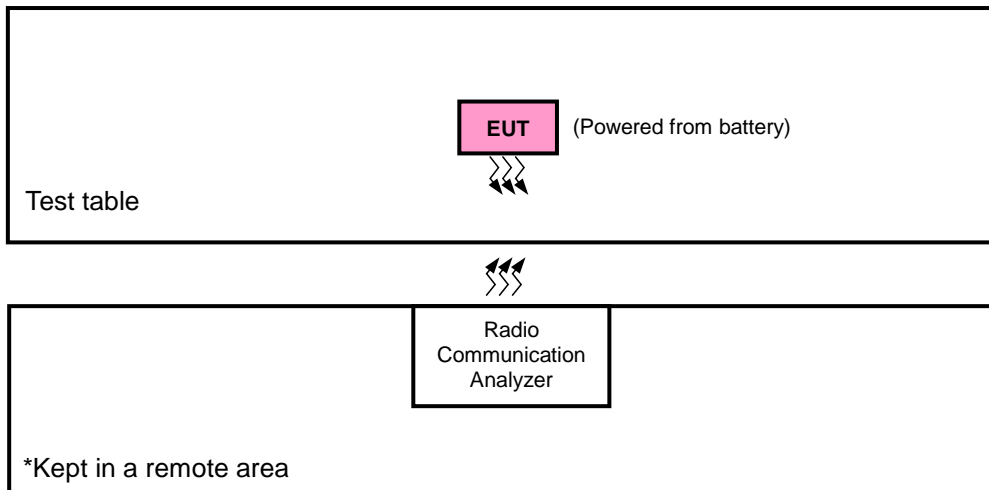

#### 3.2.1 Description of Support Units

The EUT has been tested as an independent unit together with other necessary accessories or support units. The following support units or accessories were used to form a representative test configuration during the tests.

No.	Product	Brand	Model No.	Serial No.	FCC ID
1.	Radio Communication Analyzer	Anritsu	MT8820C	6201300640	N/A

No.	Signal Cable Description Of The Above Support Units
1.	N/A

Note:

1. All power cords of the above support units are non-shielded (1.8m).
2. Item 1 acted as communication partner to transfer data.

### 3.3 Test Mode Applicability and Tested Channel Detail

Pre-Scan has been conducted to determine the worst-case mode from all possible combinations between available modulations, data rates, XYZ axis, and antenna ports.

The worst case was found when positioned as the table below. Following channel(s) was (were) selected for the final test as listed below:

Band	ERP	Radiated Emission
GSM	Y-plane	Z-axis
EDGE	Y-plane	Z-axis
WCDMA	Y-plane	Z-axis
LTE Band 5	Y-plane	Z-axis
LTE Band 26	X-plane	Y-axis

#### GSM

EUT Configure Mode	Test Item	Available Channel	Tested Channel	Mode
-	ERP	128 to 251	128, 189, 251	GSM, EDGE
-	Frequency Stability	128 to 251	128, 251	GSM, EDGE
-	Occupied Bandwidth	128 to 251	128, 189, 251	GSM, EDGE
-	Band Edge	128 to 251	128, 251	GSM, EDGE
-	Peak to Average Ratio	128 to 251	128, 189, 251	GSM, EDGE
-	Conducuted Emission	128 to 251	128, 189, 251	GSM, EDGE
-	Radiated Emission	128 to 251	128, 189, 251	GSM, EDGE

#### WCDMA

EUT Configure Mode	Test Item	Available Channel	Tested Channel	Mode
-	ERP	4132 to 4233	4132, 4182, 4233	WCDMA
-	Frequency Stability	4132 to 4233	4132, 4233	WCDMA
-	Occupied Bandwidth	4132 to 4233	4132, 4182, 4233	WCDMA
-	Band Edge	4132 to 4233	4132, 4233	WCDMA
-	Peak to Average Ratio	4132 to 4233	4132, 4182, 4233	WCDMA
-	Conducuted Emission	4132 to 4233	4132, 4182, 4233	WCDMA
-	Radiated Emission	4132 to 4233	4132, 4182, 4233	WCDMA

### LTE Band 5

EUT Configure Mode	Test Item	Available Channel	Tested Channel	Channel Bandwidth	Modulation	Mode		
-	ERP	20407 to 20643	20407, 20525, 20643	1.4 MHz	QPSK, 16QAM	1 RB / 2 RB Offset		
		20415 to 20635	20415, 20525, 20635	3 MHz	QPSK, 16QAM	1 RB / 7 RB Offset		
		20425 to 20625	20425, 20525, 20625	5 MHz	QPSK, 16QAM	1 RB / 12 RB Offset		
		20450 to 20600	20450, 20525, 20600	10 MHz	QPSK, 16QAM	1 RB / 24 RB Offset		
-	Frequency Stability	20407 to 20643	20407, 20643	1.4 MHz	QPSK	1 RB / 2 RB Offset		
		20415 to 20635	20415, 20635	3 MHz	QPSK	1 RB / 7 RB Offset		
		20425 to 20625	20425, 20625	5 MHz	QPSK	1 RB / 12 RB Offset		
		20450 to 20600	20450, 20600	10 MHz	QPSK	1 RB / 24 RB Offset		
-	Occupied Bandwidth	20407 to 20643	20407, 20525, 20643	1.4 MHz	QPSK, 16QAM	6 RB / 0 RB Offset		
		20415 to 20635	20415, 20525, 20635	3 MHz	QPSK, 16QAM	15 RB / 0 RB Offset		
		20425 to 20625	20425, 20525, 20625	5 MHz	QPSK, 16QAM	25 RB / 0 RB Offset		
		20450 to 20600	20450, 20525, 20600	10 MHz	QPSK, 16QAM	50 RB / 0 RB Offset		
-	Band Edge	20407 to 20643	20407	1.4MHz	QPSK	1 RB / 0 RB Offset 6 RB / 0 RB Offset		
			20643	1.4MHz	QPSK	1 RB / 5 RB Offset 6 RB / 0 RB Offset		
		20415 to 20635	20415	3 MHz	QPSK	1 RB / 0 RB Offset 15 RB / 0 RB Offset		
			20635	3 MHz	QPSK	1 RB / 14 RB Offset 15 RB / 0 RB Offset		
		20425 to 20625	20425	5 MHz	QPSK	1 RB / 0 RB Offset 25 RB / 0 RB Offset		
			20625	5 MHz	QPSK	1 RB / 24 RB Offset 25 RB / 0 RB Offset		
		20450 to 20600	20450	10 MHz	QPSK	1 RB / 0 RB Offset 50 RB / 0 RB Offset		
			20600	10 MHz	QPSK	1 RB / 49 RB Offset 50 RB / 0 RB Offset		
		-	Peak to Average Ratio	20407 to 20643	20407, 20525, 20643	1.4 MHz	QPSK, 16QAM	6 RB / 0 RB Offset
				20415 to 20635	20415, 20525, 20635	3 MHz	QPSK, 16QAM	15 RB / 0 RB Offset
				20425 to 20625	20425, 20525, 20625	5 MHz	QPSK, 16QAM	25 RB / 0 RB Offset
				20450 to 20600	20450, 20525, 20600	10 MHz	QPSK, 16QAM	50 RB / 0 RB Offset
-	Conducted Emission	20407 to 20643	20407, 20525, 20643	1.4 MHz	QPSK	1 RB / 2 RB Offset		
		20415 to 20635	20415, 20525, 20635	3 MHz	QPSK	1 RB / 7 RB Offset		
		20425 to 20625	20425, 20525, 20625	5 MHz	QPSK	1 RB / 12 RB Offset		
		20450 to 20600	20450, 20525, 20600	10 MHz	QPSK	1 RB / 24 RB Offset		
-	Radiated Emission	20450 to 20600	20450, 20525, 20600	10 MHz	QPSK	1 RB / 24 RB Offset		

**Note:** This device was tested under all bandwidths, RB configurations and modulations. The worst case was found in QPSK modulation.

**LTE Band 26**

EUT Configure Mode	Test Item	Available Channel	Tested Channel	Channel Bandwidth	Modulation	Mode		
-	ERP	26797 to 27033	26797, 26915, 27033	1.4 MHz	QPSK, 16QAM	1 RB / 5 RB Offset		
		26805 to 27025	26805, 26915, 27025	3 MHz	QPSK, 16QAM	1 RB / 14 RB Offset		
		26815 to 27015	26815, 26915, 27015	5 MHz	QPSK, 16QAM	1 RB / 24 RB Offset		
		26840 to 26990	26840, 26915, 26990	10 MHz	QPSK, 16QAM	1 RB / 49 RB Offset		
		26865 to 26965	26865, 26915, 26965	15 MHz	QPSK, 16QAM	1 RB / 49 RB Offset		
-	Frequency Stability	26797 to 27033	26797, 27033	1.4 MHz	QPSK	1 RB / 5 RB Offset		
		26805 to 27025	26805, 27025	3 MHz	QPSK	1 RB / 14 RB Offset		
		26815 to 27015	26815, 27015	5 MHz	QPSK	1 RB / 24 RB Offset		
		26840 to 26990	26840, 26990	10 MHz	QPSK	1 RB / 49 RB Offset		
		26865 to 26965	26865, 26965	15 MHz	QPSK	1 RB / 49 RB Offset		
-	Occupied Bandwidth	26797 to 27033	26797, 26915, 27033	1.4 MHz	QPSK, 16QAM	6 RB / 0 RB Offset		
		26805 to 27025	26805, 26915, 27025	3 MHz	QPSK, 16QAM	15 RB / 0 RB Offset		
		26815 to 27015	26815, 26915, 27015	5 MHz	QPSK, 16QAM	25 RB / 0 RB Offset		
		26840 to 26990	26840, 26915, 26990	10 MHz	QPSK, 16QAM	50 RB / 0 RB Offset		
		26865 to 26965	26865, 26915, 26965	15 MHz	QPSK, 16QAM	75 RB / 0 RB Offset		
-	Band Edge	26797 to 27033	26797	1.4 MHz	QPSK	1 RB / 0 RB Offset 6 RB / 0 RB Offset		
			27033	1.4 MHz	QPSK	1 RB / 5 RB Offset 6 RB / 0 RB Offset		
		26805 to 27025	26805	3 MHz	QPSK	1 RB / 0 RB Offset 15 RB / 0 RB Offset		
			27025	3 MHz	QPSK	1 RB / 14 RB Offset 15 RB / 0 RB Offset		
		26815 to 27015	26815	5 MHz	QPSK	1 RB / 0 RB Offset 25 RB / 0 RB Offset		
			27015	5 MHz	QPSK	1 RB / 24 RB Offset 25 RB / 0 RB Offset		
		26840 to 26990	26840	10 MHz	QPSK	1 RB / 0 RB Offset 50 RB / 0 RB Offset		
			26990	10 MHz	QPSK	1 RB / 49 RB Offset 50 RB / 0 RB Offset		
		26865 to 26965	26865	15 MHz	QPSK	1 RB / 0 RB Offset 75 RB / 0 RB Offset		
			26965	15 MHz	QPSK	1 RB / 74 RB Offset 75 RB / 0 RB Offset		
		-	Peak to Average Ratio	26797 to 27033	26797, 26915, 27033	1.4 MHz	QPSK, 16QAM	1 RB / 0 RB Offset
				26805 to 27025	26805, 26915, 27025	3 MHz	QPSK, 16QAM	15 RB / 0 RB Offset
				26815 to 27015	26815, 26915, 27015	5 MHz	QPSK, 16QAM	25 RB / 0 RB Offset
				26840 to 26990	26840, 26915, 26990	10 MHz	QPSK, 16QAM	50 RB / 0 RB Offset
26865 to 26965	26865, 26915, 26965			15 MHz	QPSK, 16QAM	75 RB / 0 RB Offset		
-	Conducted Emission	26797 to 27033	26797, 26915, 27033	1.4 MHz	QPSK	1 RB / 0 RB Offset		
		26805 to 27025	26805, 26915, 27025	3 MHz	QPSK	15 RB / 0 RB Offset		
		26815 to 27015	26815, 26915, 27015	5 MHz	QPSK	25 RB / 0 RB Offset		
		26840 to 26990	26840, 26915, 26990	10 MHz	QPSK	1 RB / 0 RB Offset		
		26865 to 26965	26865, 26915, 26965	15 MHz	QPSK	25 RB / 0 RB Offset		
-	Radiated Emission	26865 to 26965	26865, 26915, 26965	15 MHz	QPSK	1 RB / 0 RB Offset		

**Note:** This device was tested under all bandwidths, RB configurations and modulations. The worst case was found in QPSK modulation.

**Test Condition:**

Test Item	Environmental Conditions	Input Power	Tested By
ERP	25 deg. C, 65 % RH	3.8 Vdc	Karl Lee
Frequency Stability	25 deg. C, 65 % RH	3.8 Vdc	Anson Lin
Occupied Bandwidth	25 deg. C, 65 % RH	3.8 Vdc	Anson Lin
Band Edge	25 deg. C, 65 % RH	3.8 Vdc	Anson Lin
Peak to Average Ratio	25 deg. C, 65 % RH	3.8 Vdc	Anson Lin
Condcudeted Emission	25 deg. C, 65 % RH	3.8 Vdc	Anson Lin
Radiated Emission	25 deg. C, 65 % RH	120 Vac, 60 Hz	Karl Lee

**3.4 EUT Operating Conditions**

The EUT makes a call to the communication simulator. The communication simulator station system controlled a EUT to export maximum output power under transmission mode and specific channel frequency.

**3.5 General Description of Applied Standards**

The EUT is a RF Product. According to the specifications of the manufacturer, it must comply with the requirements of the following standards:

**FCC 47 CFR Part 2**

**FCC 47 CFR Part 22**

**KDB 971168 D01 Power Meas License Digital Systems v02r02**

**ANSI/TIA/EIA-603-D 2010**

**Note:** All test items have been performed and recorded as per the above standards.

## 4 Test Types and Results

### 4.1 Output Power Measurement

#### 4.1.1 Limits of Output Power Measurement

Mobile / Portable station are limited to 7 watts e.r.p.

#### 4.1.2 Test Procedures

##### **EIRP / ERP Measurement:**

- a. All measurements were done at low, middle and high operational frequency range. RBW and VBW is 1 MHz for GSM, GPRS & EDGE, and 5 MHz for WCDMA and CDMA, and 10 MHz for LTE mode.
- b. Substitution method is used for E.I.R.P measurement. In the semi-anechoic chamber, EUT placed on the 0.8 m height of Turn Table, rotated the table around 360 degrees to search the maximum radiation power and receiver antenna shall be rotated vertical and horizontal polarization and moved height from 1 m to 4 m to find the maximum polar radiated power. The "Read Value" is the spectrum reading the maximum power value.
- c. The substitution horn antenna is substituted for EUT at the same position and signals generator export the CW signal to the substitution antenna via a tx cable. Rotated the Turn Table and moved receiving antenna to find the maximum radiation power. Adjust output power level of S.G to get a Value of spectrum reading equal to "Read Value" of step b. Record the power level of S.G.
- d.  $EIRP = \text{Output power level of S.G} - \text{TX cable loss} + \text{Antenna gain of substitution horn}$ . E.R.P power can be calculated form E.I.R.P power by subtracting the gain of dipole,  $E.R.P \text{ power} = E.I.P.R \text{ power} - 2.15 \text{ dBi}$ .

##### **Conducted Power Measurement:**

The EUT was set up for the maximum power with GSM, GPRS, EDGE, WCDMA, CDMA, and LTE link data modulation and link up with simulator. Set the EUT to transmit under low, middle and high channel and record the power level shown on simulator.

### 4.1.3 Test Setup

#### EIRP / ERP Measurement:

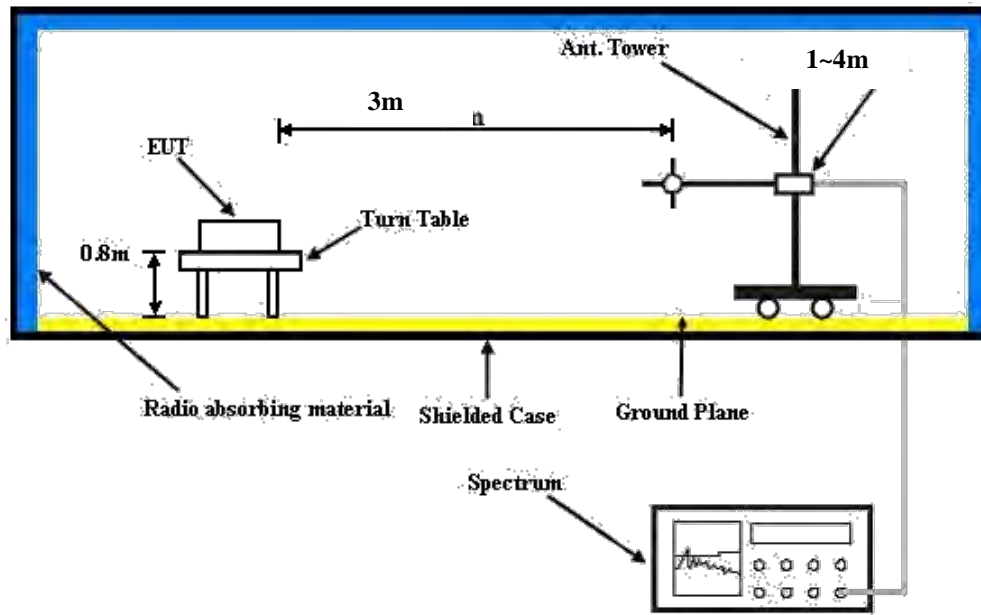

For the actual test configuration, please refer to the attached file (Test Setup Photo).

#### Conducted Power Measurement:

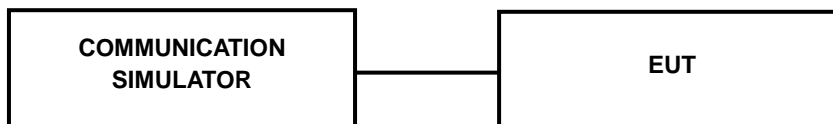

#### 4.1.4 Test Results

##### Conducted Output Power (dBm)

Band	GSM850		
Channel	128	189	251
Frequency (MHz)	824.2	836.4	848.8
GSM (GMSK, 1Tx-slot)	33.02	<b>33.31</b>	33.17
GPRS (GMSK, 1Tx-slot)	32.94	33.29	33.11
GPRS (GMSK, 2Tx-slot)	31.02	31.34	31.23
GPRS (GMSK, 3Tx-slot)	29.65	29.97	29.85
GPRS (GMSK, 4Tx-slot)	28.51	28.80	28.70
EDGE (8PSK, 1Tx-slot)	26.08	26.44	26.33
EDGE (8PSK, 2Tx-slot)	25.49	25.74	25.63
EDGE (8PSK, 3Tx-slot)	25.37	25.61	25.53
EDGE (8PSK, 4Tx-slot)	23.22	23.44	23.30
DTM (GMSK, 2Tx-slot)	30.97	31.24	31.17
DTM (GMSK, 3Tx-slot)	29.60	29.87	29.67
DTM (8PSK, 2Tx-slot)	25.27	25.51	25.42
DTM (8PSK, 3Tx-slot)	25.04	25.32	25.12

Band	WCDMA V		
Channel	4132	4182	4233
Frequency (MHz)	826.4	836.4	846.6
RMC 12.2K	23.49	<b>23.54</b>	23.22
HSDPA Subtest-1	22.50	22.55	22.27
HSDPA Subtest-2	22.48	22.53	22.21
HSDPA Subtest-3	22.03	22.08	21.82
HSDPA Subtest-4	21.93	22.06	21.74
HSUPA Subtest-1	22.57	22.60	22.32
HSUPA Subtest-2	20.40	20.54	20.26
HSUPA Subtest-3	21.47	21.58	21.30
HSUPA Subtest-4	20.54	20.58	20.29
HSUPA Subtest-5	22.36	22.50	22.14

Band / BW	RB Size	RB Offset	QPSK			3GPP MPR (dB)	16QAM			3GPP MPR (dB)
			Low Ch 20407	Mid Ch 20525	High Ch 20643		Low Ch 20407	Mid Ch 20525	High Ch 20643	
			824.7 MHz	836.5 MHz	848.3 MHz		824.7 MHz	836.5 MHz	848.3 MHz	
5 / 1.4M	1	0	23.03	23.25	23.05	0	22.07	22.29	22.08	1
	1	2	22.83	23.12	22.92	0	21.90	22.16	21.92	1
	1	5	22.16	22.47	22.32	0	21.22	21.48	21.36	1
	3	0	21.87	22.15	21.97	0	20.80	21.14	20.96	1
	3	1	21.75	22.07	21.78	0	20.69	21.05	20.73	1
	3	3	21.64	22.04	21.67	0	20.59	20.90	20.63	1
	6	0	21.11	21.22	21.18	1	20.69	21.02	20.84	2



Band / BW	RB Size	RB Offset	QPSK			3GPP MPR (dB)	16QAM			3GPP MPR (dB)
			Low Ch 20415	Mid Ch 20525	High Ch 20635		Low Ch 20415	Mid Ch 20525	High Ch 20635	
			825.5 MHz	836.5 MHz	847.5 MHz		825.5 MHz	836.5 MHz	847.5 MHz	
5 / 3M	1	0	23.09	23.30	23.10	0	22.07	22.35	22.11	1
	1	7	22.96	23.18	23.00	0	21.92	22.20	22.01	1
	1	14	22.25	22.54	22.41	0	21.30	21.53	21.42	1
	8	0	21.94	22.22	22.02	1	20.95	21.22	21.04	2
	8	3	21.88	22.15	21.92	1	20.83	21.12	20.89	2
	8	7	21.78	22.06	21.82	1	20.74	21.02	20.77	2
	15	0	21.86	22.13	21.96	1	20.80	21.09	20.92	2

Band / BW	RB Size	RB Offset	QPSK			3GPP MPR (dB)	16QAM			3GPP MPR (dB)
			Low Ch 20425	Mid Ch 20525	High Ch 20625		Low Ch 20425	Mid Ch 20525	High Ch 20625	
			826.5 MHz	836.5 MHz	846.5 MHz		826.5 MHz	836.5 MHz	846.5 MHz	
5 / 5M	1	0	23.14	23.35	23.16	0	22.18	22.40	22.19	1
	1	12	23.01	23.22	23.04	0	22.03	22.27	22.08	1
	1	24	22.34	22.61	22.49	0	21.39	21.63	21.51	1
	12	0	22.09	22.30	22.13	1	21.07	21.31	21.19	2
	12	6	21.97	22.23	22.04	1	20.96	21.23	20.98	2
	12	13	21.93	22.15	21.94	1	20.88	21.14	20.91	2
	25	0	21.99	22.21	22.08	1	20.93	21.21	21.01	2

Band / BW	RB Size	RB Offset	QPSK			3GPP MPR (dB)	16QAM			3GPP MPR (dB)
			Low Ch 20450	Mid Ch 20525	High Ch 20600		Low Ch 20450	Mid Ch 20525	High Ch 20600	
			829.0 MHz	836.5 MHz	844.0 MHz		829.0 MHz	836.5 MHz	844.0 MHz	
5 / 10M	1	0	23.21	<b>23.40</b>	23.22	0	22.24	<b>22.45</b>	22.26	1
	1	24	23.00	23.28	23.12	0	22.06	22.33	22.13	1
	1	49	22.47	22.69	22.55	0	21.45	21.70	21.58	1
	25	0	22.22	22.41	22.31	1	21.19	21.41	21.25	2
	25	12	22.14	22.34	22.19	1	21.09	21.34	21.13	2
	25	25	22.08	22.27	22.09	1	21.03	21.27	21.05	2
	50	0	22.13	22.33	22.15	1	21.07	21.33	21.18	2

Band / BW	RB Size	RB Offset	QPSK			3GPP MPR (dB)	16QAM			3GPP MPR (dB)
			Low Ch 26797	Mid Ch 26915	High Ch 27033		Low Ch 26797	Mid Ch 26915	High Ch 27033	
			824.7 MHz	836.5 MHz	848.3 MHz		824.7 MHz	836.5 MHz	848.3 MHz	
26 / 1.4M	1	0	23.23	23.16	23.09	0	22.25	22.16	22.10	1
	1	2	23.02	22.96	22.78	0	22.03	21.99	21.90	1
	1	5	22.84	22.69	22.63	0	21.95	21.74	21.63	1
	3	0	22.71	22.62	22.54	0	21.79	21.64	21.53	1
	3	1	22.67	22.58	22.44	0	21.68	21.59	21.43	1
	3	3	22.41	22.35	22.30	0	21.38	21.31	21.24	1
	6	0	21.88	21.78	21.69	1	20.89	20.75	20.65	2

Band / BW	RB Size	RB Offset	QPSK			3GPP MPR (dB)	16QAM			3GPP MPR (dB)
			Low Ch 26805	Mid Ch 26915	High Ch 27025		Low Ch 26805	Mid Ch 26915	High Ch 27025	
			825.5 MHz	836.5 MHz	847.5 MHz		825.5 MHz	836.5 MHz	847.5 MHz	
26 / 3M	1	0	23.28	23.21	23.14	0	22.30	22.22	22.12	1
	1	7	23.18	23.04	22.89	0	22.18	22.04	21.90	1
	1	14	22.95	22.81	22.76	0	21.98	21.80	21.67	1
	8	0	22.18	22.04	21.97	1	21.16	21.02	20.94	2
	8	3	22.08	22.01	21.88	1	21.07	20.98	20.83	2
	8	7	21.91	21.79	21.74	1	20.80	20.74	20.67	2
	15	0	21.95	21.88	21.79	1	20.96	20.87	20.74	2

Band / BW	RB Size	RB Offset	QPSK			3GPP MPR (dB)	16QAM			3GPP MPR (dB)
			Low Ch 26815	Mid Ch 26915	High Ch 27015		Low Ch 26815	Mid Ch 26915	High Ch 27015	
			826.5 MHz	836.5 MHz	846.5 MHz		826.5 MHz	836.5 MHz	846.5 MHz	
26 / 5M	1	0	23.31	23.24	23.17	0	22.38	22.31	22.25	1
	1	12	23.18	23.07	23.03	0	22.20	22.15	22.04	1
	1	24	23.02	22.86	22.76	0	21.95	21.90	21.80	1
	12	0	22.22	22.13	22.07	1	21.27	21.14	21.06	2
	12	6	22.18	22.11	22.00	1	21.19	21.12	21.00	2
	12	13	22.05	21.92	21.89	1	20.96	20.89	20.82	2
	25	0	22.11	22.01	21.95	1	21.12	20.97	20.89	2

Band / BW	RB Size	RB Offset	QPSK			3GPP MPR (dB)	16QAM			3GPP MPR (dB)
			Low Ch 26840	Mid Ch 26915	High Ch 26990		Low Ch 26840	Mid Ch 26915	High Ch 26990	
			829.0 MHz	836.5 MHz	844.0 MHz		829.0 MHz	836.5 MHz	844.0 MHz	
26 / 10M	1	0	23.38	23.32	23.25	0	22.43	22.35	22.28	1
	1	24	23.25	23.18	23.05	0	22.34	22.20	22.09	1
	1	49	23.02	22.98	22.86	0	22.02	21.97	21.85	1
	25	0	22.35	22.25	22.20	1	21.38	21.24	21.17	2
	25	12	22.28	22.23	22.09	1	21.28	21.21	21.06	2
	25	25	22.17	22.07	22.02	1	21.10	21.03	20.97	2
	50	0	22.23	22.16	22.13	1	21.19	21.13	21.07	2

Band / BW	RB Size	RB Offset	QPSK			3GPP MPR (dB)	16QAM			3GPP MPR (dB)
			Low Ch 26865	Mid Ch 26915	High Ch 26965		Low Ch 26865	Mid Ch 26915	High Ch 26965	
			831.5 MHz	836.5 MHz	841.5 MHz		831.5 MHz	836.5 MHz	841.5 MHz	
26 / 15M	1	0	23.43	23.37	23.32	0	22.48	22.42	22.37	1
	1	37	23.34	23.25	23.22	0	22.41	22.27	22.14	1
	1	74	23.13	23.06	22.93	0	22.11	22.07	21.96	1
	36	0	22.49	22.36	22.33	1	21.44	21.34	21.28	2
	36	19	22.38	22.34	22.28	1	21.37	21.32	21.26	2
	36	39	22.31	22.22	22.17	1	21.22	21.17	21.13	2
	75	0	22.32	22.28	22.25	1	21.32	21.24	21.16	2

**ERP Power (dBm)**

GSM							
Plane	Channel	Frequency (MHz)	LVL (dBm)	Correction Factor (dB)	ERP (dBm)	ERP (mW)	Polarization (H/V)
Y	128	824.2	-1.02	31.208	28.04	636.50	H
	189	836.4	-0.85	31.3	28.30	676.08	
	251	848.8	-0.97	31.222	28.10	645.95	
	128	824.2	-3.56	31.504	25.79	379.66	V
	189	836.4	-3.85	31.117	25.12	324.86	
	251	848.8	-3.91	31.922	25.86	385.66	

EDGE							
Plane	Channel	Frequency (MHz)	LVL (dBm)	Correction Factor (dB)	ERP (dBm)	ERP (mW)	Polarization (H/V)
Y	128	824.2	-8.03	31.208	21.03	126.71	H
	189	836.4	-7.95	31.3	21.20	131.83	
	251	848.8	-7.62	31.222	21.45	139.70	
	128	824.2	-11.33	31.504	18.02	63.45	V
	189	836.4	-10.85	31.117	18.12	64.82	
	251	848.8	-10.95	31.922	18.82	76.24	

WCDMA							
Plane	Channel	Frequency (MHz)	LVL (dBm)	Correction Factor (dB)	ERP (dBm)	ERP (mW)	Polarization (H/V)
Y	4132	826.4	-9.87	31.208	19.19	82.95	H
	4182	836.4	-9.42	31.3	19.73	93.97	
	4233	846.6	-9.75	31.222	19.32	85.55	
	4132	826.4	-13.22	31.504	16.13	41.06	V
	4182	836.4	-12.58	31.117	16.39	43.52	
	4233	846.6	-13.50	31.922	16.27	42.38	

LTE Band 5							
Channel Bandwidth: 1.4 MHz / QPSK							
Plane	Channel	Frequency (MHz)	LVL (dBm)	Correction Factor (dB)	ERP (dBm)	ERP (mW)	Polarization (H/V)
Y	20407	824.7	-10.58	31.208	18.48	70.44	H
	20525	836.5	-10.36	31.3	18.79	75.68	
	20643	848.3	-10.25	31.222	18.82	76.24	
	20407	824.7	-14.11	31.504	15.24	33.45	V
	20525	836.5	-13.85	31.117	15.12	32.49	
	20643	848.3	-13.95	31.922	15.82	38.21	
Channel Bandwidth: 1.4 MHz / 16QAM							
Y	20407	824.7	-11.36	31.208	17.70	58.86	H
	20525	836.5	-11.52	31.3	17.63	57.94	
	20643	848.3	-11.33	31.222	17.74	59.46	
	20407	824.7	-14.56	31.504	14.79	30.16	V
	20525	836.5	-14.26	31.117	14.71	29.56	
	20643	848.3	-14.99	31.922	14.78	30.07	

LTE Band 5							
Channel Bandwidth: 3 MHz / QPSK							
Plane	Channel	Frequency (MHz)	LVL (dBm)	Correction Factor (dB)	ERP (dBm)	ERP (mW)	Polarization (H/V)
Y	20415	825.5	-10.33	31.208	18.73	74.61	H
	20525	836.5	-10.62	31.3	18.53	71.29	
	20635	847.5	-10.55	31.222	18.52	71.15	
	20415	825.5	-13.88	31.504	15.47	35.27	V
	20525	836.5	-13.95	31.117	15.02	31.75	
	20635	847.5	-13.82	31.922	15.95	39.37	
Channel Bandwidth: 3 MHz / 16QAM							
Y	20415	825.5	-11.52	31.208	17.54	56.73	H
	20525	836.5	-11.65	31.3	17.50	56.23	
	20635	847.5	-11.72	31.222	17.35	54.35	
	20415	825.5	-14.63	31.504	14.72	29.68	V
	20525	836.5	-14.75	31.117	14.22	26.41	
	20635	847.5	-14.91	31.922	14.86	30.63	

LTE Band 5							
Channel Bandwidth: 5 MHz / QPSK							
Plane	Channel	Frequency (MHz)	LVL (dBm)	Correction Factor (dB)	ERP (dBm)	ERP (mW)	Polarization (H/V)
Y	20425	826.5	-10.66	31.208	18.40	69.15	H
	20525	836.5	-10.87	31.3	18.28	67.30	
	20625	846.5	-10.59	31.222	18.48	70.50	
	20425	826.5	-13.96	31.504	15.39	34.63	V
	20525	836.5	-13.75	31.117	15.22	33.24	
	20625	846.5	-13.95	31.922	15.82	38.21	
Channel Bandwidth: 5 MHz / 16QAM							
Y	20425	826.5	-11.63	31.208	17.43	55.31	H
	20525	836.5	-11.94	31.3	17.21	52.60	
	20625	846.5	-11.33	31.222	17.74	59.46	
	20425	826.5	-14.59	31.504	14.76	29.95	V
	20525	836.5	-14.56	31.117	14.41	27.59	
	20625	846.5	-14.81	31.922	14.96	31.35	

LTE Band 5							
Channel Bandwidth: 10 MHz / QPSK							
Plane	Channel	Frequency (MHz)	LVL (dBm)	Correction Factor (dB)	ERP (dBm)	ERP (mW)	Polarization (H/V)
Y	20450	829.0	-10.55	31.208	18.51	70.93	H
	20525	836.5	-10.65	31.3	18.50	70.79	
	20600	844.0	-10.72	31.222	18.35	68.42	
	20450	829.0	-13.60	31.504	15.75	37.62	V
	20525	836.5	-13.87	31.117	15.10	32.34	
	20600	844.0	-13.81	31.922	15.96	39.46	
Channel Bandwidth: 10 MHz / 16QAM							
Y	20450	829.0	-11.69	31.208	17.37	54.55	H
	20525	836.5	-11.75	31.3	17.40	54.95	
	20600	844.0	-11.36	31.222	17.71	59.05	
	20450	829.0	-14.52	31.504	14.83	30.44	V
	20525	836.5	-14.62	31.117	14.35	27.21	
	20600	844.0	-14.85	31.922	14.92	31.06	

LTE Band 26							
Channel Bandwidth: 1.4 MHz / QPSK							
Plane	Channel	Frequency (MHz)	LVL (dBm)	Correction Factor (dB)	ERP (dBm)	ERP (mW)	Polarization (H/V)
X	26797	824.7	-10.85	31.208	18.21	66.19	H
	26915	836.5	-10.77	31.3	18.38	68.87	
	27033	848.3	-10.68	31.222	18.39	69.06	
	26797	824.7	-14.23	31.504	15.12	32.54	V
	26915	836.5	-13.85	31.117	15.12	32.49	
	27033	848.3	-13.95	31.922	15.82	38.21	
Channel Bandwidth: 1.4 MHz / 16QAM							
X	26797	824.7	-11.78	31.208	17.28	53.43	H
	26915	836.5	-11.85	31.3	17.30	53.70	
	27033	848.3	-11.69	31.222	17.38	54.73	
	26797	824.7	-15.01	31.504	14.34	27.19	V
	26915	836.5	-14.95	31.117	14.02	25.22	
	27033	848.3	-14.78	31.922	14.99	31.56	

LTE Band 26							
Channel Bandwidth: 3 MHz / QPSK							
Plane	Channel	Frequency (MHz)	LVL (dBm)	Correction Factor (dB)	ERP (dBm)	ERP (mW)	Polarization (H/V)
X	26805	825.5	-10.47	31.208	18.59	72.24	H
	26915	836.5	-10.58	31.3	18.57	71.94	
	27025	847.5	-10.62	31.222	18.45	70.02	
	26805	825.5	-14.14	31.504	15.21	33.22	V
	26915	836.5	-13.63	31.117	15.34	34.17	
	27025	847.5	-13.82	31.922	15.95	39.37	
Channel Bandwidth: 3 MHz / 16QAM							
X	26805	825.5	-11.66	31.208	17.40	54.93	H
	26915	836.5	-11.74	31.3	17.41	55.08	
	27025	847.5	-11.59	31.222	17.48	56.00	
	26805	825.5	-14.85	31.504	14.50	28.21	V
	26915	836.5	-14.76	31.117	14.21	26.35	
	27025	847.5	-15.23	31.922	14.54	28.46	

LTE Band 26							
Channel Bandwidth: 5 MHz / QPSK							
Plane	Channel	Frequency (MHz)	LVL (dBm)	Correction Factor (dB)	ERP (dBm)	ERP (mW)	Polarization (H/V)
X	26815	826.5	-10.75	31.208	18.31	67.73	H
	26915	836.5	-10.59	31.3	18.56	71.78	
	27015	846.5	-10.48	31.222	18.59	72.31	
	26815	826.5	-14.31	31.504	15.04	31.94	V
	26919	836.5	-13.21	31.117	15.76	37.64	
	27015	846.5	-13.81	31.922	15.96	39.46	
Channel Bandwidth: 5 MHz / 16QAM							
X	26815	826.5	-11.75	31.208	17.31	53.80	H
	26915	836.5	-11.54	31.3	17.61	57.68	
	27015	846.5	-11.49	31.222	17.58	57.31	
	26815	826.5	-14.74	31.504	14.61	28.93	V
	26919	836.5	-14.54	31.117	14.43	27.71	
	27015	846.5	-15.44	31.922	14.33	27.11	

LTE Band 26							
Channel Bandwidth: 10 MHz / QPSK							
Plane	Channel	Frequency (MHz)	LVL (dBm)	Correction Factor (dB)	ERP (dBm)	ERP (mW)	Polarization (H/V)
X	26840	829.0	-10.74	31.208	18.32	67.89	H
	26915	836.5	-10.63	31.3	18.52	71.12	
	26990	844.0	-10.59	31.222	18.48	70.50	
	26840	829.0	-14.21	31.504	15.14	32.69	V
	26919	836.5	-13.33	31.117	15.64	36.62	
	26990	844.0	-13.91	31.922	15.86	38.57	
Channel Bandwidth: 10 MHz / 16QAM							
X	26840	829.0	-11.47	31.208	17.59	57.39	H
	26915	836.5	-11.62	31.3	17.53	56.62	
	26990	844.0	-11.57	31.222	17.50	56.26	
	26840	829.0	-14.68	31.504	14.67	29.34	V
	26919	836.5	-14.66	31.117	14.31	26.96	
	26990	844.0	-15.10	31.922	14.67	29.32	

LTE Band 26							
Channel Bandwidth: 15 MHz / QPSK							
Plane	Channel	Frequency (MHz)	LVL (dBm)	Correction Factor (dB)	ERP (dBm)	ERP (mW)	Polarization (H/V)
X	26865	831.5	-10.47	31.208	18.59	72.24	H
	26915	836.5	-10.51	31.3	18.64	73.11	
	26965	841.5	-10.55	31.222	18.52	71.15	
	26865	831.5	-14.17	31.504	15.18	32.99	V
	26915	836.5	-13.39	31.117	15.58	36.12	
	26965	841.5	-13.78	31.922	15.99	39.74	
Channel Bandwidth: 15 MHz / 16QAM							
X	26865	831.5	-11.66	31.208	17.40	54.93	H
	26915	836.5	-11.61	31.3	17.54	56.75	
	26965	841.5	-11.49	31.222	17.58	57.31	
	26865	831.5	-14.51	31.504	14.84	30.51	V
	26915	836.5	-14.46	31.117	14.51	28.23	
	26965	841.5	-15.36	31.922	14.41	27.62	



## 4.2 Frequency Stability Measurement

### 4.2.1 Limits of Frequency Stability Measurement

1.5 ppm is for base and fixed station. 2.5 ppm is for mobile station.

### 4.2.2 Test Procedure

- Device is placed at the oven room. The oven room could control the temperatures and humidity. Power warm up is at least 15 min and power applied should perform before recording frequency error.
- EUT is connected the external power supply to control the DC input power. The test voltage range is from minimum to maximum working voltage. Each step shall be record the frequency error rate.
- The temperature range step is 10 degrees in this test items. All temperature levels shall be hold the  $\pm 0.5$  °C during the measurement testing. The each temperature step shall be at least 0.5 hours, consider the EUT could be test under the stability condition.

**NOTE:** The frequency error was recorded frequency error from the communication simulator.

### 4.2.3 Test Setup

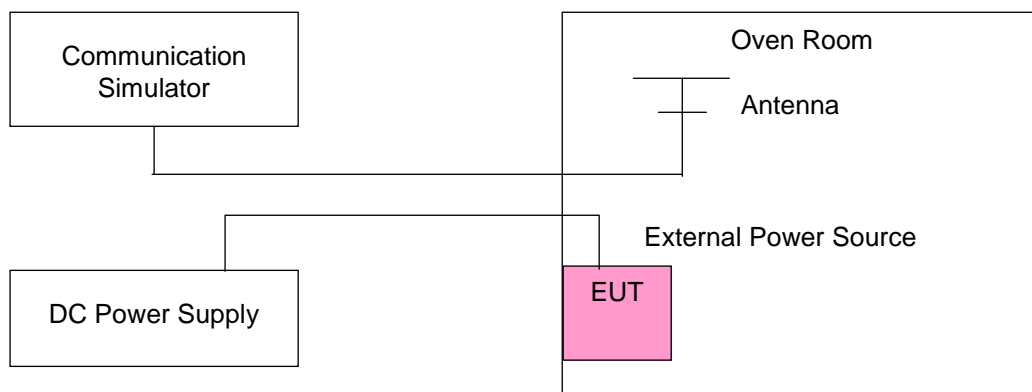

#### 4.2.4 Test Results

##### Frequency Error vs. Voltage

Voltage (Volts)	GSM				Limit (ppm)
	Low Channel		High Channel		
	Frequency (MHz)	Frequency Error (ppm)	Frequency (MHz)	Frequency Error (ppm)	
3.8	824.200002	0.003	1909.800003	0.001	2.5
3.6	824.200003	0.004	1909.800003	0.002	2.5
4.35	824.200002	0.002	1909.800003	0.001	2.5

**Note:** The applicant defined the normal working voltage of the battery is from 3.6 Vdc to 4.35 Vdc.

##### Frequency Error vs. Temperature

Temp. (°C)	GSM				Limit (ppm)
	Low Channel		High Channel		
	Frequency (MHz)	Frequency Error (ppm)	Frequency (MHz)	Frequency Error (ppm)	
-30	824.200002	0.003	1909.800002	0.001	2.5
-20	824.200004	0.005	1909.800004	0.002	2.5
-10	824.200002	0.002	1909.800002	0.001	2.5
0	824.200003	0.004	1909.800004	0.002	2.5
10	824.200004	0.004	1909.800003	0.002	2.5
20	824.199996	-0.005	1909.799999	-0.001	2.5
30	824.199998	-0.002	1909.799999	-0.001	2.5
40	824.199998	-0.003	1909.799999	-0.001	2.5
50	824.199998	-0.002	1909.799996	-0.002	2.5
55	824.199999	-0.001	1909.799997	-0.002	2.5

## Frequency Error vs. Voltage

Voltage (Volts)	EDGE				Limit (ppm)
	Low Channel		High Channel		
	Frequency (MHz)	Frequency Error (ppm)	Frequency (MHz)	Frequency Error (ppm)	
3.8	824.200003	0.004	1909.800004	0.002	2.5
3.6	824.200003	0.004	1909.800002	0.001	2.5
4.35	824.200004	0.004	1909.800003	0.002	2.5

**Note:** The applicant defined the normal working voltage of the battery is from 3.6 Vdc to 4.35 Vdc.

## Frequency Error vs. Temperature

Temp. (°C)	EDGE				Limit (ppm)
	Low Channel		High Channel		
	Frequency (MHz)	Frequency Error (ppm)	Frequency (MHz)	Frequency Error (ppm)	
-30	824.200003	0.003	1909.800002	0.001	2.5
-20	824.200002	0.002	1909.800001	0.001	2.5
-10	824.200002	0.002	1909.800001	0.001	2.5
0	824.200001	0.002	1909.800004	0.002	2.5
10	824.200003	0.004	1909.800001	0.001	2.5
20	824.199996	-0.005	1909.799999	-0.001	2.5
30	824.199998	-0.002	1909.799996	-0.002	2.5
40	824.199998	-0.003	1909.799999	-0.001	2.5
50	824.199998	-0.002	1909.799998	-0.001	2.5
55	824.199998	-0.002	1909.799997	-0.001	2.5

## Frequency Error vs. Voltage

Voltage (Volts)	WCDMA				Limit (ppm)
	Low Channel		High Channel		
	Frequency (MHz)	Frequency Error (ppm)	Frequency (MHz)	Frequency Error (ppm)	
3.8	826.400003	0.003	846.600001	0.001	2.5
3.6	826.400004	0.004	846.600003	0.004	2.5
4.35	826.400001	0.001	846.600003	0.004	2.5

**Note:** The applicant defined the normal working voltage of the battery is from 3.6 Vdc to 4.35 Vdc.

## Frequency Error vs. Temperature

Temp. (°C)	WCDMA				Limit (ppm)
	Low Channel		High Channel		
	Frequency (MHz)	Frequency Error (ppm)	Frequency (MHz)	Frequency Error (ppm)	
-30	826.400002	0.003	846.600004	0.005	2.5
-20	826.400001	0.002	846.600003	0.004	2.5
-10	826.400002	0.003	846.600002	0.002	2.5
0	826.400002	0.002	846.600001	0.001	2.5
10	826.400002	0.002	846.600004	0.004	2.5
20	826.399996	-0.005	846.599996	-0.005	2.5
30	826.399996	-0.005	846.599997	-0.004	2.5
40	826.399997	-0.003	846.599997	-0.004	2.5
50	826.399997	-0.003	846.599998	-0.002	2.5
55	826.399997	-0.003	846.599999	-0.002	2.5

Frequency Error vs. Voltage

Voltage (Volts)	LTE Band 5				Limit (ppm)
	Channel Bandwidth: 1.4 MHz				
	Low Channel		High Channel		
	Frequency (MHz)	Frequency Error (ppm)	Frequency (MHz)	Frequency Error (ppm)	
3.8	824.700001	0.001	848.300002	0.002	2.5
3.6	824.700004	0.005	848.300004	0.005	2.5
4.35	824.700004	0.005	848.300002	0.002	2.5

**Note:** The applicant defined the normal working voltage of the battery is from 3.6 Vdc to 4.35 Vdc.

Frequency Error vs. Temperature

Temp. (°C)	LTE Band 5				Limit (ppm)
	Channel Bandwidth: 1.4 MHz				
	Low Channel		High Channel		
	Frequency (MHz)	Frequency Error (ppm)	Frequency (MHz)	Frequency Error (ppm)	
-30	824.700002	0.002	848.300002	0.002	2.5
-20	824.700001	0.001	848.300003	0.003	2.5
-10	824.700003	0.004	848.300002	0.003	2.5
0	824.700003	0.003	848.300001	0.001	2.5
10	824.700001	0.002	848.300002	0.002	2.5
20	824.699998	-0.002	848.299999	-0.001	2.5
30	824.699996	-0.005	848.299999	-0.001	2.5
40	824.699997	-0.003	848.299996	-0.005	2.5
50	824.699996	-0.004	848.299996	-0.004	2.5
55	824.699998	-0.003	848.299998	-0.002	2.5

Frequency Error vs. Voltage

Voltage (Volts)	LTE Band 5				Limit (ppm)
	Channel Bandwidth: 3 MHz				
	Low Channel		High Channel		
	Frequency (MHz)	Frequency Error (ppm)	Frequency (MHz)	Frequency Error (ppm)	
3.8	825.500003	0.004	847.500001	0.002	2.5
3.6	825.500003	0.004	847.500003	0.004	2.5
4.35	825.500002	0.002	847.500003	0.003	2.5

**Note:** The applicant defined the normal working voltage of the battery is from 3.6 Vdc to 4.35 Vdc.

Frequency Error vs. Temperature

Temp. (°C)	LTE Band 5				Limit (ppm)
	Channel Bandwidth: 3 MHz				
	Low Channel		High Channel		
	Frequency (MHz)	Frequency Error (ppm)	Frequency (MHz)	Frequency Error (ppm)	
-30	825.500002	0.002	847.500003	0.003	2.5
-20	825.500003	0.004	847.500003	0.003	2.5
-10	825.500002	0.003	847.500002	0.003	2.5
0	825.500001	0.002	847.500001	0.001	2.5
10	825.500001	0.001	847.500002	0.002	2.5
20	825.499996	-0.004	847.499997	-0.004	2.5
30	825.499997	-0.004	847.499996	-0.005	2.5
40	825.499998	-0.003	847.499998	-0.002	2.5
50	825.499998	-0.002	847.499996	-0.004	2.5
55	825.499998	-0.003	847.499998	-0.002	2.5

Frequency Error vs. Voltage

Voltage (Volts)	LTE Band 5				Limit (ppm)
	Channel Bandwidth: 5 MHz				
	Low Channel		High Channel		
	Frequency (MHz)	Frequency Error (ppm)	Frequency (MHz)	Frequency Error (ppm)	
3.8	826.500004	0.004	846.500003	0.004	2.5
3.6	826.500003	0.004	846.500003	0.004	2.5
4.35	826.500004	0.004	846.500001	0.001	2.5

**Note:** The applicant defined the normal working voltage of the battery is from 3.6 Vdc to 4.35 Vdc.

Frequency Error vs. Temperature

Temp. (°C)	LTE Band 5				Limit (ppm)
	Channel Bandwidth: 5 MHz				
	Low Channel		High Channel		
	Frequency (MHz)	Frequency Error (ppm)	Frequency (MHz)	Frequency Error (ppm)	
-30	826.500003	0.003	846.500002	0.003	2.5
-20	826.500004	0.004	846.500004	0.005	2.5
-10	826.500002	0.002	846.500003	0.004	2.5
0	826.500003	0.003	846.500003	0.004	2.5
10	826.500003	0.004	846.500002	0.002	2.5
20	826.499997	-0.004	846.499998	-0.002	2.5
30	826.499999	-0.002	846.499997	-0.004	2.5
40	826.499997	-0.004	846.499999	-0.001	2.5
50	826.499998	-0.003	846.499997	-0.003	2.5
55	826.499998	-0.003	846.499998	-0.003	2.5

## Frequency Error vs. Voltage

Voltage (Volts)	LTE Band 5				Limit (ppm)
	Channel Bandwidth: 10 MHz				
	Low Channel		High Channel		
	Frequency (MHz)	Frequency Error (ppm)	Frequency (MHz)	Frequency Error (ppm)	
3.8	829.000004	0.004	844.000002	0.003	2.5
3.6	829.000004	0.005	844.000003	0.003	2.5
4.35	829.000003	0.004	844.000004	0.004	2.5

**Note:** The applicant defined the normal working voltage of the battery is from 3.6 Vdc to 4.35 Vdc.

## Frequency Error vs. Temperature

Temp. (°C)	LTE Band 5				Limit (ppm)
	Channel Bandwidth: 10 MHz				
	Low Channel		High Channel		
	Frequency (MHz)	Frequency Error (ppm)	Frequency (MHz)	Frequency Error (ppm)	
-30	829.000002	0.003	844.000001	0.001	2.5
-20	829.000003	0.004	844.000002	0.002	2.5
-10	829.000004	0.005	844.000001	0.001	2.5
0	829.000001	0.002	844.000003	0.003	2.5
10	829.000003	0.004	844.000003	0.003	2.5
20	828.999997	-0.003	843.999996	-0.004	2.5
30	828.999996	-0.005	843.999999	-0.002	2.5
40	828.999997	-0.003	843.999997	-0.004	2.5
50	828.999999	-0.001	843.999998	-0.002	2.5
55	828.999998	-0.003	843.999997	-0.004	2.5



Frequency Error vs. Voltage

Voltage (Volts)	LTE Band 26				Limit (ppm)
	Channel Bandwidth: 1.4 MHz				
	Low Channel		High Channel		
	Frequency (MHz)	Frequency Error (ppm)	Frequency (MHz)	Frequency Error (ppm)	
3.8	824.700001	0.001	848.300004	0.004	2.5
3.6	824.700001	0.002	848.300003	0.004	2.5
4.35	824.700003	0.004	848.300004	0.004	2.5

**Note:** The applicant defined the normal working voltage of the battery is from 3.6 Vdc to 4.35 Vdc.

Frequency Error vs. Temperature

Temp. (°C)	LTE Band 26				Limit (ppm)
	Channel Bandwidth: 1.4 MHz				
	Low Channel		High Channel		
	Frequency (MHz)	Frequency Error (ppm)	Frequency (MHz)	Frequency Error (ppm)	
-30	824.700003	0.003	848.300001	0.001	2.5
-20	824.700004	0.005	848.300002	0.002	2.5
-10	824.700002	0.003	848.300004	0.005	2.5
0	824.700003	0.003	848.300002	0.003	2.5
10	824.700003	0.004	848.300003	0.004	2.5
20	824.699999	-0.001	848.299997	-0.003	2.5
30	824.699999	-0.002	848.299997	-0.004	2.5
40	824.699997	-0.004	848.299998	-0.002	2.5
50	824.699996	-0.005	848.299996	-0.005	2.5
55	824.699999	-0.001	848.299998	-0.003	2.5

## Frequency Error vs. Voltage

Voltage (Volts)	LTE Band 26				Limit (ppm)
	Channel Bandwidth: 3 MHz				
	Low Channel		High Channel		
	Frequency (MHz)	Frequency Error (ppm)	Frequency (MHz)	Frequency Error (ppm)	
3.8	825.500002	0.002	847.500003	0.003	2.5
3.6	825.500004	0.004	847.500002	0.002	2.5
4.35	825.500002	0.003	847.500001	0.001	2.5

**Note:** The applicant defined the normal working voltage of the battery is from 3.6 Vdc to 4.35 Vdc.

## Frequency Error vs. Temperature

Temp. (°C)	LTE Band 26				Limit (ppm)
	Channel Bandwidth: 3 MHz				
	Low Channel		High Channel		
	Frequency (MHz)	Frequency Error (ppm)	Frequency (MHz)	Frequency Error (ppm)	
-30	825.500002	0.003	847.500002	0.002	2.5
-20	825.500002	0.003	847.500004	0.004	2.5
-10	825.500002	0.002	847.500002	0.002	2.5
0	825.500002	0.002	847.500001	0.001	2.5
10	825.500003	0.004	847.500002	0.002	2.5
20	825.499998	-0.002	847.499997	-0.004	2.5
30	825.499997	-0.003	847.499998	-0.002	2.5
40	825.499998	-0.003	847.499997	-0.004	2.5
50	825.499997	-0.004	847.499999	-0.002	2.5
55	825.499997	-0.004	847.499998	-0.003	2.5

Frequency Error vs. Voltage

Voltage (Volts)	LTE Band 26				Limit (ppm)
	Channel Bandwidth: 5 MHz				
	Low Channel		High Channel		
	Frequency (MHz)	Frequency Error (ppm)	Frequency (MHz)	Frequency Error (ppm)	
3.8	826.500003	0.004	846.500001	0.001	2.5
3.6	826.500002	0.003	846.500002	0.003	2.5
4.35	826.500002	0.002	846.500002	0.002	2.5

**Note:** The applicant defined the normal working voltage of the battery is from 3.6 Vdc to 4.35 Vdc.

Frequency Error vs. Temperature

Temp. (°C)	LTE Band 26				Limit (ppm)
	Channel Bandwidth: 5 MHz				
	Low Channel		High Channel		
	Frequency (MHz)	Frequency Error (ppm)	Frequency (MHz)	Frequency Error (ppm)	
-30	826.500002	0.002	846.500003	0.003	2.5
-20	826.500004	0.005	846.500003	0.003	2.5
-10	826.500003	0.003	846.500003	0.004	2.5
0	826.500004	0.005	846.500002	0.002	2.5
10	826.500003	0.003	846.500003	0.003	2.5
20	826.499997	-0.004	846.499996	-0.004	2.5
30	826.499997	-0.004	846.499997	-0.004	2.5
40	826.499998	-0.003	846.499999	-0.002	2.5
50	826.499999	-0.001	846.499999	-0.001	2.5
55	826.499997	-0.003	846.499996	-0.004	2.5

Frequency Error vs. Voltage

Voltage (Volts)	LTE Band 26				Limit (ppm)
	Channel Bandwidth: 10 MHz				
	Low Channel		High Channel		
	Frequency (MHz)	Frequency Error (ppm)	Frequency (MHz)	Frequency Error (ppm)	
3.8	829.000004	0.005	844.000002	0.002	2.5
3.6	829.000004	0.005	844.000002	0.002	2.5
4.35	829.000002	0.002	844.000002	0.002	2.5

**Note:** The applicant defined the normal working voltage of the battery is from 3.6 Vdc to 4.35 Vdc.

Frequency Error vs. Temperature

Temp. (°C)	LTE Band 26				Limit (ppm)
	Channel Bandwidth: 10 MHz				
	Low Channel		High Channel		
	Frequency (MHz)	Frequency Error (ppm)	Frequency (MHz)	Frequency Error (ppm)	
-30	829.000004	0.005	844.000002	0.002	2.5
-20	829.000002	0.002	844.000004	0.004	2.5
-10	829.000004	0.005	844.000002	0.002	2.5
0	829.000001	0.001	844.000002	0.002	2.5
10	829.000003	0.003	844.000002	0.003	2.5
20	828.999997	-0.004	843.999999	-0.002	2.5
30	828.999998	-0.003	843.999997	-0.003	2.5
40	828.999999	-0.002	843.999997	-0.004	2.5
50	828.999998	-0.003	843.999999	-0.002	2.5
55	828.999997	-0.004	843.999999	-0.001	2.5

Frequency Error vs. Voltage

Voltage (Volts)	LTE Band 26				Limit (ppm)
	Channel Bandwidth: 15 MHz				
	Low Channel		High Channel		
	Frequency (MHz)	Frequency Error (ppm)	Frequency (MHz)	Frequency Error (ppm)	
3.8	831.500002	0.002	841.500001	0.002	2.5
3.6	831.500002	0.002	841.500001	0.001	2.5
4.35	831.500004	0.004	841.500002	0.002	2.5

**Note:** The applicant defined the normal working voltage of the battery is from 3.6 Vdc to 4.35 Vdc.

Frequency Error vs. Temperature

Temp. (°C)	LTE Band 26				Limit (ppm)
	Channel Bandwidth: 15 MHz				
	Low Channel		High Channel		
	Frequency (MHz)	Frequency Error (ppm)	Frequency (MHz)	Frequency Error (ppm)	
-30	831.500003	0.004	841.500002	0.002	2.5
-20	831.500002	0.003	841.500004	0.005	2.5
-10	831.500003	0.004	841.500003	0.003	2.5
0	831.500002	0.003	841.500003	0.003	2.5
10	831.500002	0.003	841.500004	0.004	2.5
20	831.499997	-0.004	841.499998	-0.002	2.5
30	831.499997	-0.003	841.499997	-0.003	2.5
40	831.499997	-0.004	841.499997	-0.004	2.5
50	831.499997	-0.004	841.499998	-0.003	2.5
55	831.499997	-0.003	841.499998	-0.002	2.5

### 4.3 Occupied Bandwidth Measurement

#### 4.3.1 Test Procedure

The EUT makes a call to the communication simulator. All measurements were done at low, middle and high operational frequency range. The communication simulator station system controlled a EUT to export maximum output power under transmission mode and specific channel frequency. Use OBW measurement function of Spectrum analyzer to measure 99 % occupied bandwidth.

#### 4.3.2 Test Setup

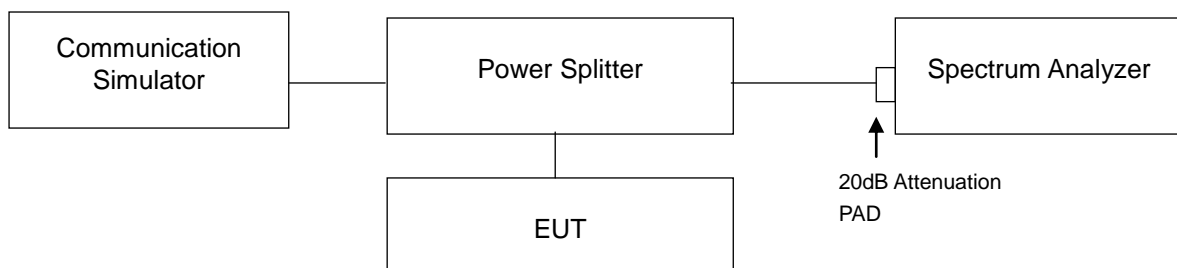

### 4.3.3 Test Result

Channel	Frequency (MHz)	99 % Occupied Bandwidth (kHz)		Channel	Frequency (MHz)	99 % Occupied Bandwidth (MHz)
		GSM	EDGE			WCDMA
128	824.2	243.76	243.11	4132	826.4	4.14
189	836.4	244.17	245.99	4182	836.4	4.14
251	848.8	244.75	244.04	4233	846.6	4.13

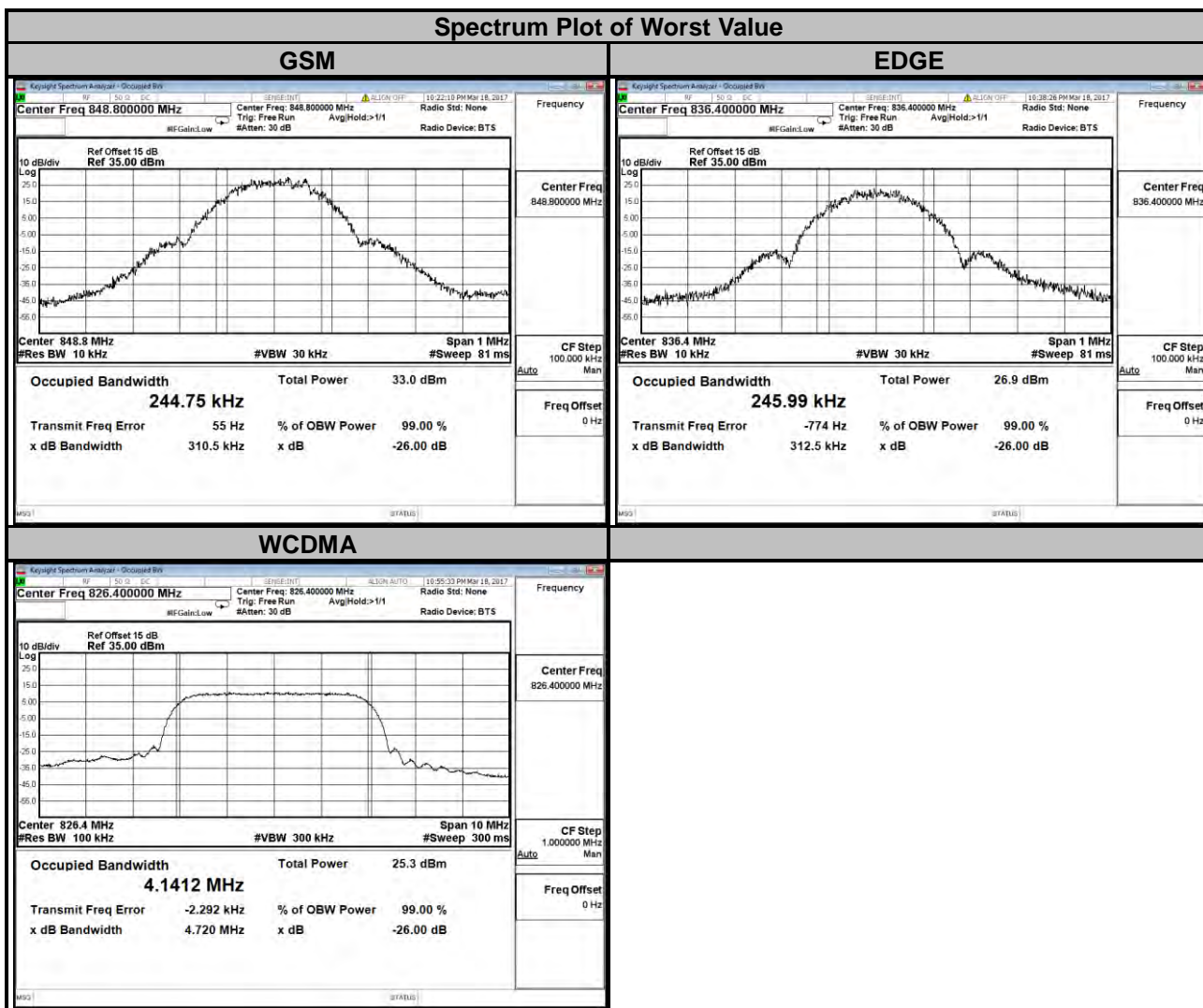

LTE Band 5							
Channel Bandwidth: 1.4 MHz				Channel Bandwidth: 3 MHz			
Channel	Frequency (MHz)	99 % Occupied Bandwidth (MHz)		Channel	Frequency (MHz)	99 % Occupied Bandwidth (MHz)	
		QPSK	16QAM			QPSK	16QAM
20407	824.7	1.09	1.09	20415	825.5	2.70	2.70
20525	836.5	1.09	1.09	20525	836.5	2.70	2.70
20643	848.3	1.09	1.09	20635	847.5	2.70	2.69

### Spectrum Plot of Worst Value

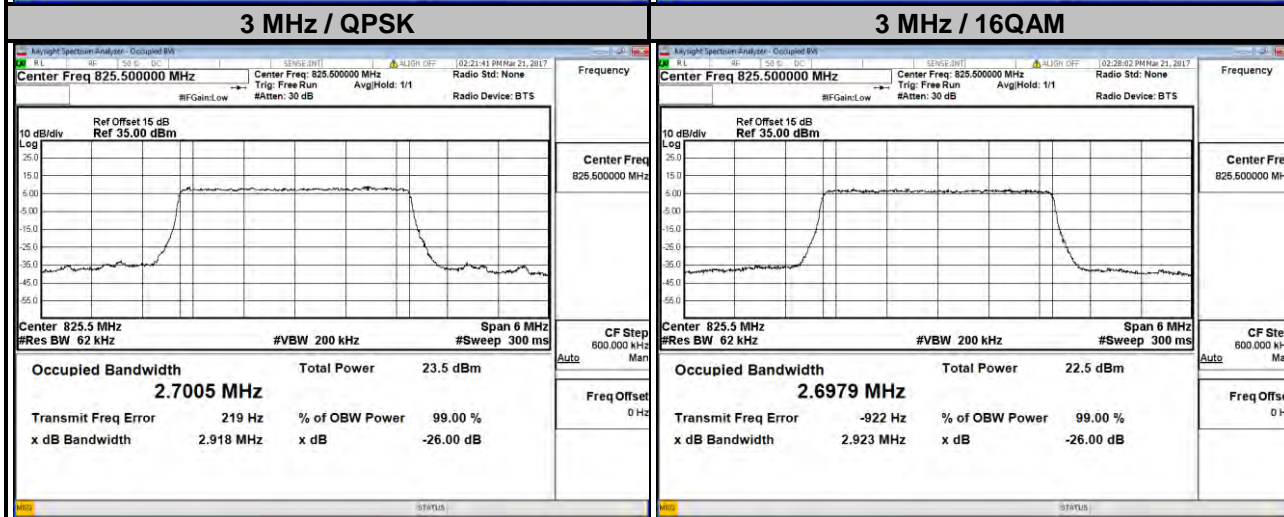
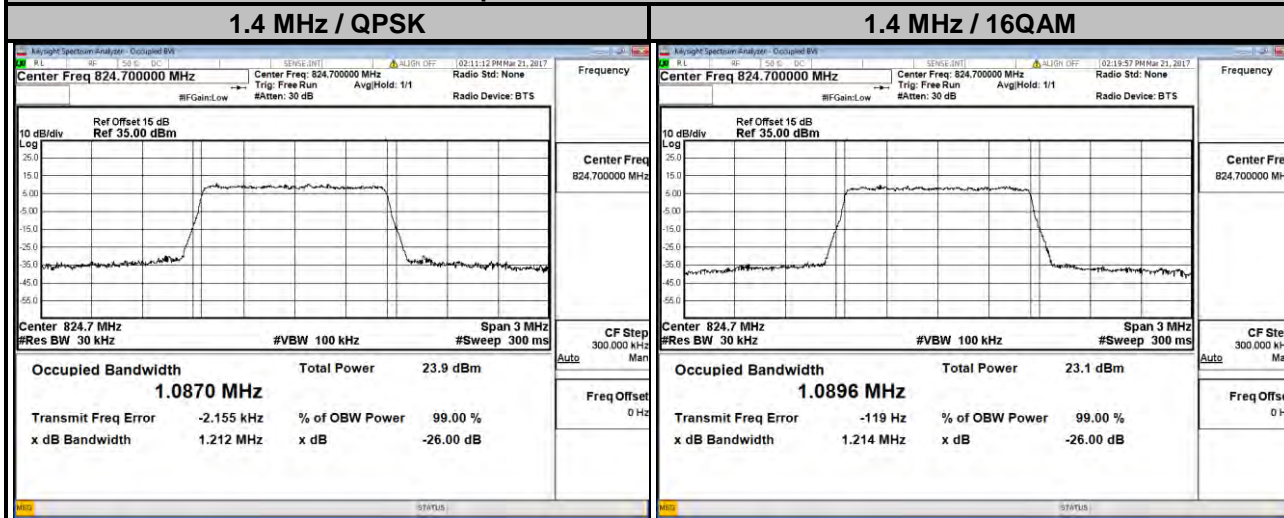



### LTE Band 5

Channel Bandwidth: 5 MHz				Channel Bandwidth: 10 MHz			
Channel	Frequency (MHz)	99 % Occupied Bandwidth (MHz)		Channel	Frequency (MHz)	99 % Occupied Bandwidth (MHz)	
		QPSK	16QAM			QPSK	16QAM
20425	826.5	4.49	4.49	20450	829.0	8.97	8.97
20525	836.5	4.49	4.49	20525	836.5	8.95	8.95
20625	846.5	4.49	4.49	20600	844.0	8.97	8.97

### Spectrum Plot of Worst Value

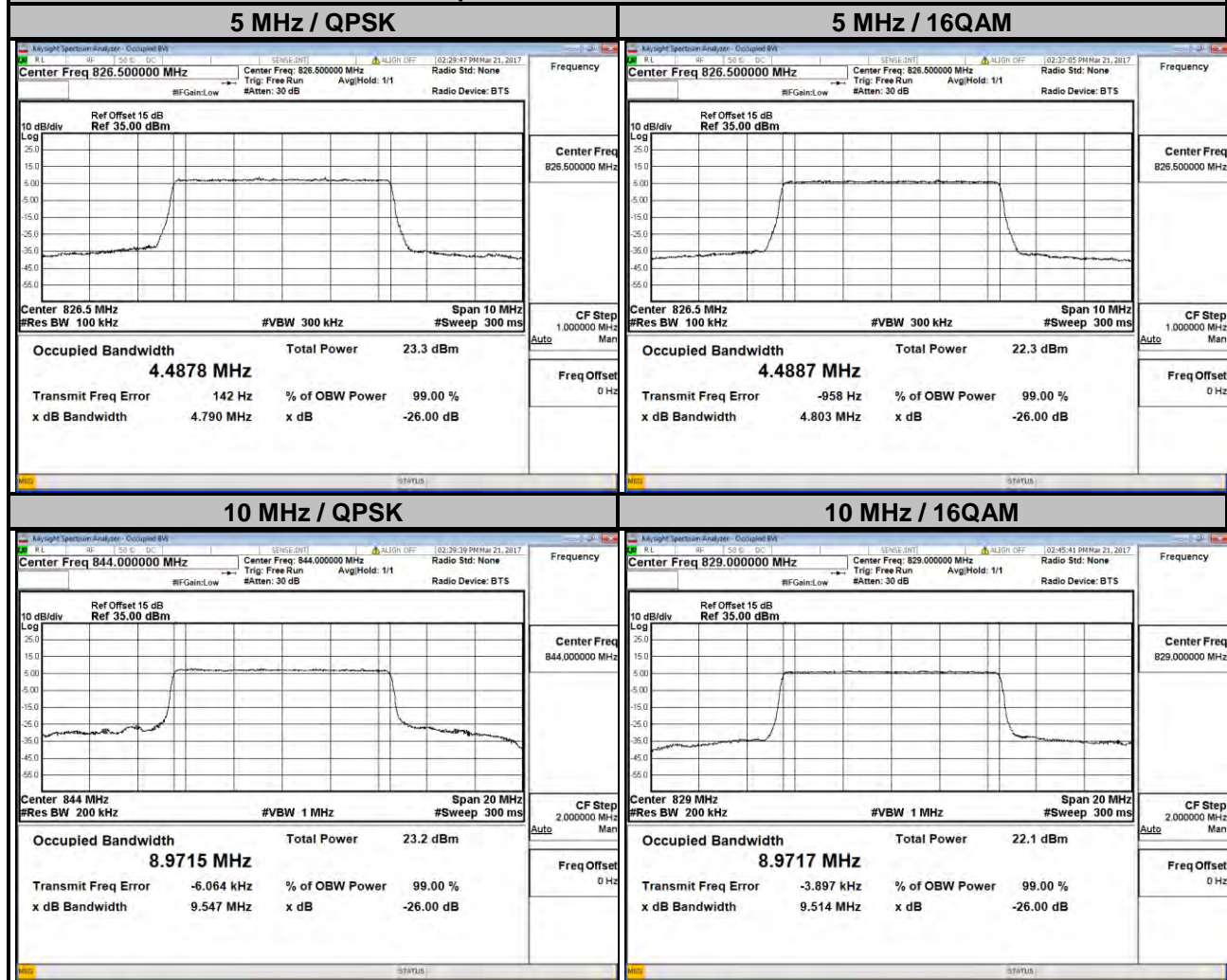

### LTE Band 26

Channel Bandwidth: 1.4 MHz				Channel Bandwidth: 3 MHz			
Channel	Frequency (MHz)	99 % Occupied Bandwidth (MHz)		Channel	Frequency (MHz)	99 % Occupied Bandwidth (MHz)	
		QPSK	16QAM			QPSK	16QAM
26797	824.7	1.09	1.09	26805	825.5	2.70	2.70
26915	836.5	1.09	1.09	26915	836.5	2.70	2.69
27033	848.3	1.09	1.09	27025	847.5	2.70	2.70

### Spectrum Plot of Worst Value

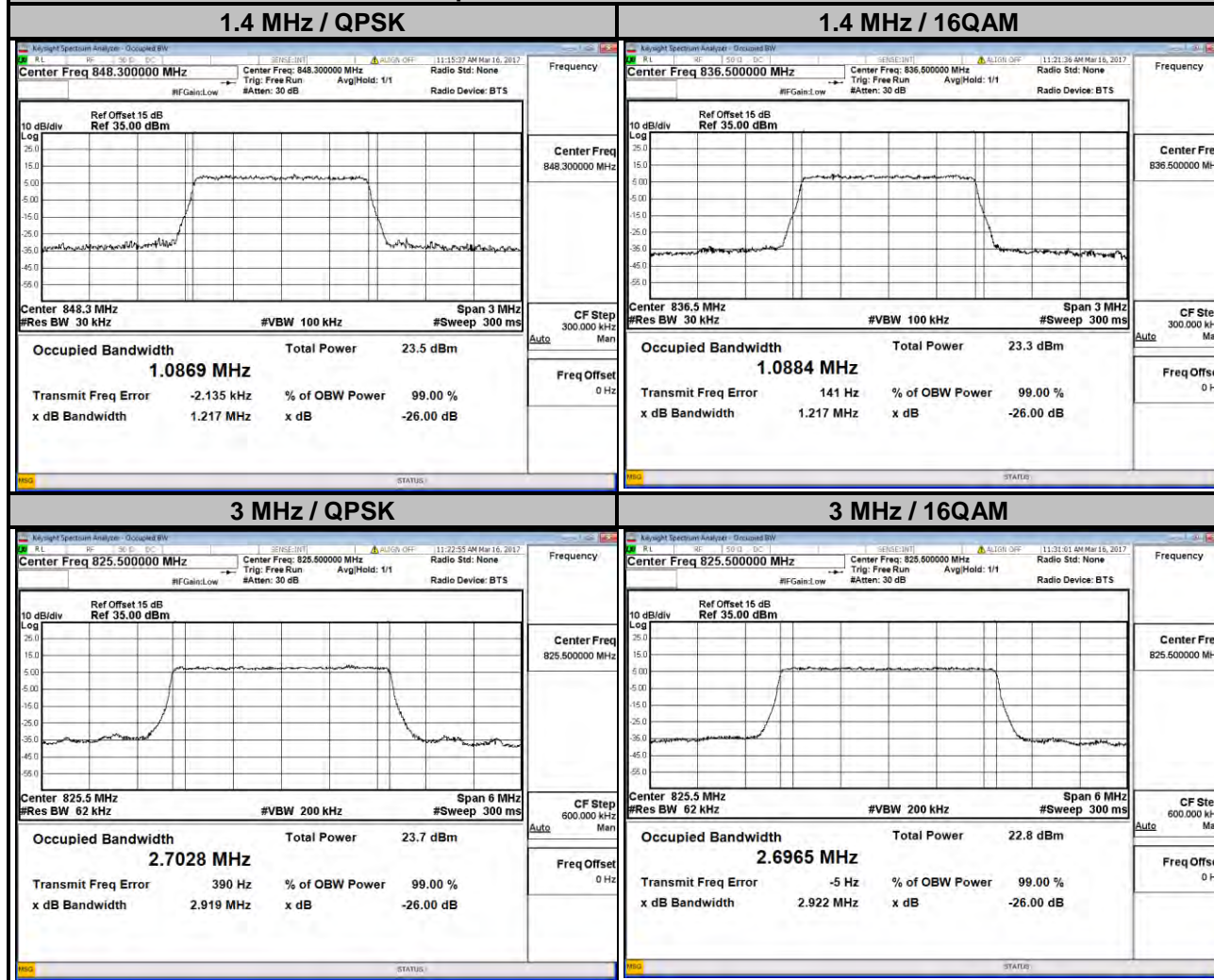

### LTE Band 26

Channel Bandwidth: 5 MHz				Channel Bandwidth: 10 MHz			
Channel	Frequency (MHz)	99 % Occupied Bandwidth (MHz)		Channel	Frequency (MHz)	99 % Occupied Bandwidth (MHz)	
		QPSK	16QAM			QPSK	16QAM
26815	826.5	4.49	4.49	26840	829.0	8.97	8.97
26915	836.5	4.49	4.49	26915	836.5	8.95	8.95
27015	846.5	4.48	4.49	26990	844.0	8.97	8.97

### Spectrum Plot of Worst Value

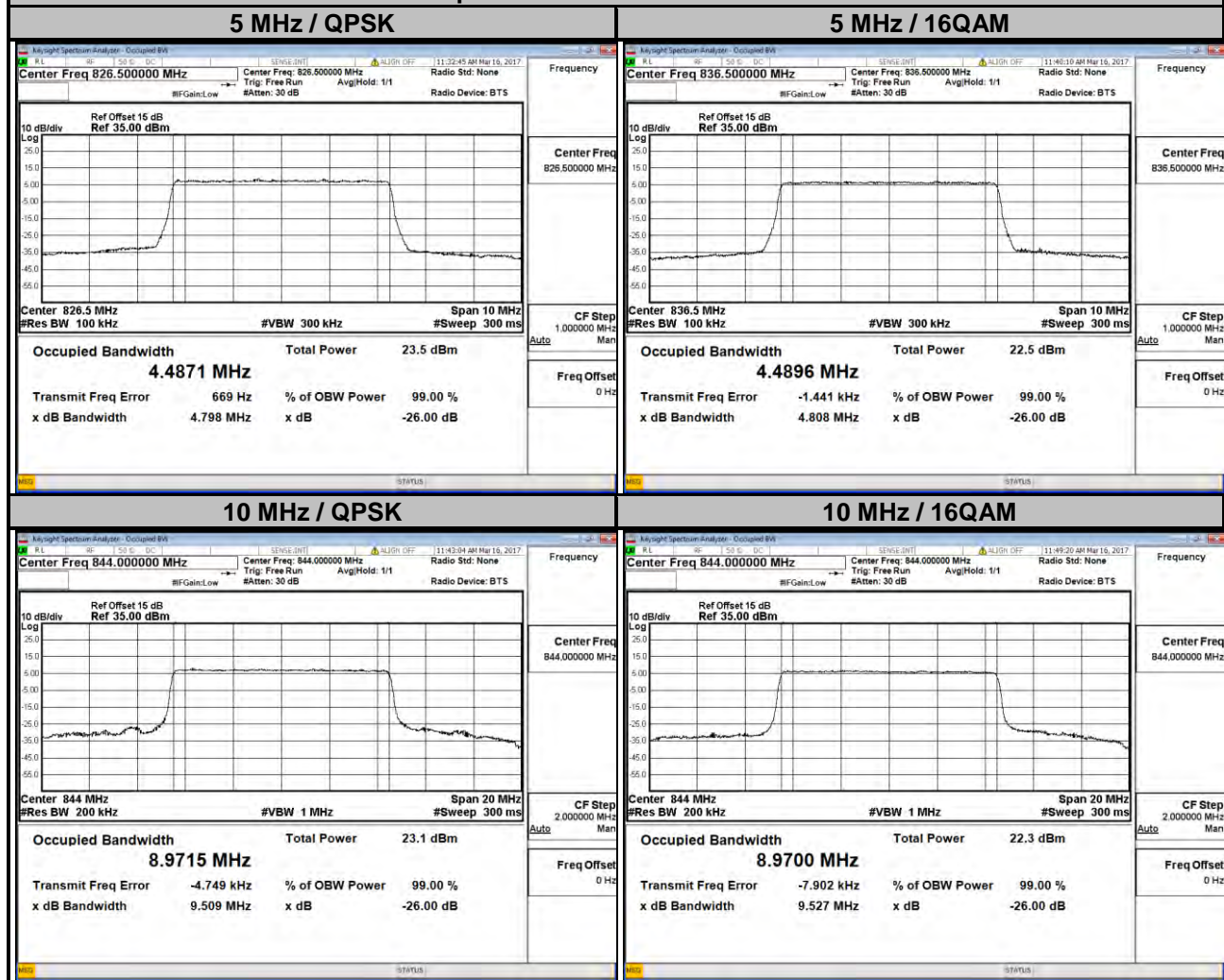

### LTE Band 26

#### Channel Bandwidth: 15 MHz

Channel	Frequency (MHz)	99 % Occupied Bandwidth (MHz)	
		QPSK	16QAM
26865	831.5	13.46	13.45
26915	836.5	13.45	13.43
26965	841.5	13.46	13.45

### Spectrum Plot of Worst Value

#### 15 MHz / QPSK

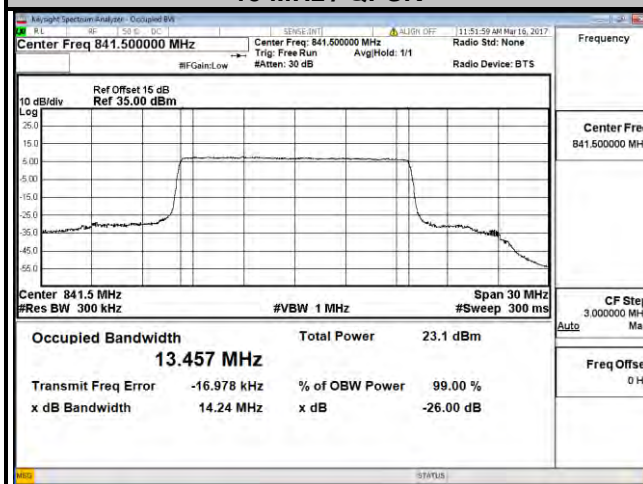

#### 15 MHz / 16QAM

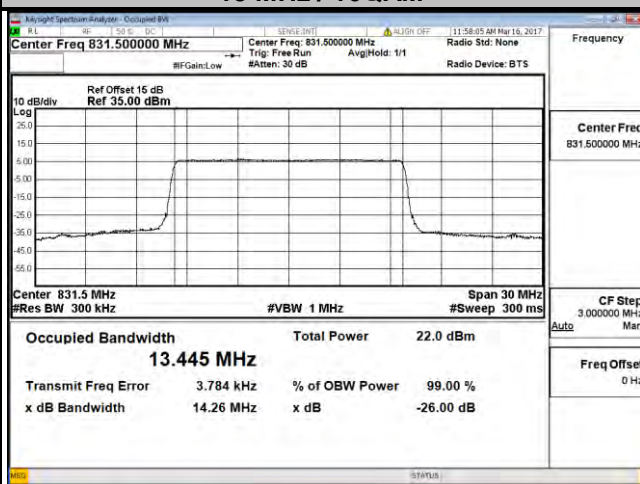

## 4.4 Band Edge Measurement

### 4.4.1 Limits of Band Edge Measurement

Power of any emission outside of the authorized operating frequency ranges must be attenuated below the transmitting power (P) by a factor of at least  $43 + 10 \log(P)$  dB. In the 1 MHz bands immediately outside and adjacent to the frequency block a resolution bandwidth of at least one percent of the emission bandwidth of the fundamental emission of the transmitter may be employed.

### 4.4.2 Test Setup

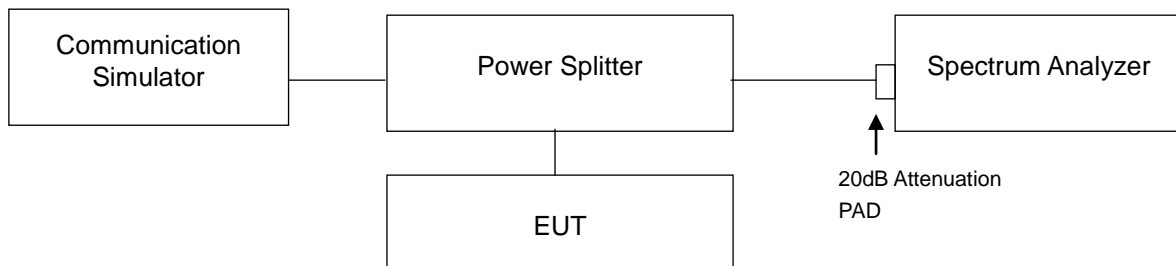

### 4.4.3 Test Procedures

- a. All measurements were done at low and high operational frequency range.
- b. The center frequency of spectrum is the band edge frequency and span is 1 MHz. RB of the spectrum is 10 kHz and VB of the spectrum is 30 kHz (GSM/GPRS/EDGE).
- c. The center frequency of spectrum is the band edge frequency and span is 5 MHz. RB of the spectrum is 100 kHz and VB of the spectrum is 300 kHz (WCDMA).
- d. The center frequency of spectrum is the band edge frequency and span is 1 MHz. RB of the spectrum is 13 kHz and VB of the spectrum is 51 kHz (LTE Bandwidth 1.4 MHz).
- e. The center frequency of spectrum is the band edge frequency and span is 1 MHz. RB of the spectrum is 30 kHz and VB of the spectrum is 100 kHz (LTE Bandwidth 3 MHz).
- f. The center frequency of spectrum is the band edge frequency and span is 1 MHz. RB of the spectrum is 100 kHz and VB of the spectrum is 300 kHz (LTE Bandwidth 5 MHz/10 MHz).
- g. The center frequency of spectrum is the band edge frequency and span is 1MHz. RB of the spectrum is 150 kHz and VB of the spectrum is 470 kHz (LTE Bandwidth 15 MHz).
- h. Record the max trace plot into the test report.

### 4.4.4 Test Results

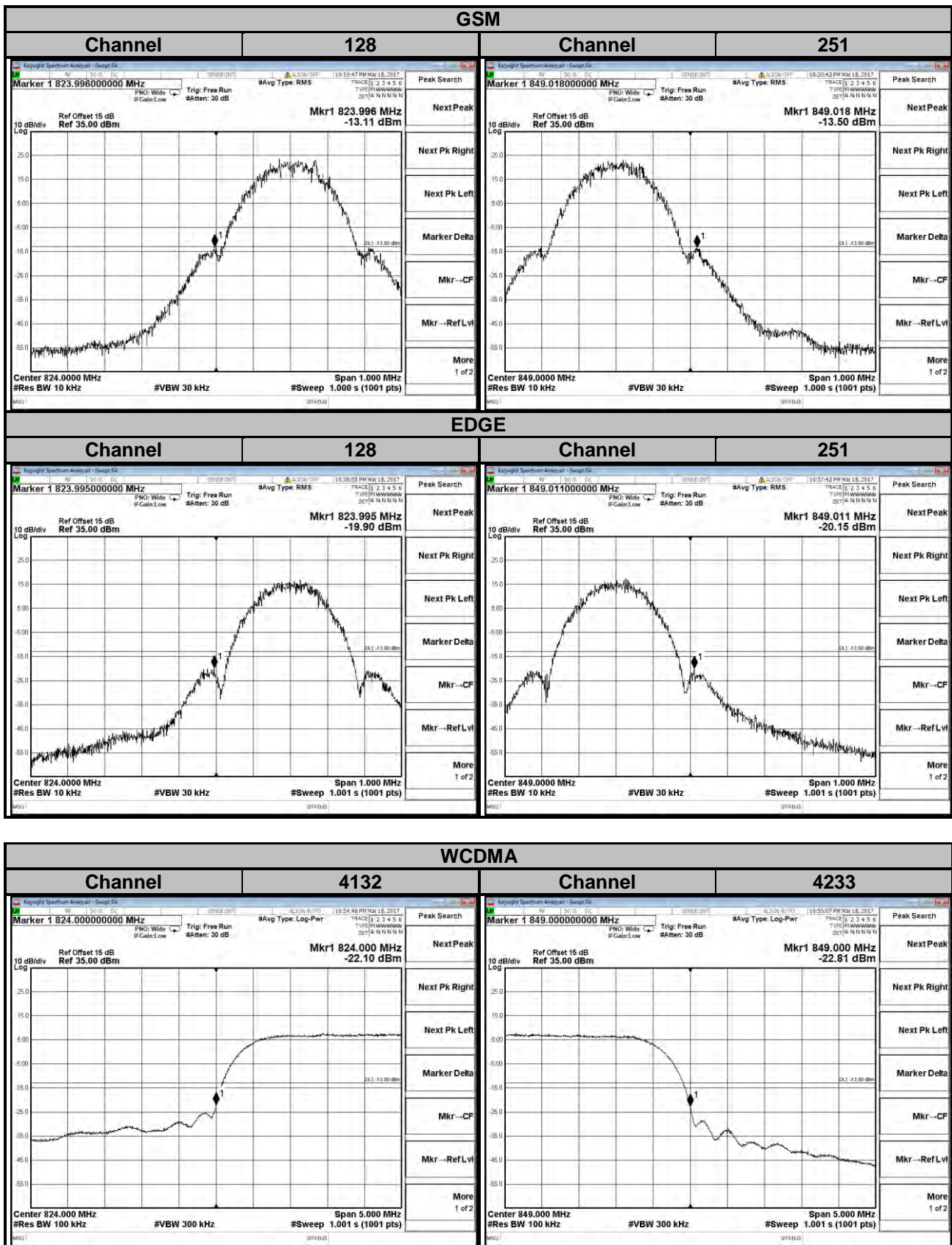

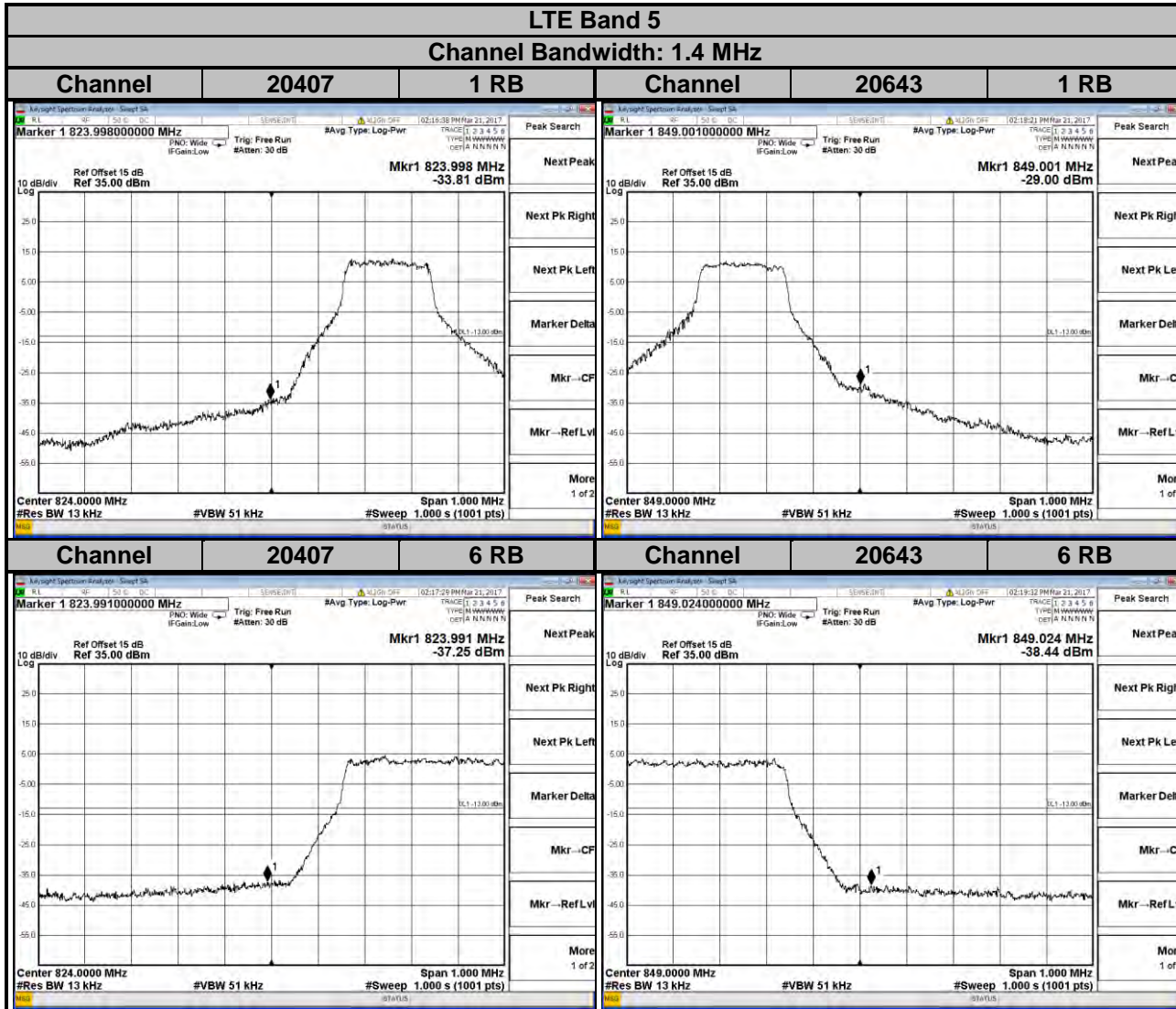

**LTE Band 5**  
**Channel Bandwidth: 3 MHz**

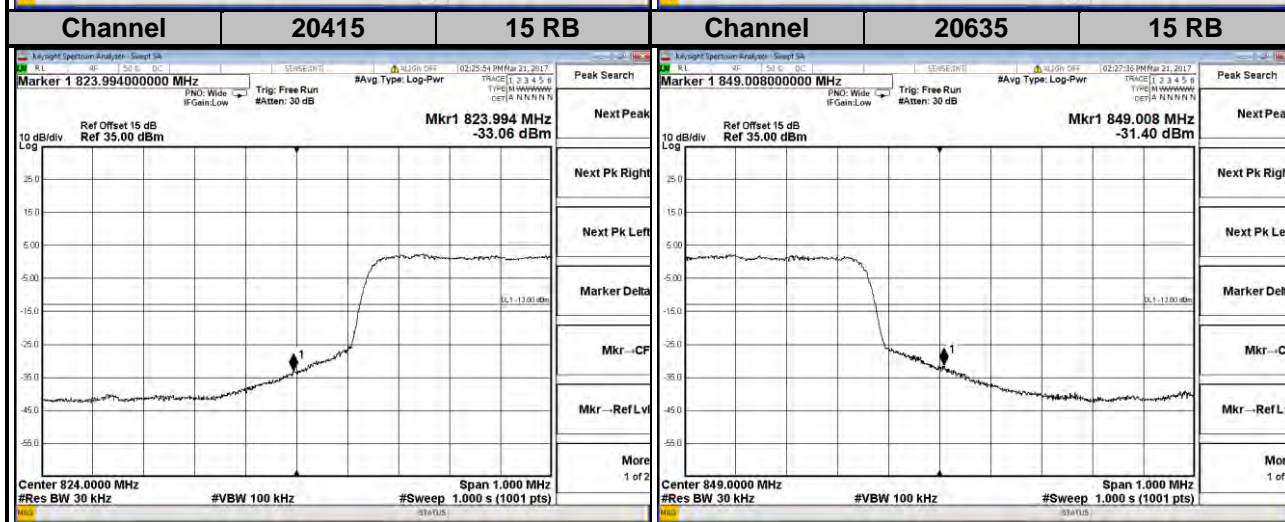
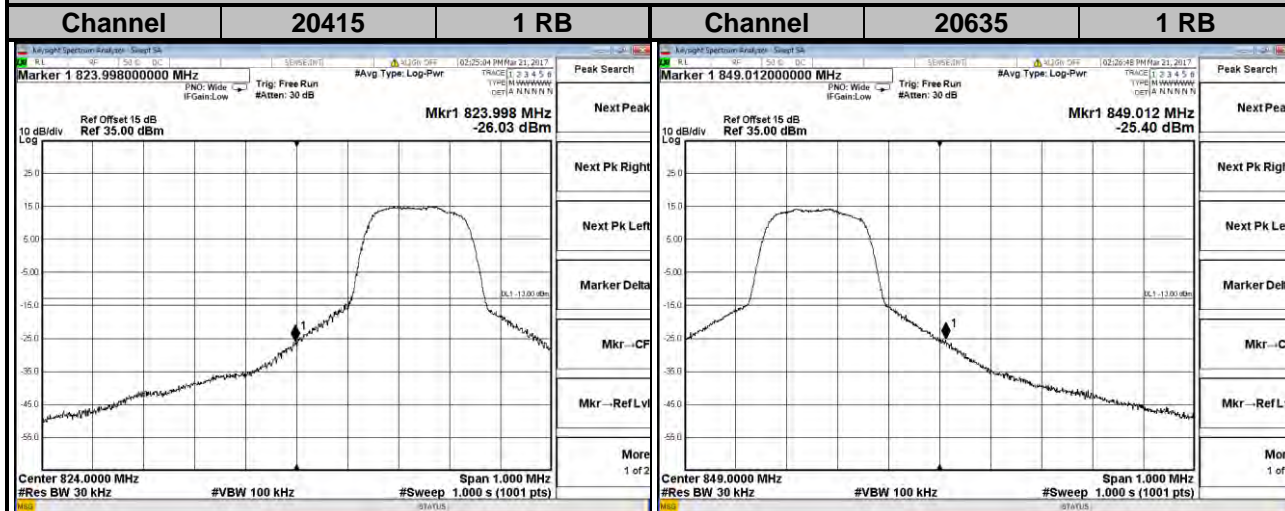



**LTE Band 5**  
**Channel Bandwidth: 5 MHz**

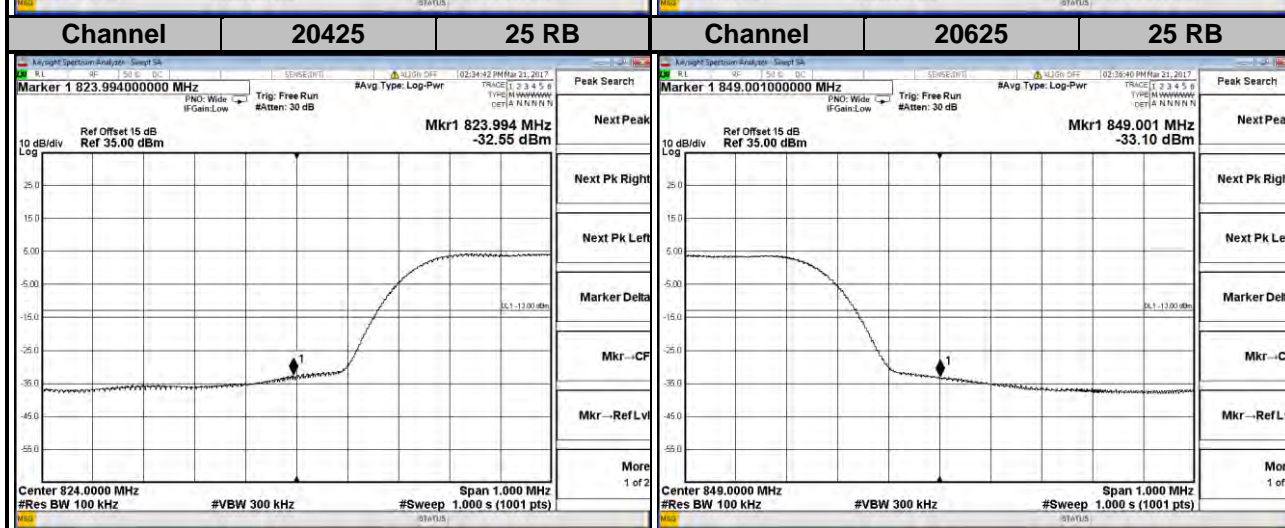
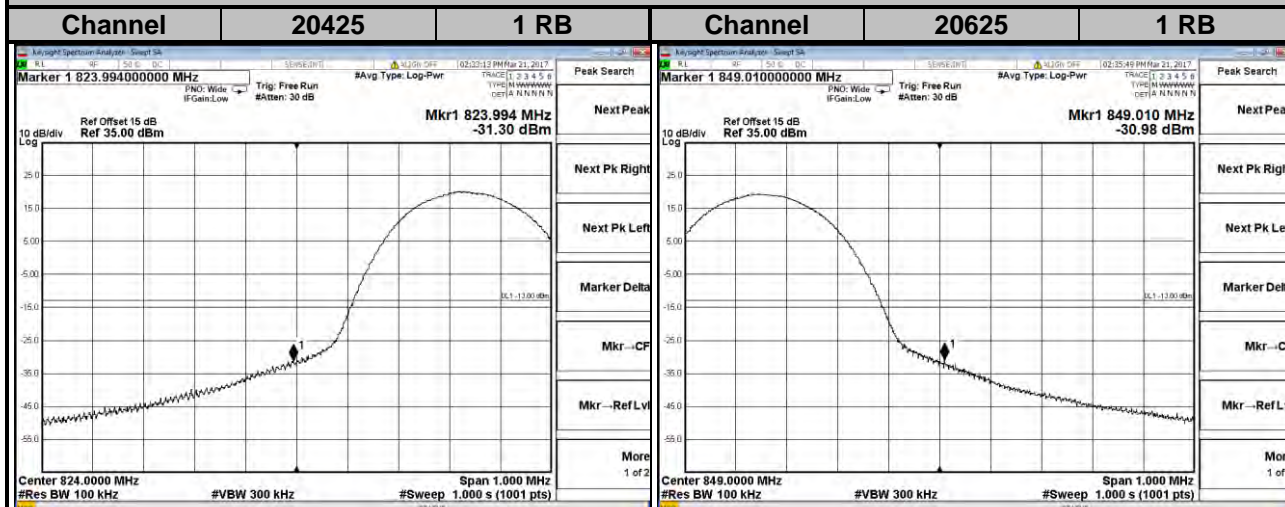

**LTE Band 5**  
**Channel Bandwidth: 10 MHz**

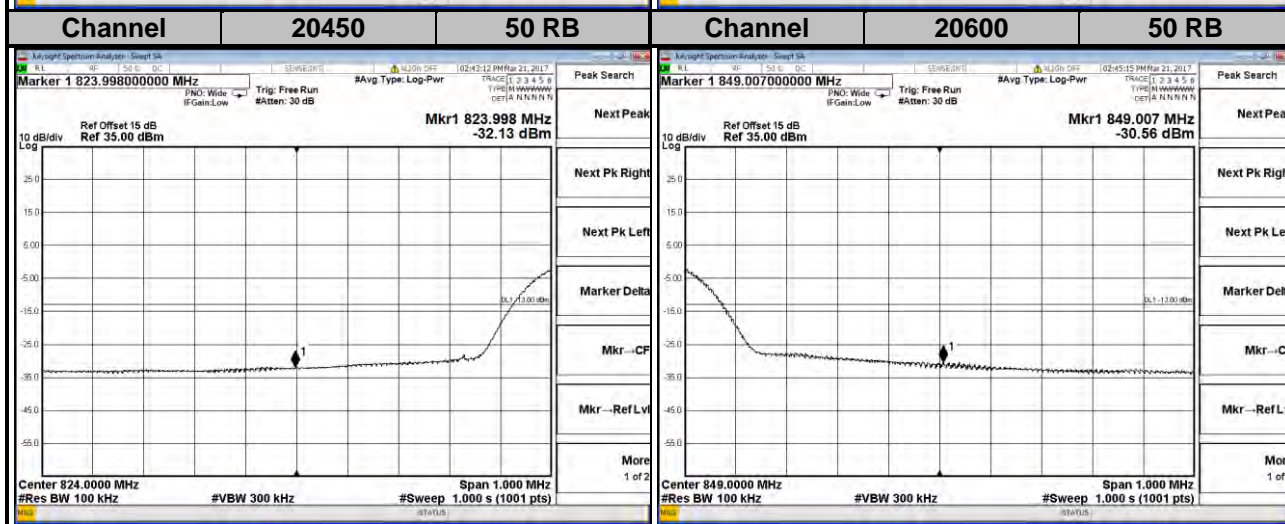
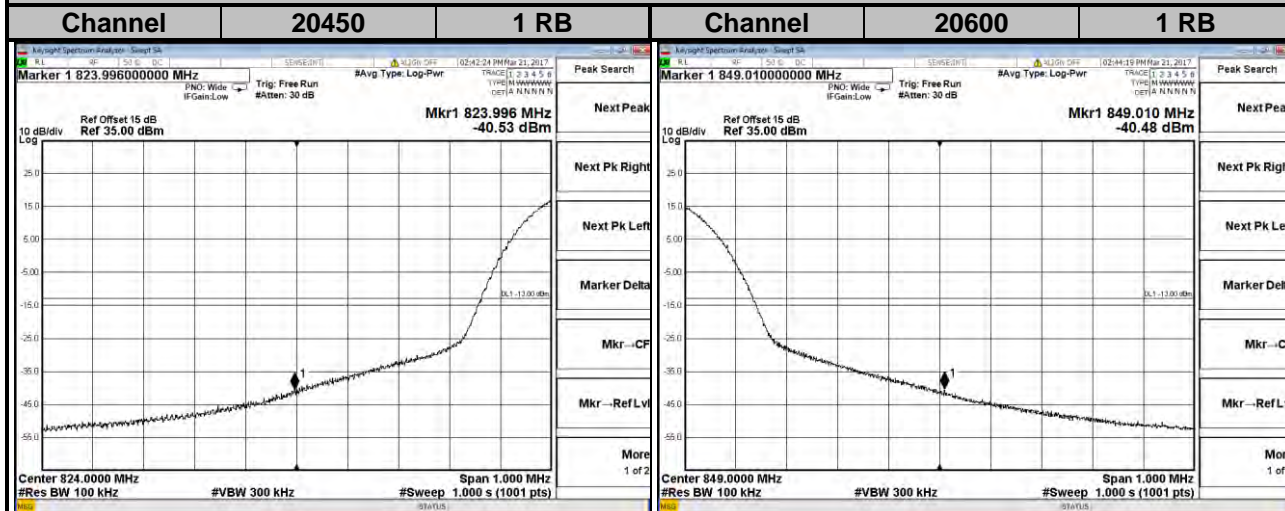

**LTE Band 26**  
**Channel Bandwidth: 1.4 MHz**

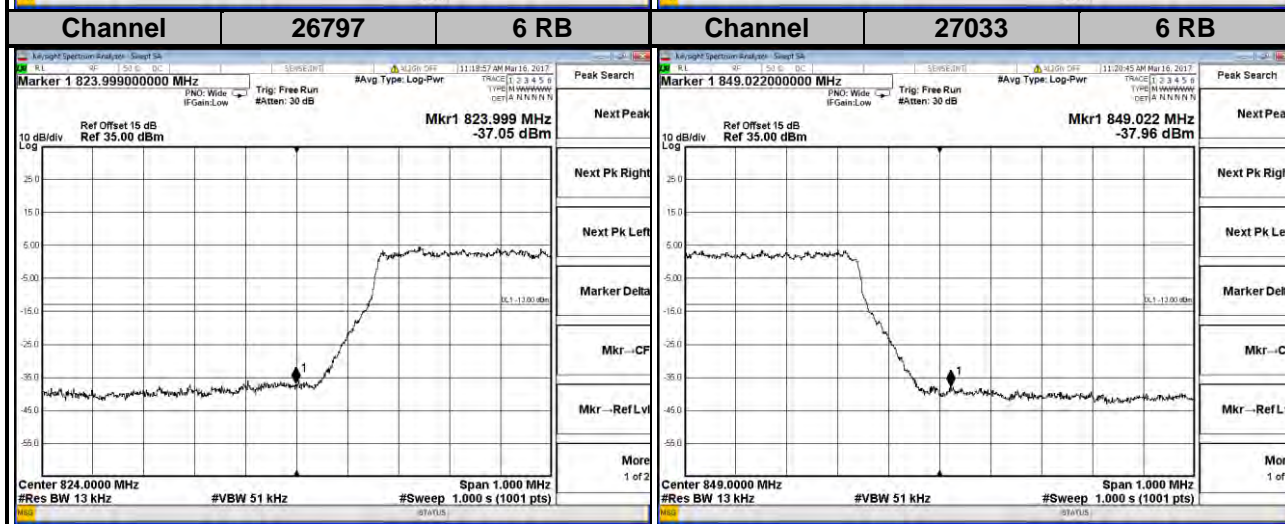
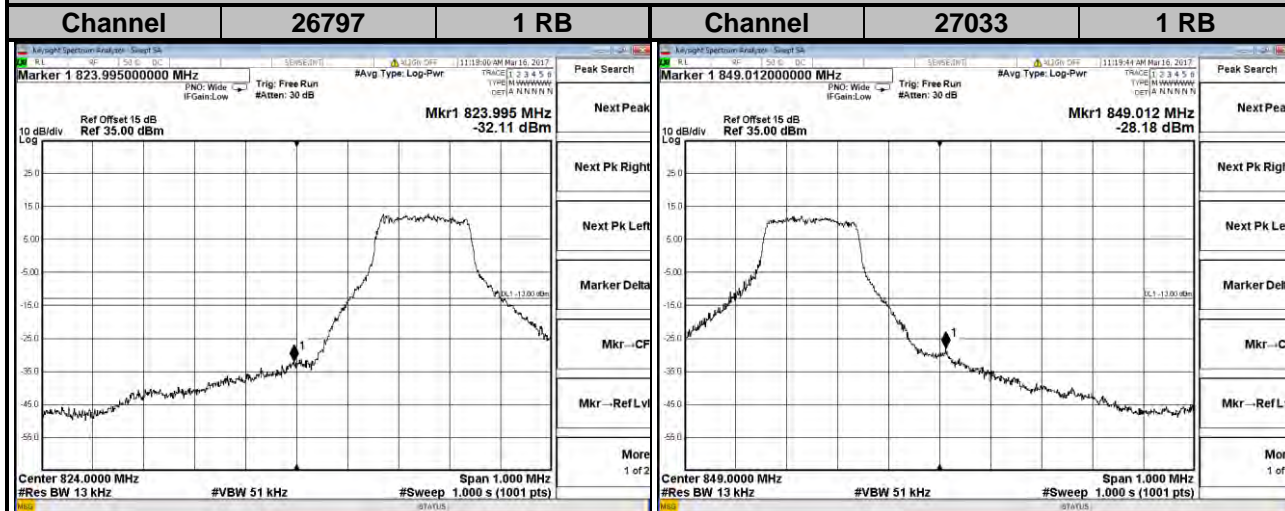

**LTE Band 26**  
**Channel Bandwidth: 3 MHz**

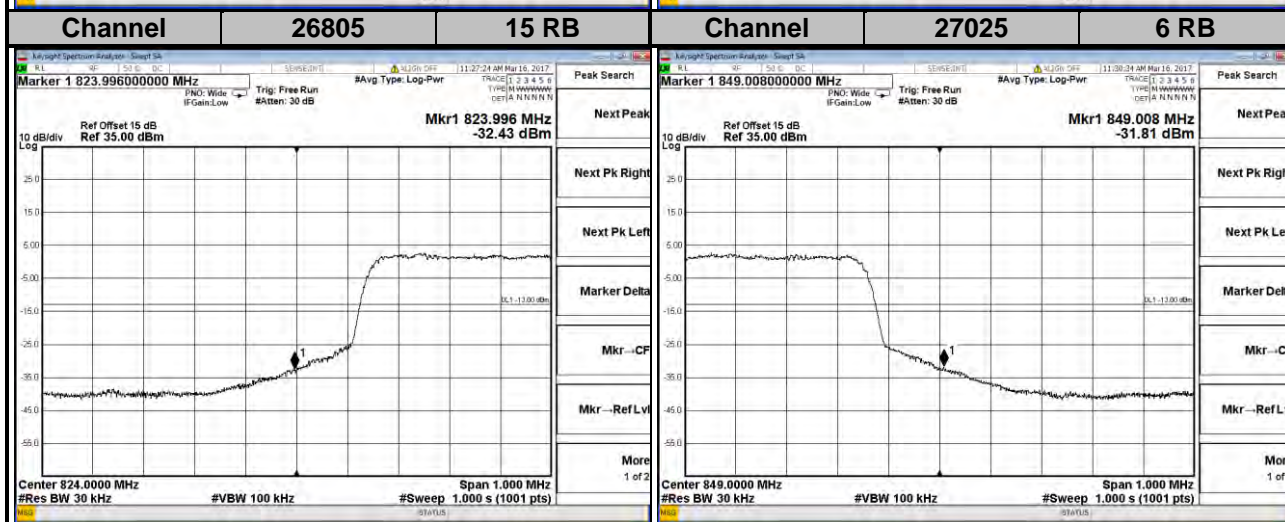
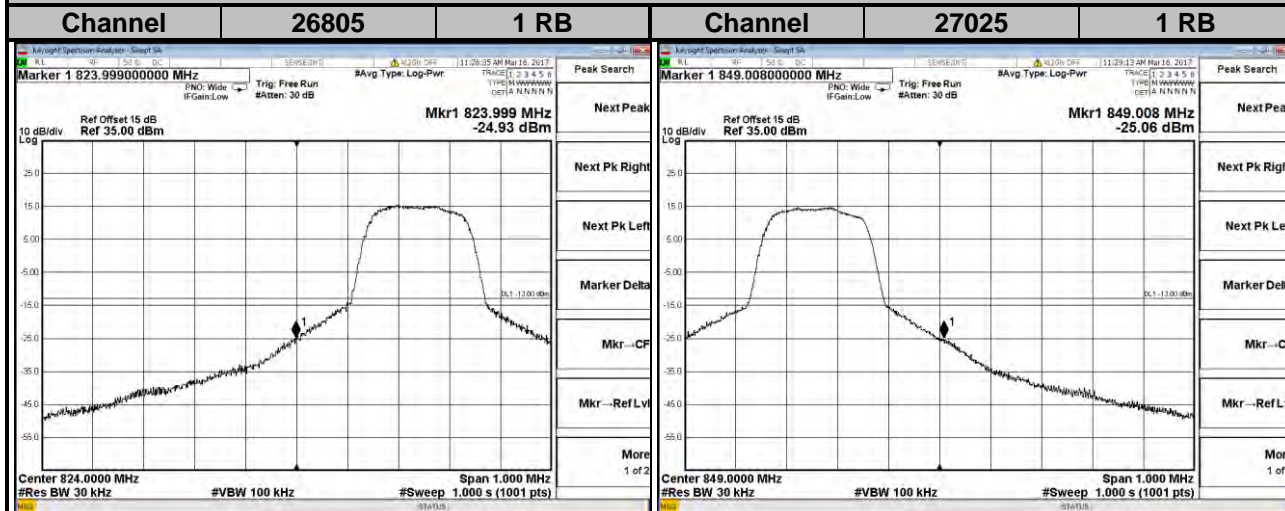

### LTE Band 26

Channel Bandwidth: 5 MHz

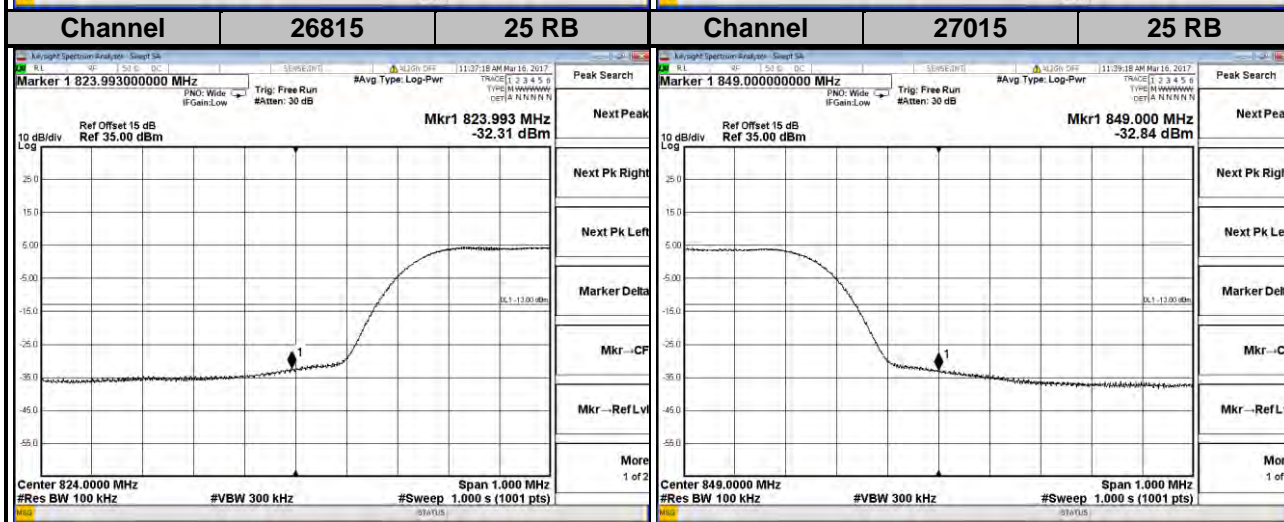
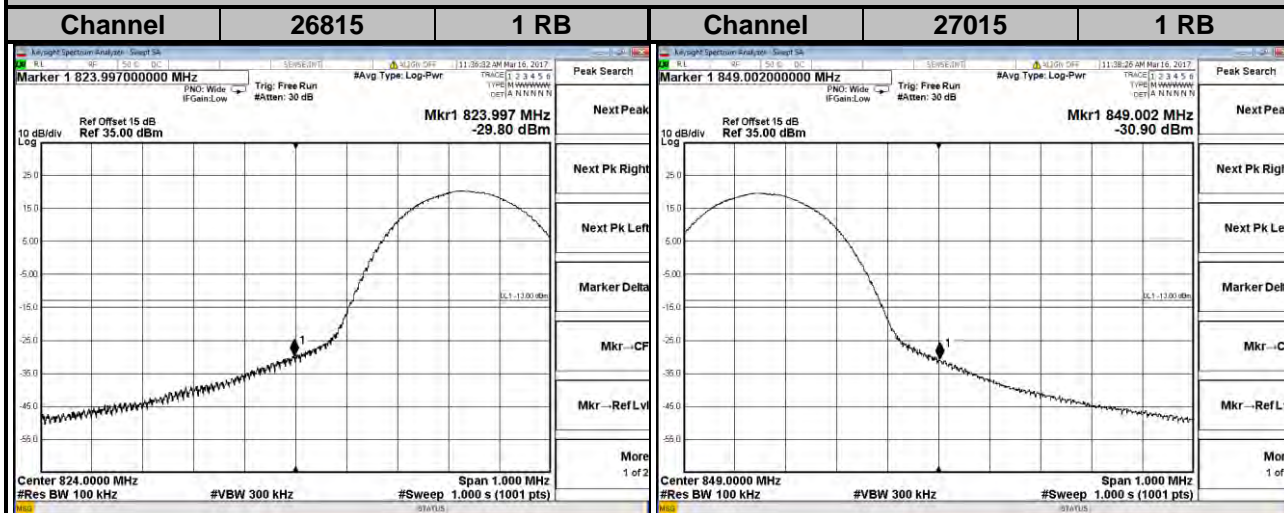

### LTE Band 26

#### Channel Bandwidth: 10 MHz

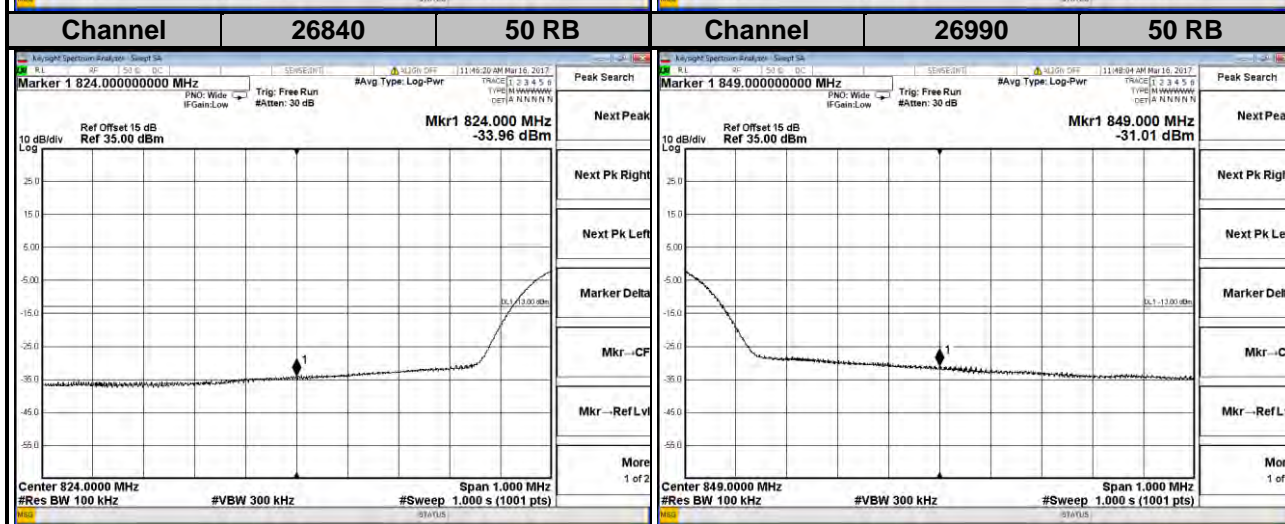
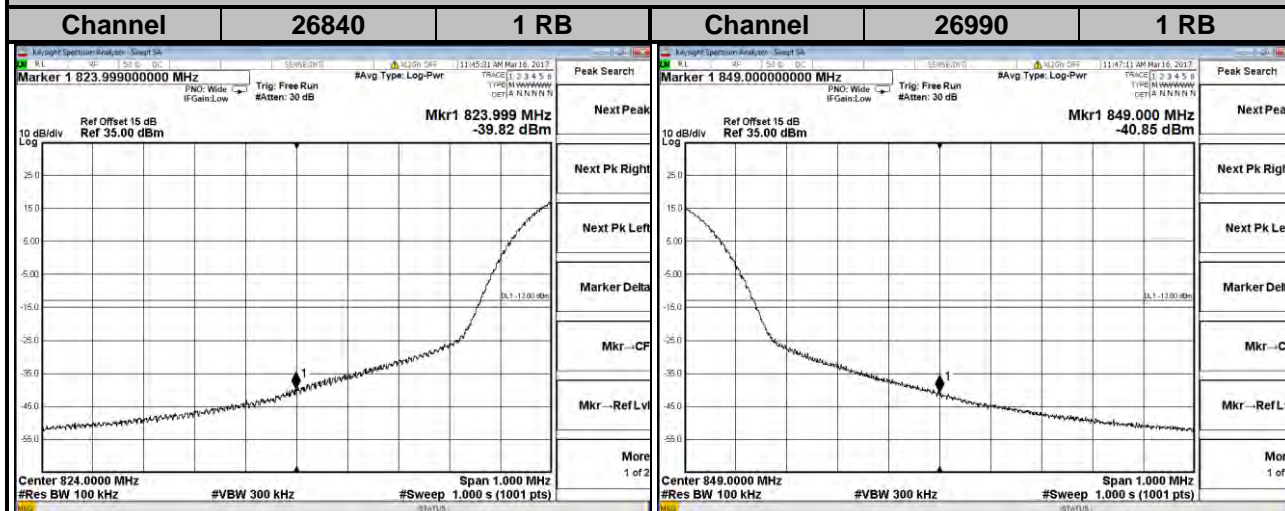

**LTE Band 26**  
**Channel Bandwidth: 15 MHz**

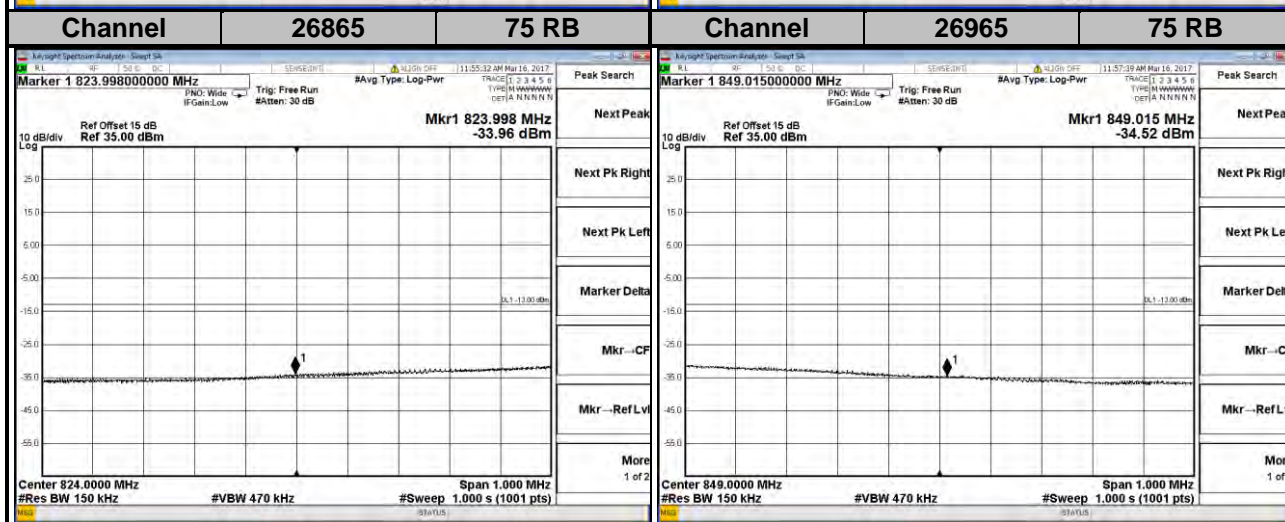
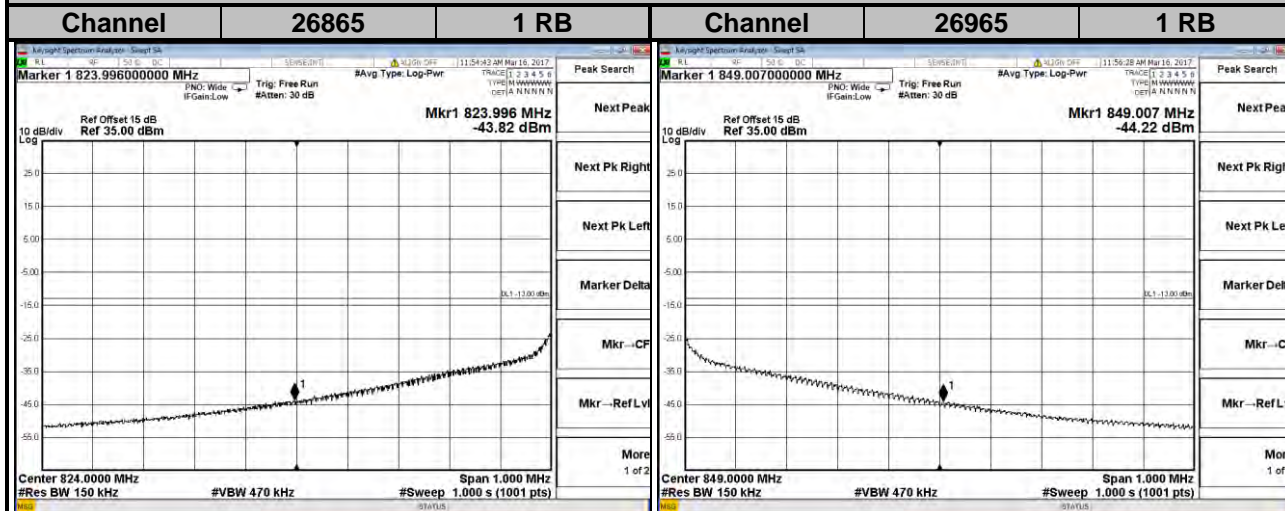

## 4.5 Peak to Average Ratio

### 4.5.1 Limits of Peak to Average Ratio Measurement

In measuring transmissions in this band using an average power technique, the peak to-average ratio (PAR) of the transmission may not exceed 13 dB.

### 4.5.2 Test Setup

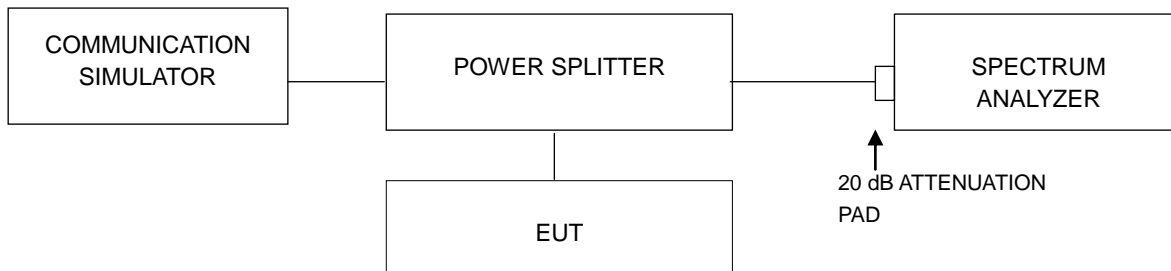

### 4.5.3 Test Procedures

1. Set resolution/measurement bandwidth  $\geq$  signal's occupied bandwidth;
2. Set the number of counts to a value that stabilizes the measured CCDF curve;
3. Record the maximum PAPR level associated with a probability of 0.1 %.



#### 4.5.4 Test Results

Channel	Frequency (MHz)	Peak to Average Ratio (dB)		Channel	Frequency (MHz)	Peak to Average Ratio (dB)
		GSM	EDGE			
128	824.2	0.38	3.46	4132	826.4	3.03
189	836.4	0.35	3.44	4182	836.4	3.03
251	848.8	0.38	3.40	4233	846.6	3.00

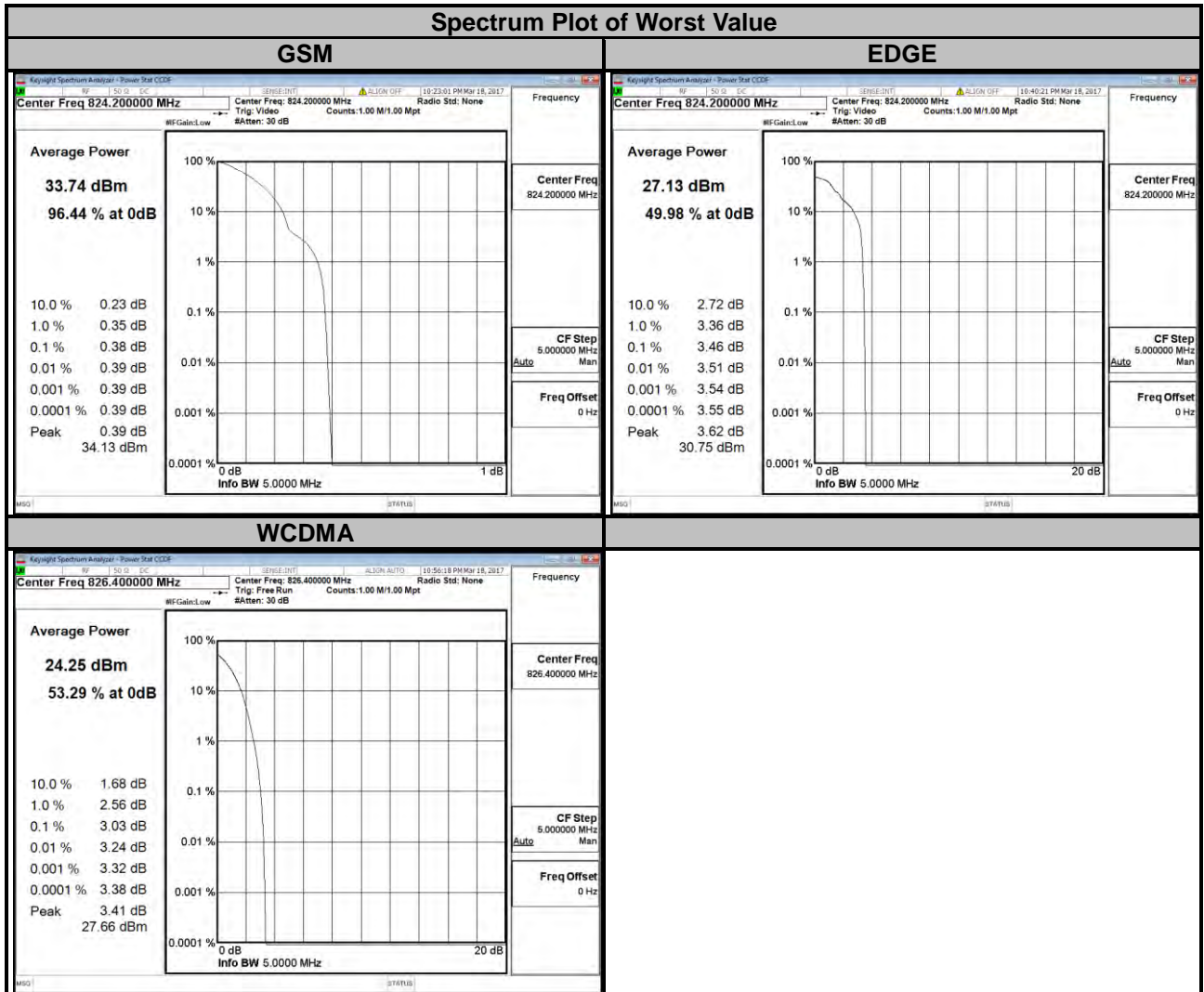

### LTE Band 5

Channel Bandwidth: 1.4 MHz				Channel Bandwidth: 3 MHz			
Channel	Frequency (MHz)	Peak to Average Ratio (dB)		Channel	Frequency (MHz)	Peak to Average Ratio (dB)	
		QPSK	16QAM			QPSK	16QAM
20407	824.7	4.06	4.75	20415	825.5	3.94	4.65
20525	836.5	4.26	4.93	20525	836.5	4.21	4.97
20643	848.3	3.44	4.22	20635	847.5	3.41	4.16

### Spectrum Plot of Worst Value

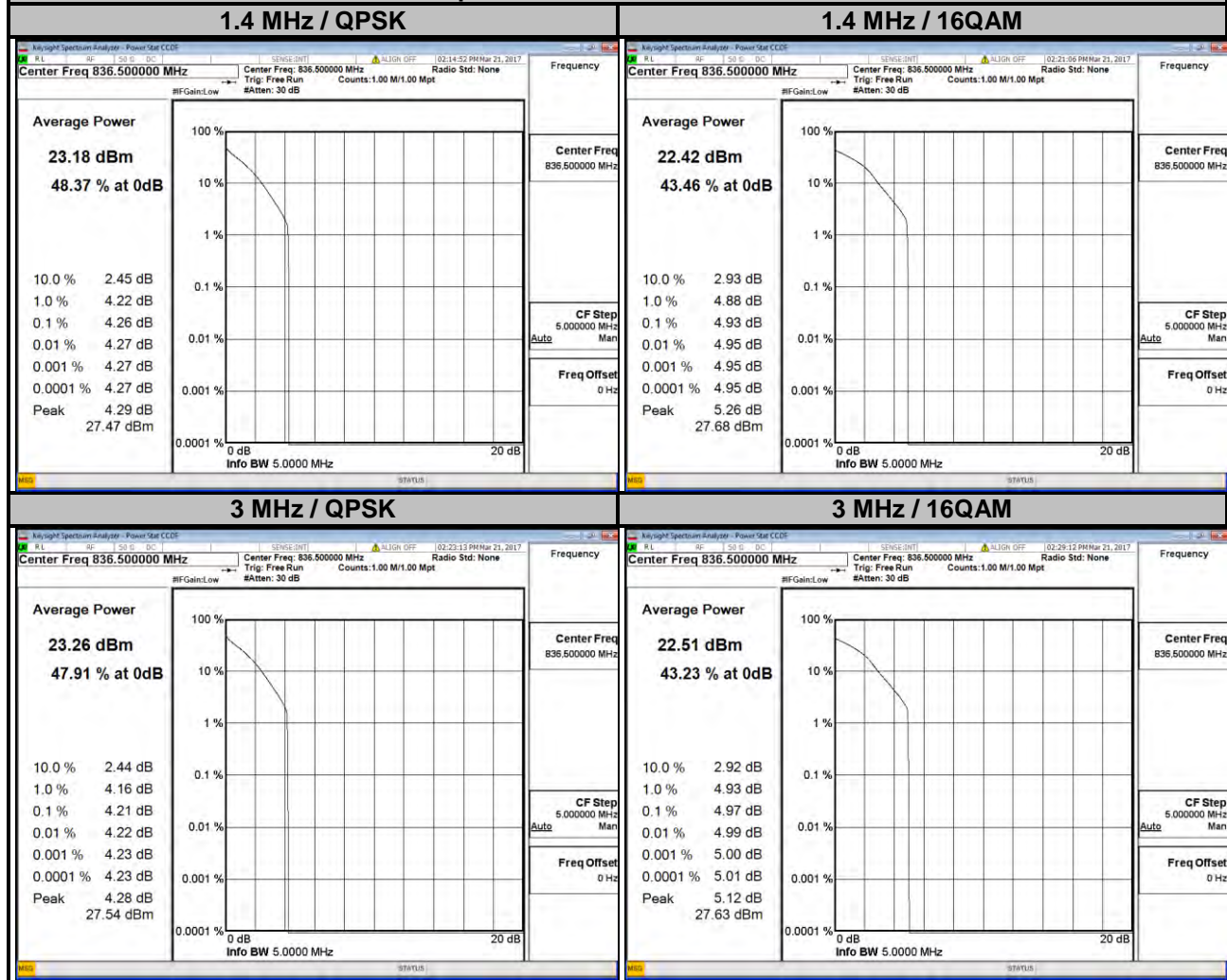

### LTE Band 5

Channel Bandwidth: 5 MHz				Channel Bandwidth: 10 MHz			
Channel	Frequency (MHz)	Peak to Average Ratio (dB)		Channel	Frequency (MHz)	Peak to Average Ratio (dB)	
		QPSK	16QAM			QPSK	16QAM
20425	826.5	3.92	4.69	20450	829.0	3.92	4.62
20525	836.5	4.35	5.08	20525	836.5	4.49	5.26
20625	846.5	3.48	4.21	20600	844.0	3.40	4.17

### Spectrum Plot of Worst Value

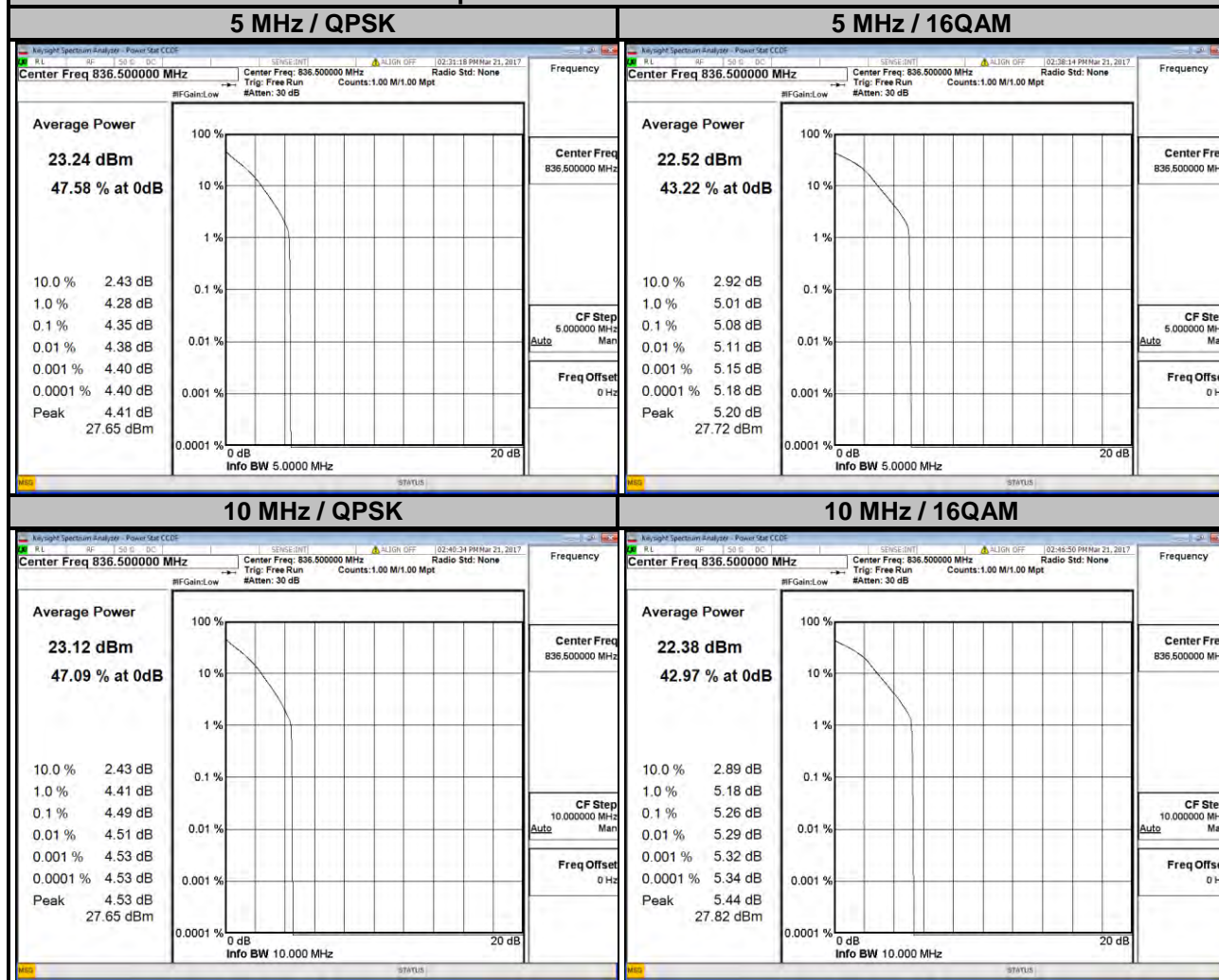

### LTE Band 26

Channel Bandwidth: 1.4 MHz				Channel Bandwidth: 3 MHz			
Channel	Frequency (MHz)	Peak to Average Ratio (dB)		Channel	Frequency (MHz)	Peak to Average Ratio (dB)	
		QPSK	16QAM			QPSK	16QAM
26797	824.7	3.85	4.51	26805	825.5	3.68	4.45
26915	836.5	4.16	4.88	26915	836.5	4.17	4.93
27033	848.3	3.43	4.20	27025	847.5	3.47	4.22

### Spectrum Plot of Worst Value

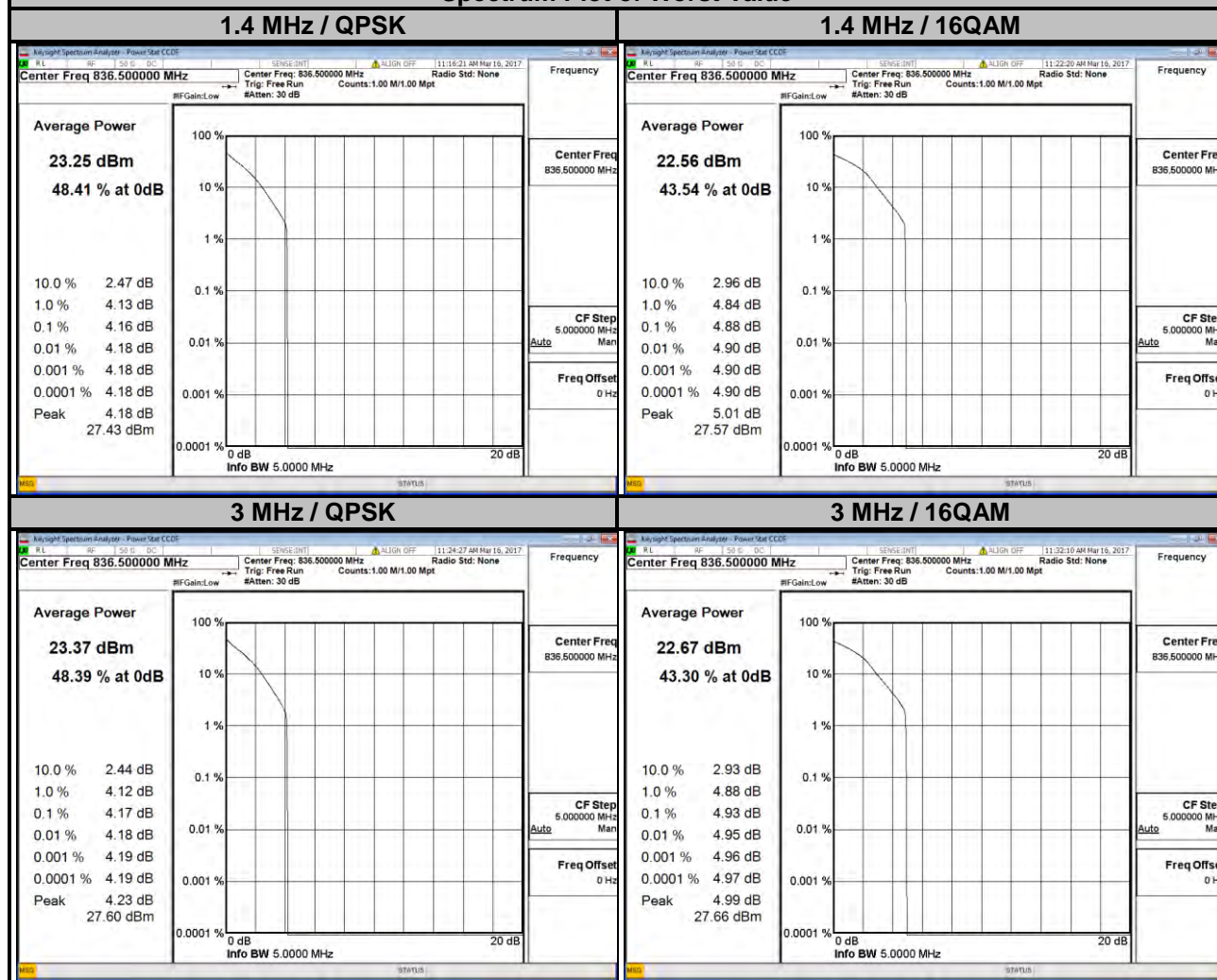

### LTE Band 26

Channel Bandwidth: 5 MHz				Channel Bandwidth: 10 MHz			
Channel	Frequency (MHz)	Peak to Average Ratio (dB)		Channel	Frequency (MHz)	Peak to Average Ratio (dB)	
		QPSK	16QAM			QPSK	16QAM
26815	826.5	3.71	4.46	26840	829.0	3.69	4.50
26915	836.5	4.25	4.98	26915	836.5	4.12	4.89
27015	846.5	3.44	4.18	26990	844.0	3.39	4.16

### Spectrum Plot of Worst Value

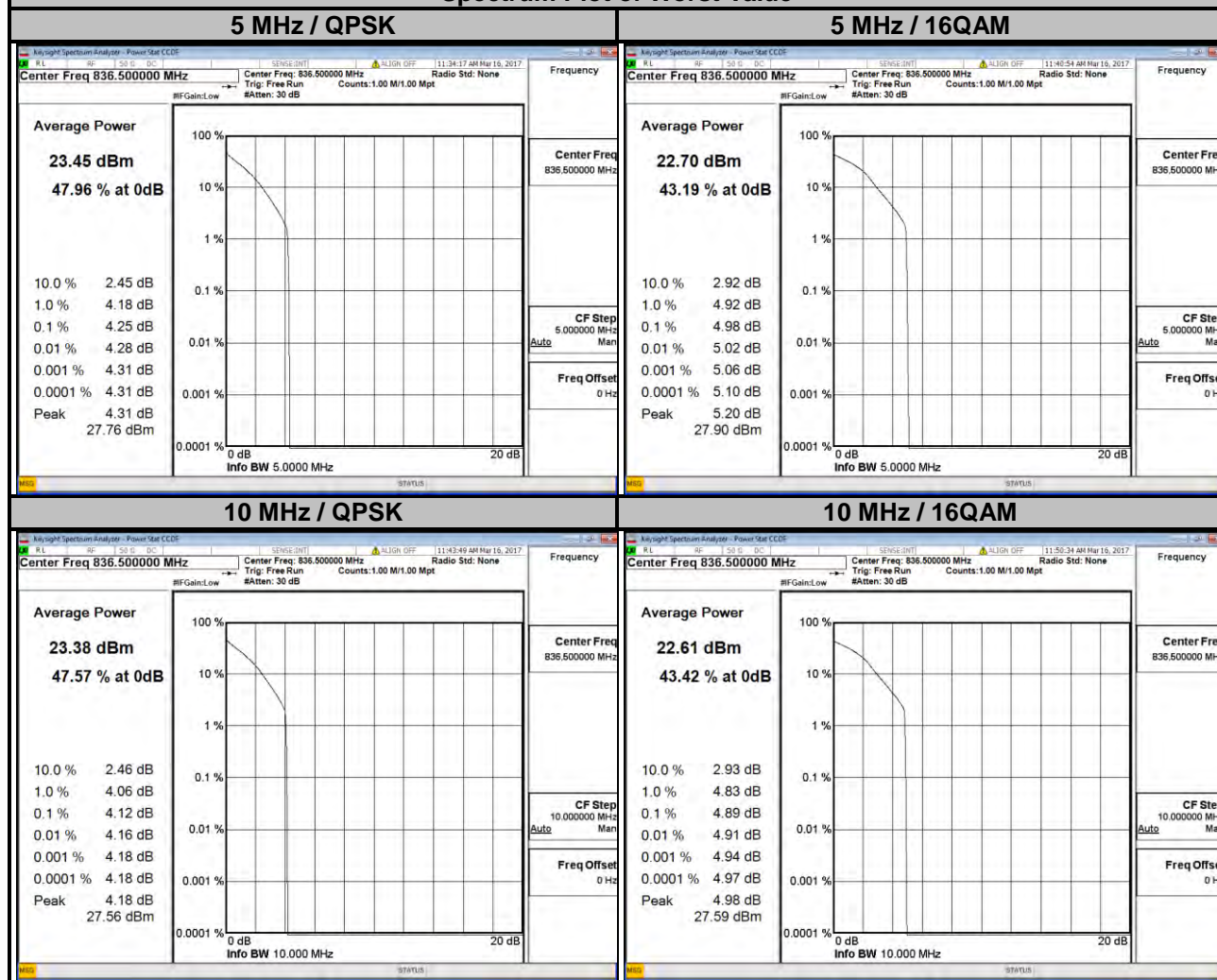

LTE Band 26			
Channel Bandwidth: 15 MHz			
Channel	Frequency (MHz)	Peak to Average Ratio (dB)	
		QPSK	16QAM
26865	831.5	3.68	4.37
26915	836.5	4.24	4.91
26965	841.5	4.14	4.74

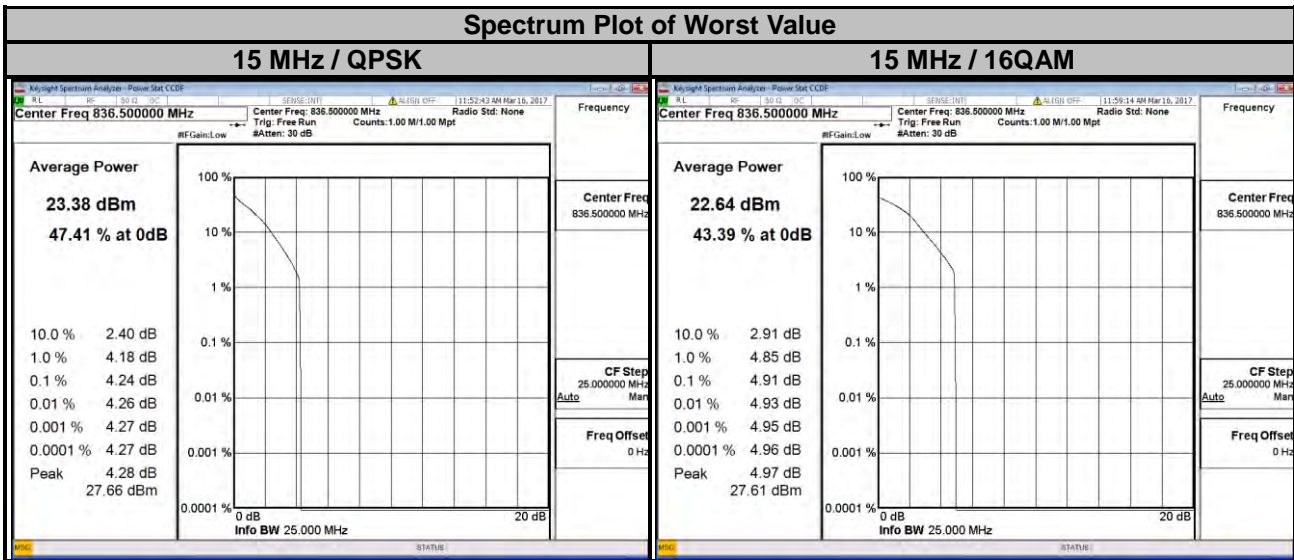

## 4.6 Conducted Spurious Emissions

### 4.6.1 Limits of Conducted Spurious Emissions Measurement

The power of any emission outside of the authorized operating frequency ranges must be attenuated below the transmitting power (P) by a factor of at least  $43 + 10 \log(P)$  dB. The emission limit equal to  $-13$  dBm.

### 4.6.2 Test Setup

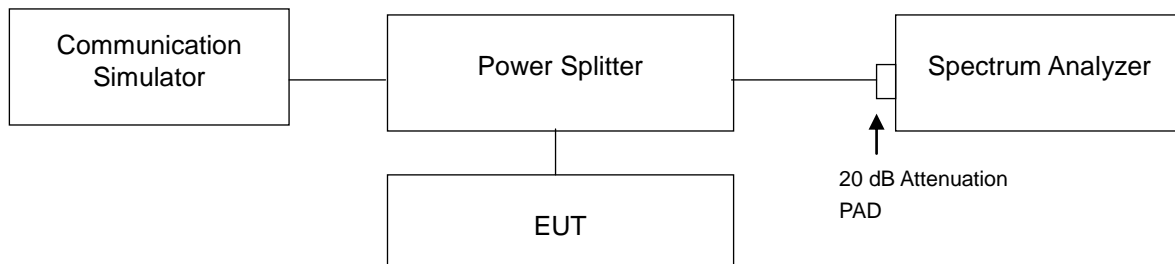

### 4.6.3 Test Procedure

- The EUT makes a phone call to the communication simulator. All measurements were done at low, middle and high operational frequency range.
- Measuring frequency range is from 9 kHz to 9 GHz. 20 dB attenuation pad is connected with spectrum. RBW=1 MHz and VBW=3 MHz is used for conducted emission measurement.

### 4.6.4 Test Results

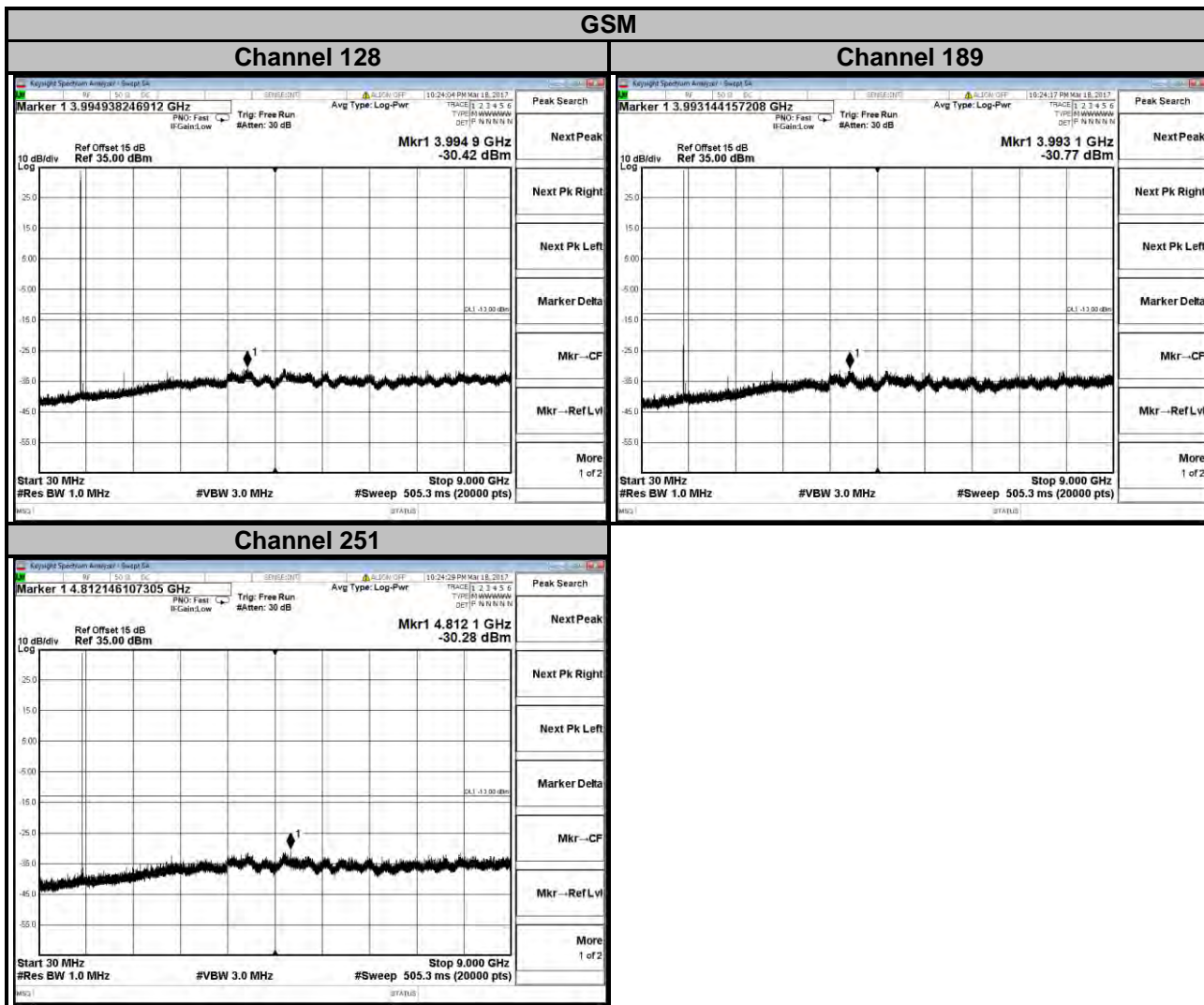



### EDGE

#### Channel 128

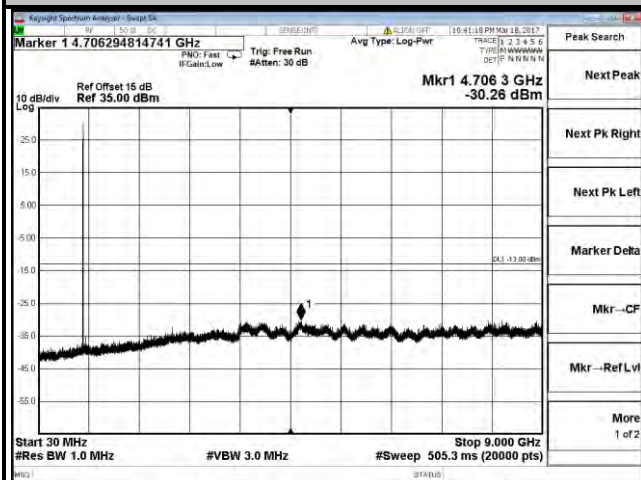

#### Channel 189

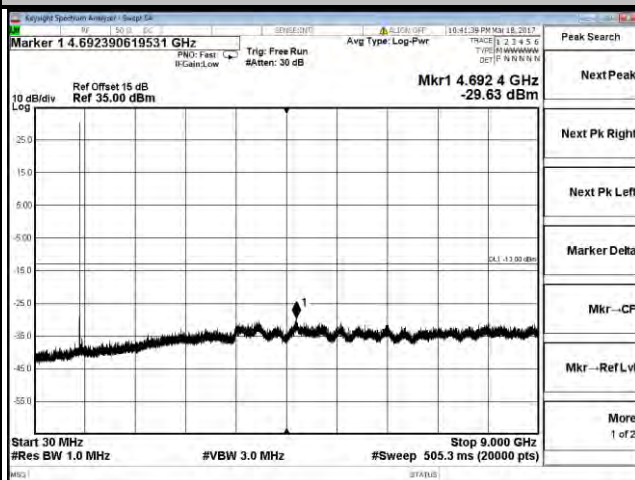

#### Channel 251

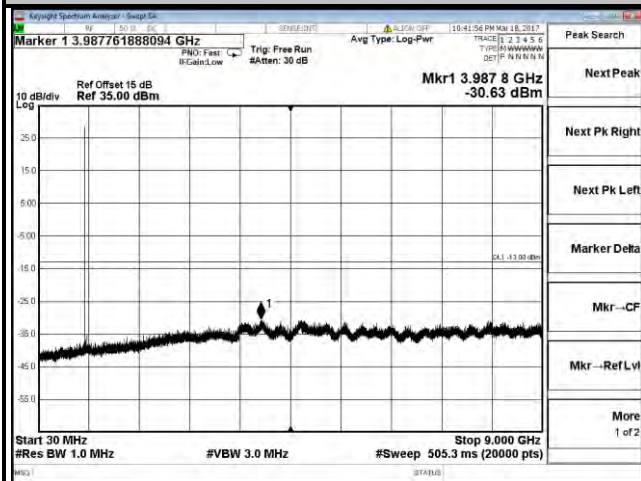

### WCDMA

#### Channel 4132

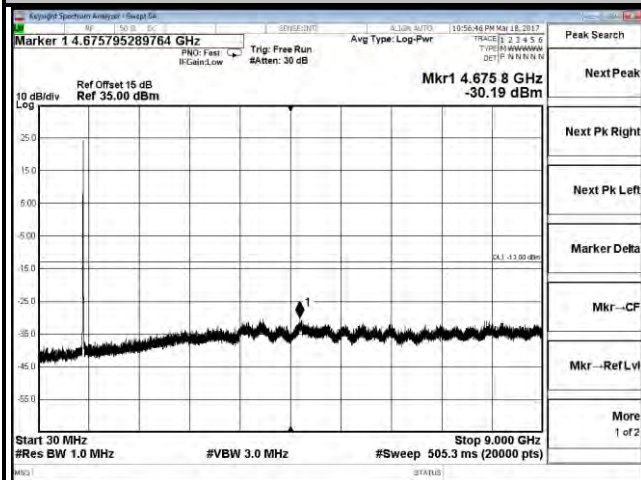

#### Channel 4182

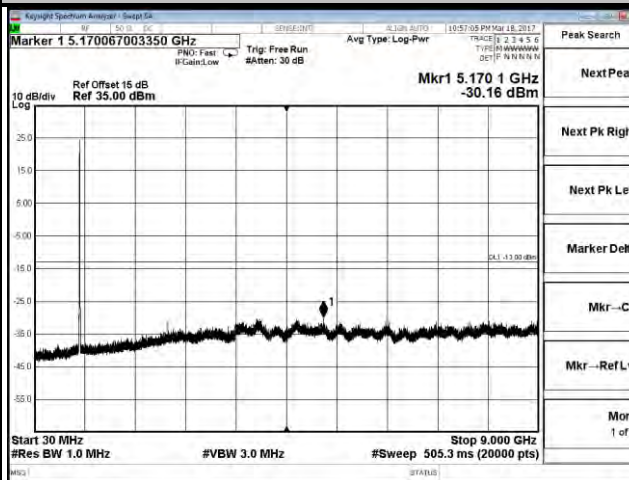

#### Channel 4233

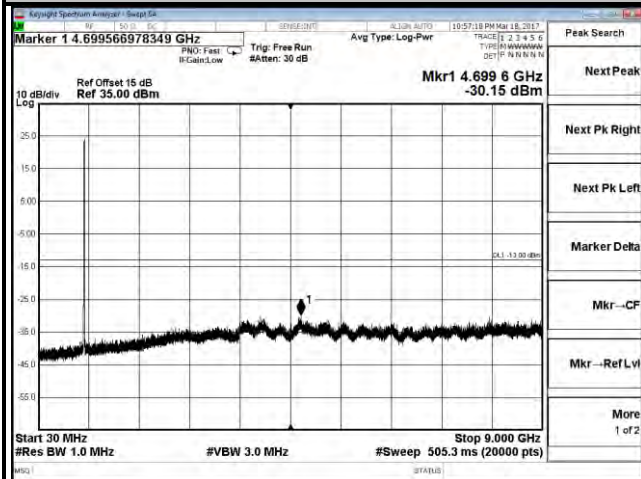

LTE Band 5

Channel Bandwidth: 1.4 MHz

Channel 20407

Channel 20525

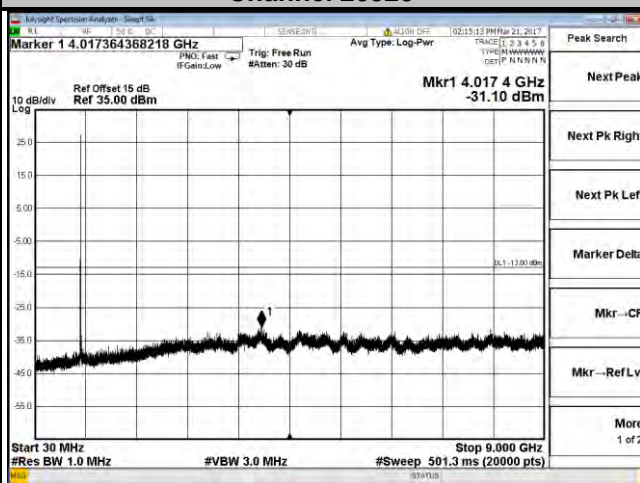
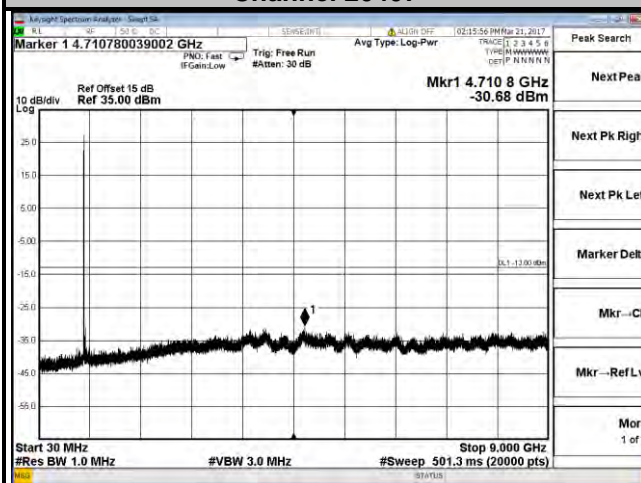

Channel 20643

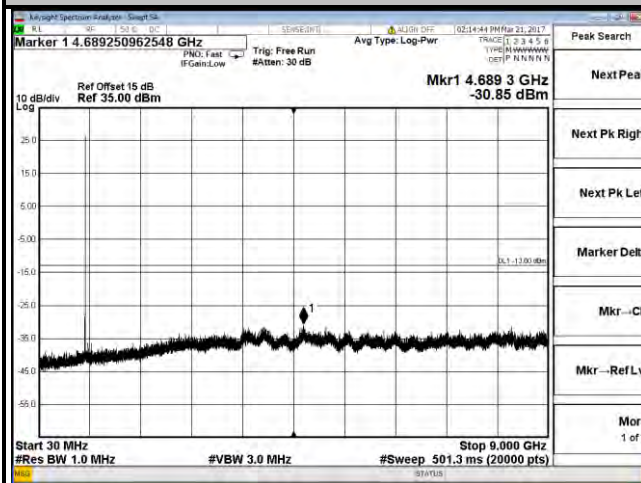

**LTE Band 5**  
**Channel Bandwidth: 3 MHz**

**Channel 20415**

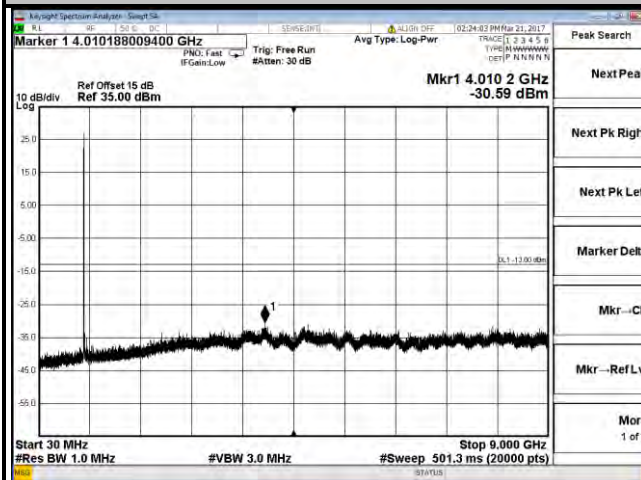

**Channel 20525**

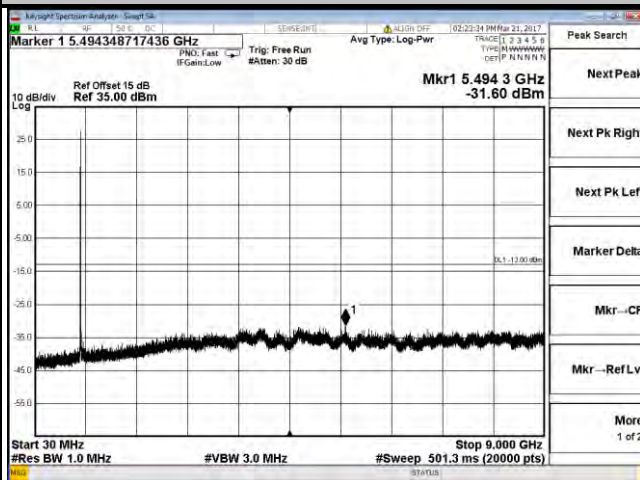

**Channel 20635**

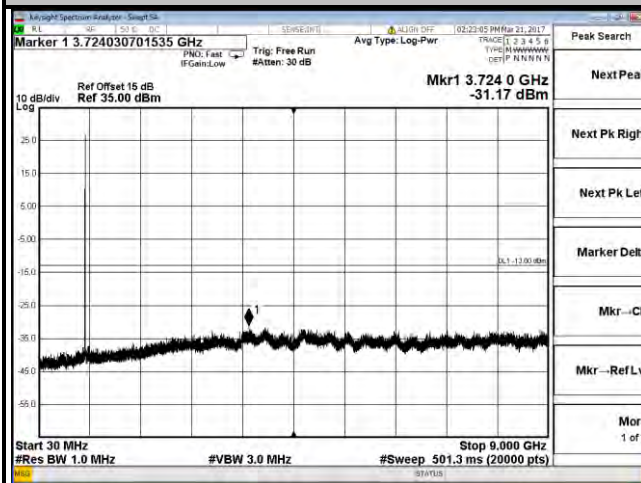

**LTE Band 5**  
**Channel Bandwidth: 5 MHz**

**Channel 20425**

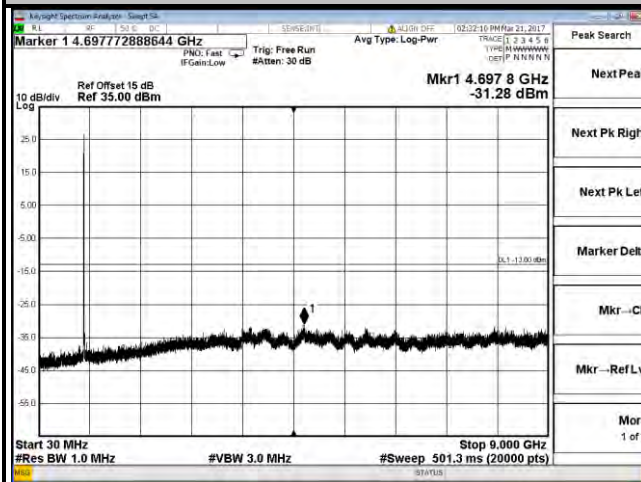

**Channel 20525**

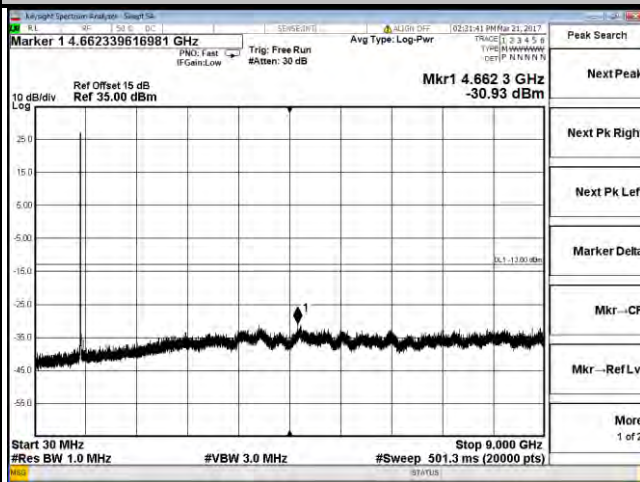

**Channel 20625**

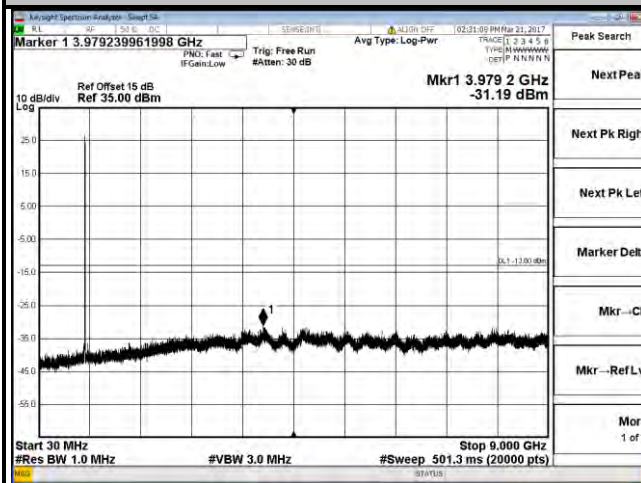

### LTE Band 5

Channel Bandwidth: 10 MHz

#### Channel 20450

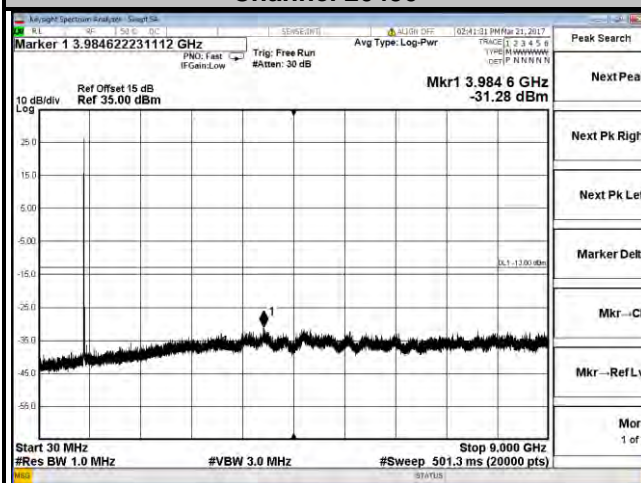

#### Channel 20525

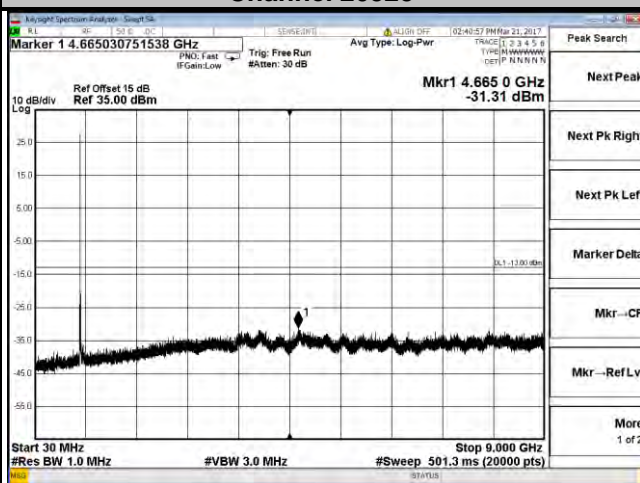

#### Channel 20600

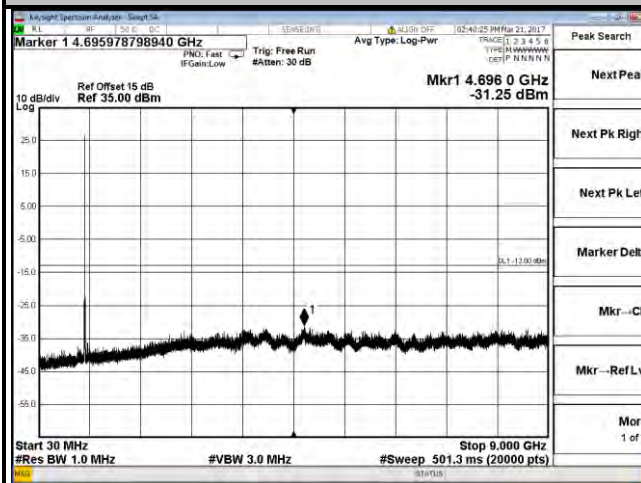

LTE Band 26

Channel Bandwidth: 1.4 MHz

Channel 26797

Channel 26915

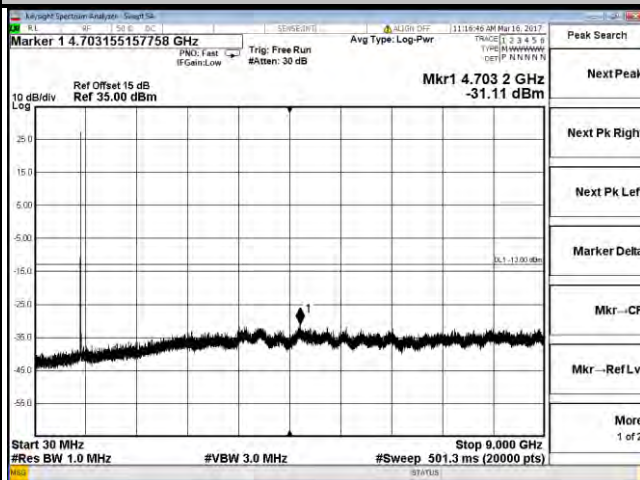
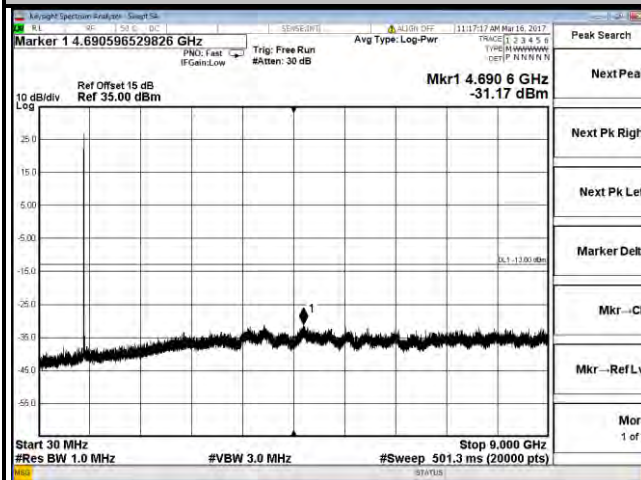

Channel 27033

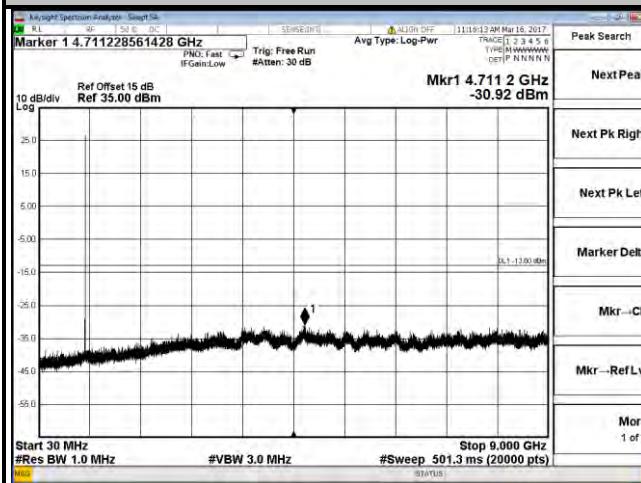

**LTE Band 26**  
**Channel Bandwidth: 3 MHz**

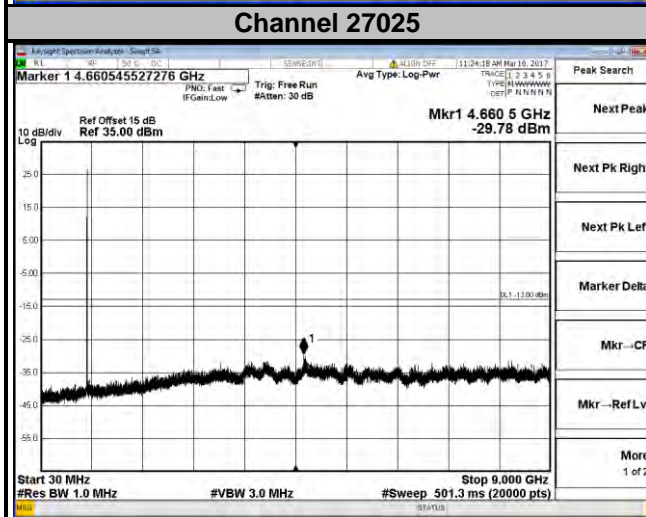
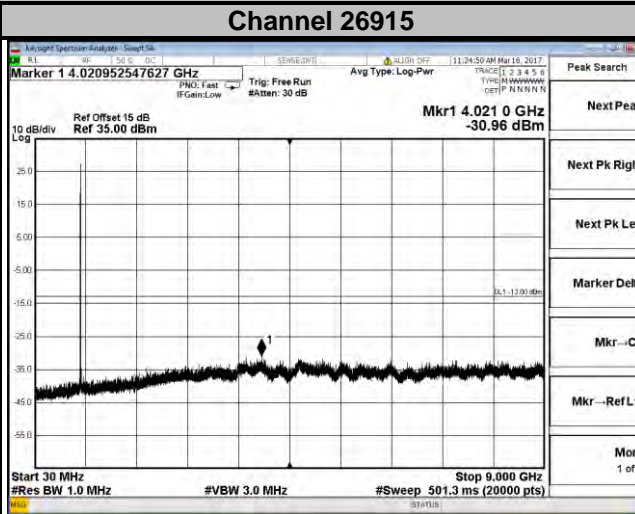
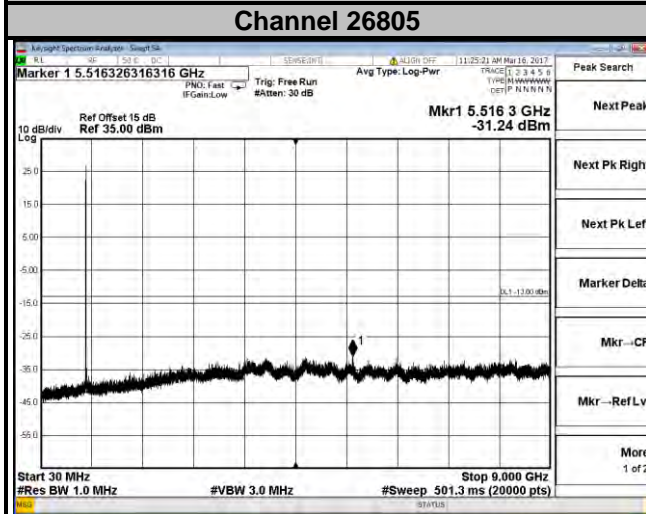



LTE Band 26  
Channel Bandwidth: 5 MHz

Channel 26815

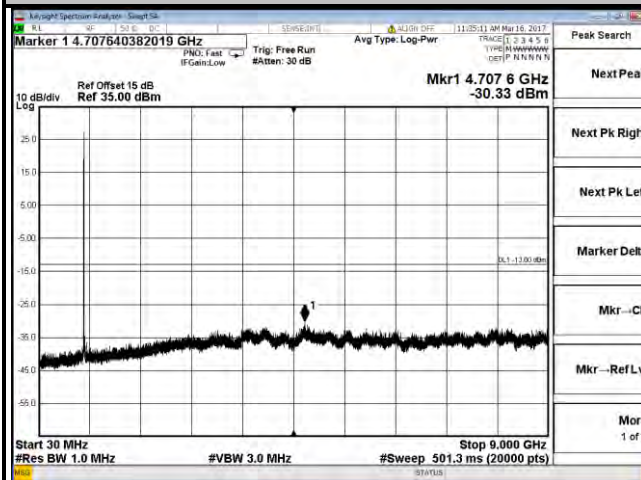

Channel 26915

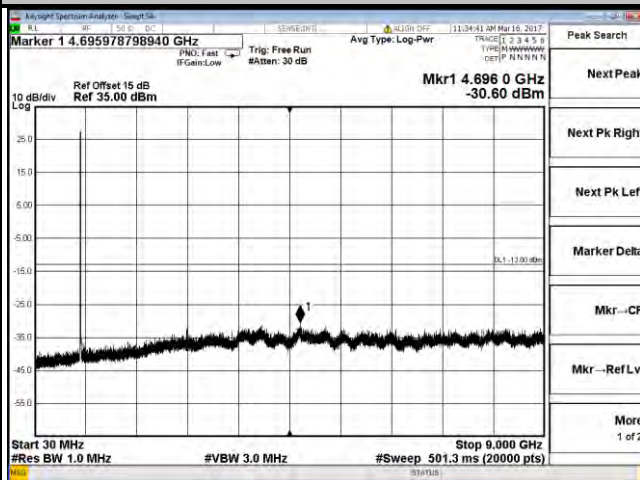

Channel 27015

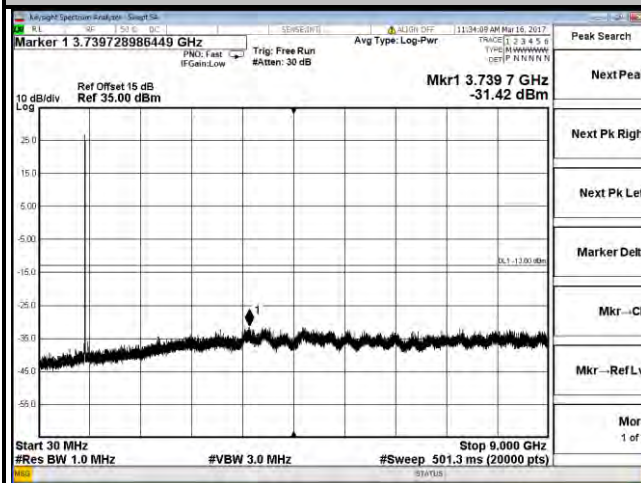

### LTE Band 26

Channel Bandwidth: 10 MHz

#### Channel 26840

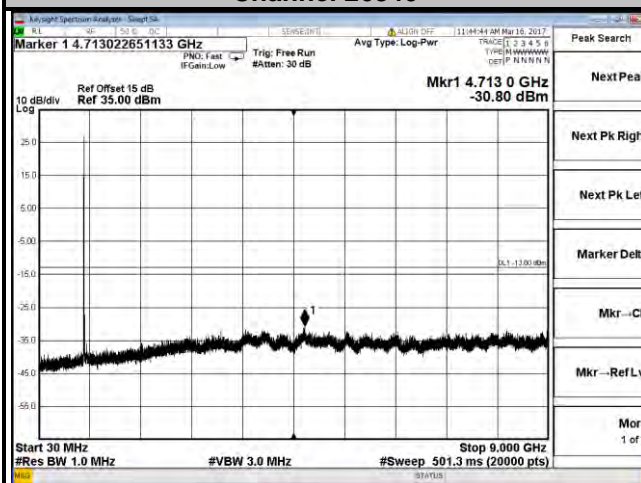

#### Channel 26915

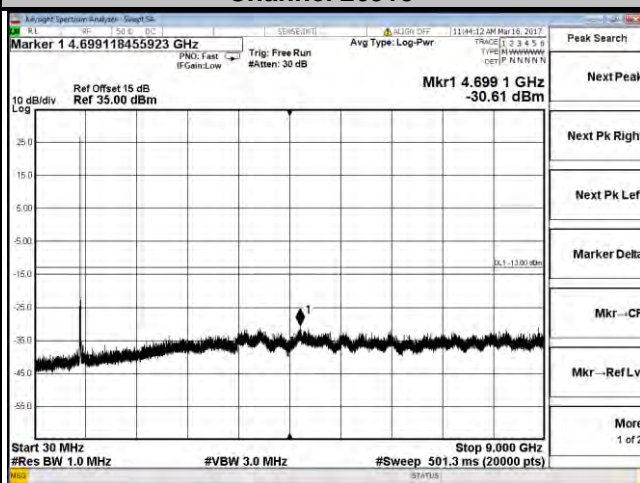

#### Channel 26990

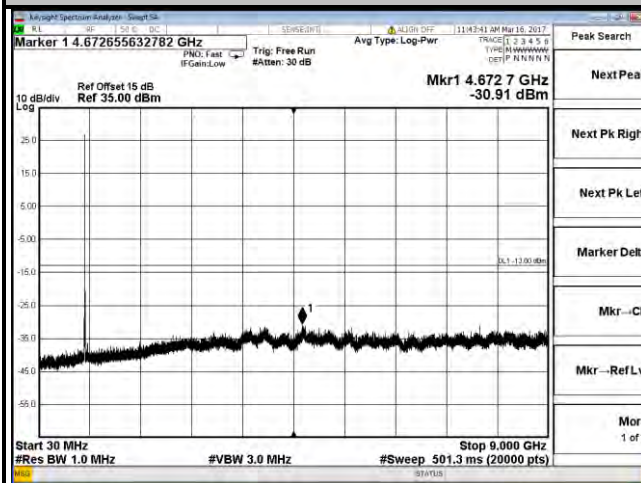

### LTE Band 26

Channel Bandwidth: 15 MHz

#### Channel 26865

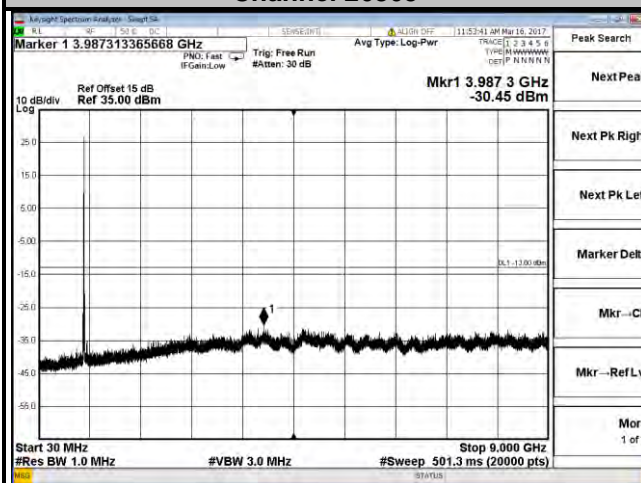

#### Channel 26915

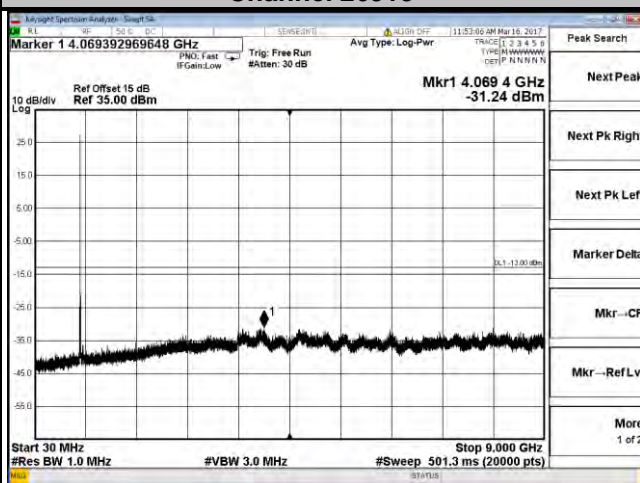

#### Channel 26965

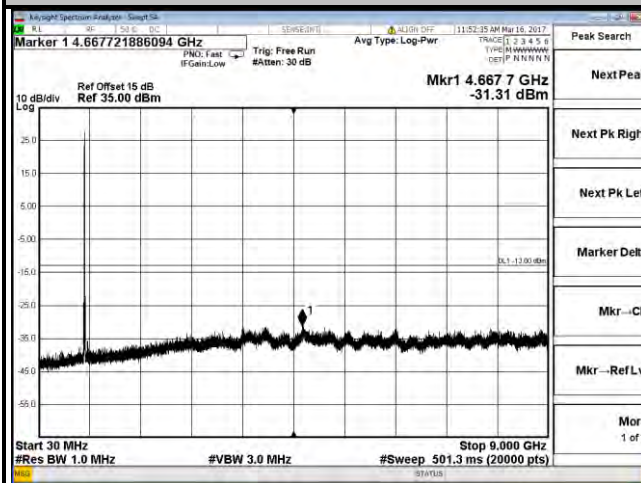

## 4.7 Radiated Emission Measurement

### 4.7.1 Limits of Radiated Emission Measurement

The power of any emission outside of the authorized operating frequency ranges must be attenuated below the transmitting power (P) by a factor of at least  $43 + 10 \log(P)$  dB. The emission limit is equal to -13 dBm.

### 4.7.2 Test Procedure

- Substitution method is used for E.I.R.P measurement. In the semi-anechoic chamber, EUT placed on the 0.8 m height of Turn Table, rotated the table around 360 degrees to search the maximum radiation power and receiver antenna shall be rotated vertical and horizontal polarization and moved height from 1 m to 4 m to find the maximum polar radiated power. The "Read Value" is the spectrum reading the maximum power value.
- The substitution horn antenna is substituted for EUT at the same position and signals generator export the CW signal to the substitution antenna via a TX cable. Rotated the Turn Table and moved receiving antenna to find the maximum radiation power. Adjust output power level of S.G to get a Value of spectrum reading equal to "Read Value" of step a. Record the power level of S.G
- $EIRP = \text{Output power level of S.G} - \text{TX cable loss} + \text{Antenna gain of substitution horn}$ .
- E.R.P power can be calculated form E.I.R.P power by subtracting the gain of dipole,  $E.R.P \text{ power} = E.I.P.R \text{ power} - 2.15 \text{ dBi}$ .

**NOTE:** The resolution bandwidth and video bandwidth of test receiver/spectrum analyzer is 1 MHz/3 MHz.

### 4.7.3 Deviation from Test Standard

No deviation.

### 4.7.4 Test Setup

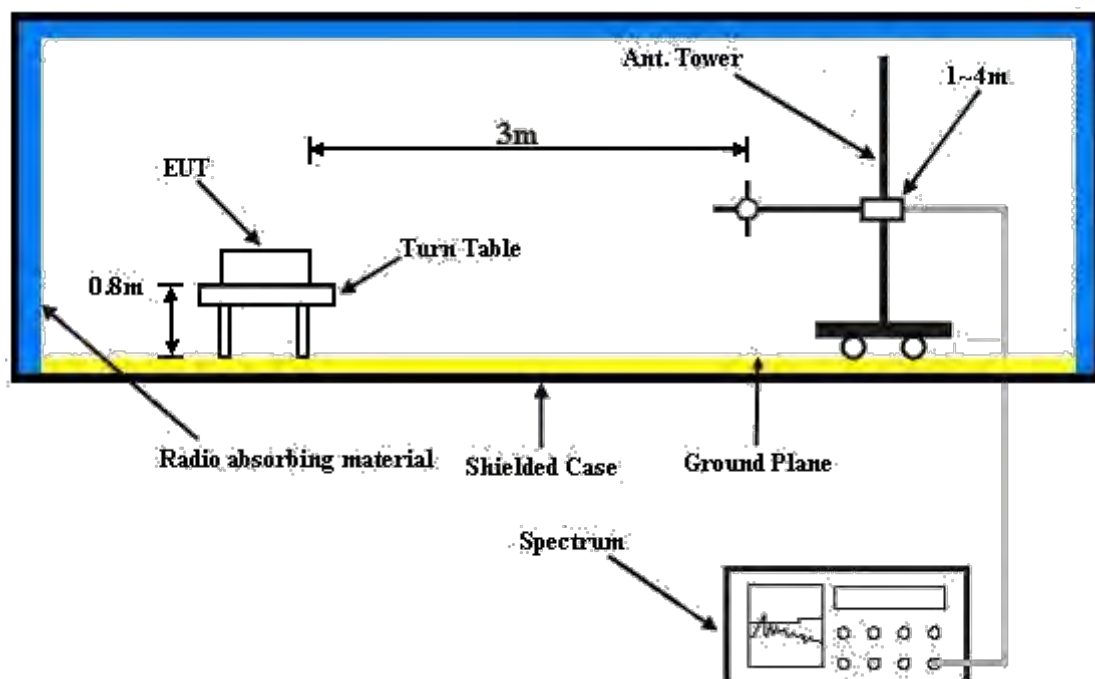

For the actual test configuration, please refer to the attached file (Test Setup Photo).

4.7.5 Test Results

GSM:  
Low Channel



Bureau Veritas Consumer Products Services Ltd., Taoyuan Branch

A D T

Data: 9

Date: 2017-03-14

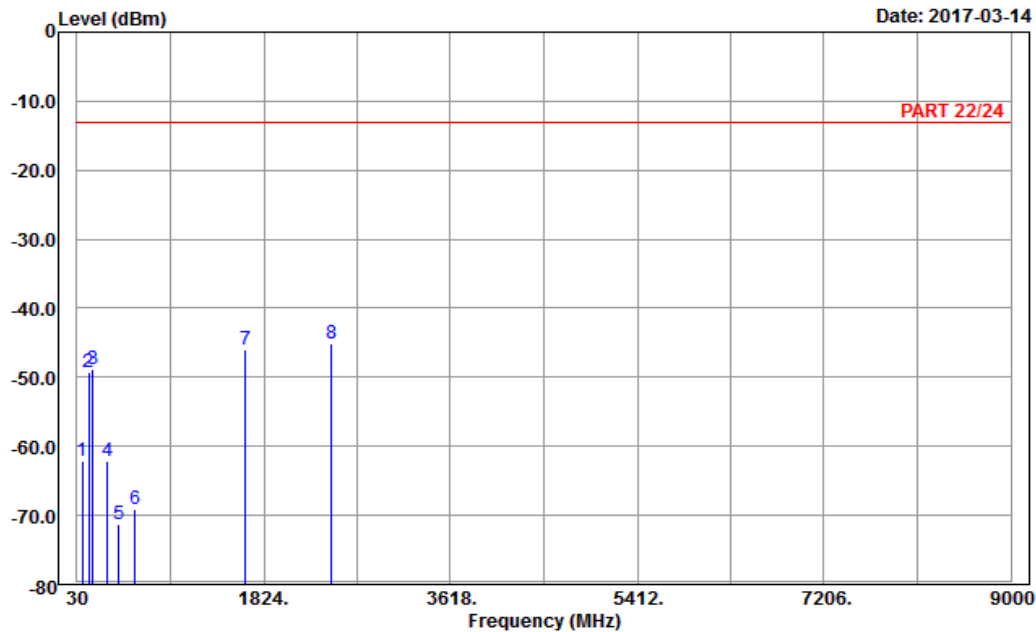

Site : 966 chamber 1  
Condition: PART 22/24 Horizontal  
Remark : GSM 850\_Link\_CH128  
Tested by: Karl Lee

	Freq	Level	Read Level	Limit Line	Over Limit	Factor	Remark
	MHz	dBm	dBm	dBm	dB	dB	
1	79.95	-62.21	-50.36	-13.00	-49.21	-11.85	Peak
2	142.32	-49.34	-41.58	-13.00	-36.34	-7.76	Peak
3	182.55	-48.80	-43.19	-13.00	-35.80	-5.61	Peak
4	324.50	-62.11	-56.44	-13.00	-49.11	-5.67	Peak
5	429.50	-71.21	-67.81	-13.00	-58.21	-3.40	Peak
6	589.80	-69.08	-69.07	-13.00	-56.08	-0.01	Peak
7	1648.40	-46.07	-53.80	-13.00	-33.07	7.73	Peak
8 pp	2472.60	-45.13	-56.16	-13.00	-32.13	11.03	Peak



A D T

Data: 10

Date: 2017-03-14

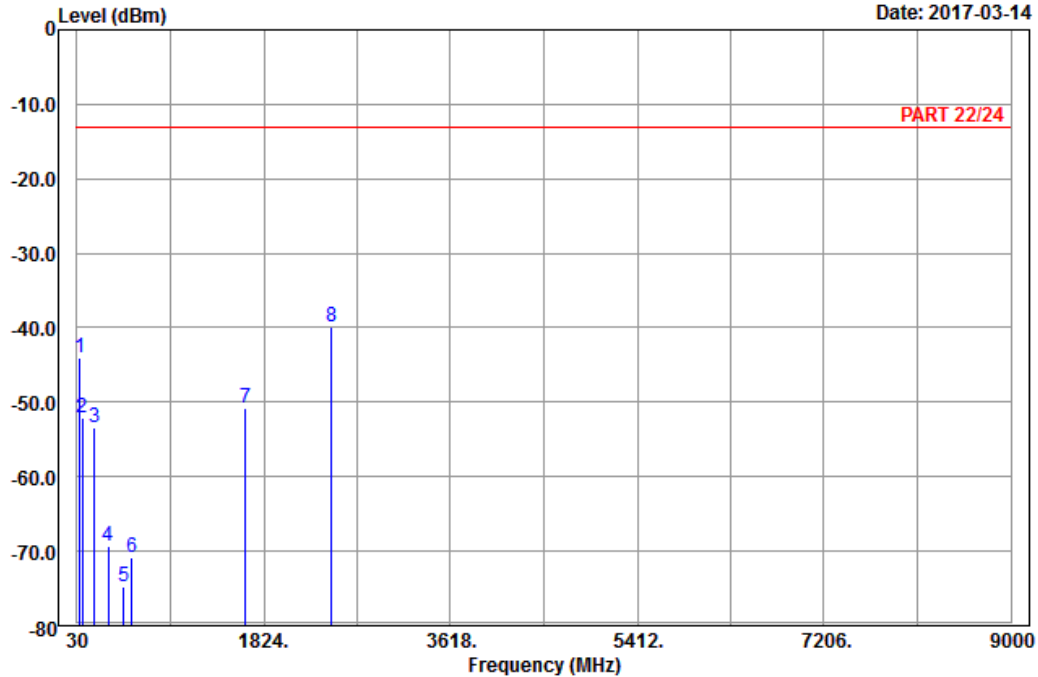

Site : 966 chamber 1  
 Condition: PART 22/24 Vertical  
 Remark : GSM 850\_Link\_CH128  
 Tested by: Karl Lee

	Freq	Level	Read Level	Limit Line	Over Limit	Factor	Remark
	MHz	dBm	dBm	dBm	dB	dB	
1	54.03	-44.11	-30.05	-13.00	-31.11	-14.06	Peak
2	81.03	-52.06	-40.40	-13.00	-39.06	-11.66	Peak
3	198.48	-53.47	-47.33	-13.00	-40.47	-6.14	Peak
4	328.70	-69.39	-63.77	-13.00	-56.39	-5.62	Peak
5	476.40	-74.72	-70.13	-13.00	-61.72	-4.59	Peak
6	552.70	-70.83	-69.29	-13.00	-57.83	-1.54	Peak
7	1648.40	-50.81	-58.54	-13.00	-37.81	7.73	Peak
8 pp	2472.60	-39.87	-50.90	-13.00	-26.87	11.03	Peak

Middle Channel



Bureau Veritas Consumer Products Services Ltd., Taoyuan Branch

A D T

Data: 5

Date: 2017-03-14

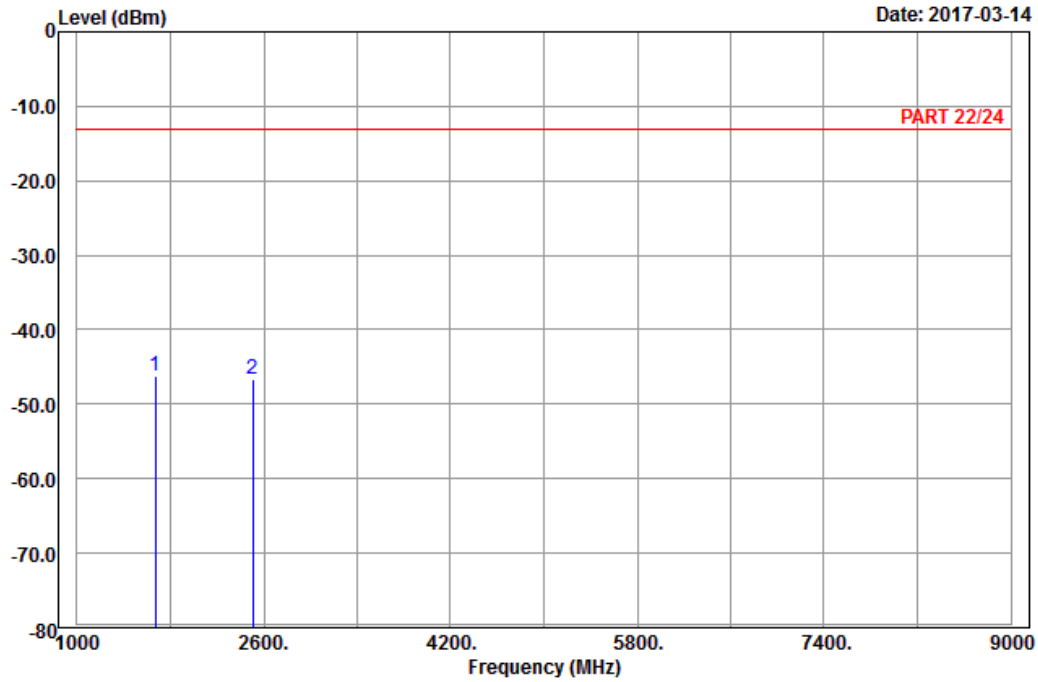

Site : 966 chamber 1  
 Condition: PART 22/24 Horizontal  
 Remark : GSM 850\_Link\_CH189  
 Tested by: Karl Lee

	Freq	Level	Read Level	Limit Line	Over Limit	Factor	Remark
	MHz	dBm	dBm	dBm	dB	dB	
1 pp	1672.80	-46.25	-54.16	-13.00	-33.25	7.91	Peak
2	2509.20	-46.69	-57.97	-13.00	-33.69	11.28	Peak



A D T

Data: 6

Date: 2017-03-14

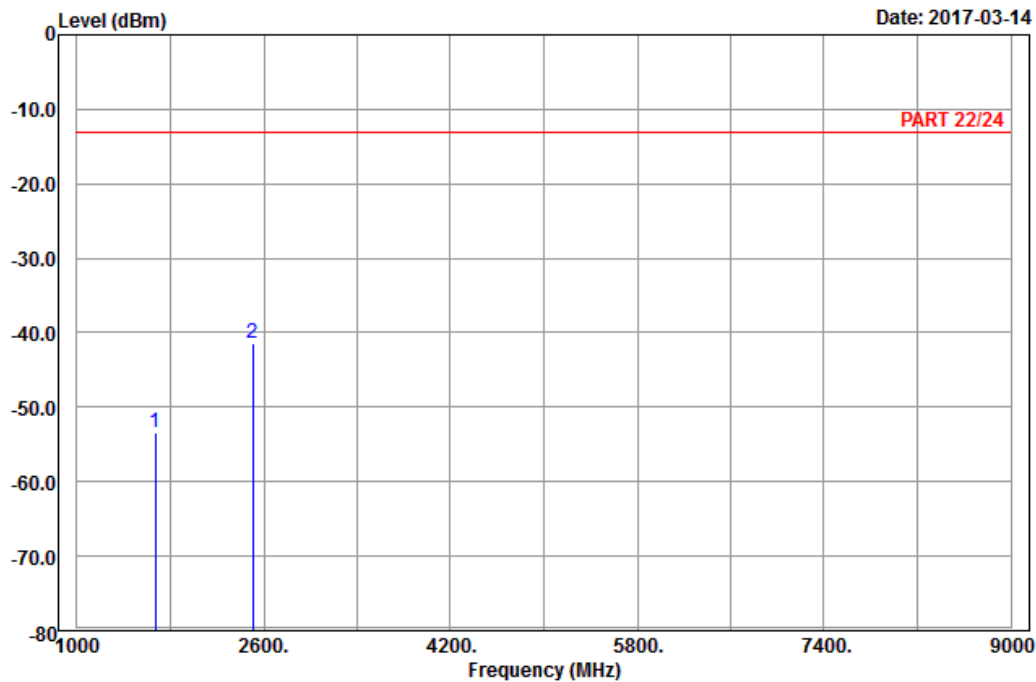

Site : 966 chamber 1  
 Condition: PART 22/24 Vertical  
 Remark : GSM 850\_Link\_CH189  
 Tested by: Karl Lee

	Freq	Level	Read Level	Limit Line	Over Limit	Factor	Remark
	MHz	dBm	dBm	dBm	dB	dB	
1	1672.80	-53.40	-61.31	-13.00	-40.40	7.91	Peak
2 pp	2509.20	-41.46	-52.74	-13.00	-28.46	11.28	Peak



# High Channel



Bureau Veritas Consumer Products Services Ltd., Taoyuan Branch

A D T

Data: 5

Date: 2017-03-14

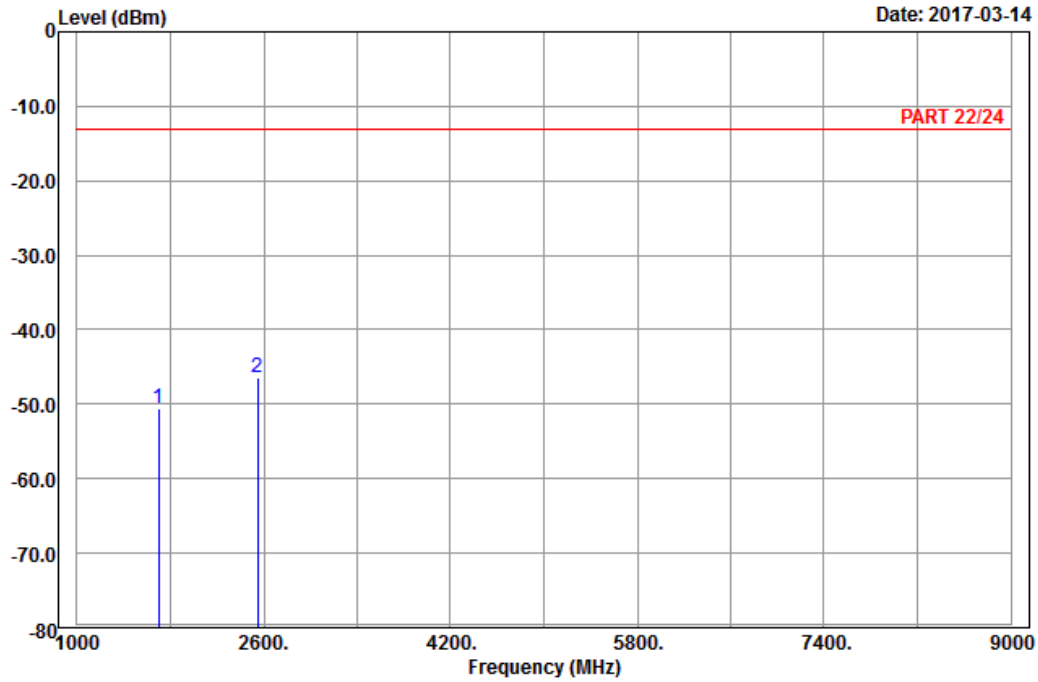

Site : 966 chamber 1  
 Condition: PART 22/24 Horizontal  
 Remark : GSM 850\_Link\_CH251  
 Tested by: Karl Lee

	Freq	Level	Read Level	Limit Line	Over Limit	Factor	Remark
	MHz	dBm	dBm	dBm	dB	dB	
1	1697.60	-50.68	-58.82	-13.00	-37.68	8.14	Peak
2	2546.40	-46.47	-57.94	-13.00	-33.47	11.47	Peak



A D T

Data: 6

Date: 2017-03-14

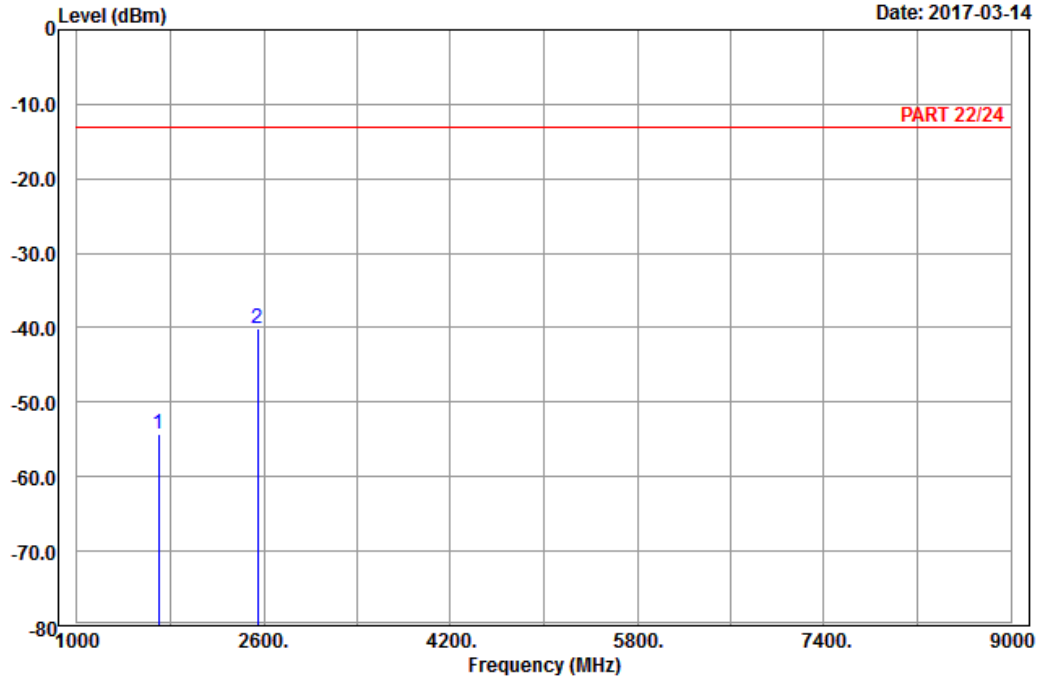

Site : 966 chamber 1  
 Condition: PART 22/24 Vertical  
 Remark : GSM 850\_Link\_CH251  
 Tested by: Karl Lee

	Freq	Level	Read Level	Limit Line	Over Limit	Factor	Remark
	MHz	dBm	dBm	dBm	dB	dB	
1	1697.60	-54.22	-62.36	-13.00	-41.22	8.14	Peak
2 pp	2546.40	-40.07	-51.54	-13.00	-27.07	11.47	Peak

EDGE:  
Low Channel



Bureau Veritas Consumer Products Services Ltd., Taoyuan Branch

A D T

Data: 5

Date: 2017-03-14

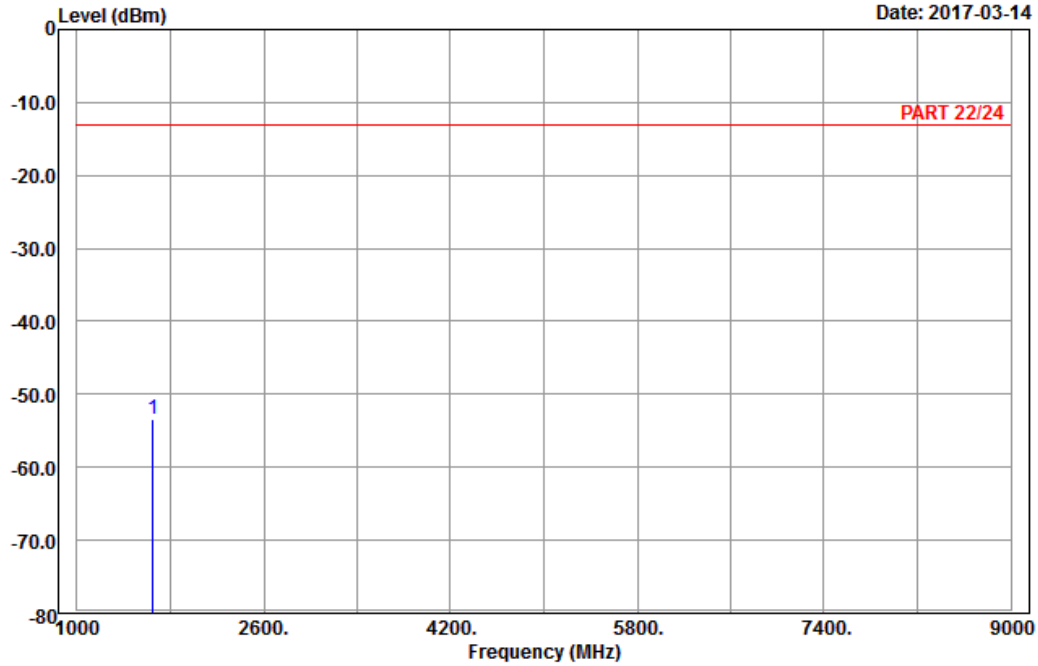

Site : 966 chamber 1  
Condition: PART 22/24 Horizontal  
Remark : EDGE 850\_Link\_CH128  
Tested by: Karl Lee

	Read	Limit	Over			
Freq	Level	Level	Line	Limit	Factor	Remark
MHz	dBm	dBm	dBm	dB	dB	
1 pp 1648.40	-53.32	-61.05	-13.00	-40.32	7.73	Peak



A D T

Data: 6

Date: 2017-03-14

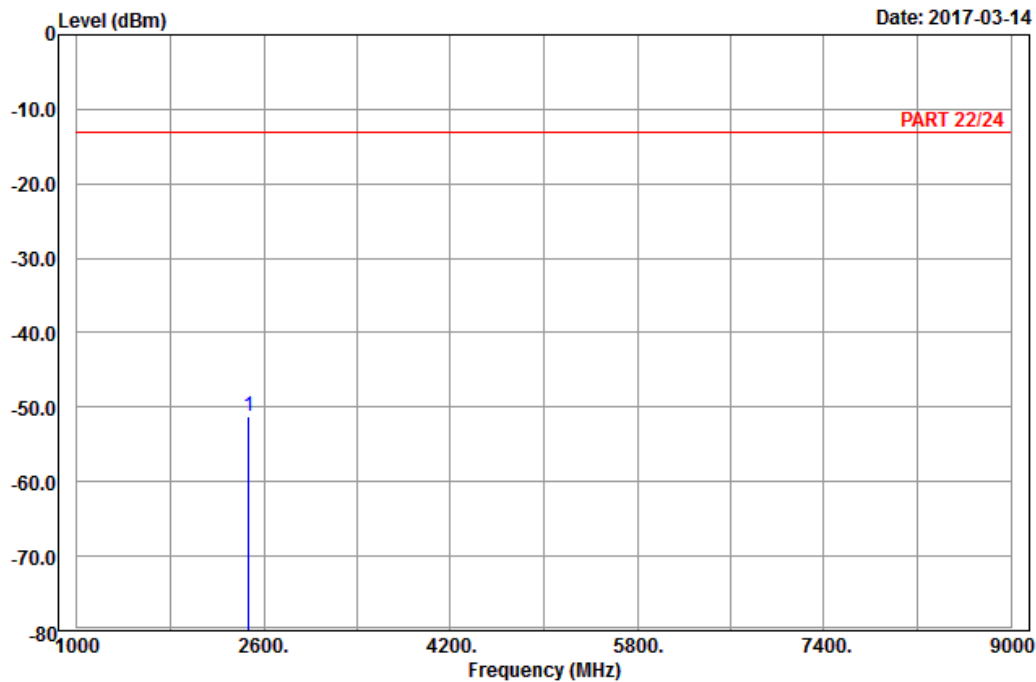

Site : 966 chamber 1  
 Condition: PART 22/24 Vertical  
 Remark : EDGE 850\_Link\_CH128  
 Tested by: Karl Lee

	Freq	Level	Read Level	Limit Line	Over Limit	Factor	Remark
	MHz	dBm	dBm	dBm	dB	dB	
1	pp 2472.60	-51.12	-62.15	-13.00	-38.12	11.03	Peak

Middle Channel



Bureau Veritas Consumer Products Services Ltd., Taoyuan Branch

A D T

Data: 5

Date: 2017-03-14

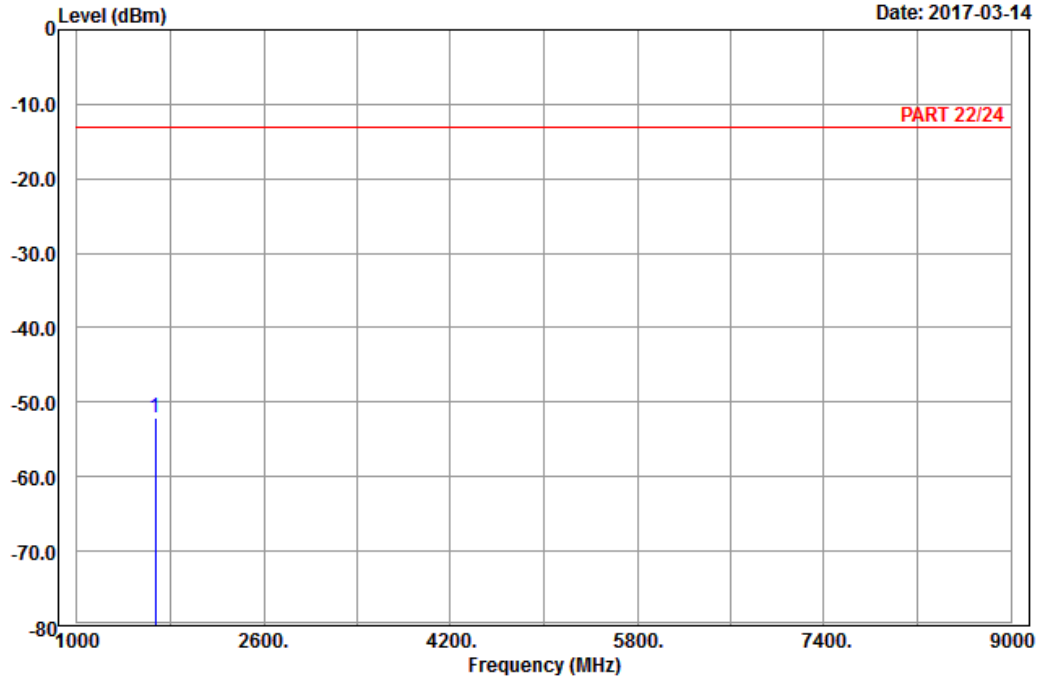

Site : 966 chamber 1  
 Condition: PART 22/24 Horizontal  
 Remark : EDGE 850\_Link\_CH189  
 Tested by: Karl Lee

	Freq	Level	Read Level	Limit Line	Over Limit	Factor	Remark
	MHz	dBm	dBm	dBm	dB	dB	
1 pp	1672.80	-52.02	-59.93	-13.00	-39.02	7.91	Peak



A D T

Data: 6

Date: 2017-03-14

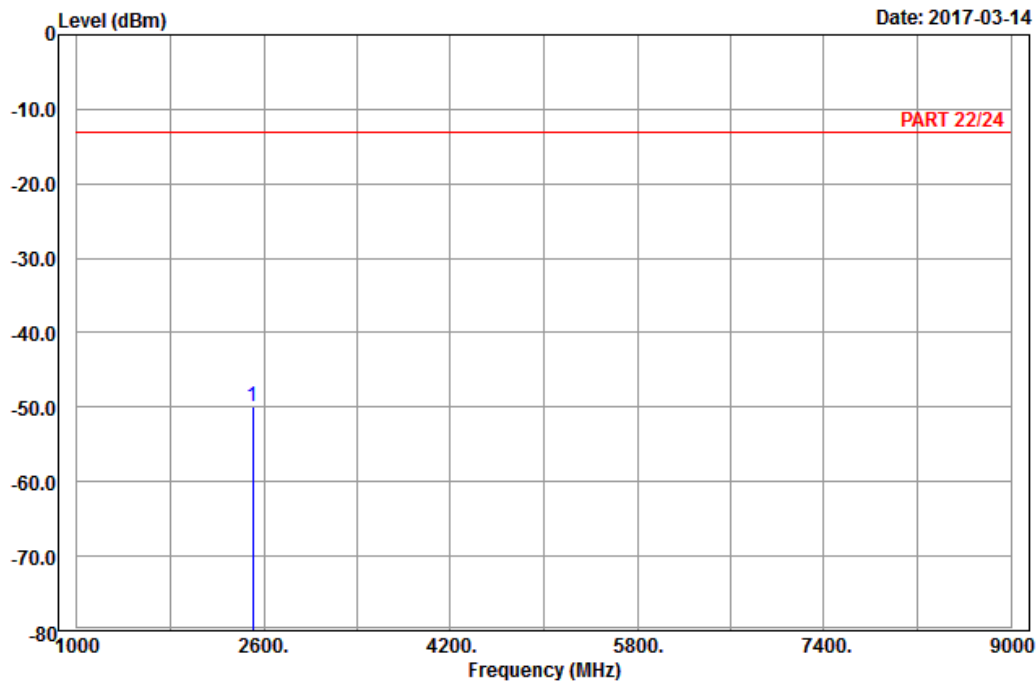

Site : 966 chamber 1  
 Condition: PART 22/24 Vertical  
 Remark : EDGE 850\_Link\_CH189  
 Tested by: Karl Lee

	Freq	Level	Read Level	Limit Line	Over Limit	Factor	Remark
	MHz	dBm	dBm	dBm	dB	dB	
1	pp 2509.20	-50.02	-61.30	-13.00	-37.02	11.28	Peak

# High Channel



Bureau Veritas Consumer Products Services Ltd., Taoyuan Branch

A D T

Data: 5

Date: 2017-03-15

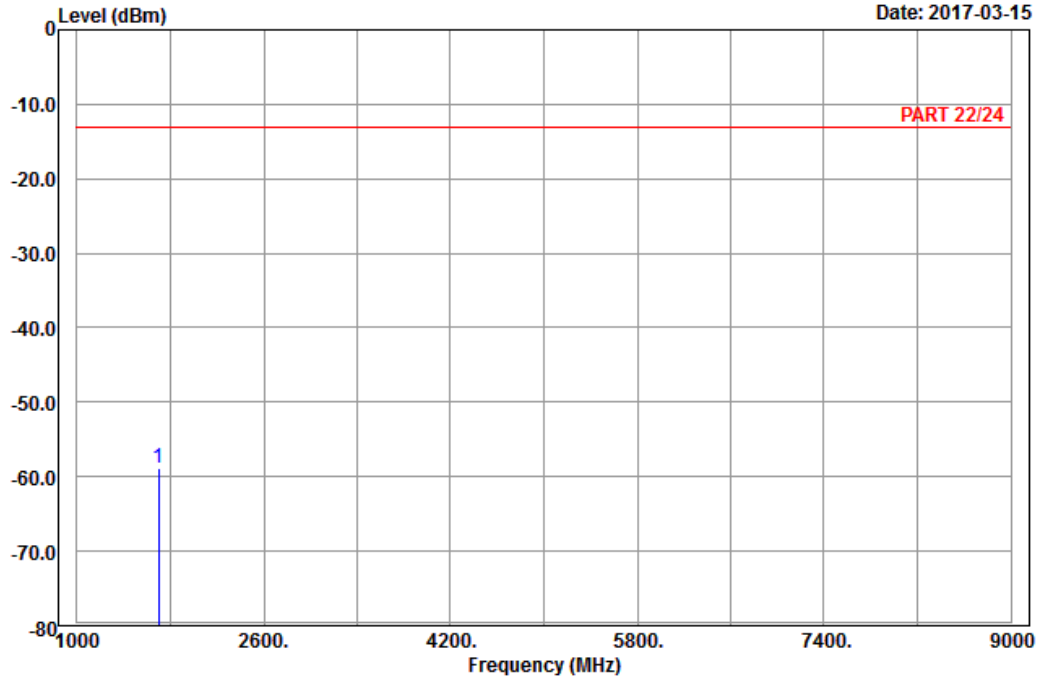

Site : 966 chamber 1  
 Condition: PART 22/24 Horizontal  
 Remark : EDGE 850\_Link\_CH251  
 Tested by: Karl Lee

	Freq	Level	Read Level	Limit Line	Over Limit	Factor	Remark
	MHz	dBm	dBm	dBm	dB	dB	
1	pp 1697.60	-58.78	-66.92	-13.00	-45.78	8.14	Peak



Bureau Veritas Consumer Products Services Ltd., Taoyuan Branch

A D T

Data: 6

Date: 2017-03-15

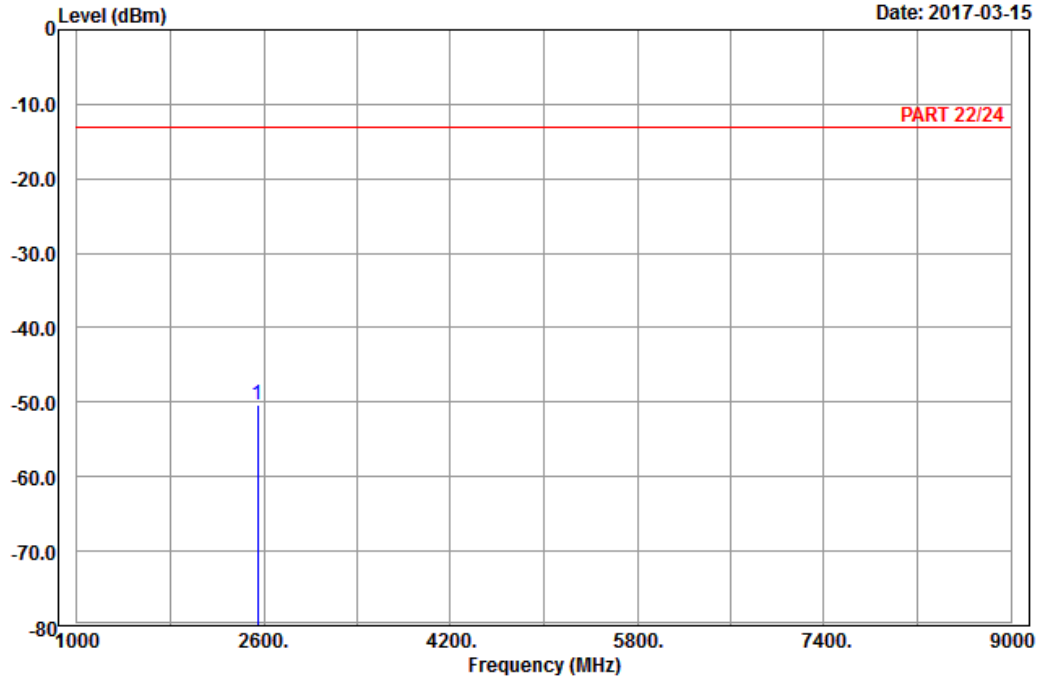

Site : 966 chamber 1  
 Condition: PART 22/24 Vertical  
 Remark : EDGE 850\_Link\_CH251  
 Tested by: Karl Lee

	Freq	Level	Read Level	Limit Line	Over Limit	Factor	Remark
	MHz	dBm	dBm	dBm	dB	dB	
1	pp 2546.40	-50.44	-61.91	-13.00	-37.44	11.47	Peak



WCDMA:  
Low Channel



Bureau Veritas Consumer Products Services Ltd., Taoyuan Branch

A D T

Data: 5

Date: 2017-03-15

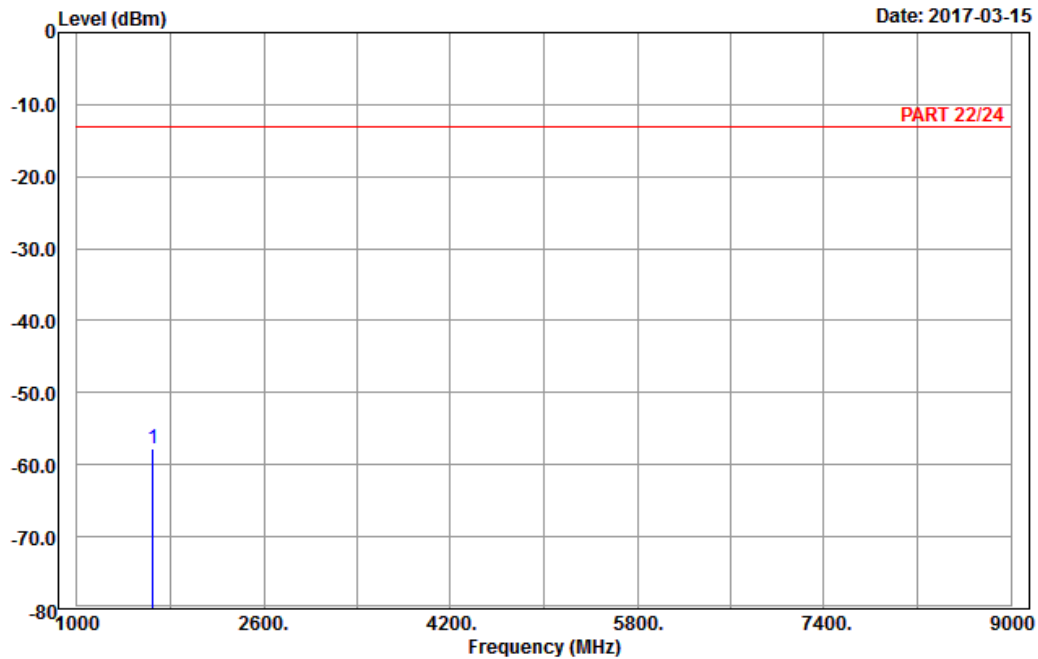

Site : 966 chamber 1  
Condition: PART 22/24 Horizontal  
Remark : Band V\_Link\_CH4132  
Tested by: Karl Lee

	Freq	Level	Read Level	Limit Line	Over Limit	Factor	Remark
	MHz	dBm	dBm	dBm	dB	dB	
1	pp 1652.80	-57.72	-65.45	-13.00	-44.72	7.73	Peak



A D T

Data: 6

Date: 2017-03-15

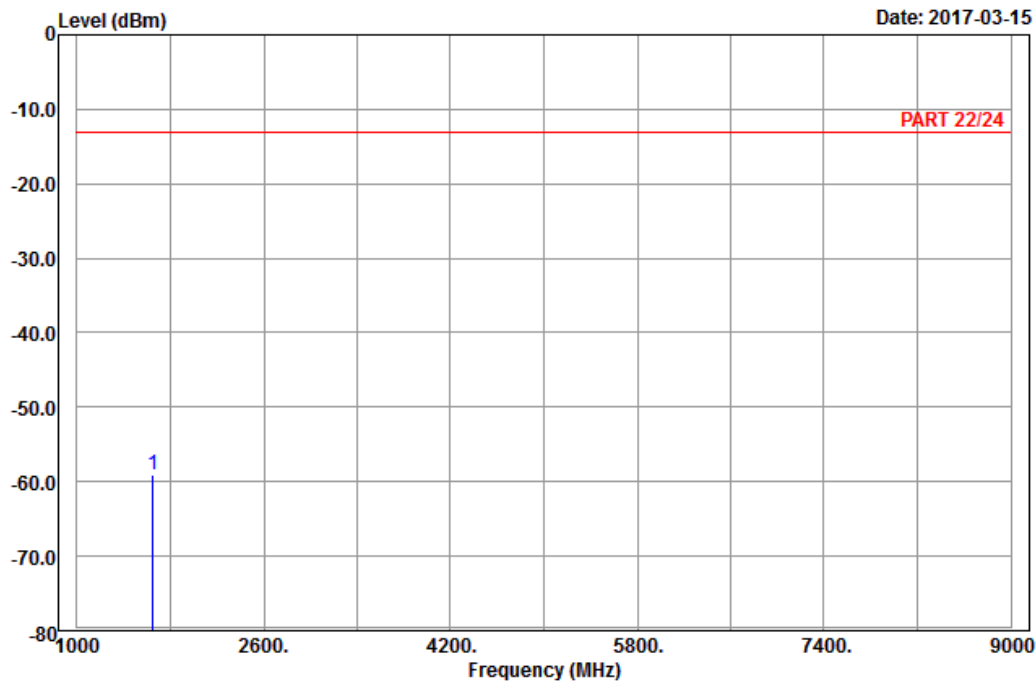

Site : 966 chamber 1  
 Condition: PART 22/24 Vertical  
 Remark : Band V\_Link\_CH4132  
 Tested by: Karl Lee

	Freq	Level	Read Level	Limit Line	Over Limit	Factor	Remark
	MHz	dBm	dBm	dBm	dB	dB	
1	pp 1652.80	-58.99	-66.72	-13.00	-45.99	7.73	Peak

Middle Channel



Bureau Veritas Consumer Products Services Ltd., Taoyuan Branch

A D T

Data: 5

Date: 2017-03-15

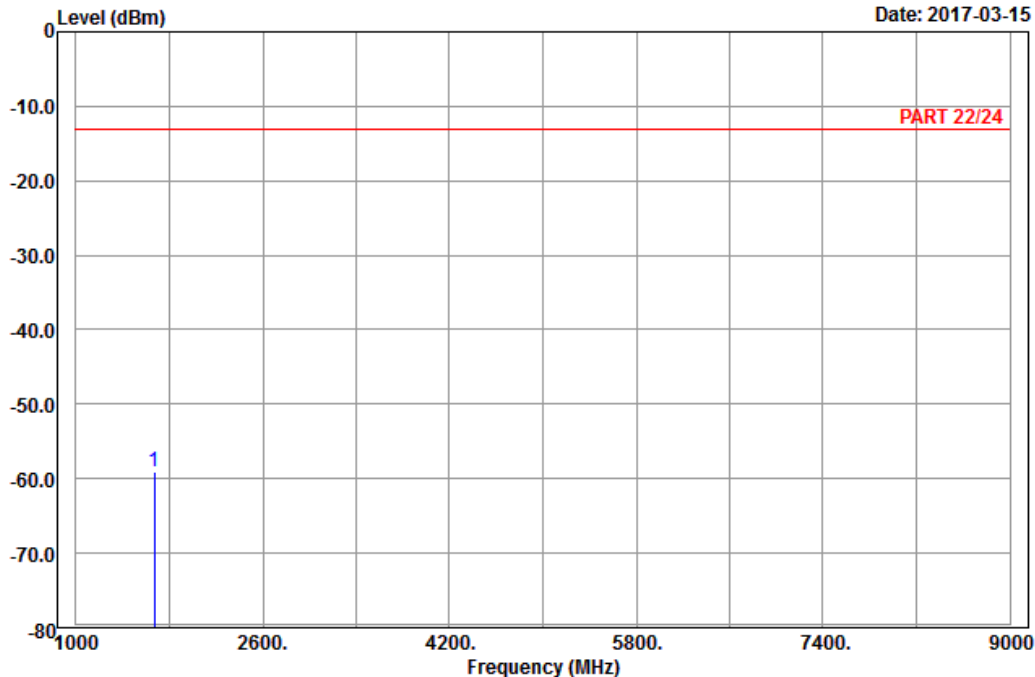

Site : 966 chamber 1  
 Condition: PART 22/24 Horizontal  
 Remark : Band V\_Link\_CH4182  
 Tested by: Karl Lee

Freq	Level	Read Level	Limit Line	Over Limit	Factor	Remark
MHz	dBm	dBm	dBm	dB	dB	
1 pp 1672.80	-58.98	-66.89	-13.00	-45.98	7.91	Peak



A D T

Data: 6

Date: 2017-03-15

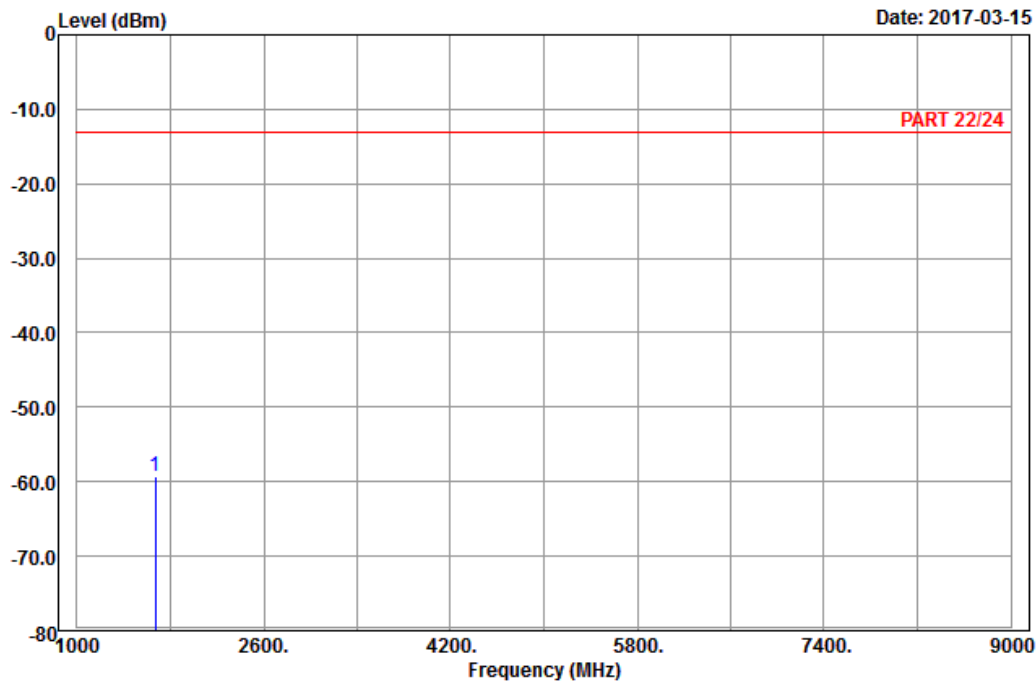

Site : 966 chamber 1  
 Condition: PART 22/24 Vertical  
 Remark : Band V\_Link\_CH4182  
 Tested by: Karl Lee

	Freq	Level	Read Level	Limit Line	Over Limit	Factor	Remark
	MHz	dBm	dBm	dBm	dB	dB	
1	pp 1672.80	-59.22	-67.13	-13.00	-46.22	7.91	Peak

High Channel



Bureau Veritas Consumer Products Services Ltd., Taoyuan Branch

A D T

Data: 5

Date: 2017-03-15

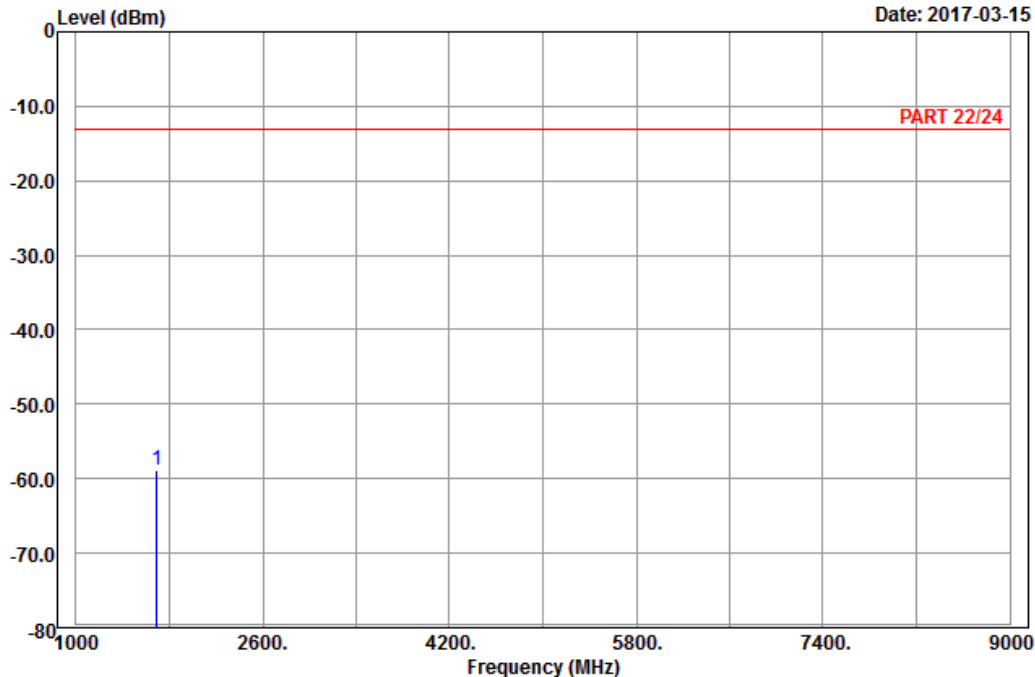

Site : 966 chamber 1  
 Condition: PART 22/24 Horizontal  
 Remark : Band V\_Link\_CH4233  
 Tested by: Karl Lee

Freq	Level	Read Level	Limit Line	Over Limit	Factor	Remark
MHz	dBm	dBm	dBm	dB	dB	
1 pp 1693.20	-58.93	-67.07	-13.00	-45.93	8.14	Peak



A D T

Data: 6

Date: 2017-03-15

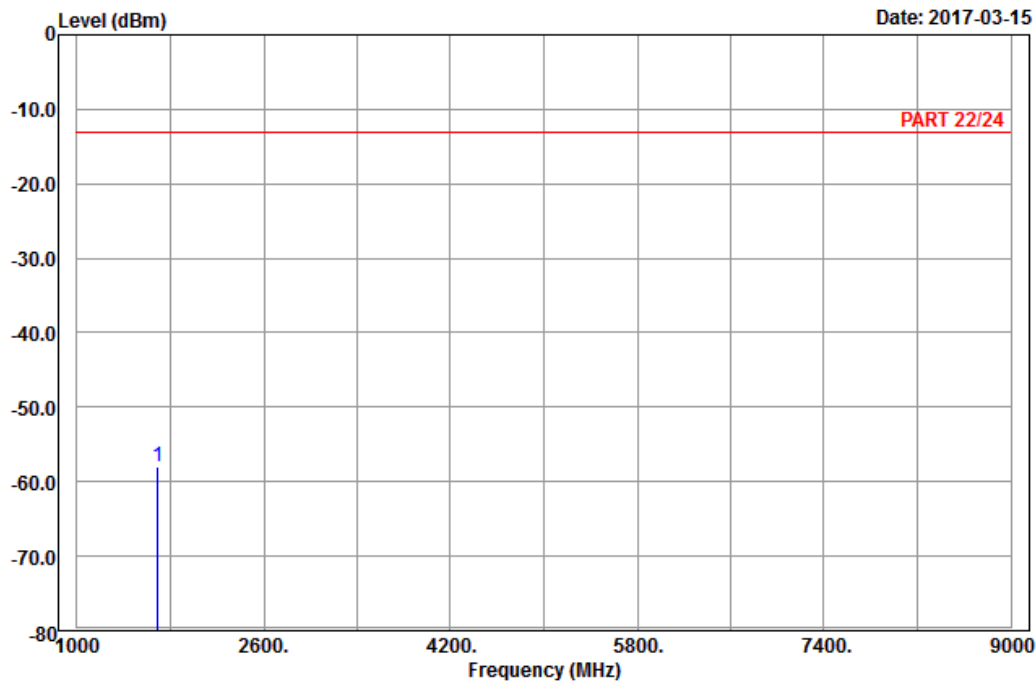

Site : 966 chamber 1  
 Condition: PART 22/24 Vertical  
 Remark : Band V\_Link\_CH4233  
 Tested by: Karl Lee

	Freq	Level	Read Level	Limit Line	Over Limit	Factor	Remark
	MHz	dBm	dBm	dBm	dB	dB	
1	pp 1693.20	-57.88	-66.02	-13.00	-44.88	8.14	Peak

LTE Band 5  
 Channel Bandwidth: 10 MHz / QPSK  
 Low Channel



Bureau Veritas Consumer Products Services Ltd., Taoyuan Branch

A D T

Data: 9

Date: 2017-03-14

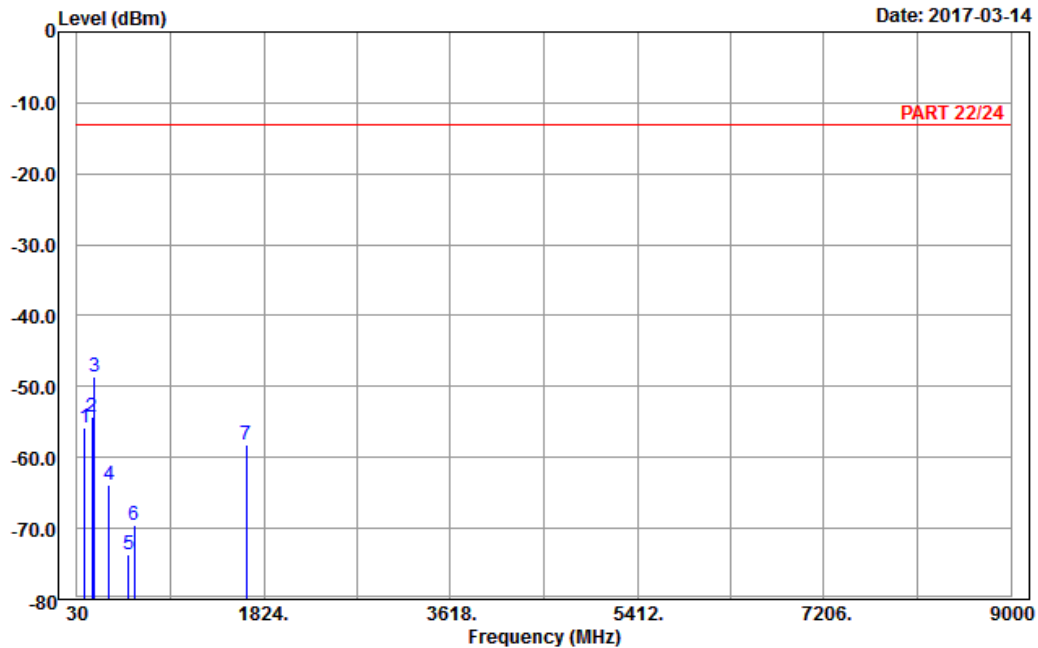

Site : 966 chamber 1  
 Condition: PART 22/24 Horizontal  
 Remark : LTE\_Band 5\_Link\_CH20450  
 Tested by: Charles Hsiao

	Freq	Level	Read Level	Limit Line	Over Limit	Factor	Remark
	MHz	dBm	dBm	dBm	dB	dB	
1	107.49	-55.83	-46.65	-13.00	-42.83	-9.18	Peak
2	171.21	-54.34	-47.84	-13.00	-41.34	-6.50	Peak
3	pp 196.86	-48.55	-42.50	-13.00	-35.55	-6.05	Peak
4	337.80	-63.95	-58.43	-13.00	-50.95	-5.52	Peak
5	524.70	-73.62	-70.11	-13.00	-60.62	-3.51	Peak
6	582.80	-69.61	-69.31	-13.00	-56.61	-0.30	Peak
7	1658.00	-58.20	-66.11	-13.00	-45.20	7.91	Peak



A D T

Data: 10

Date: 2017-03-14

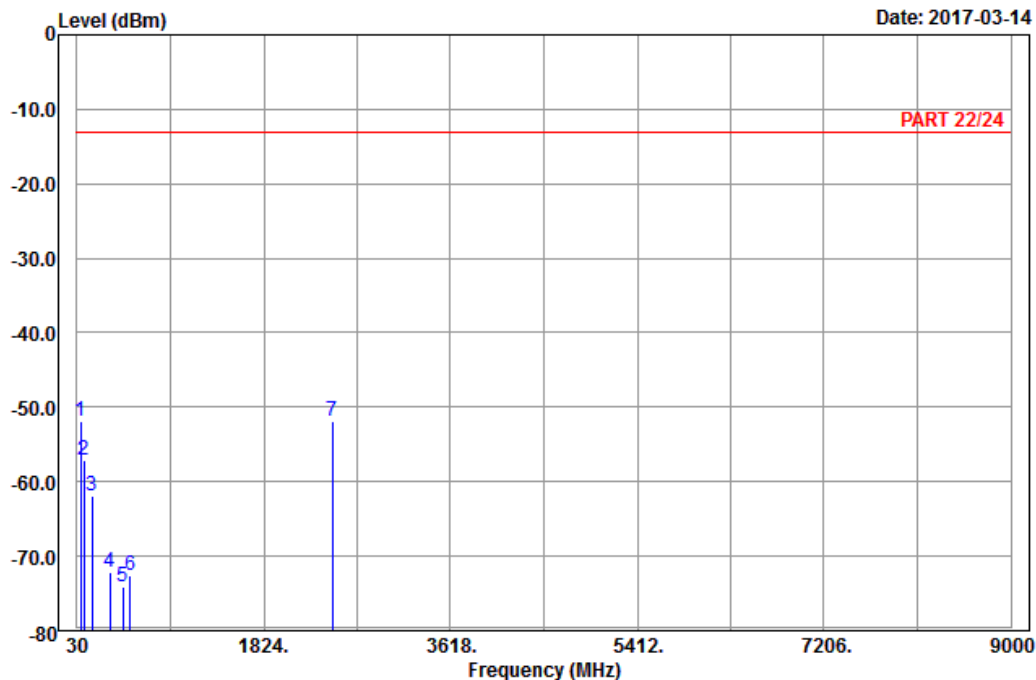

Site : 966 chamber 1  
 Condition: PART 22/24 Vertical  
 Remark : LTE\_Band 5\_Link\_CH20450  
 Tested by: Charles Hsiao

	Freq	Level	Read Level	Limit Line	Over Limit	Factor	Remark
	MHz	dBm	dBm	dBm	dB	dB	
1	61.86	-51.82	-38.03	-13.00	-38.82	-13.79	Peak
2	95.61	-57.20	-46.86	-13.00	-44.20	-10.34	Peak
3	171.48	-62.01	-55.51	-13.00	-49.01	-6.50	Peak
4	349.00	-72.07	-66.68	-13.00	-59.07	-5.39	Peak
5	472.20	-74.06	-69.58	-13.00	-61.06	-4.48	Peak
6	542.90	-72.55	-70.39	-13.00	-59.55	-2.16	Peak
7 pp	2487.00	-51.82	-62.86	-13.00	-38.82	11.04	Peak



Middle Channel



Bureau Veritas Consumer Products Services Ltd., Taoyuan Branch

A D T

Data: 5

Date: 2017-03-14

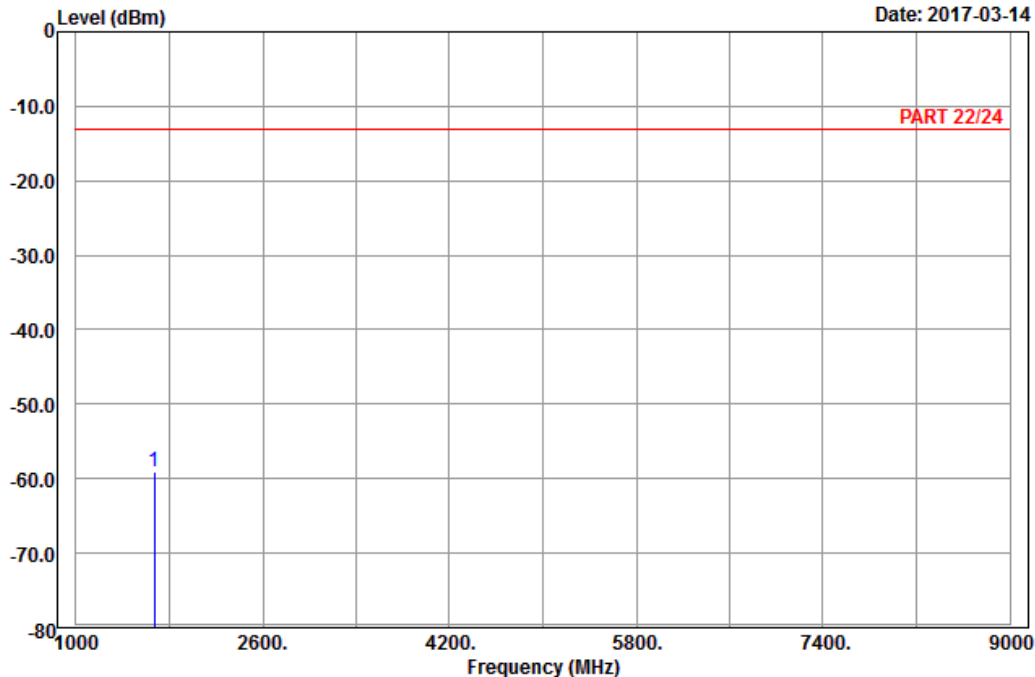

Site : 966 chamber 1  
 Condition: PART 22/24 Horizontal  
 Remark : LTE\_Band 5\_Link\_CH20525  
 Tested by: Charles Hsiao

Freq	Level	Read Level	Limit	Over	Factor	Remark
MHz	dBm	dBm	dBm	dB	dB	
1 pp 1673.00	-59.03	-66.94	-13.00	-46.03	7.91	Peak



A D T

Data: 6

Date: 2017-03-14

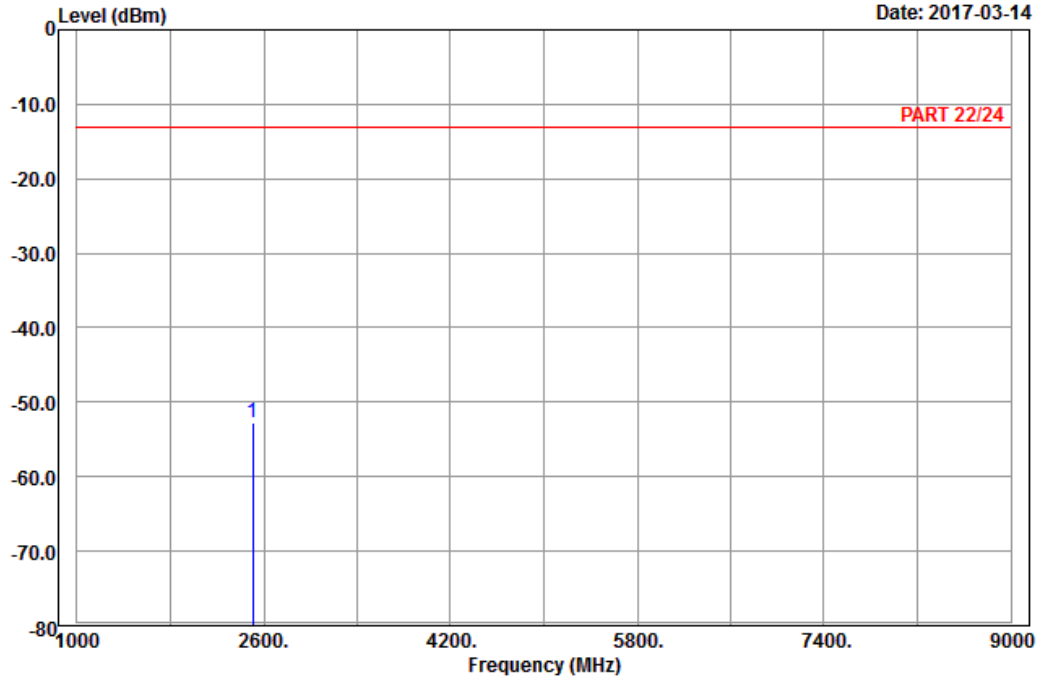

Site : 966 chamber 1  
 Condition: PART 22/24 Vertical  
 Remark : LTE\_Band 5\_Link\_CH20525  
 Tested by: Charles Hsiao

	Freq	Level	Read Level	Limit Line	Over Limit	Factor	Remark
	MHz	dBm	dBm	dBm	dB	dB	
1	pp 2509.50	-52.79	-64.07	-13.00	-39.79	11.28	Peak

High Channel



Bureau Veritas Consumer Products Services Ltd., Taoyuan Branch

A D T

Data: 5

Date: 2017-03-14

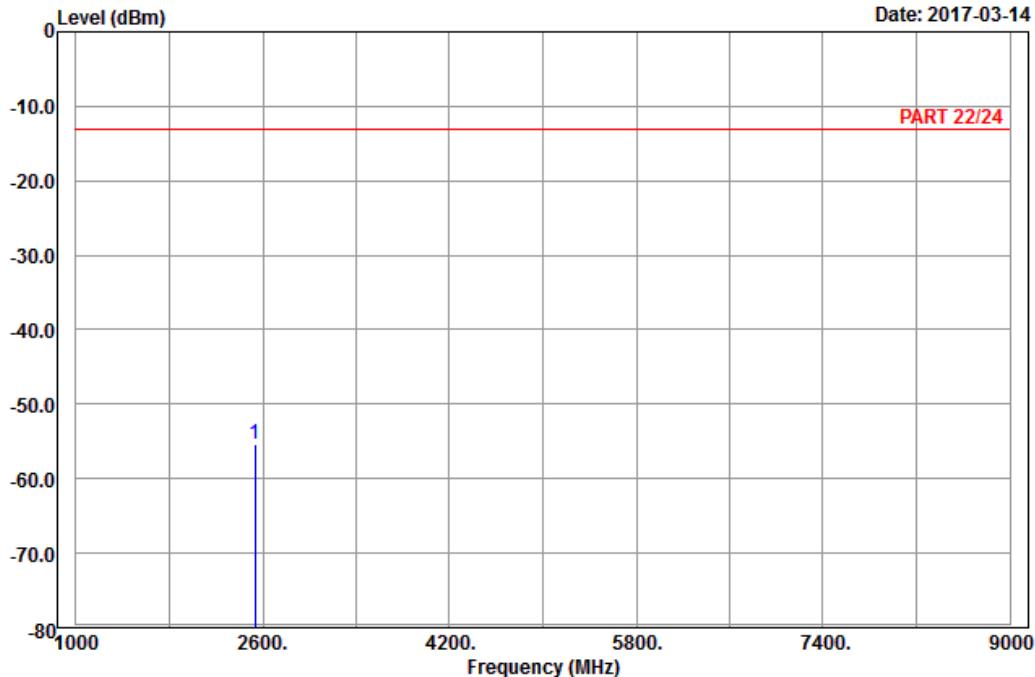

Site : 966 chamber 1  
 Condition: PART 22/24 Horizontal  
 Remark : LTE\_Band 5\_Link\_CH20600  
 Tested by: Karl Lee

Freq	Level	Read Level	Limit Line	Over Limit	Factor	Remark
MHz	dBm	dBm	dBm	dB	dB	
1 pp 2532.00	-55.46	-66.84	-13.00	-42.46	11.38	Peak



A D T

Data: 6

Date: 2017-03-14

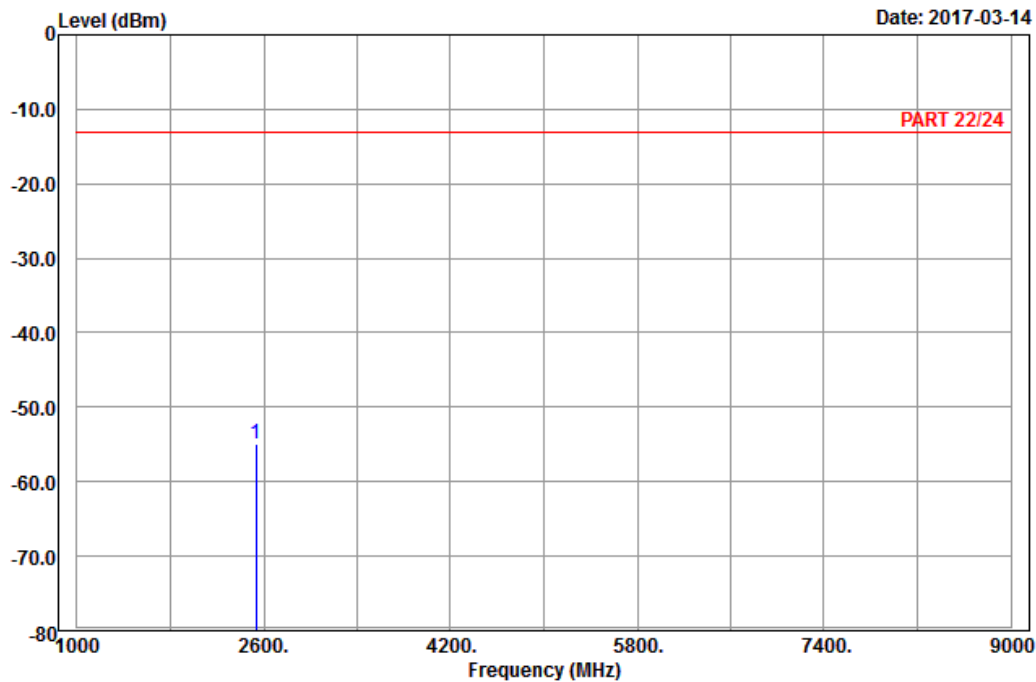

Site : 966 chamber 1  
 Condition: PART 22/24 Vertical  
 Remark : LTE\_Band 5\_Link\_CH20600  
 Tested by: Karl Lee

	Freq	Level	Read Level	Limit Line	Over Limit	Factor	Remark
	MHz	dBm	dBm	dBm	dB	dB	
1	pp 2532.00	-54.83	-66.21	-13.00	-41.83	11.38	Peak

LTE Band 26  
 Channel Bandwidth: 15 MHz / QPSK  
 Low Channel



Bureau Veritas Consumer Products Services Ltd., Taoyuan Branch

A D T

Data: 5

Date: 2017-03-16

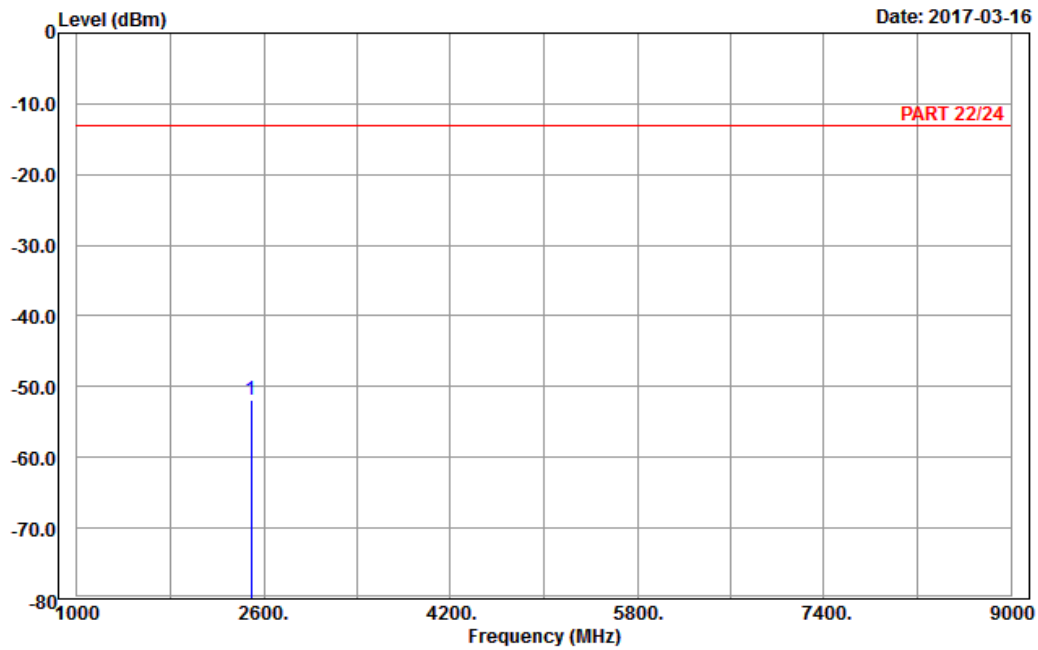

Site : 966 chamber 1  
 Condition: PART 22/24 Horizontal  
 Remark : LTE\_Band 26\_Link\_CH26865  
 Tested by: Charles Hsiao

	Read	Limit	Over			
Freq	Level	Level	Line	Limit	Factor	Remark
MHz	dBm	dBm	dBm	dB	dB	
1 pp 2494.50	-51.97	-63.01	-13.00	-38.97	11.04	Peak



A D T

Data: 6

Date: 2017-03-16

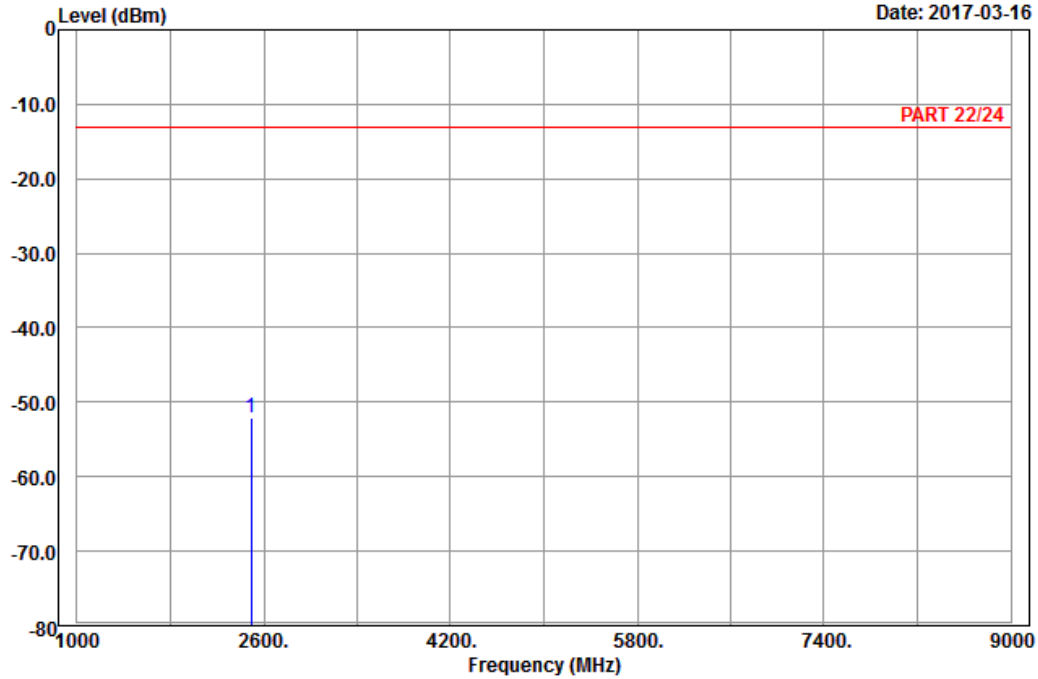

Site : 966 chamber 1  
 Condition: PART 22/24 Vertical  
 Remark : LTE\_Band 26\_Link\_CH26865  
 Tested by: Chalres Hsiao

	Read	Limit	Over			
Freq	Level	Level	Line	Limit	Factor	Remark
MHz	dBm	dBm	dBm	dB	dB	
1 pp 2494.50	-52.01	-63.05	-13.00	-39.01	11.04	Peak

Middle Channel



Bureau Veritas Consumer Products Services Ltd., Taoyuan Branch

A D T

Data: 9

Date: 2017-03-16

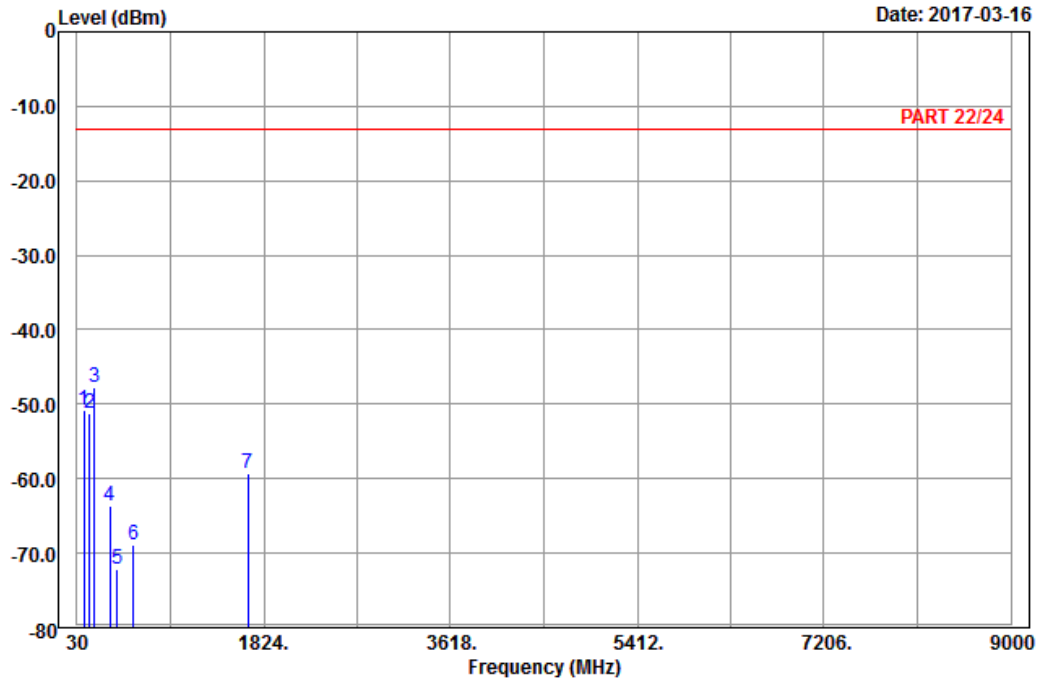

Site : 966 chamber 1  
 Condition: PART 22/24 Horizontal  
 Remark : LTE\_Band 26\_Link\_CH26915  
 Tested by: Chalres Hsiao

	Read	Limit	Over				
Freq	Level	Level	Line	Limit	Factor	Remark	
MHz	dBm	dBm	dBm	dB	dB		
1	97.77	-50.90	-40.67	-13.00	-37.90	-10.23	Peak
2	152.85	-51.14	-43.28	-13.00	-38.14	-7.86	Peak
3 pp	198.75	-47.78	-41.64	-13.00	-34.78	-6.14	Peak
4	344.10	-63.74	-58.29	-13.00	-50.74	-5.45	Peak
5	413.40	-72.19	-69.15	-13.00	-59.19	-3.04	Peak
6	571.60	-68.92	-68.14	-13.00	-55.92	-0.78	Peak
7	1673.00	-59.24	-67.15	-13.00	-46.24	7.91	Peak



A D T

Data: 10

Date: 2017-03-16

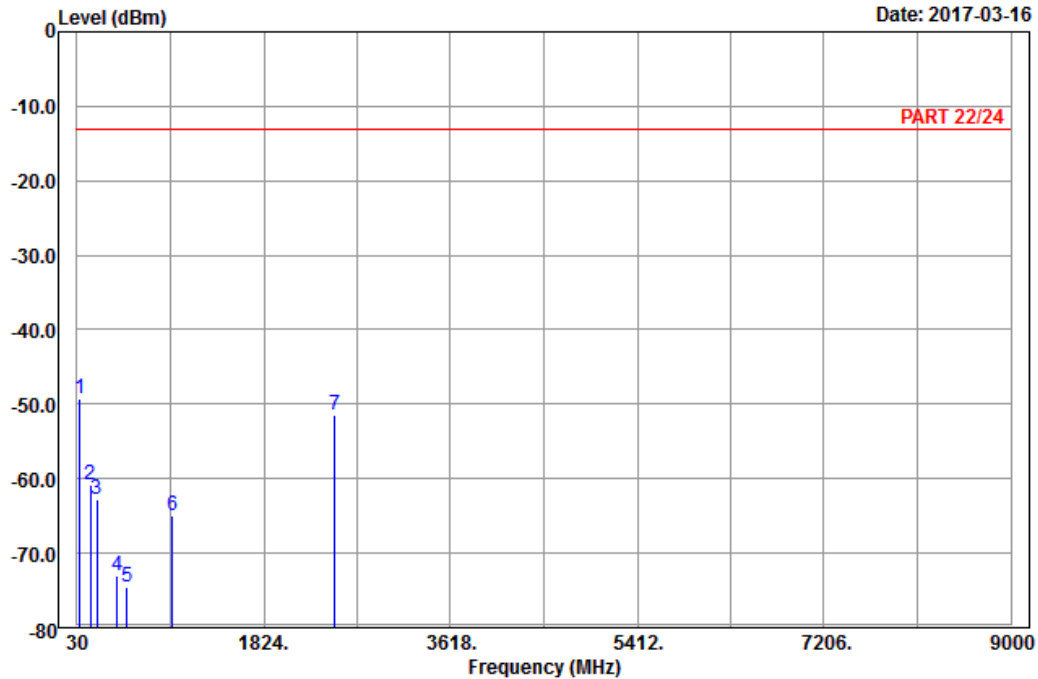

Site : 966 chamber 1  
 Condition: PART 22/24 Vertical  
 Remark : LTE\_Band 26\_Link\_CH26915  
 Tested by: Chalres Hsiao

	Freq	Level	Read Level	Limit Line	Over Limit	Factor	Remark
	MHz	dBm	dBm	dBm	dB	dB	
1 pp	59.97	-49.36	-35.29	-13.00	-36.36	-14.07	Peak
2	159.60	-60.78	-53.11	-13.00	-47.78	-7.67	Peak
3	218.19	-62.80	-56.86	-13.00	-49.80	-5.94	Peak
4	413.40	-73.07	-70.03	-13.00	-60.07	-3.04	Peak
5	507.20	-74.51	-69.72	-13.00	-61.51	-4.79	Peak
6	950.30	-64.92	-70.03	-13.00	-51.92	5.11	Peak
7	2509.50	-51.52	-62.80	-13.00	-38.52	11.28	Peak



# High Channel



Bureau Veritas Consumer Products Services Ltd., Taoyuan Branch

A D T

Data: 5

Date: 2017-03-16

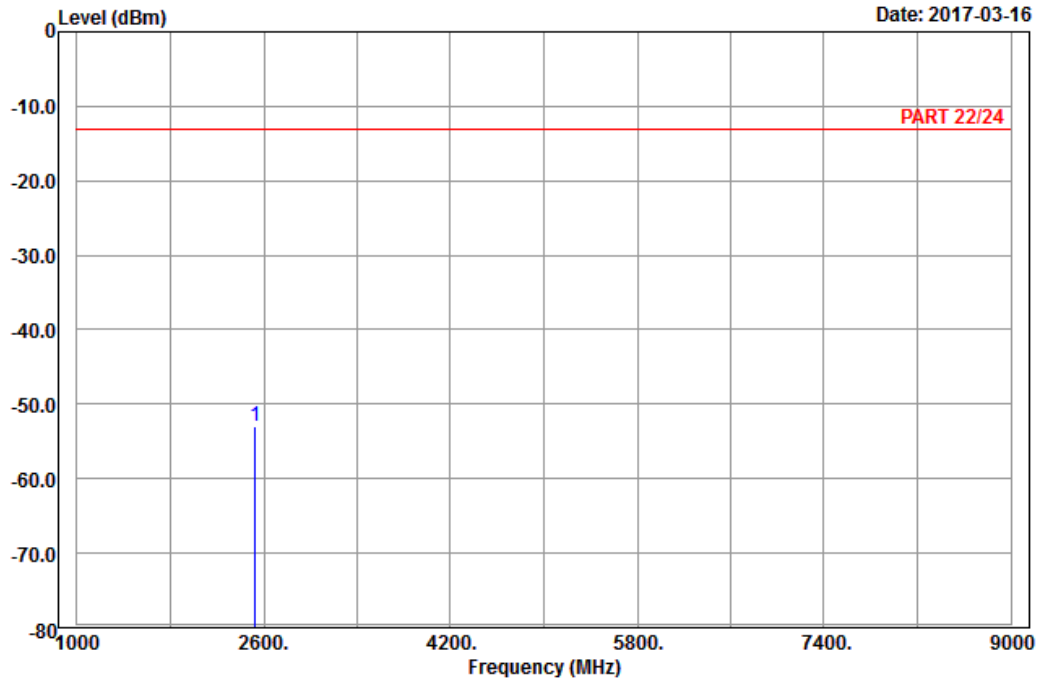

Site : 966 chamber 1  
 Condition: PART 22/24 Horizontal  
 Remark : LTE\_Band 26\_Link\_CH26965  
 Tested by: Chalres Hsiao

Freq	Level	Read Level	Limit	Over	Factor	Remark
MHz	dBm	dBm	dBm	dB	dB	
1 pp 2524.50	-52.90	-64.28	-13.00	-39.90	11.38	Peak



A D T

Data: 6

Date: 2017-03-16

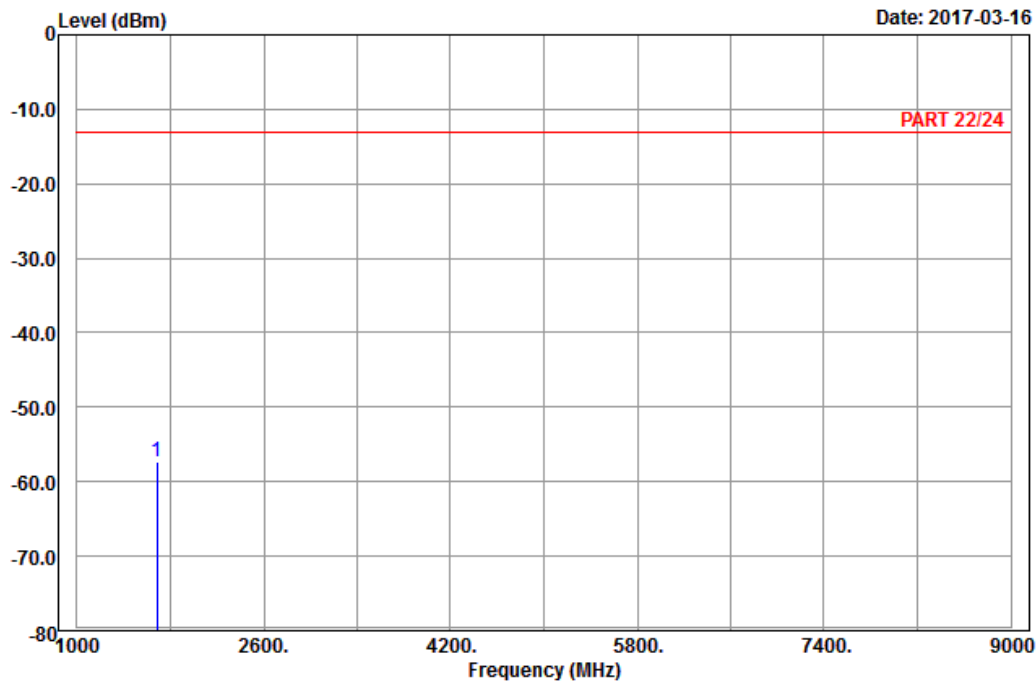

Site : 966 chamber 1  
 Condition: PART 22/24 Vertical  
 Remark : LTE\_Band 26\_Link\_CH26965  
 Tested by: Chalres Hsiao

	Read	Limit	Over			
Freq	Level	Level	Line	Limit	Factor	Remark
MHz	dBm	dBm	dBm	dB	dB	
1 pp 1683.00	-57.27	-65.29	-13.00	-44.27	8.02	Peak

## 5 Pictures of Test Arrangements

Please refer to the attached file (Test Setup Photo).

## Appendix – Information on the Testing Laboratories

We, Bureau Veritas Consumer Products Services (H.K.) Ltd., Taoyuan Branch, were founded in 1988 to provide our best service in EMC, Radio, Telecom and Safety consultation. Our laboratories are accredited and approved according to ISO/IEC 17025.

If you have any comments, please feel free to contact us at the following:

**Linko EMC/RF Lab**

Tel: 886-2-26052180

Fax: 886-2-26051924

**Hsin Chu EMC/RF/Telecom Lab**

Tel: 886-3-6668565

Fax: 886-3-6668323

**Hwa Ya EMC/RF/Safety**

Tel: 886-3-3183232

Fax: 886-3-3270892

**Email:** [service.adt@tw.bureauveritas.com](mailto:service.adt@tw.bureauveritas.com)

**Web Site:** [www.bureauveritas-adt.com](http://www.bureauveritas-adt.com)

The address and road map of all our labs can be found in our web site also.

--- END ---