



FCC TEST REPORT (PART 90S)

REPORT NO.: RF150311C27-4
MODEL NAME: HTV31
FCC ID: NM8HTV31
RECEIVED: Mar. 11, 2015
TESTED: Mar. 17, 2015 ~ Mar. 28, 2015
ISSUED: Apr. 14, 2015

APPLICANT: HTC Corporation

ADDRESS: 1F, 6-3 Baoqiang Road, Xindian District, New Taipei City, Taiwan 231

ISSUED BY: Bureau Veritas Consumer Products Services (H.K.) Ltd., Taoyuan Branch

LAB ADDRESS: No. 47-2, 14th Ling, Chia Pau Vil., Lin Kou Dist., New Taipei City, Taiwan (R.O.C.)

TEST LOCATION: No. 19, Hwa Ya 2nd Rd, Wen Hwa Vil., Kwei Shan Dist., Taoyuan City 333, Taiwan, R.O.C.

This report should not be used by the client to claim product certification, approval, or endorsement by TAF or any government agencies.



This report is for your exclusive use. Any copying or replication of this report to or for any other person or entity, or use of our name or trademark, is permitted only with our prior written permission. This report sets forth our findings solely with respect to the test samples identified herein. The results set forth in this report are not indicative or representative of the quality or characteristics of the lot from which a test sample was taken or any similar or identical product unless specifically and expressly noted. Our report includes all of the tests requested by you and the results thereof based upon the information that you provided to us. You have 60 days from date of issuance of this report to notify us of any material error or omission caused by our negligence, provided, however, that such notice shall be in writing and shall specifically address the issue you wish to raise. A failure to raise such issue within the prescribed time shall constitute your unqualified acceptance of the completeness of this report, the tests conducted and the correctness of the report contents. Unless specific mention, the uncertainty of measurement has been explicitly taken into account to declare the compliance or non-compliance to the specification

TABLE OF CONTENTS

RELEASE CONTROL RECORD	3
1 CERTIFICATION	4
2 SUMMARY OF TEST RESULTS.....	5
2.1 MEASUREMENT UNCERTAINTY	5
2.2 TEST SITE AND INSTRUMENTS	6
3 GENERAL INFORMATION	7
3.1 GENERAL DESCRIPTION OF EUT.....	7
3.2 CONFIGURATION OF SYSTEM UNDER TEST	8
3.3 DESCRIPTION OF SUPPORT UNITS.....	8
3.4 TEST ITEM AND TEST CONFIGURATION	9
3.5 EUT OPERATING CONDITIONS.....	10
3.6 GENERAL DESCRIPTION OF APPLIED STANDARDS	10
4 TEST TYPES AND RESULTS.....	11
4.1 OUTPUT POWER MEASUREMENT	11
4.1.1 LIMITS OF OUTPUT POWER MEASUREMENT	11
4.1.2 TEST PROCEDURES	11
4.1.3 TEST SETUP	12
4.1.4 TEST RESULTS	13
4.2 FREQUENCY STABILITY MEASUREMENT	17
4.2.1 LIMITS OF FREQUENCY STABILITY MEASUREMENT	17
4.2.2 TEST PROCEDURE	17
4.2.3 TEST SETUP	17
4.2.4 TEST RESULTS	18
4.3 OCCUPIED BANDWIDTH MEASUREMENT.....	19
4.3.1 TEST PROCEDURES.....	19
4.3.2 TEST SETUP	19
4.3.3 TEST RESULTS	20
4.4 EMISSION MASK MEASUREMENT	22
4.4.1 LIMITS OF BAND EDGE MEASUREMENT	22
4.4.2 TEST SETUP	22
4.4.3 TEST PROCEDURES	22
4.4.4 TEST RESULTS	23
4.5 CONDUCTED SPURIOUS EMISSIONS.....	30
4.5.1 LIMITS OF CONDUCTED SPURIOUS EMISSIONS MEASUREMENT.....	30
4.5.2 TEST PROCEDURE	30
4.5.3 TEST SETUP	30
4.5.4 TEST RESULTS	31
4.6 RADIATED EMISSION MEASUREMENT	32
4.6.1 LIMITS OF RADIATED EMISSION MEASUREMENT	32
4.6.2 TEST PROCEDURES.....	32
4.6.3 DEVIATION FROM TEST STANDARD	32
4.6.4 TEST SETUP	33
4.6.5 TEST RESULTS	34
5 PHOTOGRAPHS OF THE TEST CONFIGURATION	36
6 INFORMATION ON THE TESTING LABORATORIES	37
7 APPENDIX A – MODIFICATIONS RECORDERS FOR ENGINEERING CHANGES TO THE EUT BY THE LAB.....	38



RELEASE CONTROL RECORD

ISSUE NO.	REASON FOR CHANGE	DATE ISSUED
RF150311C27-4	Original release	Apr. 14, 2015



1 CERTIFICATION

PRODUCT: Smartphone
MODEL: HTV31
BRAND: HTC
APPLICANT: HTC Corporation
TESTED: Mar. 17, 2015 ~ Mar. 28, 2015
TEST SAMPLE: Identical Prototype
STANDARDS: **FCC PART 90, Subpart S**
FCC Part 2

The above equipment (model: HTV31) has been tested by **Bureau Veritas Consumer Products Services (H.K.) Ltd., Taoyuan Branch**, and found compliance with the requirement of the above standards. The test record, data evaluation & Equipment Under Test (EUT) configurations represented herein are true and accurate accounts of the measurements of the sample's EMC characteristics under the conditions specified in this report.

PREPARED BY : Ivy Wu , **DATE** : Apr. 14, 2015
Ivy Wu / Supervisor

APPROVED BY : Sam Chen , **DATE** : Apr. 14, 2015
Sam Chen / Senior Project Engineer

2 SUMMARY OF TEST RESULTS

The EUT has been tested according to the following specifications:

APPLIED STANDARD: FCC Part 90 & Part 2			
STANDARD SECTION	TEST TYPE	RESULT	REMARK
2.1046 90.635 (b)	Effective Radiated Power	PASS	Meet the requirement of limit.
2.1055 90.213	Frequency Stability	PASS	Meet the requirement of limit.
2.1049 90.209	Occupied Bandwidth (*)	PASS	Meet the requirement of limit.
2.1051 90.209	Emission Masks	PASS	Meet the requirement of limit.
2.1051 90.691	Conducted Spurious Emissions	PASS	Meet the requirement of limit.
2.1053 90.691	Radiated Spurious Emissions	PASS	Meet the requirement of limit. Minimum passing margin is -30.07dB at 123.15MHz.

2.1 MEASUREMENT UNCERTAINTY

Where relevant, the following measurement uncertainty levels have been estimated for tests performed on the EUT as specified in CISPR 16-4-2:

MEASUREMENT	FREQUENCY	UNCERTAINTY
Conducted emissions	9kHz~30MHz	2.44 dB
Radiated emissions	30MHz ~ 200MHz	2.93 dB
	200MHz ~1000MHz	2.95 dB
	1GHz ~ 18GHz	2.26 dB
	18GHz ~ 40GHz	1.94 dB

This uncertainty represents an expanded uncertainty expressed at approximately the 95% confidence level using a coverage factor of k=2.

2.2 TEST SITE AND INSTRUMENTS

DESCRIPTION & MANUFACTURER	MODEL NO.	SERIAL NO.	DATE OF CALIBRATION	DUE DATE OF CALIBRATION
Test Receiver Agilent	N9038A	MY51210203	Jan. 21, 2015	Jan. 21, 2016
Spectrum Analyzer Agilent	N9010A	MY52220314	Sep. 03, 2014	Sep. 02, 2015
Spectrum Analyzer ROHDE & SCHWARZ	FSU43	101261	Dec. 10, 2014	Dec. 09, 2015
BILOG Antenna SCHWARZBECK	VULB9168	9168-472	Feb. 04, 2015	Feb. 04, 2016
HORN Antenna SCHWARZBECK	BBHA 9120 D	9120D-969	Feb. 09, 2015	Feb. 09, 2016
HORN Antenna SCHWARZBECK	BBHA 9170	9170-480	Feb. 04, 2015	Feb. 04, 2016
Preamplifier EMCI	EMC 012645	980115	Dec. 12, 2014	Dec. 11, 2015
Preamplifier EMCI	EMC 184045	980116	Jan. 09, 2015	Jan. 08, 2016
Preamplifier EMCI	EMC 330H	980112	Dec. 27, 2014	Dec. 26, 2015
Power Meter Anritsu	ML2495A	1232002	Sep. 17, 2014	Sep. 16, 2015
Power Sensor Anritsu	MA2411B	1207325	Sep. 17, 2014	Sep. 16, 2015
RF signal cable HUBER+SUHNNER	SUCOFLEX 104	309219/4 2950114	Oct. 18, 2014	Oct. 17, 2015
RF signal cable HUBER+SUHNNER	SUCOFLEX 104	250130/4	Oct. 18, 2014	Oct. 17, 2015
RF Coaxial Cable Worken	8D-FB	Cable-Ch10-01	Nov. 07, 2014	Nov. 06, 2015
Software BV ADT	E3 6.120103	NA	NA	NA
Antenna Tower MF	MFA-440H	NA	NA	NA
Turn Table MF	MFT-201SS	NA	NA	NA
Antenna Tower & Turn Table Controller MF	MF-7802	NA	NA	NA
Radio Communication Analyzer	MT8820C	6201300640	Aug. 01, 2013	Jul. 31, 2015

- NOTE:**
1. The calibration interval of the above test instruments is 12 months and the calibrations are traceable to NML/ROC and NIST/USA.
 2. The test was performed in HwaYa Chamber 10.
 3. The horn antenna and HP preamplifier (model: 8449B) are used only for the measurement of emission frequency above 1GHz if tested.
 4. The FCC Site Registration No. is 690701.
 5. The IC Site Registration No. is IC 7450F-10.

3 GENERAL INFORMATION

3.1 GENERAL DESCRIPTION OF EUT

EUT	Smartphone	
MODEL NAME	HTV31	
POWER SUPPLY	5.0Vdc (adapter or host equipment) 3.83Vdc (battery)	
MODULATION TYPE	LTE Band 26	QPSK, 16QAM
FREQUENCY RANGE	LTE Band 26 (Channel Bandwidth: 1.4MHz)	814.7MHz ~ 823.3MHz
	LTE Band 26 (Channel Bandwidth: 3MHz)	815.5MHz ~ 822.5MHz
	LTE Band 26 (Channel Bandwidth: 5MHz)	816.5MHz ~ 821.5MHz
	LTE Band 26 (Channel Bandwidth: 10MHz)	819MHz
MAX. ERP POWER	LTE Band 26 (Channel Bandwidth: 1.4MHz)	75.20mW
	LTE Band 26 (Channel Bandwidth: 3MHz)	80.50mW
	LTE Band 26 (Channel Bandwidth: 5MHz)	75.54mW
	LTE Band 26 (Channel Bandwidth: 10MHz)	78.16mW
EMISSION DESIGNATOR	LTE Band 26 (Channel Bandwidth: 1.4MHz)	1M09W7D
	LTE Band 26 (Channel Bandwidth: 3MHz)	2M72G7D
	LTE Band 26 (Channel Bandwidth: 5MHz)	4M50G7D
	LTE Band 26 (Channel Bandwidth: 10MHz)	8M97G7D
ANTENNA TYPE	Fixed Internal antenna	
I/O PORTS	Refer to users' manual	
DATA CABLE	Refer to NOTE as below	
ACCESSORY DEVICES	Refer to NOTE as below	

NOTE:

1. The EUT's accessories list refers to EUT photo.
2. The above EUT information was declared by manufacturer and for more detailed features description, please refer to the manufacturer's specifications or User's Manual.

3.2 CONFIGURATION OF SYSTEM UNDER TEST

FOR RADIATION EMISSION TEST

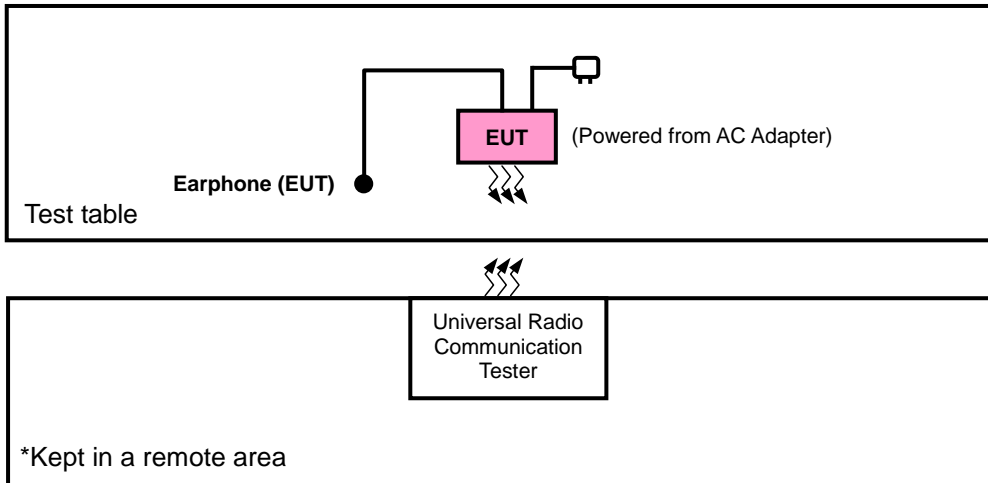

FOR E.R.P. TEST

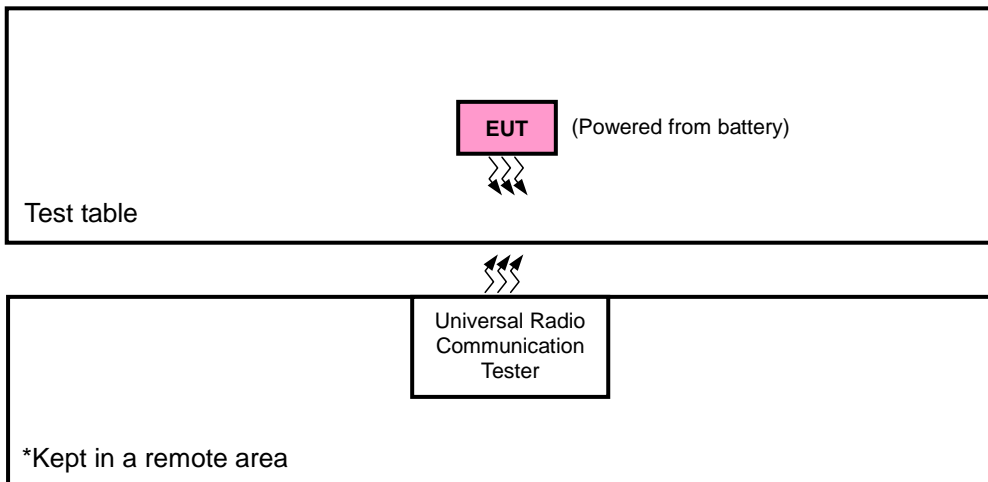

3.3 DESCRIPTION OF SUPPORT UNITS

The EUT has been tested as an independent unit together with other necessary accessories or support units.

3.4 TEST ITEM AND TEST CONFIGURATION

Pre-Scan has been conducted to determine the worst-case mode from all possible combinations between available modulations, data rates, XYZ axis and antenna ports. The worst case was found when positioned on Y-plane for ERP and X-axis for radiated emission. Following channel(s) was (were) selected for the final test as listed below:

LTE BAND 26 MODE

EUT CONFIGURE MODE	TEST ITEM	AVAILABLE CHANNEL	TESTED CHANNEL	CHANNEL BANDWIDTH	MODULATION	MODE
-	ERP	26697 to 26783	26697, 26740, 26783	1.4MHz	QPSK, 16QAM	1 RB / 0 RB Offset
		26705 to 26775	26705, 26740, 26775	3MHz	QPSK, 16QAM	1 RB / 0 RB Offset
		26715 to 26765	26715, 26740, 26765	5MHz	QPSK, 16QAM	1 RB / 0 RB Offset
		26740	26740	10MHz	QPSK, 16QAM	1 RB / 0 RB Offset
-	FREQUENCY STABILITY	26697 to 26783	26740	1.4MHz	QPSK	1 RB / 0 RB Offset
		26705 to 26775	26740	3MHz	QPSK	1 RB / 0 RB Offset
		26715 to 26765	26740	5MHz	QPSK	1 RB / 0 RB Offset
		26740	26740	10MHZ	QPSK	1 RB / 0 RB Offset
-	OCCUPIED BANDWIDTH	26697 to 26783	26697, 26740, 26783	1.4MHz	QPSK, 16QAM	6 RB / 0 RB Offset
		26705 to 26775	26705, 26740, 26775	3MHz	QPSK, 16QAM	15 RB / 0 RB Offset
		26715 to 26765	26715, 26740, 26765	5MHz	QPSK, 16QAM	25 RB / 0 RB Offset
		26740	26740	10MHz	QPSK, 16QAM	50 RB / 0 RB Offset
-	EMISSION MASK	26697 to 26783	26697, 26740, 26783	1.4MHz	QPSK, 16QAM	6 RB / 0 RB Offset
		26705 to 26775	26705, 26740, 26775	3MHz	QPSK, 16QAM	15 RB / 0 RB Offset
		26715 to 26765	26715, 26740, 26765	5MHz	QPSK, 16QAM	25 RB / 0 RB Offset
		26740	26740	10MHz	QPSK, 16QAM	50 RB / 0 RB Offset
-	CONDUCTED EMISSION	26697 to 26783	26740	1.4MHz	QPSK	1 RB / 0 RB Offset
		26705 to 26775	26740	3MHz	QPSK	1 RB / 0 RB Offset
		26715 to 26765	26740	5MHz	QPSK	1 RB / 0 RB Offset
		26740	26740	10MHZ	QPSK	1 RB / 0 RB Offset
-	RADIATED EMISSION	26740	26740	10MHZ	QPSK	1 RB / 0 RB Offset

Note: This device was tested under all bandwidths, RB configurations and modulations. The worst case was found in QPSK modulation.

TEST CONDITION:

TEST ITEM	ENVIRONMENTAL CONDITIONS	INPUT POWER	TESTED BY
ERP	26deg. C, 58%RH	3.83Vdc	Luke Chen
FREQUENCY STABILITY	26deg. C, 58%RH	3.83Vdc	Luke Chen
OCCUPIED BANDWIDTH	26deg. C, 58%RH	3.83Vdc	Luke Chen
BAND EDGE	26deg. C, 58%RH	3.83Vdc	Luke Chen
CONDUCTED EMISSION	26deg. C, 58%RH	3.83Vdc	Luke Chen
RADIATED EMISSION	25deg. C, 65%RH	120Vac, 60Hz	Hwa Chiang



3.5 EUT OPERATING CONDITIONS

The EUT makes a call to the communication simulator. The communication simulator station system controlled a EUT to export maximum output power under transmission mode and specific channel frequency.

3.6 GENERAL DESCRIPTION OF APPLIED STANDARDS

The EUT is a RF product. According to the specifications of the manufacturer, it must comply with the requirements of the following standards:

FCC 47 CFR Part 2

FCC 47 CFR Part 90

ANSI/TIA/EIA-603-C 2004

NOTE: All test items have been performed and recorded as per the above standards.



A D T

4 TEST TYPES AND RESULTS

4.1 OUTPUT POWER MEASUREMENT

4.1.1 LIMITS OF OUTPUT POWER MEASUREMENT

Mobile / Portable station are limited to 100 watts e.r.p.

4.1.2 TEST PROCEDURES

EIRP MEASUREMENT:

- a. All measurements were done at low, middle and high operational frequency range. RBW and VBW is 10MHz for LTE mode.
- b. Substitution method is used for E.I.R.P measurement. In the semi-anechoic chamber, EUT placed on the 0.8m height of Turn Table, rotated the table around 360 degrees to search the maximum radiation power and receiver antenna shall be rotated vertical and horizontal polarization and moved height from 1m to 4m to find the maximum polar radiated power. The “Read Value” is the spectrum reading the maximum power value.
- c. The substitution horn antenna is substituted for EUT at the same position and signals generator export the CW signal to the substitution antenna via a tx cable. Rotated the Turn Table and moved receiving antenna to find the maximum radiation power. Adjust output power level of S.G to get a Value of spectrum reading equal to “Read Value” of step b. Record the power level of S.G.
- d. $EIRP = \text{Output power level of S.G} - \text{TX cable loss} + \text{Antenna gain of substitution horn}.$

CONDUCTED POWER MEASUREMENT:

The EUT was set up for the maximum power with LTE link data modulation and link up with simulator. Set the EUT to transmit under low, middle and high channel and record the power level shown on simulator.

4.1.3 TEST SETUP

EIRP / ERP MEASUREMENT:

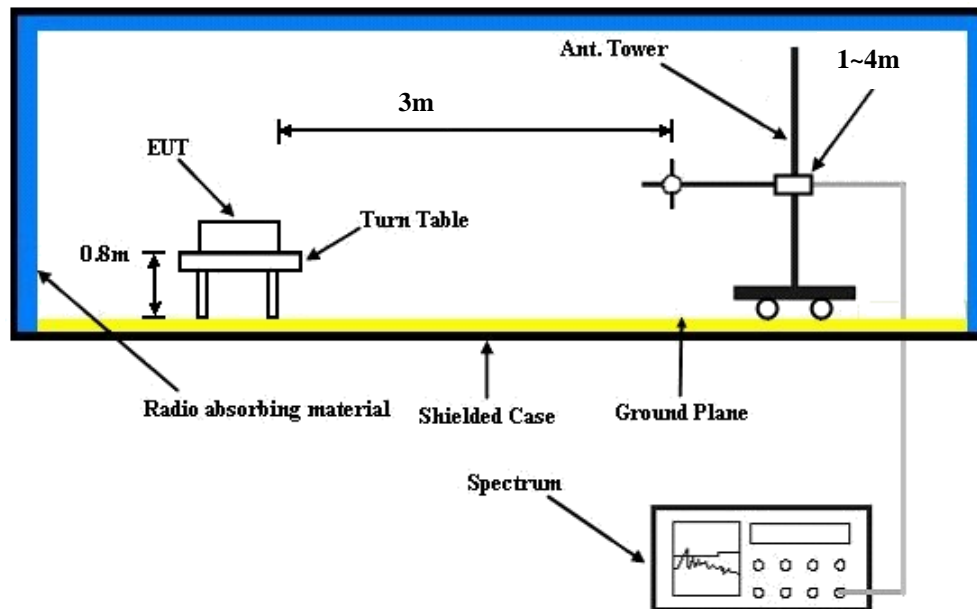

CONDUCTED POWER MEASUREMENT:

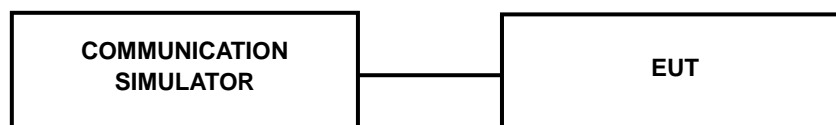



A D T

4.1.4 TEST RESULTS

CONDUCTED OUTPUT POWER (dBm)

Band / BW	RB Size	RB Offset	QPSK			3GPP MPR (dB)	16QAM			3GPP MPR (dB)
			Low CH 26697	Mid CH 26740	High CH 26783		Low CH 26697	Mid CH 26740	High CH 26783	
			814.7 MHz	819.0 MHz	823.3 MHz		814.7 MHz	819.0 MHz	823.3 MHz	
26 / 1.4M	1	0	22.02	22.15	22.04	0	20.98	21.11	21.00	1
	1	2	21.72	21.85	21.66	0	20.68	20.81	20.62	1
	1	5	22.00	22.13	21.94	0	20.96	21.09	20.90	1
	3	0	20.94	21.07	20.88	0	19.90	20.03	19.84	1
	3	1	20.92	21.05	20.86	0	19.88	20.01	19.82	1
	3	3	20.87	21.00	20.81	0	19.83	19.96	19.77	1
	6	0	20.90	21.03	20.84	1	19.86	19.99	19.80	2

Band / BW	RB Size	RB Offset	QPSK			3GPP MPR (dB)	16QAM			3GPP MPR (dB)
			Low CH 26705	Mid CH 26740	High CH 26775		Low CH 26705	Mid CH 26740	High CH 26775	
			815.5 MHz	819.0 MHz	822.5 MHz		815.5 MHz	819.0 MHz	822.5 MHz	
26 / 3M	1	0	22.12	22.23	22.12	0	21.08	21.19	21.08	1
	1	7	21.82	21.93	21.74	0	20.78	20.89	20.70	1
	1	14	22.10	22.21	22.02	0	21.06	21.17	20.98	1
	8	0	21.04	21.15	20.96	1	20.00	20.11	19.92	2
	8	3	21.02	21.13	20.94	1	19.98	20.09	19.90	2
	8	7	20.97	21.08	20.89	1	19.93	20.04	19.85	2
	15	0	21.00	21.11	20.92	1	19.96	20.07	19.88	2

Band / BW	RB Size	RB Offset	QPSK			3GPP MPR (dB)	16QAM			3GPP MPR (dB)
			Low CH 26715	Mid CH 26740	High CH 26765		Low CH 26715	Mid CH 26740	High CH 26765	
			816.5 MHz	819.0 MHz	821.5 MHz		816.5 MHz	819.0 MHz	821.5 MHz	
26 / 5M	1	0	22.17	22.32	22.21	0	21.13	21.28	21.17	1
	1	12	21.87	22.02	21.83	0	20.83	20.98	20.79	1
	1	24	22.15	22.30	22.11	0	21.11	21.26	21.07	1
	12	0	21.09	21.24	21.05	1	20.05	20.20	20.01	2
	12	6	21.07	21.22	21.03	1	20.03	20.18	19.99	2
	12	13	21.02	21.17	20.98	1	19.98	20.13	19.94	2
	25	0	21.05	21.20	21.01	1	20.01	20.16	19.97	2

Band / BW	RB Size	RB Offset	QPSK	3GPP MPR (dB)	16QAM	3GPP MPR (dB)
			Mid CH 26740		Mid CH 26740	
			819.0 MHz		819.0 MHz	
26 / 10M	1	0	22.29	0	21.25	1
	1	24	21.99	0	20.95	1
	1	49	22.27	0	21.23	1
	25	0	21.21	1	20.17	2
	25	12	21.19	1	20.15	2
	25	25	21.14	1	20.10	2
	50	0	21.17	1	20.13	2



A D T

ERP POWER (dBm)

LTE Band 26							
Channel Bandwidth: 1.4MHz / QPSK							
Plane	Channel	Frequency (MHz)	LVL (dBm)	Correction Factor(dB)	ERP(dBm)	ERP(mW)	Polarization (H/V)
Y	26697	814.7	-10.56	31.208	18.50	70.76	H
	26740	819.0	-10.70	31.3	18.45	69.98	H
	26783	823.3	-10.31	31.222	18.76	75.20	H
	26697	814.7	-18.98	31.504	10.37	10.90	V
	26740	819.0	-18.00	31.117	10.97	12.49	V
	26783	823.3	-19.37	31.922	10.40	10.97	V

LTE Band 26							
Channel Bandwidth: 1.4MHz / 16QAM							
Plane	Channel	Frequency (MHz)	LVL (dBm)	Correction Factor(dB)	ERP(dBm)	ERP(mW)	Polarization (H/V)
Y	26697	814.7	-11.38	31.208	17.68	58.59	H
	26740	819.0	-11.70	31.3	17.45	55.59	H
	26783	823.3	-12.05	31.222	17.02	50.37	H
	26697	814.7	-19.59	31.504	9.76	9.47	V
	26740	819.0	-19.33	31.117	9.64	9.20	V
	26783	823.3	-19.89	31.922	9.88	9.73	V

LTE Band 26							
Channel Bandwidth: 3MHz / QPSK							
Plane	Channel	Frequency (MHz)	LVL (dBm)	Correction Factor(dB)	ERP(dBm)	ERP(mW)	Polarization (H/V)
Y	26705	815.5	-10.00	31.208	19.06	80.50	H
	26740	819.0	-10.17	31.3	18.98	79.07	H
	26775	822.5	-10.04	31.222	19.03	80.02	H
	26705	815.5	-18.39	31.504	10.96	12.49	V
	26740	819.0	-18.39	31.117	10.58	11.42	V
	26775	822.5	-19.34	31.922	10.43	11.05	V



A D T

LTE Band 26							
Channel Bandwidth: 3MHz / 16QAM							
Plane	Channel	Frequency (MHz)	LVL (dBm)	Correction Factor(dB)	ERP(dBm)	ERP(mW)	Polarization (H/V)
Y	26705	815.5	-11.66	31.208	17.40	54.93	H
	26740	819.0	-12.06	31.3	17.09	51.17	H
	26775	822.5	-11.96	31.222	17.11	51.43	H
	26705	815.5	-19.96	31.504	9.39	8.70	V
	26740	819.0	-19.85	31.117	9.12	8.16	V
	26775	822.5	-20.12	31.922	9.65	9.23	V

LTE Band 26							
Channel Bandwidth: 5MHz / QPSK							
Plane	Channel	Frequency (MHz)	LVL (dBm)	Correction Factor(dB)	ERP(dBm)	ERP(mW)	Polarization (H/V)
Y	26715	816.5	-10.84	31.208	18.22	66.34	H
	26740	819.0	-10.55	31.3	18.60	72.44	H
	26765	821.5	-10.29	31.222	18.78	75.54	H
	26715	816.5	-18.90	31.504	10.45	11.10	V
	26740	819.0	-18.83	31.117	10.14	10.32	V
	26765	821.5	-18.60	31.922	11.17	13.10	V

LTE Band 26							
Channel Bandwidth: 5MHz / 16QAM							
Plane	Channel	Frequency (MHz)	LVL (dBm)	Correction Factor(dB)	ERP(dBm)	ERP(mW)	Polarization (H/V)
Y	26715	816.5	-11.15	31.208	17.91	61.77	H
	26740	819.0	-11.83	31.3	17.32	53.95	H
	26765	821.5	-11.91	31.222	17.16	52.02	H
	26715	816.5	-19.49	31.504	9.86	9.69	V
	26740	819.0	-19.25	31.117	9.72	9.37	V
	26765	821.5	-20.04	31.922	9.73	9.40	V



A D T

LTE Band 26							
Channel Bandwidth: 10MHz / QPSK							
Plane	Channel	Frequency (MHz)	LVL (dBm)	Correction Factor(dB)	ERP(dBm)	ERP(mW)	Polarization (H/V)
Y	26740	819.0	-10.22	31.3	18.93	78.16	H
	26740	819.0	-18.44	31.117	10.53	11.29	V

LTE Band 26							
Channel Bandwidth: 10MHz / 16QAM							
Plane	Channel	Frequency (MHz)	LVL (dBm)	Correction Factor(dB)	ERP(dBm)	ERP(mW)	Polarization (H/V)
Y	26740	819.0	-11.06	31.3	18.09	64.42	H
	26740	819.0	-19.07	31.117	9.90	9.77	V

4.2 FREQUENCY STABILITY MEASUREMENT

4.2.1 LIMITS OF FREQUENCY STABILITY MEASUREMENT

1.5 ppm is for base and fixed station. 2.5 ppm is for mobile station.

4.2.2 TEST PROCEDURE

- Device is placed at the oven room. The oven room could control the temperatures and humidity. Power warm up is at least 15 min and power applied should perform before recording frequency error.
- EUT is connected the external power supply to control the DC input power. The test voltage range is from minimum to maximum working voltage. Each step shall be record the frequency error rate.
- The temperature range step is 10 degrees in this test items. All temperature levels shall be hold the $\pm 0.5^{\circ}\text{C}$ during the measurement testing. The each temperature step shall be at least 0.5 hours, consider the EUT could be test under the stability condition.

NOTE: The frequency error was recorded frequency error from the communication simulator.

4.2.3 TEST SETUP

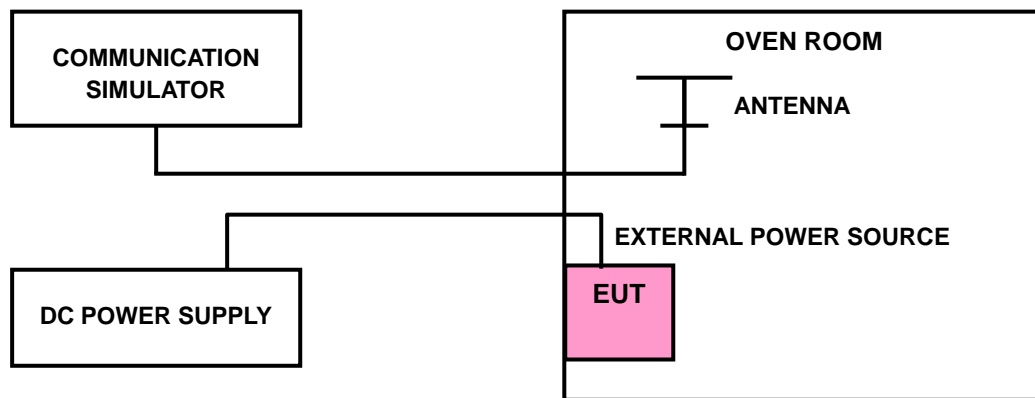

4.2.4 TEST RESULTS

FREQUENCY ERROR vs. VOLTAGE

VOLTAGE (Volts)	FREQUENCY ERROR (ppm)				LIMIT (ppm)
	LTE Band 26				
	1.4MHz	3MHz	5MHz	10MHz	
3.83	0.003	0.002	-0.001	-0.003	2.5
3.5	-0.002	0.003	-0.004	0.002	2.5
4.4	-0.003	0.005	-0.003	0.004	2.5

NOTE: The applicant defined the normal working voltage of the battery is from 3.5Vdc to 4.4Vdc.

FREQUENCY ERROR vs. TEMPERATURE

TEMP. (°C)	FREQUENCY ERROR (ppm)				LIMIT (ppm)
	LTE Band 26				
	1.4MHz	3MHz	5MHz	10MHz	
-30	0.005	0.004	-0.001	0.002	2.5
-20	0.004	0.006	-0.004	0.003	2.5
-10	0.001	0.008	-0.003	0.007	2.5
0	-0.004	0.001	-0.005	0.003	2.5
10	-0.003	-0.004	0.002	-0.002	2.5
20	-0.007	-0.003	0.007	-0.004	2.5
30	-0.001	-0.008	0.004	-0.003	2.5
40	0.006	-0.005	0.002	-0.005	2.5
50	0.007	-0.002	0.003	-0.007	2.5

4.3 OCCUPIED BANDWIDTH MEASUREMENT

4.3.1 TEST PROCEDURES

The EUT makes a call to the communication simulator. All measurements were done at low, middle and high operational frequency range. The communication simulator station system controlled a EUT to export maximum output power under transmission mode and specific channel frequency. Use OBW measurement function of Spectrum analyzer to measure 99 % occupied bandwidth.

4.3.2 TEST SETUP

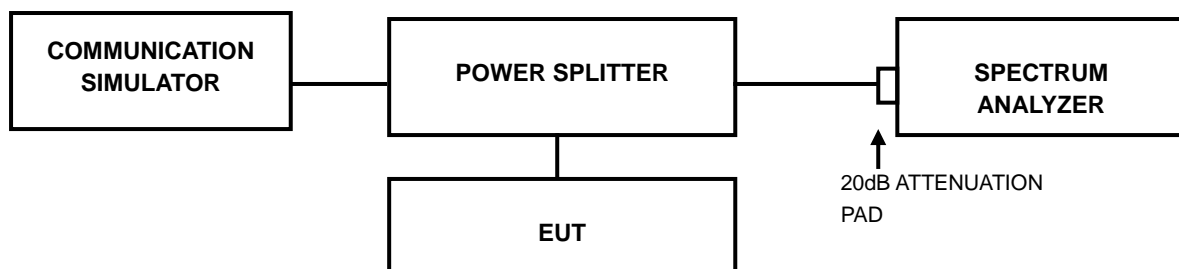

4.3.3 TEST RESULTS

LTE BAND 26							
CHANNEL BANDWIDTH: 1.4MHz				CHANNEL BANDWIDTH: 3MHz			
CHANNEL	FREQUENCY (MHz)	99% OCCUPIED BANDWIDTH (MHz)		CHANNEL	FREQUENCY (MHz)	99% OCCUPIED BANDWIDTH (MHz)	
		QPSK	16QAM			QPSK	16QAM
26697	814.7	1.0909	1.0939	26705	815.5	2.721	2.721
26740	819.0	1.0909	1.0879	26740	819.0	2.721	2.721
26783	823.3	1.0909	1.0879	26775	822.5	2.721	2.721

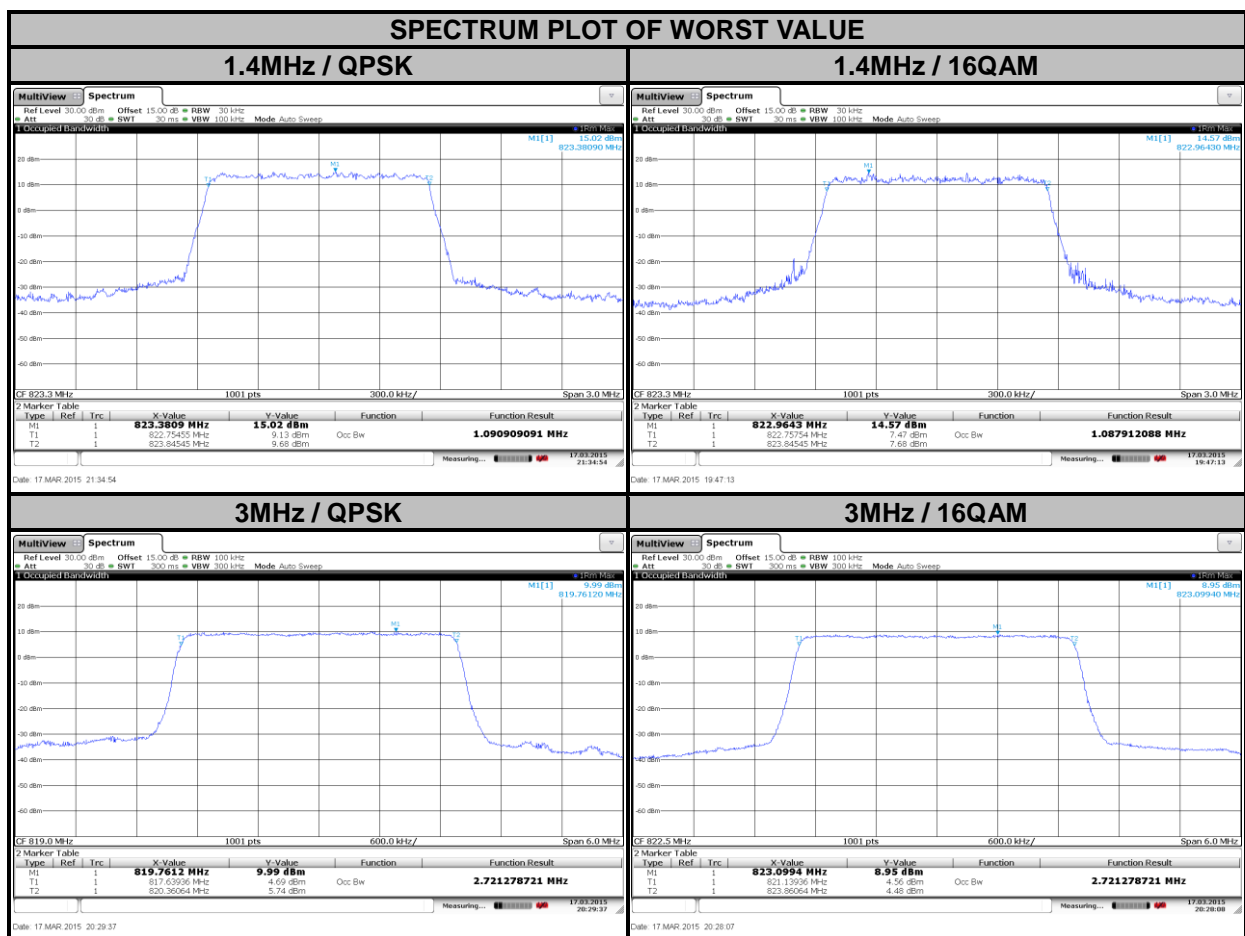



A D T

LTE BAND 26							
CHANNEL BANDWIDTH: 5MHz				CHANNEL BANDWIDTH: 10MHz			
CHANNEL	FREQUENCY (MHz)	99% OCCUPIED BANDWIDTH (MHz)		CHANNEL	FREQUENCY (MHz)	99% OCCUPIED BANDWIDTH (MHz)	
		QPSK	16QAM			QPSK	16QAM
26715	816.5	4.495	4.485	26740	819.0	8.97	8.97
26740	819.0	4.495	4.485				
26765	821.5	4.495	4.495				

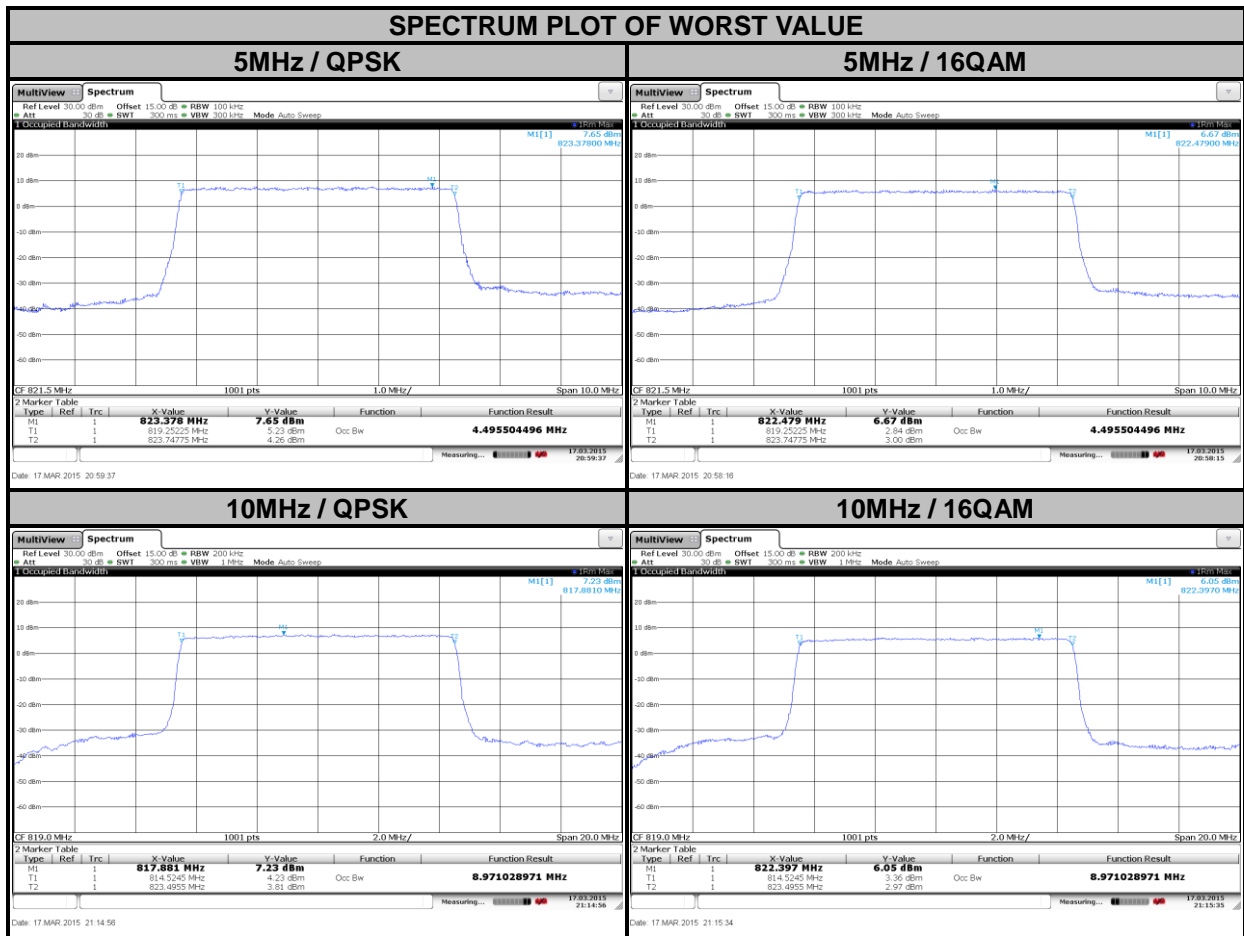

4.4 EMISSION MASK MEASUREMENT

4.4.1 LIMITS OF BAND EDGE MEASUREMENT

According to FCC part 90.691 shall be tested the emission mask. For any frequency removed from the EA licensee's frequency block by up to and including 37.5 kHz, the power of any emission shall be attenuated below the transmitter power (P) in watts by at least $116 \text{ Log}_{10}(f/6.1)$ decibels or $50+10\text{Log}_{10}(P)$ decibels or 80 decibels, whichever is the lesser attenuation, where f is the frequency removed from the center of the outer channel in the block in kilohertz and where f is greater than 12.5 kHz.

4.4.2 TEST SETUP

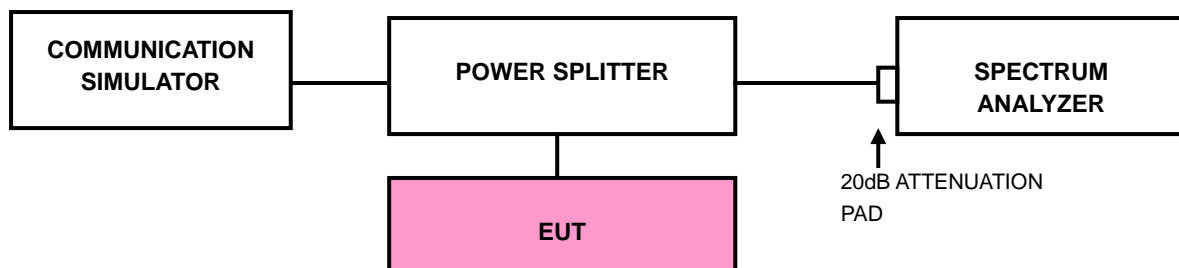

4.4.3 TEST PROCEDURES

- a. The measurement used the power splitter via EUT RF power connector between simulation base station and spectrum analyzer.
- b. Record the test plot.



A D T

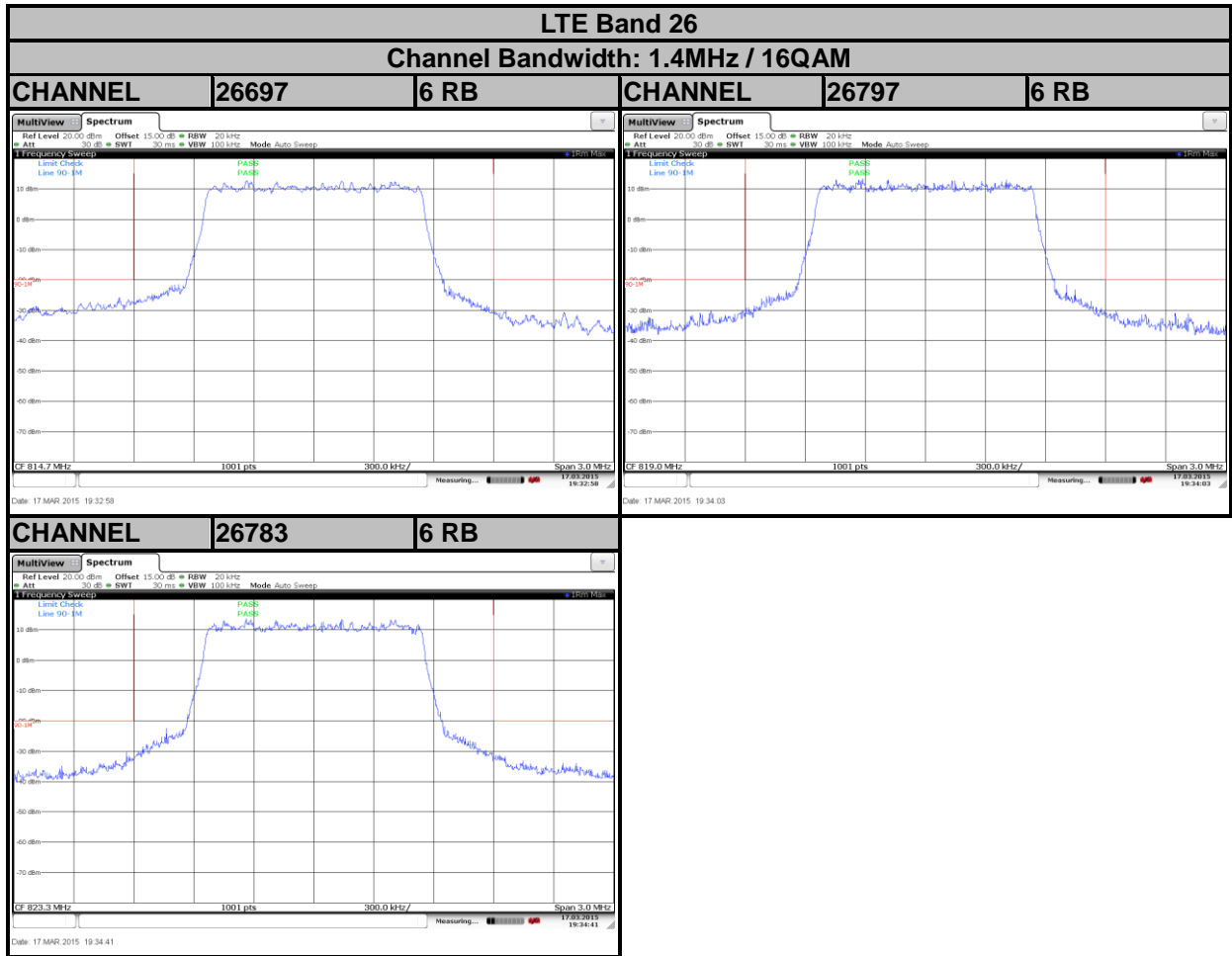



A D T

LTE Band 26

Channel Bandwidth: 3MHz / QPSK

CHANNEL	26705	15 RB	CHANNEL	26740	15 RB
----------------	--------------	--------------	----------------	--------------	--------------

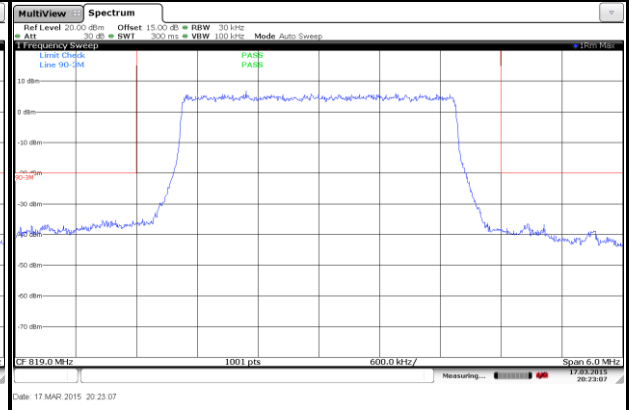
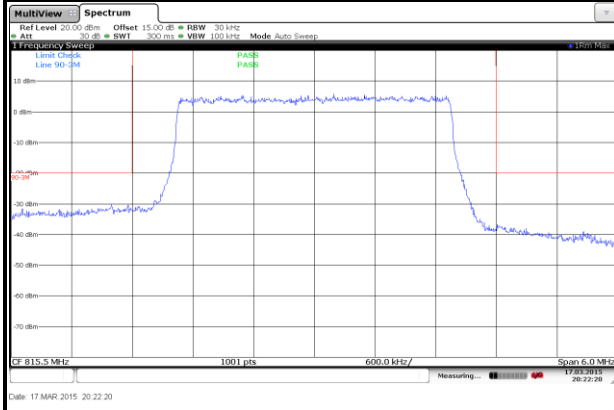

CHANNEL	26775	15 RB
----------------	--------------	--------------

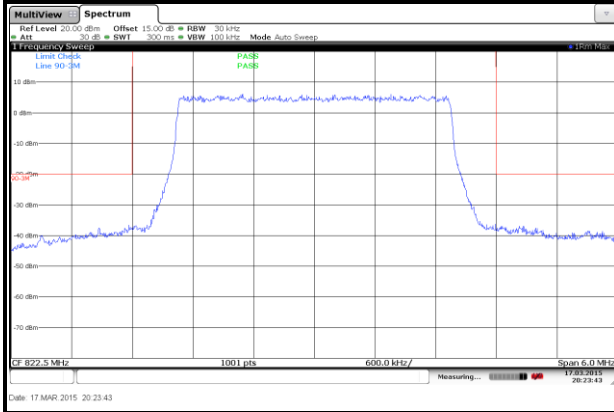



A D T

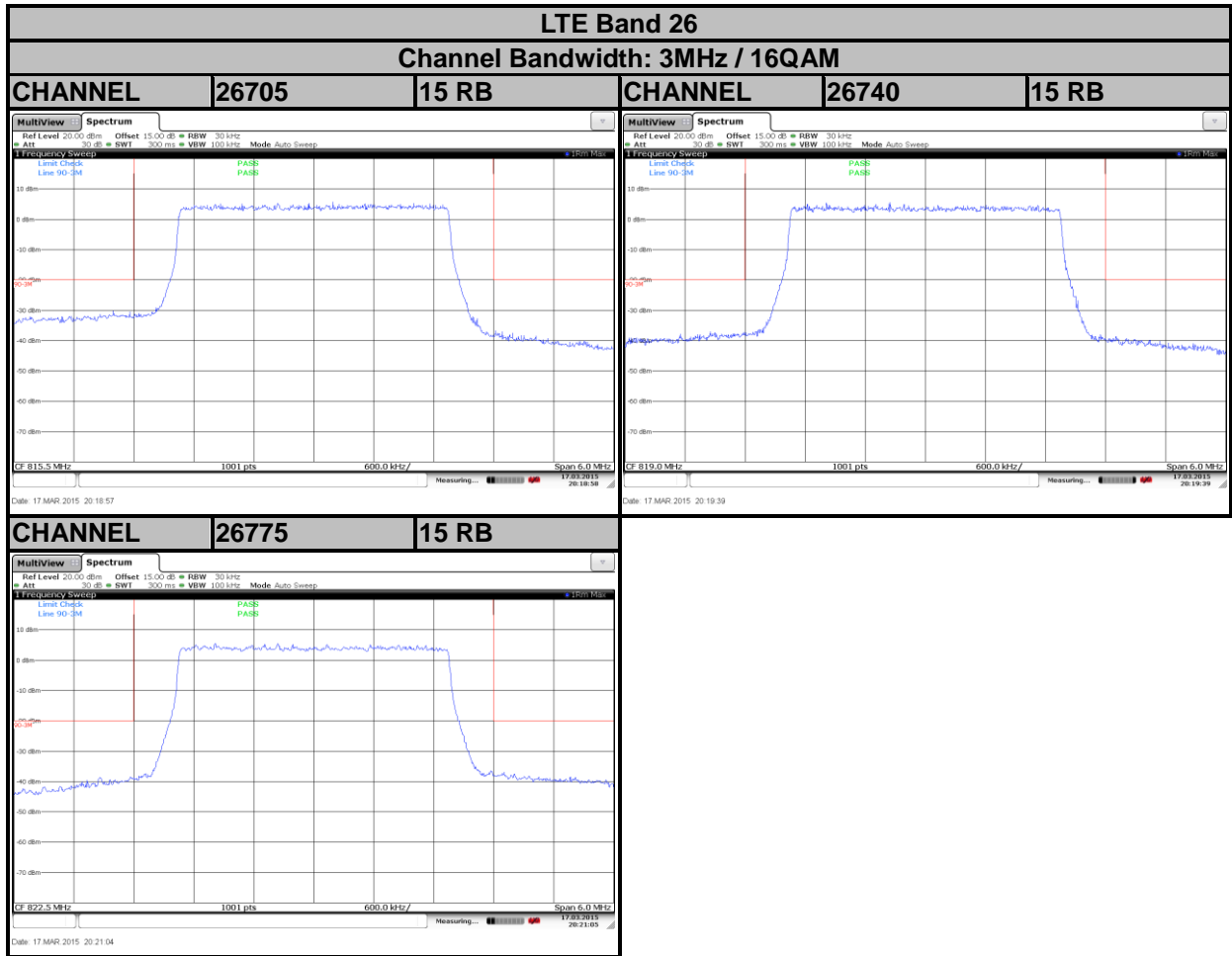



A D T

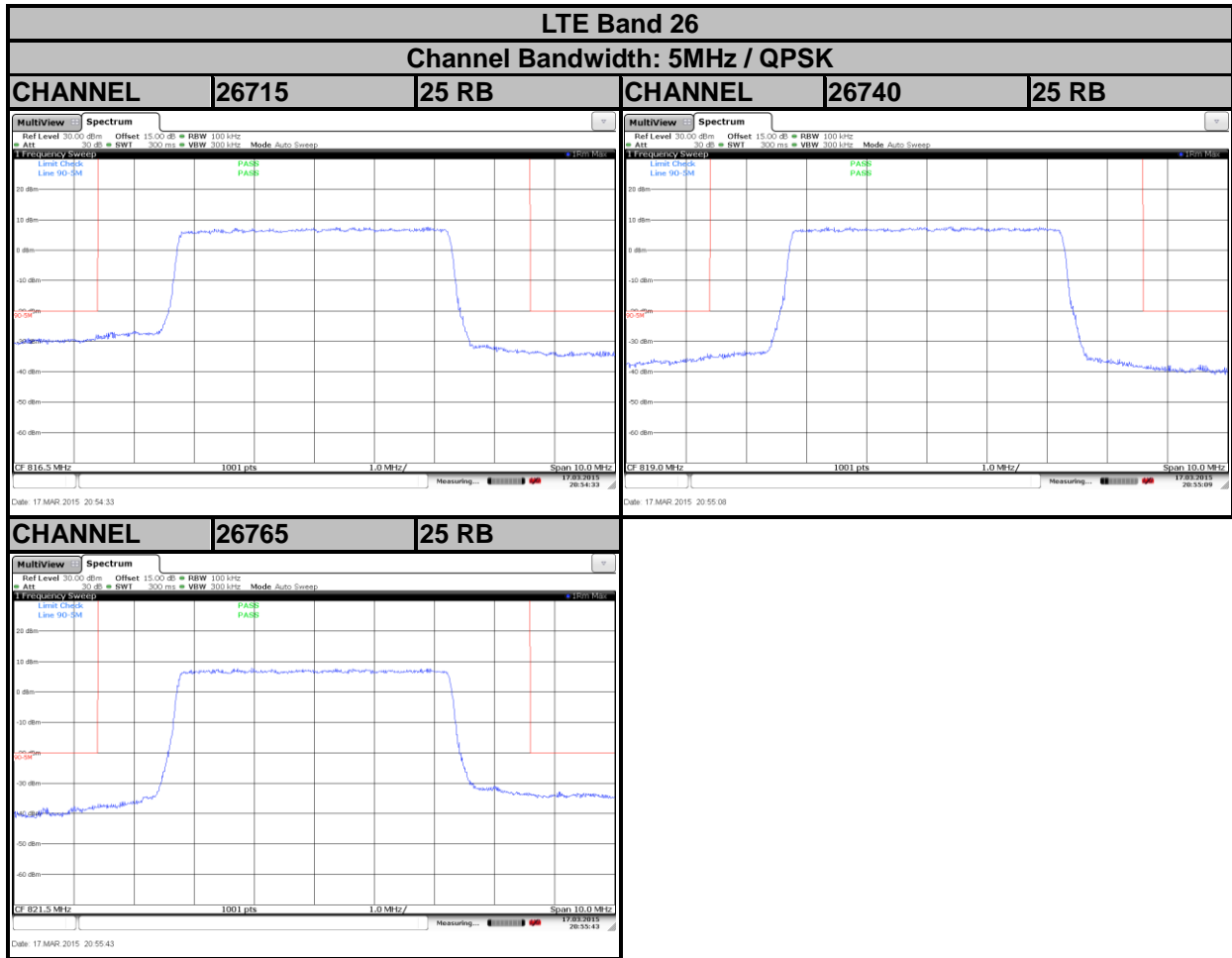



A D T

LTE Band 26

Channel Bandwidth: 5MHz / 16QAM

CHANNEL 26715 25 RB CHANNEL 26740 25 RB

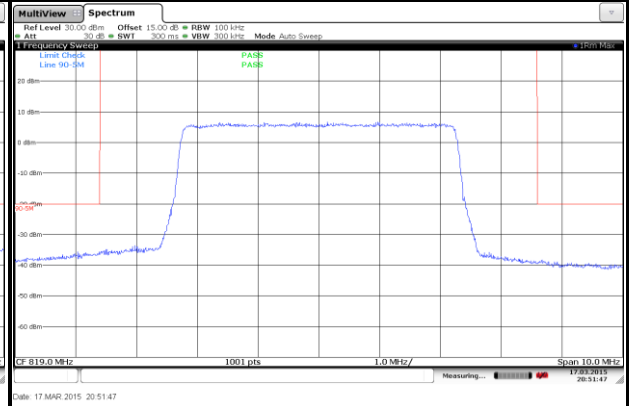
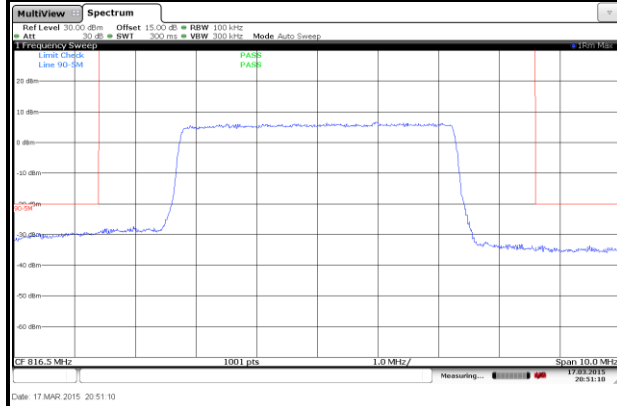

CHANNEL 26765 25 RB

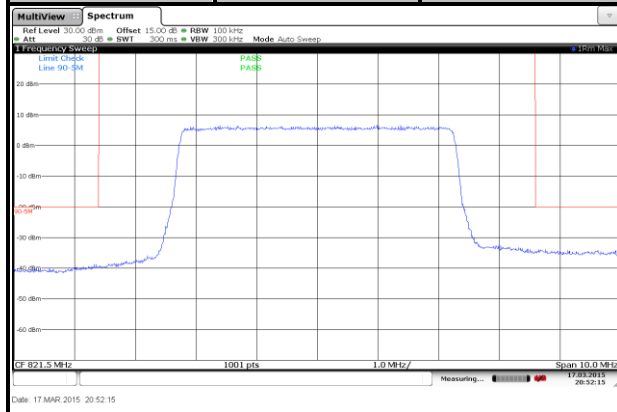



A D T

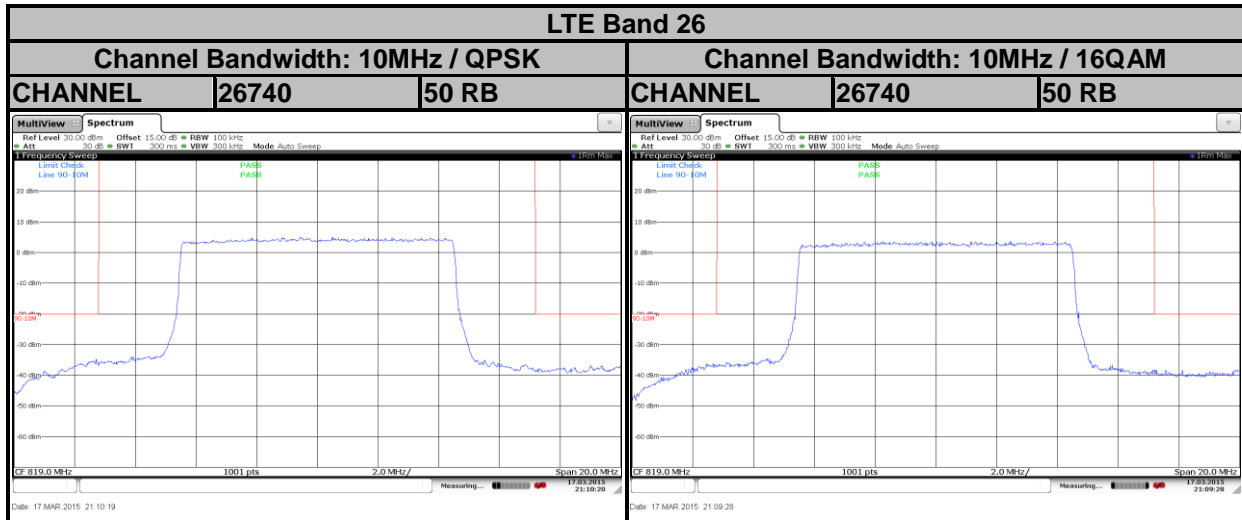

4.5 CONDUCTED SPURIOUS EMISSIONS

4.5.1 LIMITS OF CONDUCTED SPURIOUS EMISSIONS MEASUREMENT

The power of any emission outside of the authorized operating frequency ranges must be attenuated below the transmitting power (P) by a factor of at least $43 + 10 \log(P)$ dB. The emission limit is equal to -13dBm.

4.5.2 TEST PROCEDURE

- The EUT makes a phone call to the communication simulator. All measurements were done at low, middle and high operational frequency range.
- Measuring frequency range is from 30 MHz to 9GHz. 10dB attenuation pad is connected with spectrum. RBW=1MHz and VBW=3MHz is used for conducted emission measurement.

4.5.3 TEST SETUP

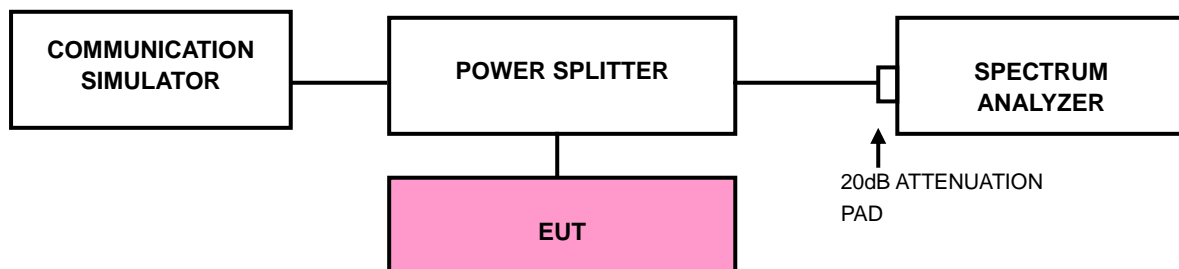



A D T

4.5.4 TEST RESULTS

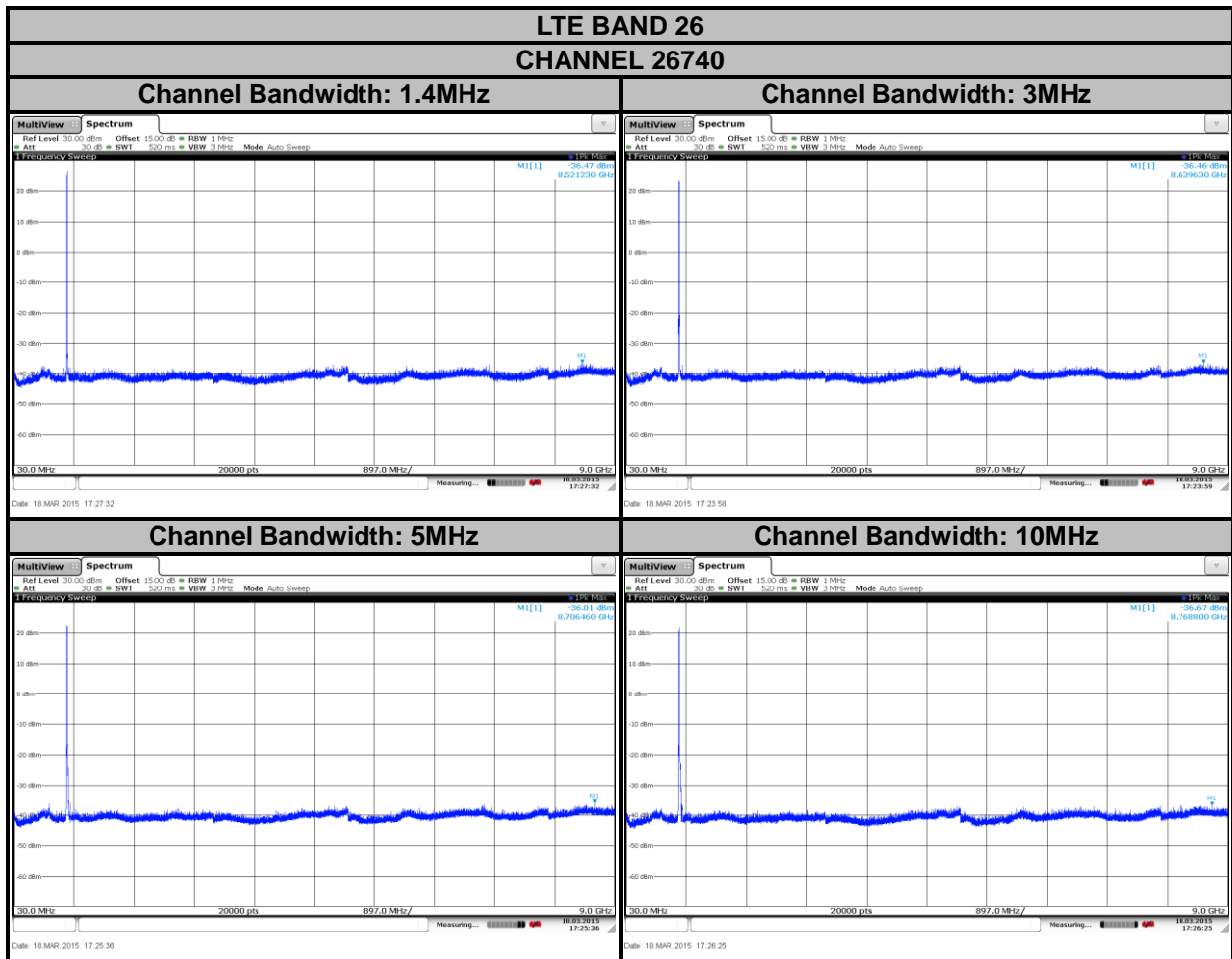

4.6 RADIATED EMISSION MEASUREMENT

4.6.1 LIMITS OF RADIATED EMISSION MEASUREMENT

The power of any emission outside of the authorized operating frequency ranges must be attenuated below the transmitting power (P) by a factor of at least $43 + 10 \log(P)$ dB. The emission limit is equal to -13dBm.

4.6.2 TEST PROCEDURES

- a. Substitution method is used for E.I.R.P measurement. In the semi-anechoic chamber, EUT placed on the 0.8m height of Turn Table, rotated the table around 360 degrees to search the maximum radiation power and receiver antenna shall be rotated vertical and horizontal polarization and moved height from 1m to 4m to find the maximum polar radiated power. The "Read Value" is the spectrum reading the maximum power value.
- b. The substitution horn antenna is substituted for EUT at the same position and signals generator export the CW signal to the substitution antenna via a TX cable. Rotated the Turn Table and moved receiving antenna to find the maximum radiation power. Adjust output power level of S.G to get a Value of spectrum reading equal to "Read Value" of step a. Record the power level of S.G
- c. $EIRP = \text{Output power level of S.G} - \text{TX cable loss} + \text{Antenna gain of substitution horn}$.
- d. E.R.P power can be calculated form E.I.R.P power by subtracting the gain of dipole, $E.R.P \text{ power} = E.I.R.P \text{ power} - 2.15\text{dBi}$.

NOTE: The resolution bandwidth and video bandwidth of test receiver/spectrum analyzer is 1MHz/3MHz.

4.6.3 DEVIATION FROM TEST STANDARD

No deviation

4.6.4 TEST SETUP

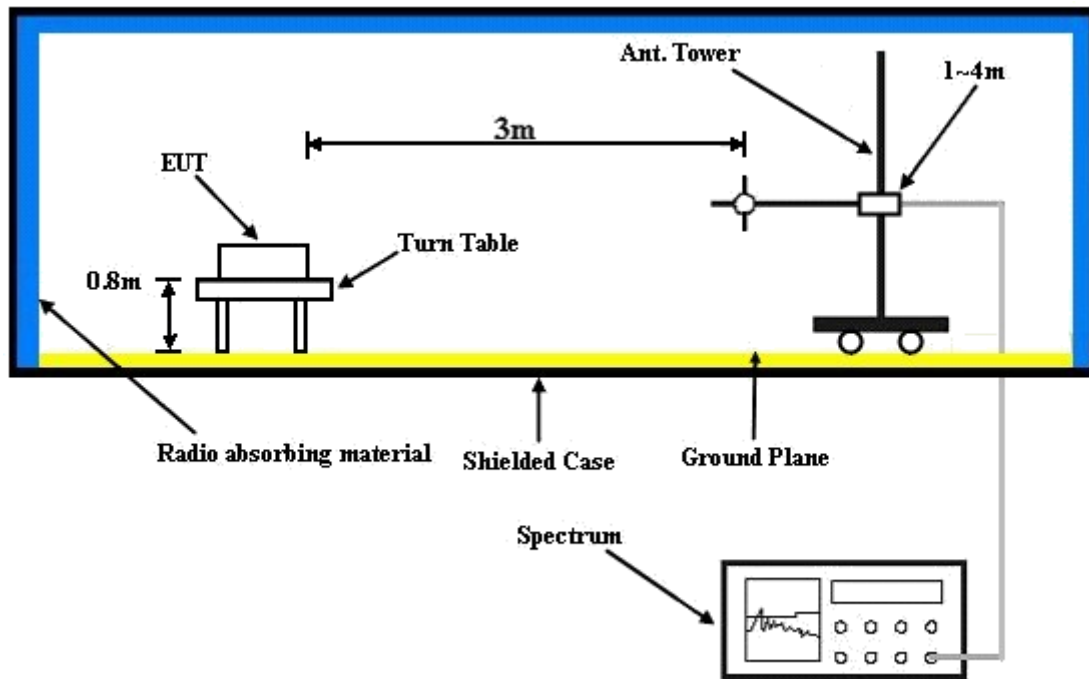

For the actual test configuration, please refer to the attached file (Test Setup Photo).



A D T

4.6.5 TEST RESULTS

LTE Band 26

CHANNEL BANDWIDTH: 10MHz / QPSK



Bureau Veritas Consumer Products Services Ltd., Taoyuan Branch

A D T

Data: 9

Date: 2015-03-28

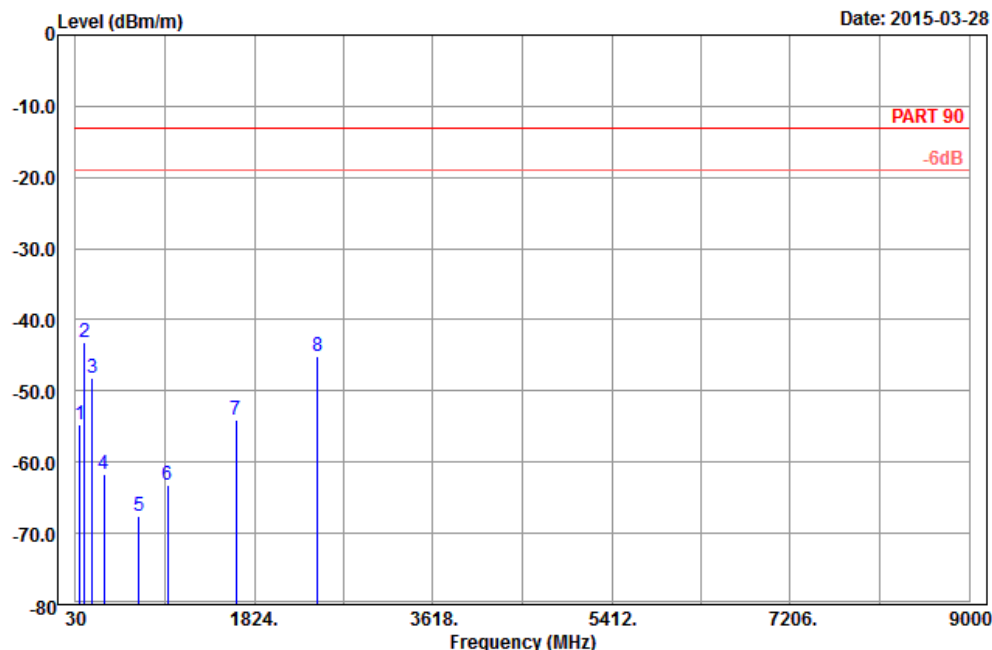

Site : 966 chamber 1
 Condition: PART 90 3m Horizontal
 Remark : LTE_Band 26_QPSK(1,0)_10M_CH26740
 Tested by: Hwa Chiang
 Plane : X

	Freq	Level	Read Level	Limit Line	Over Limit	Factor	Remark
	MHz	dBm/m	dBm	dBm/m	dB	dB/m	
1	72.12	-54.69	-42.17	-13.00	-41.69	-12.52	Peak
2	123.15	-43.07	-35.00	-13.00	-30.07	-8.07	Peak
3	194.70	-48.25	-42.29	-13.00	-35.25	-5.96	Peak
4	317.50	-61.64	-55.88	-13.00	-48.64	-5.76	Peak
5	664.00	-67.54	-67.34	-13.00	-54.54	-0.20	Peak
6	958.00	-63.25	-68.38	-13.00	-50.25	5.13	Peak
7	1638.00	-53.97	-61.53	-13.00	-40.97	7.56	Peak
8	2457.00	-45.18	-56.20	-13.00	-32.18	11.02	Peak



Bureau Veritas Consumer Products Services Ltd., Taoyuan Branch

A D T

Data: 10

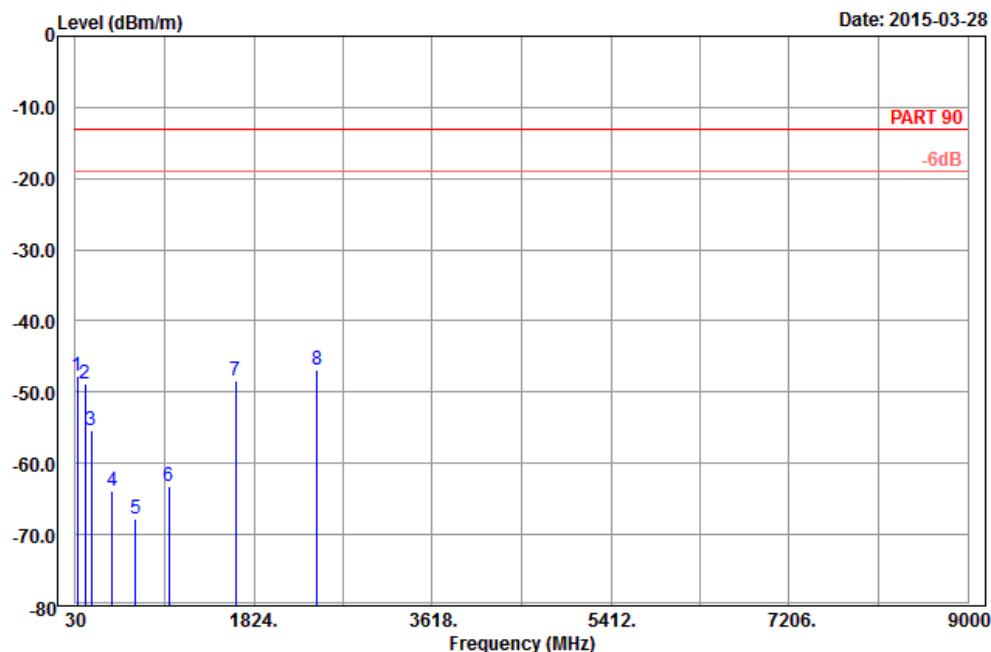

Site : 966 chamber 1
 Condition: PART 90 3m Vertical
 Remark : LTE_Band 26_QPSK(1,0)_10M_CH26740
 Tested by: Hwa Chiang
 Plane : X

	Read	Limit	Over			
Freq	Level	Level	Line	Limit	Factor	Remark
MHz	dBm/m	dBm	dBm/m	dB	dB/m	
1	47.82	-47.74	-34.63	-13.00	-34.74	-13.11 Peak
2	123.96	-48.87	-40.86	-13.00	-35.87	-8.01 Peak
3	192.00	-55.34	-49.52	-13.00	-42.34	-5.82 Peak
4	399.40	-63.88	-61.14	-13.00	-50.88	-2.74 Peak
5	632.50	-67.89	-67.95	-13.00	-54.89	0.06 Peak
6	973.40	-63.24	-68.42	-13.00	-50.24	5.18 Peak
7	1638.00	-48.36	-55.92	-13.00	-35.36	7.56 Peak
8 pp	2457.00	-46.95	-57.97	-13.00	-33.95	11.02 Peak



A D T

5 PHOTOGRAPHS OF THE TEST CONFIGURATION

Please refer to the attached file (Test Setup Photo).



6 INFORMATION ON THE TESTING LABORATORIES

We, Bureau Veritas Consumer Products Services (H.K.) Ltd., Taoyuan Branch, were founded in 1988 to provide our best service in EMC, Radio, Telecom and Safety consultation. Our laboratories are accredited and approved according to ISO/IEC 17025.

If you have any comments, please feel free to contact us at the following:

Linko EMC/RF Lab:

Tel: 886-2-26052180

Fax: 886-2-26051924

Hsin Chu EMC/RF/Telecom Lab:

Tel: 886-3-5935343

Fax: 886-3-5935342

Hwa Ya EMC/RF/Safety Lab:

Tel: 886-3-3183232

Fax: 886-3-3270892

Email: service.adt@tw.bureauveritas.com

Web Site: www.bureauveritas-adt.com

The address and road map of all our labs can be found in our web site also.



A D T

7 APPENDIX A – MODIFICATIONS RECORDERS FOR ENGINEERING CHANGES TO THE EUT BY THE LAB

No any modifications were made to the EUT by the lab during the test.

---END---