



FCC TEST REPORT (Part 24)

REPORT NO.: RF940516L02

MODEL NO.: HSTNH-H06C-WL

RECEIVED: May 16, 2005

TESTED: May 21 ~ Aug. 31, 2005

ISSUED: Sep. 07, 2005

APPLICANT: High Tech Computer Corp.

ADDRESS: 1F, 6-3, Bau-Chian Rd., Hsin Tien, Taipei, Taiwan,
R.O.C.

ISSUED BY: Advance Data Technology Corporation

LAB ADDRESS: No. 47, 14th Ling, Chia Pau Tsuen, Lin Kou Hsiang
244, Taipei Hsien, Taiwan, R.O.C.

TEST LOCATION: No. 19, Hwa Ya 2nd Rd., Wen Hwa Tsuen, Kwei
Shan Hsiang, Taoyuan Hsien 333, Taiwan, R.O.C.

This test report consists of 98 pages in total. It may be duplicated completely for legal use with the approval of the applicant. It should not be reproduced except in full, without the written approval of our laboratory. The client should not use it to claim product endorsement by CNLA, A2LA or any government agencies. The test results in the report only apply to the tested sample.



NO. 2177-01



0528
ILAC MRA



TABLE OF CONTENTS

1	CERTIFICATION.....	4
2	SUMMARY OF TEST RESULTS	5
2.1	MEASUREMENT UNCERTAINTY.....	6
3	GENERAL INFORMATION	7
3.1	GENERAL DESCRIPTION OF EUT.....	7
3.2	DESCRIPTION OF TEST MODES.....	9
3.3	GENERAL DESCRIPTION OF APPLIED STANDARDS.....	10
3.4	DESCRIPTION OF SUPPORT UNITS	10
4	TEST TYPES AND RESULTS	11
4.1	MODULATION CHARACTERISTICS	11
4.1.1	DESCRIPTION OF MODULATION TECHNIQUE.....	11
4.1.2	THE ACTIVE TIME SLOT 8 MODULATED FRAME PLOT	12
4.2	OUTPUT POWER MEASUREMENT	15
4.2.1	LIMITS OF OUTPUT POWER MEASUREMENT	15
4.2.2	TEST INSTRUMENTS	16
4.2.3	TEST PROCEDURES.....	17
4.2.4	TEST SETUP	18
4.2.5	EUT OPERATING CONDITIONS	19
4.2.6	TEST RESULTS.....	20
4.3	FREQUENCY STABILITY MEASUREMENT.....	22
4.3.1	LIMITS OF FREQUENCY STABILITY MEASUREMENT.....	22
4.3.2	TEST INSTRUMENTS	22
4.3.3	TEST PROCEDURE	23
4.3.4	TEST SETUP	23
4.3.5	TEST RESULTS.....	24
4.4	OCCUPIED BANDWIDTH MEASUREMENT	29
4.4.1	LIMITS OF OCCUPIED BANDWIDTH MEASUREMENT.....	29
4.4.2	TEST INSTRUMENTS	29
4.4.3	TEST SETUP	29
4.4.4	TEST PROCEDURES.....	30
4.4.5	EUT OPERATING CONDITION	30
4.4.6	TEST RESULTS.....	30
4.5	BAND EDGE MEASUREMENT	42
4.5.1	LIMITS OF BAND EDGE MEASUREMENT	42
4.5.2	TEST INSTRUMENTS	42
4.5.3	TEST SETUP.....	42
4.5.4	TEST PROCEDURES.....	43
4.5.5	EUT OPERATING CONDITION	43



4.5.6	TEST RESULTS.....	44
4.6	CONDUCTED SPURIOUS EMISSIONS	47
4.6.1	LIMITS OF CONDUCTED SPURIOUS EMISSIONS MEASUREMENT	47
4.6.2	TEST INSTRUMENTS	47
4.6.3	TEST PROCEDURE	48
4.6.4	TEST SETUP	48
4.6.5	EUT OPERATING CONDITIONS	48
4.6.6	TEST RESULTS.....	49
4.7	RADIATED EMISSION MEASUREMENT (BELOW 1GHz)	76
4.7.1	LIMITS OF RADIATED EMISSION MEASUREMENT	76
4.7.2	TEST INSTRUMENTS	77
4.7.3	TEST PROCEDURES.....	78
4.7.4	DEVIATION FROM TEST STANDARD	78
4.7.5	TEST SETUP	79
4.7.6	EUT OPERATING CONDITIONS	79
4.7.7	TEST RESULTS.....	80
4.8	EFFECTIVE RADIATED POWER MEASUREMENT (ABOVE 1GHz)	86
4.8.1	LIMITS OF RADIATED EMISSION MEASUREMENT	86
4.8.2	TEST INSTRUMENTS	87
4.8.3	TEST PROCEDURES.....	88
4.8.4	DEVIATION FROM TEST STANDARD	88
4.8.5	TEST SETUP	89
4.8.6	EUT OPERATING CONDITIONS	89
4.8.7	TEST RESULTS.....	90
5	INFORMATION ON THE TESTING LABORATORIES	99



1 CERTIFICATION

PRODUCT : Pocket PC Phone
MODEL NO. : HSTNH-H06C-WL
APPLICANT : High Tech Computer Corp.
TESTED : May 21 ~ Aug. 31, 2005
TEST SAMPLE : ENGINEERING SAMPLE
TEST STANDARDS : FCC Part 24, Subpart E
ANSI C63.4-2003

The above equipment has been tested by **Advance Data Technology Corporation**, and found compliance with the requirement of the above standards. The test record, data evaluation & Equipment Under Test (EUT) configurations represented herein are true and accurate accounts of the measurements of the sample's EMC characteristics under the conditions specified in this report.

PREPARED BY : Wendy Liao , **DATE:** Sep. 07, 2005
Wendy Liao

TECHNICAL
ACCEPTANCE : Gary Chang , **DATE:** Sep. 07, 2005
Responsible for RF
Gary Chang

APPROVED BY : Cody Chang , **DATE:** Sep. 07, 2005
Cody Chang / Deputy Manager

2 SUMMARY OF TEST RESULTS

The EUT has been tested according to the following specifications:

APPLIED STANDARD: FCC Part 24 & Part 2 / IC RSS-133			
STANDARD SECTION	TEST TYPE AND LIMIT	RESULT	REMARK
2.1047(d)	Modulation Characteristics	PASS	NA
2.1046 24.232	Maximum Peak Output Power Limit: max. 2 watts e.r.p peak power	PASS	Meet the requirement of limit. Minimum passing margin is 29.90dBm at 1850.2MHz.
2.1055 24.235	Frequency Stability AFC Freq. Error vs. Voltage AFC Freq. Error vs. Temperature Limit: max. ± 2.5 ppm	PASS	Meet the requirement of limit.
2.1049 24.238(b)	Occupied Bandwidth	PASS	Meet the requirement of limit.
24.238(b)	Band Edge Measurements	PASS	NA
2.1051 24.238	Conducted Spurious Emissions	PASS	Meet the requirement of limit. Minimum passing margin is -29.98dB at 1740.00MHz.
2.1053 24.238	Radiated Spurious Emissions	PASS	Meet the requirement of limit. Minimum passing margin is -40.34dB at 863.93MHz.



2.1 MEASUREMENT UNCERTAINTY

Where relevant, the following measurement uncertainty levels have been estimated for tests performed on the EUT as specified in CISPR 16-4:

MEASUREMENT	FREQUENCY	UNCERTAINTY
Conducted emissions	9kHz ~ 30MHz	2.44 dB
Radiated emissions	30MHz ~ 200MHz	3.55 dB
	200MHz ~ 1000MHz	3.58 dB
	1GHz ~ 18GHz	1.10 dB
	18GHz ~ 40GHz	0.91 dB

This uncertainty represents an expanded uncertainty expressed at approximately the 95% confidence level using a coverage factor of $k=2$.

3 GENERAL INFORMATION

3.1 GENERAL DESCRIPTION OF EUT

PRODUCT	Pocket PC Phone
MODEL NO.	HSTNH-H06C-WL
POWER SUPPLY	3.7Vdc from rechargeable lithium battery 5.0Vdc from power adapter
MODULATION TYPE	GMSK / 8BPSK
FREQUENCY RANGE	Tx Frequency: 1850.2MHz ~ 1909.8MHz (PCS band) Rx Frequency: 1930.2MHz ~ 1989.8MHz (PCS band)
NUMBER OF CHANNEL	299
MAX. CONDUCTED PEAK OUTPUT POWER	GSM Mode: 29.83dBm (0.962Watts) GPRS Mode: 29.46dBm (0.883Watts) E-GPRS Mode: 29.49dBm (0.889Watts)
MAX. EIRP POWER	GSM Mode: 29.90dBm (0.977Watts) GPRS Mode: 29.51dBm (0.893Watts) E-GPRS Mode: 29.62dBm (0.916Watts)
ANTENNA TYPE	Internal PIFA antenna
DATA CABLE	1.2m USB and RS-232 shielded cable without core 1.7m non-shielded cable for earphone
I/O PORTS	Refer to user's manual
ASSOCIATED DEVICES	Earphone, cradle
EUT EXTREME VOL. RANGE	3.7Vdc to 4.2Vdc

NOTE:

1. The applicant defined the normal working voltage of the battery is from 3.7Vdc to 4.2Vdc.
2. The EUT is a GSM850/PCS1900/GPRS/E-GPRS Pocket PC Phone with wireless LAN and bluetooth functions. This report is only covered the functions of PCS1900. The wireless LAN and bluetooth functions are covered in another test report, which standard used is FCC Part 15. And the GSM850 mobile phone function is covered in another test report, which standard used is FCC Part 22.



3. The EUT have two lithium batteries listed as below:

STANDARD BATTERY:	
MODEL:	HSTNH-D06B
RATING:	3.7Vdc, 1200mAh

OPTIONAL EXTENDED BATTERY:	
MODEL:	HSTNH-D06B-HC
RATING:	3.7Vdc, 1800mAh

4. The EUT was operated with following power adapters:

ADAPTER 1:	
BRAND:	DELTA ELECTRONICS, INC.
MODEL:	EADP-10BB REV.B
INPUT:	100-240Vac, 400mA, 50-60Hz
OUTPUT:	5Vdc, 2A
POWER LINE:	DC 1.8m non-shielded cable without core

ADAPTER 2:	
BRAND:	HIPRO
MODEL:	HP-AC010L63 REV.:01
INPUT:	100-240Vac, 500mA, 50-60Hz
OUTPUT:	5Vdc, 2A
POWER LINE:	DC 1.8m non-shielded cable without core

ADAPTER 3:	
BRAND:	PHIHONG
MODEL:	PSC11A-050
INPUT:	100-240Vdc, 300mA, 50-60Hz, 26-34VA
OUTPUT:	5Vdc, 2A
POWER LINE:	DC 1.8m non-shielded cable without core

5. IMEI Code: 35640100 *****.

6. The above EUT information was declared by manufacturer and for more detailed features description, please refer to the manufacturer's specifications or User's Manual.



3.2 DESCRIPTION OF TEST MODES

299 channels are provided to this EUT in the PCS1900 band. Therefore, the low, middle and high channels are chosen for testing.

	CHANNEL	FREQUENCY	TX MODE
LOW	512	1850.2 MHz	GSM, GPRS, E-GPRS
MIDDLE	661	1880.0 MHz	GSM, GPRS, E-GPRS
HIGH	810	1909.8 MHz	GSM, GPRS, E-GPRS

NOTE:

1. Below 1 GHz, the channel 512, 661, and 810 were pre-tested in chamber. The channel 512 was chosen for final test.
2. Above 1 GHz, the channel 512, 661, and 810 were tested individually.
3. When the Power Control Level set 0, the worst case, was chosen for final test.
4. The channel space is 0.2MHz.
5. Since the EUT is considered a portable unit, it was pre-tested on the positioned of each 3 axis. The worst case was found when positioned on X-plane. Therefore only the test data of this X-plane was used for radiated emission measurement test.
6. The EUT have two lithium batteries. Therefore two test condition (Test condition A is tested with standard battery HSTNH-D06B, and B is with optional extended battery HSTNH-D06B-HC.) will be presented in the radiated emission test below 1GHz. But other tests are only tested in the worst condition B.



3.3 GENERAL DESCRIPTION OF APPLIED STANDARDS

The EUT is a Pocket PC Phone. According to the specifications of the manufacturer, it must comply with the requirements of the following standards:

FCC 47 CFR Part 2

FCC 47 CFR Part 24

IC RSS-133

ANSI C63.4-2003

NOTE: All test items have been performed and recorded as per the above standards.

3.4 DESCRIPTION OF SUPPORT UNITS

The EUT has been tested as an independent unit together with other necessary accessories or support units. The following support units or accessories were used to form a representative test configuration during the tests.

NO.	PRODUCT	BRAND	MODEL NO.	SERIAL NO.	CAL. DATE
1	Universal Radio Communication Tester	R&S	CMU200	101095	Oct. 10, 2005

NO.	SIGNAL CABLE DESCRIPTION OF THE ABOVE SUPPORT UNITS
1	NA

NOTE: All power cords of the above support units are non shielded (1.8m).



4 TEST TYPES AND RESULTS

4.1 MODULATION CHARACTERISTICS

4.1.1 DESCRIPTION OF MODULATION TECHNIQUE

According to FCC 2.1047(d), the system is used the digital modulation and accomplished with the PCS requirement as defined in the 3GPP TS 05:01, TS 05:02, TS 05:04. It uses narrowband TDMA. Eight simultaneous calls can occupy the same radio frequency.

There are 299 channels and channel space is 200kHz. The frequency band 1850 ~ 1910MHz is allocated to the uplink and 1930 ~ 1990MHz to the downlink. The uplink and downlink channel space is 80MHz and is duplex at the same time.

The modulation scheme used the GMSK (Gaussian Minimum Shift Keying) that is the special case of FSK (frequency Shift Keying). The each time slot is last about 580 μ s and data length is 156.25bits. A frame contains the eight time slots.



4.1.2 THE ACTIVE TIME SLOT 8 MODULATED FRAME PLOT FOR GSM MODE (UP-LINK WITH 1 TIME SLOT)

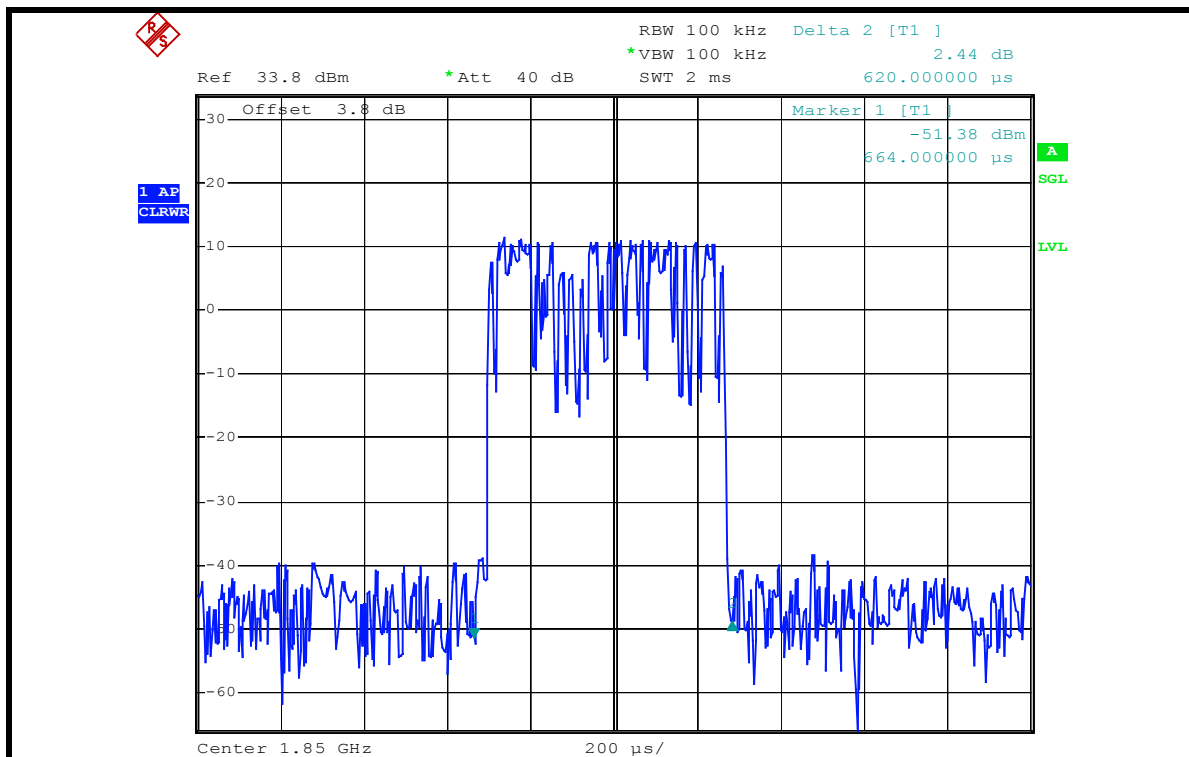
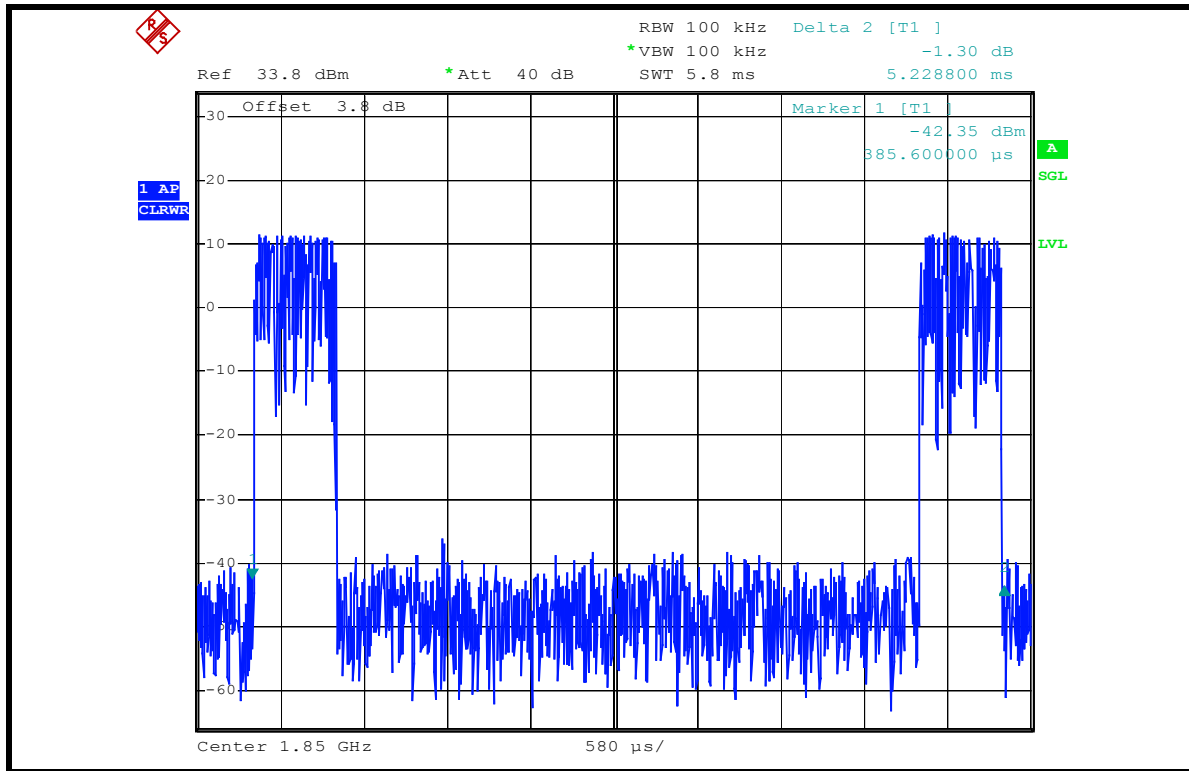



FOR GPRS MODE (UP-LINK WITH 2 TIME SLOTS)

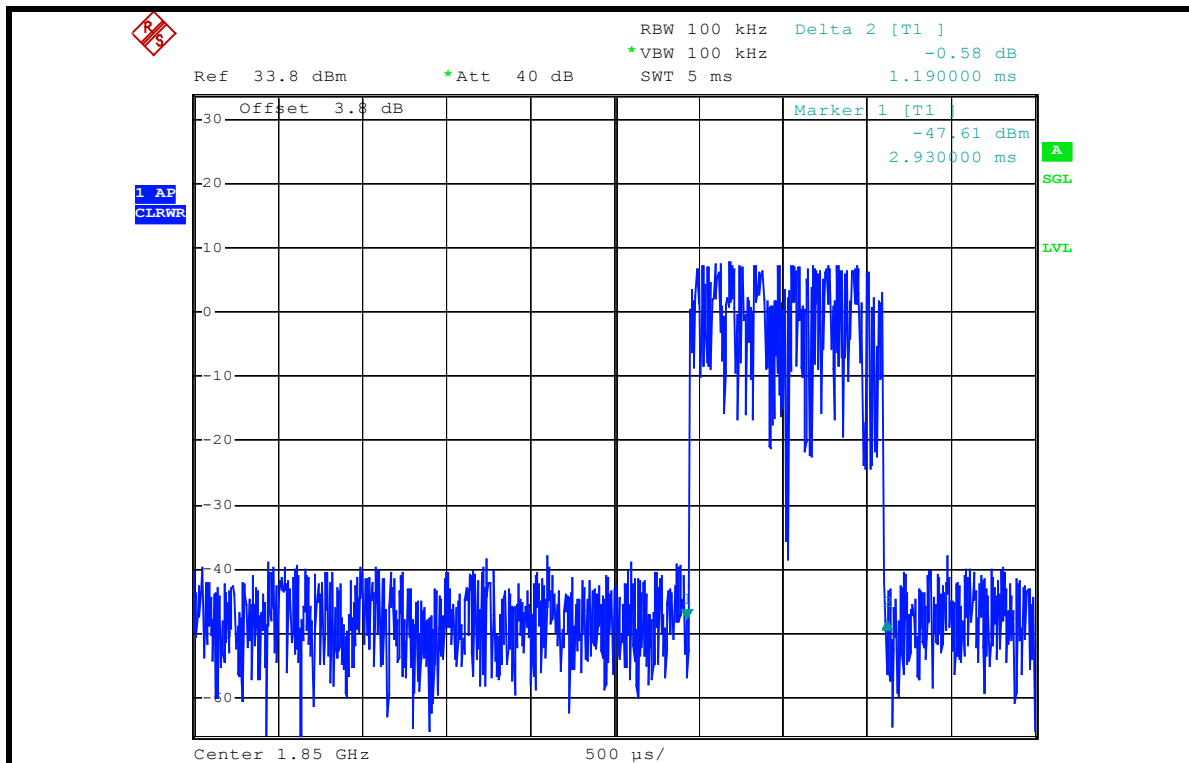
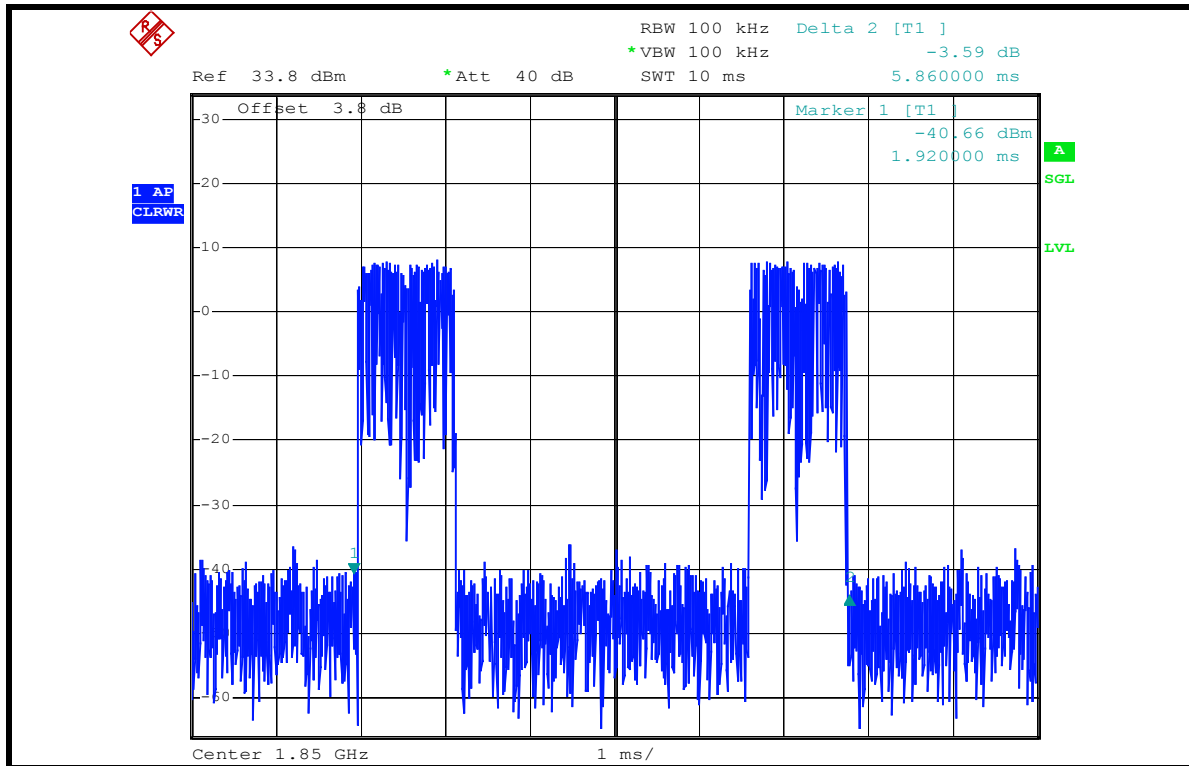



FOR E-GPRS MODE (UP-LINK WITH 2 TIME SLOTS)

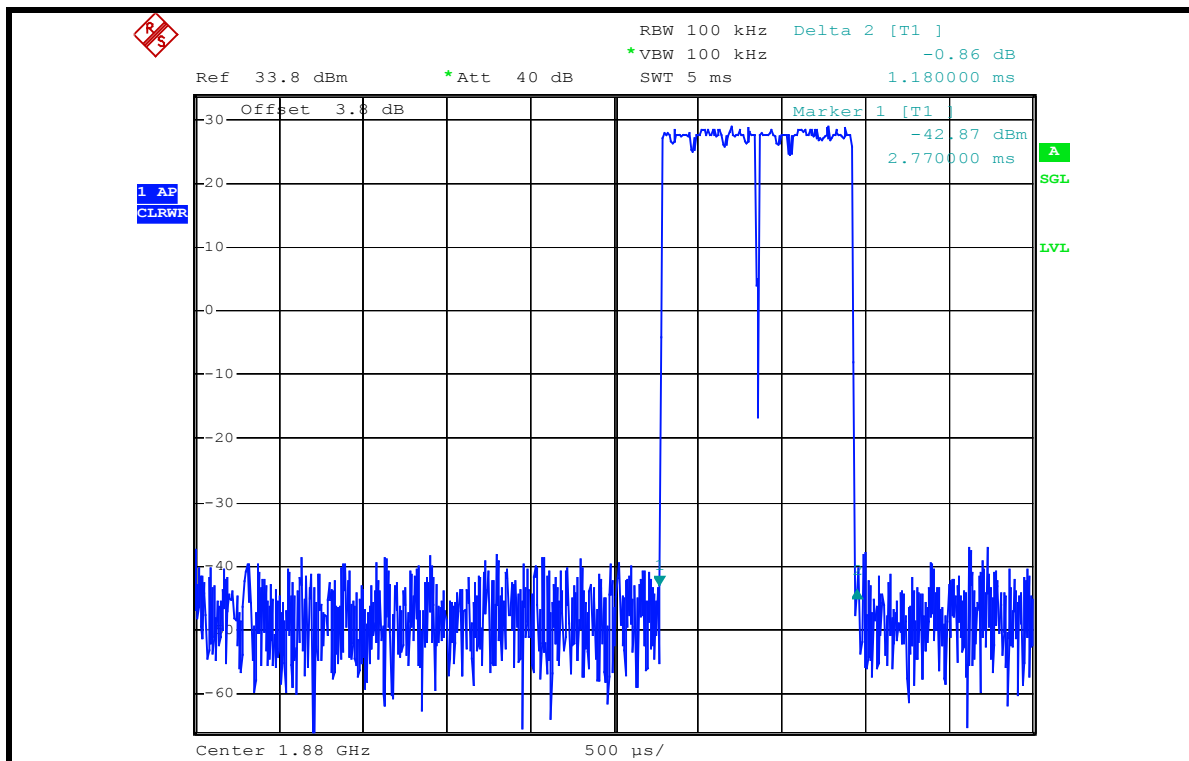
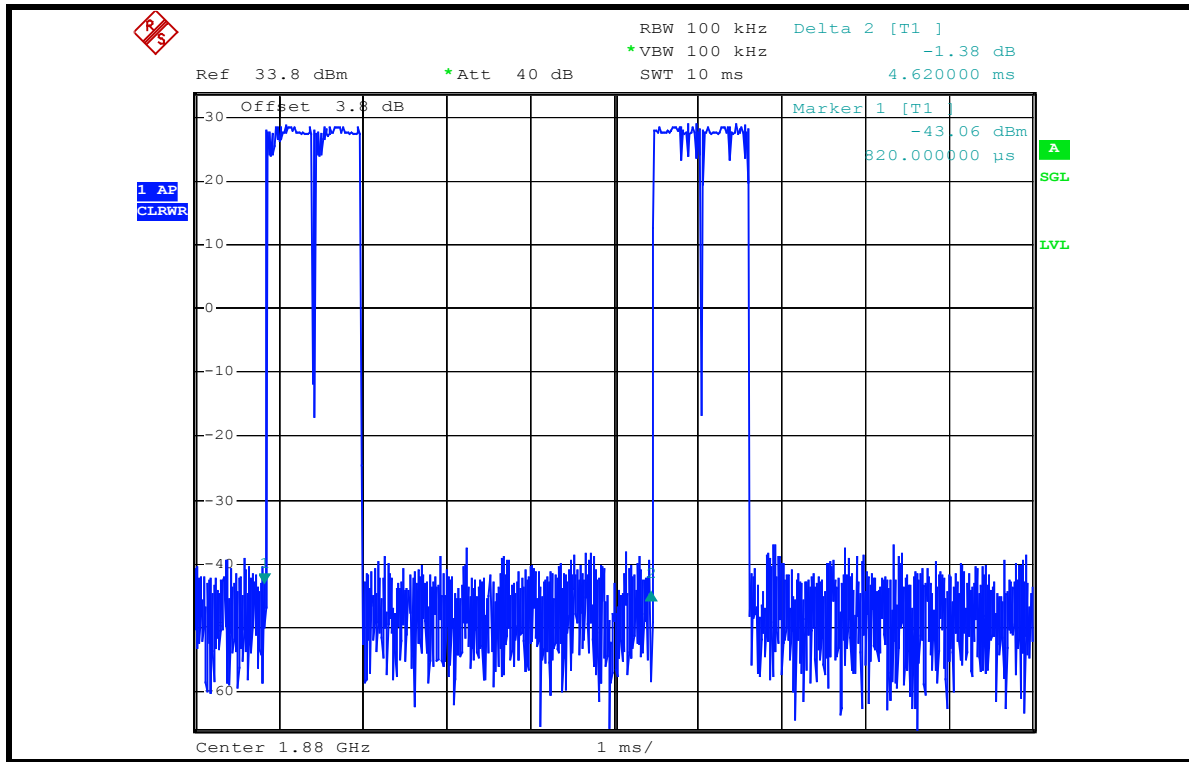



4.2 OUTPUT POWER MEASUREMENT

4.2.1 LIMITS OF OUTPUT POWER MEASUREMENT

The radiated peak output power shall be according to the specific rule Part 24.232(b) that “Mobile / Portable station are limited to 2 watts e.i.r.p” and 24.232(c) specific that “Peak transmit power must be measure over any interval of continuous transmission using instrumentation calibration in terms of rms-equivalent voltage.”



4.2.2 TEST INSTRUMENTS

DESCRIPTION & MANUFACTURER	MODEL NO.	SERIAL NO.	CALIBRATED UNTIL
Test Receiver ROHDE & SCHWARZ	ESIB7	100188	Dec. 19, 2005
Spectrum Analyzer ROHDE & SCHWARZ	FSP40	100039	Nov. 21, 2005
BILOG Antenna SCHWARZBECK	VULB9168	9168-157	Jan. 22, 2006
HORN Antenna SCHWARZBECK	BBHA 9120 D	9120D-407	Jan. 16, 2006
HORN Antenna SCHWARZBECK	BBHA 9170	BBHA 9170241	Feb. 23, 2006
Preamplifier Agilent	8449B	3008A01961	Nov. 09, 2005
Preamplifier Agilent	8447D	2944A10629	Nov. 09, 2005
RF signal cable HUBER+SUHNER	SUCOFLEX 104	218182/4	Feb. 17, 2006
RF signal cable HUBER+SUHNER	SUCOFLEX 104	218194/4	Feb. 17, 2006
Software ADT.	ADT_Radiated_V5.14	NA	NA
Antenna Tower ADT.	AT100	AT93021702	NA
Turn Table ADT.	TT100.	TT93021702	NA
Controller ADT.	SC100.	SC93021702	NA

- NOTE:**
1. The calibration interval of the above test instruments is 12 months and the calibrations are traceable to NML/ROC and NIST/USA.
 2. The test was performed in HwaYa Chamber 1.
 3. The horn antenna and HP preamplifier (model: 8449B) are used only for the measurement of emission frequency above 1GHz if tested.
 4. The IC Site Registration No. is IC4924-2.



4.2.3 TEST PROCEDURES

- a. The EUT was set up for the maximum peak power with GSM link data modulation. The power was measured with R&S Spectrum Analyzer. All measurements were done at 3 channels, 512, 661 and 810(low, middle and high operational frequency range.)
- b. The conducted peak output power used the power splitter via EUT RF power connector between simulation base station and spectrum analyzer. The path loss included the splitter loss, cable loss and 20dB pad loss. The spectrum set RB/VB 3MHz, then read peak power value and record to the test. (All transmitted path loss shall be considered in the test report data.)
- c. E.I.R.P peak power measurement. In the fully anechoic chamber, EUT placed on the 1.5m height of Turn Table, rotated the table around 360 degrees to search the maximum radiation power and receiver antenna shall be rotated vertical and horizontal polarization to find the maximum polar radiated power. The "Read Value" is the spectrum reading the maximum power value.
- d. The substitution horn antenna is substituted for EUT at the same position and signal generator export the CW signal to the calibration antenna. Rotated the Turn Table to find the maximum radiation power. "Raw" is the spectrum reading value, "SG" is signal generator export power, "TX Gain" is calibration antenna isotropic gain value, "TX cable" is the transmitted cable loss between the calibration antenna and signal generator. The "Factor" means that the transmission path loss is equal to "SG" - "TX cable" + "TX Gain" - "Raw".
- e. Actually the real E.I.R.P peak power is equal to "Read Value" + "Factor"
- f. E.R.P power can be calculated form E.I.R.P power by subtracting the gain of dipole, E.R.P power = E.I.P.R power - 2.15dBi.

NOTE: The resolution bandwidth and video bandwidth of test receiver/spectrum analyzer is 3MHz for Peak detection (PK)

4.2.4 TEST SETUP

EIRP POWER MEASUREMENT:

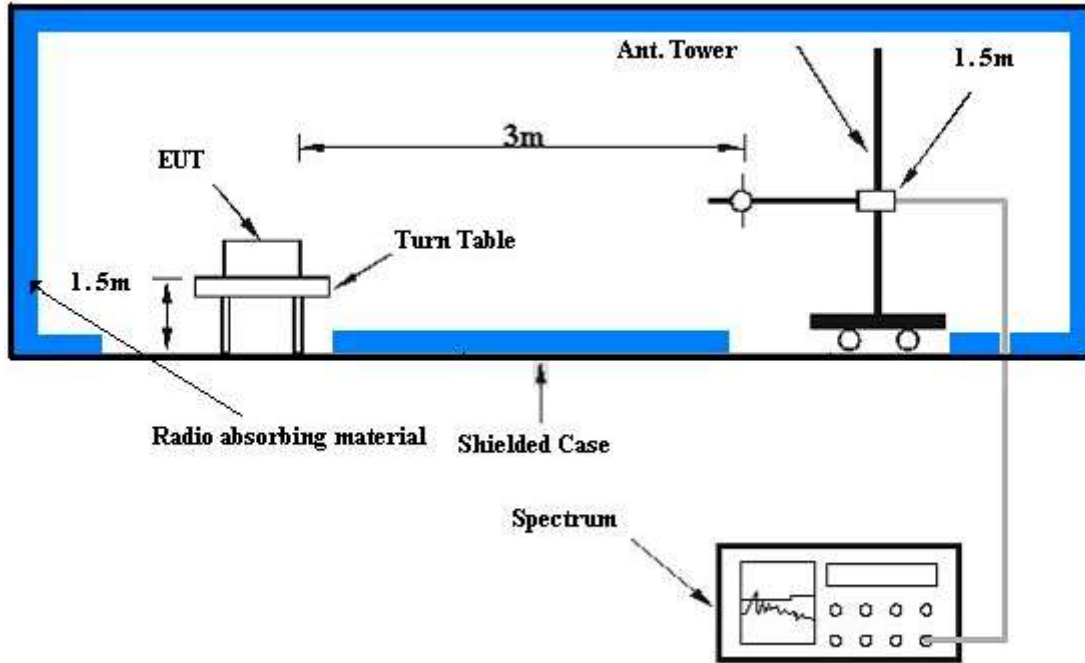

For the actual test configuration, please refer to the related item – Photographs of the Test Configuration.

CONDUCTED POWER MEASUREMENT:

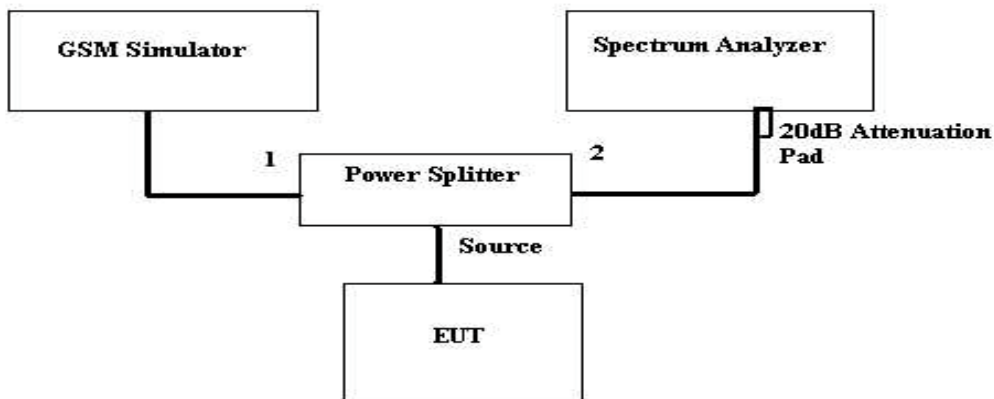

For the actual test configuration, please refer to the related item – Photographs of the Test Configuration.



4.2.5 EUT OPERATING CONDITIONS

- a. The EUT makes a phone call to the GSM simulator.
- b. The GSM simulator station system controlled an EUT to export maximum output power under transmission mode and specific channel frequency.

4.2.6 TEST RESULTS

EUT	Pocket PC Phone	MODEL	HSTNH-H06C-WL
MODE	TX connected	POWER CONTROL LEVEL	0
INPUT POWER (SYSTEM)	120Vac, 60 Hz	DETECTOR FUNCTION	Peak
ENVIRONMENTAL CONDITIONS	27deg. C, 60%RH, 991hPa	TESTED BY	Long Chen

FOR GSM MODE (UP-LINK WITH 1 TIME SLOT)

CONDUCTED PEAK OUTPUT POWER					
CHANNEL NO.	FREQUENCY (MHz)	RAW VALUE (dBm)	CORRECTION FACTOR (dB)	PEAK OUTPUT POWER	
				dBm	Watt
512	1850.2	26.03	3.80	29.83	0.962
661	1880.0	25.80	3.80	29.60	0.912
810	1909.8	25.51	3.80	29.31	0.853

FOR GPRS MODE (UP-LINK WITH 2 TIME SLOTS)

CONDUCTED PEAK OUTPUT POWER					
CHANNEL NO.	FREQUENCY (MHz)	RAW VALUE (dBm)	CORRECTION FACTOR (dB)	PEAK OUTPUT POWER	
				dBm	Watt
512	1850.2	25.66	3.80	29.46	0.883
661	1880.0	25.42	3.80	29.22	0.836
810	1909.8	25.12	3.80	28.92	0.780

FOR E-GPRS MODE (UP-LINK WITH 2 TIME SLOTS)

CONDUCTED PEAK OUTPUT POWER					
CHANNEL NO.	FREQUENCY (MHz)	RAW VALUE (dBm)	CORRECTION FACTOR (dB)	PEAK OUTPUT POWER	
				dBm	Watt
512	1850.2	25.69	3.80	29.49	0.889
661	1880.0	25.43	3.80	29.23	0.838
810	1909.8	25.02	3.80	28.82	0.762

- REMARKS:** 1. Peak Output Power (dBm) = Raw Value (dBm) + Correction Factor (dB).
2. Correction Factor (dB) = Power Splitter Loss (dB) + Cable Loss (dB).



EUT	Pocket PC Phone	MODEL	HSTNH-H06C-WL
MODE	TX connected	POWER CONTROL LEVEL	0
INPUT POWER (SYSTEM)	120Vac, 60 Hz	DETECTOR FUNCTION	Peak
ENVIRONMENTAL CONDITIONS	27deg. C, 60%RH, 991hPa	TESTED BY	Long Chen

FOR GSM MODE (UP-LINK WITH 1 TIME SLOT)

EIRP POWER					
CHANNEL NO.	FREQUENCY (MHz)	RAW VALUE (dBm)	CORRECTION FACTOR (dB)	PEAK OUTPUT POWER	
				dBm	Watt
512	1850.2	-13.30	43.20	29.90	0.977
661	1880.0	-13.97	43.70	29.73	0.940
810	1909.8	-14.78	44.20	29.42	0.875

FOR GPRS MODE (UP-LINK WITH 1 TIME SLOT)

EIRP POWER					
CHANNEL NO.	FREQUENCY (MHz)	RAW VALUE (dBm)	CORRECTION FACTOR (dB)	PEAK OUTPUT POWER	
				dBm	Watt
512	1850.2	-13.69	43.20	29.51	0.893
661	1880.0	-14.28	43.70	29.42	0.875
810	1909.8	-15.04	44.20	29.16	0.824

FOR E-GPRS MODE (UP-LINK WITH 2 TIME SLOT)

EIRP POWER					
CHANNEL NO.	FREQUENCY (MHz)	RAW VALUE (dBm)	CORRECTION FACTOR (dB)	PEAK OUTPUT POWER	
				dBm	Watt
512	1850.2	-13.58	43.20	29.62	0.916
661	1880.0	-14.24	43.70	29.46	0.883
810	1909.8	-15.12	44.20	29.08	0.809

- REMARKS:**
1. Peak Output Power (dBm) = Raw Value (dBm) + Correction Factor (dB).
 2. Correction Factor (dB) = Receiver Antenna Gain (dBi) + Cable Loss (dB) + Free Space Loss (dB).



4.3 FREQUENCY STABILITY MEASUREMENT

4.3.1 LIMITS OF FREQUENCY STABILITY MEASUREMENT

According to the FCC part 2.4235 shall be tested the frequency stability. The rule is defined that "The frequency stability shall be sufficient to ensure that the fundamental emission stays within the authorized frequency block." The frequency error rate is according to the JTC standard that the frequency error rate shall be accurate to within 2.5ppm of the received frequency from the base station. The test extreme voltage is according to the 2.1055(d)(1) Vary primary supply voltage from 85 to 115 percent of the nominal value for other than hand carried battery equipment and the extreme temperature rule is comply with the 2.1055(a)(1) $-30^{\circ}\text{C} \sim 50^{\circ}\text{C}$.

4.3.2 TEST INSTRUMENTS

DESCRIPTION & MANUFACTURER	MODEL NO.	SERIAL NO.	CALIBRATED UNTIL
UNIVERSAL RADIO COMMUNICATION TESTER	CMU 200	101372	Nov. 24, 2005
* Hewlett Packard RF cable	8120-6192	01428251	NA
* Suhner RF cable	Sucoflex104	204850/4	NA
* WIT Standard Temperature & Humidity Chamber	TH-4S-C	W981030	Jul. 18, 2005

- NOTE:**
1. The calibration interval of the above test instruments is 12 months. And the calibrations are traceable to NML/ROC and NIST/USA.
 2. "*" = These equipments are used for the final measurement.
 3. The test was performed in ADT RF OVEN room.



4.3.3 TEST PROCEDURE

- a. Because of the measure the carrier frequency under the condition of the AFC lock, it shall be used the mobile station in the GSM link mode. This is accomplished with the use of the R&S CMU200 simulator station. The oven room could control the temperatures and humidity. The GSM link channel is the 661.
- b. Power must be removed when changing from one temperature to another or one voltage to another voltage. Power warm up is at least 15 min and power applied should perform before recording frequency error.
- c. EUT is connected the external power supply to control the DC input power. The various Volts from the minimum 3.7 Volts to 4.2 Volts. Each step shall be record the frequency error rate.
- d. The temperature range step is 10 degrees in this test items. All temperature levels shall be hold the $\pm 0.5^{\circ}\text{C}$ during the measurement testing.
- e. The each temperature step shall be at least 0.5 hours, consider the EUT could be test under the stability condition.

NOTE: The frequency error was recorded frequency error from the GSM simulator.

4.3.4 TEST SETUP

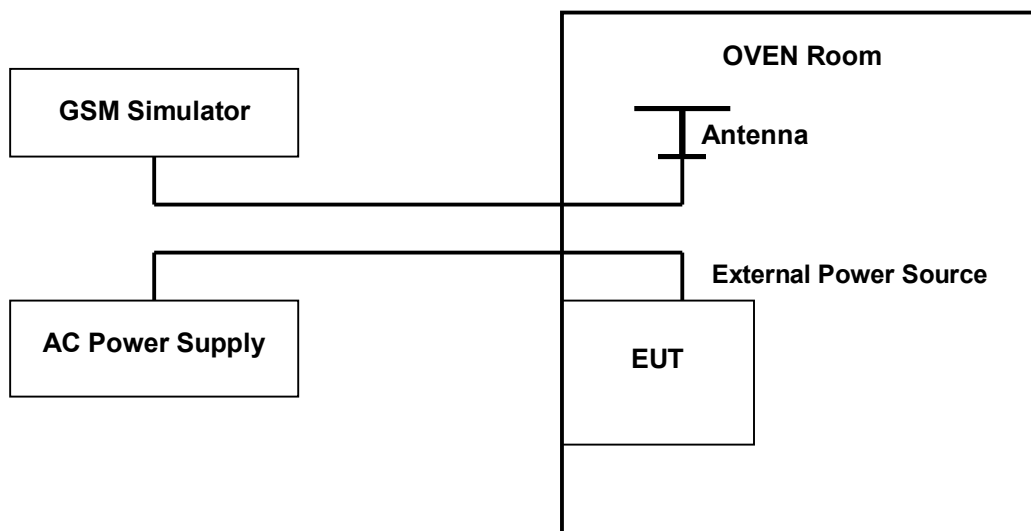



4.3.5 TEST RESULTS

EUT	Pocket PC Phone	MODEL	HSTNH-H06C-WL
MODE	TX channel 661	POWER CONTROL LEVEL	0
INPUT POWER (SYSTEM)	120Vac, 60 Hz	ENVIRONMENTAL CONDITIONS	27deg. C, 60%RH, 991hPa
TESTED BY	Long Chen		

FOR GSM MODE (UP-LINK WITH 1 TIME SLOT)

AFC FREQUENCY ERROR vs. VOLTAGE			
VOLTAGE (Volts)	FREQUENCY ERROR (Hz)	FREQUENCY ERROR (ppm)	LIMIT (ppm)
3.7	-124	-0.065263158	2.5
3.8	-113	-0.059473684	2.5
3.9	-100	-0.052631579	2.5
4.0	-109	-0.057368421	2.5
4.1	-116	-0.061052632	2.5
4.2	-129	-0.067894737	2.5

FOR GPRS MODE (UP-LINK WITH 2 TIME SLOTS)

AFC FREQUENCY ERROR vs. VOLTAGE			
VOLTAGE (Volts)	FREQUENCY ERROR (Hz)	FREQUENCY ERROR (ppm)	LIMIT (ppm)
3.7	-131	-0.068947368	2.5
3.8	-125	-0.065789474	2.5
3.9	-100	-0.052631579	2.5
4.0	-107	-0.056315789	2.5
4.1	-120	-0.063157895	2.5
4.2	-139	-0.073157895	2.5

NOTE: The applicant defined the normal working voltage of the battery is from 3.7Vdc to 4.2Vdc.

**FOR E-GPRS MODE (UP-LINK WITH 2 TIME SLOTS)**

AFC FREQUENCY ERROR vs. VOLTAGE			
VOLTAGE (Volts)	FREQUENCY ERROR (Hz)	FREQUENCY ERROR (ppm)	LIMIT (ppm)
3.7	-130	-0.068421053	2.5
3.8	-126	-0.066315789	2.5
3.9	-102	-0.053684211	2.5
4.0	-109	-0.057368421	2.5
4.1	-124	-0.065263158	2.5
4.2	-143	-0.075263158	2.5

NOTE: The applicant defined the normal working voltage of the battery is from 3.7Vdc to 4.2Vdc.



EUT	Pocket PC Phone	MODEL	HSTNH-H06C-WL
MODE	TX channel 661	POWER CONTROL LEVEL	0
INPUT POWER (SYSTEM)	120Vac, 60 Hz	ENVIRONMENTAL CONDITIONS	27deg. C, 60%RH, 991hPa
TESTED BY	Long Chen		

FOR GSM MODE (UP-LINK WITH 1 TIME SLOT)

AFC FREQUENCY ERROR vs. VOLTAGE			
Temp. (°C)	Frequency Error (Hz)	Frequency Error (ppm)	Limit (ppm)
55	-78	-0.041052632	2.5
50	-67	-0.035263158	2.5
40	-60	-0.031578947	2.5
30	-64	-0.033684211	2.5
20	-70	-0.036842105	2.5
10	-79	-0.041578947	2.5
0	-88	-0.046315789	2.5
-10	-102	-0.053684211	2.5

**FOR GPRS MODE (UP-LINK WITH 2 TIME SLOTS)**

AFC FREQUENCY ERROR vs. VOLTAGE			
Temp. (°C)	Frequency Error (Hz)	Frequency Error (ppm)	Limit (ppm)
55	-82	-0.043157895	2.5
50	-69	-0.036315789	2.5
40	-63	-0.033157895	2.5
30	-66	-0.034736842	2.5
20	-75	-0.039473684	2.5
10	-81	-0.042631579	2.5
0	-89	-0.046842105	2.5
-10	-114	-0.060000000	2.5

**FOR E-GPRS MODE (UP-LINK WITH 2 TIME SLOTS)**

AFC FREQUENCY ERROR vs. VOLTAGE			
Temp. (°C)	Frequency Error (Hz)	Frequency Error (ppm)	Limit (ppm)
55	-83	-0.043684211	2.5
50	-71	-0.037368421	2.5
40	-65	-0.034210526	2.5
30	-63	-0.033157895	2.5
20	-71	-0.037368421	2.5
10	-83	-0.043684211	2.5
0	-92	-0.048421053	2.5
-10	-118	-0.062105263	2.5



4.4 OCCUPIED BANDWIDTH MEASUREMENT

4.4.1 LIMITS OF OCCUPIED BANDWIDTH MEASUREMENT

According to FCC 24.238(b) specified that emission bandwidth is defined as the width of the signal between two points, one below the carrier center frequency and one above the carrier center frequency, outside of which all emissions are attenuated at least 26 dB below the transmitter power.

4.4.2 TEST INSTRUMENTS

DESCRIPTION & MANUFACTURER	MODEL NO.	SERIAL NO.	CALIBRATED UNTIL
* ROHDE & SCHWARZ Spectrum Analyzer	FSP40	100035	Apr. 13, 2006
UNIVERSAL RADIO COMMUNICATION TESTER	CMU 200	101372	Nov. 24, 2005
* Mini-Circuits Power Splitter	ZAPD-4	400005	NA
* Hewlett Packard RF cable	8120-6192	01428251	NA
* JFW 20dB attenuation	50HF-020-SMA	NA	NA
* Suhner RF cable	Sucoflex104	204850/4	NA

NOTE: 1. The calibration interval of the above test instruments is 12 months. And the calibrations are traceable to NML/ROC and NIST/USA.

2. "*" = These equipments are used for the final measurement.

4.4.3 TEST SETUP

Same as Item 4.2.4 (Conducted Power Setup)

4.4.4 TEST PROCEDURES

- a. The EUT was set up for the maximum peak power with GSM link data modulation. The power was measured with R&S Spectrum Analyzer. All measurements were done at 3 channels, 512, 661 and 810(low, middle and high operational frequency range.)
- b. The conducted occupied bandwidth used the power splitter via EUT RF power connector between simulation base station and spectrum analyzer. This splitter loss and cable loss are the worst loss 4dB in the transmitted path track.
- c. FCC 24.238(b) required a measurement bandwidth is the fundamental emission below 26dB bandwidth.

4.4.5 EUT OPERATING CONDITION

- a. The EUT makes a phone call to the GSM simulator.
- b. The GSM simulator station system controlled a EUT to export maximum and minimum output power under transmission mode and specific channel frequency Same as Item 4.4.5

4.4.6 TEST RESULTS

FOR GSM MODE (UP-LINK WITH 1 TIME SLOT)

FREQUENCY (MHz)	MAX. OUTPUT POWER -26 dBc BANDWIDTH (kHz)	MIN. OUTPUT POWER -26 dBc BANDWIDTH (kHz)
1850.2	302	296
1880.0	312	306
1909.8	312	310



FOR GSM MODE (UP-LINK WITH 1 TIME SLOT)

CH 512 MAX. POWER

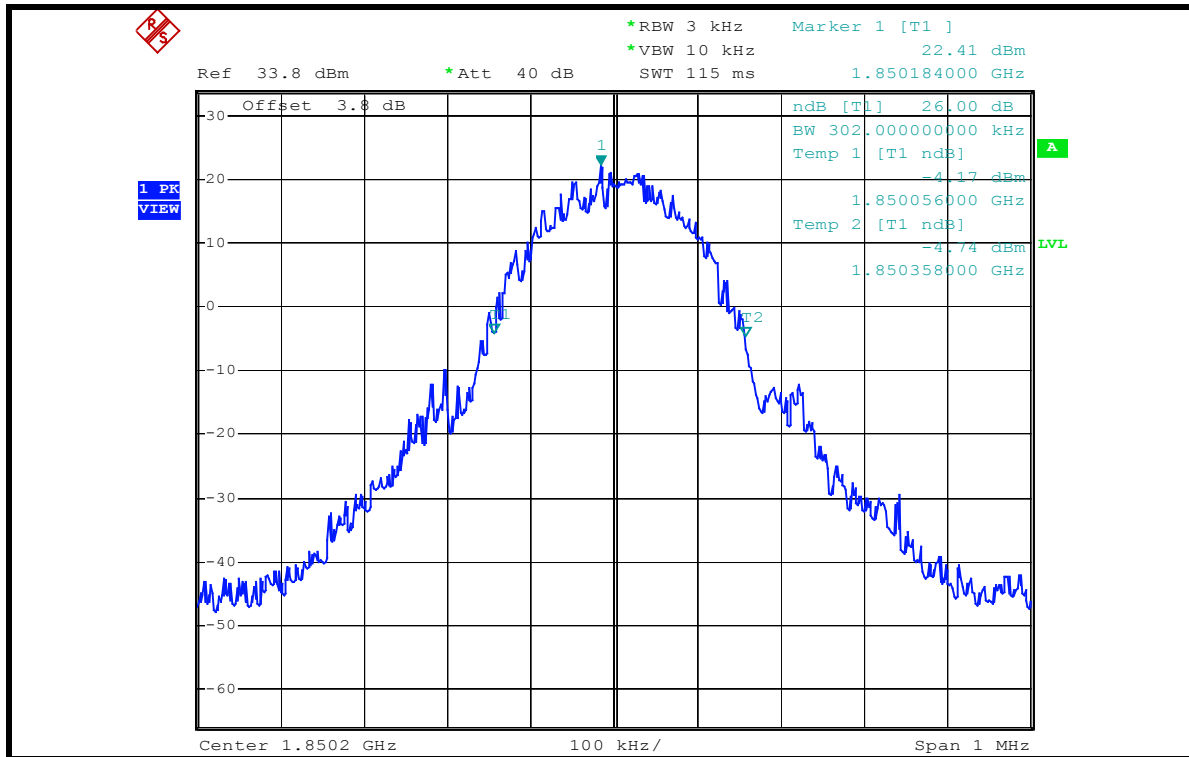

CH 512 MIN. POWER

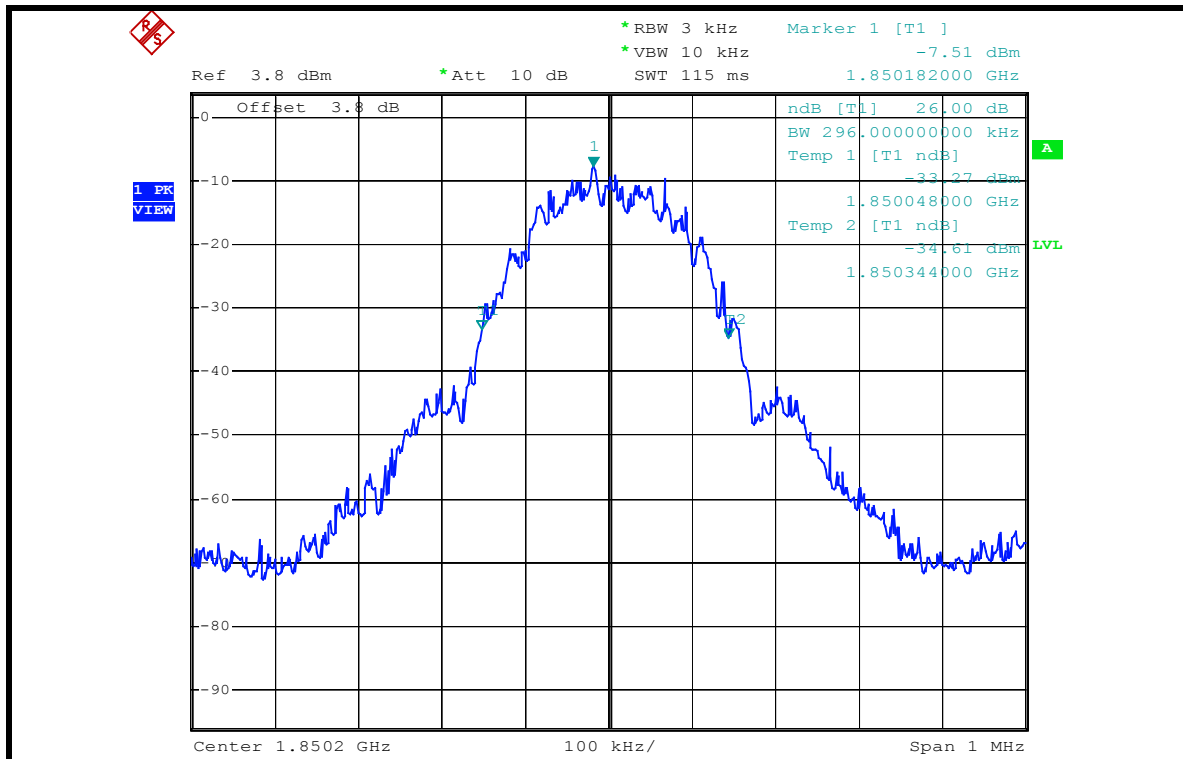



CH 661 MAX. POWER

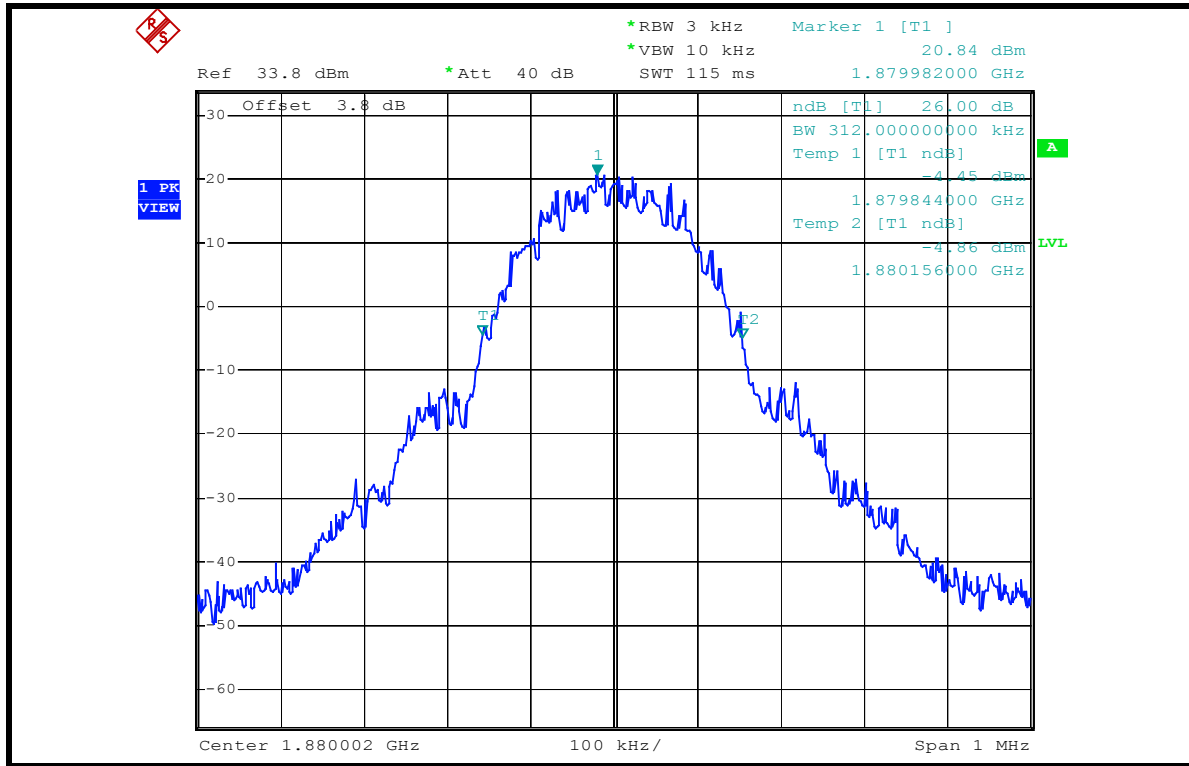

CH 661 MIN. POWER

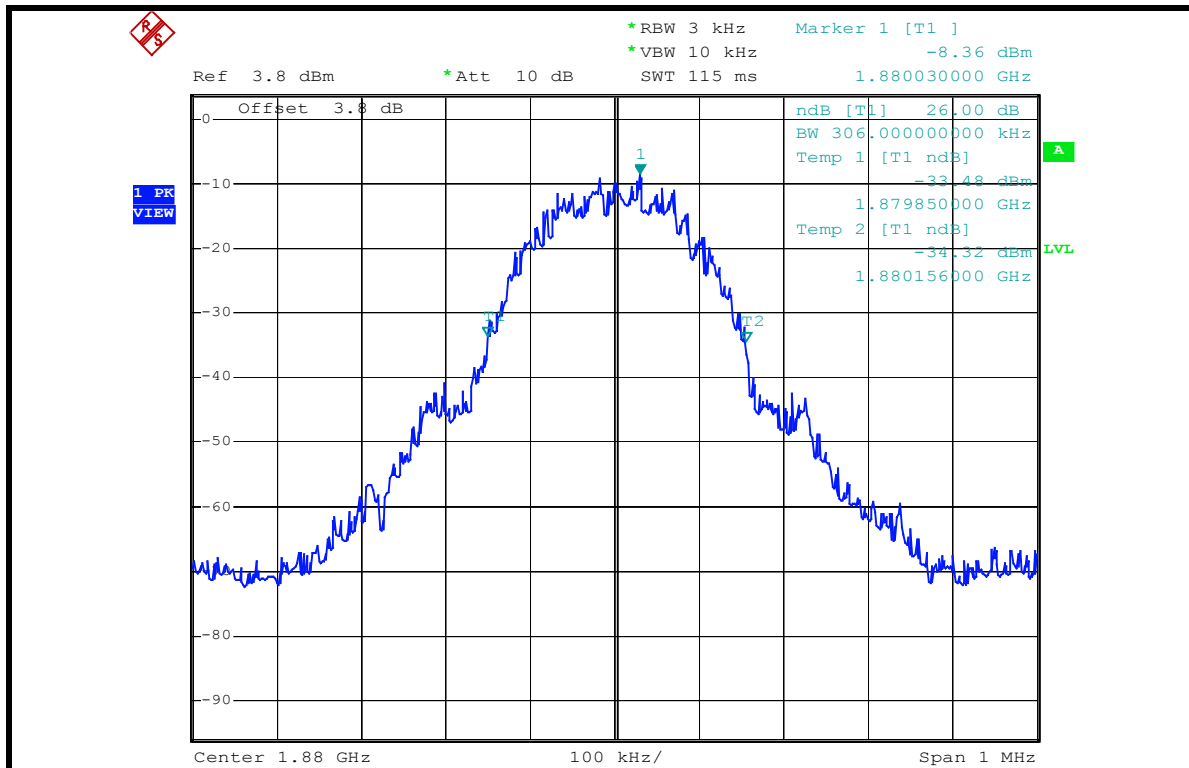



CH 810 MAX. POWER

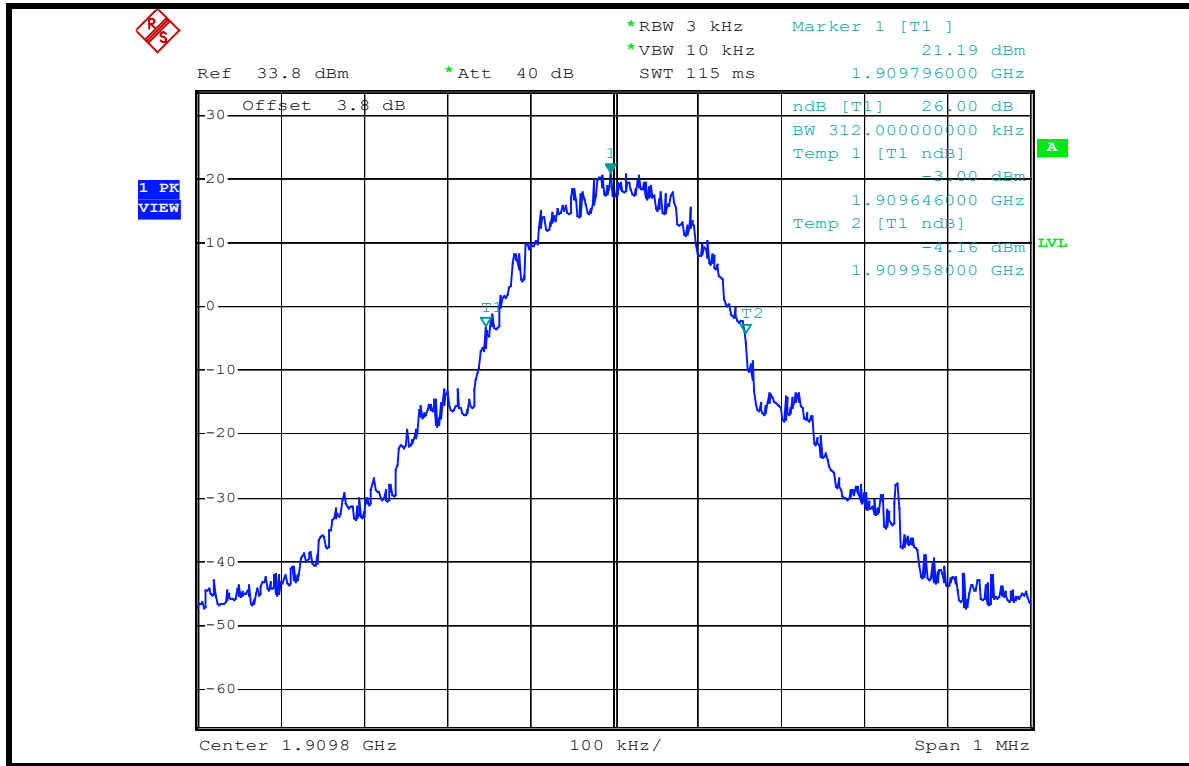

CH 810 MIN. POWER

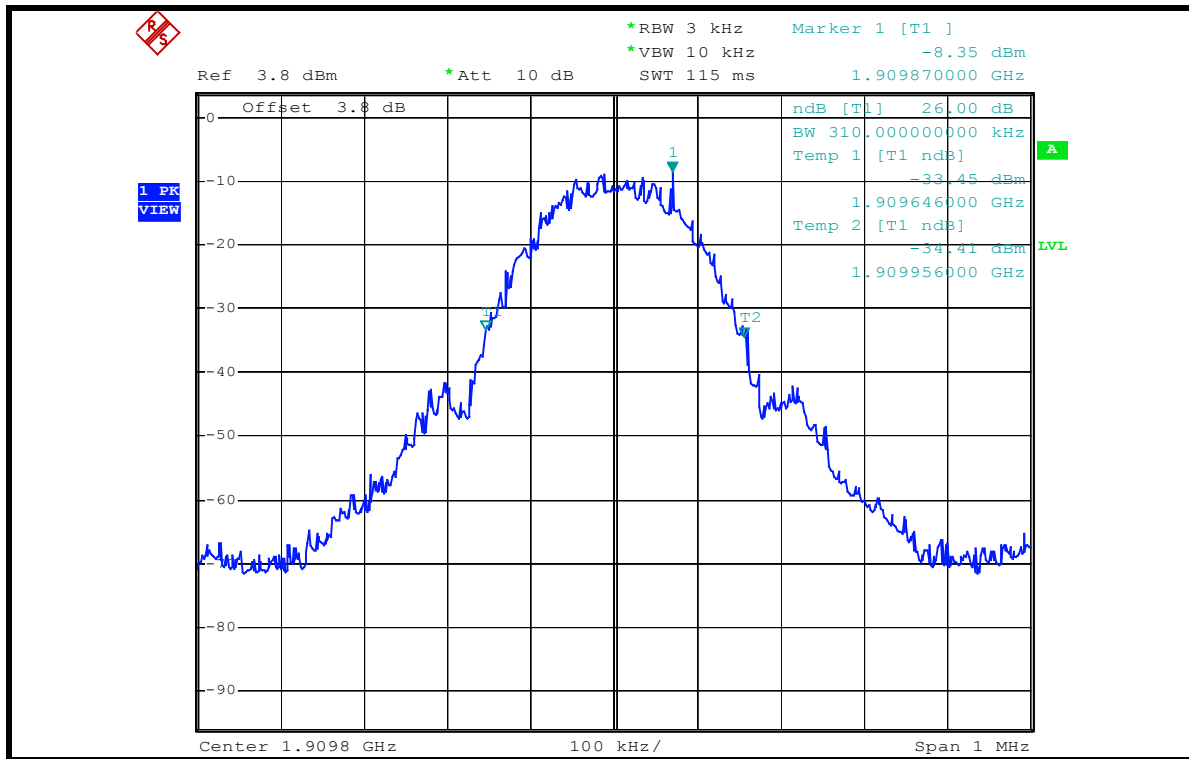

**FOR GPRS MODE (UP-LINK WITH 2 TIME SLOTS)**

FREQUENCY (MHz)	MAX. OUTPUT POWER -26 dBc BANDWIDTH (kHz)	MIN. OUTPUT POWER -26 dBc BANDWIDTH (kHz)
1850.2	286	286
1880.0	284	286
1909.8	312	286



FOR GPRS MODE (UP-LINK WITH 2 TIME SLOTS)

CH 512 MAX. POWER

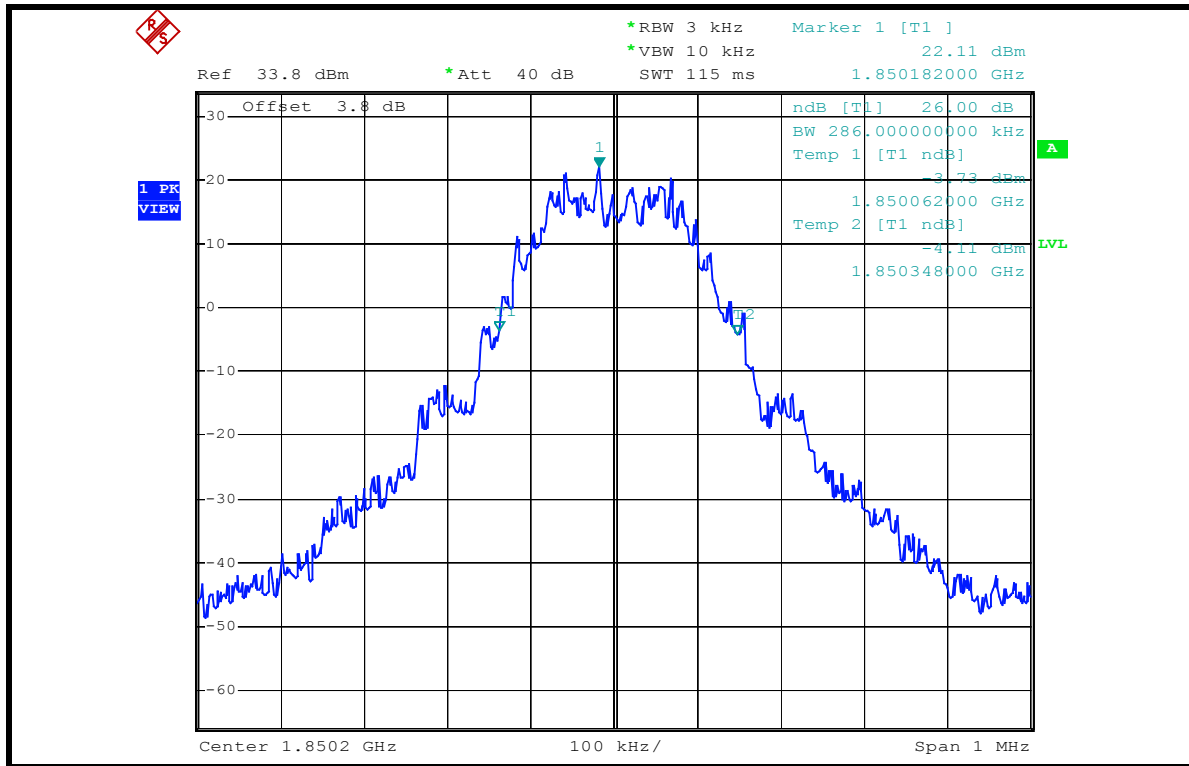

CH 512 MIN. POWER

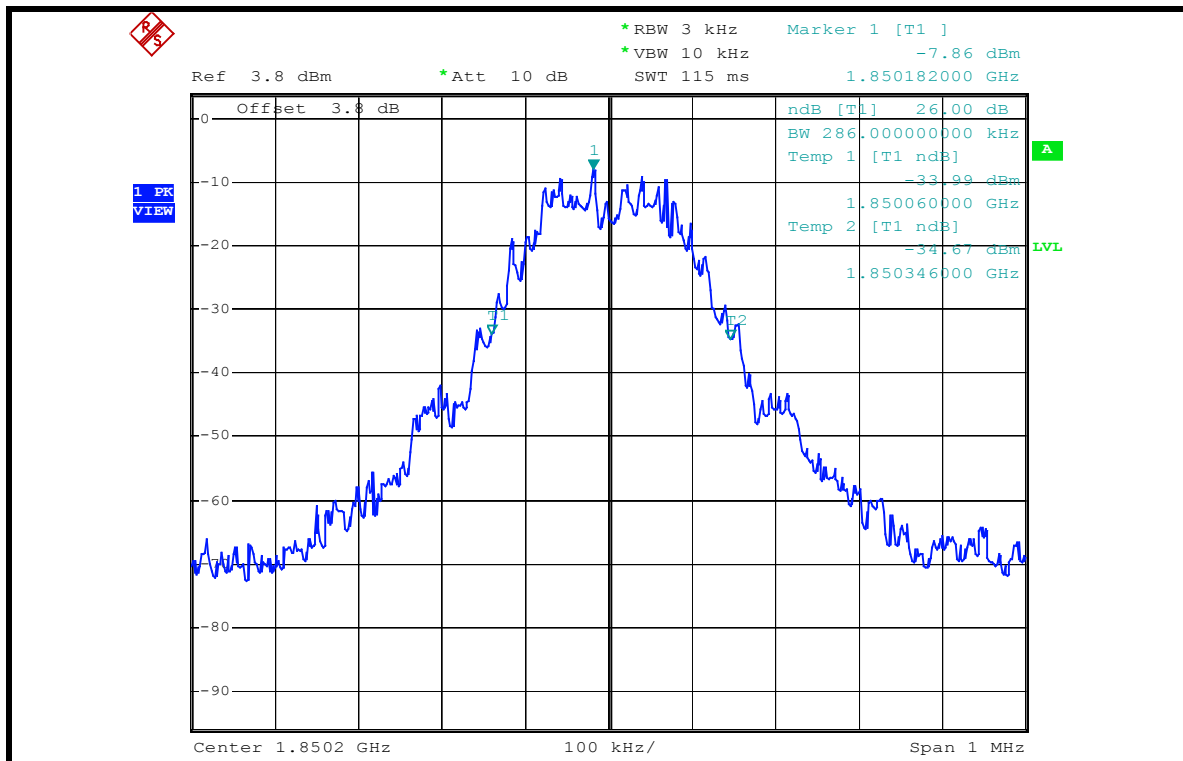



CH 661 MAX. POWER

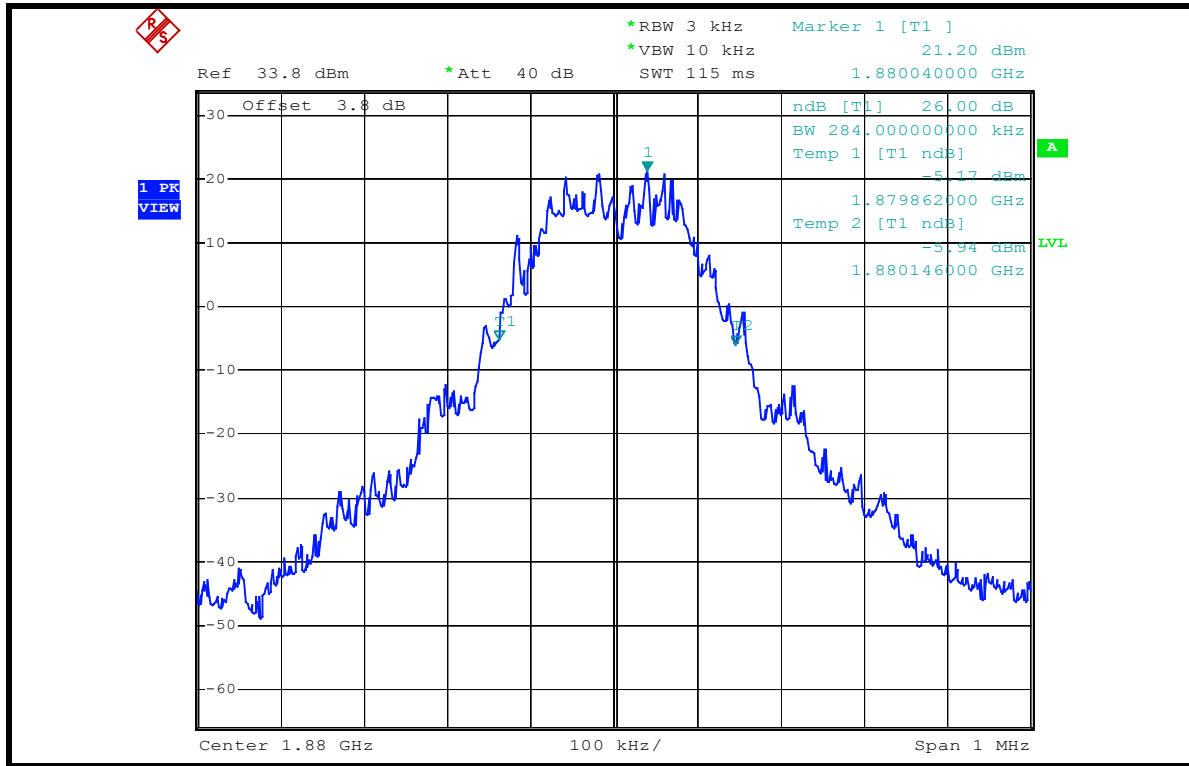

CH 661 MIN. POWER

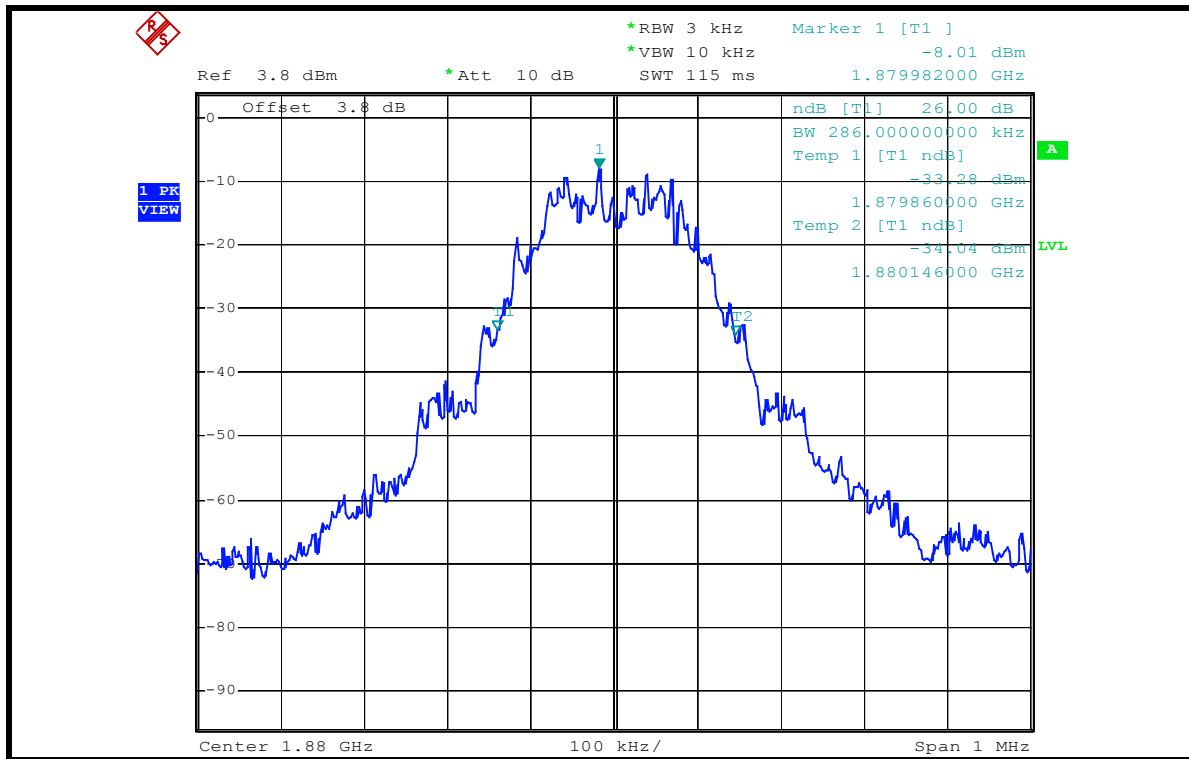



CH 810 MAX. POWER

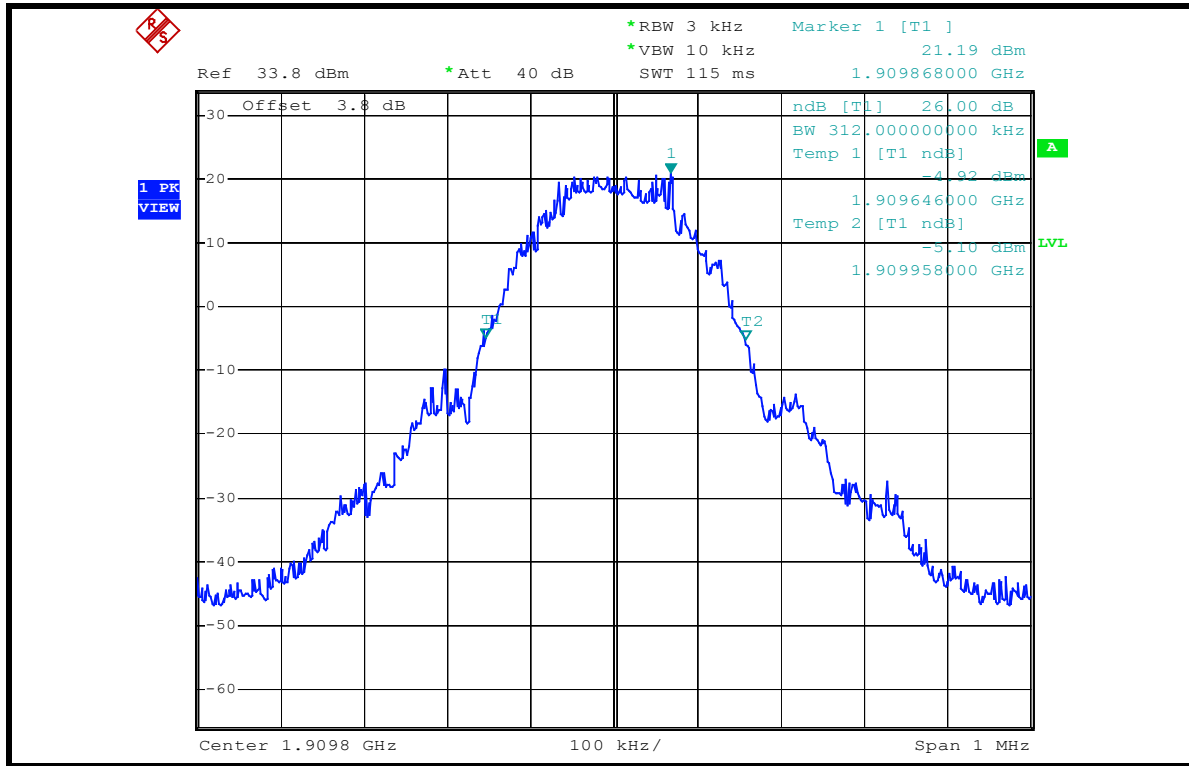

CH 810 MIN. POWER

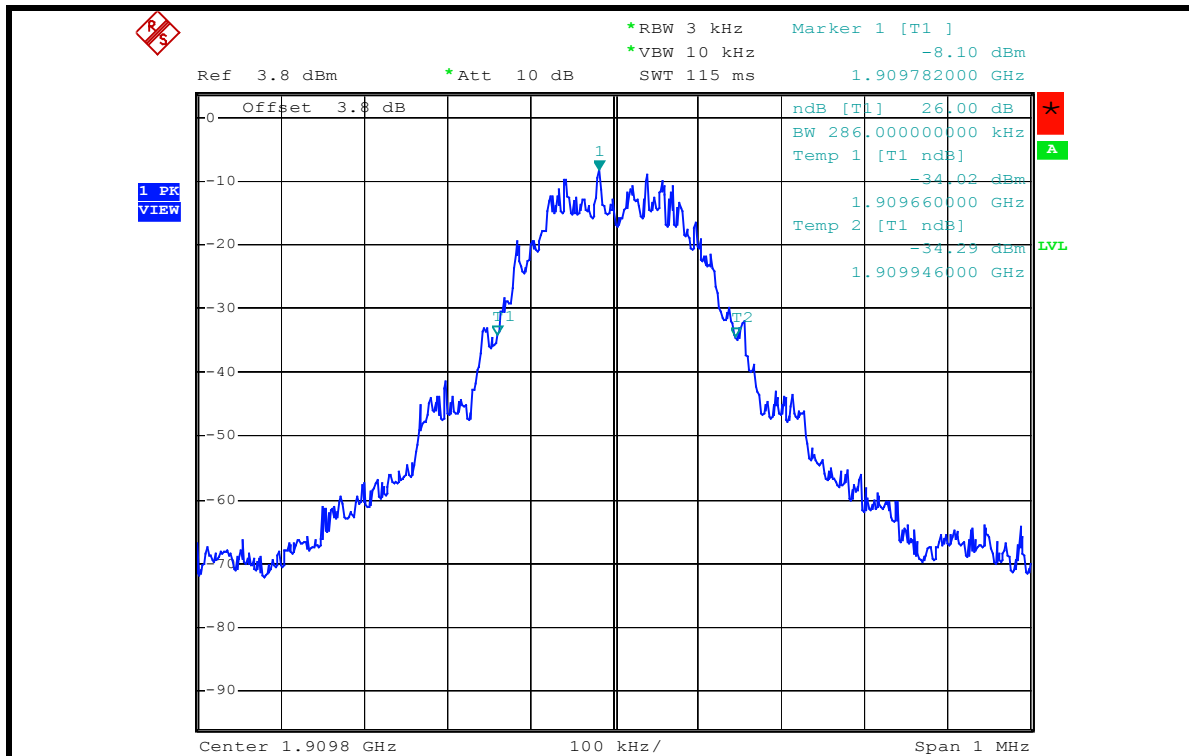

**FOR E-GPRS MODE (UP-LINK WITH 2 TIME SLOTS)**

FREQUENCY (MHz)	MAX. OUTPUT POWER -26 dBc BANDWIDTH (kHz)	MIN. OUTPUT POWER -26 dBc BANDWIDTH (kHz)
1850.2	304	306
1880.0	316	284
1909.8	312	288



FOR E-GPRS MODE (UP-LINK WITH 2 TIME SLOTS)

CH 512 MAX. POWER

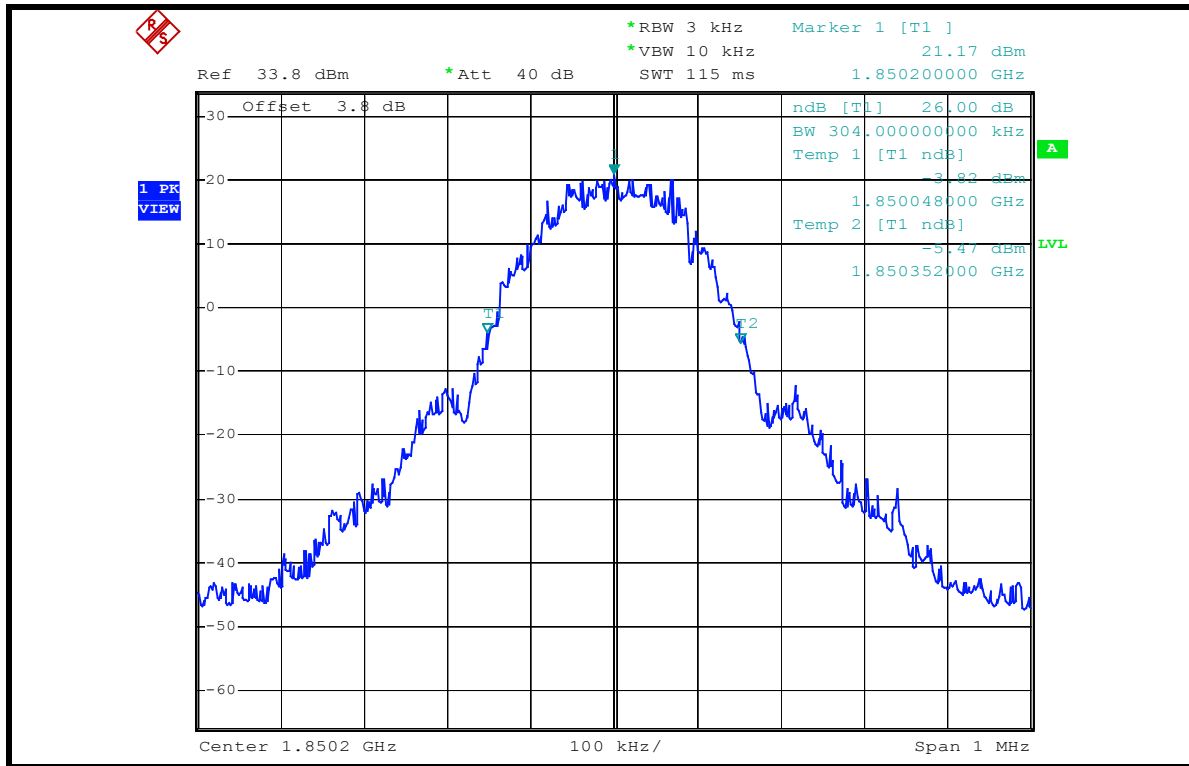

CH 512 MIN. POWER

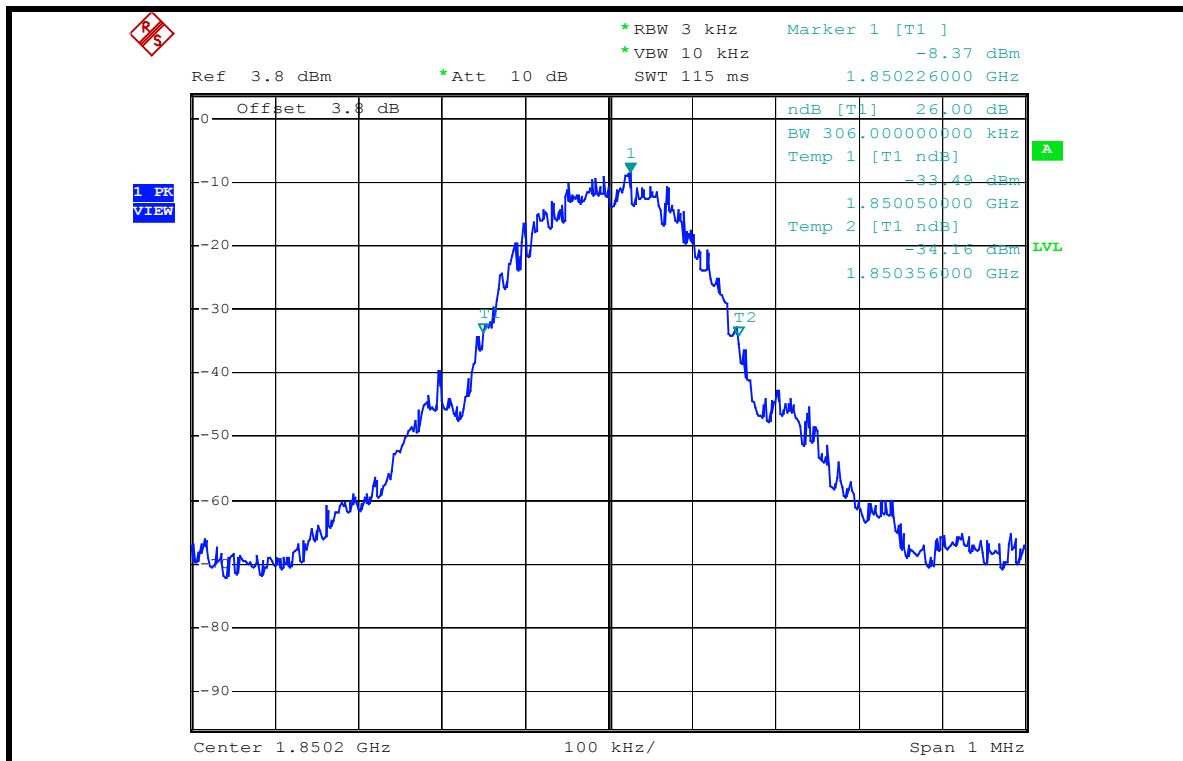



CH 661 MAX. POWER

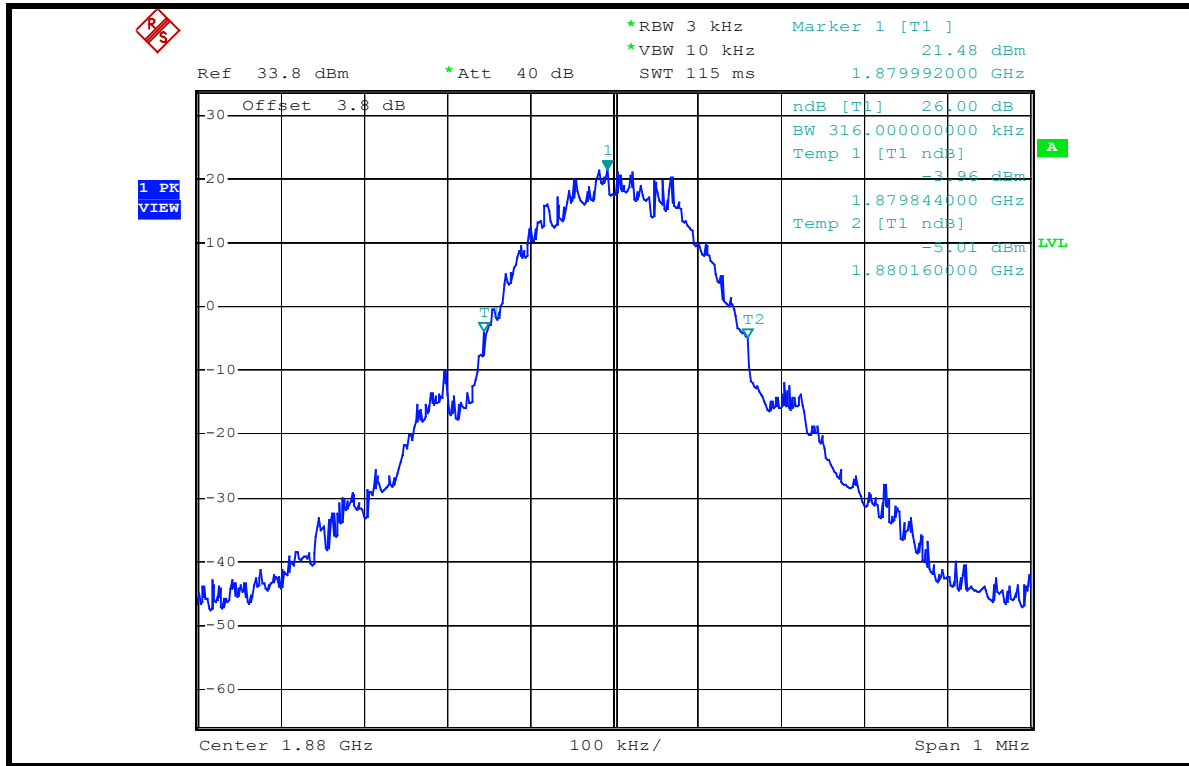

CH 661 MIN. POWER

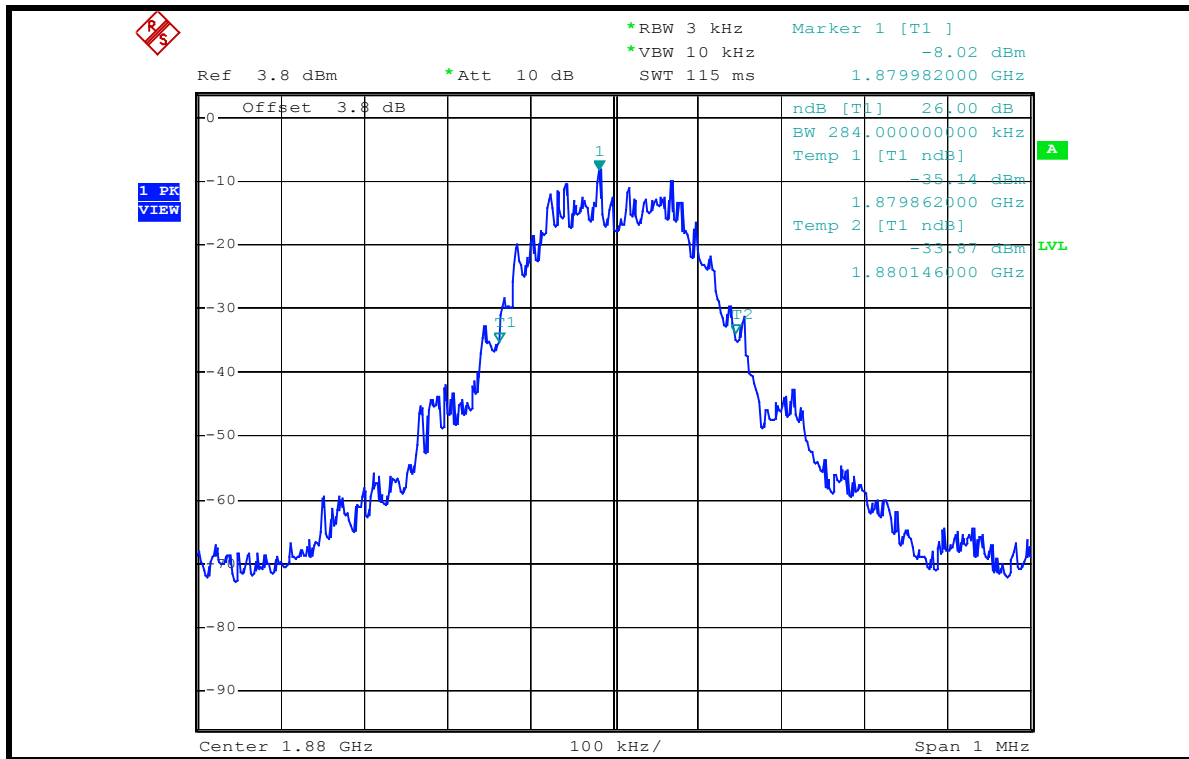



CH 810 MAX. POWER

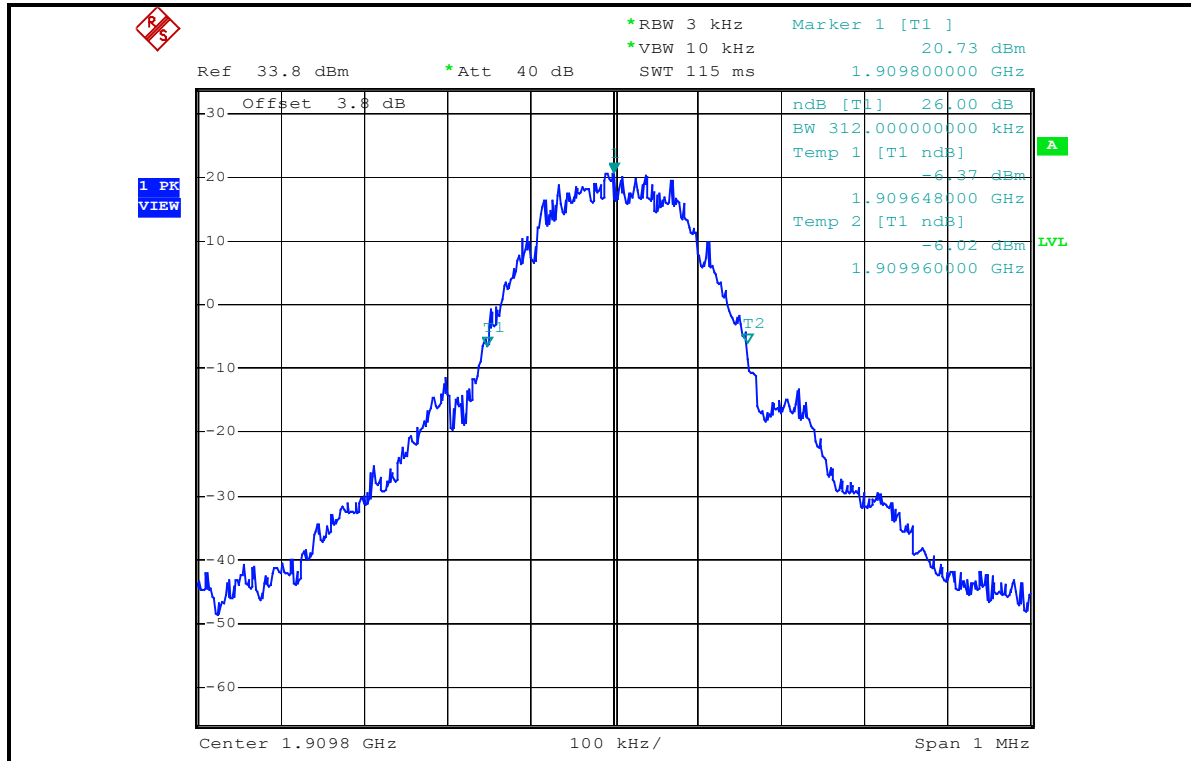

CH 810 MIN. POWER

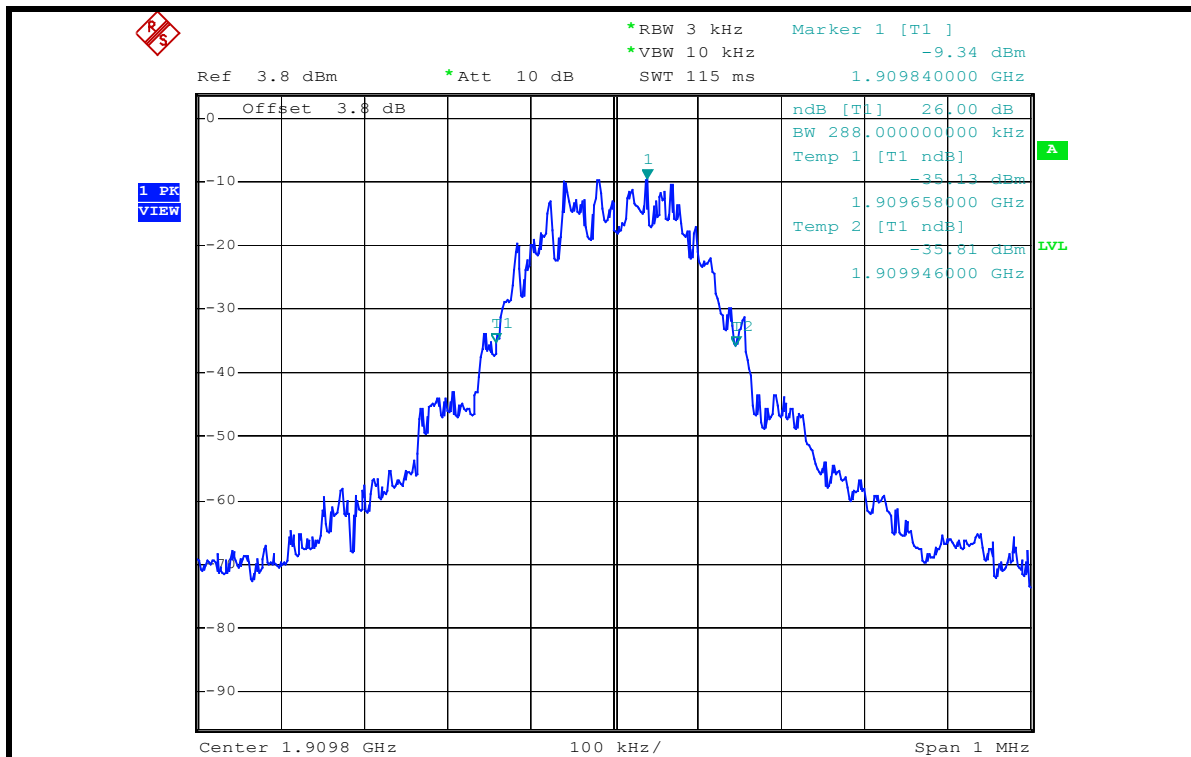



4.5 BAND EDGE MEASUREMENT

4.5.1 LIMITS OF BAND EDGE MEASUREMENT

The PCS frequency bands refer to the FCC 24.229 rule. According to FCC 24.238(a) specified that power of any emission outside of the authorized operating frequency ranges must be attenuated below the transmitting power (P) by a factor of at least $43 + 10 \log(P)$ dB. In the 1 MHz bands immediately outside and adjacent to the frequency block a resolution bandwidth of at least one percent of the emission bandwidth of the fundamental emission of the transmitter may be employed. Then we measure that the bandwidth is about 300kHz and the resolution bandwidth is 3kHz.

4.5.2 TEST INSTRUMENTS

DESCRIPTION & MANUFACTURER	MODEL NO.	SERIAL NO.	CALIBRATED UNTIL
* ROHDE & SCHWARZ Spectrum Analyzer	FSP40	100035	Apr. 13, 2006
UNIVERSAL RADIO COMMUNICATION TESTER	CMU200	101372	Nov. 24, 2005
* Mini-Circuits Power Splitter	ZAPD-4	400005	NA
* Hewlett Packard RF cable	8120-6192	01428251	NA
* JFW 20dB attenuation	50HF-020-SMA	NA	NA
* Suhner RF cable	Sucoflex104	204850/4	NA

NOTE: 1. The calibration interval of the above test instruments is 12 months. And the calibrations are traceable to NML/ROC and NIST/USA.

2. "*" = These equipments are used for the final measurement.

4.5.3 TEST SETUP

Same as Item 4.2.4 (Conducted Power Setup)



4.5.4 TEST PROCEDURES

- a. The EUT was set up for the maximum peak power with GSM link data modulation. The power was measured with R&S Spectrum Analyzer. All measurements were done at 2 channels, 512 and 810(low and high operational frequency range.)
- b. The band edge measurement used the power splitter via EUT RF power connector between simulation base station and spectrum analyzer. This splitter loss and cable loss are the worst loss 4dB in the transmitted path track.
- c. The center frequency of spectrum is the band edge frequency and span is 2 MHz. RB of the spectrum is 3kHz and VB of the spectrum is 10KHz.
- d. Record the max trace plot into the test report.

4.5.5 EUT OPERATING CONDITION

- a. The EUT makes a phone call to the GSM simulator.
- b. The GSM simulator station system controlled a EUT to export maximum output power under transmission mode and specific channel frequency Same as Item 4.4.5.



4.5.6 TEST RESULTS

FOR GSM MODE (UP-LINK WITH 1 TIME SLOT)

LOWER BAND EDGE

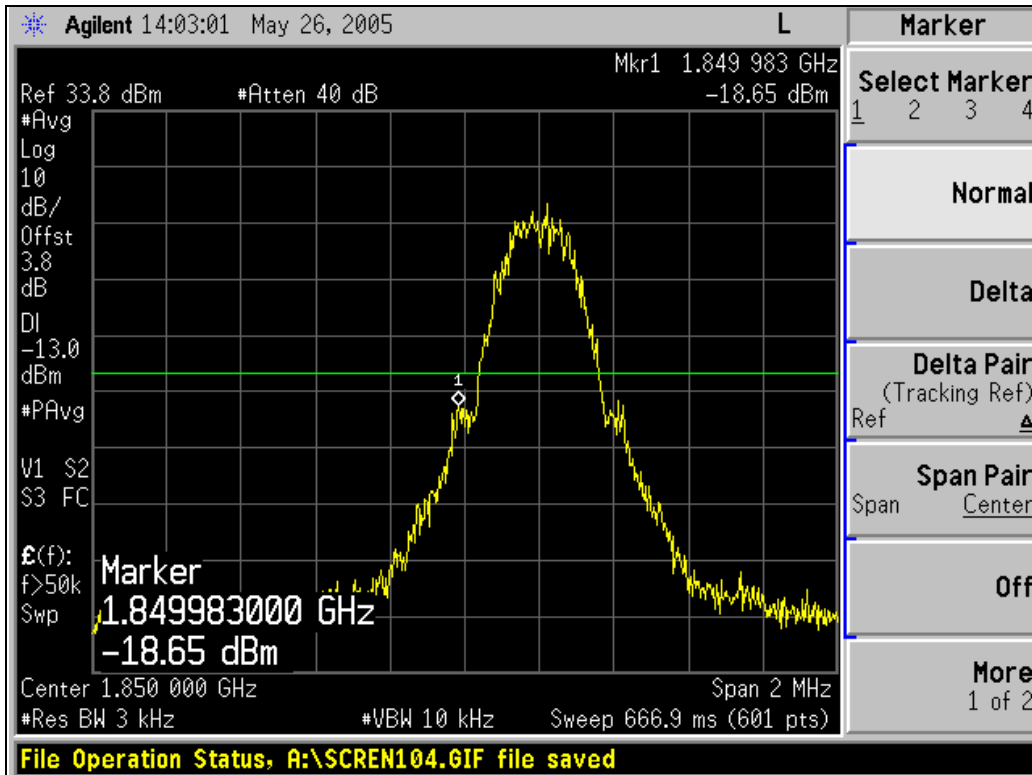

HIGHER BAND EDGE

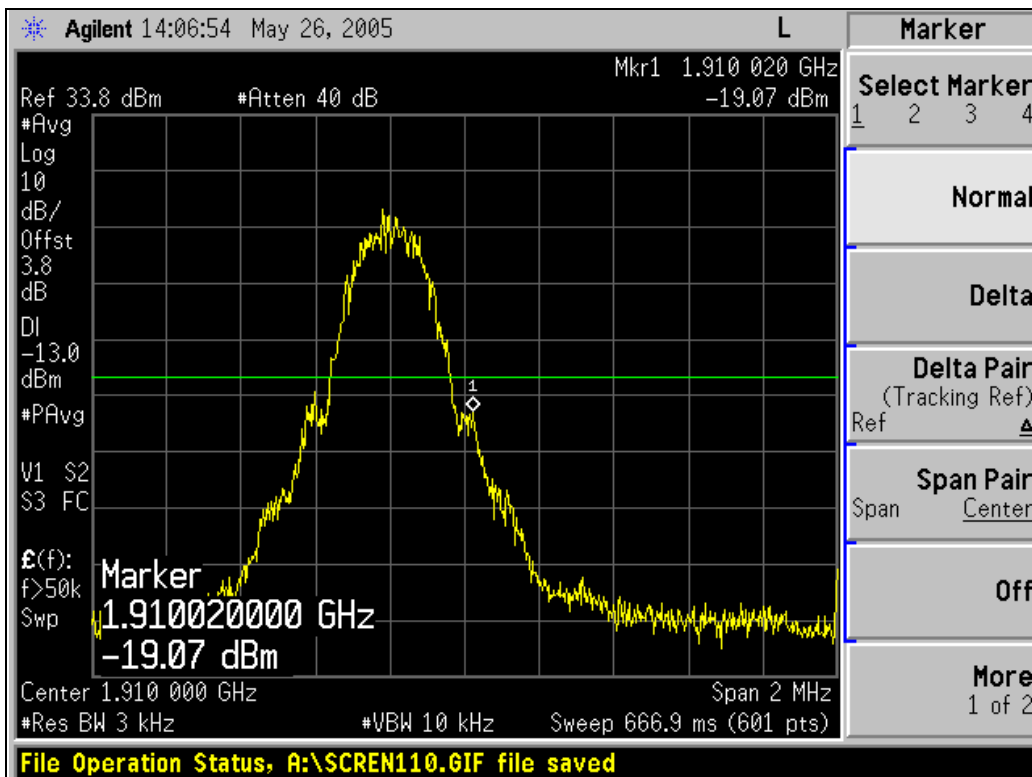



FOR GPRS MODE (UP-LINK WITH 2 TIME SLOTS)

LOWER BAND EDGE

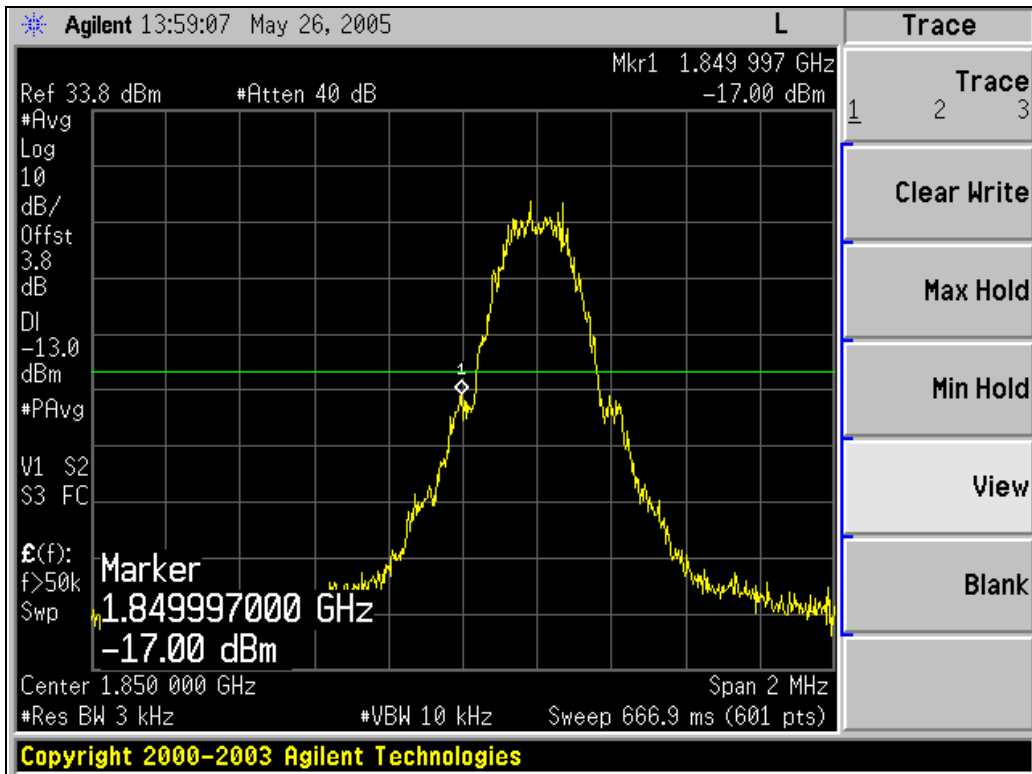

HIGHER BAND EDGE

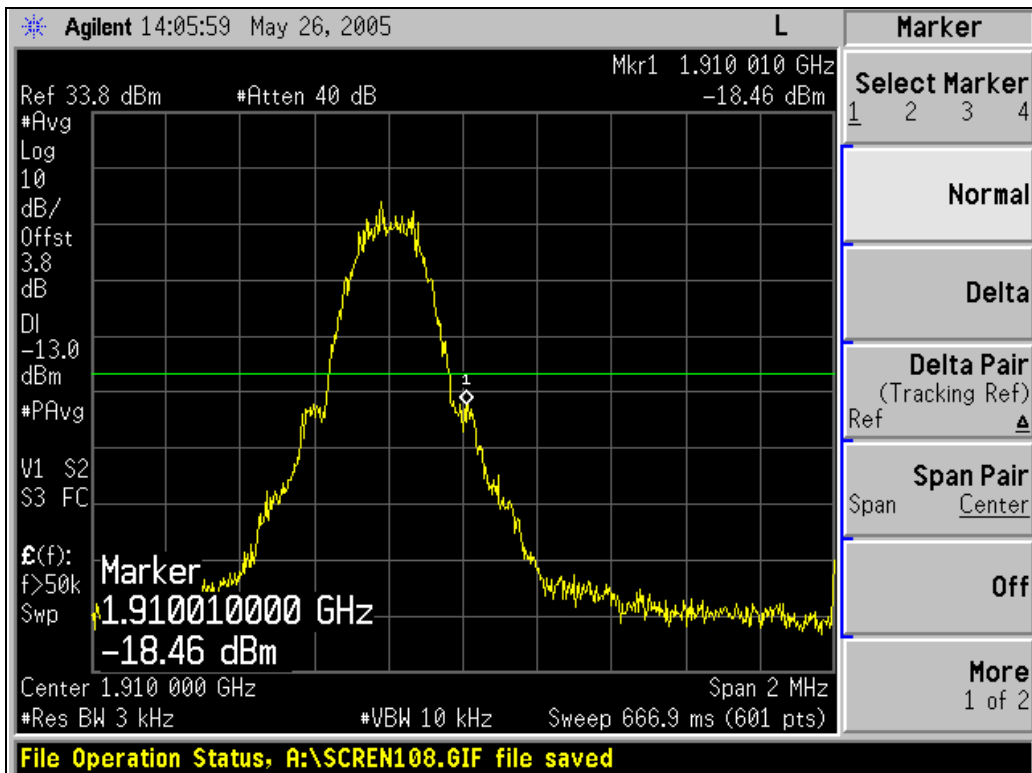



FOR E-GPRS MODE (UP-LINK WITH 2 TIME SLOTS)

LOWER BAND EDGE

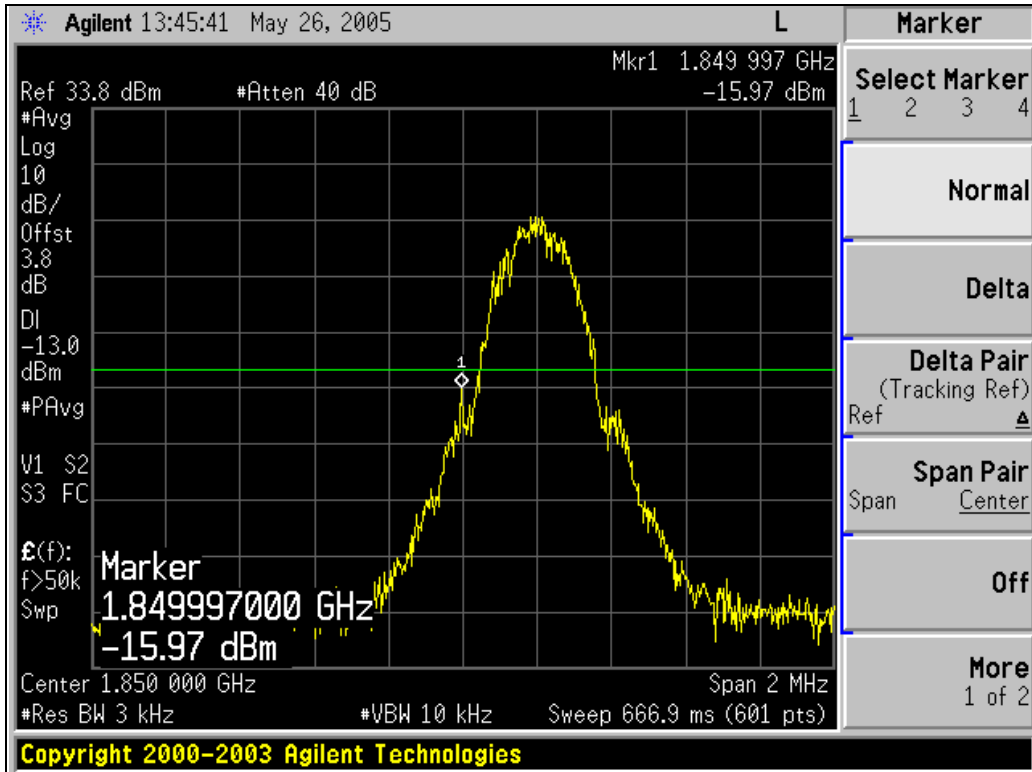

HIGHER BAND EDGE

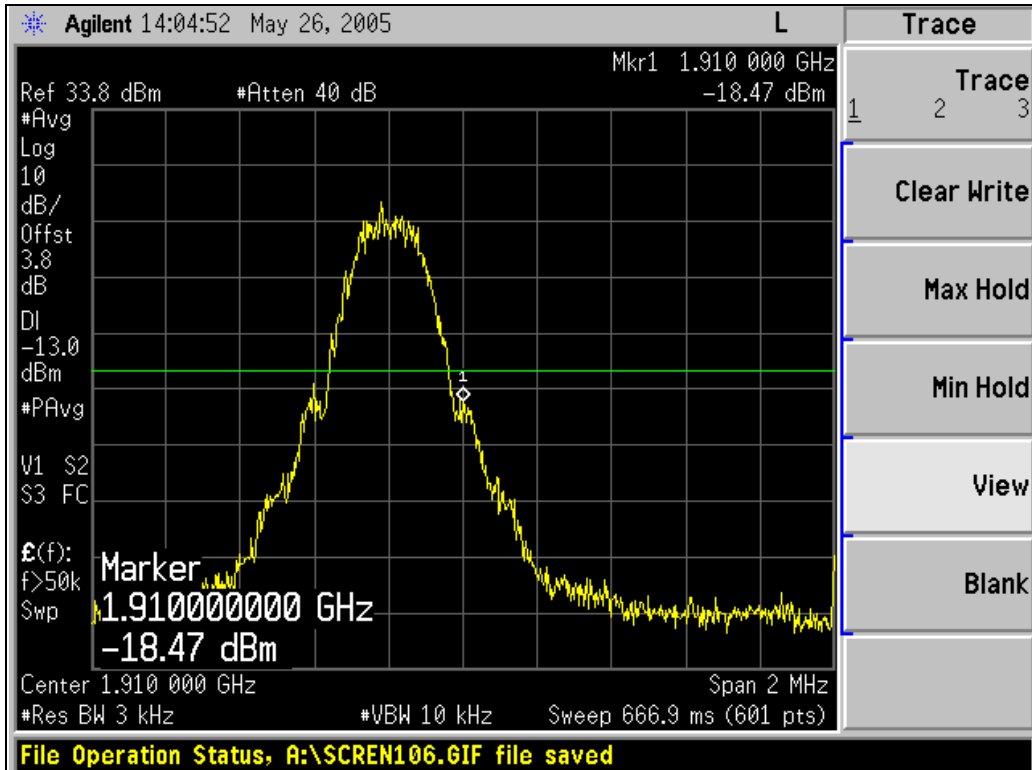



4.6 CONDUCTED SPURIOUS EMISSIONS

4.6.1 LIMITS OF CONDUCTED SPURIOUS EMISSIONS MEASUREMENT

In the FCC 24.238(a), On any frequency outside a licensee's frequency block within USPCS spectrum, the power of any emission shall be attenuated below the transmitter power (P) by at least $43 + 10 \log (P)$ dB. The limit translates in the relevant power range (1 to 0.001W). At 1W(Power Control Level 0) the specified minimum attenuation becomes 43dB and the limit of emission equal to -13dBm . At 0.001W(Power Control Level 15) the specified minimum attenuation becomes 13dB and the emission of limit equal to -13dBm . So the limit of emission is the same absolute specified line. In the FCC 24.238(c), When measuring the emission limits, the nominal carrier frequency shall be adjusted as close to the licensee's frequency block edges (low channel 512 and high channel 810), both upper and lower edges are compliance with FCC 24.238(b), Adjacent to the frequency block a resolution bandwidth of at least one percent of the emission bandwidth of the fundamental emission of the transmitter may be employed.

4.6.2 TEST INSTRUMENTS

DESCRIPTION & MANUFACTURER	MODEL NO.	SERIAL NO.	CALIBRATED UNTIL
* ROHDE & SCHWARZ Spectrum Analyzer	FSP40	100035	Apr. 13, 2006
AGILENT SIGNAL GENERATOR	E8257C	MY43320668	Dec. 06, 2005
Universal Radio Communication Tester	CMU200	101372	Nov. 24, 2005
* Wainwright Instruments Band Reject Filter	WRCG1850/1910- 1830/1930-60/10SS	SN1	NA
* Wainwright Instruments High Pass Filter	WHK3.1/18G-10SS	SN1	NA
* Mini-Circuits Power Splitter	ZAPD-4	400005	NA
* Hewlett Packard RF cable	8120-6192	01428251	NA
* JFW 20dB attenuation	50HF-020-SMA	NA	NA
* Suhner RF cable	Sucoflex104	204850/4	NA

- NOTE:**
1. The calibration interval of the above test instruments is 12 months. And the calibrations are traceable to NML/ROC and NIST/USA.
 2. "*" = These equipments are used for the final measurement.

4.6.3 TEST PROCEDURE

- a. The EUT was set up for the maximum peak power with GSM link data modulation. The power was measured with R&S Spectrum Analyzer. All measurements were done at 3 channels, 512, 661 and 810(low, middle and high operational frequency range.)
- b. The conducted spurious emission used the power splitter via EUT RF power connector between simulation base station and spectrum analyzer. This splitter loss and cable loss are the worst loss 4dB in the transmitted path track.
- c. When the spectrum scanned from 9kHz to 3GHz, it shall be connected to the band reject filter attenuated the carried frequency. The spectrum set RB/VB 1MHz.
- d. When the spectrum scanned from 3kHz to 20GHz, it shall be connected to the high pass filter attenuated the carried frequency. The spectrum set RB/VB 1MHz.

4.6.4 TEST SETUP

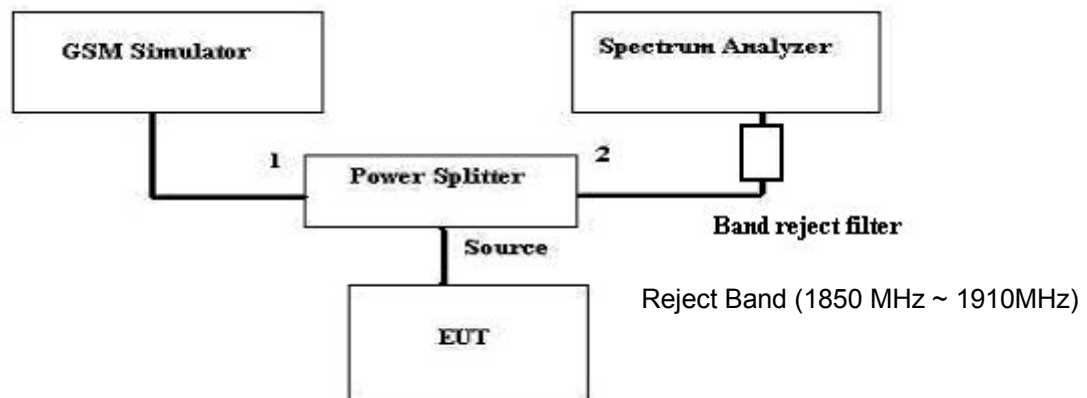

4.6.5 EUT OPERATING CONDITIONS

- a. The EUT makes a phone call to the GSM simulator.
- b. The GSM simulator station system controlled a EUT to export maximum output power under transmission mode and specific channel frequency.



4.6.6 TEST RESULTS

FOR GSM MODE (UP-LINK WITH 1 TIME SLOT)

CH 512: 9kHz ~ 3GHz

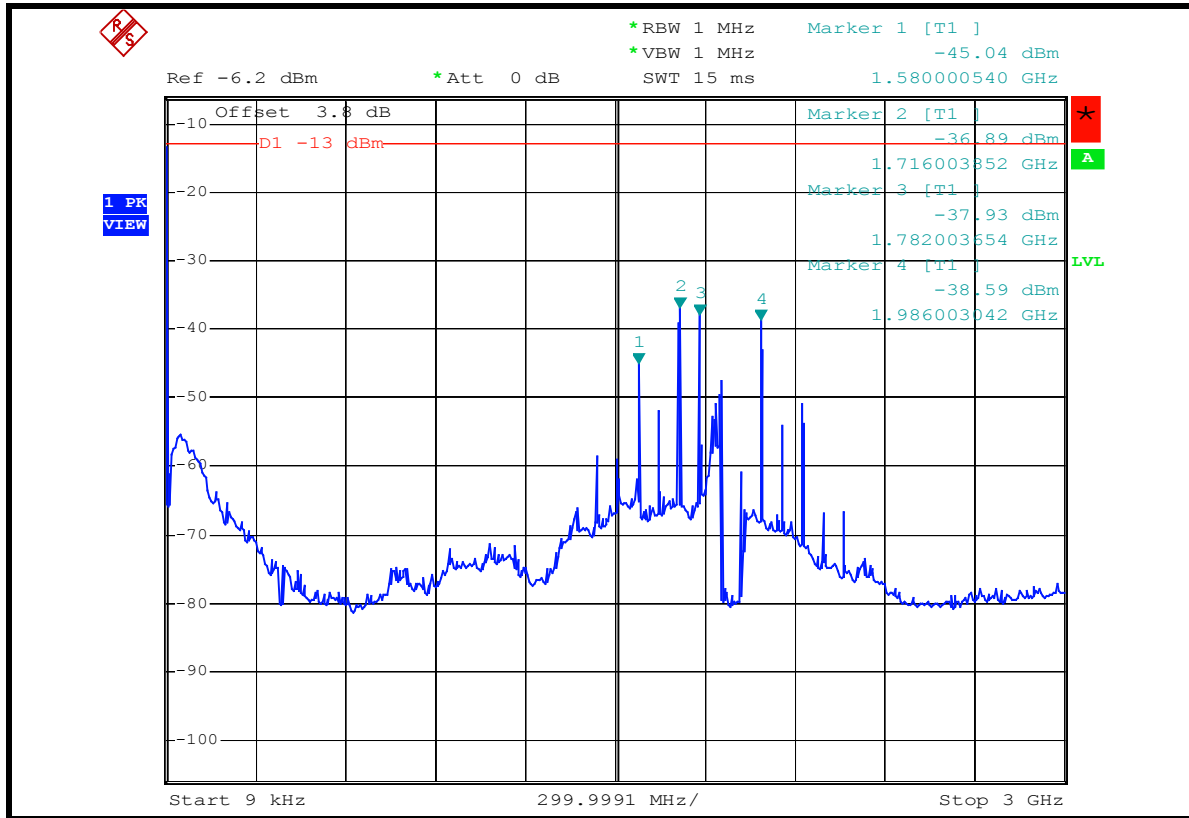



3GHz ~ 10GHz

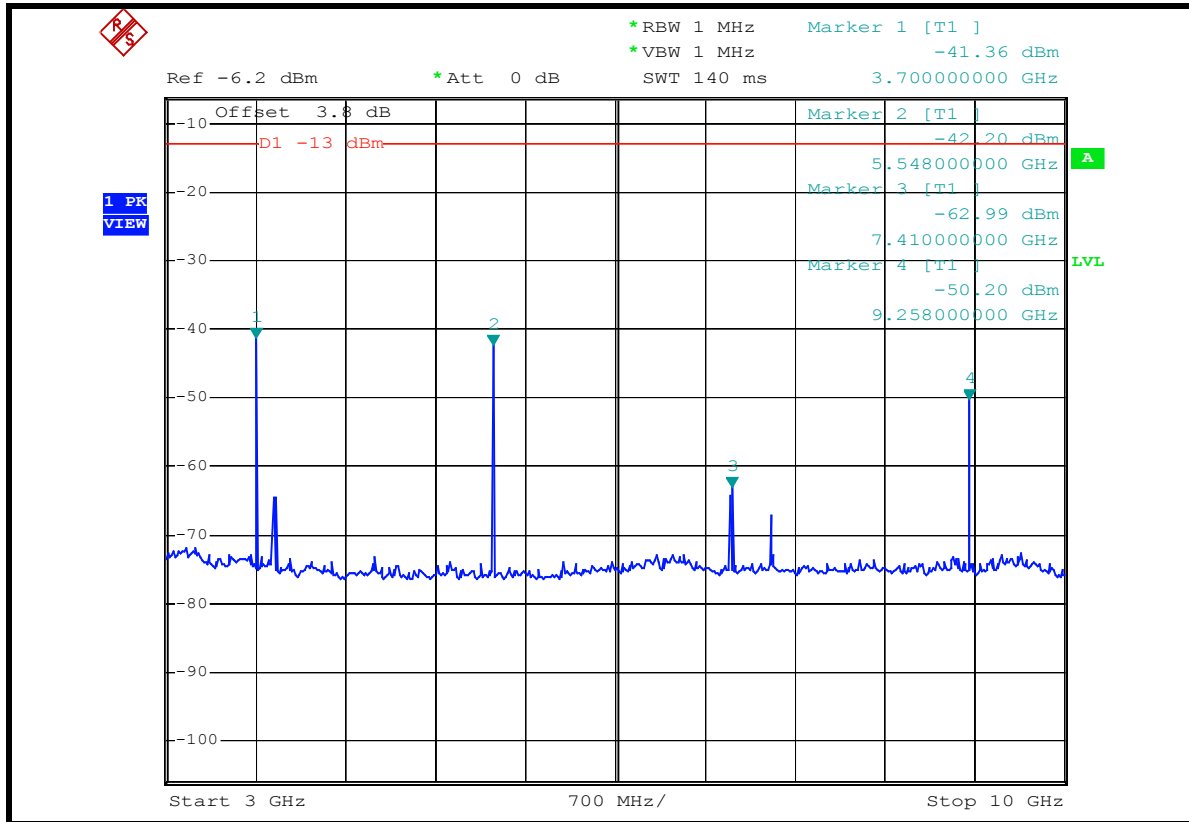

10GHz ~ 20GHz

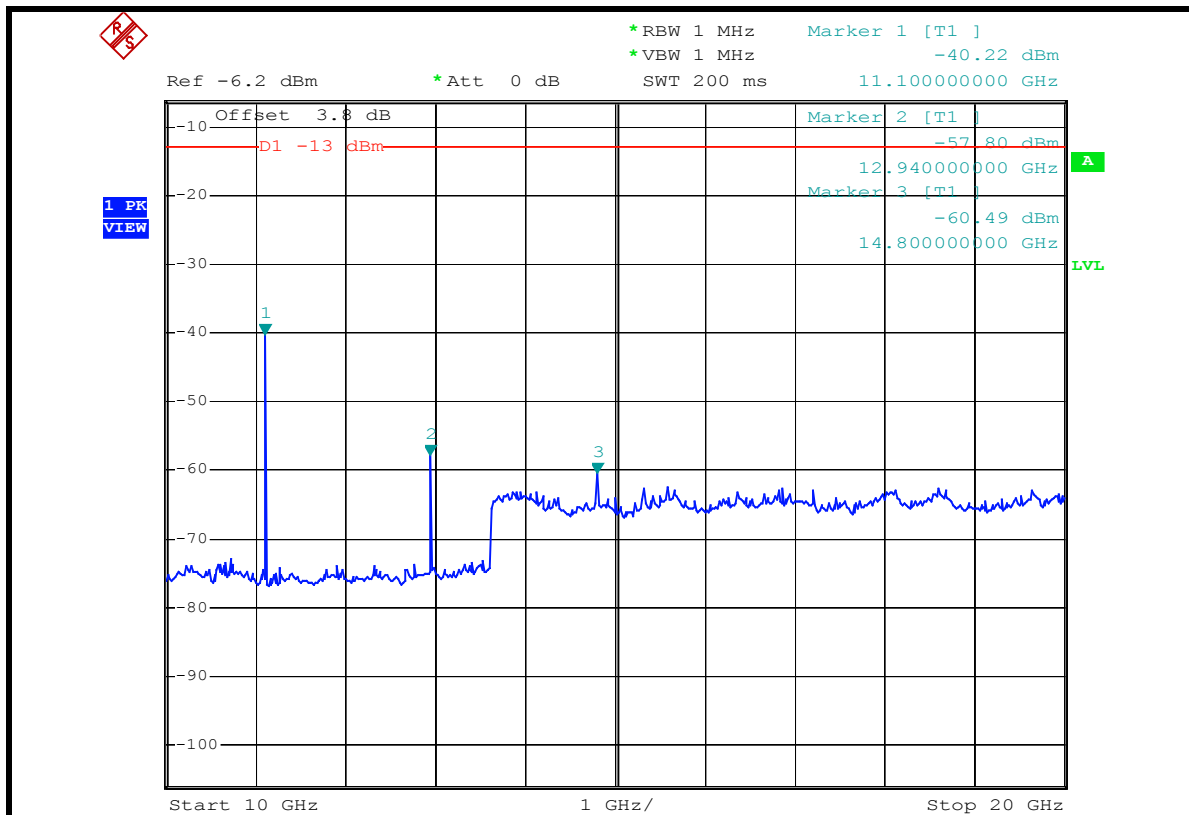



CH 661: 9kHz ~ 3GHz

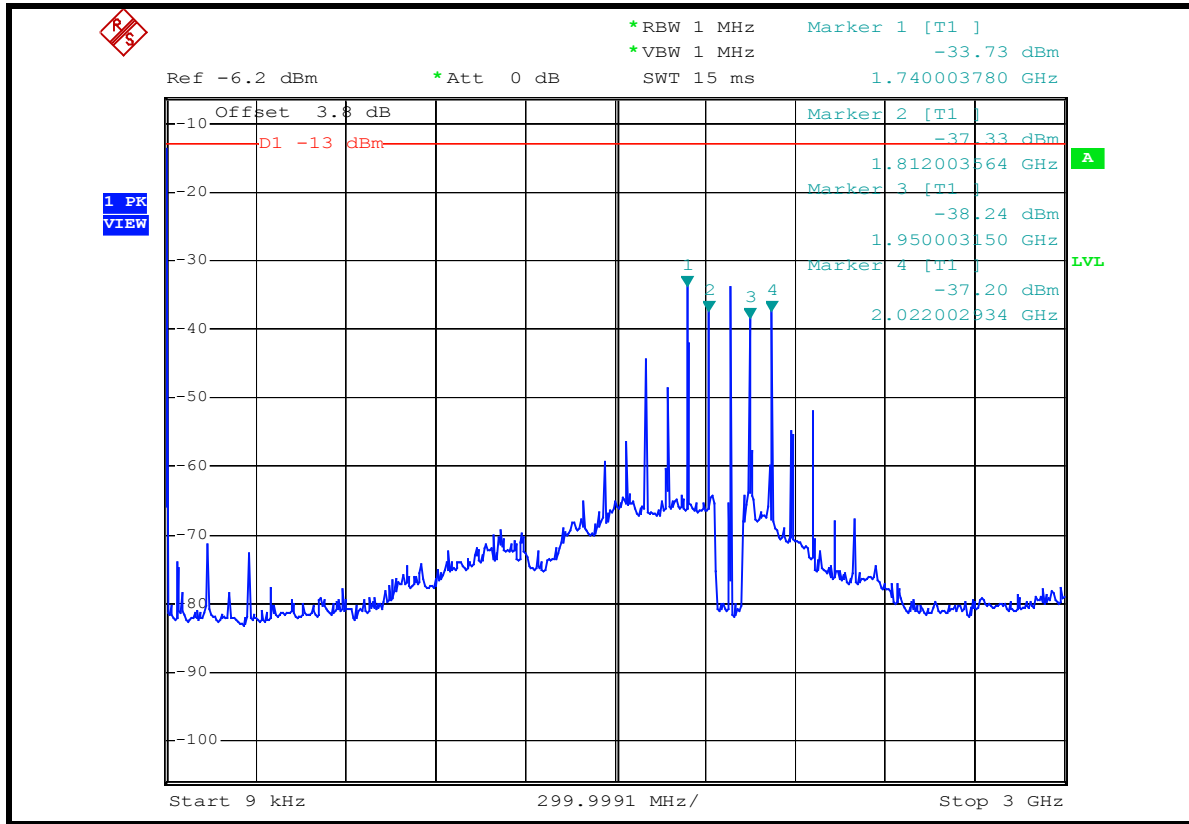



3GHz ~ 10GHz

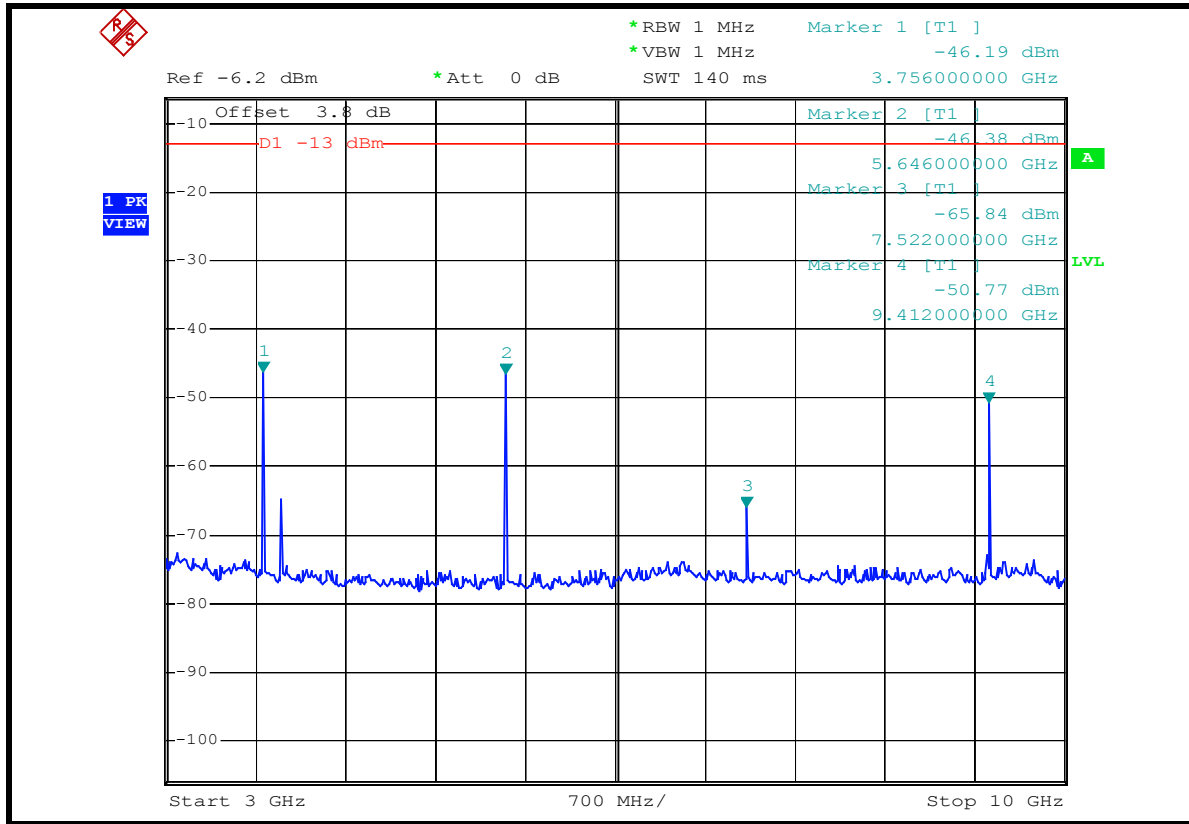

10GHz ~ 20GHz

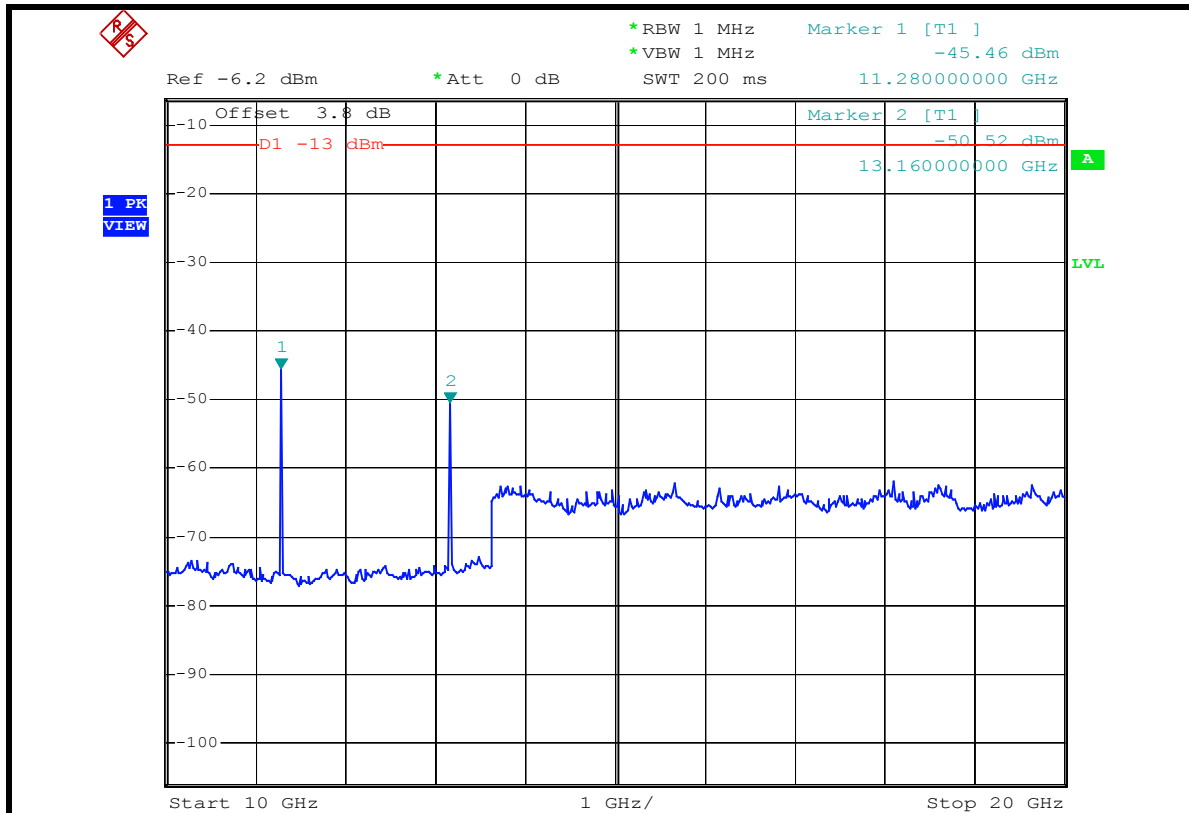



CH 810: 9kHz ~ 3GHz

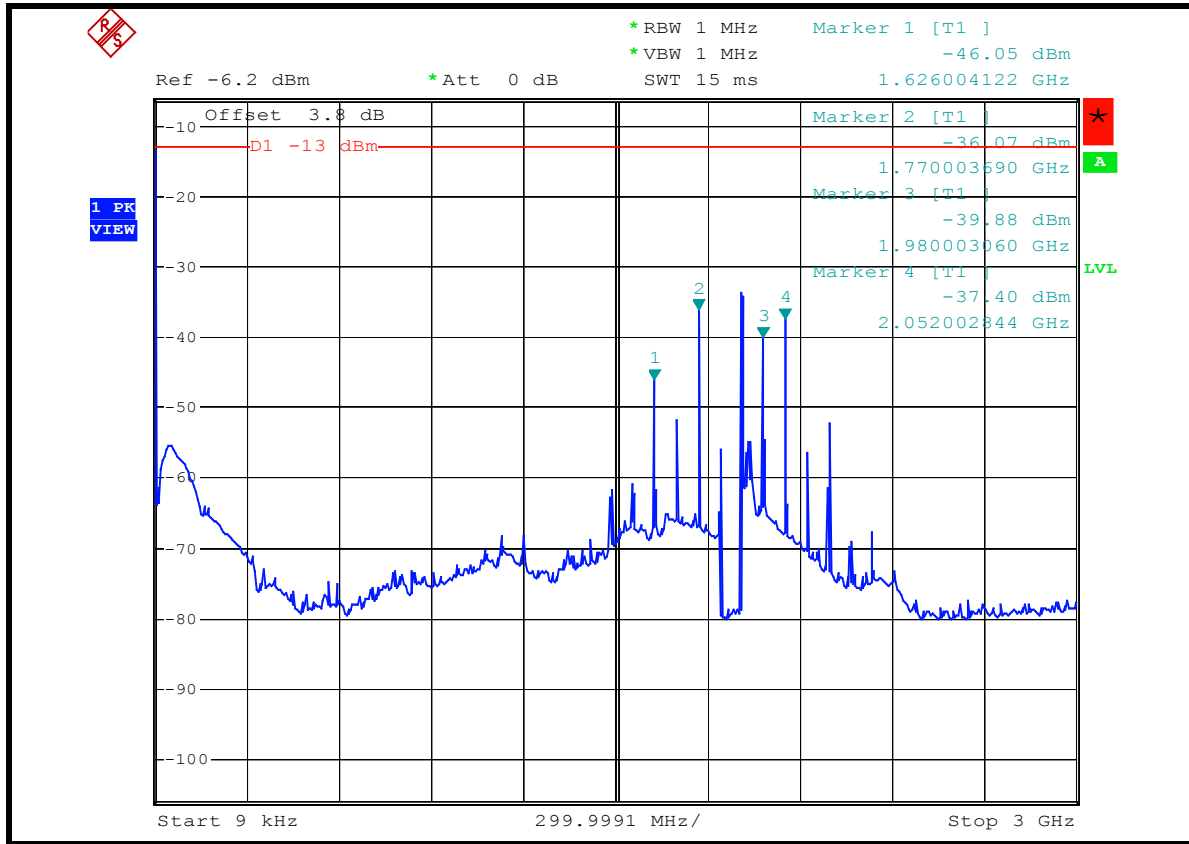



3GHz ~ 10GHz

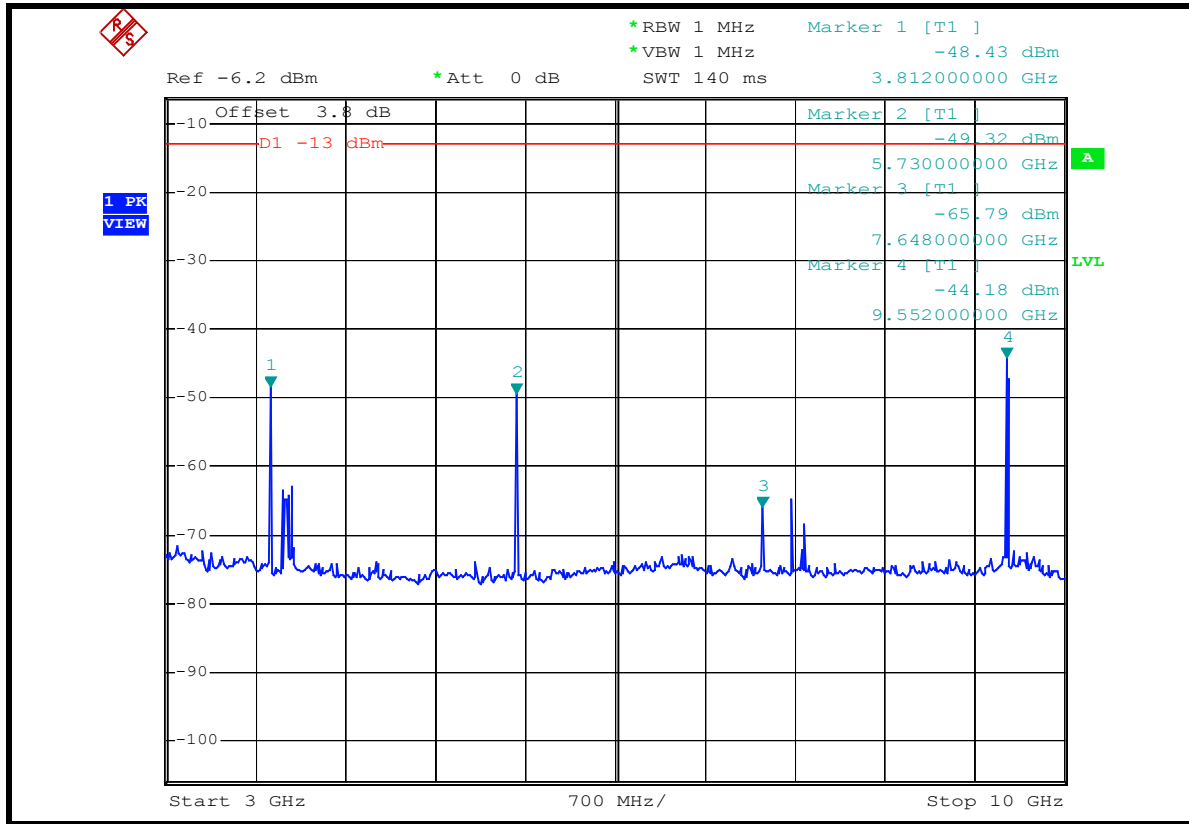

10GHz ~ 20GHz

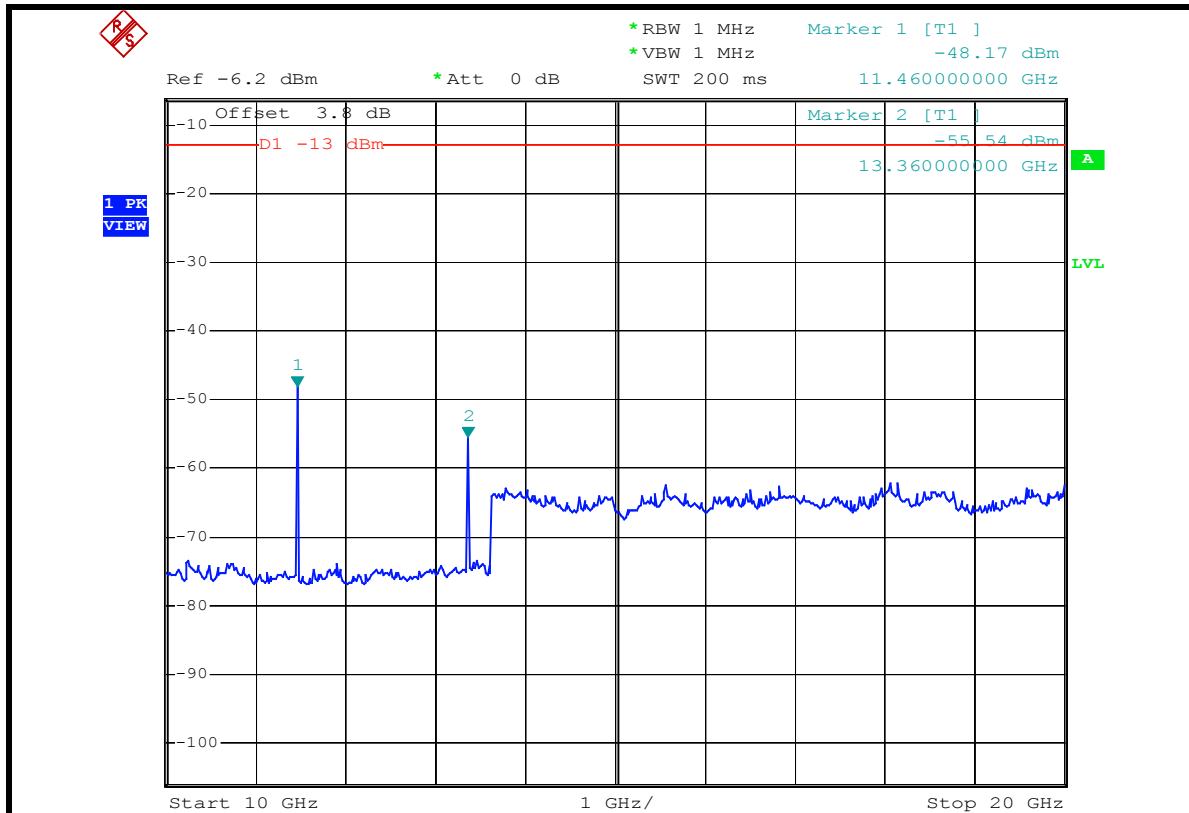



FOR GPRS MODE (UP-LINK WITH 2 TIME SLOTS)

CH 512: 9kHz ~ 3GHz

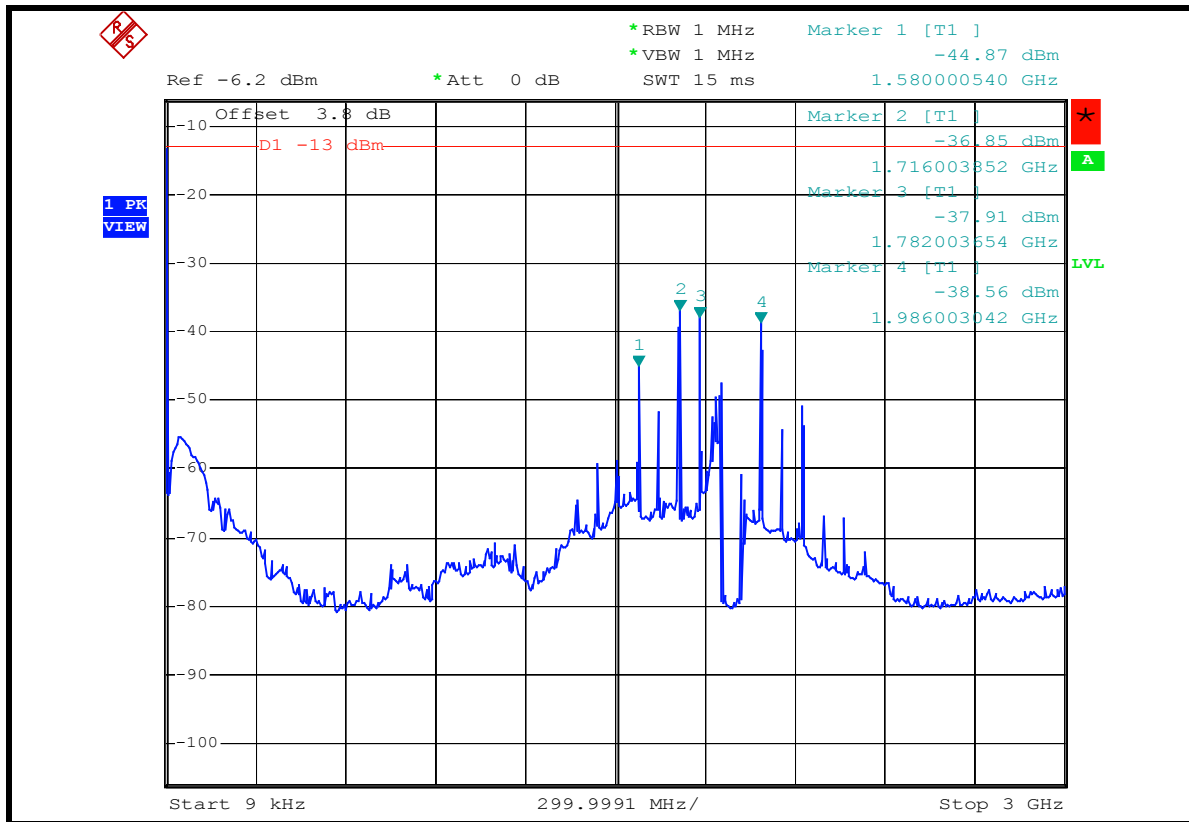



3GHz ~ 10GHz

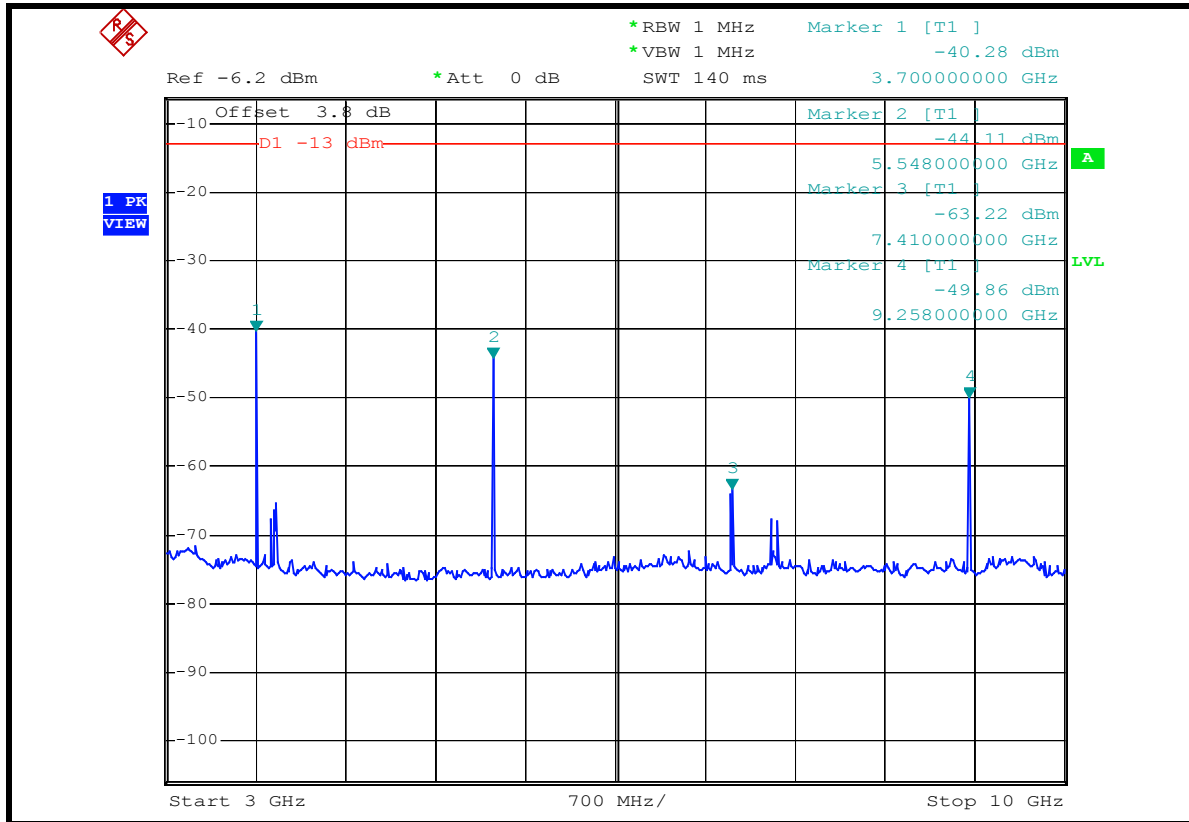

10GHz ~ 20GHz

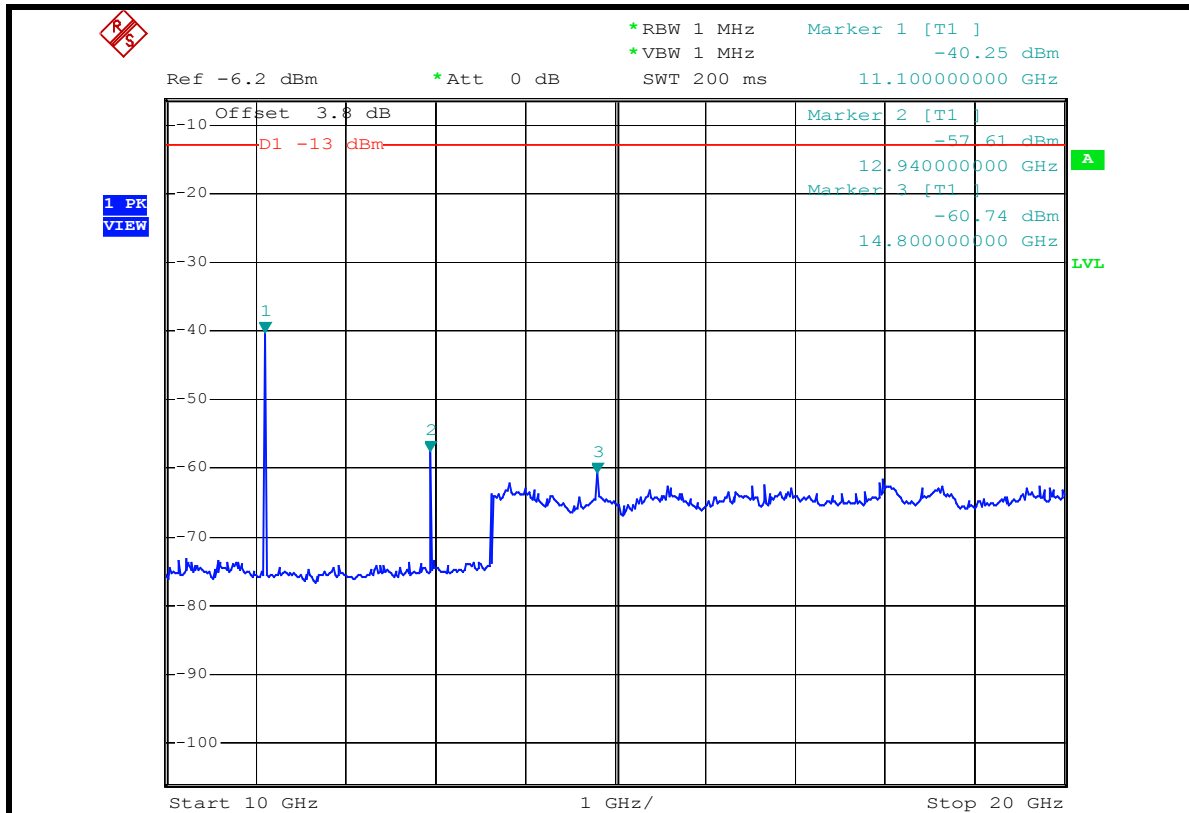



CH 661: 9kHz ~ 3GHz

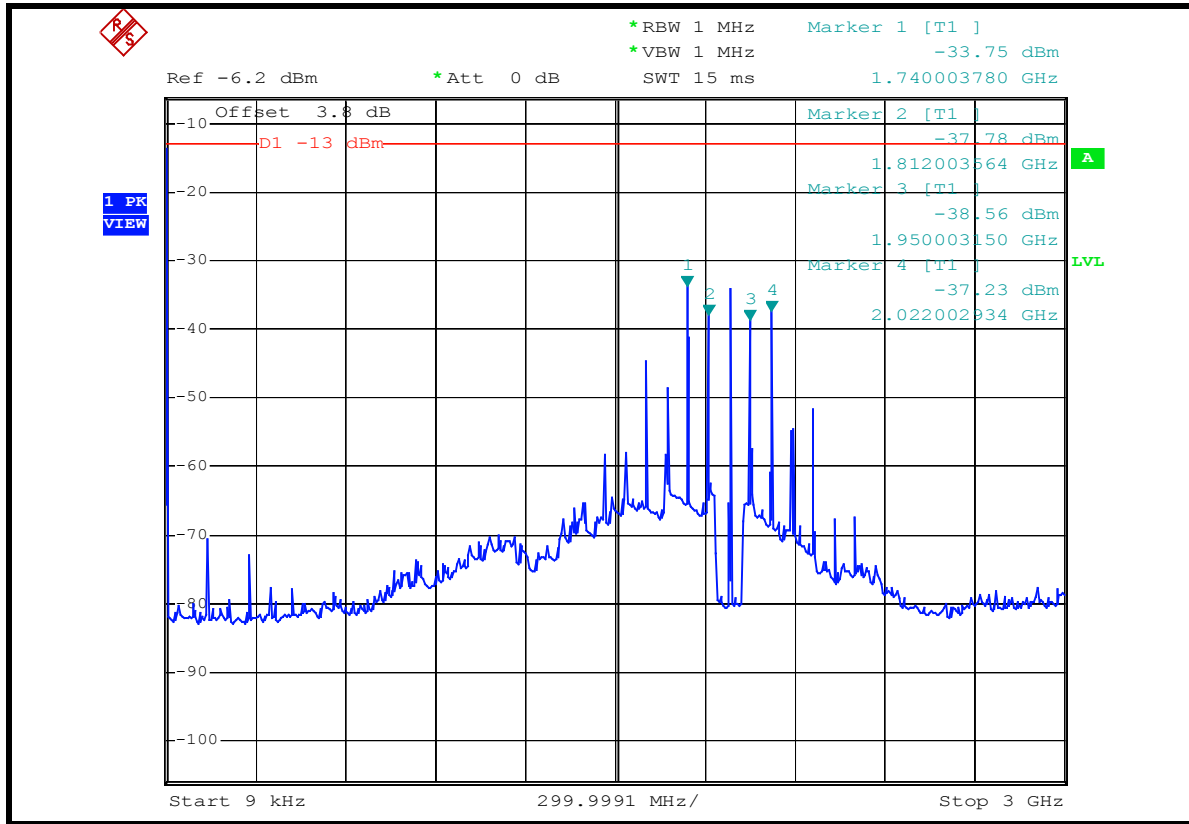



3GHz ~ 10GHz

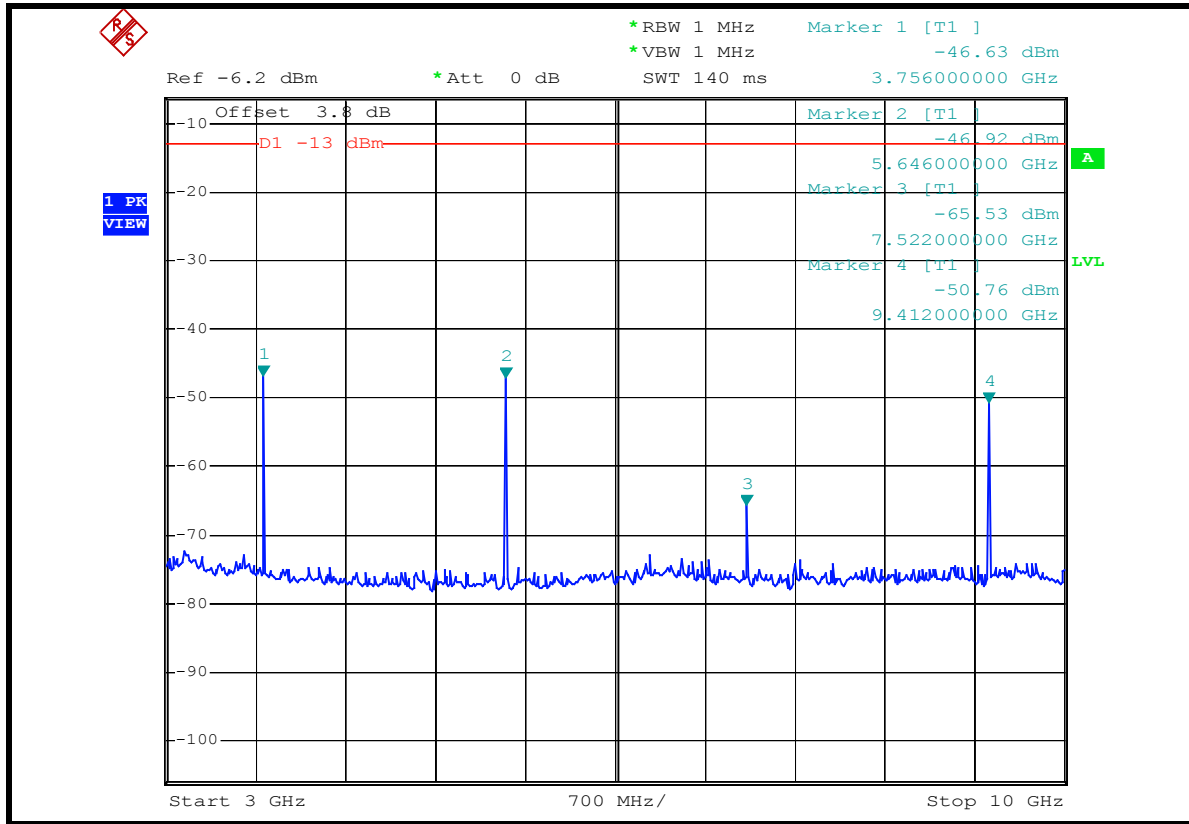

10GHz ~ 20GHz

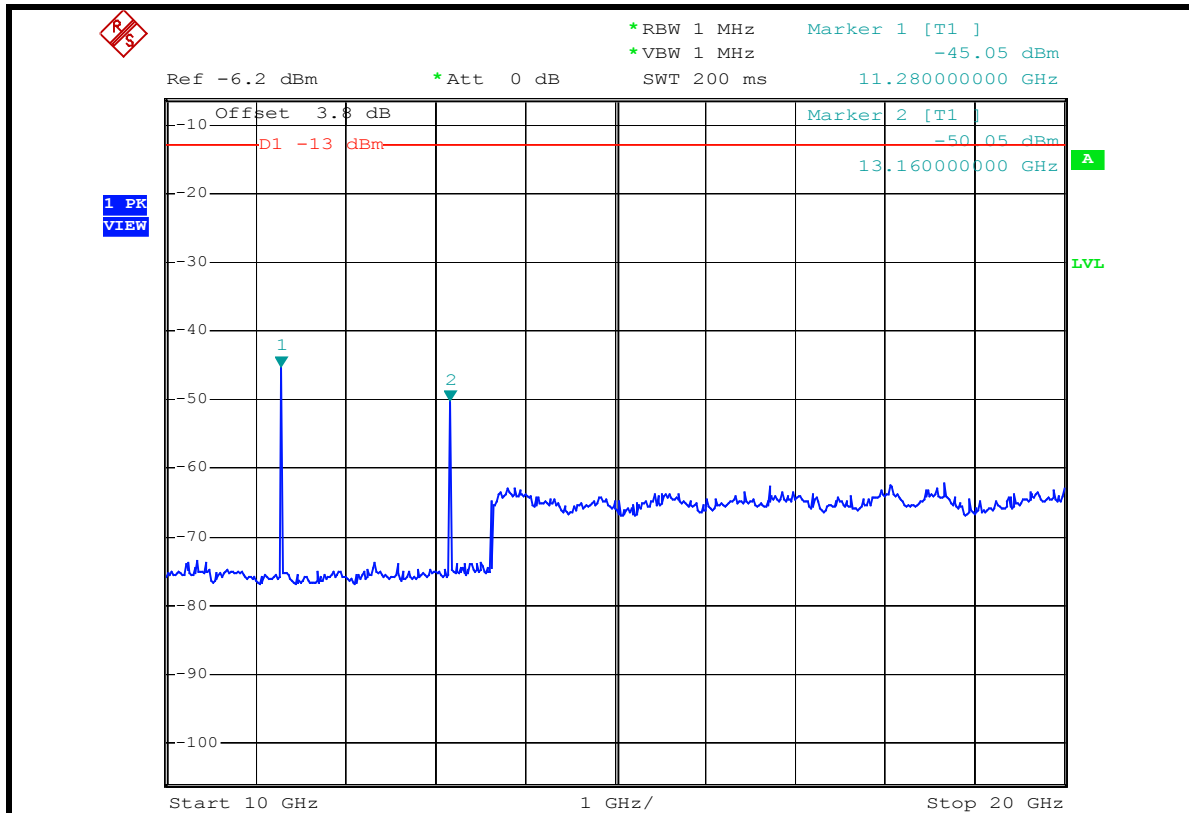



CH 810: 9kHz ~ 3GHz

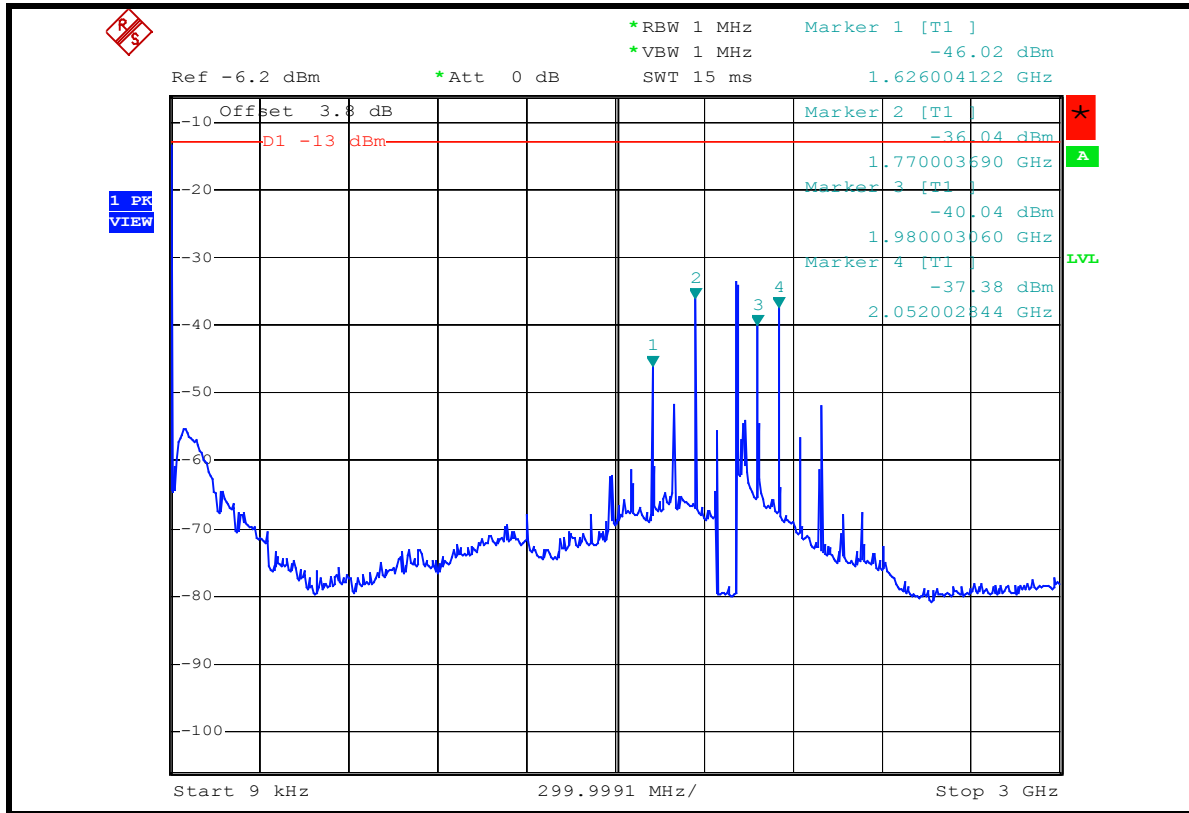



3GHz ~ 10GHz

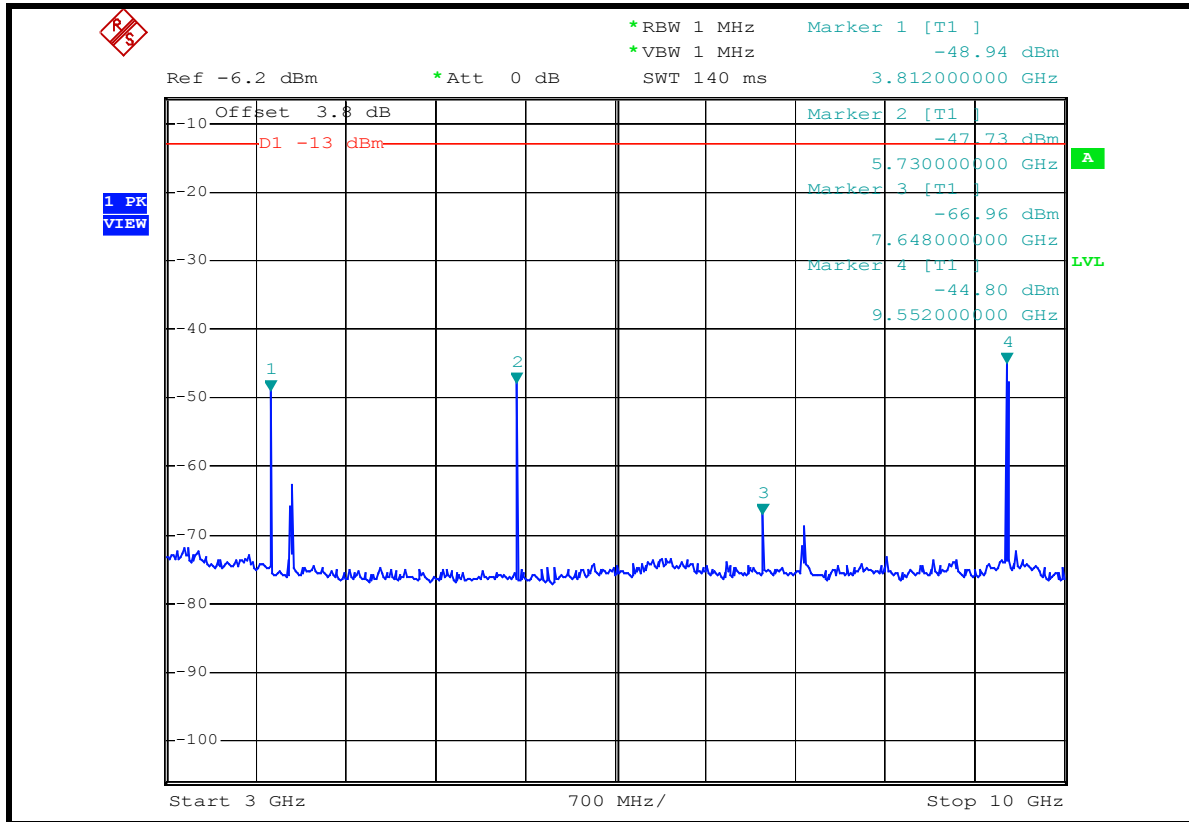

10GHz ~ 20GHz

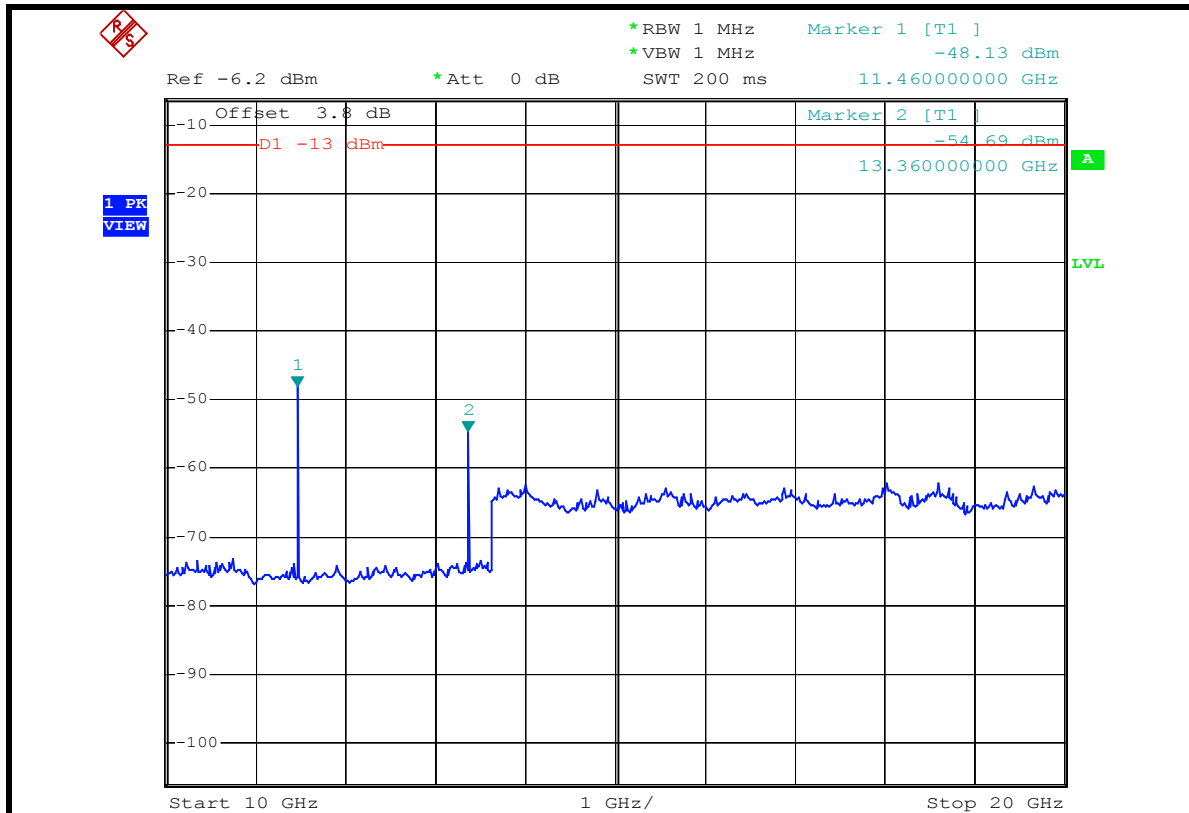



FOR E-GPRS MODE (UP-LINK WITH 2 TIME SLOTS)

CH 512: 9kHz ~ 3GHz

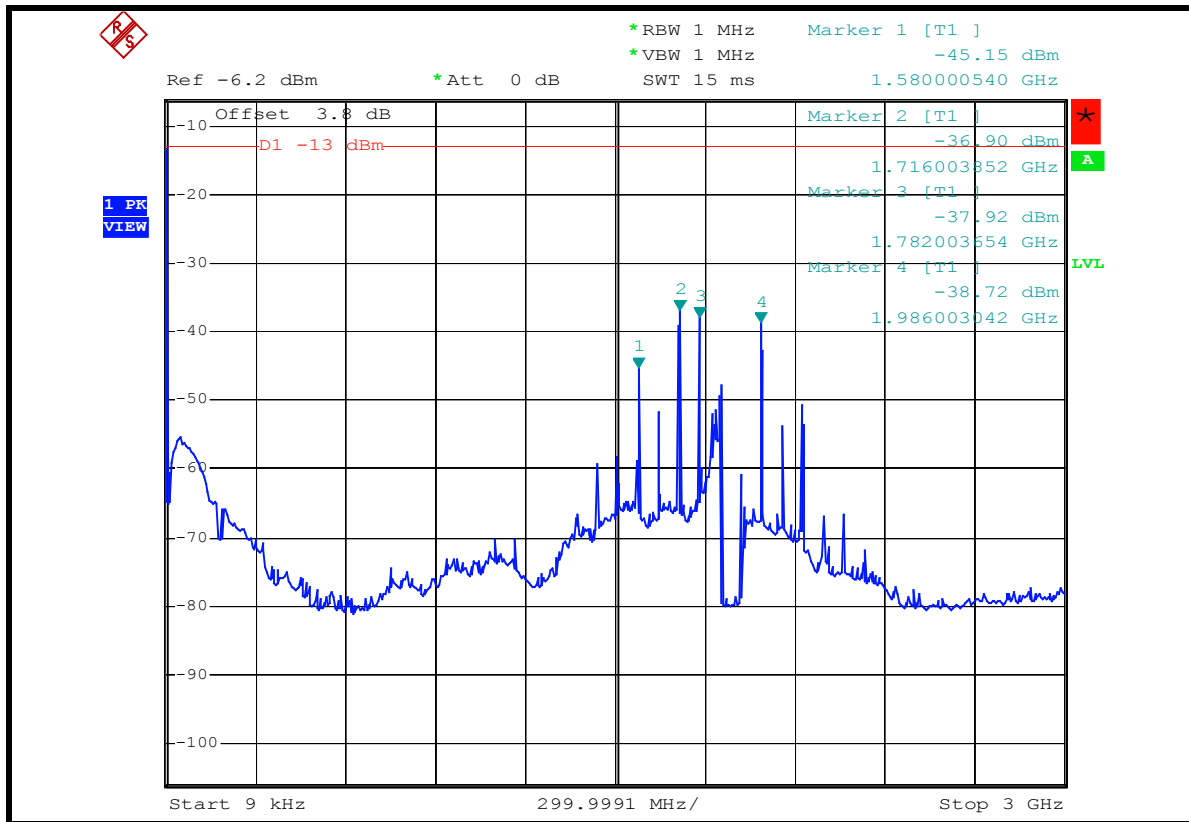



3GHz ~ 10GHz

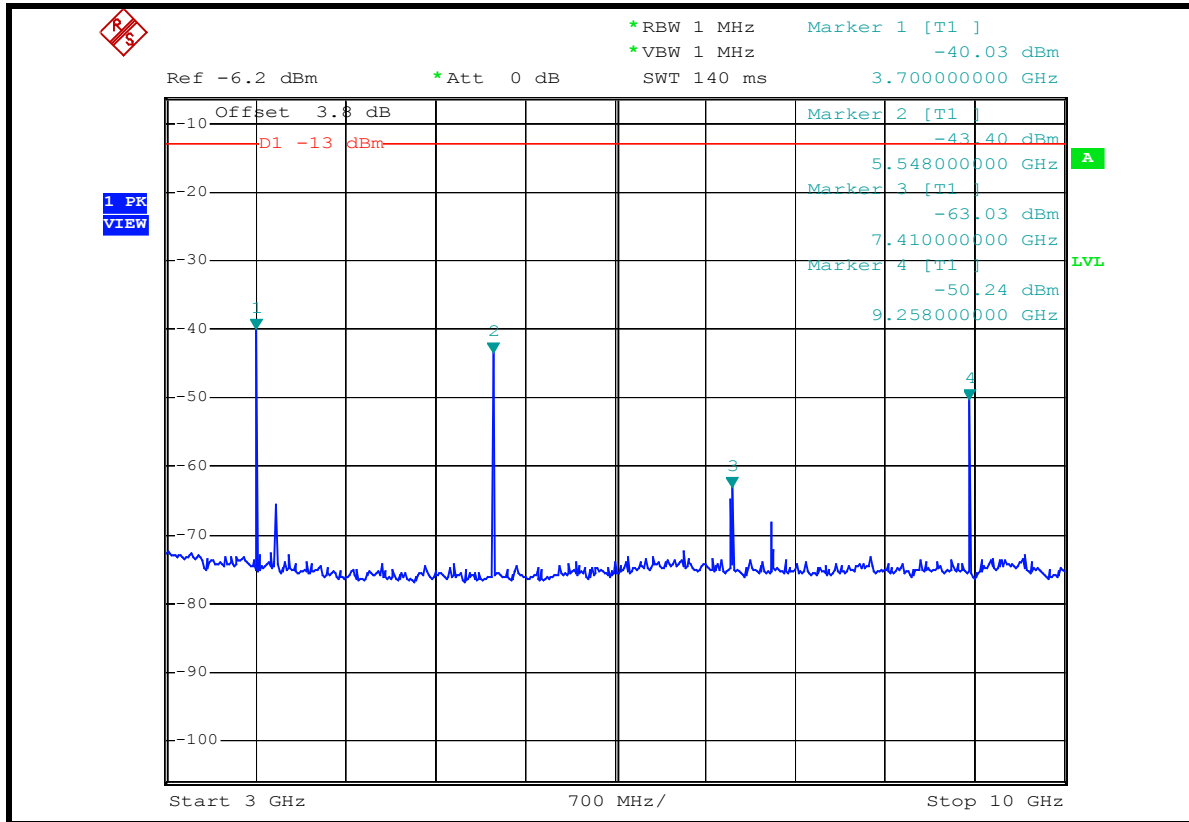

10GHz ~ 20GHz

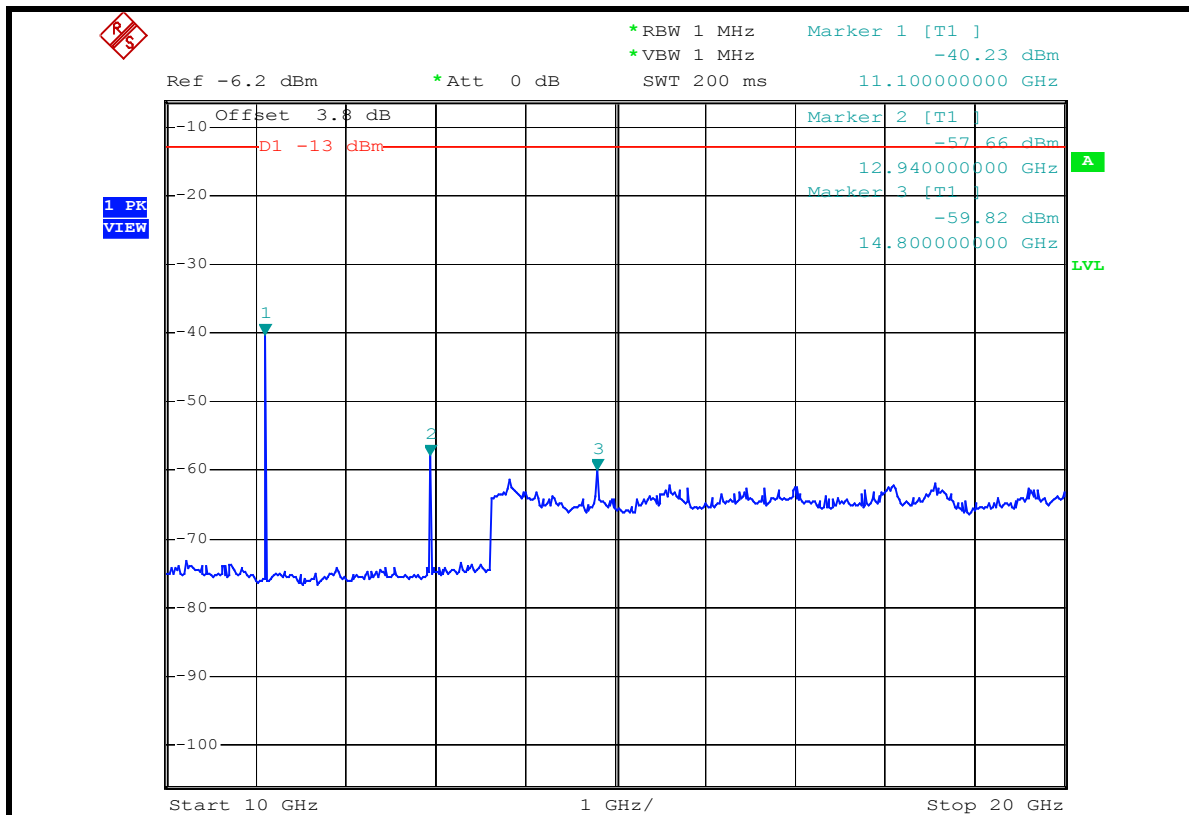



CH 661: 9kHz ~ 3GHz

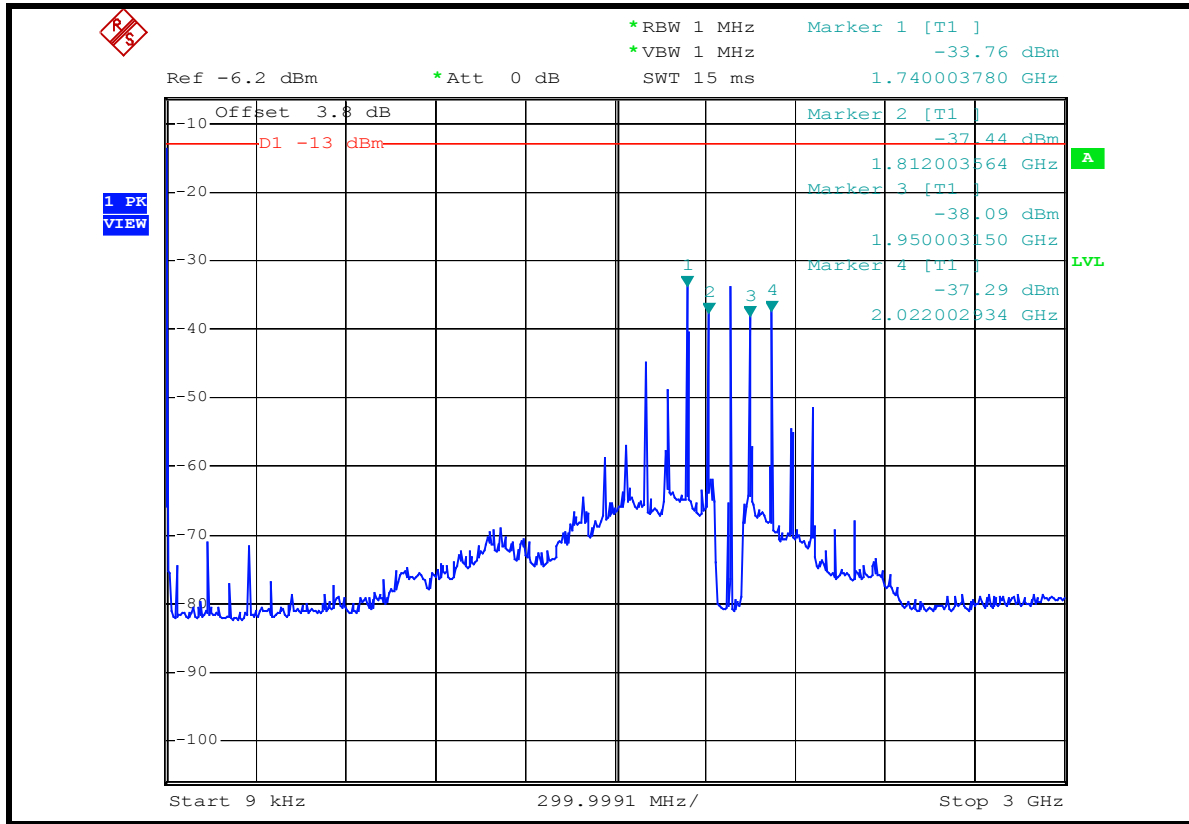



3GHz ~ 10GHz

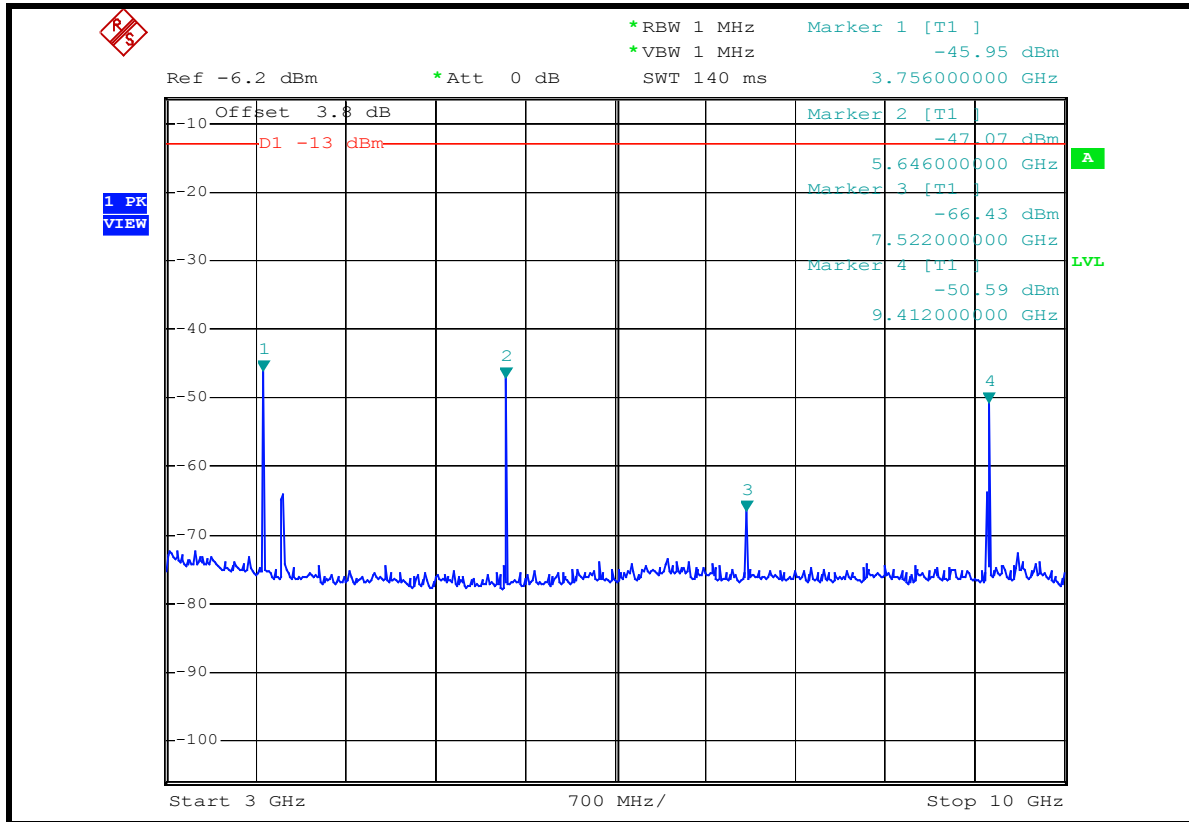

10GHz ~ 20GHz

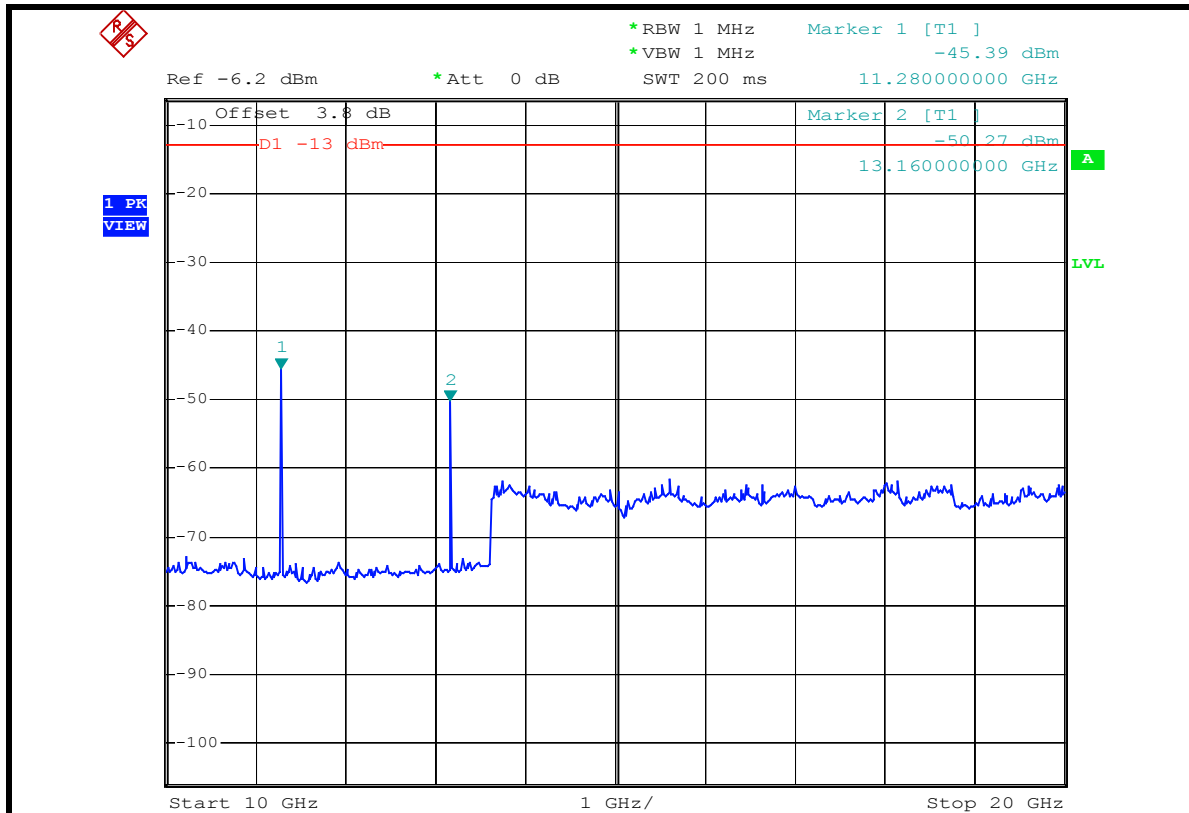



CH 810: 9kHz ~ 3GHz

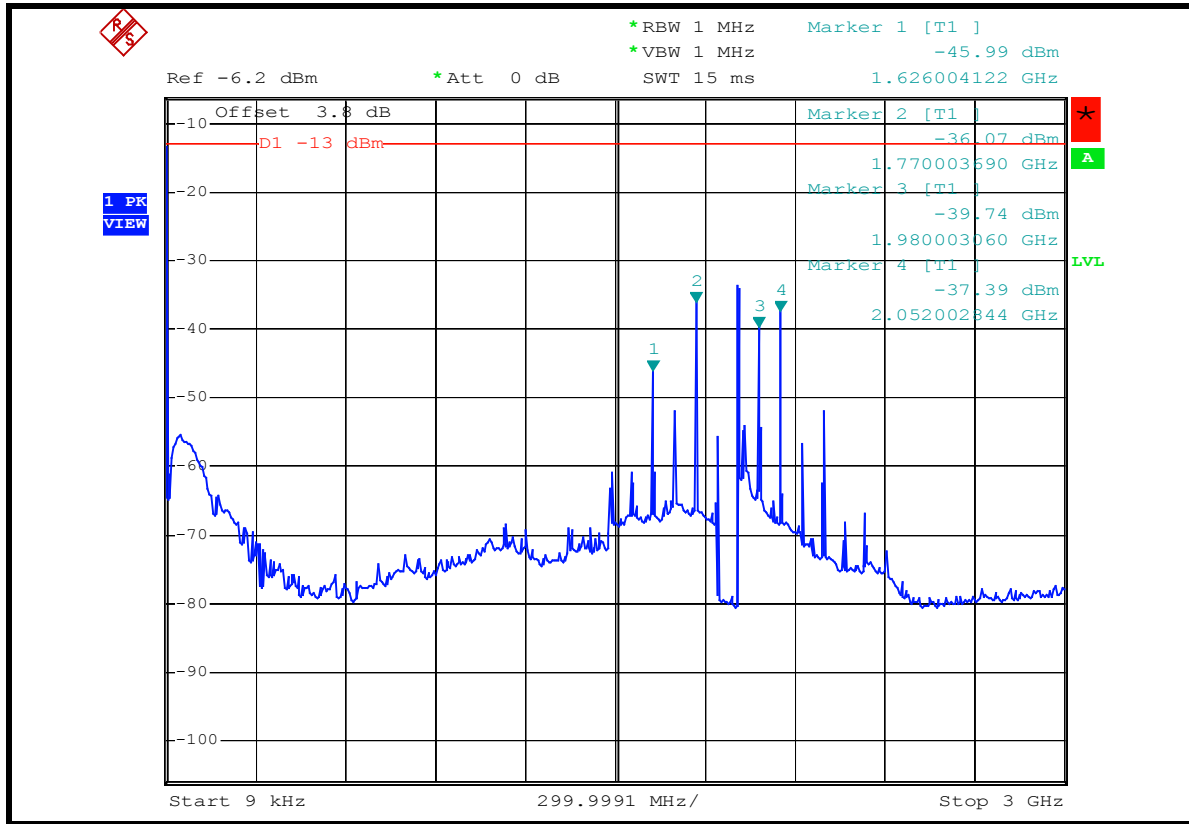



3GHz ~ 10GHz

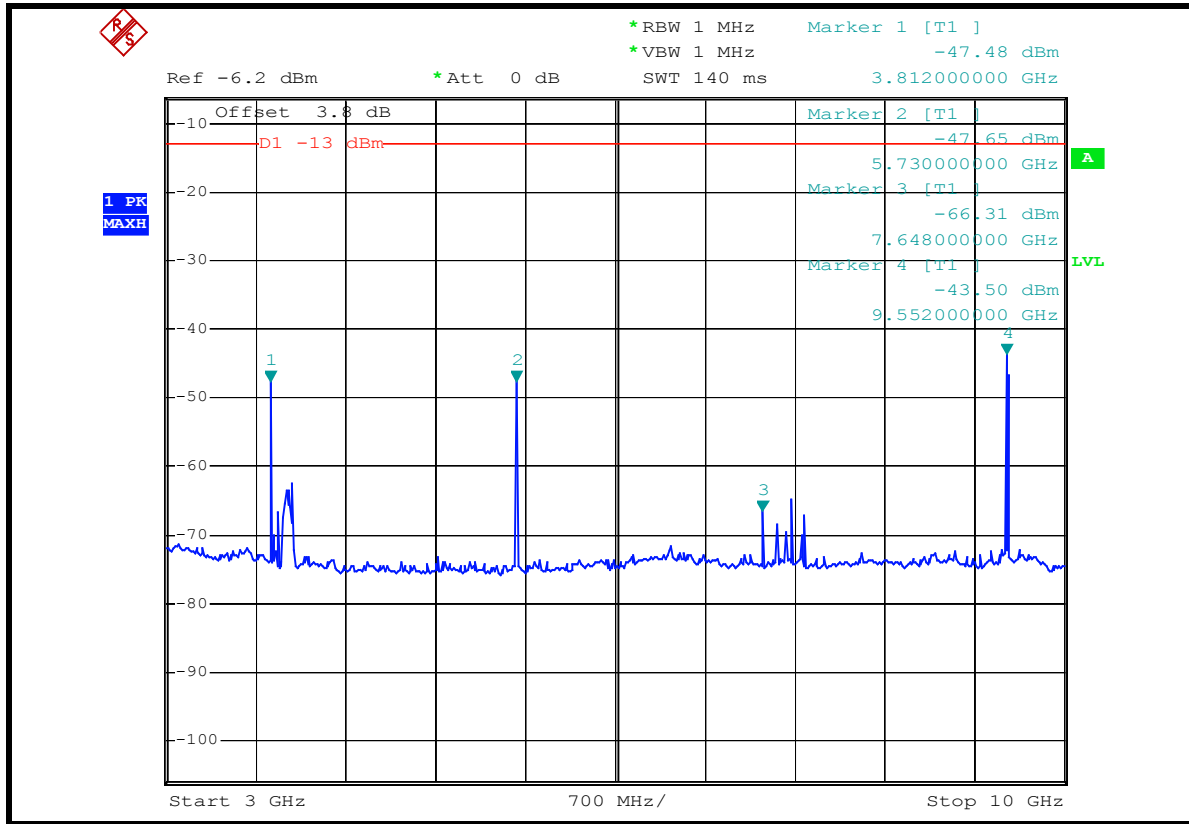

10GHz ~ 20GHz

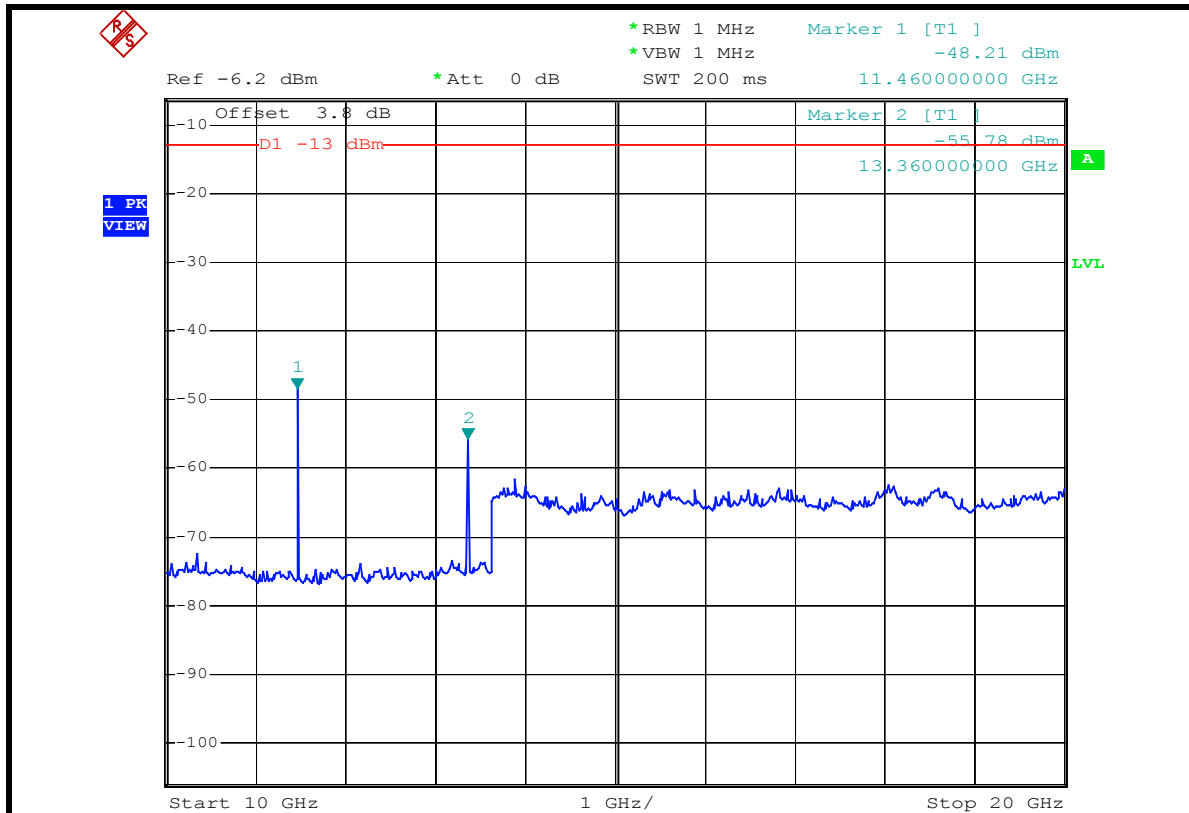

FOR GSM MODE (UP-LINK WITH 1 TIME SLOT)

EUT	Pocket PC Phone	MODEL	HSTNH-H06C-WL
MODE	TX channel 512	POWER CONTROL LEVEL	0
INPUT POWER (SYSTEM)	120Vac, 60 Hz	DETECTOR FUNCTION	Peak
ENVIRONMENTAL CONDITIONS	27deg. C, 60%RH, 991hPa	TESTED BY	Long Chen

CONDUCTED SPURIOUS EMISSION					
FREQUENCY (MHz)	CORRECTION FACTOR (dB)	S.A READING (dBm)	CONDUCTED LEVEL (dBm)	LIMIT (dBm)	MARGIN (dB)
1580	3.50	-45.04	-41.54	-13.00	-28.54
1716	3.72	-36.89	-33.17	-13.00	-20.17
1782	3.79	-37.93	-34.14	-13.00	-21.14
1986	3.81	-38.59	-34.78	-13.00	-21.78
3700	4.21	-41.36	-37.15	-13.00	-24.15
5548	4.32	-42.20	-37.88	-13.00	-24.88
7410	4.46	-62.99	-58.53	-13.00	-45.53
9258	4.52	-50.20	-45.68	-13.00	-32.68
11100	4.65	-40.22	-35.57	-13.00	-22.57
12940	5.05	-57.80	-52.75	-13.00	-39.75
14800	5.46	-60.49	-55.03	-13.00	-42.03

- REMARKS:** 1. Peak Output Power (dBm) = Raw Value (dBm) + Correction Factor (dB).
 2. Correction Factor (dB) = Power Splitter Loss (dB) + Cable Loss (dB).



EUT	Pocket PC Phone	MODEL	HSTNH-H06C-WL
MODE	TX channel 661	POWER CONTROL LEVEL	0
INPUT POWER (SYSTEM)	120Vac, 60 Hz	DETECTOR FUNCTION	Peak
ENVIRONMENTAL CONDITIONS	27deg. C, 60%RH, 991hPa	TESTED BY	Long Chen

CONDUCTED SPURIOUS EMISSION					
FREQUENCY (MHz)	CORRECTION FACTOR (dB)	S.A READING (dBm)	CONDUCTED LEVEL (dBm)	LIMIT (dBm)	MARGIN (dB)
1740	3.75	-33.73	-29.98	-13.00	-16.98
1812	3.79	-37.33	-33.54	-13.00	-20.54
1950	3.81	-38.24	-34.43	-13.00	-21.43
2022	3.83	-37.20	-33.37	-13.00	-20.37
3756	4.21	-46.19	-41.98	-13.00	-28.98
5646	4.34	-46.38	-42.04	-13.00	-29.04
7522	4.48	-65.84	-61.36	-13.00	-48.36
9412	4.55	-50.77	-46.22	-13.00	-33.22
11280	4.68	-45.46	-40.78	-13.00	-27.78
13160	5.16	-50.52	-45.36	-13.00	-32.36

- REMARKS:** 1. Peak Output Power (dBm) = Raw Value (dBm) + Correction Factor (dB).
 2. Correction Factor (dB) = Power Splitter Loss (dB) + Cable Loss (dB).



EUT	Pocket PC Phone	MODEL	HSTNH-H06C-WL
MODE	TX channel 810	POWER CONTROL LEVEL	0
INPUT POWER (SYSTEM)	120Vac, 60 Hz	DETECTOR FUNCTION	Peak
ENVIRONMENTAL CONDITIONS	27deg. C, 60%RH, 991hPa	TESTED BY	Long Chen

CONDUCTED SPURIOUS EMISSION					
FREQUENCY (MHz)	CORRECTION FACTOR (dB)	S.A READING (DbM)	CONDUCTED LEVEL (dBm)	LIMIT (dBm)	MARGIN (dB)
1626	3.53	-46.05	-42.52	-13.00	-29.52
1770	3.79	-36.07	-32.28	-13.00	-19.28
1980	3.81	-39.88	-36.07	-13.00	-23.07
2052	3.84	-37.40	-33.56	-13.00	-20.56
3812	4.23	-48.43	-44.20	-13.00	-31.20
5730	4.35	-49.32	-44.97	-13.00	-31.97
7648	4.51	-65.79	-61.28	-13.00	-48.28
9552	4.57	-44.18	-39.61	-13.00	-26.61
11460	4.71	-48.17	-43.46	-13.00	-30.46
13360	5.20	-55.54	-50.34	-13.00	-37.34

- REMARKS:** 1. Peak Output Power (dBm) = Raw Value (dBm) + Correction Factor (dB).
 2. Correction Factor (dB) = Power Splitter Loss (dB) + Cable Loss (dB).

FOR GPRS MODE (UP-LINK WITH 2 TIME SLOTS)

EUT	Pocket PC Phone	MODEL	HSTNH-H06C-WL
MODE	TX channel 512	POWER CONTROL LEVEL	0
INPUT POWER (SYSTEM)	120Vac, 60 Hz	DETECTOR FUNCTION	Peak
ENVIRONMENTAL CONDITIONS	27deg. C, 60%RH, 991hPa	TESTED BY	Long Chen

CONDUCTED SPURIOUS EMISSION					
FREQUENCY (MHz)	CORRECTION FACTOR (dB)	S.A READING (dBm)	CONDUCTED LEVEL (dBm)	LIMIT (dBm)	MARGIN (dB)
1580	3.50	-44.87	-41.37	-13.00	-28.37
1716	3.72	-36.85	-33.13	-13.00	-20.13
1782	3.79	-37.91	-34.12	-13.00	-21.12
1986	3.81	-38.56	-34.75	-13.00	-21.75
3700	4.21	-40.28	-36.07	-13.00	-23.07
5548	4.32	-44.11	-39.79	-13.00	-26.79
7410	4.46	-63.22	-58.76	-13.00	-45.76
9258	4.52	-49.86	-45.34	-13.00	-32.34
11100	4.65	-40.25	-35.60	-13.00	-22.60
12940	5.05	-57.61	-52.56	-13.00	-39.56
14800	5.46	-60.74	-55.28	-13.00	-42.28

- REMARKS:** 1. Peak Output Power (dBm) = Raw Value (dBm) + Correction Factor (dB).
 2. Correction Factor (dB) = Power Splitter Loss (dB) + Cable Loss (dB).



EUT	Pocket PC Phone	MODEL	HSTNH-H06C-WL
MODE	TX channel 661	POWER CONTROL LEVEL	0
INPUT POWER (SYSTEM)	120Vac, 60 Hz	DETECTOR FUNCTION	Peak
ENVIRONMENTAL CONDITIONS	27deg. C, 60%RH, 991hPa	TESTED BY	Long Chen

CONDUCTED SPURIOUS EMISSION					
FREQUENCY (MHz)	CORRECTION FACTOR (dB)	S.A READING (dBm)	CONDUCTED LEVEL (dBm)	LIMIT (dBm)	MARGIN (dB)
1740	3.75	-33.75	-30.00	-13.00	-17.00
1812	3.79	-37.78	-33.99	-13.00	-20.99
1950	3.81	-38.56	-34.75	-13.00	-21.75
2022	3.83	-37.23	-33.40	-13.00	-20.40
3756	4.21	-46.63	-42.42	-13.00	-29.42
5646	4.34	-46.92	-42.58	-13.00	-29.58
7522	4.48	-65.53	-61.05	-13.00	-48.05
9412	4.55	-50.76	-46.21	-13.00	-33.21
11280	4.68	-45.05	-40.37	-13.00	-27.37
13160	5.16	-50.05	-44.89	-13.00	-31.89

- REMARKS:** 1. Peak Output Power (dBm) = Raw Value (dBm) + Correction Factor (dB).
 2. Correction Factor (dB) = Power Splitter Loss (dB) + Cable Loss (dB).



EUT	Pocket PC Phone	MODEL	HSTNH-H06C-WL
MODE	TX channel 810	POWER CONTROL LEVEL	0
INPUT POWER (SYSTEM)	120Vac, 60 Hz	DETECTOR FUNCTION	Peak
ENVIRONMENTAL CONDITIONS	27deg. C, 60%RH, 991hPa	TESTED BY	Long Chen

CONDUCTED SPURIOUS EMISSION					
FREQUENCY (MHz)	CORRECTION FACTOR (dB)	S.A READING (dBm)	CONDUCTED LEVEL (dBm)	LIMIT (dBm)	MARGIN (dB)
1626	3.53	-46.02	-42.49	-13.00	-29.49
1770	3.79	-36.04	-32.25	-13.00	-19.25
1980	3.81	-40.04	-36.23	-13.00	-23.23
2052	3.84	-37.38	-33.54	-13.00	-20.54
3812	4.23	-48.94	-53.17	-13.00	-40.17
5730	4.35	-47.73	-43.38	-13.00	-30.38
7648	4.51	-66.96	-62.45	-13.00	-49.45
9552	4.57	-44.80	-40.23	-13.00	-27.23
11460	4.71	-48.13	-43.42	-13.00	-30.42
13360	5.20	-54.69	-49.49	-13.00	-36.49

- REMARKS:** 1. Peak Output Power (dBm) = Raw Value (dBm) + Correction Factor (dB).
 2. Correction Factor (dB) = Power Splitter Loss (dB) + Cable Loss (dB).

FOR E-GPRS MODE (UP-LINK WITH 2 TIME SLOTS)

EUT	Pocket PC Phone	MODEL	HSTNH-H06C-WL
MODE	TX channel 512	POWER CONTROL LEVEL	0
INPUT POWER (SYSTEM)	120Vac, 60 Hz	DETECTOR FUNCTION	Peak
ENVIRONMENTAL CONDITIONS	27deg. C, 60%RH, 991hPa	TESTED BY	Long Chen

CONDUCTED SPURIOUS EMISSION					
FREQUENCY (MHz)	CORRECTION FACTOR (dB)	S.A READING (dBm)	CONDUCTED LEVEL (dBm)	LIMIT (dBm)	MARGIN (dB)
1580	3.50	-45.15	-41.65	-13.00	-28.65
1716	3.72	-36.90	-33.18	-13.00	-20.18
1782	3.79	-37.92	-34.13	-13.00	-21.13
1986	3.81	-38.72	-34.91	-13.00	-21.91
3700	4.21	-40.03	-35.82	-13.00	-22.82
5548	4.32	-43.40	-39.08	-13.00	-26.08
7410	4.46	-63.03	-58.57	-13.00	-45.57
9258	4.52	-50.24	-45.72	-13.00	-32.72
11100	4.65	-40.23	-35.58	-13.00	-22.58
12940	5.05	-57.66	-52.61	-13.00	-39.61
14800	5.46	-59.82	-54.36	-13.00	-41.36

- REMARKS:** 1. Peak Output Power (dBm) = Raw Value (dBm) + Correction Factor (dB).
 2. Correction Factor (dB) = Power Splitter Loss (dB) + Cable Loss (dB).



EUT	Pocket PC Phone	MODEL	HSTNH-H06C-WL
MODE	TX channel 661	POWER CONTROL LEVEL	0
INPUT POWER (SYSTEM)	120Vac, 60 Hz	DETECTOR FUNCTION	Peak
ENVIRONMENTAL CONDITIONS	27deg. C, 60%RH, 991hPa	TESTED BY	Long Chen

CONDUCTED SPURIOUS EMISSION					
FREQUENCY (MHz)	CORRECTION FACTOR (dB)	S.A READING (dBm)	CONDUCTED LEVEL (dBm)	LIMIT (dBm)	MARGIN (dB)
1740	3.75	-33.76	-30.01	-13.00	-17.01
1812	3.79	-37.44	-33.65	-13.00	-20.65
1950	3.81	-38.09	-34.28	-13.00	-21.28
2022	3.83	-37.29	-33.46	-13.00	-20.46
3756	4.21	-45.95	-41.74	-13.00	-28.74
5646	4.34	-47.07	-42.73	-13.00	-29.73
7522	4.48	-66.43	-61.95	-13.00	-48.95
9412	4.55	-50.59	-46.04	-13.00	-33.04
11280	4.68	-45.39	-40.71	-13.00	-27.71
13160	5.16	-50.27	-45.11	-13.00	-32.11

- REMARKS:** 1. Peak Output Power (dBm) = Raw Value (dBm) + Correction Factor (dB).
 2. Correction Factor (dB) = Power Splitter Loss (dB) + Cable Loss (dB).



EUT	Pocket PC Phone	MODEL	HSTNH-H06C-WL
MODE	TX channel 810	POWER CONTROL LEVEL	0
INPUT POWER (SYSTEM)	120Vac, 60 Hz	DETECTOR FUNCTION	Peak
ENVIRONMENTAL CONDITIONS	27deg. C, 60%RH, 991hPa	TESTED BY	Long Chen

CONDUCTED SPURIOUS EMISSION					
FREQUENCY (MHz)	CORRECTION FACTOR (dB)	S.A READING (dBm)	CONDUCTED LEVEL (dBm)	LIMIT (dBm)	MARGIN (dB)
1626	3.53	-45.99	-42.46	-13.00	-29.46
1770	3.79	-36.07	-32.28	-13.00	-19.28
1980	3.81	-39.74	-35.93	-13.00	-22.93
2052	3.84	-37.39	-33.55	-13.00	-20.55
3812	4.23	-47.48	-43.25	-13.00	-30.25
5730	4.35	-47.65	-43.30	-13.00	-30.30
7648	4.51	-66.31	-61.80	-13.00	-48.80
9552	4.57	-43.50	-38.93	-13.00	-25.93
11460	4.71	-48.21	-43.50	-13.00	-30.50
13360	5.20	-55.78	-50.58	-13.00	-37.58

- REMARKS:** 1. Peak Output Power (dBm) = Raw Value (dBm) + Correction Factor (dB).
 2. Correction Factor (dB) = Power Splitter Loss (dB) + Cable Loss (dB).



4.7 RADIATED EMISSION MEASUREMENT (BELOW 1GHz)

4.7.1 LIMITS OF RADIATED EMISSION MEASUREMENT

In the FCC 24.238(a), On any frequency outside a licensee's frequency block within USPCS spectrum, the power of any emission shall be attenuated below the transmitter power (P) by at least $43 + 10 \log (P)$ dB. The limit translates in the relevant power range (1 to 0.001W). At 1W(Power Control Level 0) the specified minimum attenuation becomes 43dB and the limit of emission equal to -13dBm . At 0.001W(Power Control Level 15) the specified minimum attenuation becomes 13dB and the emission of limit equal to -13dBm . So the limit of emission is the same absolute specified line.



4.7.2 TEST INSTRUMENTS

DESCRIPTION & MANUFACTURER	MODEL NO.	SERIAL NO.	CALIBRATED UNTIL
Test Receiver ROHDE & SCHWARZ	ESI7	838496/016	Jan. 07, 2006
Spectrum Analyzer ROHDE & SCHWARZ	FSP40	100041	Nov. 29, 2005
BILOG Antenna SCHWARZBECK	VULB9168	9168-155	Jan. 22, 2006
HORN Antenna SCHWARZBECK	BBHA 9120D	9120D-404	Jan. 05, 2006
HORN Antenna SCHWARZBECK	BBHA 9170	BBHA 9170242	Jan. 23, 2006
Preamplifier Agilent	8447D	2944A10631	Nov. 17, 2005
Preamplifier Agilent	8449B	3008A01960	Nov. 14, 2005
RF signal cable HUBER+SUHNNER	SUCOFLEX 104	219272/4	Jan. 26, 2006
RF signal cable HUBER+SUHNNER	SUCOFLEX 104	219275/4	Jan. 26, 2006
Software ADT.	ADT_Radiated_V5.14	NA	NA
Antenna Tower inn-co GmbH	MA 4000	010303	NA
Antenna Tower Controller inn-co GmbH	CO2000	019303	NA
Turn Table ADT.	TT100.	TT93021704	NA
Turn Table Controller ADT.	SC100.	SC93021704	NA

- NOTE:**
1. The calibration interval of the above test instruments is 12 months and the calibrations are traceable to NML/ROC and NIST/USA.
 2. The test was performed in HwaYa Chamber 3.
 3. The horn antenna and HP preamplifier (model: 8449B) are used only for the measurement of emission frequency above 1GHz if tested.
 4. The IC Site Registration No. is IC4924-4.



4.7.3 TEST PROCEDURES

- a. The EUT was placed on the top of a rotating table 0.8 meters above the ground. The table was rotated 360 degrees to determine the position of the highest radiation.
- b. The EUT was set 3 meters away from the receiving antenna, which was mounted on antenna tower and its position at 0.8 m above the ground.
- c. For each suspected emission, the EUT was arranged to its worst case and the rotatable table was turned from 0 degrees to 360 degrees to find the maximum reading and recorded the value.
- d. Repeat step a ~ c for horizontal polarization.

NOTE: 1. The resolution bandwidth of spectrum analyzer is 10 kHz and the video bandwidth is 300 kHz for spurious emission below 1GHz.
2. The resolution bandwidth of spectrum analyzer is 1 MHz and the video bandwidth is 3 MHz for spurious emission above 1GHz.

4.7.4 DEVIATION FROM TEST STANDARD

No deviation

4.7.5 TEST SETUP

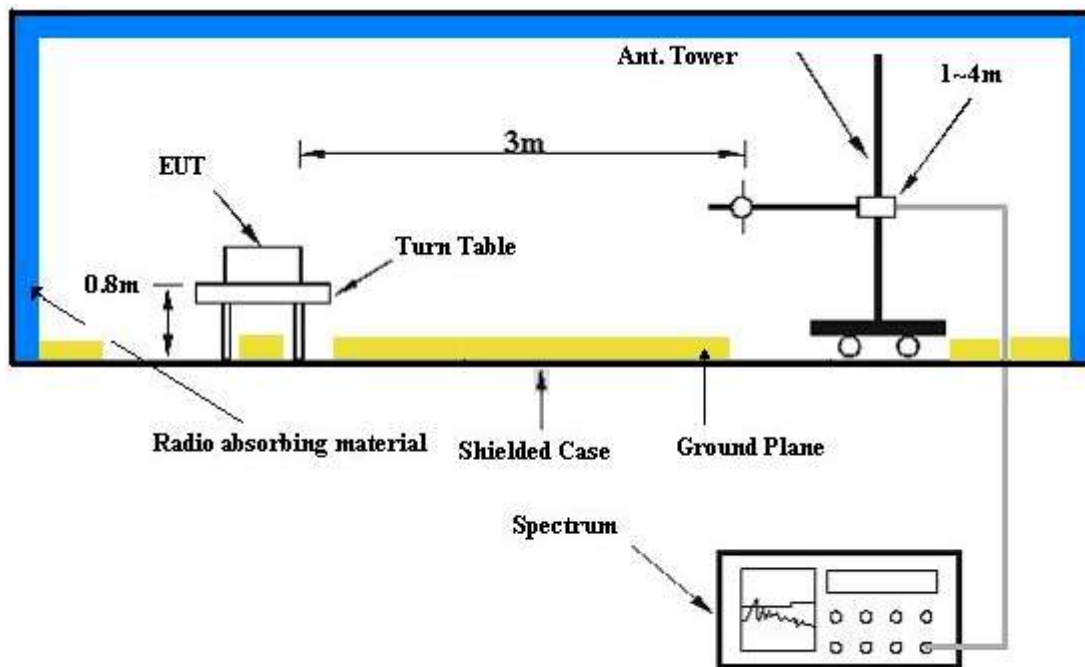

For the actual test configuration, please refer to the related item – Photographs of the Test Configuration.

4.7.6 EUT OPERATING CONDITIONS

- The notebook system makes a phone call to the GSM simulator.
- The GSM simulator station system controlled an EUT to export maximum output power under transmission mode and specific channel frequency.

4.7.7 TEST RESULTS

FOR GSM MODE (UP-LINK WITH 1 TIME SLOT)

EUT	Pocket PC Phone	MODEL	HSTNH-H06C-WL
MODE	TX channel 512	TEST CONDITION	A
FREQUENCY RANGE	Below 1000 MHz	DETECTOR FUNCTION	Quasi-Peak
INPUT POWER (SYSTEM)	120Vac, 60 Hz	ENVIRONMENTAL CONDITIONS	24deg. C, 66%RH, 991hPa
TESTED BY	Brad Wu		

EMISSION LIMIT		
MODE	MAXIMUM EMISSION LEVEL (FUNDAMENTAL FREQUENCY)	EMISSION LIMIT (UNWANTED EMISSION)
GSM	125.62 dBuV/m	82.62 dBuV/m

REMARK: Emission limit = Maximum emission level (dBuV/m) – 43dB

ANTENNA POLARITY & TEST DISTANCE: HORIZONTAL AT 3 M								
No.	Freq. (MHz)	Emission Level (dBuV/m)	Limit (dBuV/m)	Margin (dB)	Antenna Height (m)	Table Angle (Degree)	Raw Value (dBuV)	Correction Factor (dB/m)
1	39.70	31.29 QP	82.62	-51.33	1.00 H	189	16.04	15.25
2	100.01	31.03 QP	82.62	-51.59	1.00 H	24	20.12	10.91
3	138.88	32.65 QP	82.62	-49.97	1.00 H	66	18.30	14.35
4	171.87	28.73 QP	82.62	-53.89	1.25 H	236	15.00	13.73
5	399.31	29.14 QP	82.62	-53.48	1.00 H	174	12.43	16.71
6	945.54	34.87 QP	82.62	-50.75	1.25 H	29	9.59	25.28

ANTENNA POLARITY & TEST DISTANCE: VERTICAL AT 3 M								
No.	Freq. (MHz)	Emission Level (dBuV/m)	Limit (dBuV/m)	Margin (dB)	Antenna Height (m)	Table Angle (Degree)	Raw Value (dBuV)	Correction Factor (dB/m)
1	31.94	28.68 QP	82.62	-53.94	1.00 V	247	14.67	14.01
2	70.89	26.11 QP	82.62	-56.51	1.25 V	211	13.86	12.25
3	115.56	28.76 QP	82.62	-53.86	1.00 V	119	16.33	12.43
4	162.20	33.42 QP	82.62	-49.20	1.00 V	258	18.70	14.72
5	731.70	28.03 QP	82.62	-54.59	1.25 V	220	5.24	22.79
6	865.91	28.47 QP	82.62	-54.15	1.50 V	330	4.27	24.20

NOTE:

1. Emission level (dBuV/m) = Raw Value (dBuV) + Correction Factor (dB).
2. Correction Factor (dB/m) = Antenna Factor (dB/m) + Cable Factor (dB).
3. The other emission levels were very low against the limit.
4. Margin value = Emission level – Limit value.
5. This is valid for all 3 channels.

FOR GPRS MODE (UP-LINK WITH 2 TIME SLOTS)

EUT	Pocket PC Phone	MODEL	HSTNH-H06C-WL
MODE	TX channel 512	TEST CONDITION	A
FREQUENCY RANGE	Below 1000 MHz	DETECTOR FUNCTION	Quasi-Peak
INPUT POWER (SYSTEM)	120Vac, 60 Hz	ENVIRONMENTAL CONDITIONS	24deg. C, 66%RH, 991hPa
TESTED BY	Brad Wu		

EMISSION LIMIT		
MODE	MAXIMUM EMISSION LEVEL (FUNDAMENTAL FREQUENCY)	EMISSION LIMIT (UNWANTED EMISSION)
GPRS	125.68 dBuV/m	82.68 dBuV/m

REMARK: Emission limit = Maximum emission level (dBuV/m) – 43dB

ANTENNA POLARITY & TEST DISTANCE: HORIZONTAL AT 3 M								
No.	Freq. (MHz)	Emission Level (dBuV/m)	Limit (dBuV/m)	Margin (dB)	Antenna Height (m)	Table Angle (Degree)	Raw Value (dBuV)	Correction Factor (dB/m)
1	39.83	32.44 QP	82.68	-50.24	1.00 H	217	17.17	15.27
2	100.35	31.69 QP	82.68	-50.99	1.00 H	44	20.75	10.94
3	139.45	33.24 QP	82.68	-49.44	1.00 H	68	18.84	14.40
4	172.09	29.01 QP	82.68	-53.67	1.25 H	36	15.30	13.71
5	400.03	30.13 QP	82.68	-52.55	1.50 H	114	13.40	16.73
6	945.66	34.99 QP	82.68	-47.69	1.00 H	70	9.71	25.28

ANTENNA POLARITY & TEST DISTANCE: VERTICAL AT 3 M								
No.	Freq. (MHz)	Emission Level (dBuV/m)	Limit (dBuV/m)	Margin (dB)	Antenna Height (m)	Table Angle (Degree)	Raw Value (dBuV)	Correction Factor (dB/m)
1	31.91	28.55 QP	82.68	-54.13	1.00 V	217	14.55	14.00
2	70.88	26.23 QP	82.68	-56.45	1.25 V	291	13.98	12.25
3	115.62	29.14 QP	82.68	-53.54	1.00 V	140	16.71	12.43
4	162.27	33.84 QP	82.68	-48.84	1.00 V	221	19.13	14.71
5	731.83	28.16 QP	82.68	-54.52	1.00 V	338	5.37	22.79
6	865.76	29.14 QP	82.68	-53.54	1.00 V	302	4.95	24.19

NOTE:

1. Emission level (dBuV/m) = Raw Value (dBuV) + Correction Factor (dB).
2. Correction Factor (dB/m) = Antenna Factor (dB/m) + Cable Factor (dB).
3. The other emission levels were very low against the limit.
4. Margin value = Emission level – Limit value.
5. This is valid for all 3 channels.



FOR E-GPRS MODE (UP-LINK WITH 2 TIME SLOTS)

EUT	Pocket PC Phone	MODEL	HSTNH-H06C-WL
MODE	TX channel 512	TEST CONDITION	A
FREQUENCY RANGE	Below 1000 MHz	DETECTOR FUNCTION	Quasi-Peak
INPUT POWER (SYSTEM)	120Vac, 60 Hz	ENVIRONMENTAL CONDITIONS	24deg. C, 66%RH, 991hPa
TESTED BY	Brad Wu		

EMISSION LIMIT		
MODE	MAXIMUM EMISSION LEVEL (FUNDAMENTAL FREQUENCY)	EMISSION LIMIT (UNWANTED EMISSION)
E-GPRS	126.65 dBuV/m	83.65 dBuV/m

REMARK: Emission limit = Maximum emission level (dBuV/m) – 43dB

ANTENNA POLARITY & TEST DISTANCE: HORIZONTAL AT 3 M								
No.	Freq. (MHz)	Emission Level (dBuV/m)	Limit (dBuV/m)	Margin (dB)	Antenna Height (m)	Table Angle (Degree)	Raw Value (dBuV)	Correction Factor (dB/m)
1	41.31	31.59 QP	83.65	-52.06	1.00 H	218	16.26	15.33
2	101.18	31.69 QP	83.65	-51.96	1.00 H	27	20.66	11.03
3	138.92	33.24 QP	83.65	-50.41	1.00 H	206	18.89	14.35
4	172.75	30.24 QP	83.65	-53.41	1.00 H	216	16.60	13.64
5	400.40	28.87 QP	83.65	-54.78	1.00 H	102	12.13	16.74
6	946.45	35.47 QP	83.65	-48.18	1.25 H	100	10.18	25.29

ANTENNA POLARITY & TEST DISTANCE: VERTICAL AT 3 M								
No.	Freq. (MHz)	Emission Level (dBuV/m)	Limit (dBuV/m)	Margin (dB)	Antenna Height (m)	Table Angle (Degree)	Raw Value (dBuV)	Correction Factor (dB/m)
1	31.25	28.32 QP	83.65	-55.33	1.25 V	227	14.43	13.89
2	71.38	27.45 QP	83.65	-56.20	1.00 V	204	15.33	12.12
3	115.62	29.62 QP	83.65	-54.03	1.00 V	183	17.19	12.43
4	163.92	34.23 QP	83.65	-49.42	1.25 V	234	19.69	14.54
5	731.89	28.04 QP	83.65	-55.61	1.50 V	178	5.25	22.79
6	866.21	28.45 QP	83.65	-55.20	1.25 V	312	4.25	24.20

NOTE:

1. Emission level (dBuV/m) = Raw Value (dBuV) + Correction Factor (dB).
2. Correction Factor (dB/m) = Antenna Factor (dB/m) + Cable Factor (dB).
3. The other emission levels were very low against the limit.
4. Margin value = Emission level – Limit value.
5. This is valid for all 3 channels.

FOR GSM MODE (UP-LINK WITH 1 TIME SLOT)

EUT	Pocket PC Phone	MODEL	HSTNH-H06C-WL
MODE	TX channel 512	TEST CONDITION	B
FREQUENCY RANGE	Below 1000 MHz	DETECTOR FUNCTION	Quasi-Peak
INPUT POWER (SYSTEM)	120Vac, 60 Hz	ENVIRONMENTAL CONDITIONS	27deg. C, 65%RH, 991hPa
TESTED BY	Match Tsui		

EMISSION LIMIT		
MODE	MAXIMUM EMISSION LEVEL (FUNDAMENTAL FREQUENCY)	EMISSION LIMIT (UNWANTED EMISSION)
GSM	125.62 dBuV/m	82.62 dBuV/m

REMARK: Emission limit = Maximum emission level (dBuV/m) – 43dB

ANTENNA POLARITY & TEST DISTANCE: HORIZONTAL AT 3 M								
No.	Freq. (MHz)	Emission Level (dBuV/m)	Limit (dBuV/m)	Margin (dB)	Antenna Height (m)	Table Angle (Degree)	Raw Value (dBuV)	Correction Factor (dB/m)
1	115.53	30.42 QP	82.62	-52.20	1.50 H	40	18.08	12.34
2	169.96	35.81 QP	82.62	-46.81	1.50 H	67	22.12	13.69
3	700.64	36.57 QP	82.62	-46.05	1.00 H	277	14.31	22.26
4	731.74	38.18 QP	82.62	-44.44	2.00 H	70	15.19	22.99
5	832.83	35.13 QP	82.62	-48.12	1.00 H	208	11.15	23.98
6	949.46	40.72 QP	82.62	-41.90	1.00 H	115	15.11	25.61

ANTENNA POLARITY & TEST DISTANCE: VERTICAL AT 3 M								
No.	Freq. (MHz)	Emission Level (dBuV/m)	Limit (dBuV/m)	Margin (dB)	Antenna Height (m)	Table Angle (Degree)	Raw Value (dBuV)	Correction Factor (dB/m)
1	117.47	32.20 QP	82.62	-50.42	1.50 V	10	19.66	12.54
2	181.62	34.08 QP	82.62	-48.54	1.00 V	58	21.50	12.58
3	665.65	35.46 QP	82.62	-47.16	1.00 V	283	13.67	21.79
4	700.64	36.67 QP	82.62	-45.95	1.00 V	277	14.41	22.26
5	735.63	37.10 QP	82.62	-45.52	1.00 V	64	14.02	23.08
6	863.93	34.28 QP	82.62	-40.34	1.00 V	13	9.88	24.40

NOTE:

1. Emission level (dBuV/m) = Raw Value (dBuV) + Correction Factor (dB).
2. Correction Factor (dB/m) = Antenna Factor (dB/m) + Cable Factor (dB).
3. The other emission levels were very low against the limit.
4. Margin value = Emission level – Limit value.
5. This is valid for all 3 channels.

FOR GPRS MODE (UP-LINK WITH 2 TIME SLOTS)

EUT	Pocket PC Phone	MODEL	HSTNH-H06C-WL
MODE	TX channel 512	TEST CONDITION	B
FREQUENCY RANGE	Below 1000 MHz	DETECTOR FUNCTION	Quasi-Peak
INPUT POWER (SYSTEM)	120Vac, 60 Hz	ENVIRONMENTAL CONDITIONS	27deg. C, 65%RH, 991hPa
TESTED BY	Brad Wu		

EMISSION LIMIT		
MODE	MAXIMUM EMISSION LEVEL (FUNDAMENTAL FREQUENCY)	EMISSION LIMIT (UNWANTED EMISSION)
GPRS	125.68 dBuV/m	82.68 dBuV/m

REMARK: Emission limit = Maximum emission level (dBuV/m) – 43dB

ANTENNA POLARITY & TEST DISTANCE: HORIZONTAL AT 3 M								
No.	Freq. (MHz)	Emission Level (dBuV/m)	Limit (dBuV/m)	Margin (dB)	Antenna Height (m)	Table Angle (Degree)	Raw Value (dBuV)	Correction Factor (dB/m)
1	158.30	34.29 QP	82.68	-48.39	1.00 H	49	19.67	14.62
2	189.40	39.44 QP	82.68	-43.24	1.00 H	94	27.47	11.97
3	399.34	41.31 QP	82.68	-41.37	1.50 H	226	24.69	16.62
4	733.69	40.00 QP	82.68	-42.68	1.00 H	76	16.97	23.03
5	811.44	39.69 QP	82.68	-42.99	1.00 H	358	15.89	23.80

ANTENNA POLARITY & TEST DISTANCE: VERTICAL AT 3 M								
No.	Freq. (MHz)	Emission Level (dBuV/m)	Limit (dBuV/m)	Margin (dB)	Antenna Height (m)	Table Angle (Degree)	Raw Value (dBuV)	Correction Factor (dB/m)
1	63.05	30.92 QP	82.68	-51.76	1.00 V	85	17.81	13.11
2	115.53	35.89 QP	82.68	-46.79	1.00 V	220	23.55	12.34
3	158.30	36.14 QP	82.68	-46.54	1.00 V	58	21.52	14.62
4	403.23	36.97 QP	82.68	-45.71	1.50 V	127	20.25	16.72
5	731.56	36.74 QP	82.68	-45.94	1.00 V	258	13.76	22.98
6	865.87	32.80 QP	82.68	-49.88	1.00 V	70	8.37	24.43

NOTE:

1. Emission level (dBuV/m) = Raw Value (dBuV) + Correction Factor (dB).
2. Correction Factor (dB/m) = Antenna Factor (dB/m) + Cable Factor (dB).
3. The other emission levels were very low against the limit.
4. Margin value = Emission level – Limit value.
5. This is valid for all 3 channels.

FOR E-GPRS MODE (UP-LINK WITH 2 TIME SLOTS)

EUT	Pocket PC Phone	MODEL	HSTNH-H06C-WL
MODE	TX channel 512	TEST CONDITION	B
FREQUENCY RANGE	Below 1000 MHz	DETECTOR FUNCTION	Quasi-Peak
INPUT POWER (SYSTEM)	120Vac, 60 Hz	ENVIRONMENTAL CONDITIONS	27deg. C, 65%RH, 991hPa
TESTED BY	Brad Wu		

EMISSION LIMIT		
MODE	MAXIMUM EMISSION LEVEL (FUNDAMENTAL FREQUENCY)	EMISSION LIMIT (UNWANTED EMISSION)
E-GPRS	126.65 dBuV/m	83.65 dBuV/m

REMARK: Emission limit = Maximum emission level (dBuV/m) – 43dB

ANTENNA POLARITY & TEST DISTANCE: HORIZONTAL AT 3 M								
No.	Freq. (MHz)	Emission Level (dBuV/m)	Limit (dBuV/m)	Margin (dB)	Antenna Height (m)	Table Angle (Degree)	Raw Value (dBuV)	Correction Factor (dB/m)
1	61.10	30.98 QP	83.65	-52.67	1.50 H	19	17.65	13.33
2	117.47	34.69 QP	83.65	-48.96	1.50 H	16	22.15	12.54
3	154.41	35.84 QP	83.65	-47.81	1.00 H	34	21.31	14.53
4	187.45	37.98 QP	83.65	-45.67	1.50 H	70	25.86	12.12
5	733.69	38.94 QP	83.65	-44.71	1.00 H	70	15.91	23.03
6	867.82	39.13 QP	83.65	-44.52	1.00 H	10	14.66	24.47

ANTENNA POLARITY & TEST DISTANCE: VERTICAL AT 3 M								
No.	Freq. (MHz)	Emission Level (dBuV/m)	Limit (dBuV/m)	Margin (dB)	Antenna Height (m)	Table Angle (Degree)	Raw Value (dBuV)	Correction Factor (dB/m)
1	63.05	31.20 QP	83.65	-52.45	1.00 V	352	18.09	13.11
2	113.59	32.73 QP	83.65	-50.92	1.00 V	259	20.59	12.14
3	146.63	34.13 QP	83.65	-49.52	1.00 V	118	19.77	14.36
4	187.45	34.02 QP	83.65	-49.63	1.50 V	49	21.90	12.12
5	401.28	38.58 QP	83.65	-45.07	1.00 V	343	21.91	16.67
6	924.19	39.91 QP	83.65	-43.74	1.00 V	307	14.56	25.35

NOTE:

1. Emission level (dBuV/m) = Raw Value (dBuV) + Correction Factor (dB).
2. Correction Factor (dB/m) = Antenna Factor (dB/m) + Cable Factor (dB).
3. The other emission levels were very low against the limit.
4. Margin value = Emission level – Limit value.
5. This is valid for all 3 channels.



4.8 EFFECTIVE RADIATED POWER MEASUREMENT (ABOVE 1GHz)

4.8.1 LIMITS OF RADIATED EMISSION MEASUREMENT

In the FCC 24.238(a), On any frequency outside a licensee's frequency block within USPCS spectrum, the power of any emission shall be attenuated below the transmitter power (P) by at least $43 + 10 \log (P)$ dB. The limit translates in the relevant power range (1 to 0.001W). At 1W(Power Control Level 0) the specified minimum attenuation becomes 43dB and the limit of emission equal to -13dBm . At 0.001W(Power Control Level 15) the specified minimum attenuation becomes 13dB and the emission of limit equal to -13dBm . So the limit of emission is the same absolute specified line.



4.8.2 TEST INSTRUMENTS

DESCRIPTION & MANUFACTURER	MODEL NO.	SERIAL NO.	CALIBRATED UNTIL
Test Receiver ROHDE & SCHWARZ	ESI7	838496/016	Jan. 07, 2006
Spectrum Analyzer ROHDE & SCHWARZ	FSP40	100041	Nov. 29, 2005
BILOG Antenna SCHWARZBECK	VULB9168	9168-155	Jan. 22, 2006
HORN Antenna SCHWARZBECK	BBHA 9120D	9120D-404	Jan. 05, 2006
HORN Antenna SCHWARZBECK	BBHA 9170	BBHA 9170242	Jan. 23, 2006
Preamplifier Agilent	8447D	2944A10631	Nov. 17, 2005
Preamplifier Agilent	8449B	3008A01960	Nov. 14, 2005
RF signal cable HUBER+SUHNNER	SUCOFLEX 104	219272/4	Jan. 26, 2006
RF signal cable HUBER+SUHNNER	SUCOFLEX 104	219275/4	Jan. 26, 2006
Software ADT.	ADT_Radiated_V5.14	NA	NA
Antenna Tower inn-co GmbH	MA 4000	010303	NA
Antenna Tower Controller inn-co GmbH	CO2000	019303	NA
Turn Table ADT.	TT100.	TT93021704	NA
Turn Table Controller ADT.	SC100.	SC93021704	NA

- NOTE:**
1. The calibration interval of the above test instruments is 12 months and the calibrations are traceable to NML/ROC and NIST/USA.
 2. The test was performed in HwaYa Chamber 3.
 3. The horn antenna and HP preamplifier (model: 8449B) are used only for the measurement of emission frequency above 1GHz if tested.
 4. The IC Site Registration No. is IC4924-4.



4.8.3 TEST PROCEDURES

- a. The EUT was placed on the top of a rotating table 0.8 meters above the ground. The table was rotated 360 degrees to determine the position of the highest radiation.
- b. The EUT was set 3 meters away from the receiving antenna, which was mounted on antenna tower and its position at 0.8 m above the ground.
- c. For each suspected emission, the EUT was arranged to its worst case and the rotatable table was turned from 0 degrees to 360 degrees to find the maximum reading and recorded the value.
- d. The EUT is replaced by a horn antenna connected to a signal generator tuned to the frequency of emission.
- e. The signal generator level has to be adjusted to have the same emission nature.
- f. The radiated power can be calculated via the factor and antenna gain.
- g. Repeat step a ~ f for horizontal polarization.

NOTE: 1. The resolution bandwidth of spectrum analyzer is 10 kHz and the video bandwidth is 300 kHz for spurious emission below 1GHz.
2. The resolution bandwidth of spectrum analyzer is 1 MHz and the video bandwidth is 3 MHz for spurious emission above 1GHz.

4.8.4 DEVIATION FROM TEST STANDARD

No deviation

4.8.5 TEST SETUP

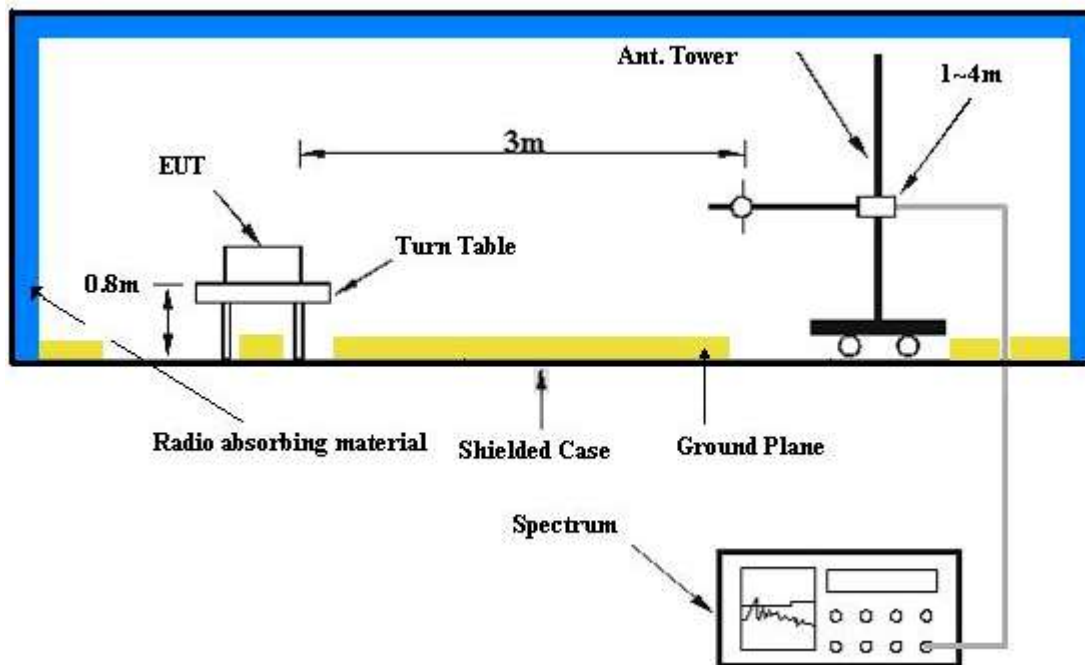

For the actual test configuration, please refer to the related item – Photographs of the Test Configuration.

4.8.6 EUT OPERATING CONDITIONS

- The notebook system makes a phone call to the GSM simulator.
- The GSM simulator station system controlled an EUT to export maximum output power under transmission mode and specific channel frequency.



4.8.7 TEST RESULTS

FOR GSM MODE (UP-LINK WITH 1 TIME SLOT)

EUT	Pocket PC Phone	MODEL	HSTNH-H06C-WL
MODE	TX channel 512	FREQUENCY RANGE	Above 1000 MHz
INPUT POWER (SYSTEM)	120Vac, 60 Hz	ENVIRONMENTAL CONDITIONS	24deg. C, 62%RH, 991hPa
TESTED BY	Brad Wu		

ANTENNA POLARITY & TEST DISTANCE: HORIZONTAL AT 3 M						
No.	Freq. (MHz)	Emission Level (dBUV)	Limit (dBm)	S.G Power Value (dBm)	Correction Factor (dB)	Power Value (dBm)
1	3700.00	48.85	-13.00	-55.58	9.20	-46.38
2	5500.00	55.27	-13.00	-50.26	10.30	-39.96
3	7401.00	54.19	-13.00	-51.16	10.12	-41.04
4	9251.00	62.87	-13.00	-42.54	10.18	-32.36
5	11100.00	75.15	-13.00	-30.91	10.83	-20.08

ANTENNA POLARITY & TEST DISTANCE: VERTICAL AT 3 M						
No.	Freq. (MHz)	Emission Level (dBUV)	Limit (dBm)	S.G Power Value (dBm)	Correction Factor (dB)	Power Value (dBm)
1	3700.00	49.28	-13.00	-55.15	9.20	-45.95
2	5500.00	56.81	-13.00	-48.72	10.30	-38.42
3	7401.00	55.47	-13.00	-49.88	10.12	-39.76
4	9251.00	64.47	-13.00	-40.94	10.18	-30.76
5	11100.00	73.89	-13.00	-32.17	10.83	-21.34

NOTE: Power Value (dBum) = S.G Power Value (dBm) + Correction Factor (dB).



EUT	Pocket PC Phone	MODEL	HSTNH-H06C-WL
MODE	TX channel 661	FREQUENCY RANGE	Above 1000 MHz
INPUT POWER (SYSTEM)	120Vac, 60 Hz	ENVIRONMENTAL CONDITIONS	24deg. C, 62%RH, 991hPa
TESTED BY	Brad Wu		

ANTENNA POLARITY & TEST DISTANCE: HORIZONTAL AT 3 M

No.	Freq. (MHz)	Emission Level (dBuV)	Limit (dBm)	S.G Power Value (dBm)	Correction Factor (dB)	Power Value (dBm)
1	3760.00	49.09	-13.00	-55.32	9.18	-46.12
2	5640.00	55.48	-13.00	-50.03	10.28	-39.75
3	7520.00	56.55	-13.00	-48.81	10.13	-38.68
4	9400.00	63.39	-13.00	-42.39	10.55	-31.84
5	11280.00	73.20	-13.00	-32.93	10.90	-22.03

ANTENNA POLARITY & TEST DISTANCE: VERTICAL AT 3 M

No.	Freq. (MHz)	Emission Level (dBuV)	Limit (dBm)	S.G Power Value (dBm)	Correction Factor (dB)	Power Value (dBm)
1	3760.00	50.45	-13.00	-53.96	9.18	-44.78
2	5640.00	56.82	-13.00	-48.69	10.28	-38.41
3	7520.00	57.49	-13.00	-47.87	10.13	-37.74
4	9400.00	67.48	-13.00	-38.30	10.55	-27.75
5	11280.00	74.90	-13.00	-31.23	10.90	-20.33

NOTE: Power Value (dBm) = S.G Power Value (dBm) + Correction Factor (dB).



EUT	Pocket PC Phone	MODEL	HSTNH-H06C-WL
MODE	TX channel 810	FREQUENCY RANGE	Above 1000 MHz
INPUT POWER (SYSTEM)	120Vac, 60 Hz	ENVIRONMENTAL CONDITIONS	24deg. C, 62%RH, 991hPa
TESTED BY	Brad Wu		

ANTENNA POLARITY & TEST DISTANCE: HORIZONTAL AT 3 M

No.	Freq. (MHz)	Emission Level (dBuV)	Limit (dBm)	S.G Power Value (dBm)	Correction Factor (dB)	Power Value (dBm)
1	3819.00	48.86	-13.00	-55.64	9.27	-46.37
2	5729.00	54.80	-13.00	-50.90	10.47	-40.43
3	7639.00	56.13	-13.00	-49.34	10.24	-39.10
4	9549.00	63.38	-13.00	-42.38	10.53	-31.85
5	11460.00	75.21	-13.00	-31.22	11.20	-20.02

ANTENNA POLARITY & TEST DISTANCE: VERTICAL AT 3 M

No.	Freq. (MHz)	Emission Level (dBuV)	Limit (dBm)	S.G Power Value (dBm)	Correction Factor (dB)	Power Value (dBm)
1	3819.00	50.22	-13.00	-54.28	9.27	-45.01
2	5729.00	56.71	-13.00	-48.99	10.47	-38.52
3	7639.00	57.21	-13.00	-48.26	10.24	-38.02
4	9549.00	65.75	-13.00	-40.01	10.53	-29.48
5	11460.00	73.85	-13.00	-32.58	11.20	-21.38

NOTE: Power Value (dBm) = S.G Power Value (dBm) + Correction Factor (dB).

FOR GPRS MODE (UP-LINK WITH 2 TIME SLOTS)

EUT	Pocket PC Phone	MODEL	HSTNH-H06C-WL
MODE	TX channel 512	FREQUENCY RANGE	Above 1000 MHz
INPUT POWER (SYSTEM)	120Vac, 60 Hz	ENVIRONMENTAL CONDITIONS	24deg. C, 62%RH, 991hPa
TESTED BY	Brad Wu		

ANTENNA POLARITY & TEST DISTANCE: HORIZONTAL AT 3 M

No.	Freq. (MHz)	Emission Level (dBuV)	Limit (dBm)	S.G Power Value (dBm)	Correction Factor (dB)	Power Value (dBm)
1	3700.00	49.15	-13.00	-55.28	9.20	-46.08
2	5500.00	56.26	-13.00	-49.27	10.30	-38.97
3	7401.00	55.29	-13.00	-50.06	10.12	-39.94
4	9251.00	63.47	-13.00	-41.94	10.18	-31.76
5	11100.00	73.69	-13.00	-32.37	10.83	-21.54

ANTENNA POLARITY & TEST DISTANCE: VERTICAL AT 3 M

No.	Freq. (MHz)	Emission Level (dBuV)	Limit (dBm)	S.G Power Value (dBm)	Correction Factor (dB)	Power Value (dBm)
1	3700.00	50.13	-13.00	-54.30	9.20	-45.10
2	5500.00	57.48	-13.00	-48.05	10.30	-37.75
3	7401.00	56.62	-13.00	-48.73	10.12	-38.61
4	9251.00	65.52	-13.00	-39.89	10.18	-29.71
5	11100.00	74.42	-13.00	-31.64	10.83	-20.81

NOTE: Power Value (dBum) = S.G Power Value (dBm) + Correction Factor (dB).



EUT	Pocket PC Phone	MODEL	HSTNH-H06C-WL
MODE	TX channel 661	FREQUENCY RANGE	Above 1000 MHz
INPUT POWER (SYSTEM)	120Vac, 60 Hz	ENVIRONMENTAL CONDITIONS	24deg. C, 62%RH, 991hPa
TESTED BY	Brad Wu		

ANTENNA POLARITY & TEST DISTANCE: HORIZONTAL AT 3 M

No.	Freq. (MHz)	Emission Level (dBuV)	Limit (dBm)	S.G Power Value (dBm)	Correction Factor (dB)	Power Value (dBm)
1	3760.00	50.74	-13.00	-53.67	9.18	-44.49
2	5640.00	56.42	-13.00	-49.09	10.28	-38.81
3	7520.00	54.85	-13.00	-50.51	10.13	-40.38
4	9400.00	61.69	-13.00	-44.09	10.55	-33.54
5	11280.00	75.61	-13.00	-30.52	10.90	-19.62

ANTENNA POLARITY & TEST DISTANCE: VERTICAL AT 3 M

No.	Freq. (MHz)	Emission Level (dBuV)	Limit (dBm)	S.G Power Value (dBm)	Correction Factor (dB)	Power Value (dBm)
1	3760.00	51.29	-13.00	-53.12	9.18	-43.94
2	5640.00	57.43	-13.00	-48.08	10.28	-37.80
3	7520.00	58.69	-13.00	-46.67	10.13	-36.54
4	9400.00	68.71	-13.00	-37.07	10.55	-26.52
5	11280.00	75.49	-13.00	-30.64	10.90	-19.74

NOTE: Power Value (dBm) = S.G Power Value (dBm) + Correction Factor (dB).



EUT	Pocket PC Phone	MODEL	HSTNH-H06C-WL
MODE	TX channel 810	FREQUENCY RANGE	Above 1000 MHz
INPUT POWER (SYSTEM)	120Vac, 60 Hz	ENVIRONMENTAL CONDITIONS	24deg. C, 62%RH, 991hPa
TESTED BY	Brad Wu		

ANTENNA POLARITY & TEST DISTANCE: HORIZONTAL AT 3 M

No.	Freq. (MHz)	Emission Level (dBuV)	Limit (dBm)	S.G Power Value (dBm)	Correction Factor (dB)	Power Value (dBm)
1	3819.00	49.97	-13.00	-54.53	9.27	-45.26
2	5729.00	55.49	-13.00	-50.21	10.47	-39.74
3	7639.00	56.84	-13.00	-48.63	10.24	-38.39
4	9549.00	64.52	-13.00	-41.24	10.53	-30.71
5	11460.00	73.43	-13.00	-33.00	11.20	-21.80

ANTENNA POLARITY & TEST DISTANCE: VERTICAL AT 3 M

No.	Freq. (MHz)	Emission Level (dBuV)	Limit (dBm)	S.G Power Value (dBm)	Correction Factor (dB)	Power Value (dBm)
1	3819.00	51.14	-13.00	-53.36	9.27	-44.09
2	5729.00	57.48	-13.00	-48.22	10.47	-37.75
3	7639.00	57.89	-13.00	-47.58	10.24	-37.34
4	9549.00	65.83	-13.00	-39.93	10.53	-29.40
5	11460.00	74.97	-13.00	-31.46	11.20	-20.26

NOTE: Power Value (dBm) = S.G Power Value (dBm) + Correction Factor (dB).

FOR E-GPRS MODE (UP-LINK WITH 2 TIME SLOTS)

EUT	Pocket PC Phone	MODEL	HSTNH-H06C-WL
MODE	TX channel 512	FREQUENCY RANGE	Above 1000 MHz
INPUT POWER (SYSTEM)	120Vac, 60 Hz	ENVIRONMENTAL CONDITIONS	24deg. C, 62%RH, 991hPa
TESTED BY	Brad Wu		

ANTENNA POLARITY & TEST DISTANCE: HORIZONTAL AT 3 M

No.	Freq. (MHz)	Emission Level (dBuV)	Limit (dBm)	S.G Power Value (dBm)	Correction Factor (dB)	Power Value (dBm)
1	3700.00	49.96	-13.00	-54.47	9.20	-45.27
2	5500.00	56.31	-13.00	-49.22	10.30	-38.92
3	7401.00	55.63	-13.00	-49.72	10.12	-39.60
4	9251.00	61.87	-13.00	-43.54	10.18	-33.36
5	11100.00	75.56	-13.00	-30.50	10.83	-19.67

ANTENNA POLARITY & TEST DISTANCE: VERTICAL AT 3 M

No.	Freq. (MHz)	Emission Level (dBuV)	Limit (dBm)	S.G Power Value (dBm)	Correction Factor (dB)	Power Value (dBm)
1	3700.00	51.14	-13.00	-53.29	9.20	-44.09
2	5500.00	55.47	-13.00	-50.06	10.30	-39.76
3	7401.00	56.87	-13.00	-48.48	10.12	-38.36
4	9251.00	65.73	-13.00	-39.68	10.18	-29.50
5	11100.00	74.77	-13.00	-31.29	10.83	-20.46

NOTE: Power Value (dBum) = S.G Power Value (dBm) + Correction Factor (dB).



EUT	Pocket PC Phone	MODEL	HSTNH-H06C-WL
MODE	TX channel 661	FREQUENCY RANGE	Above 1000 MHz
INPUT POWER (SYSTEM)	120Vac, 60 Hz	ENVIRONMENTAL CONDITIONS	24deg. C, 62%RH, 991hPa
TESTED BY	Brad Wu		

ANTENNA POLARITY & TEST DISTANCE: HORIZONTAL AT 3 M						
No.	Freq. (MHz)	Emission Level (dBuV)	Limit (dBm)	S.G Power Value (dBm)	Correction Factor (dB)	Power Value (dBm)
1	3760.00	49.13	-13.00	-55.28	9.18	-46.10
2	5640.00	54.72	-13.00	-50.79	10.28	-40.51
3	7520.00	54.09	-13.00	-51.27	10.13	-41.14
4	9400.00	64.11	-13.00	-41.67	10.55	-31.12
5	11280.00	76.23	-13.00	-29.90	10.90	-19.00

ANTENNA POLARITY & TEST DISTANCE: VERTICAL AT 3 M						
No.	Freq. (MHz)	Emission Level (dBuV)	Limit (dBm)	S.G Power Value (dBm)	Correction Factor (dB)	Power Value (dBm)
1	3760.00	51.44	-13.00	-52.97	9.18	-43.79
2	5640.00	55.14	-13.00	-50.37	10.28	-40.09
3	7520.00	56.66	-13.00	-48.70	10.13	-38.57
4	9400.00	66.58	-13.00	-39.20	10.55	-28.65
5	11280.00	75.13	-13.00	-31.00	10.90	-20.10

NOTE: Power Value (dBm) = S.G Power Value (dBm) + Correction Factor (dB).



EUT	Pocket PC Phone	MODEL	HSTNH-H06C-WL
MODE	TX channel 810	FREQUENCY RANGE	Above 1000 MHz
INPUT POWER (SYSTEM)	120Vac, 60 Hz	ENVIRONMENTAL CONDITIONS	24deg. C, 62%RH, 991hPa
TESTED BY	Brad Wu		

ANTENNA POLARITY & TEST DISTANCE: HORIZONTAL AT 3 M						
No.	Freq. (MHz)	Emission Level (dBuV)	Limit (dBm)	S.G Power Value (dBm)	Correction Factor (dB)	Power Value (dBm)
1	3819.00	50.17	-13.00	-54.33	9.27	-45.06
2	5729.00	52.26	-13.00	-53.44	10.47	-42.97
3	7639.00	57.49	-13.00	-47.98	10.24	-37.74
4	9549.00	65.46	-13.00	-40.30	10.53	-29.77
5	11460.00	74.06	-13.00	-32.37	11.20	-21.17

ANTENNA POLARITY & TEST DISTANCE: VERTICAL AT 3 M						
No.	Freq. (MHz)	Emission Level (dBuV)	Limit (dBm)	S.G Power Value (dBm)	Correction Factor (dB)	Power Value (dBm)
1	3819.00	49.65	-13.00	-54.85	9.27	-45.56
2	5729.00	54.47	-13.00	-51.23	10.47	-40.76
3	7639.00	58.89	-13.00	-46.58	10.24	-36.34
4	9549.00	67.40	-13.00	-38.36	10.53	-27.83
5	11460.00	74.28	-13.00	-32.15	11.20	-20.95

NOTE: Power Value (dBum) = S.G Power Value (dBm) + Correction Factor (dB).



5 INFORMATION ON THE TESTING LABORATORIES

We, ADT Corp., were founded in 1988 to provide our best service in EMC, Radio, Telecom and Safety consultation. Our laboratories are accredited and approved by the following approval agencies according to ISO/IEC 17025.

USA	FCC, NVLAP, UL, A2LA
GERMANY	TUV Rheinland
JAPAN	VCCI
NORWAY	NEMKO
CANADA	INDUSTRY CANADA , CSA
R.O.C.	CNLA, BSMI, DGT
NETHERLANDS	Telefication
SINGAPORE	PSB , GOST-ASIA (MOU)
RUSSIA	CERTIS (MOU)

Copies of accreditation certificates of our laboratories obtained from approval agencies can be downloaded from our web site:

www.adt.com.tw/index.5/phtml. If you have any comments, please feel free to contact us at the following:

Linko EMC/RF Lab:

Tel: 886-2-26052180

Fax: 886-2-26052943

Hsin Chu EMC/RF Lab:

Tel: 886-3-5935343

Fax: 886-3-5935342

Hwa Ya EMC/RF/Safety/Telecom Lab:

Tel: 886-3-3183232

Fax: 886-3-3185050

Linko RF Lab.

Tel: 886-3-3270910

Fax: 886-3-3270892

Email: service@adt.com.tw

Web Site: www.adt.com.tw

The address and road map of all our labs can be found in our web site also.