



## **User's Guide**

HP iPAQ Pocket PC hw6500 Series

Document Part Number: 378871-001

**HP Confidential**

**March 2005**

© 2004 Hewlett-Packard Development Company, L.P.

iPAQ is a trademark of Hewlett-Packard Development Company, L.P. in the U.S. and other countries.

Microsoft, Windows, the Windows logo, Outlook, and ActiveSync are trademarks of Microsoft Corporation in the U.S. and other countries.

HP iPAQ hw6500 Series is Powered by Windows Mobile™ 2003 Second Edition software for Pocket PC.



SD Logo is a trademark of Secure Digital.

Bluetooth is a trademark owned by its proprietor and used by Hewlett-Packard Company under license.

Hewlett-Packard Company shall not be liable for technical or editorial errors or omissions contained herein or for incidental or consequential damages in connection with the furnishing, performance, or use of this material. The information in this document is provided “as is” without warranty of any kind, including, but not limited to, the implied warranties of merchantability and fitness for a particular purpose, and is subject to change without notice. The warranties for HP products are set forth in the express limited warranty statements accompanying such products. Nothing herein should be construed as constituting an additional warranty.

This document contains proprietary information that is protected by copyright. No part of this document may be photocopied, reproduced, or translated to another language without the prior written consent of Hewlett-Packard Company.



**WARNING:** Text set off in this manner indicates that failure to follow directions could result in bodily harm or loss of life.

---



**CAUTION:** Text set off in this manner indicates that failure to follow directions could result in damage to equipment or loss of information.

---

User's Guide

HP iPAQ Pocket PC hw6500 Series

First Edition (March 2005)

Document Part Number: 378871-001

---

# Contents

## 1 Getting to Know Your HP iPAQ Mobile Messenger

Using the Stylus . . . . .	1-6
Setting the Date and Time . . . . .	1-7
Setting the Time for Home and Locations You Are Visiting . . . . .	1-7
Setting the Date . . . . .	1-8
Entering Owner Information . . . . .	1-9
Setting a Password . . . . .	1-9
Resetting the Unit . . . . .	1-11
Performing a Soft Reset . . . . .	1-11
Performing a Hard Reset . . . . .	1-12
Aligning the Screen . . . . .	1-13
Routine Care . . . . .	1-13
Protecting the Screen . . . . .	1-14
Traveling with Your HP iPAQ . . . . .	1-15

## 2 Learning the Basics

Using the Today Screen . . . . .	2-1
Navigation Bar . . . . .	2-2
Command Bar . . . . .	2-2
TodayPanel . . . . .	2-3
Status Icons . . . . .	2-4
Pop-Up Menus . . . . .	2-6
Creating information . . . . .	2-7
Customizing the Today Screen . . . . .	2-8

Customizing the Application Buttons . . . . .	2–9
Locking the Application Buttons. . . . .	2–10
Using Applications. . . . .	2–11
Opening Applications . . . . .	2–11
Minimizing Applications. . . . .	2–11
Closing Applications . . . . .	2–11
Installing Applications. . . . .	2–12
Backing Up Information . . . . .	2–12
Using iPAQ File Store Folder . . . . .	2–14

### 3 Using ActiveSync

Connecting to a Computer . . . . .	3–2
Installing ActiveSync . . . . .	3–2
Synchronizing with Your Computer . . . . .	3–3
<a href="#">Using Microsoft Exchange ActiveSync. . . . .</a>	3–4
Changing Synchronization Settings. . . . .	3–6
Copying Files . . . . .	3–7
Installing Programs . . . . .	3–9
Backing up and Restoring . . . . .	3–9
Synchronizing Links . . . . .	3–9
Using ActiveSync to Send and Receive E-mail. . . . .	3–10
Requesting Meetings . . . . .	3–10

### 4 Learning Input Methods

Using the Thumb Keyboard . . . . .	4–1
Keyboard Components . . . . .	4–2
Using the Function and Shortcut Keys . . . . .	4–2
Special Keys . . . . .	4–3
Accent Characters . . . . .	4–4
Using the On-Screen Keyboard . . . . .	4–7
Writing with the Stylus and the Letter Recognizer . . . . .	4–8
Writing with the Stylus and Microsoft Transcriber . . . . .	4–9

Writing with the Stylus and Block Recognizer . . . . .	4-10
Drawing and Writing on the Screen . . . . .	4-11
Changing Word Suggestion Options . . . . .	4-12

## 5 Using the Phone Features

SIM Card . . . . .	5-2
Inserting a SIM Card . . . . .	5-3
Removing the SIM Card . . . . .	5-4
Activating Your Phone Service . . . . .	5-5
Phone Features. . . . .	5-5
Your PIN . . . . .	5-6
Phone Buttons and Icons . . . . .	5-7
Checking Your Connection and Signal Strength . . . . .	5-9
Automatic Frequency Band Selection . . . . .	5-9
Turning the Phone On and Off. . . . .	5-9
HP Profiles . . . . .	5-10
Setting a Profile . . . . .	5-11
Switching a Profile . . . . .	5-12
Making and Receiving Phone Calls . . . . .	5-13
Making a Call . . . . .	5-13
Answering a Call . . . . .	5-14
Ending a Call . . . . .	5-14
Making a Call from Contacts. . . . .	5-14
Making a Call Using Speed Dial . . . . .	5-15
Making a Call from Call History . . . . .	5-16
Making a Conference Call . . . . .	5-16
Adjusting Phone Volume. . . . .	5-17
Enabling the Mute Function . . . . .	5-17
Setting Ring Tones . . . . .	5-17
Enabling Speakerphone Mode. . . . .	5-19
Taking Notes During a Call. . . . .	5-19
Using Voice Mail. . . . .	5-20
Putting a Call on Hold . . . . .	5-20
Using Call Waiting . . . . .	5-20
Displaying Caller ID . . . . .	5-21

Blocking Calls . . . . .	5–21
Forwarding Calls . . . . .	5–21
Changing the System Volume . . . . .	5–22
Change the Ringer Volume . . . . .	5–22
Changing the Phone Settings . . . . .	5–23
Changing Services Settings . . . . .	5–24
Viewing Available GSM/GPRS/EDGE Networks . . . . .	5–24
Using International Roaming . . . . .	5–25
Changing Network Settings . . . . .	5–26
Manually Selecting a Network . . . . .	5–26
Configuring Your HP iPAQ for Your SIM Card . . . . .	5–27
Modifying the GSM/GPRS Network Settings . . . . .	5–28
Editing Network Properties . . . . .	5–29
Creating a New Connection . . . . .	5–32
Failed Automatic SIM Detection . . . . .	5–34
TTY Functionality for the Hearing-Impaired . . . . .	5–35

## 6 Managing Multiple Wireless Connections

Using the iPAQ Wireless Manager . . . . .	6–1
Power Buttons . . . . .	6–2
Settings Buttons . . . . .	6–3
Managing Data Connections . . . . .	6–4

## 7 Making Your Data Connections

Impact of Data Connection When Phone Call is Received . . . . .	7–3
Using GSM/GPRS/EDGE Connections . . . . .	7–3
Creating a GPRS/EDGE Connection . . . . .	7–3
Setting Up a WAP Browser . . . . .	7–5
Viewing WAP Pages . . . . .	7–5
Connecting to a Private Network . . . . .	7–6
Setting Up VPN Server Connections . . . . .	7–6
Setting Up Proxy Server Settings . . . . .	7–6
Managing Your E-mail . . . . .	7–7

Entering an Internet Address . . . . .	7–7
Using a Favorites List . . . . .	7–8

## 8 Using GPS Navigation

Getting Acquainted . . . . .	8–1
GPS Navigation Features. . . . .	8–2
Downloading a Map. . . . .	8–3
Getting Started with GPS Navigation . . . . .	8–6
Using Quick Connect. . . . .	8–7
Viewing the Main Screen . . . . .	8–8
Operating the Main Screen . . . . .	8–10
Using the Menu . . . . .	8–10
Setting a Destination . . . . .	8–12
Adding a Favorite . . . . .	8–14
Using the Route Summary Screen. . . . .	8–15
Using the Map Browser. . . . .	8–16
Switching to a Schematic View. . . . .	8–18
Using the Browsers . . . . .	8–18
Selecting Locations . . . . .	8–19
Selecting your Home Location . . . . .	8–20
Selecting a Favorite . . . . .	8–21
Selecting a Recent Destination . . . . .	8–21
Selecting your GPS Position . . . . .	8–21
Selecting a Point of Interest. . . . .	8–21
Finding an Address . . . . .	8–22
Setting Your Preferences . . . . .	8–23
Setting Your Vocal Preference . . . . .	8–26

## 9 Using Bluetooth

Getting Acquainted with Bluetooth . . . . .	9–2
Understanding Terms . . . . .	9–3
Supported Services . . . . .	9–4
Working with Bluetooth Settings. . . . .	9–4
Turning On Bluetooth . . . . .	9–5

Opening Bluetooth Settings . . . . .	9-5
Setting Accessibility Properties . . . . .	9-5
Enabling Bluetooth Services . . . . .	9-6
Setting a Shared Folder . . . . .	9-8
Understanding Profiles . . . . .	9-9
Working with Bluetooth Manager . . . . .	9-12
Opening Bluetooth Manager . . . . .	9-12
Locating and Selecting a Device . . . . .	9-12
Connecting to Other Devices . . . . .	9-14
Identifying the Communications Port . . . . .	9-14
Establishing a Headphone or Stereo Speakers Connection . . . . .	9-14
Establishing an ActiveSync Connection . . . . .	9-15
Establishing a Serial Connection . . . . .	9-19
Dial-Up Networking Service . . . . .	9-20
Using Dial-Up Networking Service . . . . .	9-20
Joining a Personal Area Network . . . . .	9-21
Working with Files . . . . .	9-21
Creating a File Transfer Connection . . . . .	9-22
Sending Files . . . . .	9-22
Creating a Folder on a Remote Device . . . . .	9-22
Receiving a File from a Remote Device . . . . .	9-22
Deleting a File from a Remote Device . . . . .	9-23
Using Business Card Exchange . . . . .	9-23
Setting Up Your Business Card Information . . . . .	9-23
Opening a Connection . . . . .	9-26
Viewing Connection Status . . . . .	9-26
Closing a Connection . . . . .	9-27
Viewing Connection Information . . . . .	9-27
Working with Connections . . . . .	9-27



## 10 Using the Camera Features

Camera Components . . . . .	10-2
Taking a Photo . . . . .	10-3
Ending Your Photo Session . . . . .	10-6
Taking a Video Clip . . . . .	10-6
Adjusting the Camera Settings . . . . .	10-6
White Balance . . . . .	10-7
Color . . . . .	10-7
Compression . . . . .	10-8
Resolution . . . . .	10-8
Setting Up Other Features . . . . .	10-8
Camera Sounds . . . . .	10-8
Configuring Instant Review . . . . .	10-9
Using the Self-Timer . . . . .	10-9
Configuring File Settings . . . . .	10-10
Configuring Video Format . . . . .	10-10
Using HP Image Zone . . . . .	10-11
Viewing Thumbnail Photos . . . . .	10-13
Viewing a Photo Full-Screen . . . . .	10-13
Recording Sound With a Picture . . . . .	10-14
Viewing a Slideshow . . . . .	10-14
E-mailing a Picture . . . . .	10-16
Exiting HP Image Zone . . . . .	10-17
HP Image Transfer . . . . .	10-17
Tips for Taking Better Pictures . . . . .	10-20

## 11 Expansion Cards

Installing a Secure Digital (SD) Expansion Card . . . . .	11-1
Removing a Secure Digital (SD) Expansion Card . . . . .	11-3
Viewing the Content of Memory Cards . . . . .	11-3

## 12 Using Inbox and Messaging

Using Inbox . . . . .	12-1
Synchronizing Inbox . . . . .	12-2
Using Folders. . . . .	12-3
Setting Up an Account. . . . .	12-4
E-mail Setup . . . . .	12-5
Downloading Messages. . . . .	12-7
Compose and Send a Message. . . . .	12-8
Reply to or Forward a Message. . . . .	12-9
Receive Attachments . . . . .	12-9
Receive Meeting Requests. . . . .	12-10
Using Messaging . . . . .	12-11
Text Messaging . . . . .	12-11
Multimedia Messaging Service (MMS) . . . . .	12-13

## 13 Managing the Battery

Installing the Battery . . . . .	13-2
Removing the Battery . . . . .	13-4
Charging the Battery . . . . .	13-5
Charging with the AC Adapter . . . . .	13-6
Charging with the HP iPAQ Cradle and AC Adapter. . . . .	13-8
Charging Over a USB Connection . . . . .	13-9
Changing the Backlight Settings . . . . .	13-10
Disabling the Application Buttons . . . . .	13-10
Manually Monitoring the Battery . . . . .	13-11

## 14 Using Security Features

Using HP ProtectTools. . . . .	14-1
Setting Up Security . . . . .	14-2
Using Your HP iPAQ with HP ProtectTools. . . . .	14-5
Changing Your HP ProtectTools Settings. . . . .	14-8

## 15 Troubleshooting

Self-Test Diagnostics . . . . .	15-1
Common Problems . . . . .	15-2
ActiveSync . . . . .	15-7
Phone . . . . .	15-9
Expansion Cards . . . . .	15-11
Bluetooth . . . . .	15-12
GPS Navigation . . . . .	15-14

## A Regulatory Notices

Federal Communications Commission Notice . . . . .	A-1
Declaration of Conformity for products marked with the FCC logo—United States only . . . . .	A-2
Canadian Notice . . . . .	A-3
Avis Canadien . . . . .	A-3
European Union Regulatory Notice . . . . .	A-3
<del>Notice for France and Italy for use of     2.4 GHz wireless communication: . . . . .</del>	<del>A-4</del>
Battery Warning . . . . .	A-5
Taiwan Battery Recycling Notice . . . . .	A-6
Equipment Warning . . . . .	A-6
Airline Travel Notice . . . . .	A-6
Medical Electronic Equipment . . . . .	A-7
Wireless Notices . . . . .	A-7
U.S. Regulatory Wireless Notice . . . . .	A-7
Health and Safety Information—FCC . . . . .	A-8
Canadian Regulatory Wireless Notice . . . . .	A-8
Australian Wireless Notice . . . . .	A-9
<del>Japanese Regulatory Wireless Notice . . . . .</del>	<del>A-9</del>
Brazilian Regulatory Wireless Notice . . . . .	A-9
Singaporean Wireless Notice . . . . .	A-10
Taiwanese Wireless Notice . . . . .	A-11

**B Specifications**

System Specifications ..... B-1  
Physical Specifications..... B-4  
Operating Environment ..... B-5

HP  
Confidential

---

# Getting to Know Your HP iPAQ Mobile Messenger

Congratulations on purchasing the HP iPAQ hw6500 series Mobile Messenger. This device includes the following features - a Mobile phone, Global System for Mobile Communications/General Packet Radio Service/Enhanced Data Rates for Global Evolution (GSM/GPRS/EDGE) technology, Bluetooth, Global Positioning System Navigation (GPS), Pocket PC software, and a Digital camera on certain models. Use this chapter to find out about setting up your HP iPAQ Mobile Messenger and to learn how it works.

The software programs described below are preinstalled on your HP iPAQ or included on the Companion CD. The preinstalled programs are not deleted if your HP iPAQ loses power.

You can find detailed information for using these programs in the Help files on your HP iPAQ. To access these Help files, from the **Start** menu, tap **Help** and select a program.

In addition, Microsoft Pocket PC Basics provides instructions on operating the HP iPAQ. To locate Pocket PC Basics, go to the **Today** screen and tap **Start > Help > Pocket PC Basics**.

<b>HP iPAQ Software</b>	<b>To Access</b>	<b>Functions</b>
HP Asset Viewer	From the <b>Start</b> menu, tap <b>Settings &gt; System</b> tab > <b>HP Asset Viewer</b> .	Lists detailed information about your system and its configuration.
HP Photosmart	From the <b>Start</b> menu, tap <b>Programs &gt; HP Photosmart</b> .	Take digital photographs and modify settings with your HP iPAQ Camera.
HP Image Transfer	This software is included on the Companion CD.	Transfer digital photographs from the HP iPAQ to your personal computer.
HP Image Zone	From the <b>Start</b> menu, tap <b>Programs &gt; HP Image Zone</b> .	Display individual images and run slideshows on your HP iPAQ. Also print, send, record and e-mail images from your HP iPAQ.
HP Profiles	From the <b>Start</b> menu, tap <b>Settings &gt; System</b> tab > <b>HP Profiles</b> .	Set different profiles for ring type or loudness, turning on wireless settings, screen brightness or battery settings.
HP ProtectTools	From the <b>Start</b> menu, tap <b>Programs &gt; HP ProtectTools</b> .	<a href="#">Protects your privacy by activating password protection and encryption on your HP iPAQ.</a>

<b>HP iPAQ Software</b>	<b>To Access</b>	<b>Functions (Continued)</b>
iPAQ Backup	From the <b>Start</b> menu, tap <b>Programs &gt; iPAQ Backup</b> .	Back up your data to protect it from loss due to a drained battery, accidental deletion, or hardware failure.
iPAQ Wireless	From the <b>Today</b> screen, tap the <b>Wireless</b> icon in the bottom right of the screen.	Provides a centralized control to wireless features on your HP iPAQ. It allows you to turn all wireless features on and off and configure settings for phone and data functions using GSM/GPRS/EDGE, and Bluetooth.
Self-Test	From the <b>Start</b> menu, tap <b>Settings &gt; System tab &gt; Self Test</b> .	Run a basic diagnostic test on the device.

---

Microsoft Pocket PC Software	Functions
ActiveSync	Synchronize information between your HP iPAQ and personal computer so you have the latest information in both locations. Be sure you install ActiveSync on your personal computer before connecting the cradle and HP iPAQ to your computer.
Calculator	Perform calculations.
Calendar	Schedule appointments, meetings, and other events, and set an alarm to remind you of the appointments. Appointments for the day are displayed on the <b>Today</b> screen.
Connections	Connect your HP iPAQ to the Internet and intranet to browse Web sites, send and receive e-mail, and synchronize information using ActiveSync.
Contacts	Keep an updated list of friends and colleagues to e-mail, message, and telephone.
Inbox	Receive and send Internet e-mail, Text and MMS messages in Inbox on your HP iPAQ or from your computer if ActiveSync is installed or if synchronizing with Exchange ActiveSync over the air. You must have an e-mail address provided by your Internet Service Provider (ISP) or employer to send and receive e-mail.
Notes	Create handwritten or typed notes, drawings, and recordings.
Pocket Excel	Create and edit workbooks or view and edit Excel workbooks created on your computer.
Pocket Internet Explorer	Browse the Internet and download pages through synchronization or by connecting to the Internet.



---

**Microsoft Pocket PC  
Software**

**Functions (Continued)**

---

Pocket Word	Create new documents or view and edit Word documents created on your computer.
Ring Tones	Select different sounds to notify you of incoming calls.
Settings	Obtain quick access to settings for the backlight, clock, memory, power, regional settings, <b>Today</b> screen, password, sounds and notifications, etc.
Tasks	Keep track of your to-do list.
Terminal Services Client	Log onto your computer and use all the programs available on that computer from your HP iPAQ (Windows 2000 and XP or later).
Windows Media Player 10 Series	Play digital audio and video files in Windows Media or MP3 format on your device.

---

## Using the Stylus

Your HP iPAQ comes with a stylus that you should use to tap or write on your screen.



---

**Note:** Use the stylus to tap and write on the screen, and use your fingers to press the Power button, application buttons on the bottom of the device, and the camera's on-screen shutter button.

---



**CAUTION:** To prevent damage to your HP iPAQ screen, never use any device other than the stylus that comes with the HP iPAQ or an approved replacement to tap or write on the screen. If you lose or break your stylus, you can order extras at [www.hp.com/Go/iPAQaccessories](http://www.hp.com/Go/iPAQaccessories).

---

You can perform three basic actions using the stylus:

**Tap**—Lightly touch the screen to select or open an item. Lift the stylus after you tap an item. Tapping is equivalent to clicking an item with the mouse on your computer.

**Drag**—Place the point of the stylus on the screen and drag an item across the screen without lifting the stylus until you have completed the selection. Dragging is equivalent to dragging with the left mouse button pressed on your computer.

**Tap and hold**—Hold the stylus pointer on an item for a short time until a menu displays. Tapping and holding is equivalent to right-clicking your computer mouse button. When you tap and hold, a circle of blue dots appears around the stylus to indicate that the menu will soon pop up.

## Setting the Date and Time

When you turn on your HP iPAQ for the first time, you are requested to select your time zone. After setting the time zone, you still need to set the time and date on your unit. Tap the **Clock** icon on the Today screen to set the time and date. All three settings are located in the Clock Settings screen and can be set at the same time.

---

**Note:** By default, the time on the HP iPAQ is synchronized with your computer each time the two devices connect using ActiveSync.

---

## Setting the Time for Home and Locations You Are Visiting

From the **Start** menu, tap **Settings > System tab > Clock & Alarms** icon.

---

**Shortcut:** From the **Today** screen, tap the **Clock** icon to set the time.

---

1. Tap either **Home** or **Visiting**.
2. Tap the **time-zone** down arrow, and select the appropriate time zone.
3. Tap the hour, minutes, or seconds, and use the up and down arrows to adjust the time.

**Shortcut:** You can also adjust the time by moving the hands of the clock with the stylus.

4. Tap **AM** or **PM**.

5. Tap **OK**.
6. Tap **Yes** to save the time.

## Setting the Date

1. From the **Start** menu, tap **Settings** > **System** tab > **Clock & Alarms** icon.

**Shortcut:** From the **Today** screen, tap the **Clock** icon to set the date.

2. Tap the down arrow by the date.
3. Tap the left or right arrow to select a month and year.
4. Tap a day.
5. Tap **OK**.
6. Tap **Yes** to save the date settings.

You will need to reset your time zone, time, and date if:

- The location time (Home or Visiting) needs to be changed.
- All power to the HP iPAQ is lost, which removes all saved settings.
- You perform a full reset of your HP iPAQ.

---

**Shortcut:** From the **Today** screen, tap the **Clock** icon to set the time zone, time, and date.

---

## Entering Owner Information

You can personalize your HP iPAQ by entering owner information. To enter owner information:

1. From the **Today** screen, tap **Start > Settings > Personal tab > Owner Information**.

---

**Shortcut:** From the **Today** screen, tap **Tap here to set owner information**.

---

2. Tap in the **Name** field. A keyboard appears at the bottom of the screen. Tap on the characters to enter your name.

---

**Note:** If you prefer, you can use Letter Recognizer, Microsoft Transcriber, or Block Recognizer to input information. Refer to [Chapter 4, “Learning Input Methods”](#) for more information.

---

3. Tap the **Tab** key on the keyboard to move the cursor to the next field.
4. Continue entering whatever information you want to include.
5. To display owner information or notes at startup, tap the **Options** tab and place a checkmark in the **Identification Information** and **Notes** checkboxes.
6. Tap on the **Notes** tab to enter any notes.
7. Tap **OK** to save the information and return to the **Today** screen.

## Setting a Password

You can set a password to prevent unauthorized access to or use of your HP iPAQ.

1. From the **Start** menu, tap **Settings > Personal tab > Password**.
2. On the Password screen, tap the box next to **Prompt if device unused for**, then set the timed prompt.

3. In the Password Type box, tap the down arrow to display the dropdown box and select either **Simple 4 digit** or **Strong alphanumeric** as the password type you want to use.
4. Enter your password in the Password box using the screen keyboard and tap **OK**.

---

**Note:** Keep a record of your password in a safe place in case you forget it. If you are unable to retrieve your password, you must perform a hard reset on your HP iPAQ and will lose settings and information that are not saved in ROM. See the section in this chapter [“Performing a Hard Reset”](#) for more information.

---

## Resetting the Unit

### Performing a Soft Reset

A soft reset (also known as a normal reset) stops all running applications, but does not erase any programs or saved data.



**CAUTION:** Be sure to save any **unsaved** data before performing a soft reset since soft reset erases all **unsaved** data.

---

To perform a soft reset:

1. Locate the recessed **Reset** button on the bottom of the device to the right of the communications port.
2. Use the stylus to lightly press the **Reset** button until the screen fades.



3. Remove the stylus to restart the HP iPAQ.

The HP iPAQ restarts and displays the **Today** screen.

## Performing a Hard Reset

Perform a hard reset (also known as a full reset) when you want to clear all settings, programs, and data from RAM.



**CAUTION:** If you perform a hard reset, your HP iPAQ returns to its default settings and loses all information that is not recorded in ROM or iPAQ File Store.

---

To perform a hard reset:

1. Press and hold down the **Power** button.
2. While holding the Power button, use the stylus to lightly press the recessed **Reset** button on the bottom of the HP iPAQ for about five seconds.



3. The HP iPAQ screen fades and the device resets. Once the device resets and the screen comes back on, release the Power button and remove the stylus from the Reset button.



## Aligning the Screen

When the HP iPAQ is turned on for the first time, you are guided through a screen alignment process. You must realign your screen if:

- The HP iPAQ does not respond accurately to your taps.
- You perform a hard reset of your HP iPAQ.

To realign the HP iPAQ screen:

1. From the **Start** menu, tap **Settings** > **System** tab > **Screen** icon.
2. Tap the **Align Screen** button.

**Shortcut:** To access the **Align Screen** application without tapping on the screen, push down and hold the 5-Way Navigational button and the Contacts application button located to the left of the Navigational button.

3. Tap the cross-hair object at each location. Be precise when tapping the cross-hair object.
4. Tap **OK**.

## Routine Care

To keep your HP iPAQ in good condition and working properly, follow these guidelines:

- Keep your HP iPAQ away from excessive moisture and temperature extremes.
- Do not expose your HP iPAQ to liquids or precipitation.
- Avoid exposing your HP iPAQ to direct sunlight or strong ultraviolet light for extended periods of time.
- When not in use, store your HP iPAQ in a case. You can select from a wide variety of case options at [www.hp.com/go/ipaqaccessories](http://www.hp.com/go/ipaqaccessories).

## Protecting the Screen

---



**CAUTION:** The screen and camera lens of your HP iPAQ is made of glass and can be damaged or broken by drops, impacts, or pressure.

---

**Note:** HP is not responsible for damage that occurs as a result of your failure to follow the instructions that came with the HP branded product. Refer to the warranty document included with your HP iPAQ for more information.

---

You should observe the following practices to protect the screen and camera lens of your HP iPAQ from damage.

- When transporting your HP iPAQ in a purse, pocket, briefcase, etc., ensure the device does not get compressed, bent, dropped, hit, or sat on.
  - Do not place anything on top of your HP iPAQ to prevent damage to the screen.
  - Clean your HP iPAQ by wiping the screen, the camera lens, and the exterior with a soft, damp cloth lightly moistened only with water.
  - Avoid exposing your HP iPAQ to direct sunlight or strong ultraviolet light for extended periods of time.
  - Avoid scratching the surface of the screen and the camera lens and banging them against hard objects.
  - Use only the stylus that comes with your HP iPAQ or an approved replacement on the screen to prevent scratching it. If you lose or break your stylus, you can order extras at [www.hp.com/go/ipaqaccessories](http://www.hp.com/go/ipaqaccessories).
- 



**CAUTION:** To reduce the risk of damage to the internal components, do not spray liquid directly on the screen, or allow excess liquid to drip inside your HP iPAQ. Using soap or other cleaning products on the screen may discolor the finish and damage it.

---

## Traveling with Your HP iPAQ

Use the following guidelines when traveling with your HP iPAQ:

- Back up your information.
- Take a copy of your backup with you on an SD memory card.
- Disconnect all external devices.
- Take the AC Adapter and AC Charger Adapter with you.
- Keep your HP iPAQ in a protective case and keep it in your carry-on luggage.
- For air travel, be sure to turn off the Phone and Bluetooth. To turn off all wireless features, from the **Today** screen, tap the **iPAQ Wireless** icon in the **Command bar**, then tap the **ALL OFF** button on the iPAQ Wireless screen to turn all wireless features off.
- If you are traveling internationally, be sure you have the plug adapter appropriate for the country you are visiting.

---

**Note:** If you are planning on traveling abroad with your HP iPAQ, you may need to set up your phone features for international calling. For this purpose, refer to the information in [Chapter 5, in the section “Using International Roaming.”](#)

---

## Learning the Basics

### Using the Today Screen

When you first turn on your HP iPAQ, the **Today** screen displays. You can also display it by tapping **Start**, and **Today**. Use the **Today** screen to view:

- Date and time
- Owner information
- Upcoming appointments
- Unread and unsent messages
- Tasks that need to be completed

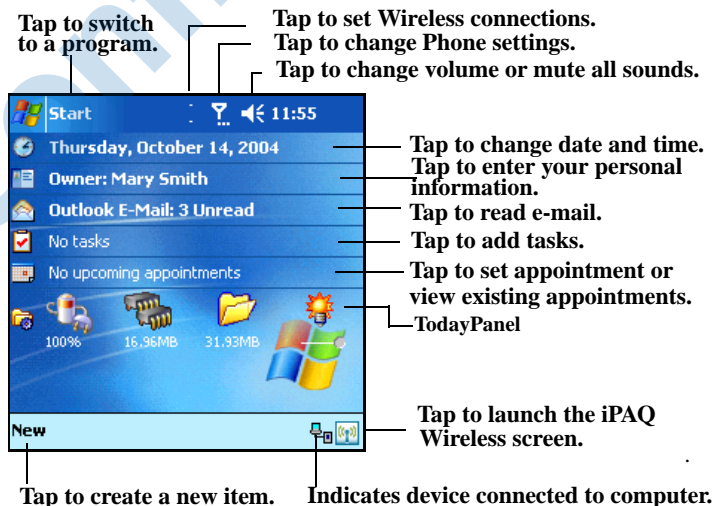

## Navigation Bar

The Navigation bar is located at the top of the screen. It displays the active program, wireless and volume status, and current time, and allows you to open programs. Use the **Start** menu to select a program.

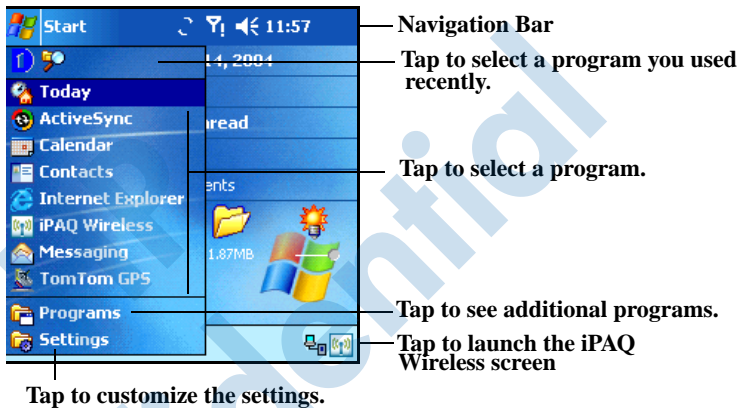

## Command Bar

Within each program, use the Command bar located at the bottom of the screen to perform tasks. Tap **New** to create a new item in the current program.

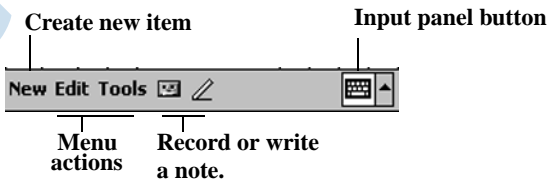

## TodayPanel

The TodayPanel is located on the Today screen above the Command bar and displays shortcuts to the following settings:

- Options and Today Settings—Tap to access Options or Today Settings.
- Battery power settings—Tap to view battery power remaining or to adjust battery power settings.
- Memory allocation settings—Tap to view or adjust memory allocations, memory available for iPAQ File Store folder, and to activate or stop a running program.
- Storage card settings—Tap to view memory available for iPAQ File Store folder.
- Backlight settings—Tap to adjust backlight settings.

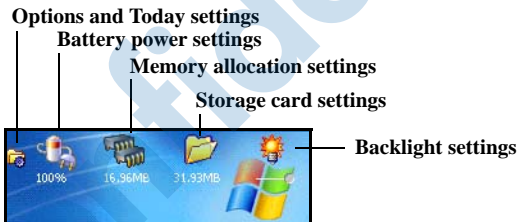

When you first power on your HP iPAQ, the TodayPanel is set to display on the Today screen. To turn it off:

1. In the TodayPanel, tap the **Options and Today Settings** icon > **Today Settings**.
2. On the Today Settings screen, scroll down and uncheck the **TodayPanel** box.









---









**Note:** To turn the TodayPanel on again, tap **Start** > **Settings** > **Today** icon > **Items** tab. On the Today Settings screen, scroll down and place a checkmark in the **TodayPanel** box.

---





## Status Icons

You may see the following status icons displayed on the Navigation or Command bar. Tap the icon on the screen to view more information related to the item.

Icon	Definition
	Inactive connection to computer or wireless network.
	Active connection to computer or wireless network.
	Microsoft ActiveSync is synchronizing.
	Speaker is on.
	Speaker is off or in mute position.
	GPRS service is registered and available if you are subscribed to the GPRS service.
	Active data connection to GPRS network.
	Phone is powered off.
	Phone is powered on.

Icon	Definition (Continued)
	Network is searching or unavailable.
	Phone connection unavailable or network error.
	Signal strength indicator for phone functions.
	A missed call. Tap this screen icon to view missed calls.
	Call Forwarding Active.
	iPAQ Wireless icon—Tap to display the iPAQ Wireless screen. The iPAQ Wireless screen provides a control center to turn all wireless activities on and off, and to configure their settings.
	One or more instant messages have been received. Tap this <b>screen icon</b> to view the messages.
	One or more e-mail/SMS/MMS, or voice messages have been received. Tap this <b>screen icon</b> to view the messages.
	Message Center indicates messages received from different communication areas such as phone or voice messages, e-mail/SMS/MMS, announcements, etc. Tap this <b>screen icon</b> to view all messages in the message center.



Icon	Definition (Continued)
	Tap to mute your phone conversation. Tap it again to continue the phone conversation.
	Event notification set to vibrate instead of alarm. To set to vibrate: Tap the <b>Speaker</b> icon in the Navigation bar and, in the pop-up menu, tap <b>Vibrate</b> .
	Battery power is low.
	Battery power is very low.
	Your HP iPAQ is connected with your personal computer. This icon appears in the Command bar only when there is an active connection.

## Pop-Up Menus

Pop-up menus allow you to quickly perform an action. Use the pop-up menu to cut, copy, rename, and delete an item, also send an e-mail or send a file to another device.

To access a pop-up menu, **tap** and **hold** the stylus on the item on which you want to perform the action. When the menu appears, tap the desired action, or tap anywhere outside the menu to close it without performing an action.

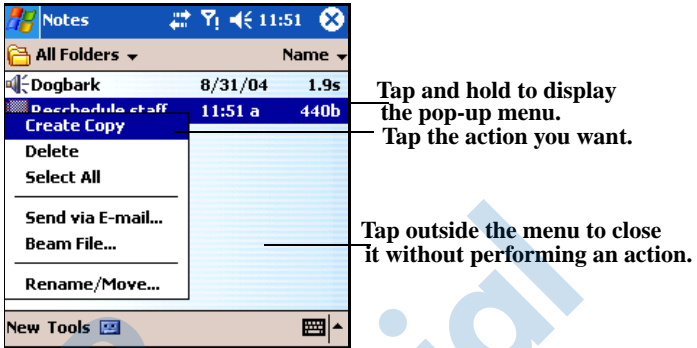

## Creating information

From the **Today** screen, you can create new information, including:

- Appointments
- Contacts
- Excel Workbooks
- Messages
- Notes
- Tasks
- Word documents

1. Tap , or from the **Start** menu, tap **Today** > **New**.
2. Tap an option to create a new item.
3. Tap **OK** after you finish creating a new item.

## Customizing the Today Screen

From the **Settings Today** screen, you can:

- Add a picture as the background.
  - Select information displayed on the **Today** screen.
  - Set the order of the information.
  - Set when to see the **Today** screen.
1. Tap , or from the **Start** menu, tap **Settings** > **Today** icon.
  2. Select **Use this picture as the background** checkbox.

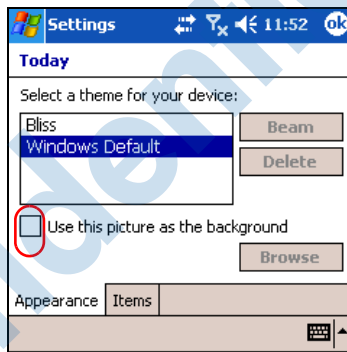

3. Tap **Browse** to select a picture from File Explorer.

4. Tap the **Items** tab to select or reorder the information on the **Today** screen.

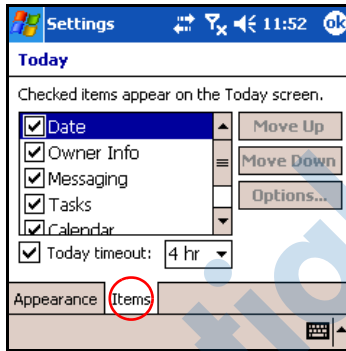

5. Tap an item to highlight it.
6. Tap **Move Up** or **Move Down** to change the order of items on the **Today** screen.

---

**Note:** You cannot change the placement of the **Date** on the **Today** screen.

---

7. Tap the down arrow in the checkbox next to **Today timeout** and select the timeout period for the **Today** screen.
8. Tap **OK**.

## Customizing the Application Buttons

You can change the Contacts and Inbox programs currently assigned to two of the application buttons on the bottom of the HP iPAQ. You can replace these assignments with two programs that you use the most.

---

**Note:** The Phone application buttons **cannot** be reassigned.

---

To change the Button assignment:

1. From the **Start** menu, tap **Settings > Personal tab > Buttons**.

2. Under **Select a button**: highlight the button to be changed, for instance - **Button 1**.
3. Tap the down arrow in the **Assign a program**: box and select your preferred program.
4. Tap **OK**.

## Locking the Application Buttons

To prevent the application buttons on your HP iPAQ from accidentally turning on and discharging the battery, the Buttons Settings include a Lock feature and a Keyguard feature to disable the buttons.

- Use the Lock feature to disable the buttons when HP iPAQ is in standby:
  1. From the **Start** menu, tap **Settings > Personal tab > Buttons**.
  2. Tap the **Lock** tab.
  3. Tap the check box next to **Disable all buttons except power button**.
  4. Tap **OK**.

---

**Note:** The next time your HP iPAQ is in standby, press one of the applications buttons to test this feature. With the Lock feature enabled, your device will not power on until the **Power** button is pressed.

---

**Important:** To make an emergency phone call while your HP iPAQ is in standby with the Lock feature enabled, press the **Power** button > tap the **iPAQ Wireless** icon > **Phone** button > **Phone Keypad** button, enter your phone number, and tap **Talk**.

---

- Use the Keyguard feature to disable the buttons when HP iPAQ is turned off:
  1. From the **Start** menu, tap **Settings > Personal tab > Buttons**.
  2. Tap the **Lock** tab.

3. Tap the check box next to **Enable Keyguard**.
4. Tap **OK**.

---

**Note:** The next time your HP iPAQ is powered off, press one of the applications buttons to test this feature. With the Keyguard feature enabled, your device will not power on until the **Contacts** and **Inbox** buttons are simultaneously pressed.

---

## Using Applications

### Opening Applications

Open any application on your HP iPAQ from the **Start** menu.

---

**Note:** You can also open an application by assigning it to one of the two available Application Buttons. The Phone Application Buttons **cannot be reassigned**. To assign the Application Buttons, from the **Today** screen, tap **Start > Settings > Buttons**.

---

To open an application:

1. Tap **Start > Programs**.
2. Tap the desired application title or logo.

### Minimizing Applications

To minimize an open application, tap the **x** at the top right of the screen.

### Closing Applications

Applications automatically close based on available memory. However, if your HP iPAQ is running slowly, you can close applications by manually closing them.

1. From the **Start** menu, tap **Settings > System tab > Memory > Running Programs** tab.

2. Tap **Stop All** or select a particular application, then tap **Stop**.

---

**Shortcut:** On the **ToDayPanel**, tap the **Memory** icon > **Running Programs** tab, select an application and tap **Stop**.

---

**Note:** To bring a currently running program to the foreground, tap **Activate**.

---

## Installing Applications

Install applications on your HP iPAQ from your:

- Computer by using Microsoft ActiveSync.
- HP iPAQ if the application file has a .cab extension.
- HP iPAQ or your computer by copying an application file that has an .exe or .cef extension.

When installing applications, look for the correct version for your HP iPAQ model or Windows Mobile™ 2003 Second Edition Software for Pocket PC Edition.

- Follow the instructions provided with the application and by the Installation Wizard to install applications from your computer.
- Tap the application file in File Explorer on your HP iPAQ and follow the instructions on the Installation Wizard to install applications on your HP iPAQ.

## Backing Up Information

Use iPAQ Backup or Microsoft ActiveSync Backup to back up and restore information on your HP iPAQ.

---

**Note:** iPAQ Backup is already installed on the HP iPAQ. You must install ActiveSync on your computer before using ActiveSync Backup.

---

To help reduce the chance of losing information, you should back up information on a regular schedule.

## Backup/Restore using iPAQ Backup

iPAQ Backup saves your data in a backup file. You may designate a file name and a location for the file to be saved. iPAQ Backup backs up to a memory card, main memory, or the iPAQ File Store folder. Close all programs on your HP iPAQ before backing up or restoring your information.



**CAUTION:** Restoring your information replaces the current information on your HP iPAQ with the information saved in your backup. If you perform a hard reset on your HP iPAQ, any user installed information stored in main memory including backup files will be deleted. For this reason, it is suggested that backup files always be saved to a memory card or to the iPAQ File Store folder.

---

To backup/restore using iPAQ Backup:

1. From the **Start** menu, tap **Programs > iPAQ Backup**.
2. Tap **Options > Switch to Advanced Mode** and select the files and folders to be backed up or restored.
3. Tap the **...** box next to **File** to select the name, location, and folder name for backed-up data.
4. Tap **OK**.
5. Press the **Backup** or **Restore** button, and press the **Start** button on the next screen.

## Backup/Restore Using ActiveSync

Close all programs on your HP iPAQ before backing up or restoring your information.



**CAUTION:** Restoring your information replaces the current information on your HP iPAQ with the information saved in your backup.

---

To backup/restore using ActiveSync:

1. Be sure the HP iPAQ is connected to your computer.



2. From your computer, open Microsoft ActiveSync. From the **Start** menu, click **Programs > Microsoft ActiveSync**.
3. From the **Tools** menu in ActiveSync, click **Backup/Restore**.
4. Click the **Backup** or **Restore** tab, and select your options.
5. Click **Backup Now** or **Restore Now**.

## Using iPAQ File Store Folder

You can install programs and save files to the iPAQ File Store folder, which is accessed from File Explorer on your HP iPAQ.

Programs and files stored in iPAQ File Store are stored in ROM and are saved if you perform a full reset of your HP iPAQ or if the battery discharges completely.

To save to iPAQ File Store:

1. Copy the files to be saved to the iPAQ File Store folder.
2. From the **Start** menu, tap **Programs > File Explorer > My Device > iPAQ File Store**.
3. Paste the selected files.

---

**Note:** Before saving files to the iPAQ File Store folder, it is a good idea to determine how much memory is available in the folder. To view the amount of memory, from the **Start** menu, tap **Settings > System tab > Memory > Storage Card** tab, then select **iPAQ File Store** from the drop-down menu.

---

---

## Using ActiveSync

You can use Microsoft ActiveSync to:

- Synchronize information between your HP iPAQ hw6500 series and up to two computers or one server so that you have the latest information in all locations.
- Change synchronization settings and the synchronization schedule.
- Copy files between your unit and computer.
- Install applications on your HP iPAQ.
- Back up and restore unit information.
- Synchronize links.
- Send and receive e-mail.
- Request meetings.



**CAUTION:** For synchronization to work properly, install Microsoft ActiveSync on your computer **before** you connect your HP iPAQ to your computer.

---

## Connecting to a Computer

Connect your HP iPAQ to your computer using Microsoft ActiveSync and the HP iPAQ cradle, a wireless infrared connection, a Wi-Fi connection or Bluetooth. For more information on using ActiveSync with Bluetooth, refer to [Chapter 9, “Using Bluetooth.”](#)

---

**Note:** When using Microsoft ActiveSync to synchronize e-mail on your computer with your HP iPAQ, you must have Microsoft Outlook 98 or later installed on your personal computer. If you do not have Outlook, install the Microsoft Outlook 2002 software from the Companion CD. Microsoft Outlook Express will **not** work with the HP iPAQ and ActiveSync.

---

## Installing ActiveSync

---



**CAUTION:** For synchronization to work properly, install Microsoft ActiveSync 3.7.1 on your computer **before** you connect your HP iPAQ to your personal computer. Earlier versions of ActiveSync will not work with the HP iPAQ hw6500 series.

---

To install Microsoft ActiveSync on your personal computer:

1. Insert the Companion CD into the CD tray or slot on your computer.
  2. When the CD displays on your computer screen, click on the **Start Here** tab, then select the link to install **Microsoft ActiveSync**.
- 

**Note:** If the Companion CD does not automatically start on your personal computer, you may need to manually start it by clicking on the Microsoft Windows **Start** menu in the lower left corner of the monitor screen, and then clicking on **Run**. In the Run dialog box, navigate to your CD drive and double-click on **SETUP.EXE** to start the Companion CD.

---

3. Follow the instructions in the installation wizard. For more help, click the ActiveSync **Help** button during installation.
4. After installing ActiveSync on your computer and, when prompted, connect the HP iPAQ to the computer using the HP iPAQ cradle.
  - a. Connect the USB connector on the cradle **1** to the USB port on your computer.
  - a. Connect one end of the AC Adapter **2** to the cradle and connect the other end to an electrical outlet to charge the unit.
  - b. Insert the HP iPAQ in the cradle **3**.

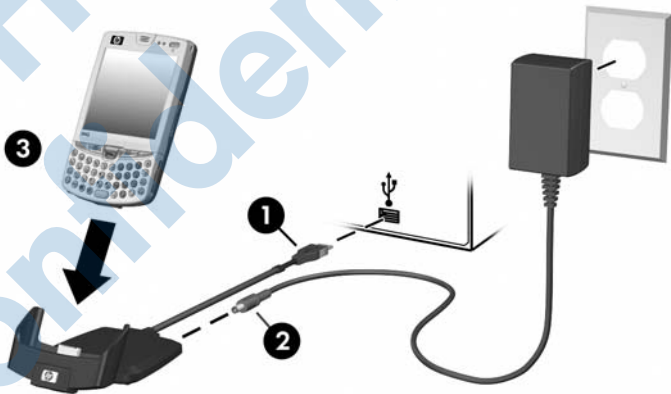

## Synchronizing with Your Computer

After you have installed ActiveSync and connected your HP iPAQ to your computer, you can:

- Create partnerships that enable you to synchronize information with up to two computers.

- Select information to be synchronized with your HP iPAQ (for example, Contacts, Calendar, Inbox, Tasks, Favorites, Files, Notes, and AvantGo).

---

**Note:** When you synchronize files, you can drag and drop the selected files from your computer to the synchronized folder on your HP iPAQ. If you named your device “PC1” when you created your partnership, then the synchronized folder is named “PC1.” When you synchronize, the files move to and from your HP iPAQ.

---

There are many error messages that can be received when synchronizing. For the best answers to troubleshooting these errors, refer to the Microsoft Windows Mobile Web site at [www.microsoft.com/windowsmobile](http://www.microsoft.com/windowsmobile). Under **Help and How To** on the left side of the screen, select **For Pocket PC**. Fill in your region, select your device name and your operating system; then, click the **Get Support** button. Under **Support Topics** on the left side of the screen, select **ActiveSync**.

## Using Microsoft Exchange ActiveSync

If your company is using Microsoft Exchange Server 2003, you can synchronize Calendar, Contacts, and E-mail with your HP iPAQ over the air without connecting to a desktop cradle. Exchange ActiveSync in Microsoft Exchange Server 2003 allows the HP iPAQ to access corporate information on a server running Exchange server (**SHOULD THIS BE ACTIVESYNC?**). It allows ActiveSync-enabled devices to synchronize mailbox items over the air (GPRS or wireless connection) without using a desktop computer, cradle, and desktop synchronization software.

You can also synchronize your mobile device with the Exchange server using the desktop pass-through option present in all Windows Mobile-based devices. Desktop pass-through allows your cradled device to use the desktop computer’s Internet connection to connect directly to Exchange ActiveSync. You can then perform tasks such as browsing the Internet or downloading IMAP/POP3 e-mail messages.

After Exchange ActiveSync creates a connection and a partnership between the device and the desktop computer, desktop pass-through is enabled by default, even if the desktop is locked or protected with a password or PIN.

Exchange ActiveSync enables you to synchronize the following items in your Exchange Server 2003 mailbox over the air:

- Calendar
- Contacts list
- E-mail messages

You can receive update notifications by means of the Always-up-to-date (AUTD) feature in Exchange Server 2003. Up-to-date notifications generated by Exchange Server 2003 initiate Exchange ActiveSync synchronization between your device and your Exchange mailbox.

---

**Note:** To set up Exchange ActiveSync, you will first need to contact your corporate IT team for the name of the corporate server with Exchange Server 2003 installed.

---

To set up Exchange ActiveSync synchronization after you have the server information:

1. On your personal computer, click the **Microsoft ActiveSync** application in your system tray.
2. Click **Options > Sync Options** tab.
3. Under Server, click in the **Enable Synchronization with a Server** box to enable it, then click **Configure**.
4. Place a checkmark in the boxes next to the features to be enabled (Calendar, Contacts, Inbox).
5. Follow the on-screen instructions to set up Exchange ActiveSync.

---

**Note:** For more information, refer to the Microsoft Windows Mobile Web site at [www.microsoft.com/windowsmobile](http://www.microsoft.com/windowsmobile).

---

## Using the Serial Infrared (IR) Connection

As an alternative to using the HP iPAQ cradle or Exchange ActiveSync, you can synchronize your HP iPAQ and your computer using an infrared connection if you have an infrared port or an infrared USB adapter installed on your computer. The infrared connection option works only on computers that have Microsoft Windows 98SE, Me, 2000, or XP operating systems installed.

To set up an infrared connection to a computer:

1. Synchronize your HP iPAQ with your computer using the HP iPAQ cradle **before** the first time you establish an ActiveSync connection via infrared.
2. Follow your computer manufacturer's instructions to install and set up an infrared port.
3. Remove the HP iPAQ from the cradle and line up the infrared port with the computer infrared port so they are unobstructed and within 12 inches (30.5 cm) of each other.
4. Initiate a connection by tapping **Start > ActiveSync > Tools > Connect via IR**. Synchronization begins on your device.
5. To disconnect, move the devices away from each other or tap **X** in the upper right of the screen to turn off.

## Changing Synchronization Settings

You can modify your synchronization settings for Microsoft ActiveSync to:

- Change when your HP iPAQ synchronizes with your computer or server.

- Change the type of connection from your HP iPAQ to your computer (for example, USB or infrared connections).

---

**Note:** The HP iPAQ hw6500 series Mobile Messenger does not support synchronization with a personal computer using a serial cable.

---

- Select the files and information to synchronize with your computer.
- Select the files and information you do not want to synchronize with your computer (for example, e-mail attachments).
- Determine how conflicts between information on your HP iPAQ and information on your computer are handled.

To change synchronization settings:

1. From the **Start** menu on your computer, click **Programs > Microsoft ActiveSync > Tools > Options**.
  - a. On the **Sync Options** tab, select the files and information to synchronize with your computer.
  - b. On the **Schedule** tab, select when your HP iPAQ synchronizes with your computer.
  - c. On the **Rules** tab, determine how conflicts between information on your HP iPAQ and information on your computer are handled.
2. Tap **OK** when you are finished.
3. From the **File** menu, click **Connection Settings**. Select the type of connection to be allowed between the HP iPAQ and the computer.

## Copying Files

You can copy files to and from your computer using **Explore** in ActiveSync and Windows Explorer.



To copy files:

1. Insert your HP iPAQ into the cradle.
2. From the **Start** menu on your computer, click **Programs > Microsoft ActiveSync**.
3. Click **Explore**.
4. Double-click the **My Pocket PC** icon.
5. On your computer, right-click the **Start** menu, and select **Explore**.
6. Locate the file to be moved.

---

**Note:** You cannot copy preinstalled files or system files.

---

7. Drag and drop your files between your HP iPAQ and your computer. ActiveSync converts the files so that they can be used by the Pocket Office applications, if necessary.

---

**Note:** Move your files directly into My Documents on your HP iPAQ (or into a folder inside My Documents), so the applications on your HP iPAQ can locate them.

---

---

**Note:** Some files may lose some of their format during the conversion process to an application on the HP iPAQ.

---

## Installing Programs

Use ActiveSync to install programs on your HP iPAQ from your computer:

1. Use the HP iPAQ Cradle to connect your HP iPAQ to your personal computer.
2. Follow the instructions in the Installation Wizard provided with the program.
3. Check the screen on your HP iPAQ to see if any further steps are necessary to complete the program installation.

## Backing up and Restoring

To help reduce the chance of losing information, you should back up information to your computer on your HP iPAQ regularly. For more information on backing up and restoring information using Microsoft ActiveSync, refer to [“Backing Up Information”](#) in Chapter 2, “Learning the Basics.”

## Synchronizing Links

You can synchronize links to Web sites from your **Favorites** list on your computer to view them offline with Pocket Internet Explorer.

1. From the **Start** menu on your computer, click **Programs** and double-click the **Internet Explorer** icon.
2. Click **Favorites** to see the list of links to your favorite Web sites.
3. To save a Web site link to Mobile Favorites, open the Web site, and click **Create Mobile Favorite**.

If you select “Favorites” as an information type to be synchronized, ActiveSync copies your mobile favorite to your HP iPAQ the next time you synchronize.

4. Follow the instructions in Synchronize information to manually synchronize your favorite links.

## Using ActiveSync to Send and Receive E-mail

You can send and receive e-mail messages by synchronizing your HP iPAQ with your computer using ActiveSync. If you are using ActiveSync to send and receive e-mail messages, the name of the folder you are using is displayed at the bottom of the screen. For more information on sending and receiving e-mail using ActiveSync, from the **Start** menu, tap **Help > Messaging**.

## Requesting Meetings

You can schedule a meeting and send a meeting request through ActiveSync. For more information, from the **Start** menu, tap **Help > Calendar**.

---

## Learning Input Methods

---



**CAUTION:** To avoid damaging your HP iPAQ screen, always use a stylus or your finger. **Never** use a pen or any type of metal pointer on the screen.

---

To input information to your HP iPAQ, you can use the Thumb Keyboard, tap the soft keyboard on the screen, or write with the Letter Recognizer, Microsoft Transcriber, or Block Recognizer in any application. You can use the stylus to draw and write on the screen in the Notes application and from any **Notes** tab in the Calendar, Contacts, and Tasks applications.

### Using the Thumb Keyboard

The integrated Thumb Keyboard is a convenient input device on your HP iPAQ product and uses a very small amount of power that is drawn from your HP iPAQ.

With the Thumb Keyboard, you can:

- Easily type text into your HP iPAQ.
- Quickly access your favorite HP iPAQ applications.
- Enter commands with special function keys.
- [Use the numeric keypad to dial phone numbers.](#)
- Launch the Calendar.
- Launch the Start menu.

## Keyboard Components









- |                     |   |
|---------------------|---|
| ❶ Blue Key          | This function key is used in conjunction with Blue symbols on the upper left of the keyboard keys to type symbols and to <a href="#">type numbers on the numeric keypad</a> . |
| ❷ Calendar button   | Press to display your calendar, press again to change the calendar format.  |
| ❸ Start menu button | Press to display the Start menu.  |

## Using the Function and Shortcut Keys

The Thumb Keyboard keys perform additional functions when pressed in the combinations indicated.



The Blue Key is a function (Fn) key on the left side of the keyboard. Blue symbols used in conjunction with the Blue Key are located on the upper left of the keys.

Keystroke Combination	Action
<b>Blue Key</b>  + any key	Enters characters printed on the upper left of the key (indicated in blue).
<b>Blue Key</b>  pressed twice	Toggles on blue keys. Press <b>Blue Key</b> once to toggle off.
<b>Blue Key</b>  + <b>down arrow</b>	Page down
<b>Blue Key</b>  + <b>up arrow</b>	Page up
<b>Blue Key</b>  + <b>left arrow</b>	Scrolls left
<b>Blue Key</b>  + <b>right arrow</b>	Scrolls right
<b>Blue Key</b>  + <b>OK</b>	Closes program

## “Sticky” Keys

The integrated keyboard uses a “Sticky Key” feature for the **Shift** and **Blue Fn** keys (known as “key modifiers”). This means that when you enter a number or symbol requiring a combination of keys to be pressed, the key modifier will stay engaged until you press the second key. It is not necessary to press both keys at the same time.

## Special Keys

Key	Function	Description
	Function (Fn) key	“Sticky Key” for invoking alternate function or symbols on most keys.
 + 	Function (Fn) key and space bar key (English only)	Used for selecting alternate characters and symbols to replace a character.

---

**Note:** To type a backslash (\) on the Thumb keyboard, first press the **Blue Fn Key + P** to create a forward slash (/), then the **Symbol/Space Bar key** to modify it as necessary. Refer to the following “Accent Characters” section for more information on modifying characters.

---

## Accent Characters

To type any of the accent characters, press the letter you require to be accented, then press the **Blue Fn Key** and the **Symbol/Space bar**. Continue pressing the **Blue Fn Key** and the **Space bar** until you reach the desired special character. For example, if you press **a**, then the **Blue Key** and the **Symbol/Space Bar**, the **a** will result in **â**. If you press the **Blue Fn Key** and **Space Bar** again, the **â** will change to **á**. If you continue to press the **Blue Fn Key** and the **Space Bar**, the accent mark over the **a** will continue to change.

To type a capital letter with an accent, press and hold down the **Shift** key and press the desired letter, then press the **Blue Fn Key** and the **Space Bar**. For example, press **Shift + a**, then press the **Blue Fn Key** and the **Space Bar**, the **A** will result in **À**.

Refer to the table below for a list of special characters.

---

**NOTE:** It is recommended that you print this table for future reference.

---

### Special Character Table

Original Character	Modified Character
a	à á â ã ä å ã ä æ
A	À Á Â Ã Ä Å Æ Æ Æ
c	ç ć Ć ©

---

**Special Character Table (Continued)**

C	Ç Ó Ć ©
d	đ
D	Ð
e	è é ê ë ě
E	È É Ê Ë Ě
i	ì í î ï
I	Ì Í Î Ï
l	ł
L	Ł
n	ñ
N	Ñ
o	ò ó ô õ ö ø œ
O	Ò Ó Ô Õ Ö Ø Æ



**Special Character Table (Continued)**

<b>Original Character</b>	<b>Modified Character</b>
p	þ ƒ
P	Þ Ƒ
r	®
R	®
s	§ š ß
S	§ Š ß
t	†
T	‡
u	ù ú û ü ũ
U	Ù Ú Û Ü Ũ
y	ý
Y	Ý
z	ž ž
Z	Ž Ž
\$	€ £ ¥
/	\\
“	' « »
(	[ { < «
)	] } > »

## Special Character Table (Continued)

Original Character	Modified Character (Continued)
+	± & - _
!	¡ ? ¿
·	: ;
*	#
@	~
%	^

## Using the On-Screen Keyboard

Use the stylus to tap letters, numbers, and symbols on the on-screen keyboard to enter typed text directly onto the screen.

**Note:** A question mark within a program indicates a **Help** file. Tap the **?** to open the Help file.

1. From any application, tap the up arrow next to the **Input Panel** icon.

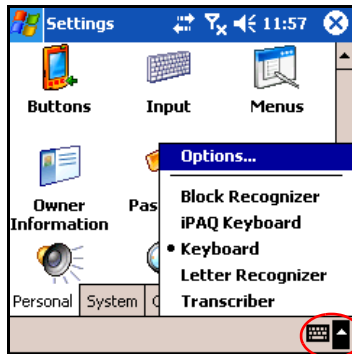

2. Tap **Keyboard** to display a keyboard on the screen.

---

**Note:** To see symbols on the keyboard, tap the **123** or **Shift** key.

---

3. Tap a letter, symbol, or number to enter information.
4. Tap **OK**.

## Writing with the Stylus and the Letter Recognizer

Use the stylus and Letter Recognizer to write letters, numbers, and symbols on the screen. Create words and sentences by writing in uppercase (ABC), lowercase (abc), and symbols (123) as instructed here.

To write with the stylus and Letter Recognizer:

1. From any application, tap the up arrow next to the **Input Panel** icon.
2. Tap **Letter Recognizer**.
3. Write a letter or symbol between the dashed line and baseline.
  - a. To display in uppercase, write a letter between the hatch marks labeled **ABC**.
  - b. To display in lowercase, write a letter between the hatch marks labeled **abc**.
  - c. Write a number or draw a symbol between the hatch marks labeled **123**.

What you write will be converted to text.

---

**Note:** For the Letter Recognizer to work effectively, write characters between the dashed line and baseline.

- If you are writing a letter like “p,” write the top portion within the dashed line and baseline, and the tail portion below the baseline.
  - If you writing a letter like “b,” write the bottom portion within the dashed line and baseline, and the top portion above the dashed line.
- 

## Writing with the Stylus and Microsoft Transcriber

Use the stylus and Microsoft Transcriber to write words, letters, numbers, and symbols anywhere on the screen.

1. From any application, tap the up arrow next to the **Input Panel** icon.
2. Tap **Transcriber** to display the **Transcriber Intro** screen.
3. Tap **OK**.
4. Tap **New** at the bottom of the screen.
5. Begin writing on the screen. What you write will be converted to text.

---

**Note:** To “teach” Transcriber your style of writing, tap on the “a” icon at the bottom of the screen to display the **Letter Shapes** screen and follow the instructions.

---

## Writing with the Stylus and Block Recognizer

Write letters, numbers, and symbols using the stylus and Block Recognizer. Create words and sentences by writing letters and numbers in specific areas.

1. From any application, tap the up arrow next to the **Input Panel** button.
2. Tap **Block Recognizer**.

---

**Note:** For online Help, tap the **?**

---

3. Write a word, letter, or symbol between the hatch marks.
  - a. To type text, write a letter between the hatch marks labeled “abc.”
  - b. To type numbers or symbols, write a number or symbol between the hatch marks labeled “123.”

What you write will be converted to text.

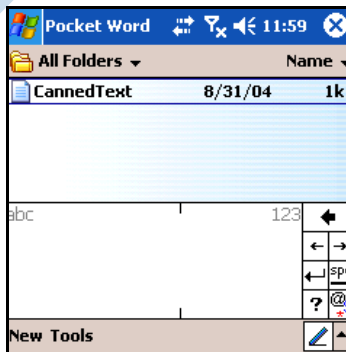

## Drawing and Writing on the Screen

Use the stylus as a pen to draw and write on the screen in the Notes program or from the **Notes** tab in Calendar, Contacts, or Tasks.

1. From the **Start** menu, tap **Notes > New**.
2. Draw and write on the screen.
3. Tap the **Pen** icon.
4. Tap **OK**.

## Converting Writing to Text

You can convert your writing to text when you write with the stylus in the Notes program or from the Notes tab in:

- Calendar
- Contacts
- Tasks

To convert writing to text:

1. From the **Start** menu, tap **Notes**.
- 

**Note:** Otherwise, tap the **Notes** tab in Calendar, Contacts, or Tasks.

---

2. Tap a note to open it.
  3. Tap **Tools**.
  4. Tap **Recognize**.
- 

**Note:** To convert a particular word or phrase, highlight it before you tap **Recognize**. If a word is not recognized, it will not be converted.

---

5. Tap **OK**.

## Changing Word Suggestion Options

As you type or write, the HP iPAQ suggests words for you in a box above the soft keyboard, Letter Recognizer, or Block Recognizer.

**Note:** This feature is unavailable [when you use the Thumb Keyboard](#) or Transcriber.

You determine:

- If words are suggested.
- The number of letters you enter before a word is suggested.
- The number of words that are suggested per entry.

To change settings for word suggestions:

1. From the **Start** menu, tap **Settings** > **Personal** tab > **Input**.
2. Tap the **Word Completion** tab.

**SHORTCUT:** From within any application, tap the **up arrow** next to the Input Panel icon and tap **Options** > **Word Completion** tab.

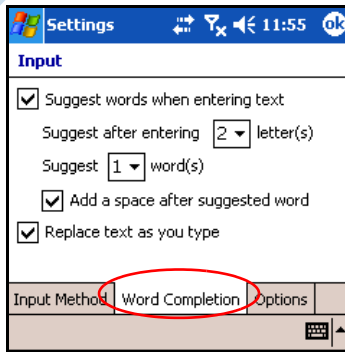

3. Tap the down arrow associated with letters and select the number of letters you want to type before a word is suggested.

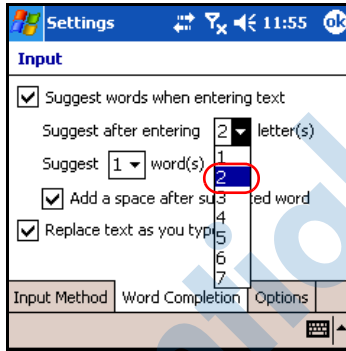

4. Tap the down arrow associated with words and select the number of words you want suggested.

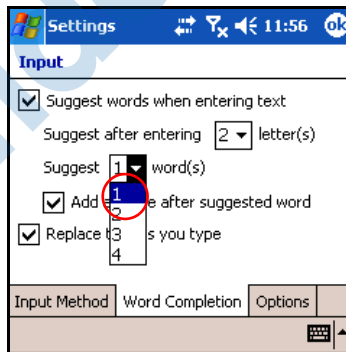

5. Tap **OK**.

---

**Note:** If you do not want any words suggested, tap the checkbox to remove the checkmark next to **Suggest words when entering text**.

---



---

## Using the Phone Features

Use the HP iPAQ Mobile Messenger phone to make and receive telephone calls and send and receive Text and MMS (Multimedia Message Service) messages. Your mobile phone service provider may provide other useful services such as voice mail.

The phone can also be used to connect to an Internet Service Provider (ISP) or work network so you can browse the Web and read e-mail. You can connect to the Internet or work network over GPRS/EDGE (General Packet Radio Service/Enhanced Data Rates for Global Evolution), or you can use GSM (Global System for Mobile Communications) for dial-up access.

For information on establishing GSM/GPRS/EDGE data connections, refer to [Chapter 7, “Making Your Data Connections.”](#)

---

**Note:** EDGE is an enhancement to GPRS technology and enables higher speed data connections than GPRS. This means faster phone multimedia capabilities such as sending and receiving SMS/MMS messages, and sharing video clips. Check with your service provider to see if they support EDGE technology. If your service provider does not support the EDGE network, the HP iPAQ will default to GPRS.

---

## SIM Card

A SIM (Subscriber Identity Module) card is required to operate the phone features on your HP iPAQ. The SIM card is a plastic card embedded with a computer chip that stores and transacts data. After the SIM card is activated by your mobile phone service provider, the computer chip will contain information about your phone number, service, registration information, and contacts, as well as memory to store speed dial numbers and text or SMS/MMS messages that you receive.

With the exception of emergency calls, the SIM card must be inserted into the SIM slot under the battery on the back of the HP iPAQ in order for voice/data calls to work.

To dial an emergency number from the Phone keypad, tap the emergency number appropriate for your region, and then tap **Talk** or **Send**.

---

**Note:** See your local telephone directory for emergency numbers used in your area. Emergency numbers can be dialed without a SIM card being inserted in the HP iPAQ and there is no charge for emergency calls.

---

---

## Inserting a SIM Card

---

**Note:** If the battery is already installed, you must remove it before inserting the SIM card. For more information on this, see [Chapter 13, “Managing the Battery.”](#)

---

To insert the SIM card into the HP iPAQ:

1. On the back of your HP iPAQ, remove the back cover:
  - a. Press down on the battery latch ❶.
  - b. Use your thumb to slide the back cover down and away from the device ❷.



2. Insert the SIM card into the SIM slot by aligning the notched corner on the card with the notched corner in the SIM slot, then push the SIM card into the SIM slot. Be sure to push it in all the way.

---

**Note:** The gold side of the SIM card should be facing down when it is inserted into the SIM slot.

---

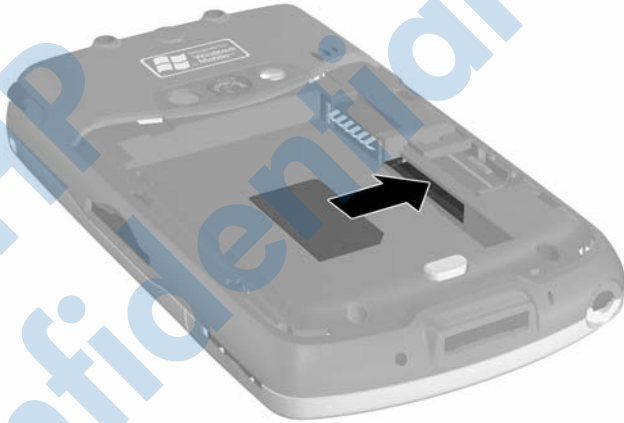

## Removing the SIM Card

1. Repeat the previous steps to remove the back cover and battery.
2. Insert the stylus into the right side of the SIM slot opening and nudge or push the SIM card out of the slot. Do not touch the metal contacts.

## Activating Your Phone Service

Before you are able to use the phone feature on your HP iPAQ, you will need to subscribe with a mobile phone service provider.

---

**Note:** If you purchased your HP iPAQ from a mobile service provider, phone service may be activated at time of purchase or the mobile service provider may include activation instructions. If you have purchased a prepaid SIM card to use with your HP iPAQ, the following information is not applicable.

---

You can place a phone call to the service provider to activate your mobile phone service. Your carrier may require the following information to activate your card:

- SIM Card Serial Number (printed on the box label or on the back of the SIM card)
- IMEI Number (printed on the system label under the removable battery)

Your mobile phone service representative will give you your wireless phone number and walk you through setting up your service.

## Phone Features

The following features are supported on your HP iPAQ; however, these features must be activated by your mobile phone service provider:

- Call Forwarding
- CSD—Circuit Switched Data
- GPRS—General Packet Radio Service
- International Dialing
- International Roaming
- Internet access

- Text Message/MMS**—Text Message Service/Multimedia Message Service
- Voice Mail**
- VPN**—Virtual Private network

You can obtain additional information on these services from your mobile phone service provider.

## Your PIN

After your SIM card is activated, it may be configured with a PIN (Personal Identification Number) to prevent unauthorized use of your mobile phone.

---

**Note:** Emergency phone calls do not require entering a PIN.

---

You can disable your PIN; however, for security reasons, it is recommended that you keep it enabled. While enabled, you must enter your PIN every time you turn on your phone features.



**CAUTION:** After three consecutive, incorrect PINs are entered, the SIM card locks to prevent further use. If the letters **PUK** (PIN Unblocking Key) display on your HP iPAQ screen, you have locked your SIM card and must enter your PUK on the screen to unlock it. If you did not receive a PUK with your SIM card, you must contact your service provider to unlock it.

---

If your HP iPAQ is ever stolen or lost, the PIN will safeguard your phone against fraudulent use.

To enable your PIN:









1. From the Phone keypad, tap **Tools > Options > Phone** tab.









2. Select **Require PIN when phone is used**.

**Note:** To change the PIN at any time, tap **CHANGE PIN**.

**Note:** To safeguard your HP iPAQ device from unauthorized use, see the section Setting a Password in [Chapter 1, “Getting to Know Your HP iPAQ Mobile Messenger.”](#)

## Phone Buttons and Icons

Phone Icons	Definition
	<ul style="list-style-type: none"> <li>■ Press this green <b>Answer/Send Application Button</b> to answer a call, access the phone keypad, and send a call.</li> <li>■ Press and hold this Button to activate the speakerphone function during a phonecall.</li> </ul>
	Press and hold this red <b>End Call Application Button</b> to end a call.
	Phone is powered off.
	Phone is powered on.
	Network is searching or unavailable.
	Phone connection unavailable or network error.
	Signal strength indicator for phone functions.
	Call missed. Tap this icon to view missed calls.

Phone Icons	Definition <i>(Continued)</i>
	Call Forwarding Active
	Phone Volume is active.
	Microphone is in mute position.
	GPRS Service is available.
	Active data connection to GPRS network.
	Event notifications set to vibrate instead of alarm. To set to vibrate: Tap <b>Speaker</b> icon in the Navigation bar and in the pop-up menu, tap <b>Vibrate</b> .
	One or more instant messages have been received. Tap this icon to view messages.
	One or more e-mail/SMS/MMS or voicemail messages have been received. Tap this icon to view messages.
	Message Center indicates messages received from different communication areas such as phone or voice messages, e-mail/SMS/MMS, announcements, etc. Tap this screen icon to view all messages in the message center.



## Checking Your Connection and Signal Strength

After you insert the activated SIM card into your HP iPAQ, your unit will connect to your service provider's network.

The powered on icon (📶) indicates that you are connected to your service provider's network. After that, a full strength is indicated by the signal strength icon (📶). The number of vertical bars in the icon diminish as the signal strength diminishes. The phone icon (📞) indicates no signal.

## Automatic Frequency Band Selection

Your HP iPAQ has an integrated GSM/GPRS/EDGE feature that supports four different frequency bands which allow for international roaming. When traveling between countries and wireless network operators, the automatic selection feature changes the frequency bands of the GSM/GPRS/EDGE connection settings. It does this by initiating an automatic search for network frequency bands when your home bands are not available. This automatic selection feature is the default setting on your HP iPAQ.

## Turning the Phone On and Off

You can turn your Phone on and off while keeping your HP iPAQ turned on.

There are several ways to turn on your Phone:

- From the **Today** screen, tap the **iPAQ Wireless** icon in the Command bar at the bottom of the screen, then tap the **Phone** button on the iPAQ Wireless screen.
- From the **Today** screen, use the numeric keypad on the Thumb Keyboard to enter a phone number. After the first or second number is entered, the phone keypad displays. Tap **Yes** when asked if you want to turn the phone on.

- Press the green Answer/Send Phone button to display the phone keypad. Enter a phone number on the keypad and tap **Yes** when asked if you want to turn the phone on.
- From the Today screen, tap the phone  icon in the Navigation bar and, from the Pop-up menu, tap **Turn off flight mode**.

**Note:** Flight mode turns on/off all wireless functions on your HP iPAQ. Turn on Flight mode when you are traveling by air to prevent a wireless function from automatically turning on.

There are two ways to turn off your phone:

- From the **Today** screen, tap the **iPAQ Wireless** icon in the Command bar, then tap the **Phone** button to turn off the phone.
- On the **Today** Screen, tap the  icon in the Navigation bar and, from the Pop-up menu, tap **Turn on flight mode**.

---

**Note:** Leave the phone turned on to receive calls when your HP iPAQ is powered off.

---

You can use other programs on your device during a call. To quickly switch back to Phone, tap the green  **Answer/Send** application button, or tap **Start > Programs > Phone**.

## HP Profiles

- To access HP Profiles, from the **Start** menu, tap **Settings > System** tab > **HP profiles**.

HP Profiles allows you to create system profiles for alerts, display power, and wireless settings to match your current environment or location. You can set up and name profiles to use at different times and for different functions. For example, you can set a certain Ring type or tone to be silent or vibrate when you are in a meeting, or loud when you are outdoors in a crowd.

You can select pre-defined profiles for specific situations. These pre-defined profiles have common settings for Alerts, Display Settings, Power, and Wireless.

There are four button icons that allow you to modify settings for Alert, Display, Power, and Wireless.

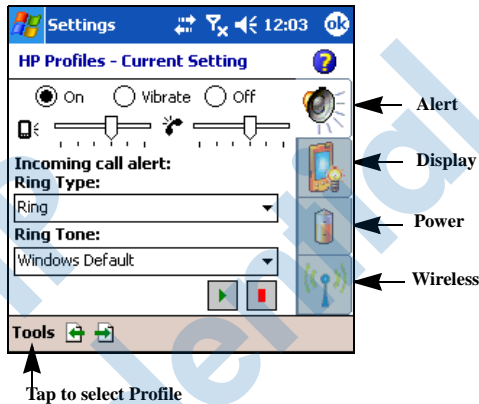

## Setting a Profile

To set a profile:

1. From the **Start** menu, tap **Settings** > **System** tab > **HP Profiles** icon.
2. Tap **Tools** > **Select Profile** and, from the drop-down list, select a profile name.

**Note:** Tapping the **Rename** selection brings up a dialog box. Enter the new name in the dialog box and tap **OK**.

3. On the right of the screen, tap the icon button that you want to set (**Alert, Display, Power, or Wireless**).
4. Select the desired settings:

- a. Use Alert to select a ring type and tone, set the type to On, Vibrate, or Off, and set the volumes for device and phone.
  - b. Use Display to adjust backlight brightness and set a timer to turn off the backlight if device is not used.
  - c. Use Power to set a timer to turn off the power if device is not used.
  - d. Use Wireless to keep wireless settings On or Off (Phone and Bluetooth).
5. Tap **OK** when you have finished setting the profile.

## Switching a Profile

To quickly switch a profile from within any application:

1. Press and hold the **Power button** to bring up the quick access menu.

---

**Note:** The quick access menu includes five tasks in addition to the profile selections that allow you to switch tasks.

---

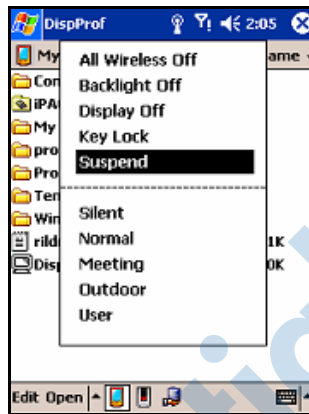

This menu is not active on Kudu yet. I will create a new screen-shot when it is active.

2. Tap the desired profile.

---

**Note:** The quick access menu disappears after 30 seconds.

---

**Note:** When the Backlight is adjusted to its lowest setting, it cannot be turned on from the quick access menu. It can only be turned back on by accessing the **Start** menu > **Settings** > **System** > **Backlight** > **Brightness** tab and adjusting the brightness level. The brightness level can also be accessed from the battery icon if the **TodayPanel** is displayed.

---

## Making and Receiving Phone Calls

You can now make local or long distance domestic calls and, if you requested the setup, you can also make international calls.

### Making a Call

1. Press the green  **Send/Answer** button to launch the phone keypad.
2. Use either the phone keypad or the numeric keypad on the Thumb Keyboard to tap the number you want to call.

3. Then tap or press the **Talk** button to dial the number.
  4. Tap **Yes** when you are asked if you want to turn the phone on.
- Refer to the following sections for alternate ways to make a call:

- “Making a Call From Contacts”
- “Making a Call Using Speed Dial”
- “Making a Call from Call History”
- “Making a Conference Call”

## Answering a Call

When you receive a phone call, the HP iPAQ rings or vibrates and a message will appear on the screen, giving you an option to either answer or ignore the incoming call.

- Tap **Answer** or press the green  **Send/Answer** button to receive the call.

---

**Note:** To silence the phone and reject the call, tap **Ignore**. This may send the caller to your voice mail or send out a busy signal, depending on your service provider.

---

## Ending a Call

When your phone call is finished, tap **End** on the Phone keypad or press and hold the red  **End Call** button to end the call.

## Making a Call from Contacts

- From the Contacts list, tap and hold the contact's phone number, then tap **Call Work**, **Call Home**, or **Call Mobile**.
- To make a call from an open contact, tap the number you want to call.

## SIM Contacts Help

When switching SIM cards between devices, use SIM Contacts to copy contacts from a new SIM card to Contacts on your device.

- ❑ To copy a contact from your SIM card onto your device, in SIM Contacts, select the contact you want to copy to your device and tap **COPY NOW**.
- ❑ To verify that your contacts have been copied to your device, switch to **Contacts** and search for the added contacts.

---

**Note:** This feature may not be available on all models.

---

## Making a Call Using Speed Dial

- From the Phone keypad, tap **Speed Dial**, and then select the speed dial location number of the desired contact. You can also press and hold the speed dial location number assigned to a contact directly from the Phone keypad.

---

**Note:**

- To dial a one-digit speed dial number from the Phone keypad, tap and hold a single keypad key.
  - To dial a two-digit speed dial number from the Phone keypad, tap the first digit, then tap and hold the second digit.
- 

## Creating a Speed Dial Entry

You can create up to 99 speed dial entries to call frequently-dialed numbers. Before you can create a speed dial entry for a phone number, that number must already exist in Contacts.

1. From the Phone keypad, tap **Speed Dial > New**.
2. Tap the desired contact name and number.

3. In the **Location** field, tap the Up/Down arrows to select an available location to assign as the new speed dial entry. The first speed dial location is reserved for your voice mail.
4. Tap **OK**.

## Creating a Speed Dial Entry from Contacts

1. Tap and hold the contact name.
2. Tap **Add to Speed Dial**.
3. Tap the Up/Down arrows to select an available location to assign as the new speed dial entry.
4. Tap **OK**.

## Editing a Speed Dial Entry

1. From the **Speed Dial** list, tap and hold the contact name in the box to the right of the assigned speed dial number.
2. Tap **Edit** or **Delete**.

## Making a Call from Call History

- From the Phone keypad, tap **Call History**, and then tap the icon next to the desired number.

## Making a Conference Call

You can create a three-way conference call between yourself and two other parties.

- From the Phone keypad, dial the first number, tap **Talk** and after the call is initiated, tap **Hold**, dial the second number, tap **Talk** and then tap **Conference**.



## Adjusting Phone Volume

During a phone call, push the Phone volume slider on the top, left side of the device up (+) or down (-).

---

**Note:** The Phone volume can only be adjusted during a phone call.

---

## Enabling the Mute Function

During a call, you can mute your microphone so that the person with whom you are speaking cannot hear you, but you can still hear him or her. This is useful if you do not want the other person to hear a conversation or background noise on your side of the call.

- From the Phone keypad, tap the microphone icon  in the Command bar to mute or unmute a call.

## Setting Ring Tones

1. Tap  > **Settings** > **System** tab > **HP Profiles**.
2. Tap the **Alert** icon and tap the drop-down list under **Ring type** to select the type of ring to be used.
3. Then tap the drop-down list under **Ring tone** and select the ring tone to be used.

4. To listen to the selected sounds, tap the **Play** icon. When you are finished listening, tap the red **Stop** icon.

---

**Note:** You can also select Ring Tones by tapping **Start > Settings > Phone** icon.

---

**Note:** To use custom.wav, .mid, or .wma files as ring tones, use ActiveSync on your personal computer to copy the file to the My Device\Windows\Rings folder on your device. Then, select the sound from the **Ring tone** list.

---

To control tapping sounds for the keypad:

1. From the **Start** menu, tap **Settings > Personal tab > Sounds & Notifications**.
2. Place a checkmark in the box next to Screen taps and select **Soft** or **Loud**. If there is no checkmark in the Screen taps box, a tone is not played.
3. Tap **OK** to save the settings.

## Changing Ring Tones

You can select a different sound to notify you of incoming calls.

1. From the Phone keypad, tap **Tools > Options**.
2. Tap the Ring tone list, and select the sound you want to use.

## Changing Keypad Tone

You can change the tone you hear when entering a phone number on the keypad. If set to Tones, the tone is heard continuously for as long as the number on the keypad is pressed. If set to Beep, the tone is heard only for one or two seconds.

1. From the Phone keypad, tap **Tools > Options**.
2. Tap the Keypad list, and select the option you want.

To prevent tones from being heard when entering a phone number, select **Off**.

## Adding Ring Tones



You can add different sounds to notify you of different events on your HP iPAQ.

1. From the **Start** menu, tap **Settings > System tab > Add Ring Tone**.
2. Tap the Ring tone list, and select the event sound you want to use, and tap the **Add** button.

## Enabling Speakerphone Mode

Your HP iPAQ has a speakerphone mode that allows you to talk hands-free or allows other people to listen to the caller.

To enable the speakerphone mode:

1. First make a phone call.
2. Hold down the green  **Answer/Send** button until the speakerphone dialog box comes on and the speakerphone icon () appears in the top Navigation bar.

---

**SHORTCUT:** From the Phone keypad, tap **Tools > Speakerphone**.

---

3. To turn off the speakerphone, hold down the  **Answer/Send** button again.



**WARNING:** Do not leave the phone in speakerphone mode and hold it to your ear, the sound may temporarily impair your hearing.

---

## Taking Notes During a Call

- To create a note during a call, tap the Note icon  in the Command bar and enter or record your note.

## Using Voice Mail

The first speed dial location is set as a default for your voice mailbox number. When you insert your SIM card into your HP iPAQ, it sets as default the voice mailbox number of your mobile service provider. You may need to configure your phone to the Voice Mail setting by dialing or setting the Voice Mail dial number or password.

To retrieve your voice mail:

- With the phone turned on and the phone keypad visible on the screen, press and release the left side of the 5-way navigation button, select **1** Voice Mail, then press .

## Putting a Call on Hold

During a phone call, tap **Hold** on the Phone keypad to put the call on hold. The call on hold appears on the top right of the dialer screen. You may switch between calls by tapping on the call on hold.

## Using Call Waiting

Call waiting notifies you of incoming calls when you are already in a phone session.

To activate Call Waiting:

1. From the Phone keypad, tap **Tools > Options > Services** tab.
2. Tap **Call Waiting > Get Settings**.
3. Select **Notify me**.
4. Tap **OK**.

---

**Note:** To stop using call waiting, select **Do not notify me**.

---

To use Call Waiting to answer an incoming call during a phone conversation, tap **Answer** to move the current phone call to **Call Waiting**. The phone call on **Call Waiting** displays on the screen. Tap **Ignore** if you do not want to answer the incoming call.

## Displaying Caller ID

You can display your caller ID when placing a phone call.

1. From the Phone keypad, tap **Tools > Options > Services** tab.
2. Tap **Caller ID > Get Settings**.
3. Select **Everyone**.
4. Tap **OK**.

---

**Note:** To prevent your caller ID from being displayed to others, select **No One**.

---

## Blocking Calls

Use call barring to block certain types of incoming and/or outgoing calls.

1. From the Phone keypad, type **Tools > Options > Services** tab.
2. Tap **Call Barring > Get Settings**.
3. Select the type of incoming and/or outgoing calls you want to block.

## Forwarding Calls

Use call forwarding to forward all incoming calls to a different number.

1. From the Phone keypad, tap **Tools > Options > Services** tab.
2. Tap **Call Forwarding > Get Settings**.

3. Select **Forward all incoming phone calls**, and specify the phone number to receive forwarded calls.

You can also use call forwarding to forward incoming calls to a different number based on your situation.

- Select **Unavailable** to forward calls only when your phone is turned off or you are unreachable.
- Select **Busy** to forward calls only when the line is busy.
- Select **No answer** to forward calls only when you can't answer your phone.



---

**Note:** To stop using Call Forwarding, clear the box next to **Forward all incoming phone calls**.

---

## Changing the System Volume

You can adjust the volume for system sounds, such as the sound you hear when you tap on program names and menu options.

- Tap the  icon in the Navigation bar.
- In the pop-up volume box, move the system volume () slider to the desired volume level.

Select **On**, **Vibrate**, or **Off** to quickly change both the system and ringer volume settings.



---

**Note:** You can also move the volume control on your device to quickly change both the ringer and system volume settings.

---

## Change the Ringer Volume

There may be times when you want to change the ringer volume on your device. For example, you may want to increase the ringer volume when you're anticipating an important call, or immediately silence the ringer when you receive a call during a meeting or when you're in a quiet environment.

- Tap the  icon in the Navigation bar.
- In the pop-up volume box, move the ringer volume (  ) slider to the desired volume level.

Select **On**, **Vibrate**, or **Off** to quickly change both the ringer and system volume settings.

You can also move the volume control on your device to quickly change both the ringer and system volume settings.

## Changing the Phone Settings

Tap **Start > Settings > Phone**.

You can customize phone settings such as the ring type and ring tone to be used for incoming calls, and the keypad tone to be used when entering phone numbers. You can also protect your phone from unauthorized use with a PIN.

- To change phone settings from the Phone keypad, tap **Tools > Options > Phone** tab.

From the **Phone** tab, you can change the following items:

- Ring type—Tap the **Ring type** list and select the desired option.
- Ring tone—Tap the **Ring tone** list and select the sound you want.
  - Note:** To use custom .wav, .mid, or .wma files as ring tones, use ActiveSync on your personal computer to copy the file to the /Windows/Rings folder on your device. Then, select the sound from the **Ring tone** list.
- Keypad tone—Tap the **Keypad** list, and select the option you want.

- ❑ Secure your Phone by placing a checkmark in the **Require PIN when phone is used** box.

---

**Note:** Your mobile service provider may already have given you a PIN to use with the Phone. After entering that PIN, you may change the PIN at any time.

---

## Changing Services Settings

You can change service settings by either of the following methods:

- From the **Start** menu, tap **Settings > Phone > Services** tab, tap a service, and then tap **Get Settings**.
- From the Phone keypad, tap **Tools > Options > Services** tab, tap a service, and then tap **Get Settings**.

You can configure settings for phone services you subscribe to through your mobile phone service provider. For example, you may want to block certain types of incoming and/or outgoing calls, forward incoming calls to a different phone number based on your situation, be notified of incoming calls when you're already in a phone session, or let others know your identity when making calls.

## Viewing Available GSM/GPRS/EDGE Networks

You can view all Global System for Mobile Communications /General Packet Radio Service/Enhanced Data Rates for Global Evolution (GSM/GPRS/EDGE) wireless networks available to you.

1. From the Phone keypad, tap **Tools > Options > Network** tab.
2. Tap **Find Network**.



## Using International Roaming

When you are planning on traveling abroad or to foreign countries, you will be able to use your HP iPAQ to call home or anywhere by first setting it up for international roaming.

At least 24 hours before you go away on your trip, you need to do the following:

---

**Note:** Depending on your mobile phone service provider, it may not be necessary to complete all of the following items to set up your phone for international roaming.

---

Contact your mobile phone service provider for the following information and services:

- Have them activate your phone for International Roaming. Depending on your mobile phone service provider, there may be an additional charge for this feature.
- 

**Note:** Once your HP iPAQ has been activated, it is set up permanently for you to use abroad.

---

- Check with your mobile phone service provider to make sure your HP iPAQ will work in the country you are going to and find out what kind of coverage you will get.
- Find out if you will need to purchase another SIM card with the correct international format on it, or if your mobile phone service provider may be able to reformat the SIM card you already have into the correct format.
- Since your HP iPAQ has GPRS and EDGE capability, you may want to ask your mobile phone service provider for an up-to-date list of foreign operators that enable you to use data functionality abroad and added costs for the service plan. Once you know which network to connect to in the country you are traveling through, you can connect to that network manually using the following instructions.

## Changing Network Settings

You can change Network Settings by either of the following methods:

- From the **Start** menu, tap **Settings > Phone > Network** tab.
- From the Phone keypad, tap **Tools > Options > Network** tab. The GSM/GPRS connection your device is currently using will be listed at the top of the screen.

You can view available networks, determine the order in which your phone accesses another network if the current one is unavailable, and specify whether you want to change networks manually or automatically. The current network will remain active until you change it, lose your signal, or change your SIM card.

## Manually Selecting a Network

---

**Note:** HP highly recommends leaving the HP iPAQ set to its automatic network settings.

---

At times, you may want to manually select a different wireless network to use, instead of your device automatically doing this for you. For example, if you want to connect to a specific network for a specific purpose, and you are authorized to use this specific network, then complete the following instructions:

1. From the Phone keypad, tap **Tools > Options > Network** tab.
2. Under Network selection, select **Manual** and select the network you want to use.

**Note:** When your current network is unavailable, tap **Select Network**, and manually select a different network to use.

---

**Note:** In the event you are unable to locate a network, you must reset the device by tapping **Start > Settings > Phone > Network** tab and under Network Selection, tap **Automatic > Find network**.

---

## Configuring Your HP iPAQ for Your SIM Card

When the SIM card connects to your service provider's network, it may be updated by your service provider to include new network parameters for faster connection. The GSM/GPRS Settings Manager automatically updates your HP iPAQ's device files with the new network parameters on your SIM card.

At times, you may need to manually edit the network settings or create your own personal network settings. To do that, you will need to modify the GSM/GPRS Settings.

The GSM/GPRS Settings Manager has the following features:

- Automatically detects the carrier and sets up the GPRS, SMS, MMS, and WAP connection information.
- Automatically detects the carrier and updates network settings on all hard and soft resets.
- Provides the User with the ability to edit network settings including GPRS, CSD, SMS, MMS, and WAP information.
- Provides the User with the ability to create their own network settings and save them under a user defined name in the iPAQ File Store folder.

## Modifying the GSM/GPRS Network Settings

The first time you use your SIM Card, the GSM/GPRS Settings Manager automatically updates changes in the network parameters if there are any. You can modify these settings to your own preference or create your own network settings.

If the automatic network detection fails, you can manually relaunch it by pressing the **Automatic detection** button on the GSM/GPRS Settings screen below.

- To access the GPRS Settings, from the **Start** menu, tap **Settings > Connections** tab > **GSM/GPRS Settings** icon. If your operator name appears in the drop-down list, it is recommended that you use that connection and, if needed, edit the default settings.



---

**Note:** In the event the automatic detection setting fails, you will need to complete one of the two following items:

- Select the appropriate country and operator name, then tap **OK**. The settings will automatically update.
  - If your operator name does not appear in the drop-down list, you must manually add it to the list by tapping the down arrow in the Operator box and tapping “**Create New . . .**”. To create a new connection, refer to “Creating a New Connection” in [Chapter 7, “Making Your Data Connections.”](#)
- 

## Editing Network Properties

---

**CAUTION:** Editing Network Properties is not recommended unless you are being accompanied by service provider Help.

---

Tapping on the **Edit Network Properties** bar on the GPRS Settings screen gives you access to the following areas:

- Internet Connection Information—Walks you through the different settings for GPRS (General Packet Radio Service) and CSD (Circuit Switched Data) connections.
- Text Message (SMS)—Allows you to modify the Text Message service center number.
- MMS Multimedia Messages—Allows you to modify the Multimedia Message Service Center (MMSC) address.
- WAP Information

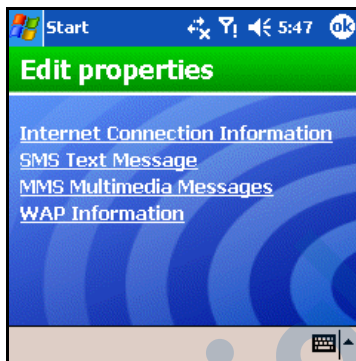

---

**Note:** To restore default connections, on the GSM/GPRS Parameters screen, select the correct country and operator name, then tap Automatic Detection.

---

## Editing an Internet Connection

If you tapped **Internet Connection Information** on the above Edit Properties screen:

1. Select the connection to edit by tapping the appropriate box and tapping **OK**.
2. Enter a name for the connection such as the carrier name.
3. Tap **Next**.
4. After **APN**: enter the Access Point Name of the server you are attempting to connect.
5. After **Name**: enter the Log on for your connection.
6. After **Password**: enter the password for your connection.
7. Tap **Next**.
8. On the next screen, tap one of the following:
  - Dynamic IP address
  - Static IP address
9. Tap **Next**.

10. On the next screen, tap one of the following:

- Dynamic DNS addresses
- Static DNS addresses

11. Tap **OK**.

## Editing SMS Text Message Settings

If you tapped **SMS Text Message** on the Edit Properties screen:

1. Under **Enter the Service Center Number**, enter the Operator Phone Number to which all Text messages will be sent for delivery by the network.
2. Tap **OK**.

---

**Note:** Text messages are only sent and received through your wireless phone service provider by using a phone number as the message address.

---

## Editing MMS Multimedia Messages Settings

If you tapped **MMS Multimedia Messages** on the Edit Properties screen:

1. Under **Enter the MMS Center Address**, enter the URL where all MMS messages are sent for delivery by the network (for example, enter <http://mms.mobilelife.co.th>).
2. Enter the following information:
  - APN:** Access Point Name of the MMS server being connected.
  - Name:** Log on name for the MMS server.
  - Password:** Password for the MMS server.
3. Tap **OK**.

## Editing WAP Information Settings

If you tap **WAP Information** on the Edit Properties screen:

1. Enter the IP address and the Port information for the WAP Gateway.
2. Tap **Next**.
3. Enter the IP address and the Port information for the secure WAP Gateway.
4. Tap **Finish**.

## Creating a New Connection

Before creating a new connection, you must obtain the following information from your service provider:

- To make a GPRS Connection:
  - APN
  - Username/Password
  - DNS address
  - IP address
- To make an SMS Text Messaging Connection:
  - SMSC—Short Message Service Center
- To make an MMS Connection:
  - MMS Center Address
  - APN (for MMS server if different than Internet connection)
  - User Name/Password
  - IP Address/Port
- To make a WAP connecton:
  - IP Address
  - Port



- WAP Gateway
- Secure WAP Gateway—IP and Port

To create a new connection:

1. Tap the down arrow under Country and select the appropriate country name.
2. Tap the down arrow under Operator, and tap **“Create new ...”**.

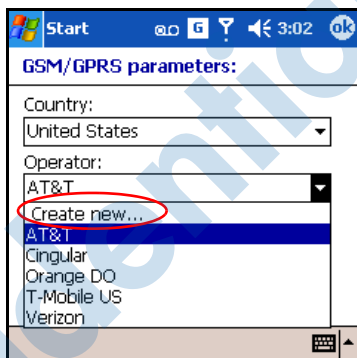

3. Tap the down arrow under **Country** and select the appropriate country name.
4. Enter the new operator name.

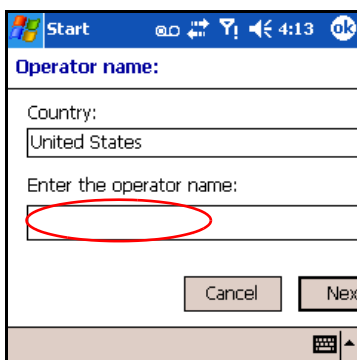

5. Tap **Next**.

## Editing Network Properties

Tapping on the **Edit Network Properties** bar on the GPRS Settings screen gives you access to the following areas:

- Internet Connection Information—Walks you through the different settings for GPRS (General Packet Radio Service) and CSD (Circuit Switched Data) connections.
- Text Message (SMS)—Allows you to modify the Text Message service center number.
- MMS Multimedia Messages—Allows you to modify the MMS (Multimedia Message Service) Center address.
- WAP Information

## Failed Automatic SIM Detection

If the SIM card is not detected by the application:

- Check to see if the SIM card is present in the HP iPAQ. If it is not present, insert the SIM card and relaunch the application.
- If the SIM card is not recognized by the application, create a new connection.
- Ensure that the contacts on your SIM card and your SIM slot are not covered with a residue or dust that would inhibit connection.

## TTY Functionality for the Hearing-Impaired

---

**Note:** The TTY software application is included on the Companion CD and must be downloaded onto the HP iPAQ before it can be enabled.

---

This HP iPAQ supports TTY (Tele-typewriter) functionality. This functionality allows hearing-impaired persons to communicate using existing telephony infrastructure, including cellular phones. To achieve this, separately purchased TTY devices must be connected to the telephones on both ends of a telephone call session, and the TTY software application must be downloaded from the Companion CD onto the HP iPAQ. The sending TTY device generates a distinct audio tone for every supported character, and these tones are decoded and converted back into text on the receiving TTY device.

Due to the use of audio compression codecs in modern digital cellular telephones, these TTY audio tones may be unintentionally distorted while being transmitted through cellular telephones. In order for TTY devices to continue to work in cellular networks, the cellular telephone must be set into a mode that optimizes the compression codec to handle TTY tones instead of the human voice.

---

**Note:** For information on connecting TTY devices to the HP iPAQ, refer to the TTY device manufacturer's documentation.

---

### Enabling TTY Support

Before connecting the optional TTY device to the phone, you must enable TTY support in order to prepare the HP iPAQ Phone to expect a TTY device to be connected.

To enable TTY support:

1. From the **Start** menu, tap **Phone > Tools > Options > TTY** tab.

2. Place a checkmark in the **Enable TTY support** box by tapping it.
3. Tap **OK**. The TTY icon displays in the Navigation bar when it is enabled.



4. Connect the optional TTY device or plug to the headphone as stated in the device manufacturer's documentation and connect the headphone to the HP iPAQ. This connection activates the TTY audio mode.

## Making a Phone Call Using the TTY Device

1. Press the green phone button on the bottom front of the HP iPAQ to launch the phone keypad, then turn on the phone functions of the HP iPAQ.
2. Dial the phone number of the person you are trying to reach who also has a TTY device connected to their phone.
3. When the phone call is answered, start typing onto the TTY keyboard.

The letters typed into the machine are turned into electrical signals that travel over regular telephone lines. When the signals reach their destination (another TTY), they are converted back into letters which appear on a display screen, are printed out on paper, or both.

When you are finished typing your phone conversation, the person on the other end of the line may begin typing their answers or comments to you.

4. To end a phone call, press and hold the red phone button on the bottom of the HP iPAQ.

---

**Note:** TTY audio mode activation may not be possible while a telephone call is already in progress.

---

**NOTE:**

- If a normal headset is connected while TTY support is enabled, the audio quality may be decreased.
  - If a Bluetooth headset is connected while TTY support is enabled, the audio quality will not change because TTY audio mode has not been activated.
  - However, if you make a phone call using a Bluetooth headset while TTY mode is enabled **AND** a plug has been inserted into the headphone jack, TTY audio mode will be activated and voice quality will decrease.
- 

## Deactivating TTY Audio Mode

To deactivate TTY audio mode:

- Remove the plug from the headphone jack or
- Uncheck the **Enable TTY support** checkbox in the **Start** menu > **Phone** > **Tools** > **Options** > **TTY** tab.

## Disabling TTY Support

To disable TTY support:

1. From the **Start** menu, tap **Phone** > **Tools** > **Options** > **TTY** tab.

2. Uncheck the **Enable TTY support** box.

---

**Note:** It has not been determined if deactivation by either method is possible while a TTY telephone call is in progress.

---

HP  
Confidential

---

# Managing Multiple Wireless Connections

## Using the iPAQ Wireless Manager

The iPAQ Wireless Manager application provides a centralized control for you to manage wireless features on the HP iPAQ.

The iPAQ Wireless screen has two individual power buttons to turn wireless features on and off—one at a time, and one **All Off** button to turn off all wireless features at the same time. The screen also includes Settings buttons to configure Phone and Bluetooth.

- To access the iPAQ Wireless screen, from the **Today** screen, tap the **iPAQ Wireless** icon (  ) in the Command bar at the bottom of the screen.

The iPAQ Wireless screen displays showing the current state of all wireless activities (  - x indicates Off).

---

**Note:** For an alternate path to the iPAQ Wireless screen, tap **Start** menu > **iPAQ Wireless**.

---



- To power on one or more wireless activities, tap the desired buttons.
- To power off one or more wireless activities, tap the desired buttons or tap the **All Off** button (  ) to power off all activities.

## Power Buttons

The two Power buttons display:

- Gray background with an **x** (  ) when they are powered off.
- Amber background when they are powered on and signals are available, but not connected.
- Green background when they are powered on and connected or associated with another device.

---

**Note:** If a button does not immediately respond when tapped, it may be busy performing a task you requested.

---



The **All Off** button displays:

- Gray background with the x (  ) when all wireless features are powered off.
- Green background when one or more wireless features are powered on.

## Settings Buttons

The settings buttons—Phone Settings, Bluetooth Settings, and Bluetooth Manager— only function when the Power buttons are enabled. With the Power button turned on, press the Settings button to open a page with information about configuration and settings for that particular wireless feature.

---

**Note:** You cannot access these configuration pages if you press the Settings buttons while in a disabled state.

---

### Phone Settings Button

First, tap the **Phone Power** button to power it on; then press the **Settings** button to open the configuration screen.

---

**Note:** For information on configuring the Phone settings, refer to [Chapter 5, “Using the Phone Features.”](#) and [Chapter 7, “Making Your Data Connections.”](#)

---

### Bluetooth Settings and Manager Buttons

First press the **Bluetooth Power** button to power it on; then press either the **Settings** or **Manager** button to open the Bluetooth settings and configuration screens.





---

**Note:** For information on configuring Bluetooth settings or manager, refer to [Chapter 9, “Using Bluetooth.”](#)

---

## Managing Data Connections

When you tap a Data Connectivity icon in the Navigation bar, it opens a drop-down Connectivity box that displays the status of your wireless data connections and information about which service is connected. From this drop-down box, you can also create new connections, access wireless settings menus, and turn on or off the wireless features.

Data Connectivity Icons	
	Inactive connection to computer or wireless network.
	Active connection to computer or wireless network.
	GPRS service is registered and available if you are subscribed to the GPRS service.
	Active data connection to GPRS network.

Tap a Data Connectivity icon to display the drop-down Connectivity box.



---

## Making Your Data Connections

The HP iPAQ hw6500 series offers you a comprehensive set of wireless capabilities to keep you connected in or out of the office. With Global System for Mobile Communications/General Packet Radio Service/Enhanced Data rates for Global Evolution (GSM/GPRS/EDGE), and Bluetooth integrated into a single device, you have broad coverage offering high speed access to the Internet, and to business and personal information.

---

**Note:** EDGE is a global standard for wireless wide-area data communication being rapidly deployed by GSM carriers worldwide. Actual download speeds may vary. Coverage is subject to transmission limitations and terrain, system, capacity and other limitations. Not all features and service options are available in all areas.

---

You can use the following options to get connected:

- Use the GPRS/EDGE technology integrated on your HP iPAQ to connect to a Virtual Private Network (VPN)
- Use the GPRS/EDGE technology integrated on your HP iPAQ to remotely connect to your mobile Internet Service Provider (ISP)

- Make a wireless GSM/GPRS/EDGE connection to place a phone call or send or receive e-mail, text message, or Multimedia Message Service (MMS) messages.

---

**Note:** EDGE technology delivers faster data speed than GPRS to mobile devices. It allows users to connect to the Internet and send and receive data, including digital images, Web pages and photographs faster than with a GSM/GPRS network. If a network provider does not have EDGE technology deployed, the HP iPAQ defaults to GPRS data transfer rates. **Because EDGE is integrated into GPRS technology when it is enabled by your service provider, there is no visible means of identifying when it is being used. You will only be aware of faster data transmission.**

---

- Transfer information between Bluetooth enabled devices
- Transfer information between two Infrared (IrDA) enabled ports

---

**Note:** Use of dial-up and wireless Internet, e-mail, corporate networks, and other wireless communications, such as Bluetooth-enabled devices, may require separately purchased additional hardware and other compatible equipment, in addition to a separately purchased service contract. Check with your service provider for availability and coverage in your area. Not all Web content may be available. Some Web content may require installation of additional software. **GPRS may not be available in all networks. GPRS data transmission speeds may vary based upon network capabilities and other conditions. The establishment and continuation of a GPRS connection depends on network availability, provider support and signal strength.**

---

---

**Note:** For more information on this subject, refer to the Help file on your HP iPAQ by tapping **Start > Help > Connections**.

---

## Impact of Data Connection When Phone Call is Received

Class B mobile phones may be attached to both GPRS and GSM services, using one service at a time. Class B enables making/receiving a voice call, or sending/receiving a text message during a GPRS connection. During voice calls or text messaging, GPRS services are suspended and then resumed automatically after the call or text message session has ended.

## Using GSM/GPRS/EDGE Connections

GSM/GPRS/EDGE technology is integrated into your HP iPAQ. To send or receive data over a GSM/GPRS/EDGE network, you must have an account with a mobile telephone service provider that supports GSM/GPRS/EDGE data services and an activated SIM card. The service provider must enable the GPRS data features on your account to activate it and [must have EDGE technology on the network for this capability to be used on the HP iPAQ](#). If EDGE is not enabled, the HP iPAQ will use GPRS.

## Creating a GPRS/EDGE Connection

A GPRS connection provides high-speed data transfer and is typically used for Web browsing and to send and receive small bursts of data such as e-mail and MMS messages.

To create a GPRS connection, you must subscribe with a GSM service provider that supports GPRS. After you configure your GPRS connection and connect to the GPRS network, you may be required to authenticate GPRS.

---

**Note:** Your service provider must enable the GPRS features on your account.

---

## Manually Configuring your GPRS connection on your HP iPAQ

---

**Note:** Use this manual process only if the automatic settings manager is not working and you are unable to make a connection.

---

1. From the **Start** menu, tap **Settings > Connections** tab > **Connections** icon.
2. Select **Add a new modem connection** from either **My ISP** or **My Work Network** sections.
3. Enter a descriptive name for the connection (for example, Phone Dialup or anything you want).
4. In the **Select a modem** list, tap **Cellular Line (GPRS)**.
5. Tap **Next**.
6. Under **Access Point Name**, enter the APN provided by your GPRS service provider.
7. Tap **Next**.
8. If required, enter your User name, Password and, if provided by your ISP or network administrator, your Domain name.  
You should not need to change any settings in Advanced. Most ISPs now use a dynamically assigned address. If your GPRS service provider specified the IP addresses for your DNS servers, tap **Advanced**, then tap the **Name Servers** tab. Select **Use specific server addresses**, and then enter the DNS addresses provided by your GPRS service provider. Tap **OK**.
9. Tap **Finish**.

## Connecting to the GPRS Network

1. From the **Start** menu, tap **Settings > Connections** tab > **Connections** icon.
2. In the drop-down list, select the service you want to use.
3. Tap **Connect**.

Your service provider can provide additional information on connecting to the Internet using GPRS.

## Setting Up a WAP Browser

Wireless application protocol (WAP) delivers content in a reduced format to fit the HP iPAQ screen. WAP protocol can accommodate the low memory limitations of handheld devices and the low-bandwidth limitations of a wireless-handheld connection.

---

**Note:** This protocol requires a GPRS/EDGE connection.

---

Before you can use the WAP browser, you must set it up.

1. From the **Start** menu, tap **Settings > Connections** tab > **Connections**.
2. Under **My Work Network**, select **Manage Existing Connections > Proxy Settings** tab.
3. Place a checkmark in the two boxes on the **My Work Network** screen and tap **Advanced**.
4. Next to **WAP** enter **Server** and **Port** information supplied by your Mobile Service Provider, and tap **OK**.

## Viewing WAP Pages

Once you have set up your WAP browser, you can view WAP pages by starting a GSM or GPRS/EDGE connection and using Pocket Internet Explorer. When you enter a Web site using Pocket Internet Explorer, remember WAP addresses are prefixed by “wsp” not “http” (example: wsp://www.xxx.com).

# Connecting to a Private Network

## Setting Up VPN Server Connections

A VPN connection enables you to securely connect to a private or a corporate network, via the Internet. To set up a VPN server connection:

1. Contact your network administrator for your user name, password, domain name, TCP/IP settings, and host name or IP address of the VPN server.
2. Be sure your data connection is active.
3. From the **Today** screen, tap **Start** > **Settings** > **Connections** tab > **Connections** > **Tasks** tab.
4. Under **My Work Network**, tap **Add a new VPN server connection**.
5. Follow the instructions in the **New Connection** wizard.

---

**Note:** For online Help for any screen in the New Connection wizard or while changing settings, tap the **?**.

---

## Setting Up Proxy Server Settings

If you are connected to your ISP or private network during synchronization, your HP iPAQ should download proper proxy settings from your computer. If these settings are not on your computer or need to be changed, you will need to set them up manually. To set up proxy server settings:

1. Contact your ISP or network administrator for the proxy server name, server type, port, type of Socks protocol used, and your user name and password.
2. Be sure your data connection is active.
3. From the **Today** screen, tap **Start** > **Settings** > **Connections** tab > **Connections** > **Tasks** tab.



4. Under **My Work Network**, tap **Edit my proxy server** > **Proxy Settings** tab.
5. Tap the **This network connects to the Internet** and **This network uses a proxy server to connect to the Internet** checkboxes.
6. In the **Proxy server** box, enter the proxy server name.
7. If you need to change port number or proxy server type settings, tap the **Advanced** button and change the desired settings.
8. Tap **OK**.

## Managing Your E-mail

You can send and receive e-mail messages by connecting directly to an e-mail server using GSM/GPRS. If you have already created a connection to a network or an ISP, you must still set up an e-mail account in Inbox. To set up your e-mail account, see [Chapter 12, "Using Inbox and Messaging."](#)

---

**Note:** The network or ISP connection must use a POP3 or IMAP4 e-mail server and an SMTP gateway.

---

## Entering an Internet Address

With Pocket Internet Explorer and a connection to the Internet, you can view Web sites on your HP iPAQ by typing an Internet address in the **Address** bar.

---

**Note:** Some Web content may require installation of additional software.

---

To enter an Internet address on your HP iPAQ:

1. From the **Start** menu, tap **Internet Explorer > Address Bar**.

---

**Note:** If the Address Bar is not visible, tap the **View** tab > **Address Bar** to turn it on.

---

2. Enter the Internet address in the **Address** bar.
3. Tap the **Go** icon.

## Using a Favorites List

With Pocket Internet Explorer and a connection to the Internet, you can view Web sites on your HP iPAQ by selecting one from your **Favorites** list.

To select a Web site from your **Favorites** list:

1. From the **Start** menu, tap **Internet Explorer**.
2. Tap the **Favorites** icon and the Web site you want to view.

---

# Using GPS Navigation

## Getting Acquainted

Your HP iPAQ includes Global Positioning System (GPS) Navigation technology. GPS Navigation technology is based on a worldwide system of GPS satellites orbiting earth that continuously transmit digital radio signals. These radio signals contain data on the satellites' locations and their exact clock time and are used to determine your location on the earth.

---

**Note:** To access GPS satellites and establish your exact position, a line of sight is required. This means your position must be situated outdoors or close to a window.

---

The GPS Navigation software provides you with turn-by-turn driving directions between your current location and your destination. With GPS, you can also look up and navigate to nearby restaurants, hotels, movie theaters, gas stations, museums and other points of interest.

To receive GPS radio signals, your GPS Navigation software must be launched [and you must have a map downloaded onto your HP iPAQ or memory card. You can select one free map to download from a list of cities in the United States, Canada, and Western Europe.](#) Instructions for downloading are included in the "Downloading a Map" section.

## GPS Navigation Features

- Your device comes with one free city map that can be downloaded from the Internet. You may purchase full map sets for a country or region at <http://www.tomtom.com/gpsnavigation>.



Some recently developed suburbs and country areas may not be included on the downloaded maps and will not be discernible on the screen.

---

- If you should lose your way in unfamiliar territory, you can use your GPS receiver to display your current position on the map.
- When planning a car trip route, include gas stations, hotels, restaurants, hospitals, airports, etc., so you can plan to stop for gas, lunch, or evening lodging at a scheduled time.
- Keep a list of favorite addresses that you use frequently (best friends or most important customers) and load into the GPS Navigation software to find a direct route to those addresses from any part of town.
- Set your GPS screen to display different color settings for daylight and night time viewing.
- Select the type of Navigation voice you want to hear when listening to Navigation directions, or turn off the sound.
- Long Term Orbit—Use this feature to update your software every three days in order to locate current satellite locations for quicker GPS connection.

## Downloading a Map

---

**Important:** A good policy to follow is to download all GPS maps to an SD memory card or to iPAQ File Store folder for safekeeping. This will prevent you from losing your map from possible power losses to the device, or from loss of software should it be necessary to perform a hard reset on the HP iPAQ.

---

You can download one free city map anywhere in the United States, Canada or Western Europe.

---

**Note:** Be sure to select your city carefully because you are allowed to download only one map free-of-charge. To download map upgrades or additional maps to your HP iPAQ, go to <http://www.tomtom.com/gpsnavigation>. A real-time traffic service is also available on a subscription basis.

---

**Important:** It is highly recommended that you cradle your HP iPAQ to download the map. When the HP iPAQ uses the connected cradle, it uses the computer's internet connectivity to download the map. Although it is possible to download a map through a GPRS connection, using a cradled connection to your personal computer is strongly recommended since map files are quite large and could be corrupted if the GPRS connection is lost during the download process. If you do not use a cradle connection, HP iPAQ sets up a GPRS internet connection which can be slow at times.

---

**Important:** Depending on your configuration, your personal computer may access the Internet through a proxy server. Before proceeding, make sure that your personal computer can access the Internet. Then, launch the browser on your personal computer, and click **Tools > Internet Options > Connections > LAN Settings**. If the "Use automatic configuration script" option is selected and the associated "Address" field is filled in, then you may have difficulty with the following steps. This situation is

---

typically encountered on corporate networks. You will then need to temporarily uncheck this option and fill in the appropriate proxy server address and port in the Proxy Server section of that screen. You may have to contact your corporate IT staff for this information, or try it at home where proxy servers are less typical.

---

To download a map:

1. Place the HP iPAQ in the cradle and make sure the cradle is connected to and synchronized with your personal computer.
  2. From the **Start** menu, tap **Programs > TTGetMap** icon.
  3. When the GPS Introductory screen displays, tap **Next**.
  4. Select either **USA and Canada** or **Europe** region and tap **Next**.
- 

**Note:** The selection areas below are included in the **USA and Canada** region. If you have selected **Europe**, your area names will be different.

---

5. From the drop-down list, select a state or Canada (at the bottom of list) and tap **Next**.
6. Select a city map from the drop-down list and tap **Next**.
7. Tap **City list** to view the list of surrounding suburbs that are included in the selected map. If these are the areas you want, then tap **Download** to start downloading the map or tap **Back** to change your city selection.

8. Tap **Yes** to confirm the map will be download to the /My Documents folder in Main Memory on your HP iPAQ.

---

**Note:** To change the folder or save to iPAQ File Store, tap **Change**.

---

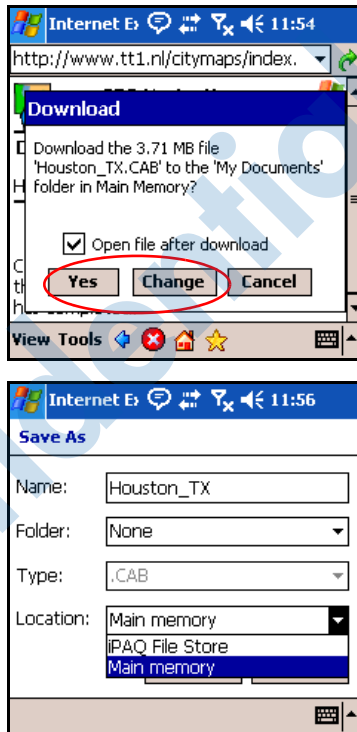

9. While the map is downloading to your device, a progress bar displays on screen. When the progress bar closes, tap the **X** in the top right corner of the screen to exit.
10. MOVE HOME ADDRESS SETTINGS AFTER LANGUAGE SELECTION.

11. Once the city map is downloaded, the next screen asks “Would you like to specify your ‘Home’ address now? Tap **No** or **Yes**.”



Providing a home address is useful. For example, you will be able to plan a route back home from anywhere with a single tap on the screen. If you tap **No**, you can always add it later.

If you tap **Yes**, you will need to perform the following steps:

- a. At the top of the next screen, after the word **City:**, enter the first letters of your home city (example: Hou for Houston) using the keyboard.
- b. From the list that displays, tap your city.
- c. At the top of the screen, after the word **Street:**, enter the first letters of your street name using the keyboard.
- d. From the list that displays, tap your street.
- e. At the top of the screen, after the words **House nr:**, enter your house number using the on-screen keypad.
- f. Tap **Done**.

After setting your home address, tap the middle of the Main screen to display the Options screen and tap **Navigate to... > Home** to display the route home.

## Getting Started with GPS Navigation

The GPS radio on your HP iPAQ turns on and off automatically as required as long as GPS Navigation is launched. When you launch GPS Navigation, the radio turns on and begins searching for satellites. When you exit GPS Navigation, the radio turns off.

To launch GPS Navigation:



1. From the **Start** menu, tap **GPS Navigation**.
2. Tap the language of your choice on the first screen.



The first time GPS is launched, you will be requested to specify a few preferences. To select your preferences:

- a. Tap anywhere on the second screen to begin.
- b. Tap an option to set up the application for Right-handed or Left-handed operation and tap **Done**.
- c. Tap which unit to use to specify how distances are displayed (Miles or Kilometers) and tap **Done**.
- d. Tap to specify your preferred clock format (1800, 6:00 pm, or 6:00), then tap **Done**.
- e. To select the voice that will be used for driving instructions:
  1. Browse through the voices by tapping the forward (▶) or backward (◀) arrows.
  2. Tap the **Test** button to hear a sample of the current voice.
  3. Tap the **Select** button to select the voice you want to use.

---

**Note:** To change the volume of the vocal instructions, tap the Change Volume icon . To turn off the vocal instructions, tap the Speaker icon .

---

## Using Quick Connect

Quick Connect is a software application that provides faster connection to roving satellites for the HP iPAQ Global Positioning System (GPS). Quick Connect automatically downloads an updated file to your device every three days through ActiveSync. The downloaded files contain information on current satellite locations which allow the GPS to connect to the satellites quicker. The Quick Connect software is included on your device; however, in order for the program to download updated files, you must cradle your HP iPAQ at least once every three days.

## Viewing the Main Screen

Use the main screen to navigate to your destination. Your position displays on the map using your GPS receiver.



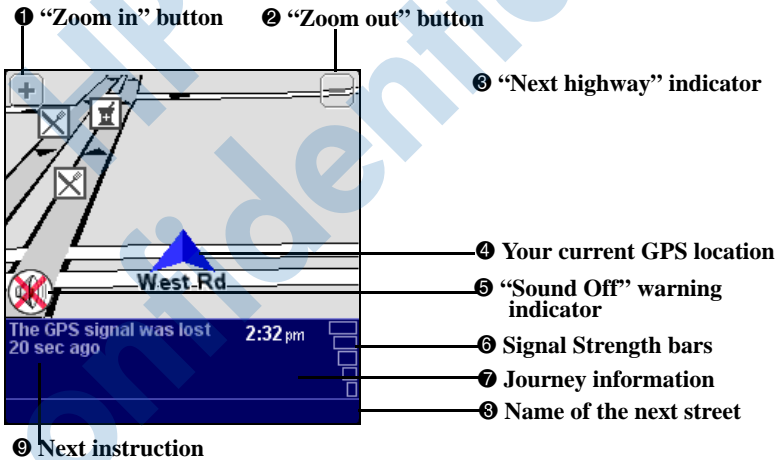

**IMPORTANT:** If your GPS receiver has not yet determined a clear position from the GPS satellites, the main screen displays your last known position. To indicate that your actual position is unknown, the screen will display in black and white instead of the standard colors.



The dark red path indicates the calculated route. The instructions guide you along this path to reach your destination.

No.	Explanation
1 +	Zoom In button. This button is always located in the same position.
2 -	Zoom out button. This button is always located in the same position.
3	Indicates the next highway on the current map.

---

No.	Explanation
④	 Your current GPS location.
⑤	 “Sound off” warning indicator. If this indicator is not shown, displayed instructions will be accompanied by voice instructions. Use the Sound preference to turn on/off voice instructions.
⑥	 Signal strength bars indicate the strength of the GPS signal.
⑦	The journey information shows the current time, estimated time of arrival and the time left to reach the destination.
⑧	The bottom of the screen shows the street name you will reach if you follow the current driving instruction.
⑨	 Your next driving instruction shows an arrow for the direction to follow and a distance indicator to that point.

---

**Note:** If you make a turn other than the one in the instructions (by mistake or on purpose), the GPS Navigation will adjust almost instantly to the new situation. It will keep guiding you to your current destination as fast as it can calculate.

---

**Note:** When the battery is low, a low battery warning will blink in the area where you normally see your current speed.

---

## Operating the Main Screen

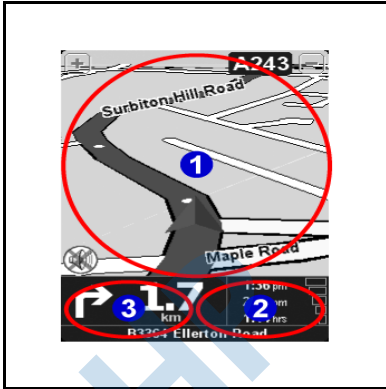

- 1 Tap somewhere in the middle of the map to open the menu.
- 2 Tap the journey information area to open the detailed route summary.
- 3 Tap the instruction area to repeat the last spoken instruction (if still available and if volume is turned on).

## Using the Menu

The menu provides access to all Navigation functions and consists of two screens. Use the ► button to browse the menu screens.

1. To open the menu, tap in the middle of the Main screen.
2. To select an icon, tap it.



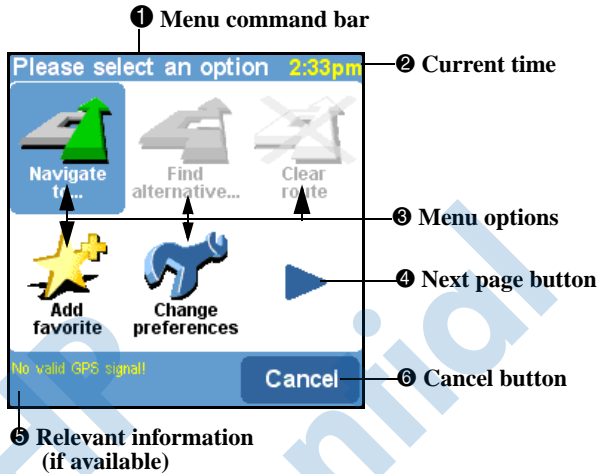

---

**Note:** If an icon is dimmed, it is not available.

---



Option	Function
	<b>Navigate to . . .</b> —Tap to calculate a route from your current position to a destination. The destination can be anything except your current position.
	<b>Find alternative</b> —Tap to recalculate a new route if you do not like the original route.
	<b>Clear route</b> —Tap to remove the calculated route. The screen will show your position on the map without providing route instructions or indicators. <b>Note:</b> Clear route is not available when there is no calculated route.
	<b>Add favorite</b> —Add a location to your Favorites list. Use any type of location except another favorite. Use the Picking locations menu to enter the location.
	<b>Change preferences</b> —Change night/day screen colors, 3D Display mode, map display, volume, voice selection, mute sound, points of interest, etc.

Option	Function
	<p><b>Plan from A to B</b>—Without a valid GPS signal, you can still use this to calculate a route. When you want to prepare for your trip in advance and you are not in your car, this is a valuable function. Use it to find out how long a trip would take, or how long it would take someone to travel to your home. The difference between this function and the <b>Navigate to...</b> function is that <b>Navigate to...</b> uses your current GPS location as the departure, and this function requires you to enter the departure location manually.</p>
	<p><b>Browse map</b>—Use to explore and search for locations in the map browser. This is a digital version of your paper map with detailed information available.</p>
	<p><b>Show route instructions</b>—Shows the calculated route as written instructions. This icon is not available when there is no route calculated.</p>
	<p><b>Guided tour</b>—Use for a brief guided tour of the application, the most important menu options, and the map browser.</p>
	<p><b>Exit application</b>—Tap to exit the GPS program.</p>

**Note:** Use the Next page icon (▶) to cycle through the two-page menu.

## Setting a Destination

To set a destination from your home address or current location to a new address:

1. Tap the middle of the map or Main screen to open the Options screen.
2. Tap the icon **Navigate to...** on the Options screen.

3. Tap the icon **Address** on the Navigate to... screen to enter a new address.

---

**Note:** After you add your frequently used addresses to your Favorites list, you will be able to tap the **Favorite** icon in place of the Address icon and tap the address from your Favorites list instead of re-entering it on the screen.

---

4. Use the keyboard to enter the first few letters of the city name and select the city from the list on the screen.
5. Use the keyboard to enter the first few letters of the Street name and select the street from the list on the screen.
6. Enter the House or street number or specify a precise location on a long street
7. Tap **Done** when you are finished and the main screen will display.

---

**Note:** You must first tap the **Navigate to...** icon on the main menu to select any of the following items: **Home**, **Favorite**, **Address**, **GPS Position**, **Recent destination**, or **Point of interest**.

---

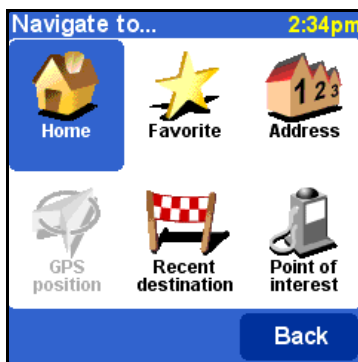

## Adding a Favorite

To quickly access the addresses that you frequently use, add them to the Favorites list:

1. Tap in the middle of the Main screen to display the Options screen.
2. Tap **Add favorite**.
3. Tap one of the following icons on the **Add as favorite** screen and complete the instructions after each item below to add a favorite:
  - Home**—If the appropriate home address displays, use the on-screen keypad to enter a name for the address, and tap **Done**.
  - Address**—Enter the City, Street, and House nr. and tap **Done**. Enter a name for the address and tap **Done**.
  - GPS position**—Shows your current location.
  - Recent destination**—Tap the appropriate address from the displayed list, enter a name for the address, and tap **Done**.
  - Point of interest**—Tap the selection icon (Pharmacy, Gas Station, Doctor, Restaurant, or Hotel/Motel) and tap the name or address from the displayed list or, if the selection you are looking for does not display, enter the first few letters of the name at the top of the screen. Tap **Done**.

## Selecting a Favorite Address

After you have added your favorite addresses to the Favorite list, you will be able to quickly select them for GPS directions.

To select a Favorite address:

1. Tap in the middle of the Main screen to open the Options screen.
2. Tap **Navigate to...** , then tap **Favorite**.



3. Tap your favorite address from the list and the Main screen with the directions to the selected address displays.

**Note:** To rename or delete an address from your Favorite list, on the Option screen, tap **Change preferences > Maintain favorites**. Tap the address to be renamed or deleted, and tap the **Rename** or **Delete** button.

## Using the Route Summary Screen

The route summary screen gives you an overview of the calculated route. From this screen, you decide how to use the route. The route summary screen displays immediately after calculating a route. For example, it displays after using **Navigate to...**, **Plan from A to B**, or **Find alternative...** .

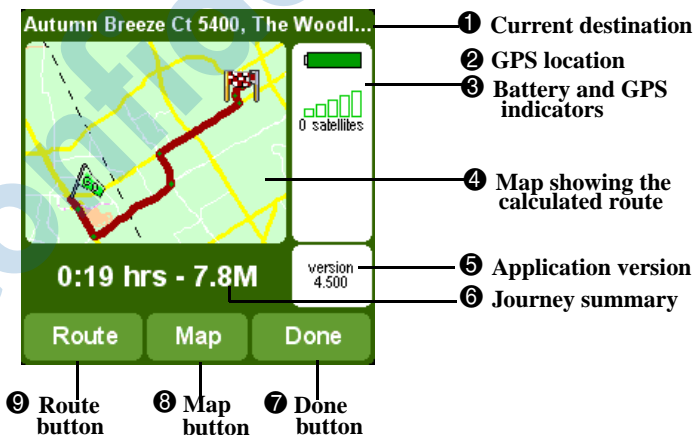

- Tap the **Route** button **9** to display a complete list of route instructions.

- Tap the **Map** button **8** to browse around on the map of your route.
- Tap the **Done** button **7** to start navigating in the main screen.

## Using the Map Browser

Use the map browser to browse the map. You will find the same items on the screen map as on a paper map, for example - cities, town, roads, streets, rivers and lakes, points of interest (such as gas stations, restaurants, hospitals, lodging, parks, etc.).



You will also be able to find your current GPS position, favorite locations, or current departure and destination.

To access the Map browser:

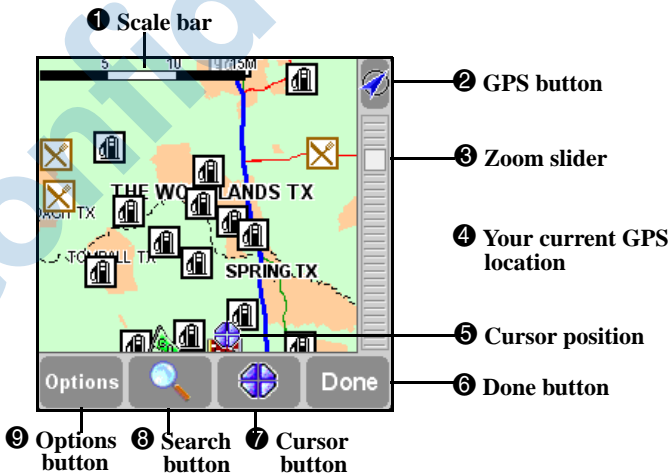
1. Tap in the middle of the Main screen.
2. Tap **Browse map** on the Options screen.



The blinking  icon (No. **5**) represents your cursor position. Tap the map anywhere to place the cursor at that position.

Option	Function
	Tap the GPS button (located on the top, right corner of the screen) to recenter the map around your current GPS location.
Options	Use the Options button to change items currently displayed on the map: <ul style="list-style-type: none"> <li>■ Show the number of roads and streets</li> <li>■ Show the number of street names</li> <li>■ Show or hide all points of interest</li> <li>■ Show or hide favorites</li> </ul>
	Use the search button to search for a specific location.
	Use the cursor button to calculate a route from your current location, find a point of interest, center the map around the cursor location, or turn the cursor location into a favorite.
<b>Done</b>	Tap <b>Done</b> to return to the main screen.

## Switching to a Schematic View

Instead of viewing the main screen, you can switch to an at-a-glance schematic view to display driving instructions. To switch to the schematic view, from the Options menu, tap **Change preferences** (  ) > **Turn Off Map display**.

**Note:** You can also set the Navigator to hide the map only when you go faster than a certain speed.

Need a functional GPS to snap this screen.

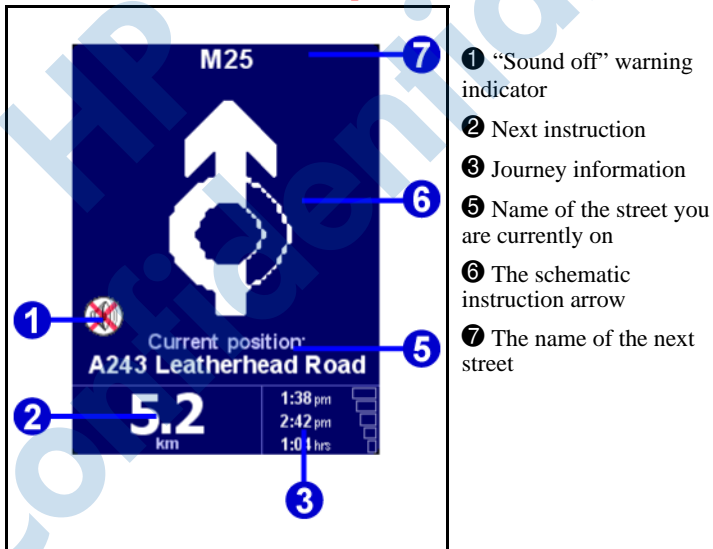

- ① “Sound off” warning indicator
- ② Next instruction
- ③ Journey information
- ④ Name of the street you are currently on
- ⑤ The schematic instruction arrow
- ⑥ The name of the next street

## Using the Browsers

- On any screen, tap a line to select it. To go back to the previous screen without selecting anything, press the **BACK** or **CANCEL** button.
- If there are more lines than are able to fit on the screen, you can browse to the other lines or pages by tapping ▲ or ▼.

- When a line has too much text to fit on a screen, it will be abbreviated. When you tap an item and keep your finger or stylus on the screen, the item will be adjusted in size in order to show the complete text.

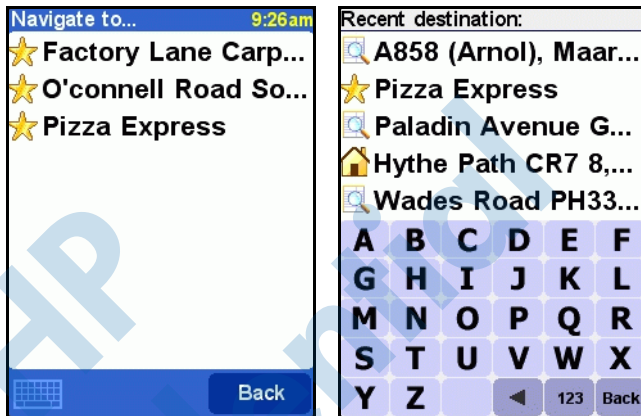

To browse for items with a particular name, type the first few letters of the name by tapping the buttons on the keyboard.

To remove a character, tap  on the keyboard.

To enter digits and special symbols, tap  to switch to the alternative keyboard.

## Selecting Locations

Use the following procedure to select an item on the **Navigate to...** screen:

1. Tap in the middle of the Main screen.
2. Tap the **Navigate to...** icon and tap one of the following icons:
  - Home—your home location
  - Favorite—favorite locations
  - Address—a city, street and house number
  - GPS position—Your current location

- ❑ Recent destination—a recently traveled location
- ❑ Point of Interest (POI)—points of interest such as a restaurant, hotel, hospital, park, hospital, etc.

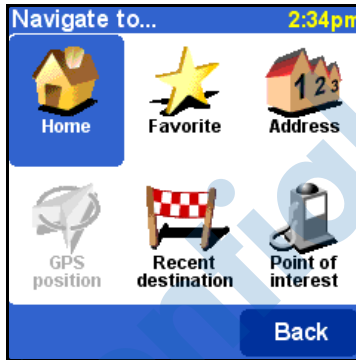

## Selecting your Home Location

- On the Options screen, tap **Navigate to...**, then tap the **Home** icon and the main screen displays showing the way home if you have already entered your home address.
- Change your Home location by using the **Change Home Location** preference on the **Change Preferences** screen. See the section on “Preferences” in this chapter.

---

**Note:** If you do not specify a Home location, the home icon in the location menu will remain dimmed.

---

## Selecting a Favorite

1. Tap in the middle of the Main screen.
2. Tap the **Navigate to...** icon, then tap **Favorite** and select an address from the displayed list.

## Selecting a Recent Destination

1. Tap in the middle of the Main screen.
2. Tap the **Navigate to...** icon, then tap **Recent destination** and select a recent destination from the displayed list.

## Selecting your GPS Position

1. Tap in the middle of the Main screen.
2. Tap the **Navigate to...** icon, then tap **GPS position**.

When you tap the GPS Position icon in the location menu, you are selecting your current location.

## Selecting a Point of Interest

1. Tap in the middle of the Main screen.
2. Tap the **Navigate to...** icon, then tap **Point of interest**.
3. Tap a category and then tap an item from the displayed list. Use the browser buttons to view all items displayed. If the item you are looking for is not displayed, enter the first few letters of the name at the top of the screen.



---

**Note:** The POI browser only shows the nearest points of interest, not all of them. If your name does not display in the list, you may have to enter more letters of the name before it appears in the list.

---

## Finding an Address

In Navigator, you find an address by going from a general description to a specific description. In other words, you first specify the city or postal code area, then the street name, and then the house number or crossing.

1. Using the Navigator keyboard, tap the first letters of the city, town, or village.
2. When the name you are looking for appears in the list below, tap it to select it.
3. Tap the first few letters of the street name.
4. When the name you are looking for appears in the list below, tap it to select it.

---

**Note:** Navigator is capable of finding streets even if the names are incomplete or misspelled. If you are looking for a street named “Avenue de Mazagran,” start entering “Maz” and forget about entering Avenue.

---



5. Tap the house number or tap the **Crossing** button and enter the names of two intersecting streets for a precise location.
6. When the name you are looking for appears in the list below, tap it to select it.

## Setting Your Preferences















You can customize your map screens to display different appearances such as colors, 3D displays, show or hide certain features, etc., and you can change the volume, the sound of the directional voice, or you can turn the volume off.

To customize your preferences:









1. From the **Start** menu, tap **GPS Navigation**.
2. Tap in the middle of the screen to display the Menu.
3. Tap the **Change preferences**  icon.
4. Use the Forward (▶) or Backward (◀) buttons to browse through the menu to view the available preferences.

5. Tap an icon from the menu to change your preference.

### Description of Preference Icons

Icon	Preferences
	Use night colors on the map display.
	Use day colors on the map display.
	3D display is visible - tap to turn off 3D display to show map from the sky.
	2D display is visible - tap to turn on 3D display to show map from a bird's eye perspective.
	Turn off map display.
	Turn on map display.
	Hide POI or Points of Interest from displaying on the map.
	Show POI or Points of Interest on the map.
	Turn on Sound/turn on voice instructions.
	Turn off Sound/disable voice instructions.
	Change Volume.
	Maintain favorites - use to rename or delete a selected favorite.
	Change Home location.
	Switch to a map of another country or area.
	Maintain POI
	Hide Clock
	Show Clock
	Set Clock
	Rotate screen

## Description of Preference Icons

Icon	Preferences
	Set day color scheme
	Set night color scheme
	Set units—allows you to specify how you want distances expressed, longitudes and latitudes displayed, and how the clock format is displayed.
	Left-handed lay-out—Important buttons and controls will be located on the left side of the screen.
	Right-handed layout—Important buttons and controls will be located on the right side of the screen.
	Delete a map
	Change the voice and/or language used for driving instructions. Tap the <b>Test</b> button to hear a sample of the voice. Refer to the following screen for more information.
	Change the language that displays on the menus and screens.
	About GPS Navigation
	Configure GPS or check your GPS signal. To configure your GPS, use backward and forward arrows to browse through the list of supported GPS devices and select your GSP device, then tap <b>DONE</b> .
	Set name display—allows you to specify how you want names displayed on the Main screen.
	Use classical icons
	Use modern icons
	Set schematic speed—Hide the map when you exceed a certain speed and display an easier-to-view schematic design with driving instructions.

## Setting Your Vocal Preference



To select a different voice, tap the forward and backward buttons to browse the different voices, and tap **Select** to select a voice.

---

**Note:** To hear a sample of a voice, tap the **Test** button.

---

To select a different language for driving instructions, tap the flag symbol and select the flag that represents the language of your country. There are more voices available to download at <http://www.tomtom.com/gpsnavigation>.

---

## Using Bluetooth

Your HP iPAQ comes with built-in Bluetooth technology that allows short-range connections and provides fast, reliable, wireless communication.

With Bluetooth powered on, you can send information or perform the following tasks wirelessly between two Bluetooth devices, within a range of approximately 10 meters (33 feet):

- Exchange contacts, calendar items, and tasks
- Send or exchange business cards
- Transfer files
- Synchronize with a computer through an ActiveSync connection
- Partner with a Bluetooth-enabled cell phone and use the cell phone as a wireless modem
- Partner with a Bluetooth-enabled portable notebook and use your HP iPAQ as a wireless modem
- Connect to other Bluetooth devices (Virtual COM port)
- Print to a Bluetooth printer
- [Use Bluetooth headphones or Stereo speakers with your HP iPAQ](#)
- [Connect to a Bluetooth keyboard](#)

- Create a personal area network (PAN) to chat, play games, etc.

---

**Note:** Use of dial-up and wireless Internet, e-mail, corporate networks, and other wireless communications, such as Bluetooth-enabled devices, may require separately purchased additional hardware and other compatible equipment, in addition to a standard Wireless Local Area Network (WLAN) or Wi-Fi infrastructure and a separately purchased service contract. Check with your service provider for availability and coverage in your area. Not all Web content may be available. Some Web sites may not be formatted to fit Pocket PC screens and may require installation of additional software.

---

## Getting Acquainted with Bluetooth

Before you start using Bluetooth to establish wireless connections, take a few minutes and familiarize yourself with:

- Terms used in this chapter
- Supported Services
- Bluetooth Settings
- Bluetooth Manager

---

**Note:** For more detailed help, refer to the Help files installed on your HP iPAQ. From the **Start** menu, tap **Help > Bluetooth**.

---

## Understanding Terms

The following Bluetooth terms are used throughout this chapter.

<b>Term</b>	<b>Definition</b>
Authentication	Verification of a numeric passkey before a connection or activity can be completed.
Authorization	Approval of a connection or activity before it can be completed.
Bonding (Paired devices)	Creating a trusted connection between your device and another. After a bond is created, the two devices become paired. A paired device does not require authentication or authorization.
Device address	Unique electronic address of a Bluetooth device.
Device discovery	Location and recognition of another Bluetooth device.
Device name	Name that a Bluetooth device provides when discovered by another device.
Encryption	Method of protecting data.
Passkey	Code you enter to authenticate connections or activities requested by other devices.
Personal Information Manager (PIM)	Collection of programs used to manage daily business tasks (for example: Contacts, Calendar, and Tasks).
Profiles	Collection of Bluetooth settings.
Service discovery	Determination of which programs you have in common with other devices.

## Supported Services

The functions that Bluetooth supports are called services. You can communicate only with Bluetooth devices that support at least one of the following service profiles:

- AV (Audio Video profile)
- BPP (Basic Printer profile)
- DUN (Dial-up Networking profile)
- FAX
- FTP (File Transfer profile)
- GAP (Generic Access profile)
- HCRP (Hard Cable Replacement profile)
- HSP (Headset profile)
- LAP (LAN Access profile)
- OBEX (Object Exchange profile)
- OPP (Object Push profile)
- PAN (Personal Area Network profile)
- SPP (Serial Port profile)
- ActiveSync (Uses SPP to connect to ActiveSync on a computer)

## Working with Bluetooth Settings

From the tabs in **Bluetooth Settings**, you can:

- Select or add a user profile
- Turn Bluetooth on and off
- Enter or change your HP iPAQ Bluetooth Identification
- Set your connection preferences
- Enable Bluetooth services



- Specify security settings
- Define settings for sharing and connecting
- View software and port information

## Turning On Bluetooth

To turn on Bluetooth:

1. From the **Today** screen, tap the **iPAQ Wireless** icon.
2. On the iPAQ Wireless screen, tap the **Bluetooth** icon.

When Bluetooth is turned on, the **Bluetooth** LED on the top of your HP iPAQ blinks blue.

To turn off Bluetooth, tap the **Bluetooth** icon again. When Bluetooth is turned off, the Bluetooth LED stops blinking and no incoming or outgoing Bluetooth connections are possible.

**Battery Saving Tip:** Turn Bluetooth off when you are not using it.

## Opening Bluetooth Settings

1. From the **Today** screen, tap the **iPAQ Wireless** icon in the Command bar.
2. On the iPAQ Wireless screen, tap **Bluetooth > Settings**.

---

**Note:** Bluetooth must be powered on to enable the Bluetooth Settings button. You cannot access the settings if you press the Bluetooth Settings button while in a disabled state. For this reason, tapping the Bluetooth button is included in all following instructions. Tapping the Bluetooth button when it is already on turns it off.

---

## Setting Accessibility Properties

Before your HP iPAQ interacts with other Bluetooth devices, you need to enter or change the accessibility properties to define how you want your HP iPAQ to interact.

To display the Accessibility screen:

1. From the **Today** screen, tap the **iPAQ Wireless** icon in the Command bar.
2. On the iPAQ Wireless screen, tap **Bluetooth > Settings > Accessibility** tab.
3. Highlight the name in the **Name** field and enter your new Device Identification name. The device name is what other devices see on their screen when they locate your device.
4. Select **Allow other devices to connect**.
5. Select either **All devices** or **Paired devices only**.



**CAUTION:** Selecting **All devices** allows any device, even those unknown to you, to connect to your HP iPAQ. After they are connected, security settings for specific services apply as specified in the Bluetooth Settings. Selecting **Paired devices only** allows only devices that you trust to connect to your HP iPAQ.

---

**Note:** Paired devices share and exchange an internally generated secure Link Key before connecting.

---

6. Select **Other devices can discover me** if you want to allow other devices to search and locate your HP iPAQ. Otherwise, leave this box unchecked.

**Note:** If another device has your device's address and you have selected **Other devices can discover me**, that device may be able to locate and connect to your device even though you did not select for it to be discovered.

---

7. Tap **OK** to save your changes.

## Enabling Bluetooth Services

You can use any of the following services when transferring files, creating a serial port connection, exchanging business card information, configuring dial-up networking, and joining a personal network.

## Automatically Enabling Services

To automatically enable services:

1. From the **Today** screen, tap the **iPAQ Wireless** icon in the Command bar.
2. Tap **Bluetooth > Settings > Services** tab.
3. In the **Services** box, select the service you want to enable: **File Transfer, Information Exchange, Serial Port, Personal Network Server, Hands free, or Dial-up Networking Server.**

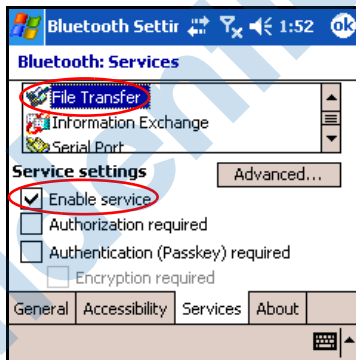

4. The **Service** you select automatically enables the **Service settings**. Tap on the appropriate checkbox to change these Service settings to your preference.
5. Tap **OK** to return to the iPAQ Wireless screen.

---

**Note:** If you select **Authorization required** in the Service Settings, you must authorize each connection. Your HP iPAQ will then always ask you if the connection should be permitted.

---

## Secure Connections using a Passkey or Bond

To establish a secure connection with another device, you can use the passkey feature or an established bond. You can also add data encryption to this type of security.

A passkey is a code you enter to authenticate connections requested by other devices. The passkey must be known and used by both parties or the connection will not be allowed.

To require a passkey or bond:

1. From the **Today** screen, tap **iPAQ Wireless > Bluetooth > Settings > Services** tab.
2. Tap the tab for the service you want to enable: **File Transfer, Information Exchange, Serial Port, Personal Network Server, Hands free, or Dial-up Networking Server**.
3. Select **Authentication (Passkey) required**.
4. Select **Encryption Required** if you want to require all data exchanged between the devices to be encrypted.
5. Tap **OK**.

## Setting a Shared Folder

You can determine the folder that other devices access when they connect to your HP iPAQ.

To select a shared folder:

1. From the **Today** screen, tap the **iPAQ Wireless** icon > **Bluetooth > Settings > Services** tab.
2. Under **Services**, tap **File Transfer**.
3. Under **Service Settings**, select your preferred settings.
4. Tap the **Advanced** tab.

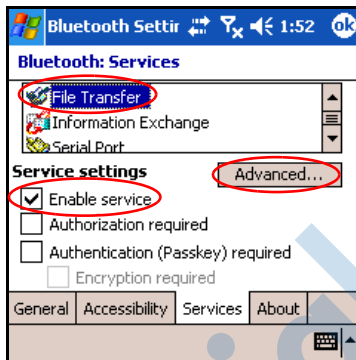

5. Tap the **Folder** icon and locate a desired file folder.
6. Tap **OK**.

## Understanding Profiles

Use profiles to quickly enable selected personal settings in multiple environments.

## Creating a Profile

To create a profile:

1. From the **Today** screen, tap the **iPAQ Wireless** icon in the Command bar
2. Tap **Bluetooth** > **Settings** > **General** tab > **Profile** icon.

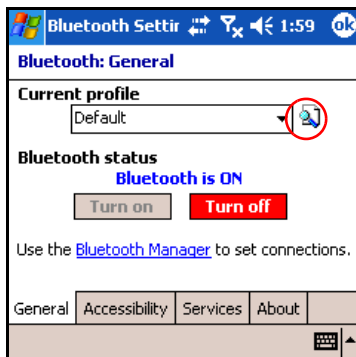

3. Tap the **New** button.
4. Enter a descriptive name.
5. Select an existing profile to use as a template.
6. Tap **OK**.

## Activating a Profile

When a new profile is created, you must activate it to function as the current profile.

To activate a profile after creating it:

1. From the **Today** screen, tap the **iPAQ Wireless** icon in the Command bar > **Bluetooth** > **Settings**.
2. From the **General** tab, select it from the **Current Profile** down arrow list.
3. Tap **OK**.

## Saving Bluetooth Configuration Settings in a Profile

To save the HP iPAQ Bluetooth configuration settings to any profile:

1. From the **Today** screen, tap the **iPAQ Wireless** icon in the Command bar > **Bluetooth** > **Settings**.
2. From the **General** tab, tap the **Profile** icon.
3. Select a profile from the **Add/Delete Profiles** list or create a new one.
4. Tap **OK**.
5. Tap the **Services** tab and specify the desired connection, sharing, and security settings in all Bluetooth **Services** selections.
6. Tap **OK** to save the changes and close **Bluetooth Services**.

## Renaming a Profile

1. From the **Today** screen, tap the **iPAQ Wireless** icon in the Command bar > **Bluetooth** > **Settings**.
2. From the **General** tab, tap the **Profile** icon.
3. Select a profile from the **Add/Delete Profiles** list.
4. Tap the **Rename** button.
5. Enter a new descriptive name.
6. Tap **OK**.

## Deleting a Profile

1. From the **Today** screen, tap the **iPAQ Wireless** icon > **Bluetooth** > **Settings**.
2. From the **General** tab, tap the **Profile** icon.
3. Select a profile from the **Add/Delete Profiles** list.
4. Tap the **Delete** button.
5. Tap **Yes** to confirm you want to delete the profile.
6. Tap **OK**.

## Working with Bluetooth Manager

Use Bluetooth Manager to:

- Establish connections
- Exchange business cards or files
- Control the on-screen display
- Display shortcuts

### Opening Bluetooth Manager

From the **Today** screen, tap the **iPAQ Wireless** icon in the Command bar > **Bluetooth** > **Manager**.

The first screen that displays is **My Shortcuts**.

---

**Note:** Bluetooth must be powered on to enable the Bluetooth Manager button. You cannot access Manager if you press the Manager button while in a disabled state. For this reason, tapping the Bluetooth power-on button is included in all following instructions. If Bluetooth is already powered on when you perform the tasks, do not tap the Bluetooth button again. Tapping the Bluetooth button when it is already on turns it off.

---

### Locating and Selecting a Device

Several tasks require you to locate a device and connect to it.

When you are required to locate a device, the Bluetooth browser assists by searching for a function that supports other Bluetooth devices.

### Pairing Devices

When you pair devices, they must exchange a computer generated security key prior to each connection. The security key is generated from a unique Bluetooth device address, a random number, and a user-defined password.



After two devices are paired, they have a trusted relationship with each other. No additional input is needed from the user. Therefore, connections and activities can be performed between the paired devices without constant authorization from the user.

---

**Note:** The remote device must have Bluetooth turned on and set up to allow discovery before the connection can occur.

---

To pair devices:

1. From the **Today** screen, tap the **iPAQ Wireless** icon in the Command bar > **Bluetooth** > **Manager**.
  2. Tap **Tools** > **Paired devices**.
  3. Tap **Add**.
  4. Tap the **Lookup**  icon.
  5. Tap the device name as it appears on the screen.
  6. Enter a password in the **Passkey** field.
  7. Tap **OK**.
  8. Enter the same password into the other device.
- 

**Note:** Some devices, such as mobile phones, need to be placed in a mode to accept a bond from another device. Refer to that device's user instructions for more information.

---

## Unpairing Devices

You can remove a paired relationship between devices.

1. From the **Today** screen, tap the **iPAQ Wireless** icon in the Command bar > **Bluetooth** > **Manager**.
2. Tap **Tools** > **Paired devices**.
3. Tap a device name.
4. Tap **Remove**.
5. Tap **Yes** to remove the pairing.

## Connecting to Other Devices

Use ActiveSync, serial and dial-up connections to communicate with other Bluetooth devices. Establish a partnership with a cell phone and set up the Bluetooth services it offers.

### Identifying the Communications Port

You can identify the virtual COM ports used to create a **serial port** connection. You may need to identify these COM ports for activities such as printing.

Use the inbound COM port when other devices initiate a serial connection. Use the outbound COM port when you initiate a serial connection to another device.

To identify the communications port:

1. From the **Today** screen, tap **iPAQ Wireless > Bluetooth > Settings > Services** tab.
2. Under Services, tap **Serial Port** and tap the **Advanced...** button.
3. Note the names of your inbound and outbound COM ports.
4. Tap **OK**.

### Establishing a Headphone or Stereo Speakers Connection

You can redirect your HP iPAQ's audio to a headphone or stereo speakers to use with your HP iPAQ.

To establish a headset connection:

1. From the **Today** screen, tap **iPAQ Wireless > Bluetooth > Manager**.
2. Tap **New > High Quality Audio setup > Next**.
3. Follow the connection wizard instructions.

## Establishing an ActiveSync Connection

You can set up an ActiveSync partnership with a Bluetooth-enabled computer by first setting up your computer, then setting up your HP iPAQ.

If you own an HP Evo Notebook or Desktop computer, you can use the Bluetooth Multiport Module presinstalled on that computer with your HP iPAQ.

If you are using other Bluetooth modules or cards on your computer, refer to the Bluetooth Configuration Manager or Settings for similar setup procedures, then skip to [“Setting Up an ActiveSync Partnership on Your HP iPAQ.”](#)

### Using the HP Bluetooth Multiport Module for Evo Notebooks and Desktops

1. Remove your HP iPAQ from the HP iPAQ Cradle.
2. Turn on Bluetooth on both the HP iPAQ and the Evo computer.
3. Right-click the Bluetooth icon in the system tray on your computer, then click **Advanced Configuration**.
4. Select the **Client Applications** tab, then write down the COM port number listed next to **Bluetooth Serial Port**.

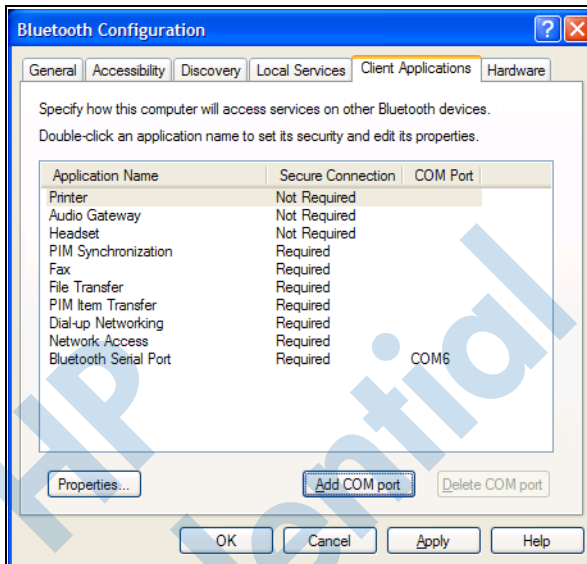

5. Select **Bluetooth Serial Port**, then click on the **Delete COM Port** button.
6. Click on the **Local Services** tab, then click **Add Serial Service**.
7. Type a name for the serial service, then select **Startup Automatically**.
8. Remove the checkmark from the **Secure Connection** box, then select the COM port that is the same as the one you wrote down earlier. Click **Apply** > **OK** > **OK**.

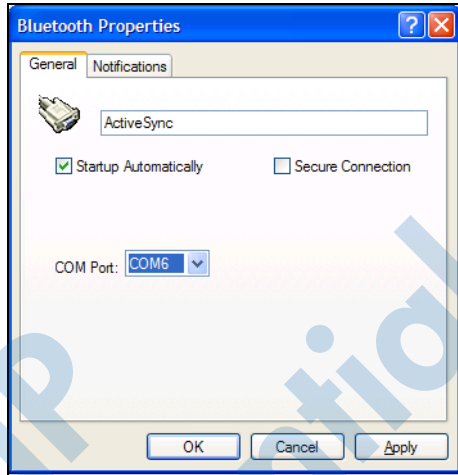

9. Open ActiveSync on your computer, then click **File > Connection Settings**.
10. Check the **Allow Serial Cable or Infrared Connection to this COM Port** box.
11. Select the COM port that is the same as the one you wrote down earlier, then click **OK**.

## Setting Up an ActiveSync Partnership on Your HP iPAQ

To establish an ActiveSync connection:

1. From the **Today** screen, tap **iPAQ Wireless > Bluetooth > Manager**.
2. Tap **New > ActiveSync via Bluetooth > Next**.



3. Follow the connection wizard instructions.

---

**Note:** Be sure the ActiveSync COM port setting on your HP iPAQ is the same as the COM port setting used for Bluetooth on your computer. See the section [“Identifying the Communications Port.”](#)

---

4. From the **Bluetooth Browser** screen, select the computer you want to synchronize with. Tap **Next**.

5. Under **Serial Port Selection**, select the name of the serial port for the computer selected above, then tap **Next > Finish**.

**Note:** If you are setting up the ActiveSync partnership with an Evo Notebook or Desktop computer, select the name you typed in Step 7 of “Using the HP Bluetooth Multiport Module for Evo Notebooks and Desktops.”



Need new screen

## Establishing a Serial Connection

Use the wireless Bluetooth serial port connection just as you would a physical serial cable connection. You must configure the application that will use the connection to the correct serial port.

To establish a serial connection:

1. From the **Today** screen, tap the **iPAQ Wireless** icon > **Bluetooth > Manager**.
2. Tap **New > Explore a Bluetooth device > Next**.
3. Follow the connection wizard instructions.

## Dial-Up Networking Service

Use dial-up networking (DUN) to connect to the internet from another Bluetooth device through your HP iPAQ.

## Using Dial-Up Networking Service

---

**Note:** An activated SIM card must be inserted in your HP iPAQ and the phone must be turned on before beginning this process.

---

To connect to a device that provides phone or modem access:

1. You must first pair the two devices. For more information, see the section on “[Pairing Devices](#)” in this chapter.

On the Alternate device:

2. Use the documentation that came with the alternate device to create a connection to the HP iPAQ hw6500 Series.
  3. On the screen that requires you to enter a phone number, use \*99#. You may need to enter the country code and area code, depending on where you are calling.
- 

**Note:** To use the HP iPAQ hw6500 Series as a dial-up networking server, use the default phone number \*99#. Depending on your location, you may not need the country code or area code. For more information on this, refer to your mobile phone service provider.

---

4. Tap **OK** to begin dialing.

On your HP iPAQ hw6500 Series:

5. On the **Bluetooth > Manager > My Shortcuts** screen, a connection dialog box briefly displays, then the network logon screen displays. To authorize the dial-up connection, tap **Accept**.



On the Alternate device:

6. A settings box displays your device dialing \*99#. On the **Bluetooth My Shortcuts** screen, you will see an icon with two green arrows pointing toward each other to indicate a connection has occurred. You can now connect to the internet.

---

**Note:** After you create the dial-up networking shortcut with a device, tap and hold the Dial-up Networking icon in the **My Shortcuts** tab of **Bluetooth Manager**, and tap **Connect**.

---

## Joining a Personal Area Network

Connect two or more Bluetooth devices to share files, collaborate or play multiplayer games.

To establish a Personal Area Network connection:

1. From the **Today** screen, tap **iPAQ Wireless > Bluetooth > Manager**.
2. Tap **New > Join a personal network > Next**.
3. Follow the Connection Wizard instructions.

## Working with Files

You can exchange information with a connected device and use the Bluetooth File Explorer to:

- Navigate through the directories.
- View files and folders.
- Create new folders.
- Send and receive files from a remote device.
- Delete and rename files on a remote device.

## Creating a File Transfer Connection

1. From the **Today** screen, tap **iPAQ Wireless > Bluetooth > Manager**.

The first screen that displays is **My Shortcuts**.

2. Tap **New > Browse files on a remote device > Next**.
3. Tap the name of the remote device when it displays on the screen.

---

**Note:** The remote device must have Bluetooth turned on and set up to allow discovery before the connection can occur.

---

## Sending Files

1. Tap and hold the file transfer shortcut icon, and tap **Connect**.
2. Tap **File > Send a File...**
3. Locate the file(s) to send.
4. Tap the file(s) to send it.
5. Tap **OK**.

## Creating a Folder on a Remote Device

1. Tap and hold the file transfer shortcut icon, and tap **Connect**.
2. Navigate to the location you want for the new folder.
3. Tap **File > Create a folder**.
4. Enter a folder name while **New Folder** is selected, and tap **Enter**.
5. Tap **OK**.

## Receiving a File from a Remote Device

1. Tap and hold a file transfer shortcut icon, and tap **Connect**.
2. Navigate to the file location on the remote device.
3. Tap the file.

4. Tap **File > Get**.
5. Tap **OK**.

## Deleting a File from a Remote Device

1. Tap and hold a file transfer shortcut icon, and tap **Connect**.
2. Navigate to the file location on the remote device.
3. Tap the file.
4. Tap **File > Delete**.
5. Tap **Yes** to verify you want to delete the selected file.
6. Tap **OK**.

## Using Business Card Exchange

Using the business card exchange, you can:

- Set up your own business card
- Send a business card to one or more devices
- Request a business card from one or more devices
- Exchange business cards with one or more devices

You must establish a default contact name to send or exchange business card information.

You must first specify your default business card on the **Information Exchange** tab in **Bluetooth Settings**. This name becomes the default for business card transfers.

## Setting Up Your Business Card Information

To set up your business card information:

1. Create a contact in the **Contacts** program that includes your name, title, and other relevant information.
2. From the **Today** screen, tap **iPAQ Wireless > Bluetooth > Settings > Services** tab.
3. Under Services, select **Information Exchange**.

4. Tap the **Advanced...** button.
5. Tap the **My business card (vCard)** icon.

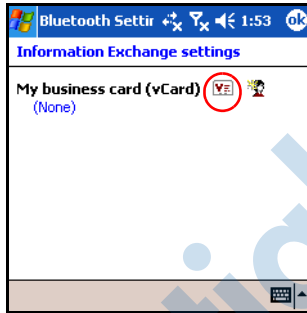

6. Select your contact name from the Contacts list.
7. Tap **OK**.

---

**Note:** To create a new business card, tap the **Contacts** icon next to the vCard icon and create a new business card. Tap **OK** when you are finished.

---

## Sending Business Cards

1. From the **Today** screen, tap the **iPAQ Wireless** icon in the Command bar > **Bluetooth** > **Manager**.
2. Tap **Tools** > **Business Card Exchange**.

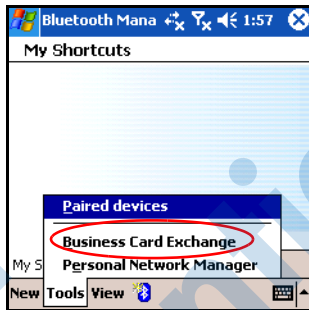

3. Tap the **Send** icon.
4. Tap the device where you want to send your business card.
5. Tap **OK**.

---

**Note:** Be sure the receiving device has been enabled to accept the transfer.

---

## Requesting Business Cards

1. From the **Today** screen, tap the **iPAQ Wireless** icon in the Command bar > **Bluetooth** > **Manager**.
2. Tap **Tools** > **Business Card Exchange**.
3. Tap the **Request** icon.
4. Tap the device from which you want to request a business card.
5. Tap **OK**.

## Exchanging Business Cards

You can exchange business card information with another device. If available, the device's information will be sent directly into your **Contacts** list in **Pocket Outlook**.

To exchange business cards:

1. From the **Today** screen, tap the **iPAQ Wireless** icon in the Command bar > **Bluetooth** > **Manager**.
2. Tap **Tools** > **Business Card Exchange**.
3. Tap the **Exchange** icon.
4. Tap the device with which you want to exchange your business card.
5. Tap **OK**.

## Opening a Connection

1. From the **Today** screen, tap the **iPAQ Wireless** icon in the Command bar > **Bluetooth** > **Manager**.
2. Tap **New** > **Explore a Bluetooth Device** and allow the discovery process to search for the Bluetooth enabled device.
3. When the discovered device icon displays on your screen, tap and hold the discovered device icon or list name, and tap **Connect**.
4. Tap **OK**.

---

**Note:** Bluetooth can be set to automatically open a connection by setting your connection preferences. For more information, refer to [Chapter 7, "Making Your Data Connections."](#)

---

## Viewing Connection Status

You can view:

- Connection's name

- Device's name
- Connection status
- Length of connection
- Signal strength

To view the connection status:

1. From the **Today** screen, tap the **iPAQ Wireless** icon in the Command bar > **Bluetooth** > **Manager**.
2. Tap and hold an active connection icon or list name, and tap **Status**.
3. Tap **OK**.

## Closing a Connection

1. From the **Today** screen, tap the **iPAQ Wireless** icon in the Command bar > **Bluetooth** > **Manager**.
2. Tap and hold the connection icon or list name.
3. Tap **Disconnect** from the menu.
4. Tap **OK**.

## Viewing Connection Information

1. From the **Today** screen, tap the **iPAQ Wireless** icon in the Command bar > **Bluetooth** > **Manager**.
2. Tap and hold the connection icon or list name.
3. Tap **Properties** from the menu.
4. Tap **OK**.

## Working with Connections

You can create shortcuts to open and view status information for all connections.

## Creating a Shortcut

Creating a shortcut to one or more services does not establish a connection. It only places a shortcut to that service on the **Shortcut** tab of the **Bluetooth Manager**.

To create a shortcut:

1. From the **Today** screen, tap the **iPAQ Wireless** icon in the Command bar > **Bluetooth** > **Manager**.
2. Tap **New**, then a type of service, and tap **Next**.
3. When the discovered device displays on your screen, tap it (device icon or list name) and tap **Next**.
4. Tap a Service Selection (Generic Serial, OBEX File Transfer, or Network Access) and tap **Next**.
5. When you have successfully created a connection shortcut, tap **Finish**.

To open the new shortcut connection:

- On My Shortcuts screen, tap and hold the new connection shortcut icon and tap **Connect**.

---

**Note:** Paired devices are designated by a checkmark.

---

## Deleting a Shortcut

1. From the **Today** screen, tap the **iPAQ Wireless** icon > **Bluetooth** > **Manager**.
2. Tap and hold the connection icon or list name to be deleted.
3. Tap **Delete** from the menu.
4. Tap **Yes** to verify the selected shortcut should be deleted.
5. Tap **OK**.



## Viewing Shortcuts

You can view shortcuts as icons or in a list format.

1. From the **Today** screen, tap the **iPAQ Wireless** icon > **Bluetooth** > **Manager**.
2. Tap **View**.
3. Tap **List** or **Icon**.
4. Tap **OK**.

HP  
Confidential

---

## Using the Camera Features

---

**Note:** Camera features are included on certain HP iPAQ hw6500 series Mobile Messenger models.

---

The camera features of the HP iPAQ allow you to turn your HP iPAQ into a mobile digital imaging center. You can share images through e-mail or the Web, or print from your HP iPAQ using Bluetooth.

The software programs described below are included on your HP iPAQ or on the Companion CD.

HP Camera Software	Function
HP Photosmart	Take digital photographs and modify settings with your HP iPAQ Camera.
HP Image Zone	Display individual images and run slideshows on your HP iPAQ. Also print, send, record and e-mail images directly from your HP iPAQ to share with friends and family.
HP Image Transfer	Transfer digital images from the HP iPAQ to your personal computer. This software is included on the Companion CD and must be downloaded to your personal computer before you can use it.

---

## Camera Components







On the back of the HP iPAQ are camera components that assist you in taking photos:





- 1 LED adds light to close-up photos taken within two feet of the camera. Press the LED toggle on/off button on the camera screen to turn the LED on or off.
- 2 Camera lens used to focus on the subject.
- 3 Mirror lens used to take a self-photo.
- 4 Camera shutter button on the side of the device.

## Taking a Photo





When you launch HP Photosmart, the camera screen above appears. The camera icons displayed on the screen are explained in the table below.

HP Photosmart Icons	Definition
	Tap to access the camera settings.
	Tap to review images.
	Tap to zoom out or press the bottom side of the Navigation button.
	Tap to zoom in or press the top side of the Navigation button.

HP Photosmart Icons	Definition ( <i>Continued</i> )
	<p>Tap to toggle on/off LED on the back of the device.</p> <ul style="list-style-type: none"> <li>■ When the LED is toggled on and the shutter button is pressed, a light flashes from the LED on the back of the device.</li> <li>■ In video mode, when the LED is toggled on, it stays lit at a low level instead of flashing.</li> </ul>
	Tap to take short movie images or video clips.
	Press or tap the Camera Shutter to snap a photo.
	Tap to exit the HP Photosmart application.
	Tap for Help.

To take a photo:

1. From the **Start** menu, tap **Programs > HP Photosmart**.
2. Locate the camera lens on the back of the HP iPAQ and frame the subject to be photographed in the digital viewfinder located on the HP iPAQ screen.
3. Tap the  icon on the screen to zoom in on the subject, or tap the  icon to zoom out.
 

**Note:** You can also press the top side of the Navigation button to zoom in, or press the bottom side of the Navigation button to zoom out. Press the Navigation button in the middle to snap a photo.
4. Make sure that both you and your subject do not move to ensure a clear image.

5. Press the **Shutter button** on the left side of the HP iPAQ or press the **Shutter** icon () on the screen to snap a photo.

---

**Tip:** You can also take photos by pressing down on the middle of the Navigation button. Use the mode that is convenient for you.

---

When you snap a photo, your HP iPAQ makes two audible shutter sounds (if you have not muted the sounds). Do not move the camera until you hear the second shutter sound. A clock runs on the screen to indicate that the photo has been taken and your HP iPAQ is processing the photo. It may take a few seconds to process and store the photo, depending on its size, quality, and complexity.

Immediately after capturing an image, a preview of the photo you just took appears so that you can decide to either discard, send, or keep the image.

- To discard the photo, tap on the **Trash** button on the screen while the preview image is being displayed.
- To e-mail or send the photo, tap on the **Send** button on the screen:
  - Select the method to be used (HP Instant Share E-mail, E-mail Attachment, Bluetooth, Infrared, or MMS) and follow the instructions on the screen.

---

**Note:** Notice that the attached image appears at the bottom of the e-mail message.



---

- To save an image, tap **OK** or simply wait for the preview to disappear from the screen and the camera application to return to the digital viewfinder.

## Ending Your Photo Session

- To exit the camera application, tap the **Close** button  on the screen.



## Taking a Video Clip

1. From the **Start** menu, tap **Programs** > **HP Photosmart**.
2. Locate the camera lens on the back of the HP iPAQ and frame the subject to be photographed in the digital viewfinder located on the HP Photosmart screen.
3. Tap the **Video** icon () on the HP Photosmart screen, then press or tap the **Shutter** icon () on the screen to begin filming the video clip.

---

**Note:** Because you are filming moving images, you will need to follow your subject with the camera if they are moving around.

---

4. To end the video clip, tap or press the **Shutter** icon on the screen again.
5. To view the video clip, tap the **Play** () icon.
6. To stop the video clip, tap the **Stop**  icon.
7. To exit the video clip and camera application, tap the **Close** () icon.

## Adjusting the Camera Settings

Besides simple “point-and-shoot” and video clips, your HP Photosmart Camera includes many other features such as:

- [Exposure settings \(white balance, auto-exposure metering\)](#)
- [Color settings](#)

- Compression settings
- Resolution settings
- Self-timer

To make changes to the camera settings:

1. From the **Start** menu, tap **Programs** > **HP Photosmart**.
2. Tap the menu icon (.
3. Select the category that you would like to modify from the **Settings** tab or the **Setup** tab, then tap **Change**.
4. Choose the best setting from the list of options.
5. Tap **OK** to exit the Settings menu.

## White Balance

To adjust the color balance in the image (depending on the lighting conditions), select from the following settings:

- Auto (default)—Automatically selects the best white balance for the shot.
- Sun—Best for outdoor shots with natural lighting (sunny or cloudy conditions).
- Tungsten—Best for indoor shots using incandescent lighting.
- Fluorescent—Best for shots taken with fluorescent lighting.

## Color

Select from the following color settings to capture images with creative effects:

- Full Color (default)—Standard color output.
- Black & White—Grayscale images.
- Sepia—Brown & White for old-fashioned images.



- Negative—Produces a color negative of the image taken.
- Cool—Blue & White images.

## Compression

Choose the photo quality from three compressions for the photos you snap. Higher-quality photos look better, especially at greater magnification. Lower-quality photos require less storage space on your HP iPAQ, and may take less time when sending by e-mail or infrared.

- Good—Lower quality and smallest file size
- Better (default)—Medium quality and file size
- Best—Higher quality and largest file size

## Resolution

Choose from four resolutions or sizes of pictures. Larger resolution size pictures require more storage space and may also take longer to process and send.

- 160 x 120 pixels
- 320 x 240 pixels
- 640 x 480 pixels
- 1280 x 960 pixels
- 1280 x 1024 pixels (default)

## Setting Up Other Features

### Camera Sounds

Camera Sounds allows you to turn on or off any sounds made when buttons are pressed.

1. From camera mode, tap  > **Setup** tab.

2. Tap **Camera Sounds**, then tap **Change**.
3. Tap **Off** to turn off the sounds, or tap **On** to turn on the sounds.
4. Tap **OK** to exit the Settings menu.

## Configuring Instant Review

Instant Review allows you to see a preview of the image you just captured to quickly determine whether you want to keep or discard the image.

To set the time period for Instant Review:

1. From camera mode, tap  > **Setup** tab.
2. Select **Instant Review** from the list, then tap **Change**.
3. Select the period of time you want the Instant Review image to remain on the screen.
4. Tap **OK** to exit the Settings menu.

## Using the Self-Timer

The Self-Timer allows you to set a short delay before a photo is snapped. Use this feature when you want to be in your own photos.

To set the timer:

1. From camera mode, tap  > **Setup** tab.
2. Select **Self-Timer** from the list, then tap **Change**.
3. Select a delay of either 2 or 10 seconds by selecting the corresponding option on the menu.
4. Tap **OK** to exit the Settings menu.

To cancel the timer:

1. Tap  > **Setup** tab.
2. Select **Self-Timer** from the list, then tap **Change**.

3. Select **Off**.
4. Tap **OK** to exit the Settings menu.

## Configuring File Settings

The file settings menu allows you to specify how images are named and stored on your HP iPAQ. Using the File tab settings, you can change the filename prefix of images you capture and adjust the image counter. Additionally, you can specify the folder on your HP iPAQ where images are stored.

To access the file settings menu:

1. From camera mode, tap  > **File** tab.
2. Make the desired changes to the file configuration.
3. Tap **OK** to exit the **Settings** menu.

---

**Note:** The filename prefix can be changed to any mixed or unmixed alpha or numeric characters, and certain symbols.

---

## Configuring Video Format

The Video format menu allows you to specify the format you want to use and the size of the video. Using the video menu, you can change the format of video clips you capture and adjust the format size. Additionally, you can set the video format to record audio whenever a video clip is being filmed.

To access the Video format menu:

1. From camera mode, tap  > **Video** tab.
2. Make the desired changes to the video configuration.
3. Place a checkmark in the **Record audio** box if you prefer to have audio with your video clips.
4. Tap **OK** to exit the **Settings** menu.

## Using HP Image Zone

---

**Note:** By default, HP Image Zone displays images that are saved in the My Documents folder on your HP iPAQ.

---

Use HP Image Zone (for the Pocket PC) to:









- View photos stored on your HP iPAQ or storage card
  - Record sounds with photos
  - [Send photos by MMS, E-mail attachments, Bluetooth, or by Infrared.](#)
  - View a slideshow
  - Print photos
- 

**Note:** You can find more information on using HP Image Zone in the Help files. Tap **Start** > **Help** > **HP Image Zone**.

---

When you launch the HP Image Zone, the following icons are displayed on the bottom of the screen.



Icon	Definition
	Tap to switch between video and camera mode.
	Tap to view the photo in full screen.
	Tap to start slideshow mode or to view video clip.
	Tap to change folders.
	Tap to delete photo or video.
	Tap to record and attach an audio clip to the photo.
	Tap to send the photo or video using your favorite method.
	Tap to print using your favorite method.

## Viewing Thumbnail Photos

To view a photo:

1. From the **Start** menu, tap **Programs > HP Image Zone**.
- 

**Note:** The viewer opens in Browse mode by default. Browse mode displays a thumbnail view of the pictures in the current folder.

---

2. Tap a thumbnail (a small representation of a larger image) to select the photo. A preview of the photo and information about it will be displayed.

To view photos in a different folder:

1. In the Command bar, tap **File > Open**.
  2. Select the desired folder.
  3. Tap **OK**. HP Image Zone now displays the photos from the new file folder you selected.
- 

**Note:** To view all photos in HP Image Zone, be sure to move your scroll bar all the way to the left and then to the right. Otherwise you might not be able to see other photos in the thumbnail view.

---

## Viewing a Photo Full-Screen

To view a photo full-screen, and to be able to zoom in or out:

1. Select the photo by tapping on its thumbnail.
2. In the Command bar, tap **Tools > View Image**, or tap on the preview window.
3. Zoom in or out using the toolbar buttons. If the photo is too large to fit on the screen, you can display other parts of the photo by dragging the stylus on the screen, or by using the Navigation buttons.
4. Tap **OK** to close the View Image screen.

## Recording Sound With a Picture

You can record sound for each picture. When the picture is displayed, the associated sound is played. Pictures with sound have a speaker icon in their thumbnails.

To add sound to a picture:

1. Select the picture by tapping on its thumbnail.
2. Tap the **Cassette** icon on the menu bar.
3. Tap the **Record** button on the **Recording** toolbar.
4. Speak into the microphone or record the sound.
5. Tap the **Stop** button on the **Recording** toolbar when you are finished.
6. Tap the **Cassette** icon on the menu bar to close the Recording toolbar.

To change audio [settings](#):

1. In the Command bar, tap **Tools > Settings > Audio** tab.
2. Select from the Record settings and/or Format settings by tapping the down arrow and tapping your selection.
3. Tap **OK**.

## Viewing a Slideshow

You can view a slideshow of the photos in the current folder.

1. To start the slideshow, in the Command bar, tap **Tools > View Slideshow**.
2. During the slideshow, tap anywhere on the screen to display the on-screen controls. You can then use the on-screen controls to move forward or backward through the slides, or to end the slideshow. You can also use the Navigation Buttons to move forward or backward through the slides.

You can control display options such as:

- Sequence—the order in which photos are displayed
- Delay—the amount of time each photo displays before the slideshow moves to the next photo
- Transition Effect—a visual effect used to exit each photo in a slideshow

To change slideshow settings:

1. In the Command bar, tap **Tools** > **Settings** > **Slideshow** tab.
2. Select the settings and effects you want to use in your slideshow.
3. Tap **OK** to exit the menu.

## Printing Photos

You can print photos from HP Image Zone by using HP Instant Share Printing if you have installed the software from the Companion CD, or from a storage card, or you can use Bluetooth to print your photos if you have access to a Bluetooth-enabled printer.

1. To print a photo from HP Instant Share Printing:
  - a. Tap the thumbnail(s) to select the photos to be printed.
  - b. In the Command bar, tap the Print icon ().
  - c. Select the number of copies to be printed and tap Save.

---

**Note:** HP Instant Share Printing will automatically print your photo when you connect your HP iPAQ to your personal computer.

---

2. To print a photo from a storage card, remove the storage card from the HP iPAQ and insert into a supported printer.  
If photos need to be moved to the card:



- a. From HP Image Zone, tap the thumbnails to select the photos to be moved.
  - b. In the Command bar, tap **File > Move to > Card**.
  - c. Tap **Yes** to confirm move.
  - d. Tap **Move** to confirm again.
3. To print a photo using Bluetooth:
- a. From HP Image Zone, tap the thumbnail to select the photo to be printed.
  - b. In the Command bar, tap **File > Print** icon.
  - c. Tap Bluetooth and select a Bluetooth printer icon on your screen.

---

**Note:** For more information on HP Image Zone, tap  > **Help**.

---

## E-mailing a Picture

You can e-mail photos directly from HP Image Zone without opening Inbox. To e-mail a photo from HP Image Zone:

1. Tap the thumbnail of the image to be e-mailed.
2. In the Command bar, tap **File > Send** and select the method to be used from the list:
  - E-mail Attachment
  - Bluetooth
  - Infrared
  - MMS
3. Tap **Next** and follow the instructions on the screen.

If you select E-mail Attachment, you can either enter the appropriate e-mail address or tap the **Contacts** icon in the Navigation bar and select the appropriate Contact name(s).

---

**Note:** Notice that the attached image appears at the bottom of the e-mail message, and in the middle of the MMS message.

---

4. Enter the subject and/or message if any and, when finished, tap **Send**.

## Exiting HP Image Zone

- To exit from HP Image Zone, from the Command Bar, tap **File > Exit**.
- To minimize HP Image Zone, tap the **X** in the upper right corner of the screen.

## HP Image Transfer

Using the HP Image Transfer software and Microsoft ActiveSync 3.7.1, you can automatically transfer photos and videos from your HP iPAQ to your personal computer. With HP Image Transfer, you can:

- transfer photos and videos from your HP iPAQ to your PC
- transfer from an SD or MMC card to your PC
- modify the image transfer settings

---

**Note:** To transfer images, you must first install Microsoft ActiveSync 3.7.1 to establish a standard partnership between your HP iPAQ and desktop computer.

---

To install HP Image Transfer:

1. From the **Companion CD**, select **Software and Accessories > Desktop Software**, and then select the **Install this** checkbox next to HP Image Transfer.

2. Select **Install Now** located at the top of the Install Desktop Software screen and follow the instructions on the screen.

Once HP Image Transfer has been installed and is recognized by ActiveSync, the ActiveSync window displays the **Image** checkbox.

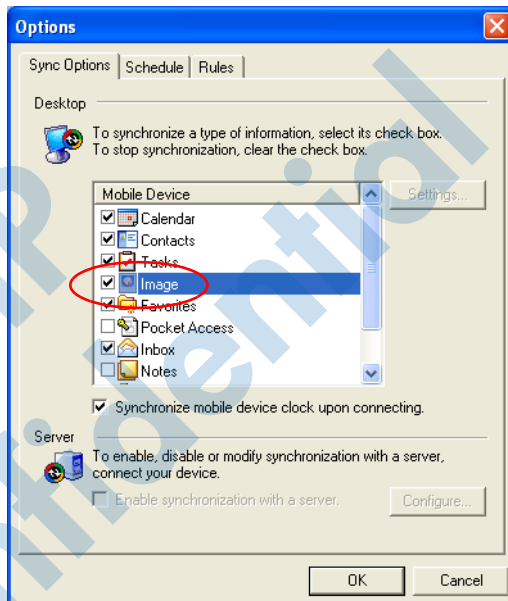

To enable and modify HP Image Transfer settings:

1. Open ActiveSync on your personal computer, if it is not already open.
2. Double-click **Image** under the Details window or select **Options** from the ActiveSync menu.
3. Select **Image** on the **Sync options** tab, and then select the **Settings** button.

**Note:** Once image transfer has been enabled, the schedule and rules you have configured for ActiveSync synchronization is also applied to your image transfers. Depending on your configuration, images may be transferred continuously while the device is connected, only upon connection, or manually.

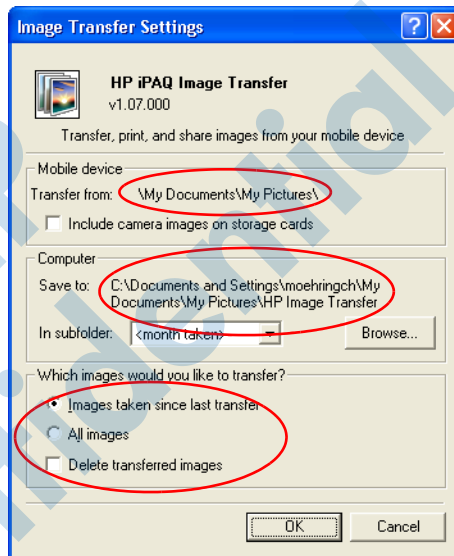

HP iPAQ Image Transfer allows the transferring of images in the following ways:

- The Mobile Device setting displays the location of the images you want to transfer from your HP iPAQ. Also, if you want to transfer images from storage cards, check the **Include camera images on storage cards** checkbox.
- The Computer setting allows you to create subfolders on your desktop computer where images can be saved. For example, you can configure the images to be transferred to a subfolder with the same name as the folder on your HP iPAQ. If you are transferring images from a folder with multiple subfolders, all the subfolders are automatically created in the

folder you designated as the **Save to:** folder. You also can designate the images to be transferred to a subfolder with the **month taken** or the **current date** as the folder name.

- **Which images would you like to transfer?** allows you to choose the transfer type of your choice:
    - Transfer images taken since your last transfer
    - Transfer all images
    - Delete transferred images from your HP iPAQ after they have been transferred
- 

**Note:** Settings on the HP iPAQ Image Transfer screen can only be changed while your HP iPAQ is connected to your desktop computer. If your HP iPAQ is not connected, you are notified that settings cannot be changed and are currently inaccessible.

---

## Tips for Taking Better Pictures

There are a number of things you can do to ensure the pictures you take with your HP Photosmart Camera are of the highest possible quality.

- When taking pictures of scenes with many fine details and many colors (for example, a farmer's market), use the **Best** compression setting.
- When taking pictures of subjects where the background has bright lights, try to frame the subject so that the bright lights do not appear in the picture.
- [When taking a picture, do not move the camera until after the first and second shutter sounds have occurred.](#)

---

## Expansion Cards

You can expand the memory and connectivity of your HP iPAQ by using SD (Secure Digital), SDIO (Secure Digital Input/Output), or mini-SD (Secure Digital) expansion cards. Use these optional expansion cards for:

- Adding functionality such as Bar Code Scanners, etc.
- Expanding the memory of your HP iPAQ for data storage

---

**Note:** Expansion cards must be purchased separately and are not included with your HP iPAQ.

---

Your HP iPAQ includes slots for an SDIO card and a mini-SD card on the side of the device. An SDIO slot can be used with various types of data cards and provides data exchange functionality. The mini-SD slot is used for data storage only.

To locate information about expansion cards, go to the following HP Web site: [www.hp.com/Go/ipaqaccessories](http://www.hp.com/Go/ipaqaccessories).

### Installing a Secure Digital (SD) Expansion Card

To install an SD or SDIO expansion card or a mini-SD expansion card into an expansion slot on the HP iPAQ:

1. Locate the two slots on the right side of the HP iPAQ.

2. Insert the expansion card into the appropriate expansion slot and push the connection edge of the card firmly into the expansion slot.

---

**Note:** Be sure the expansion card label is facing the front of the HP iPAQ before inserting it.

---

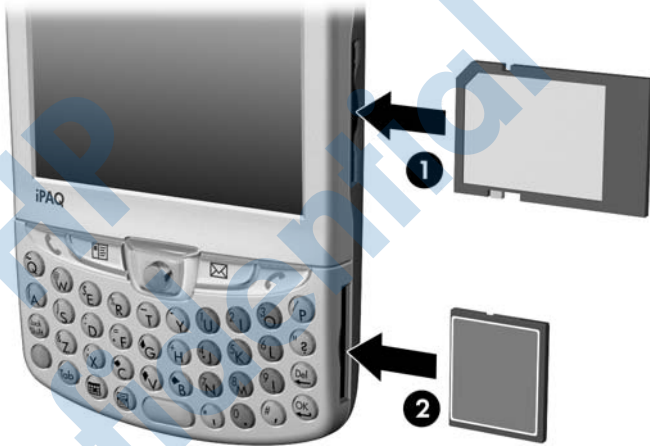

---

**Note:** The top expansion slot ❶ is the SDIO slot. It can be used with various types of data cards and provides data exchange functionality. The bottom expansion slot ❷ is the mini-SD slot and can be used only with storage cards.

---

**CAUTION:** Do not insert a mini-SD card into the SDIO slot or attempt to insert an SDIO card into the mini-SD slot.

---

**Note:** If your expansion card is not recognized, follow the card manufacturer's instructions to install it.

---

## Removing a Secure Digital (SD) Expansion Card



**CAUTION:** SD cards must first be unlocked before removal.

To remove a Secure Digital (SD) expansion card from the expansion slots on the HP iPAQ:

1. Close all applications that are using the expansion card.
2. Remove the card from the SD expansion slot by **slightly pushing down on the card** (Step ①) to unlock it.



3. When the card disengages and pops out (Step ②), pull it from the expansion slot.

## Viewing the Content of Memory Cards

Use File Explorer to view the files that are located on your optional Secure Digital card.

1. From the **Start** menu, tap **Programs > File Explorer**.
2. Tap the root directory of **My Device**, and select the Storage Card folder to see a list of files and folders.



---

# Using Inbox and Messaging

---

**Note:** To access Inbox Help on your device, from the **Start** menu, tap **Help > Messaging**.

---

## Using Inbox

You can receive Internet e-mail, text messages, or Multimedia Message Service (MMS) messages in Inbox. Internet e-mail messages are sent by using an address you receive from your Internet service provider (ISP) or your employer. [Text messages are only sent and received through your wireless phone service provider by using a phone number as the message address.](#) MMS messages are sent and received through your wireless phone service provider by using a phone number or e-mail address as the message address.

You can send and receive e-mail by synchronizing your HP iPAQ with your personal computer, or by connecting to a Post Office Protocol 3 (POP3) or Internet Message Access Protocol 4 (IMAP4) mail server. You need to set up an e-mail account for each method that you use except for Microsoft ActiveSync, which is set up by default. The ActiveSync folder on your HP iPAQ stores messages that you send and receive through synchronization with a personal computer. Account names appear as folders in the folder list (located on the left, under the navigation bar) in the Inbox message list.

With synchronization, messages are synchronized between the device Inbox and the personal computer Inbox by using ActiveSync and Microsoft Exchange or Microsoft Outlook.

## Synchronizing Inbox

After selecting Inbox for synchronization in ActiveSync, e-mail messages are synchronized as part of the general synchronization process. During synchronization:

- ❑ Messages are copied from the Inbox folder on your personal computer or the Microsoft Exchange server to the Inbox folder on your device. By default, you will receive messages from the last three days only, the first 100 lines of each new message, and file attachments of less than 100 KB in size.
  - Note:** You can only synchronize information directly with an Exchange Server if your company is running Microsoft Mobile Information Server 2002 or later.
  - Note:** You can synchronize information over the air if your company is running Microsoft Exchange Server 2003 or later.
- ❑ Messages in the Outbox folder on your device are transferred to Exchange or Outlook and then sent from those programs.
- ❑ The messages on the two computers are linked. When you delete a message on your device, it's deleted from your personal computer the next time you synchronize.
- ❑ Messages in subfolders in other e-mail folders in Outlook are synchronized only if they have been selected for synchronization in ActiveSync.
- ❑ **John Brandewie will provide a sentence on syncing over the air using Exchange Server 2003 features**

For information on initiating Inbox synchronization or changing synchronization settings, see ActiveSync Help on your personal computer.

---

**Note:** MMS messages are not received through synchronization. Instead, they are sent to your HP iPAQ via your service provider.

---

## Using Folders

Each e-mail account, text message account, and MMS account has its own folder hierarchy with five default folders: Inbox, Outbox, Deleted Items, Drafts, and Sent Items. The messages you receive and send through the mail account are stored in these folders. You can also create additional folders within each hierarchy. The Deleted Items folder contains messages that have been deleted on the device. The behavior of the Deleted Items and Sent Items folders depends on the Inbox options you have chosen.

The behavior of the folders you create depends on whether you are using ActiveSync, MMS, text messages, POP3, or IMAP4.

If you use ActiveSync, e-mail messages in the Inbox folder in Outlook will automatically be synchronized with your device. You can select to synchronize additional folders by designating them for ActiveSync; [however, when you synchronize over the air using Exchange ActiveSync, only Calendar, Contacts, and E-mail folders will synchronize](#). The folders you create and the messages you move will then be mirrored on the server. For example, if you move two messages from the Inbox folder to a folder named Family, and you have designated Family for synchronization, the server creates a copy of the Family folder and copies the messages into that folder. You can then read the messages while away from your personal computer.

If you use MMS or text messages, messages are stored in the Inbox folder.

If you use POP3 and you move e-mail messages to a folder you created, the link is broken between the messages on the device and their copies on the mail server. The next time you connect, the mail server will see that the messages are missing from the device Inbox and delete them from the server. This prevents you from having duplicate copies of a message, but it also means that you will no longer have access to messages that you move to folders created from anywhere except the device.

If you use IMAP4, the folders you create and the e-mail messages you move are mirrored on the server. Therefore, messages are available to you anytime you connect to your mail server, whether it is from your HP iPAQ or personal computer. This synchronization of folders occurs whenever you connect to your mail server, create new folders, or rename/delete folders when connected.

For all accounts except ActiveSync, you can access folder options by tapping **Tools > Manage Folders**.

## Setting Up an Account

To set up an account:

- ❑ To set up a POP3 or IMAP4 e-mail account, from the **Start** menu, tap **Inbox > Accounts > New Account**. Follow the instructions in the New Account Wizard.
- ❑ To set up an Text account, from the **Start** menu, tap **Messaging > Accounts > Accounts**, and then tap **Text Messages**. Follow the instructions on the screen.
- ❑ To set up an MMS account, from the **Start** menu, tap **Inbox > Accounts > Accounts**, and then tap **MMS**. Follow the instructions on the screen.

To set up an e-mail account on your HP iPAQ:

1. From the **Start** menu, tap **Messaging > Accounts > New Account** and enter your e-mail address.
2. Tap **Next**.
3. Enter your password and tap **Next**.
4. Check that your Account Type and Name shows a POP3 or IMAP4 connection and tap **Next**.
5. Complete the required requests on the screen and, when finished, tap **Finish**.

To connect to an e-mail account, from the **Start** menu, tap **Inbox > Accounts > Connect**.

To change options for an account:

1. From the **Start** menu, tap **Messaging > Accounts > Accounts**.
2. Tap the name of the account, and follow the instructions on the screen.

To delete an account:

1. Tap **Accounts > Accounts**.
2. Tap and hold the name of the account, and then tap **Delete**.

---

**Note:** You can set up several e-mail accounts including your ActiveSync account, but you can set up only one MMS account.

---

**IMPORTANT:** You cannot add a new account while connected. Tap **Accounts > Disconnect** to disconnect.

---

**CAUTION:** Do not delete your MMS Account because, if you need it later, you will not be able to add it back.

---

## E-mail Setup

---

**Note:** Enter the e-mail address provided by your ISP or network administrator, such as *username@servername.com* or *username@servername.net*.

---

1. In **Incoming mail**, enter the name of your e-mail server.
2. In **Outgoing mail**, enter the name of your Simple Mail Transfer Protocol (SMTP) host.
3. If you are using a network connection, in **Domain**, enter your domain name.

## Options

Tap **Options** to access additional settings for the following:

- ❑ Change the time intervals for downloading new messages by tapping the **Minute(s)** box and entering a new number of minutes.
- ❑ Download attachments.
- ❑ Limit the amount of messages downloaded.

---

**Note:** Inbox automatically picks the correct connection to use for the e-mail account you create. If you want to use a specific connection, select that connection from the Connection list. Connecting automatically may result in higher connection charges.

---

### Some Good Tips

- ❑ To save memory, Inbox downloads e-mail message headers only instead of the whole message. To automatically download the whole message, from the list, select **Get full copy of messages**.
- ❑ When using IMAP4, to save memory, Inbox does not download attachments. To download attachments, select the appropriate option. You can also select to limit the size of messages and attachments that are downloaded to your mobile device.
- ❑ If your outgoing e-mail server (SMTP) requires authentication, select **Outgoing e-mail server requires authentication**.
- ❑ If you are using an SSL connection, select **Require SSL connection**. Connections that use SSL allow you to send personal information safely.
- ❑ To save memory, limit the number of e-mails that are downloaded to your device by lowering the number of days to display. You can also increase this number. To change the number of days, tap the box with the number, and then change the number.

## Download Messages From the Server

1. In Inbox, tap **Accounts > Connect** to open a connection to the Internet or your corporate network, depending on the account.
2. Tap **Accounts** and ensure that the account you want to use is selected (marked by a bullet).
3. Tap **Connect**. The messages on your device and e-mail server are synchronized: new messages are downloaded to the device Inbox folder, messages in the device Outbox folder are sent, and messages that have been deleted from the server are removed from the device Inbox. Tap a message in the message list to open it.
4. If you read a message and decide that you need the full copy, tap **Edit > Mark for Download** while in the message window. If you are in the message list, tap and hold the message, and then tap **Mark for Download**. This will also download message attachments if you selected those options when you set up the e-mail account. You can also choose to download full copies of messages by default.
5. When finished, tap **Accounts > Disconnect**.

---

**Note:** Receiving entire messages consumes storage memory.

---

## Downloading Messages

The way you download messages depends on how you are receiving messages:

- If you receive e-mail messages through ActiveSync, begin synchronization.
- If you receive e-mail messages through a remote e-mail server, see the previous section “Download Messages From the Server.”

- MMS and text messages are automatically sent to you when your phone is turned on. Otherwise, messages are held by your service provider until the next time your phone is turned on.

## Compose and Send a Message

1. In the message list, tap **New**.
2. To select an account, tap the **From** list and select ActiveSync, MMS, Text Message, or the desired e-mail account.
3. Enter the e-mail address, text message, or MMS address of one or more recipients, separating them with a semicolon. To access addresses and phone numbers from Contacts, tap **To**.
4. Enter your message. To quickly add a canned message, tap **My Text** and tap a desired message.
5. To check spelling, tap **Edit > Spell Check**.
6. Tap **Send**. If you are working offline, the message is moved to the Outbox folder and will be sent the next time you connect.

---

**Note:** If you are sending a text message and want to know if it was received, before sending the message, tap **Edit > Options**, and select **Request text message delivery notification**.

---

## Attach a File to a Message

1. With the message open, tap **Edit > Add Attachment**.
2. Select the file you want to attach. OLE objects cannot be attached to Inbox messages.

Inbox automatically converts Pocket Word files that you attach to messages to .doc format and Pocket Excel files to .xls format.

---

**Note:** Files attached to Text Messages/MMS messages are removed from the message when sent.

---



## Reply to or Forward a Message

1. Tap on the message to open it, tap the reply icon in the navigation bar, and then tap **Reply**, **Reply All**, or **Forward**.
2. Enter your response. To quickly add common messages, tap **My Text** and tap a desired message.
3. To check spelling, tap **Edit** > **Spell Check**.
4. Tap **Send**.

---

**Note:** Selections in the **Tools** > **Options** > **Message** tab determine whether the original text is included with the outgoing message.

---

## Receive Attachments

Attachments sent with an e-mail message or downloaded from the server appear as an icon at the bottom of the message in its own window pane. Tapping the attachment icon opens the attachment if it has been fully downloaded. You can mark an attachment for downloading (IMAP4 account only) the next time you connect.

- If you receive messages through synchronization, start ActiveSync on your personal computer, and click **File** > **Mobile Device**, and then select your mobile device. Click **Tools** > **Options**. Select the message account, click **Settings** > **Include File Attachments**.
- If you receive messages through a remote e-mail server and have an IMAP4 account, in Inbox on the device, tap **Accounts** > **Accounts**, and then tap **IMAP4**. Tap **Next** until

you reach Server Information, and then tap **Options**. Tap **Next** twice, and then select **Get full copy of messages** and **When getting full copy, get attachments**.

---

**Note:** Embedded images and OLE objects cannot be received as attachments.

An embedded message can be viewed as an attachment when using IMAP4 to receive e-mail. However, this feature does not work if TNEF is enabled so you can receive meeting requests on Microsoft Exchange Server 5.5.

---

## Receive Meeting Requests

If you receive your e-mail messages through ActiveSync, you will automatically receive meeting requests. If you connect directly to an e-mail server, the server must be running Microsoft Exchange Server 5.5 or 2000 for you to receive meeting requests. If you are running Microsoft Exchange Server 2000, you will automatically receive meeting requests in your Inbox.

To receive meeting requests on Microsoft Exchange Server 5.5:

- ❑ Ask your system administrator to activate Rich Text Format and TNEF support for your account. If TNEF is enabled, you will not receive messages that are included in other messages as attachments, and you will not be able to tell if a message has an attachment until you get the full copy. In addition, download time may be longer.
- ❑ While setting up your mail account, select **Get file attachments**.

After you are set up to receive meeting requests:

1. If you connect directly to an e-mail server and only receive message headers and/or a limited number of lines per message, tap and hold the message that you think is a meeting request, and then tap **Mark for Download**.
2. Open the meeting request.

3. Tap the response icon (  ) and, from the pop-up menu, tap **Accept, Tentative, or Decline**. If you want, you can also include a written message with the response. The response will be sent the next time that you synchronize or connect to your e-mail server, and your device Calendar will be updated.

## Create or Change a Signature

To create or change an account signature:

1. From the **Start** menu, tap **Inbox > Tools > Options**.
2. Tap **Signatures**.
3. Select an account for which you are creating or changing a signature.
4. Select **Use signature with this account** if the check box is not already selected.
5. Select **Use when replying and forwarding** if wanted.
6. Enter a signature in the box.

---

**Note:** You can use a different signature with each account.

---

To stop using a signature, clear the **Use signature with this account** check box.

## Using Messaging

### Text Messaging

Text messaging is the transmission of short text messages to and from a mobile phone, fax machine and/or IP address. A single text message should be no longer than 160 alpha-numeric characters and contain no images or graphics.

Messages longer than 160 alpha-numeric characters will be sent as multiple text messages. A character count is visible when text messages (**New/Reply/Forward**) are composed. The count also shows how many text messages will be generated when the message is sent.

You can send Text Messages using the Phone keypad or from Messaging:

1. From the Phone keypad, tap **Tools > Send Text Message**. From Messaging, tap **Accounts > Text Messages**.
2. Tap **New**.
3. In the **To** field, enter either the e-mail address or Text Message Number of one or more recipients, separating them with a semicolon, or select a name from the contact list by tapping the **Address Book** button in the Navigation bar. All e-mail addresses entered in the e-mail fields in Contacts appear in the Address Book.
4. Enter your message. To enter preset messages, tap **My Text** and select a message.
5. When the message is finished, tap **Send**.

---

**Note:** If you are working offline, the message is moved to the Outbox folder and will be sent the next time you connect.

---

## Receiving Text Messages

When you receive Text messages, the e-mail icon (✉) notifies you by displaying in the Navigation bar.

**Note:** The e-mail icon (✉) also notifies you of e-mail and MMS messages.

- Tap on the e-mail icon to view the Text message.

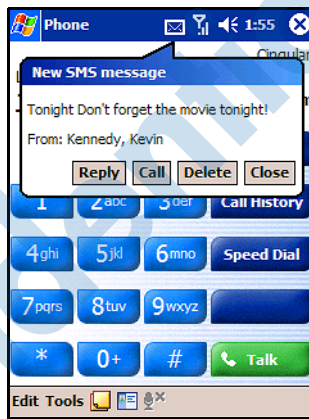









Need new  
screenshot

## Multimedia Messaging Service (MMS)

The Multimedia Messaging Service (MMS) is a method of transmitting photographs or video clips, sound files and short text messages over wireless networks using Wireless Application Protocol (WAP).

An MMS message is created by adding various slides. Each slide may consist of a photograph or video clip, sound file, and text. The MMS Composer is located in your device's Inbox and can be accessed from the Start menu or the Today screen.

You may see the following icons displayed on the MMS Composer screens:

Icon	Definition
	Tap to preview MMS message
	Tap to send an MMS message
	Navigation buttons - Tap to navigate forward and backward through the slides
	Tap to display photos/videos as file list
	Tap to display thumbnails
	Tap to display individual photos
	Tap to select an item
	Tap to return to previous screen or cancel
	Tap to bring up Recording controls

To create an MMS slide:

1. From the **Start** menu, tap **Messaging > Accounts > MMS > New**.

2. In the Choose A MMS screen, tap a format icon to create a new MMS message.

---

**NOTE:** Messages are created by combining one or more slides on an MMS. A slide can consist of a photograph or video clip, sound file, and text. The size of an MMS that you can send depends on your service provider limitations. To see the memory allowed per MMS, tap **Start > Messaging > Tools > MMS Settings > Servers > Default server** and scroll down to the bottom of the screen.

---

3. Tap the **Tap here to insert a photo or video clip** box to choose a photo or video to be inserted.
4. On the top, left of the next screen, tap **My Pictures** to select the specific location of the photos or videos to be inserted.

---

**NOTE:** You can only add a single photo or a single video clip to each MMS slide.

---

5. Tap the photo or video clip to be inserted, then tap the **Select** icon () at the bottom of the screen.
6. To add a second or third slide, from the Messaging screen, tap **Edit > Insert Slide** and tap the photo or video clip to be inserted, then tap the **Select** icon ()
7. Tap in the **Insert text here** box and enter the text to be sent, or tap the Canned Text icon to see a list of pre-saved text messages. Tap the one you want and tap the Select icon ()
8. Tap in the **Tap here to insert an audio clip** box to add an audio clip.

---



**NOTE:** You can either add an existing sound file, or record a new one.

---

9. Tap on the pull-down **My Sounds** to select a location that contains audio files.

10. Tap the audio clip to be added and tap the Select icon ()

---

**NOTE:** To preview the audio clip before selecting it, use the playback controls on the bottom of the screen. Play/Pause () and Stop () controls are available.

---

**NOTE:** To record a new audio clip, tap the diskette tape icon () to bring up controls that allow you to record new audio.

---

11. Tap the Send icon () to send the message.

---

**NOTE:** The MMS message will not be sent until you enter the recipient's address. See the following "Sending a Message" section for information on addressing the message.

---

## Viewing a Message

To review a received message or preview a message that you created, you can use the playback controls (Play/Pause, Stop) on the MMS Composer screen. You can pause the message anytime during playback.

To view the slides manually, use the navigation buttons



to scroll through the message.

## Sending a Message

To send the message, you must enter the following information:

1. Enter the recipient's phone number or tap **To Phone** to view your phone book.
2. Enter the recipient's e-mail address or tap **To E-mail** to view your address book.
3. Enter the subject of the message.



4. When you're ready, tap **Send**. Otherwise, tap **Cancel**.

---

**Note:** If you are working offline, the message is moved to the Outbox folder and will be sent the next time you connect.

---

HP  
Confidential

---

## Managing the Battery

Your HP iPAQ is shipped with the rechargeable battery partially charged. It is recommended that you fully charge the HP iPAQ battery **before** setting up the unit, and recharge regularly. Your HP iPAQ uses some power to maintain files in RAM and the clock. While working at your desk, keep the HP iPAQ and AC Adapter connected through the HP iPAQ cradle. When you travel, it is recommended that you carry the AC Adapter, Charger Adapter plug, or an optional spare battery with you.



**CAUTION:** Use only an HP approved battery for your HP iPAQ. Using a battery not approved by HP will void the warranty. Inserting a battery that does not comply with HP requirements may cause the HP iPAQ to malfunction.

The HP iPAQ also has a small internal backup battery that allows you to change the main battery without losing RAM data (user-installed programs and data) as long as the main battery is replaced immediately (within 15 minutes). The internal battery can only be removed by qualified HP Technical Support.

**Battery Saving Tip:** To ensure you always have battery power available, you can purchase an extra Standard Battery or Extended Battery. These batteries can be charged using the HP iPAQ. To purchase an extra battery, refer to the HP Web site at [www.hp.com/products/pocketpc](http://www.hp.com/products/pocketpc).

## Installing the Battery

To install the removable/rechargeable battery in the HP iPAQ hw6500 series:

1. First remove the back cover of the device by pressing down on the battery latch **1** and sliding the cover down **2** and off of the device.



2. Align the battery connectors with the housing pins **1** in the battery compartment and insert the battery.

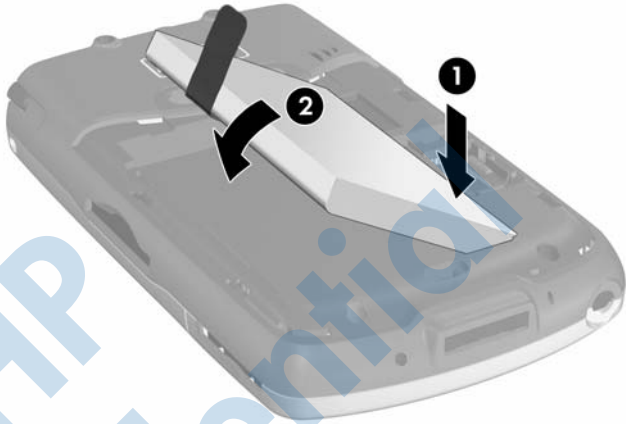

Batterij niet weggooien, maar inleveren als KCA.

3. Press the battery down into the battery housing **2**.

4. Replace the back cover by aligning the two tabs on the top of the cover ❶ with the two latches in the cover compartment and sliding the back cover on until it clicks into place ❷.

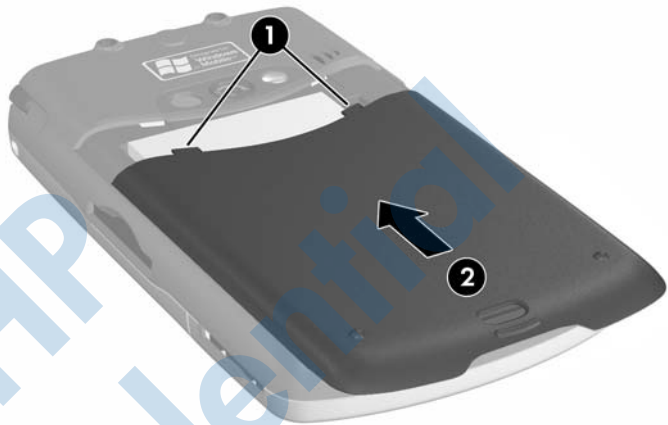

---

**Note:** If the battery is fully discharged, you must connect the AC Adapter to the HP iPAQ to fully charge it before continuing. It takes up to four hours to fully charge a completely drained battery.

---

## Removing the Battery

---

 **CAUTION:** Before removing the battery, use iPAQ Backup or ActiveSync to back up data on your HP iPAQ. If you need to clear the memory during the removal process, you will be able to restore the data. To prevent losing information, you can also copy user-installed applications to the iPAQ File Store folder.

---

To remove the battery from the HP iPAQ hw6500 Series:

1. Repeat the above procedure for removing the battery cover.
2. Remove the battery from the compartment by lifting the tab.



**CAUTION:** Because most of the applications and data you install on your HP iPAQ are held in memory (RAM), you will need to reinstall them if the battery completely discharges or if the battery is removed from the unit for more than 15 minutes. Otherwise, when fully charged, the internal backup battery will save the user installed data for up to 15 minutes when the standard battery is removed. Before removing the battery, check to see that the internal backup battery is fully charged by tapping the **Battery** icon in the TodayPanel. If the TodayPanel is not available, tap **Start > Settings > System** tab > **Power** icon.

You do not need to reinstall applications and data installed in the iPAQ File Store folder because they are saved in nonvolatile memory.

## Charging the Battery

### Battery Saving Tips:

- Leave your HP iPAQ connected to AC power at all times when you're not using it.
- Set your HP iPAQ to turn off after a short time if not being used.
- Set the backlight to go off quickly after you stop using your HP iPAQ.
- Turn off all wireless activities when not in use.
- Turn off the "Receive all incoming beams" setting and receive infrared beams manually instead.
- You can program an Application Button to turn off the screen when an MP3 is playing, saving battery power used to run the screen. Tap **Start > Windows Media > Tools > Settings > Buttons**. From the **Select Function** drop-down list, tap **Screen Toggle**. Press either the Contacts or Inbox application buttons on the front of your HP iPAQ, then tap **OK**.
- Power off your HP iPAQ when it is being charged to allow it to charge at a faster rate.

**Note:** If the battery is completely discharged, it will power on and will trickle charge for approximately 20 minutes when it is connected to the AC Adapter or the Cradle. During this trickle charge, the device will not operate if removed from the AC power source and will not operate on main battery power. It is recommended that you leave the device connected to the AC power source long enough to power the device (approximately 30 minutes).

---

## Charging with the AC Adapter

The standard AC Adapter works in a standard electrical outlet. You can also charge your HP iPAQ in your automobile with an automobile adapter that works in your vehicle's electrical cigarette lighter or a 12-volt power outlet.

To purchase an automobile adapter, refer to the HP Web site at: [www.hp.com/go/ipaqaccessories](http://www.hp.com/go/ipaqaccessories).



**CAUTION:** Use only HP recommended AC adapters.

---

To charge the HP iPAQ using the AC Adapter:

1. Insert the AC Adapter plug into the AC Charger adapter ❶.
2. Plug the AC Adapter into an electrical outlet ❷.
3. Insert the AC Charger adapter into the communications port on the bottom of the HP iPAQ ❸.



**CAUTION:** To avoid damaging your HP iPAQ or the AC Adapter, check to be sure all connectors are properly aligned before connecting them.

---



4. When the Power button indicator on the top of the HP iPAQ turns solid amber, the unit is fully charged and you can disconnect the AC Adapter. The approximate time to fully charge a drained battery is four hours.

---

**Note:** A standard battery can be charged in about four hours, an optional extended battery takes longer.

---



## Charging with the HP iPAQ Cradle and AC Adapter

Use the HP iPAQ Cradle to charge the HP iPAQ.

**Note:** It is not necessary to synchronize your HP iPAQ before charging it.

To charge the HP iPAQ using the cradle:

1. Plug the AC Adapter into an electrical outlet **1** and connect the other end of the AC Adapter to the AC connector on the cradle **2**.
2. Slide the bottom of your HP iPAQ into the cradle **3** and push firmly to seat it.



**CAUTION:** To avoid damaging your HP iPAQ or the cradle, check to be sure the HP iPAQ and cradle connectors are properly aligned before pushing the HP iPAQ into the cradle.

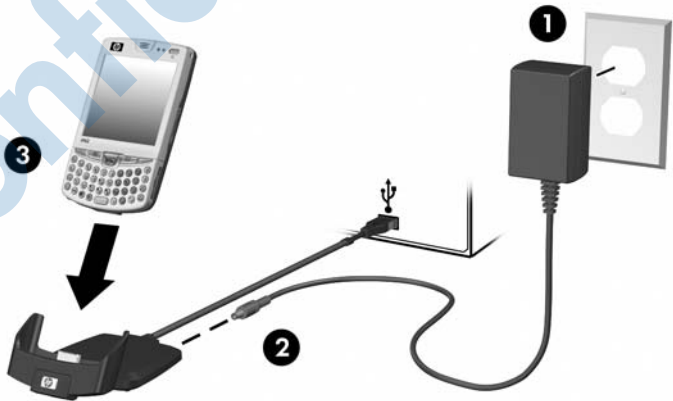

**Note:** The amber charge light on the Power button blinks while the battery is recharging and turns solid amber (nonblinking) when the battery is fully charged.

## Charging Over a USB Connection

You can charge your HP iPAQ with a USB connection to a personal computer or notebook computer using the HP iPAQ Cradle without an AC Adapter connected, or by using an optional USB Autosync Cable. Insert the HP iPAQ into the cradle and connect the cradle to your personal computer or notebook computer, or connect the Autosync Cable to the HP iPAQ and your personal computer or notebook computer. The HP iPAQ will charge using power from the computer.

**Note:** HP recommends that you power off your HP iPAQ while using the USB charging feature. If your HP iPAQ is powered on, your device will consume more current than is being supplied by the USB charging and the main battery will not be charged. During this state, the charging LED will not blink since it is not charging.

To enable USB charging:

1. From the **Start** menu, tap **Settings > System** tab > **Power** icon > **USB Charging** tab.
2. Select **Use USB Charging**.

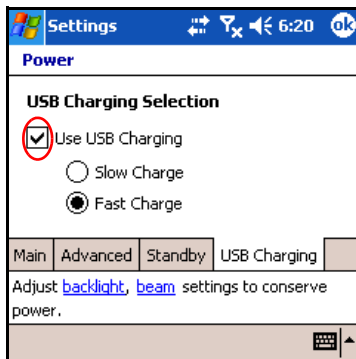

For faster charging, turn off all wireless activity and place your HP iPAQ in standby mode.

---

**Note:** The charging indicator does not blink when the HP iPAQ is turned on and being charged with a USB connection.

---

## Changing the Backlight Settings

To change the backlight settings in order to conserve more battery power:

1. From the **Start** menu, tap **Settings** > **System** tab > **Backlight**.
2. Select the following backlight tabs to change the settings:
  - Battery Power
  - External Power
  - Brightness

### **Battery Saving Tips:**

- Set the backlight to go off quickly after you stop using your HP iPAQ, or move the slide bar to **Power Save** mode to turn off the backlight completely. You can also set the backlight to turn on when a button is pressed or when the screen is tapped.
- Turn off all wireless connections and Bluetooth when they are not being used.

## Disabling the Application Buttons

Pressing the Contacts or Inbox Application Buttons on the front of your HP iPAQ will turn your device on by default.

**Battery Saving Tip:** To reduce incidence of accidentally powering on the HP iPAQ, you may choose to disable the Application and Record Buttons Auto Power On feature.

To disable the Auto Power On function of the Application Buttons or the Record Button:

1. Tap **Start** > **Settings** > **Personal** tab > **Buttons** > **Lock** tab.
2. Tap in the **Disable all buttons except power button** checkbox.
3. Tap **OK**.

---

**Note:** If you disable the Auto Power On feature for the Application Buttons, the Power Button still turns the unit on. Once the unit is turned on, all buttons will function according to their programmed functions.

---

## Manually Monitoring the Battery

To manually monitor the battery power:

1. From the **Start** menu, tap **Settings** > **System** tab > **Power** icon.
2. Tap **OK**.

---

## Using Security Features

The widespread use of Pocket PC devices has significantly increased employee productivity. However, non-secured or inadequately secured Pocket PC devices are creating network security issues for the corporate workplace when they connect to a secure network.

Valuable information is bypassing network security and being stored on inadequately secured Pocket PC devices. The HP ProtectTools security features provide on-device security protection so there is less risk of losing sensitive information on your HP iPAQ.

### Using HP ProtectTools

HP ProtectTools helps protect your HP iPAQ by providing authentication and encryption of e-mail, calendar, contacts, notes, tasks, and/or all files stored in the My Documents folder. It can also be used to encrypt data stored on expansion cards.

When you enable HP ProtectTools, you have the option of entering a PIN and/or password to access the HP iPAQ. If you forget your PIN or password, you can access the device with a backup question and answer or [contact your administrator to manually authenticate](#).

---

**Note:** HP ProtectTools does not replace or interact with the security on your mobile phone's SIM card. While you can use the same PIN and/or password for both HP ProtectTools and your SIM card, it is recommended, for maximum security, that you use different PINs and/or passwords.

---



**CAUTION:** HP ProtectTools helps protect your HP iPAQ and the data stored on it. If you are unable to access your device with any of the above methods, there is no way to unlock your device. You have to restore your device to factory settings, resulting in the loss of **all** data on your HP iPAQ, including data stored in iPAQ File Store. It is recommended that you remember your PIN/password and question/answer.

If you are unable to access your device, you will still be able to use your mobile phone to make and receive calls, and data stored on your SIM card will not be lost. However, you will not be able to access other applications (such as Contacts, Tasks, or Notes) from the phone application until you unlock your device.

---

## Setting Up Security

You should only need to set up security one time. You can make changes to any of your security settings at a later time without going through the setup procedure again. Refer to “[Manage Security Settings](#)” later in this chapter for more information.

To set up security on your HP iPAQ:

1. Tap **Start** > **Settings** > **Personal** tab > **HP ProtectTools**.
2. The security configuration screen displays the message “Do you want to configure HP ProtectTools security on your device?” Tap **Yes**.
3. On the **Lock Settings** screen, select your choices for the following:
  - Lock device**—secures device by requiring your PIN or password to authenticate access to the HP iPAQ.

- Log off**—secures device by requiring your PIN or password, stops running all programs, and encrypts your data. You can also select the amount of time between when you last used the device and when the data is encrypted.

---

**Note:** Because encryption/decryption can take some time, if you use your device frequently, you may want to select a longer period of time.

---

4. Tap **Next**.

5. From the **Unlock Settings** screen, select the method in which you want to unlock your HP iPAQ, along with the number of attempts allowed for each setting:

- Simple 4-digit PIN**—enter a minimum four-digit number
- Password**—enter a combination of numbers and/or letters of any length
- Strong alphanumeric password**—enter a minimum of eight characters including at least one uppercase letter, one lowercase letter, and one number

6. Tap **Next**.

7. From the **Fail-Safe Settings** screen:

- Select the number of attempts you have to answer your hint question correctly.
- Select what the device should do if you fail to answer your hint question correctly after the associated number of attempts.

---

**Note:** It is recommended that you select the default, **Pause before retrying question**.

---

- Select whether to keep security after a hard reset.

---

**Note:** It is recommended that you select this option to ensure that the data stored in your HP iPAQ remains secure after a hard reset.

---

8. Tap **Next**.

9. From the **Encryption Settings** screen:

- Select the encryption strength.
  - ◆ **Lite** is the fastest but least secure algorithm.
  - ◆ **Blowfish** is both fast and secure.
  - ◆ **Triple DES** and **AES** are the most secure, but AES encrypts data faster than Triple DES.

---

**Note:** It is recommended that you use the default, **AES**.

---

- Select which data you want encrypted. If you select to have the My Documents folder encrypted, you can also choose whether to encrypt media files (for example, audio or video files). Media files often take longer to encrypt and decrypt than other file types.
- Select whether you want the encryption status displayed. Selecting this option allows you to monitor the encryption/decryption process. Refer to [“Encrypting/Decrypting Data”](#) later in this chapter for more information.

10. Tap **Next**.

11. From the **Security Configuration Complete** screen, tap **Continue** to create your PIN or password, and answer your hint question.



12. Prior to entering your PIN or password, you are asked for a passphrase. Tap **OK**, then follow the on-screen instructions to create a passphrase.

---

**Note:** The passphrase is not something you need to remember on a daily basis, but you should remember it for future reference. For more information on passphrases, tap the **More Information...** button.

---

13. Tap **OK**.
14. If requested, enter your PIN or password two times for verification purposes.
15. From the **Set up Passwords** screen, select your hint question by tapping the left and right arrow buttons near the question. Answer the question two times for verification purposes.
16. Tap **OK**. Your HP iPAQ resets itself after a few seconds, or you can tap the **Reset Device** button to reset the device immediately.

---

**Note:** After the device has completed the reset process, you are asked for your PIN and/or password before you can begin using it again.

---

## Using Your HP iPAQ with HP ProtectTools

### Unlocking Your HP iPAQ

The authentication method for unlocking your HP iPAQ is as follows:

- Enter your PIN and/or password when prompted. If you successfully enter the requested information, the device unlocks.

- After the number of attempts you selected during setup, if you still do not successfully enter your PIN and/or password correctly, you are prompted to answer the hint question you defined. If you successfully answer your hint question, the device unlocks.

---

**Note:** After you successfully authenticate, you are prompted to reset any authentication information you didn't enter correctly. For example, if you forgot your PIN, but successfully enter your hint question/answer, you are prompted to enter a new PIN.

---

- If you do not answer your hint question successfully and you selected the **Pause before retrying question** option on the **Fail-Safe Settings** screen, there is an increasing time delay between hint question/answer attempts until you enter the correct answer. If you have completely forgotten the answer to your hint question and will not remember it with further attempts, then you must tap the **Reset Device** button.



**CAUTION:** If you tap the **Reset Device** button, you lose all data on the device, including the iPAQ File Store. If you choose this option, be aware that resetting iPAQ File Store could take a long time after the iPAQ initialization process has been completed. It is recommended that you connect your device to AC power during this period to avoid timeouts or loss of power.

If you perform a hard reset instead of tapping the **Reset Device** button AND you selected **Keep Security** on the **Fail-Safe Settings** screen, your HP iPAQ returns to its default settings and loses all information (files, settings, etc.) except data stored in iPAQ File Store. In this case, you must still answer your hint question to regain access to your HP iPAQ. For more information on performing a hard reset, refer to [Chapter 1, "Getting to Know Your HP iPAQ Mobile Messenger."](#)

---

## Encrypting/Decrypting Data

If your HP iPAQ has been off for longer than the time you selected during setup, your data is encrypted. When you turn the device on, you are prompted to authenticate your PIN, and/or

password. After successful authentication, your data is decrypted. This may take a few moments depending on the amount of data you chose to have encrypted. However, encryption runs in the background, and you can perform other tasks on your HP iPAQ during this time.

You can monitor the decryption process in two ways:

- If you selected **Display encryption status** on the Encryption Settings screen during setup, the HP ProtectTools window displays the decryption status. New Screen
- If you choose not to display this status, the encryption/decryption process proceeds in the background, allowing you to use your HP iPAQ for other purposes.
- In either case, a blue lock icon appears in the Taskbar at the bottom of the Today screen during decryption. When the icon disappears, decryption is complete. Typically the HP iPAQ responds more slowly during the encryption/decryption process.

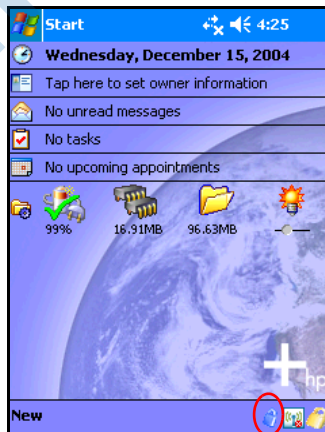

You must authenticate yourself and wait for the decryption process to complete before synchronizing using Microsoft ActiveSync. If decryption is not complete before synchronization begins, ActiveSync may not be initiated. To correct the problem, disconnect and reconnect the device after decryption is complete.

If you enable Server Synchronization on ActiveSync, it is recommended that you do not select a Mobile Schedule to automatically initiate synchronization. Since authentication and decryption are necessary when the HP iPAQ is turned on, automatic synchronization does not work properly when HP ProtectTools is enabled. The same problem may also arise when using other server-based synchronization products.

## Changing Your HP ProtectTools Settings

If you want to change any of your security information, you can do so easily. Tap the yellow lock icon in the Taskbar at the bottom of the Today screen.

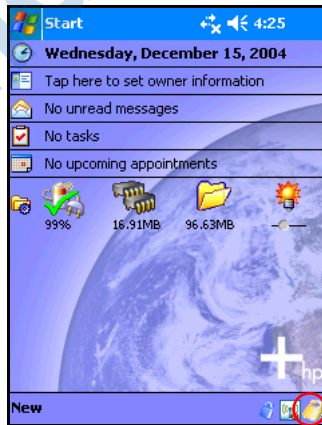

Five options are displayed:

- Lock Device
- Logoff

- Change Passwords
- Manage Encrypted Folders
- Manage Security Settings

## Lock Device

Selecting this option allows you to manually lock your HP iPAQ, requiring authentication to access the device. Data and files are not encrypted.

## Logoff

Selecting this option allows you to manually log off your HP iPAQ, requiring authentication to access the device. Data and files are encrypted.

## Change Passwords

To change your PIN or Password:

1. Tap **Change Passwords**.
2. Enter your current PIN or password to authenticate yourself.
3. Select the information you want to change (PIN/password or Question/Answer pair), then tap the **Change** button.
4. Follow the on-screen instructions to make the change.

## Manage Encrypted Folders

By default, all data in the My Documents folder is encrypted. Selecting Manage Encrypted Folders allows you to choose other folders to store encrypted data. These can include data stored on expansion cards.

To select other folders to store encrypted data:

1. Tap **Manage Encrypted Folders**.
2. Tap **Encrypted Folder** at the bottom of the screen.

3. Tap **Add**.
4. Enter the name, location, and estimated size of the folder to be encrypted.

---

**Note:** The size of the folder is its maximum size and cannot be changed.

---

5. Tap **OK**. The device formats the new folder.
6. Tap **OK**.

---

**Note:** You cannot encrypt existing folders.

For more information on managing encrypted folders, refer to HP ProtectTools Help. To access encryption Help, from the **Today** screen, tap the **Yellow Lock** icon > **Yellow Lock** icon in upper-left corner of the **HP ProtectTools** screen > **Help** > **Understanding encryption**.

---

## Manage Security Settings

You can disable security or make changes to any of the settings you selected during setup.

To make changes to security settings:

1. Tap **Manage Security Settings**.
2. Enter your PIN or password to authenticate yourself.
3. To disable security, tap the **Disable Security** button.
4. To change any previously selected security settings, tap the appropriate tab at the bottom of the screen and follow the on-screen instructions. The screens match those used during the setup process. For more information, refer to “[Setting Up Security](#)” earlier in this chapter.

5. Use the **Programs** tab to select any programs you do not want to stop running when you log off. For more information, tap the **Programs** tab, then tap **Help** at the bottom of the screen.

HP  
Confidential

HP  
Confidential



---

## Troubleshooting

### Self-Test Diagnostics

Use the Self-Test application to run tests on the operation of your device. The diagnostics application tests for sound, notification, GSM/GPRS, and buttons.

To run the Self-Test application:

1. From the **Start** menu, tap **Settings** > **System** tab > **Self-Test**.
2. Place a check in the checkbox next to the items to be tested or in all checkboxes to test all of them.
3. Tap **Start**.
4. Follow the screen instructions as tests are performed on each requested item. Tap **OK** or **Cancel** as required as you proceed through the testing. If you cancel a test, the test status is set to **FAIL**.

---

**Note:** You will receive Error messages with specific information on items that fail. For instance, if you checked sound and it is not working properly, you could get an Error message that says something like the following: “Error detecting sound.” Use the information in the Error messages to correct the device item.

---

5. After the last test is performed, the test result screen displays the results of all performed tests. The final status will either be PASS or FAIL. When you tap **Finish**, you will be asked if you want to create a SelfTest log file.
  - ❑ Tap **Yes** to create the log file in My Documents folder. The log file will contain the results of the test with a time and date stamp.
  - ❑ Tap **No** to skip the log file output.

## Common Problems

To receive support from an HP-qualified technical support specialist, visit the HP support Web site at [www.hp.com/support](http://www.hp.com/support). To find information on the support Web site for your specific product, be sure to have your model or product name available.

To access HP Instant Support:

1. On your personal computer, go to [www.hp.com/support](http://www.hp.com/support).
2. Select your country or region.
3. Select **See support and troubleshooting information**, and then type your product model number.
4. Click the >> button.
5. Click **contact support**.

---

**Note:** For troubleshooting information on Microsoft Operating System applications, go to [www.microsoft.com/mobile/](http://www.microsoft.com/mobile/).

---

You can use the following suggestions to troubleshoot problems with your HP iPAQ.

Problem	Solution
I cannot see anything on the screen.	<ul style="list-style-type: none"> <li>■ Be sure the HP iPAQ is powered on.</li> <li>■ Be sure the HP iPAQ battery is charged.</li> <li>■ Be sure the HP iPAQ is connected to the AC Adapter and the HP iPAQ Cradle.</li> <li>■ Reset the device by using the stylus to lightly press the <b>Reset</b> button.</li> <li>■ Remove and replace the battery.</li> </ul>
I cannot keep my battery charged.	<ul style="list-style-type: none"> <li>■ Always keep the HP iPAQ connected to the AC Adapter when you are not using it.</li> <li>■ Tap <b>Start &gt; Settings &gt; System</b> tab &gt; <b>Power &gt; backlight settings</b>. In backlight settings, place a checkmark in the check box next to <b>Turn off backlight if device is not used for</b> and select <b>30 seconds</b> to conserve more battery power.</li> <li>■ Tap <b>Start &gt; Settings &gt; System</b> tab &gt; <b>Power &gt; Advanced</b> tab. In battery power settings, set the battery power <b>To turn off device if not used for 2 minutes</b>.</li> <li>■ Turn off the Phone, Bluetooth, and all wireless connections when not in use.</li> <li>■ Check to make sure you are using an HP authorized battery.</li> </ul>
Unit will not turn on.	<p>Try one or all of the following:</p> <ol style="list-style-type: none"> <li>1. Reset the unit. Refer to the information on <b>Resetting the Unit</b> in <a href="#">Chapter 1, "Getting to Know Your HP iPAQ Mobile Messenger."</a></li> <li>2. Remove and replace the battery and wait for the unit to power on.</li> <li>3. Connect the unit to the AC Adapter connected to an electrical outlet or to your connected HP iPAQ Cradle to recharge the battery.</li> </ol> <p><b>Note:</b> After you have tried the above solutions and your HP iPAQ still does not turn on, contact your HP Help support by referring to the telephone numbers listed at <a href="http://www.hp.com/country/us/en/wwcontact.html">http://www.hp.com/country/us/en/wwcontact.html</a>.</p>

Problem	Solution ( <i>Continued</i> )
The backlight keeps turning off.	In Backlight Settings, increase the amount of time the backlight stays on if not in use. From the <b>Start</b> menu, tap <b>Settings &gt; System tab &gt; Backlight</b> icon.
Message displays on the HP iPAQ screen that the battery is not recognized.	In this event, the HP iPAQ uses the remaining power available in the battery, but the battery will not charge and the charging LED will not blink. It is recommended that you back up information stored on your HP iPAQ and purchase an HP authorized battery.
Message displays on the HP iPAQ screen that the battery temperature is out of range.	The HP iPAQ goes into a suspend mode and battery charging is prohibited. The device will not operate until the battery is within the acceptable temperature range (32° to 104° F). Remove the HP iPAQ from extreme hot or cold environmental conditions.
I want to ship my HP iPAQ to a repair facility.	<ol style="list-style-type: none"> <li>1. Back up your information to a memory card or external source for safekeeping.</li> <li>2. Disconnect all external devices.</li> <li>3. Pack your HP iPAQ and any external devices in protective packaging as requested by Customer Support. Include any additional documentation or items as instructed by Customer Support.</li> </ol>

Problem	Solution ( <i>Continued</i> )
I cannot connect to a network.	<ul style="list-style-type: none"> <li>■ Be sure you have added the necessary server information.</li> <li>■ Be sure the network you are attempting to connect to is available and not busy.</li> <li>■ Check the signal strength.</li> <li>■ Be sure your user name and password are correct.</li> <li>■ Tap <b>Start &gt; Settings &gt; Connections</b> tab &gt; <b>Connections</b> and check your connection settings. Tap <b>OK</b> when you are finished to save your changes.</li> <li>■ Be sure the IP Address is correct.</li> <li>■ Reset the device by using the stylus to lightly press the <b>Reset</b> button.</li> <li>■ Check with your service provider for current connection problems.</li> <li>■ Run the self-test diagnostics.</li> </ul>
When I try to open the Inbox, I receive an error or the application hangs.	<ul style="list-style-type: none"> <li>■ Check to see if your wireless application is turned on and you are receiving a wireless signal.</li> <li>■ Check to see if your SIM card is inserted in your HP iPAQ.</li> <li>■ Limit the number of e-mail services you create.</li> </ul>
I cannot configure the Calendar.	Tap <b>Start &gt; Help &gt; Calendar</b> and tap on the subjects listed under <b>How To</b> for information on configuring the Calendar settings.
I get an error when I try to record a note in Calendar or in Tasks.	Try using a more compressed recording format in Calendar or Tasks (8,000 Hz, Mono [8 KB/s] is the most compressed format available). To switch to a more compressed recording format, from the <b>Today</b> screen, tap <b>Start &gt; Settings &gt; Input &gt; Options</b> tab.
I want to see the current date.	<ol style="list-style-type: none"> <li>1. From the <b>Today</b> screen, tap <b>Start &gt; Calendar</b>.</li> <li>2. Tap the <b>Go-to-Today</b> icon to see today's date.</li> </ol>
I cannot see all my appointments.	Be sure the appointment you created is in the selected category.

Problem	Solution ( <i>Continued</i> )
I cannot find the document or workbook I saved.	Pocket Word and Excel recognize and display documents in only one folder below My Documents. For example, if you created another folder in the Personal folder in My Documents, the documents in that folder will not be shown. To find your document or workbook, tap <b>Start &gt; Programs &gt; File Explorer</b> . Open the folder you created, then tap the file you're looking for.
My device is always asking me for a password.	Tap <b>Start &gt; Settings &gt; Personal tab &gt; Password</b> to be sure the password settings are configured as you wish.
I cannot find files sent to me by another device.	Check My Documents, which is the default save location used to receive files.
Screen freezes, responds slowly, or no response.	Try resetting your HP iPAQ. Refer to the information on <b>Resetting the Unit</b> in <a href="#">Chapter 1, "Getting to Know Your HP iPAQ Mobile Messenger."</a>
Stylus taps have inappropriate or slow response.	Realign the screen. From the <b>Start</b> menu, tap <b>Settings &gt; System tab &gt; Screen &gt; Align Screen</b> , and follow the instructions.
My device keeps running out of memory.	<ul style="list-style-type: none"> <li>■ Move programs or data to a memory storage card such as an SDIO or mini-SD expansion card.</li> <li>■ Set some programs (such as Notes or Pocket Word) to automatically save new files on the expansion card.</li> <li>■ Move e-mail attachments to the expansion card.</li> <li>■ Delete old or unnecessary files by tapping <b>Start &gt; Programs &gt; File Explorer</b>. Tap and hold the file, then from the Pop-up menu, tap <b>Delete</b>.</li> <li>■ Remove programs you do not use by tapping <b>Start &gt; Settings &gt; System tab &gt; Remove Programs</b>. Tap the program to be removed and then tap <b>Remove</b>.</li> <li>■ Clear program memory by tapping <b>Start &gt; Settings &gt; System tab &gt; Memory &gt; Running Programs</b> tab. Tap the programs to be cleared and then tap <b>Stop</b>.</li> </ul>

# ActiveSync

For more information on Microsoft ActiveSync, refer to [Chapter 3, “Using ActiveSync.”](#)

Problem	Solution
I cannot connect to my computer using the HP iPAQ Cradle.	<ul style="list-style-type: none"> <li>■ Be sure you have installed Microsoft ActiveSync 3.7.1 or a later version on your host computer before connecting your HP iPAQ to it.</li> <li>■ Be sure your HP iPAQ is connected to the HP iPAQ Cradle, and that the cradle is connected to your computer.</li> <li>■ Be sure your HP iPAQ is securely seated in the cradle and is making contact with the cradle connector.</li> <li>■ Be sure you are running Microsoft Windows 98SE, Me, 2000, or XP and that you have installed Microsoft ActiveSync 3.7.1 or a later version on your computer. Also be sure you are connecting directly to a USB port on your computer and not through a USB hub.</li> <li>■ Try resetting your HP iPAQ. Refer to the information on <a href="#">Resetting the Unit</a> in <a href="#">Chapter 1, “Getting to Know Your HP iPAQ Mobile Messenger.”</a></li> <li>■ Uninstall and reinstall ActiveSync.</li> <li>■ If you are running personal firewall software, try disabling it. If you are then able to synchronize, contact the software vendor for information on configuring the required exclusions to eliminate this problem.</li> </ul>
I connected my HP iPAQ before installing Microsoft ActiveSync.	<ol style="list-style-type: none"> <li>1. Disconnect the HP iPAQ from your computer.</li> <li>2. In Windows 98 or 2000, click <b>Start &gt; Settings &gt; Control Panel &gt; System</b>. The Device Manager opens automatically. Locate and select the “unknown” USB device record and click Remove (Uninstall in Windows 2000).</li> <li>3. Restart your computer and allow it to detect the USB device.</li> <li>4. Install Microsoft ActiveSync 3.7.1 or higher.</li> <li>5. Reconnect the HP iPAQ to the computer.</li> </ol>

Problem	Solution ( <i>Continued</i> )
<p>Microsoft ActiveSync cannot locate my HP iPAQ when I synchronize.</p>	<ul style="list-style-type: none"> <li>■ Be sure the device is on and the charging/communications port on the bottom of the HP iPAQ is connected to the communications port in the HP iPAQ cradle.</li> <li>■ Be sure all cables are securely connected.</li> <li>■ Remove your HP iPAQ from the HP iPAQ cradle or disconnect it from the Autosync cable, power on the unit by pressing the <b>Power</b> button, then put it back in the HP iPAQ cradle or reconnect it to the Autosync cable.</li> <li>■ Reset the device by using the stylus to lightly press the <b>Reset</b> button.</li> <li>■ Check <b>Connection Settings</b> in ActiveSync on your computer to ensure the communications port you are using is active.</li> </ul>
<p>I cannot open e-mail in the Inbox after I restore using Microsoft ActiveSync.</p>	<p>Use Microsoft ActiveSync to synchronize your HP iPAQ with your computer. For more information, refer to the “Synchronizing with Your Computer” section in <a href="#">Chapter 3, “Using ActiveSync.”</a></p>
<p>I tried to synchronize a workbook and the file is unresolved in Microsoft ActiveSync.</p>	<p>Pocket Excel does not support all Excel formatting; therefore, Microsoft ActiveSync cannot synchronize the file.</p>



# Phone

For more information on using the Phone, refer to [Chapter 5, “Using the Phone Features.”](#)

Problem	Solution
Phone will not turn on.	<ul style="list-style-type: none"> <li>■ Check to see if your SIM card is inserted in the HP iPAQ.</li> <li>■ Be sure the battery in your HP iPAQ is charged.</li> <li>■ If the HP iPAQ is powering on and the phone still does not turn on, contact your mobile phone service provider for help.</li> </ul>
I am unable to dial out or receive incoming phone calls.	<ul style="list-style-type: none"> <li>■ Check to see if your SIM card is inserted in the HP iPAQ.</li> <li>■ Make sure your wireless connection to your mobile service provider is turned on and your unit displays the appropriate signal strength.</li> <li>■ Is the signal strength icon (  ) displaying a diminished number of vertical bars in the icon? If so, you may be in an area outside of the phone network.</li> <li>■ You may need to change the band frequency.</li> <li>■ If you still cannot dial out or receive phone calls, contact your mobile service provider for help.</li> </ul>
Phone cuts off in the middle of phone conversations.	Be sure the battery on your HP iPAQ is fully charged.

Problem	Solution ( <i>Continued</i> )
Phone runs out of memory.	<p>HP iPAQ automatically manages the allocation of memory between storage and program memory. When memory is low, try the following:</p> <ul style="list-style-type: none"> <li>■ Move data to a storage card.</li> <li>■ Move e-mail attachments to a storage card.</li> <li>■ Delete e-mail or files no longer needed.</li> <li>■ In Internet Explorer options, delete all files and clear history.</li> <li>■ Delete old or unnecessary files by tapping <b>Start &gt; Programs &gt; File Explorer</b>. Tap and hold the file, then from the Pop-up menu, tap <b>Delete</b>.</li> <li>■ Remove programs no longer used by tapping <b>Start &gt; Settings &gt; System tab &gt; Remove Programs</b>. Tap the program to be removed and then tap <b>Remove</b>.</li> <li>■ Clear program memory by tapping <b>Start &gt; Settings &gt; System tab &gt; Memory &gt; Running Programs</b> tab. Tap the programs to be cleared and then tap <b>Stop</b>.</li> </ul>

## Expansion Cards

For more information on expansion cards, refer to [Chapter 11, “Expansion Cards.”](#)

Problem	Solution
My HP iPAQ does not recognize the SD expansion card.	<ul style="list-style-type: none"> <li>■ Be sure you have firmly pushed the SD expansion card into the HP iPAQ.</li> <li>■ Be sure any third party drivers are installed.</li> <li>■ Reset the device by using the stylus to lightly press the <b>Reset</b> button on the bottom of the HP iPAQ.</li> </ul>
I cannot insert my SD card.	<ul style="list-style-type: none"> <li>■ Be sure the label is facing the front of the unit.</li> <li>■ Be sure you are not inserting the card at an angle.</li> <li>■ Be sure you insert the connection area first.</li> <li>■ Be sure you are not inserting an SD size card into the mini-SD slot.</li> </ul>
I cannot remove my SD card.	Push the SD card in to release the locking mechanism. The card will pop out slightly and can then be easily removed.

# Bluetooth

For more information on Bluetooth, refer to [Chapter 9, “Using Bluetooth.”](#)

Problem	Solution
I cannot discover another Bluetooth device.	<ul style="list-style-type: none"> <li>■ Be sure Bluetooth is turned on.</li> <li>■ Move closer to the other device.</li> <li>■ Be sure you have not limited your ability to see devices.</li> <li>■ Be sure the device you are attempting to connect to is on and allows access to being discovered by other devices.</li> </ul>
I can see other devices, but I cannot connect or exchange data with them.	<ul style="list-style-type: none"> <li>■ Be sure Bluetooth is turned on.</li> <li>■ Be sure your device has been set up to allow other devices to connect and your service settings are enabled.</li> <li>■ Move closer to the device.</li> <li>■ Be sure the other device has not restricted your access.</li> <li>■ Try initiating pairing from the other device. Some Bluetooth-enabled device can only initiate pairing and cannot respond to pairing requests from other devices.</li> </ul>
Other devices cannot find or connect to my device.	<ul style="list-style-type: none"> <li>■ Be sure Bluetooth is turned on.</li> <li>■ Move closer to the other device.</li> <li>■ Be sure you have not restricted other devices from finding yours.</li> <li>■ Check your Bluetooth settings to ensure you have allowed your device to be discovered and others to connect.</li> </ul>



Problem	Solution ( <i>Continued</i> )
<p>Other devices do not receive my correct business card information.</p>	<ul style="list-style-type: none"> <li>■ Be sure you have correctly set up your business card information in <b>Bluetooth Settings</b>.</li> <li>■ Check <b>Bluetooth Settings</b> to be sure you have not restricted this function.</li> </ul>
<p>The HP iPAQ cannot find my Bluetooth-enabled Mobile phone.</p>	<ul style="list-style-type: none"> <li>■ Be sure your mobile phone is in discoverable mode.</li> <li>■ Contact your mobile phone manufacturer and ask if there is a firmware upgrade.</li> </ul>

HP Confidential

# GPS Navigation

For more information on GPS, refer to [Chapter 8, “Using GPS Navigation.”](#)

Problem	Solution
<p>My GPS Navigation is not functioning or is not accessing the satellites.</p>	<ul style="list-style-type: none"> <li>■ Be sure you have launched GPS Navigation.</li> <li>■ Be sure you are positioned close to a window or outdoors as a line of sight is required to access the GPS satellites. If you are still having difficulty acquiring a GPS signal, try outdoors where you have a complete view of the sky.</li> </ul> <p><b>Note:</b> To see if GPS Navigation has any activity, with the GPS Navigation software running:</p> <ul style="list-style-type: none"> <li><input type="checkbox"/> Tap in the middle of a map screen.</li> <li><input type="checkbox"/> Tap the <b>Change Preferences</b> icon (  ).</li> <li><input type="checkbox"/> Tap the right arrow 4 times, then tap <b>Configure GPS</b>. You should see some activity on the screen.</li> </ul> <ul style="list-style-type: none"> <li>■ If you have not updated the GPS Navigation recently with the LTO Satellite Location software, you may need to wait a few minutes longer to locate the satellites.</li> <li>■ Be sure your HP iPAQ battery is charged.</li> <li>■ If, after trying all of the above, your GPS Navigation still does not function, visit the following Web site for more information -<a href="http://www.tomtom.com/gpsnavigation">http://www.tomtom.com/gpsnavigation</a>.</li> </ul>
<p>I cannot locate the requested address using the address screen.</p>	<ul style="list-style-type: none"> <li>■ Try entering more street address letters on the top of the address screen or use the crossroads definition.</li> <li>■ Does the requested address fall within the boundaries of the city or area map downloaded to your HP iPAQ? If it does not, then this address will not be available on the map.</li> </ul>

Problem	Solution ( <i>Continued</i> )
<p>The map route screen does not display clearly during the daytime.</p>	<p>You may have your screen preferences set to Nighttime viewing. To change the viewing preferences:</p> <ol style="list-style-type: none"> <li>1. With GPS Navigation software running, tap in the middle of a map screen.</li> <li>2. Tap the <b>Change Preferences</b> icon .</li> <li>3. Tap the <b>Use Day Colors</b> icon .</li> </ol>
<p>GPS Navigator states there is no map available when I launch it.</p>	<ul style="list-style-type: none"> <li>■ If you copied your map to an SD memory card, is your memory card inserted?</li> <li>■ If you recently lost power to your HP iPAQ or performed a hard reset, and you did not back up your software before either of these situations occurred, your map was deleted unless it was copied to a memory card or to iPAQ File Store folder. You can download the same map or previously purchased maps, free-of-charge, to your HP iPAQ by running the Get A Map download program.</li> </ul>
<p>I need a map for a different area.</p>	<p>You may purchase full map sets for other regions in the United States, Canada, and Western Europe at <a href="http://www.tomtom.com/gpsnavigation">http://www.tomtom.com/gpsnavigation</a>.</p>

HP  
Confidential



---

## Regulatory Notices

### Federal Communications Commission Notice

This equipment has been tested and found to comply with the limits for a Class B digital device, pursuant to Part 15 of the FCC Rules. These limits are designed to provide reasonable protection against harmful interference in a residential installation. This equipment generates, uses, and can radiate radio frequency energy and, if not installed and used in accordance with the instructions, may cause harmful interference to radio communications. However, there is no guarantee that interference will not occur in a particular installation. If this equipment does cause harmful interference to radio or television reception, which can be determined by turning the equipment off and on, the user is encouraged to try to correct the interference by one or more of the following measures:

- Reorient or relocate the receiving antenna
- Increase the separation between the equipment and receiver
- Connect the equipment into an outlet on a circuit different from that to which the receiver is connected
- Consult the dealer or an experienced radio or television technician for help

## **Modifications**

The FCC requires the user to be notified that any changes or modifications made to this device that are not expressly approved by Hewlett-Packard Company may void the authority to operate the equipment.

## **Cables**

Connections to this device must be made with shielded cables with metallic RFI/EMI connector hoods in order to maintain compliance with FCC Rules and Regulations.

## **Declaration of Conformity for products marked with the FCC logo—United States only**

This device complies with Part 15 of the FCC Rules. Operation is subject to the following two conditions: (1) this device may not cause harmful interference, and (2) this device must accept any interference received, including interference that may cause undesired operation.

For questions regarding your product, contact:

Hewlett-Packard Development Company, L.P.  
P. O. Box 692000, Mail Stop 530113  
Houston, Texas 77269-2000

Or, call 1-800-652-6672

For questions regarding this FCC declaration, contact:

Hewlett-Packard Development Company, L.P.  
P. O. Box 692000, Mail Stop 510101  
Houston, Texas 77269-2000

Or, call (281) 514-3333

To identify this product, refer to the Part, Series, or Model number found on the product.

## Canadian Notice

This Class B digital apparatus meets all requirements of the Canadian Interference-Causing Equipment Regulations.

## Avis Canadien

Cet appareil numérique de la classe B respecte toutes les exigences du Règlement sur le matériel brouilleur du Canada.

## European Union Regulatory Notice

This product complies with the following EU Directives:

- Low Voltage Directive 73/23/EEC
- EMC Directive 89/336/EEC

**Note:** CE Compliance of this product is valid only if powered with the correct HP-provided and CE marked AC adapter.

If this product has telecommunication functionality, it also complies with the essential requirements of:

- R&TTE Directive 1999/5/EC

Compliance with these directives implies conformity to applicable harmonized European standards (European Norms) which are listed on the EU Declaration of Conformity issued by Hewlett-Packard for this product or product family.

This compliance is indicated by the following conformity marking placed on the product:



This marking is valid for non-Telecom products and EU harmonized Telecom products (e.g. Bluetooth).



XXXX\*



This marking is valid for EU non-harmonized Telecom products .

\*Notified body number (used only if applicable - refer to the product label).

The telecommunications functionality of this product may be used in the following EU and EFTA countries:

Austria, Belgium, Cyprus, Czech Republic, Denmark, Estonia, Finland, France, Germany, Greece, Hungary, Iceland, Ireland, Italy, Latvia, Liechtenstein, Lithuania, Luxembourg, Malta, Netherlands, Norway, Poland, Portugal, Slovak Republic, Slovenia, Spain, Sweden, Switzerland, and United Kingdom.

## ~~Notice for France and Italy for use of 2.4 GHz wireless communication:~~

### ~~France:~~

~~L'utilisation de cet équipement (2.4GHz Wireless LAN) est soumise a certaines restrictions: Cet équipement peut être utilisé à l'intérieur d'un bâtiment en utilisant toutes les fréquences de 2400 à 2483.5MHz (Chaîne 1-13). Pour une utilisation en environnement extérieur, vous devez utiliser les fréquences comprises entre 2454-2483.5MHz (Chaîne 10-13). Pour les dernières restrictions, voir <http://www.art.telecom.fr>.~~

~~For 2.4 GHz Wireless LAN operation of this product certain restrictions apply: This product may be used indoor for the entire 2400-2483.5 MHz frequency band (channels 1-13). For outdoor~~

~~use, only 2454-2483.5 MHz frequency band (channels 10-13) may be used. For the latest requirements, see <http://www.art-telecom.fr>.~~

## Italy:

~~E' necessaria una concessione ministeriale anche per l'uso del prodotto. Verifici per favore con il proprio distributore o direttamente presso la Direzione Generale Pianificazione e Gestione Frequenze.~~

~~License required for use. Verify with your dealer or directly with General Direction for Frequency Planning and Management (Direzione Generale Pianificazione e Gestione Frequenze).~~

## Battery Warning



**WARNING:** This HP iPAQ device contains a LITHIUM-ION rechargeable battery. To reduce the risk of fire or burns, do not disassemble, crush, puncture, short external contacts, or dispose of in fire or water. Replace only with the HP battery Spare Part Number xxxxxx-001. Replacing with a non-approved HP battery will void the warranty.



**CAUTION:** Risk of explosion if battery is replaced by an incorrect type. Dispose of used batteries according to the instructions.



Because of the type of battery used in your HP iPAQ, follow local regulations regarding the safe disposal of the battery. Your vendor can advise you on local regulations, and/or the existence of any battery disposal programs in operation.

## Taiwan Battery Recycling Notice



廢電池請回收

## Equipment Warning

---



**WARNING:** To reduce the risk of personal injury, electrical shock, fire or damage to the equipment:

- Plug the AC Adapter into an electrical outlet that is easily accessible at all times.
  - Disconnect power from the equipment by unplugging the AC Adapter from the electrical outlet.
  - Do not pull on power cables. When unplugging from the electrical outlet, grasp the AC Adapter and pull out from the electrical outlet.
  - Do not place anything on the power cables. Arrange them so that no one may accidentally step on or trip over them.
- 

## Airline Travel Notice

Turn off your HP iPAQ before boarding any aircraft. Federal Aviation Administration (FAA) regulations require you to have permission from a crew member to use the phone features on your HP iPAQ while the plane is on the ground. To prevent interference with wireless systems, local Radio Frequency (RF) regulations prohibit using the phone features on your HP iPAQ while the plane is in the air. Use it on the ground only with crew permission. Use of the HP iPAQ features other than the phone is at the discretion of the airline.

## Medical Electronic Equipment

If you have a medical condition that requires you to use a pacemaker, hearing aid, or any type of medical electronic equipment, consult the manufacturer of the equipment to determine if the medical equipment is shielded from RF energy. Turn off your HP iPAQ in health care facilities or hospitals when there are posted restrictions requiring you to do so.

## Wireless Notices

In some environments, the use of wireless devices may be restricted. Such restrictions may apply aboard airplanes, in hospitals, near explosives, in hazardous locations, etc. If you are uncertain of the policy that applies to the use of this device, please ask for authorization to use it prior to turning it on.

## U.S. Regulatory Wireless Notice

---



**WARNING:** Exposure to Radio Frequency (RF) Radiation  
The radiated output power of this device is far below the FCC radio frequency exposure limits. *Nevertheless, users concerned with the risk of Radio Frequency exposure may wish to limit the duration of calls and position the antenna as far away from the body as practical.* For body worn operation, this ~~phone device~~ has been tested and meets the FCC RF exposure guidelines when used with the Hewlett-Packard accessories supplied with or designated for this product. Use of other accessories may not ensure compliance with FCC RF exposure guidelines.

---

## U.S. Regulatory Notice For 900/1800 GSM Frequency Bands

This device contains 900/1800 MHz GSM functions that are not operational in U.S. territories. This filing is only applicable for GSM 850 MHz and PCS 1900 MHz operations.

## Health and Safety Information—FCC

Since your HP wireless phone is a radio transmitter and receiver, you may be exposed to Radio Frequency (RF) signals when it is powered on. However, your HP wireless phone has been designed so that it does not exceed the emission limits for exposure to radio frequency energy that are set by the Federal Communications Commission of the U.S. Government. These limits are part of comprehensive guidelines and establish permitted levels of RF energy for the general population. The guidelines are based on the safety standards previously set by both the United States and international standards:

This equipment under test has been shown to be capable of compliance for localized Specific Absorption Rate (SAR) for uncontrolled environment/general population exposure limits specified in ANSI/IEEE Standard C95.1-1992 and had been tested in accordance with measurement procedures specified in FCC/OET Bulletin 65 Supplement C (2001) and IEEE Standard 1528-200X (Draft 6.5, January 2002). Ministry of Health (Canada), Safety Code 6. The standards include a substantial safety margin designed to assure the safety of all persons, regardless of age and health. The exposure standard for wireless mobile phones employs a unit of measure known as the Specific Absorption Rate (SAR). The SAR limit set by the FCC is 1.6W/kg.

---

**NOTE:** In the U.S. and Canada, the SAR limit for mobile phones used by the public is 1.6 watts/kg (W/kg) averaged over one gram of tissue. The standard incorporates a substantial margin of safety to give additional protection to the public and to account for any variations.

---

## Canadian Regulatory Wireless Notice

Operation is subject to the following two conditions: (1) this device may not cause interference, and (2) this device must accept any interference, including interference that may cause undesired operation of the device.



## Australian Wireless Notice



**WARNING:** Switch off this device whenever in an area with a potentially explosive atmosphere (i.e., service stations, chemical plants, etc.).

## ~~Japanese Regulatory Wireless Notice~~

この機器の使用周波数帯では、電子レンジ等の産業・科学・医療用機器のほ  
 ぼの製造ライン等で使用されている移動体識別用の構内無線局（免許を要す  
 無線局）及び特定小電力無線局（免許を要しない無線局）が運用されています  
 この機器を使用する前に、近くで移動体識別用の構内無線局及び特定小電  
 力無線局が運用されていないことを確認して下さい。

万一、この機器から移動体識別用の構内無線局に対して電波干渉の事例が  
 生じた場合には、速やかに使用周波数を変更するか又は電波の発射を停止し  
 上、下記連絡先にご連絡頂き、混信回避のための処置等（例えば、パーティ  
 ユンの設置など）についてご相談して下さい。

その他、この機器から移動体識別用の特定小電力無線局に対して電波干渉  
 事例が発生した場合など何かお困りのことが起きたときは、次の連絡先へお  
 い合わせ下さい。

連絡先：日本ヒューレット・パッカド株式会社 TEL：0120-01412



## Brazilian Regulatory Wireless Notice

Este equipamento opera em caráter secundário, isto é, não tem direito a proteção contra interferência prejudicial, mesmo de estações do mesmo tipo, e não pode causar interferência a sistemas operando em caráter primário.

## Singaporean Wireless Notice

- Switch off your cellular telephone when in an aircraft. The use of cellular telephones in an aircraft may be dangerous to the operation of the aircraft, disrupt the cellular network, and is illegal. Failure to observe this instruction may lead to suspension or denial of cellular services to the offender, or legal action or both.
- Users are advised not to use the equipment when at a refueling point.
- Users are reminded of the need to observe restrictions on the use of radio equipment in fuel depots, chemical plants or where blasting operations are in progress.
- The use of the Alert device to operate a vehicle's lights or horn on public roads is not permitted.
- It is advised that a handheld microphone or telephone handset should not be used by the driver while the vehicle is moving, except in an emergency. Speak only into a fixed, neck slung or clipped-on microphone when it would not distract your attention from the road.
- As with other mobile radio transmitting equipment, users are advised that for satisfactory operation of the equipment and for the safety of personnel, it is recommended that no part of the human body be allowed to come too close to the antenna during operation of the equipment.
- This device has been designed to comply with applicable requirements for exposure to radio waves based on scientific guidelines that include margins intended to assure the safety of all people, regardless of health and age. These radio wave exposure guidelines employ a unit of measurement known as the Specific Absorption Rate (SAR). Tests for SAR are conducted using standardized methods with the phone transmitting at its highest certified power level in all used frequency bands. The SAR data information is based on CENELEC's standards EN50360 and EN50361 which use

the limit of 2 W/kg averaged over 10 grams of tissue. The highest SAR value for this model phone when tested is as follows:

- ❑ GSM900: 0.652 W/kg (10g) (CHANGE- WALTER?)
- ❑ PCN1800: 0.487 W/kg (10g)(CHANGE- WALTER?)

## Taiwanese Wireless Notice

註：

1. SAR 標準值1.6W/Kg ；  
送測產品實測值GSM:900 為 W/Kg °  
PCN:1800 為 W/Kg °

2.  減少電磁波影響，請妥適使用。

HP  
Confidential

**B****Specifications****System Specifications**

<b>System Feature</b>	<b>Description</b>
Processor	Intel® PXA272 Processor 312 MHz
Operating System	Windows Mobile™ 2003 Second Edition software for Pocket PC - Phone Edition
SDRAM	64-MB SDRAM (46 MB user accessible)
ROM	64-MB Flash ROM
iPAQ File Store (nonvolatile memory)	Up to 8-MB Storage (not available in Traditional Chinese, and Simplified Chinese versions)
External Power	10 watt maximum output AC Adapter
Display	56 x 56 mm (2.205 x 2.205 inches) transfective TFT QVGA color, 240 x 240 pixels, 0.24 mm dot pitch, 64K-color support, touch screen.
LED Backlight	Multi-level brightness adjustment with power save mode
SD I/O slot	Supports 1-bit SDIO and 4-bit SD/MMC memory standard
Mini-SD slot	Supports 1-bit and 4-bit SD/MMC type memory standard
Audio	Integrated microphone, receiver, speaker and one 2.5 mm stereo earphone/microphone jack, MP3 stereo (through audio jack and speaker) Handsfree speaker phone

<b>System Feature</b>	<b>Description (Continued)</b>
Camera	Built-in SXGA 1.2MP with LED flash, 640 x 480 resolution, JPEG and 3GP format, support for still image, and video playback, H.263 & MPEG4 (not included with all models)
Keyboard	Integrated QWERTY Thumb Keyboard with 26 LED backlit alpha-numeric keys, one Function key, and two application buttons - Calendar and Start menu buttons.
Wired Ear Bud Headset	2.5 mm plug with single earbud - Included in box.
Antenna	Internal
Bluetooth	Class II device; up to 4 dBm transmit, typical 10 meter range (approximately 33 feet) - High-speed, low-power, short-range wireless communication with other Bluetooth devices
Infrared (IrDA)	Serial IrDA SIR, data transfer up to 115.2 Kb per second
SIM Card	3V, SIM standards, Phase 1, 2, 2+, CPHS, SIM Toolkit
<b>GSM / GPRS / EDGE Technology</b>	Global voice and data wireless network (Global System for Mobile Communications [GSM], General Packet Radio Services [GPRS], Enhanced Data rates for Global Evolution [EDGE])
GSM voice features	Half Rate, Full Rate, Enhanced Full Rate, Adaptive Multi-Rate (HR,FR/EFR/AMR) Echo cancelation and noise reduction Full duplex hands-free
GSM Data	Circuit Switched Data - GSM Transparent and non-transparent (NT) data V.42bis data compression for GSM NT data
GPRS Data Features	Class B GPRS Multi slot Class 10, Quadband Coding Schemes: CS1 to CS4, Network Mode 1-4
EDGE Features	Class 10, Support for E-GPRS coding schemes MCS1 to MCS9 in both the uplink and downlink

<b>System Feature</b>	<b>Description (Continued)</b>
<b>GSM / GPRS / EDGE Technology (Continued)</b>	Global voice and data wireless network (Global System for Mobile Communications [GSM], General Packet Radio Services [GPRS], Enhanced Data Rates for Global Evolution [EDGE])
Circuit Switched Data	Normal Single Slot GSM Circuit Switched Data @ 9.6 Kbps Transparent and Non-Transparent data High Speed Circuit Switched Data (HSCSD) multi-slot GSM data calls of maximum uplink/downlink speeds of 43.2Kbps/14.4Kbps or 28.8Kbps/28.8Kbps
Supplementary Services Supported	Call Forwarding, Call Barring, Multiparty, Calling Line Identity, Call Waiting and Call Hold
Unstructured Supplementary Service Data	USSD Phase 2 (MO & MT)
Encryption	GEA1
Authentication	Password Authentication Protocol (PAP) or Challenge Authentication Protocol (CHAP)
Messaging Services	<ul style="list-style-type: none"> <li>■ Text messaging for GSM, both mobile-oriented and mobile-terminated</li> <li>■ MMS (Multimedia Message Service)</li> <li>■ Cell Broadcast</li> </ul>
Ring Tones file formats	MIDI Type 0, WMA, WAV

System Feature	Description ( <i>Continued</i> )
<b>LED Indicators:</b>	
Charging LED	<ul style="list-style-type: none"> <li>■ Blinking green indicates Notification, tone, pop-up message.</li> <li>■ Blinking amber indicates unit is charging.</li> <li>■ Solid amber indicates unit is fully charged.</li> <li>■ When connected to AC power, LED off indicates power to unit is off.</li> </ul> <p><b>NOTE:</b> Power LED does not light when the HP iPAQ is disconnected from AC power.</p>
Bluetooth (LED on right)	<ul style="list-style-type: none"> <li>■ Blinking blue indicates Bluetooth is powered On.</li> <li>■ LED off indicates Bluetooth is powered Off.</li> </ul>
<b>Phone Indicators:</b>	
	<ul style="list-style-type: none"> <li>■ Vibrate</li> <li>■ Audible</li> <li>■ Visual message on the display</li> </ul>
Battery	Removable/rechargeable 1250 mAh, 3.7 Volt, Lithium-ion battery with internal backup battery to maintain data during main battery replacement.

## Physical Specifications

### HP iPAQ hw6500 Series

	US	Metric
Length	4.645 in	118.0 mm
Width	2.795 in	71.0 mm
Depth	0.826 in	21.0 mm
Weight	5.82 oz	165 g



# Operating Environment

## Environment

		US	Metric
Temperature	Operating	32° to 104° F	0° to 40° C
	Nonoperating	-4° to 140° F	-20° to 60° C
Relative Humidity	Operating	up to 90%	up to 90%
	Nonoperating	up to 90%	up to 90%
Maximum Altitude	Operating	15,000 ft	4,572 m
	Nonoperating	40,000 ft	12,192 m