

FCC TEST REPORT (PART 15)

REPORT NO.: RF950109L04F

MODEL NO.: HERM200

RECEIVED: Aug. 04, 2006

TESTED: Aug. 07 ~ Aug. 08, 2006

ISSUED: Aug. 14, 2006

APPLICANT: High Tech Computer Corp.

ADDRESS: 23, Hsin-Hua Rd., Taoyuan, 330, Taiwan, R.O.C.

ISSUED BY: Advance Data Technology Corporation

LAB ADDRESS: No. 47, 14th Ling, Chia Pau Tsuen, Lin Kou Hsiang 244, Taipei Hsien, Taiwan, R.O.C.

TEST LOCATION: No. 19, Hwa Ya 2nd Rd., Wen Hwa Tsuen, Kwei Shan Hsiang, Taoyuan Hsien 333, Taiwan, R.O.C.

This test report consists of 156 pages in total. It may be duplicated completely for legal use with the approval of the applicant. It should not be reproduced except in full, without the written approval of our laboratory. The client should not use it to claim product endorsement by CNLA, A2LA or any government agencies. The test results in the report only apply to the tested sample.



NO. 2177-01



0528



TABLE OF CONTENTS

1.	CERTIFICATION	5
2.	SUMMARY OF TEST RESULTS	6
2.1	MEASUREMENT UNCERTAINTY	7
3.	GENERAL INFORMATION	8
3.1	GENERAL DESCRIPTION OF EUT	8
3.2	DESCRIPTION OF TEST MODES	10
3.2.1	CONFIGURATION OF SYSTEM UNDER TEST	12
3.2.2	TEST MODE APPLICABILITY AND TESTED CHANNEL DETAIL:	13
3.3.3	GENERAL DESCRIPTION OF APPLIED STANDARDS	19
3.3.4	DESCRIPTION OF SUPPORT UNITS	19
4.	TEST TYPES AND RESULTS (FOR WIRELESS LAN FUNCTION)	20
4.1	CONDUCTED EMISSION MEASUREMENT	20
4.1.1	LIMITS OF CONDUCTED EMISSION MEASUREMENT	20
4.1.2	TEST INSTRUMENTS	20
4.1.3	TEST PROCEDURES	21
4.1.4	DEVIATION FROM TEST STANDARD	21
4.1.5	TEST SETUP	22
4.1.6	EUT OPERATING CONDITIONS	22
4.1.7	TEST RESULTS	23
4.2	RADIATED EMISSION MEASUREMENT	47
4.2.1	LIMITS OF RADIATED EMISSION MEASUREMENT	47
4.2.2	TEST INSTRUMENTS	48
4.2.3	TEST PROCEDURES	49
4.2.4	DEVIATION FROM TEST STANDARD	49
4.2.5	TEST SETUP	50
4.2.6	EUT OPERATING CONDITIONS	50
4.2.7	TEST RESULTS	51
4.3	6dB BANDWIDTH MEASUREMENT	62
4.3.1	LIMITS OF 6dB BANDWIDTH MEASUREMENT	62
4.3.2	TEST INSTRUMENTS	62
4.3.3	TEST PROCEDURE	62
4.3.4	DEVIATION FROM TEST STANDARD	62
4.3.5	TEST SETUP	63
4.3.6	EUT OPERATING CONDITIONS	63
4.3.7	TEST RESULTS	64
4.4	MAXIMUM PEAK OUTPUT POWER	70
4.4.1	LIMITS OF MAXIMUM PEAK OUTPUT POWER MEASUREMENT	70
4.4.2	TEST INSTRUMENTS	70
4.4.3	TEST PROCEDURES	71
4.4.4	DEVIATION FROM TEST STANDARD	71
4.4.5	TEST SETUP	71
4.4.6	EUT OPERATING CONDITIONS	71
4.4.7	TEST RESULTS	72
4.5	POWER SPECTRAL DENSITY MEASUREMENT	73
4.5.1	LIMITS OF POWER SPECTRAL DENSITY MEASUREMENT	73
4.5.2	TEST INSTRUMENTS	73
4.5.3	TEST PROCEDURE	74
4.5.4	DEVIATION FROM TEST STANDARD	74



4.5.5 TEST SETUP	74
4.5.6 EUT OPERATING CONDITION	74
4.5.7 TEST RESULTS	75
4.6 BAND EDGES MEASUREMENT	81
4.6.1 LIMITS OF BAND EDGES MEASUREMENT	81
4.6.2 TEST INSTRUMENTS	81
4.6.3 TEST PROCEDURE	81
4.6.4 DEVIATION FROM TEST STANDARD	81
4.6.5 EUT OPERATING CONDITION	81
4.6.6 TEST RESULTS	82
4.7 ANTENNA REQUIREMENT	90
4.7.1 STANDARD APPLICABLE	90
4.7.2 ANTENNA CONNECTED CONSTRUCTION	90
5. TEST TYPES AND RESULTS (FOR BLUETOOTH FUNCTION)	91
5.1 CONDUCTED EMISSION MEASUREMENT	91
5.1.1 LIMITS OF CONDUCTED EMISSION MEASUREMENT	91
5.1.2 TEST INSTRUMENTS	91
5.1.3 TEST PROCEDURES	92
5.1.4 DEVIATION FROM TEST STANDARD	92
5.1.5 TEST SETUP	93
5.1.6 EUT OPERATING CONDITIONS	93
5.1.7 TEST RESULTS	94
5.2 RADIATED EMISSION MEASUREMENT	118
5.2.1 LIMITS OF RADIATED EMISSION MEASUREMENT	118
5.2.2 TEST INSTRUMENTS	119
5.2.3 TEST PROCEDURES	120
5.2.4 DEVIATION FROM TEST STANDARD	120
5.2.5 TEST SETUP	121
5.2.6 EUT OPERATING CONDITIONS	121
5.2.7 TEST RESULTS	122
5.3 NUMBER OF HOPPING FREQUENCY USED	130
5.3.1 LIMIT OF HOPPING FREQUENCY USED	130
5.3.2 TEST INSTRUMENTS	130
5.3.3 TEST PROCEDURES	130
5.3.4 DEVIATION FROM TEST STANDARD	131
5.3.5 TEST SETUP	131
5.3.6 TEST RESULTS	131
5.4 DWELL TIME ON EACH CHANNEL	133
5.4.1 LIMIT OF DWELL TIME USED	133
5.4.2 TEST INSTRUMENTS	133
5.4.3 TEST PROCEDURES	133
5.4.4 DEVIATION FROM TEST STANDARD	133
5.4.5 TEST SETUP	134
5.4.6 TEST RESULTS	134
5.5 CHANNEL BANDWIDTH	138
5.5.1 LIMITS OF CHANNEL BANDWIDTH	138
5.5.2 TEST INSTRUMENTS	138
5.5.3 TEST PROCEDURE	138
5.5.4 DEVIATION FROM TEST STANDARD	139
5.5.5 TEST SETUP	139



5.5.6 EUT OPERATING CONDITION	139
5.5.7 TEST RESULTS	139
5.6 HOPPING CHANNEL SEPARATION.....	142
5.6.1 LIMIT OF HOPPING CHANNEL SEPARATION	142
5.6.2 TEST INSTRUMENTS	142
5.6.3 TEST PROCEDURES.....	142
5.6.4 DEVIATION FROM TEST STANDARD	143
5.6.5 TEST SETUP	143
5.6.6 TEST RESULTS	143
5.7 MAXIMUM PEAK OUTPUT POWER.....	146
5.7.1 LIMITS OF MAXIMUM PEAK OUTPUT POWER MEASUREMENT.....	146
5.7.2 TEST INSTRUMENTS	146
5.7.3 TEST PROCEDURES.....	146
5.7.4 DEVIATION FROM TEST STANDARD	146
5.7.5 TEST SETUP	147
5.7.6 EUT OPERATING CONDITION	147
5.7.7 TEST RESULTS	147
5.8 BAND EDGES MEASUREMENT	150
5.8.1 LIMITS OF BAND EDGES MEASUREMENT	150
5.8.2 TEST INSTRUMENTS	150
5.8.3 TEST PROCEDURE	150
5.8.4 DEVIATION FROM TEST STANDARD	150
5.8.5 EUT OPERATING CONDITION	150
5.8.6 TEST RESULTS	151
5.9 ANTENNA REQUIREMENT	154
5.9.1 STANDARD APPLICABLE	154
5.9.2 ANTENNA CONNECTED CONSTRUCTION.....	154
6. INFORMATION ON THE TESTING LABORATORIES.....	155
APPENDIX-A.....	A-1



1. CERTIFICATION

PRODUCT: Pocket PC Phone

MODEL NO.: HERM200

TEST SAMPLE: ENGINEERING SAMPLE

TESTED: Aug. 07 ~ Aug. 08, 2006

APPLICANT: High Tech Computer Corp.

STANDARDS: FCC Part 15, Subpart C (Section 15.247),
ANSI C63.4-2003

The above equipment have been tested by **Advance Data Technology Corporation**, and found compliance with the requirement of the above standards. The test record, data evaluation & Equipment Under Test (EUT) configurations represented herein are true and accurate accounts of the measurements of the sample's EMC characteristics under the conditions specified in this report.

PREPARED BY : Andrea Hsia , **DATE:** Aug. 14, 2006
Andrea Hsia

TECHNICAL
ACCEPTANCE : Long Chen , **DATE:** Aug. 14, 2006
Responsible for RF Long Chen

APPROVED BY : Gary Chang , **DATE:** Aug. 14, 2006
Gary Chang / Supervisor

2. SUMMARY OF TEST RESULTS

The EUT has been tested according to the following specifications:

FOR WIRELESS LAN FUNCTION:

APPLIED STANDARD: FCC Part 15, Subpart C			
STANDARD SECTION	TEST TYPE AND LIMIT	RESULT	REMARK
15.207	AC Power Conducted Emission	PASS	Meet the requirement of limit. Minimum passing margin is -11.08dB at 2.207MHz.
15.247(a)(2)	Spectrum Bandwidth of a Direct Sequence Spread Spectrum System Limit: min. 500kHz	PASS	Meet the requirement of limit
15.247(b)	Maximum Peak Output Power Limit: max. 30dBm	PASS	Meet the requirement of limit
15.247(d)	Radiated Emissions Limit: Table 15.209	PASS	Meet the requirement of limit. Minimum passing margin is -2.46dB at 2390.00MHz.
15.247(e)	Power Spectral Density Limit: max. 8dBm	PASS	Meet the requirement of limit
15.247(d)	Band Edge Measurement Limit: 20dB less than the peak value of fundamental frequency	PASS	Meet the requirement of limit

FOR BLUETOOTH FUNCTION:

APPLIED STANDARD: FCC Part 15, Subpart C			
STANDARD SECTION	TEST TYPE AND LIMIT	RESULT	REMARK
15.207	AC Power Conducted Emission	PASS	Meet the requirement of limit Minimum passing margin is -13.07dB at 2.605MHz.
15.247(a)(1)(iii)	Number of Hopping Frequency Used Spec.: At least 15 channels	PASS	Meet the requirement of limit
15.247(a)(1)(iii)	Dwell Time on Each Channel Spec. : Max. 0.4 second within 31.6 second	PASS	Meet the requirement of limit
15.247(a)(1)	1. Hopping Channel Separation Spec. : Min. 25 kHz or 20 dB bandwidth, whichever is greater 2. Spectrum Bandwidth of a Frequency Hopping Sequence Spread Spectrum System	PASS	Meet the requirement of limit
15.247(b)	Maximum Peak Output Power Spec.: max. 30dBm	PASS	Meet the requirement of limit
15.247(d)	Transmitter Radiated Emissions Spec.: Table 15.209	PASS	Meet the requirement of limit Minimum passing margin is -2.82 dB at 111.64MHz.
15.247(d)	Band Edge Measurement	PASS	Meet the requirement of limit

2.1 MEASUREMENT UNCERTAINTY

Where relevant, the following measurement uncertainty levels have been estimated for tests performed on the EUT as specified in CISPR 16-4:

MEASUREMENT	FREQUENCY	UNCERTAINTY
Conducted emissions	9kHz ~ 30MHz	2.44 dB
Radiated emissions	30MHz ~ 200MHz	3.73 dB
	200MHz ~ 1000MHz	3.74 dB
	1GHz ~ 18GHz	2.20 dB
	18GHz ~ 40GHz	1.88 dB

This uncertainty represents an expanded uncertainty expressed at approximately the 95% confidence level using a coverage factor of k=2.

3. GENERAL INFORMATION

3.1 GENERAL DESCRIPTION OF EUT

PRODUCT	Pocket PC Phone
MODEL NO.	HERM200
FCC ID	NM8HERM200
POWER SUPPLY	3.70Vdc from rechargeable lithium battery 5.00Vdc from power adapter 5.00Vdc from host equipment
MODULATION TYPE	Wireless LAN: CCK, DQPSK, DBPSK for DSSS 64QAM, 16QAM, QPSK, BPSK for OFDM Bluetooth: GFSK for FHSS
MODULATION TECHNOLOGY	DSSS, OFDM, FHSS
TRANSFER RATE	Wireless LAN: 802.11b: 11/5.5/2/1Mbps 802.11g: 54/48/36/24/18/12/9/6Mbps Bluetooth: 723Kbps
FREQUENCY RANGE	Wireless LAN: 802.11b & 802.11g: 2.412 ~ 2.462GHz Bluetooth: 2.402 ~ 2.480GHz
NUMBER OF CHANNEL	Wireless LAN: 802.11b & 802.11g: 11 Bluetooth: 79
OUTPUT POWER	Wireless LAN: 39.902mW for 802.11b 50.466mW for 802.11g Bluetooth: 1.000mW
ANTENNA TYPE	Wireless LAN: monopole antenna with -1.0dBi gain Bluetooth: PIFA antenna with -1.0dBi gain
DATA CABLE	1.2m USB shielded cable without core
I/O PORTS	Refer to user's manual
ASSOCIATED DEVICES	1.7m non-shielded cable for earphone

NOTE:

1. The EUT was designed with CCD function.
2. The EUT is a GSM850/PCS1900/GPRS/E-GPRS/WCDMA850/WCDMA1900 Pocket PC Phone with wireless LAN and bluetooth functions. This report is only covered the functions of wireless LAN and bluetooth. The mobile phone function is covered in another two test reports, which standards used are FCC Part 24 and FCC Part 22.

3. The EUT have lithium battery listed as below:

STANDARD BATTERY 1:	
MODEL:	PA16A
RATING:	3.7Vdc, 1350mAh

STANDARD BATTERY 2:	
MODEL:	HERM161
RATING:	3.7Vdc, 1350mAh

STANDARD BATTERY 3:	
MODEL:	HERM160
RATING:	3.7Vdc, 1300mAh

4. The EUT was operated with following power adapters:

ADAPTER 1:	
BRAND:	PHIHONG
MODEL:	PSAA05A-050
INPUT:	100~240Vac, 0.2A, 50-60Hz
OUTPUT:	5.00Vdc, 1A
POWER LINE:	DC 1.8m non-shielded cable without core

ADAPTER 2:	
BRAND:	TPT
MODEL:	JHA050100UU05
INPUT:	100-240Vac ~ 50-60Hz, 0.3A,
OUTPUT:	5.00Vdc, 1A
POWER LINE:	DC 1.8m non-shielded cable without core

ADAPTER 3:	
BRAND:	Delta
MODEL:	ADP-5FH B
INPUT:	100-240Vdc ~ 0.2A, 50-60Hz
OUTPUT:	5.00Vdc, 1A
POWER LINE:	DC 1.8m non-shielded cable without core

5. The EUT operates in the 2.4GHz frequency spectrum and complies with 802.11b & 802.11g techniques.

6. The above EUT information was declared by manufacturer and for more detailed features description, please refer to the manufacturer's specifications or User's Manual.

3.2 DESCRIPTION OF TEST MODES

Since the EUT is considered a portable unit, it was pre-tested on the positioned of each 3 axis. For wireless LAN function, the worst case was found when positioned on Z-plane. Therefore only the test data of this Z-plane was used for radiated test.

And for Bluetooth function, the worst case was found when positioned on Y-plane. Therefore only the test data of this Y-plane was used for radiated test.

There are 5 test modes presented in the report as below.

TEST MODE	TEST CONDITION
A	The EUT with standard battery 2 connected, and was powered by the adapter 1 with CCD.
B	The EUT with standard battery 2 connected, and was powered by the adapter 2 with CCD.
C	The EUT with standard battery 2 connected, and was powered by the adapter 3 with CCD.
D	The EUT with standard battery connected with the earphone, and was powered by standard battery 2 with CCD.
E	The EUT with standard battery 2 connected with notebook via USB cable with CCD.

11 channels are provided to the EUT for wireless LAN function:

CHANNEL	FREQUENCY	CHANNEL	FREQUENCY
1	2412 MHz	7	2442 MHz
2	2417 MHz	8	2447 MHz
3	2422 MHz	9	2452 MHz
4	2427 MHz	10	2457 MHz
5	2432 MHz	11	2462 MHz
6	2437 MHz		

79 channels are provided to this EUT for bluetooth function:

CHANNEL	FREQ. (MHz)	CHANNEL	FREQ. (MHz)	CHANNEL	FREQ. (MHz)	CHANNEL	FREQ. (MHz)
0	2402	20	2422	40	2442	60	2462
1	2403	21	2423	41	2443	61	2463
2	2404	22	2424	42	2444	62	2464
3	2405	23	2425	43	2445	63	2465
4	2406	24	2426	44	2446	64	2466
5	2407	25	2427	45	2447	65	2467
6	2408	26	2428	46	2448	66	2468
7	2409	27	2429	47	2449	67	2469
8	2410	28	2430	48	2450	68	2470
9	2411	29	2431	49	2451	69	2471
10	2412	30	2431	50	2452	70	2472
11	2413	31	2433	51	2453	71	2473
12	2414	32	2434	52	2454	72	2474
13	2415	33	2435	53	2455	73	2475
14	2416	34	2436	54	2456	74	2476
15	2417	35	2437	55	2457	75	2477
16	2418	36	2438	56	2458	76	2478
17	2419	37	2439	57	2459	77	2479
18	2420	38	2440	58	2460	78	2480
19	2421	39	2441	59	2461		

3.2.1 CONFIGURATION OF SYSTEM UNDER TEST

TEST MODE A, B, C

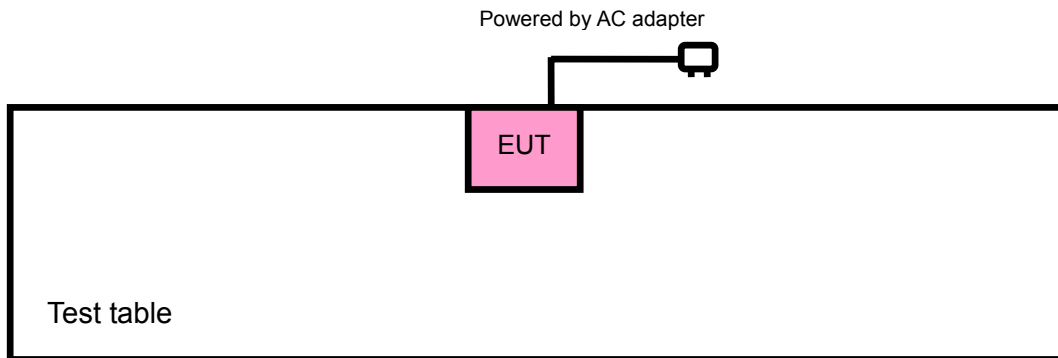

TEST MODE D

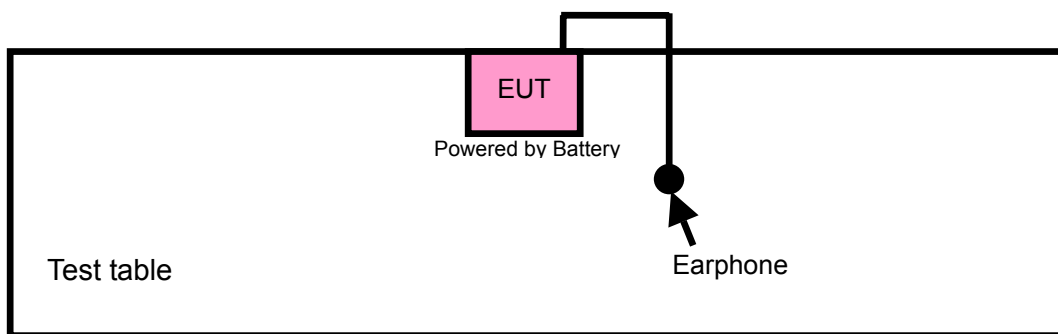

TEST MODE E

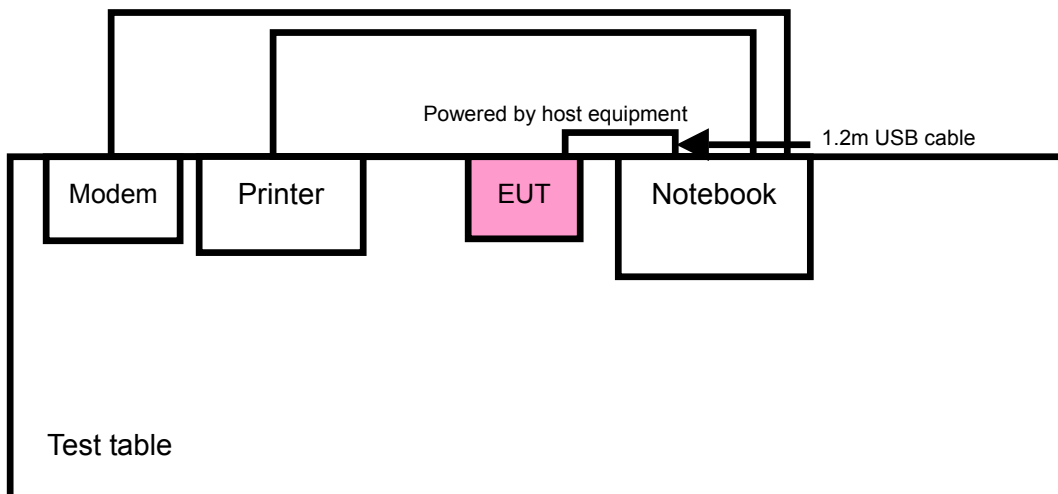

3.2.2 TEST MODE APPLICABILITY AND TESTED CHANNEL DETAIL:

FOR WIRELESS LAN FUNCTION:

EUT CONFIGURE MODE	APPLICABLE TO				DESCRIPTION
	PLC	RE<1G	RE≥1G	APCM	
A	√	√	-	-	The EUT with standard battery 2 connected, and was powered by the adapter 1 with CCD.
B	√	√	-	-	The EUT with standard battery 2 connected, and was powered by the adapter 2 with CCD.
C	√	√	-	-	The EUT with standard battery 2 connected, and was powered by the adapter 3 with CCD.
D	-	√	-	-	The EUT with standard battery connected with the earphone, and was powered by standard battery 2 with CCD.
E	√	√	√	√	The EUT with standard battery 2 connected with notebook via USB cable with CCD.

Where **PLC:** Power Line Conducted Emission
RE≥1G: Radiated Emission above 1GHz

RE<1G RE: Radiated Emission below 1GHz
APCM: Antenna Port Conducted Measurement

NOTE: “-“ means no effect.

POWER LINE CONDUCTED EMISSION TEST:

- Pre-Scan has been conducted to determine the worst-case mode from all possible combinations between available modulations, data rates and antenna ports (if EUT with antenna diversity architecture).
- Following channel(s) was (were) selected for the final test as listed below.

EUT CONFIGURE MODE	AVAILABLE CHANNEL	TESTED CHANNEL	MODULATION TECHNOLOGY	MODULATION TYPE	DATA RATE (Mbps)
A	1 to 11	1, 6, 11	11g OFDM	BPSK	6
B	1 to 11	1, 6, 11	11g OFDM	BPSK	6
C	1 to 11	1, 6, 11	11g OFDM	BPSK	6
E	1 to 11	1, 6, 11	11g OFDM	BPSK	6

RADIATED EMISSION TEST (BELOW 1 GHz):

- Pre-Scan has been conducted to determine the worst-case mode from all possible combinations between available modulations, data rates, antenna ports (if EUT with antenna diversity architecture), X, Y and Z Axis.
- Following channel(s) was (were) selected for the final test as listed below.

EUT CONFIGURE MODE	AVAILABLE CHANNEL	TESTED CHANNEL	MODULATION TECHNOLOGY	MODULATION TYPE	DATA RATE (Mbps)	AXIS
A	1 to 11	11	11g OFDM	BPSK	6	Z
B	1 to 11	11	11g OFDM	BPSK	6	Z
C	1 to 11	11	11g OFDM	BPSK	6	Z
D	1 to 11	11	11g OFDM	BPSK	6	Z
E	1 to 11	11	11g OFDM	BPSK	6	Z

RADIATED EMISSION TEST (ABOVE 1 GHz):

- Pre-Scan has been conducted to determine the worst-case mode from all possible combinations between available modulations, data rates, antenna ports (if EUT with antenna diversity architecture).
- Following channel(s) was (were) selected for the final test as listed below.

EUT CONFIGURE MODE	AVAILABLE CHANNEL	TESTED CHANNEL	MODULATION TECHNOLOGY	MODULATION TYPE	DATA RATE (Mbps)
E	1 to 11	1, 6, 11	11b DSSS	DBPSK	1
E	1 to 11	1, 6, 11	11g OFDM	BPSK	6

BANDEDGE MEASUREMENT:

- Pre-Scan has been conducted to determine the worst-case mode from all possible combinations between available modulations, data rates and antenna ports (if EUT with antenna diversity architecture).
- Following channel(s) was (were) selected for the final test as listed below.

AVAILABLE CHANNEL	TESTED CHANNEL	MODULATION TECHNOLOGY	MODULATION TYPE	DATA RATE (Mbps)
1 to 11	1, 11	11b DSSS	DBPSK	1
1 to 11	1, 11	11g OFDM	BPSK	6



ANTENNA PORT CONDUCTED MEASUREMENT:

- Pre-Scan has been conducted to determine the worst-case mode from all possible combinations between available modulations, data rates and antenna ports (if EUT with antenna diversity architecture).
- Following channel(s) was (were) selected for the final test as listed below.

AVAILABLE CHANNEL	TESTED CHANNEL	MODULATION TECHNOLOGY	MODULATION TYPE	DATA RATE (Mbps)
1 to 11	1, 6, 11	11b DSSS	DBPSK	1
1 to 11	1, 6, 11	11g OFDM	BPSK	6

FOR BLUETOOTH FUNCTION:

EUT CONFIGURE MODE	APPLICABLE TO				DESCRIPTION
	PLC	RE<1G	RE≥1G	APCM	
A	√	√	-	-	The EUT with standard battery 2 connected, and was powered by the adapter 1 with CCD.
B	√	√	-	-	The EUT with standard battery 2 connected, and was powered by the adapter 2 with CCD.
C	√	√	-	-	The EUT with standard battery 2 connected, and was powered by the adapter 3 with CCD.
D	-	√	-	-	The EUT with standard battery connected with the earphone, and was powered by standard battery 2 with CCD.
E	√	√	√	√	The EUT with standard battery 2 connected with notebook via USB cable with CCD.

Where **PLC**: Power Line Conducted Emission
RE≥1G: Radiated Emission above 1GHz

RE<1G RE: Radiated Emission below 1GHz
APCM: Antenna Port Conducted Measurement

NOTE: “-“ means no effect.

POWER LINE CONDUCTED EMISSION TEST:

- Pre-Scan has been conducted to determine the worst-case mode from all possible combinations between available modulations, antenna ports (if EUT with antenna diversity architecture), and packet types.
- Following channel(s) was (were) selected for the final test as listed below.

EUT CONFIGURE MODE	AVAILABLE CHANNEL	TESTED CHANNEL	MODULATION TECHNOLOGY	MODULATION TYPE	PACKET TYPE
A	0 to 78	0, 39, 78	FHSS	GFSK	DH5
B	0 to 78	0, 39, 78	FHSS	GFSK	DH5
C	0 to 78	0, 39, 78	FHSS	GFSK	DH5
E	0 to 78	0, 39, 78	FHSS	GFSK	DH5

RADIATED EMISSION TEST (BELOW 1 GHz):

- Pre-Scan has been conducted to determine the worst-case mode from all possible combinations between available modulations, data rates, antenna ports (if EUT with antenna diversity architecture), X, Y, Z Axis, and packet type.
- Following channel(s) was (were) selected for the final test as listed below.

EUT CONFIGURE MODE	AVAILABLE CHANNEL	TESTED CHANNEL	MODULATION TECHNOLOGY	MODULATION TYPE	PACKET TYPE	AXIS
A	0 to 78	78	FHSS	GFSK	DH5	Y
B	0 to 78	78	FHSS	GFSK	DH5	Y
C	0 to 78	78	FHSS	GFSK	DH5	Y
D	0 to 78	78	FHSS	GFSK	DH5	Y
E	0 to 78	78	FHSS	GFSK	DH5	Y

RADIATED EMISSION TEST (ABOVE 1 GHz):

- Pre-Scan has been conducted to determine the worst-case mode from all possible combinations between available modulations, data rates, antenna ports (if EUT with antenna diversity architecture), X, Y, Z Axis, and packet type.
- Following channel(s) was (were) selected for the final test as listed below.

EUT CONFIGURE MODE	AVAILABLE CHANNEL	TESTED CHANNEL	MODULATION TECHNOLOGY	MODULATION TYPE	PACKET TYPE	AXIS
E	0 to 78	0, 39, 78	FHSS	GFSK	DH5	Y

BANDEDGE MEASUREMENT:

- Pre-Scan has been conducted to determine the worst-case mode from all possible combinations between available modulations, antenna ports (if EUT with antenna diversity architecture), and packet types.
- Following channel(s) was (were) selected for the final test as listed below.

AVAILABLE CHANNEL	TESTED CHANNEL	MODULATION TECHNOLOGY	MODULATION TYPE	PACKET TYPE
0 to 78	0, 78	FHSS	GFSK	DH5

ANTENNA PORT CONDUCTED MEASUREMENT:

- Pre-Scan has been conducted to determine the worst-case mode from all possible combinations between available modulations, antenna ports (if EUT with antenna diversity architecture), and packet types.
- Following channel(s) was (were) selected for the final test as listed below.

AVAILABLE CHANNEL	TESTED CHANNEL	MODULATION TECHNOLOGY	MODULATION TYPE	PACKET TYPE
0 to 78	0, 39, 78	FHSS	GFSK	DH5



3.3.3 GENERAL DESCRIPTION OF APPLIED STANDARDS

The EUT is a RF Product. According to the specifications of the manufacturer, it must comply with the requirements of the following standards:

FCC Part 15, Subpart C. (15.247)

ANSI C63.4- 2003

All test items have been performed and recorded as per the above standards.

NOTE: The EUT is also considered as a kind of computer peripheral, because the connection to computer is necessary for typical use. It has been verified to comply with the requirements of FCC Part 15, Subpart B, Class B (DoC). The test report has been issued separately.

3.3.4 DESCRIPTION OF SUPPORT UNITS

The EUT has been tested as an independent unit together with other necessary accessories or support units. The following support units or accessories were used to form a representative test configuration during the tests.

NO.	PRODUCT	BRAND	MODEL NO.	SERIAL NO.	FCC ID
1	NOTEBOOK COMPUTER	DELL	PP05L	12130898320	E2K24CLNS
2	MODEM	ACEEX	1414V/3	0401008248	IFAXDM1414
3	PRINTER	EPSON	LQ-300+	DCGY047265	FCC DoC Approved

NO.	SIGNAL CABLE DESCRIPTION OF THE ABOVE SUPPORT UNITS
1	NA
2	1.2 m shielded cable without core
3	1.2 m shielded cable without core

NOTE: All power cords of the above support units are non shielded (1.8m).

4. TEST TYPES AND RESULTS (FOR WIRELESS LAN FUNCTION)

4.1 CONDUCTED EMISSION MEASUREMENT

4.1.1 LIMITS OF CONDUCTED EMISSION MEASUREMENT

FREQUENCY OF EMISSION (MHz)	CONDUCTED LIMIT (dB μ V)	
	Quasi-peak	Average
0.15 ~ 0.5	66 to 56	56 to 46
0.5 ~ 5	56	46
5 ~ 30	60	50

- NOTE:**
1. The lower limit shall apply at the transition frequencies.
 2. The limit decreases in line with the logarithm of the frequency in the range of 0.15 to 0.50 MHz.
 3. All emanations from a class A/B digital device or system, including any network of conductors and apparatus connected thereto, shall not exceed the level of field strengths specified above.

4.1.2 TEST INSTRUMENTS

DESCRIPTION & MANUFACTURER	MODEL NO.	SERIAL NO.	CALIBRATED UNTIL
Test Receiver ROHDE & SCHWARZ	ESCS30	100288	Nov. 02, 2006
RF signal cable Woken	5D-FB	Cable-HYCO3-01	Jan. 06, 2007
LISN ROHDE & SCHWARZ	ESH2-Z5	100100	Jan. 09, 2007
LISN ROHDE & SCHWARZ	ESH3-Z5	100311	Jan. 22, 2007
Software ADT	ADT_Cond_V3	NA	NA

- NOTE:**
1. The calibration interval of the above test instruments is 12 months and the calibrations are traceable to NML/ROC and NIST/USA.
 2. The test was performed in HwaYa Shielded Room 2.
 3. The VCCI Site Registration No. is C-2047.

4.1.3 TEST PROCEDURES

- a. The EUT was placed 0.4 meters from the conducting wall of the shielded room with EUT being connected to the power mains through a line impedance stabilization network (LISN). Other support units were connected to the power mains through another LISN. The two LISNs provide 50 ohm/ 50uH of coupling impedance for the measuring instrument.
- b. Both lines of the power mains connected to the EUT were checked for maximum conducted interference.
- c. The frequency range from 150kHz to 30MHz was searched. Emission levels under (Limit - 20dB) was not recorded.

4.1.4 DEVIATION FROM TEST STANDARD

No deviation

4.1.5 TEST SETUP

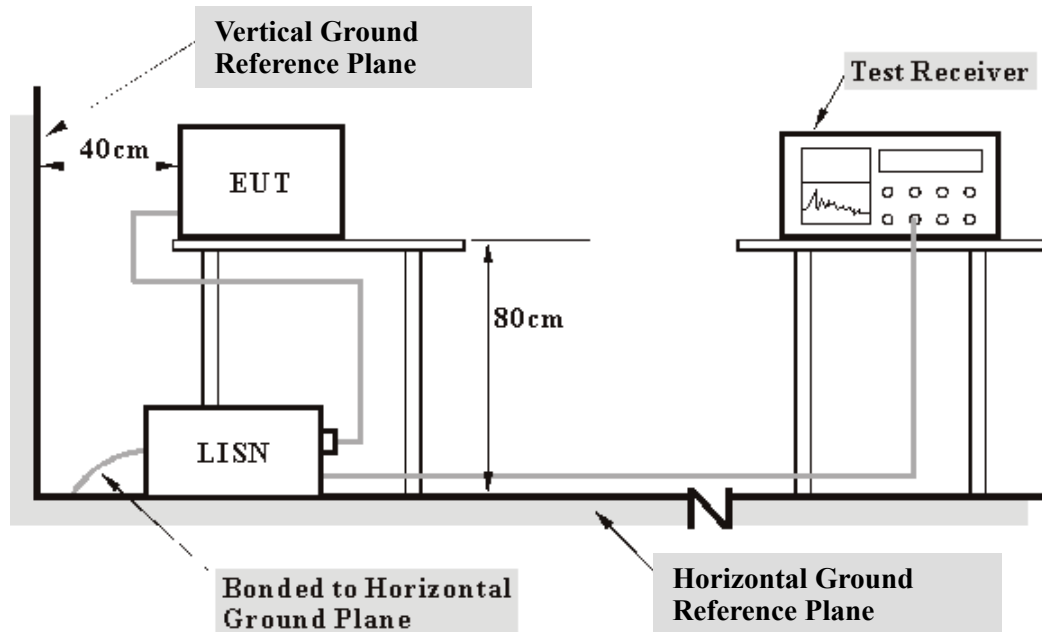

- Note:**
1. Support units were connected to second LISN.
 2. Both of LISNs (AMN) 80 cm from EUT and at the least 80 cm from other units and other metal planes support units.

For the actual test configuration, please refer to the related item – Photographs of the Test Configuration.

4.1.6 EUT OPERATING CONDITIONS

TEST MODE A ~ C:

The EUT placed on the testing table and set it under transmission condition continuously at specific channel frequency.

TEST MODE E:

- a. Connected the EUT to a notebook system via USB cable and placed on a testing table.
- b. The notebook system ran a test program (provided by manufacturer) to enable EUT under transmission condition continuously at specific channel frequency.
- c. The notebook system sent "H" messages to its screen.
- d. The notebook system sent "H" messages to modem.
- e. The notebook system sent "H" messages to printer, and the printer printed them on paper.
- f. Steps c ~ e were repeated.

4.1.7 TEST RESULTS

CONDUCTED WORST CASE DATA (FOR ADAPTER: PSAA05A-050):

EUT TEST CONDITION		MEASUREMENT DETAIL	
CHANNEL	Channel 1	PHASE	Line 1
MODULATION TYPE	BPSK	6dB BANDWIDTH	9 kHz
ENVIRONMENTAL CONDITIONS	20deg. C, 60%RH, 991hPa	INPUT POWER (SYSTEM)	120Vac, 60 Hz
TRANSFER RATE	6Mbps	TEST MODE	A
TESTED BY	Match Tsui		

NO	FREQ. [MHz]	CORR. FACTOR (dB)	READING VALUE [dB (uV)]		EMISSION LEVEL [dB (uV)]		LIMIT [dB (uV)]		MARGIN (dB)	
			Q.P.	AV.	Q.P.	AV.	Q.P.	AV.	Q.P.	AV.
			1	0.185	0.10	35.28	-	35.38	-	64.25
2	0.306	0.10	29.22	-	29.32	-	60.07	50.07	-30.75	-
3	0.494	0.10	31.43	-	31.53	-	56.10	46.10	-24.57	-
4	0.861	0.10	32.96	-	33.06	-	56.00	46.00	-22.94	-
5	2.215	0.22	42.27	-	42.49	-	56.00	46.00	-13.51	-
6	15.733	0.62	32.89	-	33.51	-	60.00	50.00	-26.49	-

- REMARKS:**
1. Q.P. and AV. are abbreviations of quasi-peak and average individually.
 2. "-": The Quasi-peak reading value also meets average limit and measurement with the average detector is unnecessary.
 3. The emission levels of other frequencies were very low against the limit.
 4. Margin value = Emission level - Limit value
 5. Correction factor = Insertion loss + Cable loss
 6. Emission Level = Correction Factor + Reading Value.

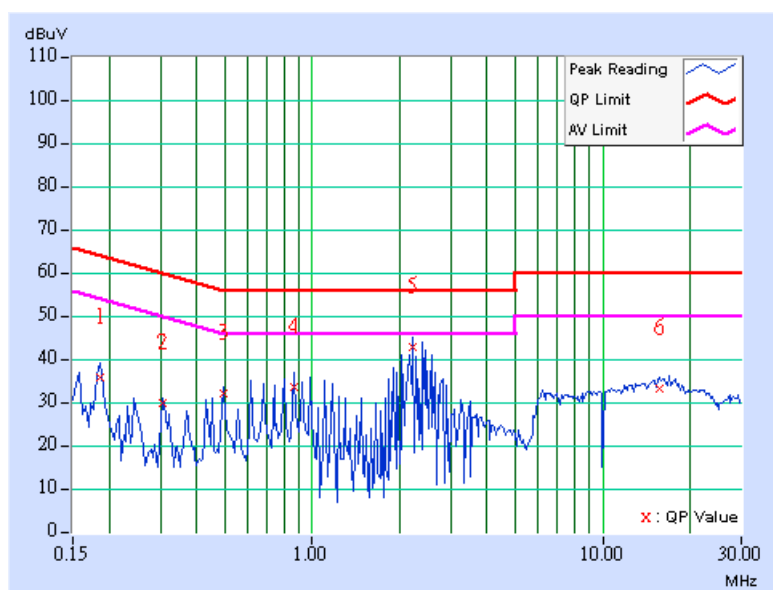

EUT TEST CONDITION		MEASUREMENT DETAIL	
CHANNEL	Channel 1	PHASE	Line 2
MODULATION TYPE	BPSK	6dB BANDWIDTH	9 kHz
ENVIRONMENTAL CONDITIONS	20deg. C, 60%RH, 991hPa	INPUT POWER (SYSTEM)	120Vac, 60 Hz
TRANSFER RATE	6Mbps	TEST MODE	A
TESTED BY	Match Tsui		

NO	FREQ. [MHz]	CORR. FACTOR (dB)	READING VALUE [dB (uV)]		EMISSION LEVEL [dB (uV)]		LIMIT [dB (uV)]		MARGIN (dB)	
			Q.P.	AV.	Q.P.	AV.	Q.P.	AV.	Q.P.	AV.
			1	0.185	0.10	37.14	-	37.24	-	64.25
2	0.248	0.10	28.26	-	28.36	-	61.84	51.84	-33.48	-
3	0.494	0.12	33.50	-	33.62	-	56.10	46.10	-22.49	-
4	2.277	0.22	40.08	-	40.30	-	56.00	46.00	-15.70	-
5	6.277	0.40	32.48	-	32.88	-	60.00	50.00	-27.12	-
6	14.332	0.61	31.21	-	31.82	-	60.00	50.00	-28.18	-

- REMARKS:**
1. Q.P. and AV. are abbreviations of quasi-peak and average individually.
 2. "-": The Quasi-peak reading value also meets average limit and measurement with the average detector is unnecessary.
 3. The emission levels of other frequencies were very low against the limit.
 4. Margin value = Emission level - Limit value.
 5. Correction factor = Insertion loss + Cable loss.
 6. Emission Level = Correction Factor + Reading Value.

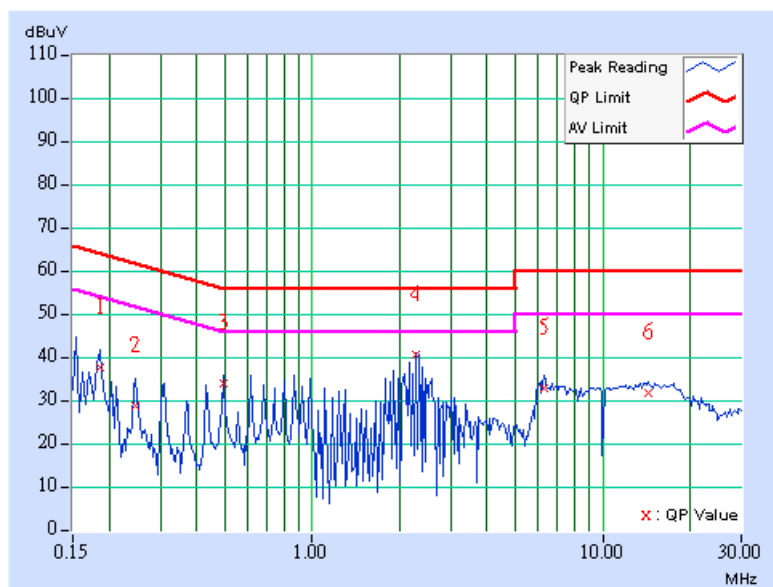

EUT TEST CONDITION		MEASUREMENT DETAIL	
CHANNEL	Channel 6	PHASE	Line 1
MODULATION TYPE	BPSK	6dB BANDWIDTH	9 kHz
ENVIRONMENTAL CONDITIONS	20deg. C, 60%RH, 991hPa	INPUT POWER (SYSTEM)	120Vac, 60 Hz
TRANSFER RATE	6Mbps	TEST MODE	A
TESTED BY	Match Tsui		

NO	FREQ. [MHz]	CORR. FACTOR (dB)	READING VALUE [dB (uV)]		EMISSION LEVEL [dB (uV)]		LIMIT [dB (uV)]		MARGIN (dB)	
			Q.P.	AV.	Q.P.	AV.	Q.P.	AV.	Q.P.	AV.
			1	0.185	0.10	34.07	-	34.17	-	64.25
2	0.306	0.10	29.05	-	29.15	-	60.07	50.07	-30.92	-
3	0.494	0.10	32.38	-	32.48	-	56.10	46.10	-23.62	-
4	2.273	0.22	43.99	-	44.21	-	56.00	46.00	-11.79	-
5	6.324	0.37	30.27	-	30.64	-	60.00	50.00	-29.36	-
6	16.273	0.61	28.25	-	28.86	-	60.00	50.00	-31.14	-

- REMARKS:**
1. Q.P. and AV. are abbreviations of quasi-peak and average individually.
 2. "-": The Quasi-peak reading value also meets average limit and measurement with the average detector is unnecessary.
 3. The emission levels of other frequencies were very low against the limit.
 4. Margin value = Emission level - Limit value.
 5. Correction factor = Insertion loss + Cable loss.
 6. Emission Level = Correction Factor + Reading Value.

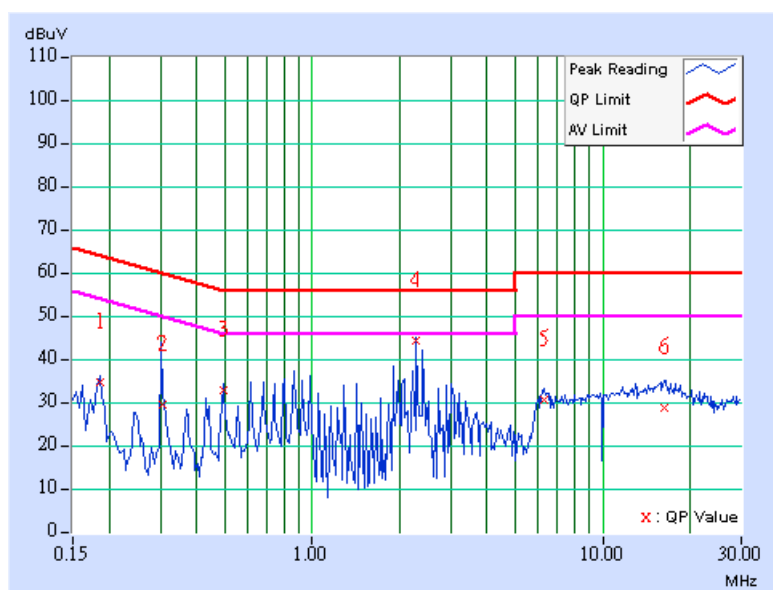

EUT TEST CONDITION		MEASUREMENT DETAIL	
CHANNEL	Channel 6	PHASE	Line 2
MODULATION TYPE	BPSK	6dB BANDWIDTH	9 kHz
ENVIRONMENTAL CONDITIONS	20deg. C, 60%RH, 991hPa	INPUT POWER (SYSTEM)	120Vac, 60 Hz
TRANSFER RATE	6Mbps	TEST MODE	A
TESTED BY	Match Tsui		

NO	FREQ. [MHz]	CORR. FACTOR (dB)	READING VALUE [dB (uV)]		EMISSION LEVEL [dB (uV)]		LIMIT [dB (uV)]		MARGIN (dB)	
			Q.P.	AV.	Q.P.	AV.	Q.P.	AV.	Q.P.	AV.
			1	0.185	0.10	35.59	-	35.69	-	64.25
2	0.306	0.10	31.64	-	31.74	-	60.07	50.07	-28.33	-
3	0.490	0.11	33.84	-	33.95	-	56.17	46.17	-22.22	-
4	2.152	0.21	35.86	-	36.07	-	56.00	46.00	-19.93	-
5	6.207	0.40	30.58	-	30.98	-	60.00	50.00	-29.02	-
6	15.664	0.62	29.44	-	30.06	-	60.00	50.00	-29.94	-

- REMARKS:**
1. Q.P. and AV. are abbreviations of quasi-peak and average individually.
 2. "-": The Quasi-peak reading value also meets average limit and measurement with the average detector is unnecessary.
 3. The emission levels of other frequencies were very low against the limit.
 4. Margin value = Emission level - Limit value.
 5. Correction factor = Insertion loss + Cable loss.
 6. Emission Level = Correction Factor + Reading Value.

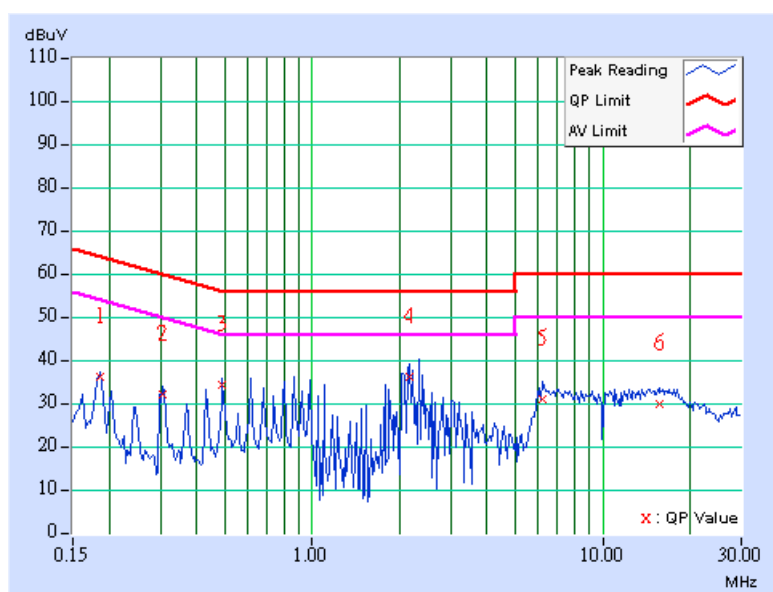

EUT TEST CONDITION		MEASUREMENT DETAIL	
CHANNEL	Channel 11	PHASE	Line 1
MODULATION TYPE	BPSK	6dB BANDWIDTH	9 kHz
ENVIRONMENTAL CONDITIONS	20deg. C, 60%RH, 991hPa	INPUT POWER (SYSTEM)	120Vac, 60 Hz
TRANSFER RATE	6Mbps	TEST MODE	A
TESTED BY	Match Tsui		

NO	FREQ. [MHz]	CORR. FACTOR (dB)	READING VALUE [dB (uV)]		EMISSION LEVEL [dB (uV)]		LIMIT [dB (uV)]		MARGIN (dB)	
			Q.P.	AV.	Q.P.	AV.	Q.P.	AV.	Q.P.	AV.
	1	0.185	0.10	33.41	-	33.51	-	64.25	54.25	-30.74
2	0.244	0.10	24.67	-	24.77	-	61.97	51.97	-37.20	-
3	0.677	0.10	31.71	-	31.81	-	56.00	46.00	-24.19	-
4	2.207	0.22	44.70	-	44.92	-	56.00	46.00	-11.08	-
5	6.320	0.37	30.41	-	30.78	-	60.00	50.00	-29.22	-
6	15.402	0.62	31.16	-	31.78	-	60.00	50.00	-28.22	-

- REMARKS:**
1. Q.P. and AV. are abbreviations of quasi-peak and average individually.
 2. "-": The Quasi-peak reading value also meets average limit and measurement with the average detector is unnecessary.
 3. The emission levels of other frequencies were very low against the limit.
 4. Margin value = Emission level - Limit value.
 5. Correction factor = Insertion loss + Cable loss.
 6. Emission Level = Correction Factor + Reading Value.

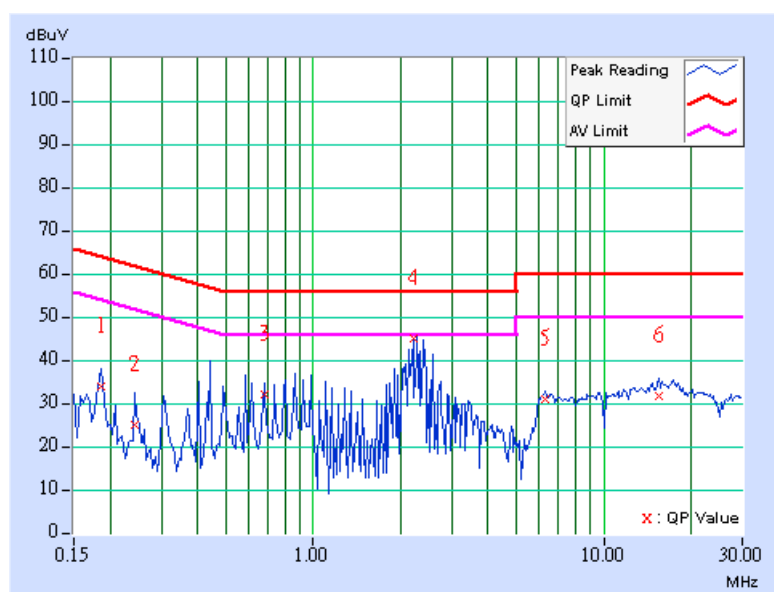

EUT TEST CONDITION		MEASUREMENT DETAIL	
CHANNEL	Channel 11	PHASE	Line 2
MODULATION TYPE	BPSK	6dB BANDWIDTH	9 kHz
ENVIRONMENTAL CONDITIONS	20deg. C, 60%RH, 991hPa	INPUT POWER (SYSTEM)	120Vac, 60 Hz
TRANSFER RATE	6Mbps	TEST MODE	A
TESTED BY	Match Tsui		

NO	FREQ. [MHz]	CORR. FACTOR (dB)	READING VALUE [dB (uV)]		EMISSION LEVEL [dB (uV)]		LIMIT [dB (uV)]		MARGIN (dB)	
			Q.P.	AV.	Q.P.	AV.	Q.P.	AV.	Q.P.	AV.
			1	0.185	0.10	34.96	-	35.06	-	64.25
2	0.306	0.10	31.84	-	31.94	-	60.07	50.07	-28.13	-
3	0.861	0.18	31.59	-	31.77	-	56.00	46.00	-24.23	-
4	2.023	0.20	38.85	-	39.05	-	56.00	46.00	-16.95	-
5	6.262	0.40	33.01	-	33.41	-	60.00	50.00	-26.59	-
6	16.633	0.61	30.60	-	31.21	-	60.00	50.00	-28.79	-

- REMARKS:**
1. Q.P. and AV. are abbreviations of quasi-peak and average individually.
 2. "-": The Quasi-peak reading value also meets average limit and measurement with the average detector is unnecessary.
 3. The emission levels of other frequencies were very low against the limit.
 4. Margin value = Emission level - Limit value.
 5. Correction factor = Insertion loss + Cable loss.
 6. Emission Level = Correction Factor + Reading Value.

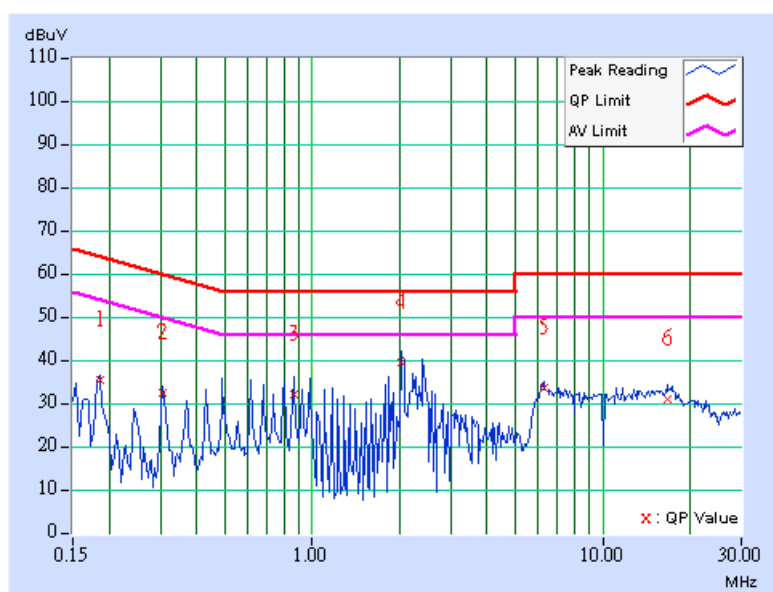

CONDUCTED WORST CASE DATA (FOR ADAPTER: JHA050100UU05):

EUT TEST CONDITION		MEASUREMENT DETAIL	
CHANNEL	Channel 1	PHASE	Line 1
MODULATION TYPE	BPSK	6dB BANDWIDTH	9 kHz
ENVIRONMENTAL CONDITIONS	20deg. C, 60%RH, 991hPa	INPUT POWER (SYSTEM)	120Vac, 60 Hz
TRANSFER RATE	6Mbps	TEST MODE	B
TESTED BY	Match Tsui		

NO	FREQ. [MHz]	CORR. FACTOR (dB)	READING VALUE [dB (uV)]		EMISSION LEVEL [dB (uV)]		LIMIT [dB (uV)]		MARGIN (dB)	
			Q.P.	AV.	Q.P.	AV.	Q.P.	AV.	Q.P.	AV.
			1	0.166	0.10	47.60	-	47.70	-	65.18
2	0.270	0.10	39.93	-	40.03	-	61.13	51.13	-21.10	-
3	0.380	0.10	40.98	-	41.08	-	58.27	48.27	-17.19	-
4	0.705	0.15	38.74	-	38.89	-	56.00	46.00	-17.11	-
5	2.926	0.32	41.86	-	42.18	-	56.00	46.00	-13.82	-
6	9.320	0.46	36.79	-	37.25	-	60.00	50.00	-22.75	-

- REMARKS:**
1. Q.P. and AV. are abbreviations of quasi-peak and average individually.
 2. "-": The Quasi-peak reading value also meets average limit and measurement with the average detector is unnecessary.
 3. The emission levels of other frequencies were very low against the limit.
 4. Margin value = Emission level - Limit value
 5. Correction factor = Insertion loss + Cable loss
 6. Emission Level = Correction Factor + Reading Value.

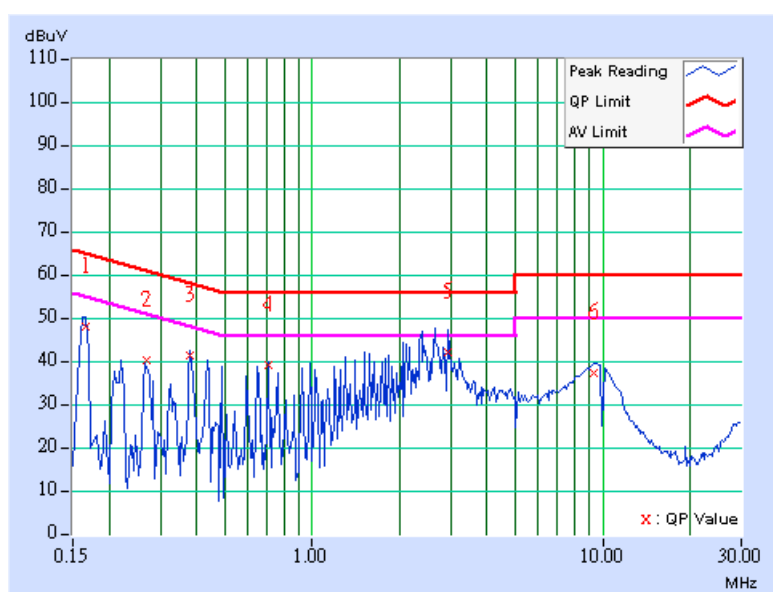

EUT TEST CONDITION		MEASUREMENT DETAIL	
CHANNEL	Channel 1	PHASE	Line 2
MODULATION TYPE	BPSK	6dB BANDWIDTH	9 kHz
ENVIRONMENTAL CONDITIONS	20deg. C, 60%RH, 991hPa	INPUT POWER (SYSTEM)	120Vac, 60 Hz
TRANSFER RATE	6Mbps	TEST MODE	B
TESTED BY	Match Tsui		

NO	FREQ. [MHz]	CORR. FACTOR (dB)	READING VALUE [dB (uV)]		EMISSION LEVEL [dB (uV)]		LIMIT [dB (uV)]		MARGIN (dB)	
			Q.P.	AV.	Q.P.	AV.	Q.P.	AV.	Q.P.	AV.
			1	0.162	0.10	47.42	-	47.52	-	65.38
2	0.271	0.10	41.91	-	42.01	-	61.08	51.08	-19.07	-
3	0.380	0.10	38.96	-	39.06	-	58.27	48.27	-19.21	-
4	0.705	0.10	35.67	-	35.77	-	56.00	46.00	-20.23	-
5	2.926	0.28	43.15	-	43.43	-	56.00	46.00	-12.57	-
6	9.758	0.46	33.30	-	33.76	-	60.00	50.00	-26.24	-

- REMARKS:**
1. Q.P. and AV. are abbreviations of quasi-peak and average individually.
 2. "-": The Quasi-peak reading value also meets average limit and measurement with the average detector is unnecessary.
 3. The emission levels of other frequencies were very low against the limit.
 4. Margin value = Emission level - Limit value.
 5. Correction factor = Insertion loss + Cable loss.
 6. Emission Level = Correction Factor + Reading Value.

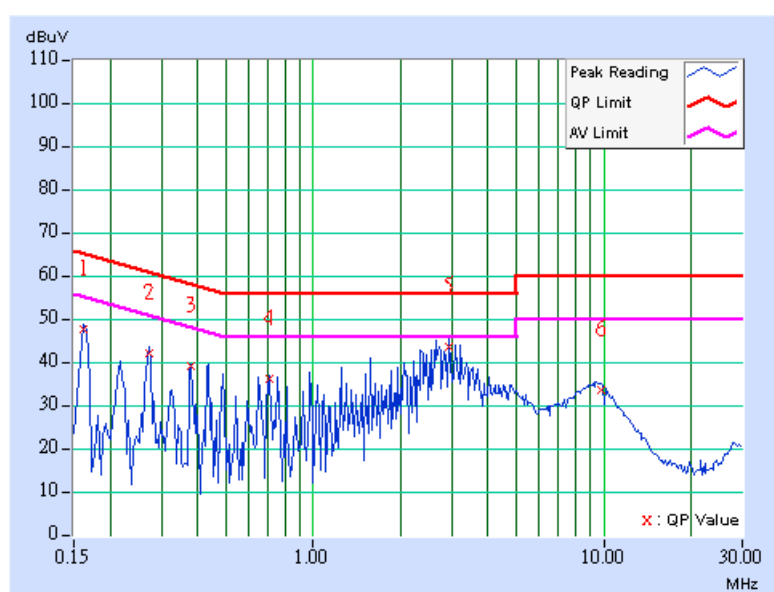

EUT TEST CONDITION		MEASUREMENT DETAIL	
CHANNEL	Channel 6	PHASE	Line 1
MODULATION TYPE	BPSK	6dB BANDWIDTH	9 kHz
ENVIRONMENTAL CONDITIONS	20deg. C, 60%RH, 991hPa	INPUT POWER (SYSTEM)	120Vac, 60 Hz
TRANSFER RATE	6Mbps	TEST MODE	B
TESTED BY	Match Tsui		

NO	FREQ. [MHz]	CORR. FACTOR (dB)	READING VALUE [dB (uV)]		EMISSION LEVEL [dB (uV)]		LIMIT [dB (uV)]		MARGIN (dB)	
			Q.P.	AV.	Q.P.	AV.	Q.P.	AV.	Q.P.	AV.
			1	0.162	0.10	49.69	-	49.79	-	65.38
2	0.271	0.10	39.22	-	39.32	-	61.08	51.08	-21.76	-
3	0.380	0.10	39.65	-	39.75	-	58.27	48.27	-18.52	-
4	1.297	0.20	39.88	-	40.08	-	56.00	46.00	-15.92	-
5	2.703	0.29	43.38	-	43.67	-	56.00	46.00	-12.33	-
6	9.379	0.46	36.17	-	36.63	-	60.00	50.00	-23.37	-

- REMARKS:**
1. Q.P. and AV. are abbreviations of quasi-peak and average individually.
 2. "-": The Quasi-peak reading value also meets average limit and measurement with the average detector is unnecessary.
 3. The emission levels of other frequencies were very low against the limit.
 4. Margin value = Emission level - Limit value.
 5. Correction factor = Insertion loss + Cable loss.
 6. Emission Level = Correction Factor + Reading Value.

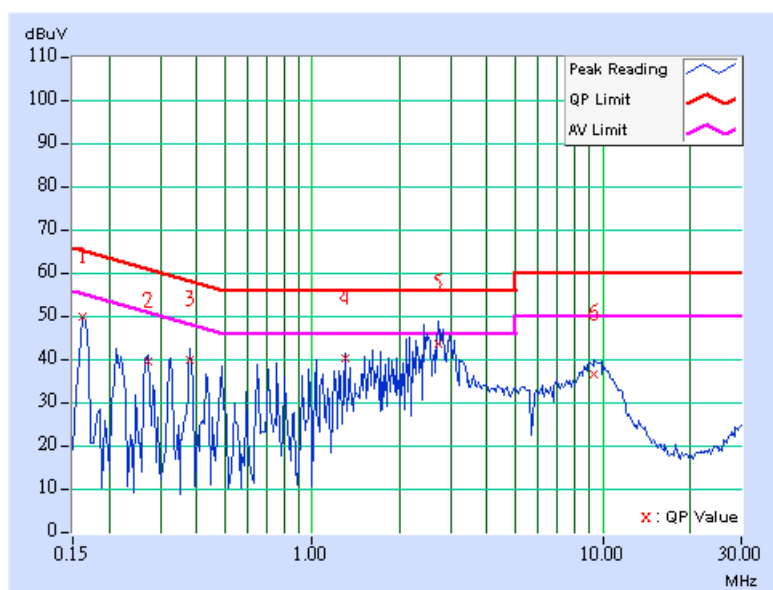

EUT TEST CONDITION		MEASUREMENT DETAIL	
CHANNEL	Channel 6	PHASE	Line 2
MODULATION TYPE	BPSK	6dB BANDWIDTH	9 kHz
ENVIRONMENTAL CONDITIONS	20deg. C, 60%RH, 991hPa	INPUT POWER (SYSTEM)	120Vac, 60 Hz
TRANSFER RATE	6Mbps	TEST MODE	B
TESTED BY	Match Tsui		

NO	FREQ. [MHz]	CORR. FACTOR (dB)	READING VALUE [dB (uV)]		EMISSION LEVEL [dB (uV)]		LIMIT [dB (uV)]		MARGIN (dB)	
			Q.P.	AV.	Q.P.	AV.	Q.P.	AV.	Q.P.	AV.
			1	0.162	0.10	46.31	-	46.41	-	65.38
2	0.216	0.10	40.77	-	40.87	-	62.96	52.96	-22.09	-
3	0.324	0.10	34.42	-	34.52	-	59.60	49.60	-25.08	-
4	0.978	0.10	31.91	-	32.01	-	56.00	46.00	-23.99	-
5	2.926	0.28	41.91	-	42.19	-	56.00	46.00	-13.81	-
6	9.756	0.46	29.15	-	29.61	-	60.00	50.00	-30.39	-

- REMARKS:**
1. Q.P. and AV. are abbreviations of quasi-peak and average individually.
 2. "-": The Quasi-peak reading value also meets average limit and measurement with the average detector is unnecessary.
 3. The emission levels of other frequencies were very low against the limit.
 4. Margin value = Emission level - Limit value.
 5. Correction factor = Insertion loss + Cable loss.
 6. Emission Level = Correction Factor + Reading Value.

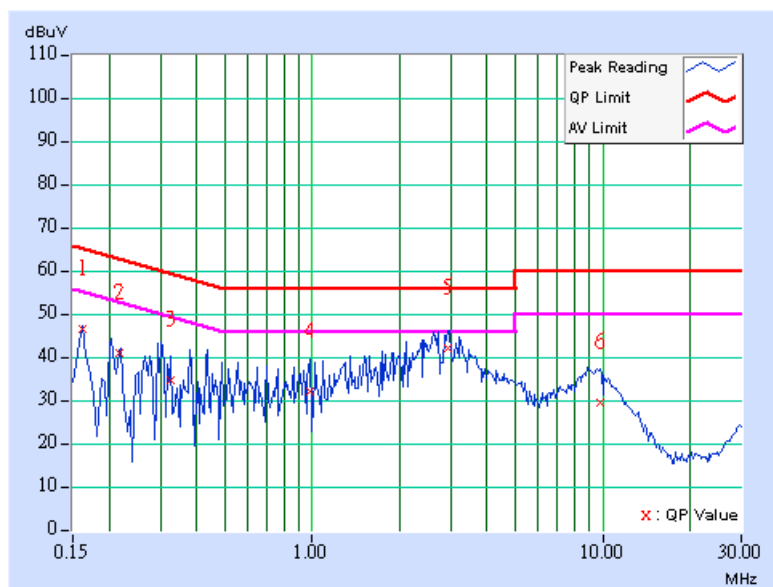

EUT TEST CONDITION		MEASUREMENT DETAIL	
CHANNEL	Channel 11	PHASE	Line 1
MODULATION TYPE	BPSK	6dB BANDWIDTH	9 kHz
ENVIRONMENTAL CONDITIONS	20deg. C, 60%RH, 991hPa	INPUT POWER (SYSTEM)	120Vac, 60 Hz
TRANSFER RATE	6Mbps	TEST MODE	B
TESTED BY	Match Tsui		

NO	FREQ. [MHz]	CORR. FACTOR (dB)	READING VALUE [dB (uV)]		EMISSION LEVEL [dB (uV)]		LIMIT [dB (uV)]		MARGIN (dB)	
			Q.P.	AV.	Q.P.	AV.	Q.P.	AV.	Q.P.	AV.
			1	0.163	0.10	49.69	-	49.79	-	65.31
2	0.270	0.10	42.83	-	42.93	-	61.13	51.13	-18.20	-
3	0.326	0.10	39.33	-	39.43	-	59.56	49.56	-20.13	-
4	0.814	0.17	35.88	-	36.05	-	56.00	46.00	-19.95	-
5	2.772	0.30	39.16	-	39.46	-	56.00	46.00	-16.54	-
6	10.023	0.46	34.75	-	35.21	-	60.00	50.00	-24.79	-

- REMARKS:**
1. Q.P. and AV. are abbreviations of quasi-peak and average individually.
 2. "-": The Quasi-peak reading value also meets average limit and measurement with the average detector is unnecessary.
 3. The emission levels of other frequencies were very low against the limit.
 4. Margin value = Emission level - Limit value.
 5. Correction factor = Insertion loss + Cable loss.
 6. Emission Level = Correction Factor + Reading Value.

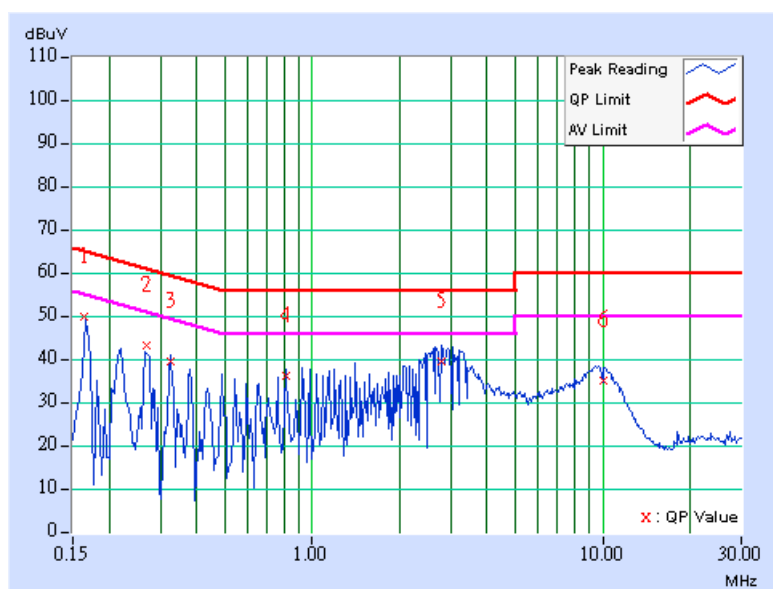

EUT TEST CONDITION		MEASUREMENT DETAIL	
CHANNEL	Channel 11	PHASE	Line 2
MODULATION TYPE	BPSK	6dB BANDWIDTH	9 kHz
ENVIRONMENTAL CONDITIONS	20deg. C, 60%RH, 991hPa	INPUT POWER (SYSTEM)	120Vac, 60 Hz
TRANSFER RATE	6Mbps	TEST MODE	B
TESTED BY	Match Tsui		

NO	FREQ. [MHz]	CORR. FACTOR (dB)	READING VALUE [dB (uV)]		EMISSION LEVEL [dB (uV)]		LIMIT [dB (uV)]		MARGIN (dB)	
			Q.P.	AV.	Q.P.	AV.	Q.P.	AV.	Q.P.	AV.
			1	0.164	0.10	49.79	-	49.89	-	65.28
2	0.271	0.10	43.70	-	43.80	-	61.08	51.08	-17.28	-
3	0.326	0.10	39.62	-	39.72	-	59.56	49.56	-19.84	-
4	0.705	0.10	38.23	-	38.33	-	56.00	46.00	-17.67	-
5	2.719	0.26	41.59	-	41.85	-	56.00	46.00	-14.15	-
6	10.031	0.46	30.01	-	30.47	-	60.00	50.00	-29.53	-

- REMARKS:**
1. Q.P. and AV. are abbreviations of quasi-peak and average individually.
 2. "-": The Quasi-peak reading value also meets average limit and measurement with the average detector is unnecessary.
 3. The emission levels of other frequencies were very low against the limit.
 4. Margin value = Emission level - Limit value.
 5. Correction factor = Insertion loss + Cable loss.
 6. Emission Level = Correction Factor + Reading Value.

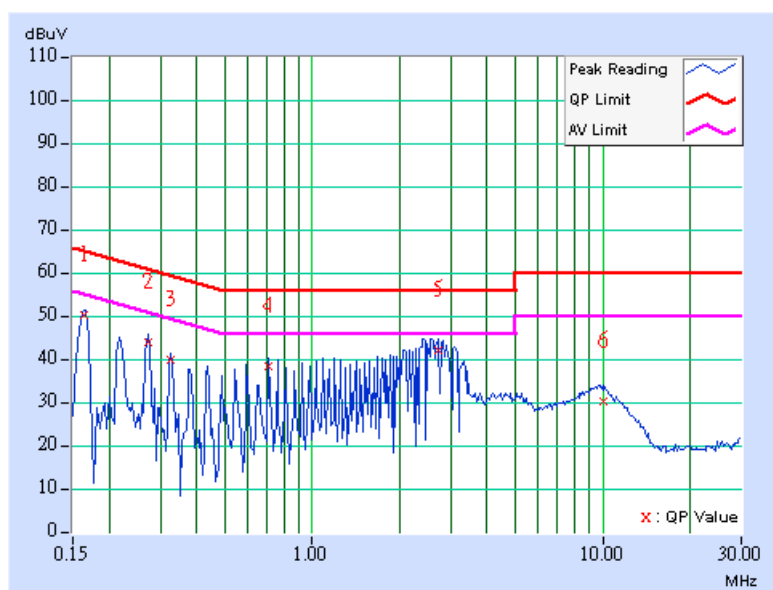

Conducted Worst Case Data (For adapter: ADP-5FH B):

EUT TEST CONDITION		MEASUREMENT DETAIL	
CHANNEL	Channel 1	PHASE	Line 1
MODULATION TYPE	BPSK	6dB BANDWIDTH	9 kHz
ENVIRONMENTAL CONDITIONS	20deg. C, 60%RH, 991hPa	INPUT POWER (SYSTEM)	120Vac, 60 Hz
TRANSFER RATE	6Mbps	TEST MODE	C
TESTED BY	Match Tsui		

NO	FREQ. [MHz]	CORR. FACTOR (dB)	READING VALUE [dB (uV)]		EMISSION LEVEL [dB (uV)]		LIMIT [dB (uV)]		MARGIN (dB)	
			Q.P.	AV.	Q.P.	AV.	Q.P.	AV.	Q.P.	AV.
			1	0.181	0.10	34.89	-	34.99	-	64.43
2	0.314	0.10	35.83	-	35.93	-	59.86	49.86	-23.93	-
3	0.498	0.12	36.05	-	36.17	-	56.04	46.04	-19.87	-
4	1.688	0.20	35.21	-	35.41	-	56.00	46.00	-20.59	-
5	4.727	0.47	34.59	-	35.06	-	56.00	46.00	-20.94	-
6	7.117	0.46	37.11	-	37.57	-	60.00	50.00	-22.43	-

- REMARKS:**
1. Q.P. and AV. are abbreviations of quasi-peak and average individually.
 2. "-": The Quasi-peak reading value also meets average limit and measurement with the average detector is unnecessary.
 3. The emission levels of other frequencies were very low against the limit.
 4. Margin value = Emission level - Limit value.
 5. Correction factor = Insertion loss + Cable loss.
 6. Emission Level = Correction Factor + Reading Value.

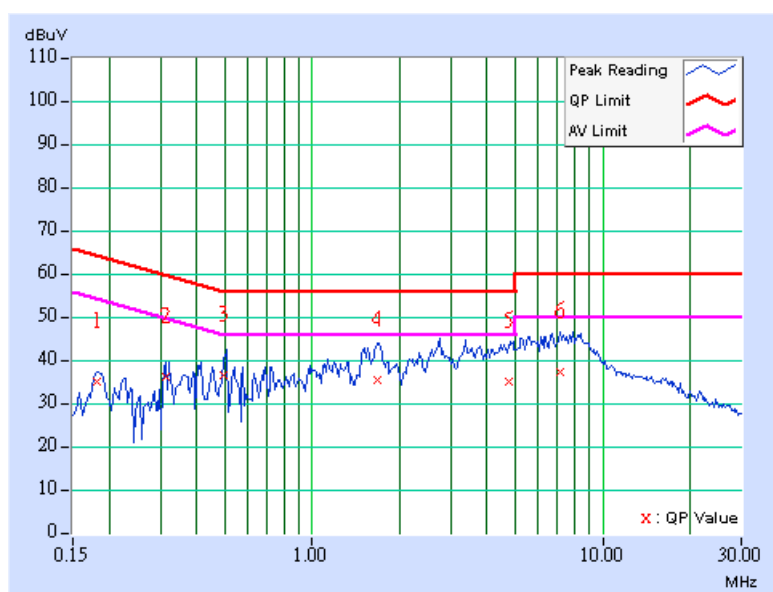

EUT TEST CONDITION		MEASUREMENT DETAIL	
CHANNEL	Channel 1	PHASE	Line 2
MODULATION TYPE	BPSK	6dB BANDWIDTH	9 kHz
ENVIRONMENTAL CONDITIONS	20deg. C, 60%RH, 991hPa	INPUT POWER (SYSTEM)	120Vac, 60 Hz
TRANSFER RATE	6Mbps	TEST MODE	C
TESTED BY	Match Tsui		

NO	FREQ. [MHz]	CORR. FACTOR (dB)	READING VALUE [dB (uV)]		EMISSION LEVEL [dB (uV)]		LIMIT [dB (uV)]		MARGIN (dB)	
			Q.P.	AV.	Q.P.	AV.	Q.P.	AV.	Q.P.	AV.
			1	0.181	0.10	40.51	-	40.61	-	64.43
2	0.318	0.10	38.76	-	38.86	-	59.76	49.76	-20.90	-
3	0.556	0.10	37.50	-	37.60	-	56.00	46.00	-18.40	-
4	1.660	0.17	34.08	-	34.25	-	56.00	46.00	-21.75	-
5	3.414	0.32	32.48	-	32.80	-	56.00	46.00	-23.20	-
6	6.254	0.40	33.77	-	34.17	-	60.00	50.00	-25.83	-

- REMARKS:**
1. Q.P. and AV. are abbreviations of quasi-peak and average individually.
 2. "-": The Quasi-peak reading value also meets average limit and measurement with the average detector is unnecessary.
 3. The emission levels of other frequencies were very low against the limit.
 4. Margin value = Emission level - Limit value.
 5. Correction factor = Insertion loss + Cable loss.
 6. Emission Level = Correction Factor + Reading Value.

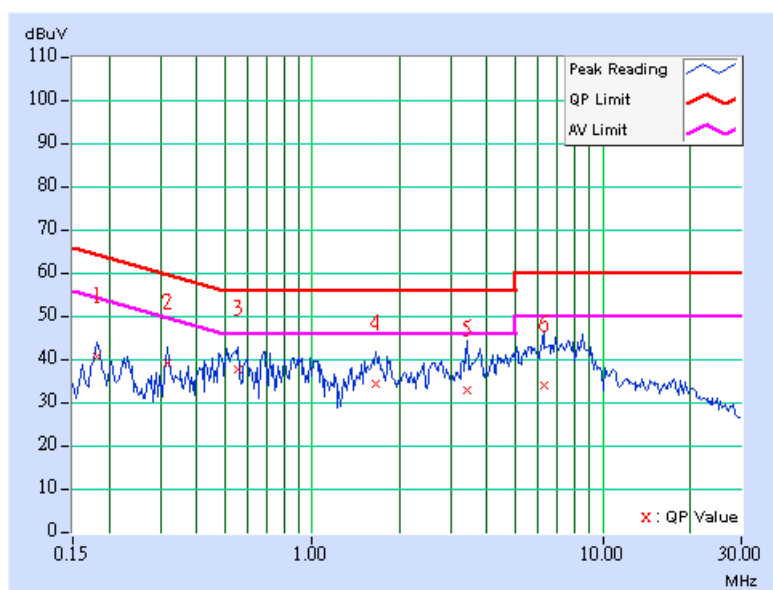

EUT TEST CONDITION		MEASUREMENT DETAIL	
CHANNEL	Channel 6	PHASE	Line 1
MODULATION TYPE	BPSK	6dB BANDWIDTH	9 kHz
ENVIRONMENTAL CONDITIONS	20deg. C, 60%RH, 991hPa	INPUT POWER (SYSTEM)	120Vac, 60 Hz
TRANSFER RATE	6Mbps	TEST MODE	C
TESTED BY	Match Tsui		

NO	FREQ. [MHz]	CORR. FACTOR (dB)	READING VALUE [dB (uV)]		EMISSION LEVEL [dB (uV)]		LIMIT [dB (uV)]		MARGIN (dB)	
			Q.P.	AV.	Q.P.	AV.	Q.P.	AV.	Q.P.	AV.
			1	0.169	0.10	33.45	-	33.55	-	65.03
2	0.263	0.10	32.59	-	32.69	-	61.33	51.33	-28.64	-
3	0.392	0.10	36.33	-	36.43	-	58.02	48.02	-21.59	-
4	1.512	0.20	29.61	-	29.81	-	56.00	46.00	-26.19	-
5	4.906	0.47	31.41	-	31.88	-	56.00	46.00	-24.12	-
6	8.547	0.46	34.79	-	35.25	-	60.00	50.00	-24.75	-

- REMARKS:**
1. Q.P. and AV. are abbreviations of quasi-peak and average individually.
 2. "-": The Quasi-peak reading value also meets average limit and measurement with the average detector is unnecessary.
 3. The emission levels of other frequencies were very low against the limit.
 4. Margin value = Emission level - Limit value.
 5. Correction factor = Insertion loss + Cable loss.
 6. Emission Level = Correction Factor + Reading Value.

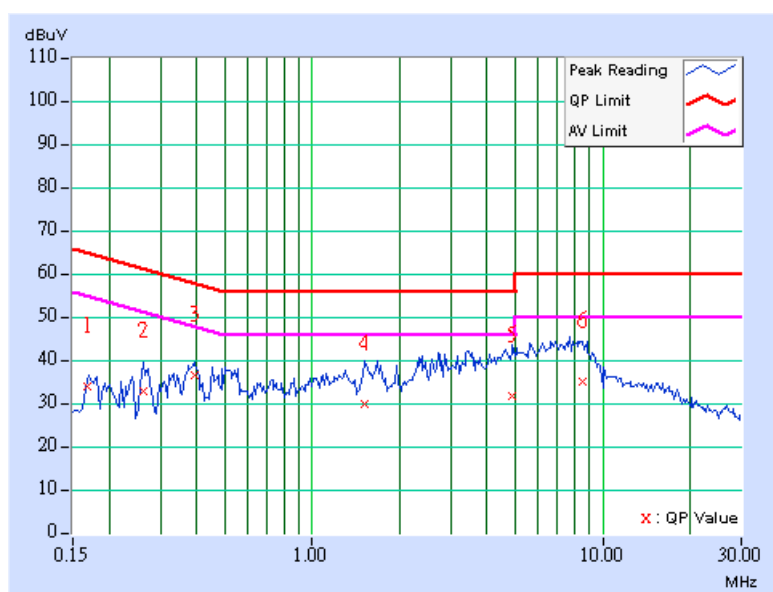

EUT TEST CONDITION		MEASUREMENT DETAIL	
CHANNEL	Channel 6	PHASE	Line 2
MODULATION TYPE	BPSK	6dB BANDWIDTH	9 kHz
ENVIRONMENTAL CONDITIONS	20deg. C, 60%RH, 991hPa	INPUT POWER (SYSTEM)	120Vac, 60 Hz
TRANSFER RATE	6Mbps	TEST MODE	C
TESTED BY	Match Tsui		

NO	FREQ. [MHz]	CORR. FACTOR (dB)	READING VALUE [dB (uV)]		EMISSION LEVEL [dB (uV)]		LIMIT [dB (uV)]		MARGIN (dB)	
			Q.P.	AV.	Q.P.	AV.	Q.P.	AV.	Q.P.	AV.
	1	0.174	0.10	38.29	-	38.39	-	64.79	54.79	-26.40
2	0.326	0.10	38.24	-	38.34	-	59.57	49.57	-21.23	-
3	0.552	0.10	38.54	-	38.64	-	56.00	46.00	-17.36	-
4	1.680	0.17	29.10	-	29.27	-	56.00	46.00	-26.73	-
5	5.180	0.39	30.45	-	30.84	-	60.00	50.00	-29.16	-
6	7.363	0.42	33.08	-	33.50	-	60.00	50.00	-26.50	-

- REMARKS:**
1. Q.P. and AV. are abbreviations of quasi-peak and average individually.
 2. "-": The Quasi-peak reading value also meets average limit and measurement with the average detector is unnecessary.
 3. The emission levels of other frequencies were very low against the limit.
 4. Margin value = Emission level - Limit value.
 5. Correction factor = Insertion loss + Cable loss.
 6. Emission Level = Correction Factor + Reading Value.

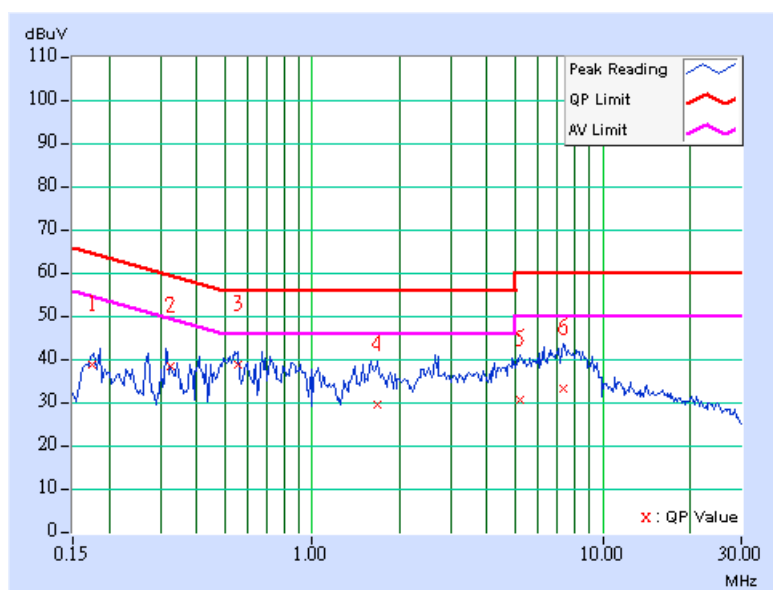

EUT TEST CONDITION		MEASUREMENT DETAIL	
CHANNEL	Channel 11	PHASE	Line 1
MODULATION TYPE	BPSK	6dB BANDWIDTH	9 kHz
ENVIRONMENTAL CONDITIONS	20deg. C, 60%RH, 991hPa	INPUT POWER (SYSTEM)	120Vac, 60 Hz
TRANSFER RATE	6Mbps	TEST MODE	C
TESTED BY	Match Tsui		

NO	FREQ. [MHz]	CORR. FACTOR (dB)	READING VALUE [dB (uV)]		EMISSION LEVEL [dB (uV)]		LIMIT [dB (uV)]		MARGIN (dB)	
			Q.P.	AV.	Q.P.	AV.	Q.P.	AV.	Q.P.	AV.
			1	0.267	0.10	35.52	-	35.62	-	61.20
2	0.396	0.10	38.10	-	38.20	-	57.93	47.93	-19.73	-
3	0.545	0.12	32.19	-	32.31	-	56.00	46.00	-23.69	-
4	1.676	0.20	23.06	-	23.26	-	56.00	46.00	-32.74	-
5	4.398	0.47	28.67	-	29.14	-	56.00	46.00	-26.86	-
6	8.254	0.46	35.82	-	36.28	-	60.00	50.00	-23.72	-

- REMARKS:**
1. Q.P. and AV. are abbreviations of quasi-peak and average individually.
 2. "-": The Quasi-peak reading value also meets average limit and measurement with the average detector is unnecessary.
 3. The emission levels of other frequencies were very low against the limit.
 4. Margin value = Emission level - Limit value.
 5. Correction factor = Insertion loss + Cable loss.
 6. Emission Level = Correction Factor + Reading Value.

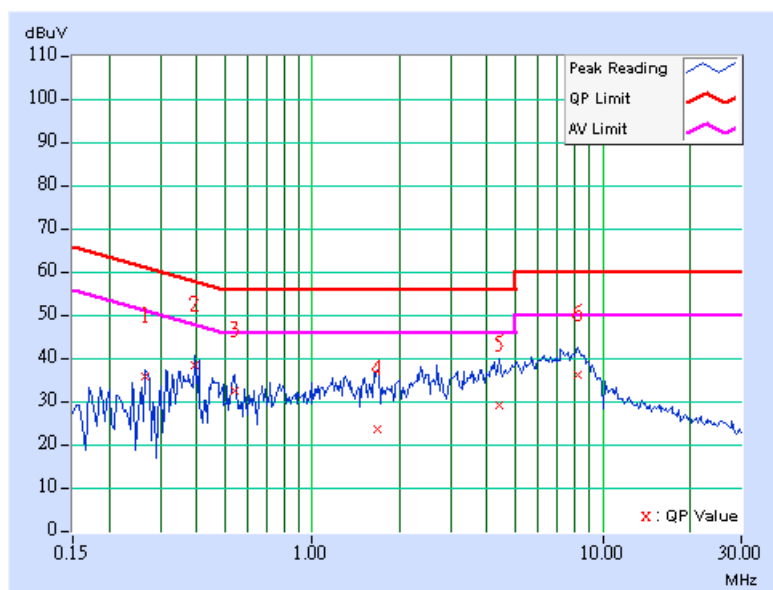

EUT TEST CONDITION		MEASUREMENT DETAIL	
CHANNEL	Channel 11	PHASE	Line 2
MODULATION TYPE	BPSK	6dB BANDWIDTH	9 kHz
ENVIRONMENTAL CONDITIONS	20deg. C, 60%RH, 991hPa	INPUT POWER (SYSTEM)	120Vac, 60 Hz
TRANSFER RATE	6Mbps	TEST MODE	C
TESTED BY	Match Tsui		

NO	FREQ. [MHz]	CORR. FACTOR (dB)	READING VALUE [dB (uV)]		EMISSION LEVEL [dB (uV)]		LIMIT [dB (uV)]		MARGIN (dB)	
			Q.P.	AV.	Q.P.	AV.	Q.P.	AV.	Q.P.	AV.
			1	0.166	0.10	33.90	-	34.00	-	65.18
2	0.318	0.10	36.62	-	36.72	-	59.76	49.76	-23.04	-
3	0.545	0.10	37.13	-	37.23	-	56.00	46.00	-18.77	-
4	2.320	0.23	27.17	-	27.40	-	56.00	46.00	-28.60	-
5	4.793	0.38	26.22	-	26.60	-	56.00	46.00	-29.40	-
6	8.148	0.43	32.47	-	32.90	-	60.00	50.00	-27.10	-

- REMARKS:**
1. Q.P. and AV. are abbreviations of quasi-peak and average individually.
 2. "-": The Quasi-peak reading value also meets average limit and measurement with the average detector is unnecessary.
 3. The emission levels of other frequencies were very low against the limit.
 4. Margin value = Emission level - Limit value.
 5. Correction factor = Insertion loss + Cable loss.
 6. Emission Level = Correction Factor + Reading Value.

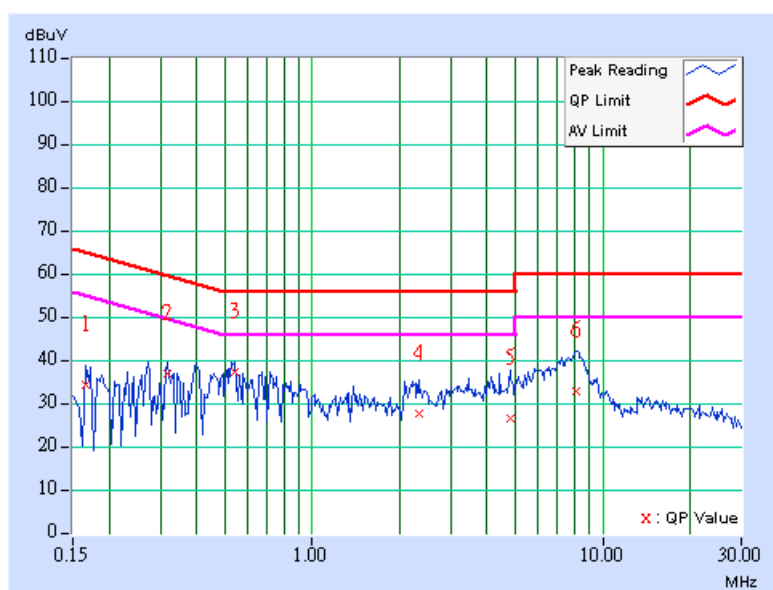

Conducted Worst Case Data (For USB Cable)

EUT TEST CONDITION		MEASUREMENT DETAIL	
CHANNEL	Channel 1	PHASE	Line 1
MODULATION TYPE	BPSK	6dB BANDWIDTH	9 kHz
ENVIRONMENTAL CONDITIONS	20deg. C, 60%RH, 991hPa	INPUT POWER (SYSTEM)	120Vac, 60 Hz
TRANSFER RATE	6Mbps	TEST MODE	E
TESTED BY	Match Tsui		

NO	FREQ. [MHz]	CORR. FACTOR (dB)	READING VALUE [dB (uV)]		EMISSION LEVEL [dB (uV)]		LIMIT [dB (uV)]		MARGIN (dB)	
			Q.P.	AV.	Q.P.	AV.	Q.P.	AV.	Q.P.	AV.
			1	0.158	0.10	44.54	-	44.64	-	65.58
2	0.193	0.10	42.99	-	43.09	-	63.91	53.91	-20.82	-
3	0.355	0.10	25.41	-	25.51	-	58.85	48.85	-33.34	-
4	1.473	0.15	27.54	-	27.69	-	56.00	46.00	-28.31	-
5	9.891	0.36	30.47	-	30.83	-	60.00	50.00	-29.17	-
6	13.891	0.57	32.03	-	32.60	-	60.00	50.00	-27.40	-

- REMARKS:**
1. Q.P. and AV. are abbreviations of quasi-peak and average individually.
 2. "-": The Quasi-peak reading value also meets average limit and measurement with the average detector is unnecessary.
 3. The emission levels of other frequencies were very low against the limit.
 4. Margin value = Emission level - Limit value.
 5. Correction factor = Insertion loss + Cable loss.
 6. Emission Level = Correction Factor + Reading Value.

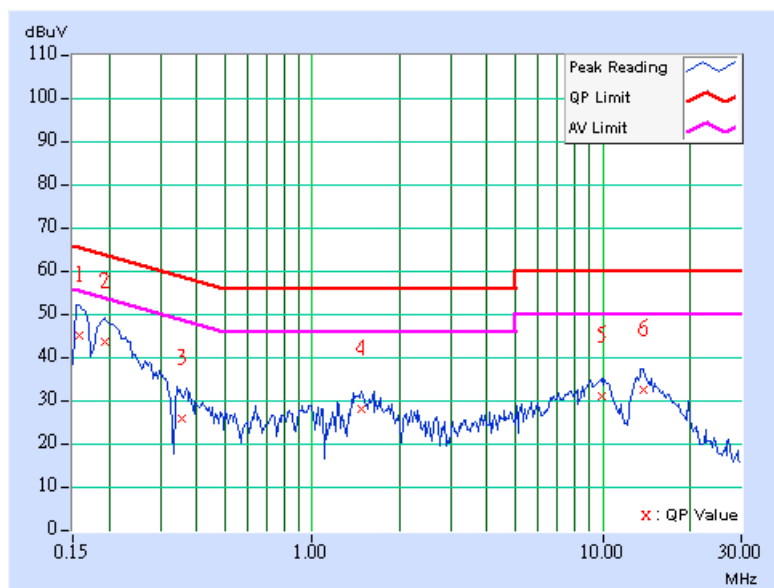

EUT TEST CONDITION		MEASUREMENT DETAIL	
CHANNEL	Channel 1	PHASE	Line 2
MODULATION TYPE	BPSK	6dB BANDWIDTH	9 kHz
ENVIRONMENTAL CONDITIONS	20deg. C, 60%RH, 991hPa	INPUT POWER (SYSTEM)	120Vac, 60 Hz
TRANSFER RATE	6Mbps	TEST MODE	E
TESTED BY	Match Tsui		

NO	FREQ. [MHz]	CORR. FACTOR (dB)	READING VALUE [dB (uV)]		EMISSION LEVEL [dB (uV)]		LIMIT [dB (uV)]		MARGIN (dB)	
			Q.P.	AV.	Q.P.	AV.	Q.P.	AV.	Q.P.	AV.
			1	0.162	0.10	44.30	-	44.40	-	65.38
2	0.209	0.10	44.52	-	44.62	-	63.26	53.26	-18.64	-
3	0.443	0.11	21.99	-	22.10	-	57.01	47.01	-34.91	-
4	1.480	0.20	27.48	-	27.68	-	56.00	46.00	-28.32	-
5	10.027	0.46	30.42	-	30.88	-	60.00	50.00	-29.12	-
6	13.328	0.57	31.18	-	31.75	-	60.00	50.00	-28.25	-

- REMARKS:**
1. Q.P. and AV. are abbreviations of quasi-peak and average individually.
 2. "-": The Quasi-peak reading value also meets average limit and measurement with the average detector is unnecessary.
 3. The emission levels of other frequencies were very low against the limit.
 4. Margin value = Emission level - Limit value.
 5. Correction factor = Insertion loss + Cable loss.
 6. Emission Level = Correction Factor + Reading Value.

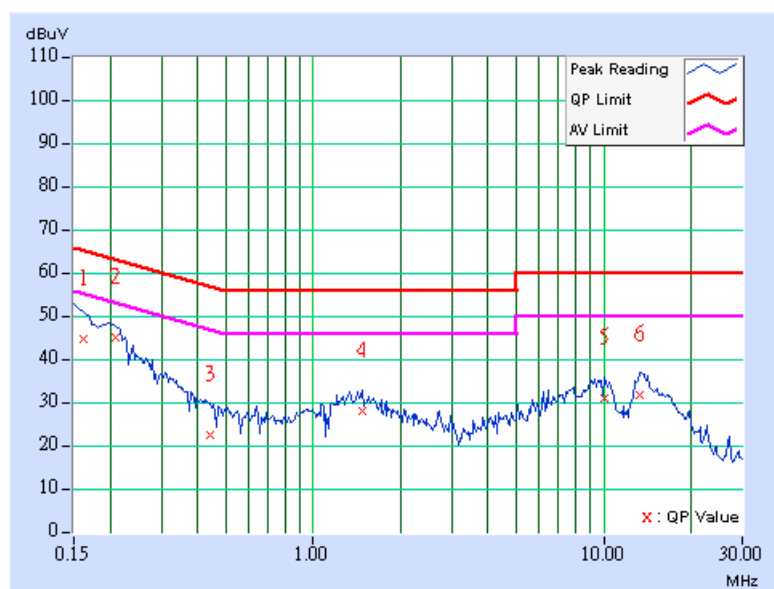

EUT TEST CONDITION		MEASUREMENT DETAIL	
CHANNEL	Channel 6	PHASE	Line 1
MODULATION TYPE	BPSK	6dB BANDWIDTH	9 kHz
ENVIRONMENTAL CONDITIONS	20deg. C, 60%RH, 991hPa	INPUT POWER (SYSTEM)	120Vac, 60 Hz
TRANSFER RATE	6Mbps	TEST MODE	E
TESTED BY	Match Tsui		

NO	FREQ. [MHz]	CORR. FACTOR (dB)	READING VALUE [dB (uV)]		EMISSION LEVEL [dB (uV)]		LIMIT [dB (uV)]		MARGIN (dB)	
			Q.P.	AV.	Q.P.	AV.	Q.P.	AV.	Q.P.	AV.
			1	0.166	0.10	42.45	-	42.55	-	65.18
2	0.205	0.10	41.26	-	41.36	-	63.42	53.42	-22.06	-
3	0.470	0.10	21.44	-	21.54	-	56.51	46.51	-34.97	-
4	1.566	0.16	26.68	-	26.84	-	56.00	46.00	-29.16	-
5	10.219	0.37	30.49	-	30.86	-	60.00	50.00	-29.14	-
6	13.422	0.54	31.64	-	32.18	-	60.00	50.00	-27.82	-

- REMARKS:**
1. Q.P. and AV. are abbreviations of quasi-peak and average individually.
 2. "-": The Quasi-peak reading value also meets average limit and measurement with the average detector is unnecessary.
 3. The emission levels of other frequencies were very low against the limit.
 4. Margin value = Emission level - Limit value.
 5. Correction factor = Insertion loss + Cable loss.
 6. Emission Level = Correction Factor + Reading Value.

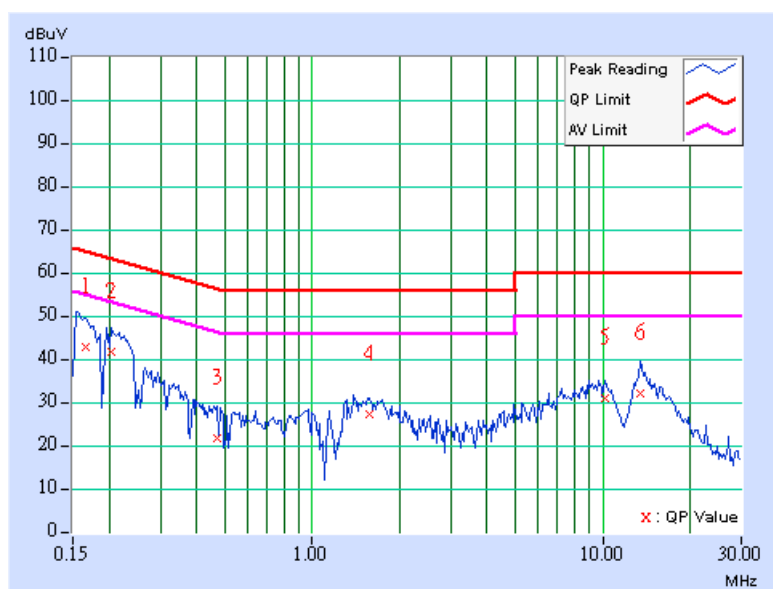

EUT TEST CONDITION		MEASUREMENT DETAIL	
CHANNEL	Channel 6	PHASE	Line 2
MODULATION TYPE	BPSK	6dB BANDWIDTH	9 kHz
ENVIRONMENTAL CONDITIONS	20deg. C, 60%RH, 991hPa	INPUT POWER (SYSTEM)	120Vac, 60 Hz
TRANSFER RATE	6Mbps	TEST MODE	E
TESTED BY	Match Tsui		

NO	FREQ. [MHz]	CORR. FACTOR (dB)	READING VALUE [dB (uV)]		EMISSION LEVEL [dB (uV)]		LIMIT [dB (uV)]		MARGIN (dB)	
			Q.P.	AV.	Q.P.	AV.	Q.P.	AV.	Q.P.	AV.
			1	0.160	0.10	43.43	-	43.53	-	65.45
2	0.216	0.10	43.04	-	43.14	-	62.96	52.96	-19.82	-
3	0.416	0.10	23.63	-	23.73	-	57.54	47.54	-33.80	-
4	1.449	0.20	27.22	-	27.42	-	56.00	46.00	-28.58	-
5	9.719	0.46	30.46	-	30.92	-	60.00	50.00	-29.08	-
6	13.895	0.59	31.78	-	32.37	-	60.00	50.00	-27.63	-

- REMARKS:**
1. Q.P. and AV. are abbreviations of quasi-peak and average individually.
 2. "-": The Quasi-peak reading value also meets average limit and measurement with the average detector is unnecessary.
 3. The emission levels of other frequencies were very low against the limit.
 4. Margin value = Emission level - Limit value.
 5. Correction factor = Insertion loss + Cable loss.
 6. Emission Level = Correction Factor + Reading Value.

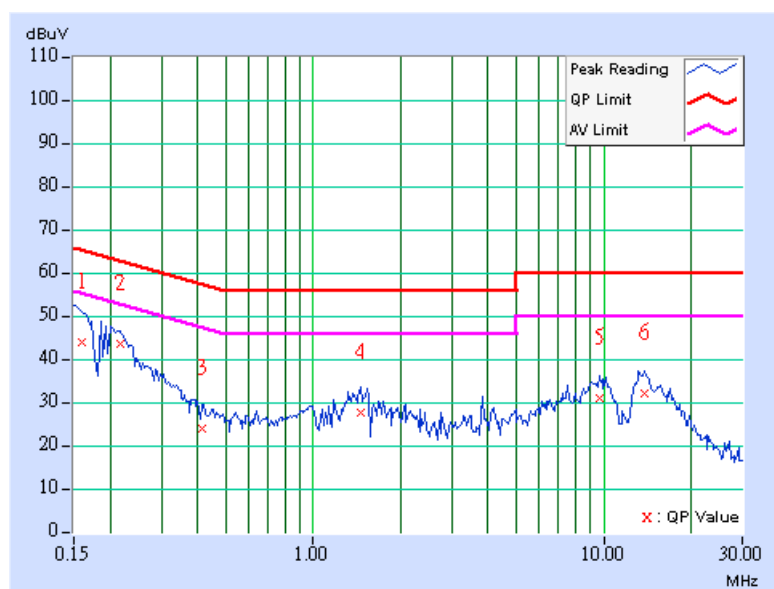

EUT TEST CONDITION		MEASUREMENT DETAIL	
CHANNEL	Channel 11	PHASE	Line 1
MODULATION TYPE	BPSK	6dB BANDWIDTH	9 kHz
ENVIRONMENTAL CONDITIONS	20deg. C, 60%RH, 991hPa	INPUT POWER (SYSTEM)	120Vac, 60 Hz
TRANSFER RATE	6Mbps	TEST MODE	E
TESTED BY	Match Tsui		

NO	FREQ. [MHz]	CORR. FACTOR (dB)	READING VALUE [dB (uV)]		EMISSION LEVEL [dB (uV)]		LIMIT [dB (uV)]		MARGIN (dB)	
			Q.P.	AV.	Q.P.	AV.	Q.P.	AV.	Q.P.	AV.
			1	0.154	0.10	42.66	-	42.76	-	65.79
2	0.190	0.10	38.58	-	38.68	-	64.03	54.03	-25.35	-
3	0.416	0.10	23.38	-	23.48	-	57.54	47.54	-34.06	-
4	1.598	0.16	26.71	-	26.87	-	56.00	46.00	-29.13	-
5	9.773	0.36	30.68	-	31.04	-	60.00	50.00	-28.96	-
6	13.918	0.57	31.92	-	32.49	-	60.00	50.00	-27.51	-

- REMARKS:**
1. Q.P. and AV. are abbreviations of quasi-peak and average individually.
 2. "-": The Quasi-peak reading value also meets average limit and measurement with the average detector is unnecessary.
 3. The emission levels of other frequencies were very low against the limit.
 4. Margin value = Emission level - Limit value.
 5. Correction factor = Insertion loss + Cable loss.
 6. Emission Level = Correction Factor + Reading Value.

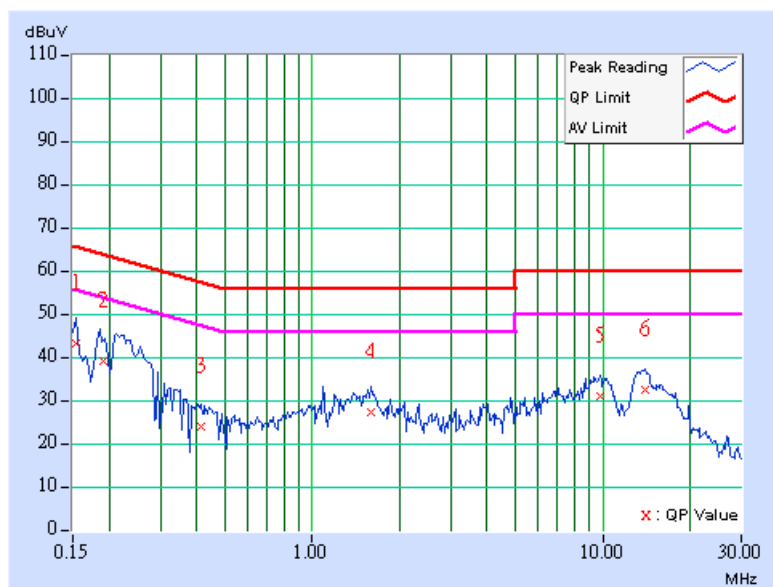

EUT TEST CONDITION		MEASUREMENT DETAIL	
CHANNEL	Channel 11	PHASE	Line 2
MODULATION TYPE	BPSK	6dB BANDWIDTH	9 kHz
ENVIRONMENTAL CONDITIONS	20deg. C, 60%RH, 991hPa	INPUT POWER (SYSTEM)	120Vac, 60 Hz
TRANSFER RATE	6Mbps	TEST MODE	E
TESTED BY	Match Tsui		

NO	FREQ. [MHz]	CORR. FACTOR (dB)	READING VALUE [dB (uV)]		EMISSION LEVEL [dB (uV)]		LIMIT [dB (uV)]		MARGIN (dB)	
			Q.P.	AV.	Q.P.	AV.	Q.P.	AV.	Q.P.	AV.
			1	0.167	0.10	39.52	-	39.62	-	65.12
2	0.213	0.10	43.66	-	43.76	-	63.11	53.11	-19.35	-
3	0.412	0.10	23.71	-	23.81	-	57.61	47.61	-33.80	-
4	1.590	0.20	26.11	-	26.31	-	56.00	46.00	-29.69	-
5	10.074	0.46	30.64	-	31.10	-	60.00	50.00	-28.90	-
6	13.781	0.59	31.88	-	32.47	-	60.00	50.00	-27.53	-

- REMARKS:**
1. Q.P. and AV. are abbreviations of quasi-peak and average individually.
 2. "-": The Quasi-peak reading value also meets average limit and measurement with the average detector is unnecessary.
 3. The emission levels of other frequencies were very low against the limit.
 4. Margin value = Emission level - Limit value.
 5. Correction factor = Insertion loss + Cable loss.
 6. Emission Level = Correction Factor + Reading Value.

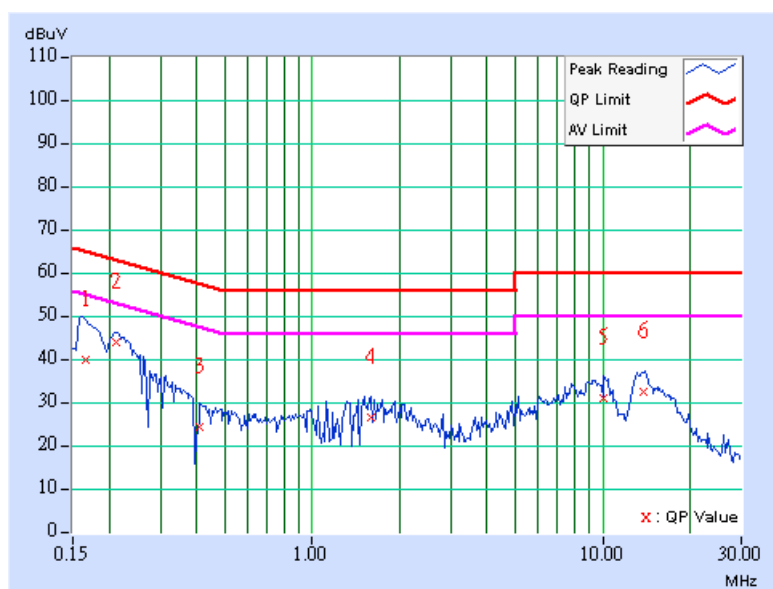

4.2 RADIATED EMISSION MEASUREMENT

4.2.1 LIMITS OF RADIATED EMISSION MEASUREMENT

Emissions radiated outside of the specified bands, shall be according to the general radiated limits in 15.209 as following:

FREQUENCIES (MHz)	FIELD STRENGTH (microvolts/meter)	MEASUREMENT DISTANCE (meters)
0.009 ~ 0.490	2400/F(kHz)	300
0.490 ~ 1.705	24000/F(kHz)	30
1.705 ~ 30.0	30	30
30 ~ 88	100	3
88 ~ 216	150	3
216 ~ 960	200	3
Above 960	500	3

NOTE:

1. The lower limit shall apply at the transition frequencies.
2. Emission level (dBuV/m) = 20 log Emission level (uV/m).
3. As shown in 15.35(b), for frequencies above 1000MHz, the field strength limits are based on average detector, however, the peak field strength of any emission shall not exceed the maximum permitted average limits, specified above by more than 20dB under any condition of modulation.

4.2.2 TEST INSTRUMENTS

DESCRIPTION & MANUFACTURER	MODEL NO.	SERIAL NO.	CALIBRATED UNTIL
Test Receiver ROHDE & SCHWARZ	ESIB7	100188	Dec. 20, 2006
Spectrum Analyzer ROHDE & SCHWARZ	FSP40	100039	Nov. 27, 2006
BILOG Antenna SCHWARZBECK	VULB9168	9168-157	Jan. 15, 2007
HORN Antenna SCHWARZBECK	BBHA 9120 D	9120D-407	Jan. 22, 2007
HORN Antenna SCHWARZBECK	BBHA 9170	BBHA9170147	Jan. 26, 2007
Preamplifier Agilent	8449B	3008A01961	Oct. 23, 2006
Preamplifier Agilent	8447D	2944A10629	Oct. 27, 2006
RF signal cable HUBER+SUHNER	SUCOFLEX 104	214380/4	Jan. 16, 2007
RF signal cable HUBER+SUHNER	SUCOFLEX 104	219266/4	Jan. 16, 2007
Software ADT.	ADT_Radiated_V5.14	NA	NA
Antenna Tower ADT.	AT100	AT93021702	NA
Turn Table ADT.	TT100.	TT93021702	NA
Controller ADT.	SC100.	SC93021702	NA

- NOTE:**
1. The calibration interval of the above test instruments is 12 months and the calibrations are traceable to NML/ROC and NIST/USA.
 2. The test was performed in HwaYa Chamber 1.
 3. The horn antenna and HP preamplifier (model: 8449B) are used only for the measurement of emission frequency above 1GHz if tested.
 4. The IC Site Registration No. is IC4924-2.

4.2.3 TEST PROCEDURES

- a. The EUT was placed on the top of a rotating table 0.8 meters above the ground at a 3 meter semi-anechoic chamber. The table was rotated 360 degrees to determine the position of the highest radiation.
- b. The EUT was set 3 meters away from the interference-receiving antenna, which was mounted on the top of a variable-height antenna tower.
- c. The antenna is a broadband antenna, and its height is varied from one meter to four meters above the ground to determine the maximum value of the field strength. Both horizontal and vertical polarizations of the antenna are set to make the measurement.
- d. For each suspected emission, the EUT was arranged to its worst case and then the antenna was tuned to heights from 1 meter to 4 meters and the rotatable table was turned from 0 degrees to 360 degrees to find the maximum reading.
- e. The test-receiver system was set to Peak Detect Function and Specified Bandwidth with Maximum Hold Mode.
- f. If the emission level of the EUT in peak mode was lower than the limit specified, then testing could be stopped and the peak values of the EUT would be reported. Otherwise the emissions would be re-tested one by one using the peak, quasi-peak or average method as specified and then reported in a data sheet.

NOTE:

1. The resolution bandwidth and video bandwidth of test receiver/spectrum analyzer is 120kHz for Quasi-peak detection at frequency below 1GHz.
2. The resolution bandwidth and video bandwidth of test receiver/spectrum analyzer is 1 MHz for Peak detection (PK) at frequency above 1GHz.
3. The resolution bandwidth of test receiver/spectrum analyzer is 1 MHz and the video bandwidth is 10Hz for Average detection (AV) at frequency above 1GHz.

4.2.4 DEVIATION FROM TEST STANDARD

No deviation

4.2.5 TEST SETUP

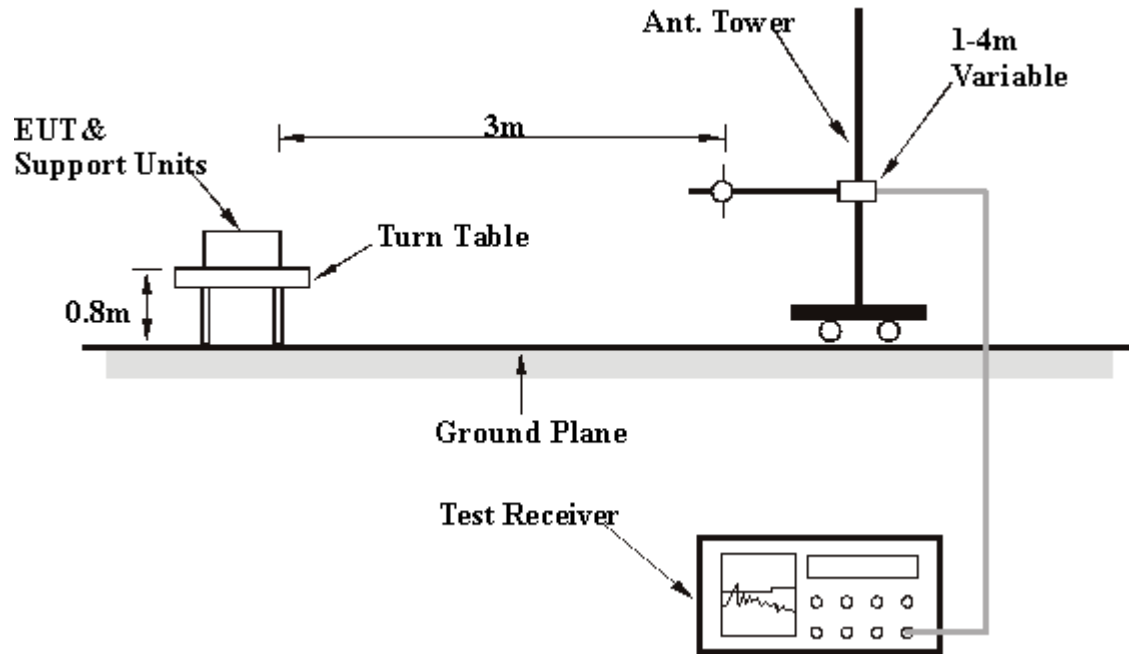

For the actual test configuration, please refer to the related item – Photographs of the Test Configuration.

4.2.6 EUT OPERATING CONDITIONS

Same as 4.1.6

4.2.7 TEST RESULTS

RADIATED WORST CASE DATA (FOR ADAPTER: PSAA05A-050):

EUT TEST CONDITION		MEASUREMENT DETAIL	
CHANNEL	Channel 11	FREQUENCY RANGE	Below 1000MHz
MODULATION TYPE	BPSK	DETECTOR FUNCTION	Quasi-Peak
TRANSFER RATE	6Mbps	INPUT POWER (SYSTEM)	120Vac, 60 Hz
ENVIRONMENTAL CONDITIONS	28deg. C, 72%RH, 991hPa	TEST MODE	A
TESTED BY	Lori Chiu		

ANTENNA POLARITY & TEST DISTANCE: HORIZONTAL AT 3 M								
No.	Freq. (MHz)	Emission Level (dBuV/m)	Limit (dBuV/m)	Margin (dB)	Antenna Height (m)	Table Angle (Degree)	Raw Value (dBuV)	Correction Factor (dB/m)
1	51.38	24.47 QP	40.00	-15.53	1.00 H	103	10.23	14.25
2	801.72	26.05 QP	46.00	-19.95	1.50 H	100	0.03	26.02
3	815.33	26.22 QP	46.00	-19.78	2.00 H	202	0.01	26.20
4	863.93	26.92 QP	46.00	-19.08	1.50 H	100	0.13	26.79
5	906.69	28.59 QP	46.00	-17.41	1.00 H	85	1.20	27.39
6	926.13	28.44 QP	46.00	-17.56	1.50 H	100	0.13	28.30
7	945.57	28.86 QP	46.00	-17.14	1.00 H	319	-0.35	29.21

ANTENNA POLARITY & TEST DISTANCE: VERTICAL AT 3 M								
No.	Freq. (MHz)	Emission Level (dBuV/m)	Limit (dBuV/m)	Margin (dB)	Antenna Height (m)	Table Angle (Degree)	Raw Value (dBuV)	Correction Factor (dB/m)
1	53.33	35.36 QP	40.00	-4.64	1.00 V	40	21.27	14.09
2	84.43	26.14 QP	40.00	-13.86	1.00 V	331	16.21	9.92
3	99.98	24.76 QP	43.50	-18.74	1.00 V	187	15.77	8.99
4	871.70	26.64 QP	46.00	-19.36	1.00 V	52	-0.22	26.85
5	906.69	27.15 QP	46.00	-18.85	1.00 V	10	-0.24	27.39
6	928.08	28.06 QP	46.00	-17.94	1.00 V	16	-0.33	28.39

- REMARKS:**
1. Emission level (dBuV/m) = Raw Value (dBuV) + Correction Factor (dB/m).
 2. Correction Factor (dB/m) = Antenna Factor (dB/m) + Cable Factor (dB).
 3. The other emission levels were very low against the limit.
 4. Margin value = Emission level – Limit value.

RADIATED WORST CASE DATA (FOR ADAPTER: JHA050100UU05):

EUT TEST CONDITION		MEASUREMENT DETAIL	
CHANNEL	Channel 11	FREQUENCY RANGE	Below 1000MHz
MODULATION TYPE	BPSK	DETECTOR FUNCTION	Quasi-Peak
TRANSFER RATE	6Mbps	INPUT POWER (SYSTEM)	120Vac, 60 Hz
ENVIRONMENTAL CONDITIONS	28deg. C, 72%RH, 991hPa	TEST MODE	B
TESTED BY	Lori Chiu		

ANTENNA POLARITY & TEST DISTANCE: HORIZONTAL AT 3 M

No.	Freq. (MHz)	Emission Level (dBuV/m)	Limit (dBuV/m)	Margin (dB)	Antenna Height (m)	Table Angle (Degree)	Raw Value (dBuV)	Correction Factor (dB/m)
1	119.42	22.20 QP	43.50	-21.30	1.00 H	235	11.44	10.76
2	134.97	22.22 QP	43.50	-21.28	1.00 H	214	9.44	12.78
3	214.67	22.41 QP	43.50	-21.09	1.00 H	49	11.10	11.31
4	716.19	24.15 QP	46.00	-21.85	1.00 H	106	-0.52	24.67
5	747.29	24.84 QP	46.00	-21.16	1.00 H	106	-0.85	25.69
6	755.07	26.08 QP	46.00	-19.92	1.50 H	25	0.28	25.80
7	844.49	25.70 QP	46.00	-20.30	1.00 H	76	-0.91	26.60
8	850.32	26.37 QP	46.00	-19.63	1.00 H	235	-0.31	26.68
9	902.81	38.60 QP	46.00	-7.40	1.00 H	106	11.39	27.21
10	910.58	36.54 QP	46.00	-9.46	1.50 H	25	8.97	27.57

ANTENNA POLARITY & TEST DISTANCE: VERTICAL AT 3 M

No.	Freq. (MHz)	Emission Level (dBuV/m)	Limit (dBuV/m)	Margin (dB)	Antenna Height (m)	Table Angle (Degree)	Raw Value (dBuV)	Correction Factor (dB/m)
1	64.99	26.83 QP	40.00	-13.17	1.00 V	238	14.16	12.68
2	98.04	23.25 QP	43.50	-20.25	1.00 V	238	14.22	9.02
3	830.88	25.56 QP	46.00	-20.44	1.00 V	358	-0.86	26.42
4	863.93	25.84 QP	46.00	-20.16	1.00 V	160	-0.95	26.79
5	902.81	34.29 QP	46.00	-11.71	1.00 V	28	7.07	27.21
6	910.58	32.62 QP	46.00	-13.38	1.00 V	238	5.04	27.57
7	959.18	28.17 QP	46.00	-17.83	1.00 V	190	-1.04	29.22

- REMARKS:**
1. Emission level (dBuV/m) = Raw Value (dBuV) + Correction Factor (dB/m).
 2. Correction Factor (dB/m) = Antenna Factor (dB/m) + Cable Factor (dB).
 3. The other emission levels were very low against the limit.
 4. Margin value = Emission level – Limit value.



RADIATED WORST CASE DATA (FOR ADAPTER: ADP-5FH B):

EUT TEST CONDITION		MEASUREMENT DETAIL	
CHANNEL	Channel 11	FREQUENCY RANGE	Below 1000MHz
MODULATION TYPE	BPSK	DETECTOR FUNCTION	Quasi-Peak
TRANSFER RATE	6Mbps	INPUT POWER (SYSTEM)	120Vac, 60 Hz
ENVIRONMENTAL CONDITIONS	24deg. C, 68%RH, 991hPa	TEST MODE	C
TESTED BY	Lori Chiu		

ANTENNA POLARITY & TEST DISTANCE: HORIZONTAL AT 3 M								
No.	Freq. (MHz)	Emission Level (dBuV/m)	Limit (dBuV/m)	Margin (dB)	Antenna Height (m)	Table Angle (Degree)	Raw Value (dBuV)	Correction Factor (dB/m)
1	61.10	22.39 QP	40.00	-17.61	1.00 H	115	9.04	13.35
2	125.25	27.06 QP	43.50	-16.44	1.50 H	118	15.56	11.50
3	193.29	23.95 QP	43.50	-19.55	1.00 H	115	12.67	11.28
4	206.89	27.99 QP	43.50	-15.51	1.00 H	244	16.93	11.06
5	842.55	26.02 QP	46.00	-19.98	1.00 H	85	-0.56	26.57
6	860.04	26.39 QP	46.00	-19.61	1.00 H	64	-0.37	26.76
7	904.75	26.47 QP	46.00	-19.53	1.00 H	85	-0.83	27.30
8	922.24	27.45 QP	46.00	-18.55	1.00 H	64	-0.67	28.12

ANTENNA POLARITY & TEST DISTANCE: VERTICAL AT 3 M								
No.	Freq. (MHz)	Emission Level (dBuV/m)	Limit (dBuV/m)	Margin (dB)	Antenna Height (m)	Table Angle (Degree)	Raw Value (dBuV)	Correction Factor (dB/m)
1	61.10	31.70 QP	40.00	-8.30	1.00 V	19	18.35	13.35
2	129.14	24.54 QP	43.50	-18.96	1.00 V	241	12.53	12.01
3	197.17	24.11 QP	43.50	-19.39	1.00 V	283	13.09	11.02
4	840.60	26.62 QP	46.00	-19.38	1.00 V	148	0.07	26.55
5	846.43	26.53 QP	46.00	-19.47	1.00 V	241	-0.10	26.63
6	904.75	26.67 QP	46.00	-19.33	1.00 V	10	-0.63	27.30
7	918.36	28.34 QP	46.00	-17.66	1.00 V	250	0.40	27.94

- REMARKS:**
1. Emission level (dBuV/m) = Raw Value (dBuV) + Correction Factor (dB/m).
 2. Correction Factor (dB/m) = Antenna Factor (dB/m) + Cable Factor (dB).
 3. The other emission levels were very low against the limit.
 4. Margin value = Emission level – Limit value.



RADIATED WORST CASE DATA (POWER FROM BATTERY):

EUT TEST CONDITION		MEASUREMENT DETAIL	
CHANNEL	Channel 11	FREQUENCY RANGE	Below 1000MHz
MODULATION TYPE	BPSK	DETECTOR FUNCTION	Quasi-Peak
TRANSFER RATE	6Mbps	INPUT POWER (SYSTEM)	120Vac, 60 Hz
ENVIRONMENTAL CONDITIONS	24deg. C, 68%RH, 991hPa	TEST MODE	D
TESTED BY	Lori Chiu		

ANTENNA POLARITY & TEST DISTANCE: HORIZONTAL AT 3 M								
No.	Freq. (MHz)	Emission Level (dBuV/m)	Limit (dBuV/m)	Margin (dB)	Antenna Height (m)	Table Angle (Degree)	Raw Value (dBuV)	Correction Factor (dB/m)
1	76.65	28.45 QP	40.00	-11.55	1.00 H	82	17.49	10.96
2	745.35	25.05 QP	46.00	-20.95	1.00 H	307	-0.58	25.63
3	780.34	25.52 QP	46.00	-20.48	1.50 H	202	-0.39	25.91
4	797.84	25.59 QP	46.00	-20.41	1.00 H	82	-0.39	25.99
5	840.60	25.72 QP	46.00	-20.28	1.50 H	256	-0.83	26.55
6	861.98	26.49 QP	46.00	-19.51	1.50 H	94	-0.28	26.77
7	902.81	26.73 QP	46.00	-19.27	1.50 H	256	-0.48	27.21
8	916.41	27.95 QP	46.00	-18.05	1.50 H	241	0.10	27.85

ANTENNA POLARITY & TEST DISTANCE: VERTICAL AT 3 M								
No.	Freq. (MHz)	Emission Level (dBuV/m)	Limit (dBuV/m)	Margin (dB)	Antenna Height (m)	Table Angle (Degree)	Raw Value (dBuV)	Correction Factor (dB/m)
1	35.83	19.85 QP	40.00	-20.15	1.00 V	52	6.61	13.24
2	76.65	18.45 QP	40.00	-21.55	1.00 V	358	7.49	10.96
3	716.19	24.05 QP	46.00	-21.95	1.00 V	196	-0.62	24.67
4	751.18	24.90 QP	46.00	-21.10	1.00 V	157	-0.89	25.78
5	766.73	24.76 QP	46.00	-21.24	1.00 V	358	-1.09	25.85
6	803.67	26.24 QP	46.00	-19.76	1.50 V	145	0.20	26.05
7	844.49	25.89 QP	46.00	-20.11	1.00 V	157	-0.71	26.60
8	869.76	26.03 QP	46.00	-19.97	1.50 V	43	-0.80	26.84

- REMARKS:**
1. Emission level (dBuV/m) = Raw Value (dBuV) + Correction Factor (dB/m).
 2. Correction Factor (dB/m) = Antenna Factor (dB/m) + Cable Factor (dB).
 3. The other emission levels were very low against the limit.
 4. Margin value = Emission level – Limit value.

RADIATED WORST CASE DATA (USB CABLE):

EUT TEST CONDITION		MEASUREMENT DETAIL	
CHANNEL	Channel 11	FREQUENCY RANGE	Below 1000MHz
MODULATION TYPE	BPSK	DETECTOR FUNCTION	Quasi-Peak
TRANSFER RATE	6Mbps	INPUT POWER (SYSTEM)	3.7Vdc
ENVIRONMENTAL CONDITIONS	22deg. C, 68%RH, 991hPa	TEST MODE	E
TESTED BY	Lori Chiu		

ANTENNA POLARITY & TEST DISTANCE: HORIZONTAL AT 3 M								
No.	Freq. (MHz)	Emission Level (dBuV/m)	Limit (dBuV/m)	Margin (dB)	Antenna Height (m)	Table Angle (Degree)	Raw Value (dBuV)	Correction Factor (dB/m)
1	111.64	39.51 QP	43.50	-3.99	1.50 H	7	29.47	10.05
2	350.74	37.84 QP	46.00	-8.16	1.00 H	145	21.54	16.31
3	366.29	33.72 QP	46.00	-12.28	1.00 H	313	16.90	16.82
4	393.51	31.26 QP	46.00	-14.74	1.00 H	196	13.54	17.72
5	465.43	28.56 QP	46.00	-17.44	1.00 H	313	9.26	19.30
6	681.20	28.21 QP	46.00	-17.79	1.00 H	145	4.49	23.72
7	959.18	29.03 QP	46.00	-16.97	1.50 H	10	-0.19	29.22

ANTENNA POLARITY & TEST DISTANCE: VERTICAL AT 3 M								
No.	Freq. (MHz)	Emission Level (dBuV/m)	Limit (dBuV/m)	Margin (dB)	Antenna Height (m)	Table Angle (Degree)	Raw Value (dBuV)	Correction Factor (dB/m)
1	63.05	33.53 QP	40.00	-6.47	1.00 V	79	20.52	13.01
2	111.64	38.32 QP	43.50	-5.18	1.50 V	169	28.27	10.05
3	150.52	36.34 QP	43.50	-7.16	1.00 V	100	22.92	13.42
4	164.13	28.50 QP	43.50	-15.00	1.00 V	82	15.35	13.15
5	352.69	30.44 QP	46.00	-15.56	1.00 V	88	14.07	16.37
6	681.20	29.04 QP	46.00	-16.96	1.00 V	154	5.32	23.72
7	951.40	29.83 QP	46.00	-16.17	1.00 V	295	0.45	29.39

- REMARKS:**
1. Emission level (dBuV/m) = Raw Value (dBuV) + Correction Factor (dB/m).
 2. Correction Factor (dB/m) = Antenna Factor (dB/m) + Cable Factor (dB).
 3. The other emission levels were very low against the limit.
 4. Margin value = Emission level – Limit value.

802.11b DSSS MODULATION

EUT TEST CONDITION		MEASUREMENT DETAIL	
CHANNEL	Channel 1	FREQUENCY RANGE	1 ~ 25GHz
MODULATION TYPE	DBPSK	DETECTOR FUNCTION	Peak (PK) Average (AV)
TRANSFER RATE	1Mbps	ENVIRONMENTAL CONDITIONS	20deg. C, 60%RH, 991hPa
INPUT POWER (SYSTEM)	120Vac, 60 Hz	TEST MODE	E
TESTED BY	Morgan Chen		

ANTENNA POLARITY & TEST DISTANCE: HORIZONTAL AT 3 M

No.	Freq. (MHz)	Emission Level (dBuV/m)	Limit (dBuV/m)	Margin (dB)	Antenna Height (m)	Table Angle (Degree)	Raw Value (dBuV)	Correction Factor (dB/m)
1	2390.00	57.12 PK	74.00	-16.88	1.02 H	341	25.21	31.91
1	2390.00	43.59 AV	54.00	-10.41	1.02 H	341	11.67	31.91
2	*2412.00	100.63 PK			1.05 H	325	68.59	32.04
2	*2412.00	97.25 AV			1.05 H	325	65.21	32.04
3	4824.00	52.33 PK	74.00	-21.67	1.05 H	261	14.82	37.51
3	4824.00	39.41 AV	54.00	-14.59	1.05 H	261	1.90	37.51

ANTENNA POLARITY & TEST DISTANCE: VERTICAL AT 3 M

No.	Freq. (MHz)	Emission Level (dBuV/m)	Limit (dBuV/m)	Margin (dB)	Antenna Height (m)	Table Angle (Degree)	Raw Value (dBuV)	Correction Factor (dB/m)
1	2390.00	59.33 PK	74.00	-14.67	1.15 V	152	27.42	31.91
1	2390.00	45.61 AV	54.00	-8.39	1.15 V	152	13.70	31.91
2	*2412.00	102.78 PK			1.15 V	155	70.74	32.04
2	*2412.00	99.12 AV			1.15 V	155	67.08	32.04
3	4824.00	54.11 PK	74.00	-19.89	1.03 V	212	16.60	37.51
3	4824.00	41.02 AV	54.00	-12.98	1.03 V	212	3.51	37.51

- REMARKS:**
1. Emission level (dBuV/m) = Raw Value (dBuV) + Correction Factor (dB/m).
 2. Correction Factor (dB/m) = Antenna Factor (dB/m) + Cable Factor (dB).
 3. The other emission levels were very low against the limit.
 4. Margin value = Emission level – Limit value.
 5. “ * “: Fundamental frequency.

EUT TEST CONDITION		MEASUREMENT DETAIL	
CHANNEL	Channel 6	FREQUENCY RANGE	1 ~ 25GHz
MODULATION TYPE	DBPSK	DETECTOR FUNCTION	Peak (PK) Average (AV)
TRANSFER RATE	1Mbps	ENVIRONMENTAL CONDITIONS	20deg. C, 60%RH, 991hPa
INPUT POWER (SYSTEM)	120Vac, 60 Hz	TEST MODE	E
TESTED BY	Morgan Chen		

ANTENNA POLARITY & TEST DISTANCE: HORIZONTAL AT 3 M								
No.	Freq. (MHz)	Emission Level (dBuV/m)	Limit (dBuV/m)	Margin (dB)	Antenna Height (m)	Table Angle (Degree)	Raw Value (dBuV)	Correction Factor (dB/m)
1	*2437.00	101.12 PK			1.08 H	352	68.92	32.20
1	*2437.00	96.98 AV			1.08 H	352	64.78	32.20
2	4874.00	48.12 PK	74.00	-25.88	1.08 H	252	10.57	37.55
2	4874.00	36.01 AV	54.00	-17.99	1.08 H	252	-1.54	37.55

ANTENNA POLARITY & TEST DISTANCE: VERTICAL AT 3 M								
No.	Freq. (MHz)	Emission Level (dBuV/m)	Limit (dBuV/m)	Margin (dB)	Antenna Height (m)	Table Angle (Degree)	Raw Value (dBuV)	Correction Factor (dB/m)
1	*2437.00	103.02 PK			1.09 V	135	70.82	32.20
1	*2437.00	99.32 AV			1.09 V	135	67.12	32.20
2	4874.00	50.85 PK	74.00	-23.15	1.00 V	241	13.30	37.55
2	4874.00	38.12 AV	54.00	-15.88	1.00 V	241	0.57	37.55

- REMARKS:**
1. Emission level (dBuV/m) = Raw Value (dBuV) + Correction Factor (dB/m).
 2. Correction Factor (dB/m) = Antenna Factor (dB/m) + Cable Factor (dB).
 3. The other emission levels were very low against the limit.
 4. Margin value = Emission level – Limit value.
 5. “ * “: Fundamental frequency.

EUT TEST CONDITION		MEASUREMENT DETAIL	
CHANNEL	Channel 11	FREQUENCY RANGE	1 ~ 25GHz
MODULATION TYPE	DBPSK	DETECTOR FUNCTION	Peak (PK) Average (AV)
TRANSFER RATE	1Mbps	ENVIRONMENTAL CONDITIONS	20deg. C, 60%RH, 991hPa
INPUT POWER (SYSTEM)	120Vac, 60 Hz	TEST MODE	E
TESTED BY	Morgan Chen		

ANTENNA POLARITY & TEST DISTANCE: HORIZONTAL AT 3 M								
No.	Freq. (MHz)	Emission Level (dBuV/m)	Limit (dBuV/m)	Margin (dB)	Antenna Height (m)	Table Angle (Degree)	Raw Value (dBuV)	Correction Factor (dB/m)
1	*2462.00	100.02 PK			1.03 H	341	67.67	32.35
1	*2462.00	97.12 AV			1.03 H	341	64.77	32.35
2	2483.50	56.55 PK	74.00	-17.45	1.02 H	344	24.06	32.49
2	2483.50	43.52 AV	54.00	-10.48	1.02 H	344	11.03	32.49
3	4924.00	48.12 PK	74.00	-25.88	1.08 H	32	10.54	37.58
3	4924.00	35.11 AV	54.00	-18.89	1.08 H	32	-2.47	37.58

ANTENNA POLARITY & TEST DISTANCE: VERTICAL AT 3 M								
No.	Freq. (MHz)	Emission Level (dBuV/m)	Limit (dBuV/m)	Margin (dB)	Antenna Height (m)	Table Angle (Degree)	Raw Value (dBuV)	Correction Factor (dB/m)
1	*2462.00	102.35 PK			1.12 V	135	70.00	32.35
1	*2462.00	99.29 AV			1.12 V	135	66.94	32.35
2	2483.50	58.32 PK	74.00	-15.68	1.12 V	132	25.83	32.49
2	2483.50	45.39 AV	54.00	-8.61	1.12 V	132	12.90	32.49
3	4924.00	50.85 PK	74.00	-23.15	1.03 V	232	13.27	37.58
3	4924.00	37.95 AV	54.00	-16.05	1.03 V	232	0.37	37.58

- REMARKS:**
1. Emission level (dBuV/m) = Raw Value (dBuV) + Correction Factor (dB/m).
 2. Correction Factor (dB/m) = Antenna Factor (dB/m) + Cable Factor (dB).
 3. The other emission levels were very low against the limit.
 4. Margin value = Emission level – Limit value.
 5. “ * “: Fundamental frequency.

802.11g OFDM MODULATION

EUT TEST CONDITION		MEASUREMENT DETAIL	
CHANNEL	Channel 1	FREQUENCY RANGE	1 ~ 25GHz
MODULATION TYPE	BPSK	DETECTOR FUNCTION	Peak (PK) Average (AV)
TRANSFER RATE	6Mbps	ENVIRONMENTAL CONDITIONS	20deg. C, 60%RH, 991hPa
INPUT POWER (SYSTEM)	120Vac, 60 Hz	TEST MODE	E
TESTED BY	Morgan Chen		

ANTENNA POLARITY & TEST DISTANCE: HORIZONTAL AT 3 M

No.	Freq. (MHz)	Emission Level (dBuV/m)	Limit (dBuV/m)	Margin (dB)	Antenna Height (m)	Table Angle (Degree)	Raw Value (dBuV)	Correction Factor (dB/m)
1	2390.00	68.68 PK	74.00	-5.32	1.45 H	125	36.77	31.91
1	2390.00	50.39 AV	54.00	-3.61	1.45 H	125	18.48	31.91
2	*2412.00	104.23 PK			1.44 H	125	72.19	32.04
2	*2412.00	94.32 AV			1.44 H	125	62.28	32.04
3	4824.00	45.32 PK	74.00	-28.68	1.05 H	352	7.81	37.51
3	4824.00	33.81 AV	54.00	-20.19	1.05 H	352	-3.70	37.51

ANTENNA POLARITY & TEST DISTANCE: VERTICAL AT 3 M

No.	Freq. (MHz)	Emission Level (dBuV/m)	Limit (dBuV/m)	Margin (dB)	Antenna Height (m)	Table Angle (Degree)	Raw Value (dBuV)	Correction Factor (dB/m)
1	2390.00	69.85 PK	74.00	-4.15	1.18 V	135	37.94	31.91
1	2390.00	51.54 AV	54.00	-2.46	1.18 V	135	19.63	31.91
2	*2412.00	105.68 PK			1.33 V	12	73.64	32.04
2	*2412.00	96.28 AV			1.33 V	12	64.24	32.04
3	4824.00	51.58 PK	74.00	-22.42	1.35 V	241	14.07	37.51
3	4824.00	38.09 AV	54.00	-15.91	1.35 V	241	0.58	37.51

- REMARKS:**
1. Emission level (dBuV/m) = Raw Value (dBuV) + Correction Factor (dB/m).
 2. Correction Factor (dB/m) = Antenna Factor (dB/m) + Cable Factor (dB).
 3. The other emission levels were very low against the limit.
 4. Margin value = Emission level – Limit value.
 5. “ * “: Fundamental frequency.

EUT TEST CONDITION		MEASUREMENT DETAIL	
CHANNEL	Channel 6	FREQUENCY RANGE	1 ~ 25GHz
MODULATION TYPE	BPSK	DETECTOR FUNCTION	Peak (PK) Average (AV)
TRANSFER RATE	6Mbps	ENVIRONMENTAL CONDITIONS	20deg. C, 60%RH, 991hPa
INPUT POWER (SYSTEM)	120Vac, 60 Hz	TEST MODE	E
TESTED BY	Morgan Chen		

ANTENNA POLARITY & TEST DISTANCE: HORIZONTAL AT 3 M								
No.	Freq. (MHz)	Emission Level (dBuV/m)	Limit (dBuV/m)	Margin (dB)	Antenna Height (m)	Table Angle (Degree)	Raw Value (dBuV)	Correction Factor (dB/m)
1	*2437.00	104.35 PK			1.05 H	312	72.15	32.20
1	*2437.00	94.65 AV			1.05 H	312	62.45	32.20
2	4874.00	48.55 PK	74.00	-25.45	1.05 H	323	11.00	37.55
2	4874.00	35.08 AV	54.00	-18.92	1.05 H	323	-2.47	37.55

ANTENNA POLARITY & TEST DISTANCE: VERTICAL AT 3 M								
No.	Freq. (MHz)	Emission Level (dBuV/m)	Limit (dBuV/m)	Margin (dB)	Antenna Height (m)	Table Angle (Degree)	Raw Value (dBuV)	Correction Factor (dB/m)
1	*2437.00	106.44 PK			1.19 V	132	74.24	32.20
1	*2437.00	95.88 AV			1.19 V	132	63.68	32.20
2	4874.00	50.86 PK	74.00	-23.14	1.24 V	268	13.31	37.55
2	4874.00	38.29 AV	54.00	-15.71	1.24 V	268	0.74	37.55

- REMARKS:**
1. Emission level (dBuV/m) = Raw Value (dBuV) + Correction Factor (dB/m).
 2. Correction Factor (dB/m) = Antenna Factor (dB/m) + Cable Factor (dB).
 3. The other emission levels were very low against the limit.
 4. Margin value = Emission level – Limit value.
 5. “ * “: Fundamental frequency.

EUT TEST CONDITION		MEASUREMENT DETAIL	
CHANNEL	Channel 11	FREQUENCY RANGE	1 ~ 25GHz
MODULATION TYPE	BPSK	DETECTOR FUNCTION	Peak (PK) Average (AV)
TRANSFER RATE	6Mbps	ENVIRONMENTAL CONDITIONS	20deg. C, 60%RH, 991hPa
INPUT POWER (SYSTEM)	120Vac, 60 Hz	TEST MODE	E
TESTED BY	Morgan Chen		

ANTENNA POLARITY & TEST DISTANCE: HORIZONTAL AT 3 M								
No.	Freq. (MHz)	Emission Level (dBuV/m)	Limit (dBuV/m)	Margin (dB)	Antenna Height (m)	Table Angle (Degree)	Raw Value (dBuV)	Correction Factor (dB/m)
1	*2462.00	104.02 PK			1.05 H	308	71.67	32.35
1	*2462.00	93.95 AV			1.05 H	308	61.60	32.35
2	2483.50	67.32 PK	74.00	-6.68	1.05 H	302	34.83	32.49
2	2483.50	48.32 AV	54.00	-5.68	1.05 H	302	15.83	32.49
3	4924.00	47.32 PK	74.00	-26.68	1.00 H	258	9.74	37.58
3	4924.00	37.08 AV	54.00	-16.92	1.00 H	258	-0.50	37.58

ANTENNA POLARITY & TEST DISTANCE: VERTICAL AT 3 M								
No.	Freq. (MHz)	Emission Level (dBuV/m)	Limit (dBuV/m)	Margin (dB)	Antenna Height (m)	Table Angle (Degree)	Raw Value (dBuV)	Correction Factor (dB/m)
1	*2462.00	105.32 PK			1.23 V	135	72.97	32.35
1	*2462.00	95.65 AV			1.23 V	135	63.30	32.35
2	2483.50	68.56 PK	74.00	-5.44	1.12 V	125	36.07	32.49
2	2483.50	49.41 AV	54.00	-4.59	1.12 V	125	16.92	32.49
3	4824.00	50.32 PK	74.00	-23.68	1.08 V	252	12.81	37.51
3	4824.00	37.08 AV	54.00	-16.92	1.08 V	252	-0.43	37.51

- REMARKS:**
1. Emission level (dBuV/m) = Raw Value (dBuV) + Correction Factor (dB/m).
 2. Correction Factor (dB/m) = Antenna Factor (dB/m) + Cable Factor (dB).
 3. The other emission levels were very low against the limit.
 4. Margin value = Emission level – Limit value.
 5. “ * “: Fundamental frequency.



4.3 6dB BANDWIDTH MEASUREMENT

4.3.1 LIMITS OF 6dB BANDWIDTH MEASUREMENT

The minimum of 6dB Bandwidth Measurement is 0.5 MHz.

4.3.2 TEST INSTRUMENTS

DESCRIPTION & MANUFACTURER	MODEL NO.	SERIAL NO.	CALIBRATED UNTIL
SPECTRUM ANALYZER	FSEK 30	100049	Aug. 14, 2006

NOTE: The calibration interval of the above test instruments is 12 months and the calibrations are traceable to NML/ROC and NIST/USA.

4.3.3 TEST PROCEDURE

The transmitter output was connected to the spectrum analyzer through an attenuator. The bandwidth of the fundamental frequency was measured by spectrum analyzer with 100kHz RBW and 100kHz VBW. The 6dB bandwidth is defined as the total spectrum the power of which is higher than peak power minus 6dB.

4.3.4 DEVIATION FROM TEST STANDARD

No deviation

4.3.5 TEST SETUP



4.3.6 EUT OPERATING CONDITIONS

The software provided by client to enable the EUT under transmission condition continuously at lowest, middle and highest channel frequencies individually.



4.3.7 TEST RESULTS

802.11b DSSS MODULATION

MODULATION TYPE	DBPSK	TRANSFER RATE	1Mbps
INPUT POWER (SYSTEM)	120Vac, 60 Hz	ENVIRONMENTAL CONDITIONS	22deg. C, 63%RH, 991hPa
TESTED BY	Morgan Chen		

CHANNEL	CHANNEL FREQUENCY (MHz)	6dB BANDWIDTH (MHz)	MINIMUM LIMIT (MHz)	PASS/FAIL
1	2412	13.56	0.5	PASS
6	2437	13.56	0.5	PASS
11	2462	13.56	0.5	PASS

CH1

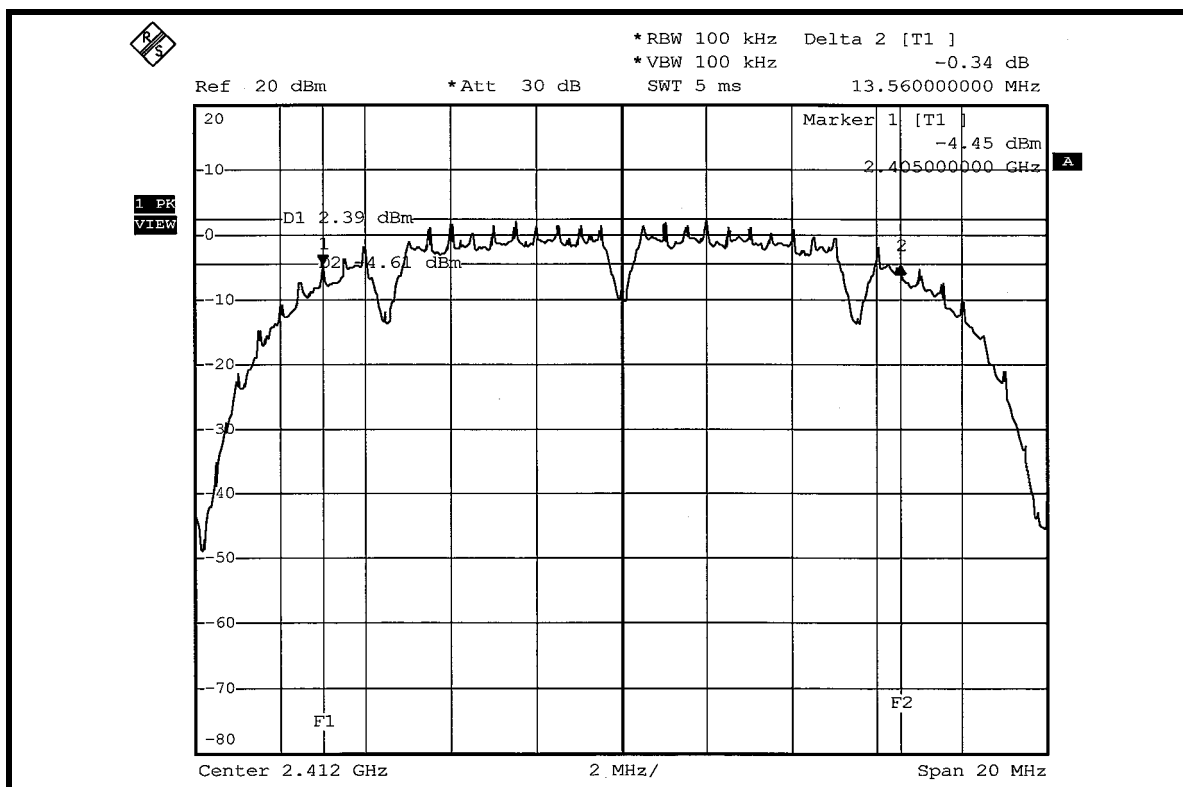

CH6

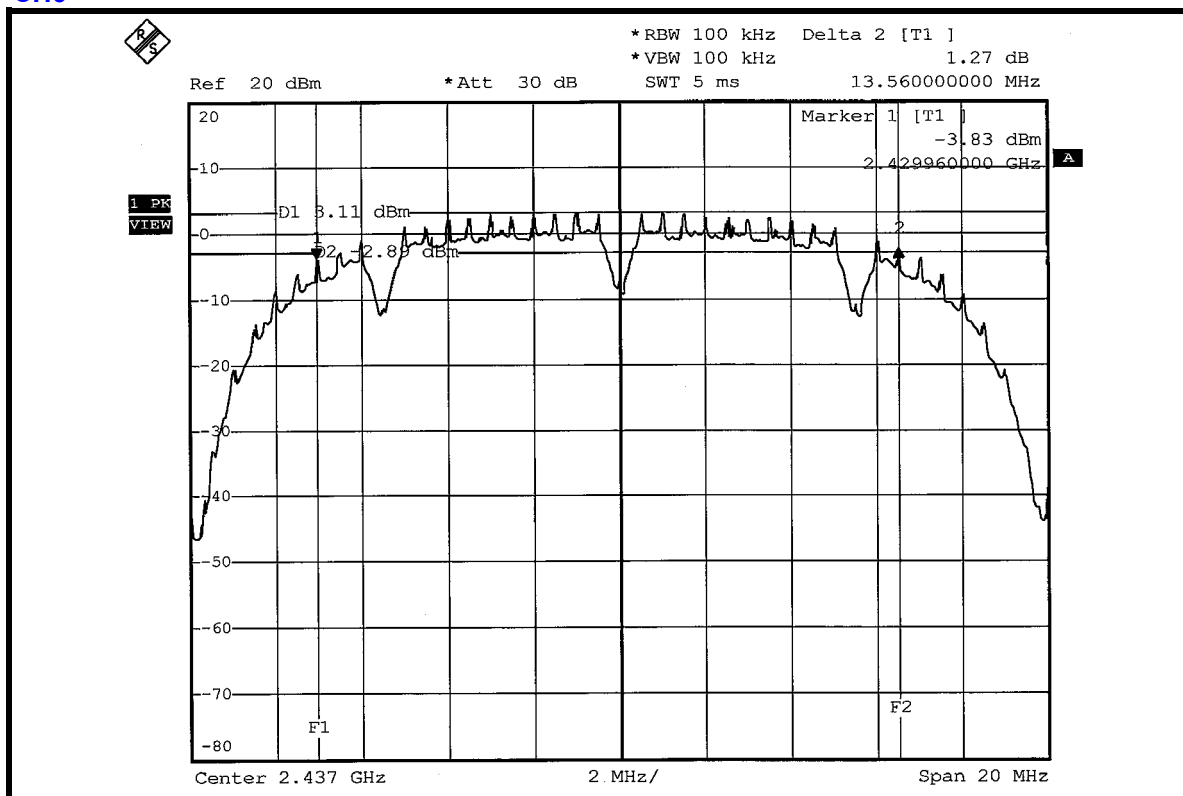

CH11

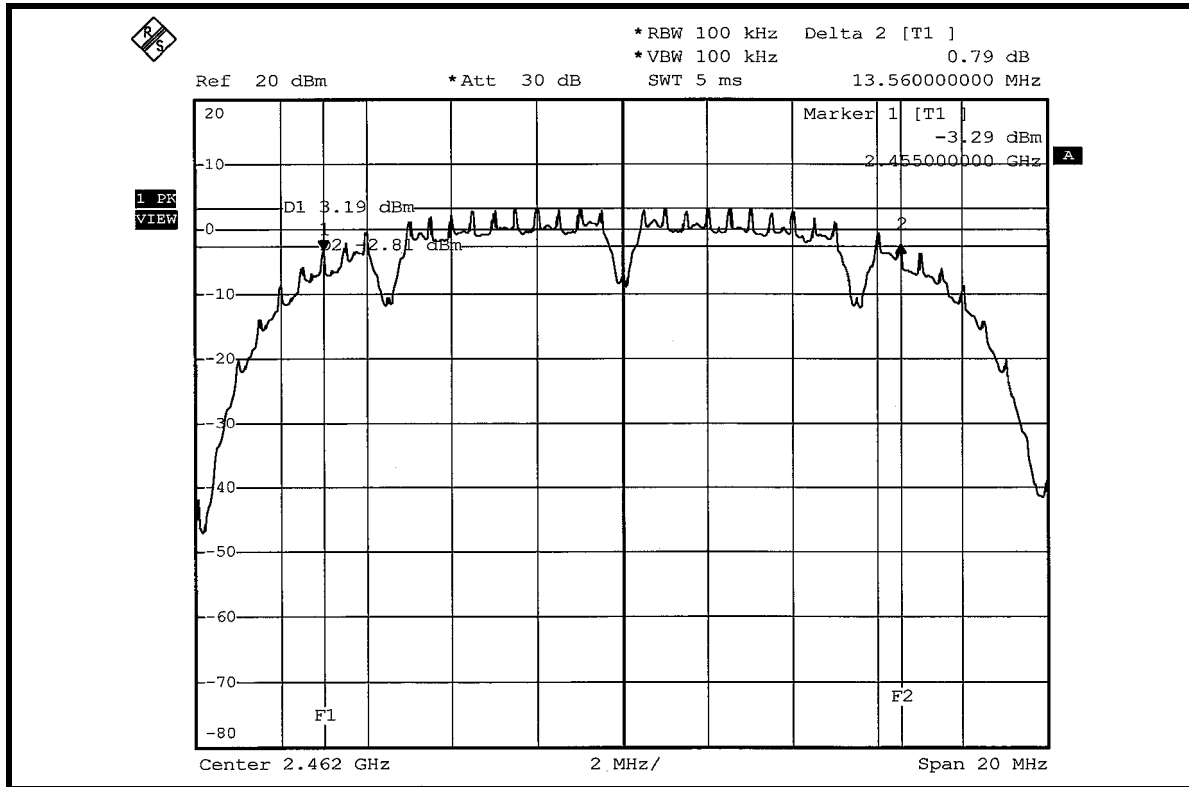



802.11g OFDM MODULATION

MODULATION TYPE	BPSK	TRANSFER RATE	6Mbps
INPUT POWER (SYSTEM)	120Vac, 60 Hz	ENVIRONMENTAL CONDITIONS	22deg. C, 63%RH, 991hPa
TESTED BY	Morgan Chen		

CHANNEL	CHANNEL FREQUENCY (MHz)	6dB BANDWIDTH (MHz)	MINIMUM LIMIT (MHz)	PASS/FAIL
1	2412	16.48	0.5	PASS
6	2437	16.44	0.5	PASS
11	2462	16.48	0.5	PASS

CH1

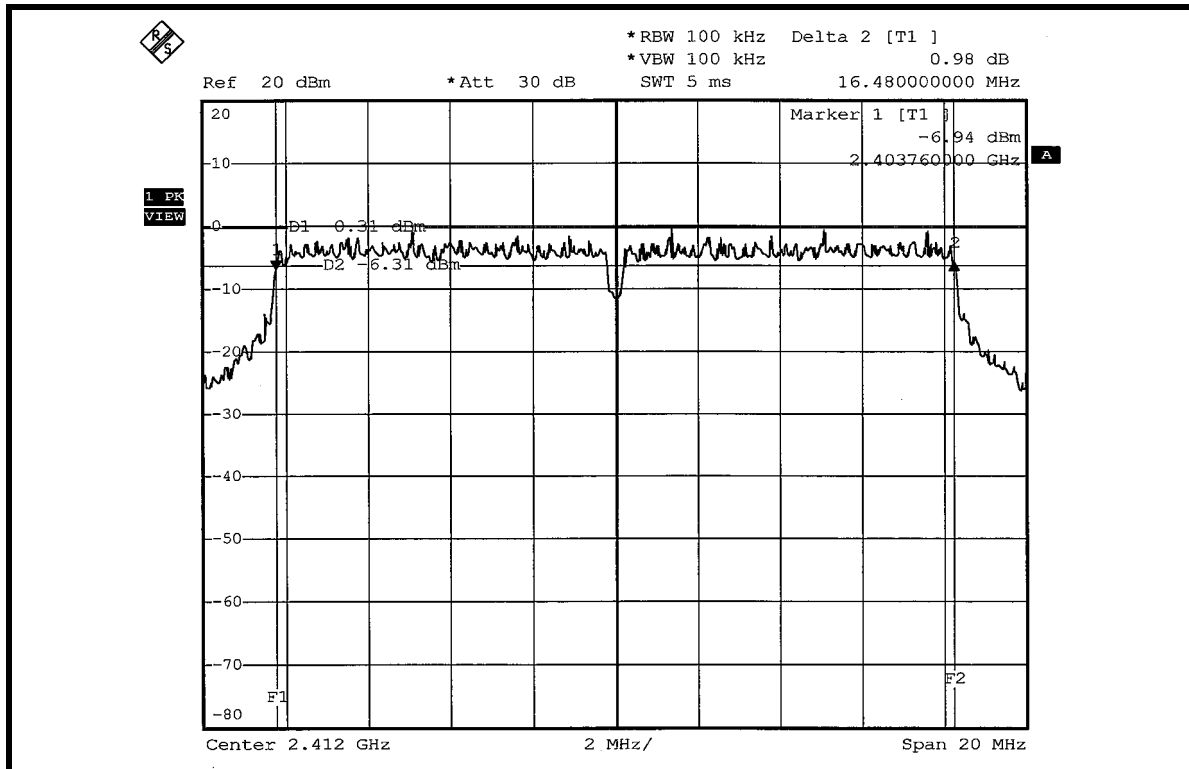

CH6

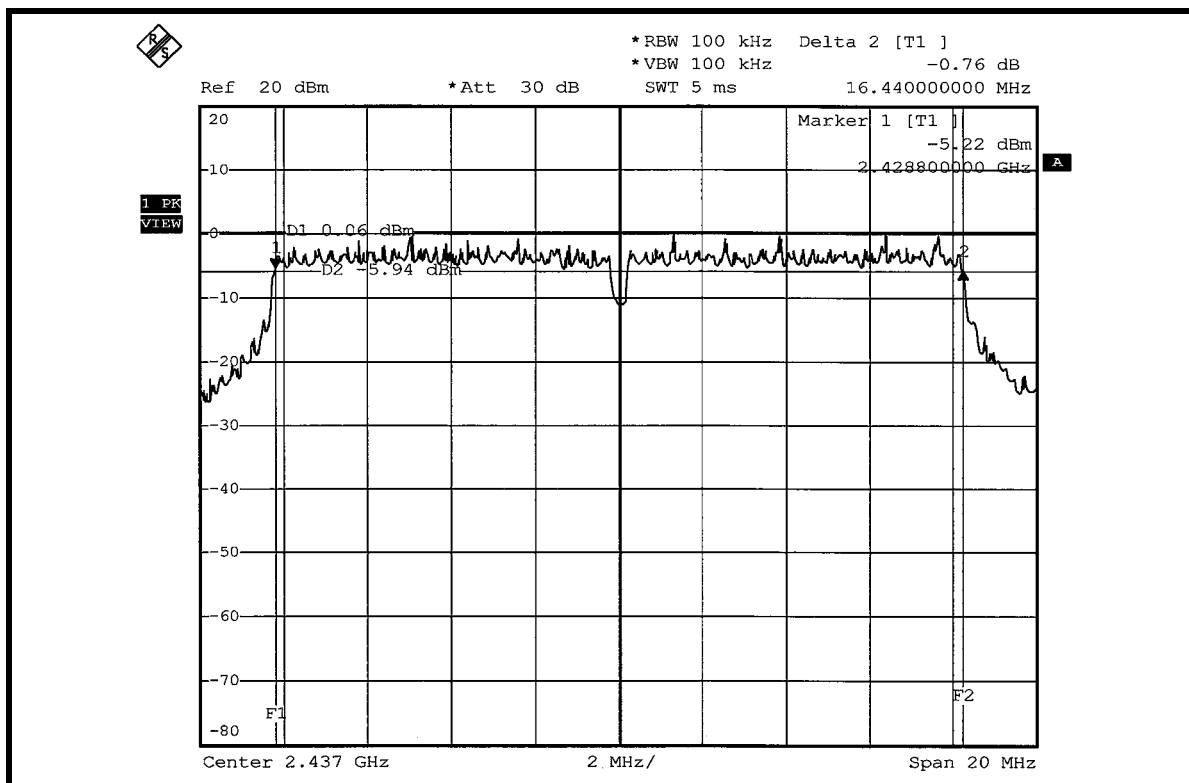

CH11

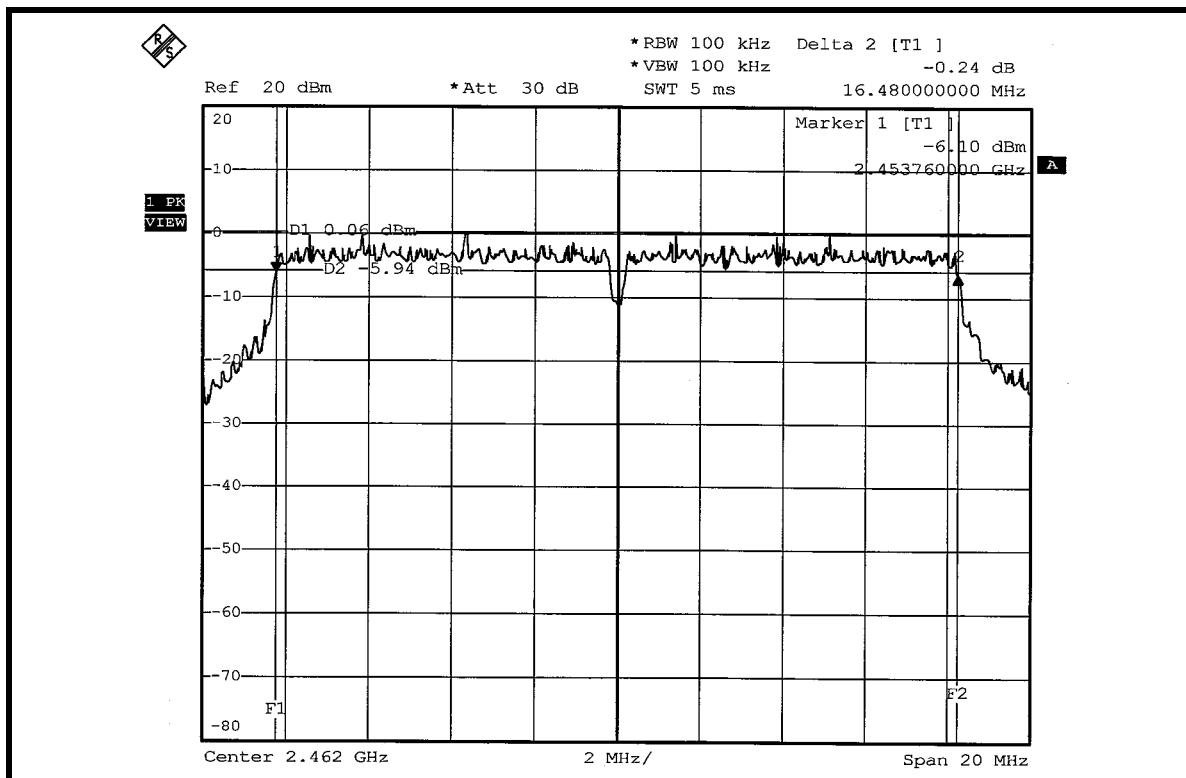



4.4 MAXIMUM PEAK OUTPUT POWER

4.4.1 LIMITS OF MAXIMUM PEAK OUTPUT POWER MEASUREMENT

The Maximum Peak Output Power Measurement is 30dBm.

4.4.2 TEST INSTRUMENTS

DESCRIPTION & MANUFACTURER	MODEL NO.	SERIAL NO.	CALIBRATED UNTIL
R&S SPECTRUM ANALYZER	FSEK30	100049	Aug. 14, 2006
AGILENT SIGNAL GENERATOR	E8257C	MY43320668	Dec. 07, 2006
DIGITAL RT OSCILLOSCOPE	TDS1012	C037299	Nov. 28, 2006
NARDA DETECTOR	4503A	FSCM99899	NA

NOTE: The calibration interval of the above test instruments is 12 months and the calibrations are traceable to NML/ROC and NIST/USA.

4.4.3 TEST PROCEDURES

1. A detector was used on the output port of the EUT. An oscilloscope was used to read the response of the detector.
2. Replaced the EUT by the signal generator. The center frequency of the S.G was adjusted to the center frequency of the measured channel.
3. Adjusted the power to have the same reading on oscilloscope. Record the power level.

4.4.4 DEVIATION FROM TEST STANDARD

No deviation

4.4.5 TEST SETUP



4.4.6 EUT OPERATING CONDITIONS

Same as Item 4.3.6

4.4.7 TEST RESULTS

802.11b DSSS MODULATION

MODULATION TYPE	DBPSK	TRANSFER RATE	1Mbps
INPUT POWER (SYSTEM)	120Vac, 60 Hz	ENVIRONMENTAL CONDITIONS	22deg. C, 63%RH, 991hPa
TESTED BY	Morgan Chen		

CHANNEL	CHANNEL FREQUENCY (MHz)	PEAK POWER OUTPUT (mW)	PEAK POWER OUTPUT (dBm)	PEAK POWER LIMIT (dBm)	PASS/FAIL
1	2412	31.769	15.02	30	PASS
6	2437	35.645	15.52	30	PASS
11	2462	39.902	16.01	30	PASS

802.11g OFDM MODULATION

MODULATION TYPE	BPSK	TRANSFER RATE	6Mbps
INPUT POWER (SYSTEM)	120Vac, 60 Hz	ENVIRONMENTAL CONDITIONS	22deg. C, 63%RH, 991hPa
TESTED BY	Morgan Chen		

CHANNEL	CHANNEL FREQUENCY (MHz)	PEAK POWER OUTPUT (mW)	PEAK POWER OUTPUT (dBm)	PEAK POWER LIMIT (dBm)	PASS/FAIL
1	2412	44.668	16.50	30	PASS
6	2437	50.466	17.03	30	PASS
11	2462	50.119	17.00	30	PASS



4.5 POWER SPECTRAL DENSITY MEASUREMENT

4.5.1 LIMITS OF POWER SPECTRAL DENSITY MEASUREMENT

The Maximum of Power Spectral Density Measurement is 8dBm.

4.5.2 TEST INSTRUMENTS

DESCRIPTION & MANUFACTURER	MODEL NO.	SERIAL NO.	CALIBRATED UNTIL
R&S SPECTRUM ANALYZER	FSEK30	100049	Aug. 14, 2006

NOTE: The calibration interval of the above test instruments is 12 months and the calibrations are traceable to NML/ROC and NIST/USA.

4.5.3 TEST PROCEDURE

The transmitter output was connected to the spectrum analyzer through an attenuator, the bandwidth of the fundamental frequency was measured with the spectrum analyzer using 3kHz RBW and 30kHz VBW, set sweep time = span/3kHz. The power spectral density was measured and recorded.

The sweep time is allowed to be longer than span/3kHz for a full response of the mixer in the spectrum analyzer.

4.5.4 DEVIATION FROM TEST STANDARD

No deviation

4.5.5 TEST SETUP



4.5.6 EUT OPERATING CONDITION

Same as Item 4.3.6



4.5.7 TEST RESULTS

802.11b DSSS MODULATION

MODULATION TYPE	DBPSK	TRANSFER RATE	1Mbps
INPUT POWER (SYSTEM)	120Vac, 60 Hz	ENVIRONMENTAL CONDITIONS	22deg. C, 63%RH, 991hPa
TESTED BY	Morgan Chen		

CHANNEL	CHANNEL FREQUENCY (MHz)	RF POWER LEVEL IN 3kHz BW (dBm)	MAXIMUM LIMIT (dBm)	PASS/FAIL
1	2412	-11.36	8	PASS
6	2437	-10.80	8	PASS
11	2462	-10.39	8	PASS

CH1

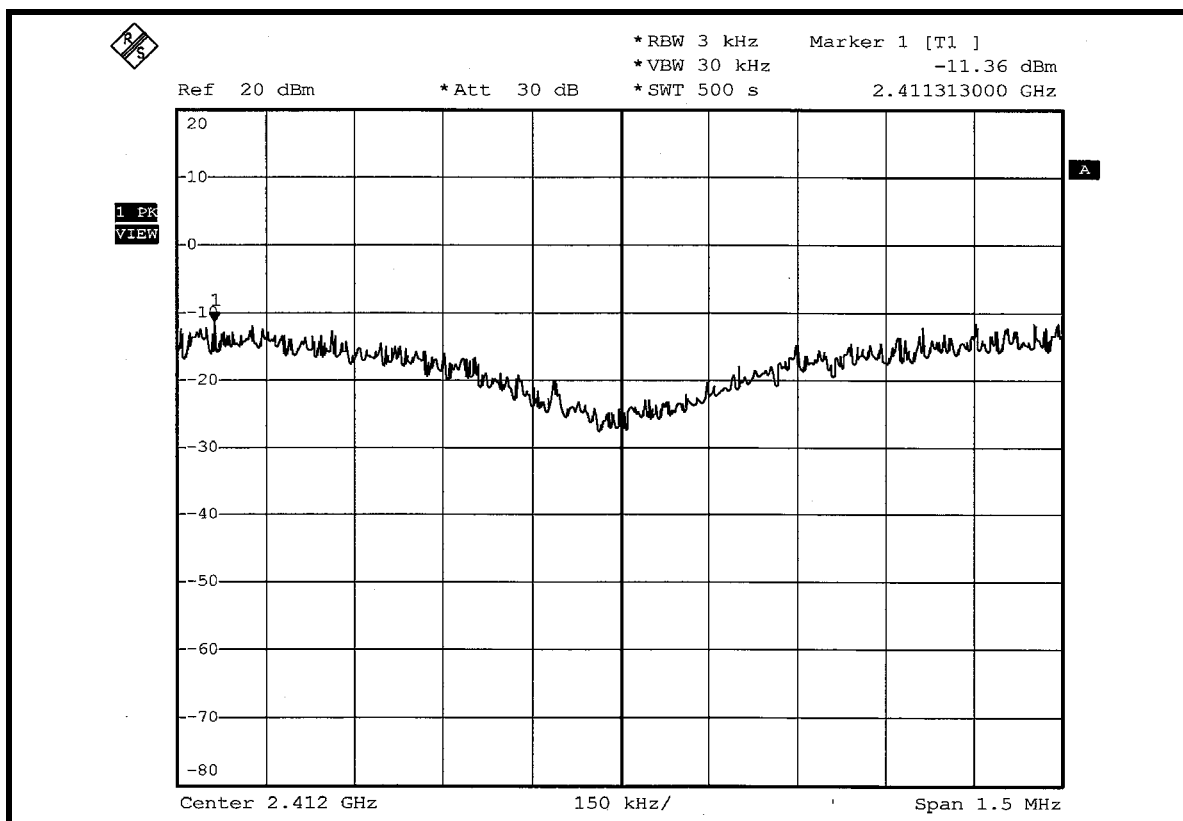

CH6

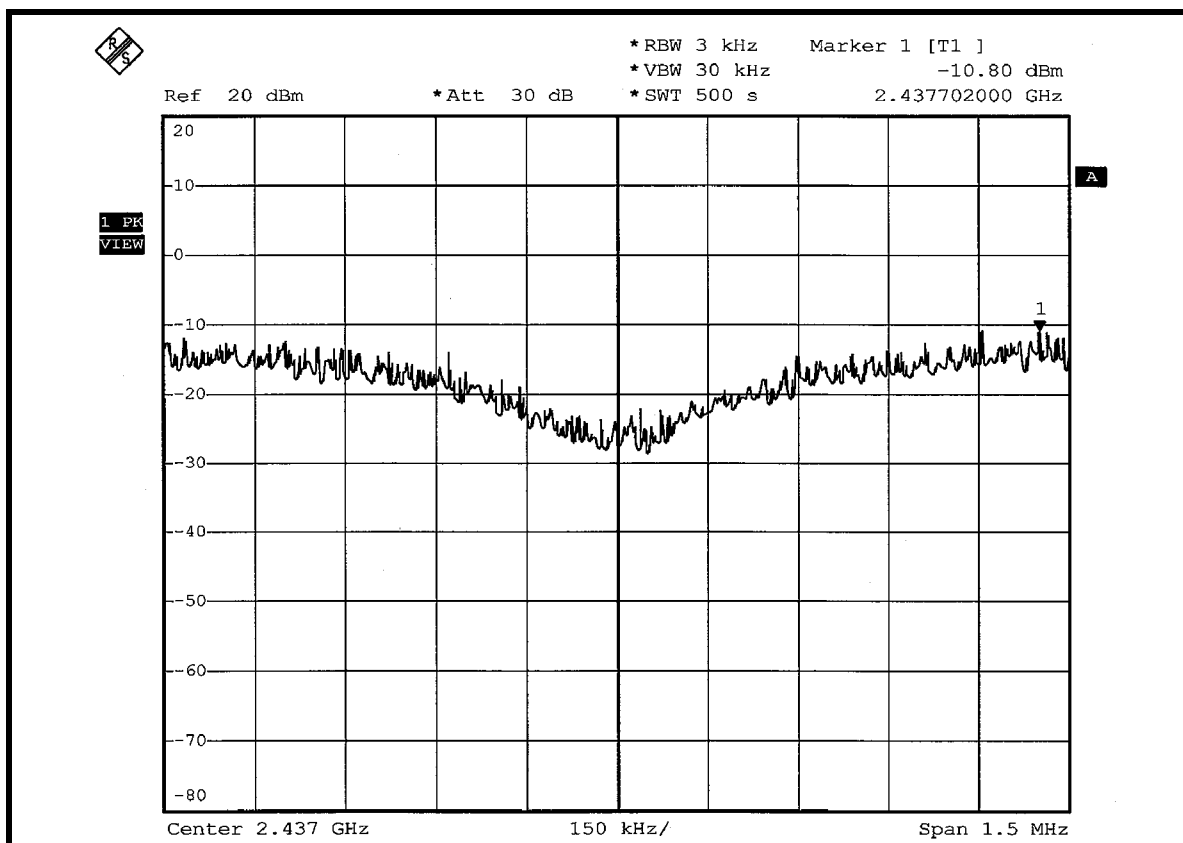

CH11

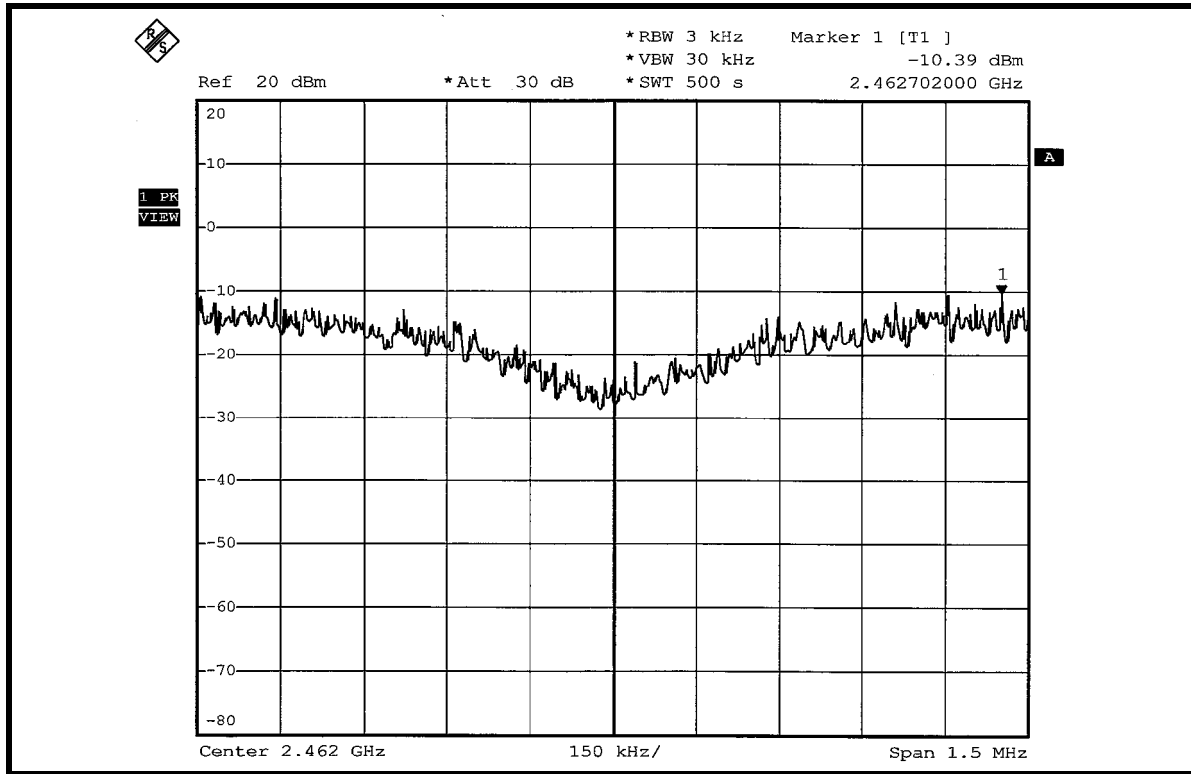



802.11g OFDM MODULATION

MODULATION TYPE	BPSK	TRANSFER RATE	6Mbps
INPUT POWER (SYSTEM)	120Vac, 60 Hz	ENVIRONMENTAL CONDITIONS	22deg. C, 63%RH, 991hPa
TESTED BY	Morgan Chen		

CHANNEL	CHANNEL FREQUENCY (MHz)	RF POWER LEVEL IN 3kHz BW (dBm)	MAXIMUM LIMIT (dBm)	PASS/FAIL
1	2412	-14.15	8	PASS
6	2437	-13.71	8	PASS
11	2462	-13.61	8	PASS

CH1

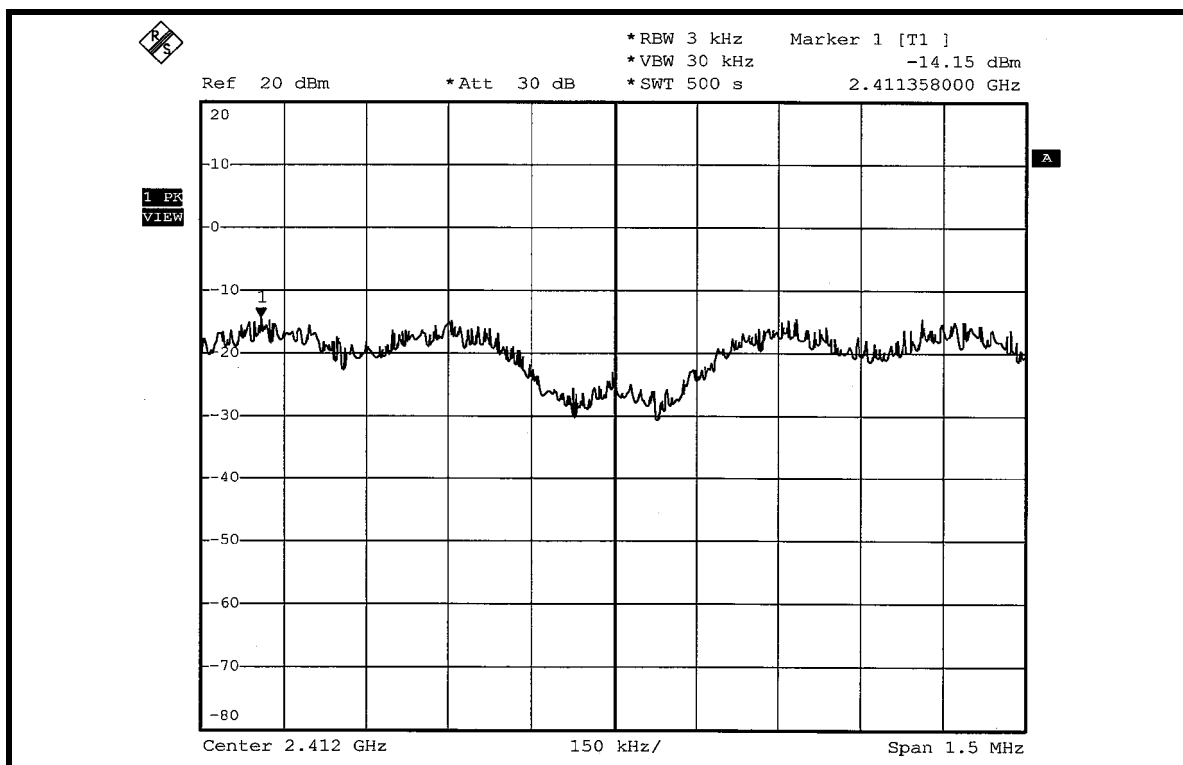

CH6

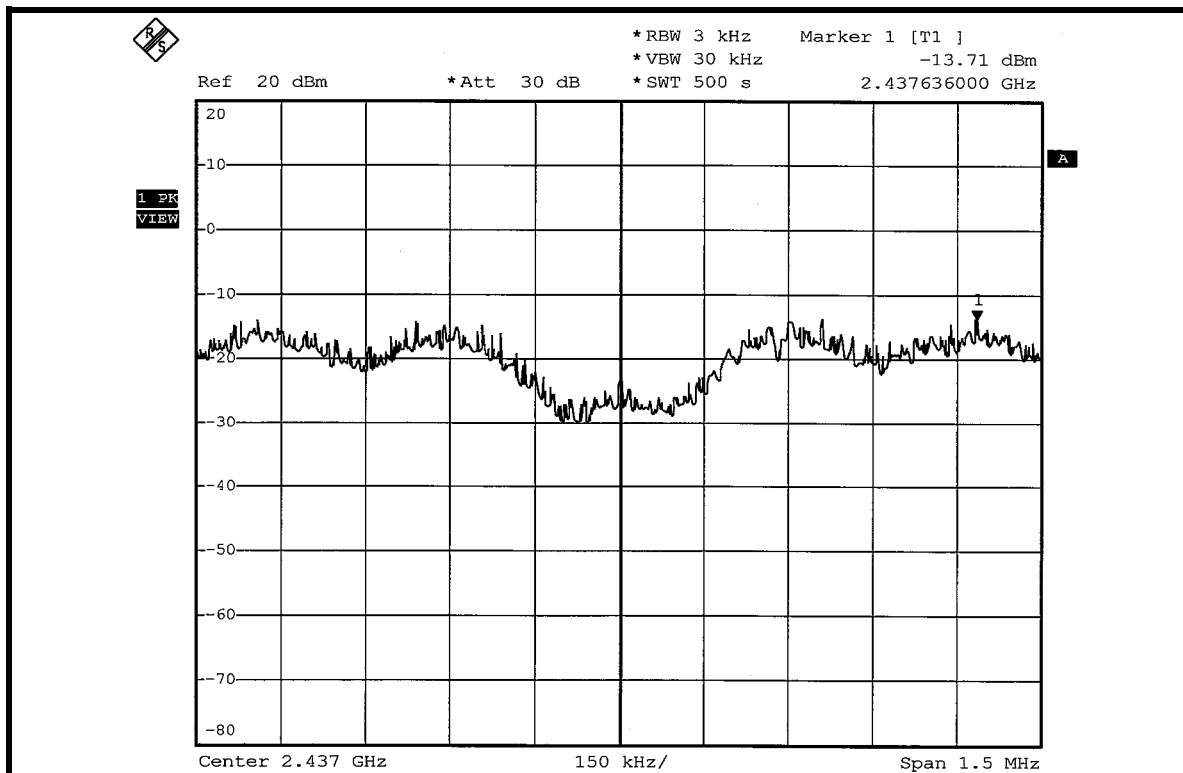

CH11

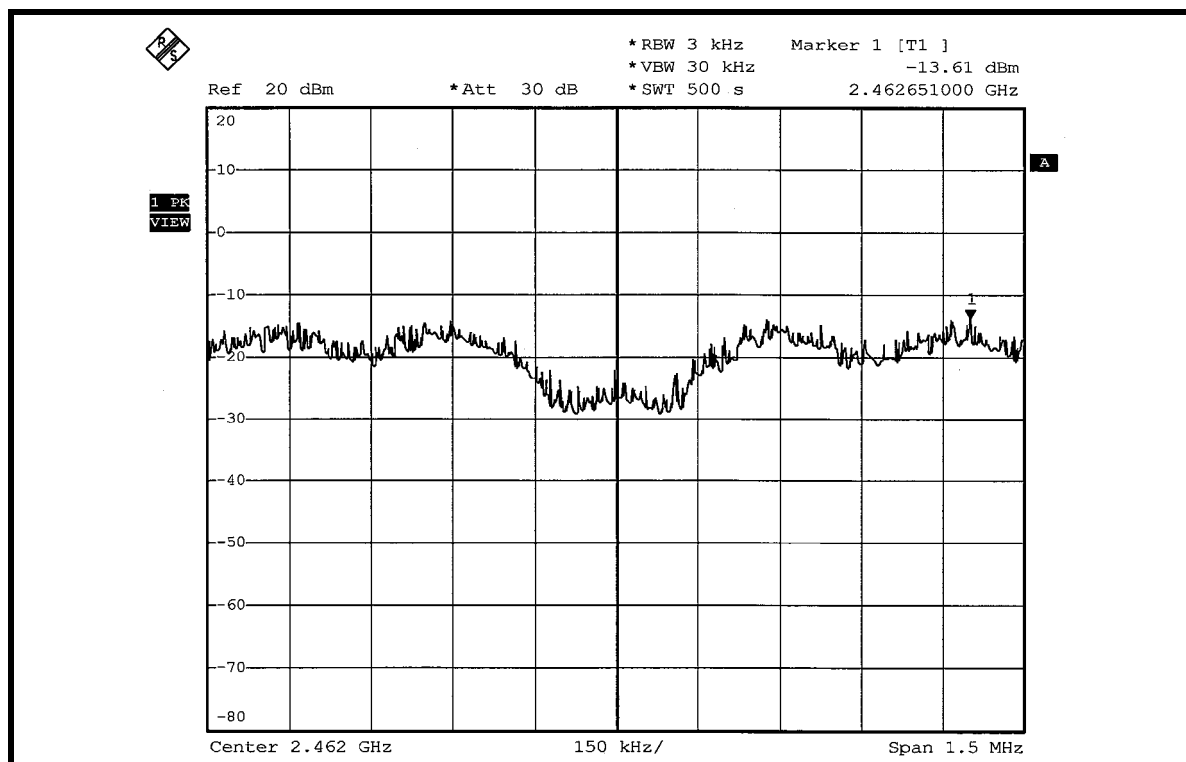



4.6 BAND EDGES MEASUREMENT

4.6.1 LIMITS OF BAND EDGES MEASUREMENT

Below -20dB of the highest emission level of operating band (in 100kHz Resolution Bandwidth).

4.6.2 TEST INSTRUMENTS

DESCRIPTION & MANUFACTURER	MODEL NO.	SERIAL NO.	CALIBRATED UNTIL
R&S SPECTRUM ANALYZER	FSEK30	100049	Aug. 14, 2006

NOTE: The calibration interval of the above test instruments is 12 months and the calibrations are traceable to NML/ROC and NIST/USA.

4.6.3 TEST PROCEDURE

The transmitter output was connected to the spectrum analyzer via a low lose cable. Set both RBW and VBW of spectrum analyzer to 100 kHz and 100 kHz with suitable frequency span including 100 MHz bandwidth from band edge. The band edges was measured and recorded.

The spectrum plots (Peak RBW=VBW=100kHz; Average RBW=1MHz, VBW=10Hz) are attached on the following pages.

4.6.4 DEVIATION FROM TEST STANDARD

No deviation

4.6.5 EUT OPERATING CONDITION

Same as Item 4.3.6

4.6.6 TEST RESULTS

The spectrum plots are attached on the following 12 images. D1 line indicates the highest level, and D2 line indicates the 20dB offset below D1. It shows compliance with the requirement in part 15.247(d).

802.11b DSSS MODULATION

NOTE 1:

The band edge emission plot on page 83 show 49.35dBc delta between carrier maximum power and local maximum emission in restrict band (2.3884GHz). The emission of carrier strength list in the test result of channel 1 at the item 4.2.7 is 102.78dBuV/m (Peak), so the maximum field strength in restrict band is $102.78 - 49.35 = 53.43$ dBuV/m, which is under 74dBuV/m limit.

The band edge emission plot on page 83 show 52.79dBc delta between carrier maximum power and local maximum emission in restrict band (2.3900GHz). The emission of carrier strength list in the test result of channel 1 at the item 4.2.7 is 99.12dBuV/m (Average), so the maximum field strength in restrict band is $99.12 - 52.79 = 46.33$ dBuV/m, which is under 54dBuV/m limit.

NOTE 2:

The band edge emission plot on the page 84 show 50.66dBc delta between carrier maximum power and local maximum emission in restrict band (2.4877GHz). The emission of carrier strength list in the test result of channel 11 at the item 4.2.7 is 102.35dBuV/m (Peak), so the maximum field strength in restrict band is $102.35 - 50.66 = 51.69$ dBuV/m, which is under 74dBuV/m limit.

The band edge emission plot on the page 85 show 51.35dBc delta between carrier maximum power and local maximum emission in restrict band (2.4835GHz). The emission of carrier strength list in the test result of channel 11 at the item 4.2.7 is 99.29dBuV/m (Average), so the maximum field strength in restrict band is $99.29 - 51.35 = 47.94$ dBuV/m, which is under 54dBuV/m limit.

802.11b DSSS MODULATION

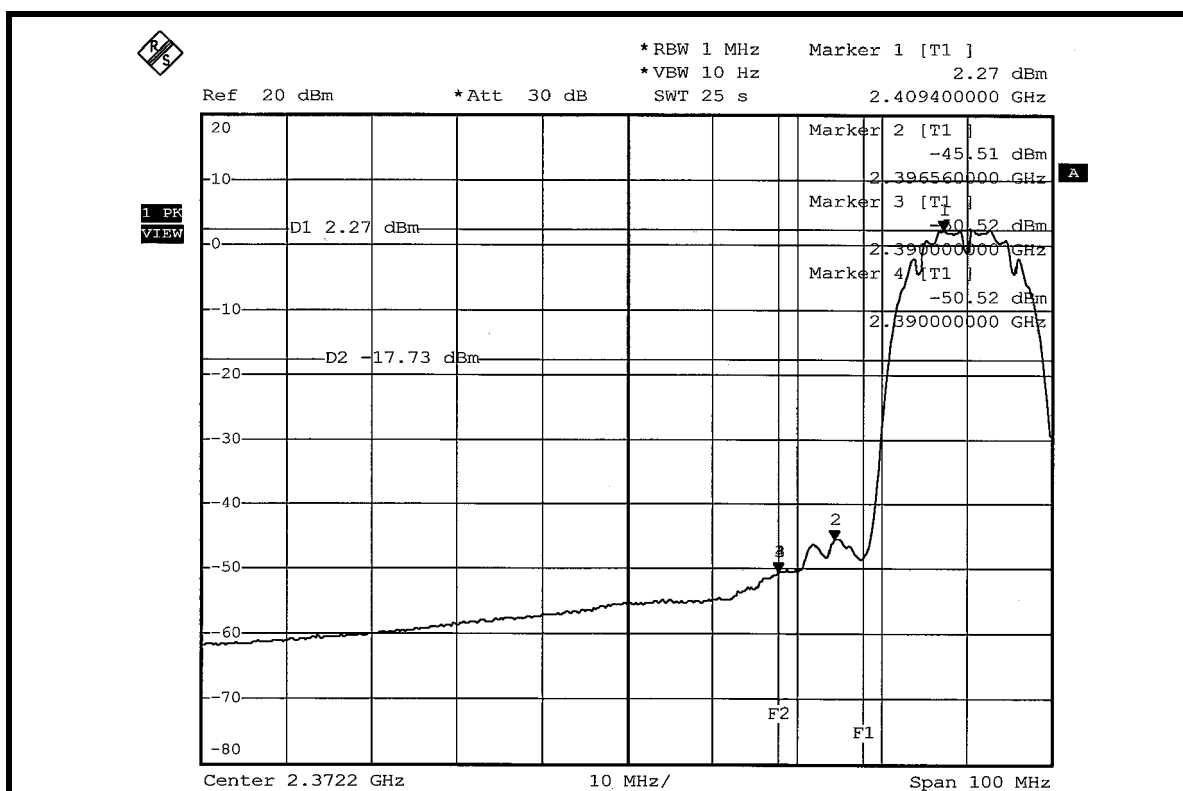
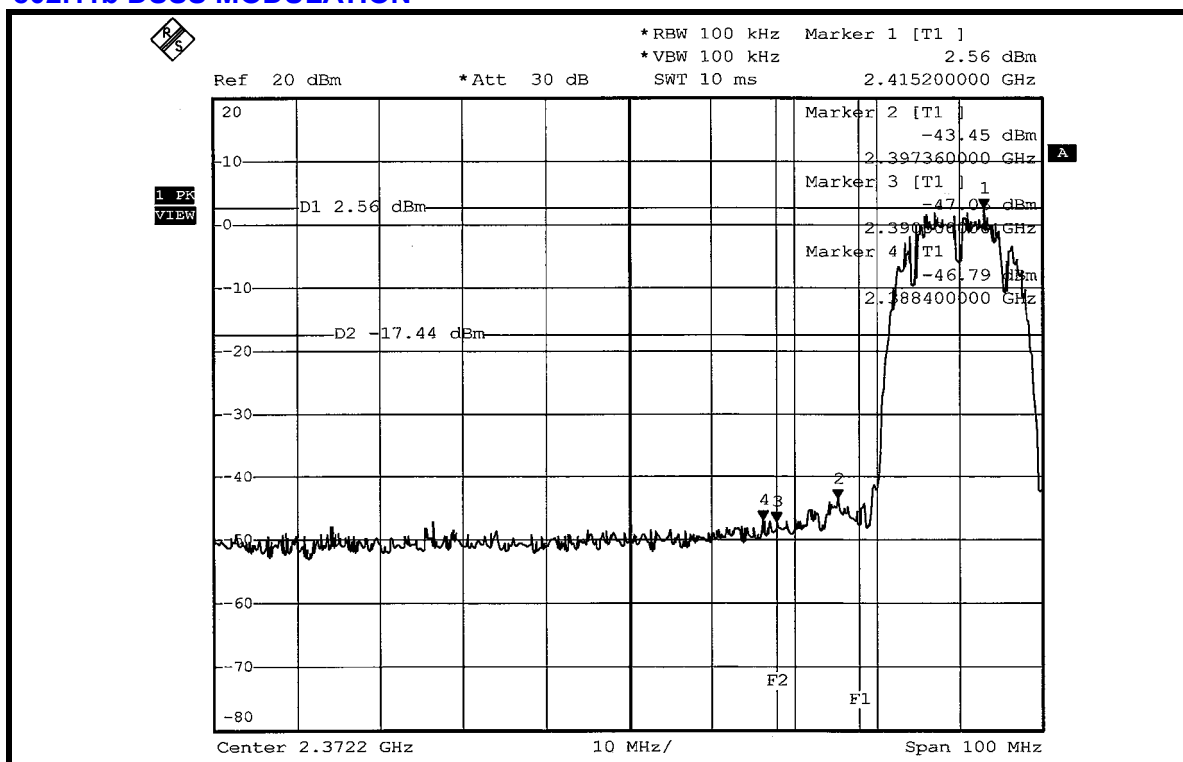

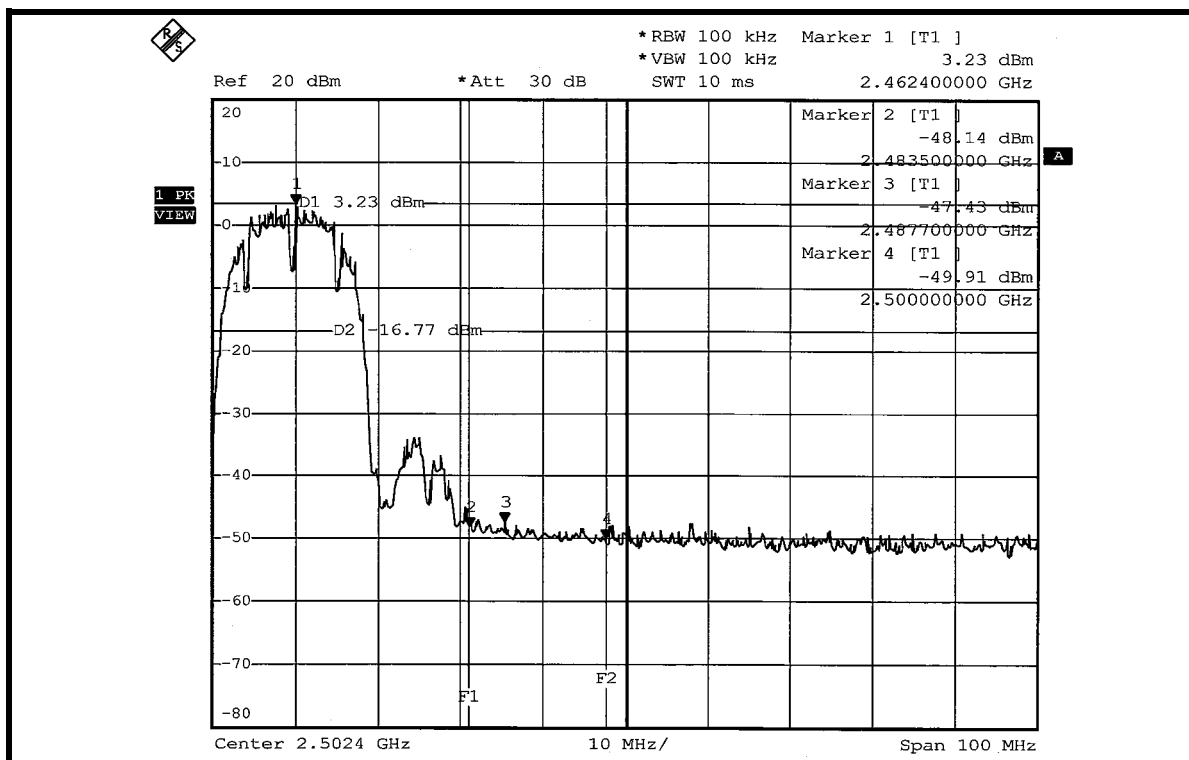
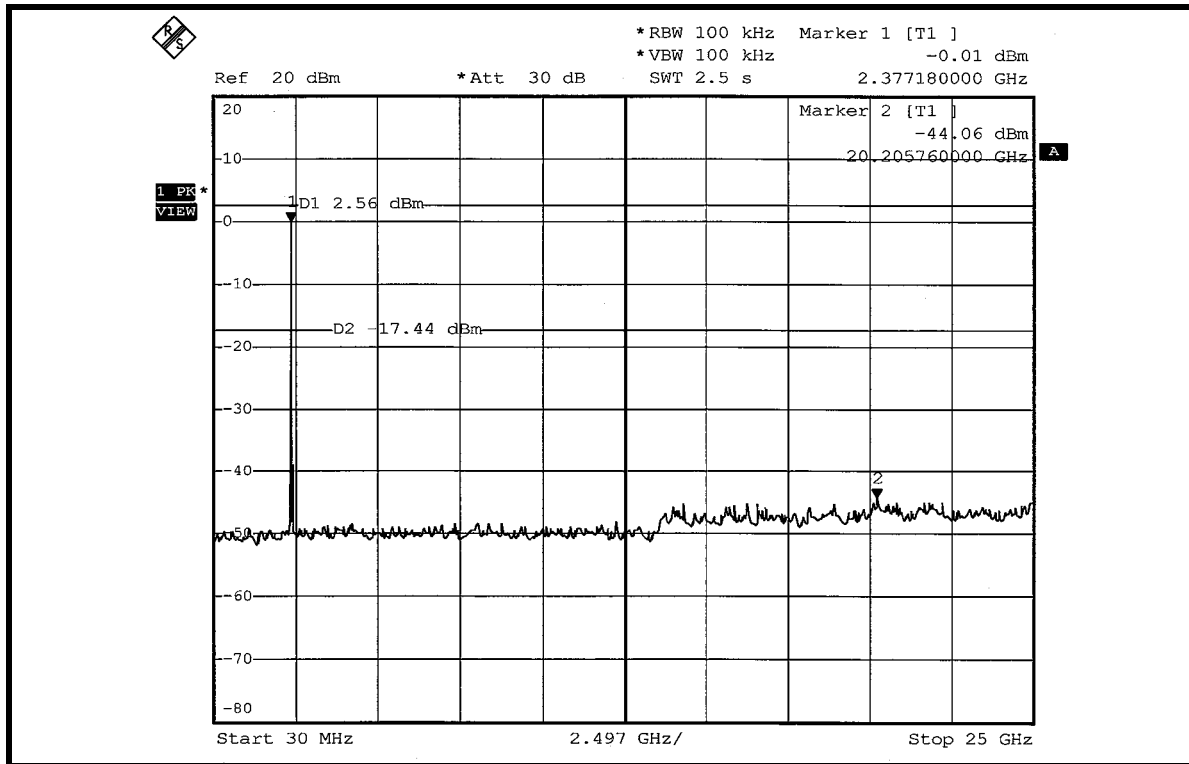

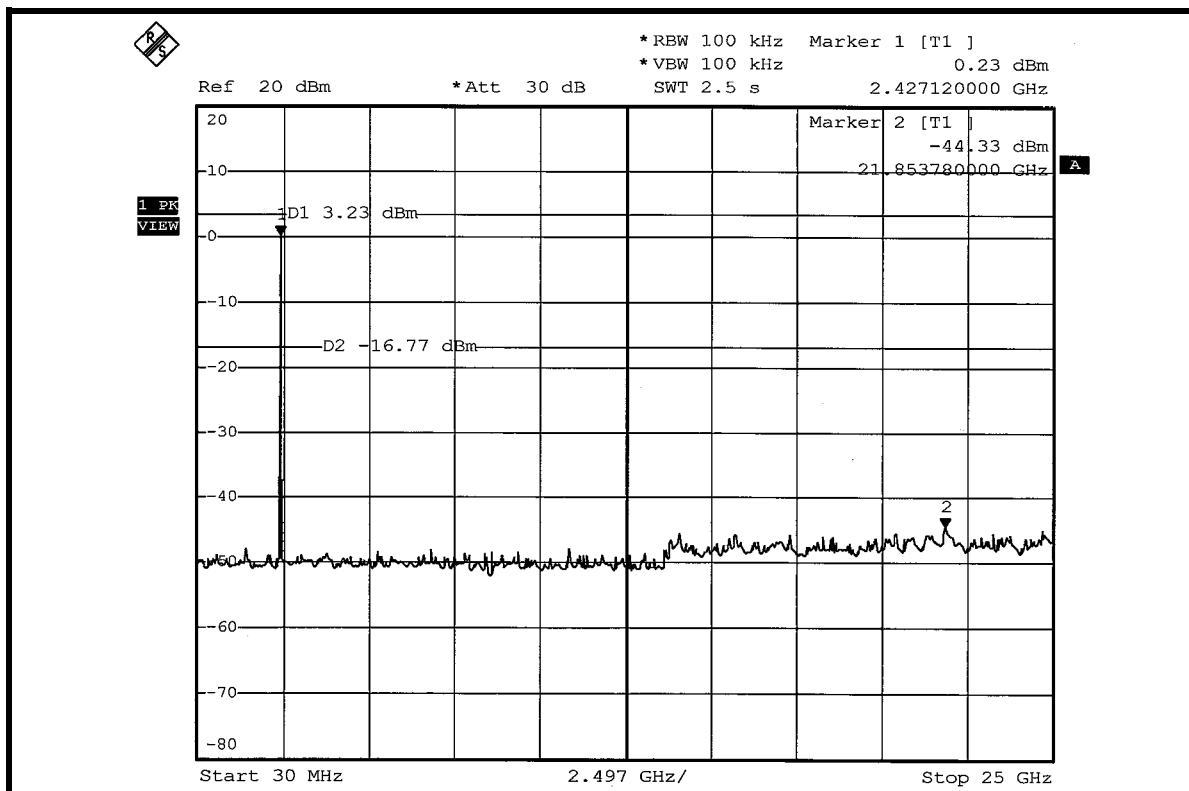
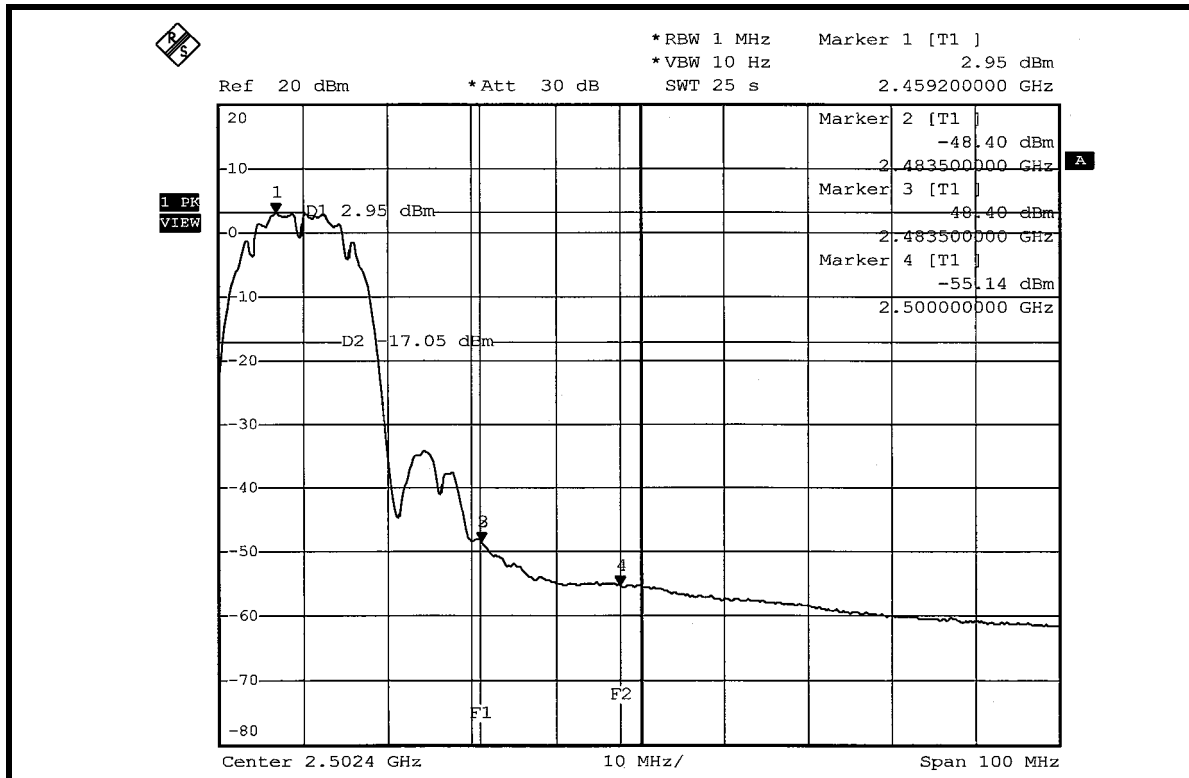

802.11g OFDM MODULATION

NOTE 1:

The band edge emission plot on page 87 show 42.00dBc delta between carrier maximum power and local maximum emission in restrict band (2.3892GHz). The emission of carrier strength list in the test result of channel 1 at the item 4.2.7 is 105.68dBuV/m (Peak), so the maximum field strength in restrict band is $105.68 - 42.00 = 63.68$ dBuV/m, which is under 74dBuV/m limit.

The band edge emission plot on page 87 show 47.83Bc delta between carrier maximum power and local maximum emission in restrict band (2.3900GHz). The emission of carrier strength list in the test result of channel 1 at the item 4.2.7 is 96.28dBuV/m (Average), so the maximum field strength in restrict band is $96.28 - 47.83 = 48.45$ dBuV/m, which is under 54dBuV/m limit.

NOTE 2:

The band edge emission plot on the page 88 show 39.12dBc delta between carrier maximum power and local maximum emission in restrict band (2.4835GHz). The emission of carrier strength list in the test result of channel 11 at the item 4.2.7 is 105.32dBuV/m (Peak), so the maximum field strength in restrict band is $105.32 - 39.12 = 66.20$ dBuV/m, which is under 74dBuV/m limit.

The band edge emission plot on the page 89 show 42.02dBc delta between carrier maximum power and local maximum emission in restrict band (2.4835GHz). The emission of carrier strength list in the test result of channel 11 at the item 4.2.7 is 95.65dBuV/m (Average), so the maximum field strength in restrict band is $95.65 - 42.02 = 53.63$ dBuV/m, which is under 54dBuV/m limit.

802.11g OFDM MODULATION

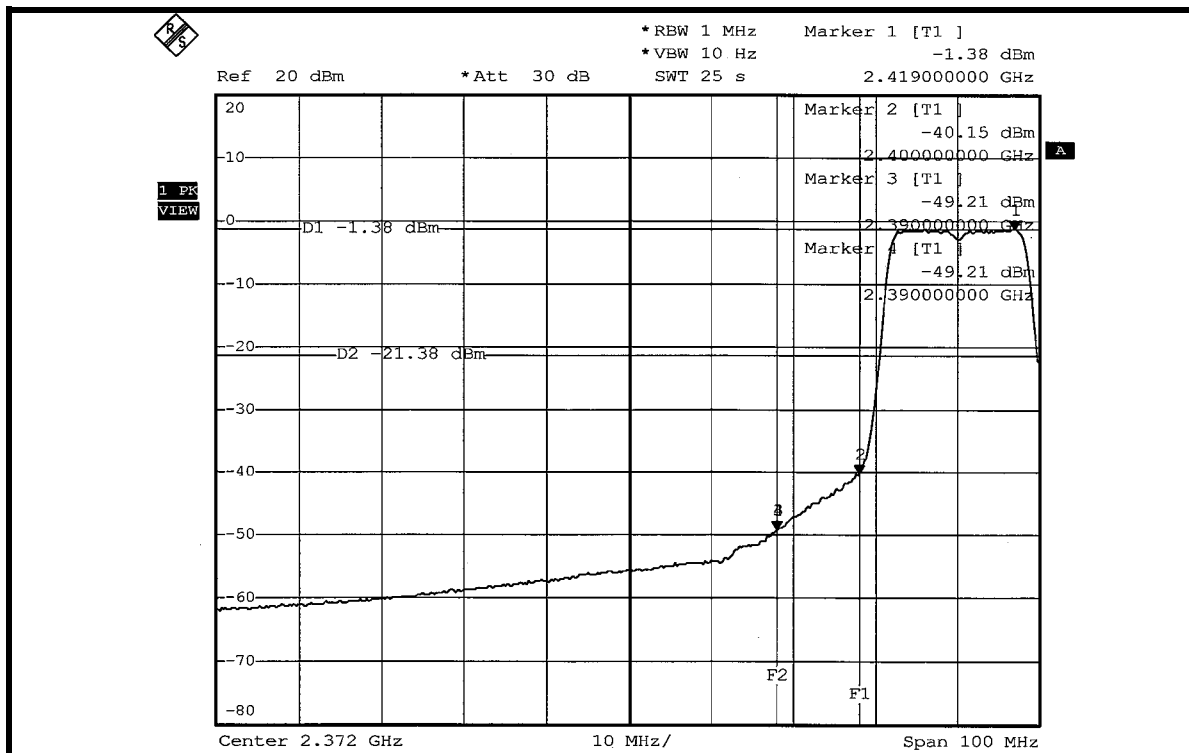
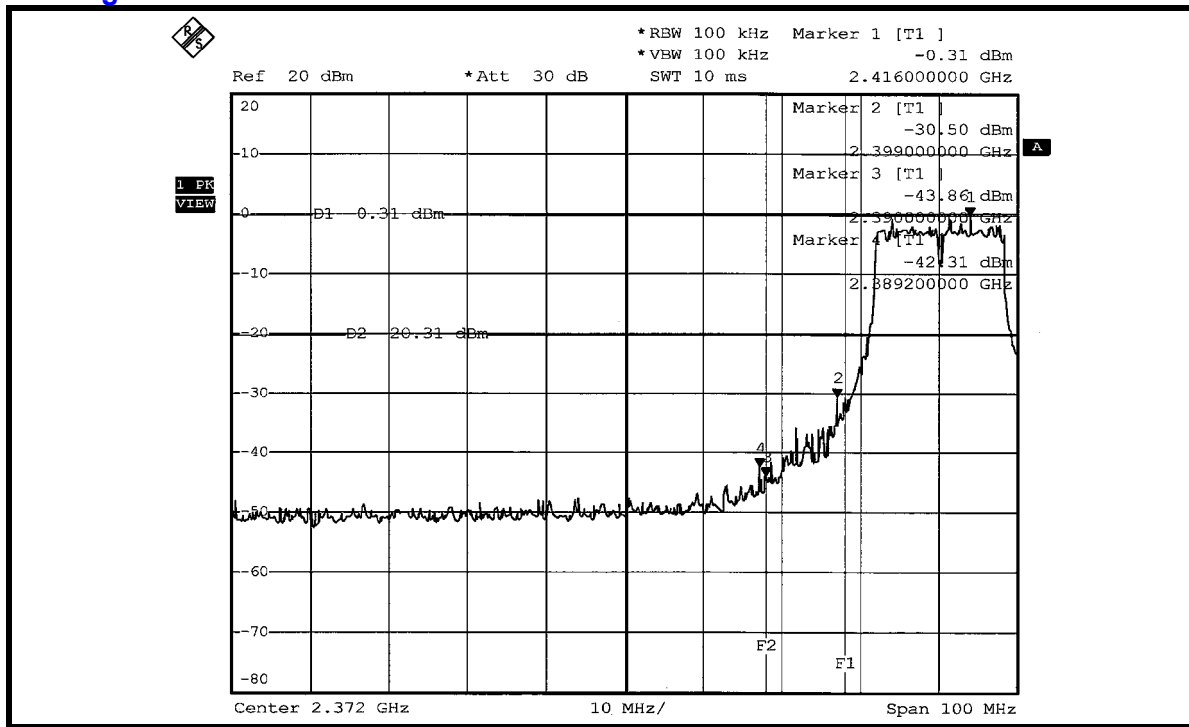

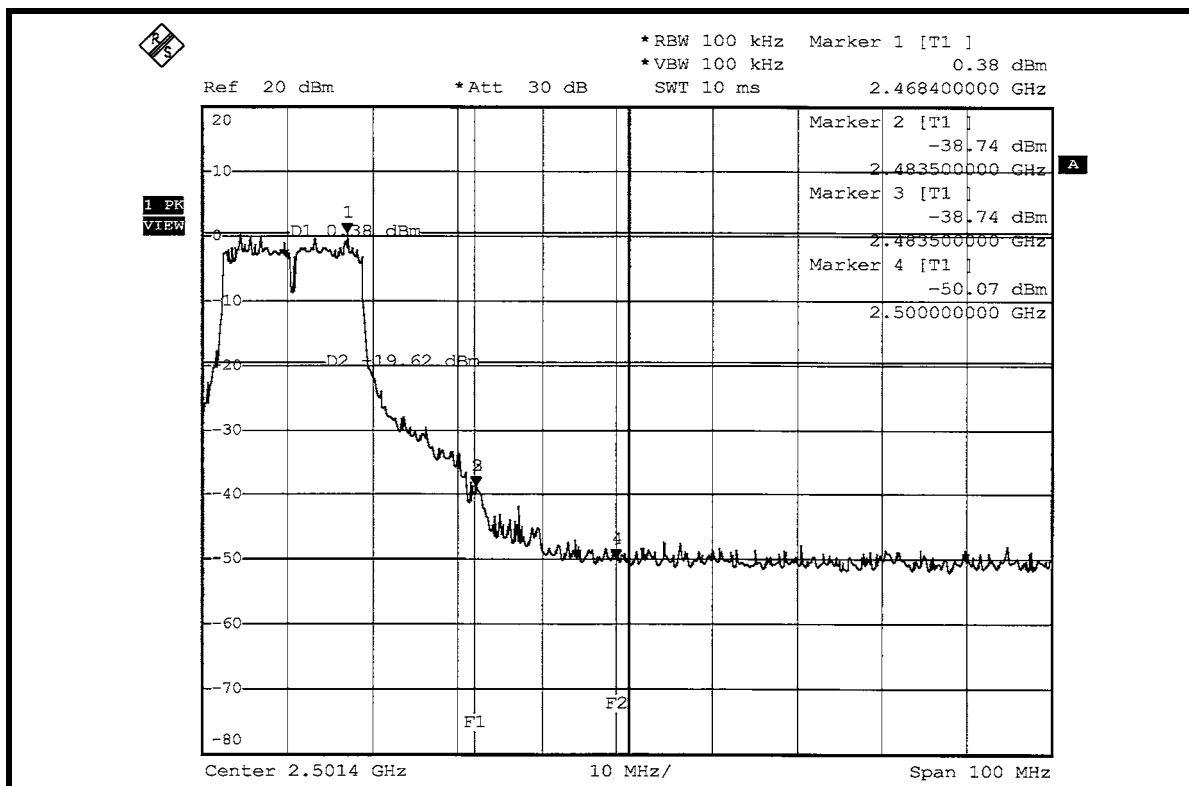
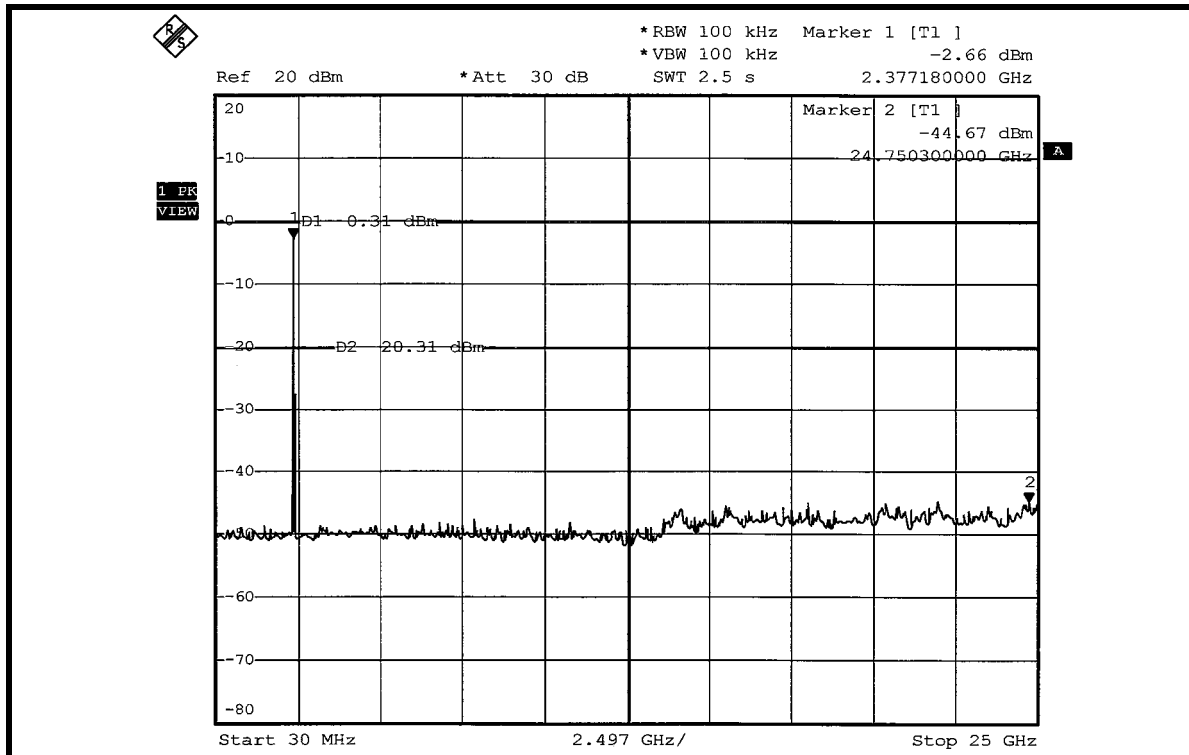

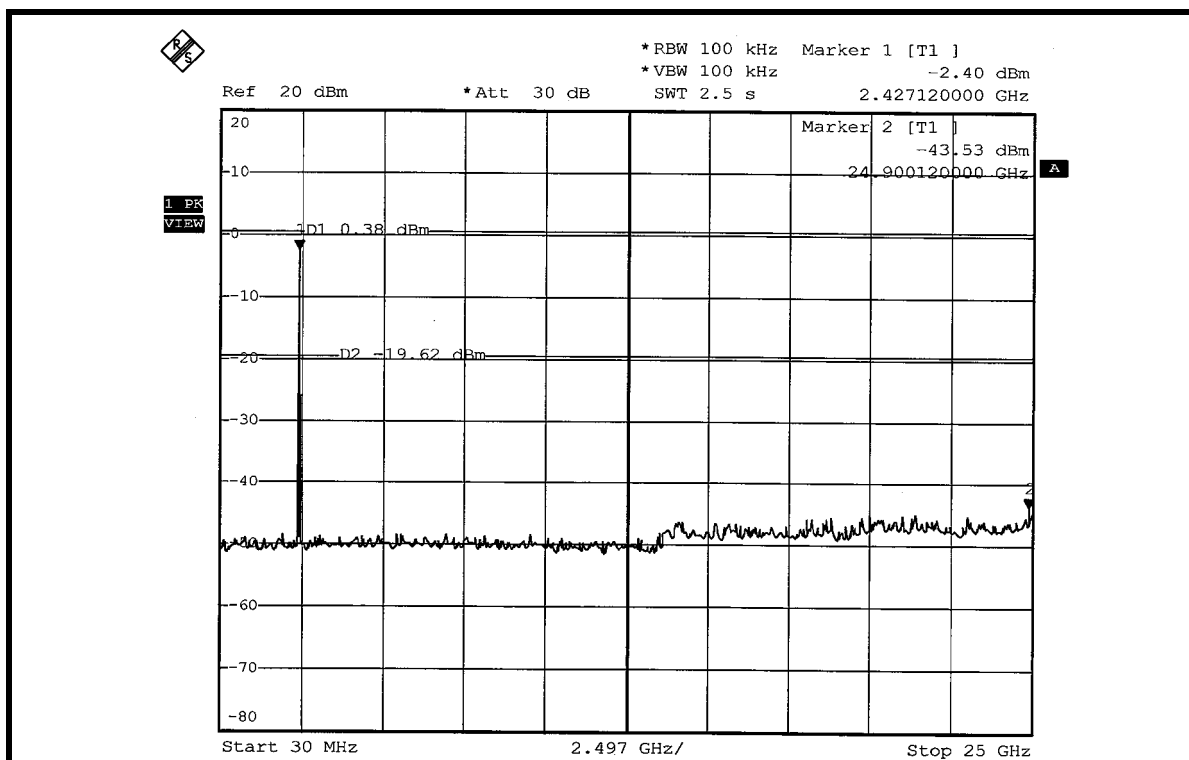
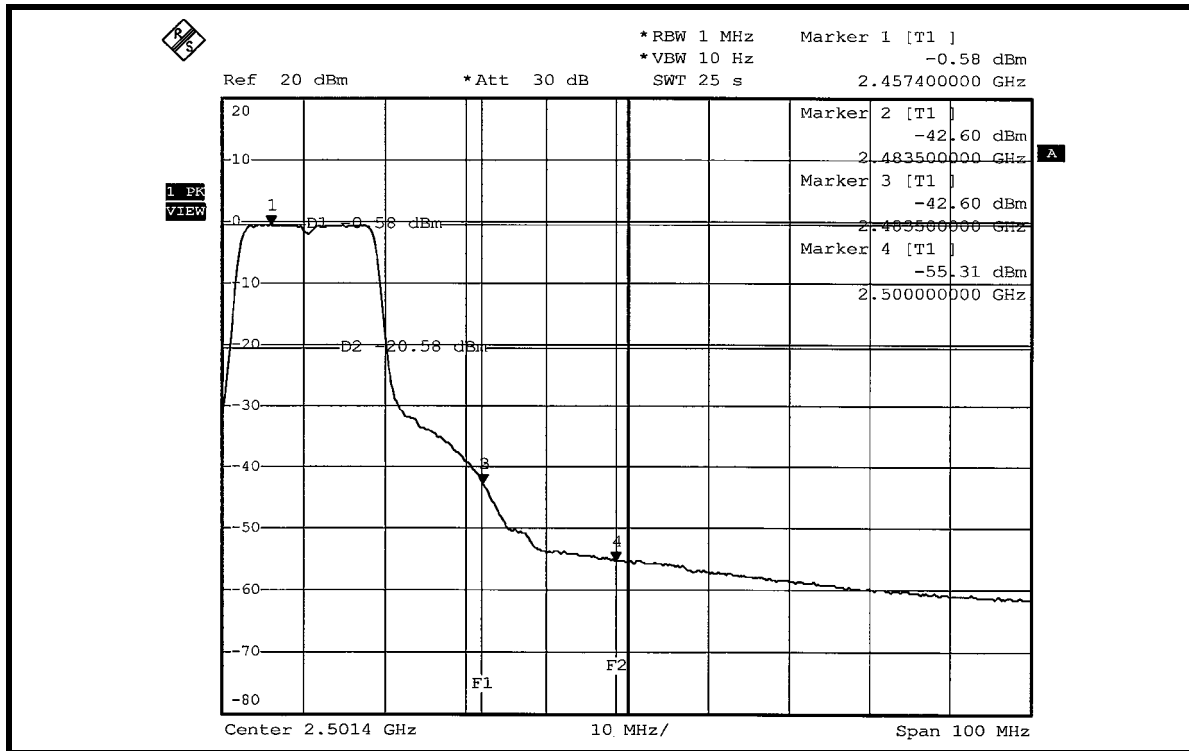



4.7 ANTENNA REQUIREMENT

4.7.1 STANDARD APPLICABLE

For intentional device, according to FCC 47 CFR Section 15.203, an intentional radiator shall be designed to ensure that no antenna other than that furnished by the responsible party shall be used with the device. And according to FCC 47 CFR Section 15.247 (b), if transmitting antennas of directional gain greater than 6dBi are used, the power shall be reduced by the amount in dB that the directional gain of the antenna exceeds 6dBi.

4.7.2 ANTENNA CONNECTED CONSTRUCTION

The antenna used in this product is monopole antenna without connector. The maximum Gain of the antenna is -1.0dBi .

5. TEST TYPES AND RESULTS (FOR BLUETOOTH FUNCTION)

5.1 CONDUCTED EMISSION MEASUREMENT

5.1.1 LIMITS OF CONDUCTED EMISSION MEASUREMENT

FREQUENCY OF EMISSION (MHz)	CONDUCTED LIMIT (dB μ V)	
	Quasi-peak	Average
0.15 ~ 0.5	66 to 56	56 to 46
0.5 ~ 5	56	46
5 ~ 30	60	50

- NOTE:**
1. The lower limit shall apply at the transition frequencies.
 2. The limit decreases in line with the logarithm of the frequency in the range of 0.15 to 0.50 MHz.
 3. All emanations from a class A/B digital device or system, including any network of conductors and apparatus connected thereto, shall not exceed the level of field strengths specified above.

5.1.2 TEST INSTRUMENTS

DESCRIPTION & MANUFACTURER	MODEL NO.	SERIAL NO.	CALIBRATED UNTIL
Test Receiver ROHDE & SCHWARZ	ESCS30	100288	Nov. 02, 2006
RF signal cable Woken	5D-FB	Cable-HYCO3-01	Jan. 06, 2007
LISN ROHDE & SCHWARZ	ESH2-Z5	100100	Jan. 09, 2007
LISN ROHDE & SCHWARZ	ESH3-Z5	100311	Jan. 22, 2007
Software ADT	ADT_Cond_V3	NA	NA

- NOTE:**
1. The calibration interval of the above test instruments is 12 months and the calibrations are traceable to NML/ROC and NIST/USA.
 2. The test was performed in HwaYa Shielded Room 2.
 3. The VCCI Site Registration No. is C-20

5.1.3 TEST PROCEDURES

- a. The EUT was placed 0.4 meters from the conducting wall of the shielded room with EUT being connected to the power mains through a line impedance stabilization network (LISN). Other support units were connected to the power mains through another LISN. The two LISNs provide 50 ohm/ 50uH of coupling impedance for the measuring instrument.
- b. Both lines of the power mains connected to the EUT were checked for maximum conducted interference.
- c. The frequency range from 150kHz to 30MHz was searched. Emission levels under (Limit - 20dB) was not recorded.

5.1.4 DEVIATION FROM TEST STANDARD

No deviation

5.1.5 TEST SETUP

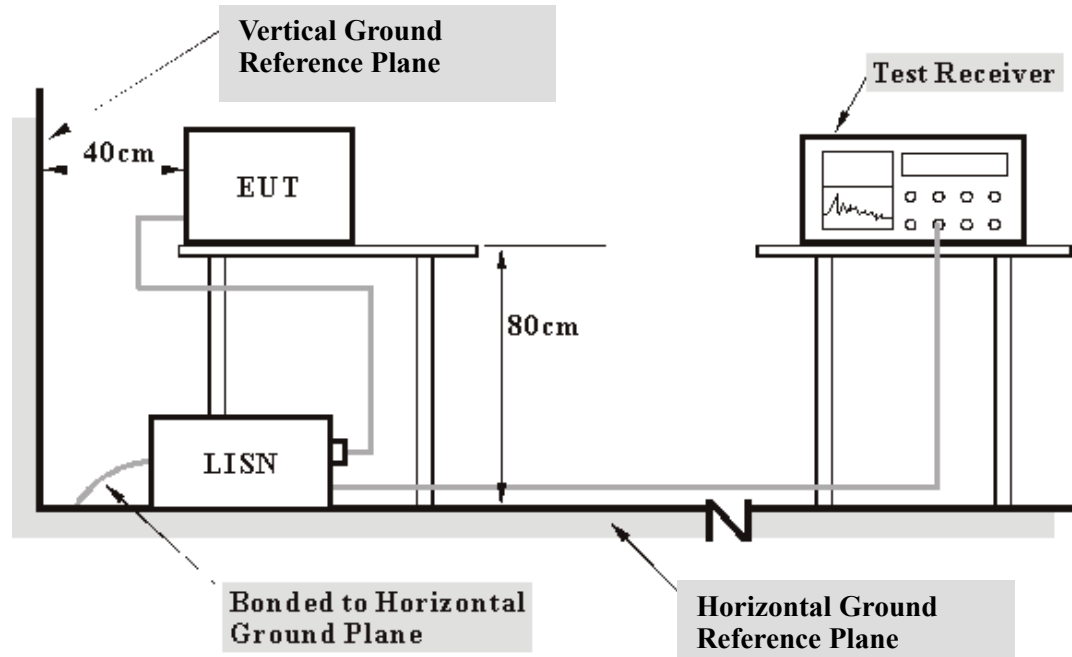

- Note:**
1. Support units were connected to second LISN.
 2. Both of LISNs (AMN) 80 cm from EUT and at the least 80 cm from other units and other metal planes support units.

For the actual test configuration, please refer to the related item – Photographs of the Test Configuration.

5.1.6 EUT OPERATING CONDITIONS

TEST MODE A ~ C:

The EUT placed on the testing table and set it under transmission condition continuously at specific channel frequency.

TEST MODE E:

- a. Connected the EUT to a notebook system via USB cable and placed on a testing table.
- b. The notebook system ran a test program (provided by manufacturer) to enable EUT under transmission condition continuously at specific channel frequency.
- c. The notebook system sent "H" messages to its screen.
- d. The notebook system sent "H" messages to modem.
- e. The notebook system sent "H" messages to printer, and the printer printed them on paper.
- f. Steps c ~ e were repeated.

5.1.7 TEST RESULTS

CONDUCTED WORST CASE DATA (FOR ADAPTER: PSAA05A-050):

EUT TEST CONDITION		MEASUREMENT DETAIL	
CHANNEL	Channel 0	PHASE	Line 1
MODULATION TYPE	GFSK	6dB BANDWIDTH	9 kHz
ENVIRONMENTAL CONDITIONS	20deg. C, 60%RH, 991hPa	INPUT POWER (SYSTEM)	120Vac, 60 Hz
TEST MODE	A	TESTED BY	Match Tsui

NO	FREQ. [MHz]	CORR. FACTOR (dB)	READING VALUE [dB (uV)]		EMISSION LEVEL [dB (uV)]		LIMIT [dB (uV)]		MARGIN (dB)	
			Q.P.	AV.	Q.P.	AV.	Q.P.	AV.	Q.P.	AV.
			1	0.183	0.10	33.47	-	33.57	-	64.33
2	0.306	0.10	30.15	-	30.25	-	60.07	50.07	-29.82	-
3	0.490	0.10	32.60	-	32.70	-	56.17	46.17	-23.47	-
4	2.082	0.21	38.87	-	39.08	-	56.00	46.00	-16.92	-
5	6.254	0.37	30.86	-	31.23	-	60.00	50.00	-28.77	-
6	17.727	0.59	32.39	-	32.98	-	60.00	50.00	-27.02	-

- REMARKS:**
1. Q.P. and AV. are abbreviations of quasi-peak and average individually.
 2. "-": The Quasi-peak reading value also meets average limit and measurement with the average detector is unnecessary.
 3. The emission levels of other frequencies were very low against the limit.
 4. Margin value = Emission level - Limit value
 5. Correction factor = Insertion loss + Cable loss
 6. Emission Level = Correction Factor + Reading Value.

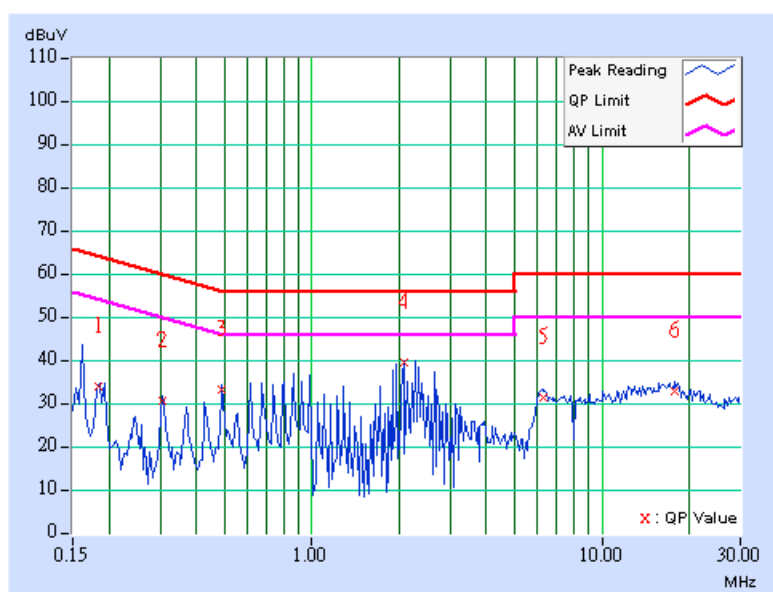

EUT TEST CONDITION		MEASUREMENT DETAIL	
CHANNEL	Channel 0	PHASE	Line 2
MODULATION TYPE	GFSK	6dB BANDWIDTH	9 kHz
ENVIRONMENTAL CONDITIONS	20deg. C, 60%RH, 991hPa	INPUT POWER (SYSTEM)	120Vac, 60 Hz
TEST MODE	A	TESTED BY	Match Tsui

NO	FREQ. [MHz]	CORR. FACTOR (dB)	READING VALUE [dB (uV)]		EMISSION LEVEL [dB (uV)]		LIMIT [dB (uV)]		MARGIN (dB)	
			Q.P.	AV.	Q.P.	AV.	Q.P.	AV.	Q.P.	AV.
1	0.181	0.10	33.15	-	33.25	-	64.43	54.43	-31.18	-
2	0.306	0.10	31.86	-	31.96	-	60.07	50.07	-28.11	-
3	0.490	0.11	34.20	-	34.31	-	56.17	46.17	-21.86	-
4	2.270	0.22	40.70	-	40.92	-	56.00	46.00	-15.08	-
5	6.441	0.41	32.57	-	32.98	-	60.00	50.00	-27.02	-
6	15.766	0.62	30.33	-	30.95	-	60.00	50.00	-29.05	-

- REMARKS:**
1. Q.P. and AV. are abbreviations of quasi-peak and average individually.
 2. "-": The Quasi-peak reading value also meets average limit and measurement with the average detector is unnecessary.
 3. The emission levels of other frequencies were very low against the limit.
 4. Margin value = Emission level - Limit value.
 5. Correction factor = Insertion loss + Cable loss.
 6. Emission Level = Correction Factor + Reading Value.

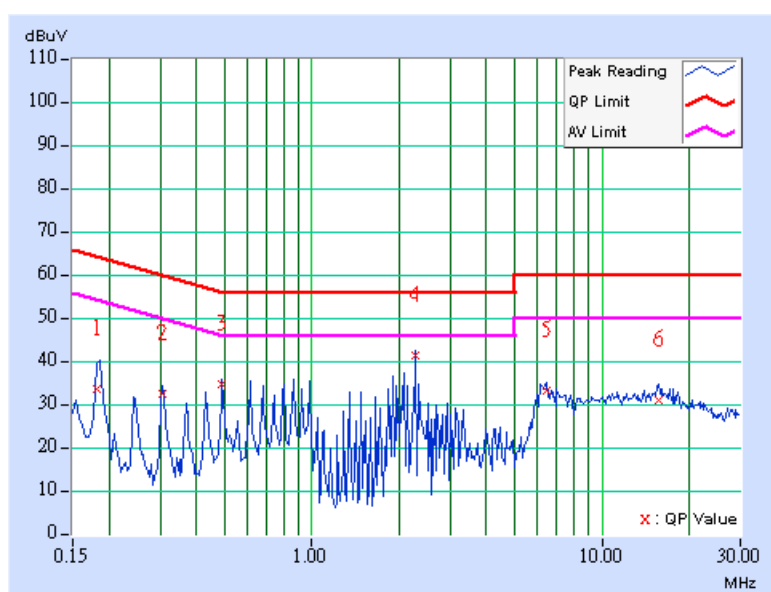

EUT TEST CONDITION		MEASUREMENT DETAIL	
CHANNEL	Channel 39	PHASE	Line 1
MODULATION TYPE	GFSK	6dB BANDWIDTH	9 kHz
ENVIRONMENTAL CONDITIONS	20deg. C, 60%RH, 991hPa	INPUT POWER (SYSTEM)	120Vac, 60 Hz
TEST MODE	A	TESTED BY	Match Tsui

NO	FREQ. [MHz]	CORR. FACTOR (dB)	READING VALUE [dB (uV)]		EMISSION LEVEL [dB (uV)]		LIMIT [dB (uV)]		MARGIN (dB)	
			Q.P.	AV.	Q.P.	AV.	Q.P.	AV.	Q.P.	AV.
			1	0.185	0.10	32.79	-	32.89	-	64.25
2	0.306	0.10	30.21	-	30.31	-	60.07	50.07	-29.76	-
3	0.861	0.10	31.93	-	32.03	-	56.00	46.00	-23.97	-
4	2.086	0.21	40.50	-	40.71	-	56.00	46.00	-15.29	-
5	6.316	0.37	31.23	-	31.60	-	60.00	50.00	-28.40	-
6	17.414	0.60	31.26	-	31.86	-	60.00	50.00	-28.14	-

- REMARKS:**
1. Q.P. and AV. are abbreviations of quasi-peak and average individually.
 2. "-": The Quasi-peak reading value also meets average limit and measurement with the average detector is unnecessary.
 3. The emission levels of other frequencies were very low against the limit.
 4. Margin value = Emission level - Limit value.
 5. Correction factor = Insertion loss + Cable loss.
 6. Emission Level = Correction Factor + Reading Value.

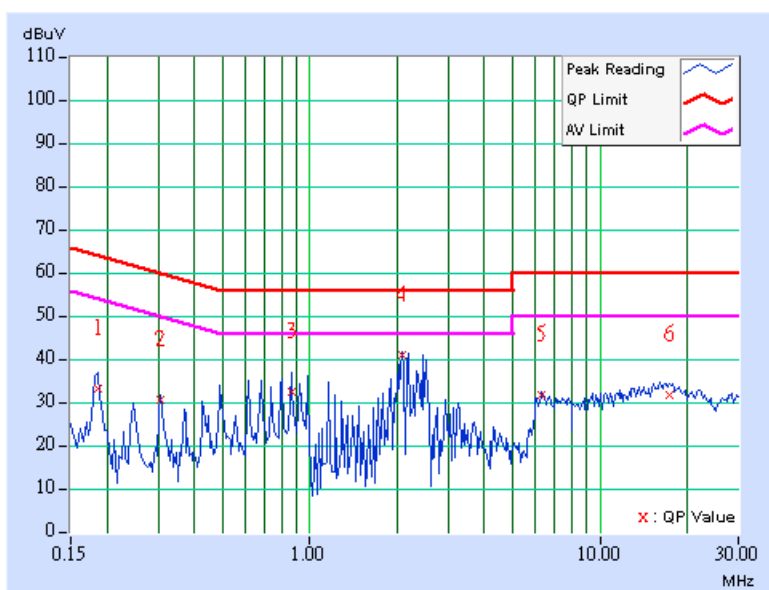

EUT TEST CONDITION		MEASUREMENT DETAIL	
CHANNEL	Channel 39	PHASE	Line 2
MODULATION TYPE	GFSK	6dB BANDWIDTH	9 kHz
ENVIRONMENTAL CONDITIONS	20deg. C, 60%RH, 991hPa	INPUT POWER (SYSTEM)	120Vac, 60 Hz
TEST MODE	A	TESTED BY	Match Tsui

NO	FREQ. [MHz]	CORR. FACTOR (dB)	READING VALUE [dB (uV)]		EMISSION LEVEL [dB (uV)]		LIMIT [dB (uV)]		MARGIN (dB)	
			Q.P.	AV.	Q.P.	AV.	Q.P.	AV.	Q.P.	AV.
			1	0.185	0.10	34.23	-	34.33	-	64.25
2	0.306	0.10	31.82	-	31.92	-	60.07	50.07	-28.15	-
3	0.490	0.11	34.16	-	34.27	-	56.17	46.17	-21.90	-
4	2.270	0.22	40.26	-	40.48	-	56.00	46.00	-15.52	-
5	6.195	0.40	32.97	-	33.37	-	60.00	50.00	-26.63	-
6	16.559	0.61	30.96	-	31.57	-	60.00	50.00	-28.43	-

- REMARKS:**
1. Q.P. and AV. are abbreviations of quasi-peak and average individually.
 2. "-": The Quasi-peak reading value also meets average limit and measurement with the average detector is unnecessary.
 3. The emission levels of other frequencies were very low against the limit.
 4. Margin value = Emission level - Limit value.
 5. Correction factor = Insertion loss + Cable loss.
 6. Emission Level = Correction Factor + Reading Value.

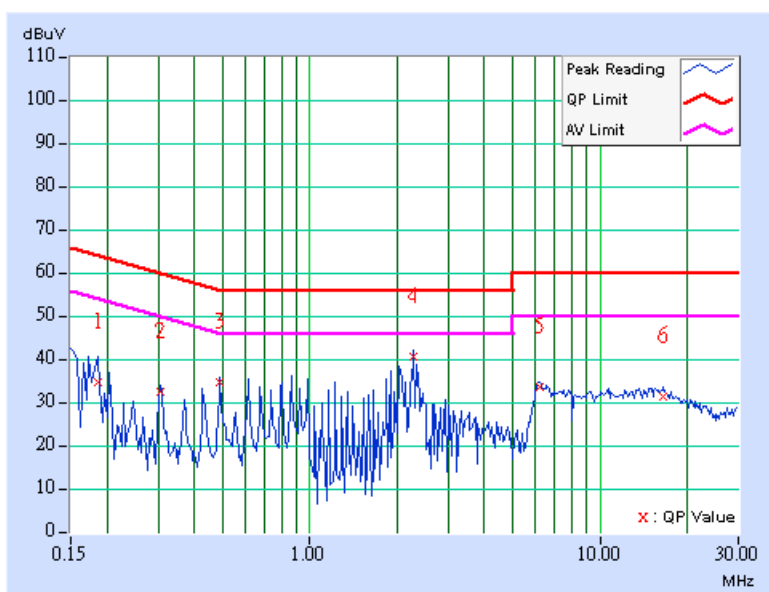

EUT TEST CONDITION		MEASUREMENT DETAIL	
CHANNEL	Channel 78	PHASE	Line 1
MODULATION TYPE	GFSK	6dB BANDWIDTH	9 kHz
ENVIRONMENTAL CONDITIONS	20deg. C, 60%RH, 991hPa	INPUT POWER (SYSTEM)	120Vac, 60 Hz
TEST MODE	A	TESTED BY	Match Tsui

NO	FREQ. [MHz]	CORR. FACTOR (dB)	READING VALUE [dB (uV)]		EMISSION LEVEL [dB (uV)]		LIMIT [dB (uV)]		MARGIN (dB)	
			Q.P.	AV.	Q.P.	AV.	Q.P.	AV.	Q.P.	AV.
			1	0.181	0.10	32.16	-	32.26	-	64.43
2	0.306	0.10	30.13	-	30.23	-	60.07	50.07	-29.84	-
3	0.857	0.10	31.25	-	31.35	-	56.00	46.00	-24.65	-
4	2.086	0.21	35.52	-	35.73	-	56.00	46.00	-20.27	-
5	6.313	0.37	27.36	-	27.73	-	60.00	50.00	-32.27	-
6	17.414	0.60	29.18	-	29.78	-	60.00	50.00	-30.22	-

- REMARKS:**
1. Q.P. and AV. are abbreviations of quasi-peak and average individually.
 2. "-": The Quasi-peak reading value also meets average limit and measurement with the average detector is unnecessary.
 3. The emission levels of other frequencies were very low against the limit.
 4. Margin value = Emission level - Limit value.
 5. Correction factor = Insertion loss + Cable loss.
 6. Emission Level = Correction Factor + Reading Value.

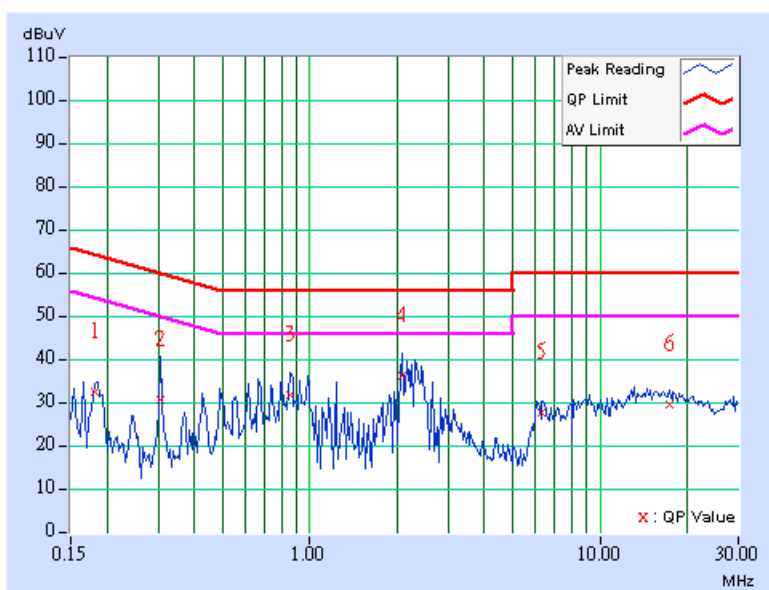

EUT TEST CONDITION		MEASUREMENT DETAIL	
CHANNEL	Channel 78	PHASE	Line 2
MODULATION TYPE	GFSK	6dB BANDWIDTH	9 kHz
ENVIRONMENTAL CONDITIONS	20deg. C, 60%RH, 991hPa	INPUT POWER (SYSTEM)	120Vac, 60 Hz
TEST MODE	A	TESTED BY	Match Tsui

NO	FREQ. [MHz]	CORR. FACTOR (dB)	READING VALUE [dB (uV)]		EMISSION LEVEL [dB (uV)]		LIMIT [dB (uV)]		MARGIN (dB)	
			Q.P.	AV.	Q.P.	AV.	Q.P.	AV.	Q.P.	AV.
			1	0.185	0.10	34.11	-	34.21	-	64.25
2	0.306	0.10	31.64	-	31.74	-	60.07	50.07	-28.33	-
3	0.861	0.18	30.44	-	30.62	-	56.00	46.00	-25.38	-
4	2.211	0.22	35.93	-	36.15	-	56.00	46.00	-19.85	-
5	6.316	0.40	32.11	-	32.51	-	60.00	50.00	-27.49	-
6	16.805	0.60	29.92	-	30.52	-	60.00	50.00	-29.48	-

- REMARKS:**
1. Q.P. and AV. are abbreviations of quasi-peak and average individually.
 2. "-": The Quasi-peak reading value also meets average limit and measurement with the average detector is unnecessary.
 3. The emission levels of other frequencies were very low against the limit.
 4. Margin value = Emission level - Limit value.
 5. Correction factor = Insertion loss + Cable loss.
 6. Emission Level = Correction Factor + Reading Value.

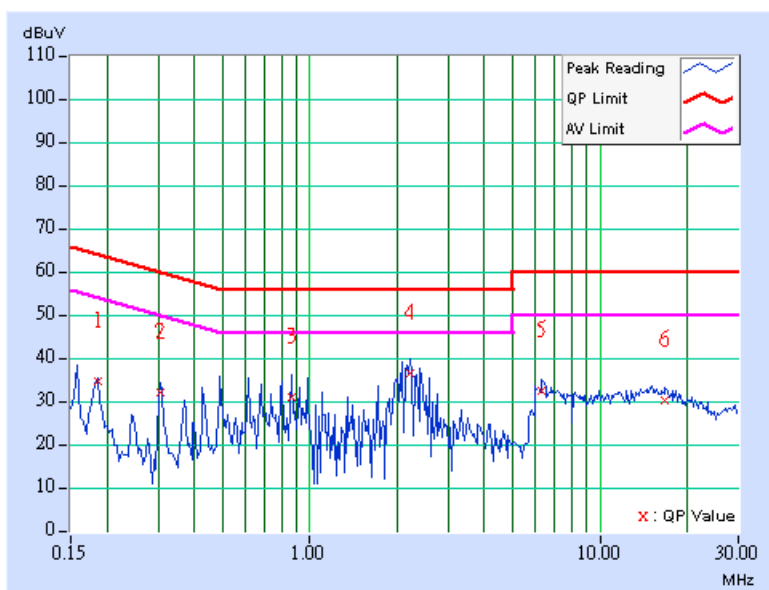

CONDUCTED WORST CASE DATA (FOR ADAPTER: JHA050100UU05):

EUT TEST CONDITION		MEASUREMENT DETAIL	
CHANNEL	Channel 0	PHASE	Line 1
MODULATION TYPE	GFSK	6dB BANDWIDTH	9 kHz
ENVIRONMENTAL CONDITIONS	20deg. C, 60%RH, 991hPa	INPUT POWER (SYSTEM)	120Vac, 60 Hz
TEST MODE	B	TESTED BY	Match Tsui

NO	FREQ. [MHz]	CORR. FACTOR (dB)	READING VALUE [dB (uV)]		EMISSION LEVEL [dB (uV)]		LIMIT [dB (uV)]		MARGIN (dB)	
			Q.P.	AV.	Q.P.	AV.	Q.P.	AV.	Q.P.	AV.
			1	0.166	0.10	45.95	-	46.05	-	65.18
2	0.216	0.10	41.96	-	42.06	-	62.96	52.96	-20.90	-
3	0.271	0.10	43.01	-	43.11	-	61.08	51.08	-17.97	-
4	0.814	0.17	38.40	-	38.57	-	56.00	46.00	-17.43	-
5	2.605	0.28	42.01	-	42.29	-	56.00	46.00	-13.71	-
6	9.262	0.46	32.76	-	33.22	-	60.00	50.00	-26.78	-

- REMARKS:**
1. Q.P. and AV. are abbreviations of quasi-peak and average individually.
 2. "-": The Quasi-peak reading value also meets average limit and measurement with the average detector is unnecessary.
 3. The emission levels of other frequencies were very low against the limit.
 4. Margin value = Emission level - Limit value
 5. Correction factor = Insertion loss + Cable loss
 6. Emission Level = Correction Factor + Reading Value.

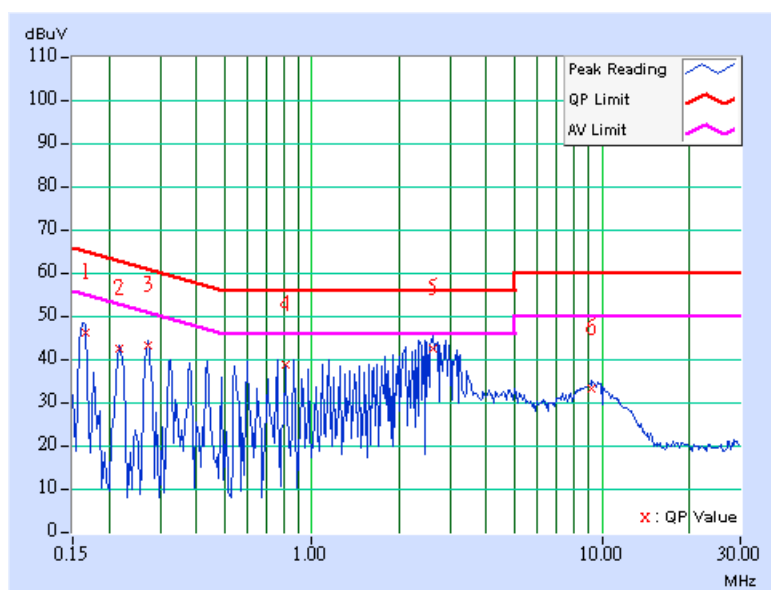

EUT TEST CONDITION		MEASUREMENT DETAIL	
CHANNEL	Channel 0	PHASE	Line 2
MODULATION TYPE	GFSK	6dB BANDWIDTH	9 kHz
ENVIRONMENTAL CONDITIONS	20deg. C, 60%RH, 991hPa	INPUT POWER (SYSTEM)	120Vac, 60 Hz
TEST MODE	B	TESTED BY	Match Tsui

NO	FREQ. [MHz]	CORR. FACTOR (dB)	READING VALUE [dB (uV)]		EMISSION LEVEL [dB (uV)]		LIMIT [dB (uV)]		MARGIN (dB)	
			Q.P.	AV.	Q.P.	AV.	Q.P.	AV.	Q.P.	AV.
			1	0.162	0.10	48.77	-	48.87	-	65.38
2	0.216	0.10	44.88	-	44.98	-	62.96	52.96	-17.98	-
3	0.271	0.10	42.83	-	42.93	-	61.08	51.08	-18.15	-
4	0.923	0.10	36.64	-	36.74	-	56.00	46.00	-19.26	-
5	2.934	0.28	39.45	-	39.73	-	56.00	46.00	-16.27	-
6	9.480	0.45	36.76	-	37.21	-	60.00	50.00	-22.79	-

- REMARKS:**
1. Q.P. and AV. are abbreviations of quasi-peak and average individually.
 2. "-": The Quasi-peak reading value also meets average limit and measurement with the average detector is unnecessary.
 3. The emission levels of other frequencies were very low against the limit.
 4. Margin value = Emission level - Limit value.
 5. Correction factor = Insertion loss + Cable loss.
 6. Emission Level = Correction Factor + Reading Value.

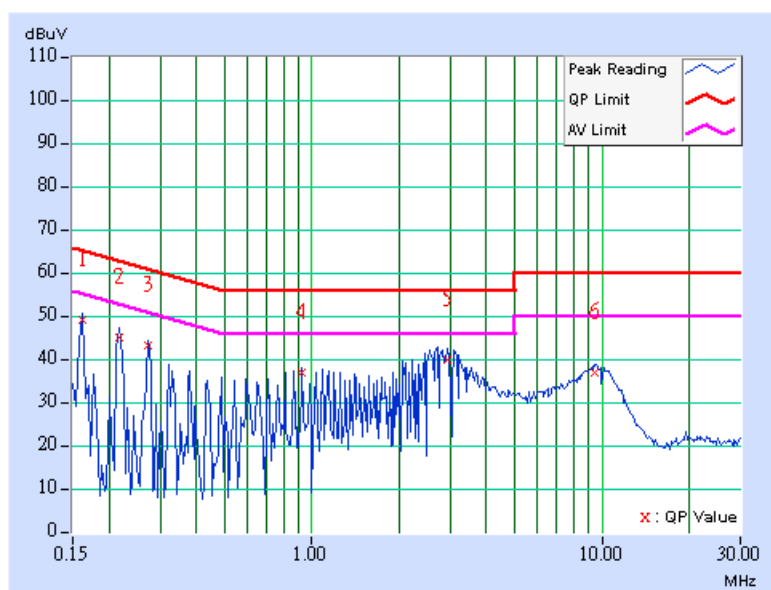

EUT TEST CONDITION		MEASUREMENT DETAIL	
CHANNEL	Channel 39	PHASE	Line 1
MODULATION TYPE	GFSK	6dB BANDWIDTH	9 kHz
ENVIRONMENTAL CONDITIONS	20deg. C, 60%RH, 991hPa	INPUT POWER (SYSTEM)	120Vac, 60 Hz
TEST MODE	B	TESTED BY	Match Tsui

NO	FREQ. [MHz]	CORR. FACTOR (dB)	READING VALUE [dB (uV)]		EMISSION LEVEL [dB (uV)]		LIMIT [dB (uV)]		MARGIN (dB)	
			Q.P.	AV.	Q.P.	AV.	Q.P.	AV.	Q.P.	AV.
			1	0.164	0.10	46.70	-	46.80	-	65.24
2	0.271	0.10	43.05	-	43.15	-	61.08	51.08	-17.93	-
3	0.326	0.10	39.36	-	39.46	-	59.56	49.56	-20.10	-
4	0.597	0.13	38.25	-	38.38	-	56.00	46.00	-17.62	-
5	2.551	0.27	42.53	-	42.80	-	56.00	46.00	-13.20	-
6	9.313	0.46	32.94	-	33.40	-	60.00	50.00	-26.60	-

- REMARKS:**
1. Q.P. and AV. are abbreviations of quasi-peak and average individually.
 2. "-": The Quasi-peak reading value also meets average limit and measurement with the average detector is unnecessary.
 3. The emission levels of other frequencies were very low against the limit.
 4. Margin value = Emission level - Limit value.
 5. Correction factor = Insertion loss + Cable loss.
 6. Emission Level = Correction Factor + Reading Value.

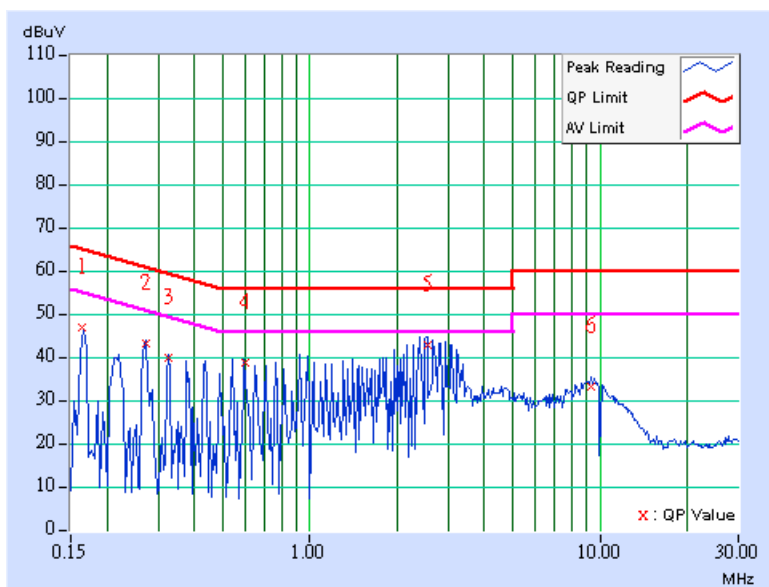

EUT TEST CONDITION		MEASUREMENT DETAIL	
CHANNEL	Channel 39	PHASE	Line 2
MODULATION TYPE	GFSK	6dB BANDWIDTH	9 kHz
ENVIRONMENTAL CONDITIONS	20deg. C, 60%RH, 991hPa	INPUT POWER (SYSTEM)	120Vac, 60 Hz
TEST MODE	B	TESTED BY	Match Tsui

NO	FREQ. [MHz]	CORR. FACTOR (dB)	READING VALUE [dB (uV)]		EMISSION LEVEL [dB (uV)]		LIMIT [dB (uV)]		MARGIN (dB)	
			Q.P.	AV.	Q.P.	AV.	Q.P.	AV.	Q.P.	AV.
			1	0.162	0.10	48.09	-	48.19	-	65.38
2	0.216	0.10	44.56	-	44.66	-	62.96	52.96	-18.30	-
3	0.271	0.10	42.55	-	42.65	-	61.08	51.08	-18.43	-
4	0.545	0.10	33.82	-	33.92	-	56.00	46.00	-22.08	-
5	2.660	0.26	40.05	-	40.31	-	56.00	46.00	-15.69	-
6	9.477	0.45	37.03	-	37.48	-	60.00	50.00	-22.52	-

- REMARKS:**
1. Q.P. and AV. are abbreviations of quasi-peak and average individually.
 2. "-": The Quasi-peak reading value also meets average limit and measurement with the average detector is unnecessary.
 3. The emission levels of other frequencies were very low against the limit.
 4. Margin value = Emission level - Limit value.
 5. Correction factor = Insertion loss + Cable loss.
 6. Emission Level = Correction Factor + Reading Value.

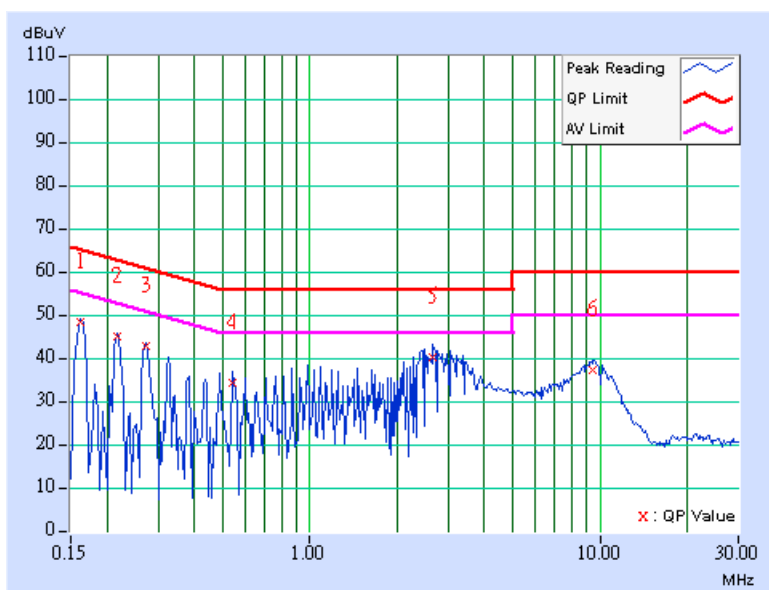

EUT TEST CONDITION		MEASUREMENT DETAIL	
CHANNEL	Channel 78	PHASE	Line 1
MODULATION TYPE	GFSK	6dB BANDWIDTH	9 kHz
ENVIRONMENTAL CONDITIONS	20deg. C, 60%RH, 991hPa	INPUT POWER (SYSTEM)	120Vac, 60 Hz
TEST MODE	B	TESTED BY	Match Tsui

NO	FREQ. [MHz]	CORR. FACTOR (dB)	READING VALUE [dB (uV)]		EMISSION LEVEL [dB (uV)]		LIMIT [dB (uV)]		MARGIN (dB)	
			Q.P.	AV.	Q.P.	AV.	Q.P.	AV.	Q.P.	AV.
			1	0.163	0.10	46.39	-	46.49	-	65.31
2	0.271	0.10	42.69	-	42.79	-	61.08	51.08	-18.29	-
3	0.380	0.10	37.69	-	37.79	-	58.27	48.27	-20.48	-
4	0.595	0.13	38.65	-	38.78	-	56.00	46.00	-17.22	-
5	2.605	0.28	42.65	-	42.93	-	56.00	46.00	-13.07	-
6	9.422	0.46	30.54	-	31.00	-	60.00	50.00	-29.00	-

- REMARKS:**
1. Q.P. and AV. are abbreviations of quasi-peak and average individually.
 2. "-": The Quasi-peak reading value also meets average limit and measurement with the average detector is unnecessary.
 3. The emission levels of other frequencies were very low against the limit.
 4. Margin value = Emission level - Limit value.
 5. Correction factor = Insertion loss + Cable loss.
 6. Emission Level = Correction Factor + Reading Value.

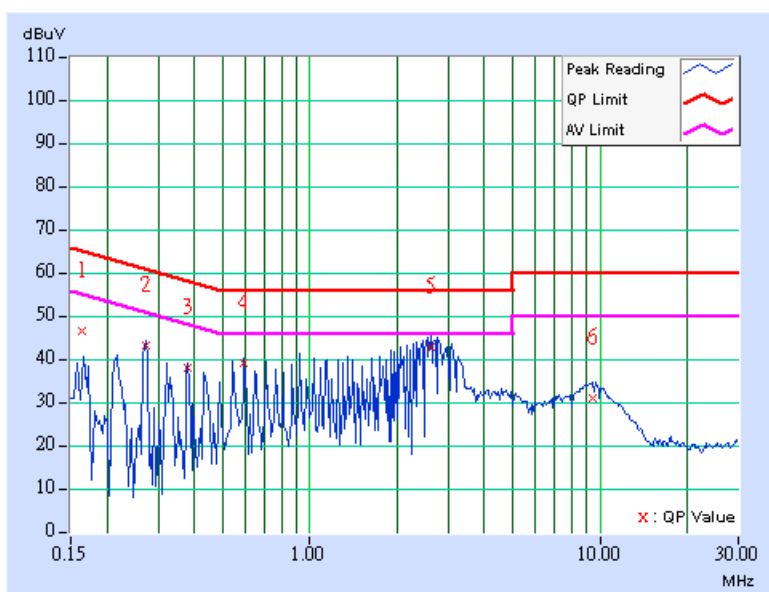

EUT TEST CONDITION		MEASUREMENT DETAIL	
CHANNEL	Channel 78	PHASE	Line 2
MODULATION TYPE	GFSK	6dB BANDWIDTH	9 kHz
ENVIRONMENTAL CONDITIONS	20deg. C, 60%RH, 991hPa	INPUT POWER (SYSTEM)	120Vac, 60 Hz
TEST MODE	B	TESTED BY	Match Tsui

NO	FREQ. [MHz]	CORR. FACTOR (dB)	READING VALUE [dB (uV)]		EMISSION LEVEL [dB (uV)]		LIMIT [dB (uV)]		MARGIN (dB)	
			Q.P.	AV.	Q.P.	AV.	Q.P.	AV.	Q.P.	AV.
			1	0.162	0.10	47.34	-	47.44	-	65.38
2	0.216	0.10	44.17	-	44.27	-	62.96	52.96	-18.69	-
3	0.271	0.10	42.13	-	42.23	-	61.08	51.08	-18.85	-
4	0.541	0.10	33.53	-	33.63	-	56.00	46.00	-22.37	-
5	3.148	0.30	39.69	-	39.99	-	56.00	46.00	-16.01	-
6	9.746	0.46	34.77	-	35.23	-	60.00	50.00	-24.77	-

- REMARKS:**
1. Q.P. and AV. are abbreviations of quasi-peak and average individually.
 2. "-": The Quasi-peak reading value also meets average limit and measurement with the average detector is unnecessary.
 3. The emission levels of other frequencies were very low against the limit.
 4. Margin value = Emission level - Limit value.
 5. Correction factor = Insertion loss + Cable loss.
 6. Emission Level = Correction Factor + Reading Value.

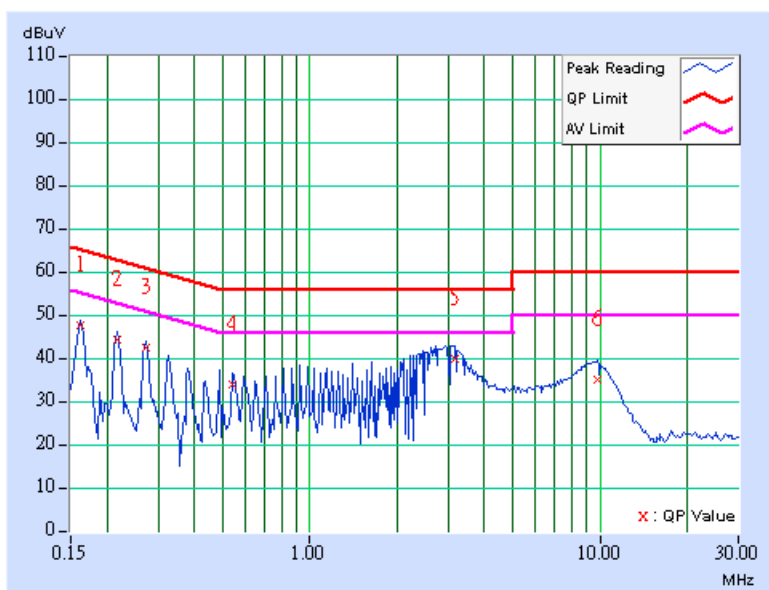

Conducted Worst Case Data (For adapter: ADP-5FH B):

EUT TEST CONDITION		MEASUREMENT DETAIL	
CHANNEL	Channel 0	PHASE	Line 1
MODULATION TYPE	GFSK	6dB BANDWIDTH	9 kHz
ENVIRONMENTAL CONDITIONS	20deg. C, 60%RH, 991hPa	INPUT POWER (SYSTEM)	120Vac, 60 Hz
TEST MODE	C	TESTED BY	Match Tsui

NO	FREQ. [MHz]	CORR. FACTOR (dB)	READING VALUE [dB (uV)]		EMISSION LEVEL [dB (uV)]		LIMIT [dB (uV)]		MARGIN (dB)	
			Q.P.	AV.	Q.P.	AV.	Q.P.	AV.	Q.P.	AV.
			1	0.185	0.10	31.42	-	31.52	-	64.25
2	0.271	0.10	35.44	-	35.54	-	61.08	51.08	-25.54	-
3	0.404	0.10	39.01	-	39.11	-	57.77	47.77	-18.66	-
4	1.355	0.20	28.81	-	29.01	-	56.00	46.00	-26.99	-
5	4.473	0.47	33.10	-	33.57	-	56.00	46.00	-22.43	-
6	7.828	0.46	35.65	-	36.11	-	60.00	50.00	-23.89	-

- REMARKS:**
1. Q.P. and AV. are abbreviations of quasi-peak and average individually.
 2. "-": The Quasi-peak reading value also meets average limit and measurement with the average detector is unnecessary.
 3. The emission levels of other frequencies were very low against the limit.
 4. Margin value = Emission level - Limit value.
 5. Correction factor = Insertion loss + Cable loss.
 6. Emission Level = Correction Factor + Reading Value.

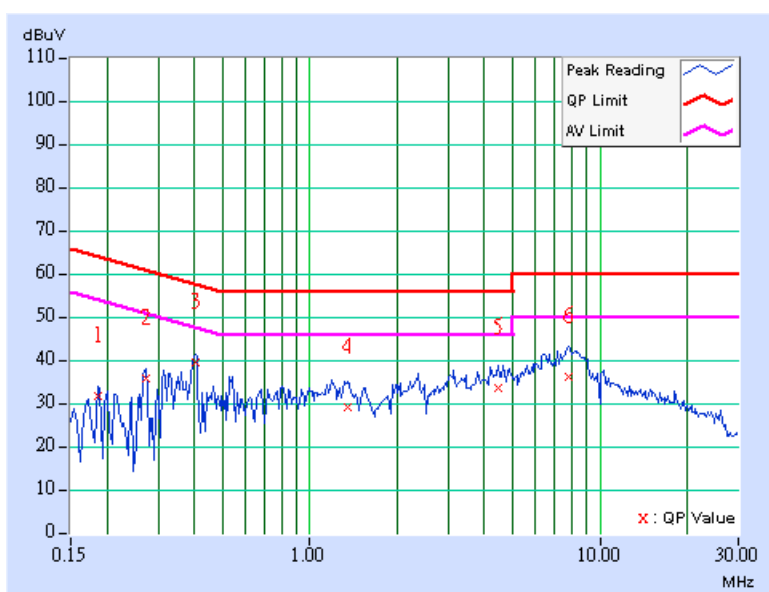

EUT TEST CONDITION		MEASUREMENT DETAIL	
CHANNEL	Channel 0	PHASE	Line 2
MODULATION TYPE	GFSK	6dB BANDWIDTH	9 kHz
ENVIRONMENTAL CONDITIONS	20deg. C, 60%RH, 991hPa	INPUT POWER (SYSTEM)	120Vac, 60 Hz
TEST MODE	C	TESTED BY	Match Tsui

NO	FREQ. [MHz]	CORR. FACTOR (dB)	READING VALUE [dB (uV)]		EMISSION LEVEL [dB (uV)]		LIMIT [dB (uV)]		MARGIN (dB)	
			Q.P.	AV.	Q.P.	AV.	Q.P.	AV.	Q.P.	AV.
			1	0.199	0.10	35.61	-	35.71	-	63.66
2	0.322	0.10	37.19	-	37.29	-	59.66	49.66	-22.37	-
3	0.537	0.10	36.83	-	36.93	-	56.00	46.00	-19.07	-
4	2.145	0.21	31.55	-	31.76	-	56.00	46.00	-24.24	-
5	4.105	0.37	26.77	-	27.14	-	56.00	46.00	-28.86	-
6	8.004	0.43	32.95	-	33.38	-	60.00	50.00	-26.62	-

- REMARKS:**
1. Q.P. and AV. are abbreviations of quasi-peak and average individually.
 2. "-": The Quasi-peak reading value also meets average limit and measurement with the average detector is unnecessary.
 3. The emission levels of other frequencies were very low against the limit.
 4. Margin value = Emission level - Limit value.
 5. Correction factor = Insertion loss + Cable loss.
 6. Emission Level = Correction Factor + Reading Value.

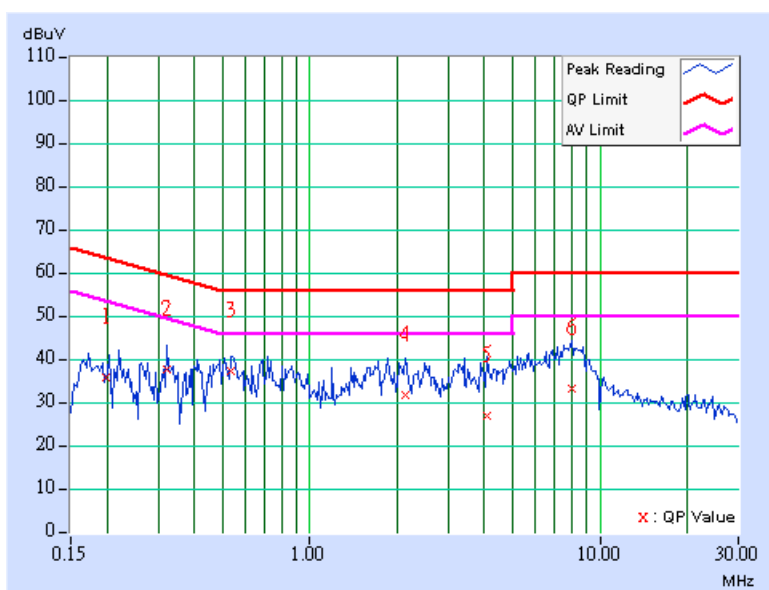

EUT TEST CONDITION		MEASUREMENT DETAIL	
CHANNEL	Channel 39	PHASE	Line 1
MODULATION TYPE	GFSK	6dB BANDWIDTH	9 kHz
ENVIRONMENTAL CONDITIONS	20deg. C, 60%RH, 991hPa	INPUT POWER (SYSTEM)	120Vac, 60 Hz
TEST MODE	C	TESTED BY	Match Tsui

NO	FREQ. [MHz]	CORR. FACTOR (dB)	READING VALUE [dB (uV)]		EMISSION LEVEL [dB (uV)]		LIMIT [dB (uV)]		MARGIN (dB)	
			Q.P.	AV.	Q.P.	AV.	Q.P.	AV.	Q.P.	AV.
			1	0.181	0.10	27.94	-	28.04	-	64.43
2	0.318	0.10	34.47	-	34.57	-	59.76	49.76	-25.19	-
3	0.396	0.10	36.04	-	36.14	-	57.93	47.93	-21.79	-
4	2.008	0.20	27.76	-	27.96	-	56.00	46.00	-28.04	-
5	5.223	0.47	27.86	-	28.33	-	60.00	50.00	-31.67	-
6	8.156	0.46	33.96	-	34.42	-	60.00	50.00	-25.58	-

- REMARKS:**
1. Q.P. and AV. are abbreviations of quasi-peak and average individually.
 2. "-": The Quasi-peak reading value also meets average limit and measurement with the average detector is unnecessary.
 3. The emission levels of other frequencies were very low against the limit.
 4. Margin value = Emission level - Limit value.
 5. Correction factor = Insertion loss + Cable loss.
 6. Emission Level = Correction Factor + Reading Value.

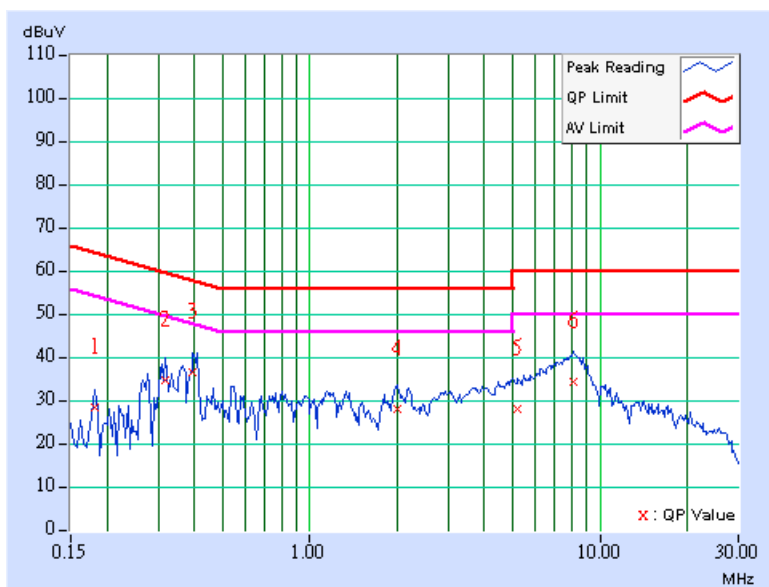

EUT TEST CONDITION		MEASUREMENT DETAIL	
CHANNEL	Channel 39	PHASE	Line 2
MODULATION TYPE	GFSK	6dB BANDWIDTH	9 kHz
ENVIRONMENTAL CONDITIONS	20deg. C, 60%RH, 991hPa	INPUT POWER (SYSTEM)	120Vac, 60 Hz
TEST MODE	C	TESTED BY	Match Tsui

NO	FREQ. [MHz]	CORR. FACTOR (dB)	READING VALUE [dB (uV)]		EMISSION LEVEL [dB (uV)]		LIMIT [dB (uV)]		MARGIN (dB)	
			Q.P.	AV.	Q.P.	AV.	Q.P.	AV.	Q.P.	AV.
			1	0.209	0.10	31.50	-	31.60	-	63.26
2	0.314	0.10	37.18	-	37.28	-	59.86	49.86	-22.58	-
3	0.408	0.10	37.39	-	37.49	-	57.69	47.69	-20.20	-
4	1.949	0.19	24.10	-	24.29	-	56.00	46.00	-31.71	-
5	4.430	0.38	26.97	-	27.35	-	56.00	46.00	-28.65	-
6	8.340	0.44	31.70	-	32.14	-	60.00	50.00	-27.86	-

- REMARKS:**
1. Q.P. and AV. are abbreviations of quasi-peak and average individually.
 2. "-": The Quasi-peak reading value also meets average limit and measurement with the average detector is unnecessary.
 3. The emission levels of other frequencies were very low against the limit.
 4. Margin value = Emission level - Limit value.
 5. Correction factor = Insertion loss + Cable loss.
 6. Emission Level = Correction Factor + Reading Value.

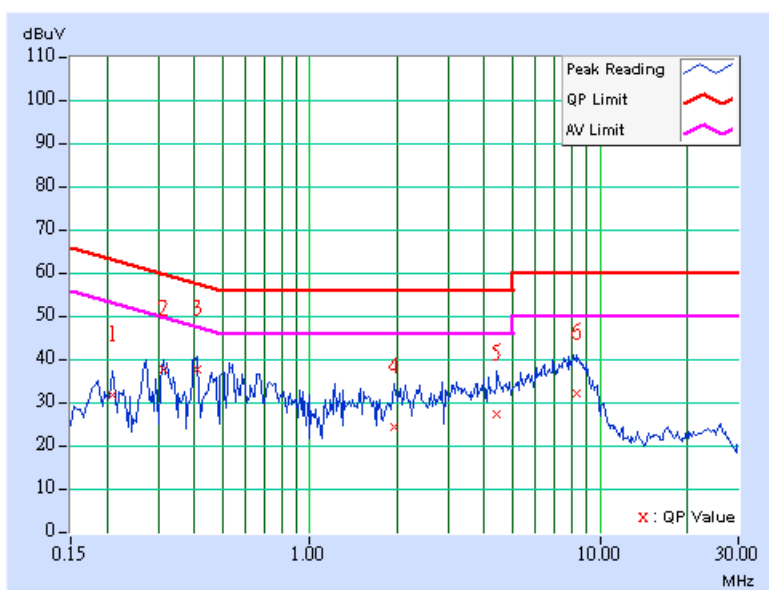

EUT TEST CONDITION		MEASUREMENT DETAIL	
CHANNEL	Channel 78	PHASE	Line 1
MODULATION TYPE	GFSK	6dB BANDWIDTH	9 kHz
ENVIRONMENTAL CONDITIONS	20deg. C, 60%RH, 991hPa	INPUT POWER (SYSTEM)	120Vac, 60 Hz
TEST MODE	C	TESTED BY	Match Tsui

NO	FREQ. [MHz]	CORR. FACTOR (dB)	READING VALUE [dB (uV)]		EMISSION LEVEL [dB (uV)]		LIMIT [dB (uV)]		MARGIN (dB)	
			Q.P.	AV.	Q.P.	AV.	Q.P.	AV.	Q.P.	AV.
			1	0.189	0.10	25.69	-	25.79	-	64.08
2	0.306	0.10	32.76	-	32.86	-	60.07	50.07	-27.21	-
3	0.400	0.10	39.17	-	39.27	-	57.85	47.85	-18.58	-
4	1.195	0.20	24.32	-	24.52	-	56.00	46.00	-31.48	-
5	3.867	0.45	26.07	-	26.52	-	56.00	46.00	-29.48	-
6	7.594	0.46	33.66	-	34.12	-	60.00	50.00	-25.88	-

- REMARKS:**
1. Q.P. and AV. are abbreviations of quasi-peak and average individually.
 2. "-": The Quasi-peak reading value also meets average limit and measurement with the average detector is unnecessary.
 3. The emission levels of other frequencies were very low against the limit.
 4. Margin value = Emission level - Limit value.
 5. Correction factor = Insertion loss + Cable loss.
 6. Emission Level = Correction Factor + Reading Value.

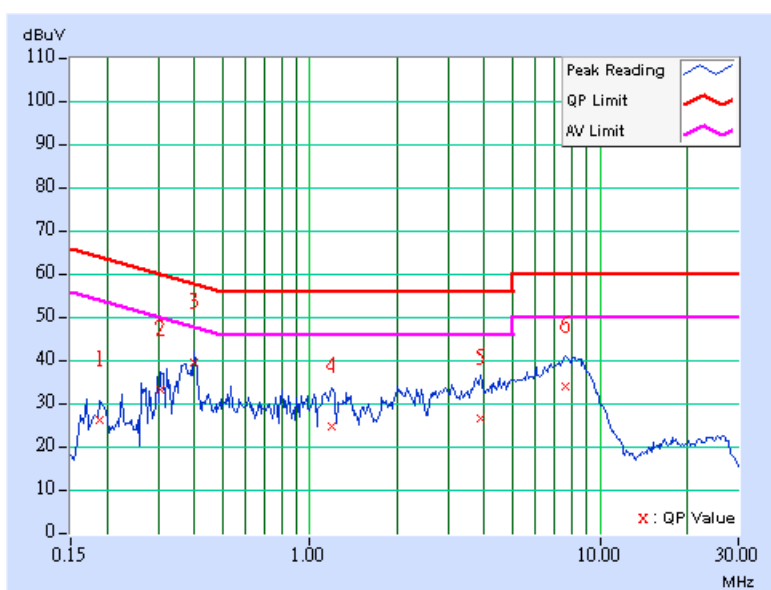

EUT TEST CONDITION		MEASUREMENT DETAIL	
CHANNEL	Channel 78	PHASE	Line 2
MODULATION TYPE	GFSK	6dB BANDWIDTH	9 kHz
ENVIRONMENTAL CONDITIONS	20deg. C, 60%RH, 991hPa	INPUT POWER (SYSTEM)	120Vac, 60 Hz
TEST MODE	C	TESTED BY	Match Tsui

NO	FREQ. [MHz]	CORR. FACTOR (dB)	READING VALUE [dB (uV)]		EMISSION LEVEL [dB (uV)]		LIMIT [dB (uV)]		MARGIN (dB)	
			Q.P.	AV.	Q.P.	AV.	Q.P.	AV.	Q.P.	AV.
			1	0.173	0.10	32.61	-	32.71	-	64.79
2	0.314	0.10	36.79	-	36.89	-	59.86	49.86	-22.97	-
3	0.408	0.10	35.92	-	36.02	-	57.69	47.69	-21.67	-
4	1.363	0.14	23.09	-	23.23	-	56.00	46.00	-32.77	-
5	5.336	0.39	25.97	-	26.36	-	60.00	50.00	-33.64	-
6	8.586	0.44	31.34	-	31.78	-	60.00	50.00	-28.22	-

- REMARKS:**
1. Q.P. and AV. are abbreviations of quasi-peak and average individually.
 2. "-": The Quasi-peak reading value also meets average limit and measurement with the average detector is unnecessary.
 3. The emission levels of other frequencies were very low against the limit.
 4. Margin value = Emission level - Limit value.
 5. Correction factor = Insertion loss + Cable loss.
 6. Emission Level = Correction Factor + Reading Value.

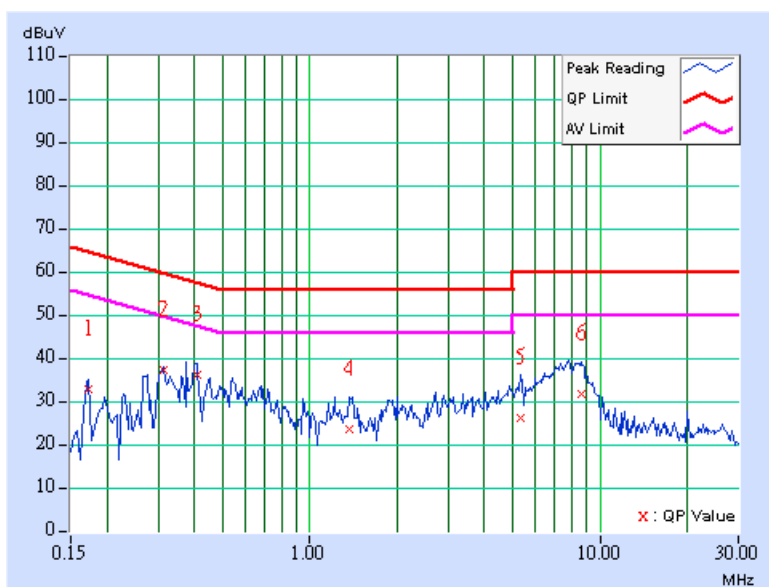

CONDUCTED WORST CASE DATA (FOR USB CABLE)

EUT TEST CONDITION		MEASUREMENT DETAIL	
CHANNEL	Channel 0	PHASE	Line 1
MODULATION TYPE	GFSK	6dB BANDWIDTH	9 kHz
ENVIRONMENTAL CONDITIONS	20deg. C, 60%RH, 991hPa	INPUT POWER (SYSTEM)	120Vac, 60 Hz
TEST MODE	E	TESTED BY	Match Tsui

NO	FREQ. [MHz]	CORR. FACTOR (dB)	READING VALUE [dB (uV)]		EMISSION LEVEL [dB (uV)]		LIMIT [dB (uV)]		MARGIN (dB)	
			Q.P.	AV.	Q.P.	AV.	Q.P.	AV.	Q.P.	AV.
			1	0.176	0.10	39.51	-	39.61	-	64.69
2	0.216	0.10	43.58	-	43.68	-	62.96	52.96	-19.28	-
3	0.427	0.10	22.85	-	22.95	-	57.30	47.30	-34.35	-
4	1.586	0.16	26.84	-	27.00	-	56.00	46.00	-29.00	-
5	9.652	0.36	30.34	-	30.70	-	60.00	50.00	-29.30	-
6	13.469	0.55	32.05	-	32.60	-	60.00	50.00	-27.40	-

- REMARKS:**
1. Q.P. and AV. are abbreviations of quasi-peak and average individually.
 2. "-": The Quasi-peak reading value also meets average limit and measurement with the average detector is unnecessary.
 3. The emission levels of other frequencies were very low against the limit.
 4. Margin value = Emission level - Limit value.
 5. Correction factor = Insertion loss + Cable loss.
 6. Emission Level = Correction Factor + Reading Value.

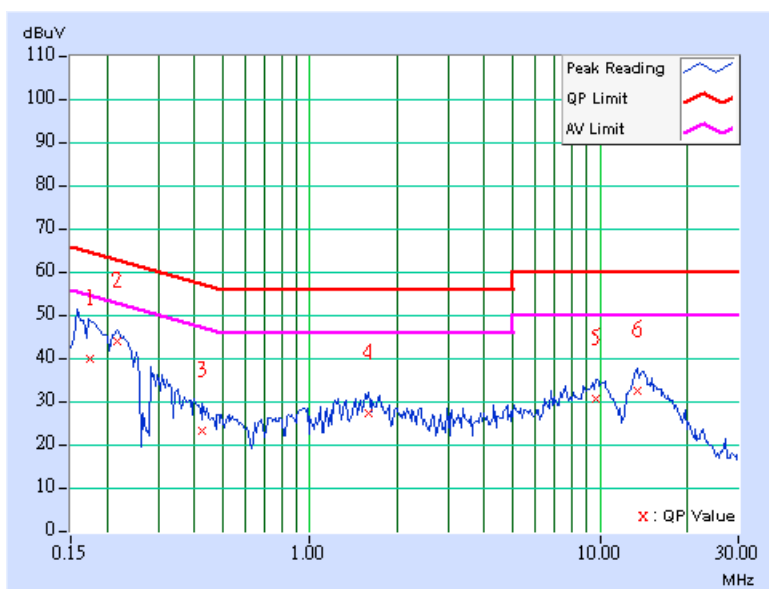

EUT TEST CONDITION		MEASUREMENT DETAIL	
CHANNEL	Channel 0	PHASE	Line 2
MODULATION TYPE	GFSK	6dB BANDWIDTH	9 kHz
ENVIRONMENTAL CONDITIONS	20deg. C, 60%RH, 991hPa	INPUT POWER (SYSTEM)	120Vac, 60 Hz
TEST MODE	E	TESTED BY	Match Tsui

NO	FREQ. [MHz]	CORR. FACTOR (dB)	READING VALUE [dB (uV)]		EMISSION LEVEL [dB (uV)]		LIMIT [dB (uV)]		MARGIN (dB)	
			Q.P.	AV.	Q.P.	AV.	Q.P.	AV.	Q.P.	AV.
			1	0.158	0.10	43.39	-	43.49	-	65.58
2	0.209	0.10	40.46	-	40.56	-	63.26	53.26	-22.70	-
3	0.435	0.11	23.86	-	23.97	-	57.15	47.15	-33.19	-
4	1.383	0.20	26.25	-	26.45	-	56.00	46.00	-29.55	-
5	9.969	0.46	30.46	-	30.92	-	60.00	50.00	-29.08	-
6	13.652	0.58	32.04	-	32.62	-	60.00	50.00	-27.38	-

- REMARKS:**
1. Q.P. and AV. are abbreviations of quasi-peak and average individually.
 2. "-": The Quasi-peak reading value also meets average limit and measurement with the average detector is unnecessary.
 3. The emission levels of other frequencies were very low against the limit.
 4. Margin value = Emission level - Limit value.
 5. Correction factor = Insertion loss + Cable loss.
 6. Emission Level = Correction Factor + Reading Value.

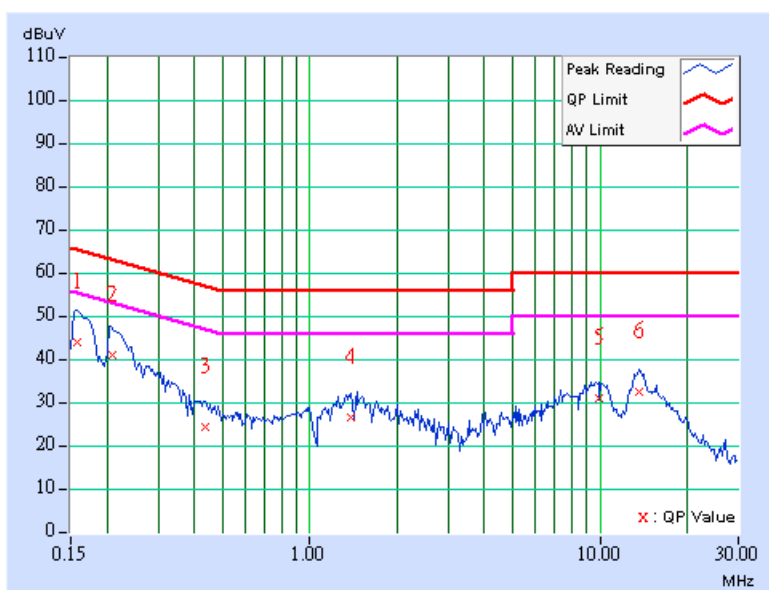

EUT TEST CONDITION		MEASUREMENT DETAIL	
CHANNEL	Channel 39	PHASE	Line 1
MODULATION TYPE	GFSK	6dB BANDWIDTH	9 kHz
ENVIRONMENTAL CONDITIONS	20deg. C, 60%RH, 991hPa	INPUT POWER (SYSTEM)	120Vac, 60 Hz
TEST MODE	E	TESTED BY	Match Tsui

NO	FREQ. [MHz]	CORR. FACTOR (dB)	READING VALUE [dB (uV)]		EMISSION LEVEL [dB (uV)]		LIMIT [dB (uV)]		MARGIN (dB)	
			Q.P.	AV.	Q.P.	AV.	Q.P.	AV.	Q.P.	AV.
			1	0.158	0.10	45.08	-	45.18	-	65.58
2	0.209	0.10	44.56	-	44.66	-	63.26	53.26	-18.60	-
3	0.443	0.10	22.64	-	22.74	-	57.01	47.01	-34.27	-
4	1.660	0.17	25.82	-	25.99	-	56.00	46.00	-30.01	-
5	9.945	0.36	30.42	-	30.78	-	60.00	50.00	-29.22	-
6	13.742	0.56	31.98	-	32.54	-	60.00	50.00	-27.46	-

- REMARKS:**
1. Q.P. and AV. are abbreviations of quasi-peak and average individually.
 2. "-": The Quasi-peak reading value also meets average limit and measurement with the average detector is unnecessary.
 3. The emission levels of other frequencies were very low against the limit.
 4. Margin value = Emission level - Limit value.
 5. Correction factor = Insertion loss + Cable loss.
 6. Emission Level = Correction Factor + Reading Value.

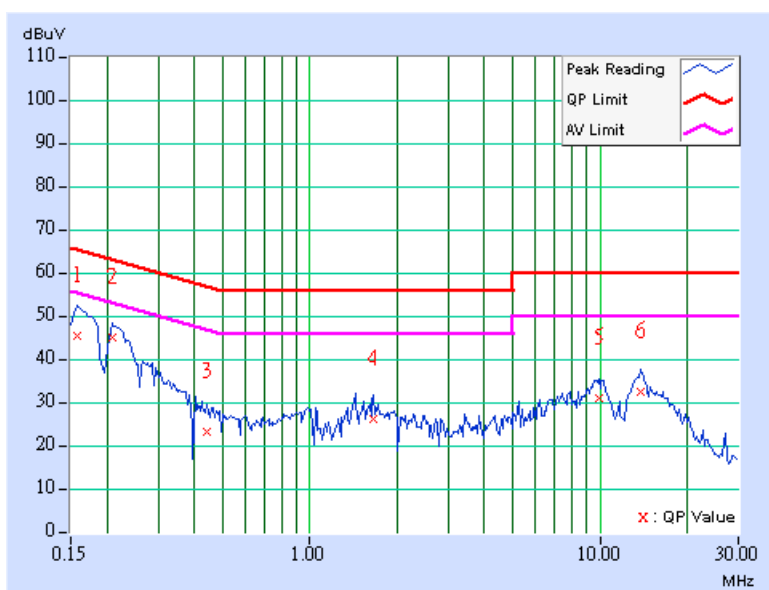

EUT TEST CONDITION		MEASUREMENT DETAIL	
CHANNEL	Channel 39	PHASE	Line 2
MODULATION TYPE	GFSK	6dB BANDWIDTH	9 kHz
ENVIRONMENTAL CONDITIONS	20deg. C, 60%RH, 991hPa	INPUT POWER (SYSTEM)	120Vac, 60 Hz
TEST MODE	E	TESTED BY	Match Tsui

NO	FREQ. [MHz]	CORR. FACTOR (dB)	READING VALUE [dB (uV)]		EMISSION LEVEL [dB (uV)]		LIMIT [dB (uV)]		MARGIN (dB)	
			Q.P.	AV.	Q.P.	AV.	Q.P.	AV.	Q.P.	AV.
			1	0.158	0.10	45.38	-	45.48	-	65.58
2	0.216	0.10	44.39	-	44.49	-	62.96	52.96	-18.47	-
3	0.455	0.11	24.40	-	24.51	-	56.79	46.79	-32.28	-
4	1.629	0.20	26.15	-	26.35	-	56.00	46.00	-29.65	-
5	10.352	0.47	29.56	-	30.03	-	60.00	50.00	-29.97	-
6	13.668	0.58	31.77	-	32.35	-	60.00	50.00	-27.65	-

- REMARKS:**
1. Q.P. and AV. are abbreviations of quasi-peak and average individually.
 2. "-": The Quasi-peak reading value also meets average limit and measurement with the average detector is unnecessary.
 3. The emission levels of other frequencies were very low against the limit.
 4. Margin value = Emission level - Limit value.
 5. Correction factor = Insertion loss + Cable loss.
 6. Emission Level = Correction Factor + Reading Value.

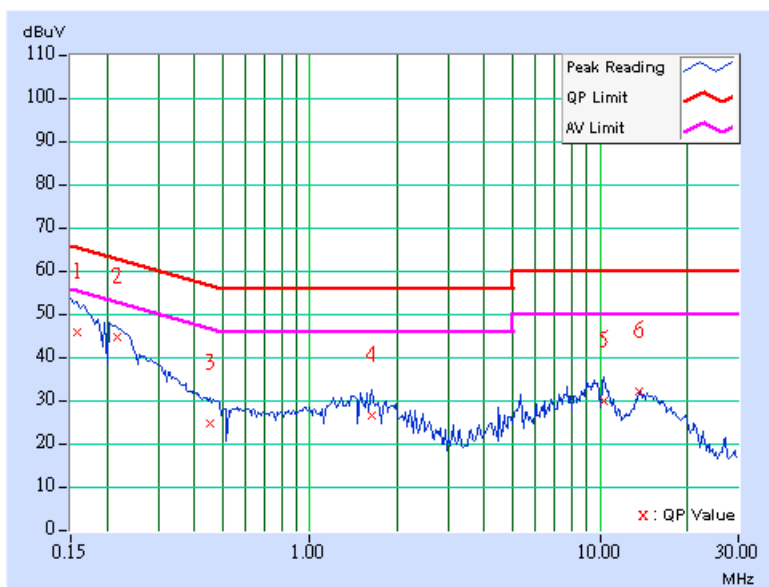

EUT TEST CONDITION		MEASUREMENT DETAIL	
CHANNEL	Channel 78	PHASE	Line 1
MODULATION TYPE	GFSK	6dB BANDWIDTH	9 kHz
ENVIRONMENTAL CONDITIONS	20deg. C, 60%RH, 991hPa	INPUT POWER (SYSTEM)	120Vac, 60 Hz
TEST MODE	E	TESTED BY	Match Tsui

NO	FREQ. [MHz]	CORR. FACTOR (dB)	READING VALUE [dB (uV)]		EMISSION LEVEL [dB (uV)]		LIMIT [dB (uV)]		MARGIN (dB)	
			Q.P.	AV.	Q.P.	AV.	Q.P.	AV.	Q.P.	AV.
			1	0.162	0.10	44.24	-	44.34	-	65.38
2	0.224	0.10	42.67	-	42.77	-	62.66	52.66	-19.89	-
3	0.380	0.10	21.95	-	22.05	-	58.27	48.27	-36.22	-
4	1.387	0.14	28.27	-	28.41	-	56.00	46.00	-27.59	-
5	9.730	0.36	30.22	-	30.58	-	60.00	50.00	-29.42	-
6	13.633	0.56	31.83	-	32.39	-	60.00	50.00	-27.61	-

- REMARKS:**
1. Q.P. and AV. are abbreviations of quasi-peak and average individually.
 2. "-": The Quasi-peak reading value also meets average limit and measurement with the average detector is unnecessary.
 3. The emission levels of other frequencies were very low against the limit.
 4. Margin value = Emission level - Limit value.
 5. Correction factor = Insertion loss + Cable loss.
 6. Emission Level = Correction Factor + Reading Value.

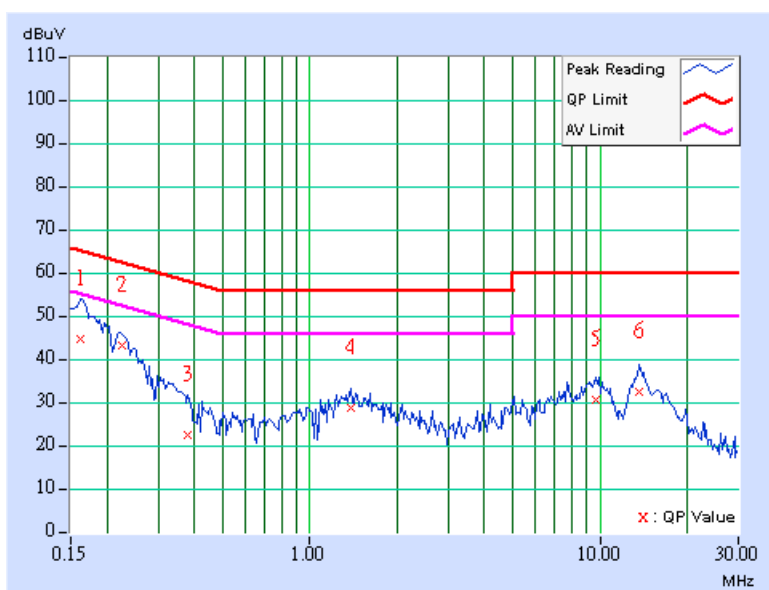

EUT TEST CONDITION		MEASUREMENT DETAIL	
CHANNEL	Channel 78	PHASE	Line 2
MODULATION TYPE	GFSK	6dB BANDWIDTH	9 kHz
ENVIRONMENTAL CONDITIONS	20deg. C, 60%RH, 991hPa	INPUT POWER (SYSTEM)	120Vac, 60 Hz
TEST MODE	E	TESTED BY	Match Tsui

NO	FREQ. [MHz]	CORR. FACTOR (dB)	READING VALUE [dB (uV)]		EMISSION LEVEL [dB (uV)]		LIMIT [dB (uV)]		MARGIN (dB)	
			Q.P.	AV.	Q.P.	AV.	Q.P.	AV.	Q.P.	AV.
			1	0.162	0.10	44.30	-	44.40	-	65.38
2	0.224	0.10	42.75	-	42.85	-	62.66	52.66	-19.81	-
3	0.439	0.11	24.14	-	24.25	-	57.08	47.08	-32.83	-
4	1.523	0.20	27.17	-	27.37	-	56.00	46.00	-28.63	-
5	9.773	0.46	30.52	-	30.98	-	60.00	50.00	-29.02	-
6	13.695	0.59	31.85	-	32.44	-	60.00	50.00	-27.56	-

- REMARKS:**
1. Q.P. and AV. are abbreviations of quasi-peak and average individually.
 2. "-": The Quasi-peak reading value also meets average limit and measurement with the average detector is unnecessary.
 3. The emission levels of other frequencies were very low against the limit.
 4. Margin value = Emission level - Limit value.
 5. Correction factor = Insertion loss + Cable loss.
 6. Emission Level = Correction Factor + Reading Value.

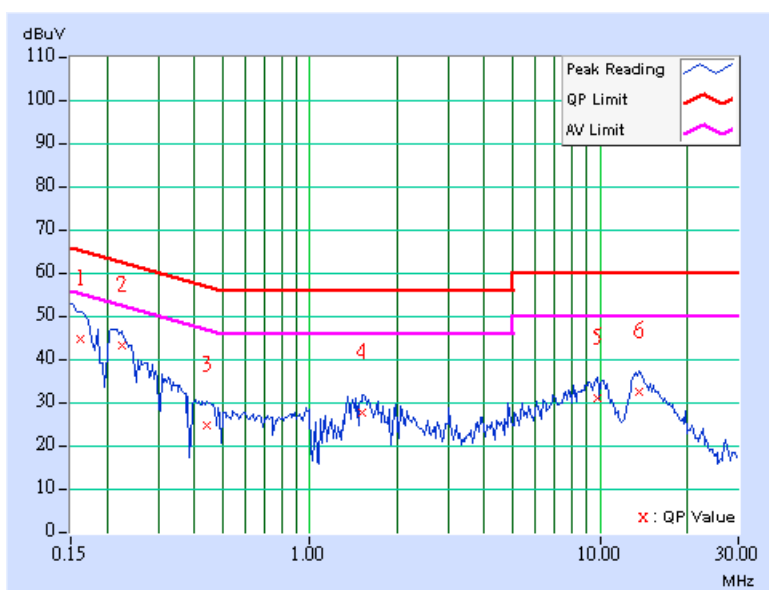

5.2 RADIATED EMISSION MEASUREMENT

5.2.1 LIMITS OF RADIATED EMISSION MEASUREMENT

Emissions radiated outside of the specified bands, shall be according to the general radiated limits in 15.209 as following:

FREQUENCIES (MHz)	FIELD STRENGTH (microvolts/meter)	MEASUREMENT DISTANCE (meters)
0.009-0.490	2400/F(kHz)	300
0.490-1.705	24000/F(kHz)	30
1.705-30.0	30	30
30-88	100	3
88-216	150	3
216-960	200	3
Above 960	500	3

NOTE:

1. The lower limit shall apply at the transition frequencies.
2. Emission level (dBuV/m) = 20 log Emission level (uV/m).
3. As shown in 15.35(b), for frequencies above 1000MHz, the field strength limits are based on average detector, however, the peak field strength of any emission shall not exceed the maximum permitted average limits, specified above by more than 20dB under any condition of modulation.

5.2.2 TEST INSTRUMENTS

DESCRIPTION & MANUFACTURER	MODEL NO.	SERIAL NO.	CALIBRATED UNTIL
Test Receiver ROHDE & SCHWARZ	ESIB7	100188	Dec. 20, 2006
Spectrum Analyzer ROHDE & SCHWARZ	FSP40	100039	Nov. 27, 2006
BILOG Antenna SCHWARZBECK	VULB9168	9168-157	Jan. 15, 2007
HORN Antenna SCHWARZBECK	BBHA 9120 D	9120D-407	Jan. 22, 2007
HORN Antenna SCHWARZBECK	BBHA 9170	BBHA9170147	Jan. 26, 2007
Preamplifier Agilent	8449B	3008A01961	Oct. 23, 2006
Preamplifier Agilent	8447D	2944A10629	Oct. 27, 2006
RF signal cable HUBER+SUHNER	SUCOFLEX 104	214380/4	Jan. 16, 2007
RF signal cable HUBER+SUHNER	SUCOFLEX 104	219266/4	Jan. 16, 2007
Software ADT.	ADT_Radiated_V5.14	NA	NA
Antenna Tower ADT.	AT100	AT93021702	NA
Turn Table ADT.	TT100.	TT93021702	NA
Controller ADT.	SC100.	SC93021702	NA

NOTE: 1. The calibration interval of the above test instruments is 12 months and the calibrations are traceable to NML/ROC and NIST/USA.

2. The test was performed in HwaYa Chamber 1.

3. The horn antenna and HP preamplifier (model: 8449B) are used only for the measurement of emission frequency above 1GHz if tested.

4. The IC Site Registration No. is IC4924-2.

5. The IC Site Registration No. is IC4924-3.

5.2.3 TEST PROCEDURES

- a. The EUT was placed on the top of a rotating table 0.8 meters above the ground at a 3 meter semi-anechoic chamber. The table was rotated 360 degrees to determine the position of the highest radiation.
- b. The EUT was set 3 meters away from the interference-receiving antenna, which was mounted on the top of a variable-height antenna tower.
- c. The antenna is a broadband antenna, and its height is varied from one meter to four meters above the ground to determine the maximum value of the field strength. Both horizontal and vertical polarizations of the antenna are set to make the measurement.
- d. For each suspected emission, the EUT was arranged to its worst case and then the antenna was tuned to heights from 1 meter to 4 meters and the rotatable table was turned from 0 degrees to 360 degrees to find the maximum reading.
- e. The test-receiver system was set to Peak Detect Function and Specified Bandwidth with Maximum Hold Mode.
- f. If the emission level of the EUT in peak mode was lower than the limit specified, then testing could be stopped and the peak values of the EUT would be reported. Otherwise the emissions would be re-tested one by one using peak, quasi-peak or average method as specified and then reported in a data sheet.

NOTE:

1. The resolution bandwidth and video bandwidth of test receiver/spectrum analyzer is 120kHz for Quasi-peak detection at frequency below 1GHz.
2. The resolution bandwidth and video bandwidth of test receiver/spectrum analyzer is 1 MHz for Peak detection (PK) at frequency above 1GHz.

5.2.4 DEVIATION FROM TEST STANDARD

No deviation

5.2.5 TEST SETUP

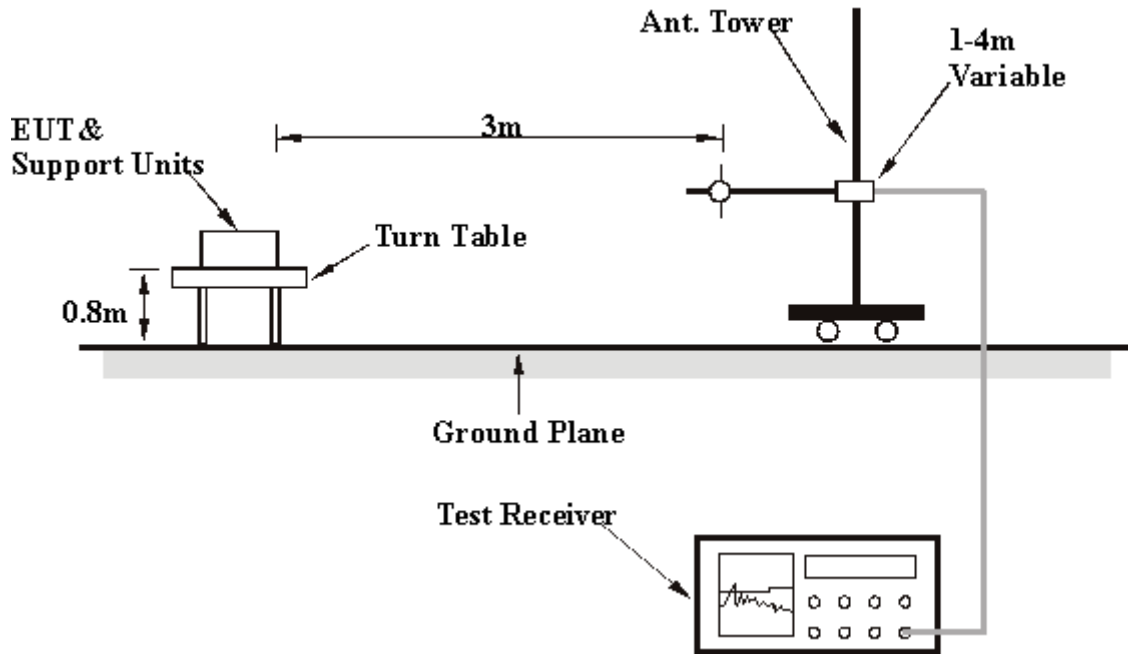

For the actual test configuration, please refer to the related item – Photographs of the Test Configuration.

5.2.6 EUT OPERATING CONDITIONS

Same as 5.1.6

5.2.7 TEST RESULTS

RADIATED WORST CASE DATA (FOR ADAPTER: PSAA05A-050):

EUT TEST CONDITION		MEASUREMENT DETAIL	
CHANNEL	Channel 78	FREQUENCY RANGE	Below 1000MHz
MODULATION TYPE	GFSK	DETECTOR FUNCTION	Quasi-Peak
TRANSFER RATE	6Mbps	INPUT POWER (SYSTEM)	120Vac, 60 Hz
ENVIRONMENTAL CONDITIONS	22deg. C, 68%RH, 991hPa	TEST MODE	A
TESTED BY	Lori Chiu		

ANTENNA POLARITY & TEST DISTANCE: HORIZONTAL AT 3 M								
No.	Freq. (MHz)	Emission Level (dBuV/m)	Limit (dBuV/m)	Margin (dB)	Antenna Height (m)	Table Angle (Degree)	Raw Value (dBuV)	Correction Factor (dB/m)
1	113.59	29.06 QP	43.50	-14.44	1.50 H	139	18.83	10.23
2	805.61	25.93 QP	46.00	-20.07	1.50 H	217	-0.14	26.07
3	821.16	25.57 QP	46.00	-20.43	1.50 H	16	-0.72	26.28
4	861.98	26.36 QP	46.00	-19.64	1.00 H	100	-0.41	26.77
5	896.97	26.84 QP	46.00	-19.16	1.50 H	73	-0.21	27.06
6	914.47	28.11 QP	46.00	-17.89	1.50 H	16	0.36	27.76

ANTENNA POLARITY & TEST DISTANCE: VERTICAL AT 3 M								
No.	Freq. (MHz)	Emission Level (dBuV/m)	Limit (dBuV/m)	Margin (dB)	Antenna Height (m)	Table Angle (Degree)	Raw Value (dBuV)	Correction Factor (dB/m)
1	49.44	30.61 QP	40.00	-9.39	1.00 V	76	16.17	14.44
2	70.82	22.75 QP	40.00	-17.25	1.00 V	112	11.04	11.71
3	813.39	26.03 QP	46.00	-19.97	1.00 V	295	-0.15	26.18
4	838.66	26.24 QP	46.00	-19.76	1.00 V	31	-0.28	26.52
5	861.98	26.03 QP	46.00	-19.97	1.00 V	253	-0.74	26.77
6	881.42	26.04 QP	46.00	-19.96	1.00 V	13	-0.89	26.93
7	933.91	28.91 QP	46.00	-17.09	1.00 V	4	0.24	28.66
8	953.35	28.47 QP	46.00	-17.53	1.00 V	319	-0.88	29.34

- REMARKS:**
1. Emission level (dBuV/m) = Raw Value (dBuV) + Correction Factor (dB/m).
 2. Correction Factor (dB/m) = Antenna Factor (dB/m) + Cable Factor (dB).
 3. The other emission levels were very low against the limit.
 4. Margin value = Emission level – Limit value.



RADIATED WORST CASE DATA (FOR ADAPTER: JHA050100UU05):

EUT TEST CONDITION		MEASUREMENT DETAIL	
CHANNEL	Channel 78	FREQUENCY RANGE	Below 1000MHz
MODULATION TYPE	GFSK	DETECTOR FUNCTION	Quasi-Peak
TRANSFER RATE	6Mbps	INPUT POWER (SYSTEM)	120Vac, 60 Hz
ENVIRONMENTAL CONDITIONS	22deg. C, 68%RH, 991hPa	TEST MODE	B
TESTED BY	Lori Chiu		

ANTENNA POLARITY & TEST DISTANCE: HORIZONTAL AT 3 M								
No.	Freq. (MHz)	Emission Level (dBuV/m)	Limit (dBuV/m)	Margin (dB)	Antenna Height (m)	Table Angle (Degree)	Raw Value (dBuV)	Correction Factor (dB/m)
1	203.01	28.63 QP	43.50	-14.87	1.00 H	1	17.70	10.93
2	766.73	25.40 QP	46.00	-20.60	2.00 H	79	-0.45	25.85
3	790.06	25.88 QP	46.00	-20.12	1.50 H	301	-0.07	25.95
4	828.94	25.84 QP	46.00	-20.16	2.00 H	79	-0.55	26.39
5	865.87	26.05 QP	46.00	-19.95	1.50 H	151	-0.75	26.80
6	904.75	26.97 QP	46.00	-19.03	2.00 H	169	-0.33	27.30
7	928.08	28.40 QP	46.00	-17.60	1.50 H	151	0.01	28.39

ANTENNA POLARITY & TEST DISTANCE: VERTICAL AT 3 M								
No.	Freq. (MHz)	Emission Level (dBuV/m)	Limit (dBuV/m)	Margin (dB)	Antenna Height (m)	Table Angle (Degree)	Raw Value (dBuV)	Correction Factor (dB/m)
1	70.82	27.38 QP	40.00	-12.62	1.00 V	229	15.68	11.71
2	745.35	25.31 QP	46.00	-20.69	1.00 V	349	-0.31	25.63
3	792.00	26.01 QP	46.00	-19.99	1.00 V	229	0.05	25.96
4	825.05	27.34 QP	46.00	-18.66	1.50 V	124	1.00	26.34
5	856.15	26.19 QP	46.00	-19.81	1.50 V	124	-0.53	26.73
6	906.69	26.96 QP	46.00	-19.04	1.00 V	292	-0.43	27.39
7	935.85	29.22 QP	46.00	-16.78	1.00 V	25	0.47	28.76

- REMARKS:**
1. Emission level (dBuV/m) = Raw Value (dBuV) + Correction Factor (dB/m).
 2. Correction Factor (dB/m) = Antenna Factor (dB/m) + Cable Factor (dB).
 3. The other emission levels were very low against the limit.
 4. Margin value = Emission level – Limit value.



RADIATED WORST CASE DATA (FOR ADAPTER: ADP-5FH B):

EUT TEST CONDITION		MEASUREMENT DETAIL	
CHANNEL	Channel 78	FREQUENCY RANGE	Below 1000MHz
MODULATION TYPE	GFSK	DETECTOR FUNCTION	Quasi-Peak
TRANSFER RATE	6Mbps	INPUT POWER (SYSTEM)	120Vac, 60 Hz
ENVIRONMENTAL CONDITIONS	22deg. C, 68%RH, 991hPa	TEST MODE	C
TESTED BY	Lori Chiu		

ANTENNA POLARITY & TEST DISTANCE: HORIZONTAL AT 3 M								
No.	Freq. (MHz)	Emission Level (dBuV/m)	Limit (dBuV/m)	Margin (dB)	Antenna Height (m)	Table Angle (Degree)	Raw Value (dBuV)	Correction Factor (dB/m)
1	129.14	30.02 QP	43.50	-13.48	2.00 H	127	18.01	12.01
2	197.17	25.81 QP	43.50	-17.69	1.00 H	103	14.79	11.02
3	809.50	25.61 QP	46.00	-20.39	1.00 H	16	-0.52	26.13
4	838.66	25.88 QP	46.00	-20.12	1.50 H	136	-0.64	26.52
5	871.70	26.28 QP	46.00	-19.72	1.00 H	16	-0.57	26.85
6	895.03	26.92 QP	46.00	-19.08	1.50 H	187	-0.12	27.04
7	918.36	28.19 QP	46.00	-17.81	1.00 H	220	0.25	27.94

ANTENNA POLARITY & TEST DISTANCE: VERTICAL AT 3 M								
No.	Freq. (MHz)	Emission Level (dBuV/m)	Limit (dBuV/m)	Margin (dB)	Antenna Height (m)	Table Angle (Degree)	Raw Value (dBuV)	Correction Factor (dB/m)
1	61.10	32.44 QP	40.00	-7.56	1.00 V	343	19.09	13.35
2	125.25	23.89 QP	43.50	-19.61	1.00 V	151	12.39	11.50
3	195.23	24.13 QP	43.50	-19.37	1.00 V	226	12.98	11.15
4	799.78	25.96 QP	46.00	-20.04	1.00 V	250	-0.04	26.00
5	854.21	26.20 QP	46.00	-19.80	1.00 V	268	-0.51	26.71
6	902.81	26.13 QP	46.00	-19.87	1.00 V	322	-1.09	27.21
7	920.30	27.63 QP	46.00	-18.37	1.00 V	166	-0.40	28.03
8	953.35	28.74 QP	46.00	-17.26	1.00 V	13	-0.60	29.34

- REMARKS:**
1. Emission level (dBuV/m) = Raw Value (dBuV) + Correction Factor (dB/m).
 2. Correction Factor (dB/m) = Antenna Factor (dB/m) + Cable Factor (dB).
 3. The other emission levels were very low against the limit.
 4. Margin value = Emission level – Limit value.



RADIATED WORST CASE DATA (POWER FROM BATTERY):

EUT TEST CONDITION		MEASUREMENT DETAIL	
CHANNEL	Channel 78	FREQUENCY RANGE	Below 1000MHz
MODULATION TYPE	GFSK	DETECTOR FUNCTION	Quasi-Peak
TRANSFER RATE	6Mbps	INPUT POWER (SYSTEM)	120Vac, 60 Hz
ENVIRONMENTAL CONDITIONS	22deg. C, 68%RH, 991hPa	TEST MODE	D
TESTED BY	Lori Chiu		

ANTENNA POLARITY & TEST DISTANCE: HORIZONTAL AT 3 M								
No.	Freq. (MHz)	Emission Level (dBuV/m)	Limit (dBuV/m)	Margin (dB)	Antenna Height (m)	Table Angle (Degree)	Raw Value (dBuV)	Correction Factor (dB/m)
1	76.65	36.58 QP	40.00	-3.42	1.50 H	64	25.62	10.96
2	757.01	25.15 QP	46.00	-20.85	1.50 H	127	-0.66	25.81
3	807.56	25.13 QP	46.00	-20.87	1.50 H	34	-0.97	26.10
4	830.88	25.65 QP	46.00	-20.35	1.00 H	55	-0.77	26.42
5	858.10	26.38 QP	46.00	-19.62	1.00 H	271	-0.37	26.74
6	906.69	26.98 QP	46.00	-19.02	1.50 H	166	-0.41	27.39
7	910.58	27.94 QP	46.00	-18.06	1.50 H	16	0.37	27.57

ANTENNA POLARITY & TEST DISTANCE: VERTICAL AT 3 M								
No.	Freq. (MHz)	Emission Level (dBuV/m)	Limit (dBuV/m)	Margin (dB)	Antenna Height (m)	Table Angle (Degree)	Raw Value (dBuV)	Correction Factor (dB/m)
1	35.83	21.95 QP	40.00	-18.05	1.00 V	313	8.71	13.24
2	76.65	27.58 QP	40.00	-12.42	1.00 V	184	16.62	10.96
3	809.50	26.14 QP	46.00	-19.86	2.00 V	160	0.01	26.13
4	838.66	26.30 QP	46.00	-19.70	1.00 V	193	-0.22	26.52
5	858.10	26.53 QP	46.00	-19.47	1.00 V	253	-0.21	26.74
6	906.69	26.71 QP	46.00	-19.29	1.50 V	208	-0.68	27.39
7	928.08	27.88 QP	46.00	-18.12	1.50 V	16	-0.51	28.39
8	957.23	28.18 QP	46.00	-17.82	1.50 V	136	-1.08	29.26

- REMARKS:**
1. Emission level (dBuV/m) = Raw Value (dBuV) + Correction Factor (dB/m).
 2. Correction Factor (dB/m) = Antenna Factor (dB/m) + Cable Factor (dB).
 3. The other emission levels were very low against the limit.
 4. Margin value = Emission level – Limit value.



RADIATED WORST CASE DATA (USB CABLE):

EUT TEST CONDITION		MEASUREMENT DETAIL	
CHANNEL	Channel 78	FREQUENCY RANGE	Below 1000MHz
MODULATION TYPE	GFSK	DETECTOR FUNCTION	Quasi-Peak
TRANSFER RATE	6Mbps	INPUT POWER (SYSTEM)	120Vac, 60 Hz
ENVIRONMENTAL CONDITIONS	22deg. C, 68%RH, 991hPa	TEST MODE	E
TESTED BY	Lori Chiu		

ANTENNA POLARITY & TEST DISTANCE: HORIZONTAL AT 3 M								
No.	Freq. (MHz)	Emission Level (dBuV/m)	Limit (dBuV/m)	Margin (dB)	Antenna Height (m)	Table Angle (Degree)	Raw Value (dBuV)	Correction Factor (dB/m)
1	109.70	38.20 QP	43.50	-5.30	1.00 H	226	28.32	9.87
2	146.63	28.17 QP	43.50	-15.33	1.50 H	34	14.74	13.43
3	325.47	31.51 QP	46.00	-14.49	1.00 H	64	15.56	15.95
4	337.13	36.90 QP	46.00	-9.10	1.00 H	61	20.79	16.11
5	364.35	36.79 QP	46.00	-9.21	2.00 H	31	20.03	16.76
6	467.37	28.42 QP	46.00	-17.58	1.50 H	259	9.08	19.34
7	681.20	28.08 QP	46.00	-17.92	1.00 H	52	4.36	23.72
8	801.72	29.04 QP	46.00	-16.96	1.50 H	34	3.02	26.02
9	931.96	28.58 QP	46.00	-17.42	1.00 H	52	0.01	28.57

ANTENNA POLARITY & TEST DISTANCE: VERTICAL AT 3 M								
No.	Freq. (MHz)	Emission Level (dBuV/m)	Limit (dBuV/m)	Margin (dB)	Antenna Height (m)	Table Angle (Degree)	Raw Value (dBuV)	Correction Factor (dB/m)
1	59.16	29.61 QP	40.00	-10.39	1.50 V	292	16.00	13.61
2	111.64	40.68 QP	43.50	-2.82	1.00 V	10	30.63	10.05
3	146.63	33.59 QP	43.50	-9.91	1.00 V	82	20.16	13.43
4	348.80	31.50 QP	46.00	-14.50	1.00 V	256	15.23	16.27
5	360.46	29.62 QP	46.00	-16.38	1.50 V	163	12.99	16.63
6	665.65	35.88 QP	46.00	-10.12	2.00 V	31	12.51	23.38
7	700.64	28.46 QP	46.00	-17.54	1.00 V	115	4.30	24.16
8	933.91	28.63 QP	46.00	-17.37	1.00 V	292	-0.04	28.66

- REMARKS:**
1. Emission level (dBuV/m) = Raw Value (dBuV) + Correction Factor (dB/m).
 2. Correction Factor (dB/m) = Antenna Factor (dB/m) + Cable Factor (dB).
 3. The other emission levels were very low against the limit.
 4. Margin value = Emission level – Limit value.

EUT TEST CONDITION		MEASUREMENT DETAIL	
CHANNEL	Channel 0	FREQUENCY RANGE	1 ~ 25GHz
MODULATION TYPE	GFSK	DETECTOR FUNCTION	Peak (PK) Average (AV)
INPUT POWER (SYSTEM)	120Vac, 60 Hz	ENVIRONMENTAL CONDITIONS	20deg. C, 60%RH, 991hPa
TEST MODE	E	TESTED BY	Lori Chiu

ANTENNA POLARITY & TEST DISTANCE: HORIZONTAL AT 3 M								
No.	Freq. (MHz)	Emission Level (dBuV/m)	Limit (dBuV/m)	Margin (dB)	Antenna Height (m)	Table Angle (Degree)	Raw Value (dBuV)	Correction Factor (dB/m)
1	2390.00	41.38 PK	74.00	-32.62	1.03 H	285	9.47	31.91
1	2390.00	33.82 AV	54.00	-20.18	1.03 H	285	1.91	31.91
2	*2402.00	95.89 PK			1.08 H	285	63.91	31.98
2	*2402.00	65.89 AV			1.08 H	285	33.91	31.98
3	4804.00	50.58 PK	74.00	-23.42	1.08 H	245	13.09	37.49
3	4804.00	20.58 AV	54.00	-33.42	1.08 H	245	-16.91	37.49

ANTENNA POLARITY & TEST DISTANCE: VERTICAL AT 3 M								
No.	Freq. (MHz)	Emission Level (dBuV/m)	Limit (dBuV/m)	Margin (dB)	Antenna Height (m)	Table Angle (Degree)	Raw Value (dBuV)	Correction Factor (dB/m)
1	2390.00	38.48 PK	74.00	-35.52	1.08 V	255	6.57	31.91
1	2390.00	31.11 AV	54.00	-22.89	1.08 V	255	-0.80	31.91
2	*2402.00	91.32 PK			1.08 V	215	59.34	31.98
2	*2402.00	61.32 AV			1.08 V	215	29.34	31.98
3	4804.00	46.25 PK	74.00	-27.75	1.05 V	352	8.76	37.49
3	4804.00	16.25 AV	54.00	-37.75	1.05 V	352	-21.24	37.49

- REMARKS:**
1. Emission level (dBuV/m) = Raw Value (dBuV) + Correction Factor (dB/m).
 2. Correction Factor (dB/m) = Antenna Factor (dB/m) + Cable Factor (dB).
 3. The other emission levels were very low against the limit.
 4. Margin value = Emission level – Limit value.
 5. The DH5 packet was the worse case duty cycle for a transmit dwell time on a channel, based upon bluetooth theory the transmitter is on 0.625 * 5 per 247 ms per channel. Therefore, the duty cycle be equal to $20\log(3.125/100) = -30$ dB.
 6. Average value = peak reading – $20\log(\text{duty cycle})$.

EUT TEST CONDITION		MEASUREMENT DETAIL	
CHANNEL	Channel 39	FREQUENCY RANGE	1 ~ 25GHz
MODULATION TYPE	GFSK	DETECTOR FUNCTION	Peak (PK) Average (AV)
INPUT POWER (SYSTEM)	120Vac, 60 Hz	ENVIRONMENTAL CONDITIONS	20deg. C, 60%RH, 991hPa
TEST MODE	E	TESTED BY	Lori Chiu

ANTENNA POLARITY & TEST DISTANCE: HORIZONTAL AT 3 M								
No.	Freq. (MHz)	Emission Level (dBuV/m)	Limit (dBuV/m)	Margin (dB)	Antenna Height (m)	Table Angle (Degree)	Raw Value (dBuV)	Correction Factor (dB/m)
1	*2441.00	96.89 PK			1.02 H	258	64.66	32.22
1	*2441.00	66.89 AV			1.02 H	258	34.67	32.22
2	4882.00	52.55 PK	74.00	-21.45	1.08 H	255	14.99	37.56
2	4882.00	22.55 AV	54.00	-31.45	1.08 H	255	-15.01	37.56

ANTENNA POLARITY & TEST DISTANCE: VERTICAL AT 3 M								
No.	Freq. (MHz)	Emission Level (dBuV/m)	Limit (dBuV/m)	Margin (dB)	Antenna Height (m)	Table Angle (Degree)	Raw Value (dBuV)	Correction Factor (dB/m)
1	*2441.00	92.32 PK			1.55 V	251	60.10	32.22
1	*2441.00	62.32 AV			1.55 V	251	30.10	32.22
2	4882.00	50.58 PK	74.00	-23.42	1.00 V	252	13.02	37.56
2	4882.00	20.58 AV	54.00	-33.42	1.00 V	252	-16.98	37.56

- REMARKS:**
1. Emission level (dBuV/m) = Raw Value (dBuV) + Correction Factor (dB/m).
 2. Correction Factor (dB/m) = Antenna Factor (dB/m) + Cable Factor (dB).
 3. The other emission levels were very low against the limit.
 4. Margin value = Emission level – Limit value.
 5. The DH5 packet was the worse case duty cycle for a transmit dwell time on a channel, based upon bluetooth theory the transmitter is on 0.625 * 5 per 247 ms per channel. Therefore, the duty cycle be equal to $20\log(3.125/100) = -30$ dB.
 6. Average value = peak reading – $20\log(\text{duty cycle})$.

EUT TEST CONDITION		MEASUREMENT DETAIL	
CHANNEL	Channel 78	FREQUENCY RANGE	1 ~ 25GHz
MODULATION TYPE	GFSK	DETECTOR FUNCTION	Peak (PK) Average (AV)
INPUT POWER (SYSTEM)	120Vac, 60 Hz	ENVIRONMENTAL CONDITIONS	20deg. C, 60%RH, 991hPa
TEST MODE	E	TESTED BY	Lori Chiu

ANTENNA POLARITY & TEST DISTANCE: HORIZONTAL AT 3 M								
No.	Freq. (MHz)	Emission Level (dBuV/m)	Limit (dBuV/m)	Margin (dB)	Antenna Height (m)	Table Angle (Degree)	Raw Value (dBuV)	Correction Factor (dB/m)
1	*2480.00	97.45 PK			1.05 H	262	64.98	32.47
1	*2480.00	67.45 AV			1.05 H	262	34.98	32.47
2	2483.50	46.32 PK	74.00	-27.68	1.06 H	266	13.83	32.49
2	2483.50	38.22 AV	54.00	-15.78	1.06 H	266	5.73	32.49
3	4960.00	50.23 PK	74.00	-23.77	1.00 H	255	12.64	37.59
3	4960.00	20.23 AV	54.00	-33.77	1.00 H	255	-17.36	37.59

ANTENNA POLARITY & TEST DISTANCE: VERTICAL AT 3 M								
No.	Freq. (MHz)	Emission Level (dBuV/m)	Limit (dBuV/m)	Margin (dB)	Antenna Height (m)	Table Angle (Degree)	Raw Value (dBuV)	Correction Factor (dB/m)
1	*2480.00	93.22 PK			1.18 V	212	60.75	32.47
1	*2480.00	63.22 AV			1.18 V	212	30.75	32.47
2	2483.50	42.12 PK	74.00	-31.88	1.02 V	321	9.63	32.49
2	2483.50	34.08 AV	54.00	-19.92	1.02 V	321	1.59	32.49
3	4960.00	45.12 PK	74.00	-28.88	1.08 V	142	7.53	37.59
3	4960.00	15.12 AV	54.00	-38.88	1.08 V	142	-22.47	37.59

- REMARKS:**
1. Emission level (dBuV/m) = Raw Value (dBuV) + Correction Factor (dB/m).
 2. Correction Factor (dB/m) = Antenna Factor (dB/m) + Cable Factor (dB).
 3. The other emission levels were very low against the limit.
 4. Margin value = Emission level – Limit value.
 5. The DH5 packet was the worse case duty cycle for a transmit dwell time on a channel, based upon bluetooth theory the transmitter is on 0.625 * 5 per 247 ms per channel. Therefore, the duty cycle be equal to $20\log(3.125/100) = -30$ dB.
 6. Average value = peak reading – $20\log(\text{duty cycle})$.



5.3 NUMBER OF HOPPING FREQUENCY USED

5.3.1 LIMIT OF HOPPING FREQUENCY USED

At least 15 channels frequencies, and should be equally spaced.

5.3.2 TEST INSTRUMENTS

DESCRIPTION & MANUFACTURER	MODEL NO.	SERIAL NO.	CALIBRATED UNTIL
SPECTRUM ANALYZER	FSEK30	100049	Aug. 14, 2006

NOTE: The calibration interval of the above test instruments is 12 months. And the calibrations are traceable to NML/ROC and NIST/USA.

5.3.3 TEST PROCEDURES

- a. Check the calibration of the measuring instrument (SA) using either an internal calibrator or a known signal from an external generator.
- b. Turn on the EUT and connect its antenna terminal to measurement via a low loss cable. Then set it to any one measured frequency within its operating range and make sure the instrument is operated in its linear range.
- c. Set the SA on MaxHold Mode, and then keep the EUT in hopping mode. Record all the signals from each channel until each one has been recorded.
- d. Set the SA on View mode and then plot the result on SA screen.
- e. Repeat above procedures until all frequencies measured were complete.

5.3.4 DEVIATION FROM TEST STANDARD

No deviation.

5.3.5 TEST SETUP



5.3.6 TEST RESULTS

There are 79 hopping frequencies in the hopping mode. Please refer to next two pages for the test result. On the plots, it shows that the hopping frequencies are equally spaced.

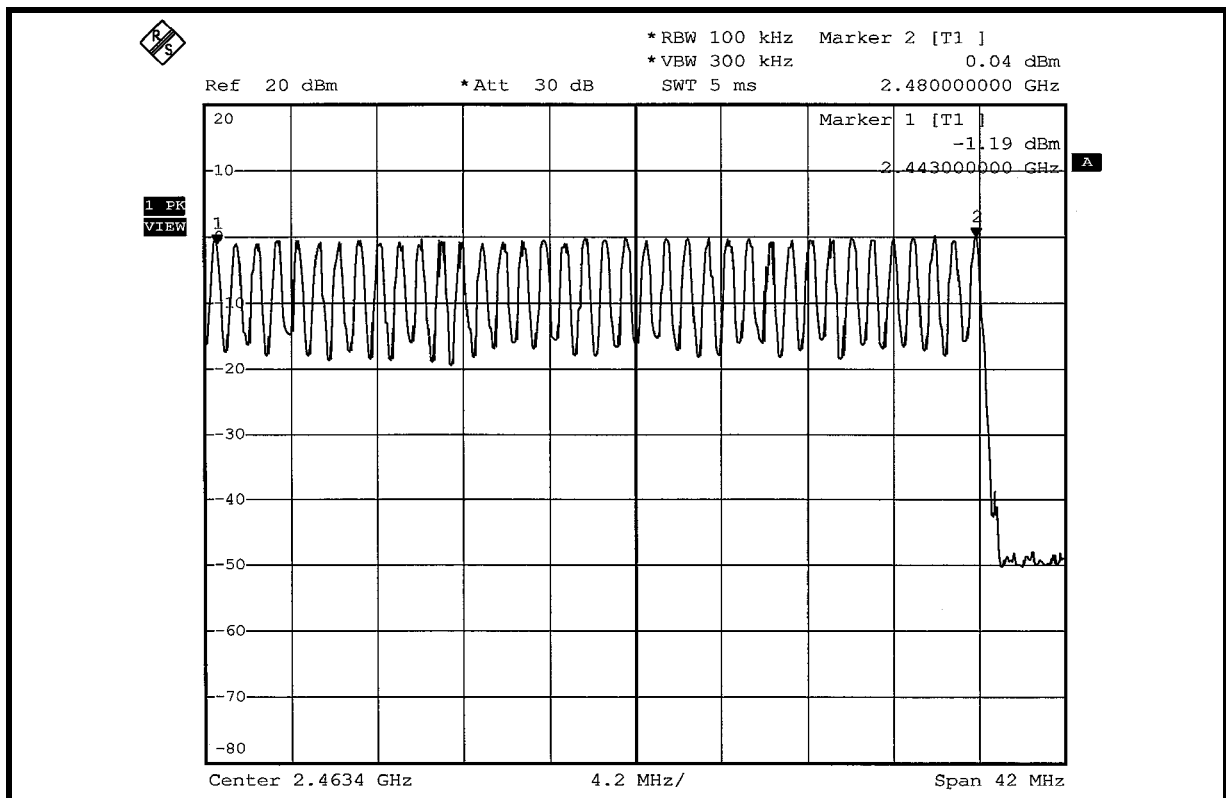
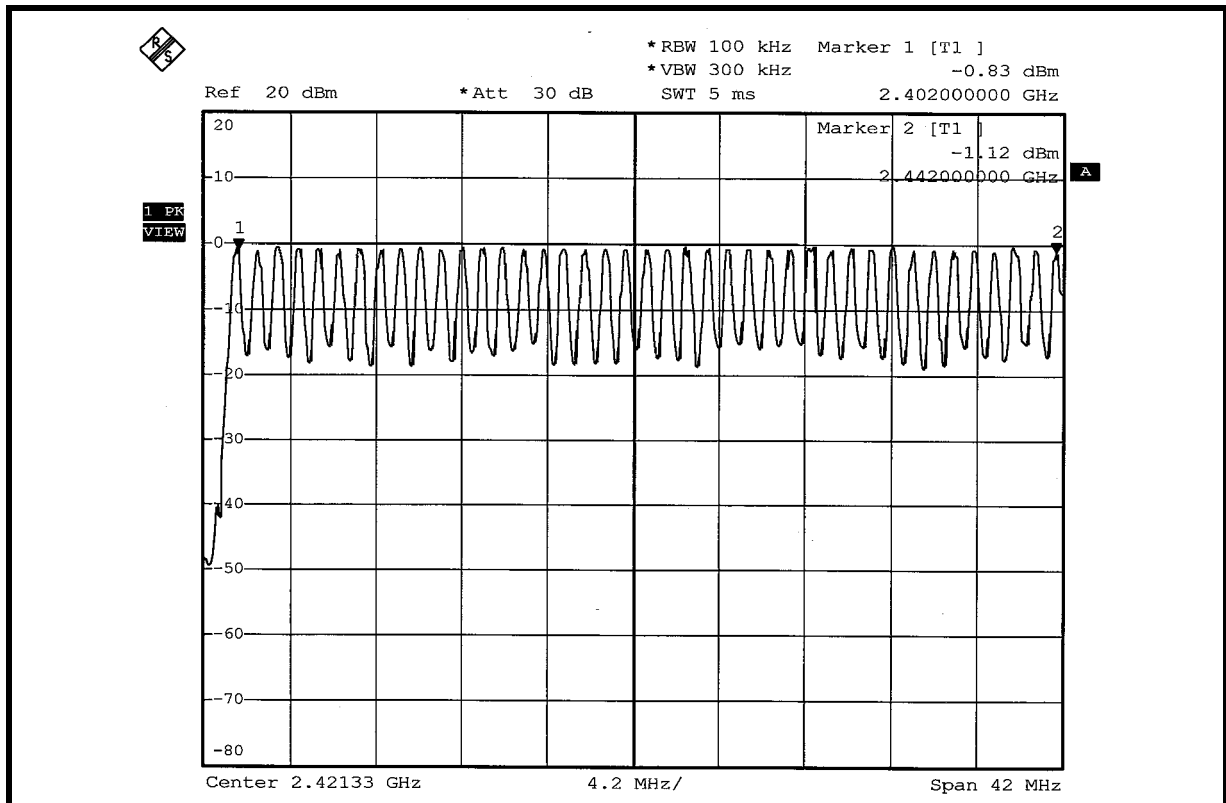



5.4 DWELL TIME ON EACH CHANNEL

5.4.1 LIMIT OF DWELL TIME USED

The average time of occupancy on any channel shall not be greater than 0.4 seconds within a period of 0.4 seconds multiplied by the number of hopping channels employed.

5.4.2 TEST INSTRUMENTS

DESCRIPTION & MANUFACTURER	MODEL NO.	SERIAL NO.	CALIBRATED UNTIL
SPECTRUM ANALYZER	FSEK30	100049	Aug. 14, 2006

NOTES: The calibration interval of the above test instruments is 12 months. And the calibrations are traceable to NML/ROC and NIST/USA.

5.4.3 TEST PROCEDURES

- a. Check the calibration of the measuring instrument (SA) using either an internal calibrator or a known signal from an external generator.
- b. Turn on the EUT and connect its antenna terminal to measurement via a low loss cable. Then set it to any one measured frequency within its operating range and make sure the instrument is operated in its linear range.
- c. Adjust the center frequency of SA on any frequency be measured and set SA to zero span mode. And then, set RBW and VBW of spectrum analyzer to proper value.
- d. Measure the time duration of one transmission on the measured frequency. And then plot the result with time difference of this time duration.
- e. Repeat above procedures until all different time-slot modes have been completed.

5.4.4 DEVIATION FROM TEST STANDARD

No deviation.

5.4.5 TEST SETUP



5.4.6 TEST RESULTS

MODE	NUMBER OF TRANSMISSION IN A 31.6 (79HOPPING*0.4)	LENGTH OF TRANSMISSION TIME (msec)	RESULT (msec)	LIMIT (msec)
DH1	49 (times / 5 sec) * 6.32 = 309.68 times	0.468	144.930	400
DH3	27 (times / 5 sec) * 6.32 = 170.64 times	1.728	294.866	400
DH5	16 (times / 5 sec) * 6.32 = 101.12 times	3.000	303.360	400

NOTE: Test plots of the transmitting time slot are shown on next 3 pages.

DH1

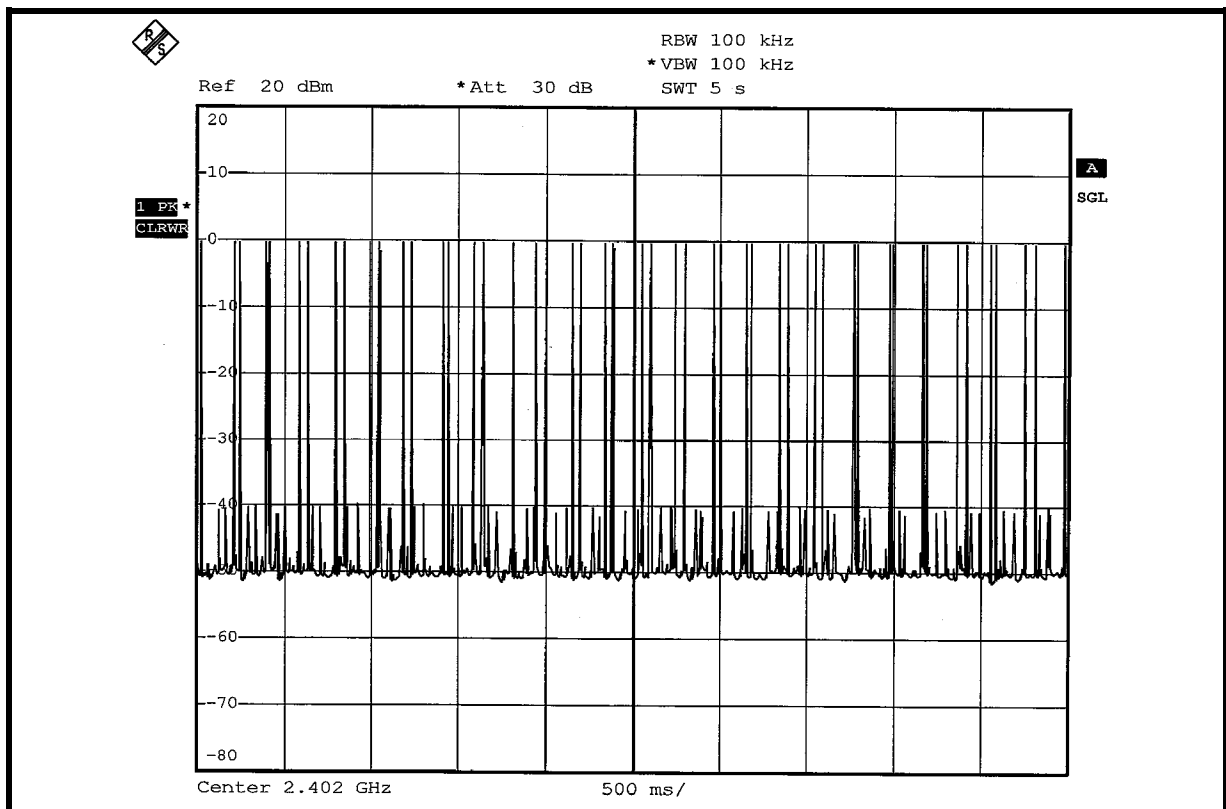
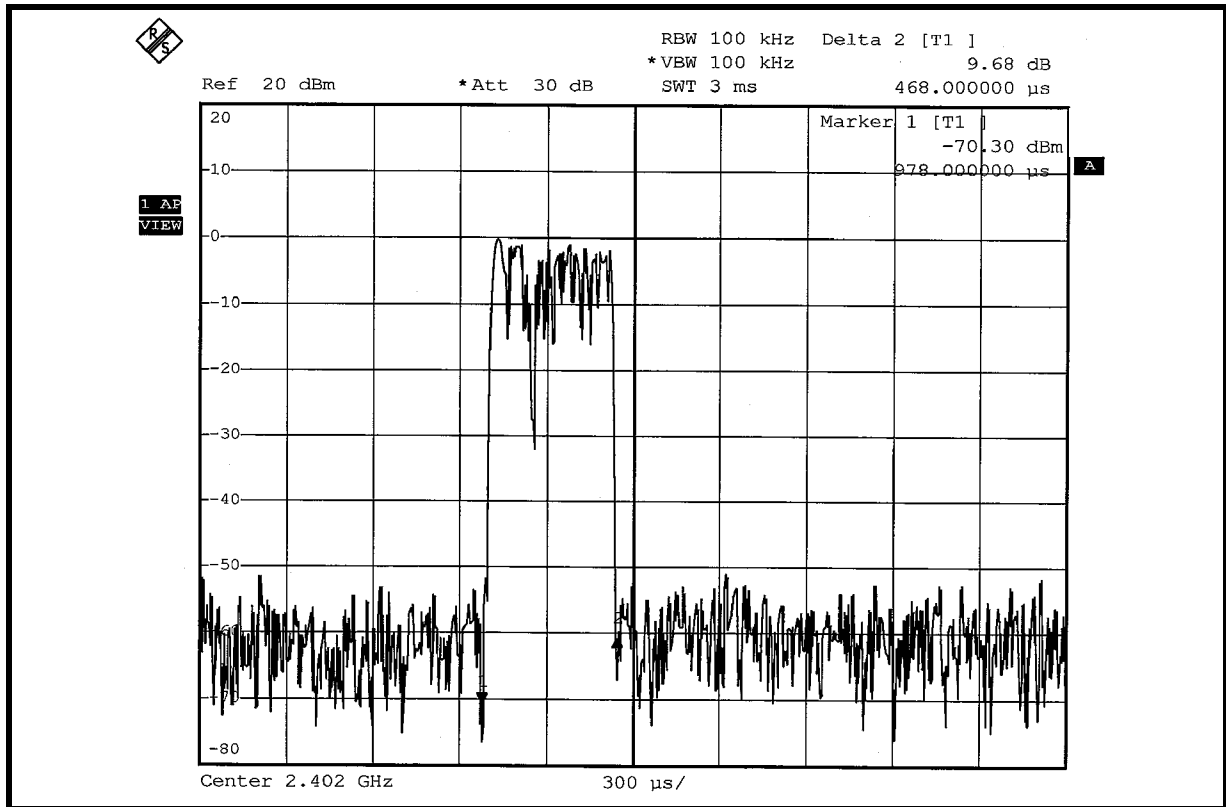

DH5

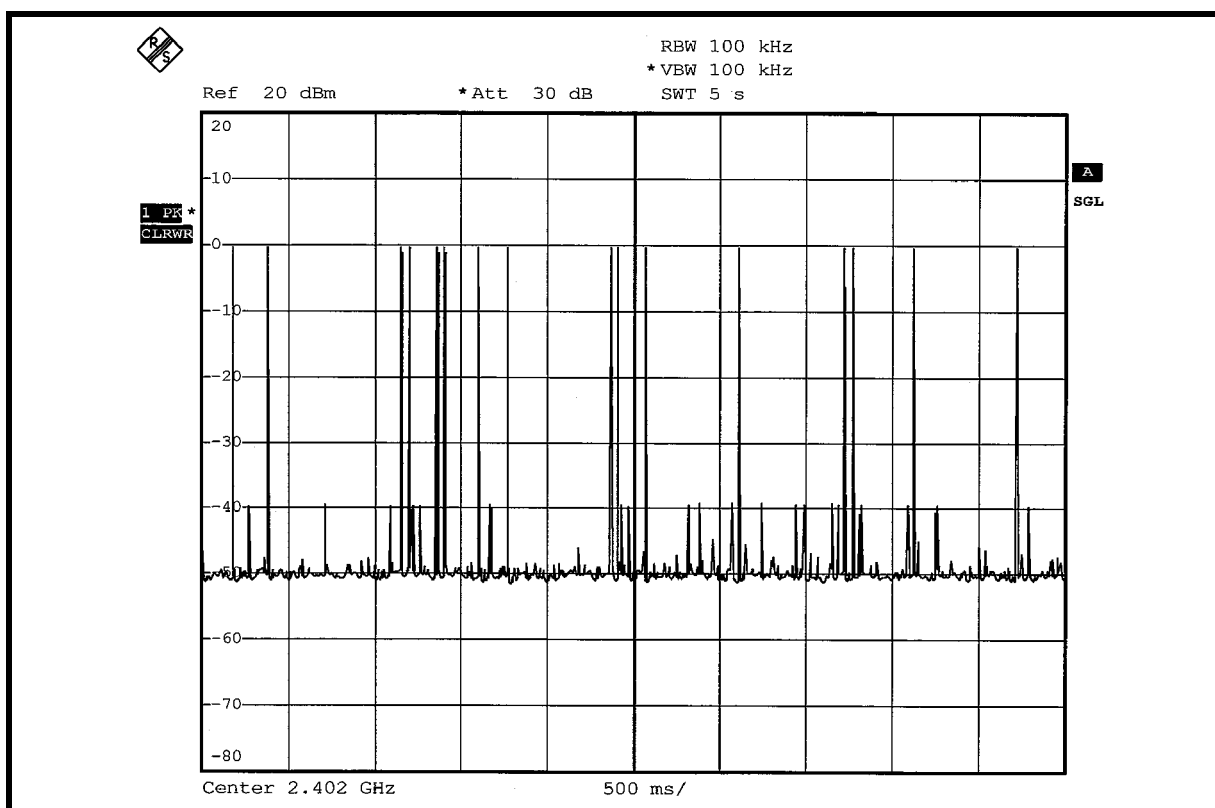
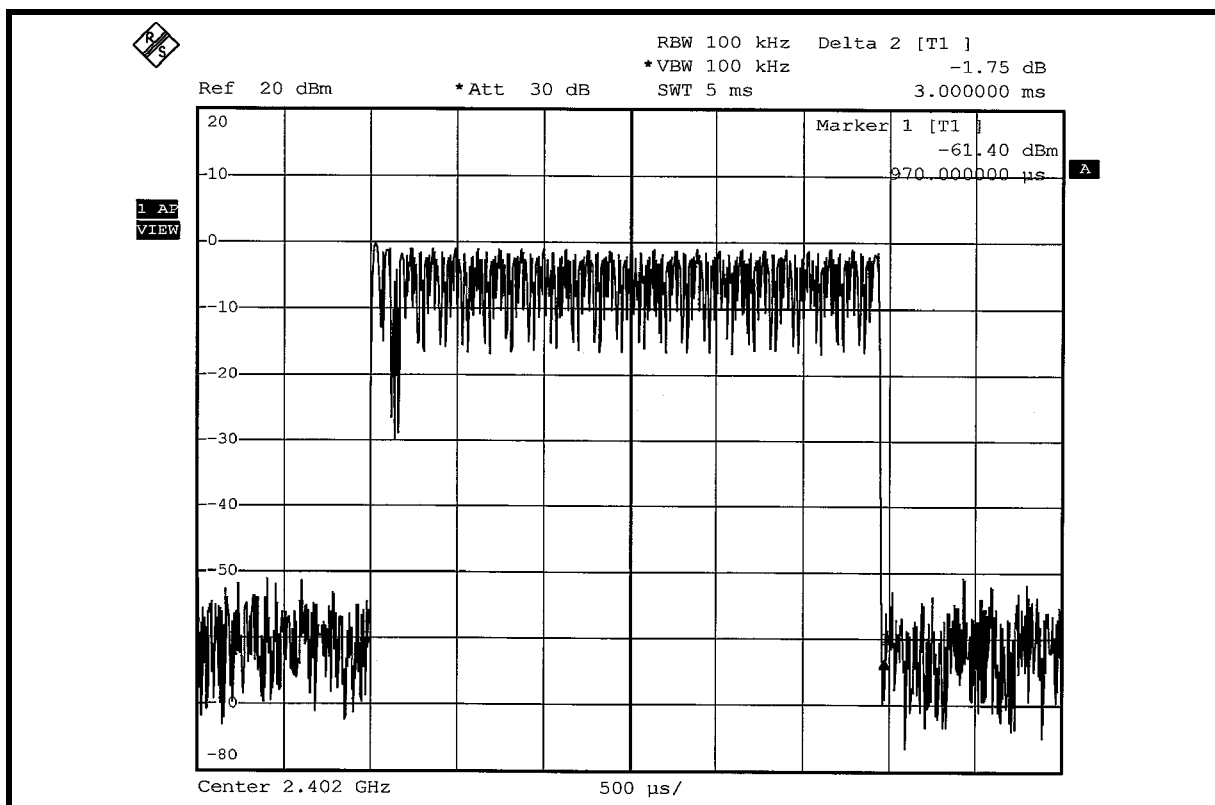



5.5 CHANNEL BANDWIDTH

5.5.1 LIMITS OF CHANNEL BANDWIDTH

For frequency hopping system operating in the 2400-2483.5MHz, If the 20dB bandwidth of hopping channel is greater than 25kHz, the 20dB bandwidth of hopping channel shall be a minimum limit for the hopping channel separation.

5.5.2 TEST INSTRUMENTS

DESCRIPTION & MANUFACTURER	MODEL NO.	SERIAL NO.	CALIBRATED UNTIL
SPECTRUM ANALYZER	FSEK30	100049	Aug. 14, 2006

NOTE: The calibration interval of the above test instruments is 12 months. And the calibrations are traceable to NML/ROC and NIST/USA.

5.5.3 TEST PROCEDURE

- a. Check the calibration of the measuring instrument using either an internal calibrator or a known signal from an external generator.
- b. Turn on the EUT and connect it to measurement instrument. Then set it to any one convenient frequency within its operating range. Set a reference level on the measuring instrument equal to the highest peak value.
- c. Measure the frequency difference of two frequencies that were attenuated 20dB from the reference level. Record the frequency difference as the emission bandwidth.
- d. Repeat above procedures until all frequencies measured were complete.

5.5.4 DEVIATION FROM TEST STANDARD

No deviation.

5.5.5 TEST SETUP



5.5.6 EUT OPERATING CONDITION

The software provided by client enabled the EUT to transmit and receive data at lowest, middle and highest channel frequencies individually.

5.5.7 TEST RESULTS

MODULATION TYPE	GFSK	ENVIRONMENTAL CONDITIONS	23deg. C, 54%RH, 991hPa
INPUT POWER (SYSTEM)	120Vac, 60 Hz	TESTED BY	Lori Chiu

CHANNEL	CHANNEL FREQUENCY (MHz)	20dB BANDWIDTH (MHz)
0	2402	0.948
39	2441	0.969
78	2480	0.969

CH 0

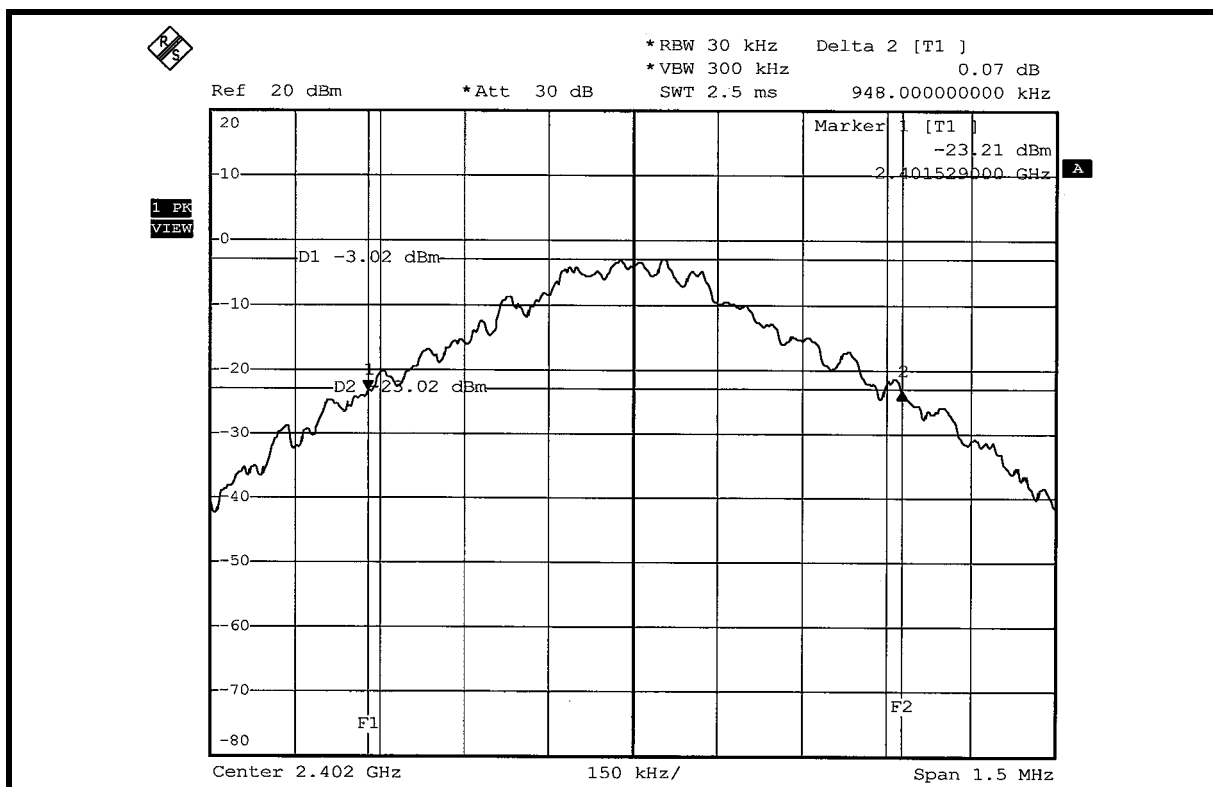

CH 39

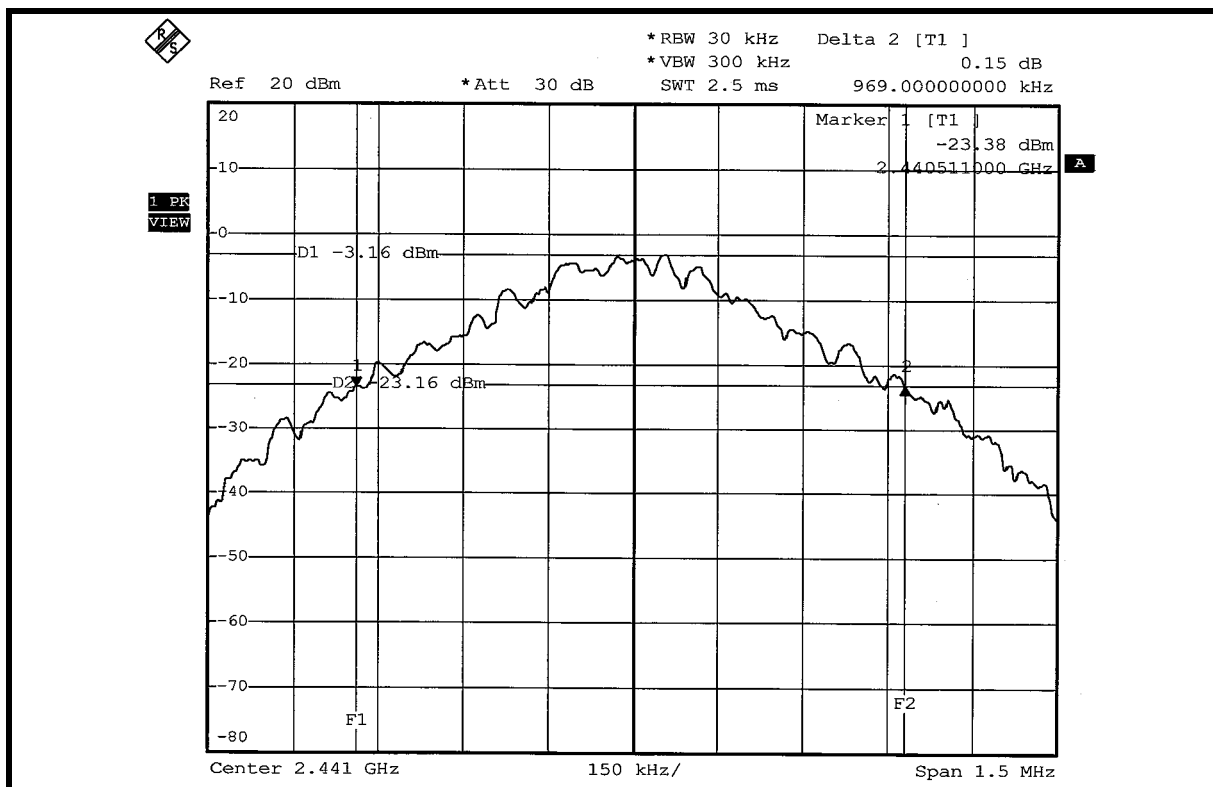

CH 78

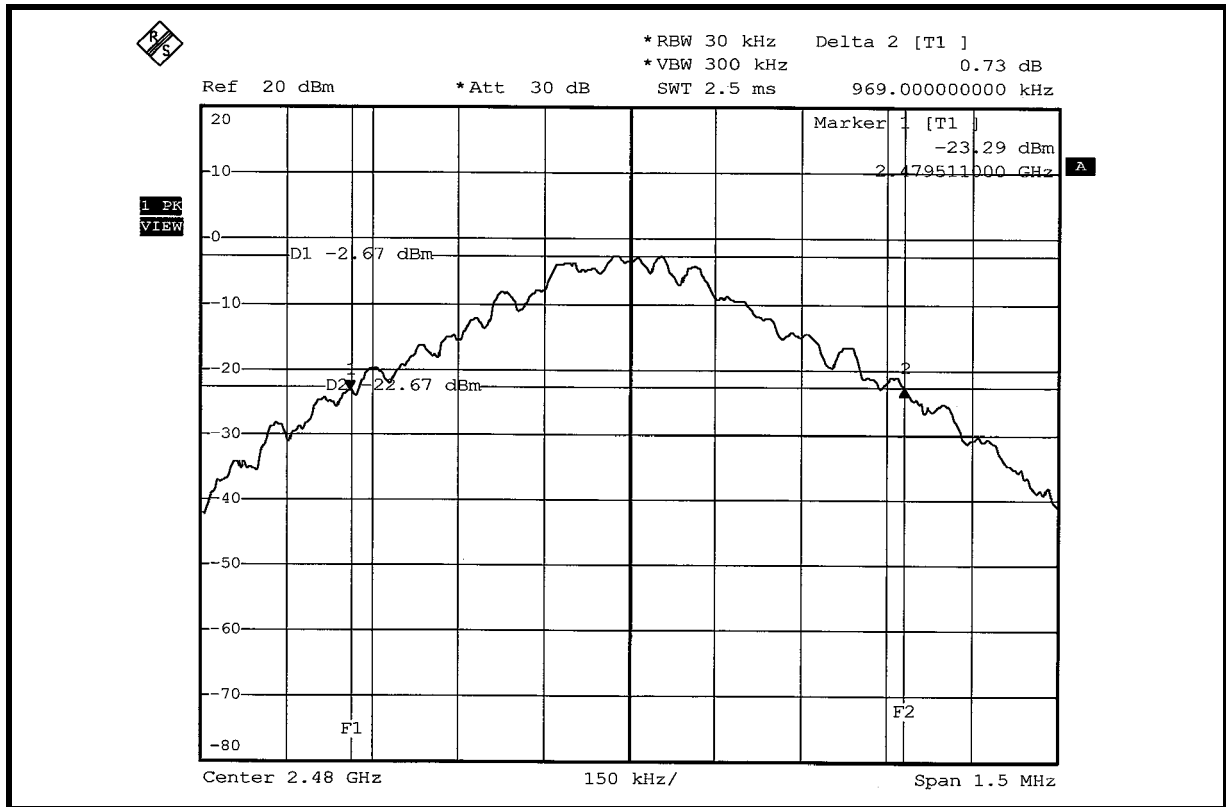



5.6 HOPPING CHANNEL SEPARATION

5.6.1 LIMIT OF HOPPING CHANNEL SEPARATION

At least 25kHz or 20dB bandwidth (whichever is greater).

5.6.2 TEST INSTRUMENTS

DESCRIPTION & MANUFACTURER	MODEL NO.	SERIAL NO.	CALIBRATED UNTIL
SPECTRUM ANALYZER	FSEK30	100049	Aug. 14, 2006

NOTES: The calibration interval of the above test instruments is 12 months. And the calibrations are traceable to NML/ROC and NIST/USA.

5.6.3 TEST PROCEDURES

1. Check the calibration of the measuring instrument using either an internal calibrator or a known signal from an external generator.
2. Turn on the EUT and connect it to measurement instrument. Then set it to any one convenient frequency within its operating range.
3. By using the MaxHold function record the separation of two adjacent channels.
4. Measure the frequency difference of these two adjacent channels by SA MARK function. And then plot the result on SA screen.
5. Repeat above procedures until all frequencies measured were complete.

5.6.4 DEVIATION FROM TEST STANDARD

No deviation

5.6.5 TEST SETUP



5.6.6 TEST RESULTS

MODULATION TYPE	GFSK	ENVIRONMENTAL CONDITIONS	23deg. C, 54%RH, 991hPa
INPUT POWER (SYSTEM)	120Vac, 60 Hz	TESTED BY	Lori Chiu

CHANNEL	FREQUENCY (MHz)	ADJACENT CHANNEL SEPARATION (MHz)	MINIMUM LIMIT (MHz)	PASS / FAIL
0	2402	1.025	0.948	PASS
39	2441	1.050	0.969	PASS
78	2480	1.005	0.969	PASS

NOTE: The minimum limit is 20dB bandwidth. Test results please refer to next two pages.

CH 0

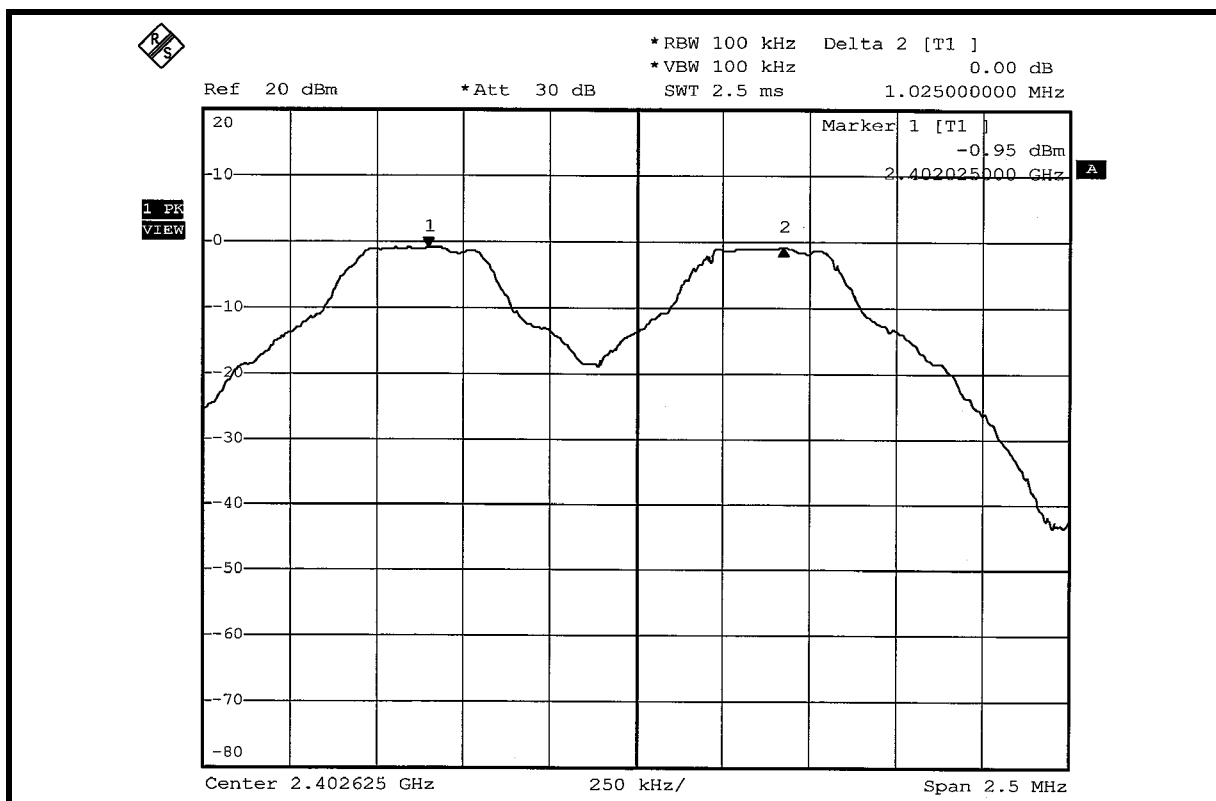

CH 39

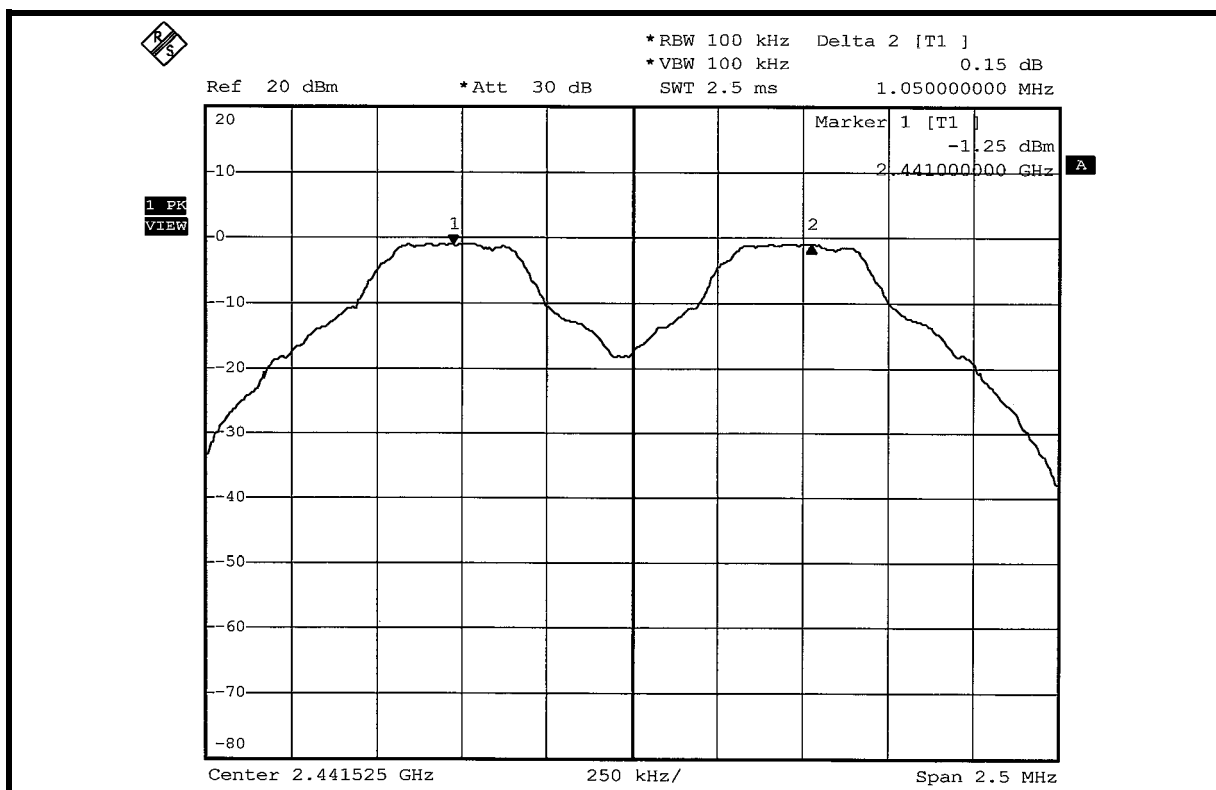

CH 78

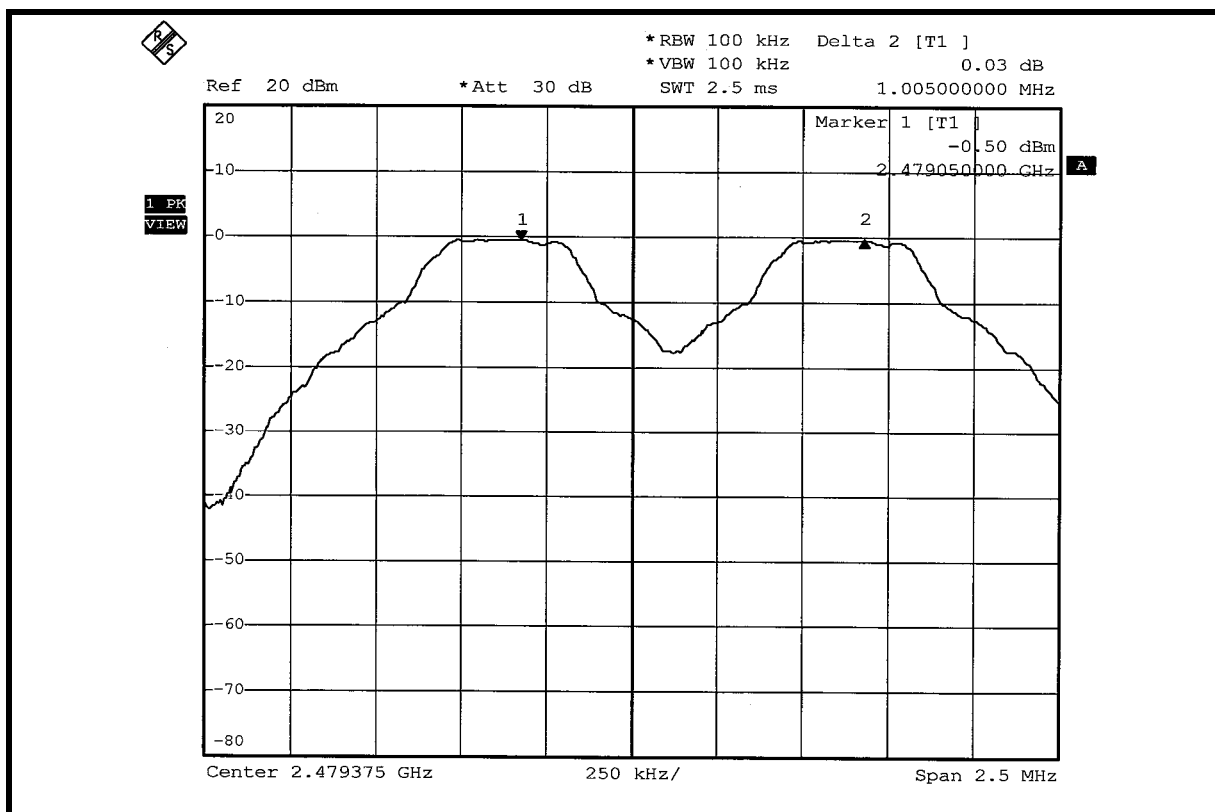



5.7 MAXIMUM PEAK OUTPUT POWER

5.7.1 LIMITS OF MAXIMUM PEAK OUTPUT POWER MEASUREMENT

The Maximum Peak Output Power Measurement is 30dBm.

5.7.2 TEST INSTRUMENTS

DESCRIPTION & MANUFACTURER	MODEL NO.	SERIAL NO.	CALIBRATED UNTIL
SPECTRUM ANALYZER	FSEK30	100049	Aug. 14, 2006

NOTE: The calibration interval of the above test instruments is 12 months and the calibrations are traceable to NML/ROC and NIST/USA.

5.7.3 TEST PROCEDURES

- a. Check the calibration of the measuring instrument using either an internal calibrator or a known signal from an external generator.
- b. Turn on the EUT and connect it to measurement instrument. Then set it to any one convenient frequency within its operating range. Set a reference level on the measuring instrument equal to the highest peak value.
- c. The center frequency of the spectrum analyzer is set to the fundamental frequency and using 1 MHz RBW and 3 MHz VBW.
- d. Measure the captured power within the band and recording the plot.
- e. Repeat above procedures until all frequencies required were complete.

5.7.4 DEVIATION FROM TEST STANDARD

No deviation

5.7.5 TEST SETUP



For the actual test configuration, please refer to the related Item – Photographs of the Test Configuration.

5.7.6 EUT OPERATING CONDITION

The software provided by client enabled the EUT to transmit and receive data at lowest, middle and highest channel frequencies individually.

5.7.7 TEST RESULTS

MODULATION TYPE	GFSK	ENVIRONMENTAL CONDITIONS	23deg. C, 54%RH, 991hPa
INPUT POWER (SYSTEM)	120Vac, 60 Hz	TESTED BY	Lori Chiu

CHANNEL	CHANNEL FREQUENCY (MHz)	PEAK POWER OUTPUT (mW)	PEAK POWER OUTPUT (dBm)	PEAK POWER LIMIT (dBm)	PASS/FAIL
0	2402	0.912	-0.40	30	PASS
39	2441	0.881	-0.55	30	PASS
78	2480	1.000	0.00	30	PASS

CH 0

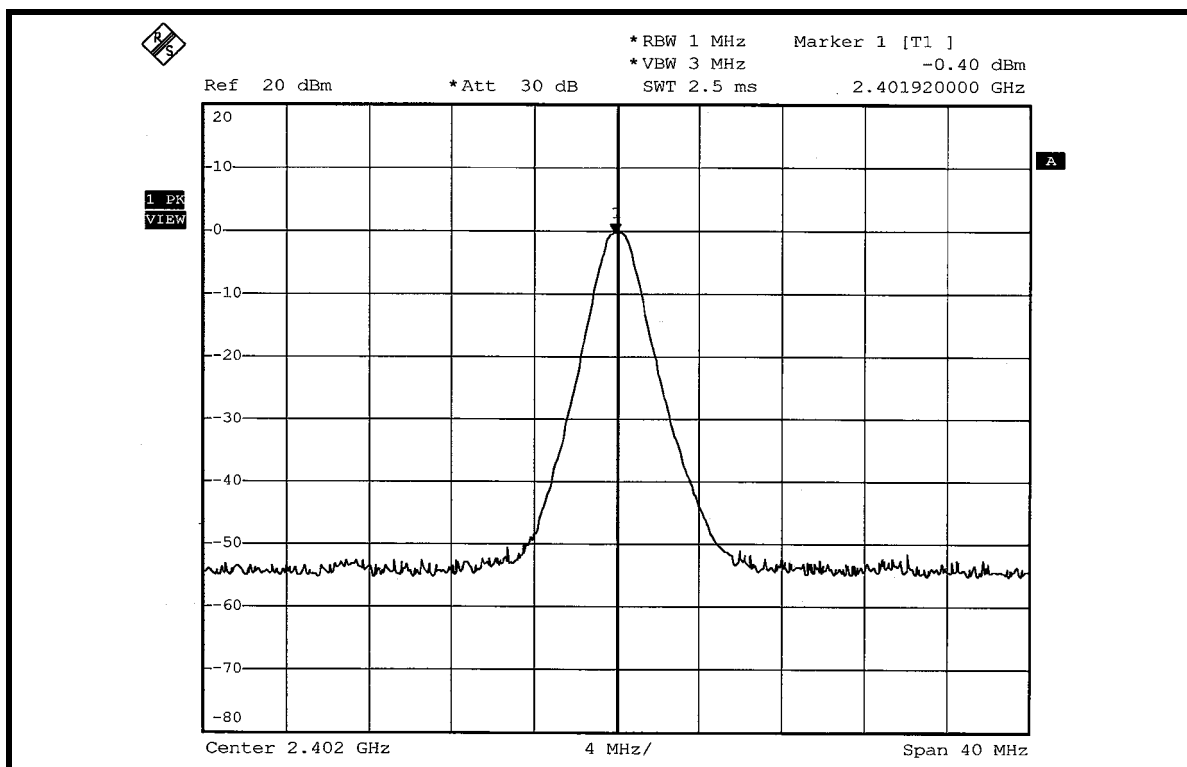

CH 39

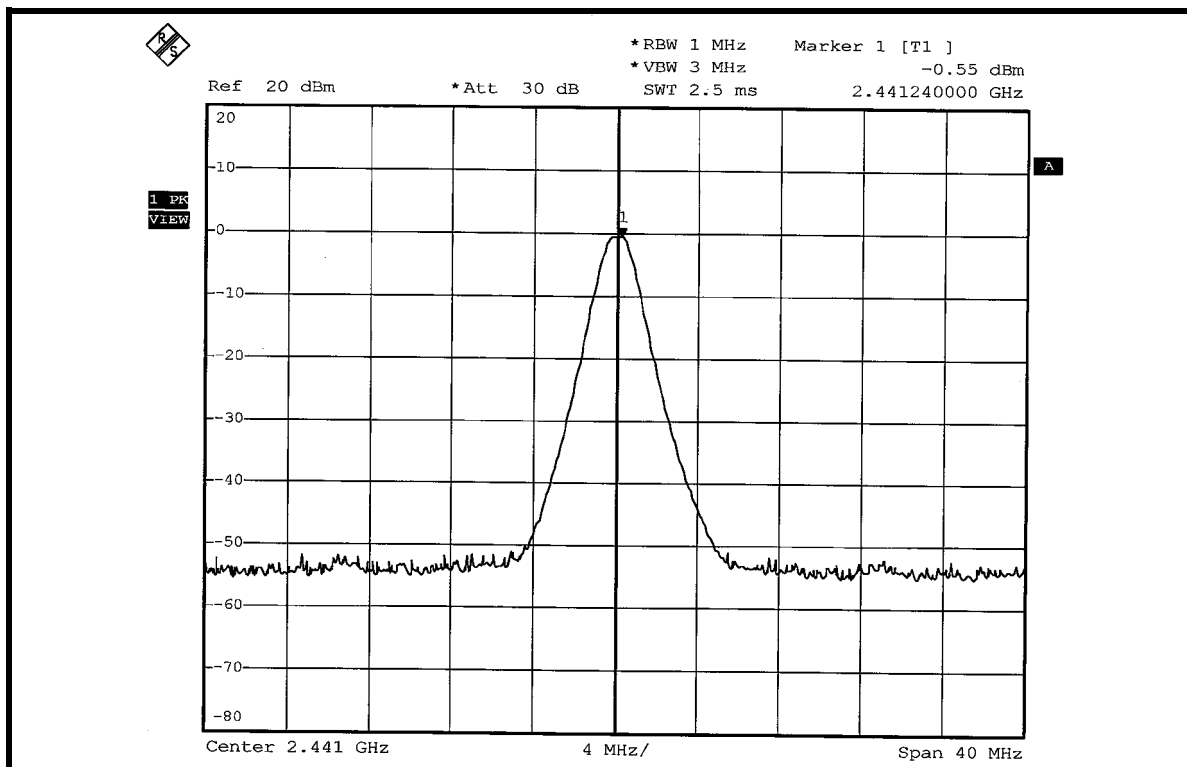

CH 78

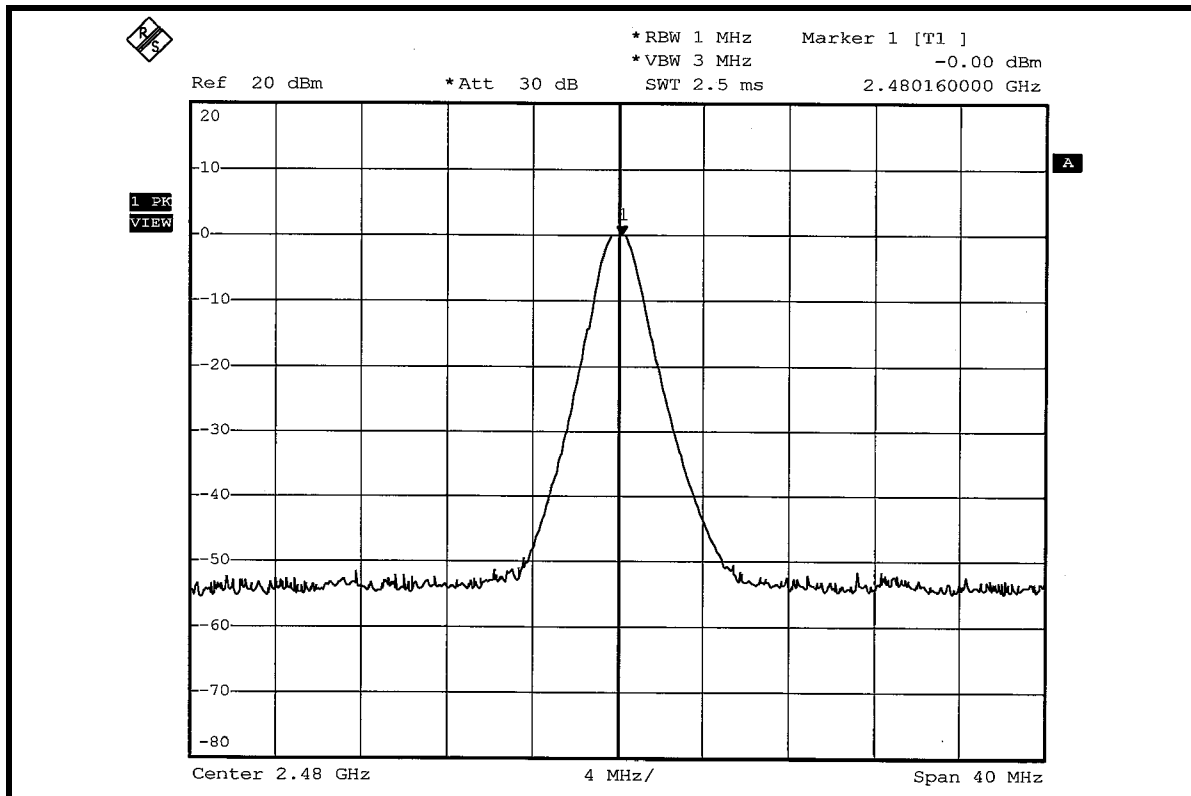



5.8 BAND EDGES MEASUREMENT

5.8.1 LIMITS OF BAND EDGES MEASUREMENT

Below -20dB of the highest emission level of operating band (in 100KHz RBW).

5.8.2 TEST INSTRUMENTS

DESCRIPTION & MANUFACTURER	MODEL NO.	SERIAL NO.	CALIBRATED UNTIL
SPECTRUM ANALYZER	FSEK30	100049	Aug. 14, 2006

NOTES: The calibration interval of the above test instruments is 12 months. And the calibrations are traceable to NML/ROC and NIST/USA.

5.8.3 TEST PROCEDURE

The transmitter output was connected to the spectrum analyzer via a low lose cable. Set both RBW and VBW of spectrum analyzer to 100 kHz with suitable frequency span including 100 MHz bandwidth from band edge. The band edges was measured and recorded.

5.8.4 DEVIATION FROM TEST STANDARD

No deviation.

5.8.5 EUT OPERATING CONDITION

The software provided by client enabled the EUT to transmit and receive data at lowest, middle and highest channel frequencies individually.



5.8.6 TEST RESULTS

The spectrum plots are attached on the following 4 images. D2 line indicates the highest level, D1 line indicates the 20dB offset below D2. It shows compliance with the requirement in part 15.247(d).

NOTE 1:

The band edge emission plot on page 152 shows 48.44dBc between carrier maximum power and local maximum emission in restrict band (2.3370GHz). The emission of carrier strength list in the test result of channel 0 at the item 5.2.7 is 95.89dBuV/m (Peak), so the maximum field strength in restrict band is $95.89 - 48.44 = 47.45$ dBuV/m, which is under 74 dBuV/m limit.

Average value = $47.45 - 30.00 = 17.45$ dBuV/m, which is under 54dBuV/m limit.

*The DH5 packet was the worse case duty cycle for a transmit dwell time on a channel, based upon bluetooth theory the transmitter is on $0.625 * 5$ per 296.25 ms per channel. Therefore, the duty cycle be equal to: $20\log(3.125/100) = -30$ dB.

Average value = peak reading -30

NOTE 2:

The band edge emission plot on page 153 shows 48.97dBc between carrier maximum power and local maximum emission in restrict band (2.4867GHz). The emission of carrier strength list in the test result of channel 78 at the item 5.2.7 is 97.45dBuV/m (Peak), so the maximum field strength in restrict band is $97.45 - 48.97 = 48.48$ dBuV/m, which is under 74 dBuV/m limit.

Average value = $48.48 - 30.00 = 18.48$ dBuV/m, which is under 54dBuV/m limit.

*The DH5 packet was the worse case duty cycle for a transmit dwell time on a channel, based upon bluetooth theory the transmitter is on $0.625 * 5$ per 296.25 ms per channel. Therefore, the duty cycle be equal to: $20\log(3.125/100) = -30$ dB.

Average value = peak reading -30

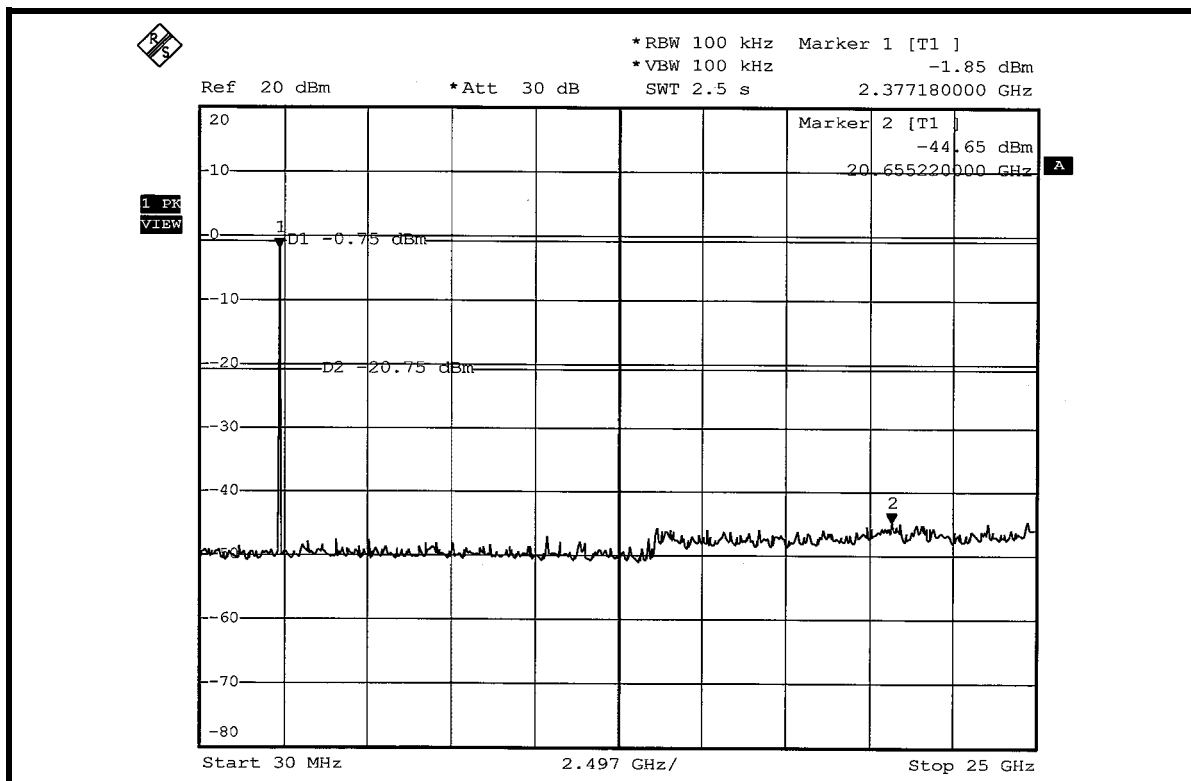
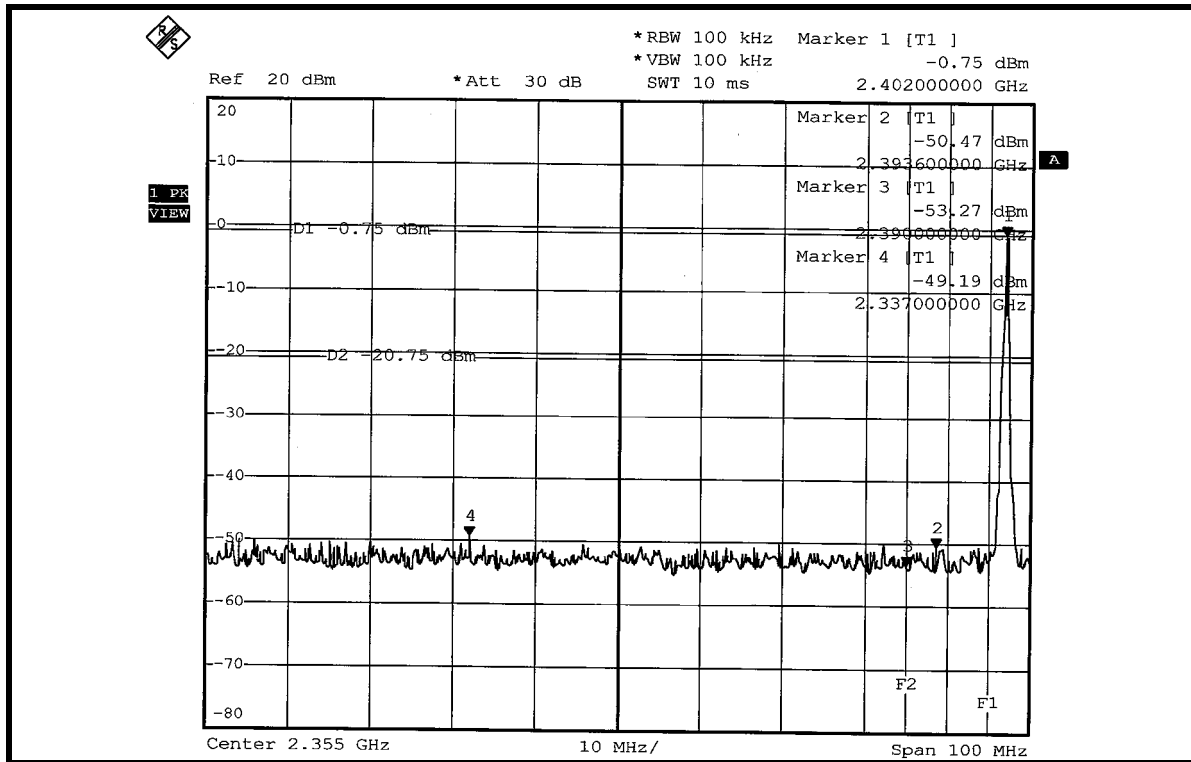

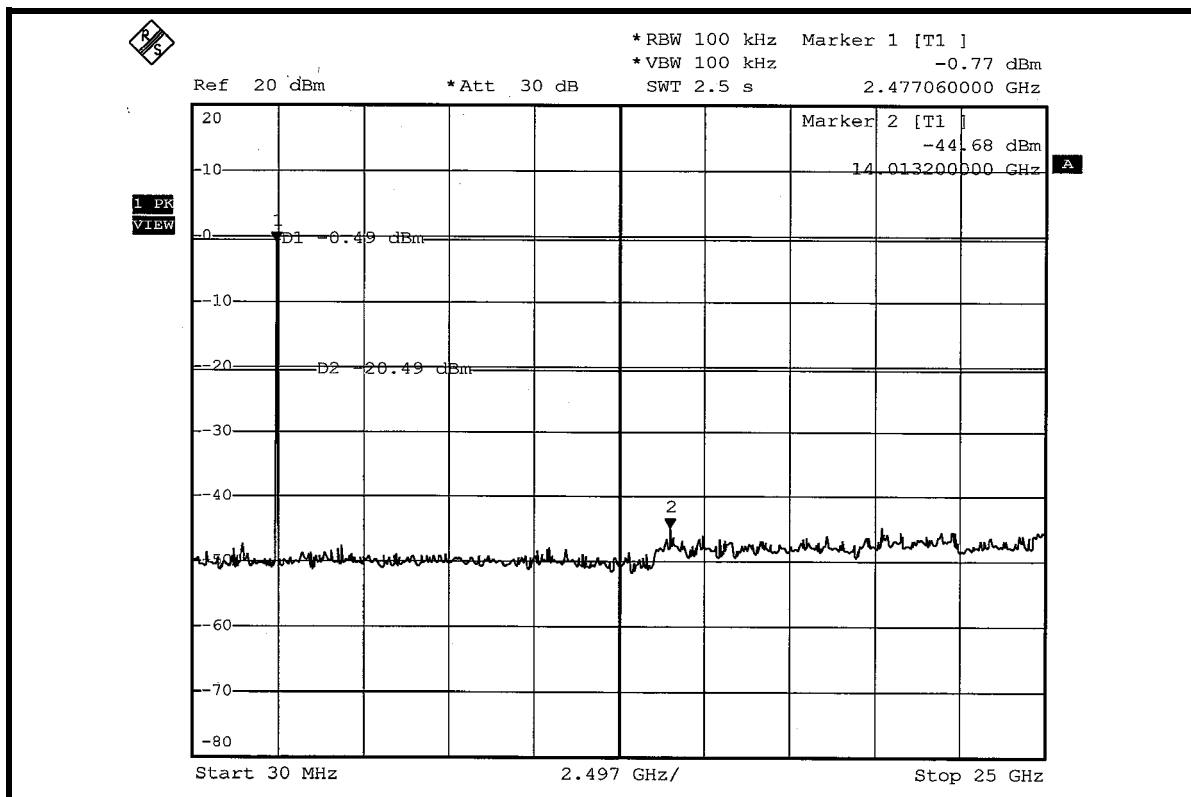
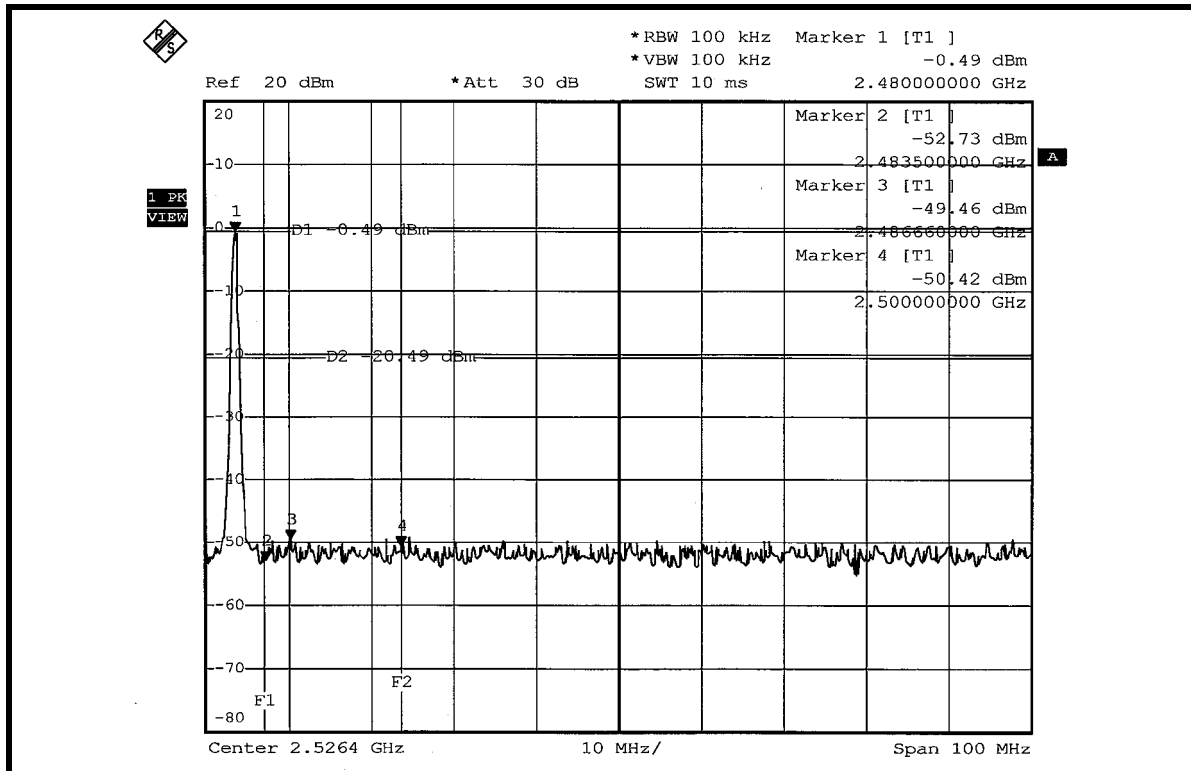



5.9 ANTENNA REQUIREMENT

5.9.1 STANDARD APPLICABLE

For intentional device, according to FCC 47 CFR Section 15.203, an intentional radiator shall be designed to ensure that no antenna other than that furnished by the responsible party shall be used with the device.

And according to FCC 47 CFR Section 15.247 (b), if transmitting antennas of directional gain greater than 6dBi are used, the power shall be reduced by the amount in dB that the directional gain of the antenna exceeds 6dBi.

5.9.2 ANTENNA CONNECTED CONSTRUCTION

The antenna used in this product is PIFA antenna without antenna connector. The maximum gain of this antenna is -1.0dBi .



6. INFORMATION ON THE TESTING LABORATORIES

We, ADT Corp., were founded in 1988 to provide our best service in EMC, Radio, Telecom and Safety consultation. Our laboratories are accredited and approved by the following approval agencies according to ISO/IEC 17025.

USA	FCC, UL, A2LA
GERMANY	TUV Rheinland
JAPAN	VCCI
NORWAY	NEMKO
CANADA	INDUSTRY CANADA , CSA
R.O.C.	CNLA, BSMI, DGT
NETHERLANDS	Telefication
SINGAPORE	PSB , GOST-ASIA (MOU)
RUSSIA	CERTIS (MOU)

Copies of accreditation certificates of our laboratories obtained from approval agencies can be downloaded from our web site:

www.adt.com.tw/index.5/phtml. If you have any comments, please feel free to contact us at the following:

Linko EMC/RF Lab:

Tel: 886-2-26052180

Fax: 886-2-26052943

Hsin Chu EMC/RF Lab:

Tel: 886-3-5935343

Fax: 886-3-5935342

Hwa Ya EMC/RF/Safety Telecom Lab:

Tel: 886-3-3183232

Fax: 886-3-3185050

Web Site: www.adt.com.tw

The address and road map of all our labs can be found in our web site also.



APPENDIX-A

MODIFICATIONS RECORDERS FOR ENGINEERING CHANGES TO THE EUT BY THE LAB

No any modifications are made to the EUT by the lab during the test