

FCC Test Report

Report No.: RF160526C24-3

FCC ID: NM8G-2PW4100

Test Model: G-2PW4100

Received Date: May 26, 2016

Test Date: Jun. 18, 2016 ~ Jun. 23, 2016

Issued Date: Aug. 04, 2016

Applicant: HTC Corporation

Address: 1F, 6-3 Baoqiang Road, Xindian District, New Taipei City, Taiwan 231

Issued By: Bureau Veritas Consumer Products Services (H.K.) Ltd., Taoyuan Branch

Lab Address: No. 47-2, 14th Ling, Chia Pau Vil., Lin Kou Dist., New Taipei City, Taiwan
(R.O.C)

Test Location (1): No. 19, Hwa Ya 2nd Rd, Wen Hwa Tsuen, Kwei Shan Hsiang, Taoyuan
Hsien 333, Taiwan, R.O.C.



This report is for your exclusive use. Any copying or replication of this report to or for any other person or entity, or use of our name or trademark, is permitted only with our prior written permission. This report sets forth our findings solely with respect to the test samples identified herein. The results set forth in this report are not indicative or representative of the quality or characteristics of the lot from which a test sample was taken or any similar or identical product unless specifically and expressly noted. Our report includes all of the tests requested by you and the results thereof based upon the information that you provided to us. You have 60 days from date of issuance of this report to notify us of any material error or omission caused by our negligence, provided, however, that such notice shall be in writing and shall specifically address the issue you wish to raise. A failure to raise such issue within the prescribed time shall constitute your unqualified acceptance of the completeness of this report, the tests conducted and the correctness of the report contents. Unless specific mention, the uncertainty of measurement has been explicitly taken into account to declare the compliance or non-compliance to the specification. The report must not be used by the client to claim product certification, approval, or endorsement by TAF or any government agencies.

Table of Contents

Release Control Record	4
1 Certificate of Conformity	5
2 Summary of Test Results	6
2.1 Measurement Uncertainty	6
2.2 Modification Record	6
3 General Information	7
3.1 General Description of EUT	7
3.2 Description of Test Modes.....	9
3.2.1 Test Mode Applicability and Tested Channel Detail.....	11
3.3 Duty Cycle of Test Signal	13
3.4 Description of Support Units	17
3.4.1 Configuration of System under Test	17
3.5 General Description of Applied Standards.....	17
4 Test Types and Results	18
4.1 Radiated Emission and Bandedge Measurement	18
4.1.1 Limits of Radiated Emission and Bandedge Measurement	18
4.1.2 Limits of Unwanted Emission Out of The Restricted Bands.....	18
4.1.3 Test Instruments	19
4.1.4 Test Procedures.....	20
4.1.5 Deviation from Test Standard	20
4.1.6 Test Set Up	21
4.1.7 EUT Operating Conditions.....	21
4.1.8 Test Results	22
4.2 Conducted Emission Measurement.....	64
4.2.1 Limits of Conducted Emission Measurement	64
4.2.2 Test Instruments	64
4.2.3 Test Procedures.....	65
4.2.4 Deviation from Test Standard	65
4.2.5 Test Setup.....	65
4.2.6 EUT Operating Conditions.....	65
4.2.7 Test Results	66
4.3 Transmit Power Measurement.....	68
4.3.1 Limits of Transmit Power Measurement	68
4.3.2 Test Setup.....	68
4.3.3 Test Instruments	69
4.3.4 Test Procedure	69
4.3.5 Deviation from Test Standard	69
4.3.6 EUT Operating Conditions.....	69
4.3.7 Test Result	70
4.4 Peak Power Spectral Density Measurement	77
4.4.1 Limits of Peak Power Spectral Density Measurement	77
4.4.2 Test Setup.....	77
4.4.3 Test Instruments	77
4.4.4 Test Procedures.....	77
4.4.5 Deviation from Test Standard	78
4.4.6 EUT Operating Conditions.....	78
4.4.7 Test Results	78
4.5 Frequency Stability	85
4.5.1 Limit of Frequency Stability Measurement	85
4.5.2 Test Setup.....	85
4.5.3 Test Instruments	85
4.5.4 Test Procedure	85
4.5.5 Deviation from Test Standard	85

4.5.6 EUT Operating Condition	85
4.5.7 Test Results	86
4.6 6dB Bandwidth Measurement.....	87
4.6.1 Limits of 6dB Bandwidth Measurement.....	87
4.6.2 Test Setup.....	87
4.6.3 Test Instruments	87
4.6.4 Test Procedure	87
4.6.5 Deviation from Test Standard	87
4.6.6 EUT Operating Condition	87
4.6.7 Test Results	88
5 Pictures of Test Arrangements.....	90
Appendix – Information on the Testing Laboratories	91

Release Control Record

Issue No.	Description	Date Issued
RF160526C24-3	Original Release	Aug. 04, 2016

1 Certificate of Conformity

Product: Smartphone
Test Model: G-2PW4100
Sample Status: Production Unit
Applicant: HTC Corporation
Test Date: Jun. 18, 2016 ~ Jun. 23, 2016
Standards: 47 CFR FCC Part 15, Subpart E (Section 15.407)
ANSI C63.10:2013

The above equipment has been tested by **Bureau Veritas Consumer Products Services (H.K.) Ltd., Taoyuan Branch**, and found compliance with the requirement of the above standards. The test record, data evaluation & Equipment Under Test (EUT) configurations represented herein are true and accurate accounts of the measurements of the sample's EMC characteristics under the conditions specified in this report.

Prepared by :  , **Date:** Aug. 04, 2016
Ivonne Wu / Supervisor

Approved by :  , **Date:** Aug. 04, 2016
Stanley Wu / Assistant Manager

2 Summary of Test Results

47 CFR FCC Part 15, Subpart E (Section 15.407)			
FCC Clause	Test Item	Result	Remarks
15.407(b)(6)	AC Power Conducted Emissions	Pass	Meet the requirement of limit. Minimum passing margin is -14.41 dB at 0.56866 MHz.
15.407(b) (1/2/3/4/6)	Radiated Emissions & Band Edge Measurement	Pass	Meet the requirement of limit. Minimum passing margin is -3.03 dB at 30 MHz.
15.407(a)(1/2 /3)	Max Average Transmit Power	Pass	Meet the requirement of limit.
15.407(a)(1/2 /3)	Peak Power Spectral Density	Pass	Meet the requirement of limit.
15.407(e)	6 dB Bandwidth	Pass	Meet the requirement of limit. (U-NII-3 Band only)
15.407(g)	Frequency Stability	Pass	Meet the requirement of limit.
15.203	Antenna Requirement	Pass	No antenna connector is used.

2.1 Measurement Uncertainty

Where relevant, the following measurement uncertainty levels have been estimated for tests performed on the EUT as specified in CISPR 16-4-2:

Measurement	Frequency	Expanded Uncertainty (k=2) (±)
Conducted Emissions at mains ports	150 kHz ~ 30 MHz	2.44 dB
Radiated Emissions up to 1 GHz	30 MHz ~ 200 MHz	2.93 dB
	200 MHz ~ 1000 MHz	2.95 dB
Radiated Emissions above 1 GHz	1 GHz ~ 18 GHz	2.26 dB
	18 GHz ~ 40 GHz	1.94 dB

2.2 Modification Record

There were no modifications required for compliance.

3 General Information

3.1 General Description of EUT

Product	Smartphone
Test Model	G-2PW4100
Status of EUT	Production Unit
Power Supply Rating	5.0 Vdc (adapter or host equipment) 3.85 Vdc (Li-ion battery)
Modulation Type	256QAM, 64QAM, 16QAM, QPSK, BPSK
Modulation Technology	OFDM
Transfer Rate	802.11a: 54.0/ 48.0/ 36.0/ 24.0/ 18.0/ 12.0/ 9.0/ 6.0 Mbps 802.11n: up to MCS15 802.11ac: up to V9
Operating Frequency	5180 ~ 5240 MHz, 5260 ~ 5320 MHz, 5500 ~ 5700 MHz, 5745 ~ 5825 MHz
Number of Channel	5180 ~ 5240 MHz: 4 for 802.11a, 802.11n (HT20) 2 for 802.11n (HT40) 1 for 802.11ac (VHT80) 5260 ~ 5320 MHz: 4 for 802.11a, 802.11n (HT20) 2 for 802.11n (HT40) 1 for 802.11ac (VHT80) 5500 ~ 5700 MHz: 11 for 802.11a, 802.11n (HT20) 5 for 802.11n (HT40) 2 for 802.11ac (VHT80) 5745 ~ 5825 MHz: 5 for 802.11a, 802.11n (HT20) 2 for 802.11n (HT40) 1 for 802.11ac (VHT80)
Output Power	42.31 mW for 5180 ~ 5240 MHz 42.78 mW for 5260 ~ 5320 MHz 41.92 mW for 5500 ~ 5700 MHz 41.99 mW for 5745 ~ 5825 MHz
Antenna Type	PIFA antenna with -1.2 dBi gain (Main) PIFA antenna with -6 dBi gain (Aux.)
Antenna Connector	N/A
Accessory Device	Refer to Note as below
Data Cable Supplied	Refer to Note as below

Note:

1. The EUT incorporates a MIMO function. Physically, the EUT provides two completed transmitters and two receivers.

Modulation Mode	Tx Function
802.11a	1TX (SISO)
802.11n (HT20)	2TX (MIMO)
802.11n (HT40)	2TX (MIMO)
802.11ac (VHT80)	2TX (MIMO)

* The modulation and bandwidth are similar for 802.11n mode for HT20 / HT40 and 802.11ac mode for VHT20 / VHT40, therefore investigated worst case to representative mode in test report. (Final test mode refer section 3.2.1)

2. The EUT's accessories list refers to Ext. Pho.
3. The above EUT information is declared by manufacturer and for more detailed features description, please refer to the manufacturer's specifications or user's manual.

3.2 Description of Test Modes

FOR 5180 ~ 5240 MHz

4 channels are provided for 802.11a, 802.11n (HT20):

Channel	Frequency (MHz)	Channel	Frequency (MHz)
36	5180	44	5220
40	5200	48	5240

2 channels are provided for 802.11n (HT40):

Channel	Frequency (MHz)	Channel	Frequency (MHz)
38	5190	46	5230

1 channel is provided for 802.11ac (VHT80):

Channel	Frequency (MHz)
42	5210

FOR 5260 ~ 5320 MHz

4 channels are provided for 802.11a, 802.11n (HT20):

Channel	Frequency (MHz)	Channel	Frequency (MHz)
52	5260	60	5300
56	5280	64	5320

2 channels are provided for 802.11n (HT40):

Channel	Frequency (MHz)	Channel	Frequency (MHz)
54	5270	62	5310

1 channel is provided for 802.11ac (VHT80):

Channel	Frequency (MHz)
58	5290

FOR 5500 ~ 5700 MHz

11 channels are provided for 802.11a, 802.11n (HT20):

Channel	Frequency (MHz)	Channel	Frequency (MHz)
100	5500	124	5620
104	5520	128	5640
108	5540	132	5660
112	5560	136	5680
116	5580	140	5700
120	5600		

5 channels are provided for 802.11n (HT40):

Channel	Frequency (MHz)	Channel	Frequency (MHz)
102	5510	126	5630
110	5550	134	5670
118	5590		

2 channels are provided for 802.11ac (VHT80):

Channel	Frequency (MHz)	Channel	Frequency (MHz)
106	5530	122	5610

FOR 5745 ~ 5825 MHz:

5 channels are provided for 802.11a, 802.11n (HT20):

Channel	Frequency (MHz)	Channel	Frequency (MHz)
149	5745	161	5805
153	5765	165	5825
157	5785		

2 channels are provided for 802.11n (HT40):

Channel	Frequency (MHz)	Channel	Frequency (MHz)
151	5755	159	5795

1 channel is provided for 802.11ac (VHT80):

Channel	Frequency (MHz)
155	5775

3.2.1 Test Mode Applicability and Tested Channel Detail

EUT Configure Mode	Applicable To				Description
	RE \geq 1G	RE $<$ 1G	PLC	APCM	
-	√	√	√	√	-

Where **RE \geq 1G**: Radiated Emission above 1 GHz **RE $<$ 1G**: Radiated Emission below 1 GHz
PLC: Power Line Conducted Emission **APCM**: Antenna Port Conducted Measurement

NOTE:

- The EUT had been pre-tested on the positioned of each 3 axis. The worst case was found when positioned on **Y-plane** for 5180-5240 MHz & 5260-5320 MHz & 5500-5700MHz and **Z-plane** for 5745-5825 MHz.
- "-" means no effect.

Radiated Emission Test (Above 1 GHz):

- Pre-Scan has been conducted to determine the worst-case mode from all possible combinations between available modulations, data rates and antenna ports (if EUT with antenna diversity architecture).
- Following channel(s) was (were) selected for the final test as listed below.

EUT Configure Mode	Frequency Band (MHz)	Mode	Available Channel	Tested Channel	Modulation Technology	Modulation Type	Data Rate (Mbps)
-	5180-5240	802.11a	36 to 48	36, 44, 48	OFDM	BPSK	6.0
-		802.11n (HT20)	36 to 48	36, 44, 48	OFDM	BPSK	MCS0
-		802.11n (HT40)	38 to 46	38, 46	OFDM	BPSK	MCS0
-		802.11ac (VHT80)	42	42	OFDM	BPSK	V0
-	5260-5320	802.11a	52 to 64	52, 60, 64	OFDM	BPSK	6.0
-		802.11n (HT20)	52 to 64	52, 60, 64	OFDM	BPSK	MCS0
-		802.11n (HT40)	54 to 62	54, 62	OFDM	BPSK	MCS0
-		802.11ac (VHT80)	58	58	OFDM	BPSK	V0
-	5500-5700	802.11a	100 to 140	100, 116, 140	OFDM	BPSK	6.0
-		802.11n (HT20)	100 to 140	100, 116, 140	OFDM	BPSK	MCS0
-		802.11n (HT40)	102 to 134	102, 110, 134	OFDM	BPSK	MCS0
-		802.11ac (VHT80)	106 to 122	106, 122	OFDM	BPSK	V0
-	5745-5825	802.11a	149 to 165	149, 157, 165	OFDM	BPSK	6.0
-		802.11n (HT20)	149 to 165	149, 157, 165	OFDM	BPSK	MCS0
-		802.11n (HT40)	151 to 159	151, 159	OFDM	BPSK	MCS0
-		802.11ac (VHT80)	155	155	OFDM	BPSK	V0

Radiated Emission Test (Below 1 GHz):

- Pre-Scan has been conducted to determine the worst-case mode from all possible combinations between available modulations, data rates and antenna ports (if EUT with antenna diversity architecture).
- Following channel(s) was (were) selected for the final test as listed below.

EUT Configure Mode	Frequency Band (MHz)	Mode	Available Channel	Tested Channel	Modulation Technology	Modulation Type	Data Rate (Mbps)
-	5180-5240	802.11ac (VHT80)	42	42	OFDM	BPSK	V0
-	5260-5320	802.11n (HT40)	54 to 62	62	OFDM	BPSK	V0
-	5500-5700	802.11ac (VHT80)	106 to 122	106	OFDM	BPSK	V0
-	5745-5825	802.11ac (VHT80)	155	155	OFDM	BPSK	V0

Power Line Conducted Emission Test:

Pre-Scan has been conducted to determine the worst-case mode from all possible combinations between available modulations, data rates and antenna ports (if EUT with antenna diversity architecture).

Following channel(s) was (were) selected for the final test as listed below.

EUT Configure Mode	Frequency Band (MHz)	Mode	Available Channel	Tested Channel	Modulation Technology	Modulation Type	Data Rate (Mbps)
-	5500-5700	802.11ac (VHT80)	106 to 122	106	OFDM	BPSK	V0

Antenna Port Conducted Measurement:

This item includes all test value of each mode, but only includes spectrum plot of worst value of each mode.

Pre-Scan has been conducted to determine the worst-case mode from all possible combinations between available modulations, data rates and antenna ports (if EUT with antenna diversity architecture).

Following channel(s) was (were) selected for the final test as listed below.

EUT Configure Mode	Frequency Band (MHz)	Mode	Available Channel	Tested Channel	Modulation Technology	Modulation Type	Data Rate (Mbps)
-	5180-5240	802.11a	36 to 48	36, 44, 48	OFDM	BPSK	6.0
-		802.11n (HT20)	36 to 48	36, 44, 48	OFDM	BPSK	MCS0
-		802.11n (HT40)	38 to 46	38, 46	OFDM	BPSK	MCS0
-		802.11ac (VHT80)	42	42	OFDM	BPSK	V0
-	5260-5320	802.11a	52 to 64	52, 60, 64	OFDM	BPSK	6.0
-		802.11n (HT20)	52 to 64	52, 60, 64	OFDM	BPSK	MCS0
-		802.11n (HT40)	54 to 62	54, 62	OFDM	BPSK	MCS0
-		802.11ac (VHT80)	58	58	OFDM	BPSK	V0
-	5500-5700	802.11a	100 to 140	100, 116, 140	OFDM	BPSK	6.0
-		802.11n (HT20)	100 to 140	100, 116, 140	OFDM	BPSK	MCS0
-		802.11n (HT40)	102 to 134	102, 110, 134	OFDM	BPSK	MCS0
-		802.11ac (VHT80)	106 to 122	106, 122	OFDM	BPSK	V0
-	5745-5825	802.11a	149 to 165	149, 157, 165	OFDM	BPSK	6.0
-		802.11n (HT20)	149 to 165	149, 157, 165	OFDM	BPSK	MCS0
-		802.11n (HT40)	151 to 159	151, 159	OFDM	BPSK	MCS0
-		802.11ac (VHT80)	155	155	OFDM	BPSK	V0

Test Condition:

Applicable To	Environmental Conditions	Input Power	Tested by
RE \geq 1G	25 deg. C, 65 % RH	120 Vac, 60 Hz	Toby Tian
RE $<$ 1G	25 deg. C, 65 % RH	120 Vac, 60 Hz	Toby Tian
PLC	25 deg. C, 65 % RH	120 Vac, 60 Hz	Toby Tian
APCM	25 deg. C, 65 % RH	3.85 Vdc	Taylor Liu

3.3 Duty Cycle of Test Signal

MODULATION TYPE: BPSK

Duty cycle of test signal is < 98 %, duty factor is required.

802.11a: Duty cycle = $1.926/2.035 = 0.946$, Duty factor = $10 * \log(1/0.946) = 0.24$

802.11n (HT20): Duty cycle = $2.051/2.171 = 0.945$, Duty factor = $10 * \log(1/0.945) = 0.25$

802.11n (HT40): Duty cycle = $0.921/1.058 = 0.871$, Duty factor = $10 * \log(1/0.871) = 0.60$

802.11ac (VHT80): Duty cycle = $432.69/560.90 = 0.771$, Duty factor = $10 * \log(1/0.771) = 1.13$

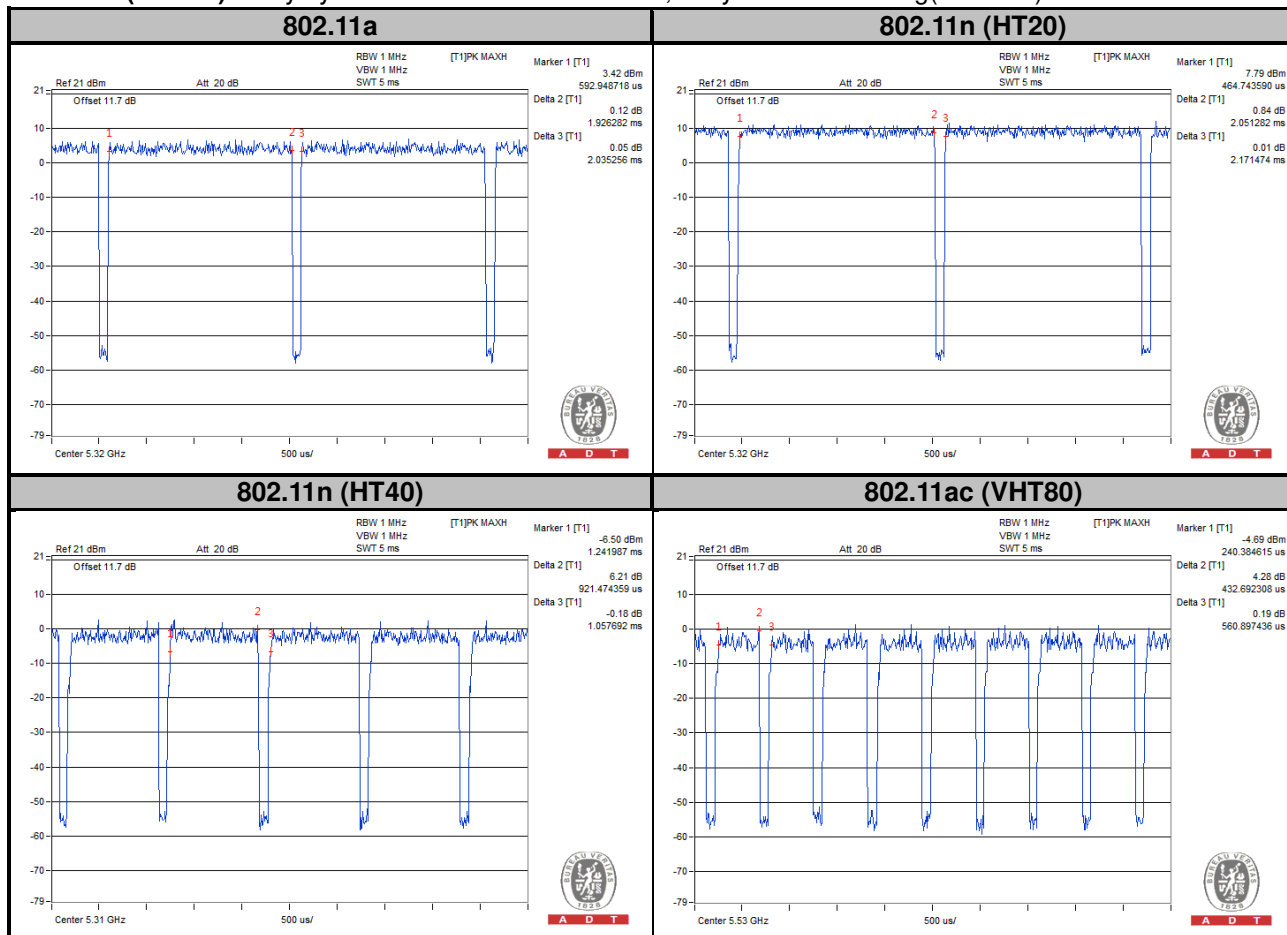

MODULATION TYPE: QPSK

Duty cycle of test signal is < 98 %, duty factor is required.

802.11a: Duty cycle = 0.981/1.082 = 0.907, Duty factor = $10 * \log(1/0.907) = 0.43$

802.11n (HT20): Duty cycle = 1.034/1.154 = 0.896, Duty factor = $10 * \log(1/0.896) = 0.48$

802.11n (HT40): Duty cycle = 464.74/592.95 = 0.784, Duty factor = $10 * \log(1/0.784) = 1.06$

802.11ac (VHT80): Duty cycle = 217.95/349.36 = 0.624, Duty factor = $10 * \log(1/0.624) = 2.05$

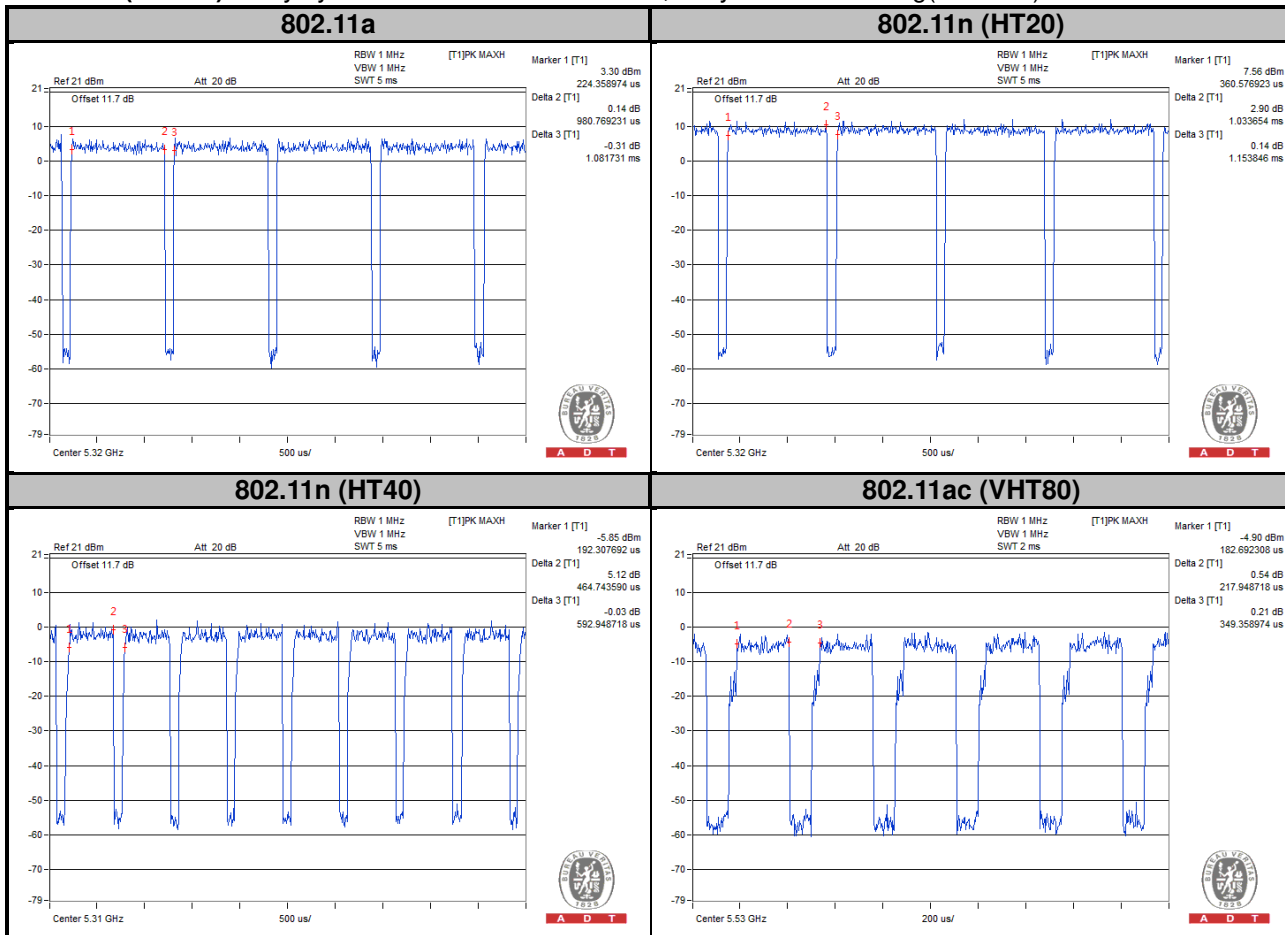

MODULATION TYPE: 16QAM

Duty cycle of test signal is < 98 %, duty factor is required.

802.11a: Duty cycle = 508.01/608.97 = 0.834, Duty factor = $10 * \log(1/0.834) = 0.79$

802.11n (HT20): Duty cycle = 520.83/641.03 = 0.812, Duty factor = $10 * \log(1/0.812) = 0.90$

802.11n (HT40): Duty cycle = 232.37/376.60 = 0.617, Duty factor = $10 * \log(1/0.617) = 2.10$

802.11ac (VHT80): Duty cycle = 118.59/243.59 = 0.487, Duty factor = $10 * \log(1/0.487) = 3.13$

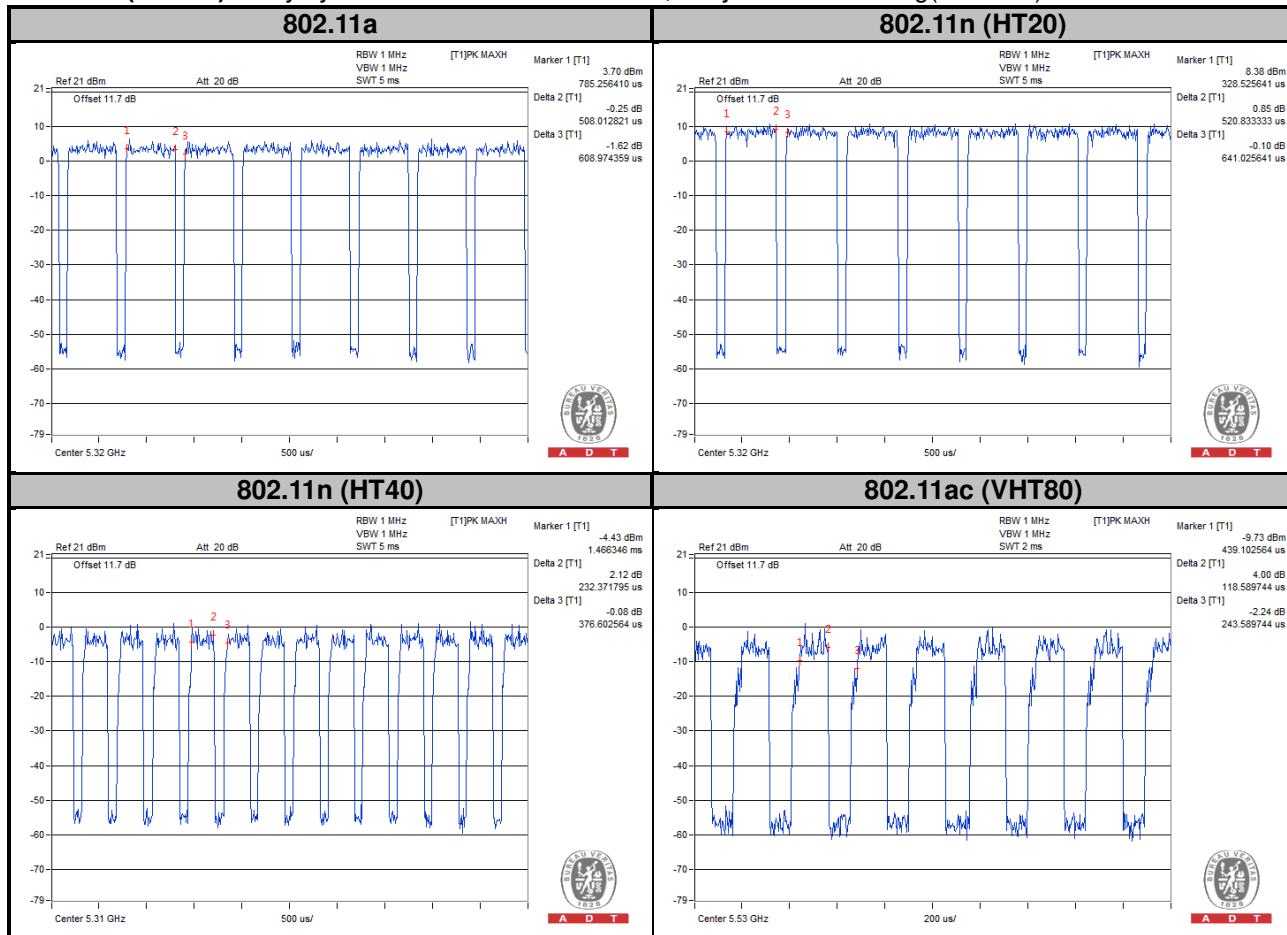

MODULATION TYPE: 64QAM

Duty cycle of test signal is < 98 %, duty factor is required.

802.11a: Duty cycle = $264.42/376.60 = 0.702$, Duty factor = $10 * \log(1/0.702) = 1.54$

802.11n (HT20): Duty cycle = $267.63/384.62 = 0.696$, Duty factor = $10 * \log(1/0.696) = 1.57$

802.11n (HT40): Duty cycle = $131.09/264.42 = 0.496$, Duty factor = $10 * \log(1/0.496) = 3.05$

802.11ac (VHT80): Duty cycle = $67.31/195.51 = 0.344$, Duty factor = $10 * \log(1/0.344) = 4.63$

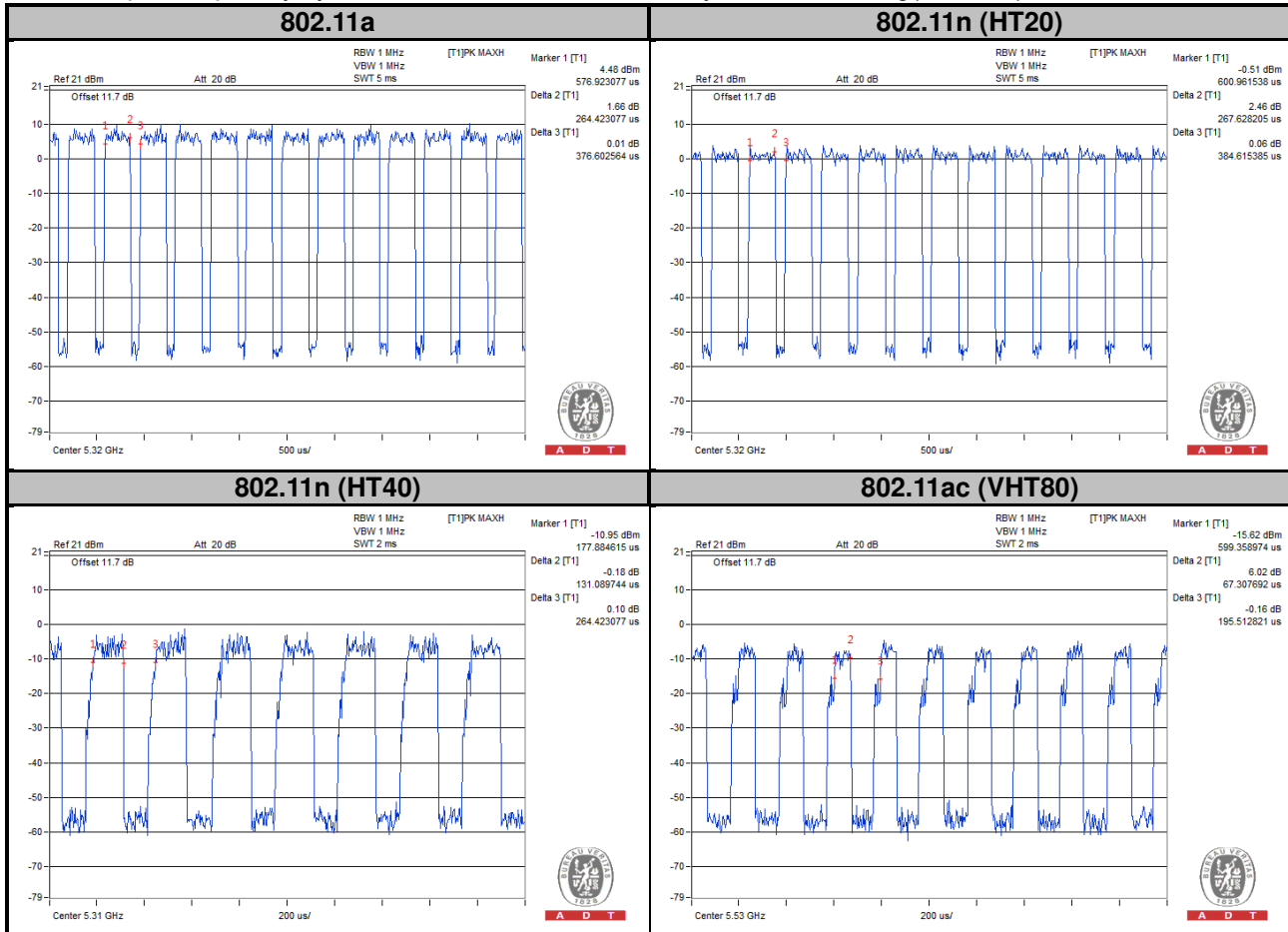

MODULATION TYPE: 256QAM

Duty cycle of test signal is < 98 %, duty factor is required.

802.11ac (VHT80): Duty cycle = $44.87/182.69 = 0.246$, Duty factor = $10 * \log(1/0.246) = 6.10$

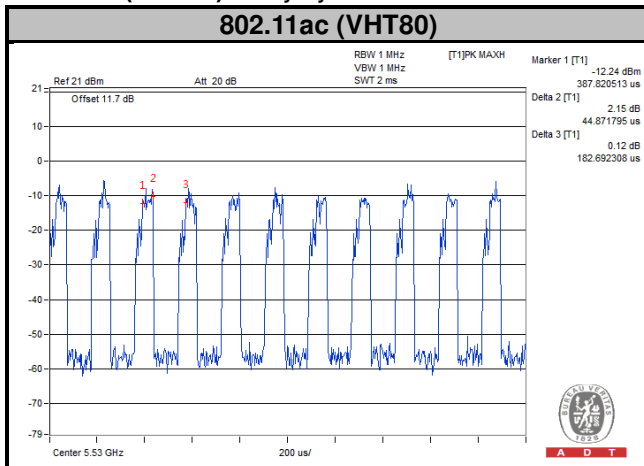

3.4 Description of Support Units

The EUT has been tested as an independent unit together with other necessary accessories or support units.

3.4.1 Configuration of System under Test

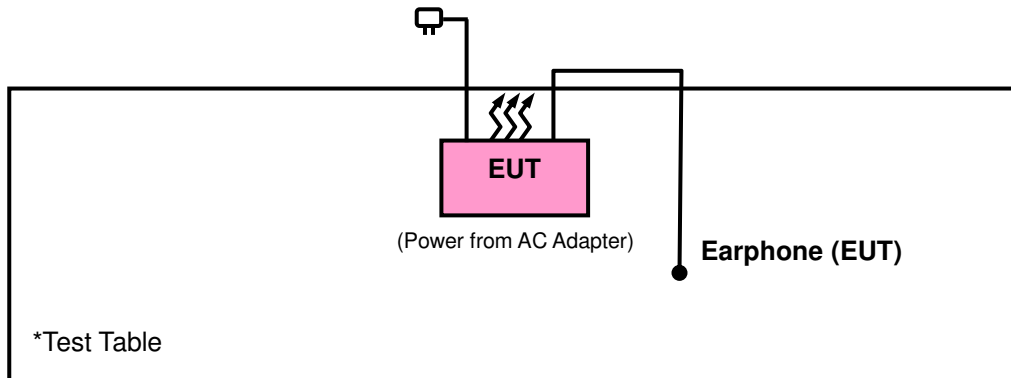

3.5 General Description of Applied Standards

The EUT is a RF Product. According to the specifications of the manufacturer, it must comply with the requirements of the following standards:

FCC Part 15, Subpart E (15.407)

789033 D02 General UNII Test Procedures New Rules v01r02

644545 D01 Guidance for IEEE 802 11ac v01r02

662911 D01 Multiple Transmitter Output v02r01

ANSI C63.10-2013

All test items have been performed and recorded as per the above standards.

NOTE: The EUT has been verified to comply with the requirements of FCC Part 15, Subpart B, Class B (DoC).
The test report has been issued separately.

4 Test Types and Results

4.1 Radiated Emission and Bandedge Measurement

4.1.1 Limits of Radiated Emission and Bandedge Measurement

Radiated emissions which fall in the restricted bands must comply with the radiated emission limits specified as below table. Other emissions shall be at least 20 dB below the highest level of the desired power:

Frequencies (MHz)	Field Strength (microvolts/meter)	Measurement Distance (meters)
0.009 ~ 0.490	2400/F (kHz)	300
0.490 ~ 1.705	24000/F (kHz)	30
1.705 ~ 30.0	30	30
30 ~ 88	100	3
88 ~ 216	150	3
216 ~ 960	200	3
Above 960	500	3

NOTE:

1. The lower limit shall apply at the transition frequencies.
2. Emission level (dBuV/m) = 20 log Emission level (uV/m).
3. For frequencies above 1000 MHz, the field strength limits are based on average detector, however, the peak field strength of any emission shall not exceed the maximum permitted average limits, specified above by more than 20 dB under any condition of modulation.

4.1.2 Limits of Unwanted Emission Out of the Restricted Bands

Applicable To	Limit	
789033 D02 General UNII Test Procedures New Rules v01r02	Field Strength at 3 m	
	PK: 74 (dBμV/m)	AV: 54 (dBμV/m)
Applicable To	EIRP Limit	Equivalent Field Strength at 3 m
15.407(b)(1)	PK: -27 (dBm/MHz)	PK: 68.2 (dBμV/m)
15.407(b)(2)		
15.407(b)(3)		
15.407(b)(4)	PK: -27 (dBm/MHz) ^{*1} PK: -17 (dBm/MHz) ^{*2}	PK: 68.2 (dBμV/m) ^{*1} PK: 78.2 (dBμV/m) ^{*2}

NOTE: ^{*1} beyond 10 MHz of the band edge ^{*2} within 10 MHz of band edge

The following formula is used to convert the equipment isotropic radiated power (eirp) to field strength:

$$E = \frac{1000000\sqrt{30P}}{3} \mu\text{V/m, where } P \text{ is the eirp (Watts).}$$

4.1.3 Test Instruments

Description & Manufacturer	Model No.	Serial No.	Date of Calibration	Due Date of Calibration
Test Receiver Agilent	N9038A	MY51210203	Jan. 21, 2016	Jan. 20, 2017
Spectrum Analyzer Agilent	N9010A	MY52220314	Sep. 03, 2015	Sep. 02, 2016
Spectrum Analyzer ROHDE & SCHWARZ	FSU43	101261	Dec. 17, 2015	Dec. 16, 2016
BILOG Antenna SCHWARZBECK	VULB9168	9168-472	Jan. 07, 2016	Jan. 06, 2017
HORN Antenna SCHWARZBECK	BBHA 9120 D	9120D-969	Jan. 04, 2016	Jan. 03, 2017
HORN Antenna SCHWARZBECK	BBHA 9170	9170-480	Jan. 08, 2016	Jan. 07, 2017
Agilent Communications Tester-Wireless	8960 Series 10	MY53201073	Jul. 03, 2015	Jul. 02, 2017
Preamplifier EMCI	EMC 012645	980115	Dec. 21, 2015	Dec. 20, 2016
Preamplifier EMCI	EMC 184045	980116	Dec. 21, 2015	Dec. 20, 2016
Preamplifier EMCI	EMC 330H	980112	Dec. 28, 2015	Dec. 27, 2016
Power Meter Anritsu	ML2495A	1232002	Sep. 21, 2015	Sep. 20, 2016
Power Sensor Anritsu	MA2411B	1207325	Sep. 21, 2015	Sep. 20, 2016
RF signal cable HUBER+SUHNNER	SUCOFLEX 104	309219/4 2950114	Oct. 12, 2015	Oct. 11, 2016
RF signal cable HUBER+SUHNNER	SUCOFLEX 104	250130/4	Oct. 12, 2015	Oct. 11, 2016
RF Coaxial Cable Worken	8D-FB	Cable-Ch10-01	Oct. 12, 2015	Oct. 11, 2016
Software BV ADT	E3 6.120103	NA	NA	NA
Antenna Tower MF	MFA-440H	NA	NA	NA
Turn Table MF	MFT-201SS	NA	NA	NA
Antenna Tower & Turn Table Controller MF	MF-7802	NA	NA	NA

- Note: 1. The calibration interval of the above test instruments is 12 / 24 months and the calibrations are traceable to NML/ROC and NIST/USA.
2. The test was performed in HwaYa Chamber 10.
3. The horn antenna and preamplifier (model: EMC 184045) are used only for the measurement of emission frequency above 1 GHz if tested.
4. The FCC Site Registration No. is 690701.
5. The IC Site Registration No. is IC7450F-10.

4.1.4 Test Procedures

- a. The EUT was placed on the top of a rotating table 0.8 meters (for below 1 GHz) / 1.5 meters (for above 1 GHz) above the ground at 3 meter chamber room for test. The table was rotated 360 degrees to determine the position of the highest radiation.
- b. The EUT was set 3 meters away from the interference-receiving antenna, which was mounted on the top of a variable-height antenna tower.
- c. The height of antenna is varied from one meter to four meters above the ground to determine the maximum value of the field strength. Both horizontal and vertical polarizations of the antenna are set to make the measurement.
- d. For each suspected emission, the EUT was arranged to its worst case and then the antenna was tuned to heights from 1 meter to 4 meters and the rotatable table was turned from 0 degrees to 360 degrees to find the maximum reading.
- e. The test-receiver system was set to quasi-peak detect function and specified bandwidth with maximum hold mode when the test frequency is below 1 GHz.
- f. The test-receiver system was set to peak and average detected function and specified bandwidth with maximum hold mode when the test frequency is above 1 GHz. If the peak reading value also meets average limit, measurement with the average detector is unnecessary.

Note:

1. The resolution bandwidth and video bandwidth of test receiver/spectrum analyzer is 120 kHz for Quasi-peak detection (QP) at frequency below 1 GHz.
2. The resolution bandwidth of test receiver/spectrum analyzer is 1 MHz and the video bandwidth is 3 MHz for Peak detection (PK) at frequency above 1 GHz.
3. The resolution bandwidth of test receiver/spectrum analyzer is 1 MHz and the video bandwidth is 3 MHz for RMS Average (Duty cycle < 98 %) for Average detection (AV) at frequency above 1 GHz, then the measurement results was added to a correction factor ($10 \log(1/\text{duty cycle})$).
4. The resolution bandwidth of test receiver/spectrum analyzer is 1 MHz and the video bandwidth is 10 Hz (Duty cycle ≥ 98 %) for Average detection (AV) at frequency above 1 GHz.
5. All modes of operation were investigated and the worst-case emissions are reported.

4.1.5 Deviation from Test Standard

No deviation.

4.1.6 Test Set Up

<Frequency Range below 1 GHz>

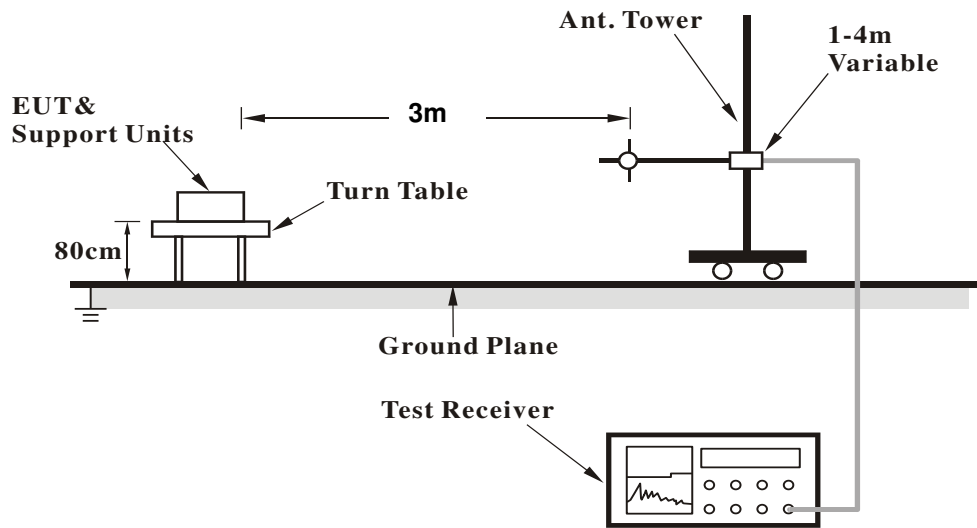

<Frequency Range above 1 GHz>

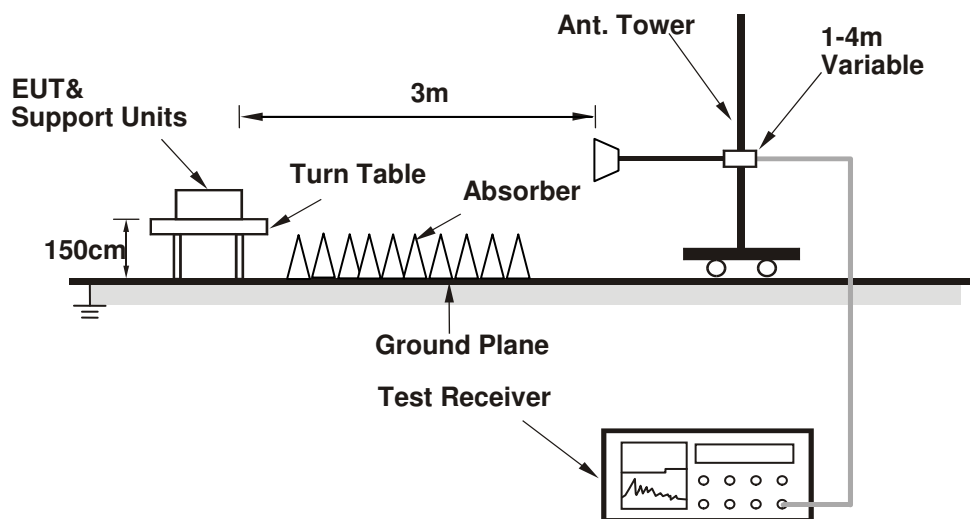

For the actual test configuration, please refer to the attached file (Test Setup Photo).

4.1.7 EUT Operating Conditions

- a. Placed the EUT on a testing table.
- b. Use the software to control the EUT under transmission condition continuously at specific channel frequency.

4.1.8 Test Results
 Above 1 GHz Data :
 <1TX>
 802.11a

EUT Test Condition		Measurement Detail	
Channel	Channel 36	Frequency Range	1 GHz ~ 40 GHz
Input Power	120 Vac, 60 Hz	Detector Function	Peak (PK) Average (AV)
Environmental Conditions	25 deg. C, 65 % RH	Tested By	Toby Tian

Antenna Polarity & Test Distance: Horizontal at 3 m										
Frequency (MHz)	Emission Level (dBuV/m)	Read Level (dBuV)	Limit (dBuV/m)	Margin (dB)	Antenna Factor (dB/m)	Cable Loss (dB)	Preamp Factor (dB)	Antenna Height (cm)	Table Angle (Degree)	Remark
5126	40.11	39.9	54	-13.89	31.31	6.2	37.3	200	239	Average
5126	60.25	60.04	74	-13.75	31.31	6.2	37.3	200	239	Peak
5180	92.3	92.07			31.35	6.22	37.34	200	239	Average
5180	101.68	101.45			31.35	6.22	37.34	200	239	Peak
5450	38.35	37.53	54	-15.65	31.56	6.34	37.08	200	239	Average
5450	59.92	59.1	74	-14.08	31.56	6.34	37.08	200	239	Peak

Antenna Polarity & Test Distance: Vertical at 3 m										
Frequency (MHz)	Emission Level (dBuV/m)	Read Level (dBuV)	Limit (dBuV/m)	Margin (dB)	Antenna Factor (dB/m)	Cable Loss (dB)	Preamp Factor (dB)	Antenna Height (cm)	Table Angle (Degree)	Remark
5144	41.13	40.93	54	-12.87	31.32	6.2	37.32	190	308	Average
5144	60.16	59.96	74	-13.84	31.32	6.2	37.32	190	308	Peak
5180	95.01	94.78			31.35	6.22	37.34	190	308	Average
5180	104.4	104.17			31.35	6.22	37.34	190	308	Peak
5448	38.33	37.56	54	-15.67	31.56	6.34	37.13	190	308	Average
5448	59.41	58.64	74	-14.59	31.56	6.34	37.13	190	308	Peak

Remarks:

- Emission Level = Read Level + Antenna Factor + Cable Loss - Preamp Factor
 Margin value = Emission level – Limit value
- 5180 MHz: Fundamental Frequency

EUT Test Condition		Measurement Detail	
Channel	Channel 44	Frequency Range	1 GHz ~ 40 GHz
Input Power	120 Vac, 60 Hz	Detector Function	Peak (PK) Average (AV)
Environmental Conditions	25 deg. C, 65 % RH	Tested By	Toby Tian

Antenna Polarity & Test Distance: Horizontal at 3 m										
Frequency (MHz)	Emission Level (dBuV/m)	Read Level (dBuV)	Limit (dBuV/m)	Margin (dB)	Antenna Factor (dB/m)	Cable Loss (dB)	Preamp Factor (dB)	Antenna Height (cm)	Table Angle (Degree)	Remark
5036	38.89	38.75	54	-15.11	31.23	6.15	37.24	200	239	Average
5036	59.87	59.73	74	-14.13	31.23	6.15	37.24	200	239	Peak
5220	91.78	91.53			31.37	6.24	37.36	200	239	Average
5220	101.32	101.07			31.37	6.24	37.36	200	239	Peak
5416	38.16	37.49	54	-15.84	31.53	6.32	37.18	200	239	Average
5416	59.78	59.11	74	-14.22	31.53	6.32	37.18	200	239	Peak

Antenna Polarity & Test Distance: Vertical at 3 m										
Frequency (MHz)	Emission Level (dBuV/m)	Read Level (dBuV)	Limit (dBuV/m)	Margin (dB)	Antenna Factor (dB/m)	Cable Loss (dB)	Preamp Factor (dB)	Antenna Height (cm)	Table Angle (Degree)	Remark
5054	39.78	39.62	54	-14.22	31.24	6.17	37.25	191	312	Average
5054	60.26	60.1	74	-13.74	31.24	6.17	37.25	191	312	Peak
5220	95.12	94.87			31.37	6.24	37.36	191	312	Average
5220	104.48	104.23			31.37	6.24	37.36	191	312	Peak
5444	38.4	37.64	54	-15.6	31.55	6.34	37.13	191	312	Average
5444	60.61	59.85	74	-13.39	31.55	6.34	37.13	191	312	Peak

Remarks:

- Emission Level = Read Level + Antenna Factor + Cable Loss - Preamp Factor
Margin value = Emission level – Limit value
- 5220 MHz: Fundamental Frequency

EUT Test Condition		Measurement Detail	
Channel	Channel 48	Frequency Range	1 GHz ~ 40 GHz
Input Power	120 Vac, 60 Hz	Detector Function	Peak (PK) Average (AV)
Environmental Conditions	25 deg. C, 65 % RH	Tested By	Toby Tian

Antenna Polarity & Test Distance: Horizontal at 3 m										
Frequency (MHz)	Emission Level (dBuV/m)	Read Level (dBuV)	Limit (dBuV/m)	Margin (dB)	Antenna Factor (dB/m)	Cable Loss (dB)	Preamp Factor (dB)	Antenna Height (cm)	Table Angle (Degree)	Remark
5044	38.46	38.32	54	-15.54	31.24	6.15	37.25	199	241	Average
5044	59.89	59.75	74	-14.11	31.24	6.15	37.25	199	241	Peak
5240	92.26	91.94			31.39	6.25	37.32	199	241	Average
5240	101.65	101.33			31.39	6.25	37.32	199	241	Peak
5418	38.26	37.59	54	-15.74	31.53	6.32	37.18	199	241	Average
5418	59.74	59.07	74	-14.26	31.53	6.32	37.18	199	241	Peak
Antenna Polarity & Test Distance: Vertical at 3 m										
Frequency (MHz)	Emission Level (dBuV/m)	Read Level (dBuV)	Limit (dBuV/m)	Margin (dB)	Antenna Factor (dB/m)	Cable Loss (dB)	Preamp Factor (dB)	Antenna Height (cm)	Table Angle (Degree)	Remark
5080	39.13	38.96	54	-14.87	31.27	6.17	37.27	191	312	Average
5080	60.35	60.18	74	-13.65	31.27	6.17	37.27	191	312	Peak
5240	95.27	94.95			31.39	6.25	37.32	191	312	Average
5240	104.52	104.2			31.39	6.25	37.32	191	312	Peak
5448	38.37	37.6	54	-15.63	31.56	6.34	37.13	191	312	Average
5448	59.22	58.45	74	-14.78	31.56	6.34	37.13	191	312	Peak

Remarks:

- Emission Level = Read Level + Antenna Factor + Cable Loss - Preamp Factor
Margin value = Emission level – Limit value
- 5240 MHz: Fundamental Frequency

EUT Test Condition		Measurement Detail	
Channel	Channel 52	Frequency Range	1 GHz ~ 40 GHz
Input Power	120 Vac, 60 Hz	Detector Function	Peak (PK) Average (AV)
Environmental Conditions	25 deg. C, 65 % RH	Tested By	Toby Tian

Antenna Polarity & Test Distance: Horizontal at 3 m										
Frequency (MHz)	Emission Level (dBuV/m)	Read Level (dBuV)	Limit (dBuV/m)	Margin (dB)	Antenna Factor (dB/m)	Cable Loss (dB)	Preamp Factor (dB)	Antenna Height (cm)	Table Angle (Degree)	Remark
5060	38.41	38.24	54	-15.59	31.25	6.17	37.25	200	242	Average
5060	59.99	59.82	74	-14.01	31.25	6.17	37.25	200	242	Peak
5260	92.68	92.29			31.41	6.25	37.27	200	242	Average
5260	102.38	101.99			31.41	6.25	37.27	200	242	Peak
5448	38.52	37.75	54	-15.48	31.56	6.34	37.13	200	242	Average
5448	59.72	58.95	74	-14.28	31.56	6.34	37.13	200	242	Peak
Antenna Polarity & Test Distance: Vertical at 3 m										
Frequency (MHz)	Emission Level (dBuV/m)	Read Level (dBuV)	Limit (dBuV/m)	Margin (dB)	Antenna Factor (dB/m)	Cable Loss (dB)	Preamp Factor (dB)	Antenna Height (cm)	Table Angle (Degree)	Remark
5104	38.53	38.34	54	-15.47	31.28	6.19	37.28	200	311	Average
5104	59.82	59.63	74	-14.18	31.28	6.19	37.28	200	311	Peak
5260	95.02	94.63			31.41	6.25	37.27	200	311	Average
5260	104.36	103.97			31.41	6.25	37.27	200	311	Peak
5440	38.33	37.57	54	-15.67	31.55	6.34	37.13	200	311	Average
5440	60.36	59.6	74	-13.64	31.55	6.34	37.13	200	311	Peak

Remarks:

- Emission Level = Read Level + Antenna Factor + Cable Loss - Preamp Factor
Margin value = Emission level – Limit value
- 5260 MHz: Fundamental Frequency

EUT Test Condition		Measurement Detail	
Channel	Channel 60	Frequency Range	1 GHz ~ 40 GHz
Input Power	120 Vac, 60 Hz	Detector Function	Peak (PK) Average (AV)
Environmental Conditions	25 deg. C, 65 % RH	Tested By	Toby Tian

Antenna Polarity & Test Distance: Horizontal at 3 m										
Frequency (MHz)	Emission Level (dBuV/m)	Read Level (dBuV)	Limit (dBuV/m)	Margin (dB)	Antenna Factor (dB/m)	Cable Loss (dB)	Preamp Factor (dB)	Antenna Height (cm)	Table Angle (Degree)	Remark
5120	38.17	37.99	54	-15.83	31.29	6.19	37.3	200	242	Average
5120	59.3	59.12	74	-14.7	31.29	6.19	37.3	200	242	Peak
5300	93.71	93.19			31.44	6.27	37.19	200	242	Average
5300	102.97	102.45			31.44	6.27	37.19	200	242	Peak
5448	38.58	37.81	54	-15.42	31.56	6.34	37.13	200	242	Average
5448	60.18	59.41	74	-13.82	31.56	6.34	37.13	200	242	Peak
Antenna Polarity & Test Distance: Vertical at 3 m										
Frequency (MHz)	Emission Level (dBuV/m)	Read Level (dBuV)	Limit (dBuV/m)	Margin (dB)	Antenna Factor (dB/m)	Cable Loss (dB)	Preamp Factor (dB)	Antenna Height (cm)	Table Angle (Degree)	Remark
5092	38.4	38.2	54	-15.6	31.28	6.19	37.27	200	310	Average
5092	60	59.8	74	-14	31.28	6.19	37.27	200	310	Peak
5300	94.47	93.95			31.44	6.27	37.19	200	310	Average
5300	104.2	103.68			31.44	6.27	37.19	200	310	Peak
5382	38.34	37.7	54	-15.66	31.51	6.31	37.18	200	310	Average
5382	60.11	59.47	74	-13.89	31.51	6.31	37.18	200	310	Peak

Remarks:

- Emission Level = Read Level + Antenna Factor + Cable Loss - Preamp Factor
Margin value = Emission level – Limit value
- 5300 MHz: Fundamental Frequency

EUT Test Condition		Measurement Detail	
Channel	Channel 64	Frequency Range	1 GHz ~ 40 GHz
Input Power	120 Vac, 60 Hz	Detector Function	Peak (PK) Average (AV)
Environmental Conditions	25 deg. C, 65 % RH	Tested By	Toby Tian

Antenna Polarity & Test Distance: Horizontal at 3 m										
Frequency (MHz)	Emission Level (dBuV/m)	Read Level (dBuV)	Limit (dBuV/m)	Margin (dB)	Antenna Factor (dB/m)	Cable Loss (dB)	Preamp Factor (dB)	Antenna Height (cm)	Table Angle (Degree)	Remark
5092	37.96	37.76	54	-16.04	31.28	6.19	37.27	200	302	Average
5092	59.81	59.61	74	-14.19	31.28	6.19	37.27	200	302	Peak
5320	91.69	91.14			31.45	6.29	37.19	200	302	Average
5320	101.51	100.96			31.45	6.29	37.19	200	302	Peak
5438	38.67	37.91	54	-15.33	31.55	6.34	37.13	200	302	Average
5438	59.97	59.21	74	-14.03	31.55	6.34	37.13	200	302	Peak
Antenna Polarity & Test Distance: Vertical at 3 m										
Frequency (MHz)	Emission Level (dBuV/m)	Read Level (dBuV)	Limit (dBuV/m)	Margin (dB)	Antenna Factor (dB/m)	Cable Loss (dB)	Preamp Factor (dB)	Antenna Height (cm)	Table Angle (Degree)	Remark
5084	38.45	38.28	54	-15.55	31.27	6.17	37.27	197	312	Average
5084	59.95	59.78	74	-14.05	31.27	6.17	37.27	197	312	Peak
5320	94.09	93.54			31.45	6.29	37.19	197	312	Average
5320	103.54	102.99			31.45	6.29	37.19	197	312	Peak
5436	38.63	37.89	54	-15.37	31.55	6.32	37.13	197	312	Average
5436	59.59	58.85	74	-14.41	31.55	6.32	37.13	197	312	Peak

Remarks:

- Emission Level = Read Level + Antenna Factor + Cable Loss - Preamp Factor
Margin value = Emission level – Limit value
- 5320 MHz: Fundamental Frequency

EUT Test Condition		Measurement Detail	
Channel	Channel 100	Frequency Range	1 GHz ~ 40 GHz
Input Power	120 Vac, 60 Hz	Detector Function	Peak (PK) Average (AV)
Environmental Conditions	25 deg. C, 65 % RH	Tested By	Toby Tian

Antenna Polarity & Test Distance: Horizontal at 3 m										
Frequency (MHz)	Emission Level (dBuV/m)	Read Level (dBuV)	Limit (dBuV/m)	Margin (dB)	Antenna Factor (dB/m)	Cable Loss (dB)	Preamp Factor (dB)	Antenna Height (cm)	Table Angle (Degree)	Remark
5440	39.39	38.63	54	-14.61	31.55	6.34	37.13	103	282	Average
5440	60.29	59.53	74	-13.71	31.55	6.34	37.13	103	282	Peak
5470	58.63	57.8	68.2	-9.57	31.57	6.34	37.08	103	282	Peak
5500	91.82	90.89			31.6	6.36	37.03	103	282	Average
5500	101.16	100.23			31.6	6.36	37.03	103	282	Peak
5725	58.84	57.56	68.2	-9.36	31.96	6.75	37.43	103	282	Peak
Antenna Polarity & Test Distance: Vertical at 3 m										
Frequency (MHz)	Emission Level (dBuV/m)	Read Level (dBuV)	Limit (dBuV/m)	Margin (dB)	Antenna Factor (dB/m)	Cable Loss (dB)	Preamp Factor (dB)	Antenna Height (cm)	Table Angle (Degree)	Remark
5448	39.65	38.88	54	-14.35	31.56	6.34	37.13	107	9	Average
5448	60.06	59.29	74	-13.94	31.56	6.34	37.13	107	9	Peak
5470	58.77	57.94	68.2	-9.43	31.57	6.34	37.08	107	9	Peak
5500	92.67	91.74			31.6	6.36	37.03	107	9	Average
5500	102.36	101.43			31.6	6.36	37.03	107	9	Peak
5725	59.32	58.04	68.2	-8.88	31.96	6.75	37.43	107	9	Peak

Remarks:

- Emission Level = Read Level + Antenna Factor + Cable Loss - Preamp Factor
Margin value = Emission level – Limit value
- 5500 MHz: Fundamental Frequency
- 5470 MHz & 5725 MHz: Out of Restricted Band

EUT Test Condition		Measurement Detail	
Channel	Channel 116	Frequency Range	1 GHz ~ 40 GHz
Input Power	120 Vac, 60 Hz	Detector Function	Peak (PK) Average (AV)
Environmental Conditions	25 deg. C, 65 % RH	Tested By	Toby Tian

Antenna Polarity & Test Distance: Horizontal at 3 m										
Frequency (MHz)	Emission Level (dBuV/m)	Read Level (dBuV)	Limit (dBuV/m)	Margin (dB)	Antenna Factor (dB/m)	Cable Loss (dB)	Preamp Factor (dB)	Antenna Height (cm)	Table Angle (Degree)	Remark
5410	39.96	39.3	54	-14.04	31.52	6.32	37.18	103	280	Average
5410	60.36	59.7	74	-13.64	31.52	6.32	37.18	103	280	Peak
5470	59.45	58.62	68.2	-8.75	31.57	6.34	37.08	103	280	Peak
5580	92.27	91.23			31.71	6.49	37.16	103	280	Average
5580	101.58	100.54			31.71	6.49	37.16	103	280	Peak
5725	57.95	56.67	68.2	-10.25	31.96	6.75	37.43	103	280	Peak
Antenna Polarity & Test Distance: Vertical at 3 m										
Frequency (MHz)	Emission Level (dBuV/m)	Read Level (dBuV)	Limit (dBuV/m)	Margin (dB)	Antenna Factor (dB/m)	Cable Loss (dB)	Preamp Factor (dB)	Antenna Height (cm)	Table Angle (Degree)	Remark
5438	38.34	37.58	54	-15.66	31.55	6.34	37.13	133	5	Average
5438	60.96	60.2	74	-13.04	31.55	6.34	37.13	133	5	Peak
5470	58.42	57.59	68.2	-9.78	31.57	6.34	37.08	133	5	Peak
5580	93.18	92.14			31.71	6.49	37.16	133	5	Average
5580	102.55	101.51			31.71	6.49	37.16	133	5	Peak
5725	57.79	56.51	68.2	-10.41	31.96	6.75	37.43	133	5	Peak

Remarks:

- Emission Level = Read Level + Antenna Factor + Cable Loss - Preamp Factor
Margin value = Emission level – Limit value
- 5580 MHz: Fundamental Frequency
- 5470 MHz & 5725 MHz: Out of Restricted Band

EUT Test Condition		Measurement Detail	
Channel	Channel 140	Frequency Range	1 GHz ~ 40 GHz
Input Power	120 Vac, 60 Hz	Detector Function	Peak (PK) Average (AV)
Environmental Conditions	25 deg. C, 65 % RH	Tested By	Toby Tian

Antenna Polarity & Test Distance: Horizontal at 3 m										
Frequency (MHz)	Emission Level (dBuV/m)	Read Level (dBuV)	Limit (dBuV/m)	Margin (dB)	Antenna Factor (dB/m)	Cable Loss (dB)	Preamp Factor (dB)	Antenna Height (cm)	Table Angle (Degree)	Remark
5450	40.2	39.38	54	-13.8	31.56	6.34	37.08	103	288	Average
5450	60.23	59.41	74	-13.77	31.56	6.34	37.08	103	288	Peak
5470	58.22	57.39	68.2	-9.98	31.57	6.34	37.08	103	288	Peak
5700	92.16	90.97			31.9	6.69	37.4	103	288	Average
5700	101.32	100.13			31.9	6.69	37.4	103	288	Peak
5725	59.52	58.24	68.2	-8.68	31.96	6.75	37.43	103	288	Peak
Antenna Polarity & Test Distance: Vertical at 3 m										
Frequency (MHz)	Emission Level (dBuV/m)	Read Level (dBuV)	Limit (dBuV/m)	Margin (dB)	Antenna Factor (dB/m)	Cable Loss (dB)	Preamp Factor (dB)	Antenna Height (cm)	Table Angle (Degree)	Remark
5432	38.31	37.57	54	-15.69	31.55	6.32	37.13	146	11	Average
5432	59.6	58.86	74	-14.4	31.55	6.32	37.13	146	11	Peak
5470	58.49	57.66	68.2	-9.71	31.57	6.34	37.08	146	11	Peak
5700	93.28	92.09			31.9	6.69	37.4	146	11	Average
5700	102.65	101.46			31.9	6.69	37.4	146	11	Peak
5725	59.43	58.15	68.2	-8.77	31.96	6.75	37.43	146	11	Peak

Remarks:

- Emission Level = Read Level + Antenna Factor + Cable Loss - Preamp Factor
Margin value = Emission level – Limit value
- 5700 MHz: Fundamental Frequency
- 5470 MHz & 5725 MHz: Out of Restricted Band

EUT Test Condition		Measurement Detail	
Channel	Channel 149	Frequency Range	1 GHz ~ 40 GHz
Input Power	120 Vac, 60 Hz	Detector Function	Peak (PK) Average (AV)
Environmental Conditions	25 deg. C, 65 % RH	Tested By	Toby Tian

Antenna Polarity & Test Distance: Horizontal at 3 m										
Frequency (MHz)	Emission Level (dBuV/m)	Read Level (dBuV)	Limit (dBuV/m)	Margin (dB)	Antenna Factor (dB/m)	Cable Loss (dB)	Preamp Factor (dB)	Antenna Height (cm)	Table Angle (Degree)	Remark
*5714	61.15	59.96	68.2	-7.05	31.93	6.69	37.43	150	6	Peak
*5725	59.75	58.47	78.2	-18.45	31.96	6.75	37.43	150	6	Peak
5745	92.29	91.02			31.99	6.75	37.47	150	6	Average
5745	101.4	100.13			31.99	6.75	37.47	150	6	Peak
*5850	60.05	58.53	78.2	-18.15	32.15	6.88	37.51	150	6	Peak
*5861	58.84	57.21	68.2	-9.36	32.18	6.95	37.5	150	6	Peak
Antenna Polarity & Test Distance: Vertical at 3 m										
Frequency (MHz)	Emission Level (dBuV/m)	Read Level (dBuV)	Limit (dBuV/m)	Margin (dB)	Antenna Factor (dB/m)	Cable Loss (dB)	Preamp Factor (dB)	Antenna Height (cm)	Table Angle (Degree)	Remark
*5714	59.36	58.17	68.2	-8.84	31.93	6.69	37.43	215	12	Peak
*5725	59.35	58.07	78.2	-18.85	31.96	6.75	37.43	215	12	Peak
5745	92.82	91.55			31.99	6.75	37.47	215	12	Average
5745	102.17	100.9			31.99	6.75	37.47	215	12	Peak
*5850	59.3	57.78	78.2	-18.9	32.15	6.88	37.51	215	12	Peak
*5861	59.83	58.2	68.2	-8.37	32.18	6.95	37.5	215	12	Peak

Remarks:

- Emission Level = Read Level + Antenna Factor + Cable Loss - Preamp Factor
Margin value = Emission level – Limit value
- 5745 MHz: Fundamental Frequency
- *: Out of Restricted Band

EUT Test Condition		Measurement Detail	
Channel	Channel 157	Frequency Range	1 GHz ~ 40 GHz
Input Power	120 Vac, 60 Hz	Detector Function	Peak (PK) Average (AV)
Environmental Conditions	25 deg. C, 65 % RH	Tested By	Toby Tian

Antenna Polarity & Test Distance: Horizontal at 3 m										
Frequency (MHz)	Emission Level (dBuV/m)	Read Level (dBuV)	Limit (dBuV/m)	Margin (dB)	Antenna Factor (dB/m)	Cable Loss (dB)	Preamp Factor (dB)	Antenna Height (cm)	Table Angle (Degree)	Remark
*5714	60.36	59.17	68.2	-7.84	31.93	6.69	37.43	153	2	Peak
*5725	59.07	57.79	78.2	-19.13	31.96	6.75	37.43	153	2	Peak
5785	92.09	90.77			32.04	6.82	37.54	153	2	Average
5785	101.37	100.05			32.04	6.82	37.54	153	2	Peak
*5850	61.16	59.64	78.2	-17.04	32.15	6.88	37.51	153	2	Peak
*5861	59.46	57.83	68.2	-8.74	32.18	6.95	37.5	153	2	Peak
Antenna Polarity & Test Distance: Vertical at 3 m										
Frequency (MHz)	Emission Level (dBuV/m)	Read Level (dBuV)	Limit (dBuV/m)	Margin (dB)	Antenna Factor (dB/m)	Cable Loss (dB)	Preamp Factor (dB)	Antenna Height (cm)	Table Angle (Degree)	Remark
*5714	60.11	58.92	68.2	-8.09	31.93	6.69	37.43	214	10	Peak
*5725	59.28	58	78.2	-18.92	31.96	6.75	37.43	214	10	Peak
5785	92.91	91.59			32.04	6.82	37.54	214	10	Average
5785	102.02	100.7			32.04	6.82	37.54	214	10	Peak
*5850	59.89	58.37	78.2	-18.31	32.15	6.88	37.51	214	10	Peak
*5861	58.54	56.91	68.2	-9.66	32.18	6.95	37.5	214	10	Peak

Remarks:

- Emission Level = Read Level + Antenna Factor + Cable Loss - Preamp Factor
Margin value = Emission level – Limit value
- 5785 MHz: Fundamental Frequency
- *: Out of Restricted Band

EUT Test Condition		Measurement Detail	
Channel	Channel 165	Frequency Range	1 GHz ~ 40 GHz
Input Power	120 Vac, 60 Hz	Detector Function	Peak (PK) Average (AV)
Environmental Conditions	25 deg. C, 65 % RH	Tested By	Toby Tian

Antenna Polarity & Test Distance: Horizontal at 3 m										
Frequency (MHz)	Emission Level (dBuV/m)	Read Level (dBuV)	Limit (dBuV/m)	Margin (dB)	Antenna Factor (dB/m)	Cable Loss (dB)	Preamp Factor (dB)	Antenna Height (cm)	Table Angle (Degree)	Remark
*5714	60.08	58.89	68.2	-8.12	31.93	6.69	37.43	152	7	Peak
*5725	58.18	56.9	78.2	-20.02	31.96	6.75	37.43	152	7	Peak
5825	92.27	90.8			32.12	6.88	37.53	152	7	Average
5825	101.34	99.87			32.12	6.88	37.53	152	7	Peak
*5850	61.04	59.52	78.2	-17.16	32.15	6.88	37.51	152	7	Peak
*5861	59.19	57.56	68.2	-9.01	32.18	6.95	37.5	152	7	Peak
Antenna Polarity & Test Distance: Vertical at 3 m										
Frequency (MHz)	Emission Level (dBuV/m)	Read Level (dBuV)	Limit (dBuV/m)	Margin (dB)	Antenna Factor (dB/m)	Cable Loss (dB)	Preamp Factor (dB)	Antenna Height (cm)	Table Angle (Degree)	Remark
*5714	58.85	57.66	68.2	-9.35	31.93	6.69	37.43	218	8	Peak
*5725	59.74	58.46	78.2	-18.46	31.96	6.75	37.43	218	8	Peak
5825	92.94	91.47			32.12	6.88	37.53	218	8	Average
5825	102.07	100.6			32.12	6.88	37.53	218	8	Peak
*5850	61.33	59.81	78.2	-16.87	32.15	6.88	37.51	218	8	Peak
*5861	58.98	57.35	68.2	-9.22	32.18	6.95	37.5	218	8	Peak

Remarks:

- Emission Level = Read Level + Antenna Factor + Cable Loss - Preamp Factor
Margin value = Emission level – Limit value
- 5825 MHz: Fundamental Frequency
- *: Out of Restricted Band

<2TX>

802.11n (HT20)

EUT Test Condition		Measurement Detail	
Channel	Channel 36	Frequency Range	1 GHz ~ 40 GHz
Input Power	120 Vac, 60 Hz	Detector Function	Peak (PK) Average (AV)
Environmental Conditions	25 deg. C, 65 % RH	Tested By	Toby Tian

Antenna Polarity & Test Distance: Horizontal at 3 m										
Frequency (MHz)	Emission Level (dBuV/m)	Read Level (dBuV)	Limit (dBuV/m)	Margin (dB)	Antenna Factor (dB/m)	Cable Loss (dB)	Preamp Factor (dB)	Antenna Height (cm)	Table Angle (Degree)	Remark
5052	38.47	38.31	54	-15.53	31.24	6.17	37.25	199	303	Average
5052	60.33	60.17	74	-13.67	31.24	6.17	37.25	199	303	Peak
5180	90.55	90.32			31.35	6.22	37.34	199	303	Average
5180	100.86	100.63			31.35	6.22	37.34	199	303	Peak
5458	38.1	37.28	54	-15.9	31.56	6.34	37.08	199	303	Average
5458	60.39	59.57	74	-13.61	31.56	6.34	37.08	199	303	Peak

Antenna Polarity & Test Distance: Vertical at 3 m										
Frequency (MHz)	Emission Level (dBuV/m)	Read Level (dBuV)	Limit (dBuV/m)	Margin (dB)	Antenna Factor (dB/m)	Cable Loss (dB)	Preamp Factor (dB)	Antenna Height (cm)	Table Angle (Degree)	Remark
5040	38.59	38.44	54	-15.41	31.24	6.15	37.24	200	288	Average
5040	59.69	59.54	74	-14.31	31.24	6.15	37.24	200	288	Peak
5180	92.89	92.66			31.35	6.22	37.34	200	288	Average
5180	101.85	101.62			31.35	6.22	37.34	200	288	Peak
5394	38.18	37.54	54	-15.82	31.51	6.31	37.18	200	288	Average
5394	59.36	58.72	74	-14.64	31.51	6.31	37.18	200	288	Peak

Remarks:

- Emission Level = Read Level + Antenna Factor + Cable Loss - Preamp Factor
Margin value = Emission level – Limit value
- 5180 MHz: Fundamental Frequency

EUT Test Condition		Measurement Detail	
Channel	Channel 44	Frequency Range	1 GHz ~ 40 GHz
Input Power	120 Vac, 60 Hz	Detector Function	Peak (PK) Average (AV)
Environmental Conditions	25 deg. C, 65 % RH	Tested By	Toby Tian

Antenna Polarity & Test Distance: Horizontal at 3 m										
Frequency (MHz)	Emission Level (dBuV/m)	Read Level (dBuV)	Limit (dBuV/m)	Margin (dB)	Antenna Factor (dB/m)	Cable Loss (dB)	Preamp Factor (dB)	Antenna Height (cm)	Table Angle (Degree)	Remark
5100	38.19	38	54	-15.81	31.28	6.19	37.28	199	303	Average
5100	59.96	59.77	74	-14.04	31.28	6.19	37.28	199	303	Peak
5220	92.08	91.83			31.37	6.24	37.36	199	303	Average
5220	100.78	100.53			31.37	6.24	37.36	199	303	Peak
5460	38.28	37.46	54	-15.72	31.56	6.34	37.08	199	303	Average
5460	60.26	59.44	74	-13.74	31.56	6.34	37.08	199	303	Peak

Antenna Polarity & Test Distance: Vertical at 3 m										
Frequency (MHz)	Emission Level (dBuV/m)	Read Level (dBuV)	Limit (dBuV/m)	Margin (dB)	Antenna Factor (dB/m)	Cable Loss (dB)	Preamp Factor (dB)	Antenna Height (cm)	Table Angle (Degree)	Remark
5054	38.12	37.96	54	-15.88	31.24	6.17	37.25	200	337	Average
5054	60.04	59.88	74	-13.96	31.24	6.17	37.25	200	337	Peak
5220	93.2	92.95			31.37	6.24	37.36	200	337	Average
5220	101.51	101.26			31.37	6.24	37.36	200	337	Peak
5410	38.06	37.4	54	-15.94	31.52	6.32	37.18	200	337	Average
5410	60.14	59.48	74	-13.86	31.52	6.32	37.18	200	337	Peak

Remarks:

- Emission Level = Read Level + Antenna Factor + Cable Loss - Preamp Factor
Margin value = Emission level – Limit value
- 5220 MHz: Fundamental Frequency

EUT Test Condition		Measurement Detail	
Channel	Channel 48	Frequency Range	1 GHz ~ 40 GHz
Input Power	120 Vac, 60 Hz	Detector Function	Peak (PK) Average (AV)
Environmental Conditions	25 deg. C, 65 % RH	Tested By	Toby Tian

Antenna Polarity & Test Distance: Horizontal at 3 m										
Frequency (MHz)	Emission Level (dBuV/m)	Read Level (dBuV)	Limit (dBuV/m)	Margin (dB)	Antenna Factor (dB/m)	Cable Loss (dB)	Preamp Factor (dB)	Antenna Height (cm)	Table Angle (Degree)	Remark
5052	37.9	37.74	54	-16.1	31.24	6.17	37.25	197	304	Average
5052	59.78	59.62	74	-14.22	31.24	6.17	37.25	197	304	Peak
5240	91.39	91.07			31.39	6.25	37.32	197	304	Average
5240	100.51	100.19			31.39	6.25	37.32	197	304	Peak
5460	38.17	37.35	54	-15.83	31.56	6.34	37.08	197	304	Average
5460	60.29	59.47	74	-13.71	31.56	6.34	37.08	197	304	Peak
Antenna Polarity & Test Distance: Vertical at 3 m										
Frequency (MHz)	Emission Level (dBuV/m)	Read Level (dBuV)	Limit (dBuV/m)	Margin (dB)	Antenna Factor (dB/m)	Cable Loss (dB)	Preamp Factor (dB)	Antenna Height (cm)	Table Angle (Degree)	Remark
5090	38.25	38.05	54	-15.75	31.28	6.19	37.27	200	338	Average
5090	59.65	59.45	74	-14.35	31.28	6.19	37.27	200	338	Peak
5240	92.16	91.84			31.39	6.25	37.32	200	338	Average
5240	101.64	101.32			31.39	6.25	37.32	200	338	Peak
5418	38.1	37.43	54	-15.9	31.53	6.32	37.18	200	338	Average
5418	59.66	58.99	74	-14.34	31.53	6.32	37.18	200	338	Peak

Remarks:

- Emission Level = Read Level + Antenna Factor + Cable Loss - Preamp Factor
Margin value = Emission level – Limit value
- 5240 MHz: Fundamental Frequency

EUT Test Condition		Measurement Detail	
Channel	Channel 52	Frequency Range	1 GHz ~ 40 GHz
Input Power	120 Vac, 60 Hz	Detector Function	Peak (PK) Average (AV)
Environmental Conditions	25 deg. C, 65 % RH	Tested By	Toby Tian

Antenna Polarity & Test Distance: Horizontal at 3 m										
Frequency (MHz)	Emission Level (dBuV/m)	Read Level (dBuV)	Limit (dBuV/m)	Margin (dB)	Antenna Factor (dB/m)	Cable Loss (dB)	Preamp Factor (dB)	Antenna Height (cm)	Table Angle (Degree)	Remark
5124	38.2	38	54	-15.8	31.31	6.19	37.3	198	305	Average
5124	59.42	59.22	74	-14.58	31.31	6.19	37.3	198	305	Peak
5260	91.9	91.51			31.41	6.25	37.27	198	305	Average
5260	101.89	101.5			31.41	6.25	37.27	198	305	Peak
5448	38.16	37.39	54	-15.84	31.56	6.34	37.13	198	305	Average
5448	59.58	58.81	74	-14.42	31.56	6.34	37.13	198	305	Peak
Antenna Polarity & Test Distance: Vertical at 3 m										
Frequency (MHz)	Emission Level (dBuV/m)	Read Level (dBuV)	Limit (dBuV/m)	Margin (dB)	Antenna Factor (dB/m)	Cable Loss (dB)	Preamp Factor (dB)	Antenna Height (cm)	Table Angle (Degree)	Remark
5074	38.03	37.86	54	-15.97	31.27	6.17	37.27	141	304	Average
5074	60.97	60.8	74	-13.03	31.27	6.17	37.27	141	304	Peak
5260	93.2	92.81			31.41	6.25	37.27	141	304	Average
5260	102.5	102.11			31.41	6.25	37.27	141	304	Peak
5448	38.06	37.29	54	-15.94	31.56	6.34	37.13	141	304	Average
5448	60.37	59.6	74	-13.63	31.56	6.34	37.13	141	304	Peak

Remarks:

- Emission Level = Read Level + Antenna Factor + Cable Loss - Preamp Factor
Margin value = Emission level – Limit value
- 5260 MHz: Fundamental Frequency

EUT Test Condition		Measurement Detail	
Channel	Channel 60	Frequency Range	1 GHz ~ 40 GHz
Input Power	120 Vac, 60 Hz	Detector Function	Peak (PK) Average (AV)
Environmental Conditions	25 deg. C, 65 % RH	Tested By	Toby Tian

Antenna Polarity & Test Distance: Horizontal at 3 m										
Frequency (MHz)	Emission Level (dBuV/m)	Read Level (dBuV)	Limit (dBuV/m)	Margin (dB)	Antenna Factor (dB/m)	Cable Loss (dB)	Preamp Factor (dB)	Antenna Height (cm)	Table Angle (Degree)	Remark
5014	38.01	37.88	54	-15.99	31.21	6.15	37.23	194	307	Average
5014	59.45	59.32	74	-14.55	31.21	6.15	37.23	194	307	Peak
5300	91.21	90.69			31.44	6.27	37.19	194	307	Average
5300	101.49	100.97			31.44	6.27	37.19	194	307	Peak
5392	38.89	38.25	54	-15.11	31.51	6.31	37.18	194	307	Average
5392	60.63	59.99	74	-13.37	31.51	6.31	37.18	194	307	Peak
Antenna Polarity & Test Distance: Vertical at 3 m										
Frequency (MHz)	Emission Level (dBuV/m)	Read Level (dBuV)	Limit (dBuV/m)	Margin (dB)	Antenna Factor (dB/m)	Cable Loss (dB)	Preamp Factor (dB)	Antenna Height (cm)	Table Angle (Degree)	Remark
5058	38.13	37.96	54	-15.87	31.25	6.17	37.25	147	306	Average
5058	60.94	60.77	74	-13.06	31.25	6.17	37.25	147	306	Peak
5300	93.58	93.06			31.44	6.27	37.19	147	306	Average
5300	102.41	101.89			31.44	6.27	37.19	147	306	Peak
5456	39.05	38.23	54	-14.95	31.56	6.34	37.08	147	306	Average
5456	60.72	59.9	74	-13.28	31.56	6.34	37.08	147	306	Peak

Remarks:

- Emission Level = Read Level + Antenna Factor + Cable Loss - Preamp Factor
Margin value = Emission level – Limit value
- 5300 MHz: Fundamental Frequency

EUT Test Condition		Measurement Detail	
Channel	Channel 64	Frequency Range	1 GHz ~ 40 GHz
Input Power	120 Vac, 60 Hz	Detector Function	Peak (PK) Average (AV)
Environmental Conditions	25 deg. C, 65 % RH	Tested By	Toby Tian

Antenna Polarity & Test Distance: Horizontal at 3 m										
Frequency (MHz)	Emission Level (dBuV/m)	Read Level (dBuV)	Limit (dBuV/m)	Margin (dB)	Antenna Factor (dB/m)	Cable Loss (dB)	Preamp Factor (dB)	Antenna Height (cm)	Table Angle (Degree)	Remark
5090	38.06	37.86	54	-15.94	31.28	6.19	37.27	200	305	Average
5090	59.86	59.66	74	-14.14	31.28	6.19	37.27	200	305	Peak
5320	92.75	92.2			31.45	6.29	37.19	200	305	Average
5320	101.63	101.08			31.45	6.29	37.19	200	305	Peak
5350	39.26	38.67	54	-14.74	31.48	6.29	37.18	200	305	Average
5350	59.76	59.17	74	-14.24	31.48	6.29	37.18	200	305	Peak
Antenna Polarity & Test Distance: Vertical at 3 m										
Frequency (MHz)	Emission Level (dBuV/m)	Read Level (dBuV)	Limit (dBuV/m)	Margin (dB)	Antenna Factor (dB/m)	Cable Loss (dB)	Preamp Factor (dB)	Antenna Height (cm)	Table Angle (Degree)	Remark
5078	38.31	38.14	54	-15.69	31.27	6.17	37.27	132	308	Average
5078	60.86	60.69	74	-13.14	31.27	6.17	37.27	132	308	Peak
5320	93.47	92.92			31.45	6.29	37.19	132	308	Average
5320	103.23	102.68			31.45	6.29	37.19	132	308	Peak
5442	39.42	38.66	54	-14.58	31.55	6.34	37.13	132	308	Average
5442	59.79	59.03	74	-14.21	31.55	6.34	37.13	132	308	Peak

Remarks:

- Emission Level = Read Level + Antenna Factor + Cable Loss - Preamp Factor
Margin value = Emission level – Limit value
- 5320 MHz: Fundamental Frequency

EUT Test Condition		Measurement Detail	
Channel	Channel 100	Frequency Range	1 GHz ~ 40 GHz
Input Power	120 Vac, 60 Hz	Detector Function	Peak (PK) Average (AV)
Environmental Conditions	25 deg. C, 65 % RH	Tested By	Toby Tian

Antenna Polarity & Test Distance: Horizontal at 3 m										
Frequency (MHz)	Emission Level (dBuV/m)	Read Level (dBuV)	Limit (dBuV/m)	Margin (dB)	Antenna Factor (dB/m)	Cable Loss (dB)	Preamp Factor (dB)	Antenna Height (cm)	Table Angle (Degree)	Remark
5434	38.92	38.18	54	-15.08	31.55	6.32	37.13	100	282	Average
5434	59.91	59.17	74	-14.09	31.55	6.32	37.13	100	282	Peak
5470	59.33	58.5	68.2	-8.87	31.57	6.34	37.08	100	282	Peak
5500	91.17	90.24			31.6	6.36	37.03	100	282	Average
5500	100.38	99.45			31.6	6.36	37.03	100	282	Peak
5725	59.1	57.82	68.2	-9.1	31.96	6.75	37.43	100	282	Peak
Antenna Polarity & Test Distance: Vertical at 3 m										
Frequency (MHz)	Emission Level (dBuV/m)	Read Level (dBuV)	Limit (dBuV/m)	Margin (dB)	Antenna Factor (dB/m)	Cable Loss (dB)	Preamp Factor (dB)	Antenna Height (cm)	Table Angle (Degree)	Remark
5428	38.72	38	54	-15.28	31.53	6.32	37.13	136	16	Average
5428	60.13	59.41	74	-13.87	31.53	6.32	37.13	136	16	Peak
5470	58.46	57.63	68.2	-9.74	31.57	6.34	37.08	136	16	Peak
5500	89.83	88.9			31.6	6.36	37.03	136	16	Average
5500	99	98.07			31.6	6.36	37.03	136	16	Peak
5725	58.12	56.84	68.2	-10.08	31.96	6.75	37.43	136	16	Peak

Remarks:

- Emission Level = Read Level + Antenna Factor + Cable Loss - Preamp Factor
Margin value = Emission level – Limit value
- 5500 MHz: Fundamental Frequency
- 5470 MHz & 5725 MHz: Out of Restricted Band

EUT Test Condition		Measurement Detail	
Channel	Channel 116	Frequency Range	1 GHz ~ 40 GHz
Input Power	120 Vac, 60 Hz	Detector Function	Peak (PK) Average (AV)
Environmental Conditions	25 deg. C, 65 % RH	Tested By	Toby Tian

Antenna Polarity & Test Distance: Horizontal at 3 m										
Frequency (MHz)	Emission Level (dBuV/m)	Read Level (dBuV)	Limit (dBuV/m)	Margin (dB)	Antenna Factor (dB/m)	Cable Loss (dB)	Preamp Factor (dB)	Antenna Height (cm)	Table Angle (Degree)	Remark
5426	38.37	37.65	54	-15.63	31.53	6.32	37.13	100	292	Average
5426	60.41	59.69	74	-13.59	31.53	6.32	37.13	100	292	Peak
5470	59.46	58.63	68.2	-8.74	31.57	6.34	37.08	100	292	Peak
5580	91.5	90.46			31.71	6.49	37.16	100	292	Average
5580	100.62	99.58			31.71	6.49	37.16	100	292	Peak
5725	59.39	58.11	68.2	-8.81	31.96	6.75	37.43	100	292	Peak
Antenna Polarity & Test Distance: Vertical at 3 m										
Frequency (MHz)	Emission Level (dBuV/m)	Read Level (dBuV)	Limit (dBuV/m)	Margin (dB)	Antenna Factor (dB/m)	Cable Loss (dB)	Preamp Factor (dB)	Antenna Height (cm)	Table Angle (Degree)	Remark
5362	38.37	37.75	54	-15.63	31.49	6.31	37.18	126	12	Average
5362	60.37	59.75	74	-13.63	31.49	6.31	37.18	126	12	Peak
5470	58.5	57.67	68.2	-9.7	31.57	6.34	37.08	126	12	Peak
5580	90.12	89.08			31.71	6.49	37.16	126	12	Average
5580	99.47	98.43			31.71	6.49	37.16	126	12	Peak
5725	58.88	57.6	68.2	-9.32	31.96	6.75	37.43	126	12	Peak

Remarks:

- Emission Level = Read Level + Antenna Factor + Cable Loss - Preamp Factor
Margin value = Emission level – Limit value
- 5580 MHz: Fundamental Frequency
- 5470 MHz & 5725 MHz: Out of Restricted Band

EUT Test Condition		Measurement Detail	
Channel	Channel 140	Frequency Range	1 GHz ~ 40 GHz
Input Power	120 Vac, 60 Hz	Detector Function	Peak (PK) Average (AV)
Environmental Conditions	25 deg. C, 65 % RH	Tested By	Toby Tian

Antenna Polarity & Test Distance: Horizontal at 3 m										
Frequency (MHz)	Emission Level (dBuV/m)	Read Level (dBuV)	Limit (dBuV/m)	Margin (dB)	Antenna Factor (dB/m)	Cable Loss (dB)	Preamp Factor (dB)	Antenna Height (cm)	Table Angle (Degree)	Remark
5352	38.24	37.65	54	-15.76	31.48	6.29	37.18	100	277	Average
5352	60.92	60.33	74	-13.08	31.48	6.29	37.18	100	277	Peak
5470	59.43	58.6	68.2	-8.77	31.57	6.34	37.08	100	277	Peak
5700	91.42	90.23			31.9	6.69	37.4	100	277	Average
5700	100.54	99.35			31.9	6.69	37.4	100	277	Peak
5725	59.69	58.41	68.2	-8.51	31.96	6.75	37.43	100	277	Peak
Antenna Polarity & Test Distance: Vertical at 3 m										
Frequency (MHz)	Emission Level (dBuV/m)	Read Level (dBuV)	Limit (dBuV/m)	Margin (dB)	Antenna Factor (dB/m)	Cable Loss (dB)	Preamp Factor (dB)	Antenna Height (cm)	Table Angle (Degree)	Remark
5372	38.03	37.41	54	-15.97	31.49	6.31	37.18	129	14	Average
5372	59.81	59.19	74	-14.19	31.49	6.31	37.18	129	14	Peak
5470	57.32	56.49	68.2	-10.88	31.57	6.34	37.08	129	14	Peak
5700	90.34	89.15			31.9	6.69	37.4	129	14	Average
5700	99.46	98.27			31.9	6.69	37.4	129	14	Peak
5725	59.43	58.15	68.2	-8.77	31.96	6.75	37.43	129	14	Peak

Remarks:

- Emission Level = Read Level + Antenna Factor + Cable Loss - Preamp Factor
Margin value = Emission level – Limit value
- 5700 MHz: Fundamental Frequency
- 5470 MHz & 5725 MHz: Out of Restricted Band

EUT Test Condition		Measurement Detail	
Channel	Channel 149	Frequency Range	1 GHz ~ 40 GHz
Input Power	120 Vac, 60 Hz	Detector Function	Peak (PK) Average (AV)
Environmental Conditions	25 deg. C, 65 % RH	Tested By	Toby Tian

Antenna Polarity & Test Distance: Horizontal at 3 m										
Frequency (MHz)	Emission Level (dBuV/m)	Read Level (dBuV)	Limit (dBuV/m)	Margin (dB)	Antenna Factor (dB/m)	Cable Loss (dB)	Preamp Factor (dB)	Antenna Height (cm)	Table Angle (Degree)	Remark
*5714	58.88	57.69	68.2	-9.32	31.93	6.69	37.43	205	52	Peak
*5725	60.07	58.79	78.2	-18.13	31.96	6.75	37.43	205	52	Peak
5745	93.48	92.21			31.99	6.75	37.47	205	52	Average
5745	102.82	101.55			31.99	6.75	37.47	205	52	Peak
*5850	60.25	58.73	78.2	-17.95	32.15	6.88	37.51	205	52	Peak
*5861	58.41	56.78	68.2	-9.79	32.18	6.95	37.5	205	52	Peak
Antenna Polarity & Test Distance: Vertical at 3 m										
Frequency (MHz)	Emission Level (dBuV/m)	Read Level (dBuV)	Limit (dBuV/m)	Margin (dB)	Antenna Factor (dB/m)	Cable Loss (dB)	Preamp Factor (dB)	Antenna Height (cm)	Table Angle (Degree)	Remark
*5714	58.94	57.75	68.2	-9.26	31.93	6.69	37.43	200	359	Peak
*5725	59.87	58.59	78.2	-18.33	31.96	6.75	37.43	200	359	Peak
5745	92.88	91.61			31.99	6.75	37.47	200	359	Average
5745	101.92	100.65			31.99	6.75	37.47	200	359	Peak
*5850	59.62	58.1	78.2	-18.58	32.15	6.88	37.51	200	359	Peak
*5861	59.75	58.12	68.2	-8.45	32.18	6.95	37.5	200	359	Peak

Remarks:

- Emission Level = Read Level + Antenna Factor + Cable Loss - Preamp Factor
Margin value = Emission level – Limit value
- 5745 MHz: Fundamental Frequency
- *: Out of Restricted Band

EUT Test Condition		Measurement Detail	
Channel	Channel 157	Frequency Range	1 GHz ~ 40 GHz
Input Power	120 Vac, 60 Hz	Detector Function	Peak (PK) Average (AV)
Environmental Conditions	25 deg. C, 65 % RH	Tested By	Toby Tian

Antenna Polarity & Test Distance: Horizontal at 3 m										
Frequency (MHz)	Emission Level (dBuV/m)	Read Level (dBuV)	Limit (dBuV/m)	Margin (dB)	Antenna Factor (dB/m)	Cable Loss (dB)	Preamp Factor (dB)	Antenna Height (cm)	Table Angle (Degree)	Remark
*5714	58.93	57.74	68.2	-9.27	31.93	6.69	37.43	205	48	Peak
*5725	60.92	59.64	78.2	-17.28	31.96	6.75	37.43	205	48	Peak
5785	93.66	92.34			32.04	6.82	37.54	205	48	Average
5785	102.78	101.46			32.04	6.82	37.54	205	48	Peak
*5850	60.16	58.64	78.2	-18.04	32.15	6.88	37.51	205	48	Peak
*5861	58.55	56.92	68.2	-9.65	32.18	6.95	37.5	205	48	Peak
Antenna Polarity & Test Distance: Vertical at 3 m										
Frequency (MHz)	Emission Level (dBuV/m)	Read Level (dBuV)	Limit (dBuV/m)	Margin (dB)	Antenna Factor (dB/m)	Cable Loss (dB)	Preamp Factor (dB)	Antenna Height (cm)	Table Angle (Degree)	Remark
*5714	59.89	58.7	68.2	-8.31	31.93	6.69	37.43	202	355	Peak
*5725	59.24	57.96	78.2	-18.96	31.96	6.75	37.43	202	355	Peak
5785	92.9	91.58			32.04	6.82	37.54	202	355	Average
5785	101.96	100.64			32.04	6.82	37.54	202	355	Peak
*5850	59.4	57.88	78.2	-18.8	32.15	6.88	37.51	202	355	Peak
*5861	60.44	58.81	68.2	-7.76	32.18	6.95	37.5	202	355	Peak

Remarks:

- Emission Level = Read Level + Antenna Factor + Cable Loss - Preamp Factor
Margin value = Emission level – Limit value
- 5785 MHz: Fundamental Frequency
- *: Out of Restricted Band

EUT Test Condition		Measurement Detail	
Channel	Channel 165	Frequency Range	1 GHz ~ 40 GHz
Input Power	120 Vac, 60 Hz	Detector Function	Peak (PK) Average (AV)
Environmental Conditions	25 deg. C, 65 % RH	Tested By	Toby Tian

Antenna Polarity & Test Distance: Horizontal at 3 m										
Frequency (MHz)	Emission Level (dBuV/m)	Read Level (dBuV)	Limit (dBuV/m)	Margin (dB)	Antenna Factor (dB/m)	Cable Loss (dB)	Preamp Factor (dB)	Antenna Height (cm)	Table Angle (Degree)	Remark
*5714	60.69	59.5	68.2	-7.51	31.93	6.69	37.43	203	57	Peak
*5725	60.06	58.78	78.2	-18.14	31.96	6.75	37.43	203	57	Peak
5825	93.59	92.12			32.12	6.88	37.53	203	57	Average
5825	102.73	101.26			32.12	6.88	37.53	203	57	Peak
*5850	59.24	57.72	78.2	-18.96	32.15	6.88	37.51	203	57	Peak
*5861	59.38	57.75	68.2	-8.82	32.18	6.95	37.5	203	57	Peak
Antenna Polarity & Test Distance: Vertical at 3 m										
Frequency (MHz)	Emission Level (dBuV/m)	Read Level (dBuV)	Limit (dBuV/m)	Margin (dB)	Antenna Factor (dB/m)	Cable Loss (dB)	Preamp Factor (dB)	Antenna Height (cm)	Table Angle (Degree)	Remark
*5714	59.85	58.66	68.2	-8.35	31.93	6.69	37.43	199	1	Peak
*5725	58.71	57.43	78.2	-19.49	31.96	6.75	37.43	199	1	Peak
5825	92.85	91.38			32.12	6.88	37.53	199	1	Average
5825	101.9	100.43			32.12	6.88	37.53	199	1	Peak
*5850	58.62	57.1	78.2	-19.58	32.15	6.88	37.51	199	1	Peak
*5861	58.77	57.14	68.2	-9.43	32.18	6.95	37.5	199	1	Peak

Remarks:

- Emission Level = Read Level + Antenna Factor + Cable Loss - Preamp Factor
Margin value = Emission level – Limit value
- 5825 MHz: Fundamental Frequency
- *: Out of Restricted Band

802.11n (HT40)

EUT Test Condition		Measurement Detail	
Channel	Channel 38	Frequency Range	1 GHz ~ 40 GHz
Input Power	120 Vac, 60 Hz	Detector Function	Peak (PK) Average (AV)
Environmental Conditions	25 deg. C, 65 % RH	Tested By	Toby Tian

Antenna Polarity & Test Distance: Horizontal at 3 m

Frequency (MHz)	Emission Level (dBuV/m)	Read Level (dBuV)	Limit (dBuV/m)	Margin (dB)	Antenna Factor (dB/m)	Cable Loss (dB)	Preamp Factor (dB)	Antenna Height (cm)	Table Angle (Degree)	Remark
5008	39.54	39.43	54	-14.46	31.21	6.13	37.23	201	304	Average
5008	59.64	59.53	74	-14.36	31.21	6.13	37.23	201	304	Peak
5190	89.09	88.86			31.35	6.22	37.34	201	304	Average
5190	98.04	97.81			31.35	6.22	37.34	201	304	Peak
5384	38.48	37.84	54	-15.52	31.51	6.31	37.18	201	304	Average
5384	60.47	59.83	74	-13.53	31.51	6.31	37.18	201	304	Peak

Antenna Polarity & Test Distance: Vertical at 3 m

Frequency (MHz)	Emission Level (dBuV/m)	Read Level (dBuV)	Limit (dBuV/m)	Margin (dB)	Antenna Factor (dB/m)	Cable Loss (dB)	Preamp Factor (dB)	Antenna Height (cm)	Table Angle (Degree)	Remark
5028	39.82	39.68	54	-14.18	31.23	6.15	37.24	200	338	Average
5028	60.4	60.26	74	-13.6	31.23	6.15	37.24	200	338	Peak
5190	89.73	89.5			31.35	6.22	37.34	200	338	Average
5190	98.82	98.59			31.35	6.22	37.34	200	338	Peak
5454	38.51	37.69	54	-15.49	31.56	6.34	37.08	200	338	Average
5454	60.26	59.44	74	-13.74	31.56	6.34	37.08	200	338	Peak

Remarks:

- Emission Level = Read Level + Antenna Factor + Cable Loss - Preamp Factor
Margin value = Emission level – Limit value
- 5190 MHz: Fundamental Frequency

EUT Test Condition		Measurement Detail	
Channel	Channel 46	Frequency Range	1 GHz ~ 40 GHz
Input Power	120 Vac, 60 Hz	Detector Function	Peak (PK) Average (AV)
Environmental Conditions	25 deg. C, 65 % RH	Tested By	Toby Tian

Antenna Polarity & Test Distance: Horizontal at 3 m										
Frequency (MHz)	Emission Level (dBuV/m)	Read Level (dBuV)	Limit (dBuV/m)	Margin (dB)	Antenna Factor (dB/m)	Cable Loss (dB)	Preamp Factor (dB)	Antenna Height (cm)	Table Angle (Degree)	Remark
5014	38.57	38.44	54	-15.43	31.21	6.15	37.23	199	304	Average
5014	59.36	59.23	74	-14.64	31.21	6.15	37.23	199	304	Peak
5230	89.01	88.7			31.39	6.24	37.32	199	304	Average
5230	98.2	97.89			31.39	6.24	37.32	199	304	Peak
5400	39.01	38.35	54	-14.99	31.52	6.32	37.18	199	304	Average
5400	60.42	59.76	74	-13.58	31.52	6.32	37.18	199	304	Peak
Antenna Polarity & Test Distance: Vertical at 3 m										
Frequency (MHz)	Emission Level (dBuV/m)	Read Level (dBuV)	Limit (dBuV/m)	Margin (dB)	Antenna Factor (dB/m)	Cable Loss (dB)	Preamp Factor (dB)	Antenna Height (cm)	Table Angle (Degree)	Remark
5024	38.61	38.47	54	-15.39	31.23	6.15	37.24	200	338	Average
5024	59.77	59.63	74	-14.23	31.23	6.15	37.24	200	338	Peak
5230	89.65	89.34			31.39	6.24	37.32	200	338	Average
5230	98.25	97.94			31.39	6.24	37.32	200	338	Peak
5396	38.6	37.95	54	-15.4	31.52	6.31	37.18	200	338	Average
5396	61.23	60.58	74	-12.77	31.52	6.31	37.18	200	338	Peak

Remarks:

- Emission Level = Read Level + Antenna Factor + Cable Loss - Preamp Factor
Margin value = Emission level – Limit value
- 5230 MHz: Fundamental Frequency

EUT Test Condition		Measurement Detail	
Channel	Channel 54	Frequency Range	1 GHz ~ 40 GHz
Input Power	120 Vac, 60 Hz	Detector Function	Peak (PK) Average (AV)
Environmental Conditions	25 deg. C, 65 % RH	Tested By	Toby Tian

Antenna Polarity & Test Distance: Horizontal at 3 m										
Frequency (MHz)	Emission Level (dBuV/m)	Read Level (dBuV)	Limit (dBuV/m)	Margin (dB)	Antenna Factor (dB/m)	Cable Loss (dB)	Preamp Factor (dB)	Antenna Height (cm)	Table Angle (Degree)	Remark
5066	38.69	38.52	54	-15.31	31.25	6.17	37.25	199	305	Average
5066	60.98	60.81	74	-13.02	31.25	6.17	37.25	199	305	Peak
5270	89.38	88.99			31.41	6.25	37.27	199	305	Average
5270	98.9	98.51			31.41	6.25	37.27	199	305	Peak
5422	38.67	38	54	-15.33	31.53	6.32	37.18	199	305	Average
5422	61.46	60.79	74	-12.54	31.53	6.32	37.18	199	305	Peak
Antenna Polarity & Test Distance: Vertical at 3 m										
Frequency (MHz)	Emission Level (dBuV/m)	Read Level (dBuV)	Limit (dBuV/m)	Margin (dB)	Antenna Factor (dB/m)	Cable Loss (dB)	Preamp Factor (dB)	Antenna Height (cm)	Table Angle (Degree)	Remark
5122	38.83	38.65	54	-15.17	31.29	6.19	37.3	148	302	Average
5122	60.54	60.36	74	-13.46	31.29	6.19	37.3	148	302	Peak
5270	90.59	90.2			31.41	6.25	37.27	148	302	Average
5270	99.69	99.3			31.41	6.25	37.27	148	302	Peak
5422	38.72	38.05	54	-15.28	31.53	6.32	37.18	148	302	Average
5422	60.65	59.98	74	-13.35	31.53	6.32	37.18	148	302	Peak

Remarks:

- Emission Level = Read Level + Antenna Factor + Cable Loss - Preamp Factor
Margin value = Emission level – Limit value
- 5270 MHz: Fundamental Frequency

EUT Test Condition		Measurement Detail	
Channel	Channel 62	Frequency Range	1 GHz ~ 40 GHz
Input Power	120 Vac, 60 Hz	Detector Function	Peak (PK) Average (AV)
Environmental Conditions	25 deg. C, 65 % RH	Tested By	Toby Tian

Antenna Polarity & Test Distance: Horizontal at 3 m										
Frequency (MHz)	Emission Level (dBuV/m)	Read Level (dBuV)	Limit (dBuV/m)	Margin (dB)	Antenna Factor (dB/m)	Cable Loss (dB)	Preamp Factor (dB)	Antenna Height (cm)	Table Angle (Degree)	Remark
5082	38.3	38.13	54	-15.7	31.27	6.17	37.27	202	308	Average
5082	61.92	61.75	74	-12.08	31.27	6.17	37.27	202	308	Peak
5310	89.91	89.38			31.45	6.27	37.19	202	308	Average
5310	99.43	98.9			31.45	6.27	37.19	202	308	Peak
5448	39.84	39.07	54	-14.16	31.56	6.34	37.13	202	308	Average
5448	61.72	60.95	74	-12.28	31.56	6.34	37.13	202	308	Peak
Antenna Polarity & Test Distance: Vertical at 3 m										
Frequency (MHz)	Emission Level (dBuV/m)	Read Level (dBuV)	Limit (dBuV/m)	Margin (dB)	Antenna Factor (dB/m)	Cable Loss (dB)	Preamp Factor (dB)	Antenna Height (cm)	Table Angle (Degree)	Remark
5040	38.33	38.18	54	-15.67	31.24	6.15	37.24	154	304	Average
5040	60.58	60.43	74	-13.42	31.24	6.15	37.24	154	304	Peak
5310	90.48	89.95			31.45	6.27	37.19	154	304	Average
5310	100.24	99.71			31.45	6.27	37.19	154	304	Peak
5418	39.9	39.23	54	-14.1	31.53	6.32	37.18	154	304	Average
5418	60.14	59.47	74	-13.86	31.53	6.32	37.18	154	304	Peak

Remarks:

- Emission Level = Read Level + Antenna Factor + Cable Loss - Preamp Factor
Margin value = Emission level – Limit value
- 5310 MHz: Fundamental Frequency

EUT Test Condition		Measurement Detail	
Channel	Channel 102	Frequency Range	1 GHz ~ 40 GHz
Input Power	120 Vac, 60 Hz	Detector Function	Peak (PK) Average (AV)
Environmental Conditions	25 deg. C, 65 % RH	Tested By	Toby Tian

Antenna Polarity & Test Distance: Horizontal at 3 m										
Frequency (MHz)	Emission Level (dBuV/m)	Read Level (dBuV)	Limit (dBuV/m)	Margin (dB)	Antenna Factor (dB/m)	Cable Loss (dB)	Preamp Factor (dB)	Antenna Height (cm)	Table Angle (Degree)	Remark
5438	39.57	38.81	54	-14.43	31.55	6.34	37.13	100	300	Average
5438	60.42	59.66	74	-13.58	31.55	6.34	37.13	100	300	Peak
5470	58.2	57.37	68.2	-10	31.57	6.34	37.08	100	300	Peak
5510	89.2	88.3			31.6	6.36	37.06	100	300	Average
5510	98.88	97.98			31.6	6.36	37.06	100	300	Peak
5725	59.22	57.94	68.2	-8.98	31.96	6.75	37.43	100	300	Peak
Antenna Polarity & Test Distance: Vertical at 3 m										
Frequency (MHz)	Emission Level (dBuV/m)	Read Level (dBuV)	Limit (dBuV/m)	Margin (dB)	Antenna Factor (dB/m)	Cable Loss (dB)	Preamp Factor (dB)	Antenna Height (cm)	Table Angle (Degree)	Remark
5410	38.77	38.11	54	-15.23	31.52	6.32	37.18	129	23	Average
5410	59.74	59.08	74	-14.26	31.52	6.32	37.18	129	23	Peak
5470	59.27	58.44	68.2	-8.93	31.57	6.34	37.08	129	23	Peak
5510	88.03	87.13			31.6	6.36	37.06	129	23	Average
5510	97.57	96.67			31.6	6.36	37.06	129	23	Peak
5725	58.29	57.01	68.2	-9.91	31.96	6.75	37.43	129	23	Peak

Remarks:

- Emission Level = Read Level + Antenna Factor + Cable Loss - Preamp Factor
Margin value = Emission level – Limit value
- 5510 MHz: Fundamental Frequency
- 5470 MHz & 5725 MHz: Out of Restricted Band

EUT Test Condition		Measurement Detail	
Channel	Channel 110	Frequency Range	1 GHz ~ 40 GHz
Input Power	120 Vac, 60 Hz	Detector Function	Peak (PK) Average (AV)
Environmental Conditions	25 deg. C, 65 % RH	Tested By	Toby Tian

Antenna Polarity & Test Distance: Horizontal at 3 m										
Frequency (MHz)	Emission Level (dBuV/m)	Read Level (dBuV)	Limit (dBuV/m)	Margin (dB)	Antenna Factor (dB/m)	Cable Loss (dB)	Preamp Factor (dB)	Antenna Height (cm)	Table Angle (Degree)	Remark
5434	38.66	37.92	54	-15.34	31.55	6.32	37.13	100	285	Average
5434	59.76	59.02	74	-14.24	31.55	6.32	37.13	100	285	Peak
5470	57.34	56.51	68.2	-10.86	31.57	6.34	37.08	100	285	Peak
5550	89.42	88.41			31.68	6.42	37.09	100	285	Average
5550	98.85	97.84			31.68	6.42	37.09	100	285	Peak
5725	58.98	57.7	68.2	-9.22	31.96	6.75	37.43	100	285	Peak
Antenna Polarity & Test Distance: Vertical at 3 m										
Frequency (MHz)	Emission Level (dBuV/m)	Read Level (dBuV)	Limit (dBuV/m)	Margin (dB)	Antenna Factor (dB/m)	Cable Loss (dB)	Preamp Factor (dB)	Antenna Height (cm)	Table Angle (Degree)	Remark
5460	38.7	37.88	54	-15.3	31.56	6.34	37.08	127	19	Average
5460	60.08	59.26	74	-13.92	31.56	6.34	37.08	127	19	Peak
5470	58.17	57.34	68.2	-10.03	31.57	6.34	37.08	127	19	Peak
5550	88.03	87.02			31.68	6.42	37.09	127	19	Average
5550	97.48	96.47			31.68	6.42	37.09	127	19	Peak
5725	59.27	57.99	68.2	-8.93	31.96	6.75	37.43	127	19	Peak

Remarks:

- Emission Level = Read Level + Antenna Factor + Cable Loss - Preamp Factor
Margin value = Emission level – Limit value
- 5550 MHz: Fundamental Frequency
- 5470 MHz & 5725 MHz: Out of Restricted Band

EUT Test Condition		Measurement Detail	
Channel	Channel 134	Frequency Range	1 GHz ~ 40 GHz
Input Power	120 Vac, 60 Hz	Detector Function	Peak (PK) Average (AV)
Environmental Conditions	25 deg. C, 65 % RH	Tested By	Toby Tian

Antenna Polarity & Test Distance: Horizontal at 3 m										
Frequency (MHz)	Emission Level (dBuV/m)	Read Level (dBuV)	Limit (dBuV/m)	Margin (dB)	Antenna Factor (dB/m)	Cable Loss (dB)	Preamp Factor (dB)	Antenna Height (cm)	Table Angle (Degree)	Remark
5436	38.68	37.94	54	-15.32	31.55	6.32	37.13	100	280	Average
5436	60.03	59.29	74	-13.97	31.55	6.32	37.13	100	280	Peak
5470	57.2	56.37	68.2	-11	31.57	6.34	37.08	100	280	Peak
5670	89.43	88.27			31.88	6.62	37.34	100	280	Average
5670	98.91	97.75			31.88	6.62	37.34	100	280	Peak
5725	58.97	57.69	68.2	-9.23	31.96	6.75	37.43	100	280	Peak
Antenna Polarity & Test Distance: Vertical at 3 m										
Frequency (MHz)	Emission Level (dBuV/m)	Read Level (dBuV)	Limit (dBuV/m)	Margin (dB)	Antenna Factor (dB/m)	Cable Loss (dB)	Preamp Factor (dB)	Antenna Height (cm)	Table Angle (Degree)	Remark
5384	38.48	37.84	54	-15.52	31.51	6.31	37.18	129	15	Average
5384	60.38	59.74	74	-13.62	31.51	6.31	37.18	129	15	Peak
5470	58.88	58.05	68.2	-9.32	31.57	6.34	37.08	129	15	Peak
5670	88.23	87.07			31.88	6.62	37.34	129	15	Average
5670	97.39	96.23			31.88	6.62	37.34	129	15	Peak
5725	60.12	58.84	68.2	-8.08	31.96	6.75	37.43	129	15	Peak

Remarks:

- Emission Level = Read Level + Antenna Factor + Cable Loss - Preamp Factor
Margin value = Emission level – Limit value
- 5670 MHz: Fundamental Frequency
- 5470 MHz & 5725 MHz: Out of Restricted Band

EUT Test Condition		Measurement Detail	
Channel	Channel 151	Frequency Range	1 GHz ~ 40 GHz
Input Power	120 Vac, 60 Hz	Detector Function	Peak (PK) Average (AV)
Environmental Conditions	25 deg. C, 65 % RH	Tested By	Toby Tian

Antenna Polarity & Test Distance: Horizontal at 3 m										
Frequency (MHz)	Emission Level (dBuV/m)	Read Level (dBuV)	Limit (dBuV/m)	Margin (dB)	Antenna Factor (dB/m)	Cable Loss (dB)	Preamp Factor (dB)	Antenna Height (cm)	Table Angle (Degree)	Remark
*5714	60.4	59.21	68.2	-7.8	31.93	6.69	37.43	206	38	Peak
*5725	61.29	60.01	78.2	-16.91	31.96	6.75	37.43	206	38	Peak
5755	90.76	89.47			32.01	6.75	37.47	206	38	Average
5755	99.9	98.61			32.01	6.75	37.47	206	38	Peak
*5850	60.64	59.12	78.2	-17.56	32.15	6.88	37.51	206	38	Peak
*5861	61.31	59.68	68.2	-6.89	32.18	6.95	37.5	206	38	Peak
Antenna Polarity & Test Distance: Vertical at 3 m										
Frequency (MHz)	Emission Level (dBuV/m)	Read Level (dBuV)	Limit (dBuV/m)	Margin (dB)	Antenna Factor (dB/m)	Cable Loss (dB)	Preamp Factor (dB)	Antenna Height (cm)	Table Angle (Degree)	Remark
*5714	60.66	59.47	68.2	-7.54	31.93	6.69	37.43	201	11	Peak
*5725	60.96	59.68	78.2	-17.24	31.96	6.75	37.43	201	11	Peak
5755	89.79	88.5			32.01	6.75	37.47	201	11	Average
5755	99.04	97.75			32.01	6.75	37.47	201	11	Peak
*5850	59.21	57.69	78.2	-18.99	32.15	6.88	37.51	201	11	Peak
*5861	60.12	58.49	68.2	-8.08	32.18	6.95	37.5	201	11	Peak

Remarks:

- Emission Level = Read Level + Antenna Factor + Cable Loss - Preamp Factor
Margin value = Emission level – Limit value
- 5755 MHz: Fundamental Frequency
- *: Out of Restricted Band

EUT Test Condition		Measurement Detail	
Channel	Channel 159	Frequency Range	1 GHz ~ 40 GHz
Input Power	120 Vac, 60 Hz	Detector Function	Peak (PK) Average (AV)
Environmental Conditions	25 deg. C, 65 % RH	Tested By	Toby Tian

Antenna Polarity & Test Distance: Horizontal at 3 m										
Frequency (MHz)	Emission Level (dBuV/m)	Read Level (dBuV)	Limit (dBuV/m)	Margin (dB)	Antenna Factor (dB/m)	Cable Loss (dB)	Preamp Factor (dB)	Antenna Height (cm)	Table Angle (Degree)	Remark
*5714	59.19	58	68.2	-9.01	31.93	6.69	37.43	207	67	Peak
*5725	60.43	59.15	78.2	-17.77	31.96	6.75	37.43	207	67	Peak
5795	90.78	89.43			32.07	6.82	37.54	207	67	Average
5795	99.84	98.49			32.07	6.82	37.54	207	67	Peak
*5850	59.42	57.9	78.2	-18.78	32.15	6.88	37.51	207	67	Peak
*5861	59.66	58.03	68.2	-8.54	32.18	6.95	37.5	207	67	Peak
Antenna Polarity & Test Distance: Vertical at 3 m										
Frequency (MHz)	Emission Level (dBuV/m)	Read Level (dBuV)	Limit (dBuV/m)	Margin (dB)	Antenna Factor (dB/m)	Cable Loss (dB)	Preamp Factor (dB)	Antenna Height (cm)	Table Angle (Degree)	Remark
*5714	58.97	57.78	68.2	-9.23	31.93	6.69	37.43	200	9	Peak
*5725	59.04	57.76	78.2	-19.16	31.96	6.75	37.43	200	9	Peak
5795	89.72	88.37			32.07	6.82	37.54	200	9	Average
5795	99	97.65			32.07	6.82	37.54	200	9	Peak
*5850	59.97	58.45	78.2	-18.23	32.15	6.88	37.51	200	9	Peak
*5861	59.9	58.27	68.2	-8.3	32.18	6.95	37.5	200	9	Peak

Remarks:

- Emission Level = Read Level + Antenna Factor + Cable Loss - Preamp Factor
Margin value = Emission level – Limit value
- 5795 MHz: Fundamental Frequency
- *: Out of Restricted Band

802.11ac (VHT80)

EUT Test Condition		Measurement Detail	
Channel	Channel 42	Frequency Range	1 GHz ~ 40 GHz
Input Power	120 Vac, 60 Hz	Detector Function	Peak (PK) Average (AV)
Environmental Conditions	25 deg. C, 65 % RH	Tested By	Toby Tian

Antenna Polarity & Test Distance: Horizontal at 3 m

Frequency (MHz)	Emission Level (dBuV/m)	Read Level (dBuV)	Limit (dBuV/m)	Margin (dB)	Antenna Factor (dB/m)	Cable Loss (dB)	Preamp Factor (dB)	Antenna Height (cm)	Table Angle (Degree)	Remark
5116	40.71	40.51	54	-13.29	31.29	6.19	37.28	200	308	Average
5116	59.75	59.55	74	-14.25	31.29	6.19	37.28	200	308	Peak
5210	86.4	86.15			31.37	6.24	37.36	200	308	Average
5210	96.58	96.33			31.37	6.24	37.36	200	308	Peak
5418	38.82	38.15	54	-15.18	31.53	6.32	37.18	200	308	Average
5418	60.03	59.36	74	-13.97	31.53	6.32	37.18	200	308	Peak

Antenna Polarity & Test Distance: Vertical at 3 m

Frequency (MHz)	Emission Level (dBuV/m)	Read Level (dBuV)	Limit (dBuV/m)	Margin (dB)	Antenna Factor (dB/m)	Cable Loss (dB)	Preamp Factor (dB)	Antenna Height (cm)	Table Angle (Degree)	Remark
5088	41.44	41.25	54	-12.56	31.27	6.19	37.27	201	338	Average
5088	60.51	60.32	74	-13.49	31.27	6.19	37.27	201	338	Peak
5210	87.77	87.52			31.37	6.24	37.36	201	338	Average
5210	97.66	97.41			31.37	6.24	37.36	201	338	Peak
5428	38.77	38.05	54	-15.23	31.53	6.32	37.13	201	338	Average
5428	60.49	59.77	74	-13.51	31.53	6.32	37.13	201	338	Peak

Remarks:

- Emission Level = Read Level + Antenna Factor + Cable Loss - Preamp Factor
Margin value = Emission level – Limit value
- 5210 MHz: Fundamental Frequency

EUT Test Condition		Measurement Detail	
Channel	Channel 58	Frequency Range	1 GHz ~ 40 GHz
Input Power	120 Vac, 60 Hz	Detector Function	Peak (PK) Average (AV)
Environmental Conditions	25 deg. C, 65 % RH	Tested By	Toby Tian

Antenna Polarity & Test Distance: Horizontal at 3 m										
Frequency (MHz)	Emission Level (dBuV/m)	Read Level (dBuV)	Limit (dBuV/m)	Margin (dB)	Antenna Factor (dB/m)	Cable Loss (dB)	Preamp Factor (dB)	Antenna Height (cm)	Table Angle (Degree)	Remark
5138	39.06	38.85	54	-14.94	31.31	6.2	37.3	203	309	Average
5138	60.08	59.87	74	-13.92	31.31	6.2	37.3	203	309	Peak
5290	89.15	88.68			31.43	6.27	37.23	203	309	Average
5290	98.39	97.92			31.43	6.27	37.23	203	309	Peak
5404	40.93	40.27	54	-13.07	31.52	6.32	37.18	203	309	Average
5404	60.32	59.66	74	-13.68	31.52	6.32	37.18	203	309	Peak

Antenna Polarity & Test Distance: Vertical at 3 m										
Frequency (MHz)	Emission Level (dBuV/m)	Read Level (dBuV)	Limit (dBuV/m)	Margin (dB)	Antenna Factor (dB/m)	Cable Loss (dB)	Preamp Factor (dB)	Antenna Height (cm)	Table Angle (Degree)	Remark
5108	39.15	38.95	54	-14.85	31.29	6.19	37.28	154	307	Average
5108	59.56	59.36	74	-14.44	31.29	6.19	37.28	154	307	Peak
5290	87.88	87.41			31.43	6.27	37.23	154	307	Average
5290	96.98	96.51			31.43	6.27	37.23	154	307	Peak
5446	40.71	39.94	54	-13.29	31.56	6.34	37.13	154	307	Average
5446	60.49	59.72	74	-13.51	31.56	6.34	37.13	154	307	Peak

Remarks:

- Emission Level = Read Level + Antenna Factor + Cable Loss - Preamp Factor
Margin value = Emission level – Limit value
- 5290 MHz: Fundamental Frequency

EUT Test Condition		Measurement Detail	
Channel	Channel 106	Frequency Range	1 GHz ~ 40 GHz
Input Power	120 Vac, 60 Hz	Detector Function	Peak (PK) Average (AV)
Environmental Conditions	25 deg. C, 65 % RH	Tested By	Toby Tian

Antenna Polarity & Test Distance: Horizontal at 3 m										
Frequency (MHz)	Emission Level (dBuV/m)	Read Level (dBuV)	Limit (dBuV/m)	Margin (dB)	Antenna Factor (dB/m)	Cable Loss (dB)	Preamp Factor (dB)	Antenna Height (cm)	Table Angle (Degree)	Remark
5454	42.61	41.79	54	-11.39	31.56	6.34	37.08	100	271	Average
5454	60.34	59.52	74	-13.66	31.56	6.34	37.08	100	271	Peak
5470	61.54	60.71	68.2	-6.66	31.57	6.34	37.08	100	271	Peak
5530	87.98	87.02			31.63	6.42	37.09	100	271	Average
5530	97.27	96.31			31.63	6.42	37.09	100	271	Peak
5725	58.96	57.68	68.2	-9.24	31.96	6.75	37.43	100	271	Peak
Antenna Polarity & Test Distance: Vertical at 3 m										
Frequency (MHz)	Emission Level (dBuV/m)	Read Level (dBuV)	Limit (dBuV/m)	Margin (dB)	Antenna Factor (dB/m)	Cable Loss (dB)	Preamp Factor (dB)	Antenna Height (cm)	Table Angle (Degree)	Remark
5354	40.29	39.7	54	-13.71	31.48	6.29	37.18	126	5	Average
5354	60.61	60.02	74	-13.39	31.48	6.29	37.18	126	5	Peak
5470	60.25	59.42	68.2	-7.95	31.57	6.34	37.08	126	5	Peak
5530	86.03	85.07			31.63	6.42	37.09	126	5	Average
5530	95.74	94.78			31.63	6.42	37.09	126	5	Peak
5725	59.64	58.36	68.2	-8.56	31.96	6.75	37.43	126	5	Peak

Remarks:

- Emission Level = Read Level + Antenna Factor + Cable Loss - Preamp Factor
Margin value = Emission level – Limit value
- 5530 MHz: Fundamental Frequency
- 5470 MHz & 5725 MHz: Out of Restricted Band

EUT Test Condition		Measurement Detail	
Channel	Channel 122	Frequency Range	1 GHz ~ 40 GHz
Input Power	120 Vac, 60 Hz	Detector Function	Peak (PK) Average (AV)
Environmental Conditions	25 deg. C, 65 % RH	Tested By	Toby Tian

Antenna Polarity & Test Distance: Horizontal at 3 m										
Frequency (MHz)	Emission Level (dBuV/m)	Read Level (dBuV)	Limit (dBuV/m)	Margin (dB)	Antenna Factor (dB/m)	Cable Loss (dB)	Preamp Factor (dB)	Antenna Height (cm)	Table Angle (Degree)	Remark
5458	39.89	39.07	54	-14.11	31.56	6.34	37.08	100	263	Average
5458	59.95	59.13	74	-14.05	31.56	6.34	37.08	100	263	Peak
5470	58.91	58.08	68.2	-9.29	31.57	6.34	37.08	100	263	Peak
5610	88.3	87.19			31.77	6.56	37.22	100	263	Average
5610	97.54	96.43			31.77	6.56	37.22	100	263	Peak
5725	59.19	57.91	68.2	-9.01	31.96	6.75	37.43	100	263	Peak
Antenna Polarity & Test Distance: Vertical at 3 m										
Frequency (MHz)	Emission Level (dBuV/m)	Read Level (dBuV)	Limit (dBuV/m)	Margin (dB)	Antenna Factor (dB/m)	Cable Loss (dB)	Preamp Factor (dB)	Antenna Height (cm)	Table Angle (Degree)	Remark
5354	39.02	38.43	54	-14.98	31.48	6.29	37.18	125	28	Average
5354	59.54	58.95	74	-14.46	31.48	6.29	37.18	125	28	Peak
5470	58.07	57.24	68.2	-10.13	31.57	6.34	37.08	125	28	Peak
5610	86.32	85.21			31.77	6.56	37.22	125	28	Average
5610	95.72	94.61			31.77	6.56	37.22	125	28	Peak
5725	60.34	59.06	68.2	-7.86	31.96	6.75	37.43	125	28	Peak

Remarks:

- Emission Level = Read Level + Antenna Factor + Cable Loss - Preamp Factor
Margin value = Emission level – Limit value
- 5610 MHz: Fundamental Frequency
- 5470 MHz & 5725 MHz: Out of Restricted Band

EUT Test Condition		Measurement Detail	
Channel	Channel 155	Frequency Range	1 GHz ~ 40 GHz
Input Power	120 Vac, 60 Hz	Detector Function	Peak (PK) Average (AV)
Environmental Conditions	25 deg. C, 65 % RH	Tested By	Toby Tian

Antenna Polarity & Test Distance: Horizontal at 3 m										
Frequency (MHz)	Emission Level (dBuV/m)	Read Level (dBuV)	Limit (dBuV/m)	Margin (dB)	Antenna Factor (dB/m)	Cable Loss (dB)	Preamp Factor (dB)	Antenna Height (cm)	Table Angle (Degree)	Remark
*5714	62.98	61.79	68.2	-5.22	31.93	6.69	37.43	204	35	Peak
*5725	64.76	63.48	78.2	-13.44	31.96	6.75	37.43	204	35	Peak
5775	89.86	88.5			32.04	6.82	37.5	204	35	Average
5775	98.9	97.54			32.04	6.82	37.5	204	35	Peak
*5850	60.84	59.32	78.2	-17.36	32.15	6.88	37.51	204	35	Peak
*5861	60.77	59.14	68.2	-7.43	32.18	6.95	37.5	204	35	Peak
Antenna Polarity & Test Distance: Vertical at 3 m										
Frequency (MHz)	Emission Level (dBuV/m)	Read Level (dBuV)	Limit (dBuV/m)	Margin (dB)	Antenna Factor (dB/m)	Cable Loss (dB)	Preamp Factor (dB)	Antenna Height (cm)	Table Angle (Degree)	Remark
*5714	61.51	60.32	68.2	-6.69	31.93	6.69	37.43	200	4	Peak
*5725	63.78	62.5	78.2	-14.42	31.96	6.75	37.43	200	4	Peak
5775	88.7	87.34			32.04	6.82	37.5	200	4	Average
5775	97.73	96.37			32.04	6.82	37.5	200	4	Peak
*5850	59.97	58.45	78.2	-18.23	32.15	6.88	37.51	200	4	Peak
*5861	59.99	58.36	68.2	-8.21	32.18	6.95	37.5	200	4	Peak

Remarks:

- Emission Level = Read Level + Antenna Factor + Cable Loss - Preamp Factor
Margin value = Emission level – Limit value
- 5775 MHz: Fundamental Frequency
- *: Out of Restricted Band

9 kHz ~ 30 MHz DATA:

The amplitude of spurious emissions attenuated more than 20 dB below the permissible value is not required to be report.

30 MHz ~ 1 GHz WORST-CASE DATA:

802.11ac (VHT80)

EUT Test Condition		Measurement Detail	
Channel	Channel 42	Frequency Range	30 MHz ~ 1 GHz
Input Power	120 Vac, 60 Hz	Detector Function	Peak (PK) Quasi-peak (QP)
Environmental Conditions	25 deg. C, 65 % RH	Tested By	Toby Tian

Antenna Polarity & Test Distance: Horizontal at 3 m										
Frequency (MHz)	Emission Level (dBuV/m)	Read Level (dBuV)	Limit (dBuV/m)	Margin (dB)	Antenna Factor (dB/m)	Cable Loss (dB)	Preamp Factor (dB)	Antenna Height (cm)	Table Angle (Degree)	Remark
30	31.29	49.87	40	-8.71	11.98	0.58	31.14	120	223	Peak
111.48	28.08	48.64	43.5	-15.42	10.18	1.11	31.85	128	156	Peak
191.02	29.42	49.85	43.5	-14.08	9.98	1.27	31.68	106	244	Peak
279.29	17.27	35.19	46	-28.73	12.34	1.58	31.84	139	337	Peak
446.13	20.51	34.27	46	-25.49	16.25	1.98	31.99	102	15	Peak
560.59	21.9	33.06	46	-24.1	18.7	2.2	32.06	121	332	Peak

Antenna Polarity & Test Distance: Vertical at 3 m										
Frequency (MHz)	Emission Level (dBuV/m)	Read Level (dBuV)	Limit (dBuV/m)	Margin (dB)	Antenna Factor (dB/m)	Cable Loss (dB)	Preamp Factor (dB)	Antenna Height (cm)	Table Angle (Degree)	Remark
30	36.76	55.34	40	-3.24	11.98	0.58	31.14	121	215	Peak
107.6	18.39	39.35	43.5	-25.11	9.81	1.09	31.86	117	96	Peak
159.01	24.83	42.81	43.5	-18.67	12.73	1.14	31.85	114	180	Peak
299.66	17.48	34.75	46	-28.52	12.94	1.63	31.84	120	284	Peak
450.01	19.72	33.38	46	-26.28	16.33	1.99	31.98	102	11	Peak
586.78	22.42	33.01	46	-23.58	19.3	2.24	32.13	103	40	Peak

Remarks:

- Emission Level = Read Level + Antenna Factor + Cable Loss - Preamp Factor
Margin value = Emission level – Limit value

802.11n (HT40)

EUT Test Condition		Measurement Detail	
Channel	Channel 62	Frequency Range	30 MHz ~ 1 GHz
Input Power	120 Vac, 60 Hz	Detector Function	Peak (PK) Quasi-peak (QP)
Environmental Conditions	25 deg. C, 65 % RH	Tested By	Toby Tian

Antenna Polarity & Test Distance: Horizontal at 3 m										
Frequency (MHz)	Emission Level (dBuV/m)	Read Level (dBuV)	Limit (dBuV/m)	Margin (dB)	Antenna Factor (dB/m)	Cable Loss (dB)	Preamp Factor (dB)	Antenna Height (cm)	Table Angle (Degree)	Remark
30	31.74	50.32	40	-8.26	11.98	0.58	31.14	123	129	Peak
112.45	28.41	48.89	43.5	-15.09	10.27	1.11	31.86	102	266	Peak
190.05	29.86	50.22	43.5	-13.64	10.05	1.26	31.67	103	197	Peak
406.36	18.96	33.62	46	-27.04	15.46	1.92	32.04	116	42	Peak
522.76	21.59	33.23	46	-24.41	17.84	2.13	31.61	112	186	Peak
637.22	23.13	32.84	46	-22.87	20.06	2.33	32.1	136	291	Peak

Antenna Polarity & Test Distance: Vertical at 3 m										
Frequency (MHz)	Emission Level (dBuV/m)	Read Level (dBuV)	Limit (dBuV/m)	Margin (dB)	Antenna Factor (dB/m)	Cable Loss (dB)	Preamp Factor (dB)	Antenna Height (cm)	Table Angle (Degree)	Remark
30	36.34	54.92	40	-3.66	11.98	0.58	31.14	122	81	Peak
106.63	19.61	40.69	43.5	-23.89	9.71	1.09	31.88	134	73	Peak
160.95	26.1	44.18	43.5	-17.4	12.63	1.15	31.86	135	210	Peak
289.96	18.8	36.21	46	-27.2	12.65	1.61	31.67	105	284	Peak
503.36	20.1	32.21	46	-25.9	17.4	2.1	31.61	104	70	Peak
637.22	22.9	32.61	46	-23.1	20.06	2.33	32.1	131	142	Peak

Remarks:

- Emission Level = Read Level + Antenna Factor + Cable Loss - Preamp Factor
Margin value = Emission level – Limit value

802.11ac (VHT80)

EUT Test Condition		Measurement Detail	
Channel	Channel 106	Frequency Range	30 MHz ~ 1 GHz
Input Power	120 Vac, 60 Hz	Detector Function	Peak (PK) Quasi-peak (QP)
Environmental Conditions	25 deg. C, 65 % RH	Tested By	Toby Tian

Antenna Polarity & Test Distance: Horizontal at 3 m

Frequency (MHz)	Emission Level (dBuV/m)	Read Level (dBuV)	Limit (dBuV/m)	Margin (dB)	Antenna Factor (dB/m)	Cable Loss (dB)	Preamp Factor (dB)	Antenna Height (cm)	Table Angle (Degree)	Remark
30	30.6	49.18	40	-9.4	11.98	0.58	31.14	131	281	Peak
111.48	27.94	48.5	43.5	-15.56	10.18	1.11	31.85	110	234	Peak
190.05	29.51	49.87	43.5	-13.99	10.05	1.26	31.67	122	281	Peak
280.26	17.8	35.67	46	-28.2	12.37	1.58	31.82	102	140	Peak
488.81	20.52	33.13	46	-25.48	17.1	2.07	31.78	122	284	Peak
568.35	22.5	33.5	46	-23.5	18.88	2.2	32.08	104	144	Peak

Antenna Polarity & Test Distance: Vertical at 3 m

Frequency (MHz)	Emission Level (dBuV/m)	Read Level (dBuV)	Limit (dBuV/m)	Margin (dB)	Antenna Factor (dB/m)	Cable Loss (dB)	Preamp Factor (dB)	Antenna Height (cm)	Table Angle (Degree)	Remark
30	36.97	55.55	40	-3.03	11.98	0.58	31.14	127	136	Peak
106.63	20.99	42.07	43.5	-22.51	9.71	1.09	31.88	111	347	Peak
159.98	27.51	45.51	43.5	-15.99	12.73	1.15	31.88	131	132	Peak
242.43	17.19	36.4	46	-28.81	11.15	1.46	31.82	102	242	Peak
374.35	19.5	34.86	46	-26.5	14.73	1.84	31.93	105	315	Peak
520.82	20.71	32.37	46	-25.29	17.79	2.13	31.58	137	206	Peak

Remarks:

- Emission Level = Read Level + Antenna Factor + Cable Loss - Preamp Factor
Margin value = Emission level – Limit value

802.11ac (VHT80)

EUT Test Condition		Measurement Detail	
Channel	Channel 155	Frequency Range	30 MHz ~ 1 GHz
Input Power	120 Vac, 60 Hz	Detector Function	Peak (PK) Quasi-peak (QP)
Environmental Conditions	25 deg. C, 65 % RH	Tested By	Toby Tian

Antenna Polarity & Test Distance: Horizontal at 3 m

Frequency (MHz)	Emission Level (dBuV/m)	Read Level (dBuV)	Limit (dBuV/m)	Margin (dB)	Antenna Factor (dB/m)	Cable Loss (dB)	Preamp Factor (dB)	Antenna Height (cm)	Table Angle (Degree)	Remark
30	31.11	49.69	40	-8.89	11.98	0.58	31.14	130	271	Peak
56.19	27.61	45.84	40	-12.39	12.35	0.76	31.34	121	152	Peak
111.48	28.9	49.46	43.5	-14.6	10.18	1.11	31.85	120	215	Peak
190.05	29.66	50.02	43.5	-13.84	10.05	1.26	31.67	113	35	Peak
479.11	21.07	33.96	46	-24.93	16.91	2.05	31.85	121	194	Peak
635.28	22.96	32.71	46	-23.04	20.03	2.33	32.11	113	25	Peak

Antenna Polarity & Test Distance: Vertical at 3 m

Frequency (MHz)	Emission Level (dBuV/m)	Read Level (dBuV)	Limit (dBuV/m)	Margin (dB)	Antenna Factor (dB/m)	Cable Loss (dB)	Preamp Factor (dB)	Antenna Height (cm)	Table Angle (Degree)	Remark
30	36.38	54.96	40	-3.62	11.98	0.58	31.14	136	278	Peak
94.02	21.71	44.06	43.5	-21.79	8.6	1.01	31.96	106	311	Peak
160.95	26.45	44.53	43.5	-17.05	12.63	1.15	31.86	117	305	Peak
253.1	17.5	36.34	46	-28.5	11.57	1.5	31.91	120	158	Peak
360.77	18.37	34.14	46	-27.63	14.4	1.8	31.97	100	139	Peak
496.57	20.42	32.76	46	-25.58	17.25	2.08	31.67	108	284	Peak

Remarks:

- Emission Level = Read Level + Antenna Factor + Cable Loss - Preamp Factor
Margin value = Emission level – Limit value

4.2 Conducted Emission Measurement

4.2.1 Limits of Conducted Emission Measurement

Frequency (MHz)	Conducted Limit (dBuV)	
	Quasi-peak	Average
0.15 - 0.5	66 - 56	56 - 46
0.50 - 5.0	56	46
5.0 - 30.0	60	50

Note: 1. The lower limit shall apply at the transition frequencies.

2. The limit decreases in line with the logarithm of the frequency in the range of 0.15 to 0.50 MHz.

4.2.2 Test Instruments

Description & Manufacturer	Model No.	Serial No.	Date Of Calibration	Due Date Of Calibration
Test Receiver ROHDE & SCHWARZ	ESCI	100613	Nov. 16, 2015	Nov. 15, 2016
RF signal cable (with 10dB PAD) Woken	5D-FB	Cable-cond1-01	Dec. 26, 2015	Dec. 25, 2016
LISN ROHDE & SCHWARZ (EUT)	ESH3-Z5	835239/001	Feb. 26, 2016	Feb. 25, 2017
LISN ROHDE & SCHWARZ (Peripheral)	ESH3-Z5	100311	Jul. 24, 2015	Jul. 23, 2016
Software ADT	BV ADT_Cond_ V7.3.7.3	NA	NA	NA

- Note:**
1. The calibration interval of the above test instruments is 12 months and the calibrations are traceable to NML/ROC and NIST/USA.
 2. The test was performed in HwaYa Shielded Room 1.
 3. The VCCI Site Registration No. is C-2040.

4.2.3 Test Procedures

- a. The EUT was placed 0.4 meters from the conducting wall of the shielded room with EUT being connected to the power mains through a line impedance stabilization network (LISN). Other support units were connected to the power mains through another LISN. The two LISNs provide 50 ohm/ 50uH of coupling impedance for the measuring instrument.
- b. Both lines of the power mains connected to the EUT were checked for maximum conducted interference.
- c. The frequency range from 150 kHz to 30 MHz was searched. Emission levels under (Limit -20 dB) was not recorded.

NOTE: All modes of operation were investigated and the worst-case emissions are reported.

4.2.4 Deviation from Test Standard

No deviation.

4.2.5 Test Setup

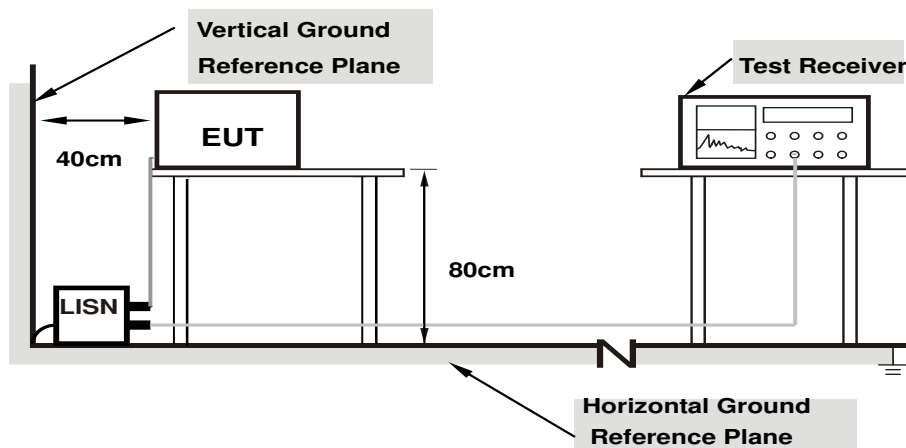

- Note: 1.Support units were connected to second LISN.
2.Both of LISNs (AMN) are 80 cm from EUT and at least 80 from other units and other metal planes**

For the actual test configuration, please refer to the attached file (Test Setup Photo).

4.2.6 EUT Operating Conditions

- a. Placed the EUT on a testing table.
- b. Use the software to control the EUT under transmission condition continuously at specific channel frequency.

4.2.7 Test Results

Frequency Range	150kHz ~ 30MHz	Detector Function & Resolution Bandwidth	Quasi-Peak (QP) / Average (AV), 9kHz
Input Power	120Vac, 60Hz	Environmental Conditions	25°C, 65%RH
Tested by	Toby Tian	Test Date	2016/6/19

Phase Of Power : Line (L)										
No	Frequency (MHz)	Correction Factor (dB)	Reading Value (dBuV)		Emission Level (dBuV)		Limit (dBuV)		Margin (dB)	
			Q.P.	AV.	Q.P.	AV.	Q.P.	AV.	Q.P.	AV.
1	0.36505	10.10	22.90	10.67	33.00	20.77	58.61	48.61	-25.61	-27.84
2	0.57228	10.14	28.49	16.65	38.63	26.79	56.00	46.00	-17.37	-19.21
3	1.15096	10.21	19.03	8.89	29.24	19.10	56.00	46.00	-26.76	-26.90
4	2.48427	10.30	22.88	11.62	33.18	21.92	56.00	46.00	-22.82	-24.08
5	4.34934	10.43	22.63	12.88	33.06	23.31	56.00	46.00	-22.94	-22.69
6	7.15672	10.58	21.69	11.62	32.27	22.20	60.00	50.00	-27.73	-27.80

Remarks:

1. Q.P. and AV. are abbreviations of quasi-peak and average individually.
2. The emission levels of other frequencies were very low against the limit.
3. Margin value = Emission level – Limit value
4. Correction factor = Insertion loss + Cable loss
5. Emission Level = Correction Factor + Reading Value

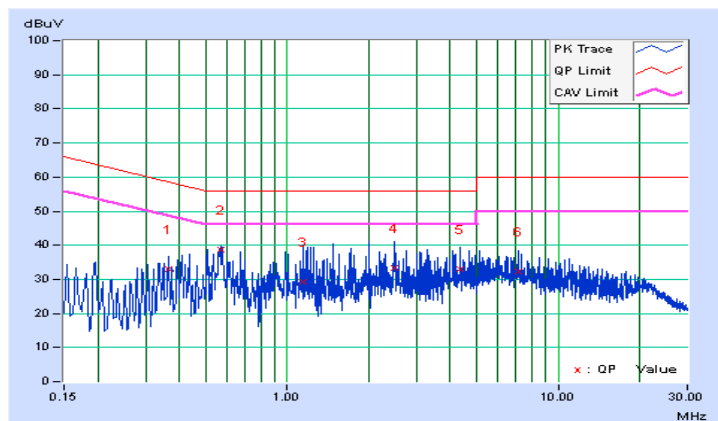

Frequency Range	150kHz ~ 30MHz	Detector Function & Resolution Bandwidth	Quasi-Peak (QP) / Average (AV), 9kHz
Input Power	120Vac, 60Hz	Environmental Conditions	25°C, 65%RH
Tested by	Toby Tian	Test Date	2016/6/19

Phase Of Power : Neutral (N)										
No	Frequency (MHz)	Correction Factor (dB)	Reading Value (dBuV)		Emission Level (dBuV)		Limit (dBuV)		Margin (dB)	
			Q.P.	AV.	Q.P.	AV.	Q.P.	AV.	Q.P.	AV.
1	0.39219	10.13	21.97	14.19	32.10	24.32	58.02	48.02	-25.92	-23.70
2	0.56866	10.15	31.32	21.44	41.47	31.59	56.00	46.00	-14.53	-14.41
3	0.98283	10.21	23.04	15.44	33.25	25.65	56.00	46.00	-22.75	-20.35
4	1.43248	10.24	23.09	17.20	33.33	27.44	56.00	46.00	-22.67	-18.56
5	2.84399	10.34	20.68	14.24	31.02	24.58	56.00	46.00	-24.98	-21.42
6	5.88988	10.55	22.72	16.17	33.27	26.72	60.00	50.00	-26.73	-23.28

Remarks:

1. Q.P. and AV. are abbreviations of quasi-peak and average individually.
2. The emission levels of other frequencies were very low against the limit.
3. Margin value = Emission level – Limit value
4. Correction factor = Insertion loss + Cable loss
5. Emission Level = Correction Factor + Reading Value

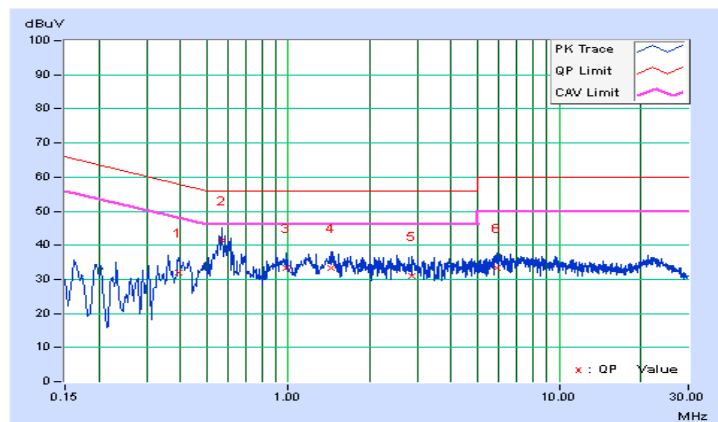

4.3 Transmit Power Measurement

4.3.1 Limits of Transmit Power Measurement

Operation Band	EUT Category	Limit
U-NII-1	Outdoor Access Point	1 Watt (30 dBm) (Max. e.i.r.p \leq 125 mW (21 dBm) at any elevation angle above 30 degrees as measured from the horizon)
	Fixed point-to-point Access Point	1 Watt (30 dBm)
	Indoor Access Point	1 Watt (30 dBm)
	√ Mobile and Portable client device	250 mW (24 dBm)
U-NII-2A	√	250 mW (24 dBm) or 11 dBm+10 log B*
U-NII-2C	√	250 mW (24 dBm) or 11 dBm+10 log B*
U-NII-3	√	1 Watt (30 dBm)

*B is the 26 dB emission bandwidth in megahertz

Per KDB 662911 Method of conducted output power measurement on IEEE 802.11 devices,

Array Gain = 0 dB (i.e., no array gain) for $N_{ANT} \leq 4$;

Array Gain = 0 dB (i.e., no array gain) for channel widths ≥ 40 MHz for any N_{ANT} ;

Array Gain = $5 \log(N_{ANT}/N_{SS})$ dB or 3 dB, whichever is less for 20 MHz channel widths with $N_{ANT} \geq 5$.

For power measurements on all other devices: Array Gain = $10 \log(N_{ANT}/N_{SS})$ dB.

4.3.2 Test Setup

<Power Output Measurement>

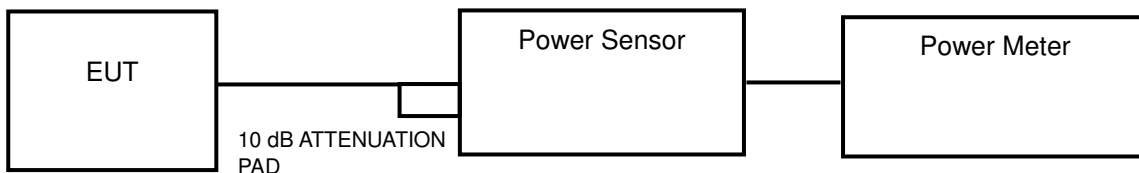

or



<26 dB Bandwidth>

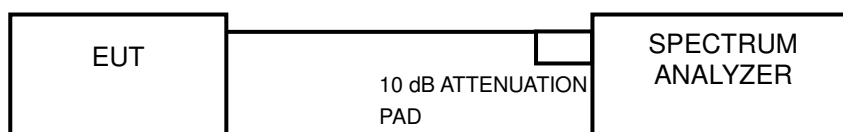

4.3.3 Test Instruments

Refer to section 4.1.2 to get information of above instrument.

4.3.4 Test Procedure

Average Power Measurement

<802.11a, 802.11n (HT20), 802.11n (HT40)>

Method PM is used to perform output power measurement, trigger and gating function of wide band power meter is enabled to measure max output power of TX on burst. Duty factor is not added to measured value.

<802.11ac (VHT80)>

Method SA-1 is used to perform output power measurement, trigger and gating function of spectrum analyzer is enabled to measure max output power of TX on burst. Duty factor is not added to measured value.

26 dB Bandwidth

- 1) Set RBW = approximately 1 % of the emission bandwidth.
- 2) Set the VBW > RBW.
- 3) Detector = Peak.
- 4) Trace mode = max hold.
- 5) Measure the maximum width of the emission that is 26 dB down from the peak of the emission. Compare this with the RBW setting of the analyzer. Readjust RBW and repeat measurement as needed until the RBW/EBW ratio is approximately 1 %.

4.3.5 Deviation from Test Standard

No deviation.

4.3.6 EUT Operating Conditions

The software provided by client to enable the EUT under transmission condition continuously at lowest, middle and highest channel frequencies individually.

4.3.7 Test Result

Power Output:

<1TX>

802.11a

Channel	Frequency (MHz)	Maximum Conducted Power (mW)	Maximum Conducted Power (dBm)	Power Limit (dBm)	Pass / Fail
36	5180	40.27	16.05	24	Pass
44	5220	41.02	16.13	24	Pass
48	5240	40.55	16.08	24	Pass
52	5260	40.93	16.12	23.83	Pass
60	5300	41.40	16.17	23.82	Pass
64	5320	40.64	16.09	23.83	Pass
100	5500	40.93	16.12	23.82	Pass
116	5580	40.55	16.08	23.81	Pass
140	5700	40.18	16.04	23.85	Pass
149	5745	40.83	16.11	30	Pass
157	5785	41.21	16.15	30	Pass
165	5825	41.40	16.17	30	Pass

Note:

For U-NII-2A, U-NII-2C Band:

1. $11 \text{ dBm} + 10\log(19.18) = 23.83 \text{ dBm} < 24 \text{ dBm}$.
2. $11 \text{ dBm} + 10\log(19.13) = 23.82 \text{ dBm} < 24 \text{ dBm}$.
3. $11 \text{ dBm} + 10\log(19.17) = 23.83 \text{ dBm} < 24 \text{ dBm}$.
4. $11 \text{ dBm} + 10\log(19.13) = 23.82 \text{ dBm} < 24 \text{ dBm}$.
5. $11 \text{ dBm} + 10\log(19.12) = 23.81 \text{ dBm} < 24 \text{ dBm}$.
6. $11 \text{ dBm} + 10\log(19.28) = 23.85 \text{ dBm} < 24 \text{ dBm}$.

<2TX>

802.11n (HT20)

Channel	Frequency (MHz)	Maximum Conducted Power (dBm)		Total Power (mW)	Total Power (dBm)	Power Limit (dBm)	Pass / Fail
		Chain 0	Chain 1				
36	5180	11.61	14.21	40.85	16.11	24	Pass
44	5220	11.96	14.25	42.31	16.26	24	Pass
48	5240	11.92	14.08	41.15	16.14	24	Pass
52	5260	11.93	14.17	41.72	16.20	24	Pass
60	5300	12.31	14.11	42.78	16.31	24	Pass
64	5320	12.26	14.01	42.00	16.23	24	Pass
100	5500	12.18	13.89	41.01	16.13	24	Pass
116	5580	12.33	13.86	41.42	16.17	24	Pass
140	5700	12.59	13.76	41.92	16.22	24	Pass
149	5745	12.58	13.78	41.99	16.23	30	Pass
157	5785	12.65	13.59	41.26	16.16	30	Pass
165	5825	12.66	13.69	41.84	16.22	30	Pass

Note:

For U-NII-2A, U-NII-2C Band:

Chain 0

1. $11 \text{ dBm} + 10\log(20.39) = 24.09 \text{ dBm} > 24 \text{ dBm}$.
2. $11 \text{ dBm} + 10\log(20.41) = 24.10 \text{ dBm} > 24 \text{ dBm}$.
3. $11 \text{ dBm} + 10\log(20.29) = 24.07 \text{ dBm} > 24 \text{ dBm}$.
4. $11 \text{ dBm} + 10\log(20.42) = 24.10 \text{ dBm} > 24 \text{ dBm}$.
5. $11 \text{ dBm} + 10\log(20.42) = 24.10 \text{ dBm} > 24 \text{ dBm}$.
6. $11 \text{ dBm} + 10\log(20.71) = 24.16 \text{ dBm} > 24 \text{ dBm}$.

Chain 1

1. $11 \text{ dBm} + 10\log(20.31) = 24.08 \text{ dBm} > 24 \text{ dBm}$.
2. $11 \text{ dBm} + 10\log(20.24) = 24.06 \text{ dBm} > 24 \text{ dBm}$.
3. $11 \text{ dBm} + 10\log(20.25) = 24.06 \text{ dBm} > 24 \text{ dBm}$.
4. $11 \text{ dBm} + 10\log(20.41) = 24.10 \text{ dBm} > 24 \text{ dBm}$.
5. $11 \text{ dBm} + 10\log(20.46) = 24.11 \text{ dBm} > 24 \text{ dBm}$.
6. $11 \text{ dBm} + 10\log(20.40) = 24.10 \text{ dBm} > 24 \text{ dBm}$.

802.11n (HT40)

Channel	Frequency (MHz)	Maximum Conducted Power (dBm)		Total Power (mW)	Total Power (dBm)	Power Limit (dBm)	Pass / Fail
		Chain 0	Chain 1				
38	5190	11.37	13.86	38.03	15.80	24	Pass
46	5230	11.55	13.98	39.29	15.94	24	Pass
54	5270	11.64	13.81	38.63	15.87	24	Pass
62	5310	11.97	13.81	39.78	16.00	24	Pass
102	5510	11.87	13.58	38.18	15.82	24	Pass
110	5550	12.25	13.75	40.50	16.07	24	Pass
134	5670	12.15	13.31	37.83	15.78	24	Pass
151	5755	12.44	13.71	41.04	16.13	30	Pass
159	5795	12.19	13.33	38.09	15.81	30	Pass

Note:

For U-NII-2A, U-NII-2C Band:

Chain 0

1. $11 \text{ dBm} + 10\log(41.53) = 27.18 \text{ dBm} > 24 \text{ dBm}$.
2. $11 \text{ dBm} + 10\log(41.81) = 27.21 \text{ dBm} > 24 \text{ dBm}$.
3. $11 \text{ dBm} + 10\log(41.82) = 27.21 \text{ dBm} > 24 \text{ dBm}$.
4. $11 \text{ dBm} + 10\log(41.86) = 27.22 \text{ dBm} > 24 \text{ dBm}$.
5. $11 \text{ dBm} + 10\log(41.80) = 27.21 \text{ dBm} > 24 \text{ dBm}$.

Chain 1

1. $11 \text{ dBm} + 10\log(42.17) = 27.25 \text{ dBm} > 24 \text{ dBm}$.
2. $11 \text{ dBm} + 10\log(41.91) = 27.22 \text{ dBm} > 24 \text{ dBm}$.
3. $11 \text{ dBm} + 10\log(41.89) = 27.22 \text{ dBm} > 24 \text{ dBm}$.
4. $11 \text{ dBm} + 10\log(42.22) = 27.26 \text{ dBm} > 24 \text{ dBm}$.
5. $11 \text{ dBm} + 10\log(41.99) = 27.23 \text{ dBm} > 24 \text{ dBm}$.

802.11ac (VHT80)

Channel	Frequency (MHz)	Maximum Conducted Power (dBm)		Total Power (mW)	Total Power (dBm)	Power Limit (dBm)	Pass / Fail
		Chain 0	Chain 1				
42	5210	12.66	13.36	40.13	16.03	24	Pass
58	5290	12.67	13.49	40.83	16.11	24	Pass
106	5530	12.57	13.41	40.00	16.02	24	Pass
122	5610	12.51	13.40	39.70	15.99	24	Pass
155	5775	12.79	13.42	40.99	16.13	30	Pass

Note:

For U-NII-2A, U-NII-2C Band:

Chain 0

1. 11 dBm + 10log (83.28) = 30.21 dBm > 24 dBm.
2. 11 dBm + 10log (83.82) = 30.23 dBm > 24 dBm.
3. 11 dBm + 10log (83.58) = 30.22 dBm > 24 dBm.

Chain 1

1. 11 dBm + 10log (82.47) = 30.16 dBm > 24 dBm.
2. 11 dBm + 10log (83.18) = 30.20 dBm > 24 dBm.
3. 11 dBm + 10log (82.88) = 30.18 dBm > 24 dBm.

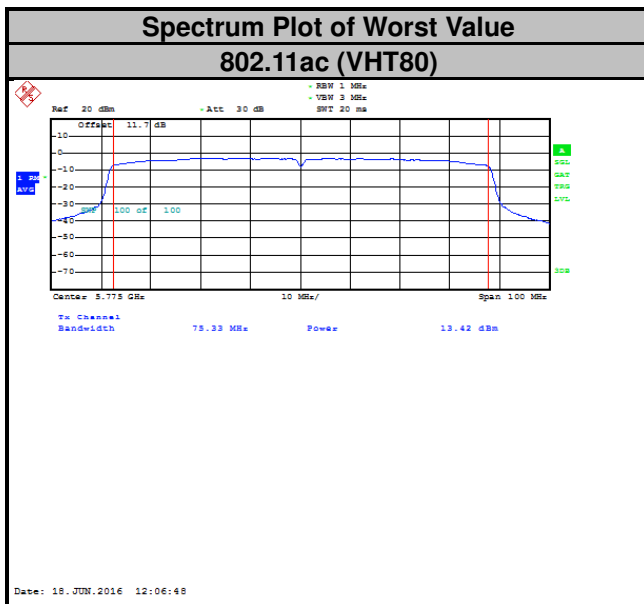

26 dB Bandwidth:

<1TX>

802.11a

Channel	Frequency (MHz)	26 dBc Bandwidth (MHz)
36	5180	19.12
44	5220	19.13
48	5240	19.13
52	5260	19.18
60	5300	19.13
64	5320	19.17
100	5500	19.13
116	5580	19.12
140	5700	19.28

<2TX>

802.11n (HT20)

Channel	Frequency (MHz)	26 dBc Bandwidth (MHz)	
		Chain 0	Chain 1
36	5180	20.36	20.14
44	5220	20.39	20.30
48	5240	20.33	20.24
52	5260	20.39	20.31
60	5300	20.41	20.24
64	5320	20.29	20.25
100	5500	20.42	20.41
116	5580	20.42	20.46
140	5700	20.71	20.40

802.11n (HT40)

Channel	Frequency (MHz)	26 dBc Bandwidth (MHz)	
		Chain 0	Chain 1
38	5190	41.80	41.84
46	5230	41.63	42.16
54	5270	41.53	42.17
62	5310	41.81	41.91
102	5510	41.82	41.89
110	5550	41.86	42.22
134	5670	41.80	41.99

802.11ac (VHT80)

Channel	Frequency (MHz)	26 dBc Bandwidth (MHz)	
		Chain 0	Chain 1
42	5210	83.13	83.12
58	5290	83.28	82.47
106	5530	83.82	83.18
122	5610	83.58	82.88

Spectrum Plot of Worst Value

802.11a

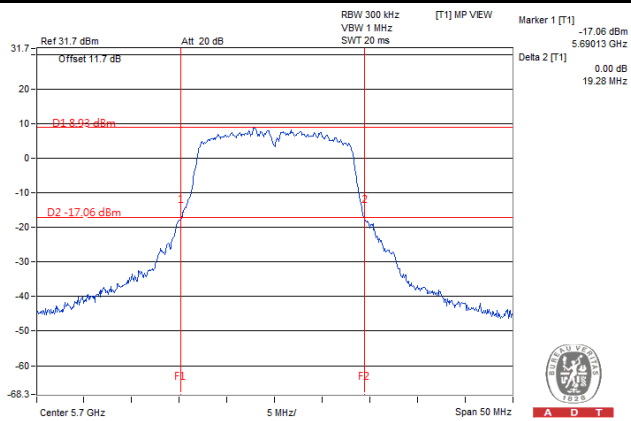

802.11n (HT20)

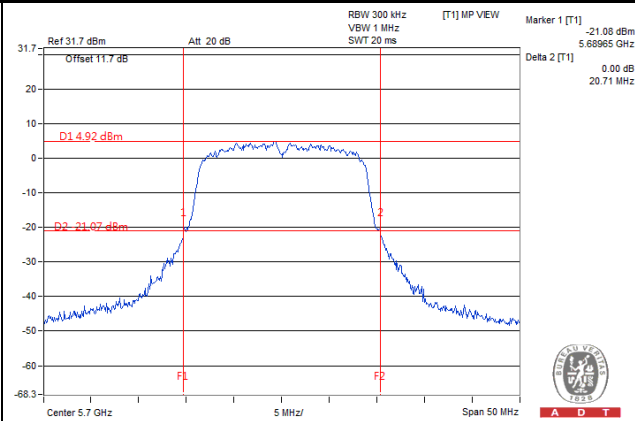

802.11n (HT40)

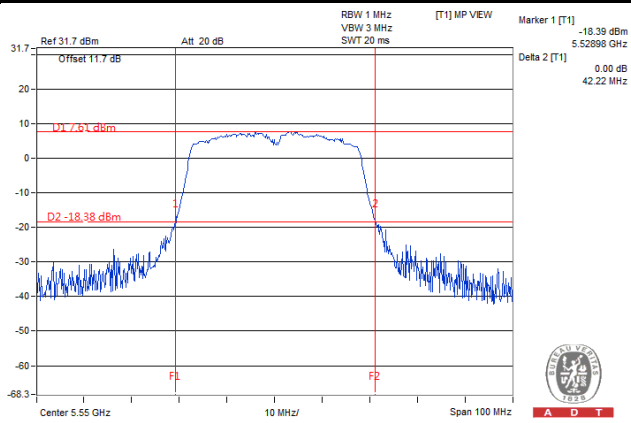

802.11ac (VHT80)

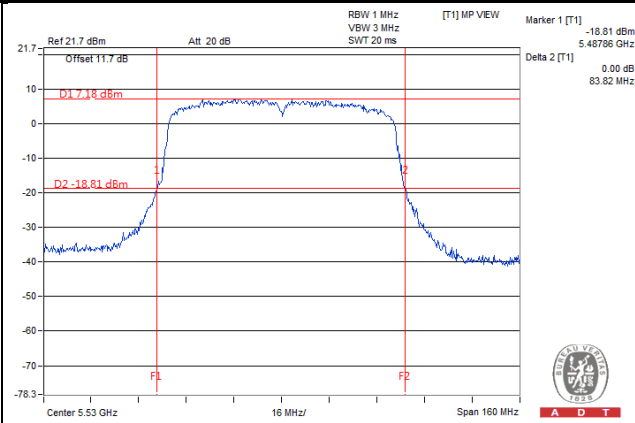

4.4 Peak Power Spectral Density Measurement

4.4.1 Limits of Peak Power Spectral Density Measurement

Operation Band	EUT Category		Limit
U-NII-1		Outdoor Access Point	17 dBm/MHz
		Fixed point-to-point Access Point	
		Indoor Access Point	
	√	Mobile and Portable client device	11 dBm/MHz
U-NII-2A		√	11 dBm/MHz
U-NII-2C		√	11 dBm/MHz
U-NII-3		√	30 dBm/500 kHz

4.4.2 Test Setup

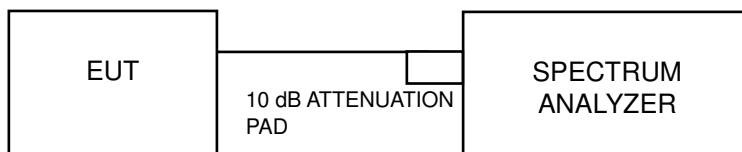

4.4.3 Test Instruments

Refer to section 4.1.3 to get information of above instrument.

4.4.4 Test Procedures

For U-NII-1, U-NII-2A, U-NII-2C band:

Using method SA-2

1. Set span to encompass the entire emission bandwidth (EBW) of the signal.
2. Set RBW = 1 MHz, Set VBW \geq 3 RBW, Detector = RMS
3. Sweep time = auto, trigger set to "free run".
4. Trace average at least 100 traces in power averaging mode.
5. Record the max value and add 10 log (1/duty cycle)

※For U-NII-3:

1. Set span to encompass the entire emission bandwidth (EBW) of the signal.
2. Set RBW = 500 kHz, Set VBW \geq 3 RBW, Detector = RMS
3. Use the peak marker function to determine the maximum power level in any 500 kHz band segment within the fundamental EBW.
4. Sweep time = auto, trigger set to "free run".
5. Trace average at least 100 traces in power averaging mode.
6. Record the max value and add 10 log (1/duty cycle)

4.4.5 Deviation from Test Standard

No deviation.

4.4.6 EUT Operating Conditions

The software provided by client to enable the EUT under transmission condition continuously at lowest, middle and highest channel frequencies individually.

4.4.7 Test Results

<1TX>

802.11a

Channel	Frequency (MHz)	PSD w/o Duty Factor (dBm)	Duty Factor	PSD with Duty Factor (dBm)	Maximum Limit (dBm)	Pass / Fail
36	5180	6.07	0.24	6.31	11	Pass
44	5220	6.19	0.24	6.43	11	Pass
48	5240	5.71	0.24	5.95	11	Pass
52	5260	6.24	0.24	6.48	11	Pass
60	5300	6.77	0.24	7.01	11	Pass
64	5320	6.36	0.24	6.60	11	Pass
100	5500	6.91	0.24	7.15	11	Pass
116	5580	6.37	0.24	6.61	11	Pass
140	5700	4.65	0.24	4.89	11	Pass

Note: Refer to section 3.3 for duty cycle spectrum plot.

<2TX>

802.11n (HT20)

Channel	Frequency (MHz)	PSD (dBm)		Total PSD w/o Duty Factor (dBm)	Duty Factor	Total PSD with Duty Factor (dBm)	Maximum Limit (dBm)	Pass / Fail
		Chain 0	Chain 1					
36	5180	1.46	0.29	3.92	0.25	4.17	11	Pass
44	5220	1.44	0.54	4.02	0.25	4.27	11	Pass
48	5240	1.58	0.55	4.11	0.25	4.35	11	Pass
52	5260	2.05	0.76	4.46	0.25	4.71	11	Pass
60	5300	2.72	1.25	5.06	0.25	5.30	11	Pass
64	5320	2.96	1.34	5.24	0.25	5.48	11	Pass
100	5500	2.77	1.28	5.10	0.25	5.35	11	Pass
116	5580	2.80	1.19	5.08	0.25	5.33	11	Pass
140	5700	1.51	0.34	3.97	0.25	4.22	11	Pass

Note:

1. Method 1 of power density measurement of KDB 662911 is using for calculating total power density. Total power density is summing entire spectra across corresponding frequency bins on the various outputs by computer.

2. For U-NII-1 Band:

Directional gain = $10 \log[(10^{G1/20} + 10^{G2/20} + \dots + 10^{GN/20})^2 / N_{ANT}] = -0.262 \text{ dBi} < 6 \text{ dBi}$, so the limit no need to reduced.

For U-NII-2A, U-NII-2C Band:

Directional gain = $10 \log[(10^{G1/20} + 10^{G2/20} + \dots + 10^{GN/20})^2 / N_{ANT}] = -0.262 \text{ dBi} < 6 \text{ dBi}$, so the limit no need to reduced.

3. Refer to section 3.3 for duty cycle spectrum plot.

802.11n (HT40)

Channel	Frequency (MHz)	PSD (dBm)		Total PSD w/o Duty Factor (dBm)	Duty Factor	Total PSD with Duty Factor (dBm)	Maximum Limit (dBm)	Pass / Fail
		Chain 0	Chain 1					
38	5190	-1.19	-2.51	1.21	0.60	1.81	11	Pass
46	5230	-1.19	-2.30	1.30	0.60	1.90	11	Pass
54	5270	-0.58	-1.94	1.80	0.60	2.40	11	Pass
62	5310	0.07	-1.45	2.39	0.60	2.99	11	Pass
102	5510	0.12	-1.26	2.49	0.60	3.09	11	Pass
110	5550	0.12	-1.51	2.39	0.60	2.99	11	Pass
134	5670	-0.63	-2.17	1.68	0.60	2.28	11	Pass

Note:

- Method 1 of power density measurement of KDB 662911 is using for calculating total power density. Total power density is summing entire spectra across corresponding frequency bins on the various outputs by computer.
- For U-NII-1 Band:**
Directional gain = $10 \log[(10^{G1/20} + 10^{G2/20} + \dots + 10^{GN/20})^2 / N_{ANT}] = -0.262 \text{ dBi} < 6 \text{ dBi}$, so the limit no need to reduced.
- For U-NII-2A, U-NII-2C Band:**
Directional gain = $10 \log[(10^{G1/20} + 10^{G2/20} + \dots + 10^{GN/20})^2 / N_{ANT}] = -0.262 \text{ dBi} < 6 \text{ dBi}$, so the limit no need to reduced.
- Refer to section 3.3 for duty cycle spectrum plot.

802.11ac (VHT80)

Channel	Frequency (MHz)	PSD (dBm)		Total PSD w/o Duty Factor (dBm)	Duty Factor	Total PSD with Duty Factor (dBm)	Maximum Limit (dBm)	Pass / Fail
		Chain 0	Chain 1					
42	5210	-5.24	-6.15	-2.66	1.13	-1.53	11	Pass
58	5290	-3.79	-5.13	-1.40	1.13	-0.27	11	Pass
106	5530	-3.44	-4.96	-1.12	1.13	0.00	11	Pass
122	5610	-3.63	-5.57	-1.48	1.13	-0.36	11	Pass

Note:

- Method 1 of power density measurement of KDB 662911 is using for calculating total power density. Total power density is summing entire spectra across corresponding frequency bins on the various outputs by computer.
- For U-NII-1 Band:**
Directional gain = $10 \log[(10^{G1/20} + 10^{G2/20} + \dots + 10^{GN/20})^2 / N_{ANT}] = -0.262 \text{ dBi} < 6 \text{ dBi}$, so the limit no need to reduced.
- For U-NII-2A, U-NII-2C Band:**
Directional gain = $10 \log[(10^{G1/20} + 10^{G2/20} + \dots + 10^{GN/20})^2 / N_{ANT}] = -0.262 \text{ dBi} < 6 \text{ dBi}$, so the limit no need to reduced.
- Refer to section 3.3 for duty cycle spectrum plot.

Spectrum Plot of Worst Value

802.11a

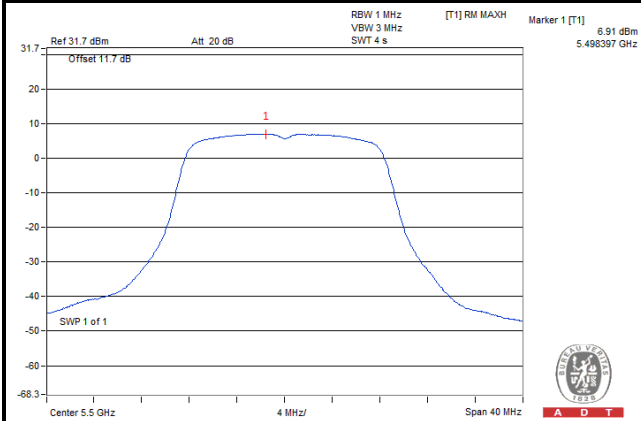

802.11n (HT20)

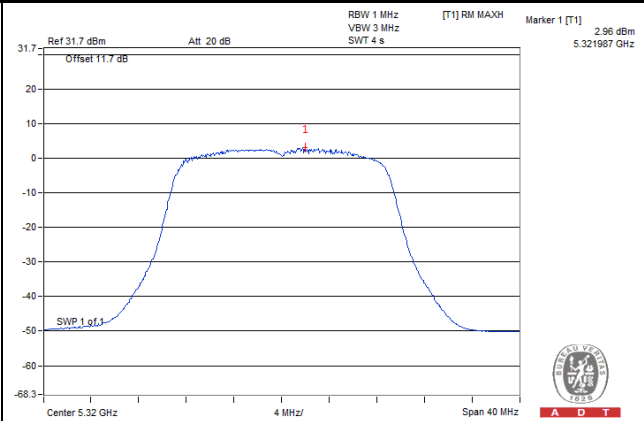

802.11n (HT40)

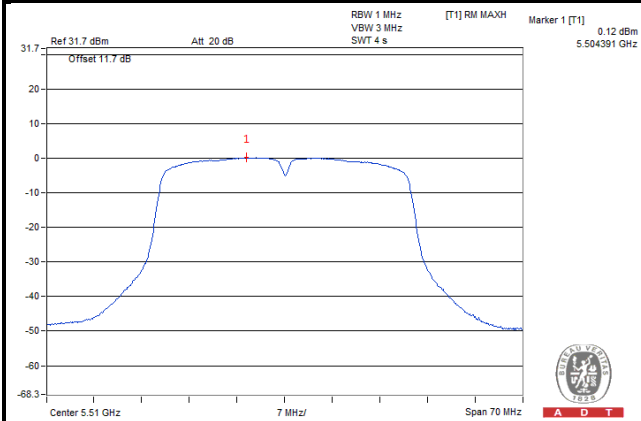

802.11ac (VHT80)

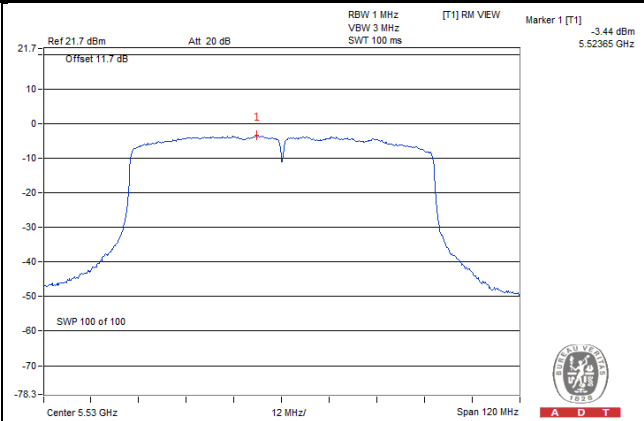

For U-NII-3 Band

<1TX>

802.11a

Channel	Frequency (MHz)	PSD w/o Duty Factor (dBm)	Duty Factor	PSD with Duty Factor (dBm)	Limit (dBm/500 kHz)	Pass / Fail
149	5745	1.19	0.24	1.43	30	Pass
157	5785	1.46	0.24	1.70	30	Pass
165	5825	1.93	0.24	2.17	30	Pass

Note: Refer to section 3.3 for duty cycle spectrum plot.

<2TX>

802.11n (HT20)

TX Chain	Channel	Frequency (MHz)	PSD (dBm/500 kHz)	10 log (N=2) dB	Total PSD without Duty Factor (dBm/500 kHz)	Duty Factor	Total PSD with Duty Factor (dBm/500 kHz)	Limit (dBm/500 kHz)	Pass / Fail
0	149	5745	-2.94	3.01	0.07	0.25	0.32	30	Pass
	157	5785	-2.42	3.01	0.59	0.25	0.84	30	Pass
	165	5825	-2.00	3.01	1.01	0.25	1.26	30	Pass
1	149	5745	-3.31	3.01	-0.30	0.25	-0.05	30	Pass
	157	5785	-3.08	3.01	-0.07	0.25	0.18	30	Pass
	165	5825	-2.59	3.01	0.42	0.25	0.67	30	Pass

Note:

- Method 1 of power density measurement of KDB 662911 is using for calculating total power density. Total power density is summing entire spectra across corresponding frequency bins on the various outputs by computer.
- Directional gain = $10 \log[(10^{G1/20} + 10^{G2/20} + \dots + 10^{GN/20})^2 / N_{ANT}] = -0.262 \text{ dBi} < 6 \text{ dBi}$, so the limit no need to reduced.
- Refer to section 3.3 for duty cycle spectrum plot.

802.11n (HT40)

TX Chain	Channel	Frequency (MHz)	PSD (dBm/500 kHz)	10 log (N=2) dB	Total PSD without Duty Factor (dBm/500 kHz)	Duty Factor	Total PSD with Duty Factor (dBm/500 kHz)	Limit (dBm/500 kHz)	Pass / Fail
0	151	5755	-6.01	3.01	-3.00	0.60	-2.40	30	Pass
	159	5795	-5.35	3.01	-2.34	0.60	-1.74	30	Pass
1	151	5755	-6.58	3.01	-3.57	0.60	-2.97	30	Pass
	159	5795	-5.90	3.01	-2.89	0.60	-2.29	30	Pass

Note:

- Method 1 of power density measurement of KDB 662911 is using for calculating total power density. Total power density is summing entire spectra across corresponding frequency bins on the various outputs by computer.
- Directional gain = $10 \log[(10^{G1/20} + 10^{G2/20} + \dots + 10^{GN/20})^2 / N_{ANT}] = -0.262 \text{ dBi} < 6 \text{ dBi}$, so the limit no need to reduced.
- Refer to section 3.3 for duty cycle spectrum plot.

802.11ac (VHT80)

TX Chain	Channel	Frequency (MHz)	PSD (dBm/500 kHz)	10 log (N=2) dB	Total PSD without Duty Factor (dBm/500 kHz)	Duty Factor	Total PSD with Duty Factor (dBm/500 kHz)	Limit (dBm/500 kHz)	Pass / Fail
0	155	5775	-7.87	3.01	-4.86	1.13	-3.73	30	Pass
1	155	5775	-8.35	3.01	-5.34	1.13	-4.21	30	Pass

Note:

- Method 1 of power density measurement of KDB 662911 is using for calculating total power density. Total power density is summing entire spectra across corresponding frequency bins on the various outputs by computer.
- Directional gain = $10 \log[(10^{G1/20} + 10^{G2/20} + \dots + 10^{GN/20})^2 / N_{ANT}] = -0.262 \text{ dBi} < 6 \text{ dBi}$, so the limit no need to reduced.
- Refer to section 3.3 for duty cycle spectrum plot.

Spectrum Plot of Worst Value

802.11a

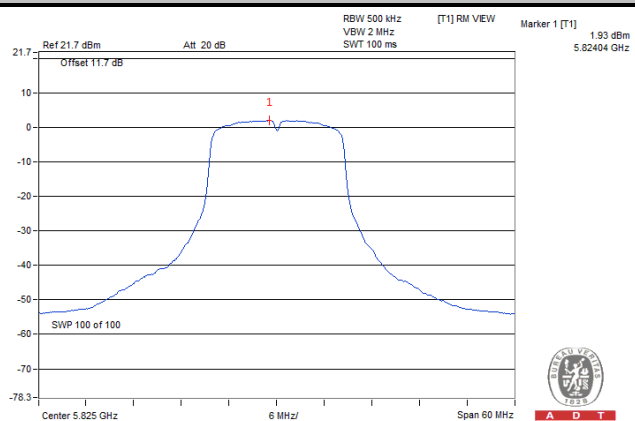

802.11n (HT20)

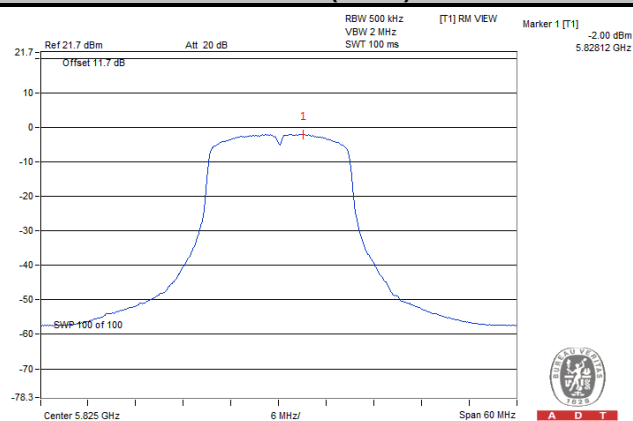

802.11n (HT40)

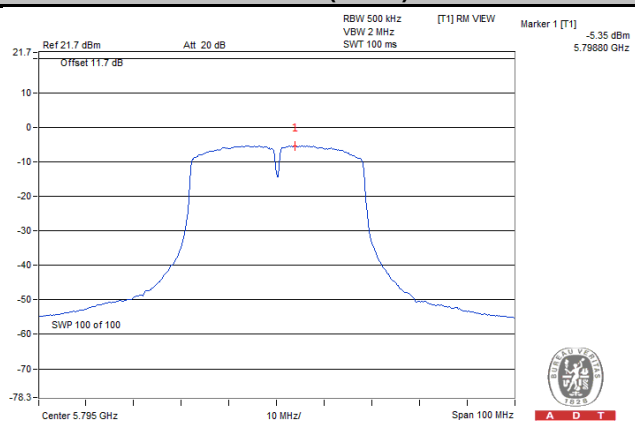

802.11ac (VHT80)

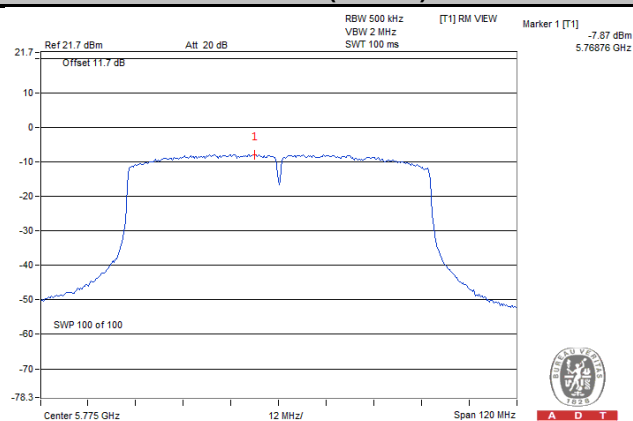

4.5 Frequency Stability

4.5.1 Limit of Frequency Stability Measurement

The frequency of the carrier signal shall be maintained within band of operation.

4.5.2 Test Setup

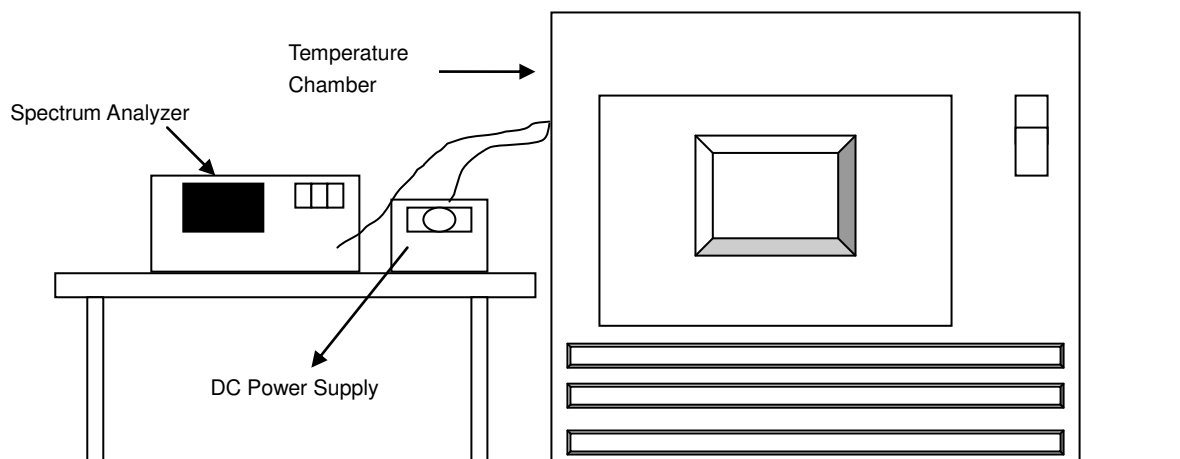

4.5.3 Test Instruments

Refer to section 4.1.3 to get information of above instrument.

4.5.4 Test Procedure

- To ensure emission at the band edge is maintained within the authorized band, those values shall be measured by radiation emissions at upper and lower frequency points, and finally compensated by frequency deviation as procedures below.
- The EUT was operated at the maximum output power, and connected to the spectrum analyzer, which is set to maximum hold function and peak detector. The peak value of the power envelope was measured and noted. The upper and lower frequency points were respectively measured relatively 10 dB lower than the measured peak value.
- The frequency deviation was calculated by adding the upper frequency point and the lower frequency point divided by two. Those detailed values of frequency deviation are provided in table below.

4.5.5 Deviation from Test Standard

No deviation.

4.5.6 EUT Operating Condition

Set the EUT transmit at un-modulation mode to test frequency stability.

4.5.7 Test Results

Frequency Stability Versus Temp.									
Operating Frequency: 5320 MHz									
Temp. (°C)	Power Supply (Vdc)	0 Minute		2 Minute		5 Minute		10 Minute	
		Measured Frequency (MHz)	Frequency Drift (ppm)	Measured Frequency (MHz)	Frequency Drift (ppm)	Measured Frequency (MHz)	Frequency Drift (ppm)	Measured Frequency (MHz)	Frequency Drift (ppm)
55	3.85	5320.016297	3.063	5320.016549	3.111	5320.016663	3.132	5320.016147	3.035
50	3.85	5320.016718	3.142	5320.016960	3.188	5320.016997	3.195	5320.016916	3.180
40	3.85	5320.016958	3.188	5320.016809	3.160	5320.016999	3.195	5320.017280	3.248
30	3.85	5320.017968	3.377	5320.018281	3.436	5320.017920	3.368	5320.017989	3.381
20	3.85	5320.019350	3.637	5320.018975	3.567	5320.019367	3.640	5320.019345	3.636
10	3.85	5320.020795	3.909	5320.020622	3.876	5320.020750	3.900	5320.020891	3.927
0	3.85	5320.019432	3.653	5320.019039	3.579	5320.019244	3.617	5320.019011	3.573
-10	3.85	5320.017432	3.277	5320.017682	3.324	5320.018040	3.391	5320.017693	3.326
-20	3.85	5320.016796	3.157	5320.017074	3.209	5320.017540	3.297	5320.017485	3.287
-30	3.85	5320.015899	2.989	5320.016110	3.028	5320.015848	2.979	5320.016217	3.048

Frequency Stability Versus Temp.									
Operating Frequency: 5320 MHz									
Temp. (°C)	Power Supply (Vdc)	0 Minute		2 Minute		5 Minute		10 Minute	
		Measured Frequency (MHz)	Frequency Drift (ppm)	Measured Frequency (MHz)	Frequency Drift (ppm)	Measured Frequency (MHz)	Frequency Drift (ppm)	Measured Frequency (MHz)	Frequency Drift (ppm)
20	3.6	5320.015995	3.007	5320.015810	2.972	5320.015589	2.930	5320.015585	2.930
	3.85	5320.019350	3.637	5320.018975	3.567	5320.019367	3.640	5320.019345	3.636
	4.4	5320.017830	3.352	5320.017560	3.301	5320.017583	3.305	5320.017352	3.262

4.6 6 dB Bandwidth Measurement

4.6.1 Limits of 6 dB Bandwidth Measurement

The minimum of 6 dB Bandwidth Measurement is 0.5 MHz.

4.6.2 Test Setup

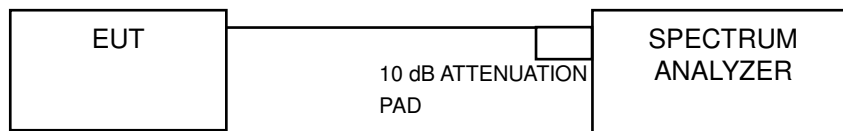

4.6.3 Test Instruments

Refer to section 4.1.3 to get information of above instrument.

4.6.4 Test Procedure

MEASUREMENT PROCEDURE REF

- Set resolution bandwidth (RBW) = 100 kHz
- Set the video bandwidth (VBW) $\geq 3 \times$ RBW, Detector = Peak.
- Trace mode = max hold.
- Sweep = auto couple.
- Measure the maximum width of the emission that is constrained by the frequencies associated with the two amplitude points (upper and lower) that are attenuated by 6 dB relative to the maximum level measured in the fundamental emission

4.6.5 Deviation from Test Standard

No deviation.

4.6.6 EUT Operating Condition

The software provided by client to enable the EUT under transmission condition continuously at lowest, middle and highest channel frequencies individually.

4.6.7 Test Results

<1TX>

802.11a

Channel	Frequency (MHz)	6 dB Bandwidth (MHz)	Minimum Limit (MHz)	Pass / Fail
149	5745	15.36	0.5	Pass
157	5785	15.17	0.5	Pass
165	5825	15.15	0.5	Pass

<2TX>

802.11n (HT20)

Channel	Frequency (MHz)	6 dB Bandwidth (MHz)		Minimum Limit (MHz)	Pass / Fail
		Chain 0	Chain 1		
149	5745	15.16	15.16	0.5	Pass
157	5785	15.11	15.13	0.5	Pass
165	5825	15.11	15.07	0.5	Pass

802.11n (HT40)

Channel	Frequency (MHz)	6 dB Bandwidth (MHz)		Minimum Limit (MHz)	Pass / Fail
		Chain 0	Chain 1		
151	5755	35.19	35.15	0.5	Pass
159	5795	33.97	35.18	0.5	Pass

802.11ac (VHT80)

Channel	Frequency (MHz)	6 dB Bandwidth (MHz)		Minimum Limit (MHz)	Pass / Fail
		Chain 0	Chain 1		
155	5775	75.27	75.33	0.5	Pass

Spectrum Plot of Worst Value

802.11a

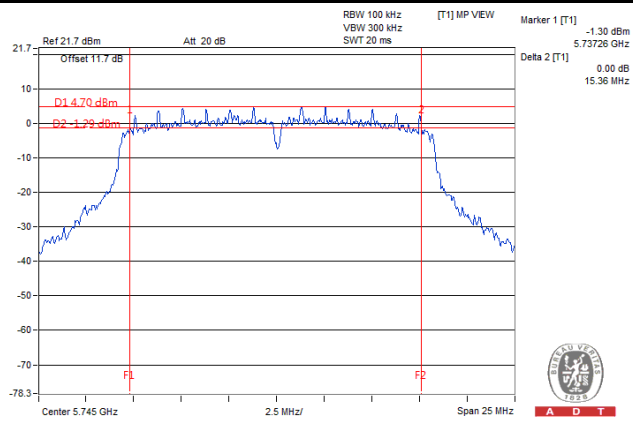

802.11n (HT20)

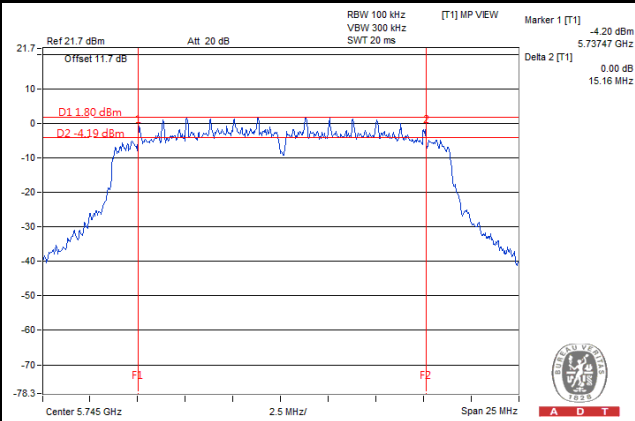

802.11n (HT40)

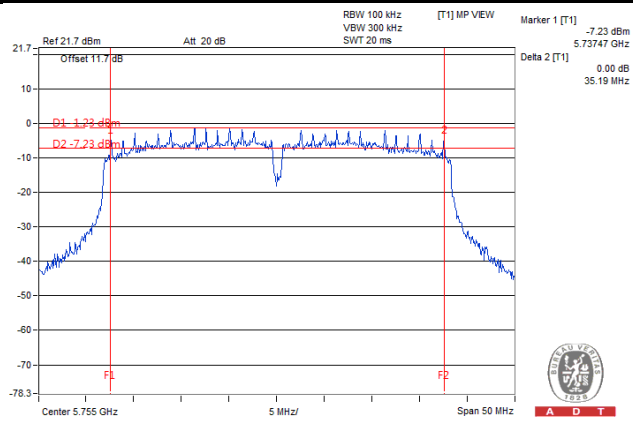

802.11ac (VHT80)

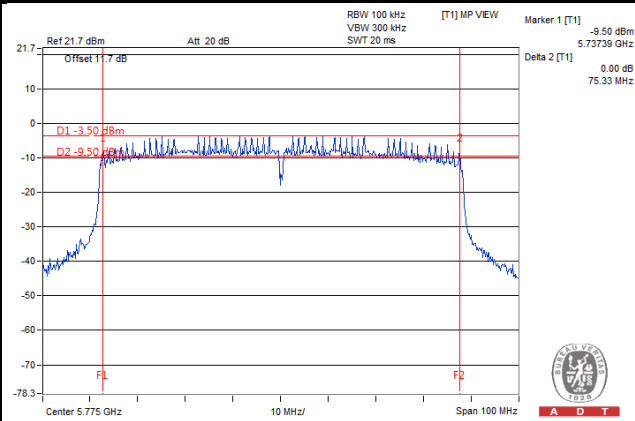

5 Pictures of Test Arrangements

Please refer to the attached file (Test Setup Photo).

Appendix – Information on the Testing Laboratories

We, Bureau Veritas Consumer Products Services (H.K.) Ltd., Taoyuan Branch, were founded in 1988 to provide our best service in EMC, Radio, Telecom and Safety consultation. Our laboratories are accredited and approved according to ISO/IEC 17025.

If you have any comments, please feel free to contact us at the following:

Linko EMC/RF Lab

Tel: 886-2-26052180

Fax: 886-2-26051924

Hsin Chu EMC/RF/Telecom Lab

Tel: 886-3-6668565

Fax: 886-3-6668323

Hwa Ya EMC/RF/Safety

Tel: 886-3-3183232

Fax: 886-3-3270892

Email: service.adt@tw.bureauveritas.com

Web Site: www.bureauveritas-adt.com

The address and road map of all our labs can be found in our web site also.

--- END ---