



FCC Test Report

According to

47 CFR Part 15 Subpart C

Equipment : PDA Phone
Model No. : DIAM110
FCC ID : NM8DM
Filing Type : Certification
Applicant : High Tech Computer Corp.
23 Xinghua Rd., Taoyuan 330, Taiwan

- The test result refers exclusively to the test presented test model / sample.
- Without written approval of SPORTON International Inc., the test report shall not be reproduced except in full.
- **Certificate or Test Report must not be used by the applicant to claim the product in this test report endorsement by NVLAP or any agency of U.S. government.**
- The data shown in this test report were carried out during Apr. 25, 2008 at **Sporton International Inc. LAB.**
- Report No.: FR832620B, Report Version: Rev.01

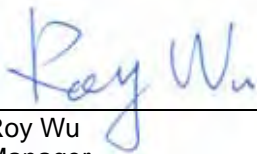

Roy Wu
Manager

SPORTON International Inc.

No. 52, Hwa Ya 1st Rd., Hwa Ya Technology Park, Kwei-Shan Hsiang, Tao Yuan Hsien, Taiwan, R.O.C.

SPORTON International Inc.

TEL : 886-3-327-3456

FAX : 886-3-328-4978

Report Version: Rev.01

Table of Contents

History of this test report ii

1. General Description of Equipment under Test1

 1.1 Applicant.....1

 1.2 Manufacturer1

 1.3 Basic Description of Equipment under Test.....1

 1.4 Feature of Equipment under Test.....1

2. Test Configuration of Equipment under Test2

 2.1 Test Manner2

 2.2 Test Mode3

 2.3 Ancillary Equipment List3

 2.4 Connection Diagram of Test System4

3. RF Utility5

4. General Information of Test6

 4.1 Test Voltage6

 4.2 Standard for Methods of Measurement6

 4.3 Test Compliance.....6

 4.4 Frequency Range6

 4.5 Test Distance.....6

5. Test Data and Test Result7

 5.1 List of Measurements and Examinations.....7

 5.2 6dB Bandwidth Measurement8

 5.3 Power Spectral Density Measurement16

 5.4 Band Edges Measurement24

 5.5 Peak Output Power Measurement.....31

 5.6 Conducted Emission.....33

 5.7 Radiated Emission Measurement.....54

 5.8 Antenna Requirements.....80

6. List of Measuring Equipments81

7. Uncertainty Evaluation82

Appendix A – Photographs of EUT

Appendix B – Setup Photographs



History of this test report

Report Issue Date: May 30, 2008

Report No.	Description

1. General Description of Equipment under Test

1.1 Applicant

High Tech Computer Corp.
23 Xinghua Rd., Taoyuan 330, Taiwan

1.2 Manufacturer

High Tech Computer Corp.
23 Xinghua Rd., Taoyuan 330, Taiwan

1.3 Basic Description of Equipment under Test

Sample A	PDA Phone with LCD Panel 1 + Photo Camera 1 + Video Camera 1
Sample B	PDA Phone with LCD Panel 2 + Photo Camera 2 + Video Camera 2
Sample C	PDA Phone with LCD Panel 1 + Photo Camera 1
Sample D	PDA Phone with LCD Panel 2 + Photo Camera 2

1.4 Feature of Equipment under Test

Product Feature & Specification			
DUT Type :	PDA Phone		
Model Name :	DIAM110		
FCC ID :	NM8DM		
Tx Frequency :	2400 MHz ~ 2483.5 MHz		
Rx Frequency :	2400 MHz ~ 2483.5 MHz		
Number of Channels :	11		
Carrier Frequency of Each Channel :	2412+(n-1)*5 MHz; n=1~11		
Channel Spacing :	5 MHz		
Maximum Output Power to Antenna :	802.11b : 18.24 dBm 802.11g : 21.76 dBm		
Antenna Type :	PIFA Antenna		
Type of Modulation :	DSSS / OFDM		
Function Type :	Transmitter		Transceiver V
DUT Stage :	Identical Prototype		

2. Test Configuration of Equipment under Test

2.1 Test Manner

- a. The EUT has been associated with peripherals pursuant to ANSI C63.4-2003 and configuration operated in a manner tended to maximize its emission characteristics in a typical application.
- b. Power Table as below:

802.11b

Channel	Frequency (MHz)	Data Rate (dBm)			
		1 Mbps	2 Mbps	5.5 Mbps	11 Mbps
CH 01	2412 MHz	18.07	18.06	18.09	18.04
CH 06	2437 MHz	18.20	18.14	18.23	18.21
CH 11	2462 MHz	18.24	18.18	18.23	18.22

802.11g

Channel	Frequency (MHz)	Data Rate (dBm)							
		6 Mbps	9 Mbps	12 Mbps	18 Mbps	24 Mbps	36 Mbps	48 Mbps	54 Mbps
CH 01	2412 MHz	21.67	21.40	20.56	20.55	19.82	19.41	18.51	17.92
CH 06	2437 MHz	21.76	21.56	20.86	20.87	19.97	19.71	18.62	18.20
CH 11	2462 MHz	21.75	21.31	20.86	20.74	19.68	19.47	18.10	17.84

The 802.11b data rate were set in 1Mbps and 802.11g set in 6Mbps, due to the highest RF output power for all testing cases.

- c. The EUT is programmed to transmit signal continuously for all testings.
- d. Frequency range investigated: conduction 150 kHz to 30 MHz, radiation 30 MHz to 25000MHz.

2.2 Test Mode

Application	Test Mode	
Radiated Emission / RF Conducted	802.11b	802.11g
	Mode 1 : CH01_2412 MHz	Mode 4: CH01_2412 MHz
	Mode 2: CH06_2437 MHz	Mode 5: CH06_2437 MHz
	Mode 3: CH11_2462 MHz	Mode 6: CH11_2462 MHz
Conducted Emission	Mode 1 : GSM1900 Idle + BT Link + WLAN Link + GPS Rx + Battery 1 + Camera 1 + Adapter 1 for Sample A	
	Mode 2 : GSM1900 Idle + BT Link + WLAN Link + GPS Rx + Battery 2 + Camera 1 + Adapter 2 for Sample A	
	Mode 3 : GSM1900 Idle + BT Link + WLAN Link + GPS Rx + Battery 3 + Camera 1 + Adapter 3 + USB Cable 1 for Sample A	
	Mode 4 : GSM1900 Idle + BT Link + WLAN Link + GPS Rx + Battery 4 + Camera 1 + Adapter 3 + USB Cable 2 for Sample A	
	Mode 5 : EDGE Idle + BT Link + WLAN Link + GPS Rx + Battery 5 + Camera 2 + USB Cable 1 Link with NB for Sample A	
	Mode 6 : WCDMA Idle + BT Link + WLAN Link + GPS Rx + Battery 5 + MPEG 4 + USB Cable 2 Link with NB for Sample A	
	Mode 7 : GSM1900 Idle + BT Link + WLAN Link + GPS Rx + Battery 2 + Camera 1 + Adapter 2 for Sample B	
	Mode 8 : GSM1900 Idle + BT Link + WLAN Link + GPS Rx + Battery 2 + Camera 1 + Adapter 2 for Sample C	
	Mode 9 : GSM1900 Idle + BT Link + WLAN Link + GPS Rx + Battery 2 + Camera 1 + Adapter 2 for Sample D	
	Mode 10 : GSM1900 Idle + BT Link + WLAN Link + GPS Rx + Battery 6 + Camera 1 + Adapter 2 for Sample B	

2.3 Ancillary Equipment List

Item	Equipment	Trade Name	Model Name	FCC ID	Data Cable	Power Cord
1.	GSM Base Station	R&S	CMU 200	N/A	N/A	Unshielded, 1.8 m
2.	GPS Station	T&E	GS-50	N/A	N/A	Unshielded, 1.8 m
3.	WLAN AP	SMC	SMC-100	HEDWG4005ACC	N/A	Unshielded, 1.8 m
4.	Notebook	DELL	D400	E2K24GBRL	N/A	AC I/P: Unshielded, 1.2 m DC O/P: Shielded, 1.8 m
5.	Bluetooth Earphone	Engotech	ET-BH111	PQY471087	N/A	N/A
6.	RS-232 Mouse	State	MS-303	DoC	Unshielded, 1.2 m	N/A
7.	i-pod	Apple	A1199	N/A	Shielded, 1.2 m	N/A

2.4 Connection Diagram of Test System

<Conducted Emission>

EUT with Adapter Mode

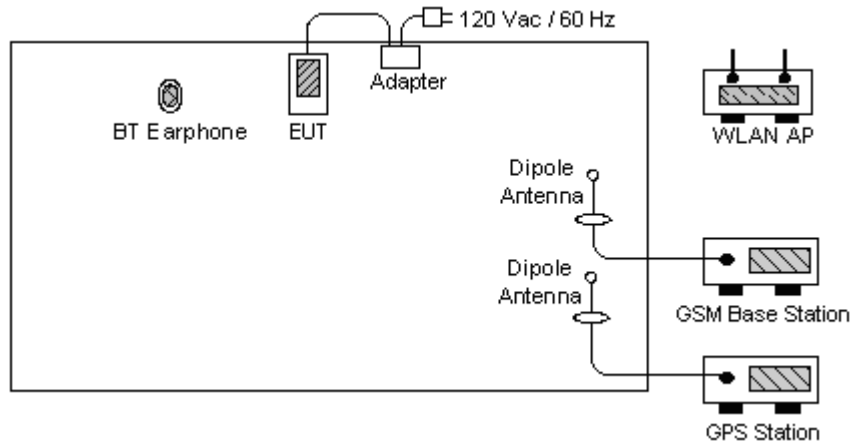

EUT with USB Link Mode

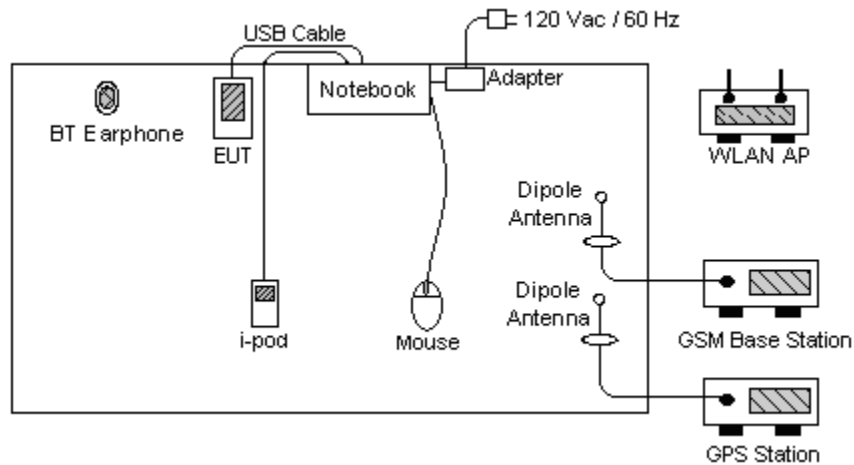

<Radiated Emission >

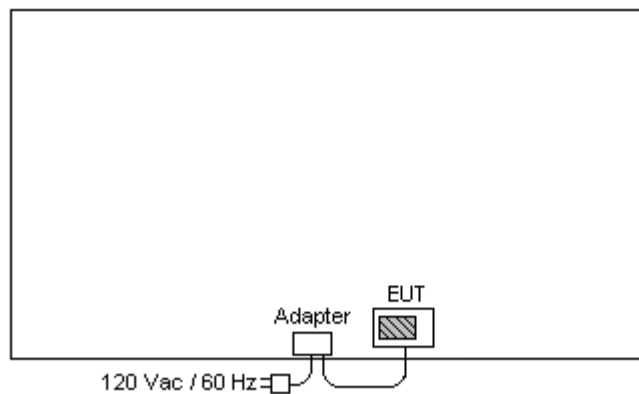

3. RF Utility

The programmed RF Utility is installed in EUT to provide channel selection, power level, data rate and the application type. RF Utility can send transmitting signal for all testings.

4. General Information of Test

Test Site Location : No. 52, Hwa Ya 1st Rd., Hwa Ya Technology Park,
Kwei-Shan Hsiang, Tao Yuan Hsien, Taiwan, R.O.C.
TEL : 886-3-327-3456
FAX : 886-3-328-4978

Test Site No : CO04-HY, 03CH06-HY
FCC Designation No : TW1022

4.1 Test Voltage

AC 120V / 60Hz

4.2 Standard for Methods of Measurement

ANSI C63.4-2003

4.3 Test Compliance

47 CFR Part 15 Subpart C

4.4 Frequency Range

- a. Conduction: from 150 kHz to 30 MHz
- b. Radiation: from 30 MHz to 25000 MHz

4.5 Test Distance

The test distance of radiated emission from antenna to EUT is 3 m.

5. Test Data and Test Result

5.1 List of Measurements and Examinations

The Emission Mode: Wireless LAN

FCC Rule	Description of Test	Result
15.207	Conducted Emission	Pass
15.247(a)(2)	6dB Bandwidth	Pass
15.247(b)(1)	Maximum Peak Output Power	Pass
15.209(a) 15.247(d)	Radiated Emission	Pass
15.247(d)	100 KHz Bandwidth of Frequency Band Edges	Pass
15.247(e)	Power Spectral Density	Pass
15.203 15.247(b)(4)	Antenna Requirement	Pass

5.2 6dB Bandwidth Measurement

5.2.1 Measuring Instruments

As described in chapter 6 of this test report.

5.2.2 Test Procedure

1. The transmitter output was connected to the spectrum analyzer directly.
2. Set RBW of spectrum analyzer to 100kHz and VBW to 100kHz.
3. The 6 dB bandwidth is defined as the frequency range where the power is higher than the peak power minus 6dB.

5.2.3 Test Setup Layout

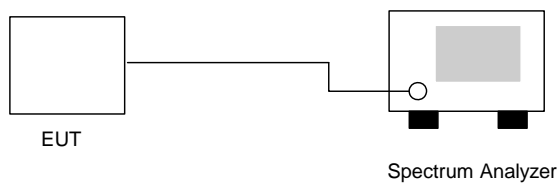

5.2.4 Test Result

- Application Type : WLAN 802.11b/g
- Temperature : 23~25
- Relative Humidity : 43~45%
- Test Enginner : Darren

▪ **802.11b**

Channel	Frequency (MHz)	6dB Emission bandwidth (MHz)	Limits (MHz)	Plot Ref. No.
01	2412	10.08	> 0.5	Mode 1
06	2437	10.08	> 0.5	Mode 2
11	2462	10.08	> 0.5	Mode 3

▪ **802.11g**

Channel	Frequency (MHz)	6dB Emission bandwidth (MHz)	Limits (MHz)	Plot Ref. No.
01	2412	16.36	> 0.5	Mode 4
06	2437	16.36	> 0.5	Mode 5
11	2462	16.36	> 0.5	Mode 6

5.2.5 6dB Bandwidth

Mode 1

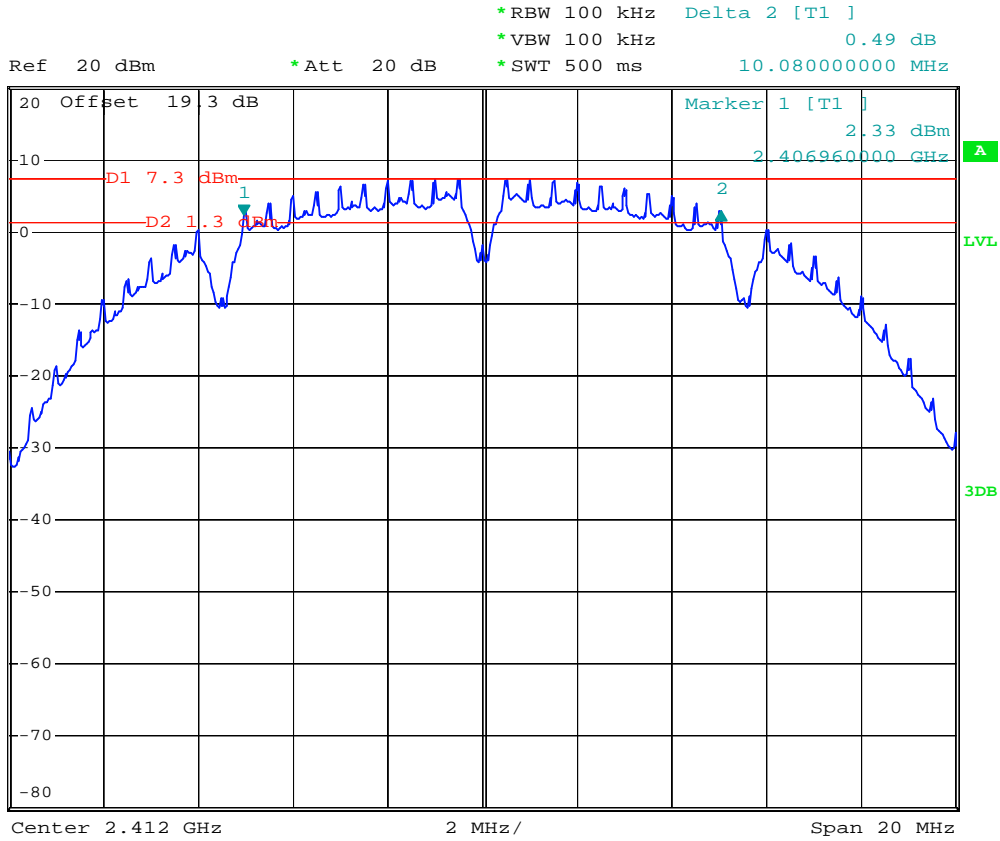

Date: 14.APR.2008 03:34:12

Mode 2

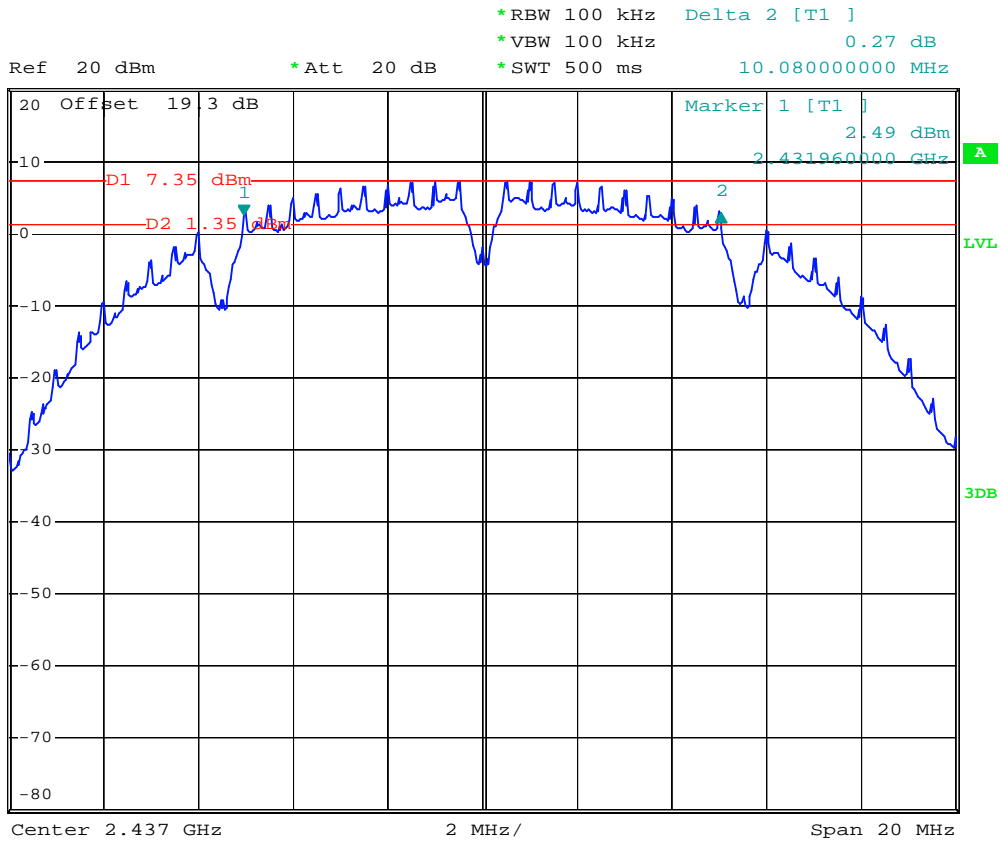

Date: 14.APR.2008 03:34:47

Mode 3



Ref 20 dBm *Att 20 dB *RBW 100 kHz Delta 2 [T1]
 *VBW 100 kHz 0.64 dB
 *SWT 500 ms 10.080000000 MHz

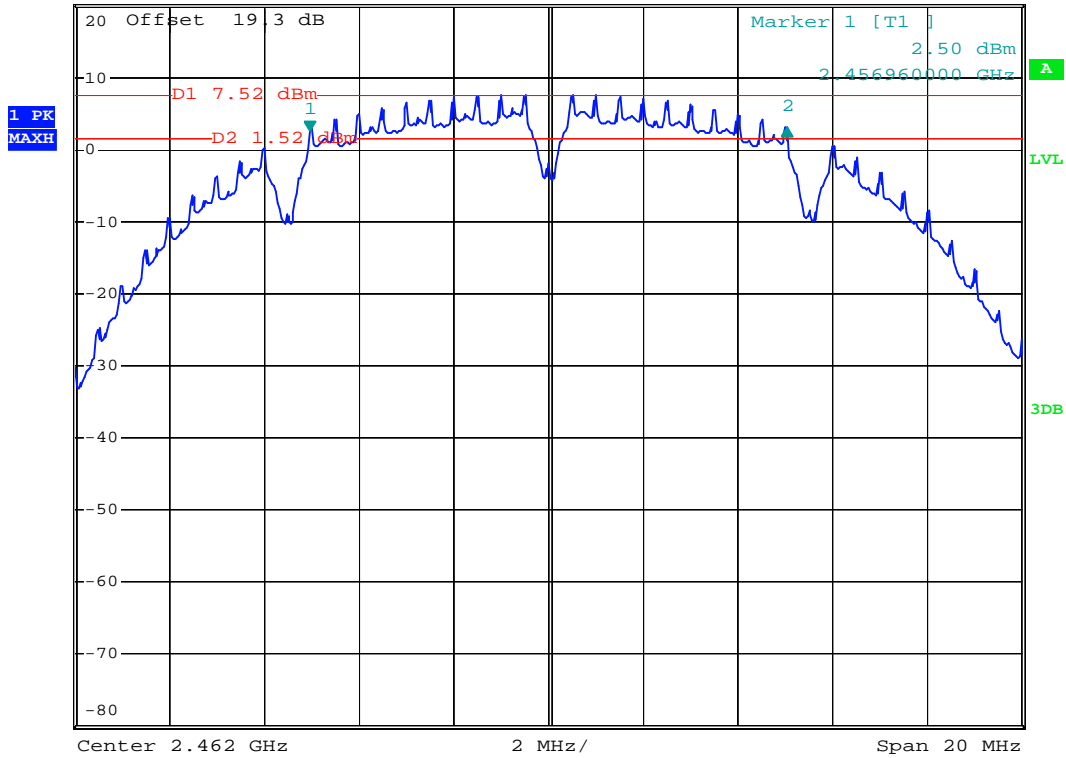

Date: 14.APR.2008 03:35:29

Mode 4



Ref 20 dBm *Att 20 dB *RBW 100 kHz Delta 2 [T1]
 *VBW 100 kHz -1.10 dB
 *SWT 500 ms 16.360000000 MHz

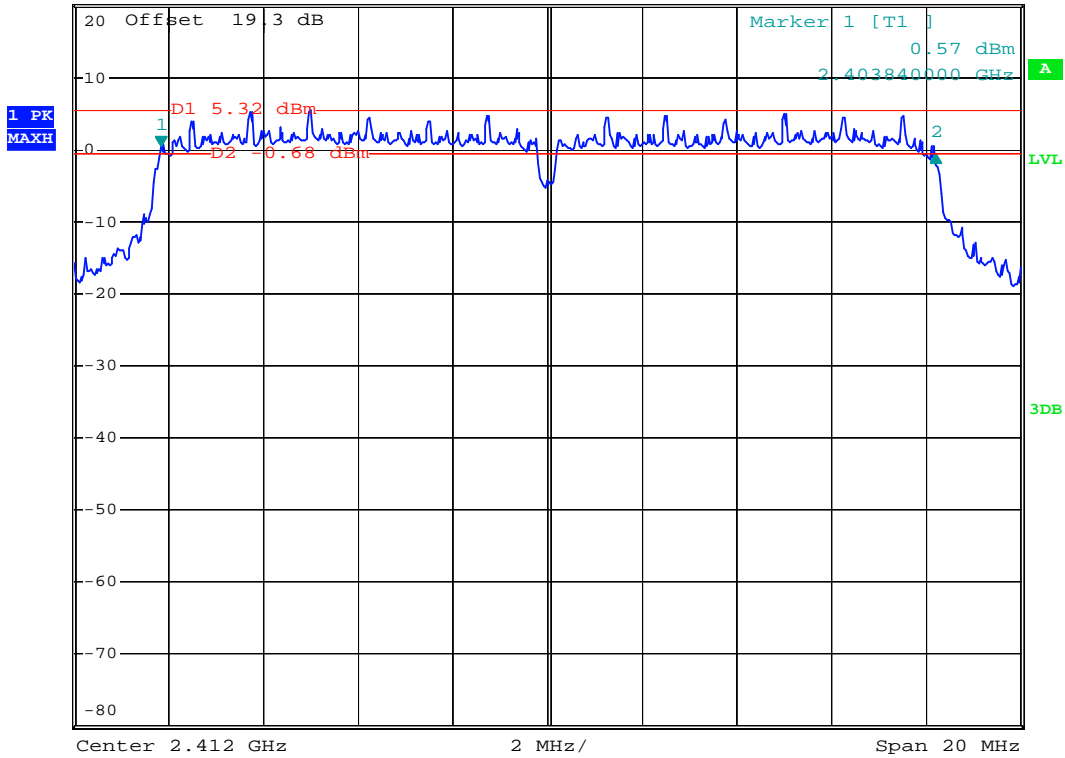

Date: 14.APR.2008 03:46:25

Mode 5



Ref 20 dBm *Att 20 dB *RBW 100 kHz Delta 2 [T1]
 *VBW 100 kHz -0.56 dB
 *SWT 500 ms 16.360000000 MHz

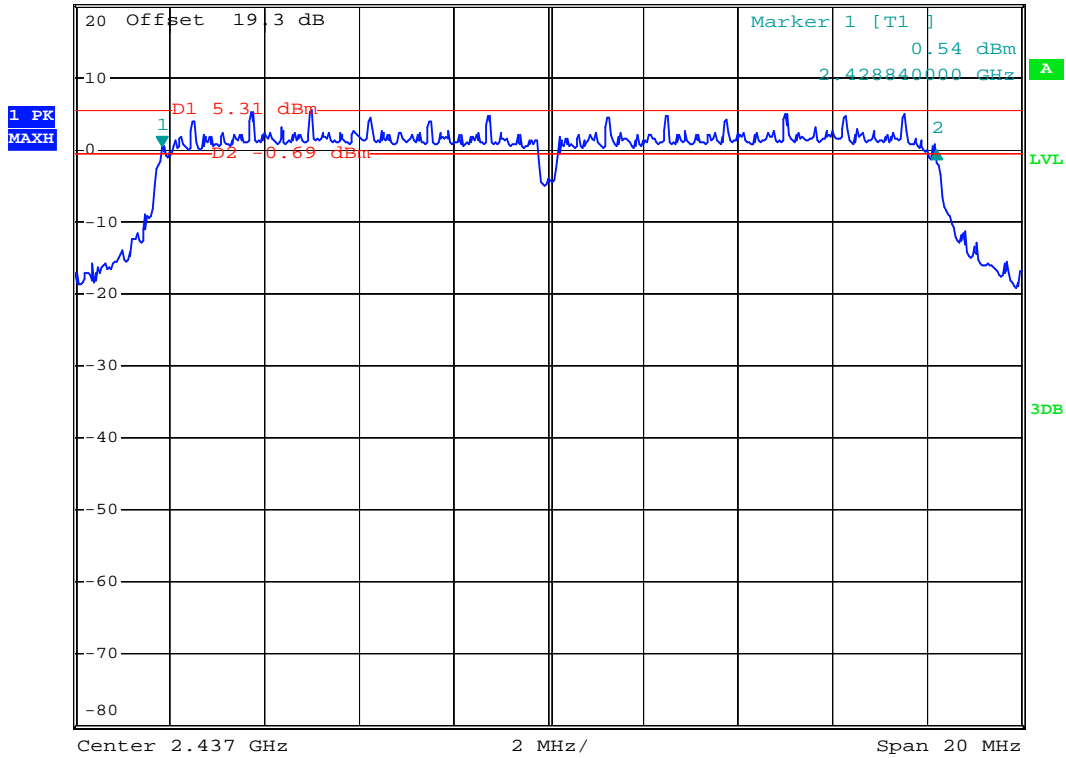

Date: 14.APR.2008 03:45:30

Mode 6



Ref 20 dBm *Att 20 dB *RBW 100 kHz Delta 2 [T1]
 *VBW 100 kHz -0.64 dB
 *SWT 500 ms 16.360000000 MHz

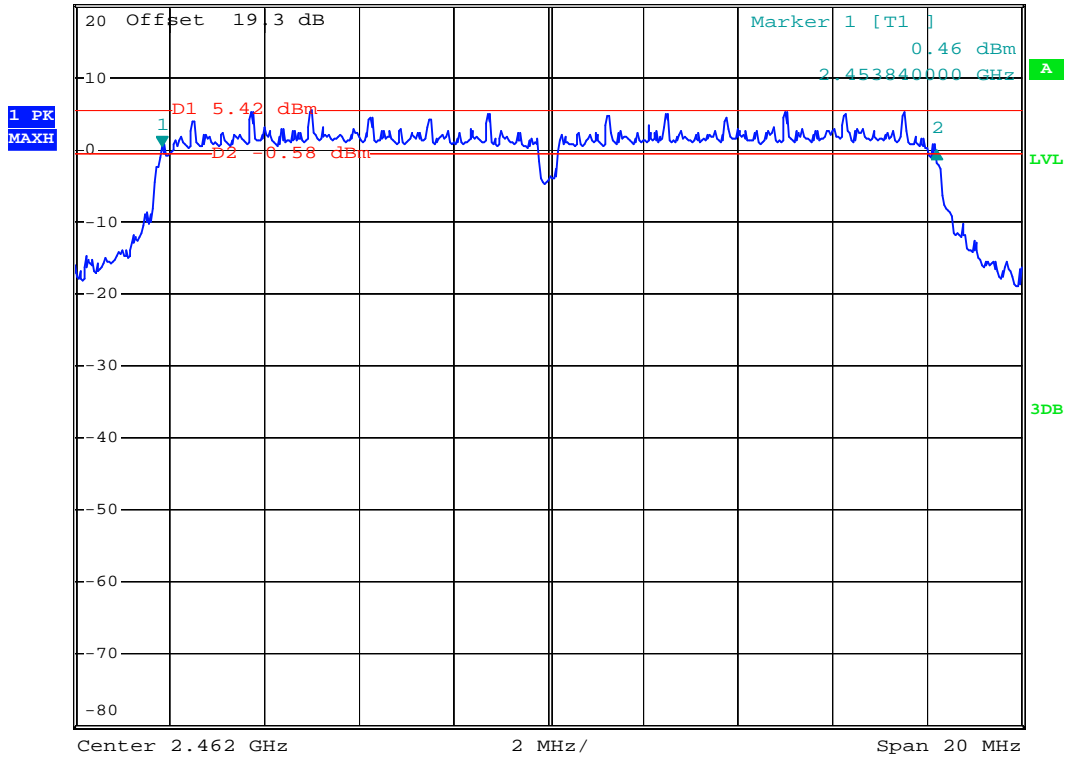

Date: 14.APR.2008 03:44:38

5.3 Power Spectral Density Measurement

5.3.1 Measuring Instruments

As described in chapter 6 of this test report.

5.3.2 Test Procedure

1. The transmitter output was connected to spectrum analyzer directly.
2. The spectrum analyzer's resolution bandwidth was set at 3kHz RBW and 30kHz VBW as that of the fundamental frequency. Set the sweep time=span/3kHz.
3. The power spectral density was measured and recorded.
4. The sweep time is allowed to be longer than span/3kHz for a full response of the mixer in the spectrum analyzer.

5.3.3 Test Setup Layout

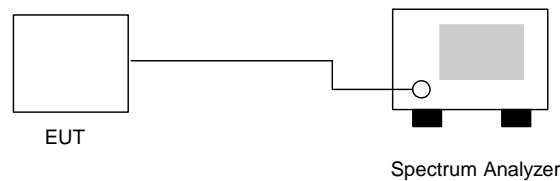

5.3.4 Test Result

- Application Type : 802.11b/g
- Temperature : 23~25
- Relative Humidity : 43~45%
- Test Enginner : Darren

802.11b

Channel	Frequency (MHz)	Power Spectral Density (dBm)	Limits (dBm)	Plot Ref. No.
01	2412	-5.80	8	Mode 1
06	2437	-5.81	8	Mode 2
11	2462	-5.83	8	Mode 3

802.11g

Channel	Frequency (MHz)	Power Spectral Density (dBm)	Limits (dBm)	Plot Ref. No.
01	2412	-9.13	8	Mode 4
06	2437	-9.01	8	Mode 5
11	2462	-8.35	8	Mode 6

5.3.5 Power Spectral Density

Mode 1

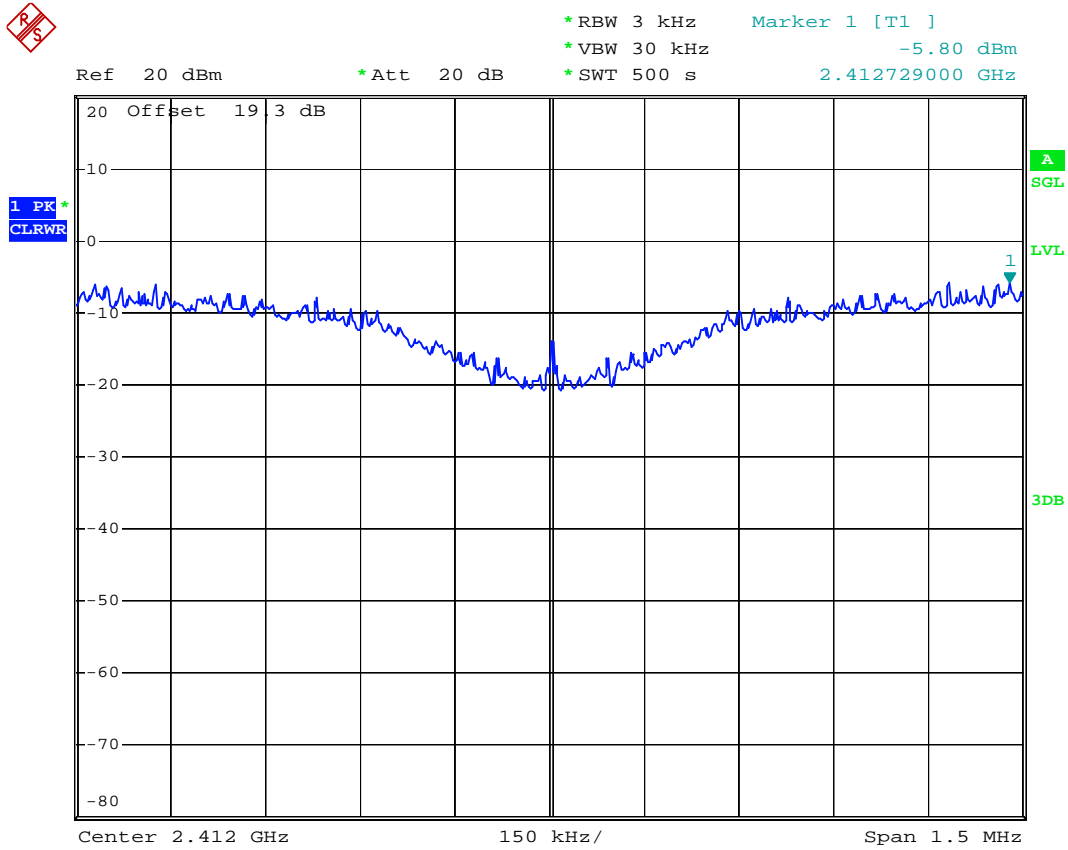

Date: 14.APR.2008 04:01:39

Mode 2



*RBW 3 kHz Marker 1 [T1]
 *VBW 30 kHz -5.81 dBm
 *SWT 500 s 2.436280000 GHz

Ref 20 dBm

*Att 20 dB

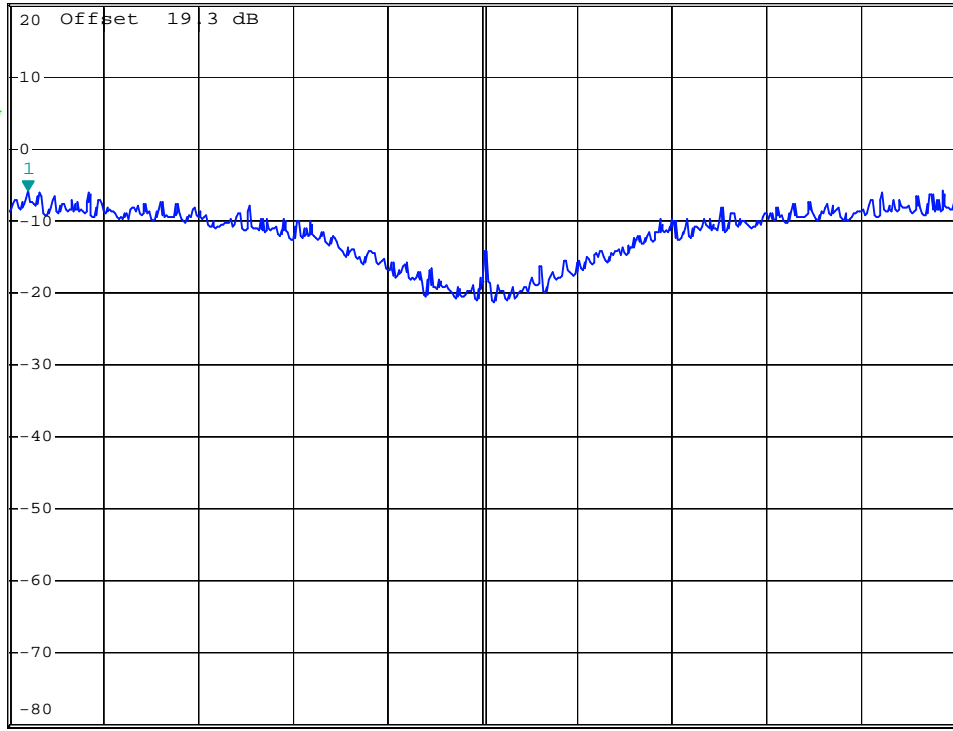

Date: 14.APR.2008 04:11:41

Mode 3



*RBW 3 kHz Marker 1 [T1]
 *VBW 30 kHz -5.83 dBm
 *SWT 500 s 2.462633000 GHz

Ref 20 dBm

*Att 20 dB

1 PK*
 CLRWR

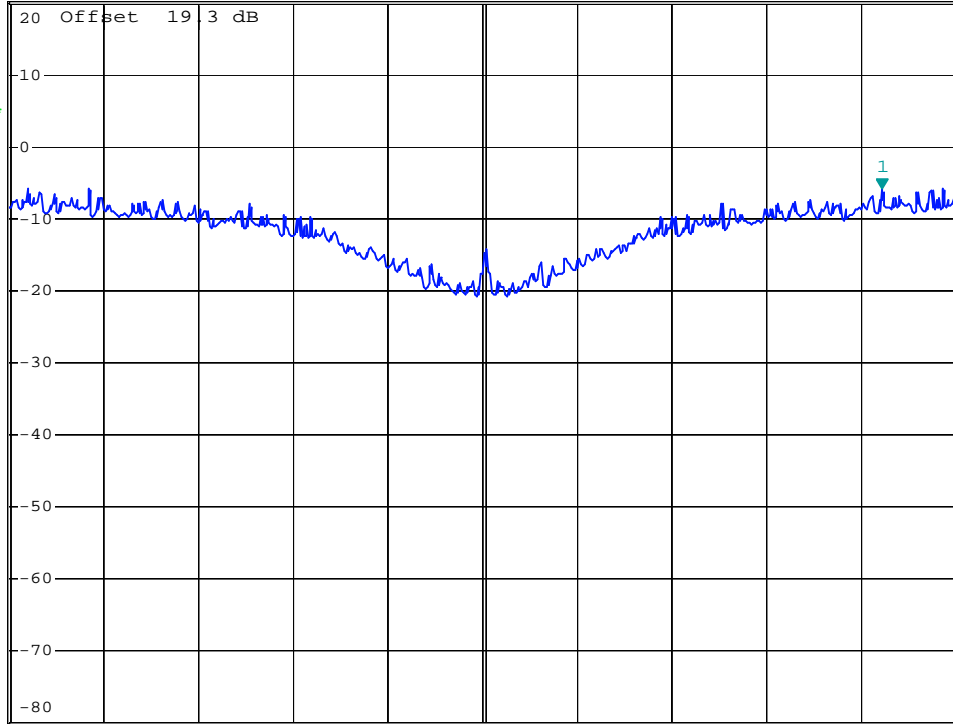

Date: 14.APR.2008 04:21:11

Mode 4



*RBW 3 kHz Marker 1 [T1]
 *VBW 30 kHz -9.13 dBm
 *SWT 500 s 2.412615000 GHz

Ref 20 dBm

*Att 20 dB

1 PK*
 CLRWR

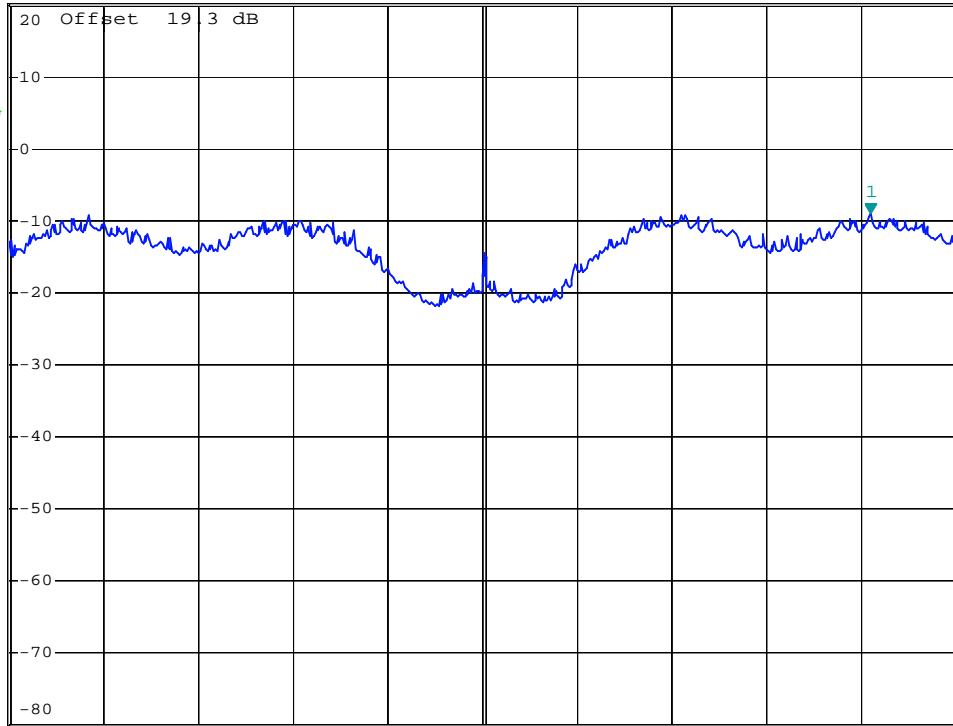

Date: 14.APR.2008 03:14:37

Mode 5



*RBW 3 kHz Marker 1 [T1]
 *VBW 30 kHz -9.01 dBm
 *SWT 500 s 2.437615000 GHz

Ref 20 dBm

*Att 20 dB

1 PK*
 CLRWR

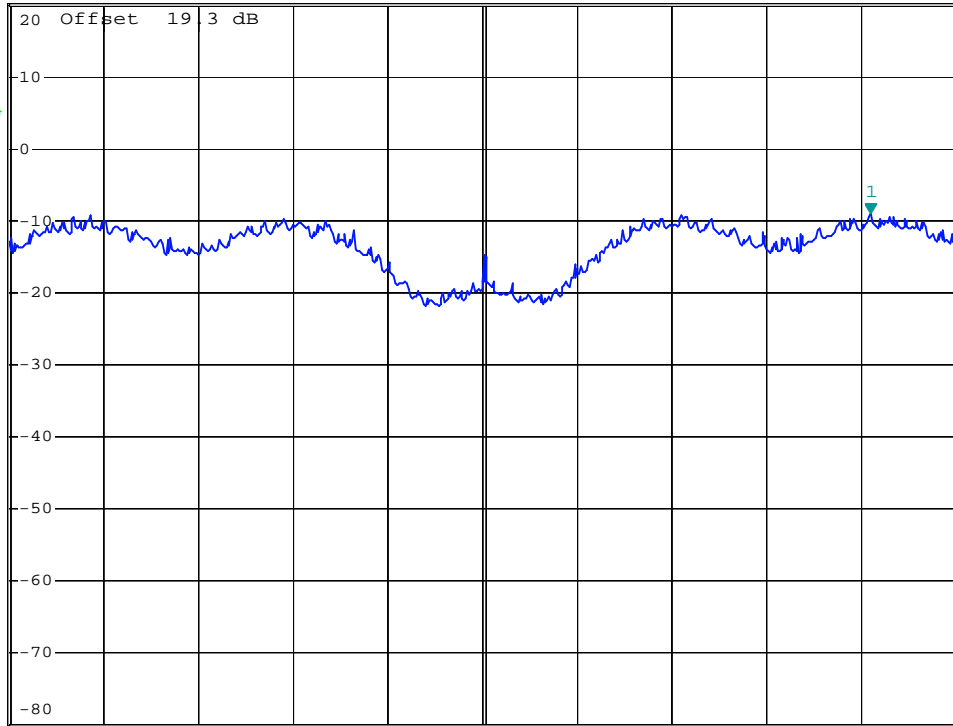

Date: 14.APR.2008 03:23:29

Mode 6



*RBW 3 kHz Marker 1 [T1]
 *VBW 30 kHz -8.35 dBm
 *SWT 500 s 2.462651000 GHz

Ref 20 dBm

*Att 20 dB

1 PK*
 CLRWR

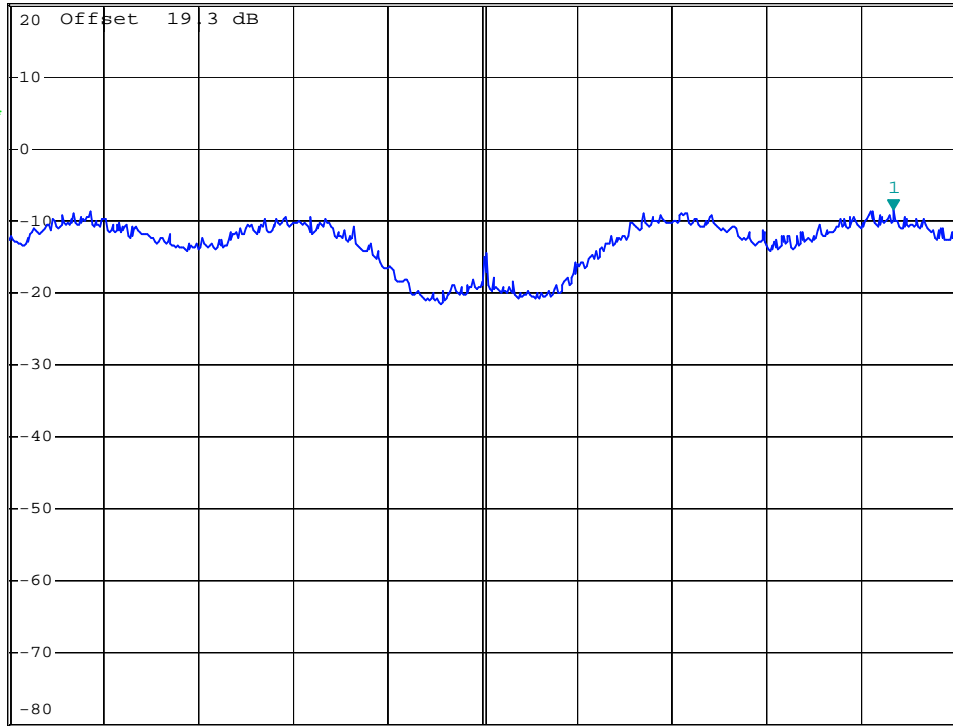

Date: 14.APR.2008 03:32:53

5.4 Band Edges Measurement

5.4.1 Measuring Instruments

As described in chapter 6 of this test report.

5.4.2 Test Procedure

1. The transmitter output was connected to the spectrum analyzer via a low lose cable.
2. Set both RBW and VBW of spectrum analyzer to 100 KHz with suitable frequency span including 100 KHz bandwidth from band edge.
3. The band edges was measured and recorded.

5.4.3 Test Result

- Application Type : WLAN 802.11b/g
- Temperature : 23~25
- Relative Humidity : 43~45%
- Test Enginner : Darren

Test Result in WLAN lower band (802.11b/g)	: PASS
Test Result in WLAN higher band (802.11b/g)	: PASS

5.4.4 Note on Band Edge Emission

➤WLAN 802.11b

CH01 (Horizontal)

Frequency (MHz)	Level (dBuV/m)	Over Limit (dB)	Limit Line (dBuV/m)	Read Level (dBuV)	Antenna Factor (dB)	Cable Loss (dB)	Preamp Factor (dB)	Ant Pos (cm)	Table Pos (deg)	Remark
2388.09	37.13	-16.87	54	37.02	31.86	3.92	35.68	123	64	Average
2388.09	49.66	-24.34	74	49.55	31.86	3.92	35.68	100	0	Peak

CH01 (Vertical)

Frequency (MHz)	Level (dBuV/m)	Over Limit (dB)	Limit Line (dBuV/m)	Read Level (dBuV)	Antenna Factor (dB)	Cable Loss (dB)	Preamp Factor (dB)	Ant Pos (cm)	Table Pos (deg)	Remark
2388.09	34.84	-19.16	54	34.73	31.86	3.92	35.68	102	35	Average
2388.09	47.31	-26.69	74	47.2	31.86	3.92	35.68	100	0	Peak

CH11 (Horizontal)

Frequency (MHz)	Level (dBuV/m)	Over Limit (dB)	Limit Line (dBuV/m)	Read Level (dBuV)	Antenna Factor (dB)	Cable Loss (dB)	Preamp Factor (dB)	Ant Pos (cm)	Table Pos (deg)	Remark
2485.37	35.82	-18.18	54	35.74	31.83	3.92	35.68	100	11	Average
2485.37	48.41	-25.59	74	48.33	31.83	3.92	35.68	100	0	Peak

CH11 (Vertical)

Frequency (MHz)	Level (dBuV/m)	Over Limit (dB)	Limit Line (dBuV/m)	Read Level (dBuV)	Antenna Factor (dB)	Cable Loss (dB)	Preamp Factor (dB)	Ant Pos (cm)	Table Pos (deg)	Remark
2484.61	31.02	-22.98	54	30.69	31.98	4.05	35.70	129	130	Average
2484.61	43.46	-30.54	74	43.13	31.98	4.05	35.70	100	0	Peak

>WLAN 802.11g

CH01 (Horizontal)

Frequency (MHz)	Level (dBuV/m)	Over Limit (dB)	Limit Line (dBuV/m)	Read Level (dBuV)	Antenna Factor (dB)	Cable Loss (dB)	Preamp Factor (dB)	Ant Pos (cm)	Table Pos (deg)	Remark
2390	46.41	-7.59	54	46.31	31.86	3.92	35.68	131	50	Average
2390	64.24	-9.76	74	64.14	31.86	3.92	35.68	100	0	Peak

CH01 (Vertical)

Frequency (MHz)	Level (dBuV/m)	Over Limit (dB)	Limit Line (dBuV/m)	Read Level (dBuV)	Antenna Factor (dB)	Cable Loss (dB)	Preamp Factor (dB)	Ant Pos (cm)	Table Pos (deg)	Remark
2390	43.72	-10.28	54	43.62	31.86	3.92	35.68	120	64	Average
2390	62.33	-11.67	74	62.23	31.86	3.92	35.68	100	0	Peak

CH11 (Horizontal)

Frequency (MHz)	Level (dBuV/m)	Over Limit (dB)	Limit Line (dBuV/m)	Read Level (dBuV)	Antenna Factor (dB)	Cable Loss (dB)	Preamp Factor (dB)	Ant Pos (cm)	Table Pos (deg)	Remark
2483.5	49.9	-4.1	54	49.56	31.98	4.05	35.70	100	13	Average
2483.5	70.5	-3.5	74	70.17	31.98	4.05	35.70	100	0	Peak

CH11 (Vertical)

Frequency (MHz)	Level (dBuV/m)	Over Limit (dB)	Limit Line (dBuV/m)	Read Level (dBuV)	Antenna Factor (dB)	Cable Loss (dB)	Preamp Factor (dB)	Ant Pos (cm)	Table Pos (deg)	Remark
2483.5	47.58	-6.42	54	47.25	31.98	4.05	35.70	120	65	Average
2483.5	66.36	-7.64	74	66.03	31.98	4.05	35.70	100	0	Peak

5.4.5 20dB Band Edge

WLAN 802.11b

CH01

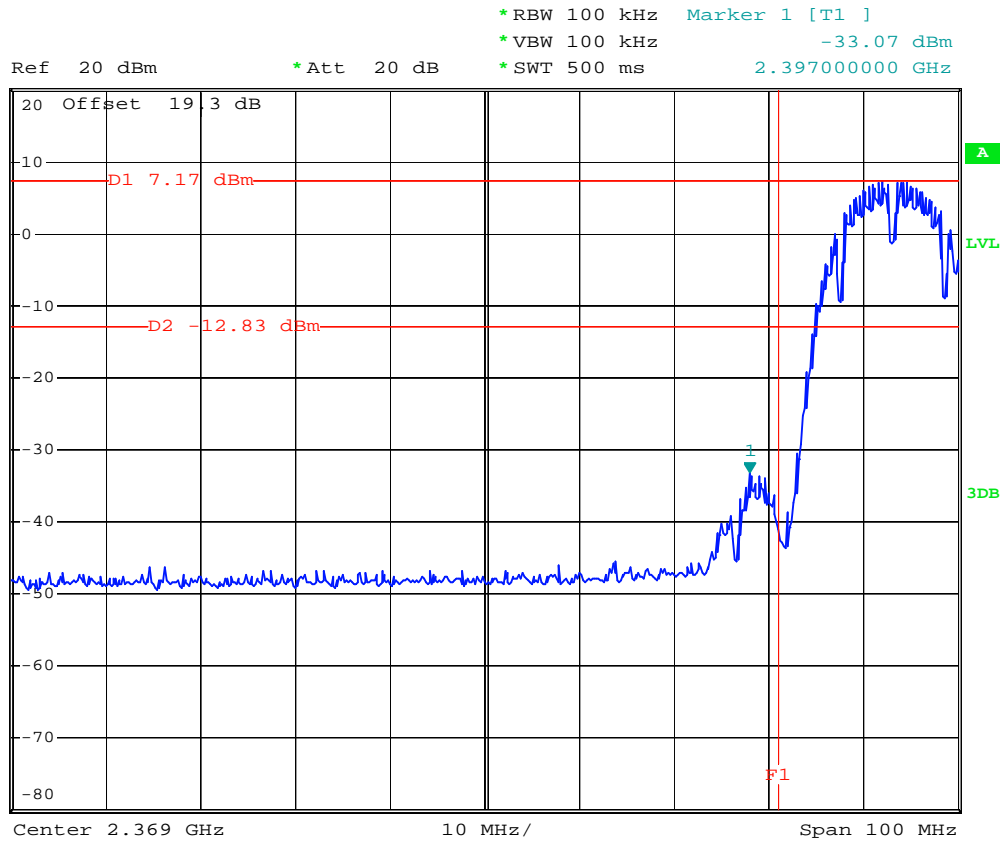

Date: 14.APR.2008 03:37:47

WLAN 802.11b

CH11



*RBW 100 kHz Marker 1 [T1]
 *VBW 100 kHz -45.60 dBm
 *SWT 500 ms 2.48720000 GHz

Ref 20 dBm

*Att 20 dB

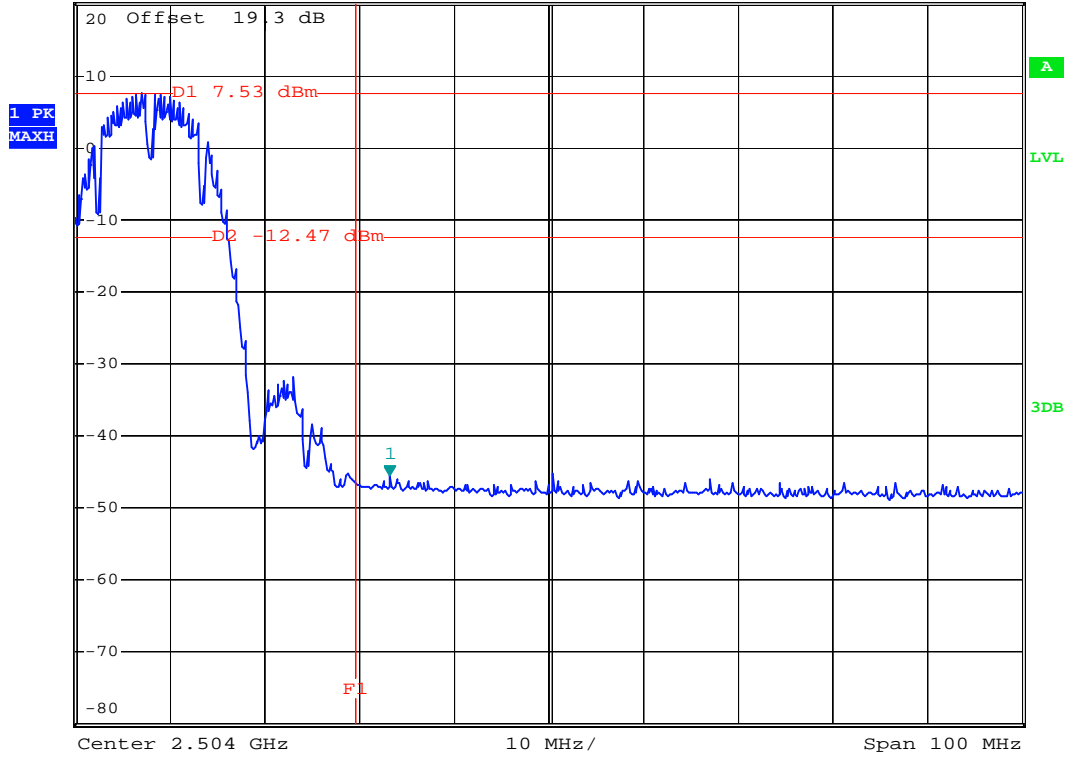

Date: 14.APR.2008 03:37:01

WLAN 802.11g

CH01

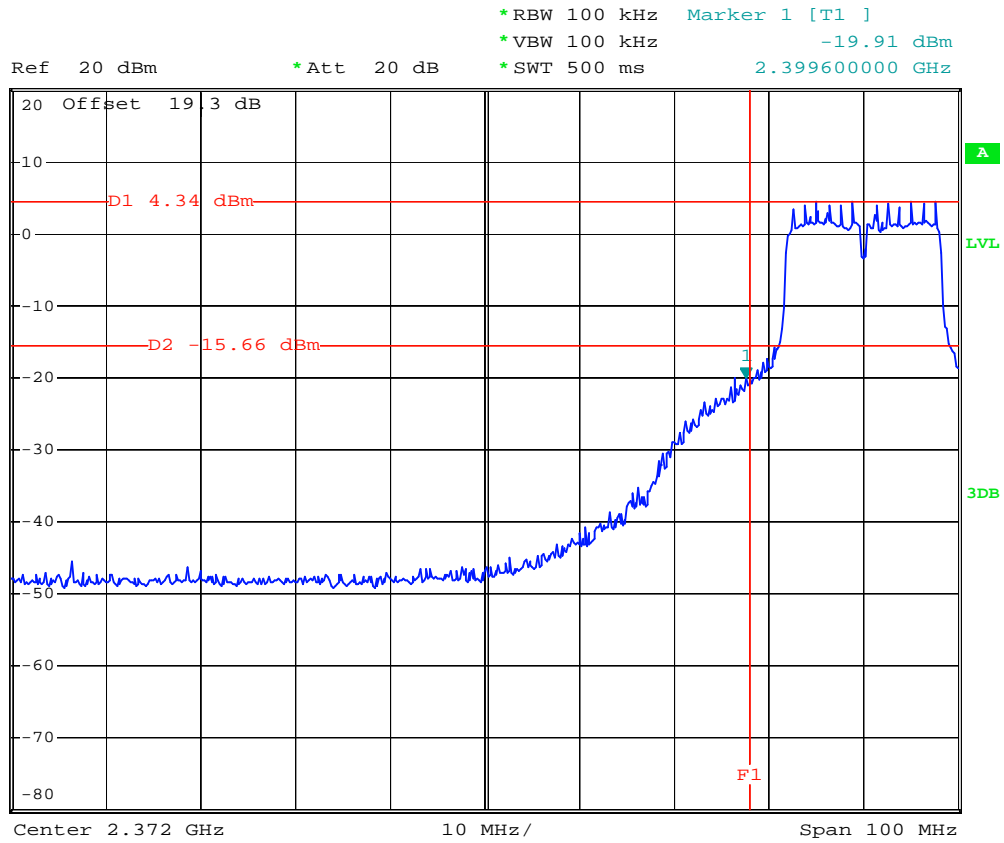

Date: 18.APR.2008 19:57:50

WLAN 802.11g

CH11



*RBW 100 kHz Marker 1 [T1]
 *VBW 100 kHz -30.83 dBm
 *SWT 500 ms 2.48360000 GHz

Ref 20 dBm

*Att 20 dB

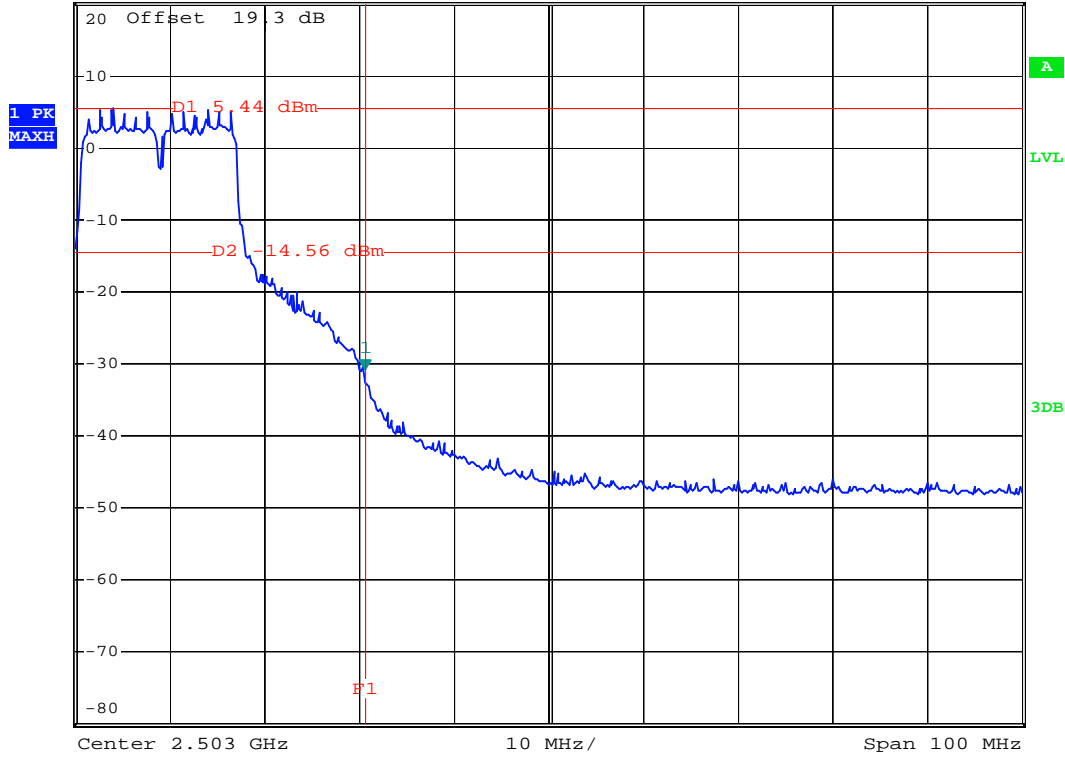

Date: 14.APR.2008 03:43:38

5.5 Peak Output Power Measurement

5.5.1 Measuring Instruments

As described in chapter 6 of this test report.

5.5.2 Test Procedure

1. The antenna port(RF output) of the EUT was connected to the input(RF input)of a power meter for WLAN measurement. The power is equal to the reading level on power meter plus cable loss at the EUT antenna terminal.
2. The antenna port (RF output) of the EUT was connected to the input (RF input) of a spectrum analyzer for BT measurement. RBW and VBW are set to 3 MHz. The cable loss has been offset before testing.

5.5.3 Test Setup Layout

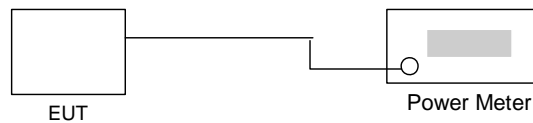

5.5.4 Test Result

- Application Type : WLAN 802.11b/g
- Temperature : 23~25
- Relative Humidity : 43~45%
- Test Enginner : Darren

WLAN 802.11b

Channel	Frequency (MHz)	Measured Output Power (dBm)	Limits (Watt/dBm)
01	2412	18.07	1W/30 dBm
06	2437	18.20	1W/30 dBm
11	2462	18.24	1W/30 dBm

WLAN 802.11g

Channel	Frequency (MHz)	Measured Output Power (dBm)	Limits (Watt/dBm)
01	2412	21.67	1W/30 dBm
06	2437	21.76	1W/30 dBm
11	2462	21.75	1W/30 dBm

5.6 Conducted Emission

5.6.1 Measuring Instruments

As described in chapter 6 of this test Report.

The receiver setting :

150 KHz ~ 30 MHz	Detector : Quasi – Peak and Average Bandwidth : 9 KHz
------------------	--

5.6.2 Test Procedures

1. The EUT was placed 0.4 meter from the conducting wall of the shielding room was kept at least 80 centimeters from any other grounded conducting surface.
2. Connect EUT to the power port of a line impedance stabilization network (LISN).
3. All the support units are connected to the other LISN.
4. The LISN provides 50 ohm coupling impedance for the measuring instrument.
5. The FCC states that a 50 ohm, 50 microhenry LISN should be used.
6. Both sides of AC line were checked for maximum conducted interference.
7. The frequency range from 150 kHz to 30 MHz was searched.
8. Set the test-receiver system to Peak Detect Function and specified bandwidth with Maximum Hold Mode.

5.6.3 Test Data

- Temperature : 23~25
- Relative Humidity : 43~45%
- Test Enginner : Darren
- Test Mode : Mode 1

The test that passed at minimum margin was marked by the frame in the following table.

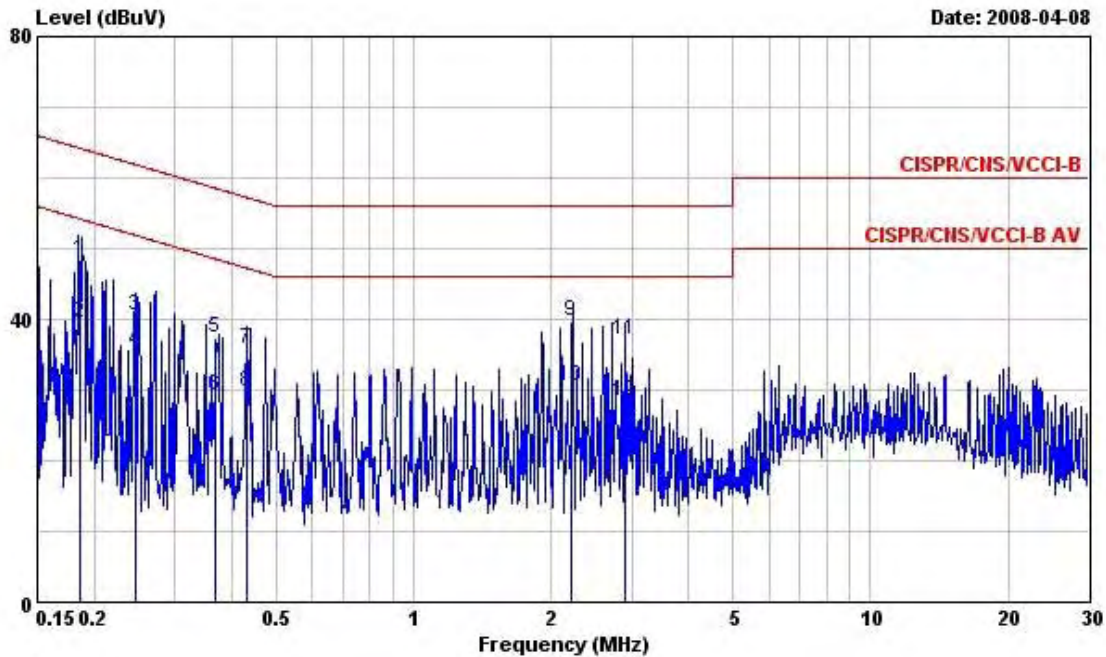

Site : CO04-HY
 Condition : CISPR/CNS/VCCI-B LISN 200604 99041 LINE
 EUT : Smart Phone WCDMA (GSM/GPRS/EDGE)
 POWER: 120V/60Hz
 Model : FR832620
 Memo : PCS1900 Idle+BT Link+WLAN Link+Battery1
 Memo : +Camera1+Adaptor A +GPS Rx
 IMEI : 357559010030397
 SAMPLE : A

	Freq	Level	Over Limit	Limit Line	Read Level	LISN Factor	Cable Loss	Remark
	MHz	dBuV	dB	dBuV	dBuV	dB	dB	
1	0.1860800	48.53	-15.68	64.21	48.29	0.10	0.14	QP
2	0.1860800	39.56	-14.65	54.21	39.32	0.10	0.14	Average
3	0.2457740	40.43	-21.47	61.90	40.01	0.10	0.32	QP
4	0.2457740	35.65	-16.25	51.90	35.23	0.10	0.32	Average
5	0.3694120	37.40	-21.11	58.51	36.64	0.10	0.66	QP
6	0.3694120	29.20	-19.31	48.51	28.44	0.10	0.66	Average
7	0.4305230	35.68	-21.56	57.24	34.87	0.10	0.71	QP
8	0.4305230	29.65	-17.59	47.24	28.84	0.10	0.71	Average
9	2.212	39.75	-16.25	56.00	39.24	0.10	0.41	QP
10	2.212	30.62	-15.38	46.00	30.11	0.10	0.41	Average
11	2.889	37.13	-18.87	56.00	36.66	0.10	0.37	QP
12	2.889	28.51	-17.49	46.00	28.04	0.10	0.37	Average

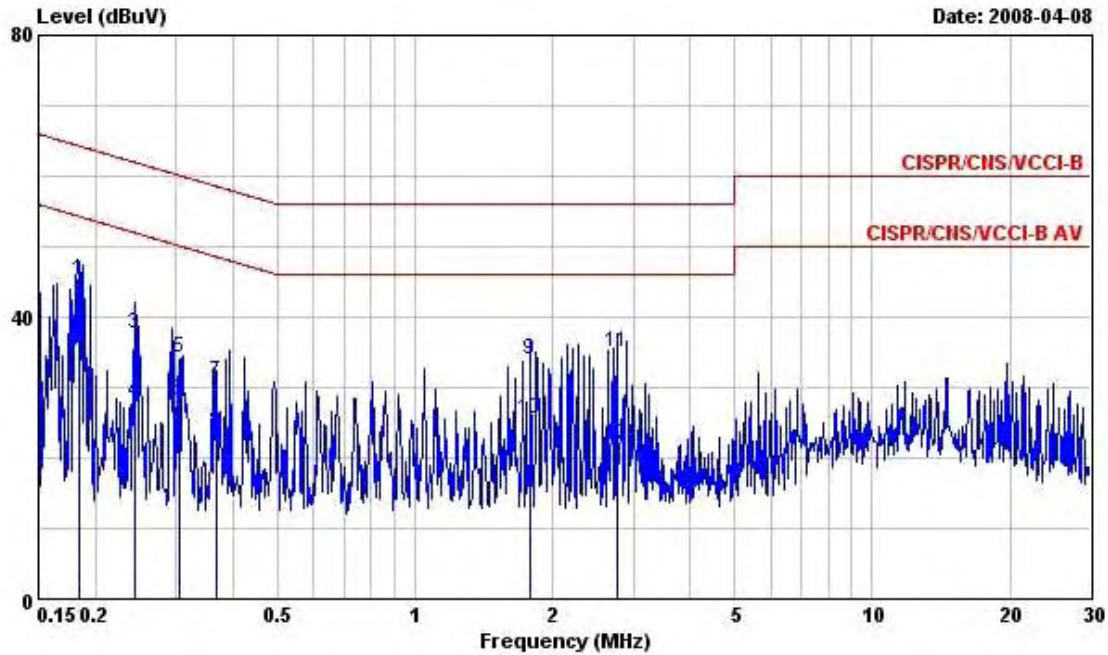

Site : CO04-HY
 Condition : CISPR/CNS/VCCI-B LISN 200604 99041 NEUTRAL
 EUT : Smart Phone WCDMA (GSM/GPRS/EDGE)
 POWER: 120V/60Hz
 Model : FR832620
 Memo : PCS1900 Idle+BT Link+WLAN Link
 Memo : Battery1 + Camera1+Adaptor A+GPS Rx
 IMEI : 357559010030397
 SAMPLE : A

	Freq	Level	Over	Limit	Read	LISN	Cable	
	MHz	dBuV	Limit	Line	Level	Factor	Loss	Remark
			dB	dBuV	dBuV	dB	dB	
1	0.1844300	45.37	-18.91	64.28	45.13	0.10	0.14	QP
2	0.1844300	35.44	-18.84	54.28	35.20	0.10	0.14	Average
3	0.2449730	37.69	-24.24	61.93	37.28	0.10	0.31	QP
4	0.2449730	27.89	-24.04	51.93	27.48	0.10	0.31	Average
5	0.3064330	34.17	-25.90	60.07	33.57	0.10	0.50	QP
6	0.3064330	28.08	-21.99	50.07	27.48	0.10	0.50	Average
7	0.3672900	30.80	-27.76	58.56	30.05	0.10	0.65	QP
8	0.3672900	23.60	-24.96	48.56	22.85	0.10	0.65	Average
9	1.779	33.90	-22.10	56.00	33.37	0.10	0.43	QP
10	1.779	25.50	-20.50	46.00	24.97	0.10	0.43	Average
11	2.764	34.93	-21.07	56.00	34.40	0.15	0.38	QP
12	2.764	21.78	-24.22	46.00	21.25	0.15	0.38	Average

- Temperature : 23~25
- Relative Humidity : 43~45%
- Test Engineer : Darren
- Test Mode : Mode 2

The test that passed at minimum margin was marked by the frame in the following table.

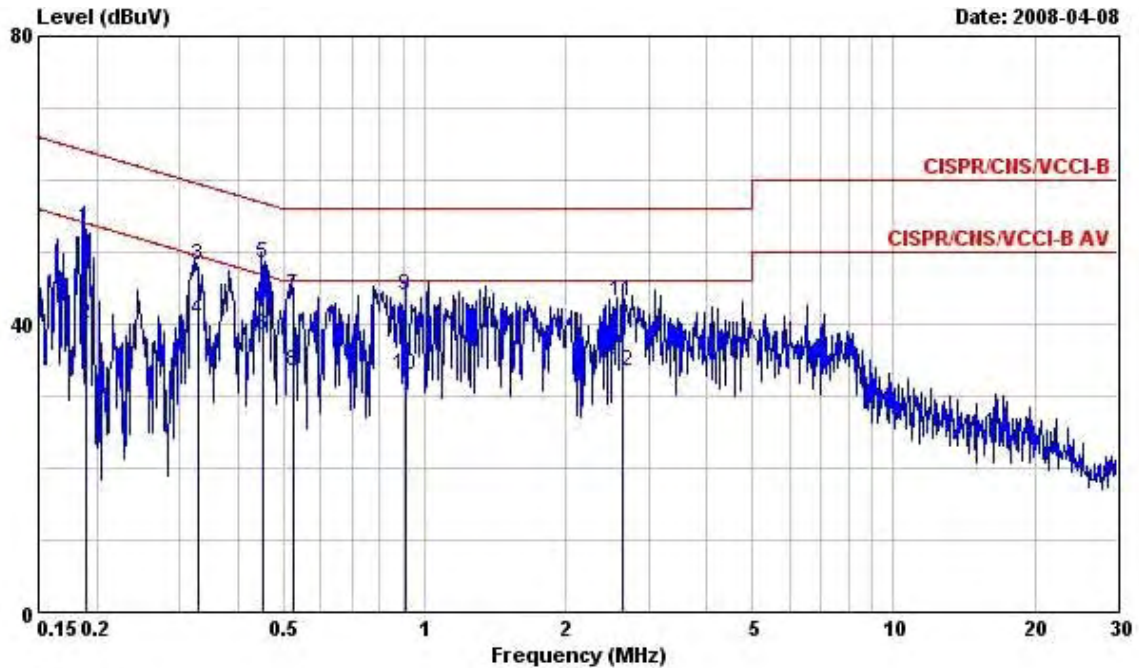

Site : CO04-HY
 Condition : CISPR/CNS/VCCI-B LISN 200604 99041 LINE
 EUT : Smart Phone WCDMA (GSM/GPRS/EDGE)
 POWER: 120V/60Hz
 Model : FR832620
 Memo : PCS1900 Idle+BT Link+WLAN Link
 Memo : Battery2 + Camear1+Adaptor B+GPS Rx
 IMEI : 357559010030397
 SAMPLE : A

	Freq	Level	Over	Limit	Read	LISN	Cable	Remark
	MHz	dBuV	Limit	Line	Level	Factor	Loss	
			dB	dBuV	dBuV	dB	dB	
1	0.1887450	53.45	-10.64	64.09	53.21	0.10	0.14	QP
2	0.1887450	39.97	-14.12	54.09	39.73	0.10	0.14	Average
3	0.3293420	48.17	-11.30	59.47	47.50	0.10	0.57	QP
4	0.3293420	40.66	-8.81	49.47	39.99	0.10	0.57	Average
5	0.4513640	48.32	-8.53	56.85	47.53	0.10	0.69	QP
6	0.4513640	38.46	-8.39	46.85	37.67	0.10	0.69	Average
7	0.5257450	43.88	-12.12	56.00	43.13	0.10	0.65	QP
8	0.5257450	33.42	-12.58	46.00	32.67	0.10	0.65	Average
9	0.9087440	43.96	-12.04	56.00	43.39	0.10	0.47	QP
10	0.9087440	32.93	-13.07	46.00	32.36	0.10	0.47	Average
11	2.640	43.15	-12.85	56.00	42.66	0.10	0.39	QP
12	2.640	33.30	-12.70	46.00	32.81	0.10	0.39	Average

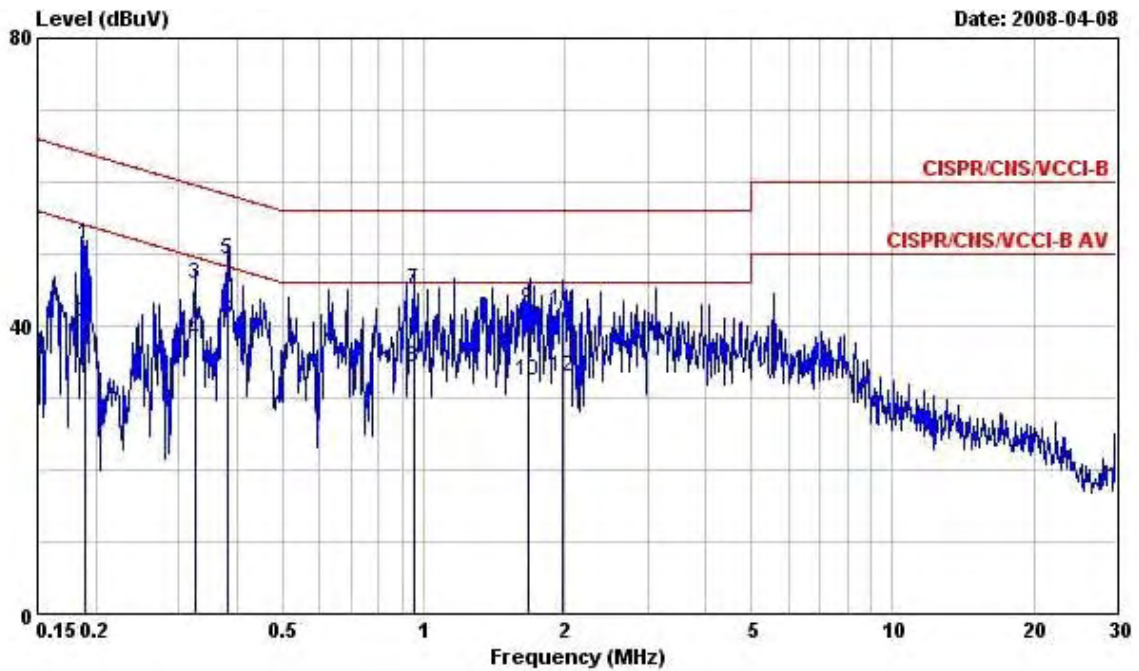

Site : CO04-HY
 Condition : CISPR/CNS/VCCI-B LISN 200604 99041 NEUTRAL
 EUT : Smart Phone WCDMA (GSM/GPRS/EDGE)
 POWER: 120V/60Hz
 Model : FR832620
 Memo : PCS1900 Idle+BT Link+WLAN Link
 Memo : Battery2 + Camera1+Adaptor B+GPS Rx
 IMEI : 357559010030397
 SAMPLE : A

	Freq	Level	Over	Limit	Read	LISN	Cable	
	MHz	dBuV	Limit	Line	Level	Factor	Loss	Remark
			dB	dBuV	dBuV	dB	dB	
1	0.1889450	51.23	-12.85	64.08	50.99	0.10	0.14	QP
2	0.1889450	40.40	-13.68	54.08	40.16	0.10	0.14	Average
3	0.3251190	45.85	-13.72	59.57	45.20	0.10	0.55	QP
4	0.3251190	37.86	-11.71	49.57	37.21	0.10	0.55	Average
5	0.3811540	49.17	-9.08	58.25	48.38	0.10	0.69	QP
6	0.3811540	40.81	-7.44	48.25	40.02	0.10	0.69	Average
7	0.9510770	44.94	-11.06	56.00	44.38	0.10	0.46	QP
8	0.9510770	34.31	-11.69	46.00	33.75	0.10	0.46	Average
9	1.678	42.38	-13.62	56.00	41.85	0.10	0.43	QP
10	1.678	32.47	-13.53	46.00	31.94	0.10	0.43	Average
11	1.980	42.09	-13.91	56.00	41.56	0.10	0.43	QP
12	1.980	32.83	-13.17	46.00	32.30	0.10	0.43	Average

- Temperature : 23~25
- Relative Humidity : 43~45%
- Test Engineer : Darren
- Test Mode : Mode 3

The test that passed at minimum margin was marked by the frame in the following table.

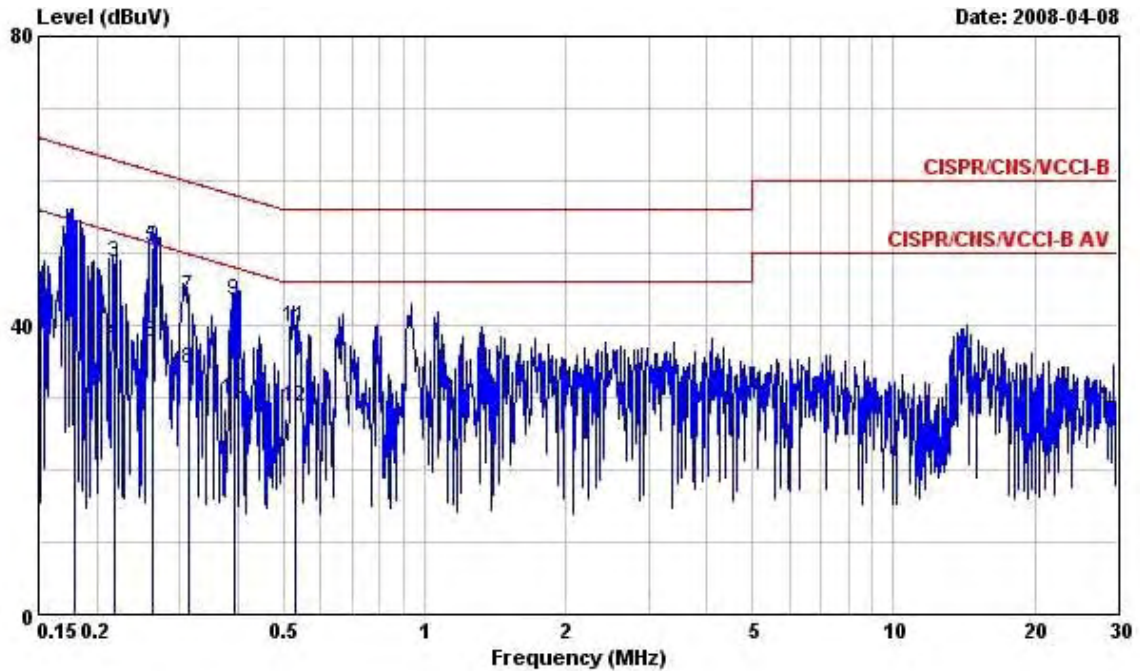

Site : CO04-HY
 Condition : CISPR/CNS/VCCI-B LISN 200604 99041 LINE
 EUT : Smart Phone WCDMA (GSM/GPRS/EDGE)
 POWER: 120V/60Hz
 Model : FR832620
 Memo : PCS1900 Idle+BT Link+WLAN Link+Battery3
 Memo : +Camera+Adaptor C+GPS Rx+USB Cable A
 IMEI : 357559010030397
 SAMPLE : A

	Freq	Level	Over	Limit	Read	LISN	Cable	Remark
	MHz	dBuV	Limit	Line	Level	Factor	Loss	
			dB	dBuV	dBuV	dB	dB	
1	0.1796920	53.09	-11.41	64.50	52.85	0.10	0.14	QP
2	0.1796920	40.98	-13.52	54.50	40.74	0.10	0.14	Average
3	0.2170340	48.77	-14.16	62.93	48.46	0.10	0.21	QP
4	0.2170340	37.57	-15.36	52.93	37.26	0.10	0.21	Average
5	0.2630270	50.68	-10.66	61.34	50.21	0.10	0.37	QP
6	0.2630270	37.72	-13.62	51.34	37.25	0.10	0.37	Average
7	0.3136910	43.82	-16.05	59.87	43.20	0.10	0.52	QP
8	0.3136910	33.96	-15.91	49.87	33.34	0.10	0.52	Average
9	0.3934320	43.39	-14.60	57.99	42.57	0.10	0.72	QP
10	0.3934320	29.81	-18.18	47.99	28.99	0.10	0.72	Average
11	0.5298950	39.78	-16.22	56.00	39.04	0.10	0.64	QP
12	0.5298950	28.65	-17.35	46.00	27.91	0.10	0.64	Average

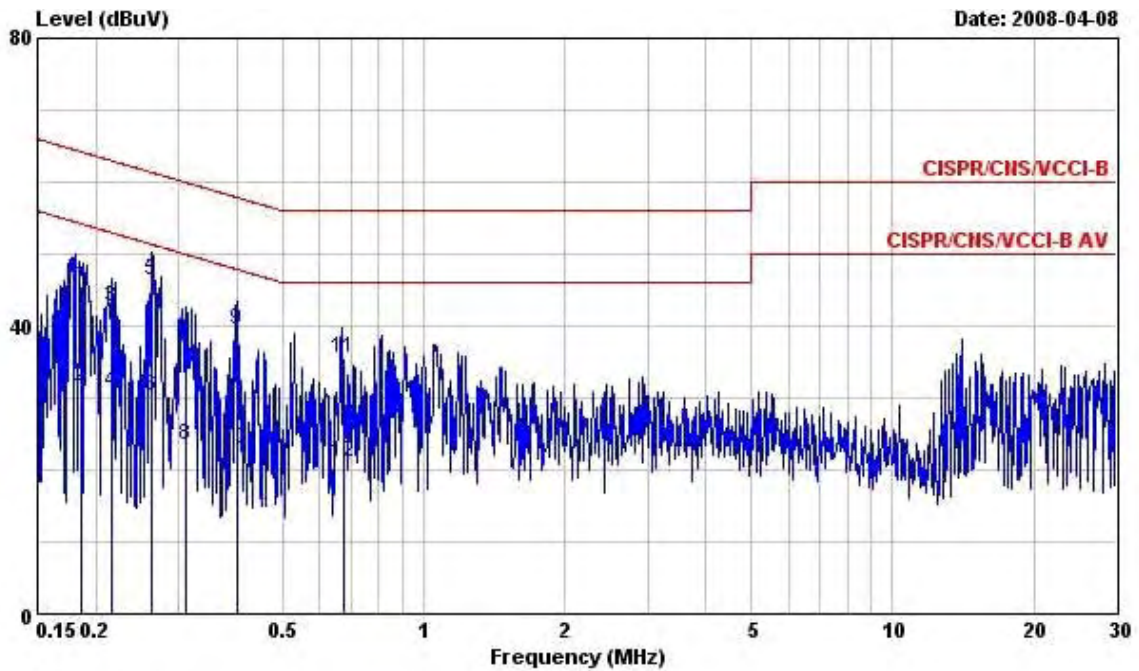

Site : CO04-HY
 Condition : CISPR/CNS/VCCI-B LISN 200604 99041 NEUTRAL
 EUT : Smart Phone WCDMA (GSM/GPRS/EDGE)
 POWER: 120V/60Hz
 Model : FR832620
 Memo : PCS1900 Idle+BT Link+WLAN Link+Battery3
 Memo : +Camearl+Adaptor C+GPS Rx+USB Cable A
 IMEI : 357559010030397
 SAMPLE : A

	Freq	Level	Over	Limit	Read	LISN	Cable	Remark
	MHz	dBuV	Limit	Line	Level	Factor	Loss	
			dB	dBuV	dBuV	dB	dB	
1	0.1851720	45.42	-18.83	64.25	45.18	0.10	0.14	QP
2	0.1851720	31.71	-22.54	54.25	31.47	0.10	0.14	Average
3	0.2152530	42.54	-20.46	63.00	42.24	0.10	0.20	QP
4	0.2152530	30.78	-22.22	53.00	30.48	0.10	0.20	Average
5	0.2621770	46.19	-15.17	61.36	45.72	0.10	0.37	QP
6	0.2621770	30.39	-20.97	51.36	29.92	0.10	0.37	Average
7	0.3102290	37.73	-22.23	59.96	37.12	0.10	0.51	QP
8	0.3102290	23.44	-26.52	49.96	22.83	0.10	0.51	Average
9	0.3995180	39.58	-18.28	57.86	38.75	0.10	0.73	QP
10	0.3995180	22.82	-25.04	47.86	21.99	0.10	0.73	Average
11	0.6752160	35.52	-20.48	56.00	34.85	0.10	0.57	QP
12	0.6752160	20.98	-25.02	46.00	20.31	0.10	0.57	Average

- Temperature : 23~25
- Relative Humidity : 43~45%
- Test Engineer : Darren
- Test Mode : Mode 4

The test that passed at minimum margin was marked by the frame in the following table.

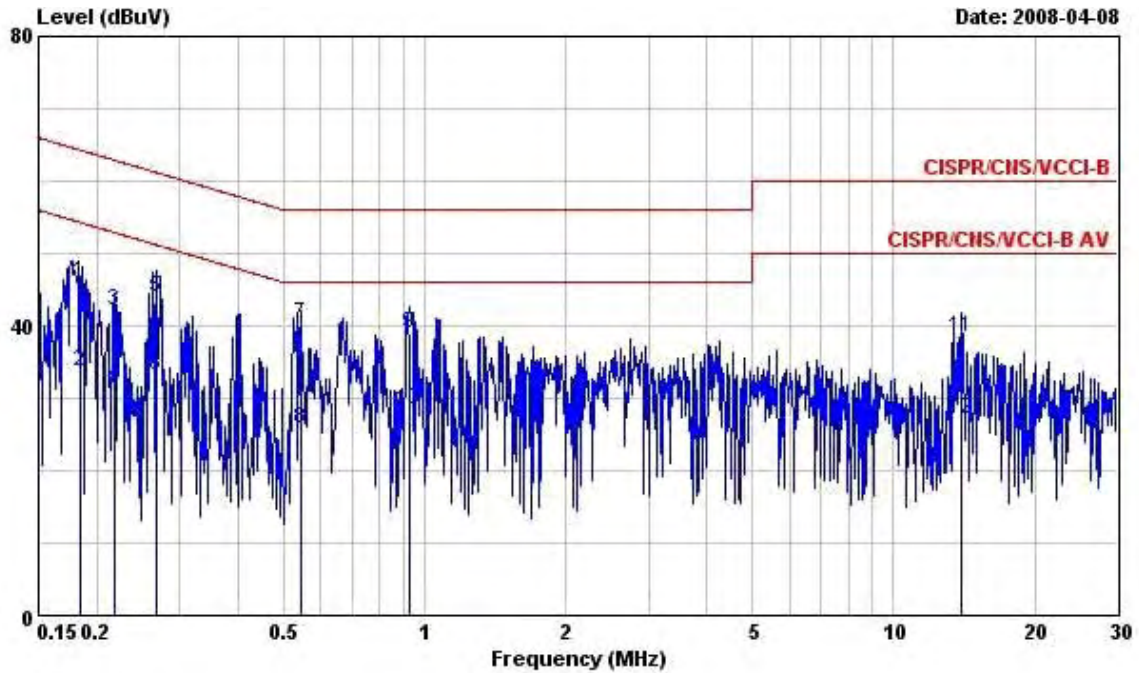

Site : CO04-HY
 Condition : CISPR/CNS/VCCI-B LISN 200604 99041 LINE
 EUT : Smart Phone WCDMA (GSM/GPRS/EDGE)
 POWER: 120V/60Hz
 Model : FR832620
 Memo : PCS1900 Idle+BT Link+WLAN Link+Battery4
 Memo : +CameraI+Adaptor C+GPS Rx+USB Cable B
 IMEI : 357559010030397
 SAMPLE : A

	Freq	Level	Over	Limit	Read	LISN	Cable	
	MHz	dBuV	Limit	Line	Level	Factor	Loss	Remark
			dB	dBuV	dBuV	dB	dB	
1	0.1847420	45.95	-18.32	64.27	45.71	0.10	0.14	QP
2	0.1847420	33.81	-20.46	54.27	33.57	0.10	0.14	Average
3	0.2185070	42.01	-20.87	62.88	41.69	0.10	0.22	QP
4	0.2185070	31.23	-21.65	52.88	30.91	0.10	0.22	Average
5	0.2671410	43.96	-17.25	61.21	43.47	0.10	0.39	QP
6	0.2671410	33.03	-18.18	51.21	32.54	0.10	0.39	Average
7	0.5435530	40.16	-15.84	56.00	39.43	0.10	0.63	QP
8	0.5435530	25.78	-20.22	46.00	25.05	0.10	0.63	Average
9	0.9282090	39.02	-16.98	56.00	38.46	0.10	0.46	QP
10	0.9282090	28.41	-17.59	46.00	27.85	0.10	0.46	Average
11	13.914	38.46	-21.54	60.00	37.77	0.53	0.16	QP
12	13.914	27.10	-22.90	50.00	26.41	0.53	0.16	Average

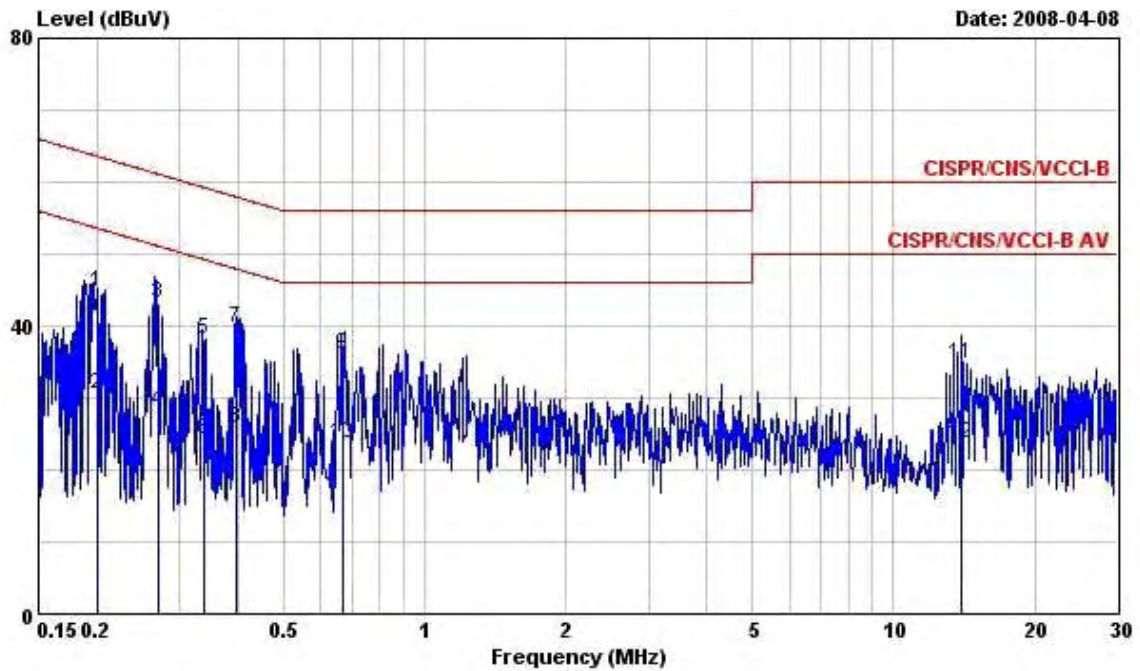

Site : CO04-HY
 Condition : CISPR/CNS/VCCI-B LISN 200604 99041 NEUTRAL
 EUT : Smart Phone WCDMA (GSM/GPRS/EDGE)
 POWER: 120V/60Hz
 Model : FR832620
 Memo : PCS1900 Idle+BT Link+WLAN Link+Battery4
 Memo : +Camearl+Adaptor C+GPS Rx+USB Cable B
 IMEI : 357559010030397
 SAMPLE : A

	Freq	Level	Over	Limit	Read	LISN	Cable	Remark
	MHz	dBuV	dB	dBuV	dBuV	dB	dB	
1	0.1999300	44.71	-18.90	63.61	44.47	0.10	0.14	QP
2	0.1999300	30.43	-23.18	53.61	30.19	0.10	0.14	Average
3	0.2692290	43.13	-18.01	61.14	42.64	0.10	0.39	QP
4	0.2692290	28.22	-22.92	51.14	27.73	0.10	0.39	Average
5	0.3383820	38.26	-20.98	59.24	37.57	0.10	0.59	QP
6	0.3383820	24.29	-24.95	49.24	23.60	0.10	0.59	Average
7	0.3976320	39.71	-18.19	57.90	38.89	0.10	0.72	QP
8	0.3976320	25.69	-22.21	47.90	24.87	0.10	0.72	Average
9	0.6696350	35.95	-20.05	56.00	35.28	0.10	0.57	QP
10	0.6696350	23.65	-22.35	46.00	22.98	0.10	0.57	Average
11	13.912	34.65	-25.35	60.00	34.19	0.30	0.16	QP
12	13.912	23.62	-26.38	50.00	23.16	0.30	0.16	Average

- Temperature : 23~25
- Relative Humidity : 43~45%
- Test Engineer : Darren
- Test Mode : Mode 5

The test that passed at minimum margin was marked by the frame in the following table.

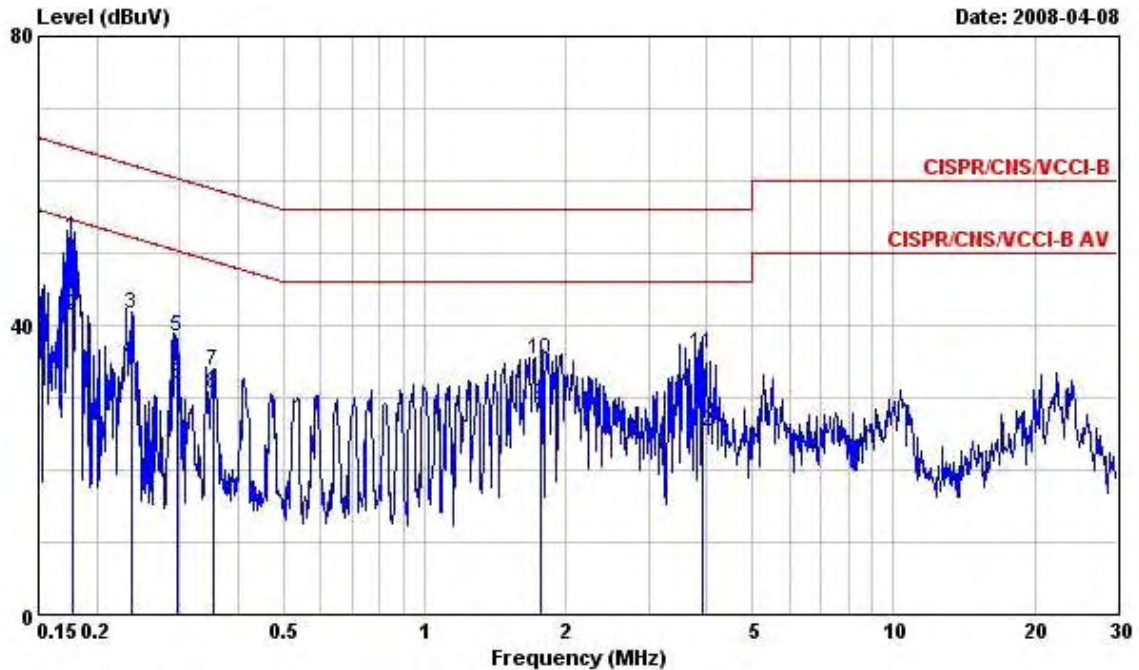

Site : CO04-HY
 Condition : CISPR/CNS/VCCI-B LISN 200604 99041 LINE
 EUT : Smart Phone WCDMA (GSM/GPRS/EDGE)
 POWER: Form NoteBook
 Model : FR832620
 Memo : EDGE Idle+BT Link+WLAN Link+Battery5
 Memo : +Camear2+USB A Link+GPS Rx
 IMEI : 357559010030397
 SAMPLE : A

	Freq	Level	Over	Limit	Read	LISN	Cable	Remark
	MHz	dBuV	dB	dBuV	dBuV	dB	dB	
1	0.1769920	52.09	-12.54	64.63	51.85	0.10	0.14	QP
2	0.1769920	41.39	-13.24	54.63	41.15	0.10	0.14	Average
3	0.2367700	41.58	-20.63	62.21	41.20	0.10	0.28	QP
4	0.2367700	34.96	-17.25	52.21	34.58	0.10	0.28	Average
5	0.2956790	38.30	-22.06	60.36	37.73	0.10	0.47	QP
6	0.2956790	31.85	-18.51	50.36	31.28	0.10	0.47	Average
7	0.3546470	33.63	-25.22	58.85	32.90	0.10	0.63	QP
8	0.3546470	30.64	-18.21	48.85	29.91	0.10	0.63	Average
9	1.772	28.86	-17.14	46.00	28.33	0.10	0.43	Average
10	1.772	35.28	-20.72	56.00	34.75	0.10	0.43	QP
11	3.908	36.06	-19.94	56.00	35.64	0.10	0.32	QP
12	3.908	25.15	-20.85	46.00	24.73	0.10	0.32	Average

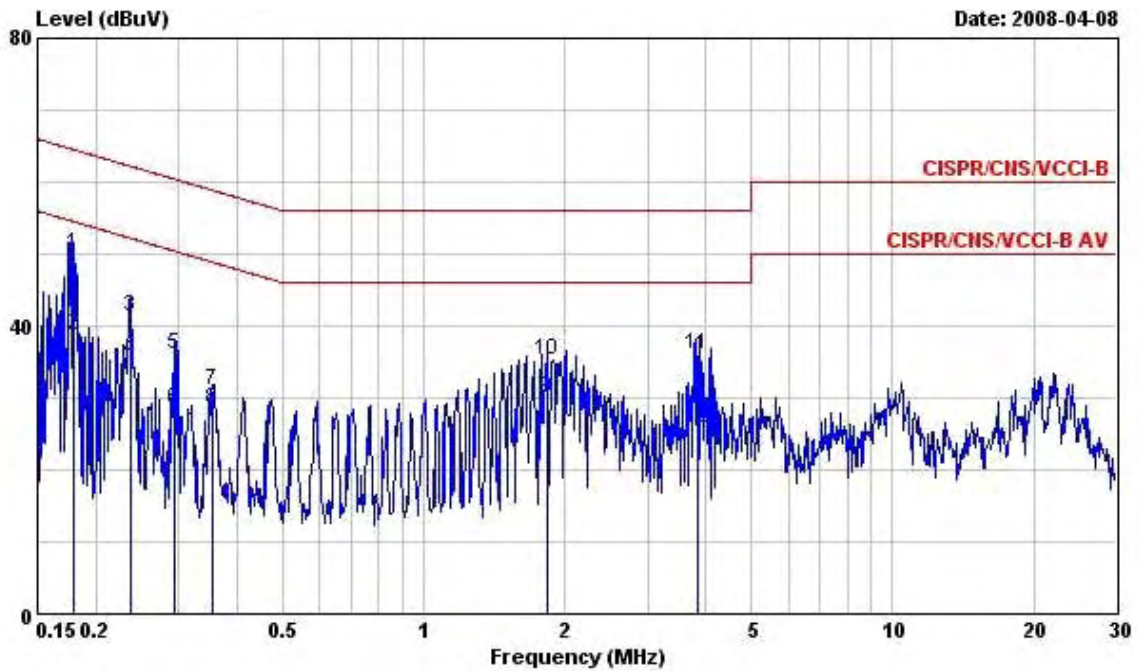

Site : CO04-HY
 Condition : CISPR/CNS/VCCI-B LISN 200604 99041 NEUTRAL
 EUT : Smart Phone WCDMA (GSM/GPRS/EDGE)
 POWER: Form NoteBook
 Model : FR832620
 Memo : EDGE Idle+BT Link+WLAN Link+Battery5
 Memo : +Camear2+USB A Link+GPS Rx
 IMEI : 357559010030397
 SAMPLE : A

	Freq	Level	Over	Limit	Read	LISN	Cable	Remark
	MHz	dBuV	Limit	Line	Level	Factor	Loss	
			dB	dBuV	dBuV	dB	dB	
1	0.1796590	50.10	-14.40	64.50	49.86	0.10	0.14	QP
2	0.1796590	38.73	-15.77	54.50	38.49	0.10	0.14	Average
3	0.2378380	41.37	-20.80	62.17	40.98	0.10	0.29	QP
4	0.2378380	35.39	-16.78	52.17	35.00	0.10	0.29	Average
5	0.2939830	35.99	-24.42	60.41	35.42	0.10	0.47	QP
6	0.2939830	28.42	-21.99	50.41	27.85	0.10	0.47	Average
7	0.3538820	30.97	-27.90	58.87	30.24	0.10	0.63	QP
8	0.3538820	28.49	-20.38	48.87	27.76	0.10	0.63	Average
9	1.828	29.87	-16.13	46.00	29.34	0.10	0.43	Average
10	1.828	35.18	-20.82	56.00	34.65	0.10	0.43	QP
11	3.854	36.12	-19.88	56.00	35.59	0.20	0.33	QP
12	3.854	25.80	-20.20	46.00	25.27	0.20	0.33	Average

- Temperature : 23~25
- Relative Humidity : 43~45%
- Test Engineer : Darren
- Test Mode : Mode 6

The test that passed at minimum margin was marked by the frame in the following table.

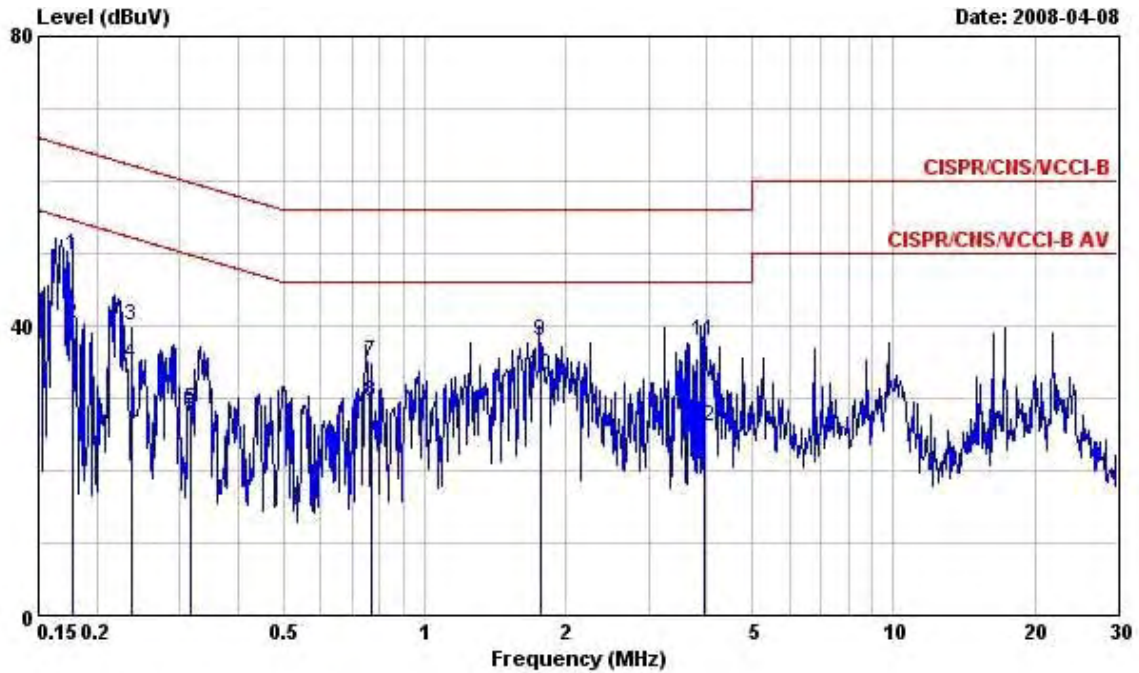

Site : CO04-HY
 Condition : CISPR/CNS/VCCI-B LISN 200604 99041 LINE
 EUT : Smart Phone WCDMA (GSM/GPRS/EDGE)
 POWER: Form NoteBook
 Model : FR832620
 Memo : WCDMA Idle+BT Idle+WLAN Idle+Battery5
 Memo : +MPEG 4+USB B Link+GPS Rx
 IMEI : 357559010030397
 SAMPLE : A

	Freq	Level	Over	Limit	Read	LISN	Cable	
	MHz	dBuV	Limit	Line	Level	Factor	Loss	Remark
			dB	dBuV	dBuV	dB	dB	
1	0.1767580	49.78	-14.86	64.64	49.54	0.10	0.14	QP
2	0.1767580	40.27	-14.37	54.64	40.03	0.10	0.14	Average
3	0.2360570	39.97	-22.26	62.23	39.59	0.10	0.28	QP
4	0.2360570	34.71	-17.52	52.23	34.33	0.10	0.28	Average
5	0.3172320	28.45	-31.33	59.78	27.82	0.10	0.53	QP
6	0.3172320	27.96	-21.82	49.78	27.33	0.10	0.53	Average
7	0.7663890	35.02	-20.98	56.00	34.40	0.10	0.52	QP
8	0.7663890	29.58	-16.42	46.00	28.96	0.10	0.52	Average
9	1.768	37.95	-18.05	56.00	37.42	0.10	0.43	QP
10	1.768	33.19	-12.81	46.00	32.66	0.10	0.43	Average
11	3.956	37.99	-18.01	56.00	37.57	0.10	0.32	QP
12	3.956	26.02	-19.98	46.00	25.60	0.10	0.32	Average

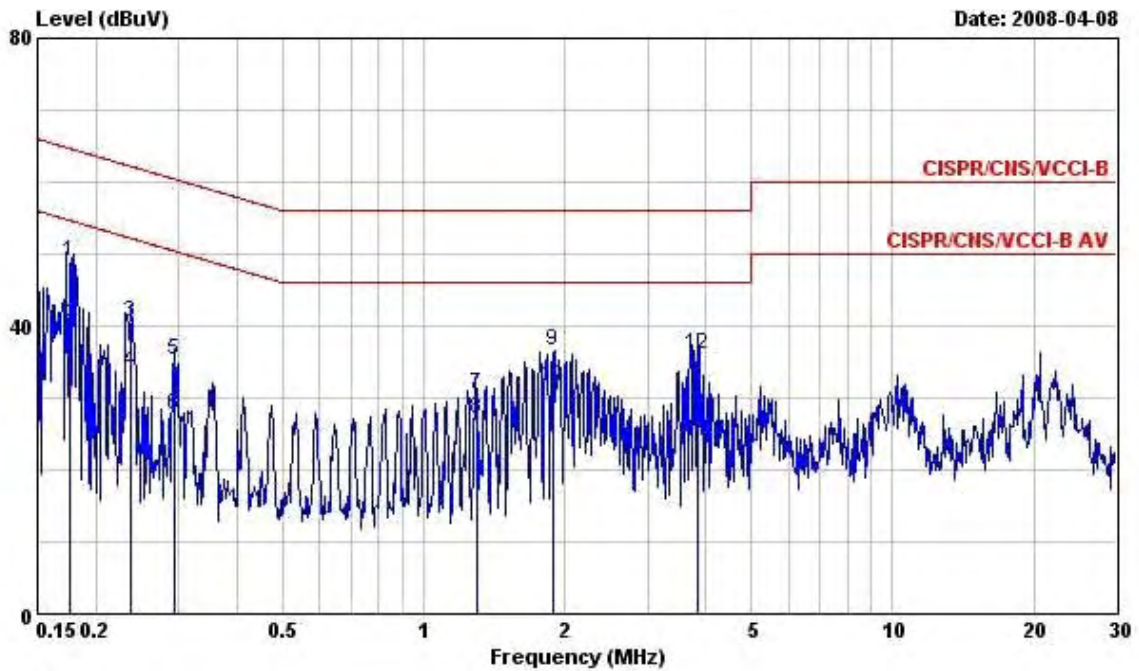

Site : CO04-HY
 Condition : CISPR/CNS/VCCI-B LISN 200604 99041 NEUTRAL
 EUT : Smart Phone WCDMA (GSM/GPRS/EDGE)
 POWER: Form NoteBook
 Model : FR832620
 Memo : WCDMA Idle+BT Idle+WLAN Idle+Battery5
 Memo : +MPEG 4+USB B Link+GPS Rx
 IMEI : 357559010030397
 SAMPLE : A

	Freq	Level	Over	Limit	Read	LISN	Cable	Remark
	MHz	dBuV	Limit	Line	Level	Factor	Loss	
			dB	dBuV	dBuV	dB	dB	
1	0.1751190	48.95	-15.76	64.71	48.71	0.10	0.14	QP
2	0.1751190	40.06	-14.65	54.71	39.82	0.10	0.14	Average
3	0.2378380	40.49	-21.68	62.17	40.10	0.10	0.29	QP
4	0.2378380	33.62	-18.55	52.17	33.23	0.10	0.29	Average
5	0.2939830	35.38	-25.03	60.41	34.81	0.10	0.47	QP
6	0.2939830	27.53	-22.88	50.41	26.96	0.10	0.47	Average
7	1.297	30.60	-25.40	56.00	30.06	0.10	0.44	QP
8	1.297	27.13	-18.87	46.00	26.59	0.10	0.44	Average
9	1.883	36.69	-19.31	56.00	36.16	0.10	0.43	QP
10	1.883	31.67	-14.33	46.00	31.14	0.10	0.43	Average
11	3.838	23.94	-22.06	46.00	23.42	0.19	0.33	Average
12	3.838	36.01	-19.99	56.00	35.49	0.19	0.33	QP

- Temperature : 23~25
- Relative Humidity : 43~45%
- Test Engineer : Darren
- Test Mode : Mode 7

The test that passed at minimum margin was marked by the frame in the following table.

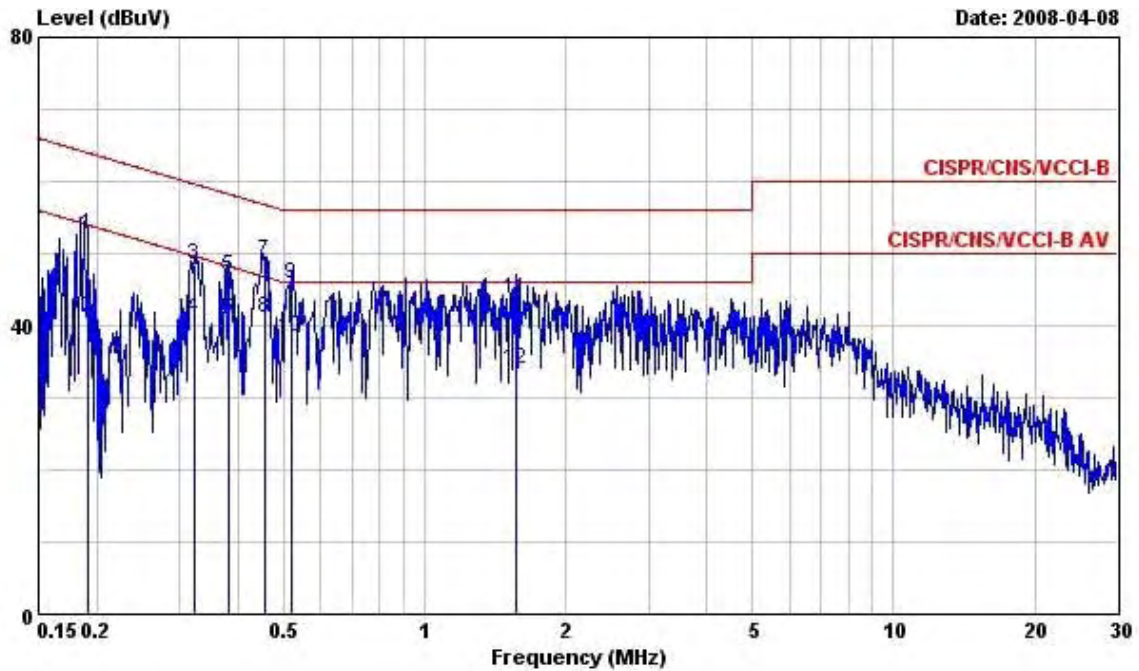

Site : CO04-HY
 Condition : CISPR/CNS/VCCI-B LISN 200604 99041 LINE
 EUT : Smart Phone WCDMA (GSM/GPRS/EDGE)
 POWER: 120V/60Hz
 Model : FR832620
 Memo : PCS1900 Idle+BT Link+WLAN Link+Battery2
 Memo : +Camera1+Apaptor B +GPS Rx
 IMEI : 357559010030751
 SAMPLE : B

	Freq	Level	Over	Limit	Read	LISN	Cable	
	MHz	dBuV	Limit	Line	Level	Factor	Loss	Remark
			dB	dBuV	dBuV	dB	dB	
1	0.1917300	52.59	-11.37	63.96	52.35	0.10	0.14	QP
2	0.1917300	41.08	-12.88	53.96	40.84	0.10	0.14	Average
3	0.3216920	48.45	-11.21	59.66	47.81	0.10	0.54	QP
4	@0.3216920	41.12	-8.54	49.66	40.48	0.10	0.54	Average
5	0.3831540	46.96	-11.25	58.21	46.17	0.10	0.69	QP
6	@0.3831540	41.03	-7.18	48.21	40.24	0.10	0.69	Average
7	@0.4558140	48.85	-7.92	56.77	48.06	0.10	0.69	QP
8	@0.4558140	40.93	-5.84	46.77	40.14	0.10	0.69	Average
9	0.5182420	45.76	-10.24	56.00	45.01	0.10	0.65	QP
10	@0.5182420	38.36	-7.64	46.00	37.61	0.10	0.65	Average
11	1.568	43.56	-12.44	56.00	43.03	0.10	0.43	QP
12	1.568	33.91	-12.09	46.00	33.38	0.10	0.43	Average

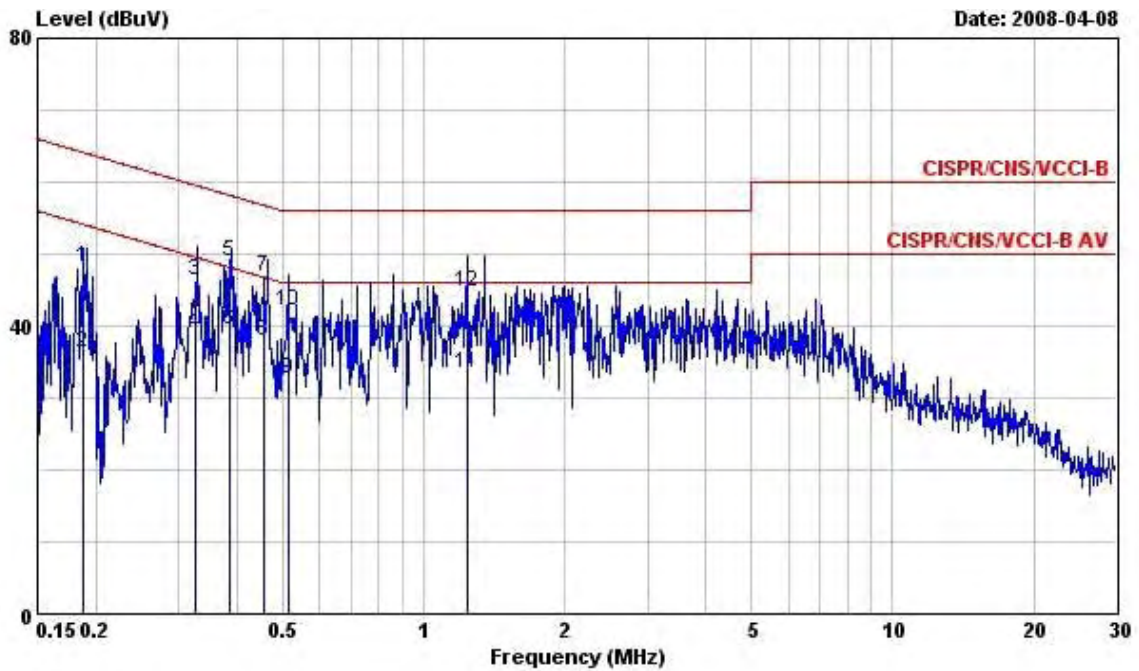

Site : CO04-HY
 Condition : CISPR/CNS/VCCI-B LISN 200604 99041 NEUTRAL
 EUT : Smart Phone WCDMA (GSM/GPRS/EDGE)
 POWER: 120V/60Hz
 Model : FR832620
 Memo : PCS1900 Idle+BT Link+WLAN Link+Battery2
 Memo : +Camera+Apator B +GPS Rx
 IMEI : 357559010030751
 SAMPLE : B

	Freq	Level	Over	Limit	Read	LISN	Cable	
	MHz	dBuV	Limit	Line	Level	Factor	Loss	Remark
			dB	dBuV	dBuV	dB	dB	
1	0.1880870	48.17	-15.95	64.12	47.93	0.10	0.14	QP
2	0.1880870	36.19	-17.93	54.12	35.95	0.10	0.14	Average
3	0.3242780	46.44	-13.16	59.60	45.79	0.10	0.55	QP
4	0.3242780	39.01	-10.59	49.60	38.36	0.10	0.55	Average
5	0.3871430	48.92	-9.20	58.12	48.12	0.10	0.70	QP
6	0.3871430	39.53	-8.59	48.12	38.73	0.10	0.70	Average
7	0.4575850	46.75	-9.99	56.74	45.96	0.10	0.69	QP
8	0.4575850	37.85	-8.89	46.74	37.06	0.10	0.69	Average
9	0.5139290	32.68	-13.32	46.00	31.93	0.10	0.65	Average
10	0.5139290	42.04	-13.96	56.00	41.29	0.10	0.65	QP
11	1.240	33.51	-12.49	46.00	32.97	0.10	0.44	Average
12	1.240	44.79	-11.21	56.00	44.25	0.10	0.44	QP

- Temperature : 23~25
- Relative Humidity : 43~45%
- Test Engineer : Darren
- Test Mode : Mode 8

The test that passed at minimum margin was marked by the frame in the following table.

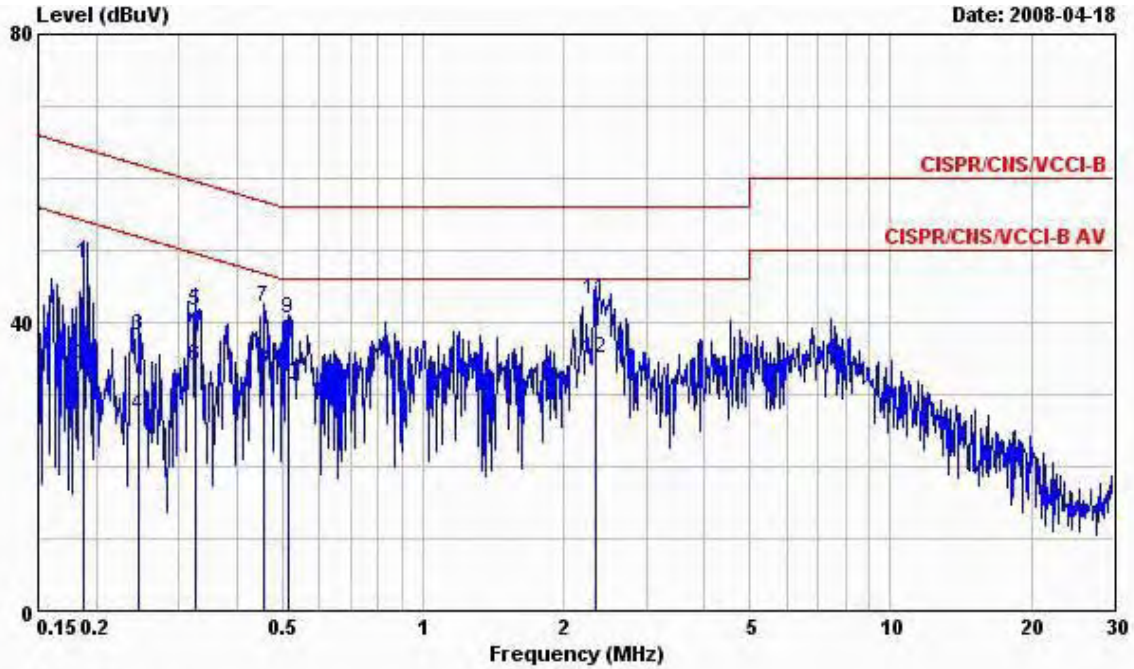

Site : CO04-HY
 Condition : CISPR/CNS/VCCI-B LISN 200604 99041 LINE
 EUT : Smart Phone WCDMA (GSM/GPRS/EDGE)
 POWER: 120V/60Hz
 Model : FR832620
 Memo : PCS1900 Idle+BT Link+WLAN Link+Battery2
 Memo : +Camera1+Apaptor B +GPS Rx
 IMEI : 357559010032062
 SAMPLE : C

	Freq	Level	Over Limit	Limit Line	Read Level	LISN Factor	Cable Loss	Remark
	MHz	dBuV	dB	dBuV	dBuV	dB	dB	
1	0.1873850	48.19	-15.96	64.15	47.95	0.10	0.14	QP
2	0.1873850	34.25	-19.90	54.15	34.01	0.10	0.14	Average
3	0.2468240	38.27	-23.59	61.86	37.85	0.10	0.32	QP
4	0.2468240	27.03	-24.83	51.86	26.61	0.10	0.32	Average
5	0.3251190	41.59	-17.98	59.57	40.94	0.10	0.55	QP
6	0.3251190	34.04	-15.53	49.57	33.39	0.10	0.55	Average
7	0.4539490	42.07	-14.73	56.80	41.28	0.10	0.69	QP
8	0.4539490	33.53	-13.27	46.80	32.74	0.10	0.69	Average
9	0.5155030	40.50	-15.50	56.00	39.75	0.10	0.65	QP
10	0.5155030	31.23	-14.77	46.00	30.48	0.10	0.65	Average
11	2.350	43.25	-12.75	56.00	42.75	0.10	0.40	QP
12	2.350	34.99	-11.01	46.00	34.49	0.10	0.40	Average

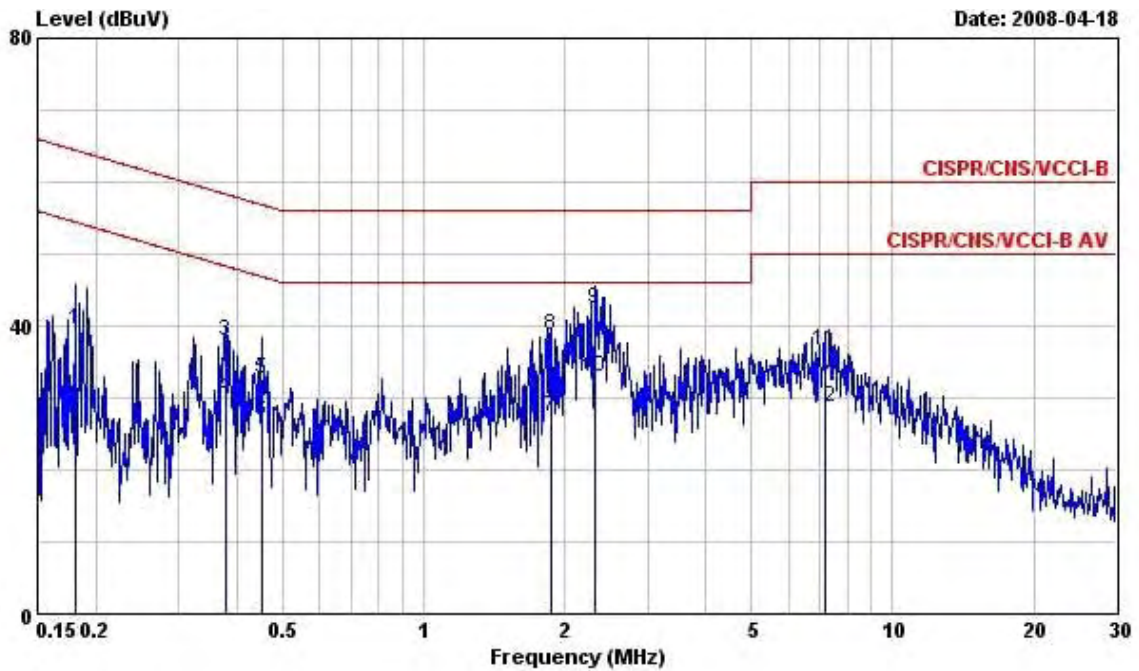

Site : CO04-HY
 Condition : CISPR/CNS/VCCI-B LISN 200604 99041 NEUTRAL
 EUT : Smart Phone WCDMA (GSM/GPRS/EDGE)
 POWER: 120V/60Hz
 Model : FR832620
 Memo : PCS1900 Idle+BT Link+WLAN Link+Battery2
 Memo : +Camera+Apaptor B +GPS Rx
 IMEI : 357559010032062
 SAMPLE : C

	Freq	Level	Over	Limit	Read	LISN	Cable	
	MHz	dBuV	Limit	Line	Level	Factor	Loss	Remark
			dB	dBuV	dBuV	dB	dB	
1	0.1805620	39.49	-24.97	64.46	39.25	0.10	0.14	QP
2	0.1805620	28.80	-25.66	54.46	28.56	0.10	0.14	Average
3	0.3791160	37.82	-20.48	58.30	37.04	0.10	0.68	QP
4	0.3791160	29.92	-18.38	48.30	29.14	0.10	0.68	Average
5	0.4515500	32.62	-24.23	56.85	31.83	0.10	0.69	QP
6	0.4515500	26.92	-19.93	46.85	26.13	0.10	0.69	Average
7	1.870	27.38	-18.62	46.00	26.85	0.10	0.43	Average
8	1.870	38.64	-17.36	56.00	38.11	0.10	0.43	QP
9	2.310	42.35	-13.65	56.00	41.82	0.12	0.41	QP
10	2.310	32.99	-13.01	46.00	32.46	0.12	0.41	Average
11	7.180	36.50	-23.50	60.00	35.98	0.26	0.26	QP
12	7.180	28.81	-21.19	50.00	28.29	0.26	0.26	Average

- Temperature : 23~25
- Relative Humidity : 43~45%
- Test Engineer : Darren
- Test Mode : Mode 9

The test that passed at minimum margin was marked by the frame in the following table.

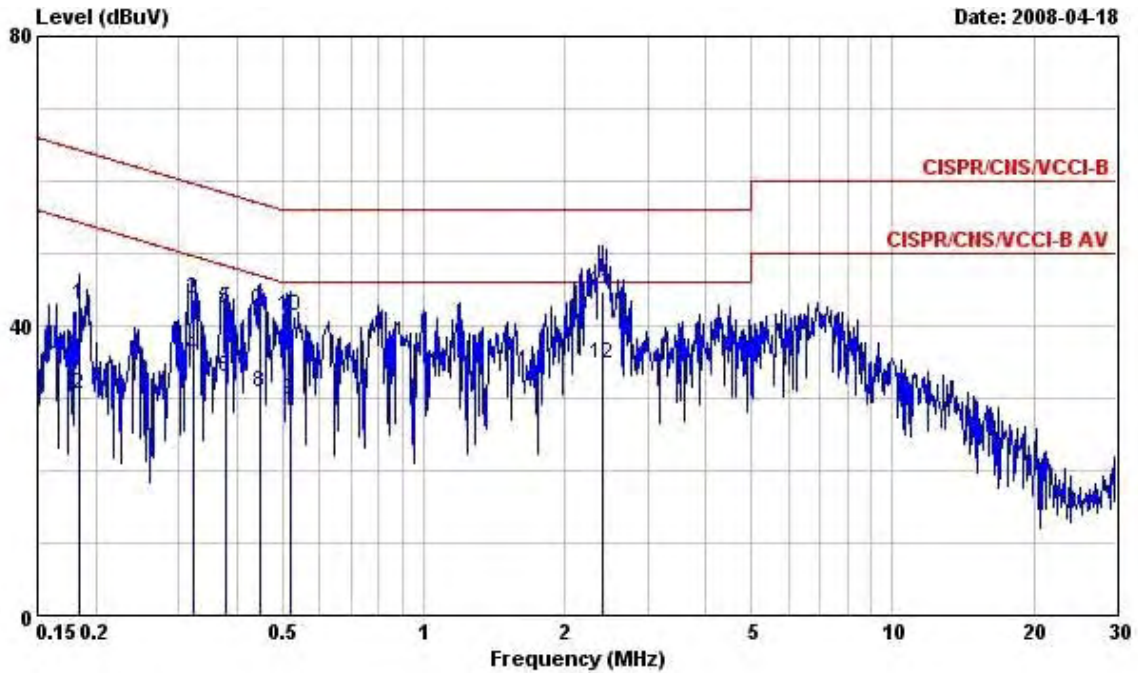

Site : CO04-HY
 Condition : CISPR/CNS/VCCI-B LISN 200604 99041 LINE
 EUT : Smart Phone WCDMA (GSM/GPRS/EDGE)
 POWER: 120V/60Hz
 Model : FR832620
 Memo : PCS1900 Idle+BT Link+WLAN Link+Battery2
 Memo : +Camera1+Apaptor B +GPS Rx
 IMEI : 357559010030538
 SAMPLE : D

	Freq	Level	Over	Limit	Read	LISN	Cable	
	MHz	dBuV	Limit	Line	Level	Factor	Loss	Remark
			dB	dBuV	dBuV	dB	dB	
1	0.1844300	42.94	-21.34	64.28	42.70	0.10	0.14	QP
2	0.1844300	30.52	-23.76	54.28	30.28	0.10	0.14	Average
3	0.3216920	43.80	-15.86	59.66	43.16	0.10	0.54	QP
4	0.3216920	35.88	-13.78	49.66	35.24	0.10	0.54	Average
5	0.3791160	42.32	-15.98	58.30	41.54	0.10	0.68	QP
6	0.3791160	32.81	-15.49	48.30	32.03	0.10	0.68	Average
7	0.4491640	42.03	-14.86	56.89	41.24	0.10	0.69	QP
8	0.4491640	30.85	-16.04	46.89	30.06	0.10	0.69	Average
9	0.5182420	29.75	-16.25	46.00	29.00	0.10	0.65	Average
10	0.5182420	41.22	-14.78	56.00	40.47	0.10	0.65	QP
11	2.400	44.73	-11.27	56.00	44.23	0.10	0.40	QP
12	2.400	34.65	-11.35	46.00	34.15	0.10	0.40	Average

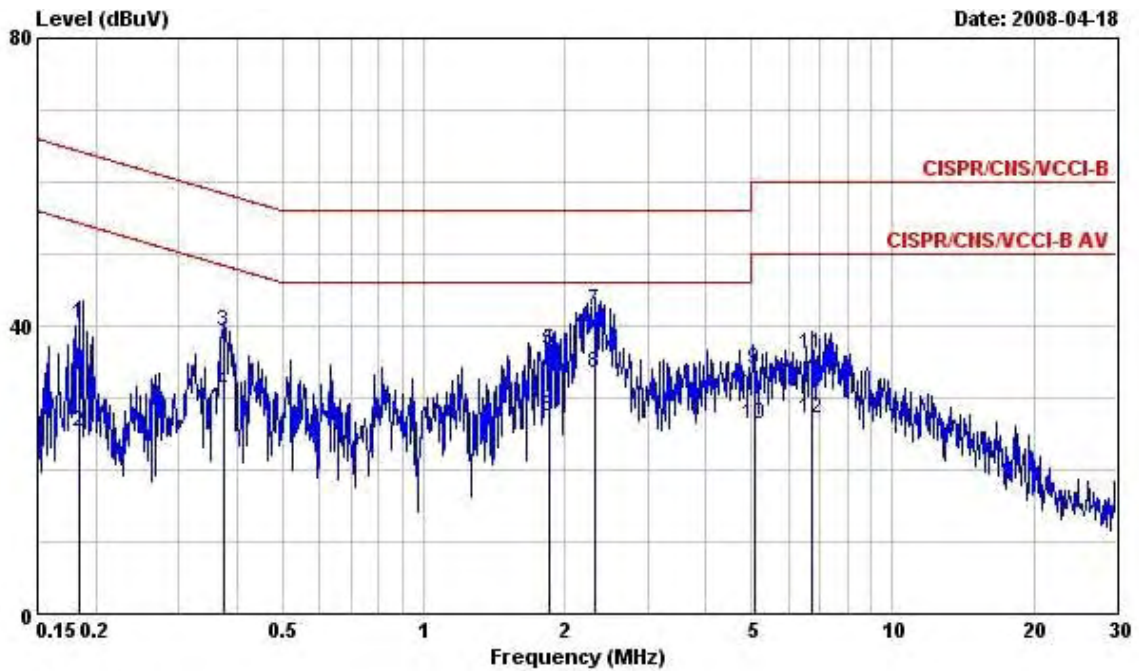

Site : CO04-HY
 Condition : CISPR/CNS/VCCI-B LISN 200604 99041 NEUTRAL
 EUT : Smart Phone WCDMA (GSM/GPRS/EDGE)
 POWER: 120V/60Hz
 Model : FR832620
 Memo : PCS1900 Idle+BT Link+WLAN Link+Battery2
 Memo : +Camera+Apator B +GPS Rx
 IMEI : 357559010030538
 SAMPLE : D

	Freq	Level	Over	Limit	Read	LISN	Cable	Remark
	MHz	dBuV	Limit	Line	Level	Factor	Loss	
			dB	dBuV	dBuV	dB	dB	
1	0.1844300	40.22	-24.06	64.28	39.98	0.10	0.14	QP
2	0.1844300	25.26	-29.02	54.28	25.02	0.10	0.14	Average
3	0.3731370	39.27	-19.16	58.43	38.50	0.10	0.67	QP
4	0.3731370	30.71	-17.72	48.43	29.94	0.10	0.67	Average
5	1.850	36.57	-19.43	56.00	36.04	0.10	0.43	QP
6	1.850	27.39	-18.61	46.00	26.86	0.10	0.43	Average
7	2.320	42.15	-13.85	56.00	41.62	0.12	0.41	QP
8	2.320	33.32	-12.68	46.00	32.79	0.12	0.41	Average
9	5.060	33.99	-26.01	60.00	33.47	0.23	0.29	QP
10	5.060	26.37	-23.63	50.00	25.85	0.23	0.29	Average
11	6.730	36.06	-23.94	60.00	35.54	0.26	0.26	QP
12	6.730	27.16	-22.84	50.00	26.64	0.26	0.26	Average

- Temperature : 23~25
- Relative Humidity : 43~45%
- Test Engineer : Darren
- Test Mode : Mode 10

The test that passed at minimum margin was marked by the frame in the following table.

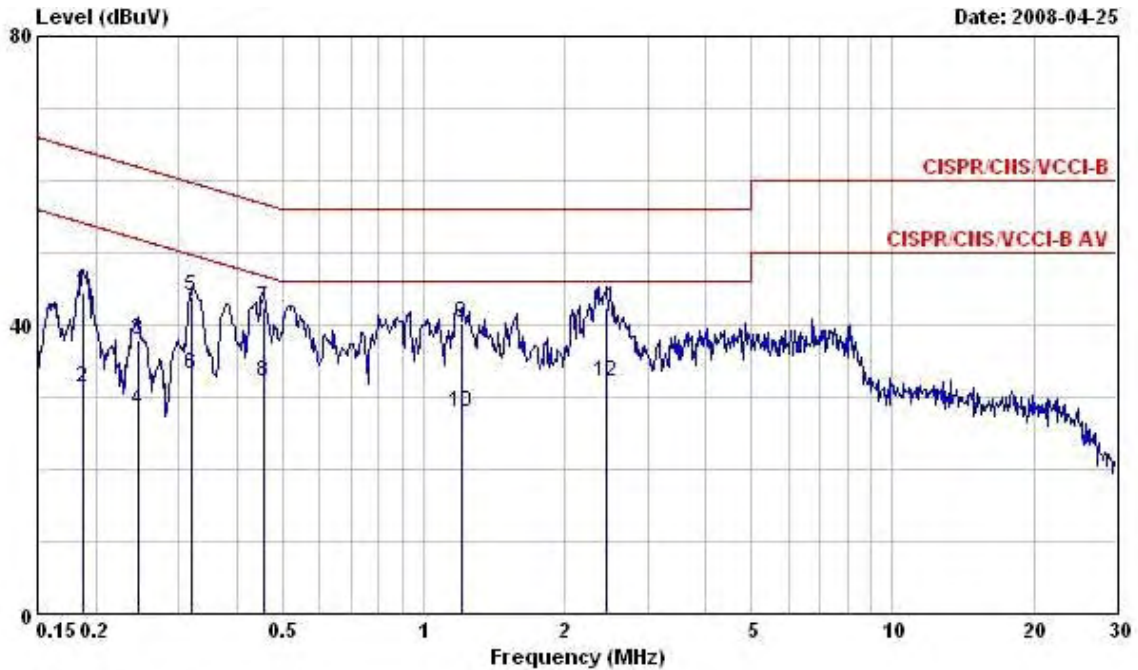

Site : CO04-HY
 Condition : CISPR/CNS/VCCI-B LISN 200604 99041 LINE
 EUT : Smart Phone WCDMA (GSM/GPRS/EDGE)
 POWER: 120V/60Hz
 Model : FR832620
 Memo : PCS1900 Idel+BT Link+WLAN Link+Battery6
 Memo : +Camera+Apaptor B +GPS Rx
 IMEI : 357559010030751
 SAMPLE : B

	Freq	Level	Over	Limit	Read	LISN	Cable	
	MHz	dBuV	dB	dBuV	dBuV	dB	dB	Remark
1	0.1883800	44.43	-19.68	64.11	44.19	0.10	0.14	QP
2	0.1883800	31.21	-22.90	54.11	30.97	0.10	0.14	Average
3	0.2455200	37.82	-24.09	61.91	37.40	0.10	0.32	QP
4	0.2455200	28.23	-23.68	51.91	27.81	0.10	0.32	Average
5	0.3199920	44.00	-15.71	59.71	43.36	0.10	0.54	QP
6	0.3199920	33.21	-16.50	49.71	32.57	0.10	0.54	Average
7	@0.4563600	42.29	-14.47	56.76	41.50	0.10	0.69	QP
8	@0.4563600	32.23	-14.53	46.76	31.44	0.10	0.69	Average
9	1.200	40.25	-15.75	56.00	39.71	0.10	0.44	QP
10	1.200	27.85	-18.15	46.00	27.31	0.10	0.44	Average
11	@ 2.460	42.47	-13.53	56.00	41.97	0.10	0.40	QP
12	@ 2.460	32.05	-13.95	46.00	31.55	0.10	0.40	Average

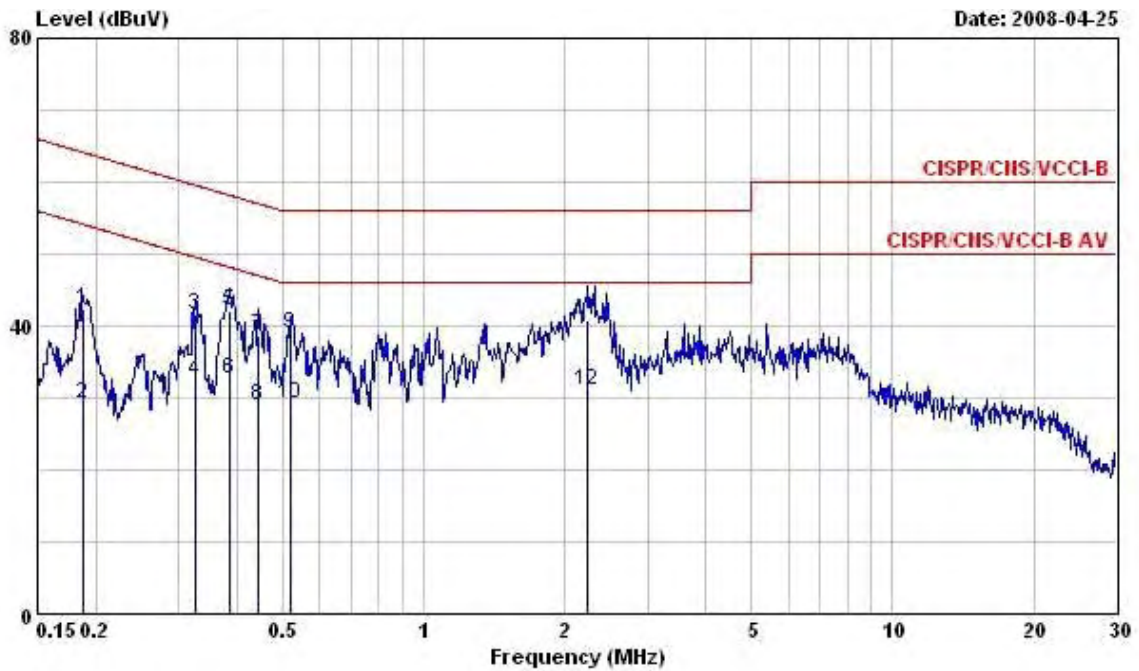

Site : CO04-HY
 Condition : CISPR/CNS/VCCI-B LISN 200604 99041 NEUTRAL
 EUT : Smart Phone WCDMA (GSM/GPRS/EDGE)
 POWER: 120V/60Hz
 Model : FR832620
 Memo : PCS1900 Idel+BT Link+WLAN Link+Battery6
 Memo : +Camera+Apator B +GPS Rx
 IMEI : 357559010030751
 SAMPLE : B

	Freq	Level	Over	Limit	Read	LISN	Cable	Remark
	MHz	dBuV	Limit	Line	Level	Factor	Loss	
			dB	dBuV	dBuV	dB	dB	
1	0.1873850	42.26	-21.89	64.15	42.02	0.10	0.14	QP
2	0.1873850	29.29	-24.86	54.15	29.05	0.10	0.14	Average
3	0.3268460	41.50	-18.03	59.53	40.84	0.10	0.56	QP
4	0.3268460	32.45	-17.08	49.53	31.79	0.10	0.56	Average
5	0.3872360	42.02	-16.10	58.12	41.22	0.10	0.70	QP
6	0.3872360	32.76	-15.36	48.12	31.96	0.10	0.70	Average
7	0.4444290	38.75	-18.23	56.98	37.95	0.10	0.70	QP
8	0.4444290	28.95	-18.03	46.98	28.15	0.10	0.70	Average
9	0.5209950	39.02	-16.98	56.00	38.27	0.10	0.65	QP
10	0.5209950	29.21	-16.79	46.00	28.46	0.10	0.65	Average
11	2.240	40.91	-15.09	56.00	40.38	0.12	0.41	QP
12	2.240	31.03	-14.97	46.00	30.50	0.12	0.41	Average

5.7 Radiated Emission Measurement

5.7.1 Measuring Instruments

As described in chapter 6 of this Report.

The spectrum analyzer setting :

30 ~ 1000 MHz	Detector : Quasi – Peak Bandwidth : 120 KHz
1 ~ 25 GHz	Detector : Peak and Average Bandwidth : 1 MHz

5.7.2 Test Procedures

1. The EUT was placed on a rotatable table top 0.8 meter above ground.
2. The EUT was set 3 meters from the interference receiving antenna which was mounted on the top of a variable height antenna tower.
3. The table was rotated 360 degrees to determine the position of the highest radiation.
4. The antenna is a broadband antenna and its height is varied between one meter and four meters above ground to find the maximum value of the field strength for both horizontal polarization and vertical polarization of the antenna.
5. For each suspected emission, the EUT was arranged to its worst case and then tune the antenna tower (from 1 m to 4 m) and turntable (from 0 degree to 360 degrees) to find the maximum reading.
6. Set the test-receiver system to Peak or CISPR quasi-peak Detect Function and specified bandwidth with Maximum Hold Mode.
7. For testing below 1GHz, If the emission level of the EUT in peak mode was 3 dB lower than the limit specified, then testing will be stopped and peak values of EUT will be reported, otherwise, the emissions will be repeated one by one using the quasi-peak method and reported.
8. For testing above 1GHz, the emission level of the EUT in peak mode was 20dB lower than average limit (that means the emission level in average mode also complies with the limit in average mode), then testing will be stopped and peak values of EUT will be reported, otherwise, the emissions will be measured in average mode again and reported.

5.7.3 Typical Test Setup Layout of Radiated Emission

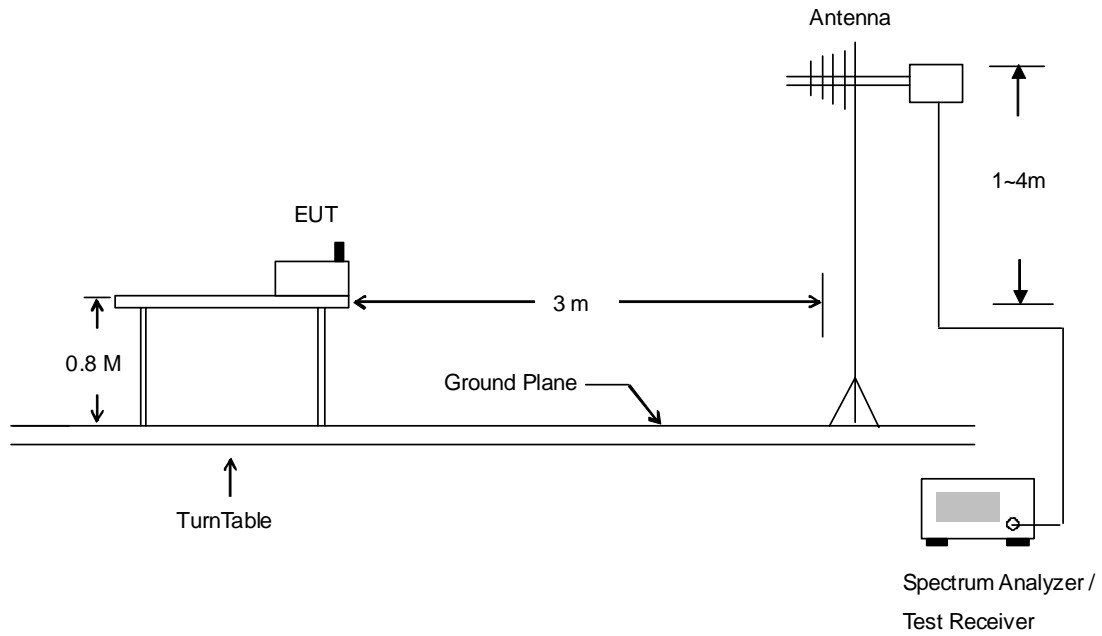

5.7.4 Test Data

- Temperature : 22~26°C
- Relating Humidity : 49~56%
- Test Enginner : Sun
- Test Mode : Mode 1
- Polarization : Horizontal (30MHz-1GHz)

The test that passed at minimum margin was marked by the boldface in the following table.

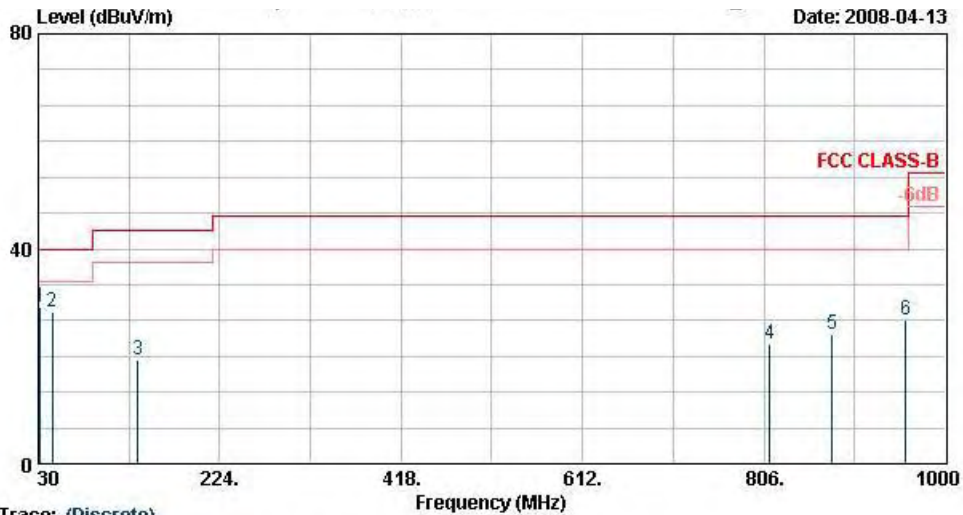

Trace: (Discrete)
 Site : 03CH06-HY
 Condition : FCC CLASS-B 3m LF-ANT(051121) HORIZONTAL
 EUT : Smart Phone WCDMA/GSM/GPRS/EDGE
 Power : 120Vac/60Hz
 Model : FR 832620
 Memo : 11b Tr_Ch01 ; 2412MHz + Adaptor
 Data Rate :
 Plane :
 TMEI : 35755901003041301

	Freq	Level	Over	Limit	Read	Antenna	Cable	Preamp	Ant	Table	Remark
	MHz	dBUV/m	dB	dBUV/m	dBUV	dB/m	dB	dB	cm	deg	
1	32.43	29.05	-10.95	40.00	44.59	17.54	0.30	33.38	100	177	Peak
2	44.58	28.30	-11.70	40.00	50.09	11.02	0.30	33.11	---	---	Peak
3	136.38	19.48	-24.02	43.50	41.74	10.73	0.50	33.50	---	---	Peak
4	812.40	22.35	-23.65	46.00	33.83	19.91	1.20	32.59	---	---	Peak
5	878.90	24.01	-21.99	46.00	35.08	20.38	1.30	32.75	---	---	Peak
6	957.30	26.87	-19.13	46.00	37.04	20.94	1.27	32.38	---	---	Peak

- Polarization : Horizontal (1GHz-25GHz)

The test that passed at minimum margin was marked by the boldface in the following table.

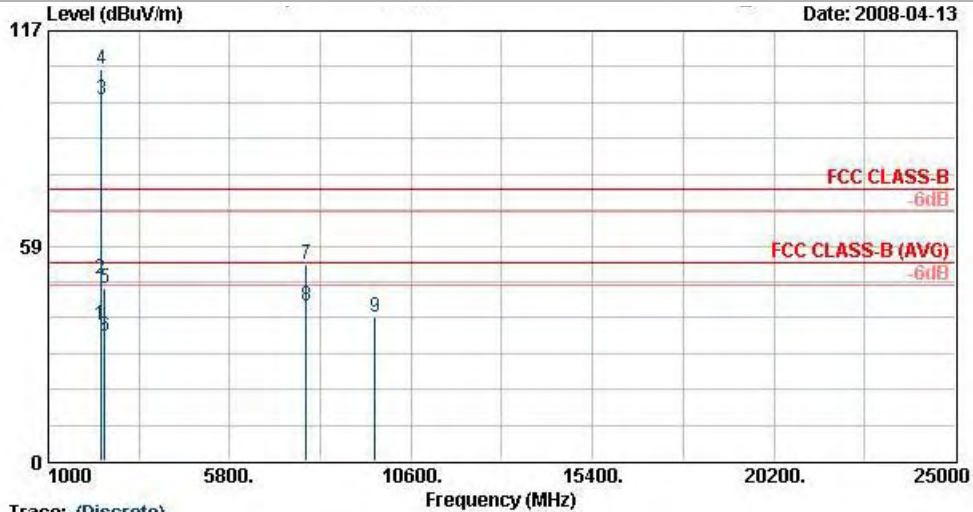

Trace: (Discrete)
 Site : 03CH06-HY
 Condition : FCC CLASS-B 3m SHF-EHF HORN HORIZONTAL
 EUT : Smart Phone WCDMA/GSM/GPRS/EDGE
 Power : 120Vac/60Hz
 Model : FR 832620
 Memo : 116 Tx_Ch01 ; 2412MHz + Adaptor
 Data Rate :
 Plane : H
 TMET : 35755001003041301

	Freq	Level	Over	Limit	Read	Antenna	Cable	Preamp	Ant	Table	Remark
	MHz	dBuV/m	Limit	Line	Level	Factor	Loss	Factor	Pos	Pos	
			dB	dBuV/m	dBuV	dB/m	dB	dB	cm	deg	
1	2388.09	37.13	-16.87	54.00	37.03	31.86	3.92	35.68	123	64	Average
2	2388.09	49.66	-24.34	74.00	49.56	31.86	3.92	35.68	100	0	Peak
3 @	2412.00	98.31			98.16	31.88	3.95	35.68	123	64	Average
4 X	2412.00	106.52			106.37	31.88	3.95	35.68	100	0	Peak
5	2484.00	46.98	-27.02	74.00	46.65	31.98	4.05	35.70	100	0	Peak
6	2484.00	33.80	-20.20	54.00	33.47	31.98	4.05	35.70	123	64	Average
7	7827.00	53.54	-20.46	74.00	46.71	35.67	7.42	36.27	100	0	Peak
8	7827.00	42.39	-11.61	54.00	35.56	35.67	7.42	36.27	100	174	Average
9	9642.00	39.25	-34.75	74.00	78.13	-10.09	7.94	36.73	100	0	Peak

Remark: #3 and #4 are Fundamental Signals.

- Polarization : Vertical (30MHz-1GHz)

The test that passed at minimum margin was marked by the boldface in the following table.

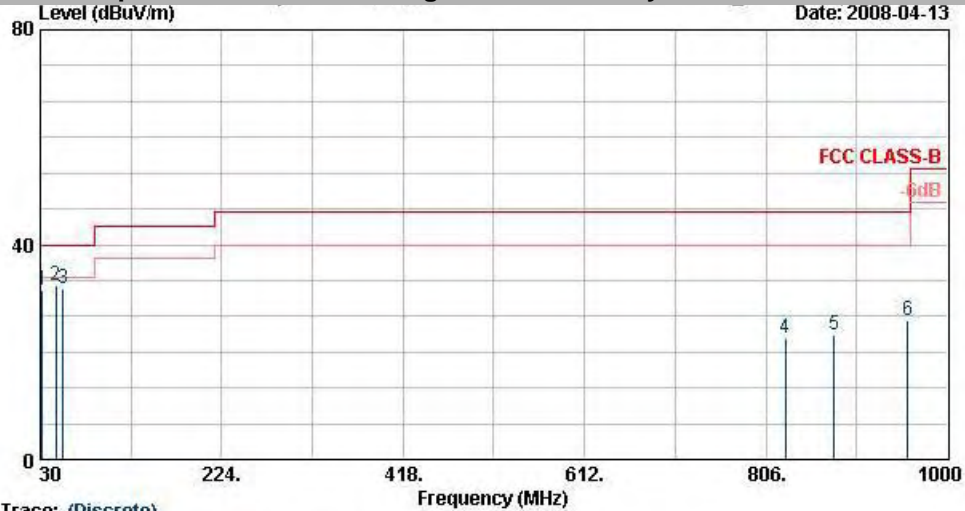

Trace: (Discrete)
 Site : 03CH06-HY
 Condition : FCC CLASS-B 3m LF-ANT(951121) VERTICAL
 EUT : Smart Phone WCDMA/GSM/GPRS/EDGE
 Power : 120Vac/60Hz
 Model : FR 832620
 Memo : 11b Tx_Ch01 ; 2412MHz + Adaptor
 Data Rate :
 Plane :
 TMET : 35755901003041301

	Freq	Level	Over	Limit	ReadAntenna	Cable	Preamp	Ant	Table	Remark
	MHz	dBuV/m	Limit	Line	Level	Loss	Factor	Pos	Pos	
			dB	dBuV/m	dBuV	dB	dB	cm	deg	
1	32.43	31.57	-8.43	40.00	47.11	17.54	0.30	33.38	---	Peak
2	46.74	32.35	-7.65	40.00	55.13	10.04	0.30	33.12	100	143 Peak
3	54.03	31.77	-8.23	40.00	57.22	7.50	0.38	33.33	---	Peak
4	826.40	22.56	-23.44	46.00	33.98	20.01	1.20	32.62	---	Peak
5	878.90	23.12	-22.88	46.00	34.19	20.38	1.30	32.75	---	Peak
6	957.30	25.97	-20.03	46.00	36.14	20.94	1.27	32.38	---	Peak

- Polarization : Vertical (1GHz-25GHz)

The test that passed at minimum margin was marked by the boldface in the following table.

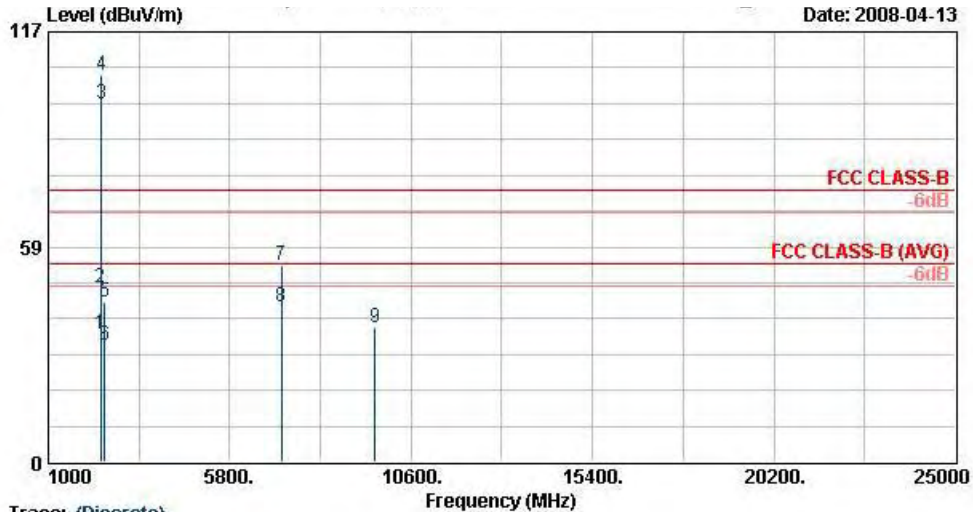

Trace: (Discrete)
 Site : 03CH06-HY
 Condition : FCC CLASS-B 3m SHF-EHF HORN VERTICAL
 EUT : Smart Phone WCDMA/GSM/GPRS/EDGE
 Power : 120Vac/60Hz
 Model : FR 832620
 Memo : 11b Tx_Ch01 ; 2412MHz + Adaptor
 Data Rate :
 Plane : H
 IMET : 35755901003041301

	Freq	Level	Over Limit	Limit Line	Read Level	Antenna Factor	Cable Loss	Preamp Factor	Ant Pos	Table Pos	Remark
	MHz	dBuV/m	dB	dBuV/m	dBuV	dB/m	dB	dB	cm	deg	
1	2388.09	34.84	-19.16	54.00	34.74	31.86	3.92	35.68	102	35	Average
2	2388.09	47.31	-26.69	74.00	47.21	31.86	3.92	35.68	100	0	Peak
3 @	2412.00	97.40			97.25	31.88	3.95	35.68	102	35	Average
4 X	2412.00	105.17			105.02	31.88	3.95	35.68	100	0	Peak
5	2500.00	43.51	-30.49	74.00	43.16	32.00	4.05	35.70	100	0	Peak
6	2500.00	31.67	-22.33	54.00	31.32	32.00	4.05	35.70	102	35	Average
7	7176.00	53.48	-20.52	74.00	46.67	35.73	7.15	36.07	100	0	Peak
8	7176.00	42.27	-11.73	54.00	35.46	35.73	7.15	36.07	100	199	Average
9	9642.00	36.38	-37.62	74.00	75.26	-10.09	7.94	36.73	100	0	Peak

Remark: #3 and #4 are Fundamental Signals.

- Test Mode : Mode 2
- Polarization : Horizontal (30MHz-1GHz)

The test that passed at minimum margin was marked by the boldface in the following table.

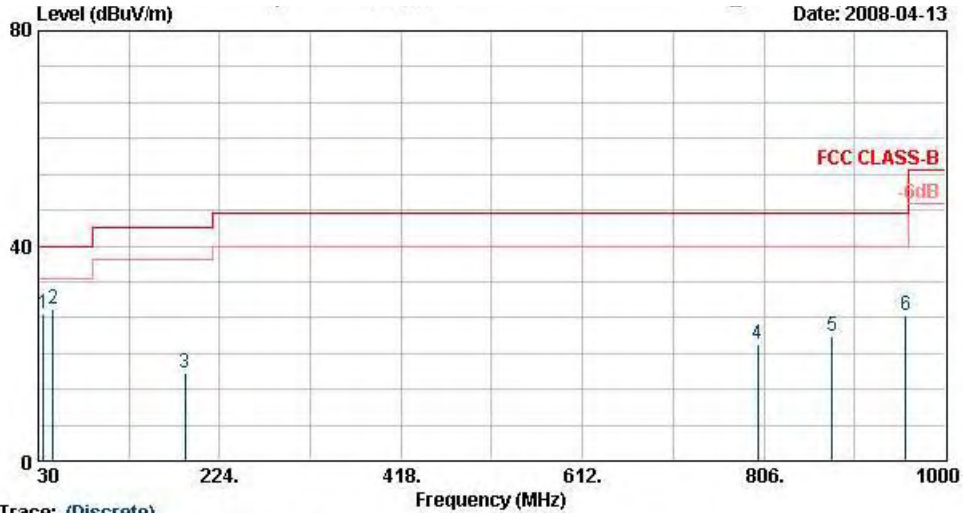

Trace: (Discrete)
 Site : 03CH06-HY
 Condition : FCC CLASS-B 3m LF-ANT(851121) HORIZONTAL
 EUT : Smart Phone WCDMA/GSM/GPRS/EDGE
 Power : 120Vac/60Hz
 Model : FR 832620
 Memo : 11b Tx_Ch06 ; 2437MHz + Adaptor
 Data Rate :
 Plane :
 TMEI : 35755901003041301

	Freq	Level	Over	Limit	Read	Antenna	Cable	Preamp	Ant	Table	Remark
	MHz	dBuV/m	Limit	Line	Level	Factor	Loss	Factor	Pos	Pos	
			dB	dBuV/m	dBuV	dB/m	dB	dB	cm	deg	
1	35.94	27.42	-12.58	40.00	44.80	15.61	0.30	33.28	---	---	Peak
2 @	45.93	28.39	-11.61	40.00	50.68	10.53	0.30	33.12	100	159	Peak
3	187.14	16.33	-27.17	43.50	39.84	9.39	0.60	33.49	---	---	Peak
4	799.80	21.59	-24.41	46.00	33.13	19.82	1.20	32.56	---	---	Peak
5	878.90	23.10	-22.90	46.00	34.17	20.38	1.30	32.75	---	---	Peak
6	957.30	27.06	-18.94	46.00	37.23	20.94	1.27	32.38	---	---	Peak

- Polarization : Horizontal (1GHz-25GHz)

The test that passed at minimum margin was marked by the boldface in the following table.

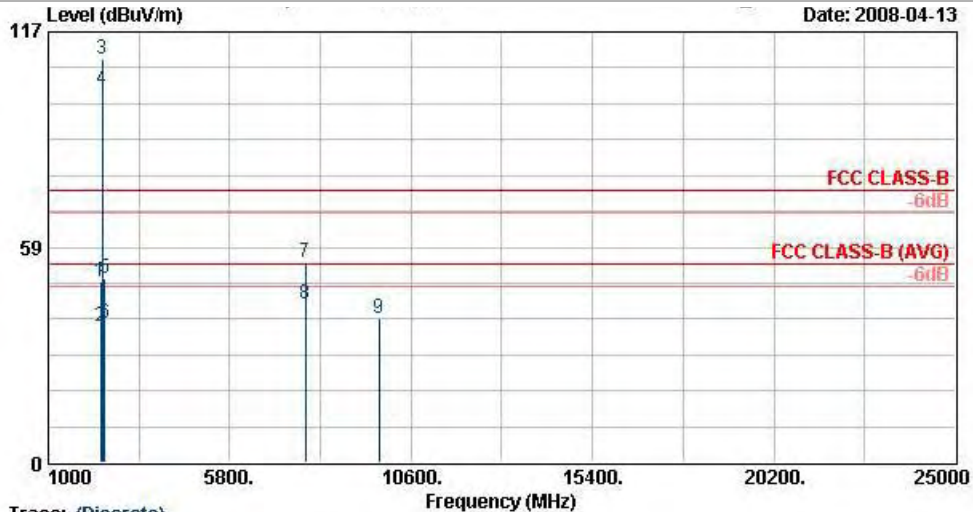

Trace: (Discrete)
 Site : 03CH06-HY
 Condition : FCC CLASS-B 3m SHF-EHF HORN HORIZONTAL
 EUT : Smart Phone WCDMA/GSM/GPRS/EDGE
 Power : 120Vac/60Hz
 Model : FR 832620
 Memo : 11b Tx_Ch06 ; 2437MHz + Adaptor
 Data Rate :
 Plane : H
 TMET : 35755901003041301

	Freq	Level	Over	Limit	Read	Antenna	Cable	Preamp	Ant	Table	Remark
	MHz	dBuV/m	Limit	Line	Level	Factor	Loss	Factor	Pos	Pos	
			dB	dBuV/m	dBuV	dB/m	dB	dB	cm	deg	
1	2382.00	49.14	-24.86	74.00	49.06	31.83	3.92	35.68	100	0	Peak
2	2382.00	37.10	-16.90	54.00	37.02	31.83	3.92	35.68	101	358	Average
3 @	2437.00	109.72			109.49	31.93	3.99	35.69	100	0	Peak
4 @	2437.00	101.49			101.26	31.93	3.99	35.69	101	358	Average
5	2484.00	50.15	-23.85	74.00	49.82	31.98	4.05	35.70	100	0	Peak
6	2484.00	37.67	-16.33	54.00	37.34	31.98	4.05	35.70	101	358	Average
7	7806.00	54.31	-19.69	74.00	47.49	35.66	7.42	36.26	100	0	Peak
8 @	7806.00	43.13	-10.87	54.00	36.31	35.66	7.42	36.26	100	210	Average
9	9747.00	39.22	-34.78	74.00	77.84	-9.85	7.98	36.75	100	0	Peak

Remark: #3 and #4 are Fundamental Signals.

- Polarization : Vertical (30MHz-1GHz)

The test that passed at minimum margin was marked by the boldface in the following table.

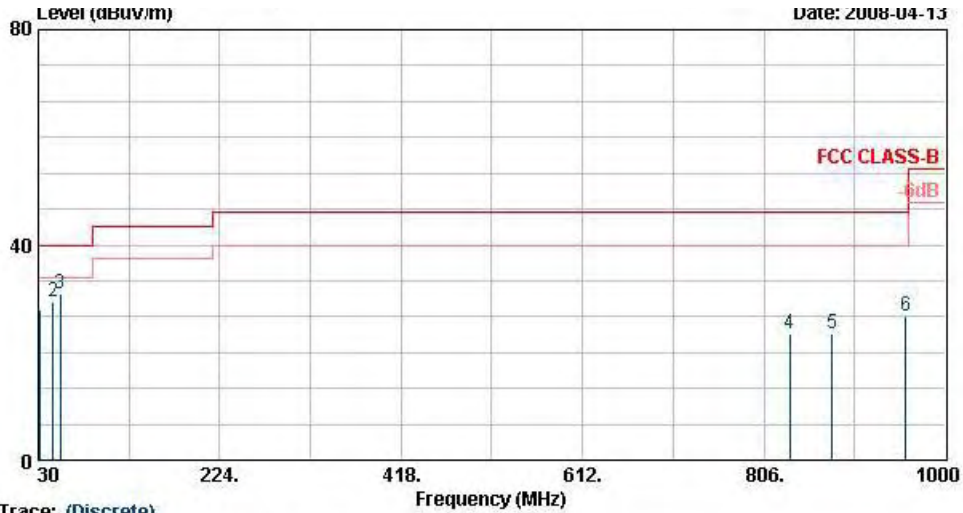

Trace: (Discrete)
 Site : D3CH06-HY
 Condition : FCC CLASS-B 3m LF-ANT(951121) VERTICAL
 EUT : Smart Phone WCDMA/GSM/GPRS/EDGE
 Power : 120Vac/60Hz
 Model : FR 832620
 Memo : 11b Tx_Ch06 ; 2437MHz + Adaptor
 Data Rate :
 Plane :
 TIME : 35755901003041301

	Freq	Level	Over	Limit	ReadAntenna	Cable	Preamp	Ant	Table	Remark	
	MHz	dBuV/m	Limit	Line	Level	Loss	Factor	Pos	Pos		
			dB	dBuV/m	dBuV	dB	dB	cm	deg		
1	31.62	27.91	-12.09	40.00	42.78	18.25	0.30	33.42	---	Peak	
2 @	45.93	29.35	-10.65	40.00	51.64	10.53	0.30	33.12	---	Peak	
3 @	53.49	31.04	-8.96	40.00	56.32	7.64	0.36	33.28	100	177	Peak
4	833.40	23.36	-22.64	46.00	34.74	20.05	1.20	32.64	---	Peak	
5	878.90	23.37	-22.63	46.00	34.44	20.38	1.30	32.75	---	Peak	
6	957.30	26.68	-19.32	46.00	36.86	20.94	1.27	32.38	---	Peak	

- Polarization : Vertical (1GHz-25GHz)

The test that passed at minimum margin was marked by the boldface in the following table.

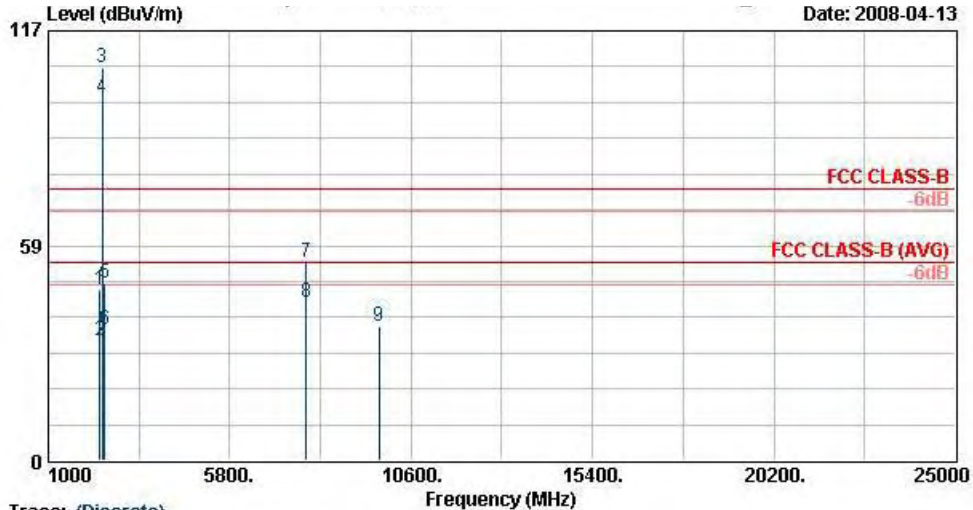

Trace: (Discrete)
 Site : 03CH06-HY
 Condition : FCC CLASS-B 3m SHF-EHF HORN VERTICAL
 EUT : Smart Phone WCDMA/GSM/GPRS/EDGE
 Power : 120Vac/60Hz
 Model : FR 832620
 Memo : 11b Tx_Ch06 ; 2437MHz + Adaptor
 Data Rate :
 Plane : H
 TMET : 35755901003041301

	Freq	Level	Over Limit	Limit	Read Level	Antenna Factor	Cable Loss	Preamp Factor	Ant Pos	Table Pos	Remark
	MHz	dBUV/m	dB	dBUV/m	dBUV	dB/m	dB	dB	cm	deg	
1	2372.00	46.37	-27.63	74.00	46.33	31.83	3.89	35.68	100	0	Peak
2	2372.00	32.48	-21.52	54.00	32.44	31.83	3.89	35.68	118	64	Average
3 @	2437.00	106.95			106.72	31.93	3.99	35.69	100	0	Peak
4 @	2437.00	98.72			98.49	31.93	3.99	35.69	118	64	Average
5	2484.00	48.22	-25.78	74.00	47.89	31.98	4.05	35.70	100	0	Peak
6	2484.00	35.61	-18.39	54.00	35.28	31.98	4.05	35.70	118	64	Average
7	7827.00	53.89	-20.11	74.00	47.06	35.67	7.42	36.27	100	0	Peak
8 @	7827.00	43.28	-10.72	54.00	36.45	35.67	7.42	36.27	100	142	Average
9	9747.00	36.51	-37.49	74.00	75.12	-9.85	7.98	36.75	100	0	Peak

Remark: #3 and #4 are Fundamental Signals.

- Test Mode : Mode 3
- Polarization : Horizontal (30MHz-1GHz)

The test that passed at minimum margin was marked by the boldface in the following table.

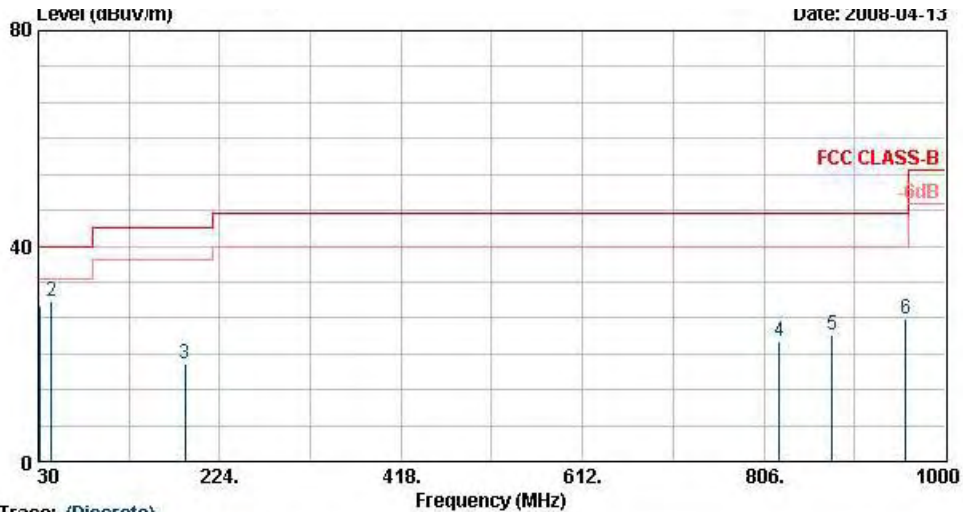

Trace: (Discrete)
 Site : 03CH06-HY
 Condition : FCC CLASS-B 3m LF-ANT(051121) HORIZONTAL
 EUT : Smart Phone WCDMA/GSM/GPRS/EDGE
 Power : 120Vac/60Hz
 Model : FR 832620
 Memo : 11b Tx_Ch11 ; 2462MHz + Adaptor
 Data Rate :
 Plane :
 TIME : 35755901003041301

	Freq	Level	Over	Limit	Read	Antenna	Cable	Preamp	Ant	Table	Remark
	MHz	dBuV/m	Limit	Line	Level	Factor	Loss	Factor	Pos	Pos	
			dB	dBuV/m	dBuV	dB/m	dB	dB	cm	deg	
1	31.08	28.90	-11.10	40.00	43.10	18.95	0.30	33.46	---	---	Peak
2	44.04	29.80	-10.20	40.00	51.11	11.52	0.30	33.13	100	285	Peak
3	187.14	18.05	-25.45	43.50	41.56	9.39	0.60	33.49	---	---	Peak
4	822.90	22.18	-23.82	46.00	33.61	19.98	1.20	32.61	---	---	Peak
5	878.90	23.39	-22.61	46.00	34.46	20.38	1.30	32.75	---	---	Peak
6	957.30	26.44	-19.56	46.00	36.61	20.94	1.27	32.38	---	---	Peak

- Polarization : Horizontal (1GHz-25GHz)

The test that passed at minimum margin was marked by the boldface in the following table.

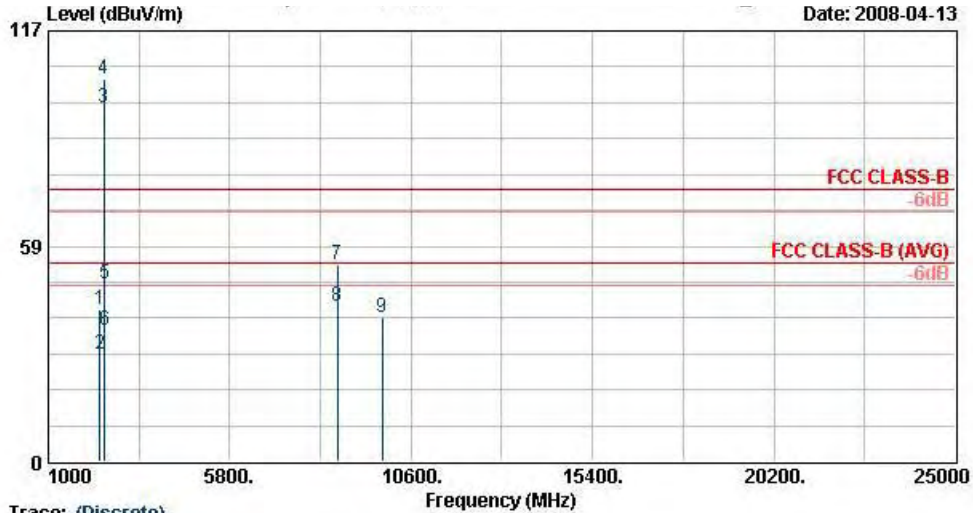

Trace: (Discrete)
 Site : 03CH06-HY
 Condition : FCC CLASS-B 3m SHF-EHF HORN HORIZONTAL
 EUT : Smart Phone WCDMA/GSM/GPRS/EDGE
 Power : 120Vac/60Hz
 Model : FR 832620
 Memo : 11b Tx_Ch11 ; 2462MHz + Adaptor
 Data Rate :
 Plane : H
 IMEI : 35755901003041301

	Freq	Level	Over	Limit	Read	Antenna	Cable	Preamp	Ant	Table	Remark
	MHz	dBuV/m	dB	dBuV/m	dBuV	dB/m	dB	dB	cm	deg	
1	2366.00	41.50	-32.50	74.00	41.49	31.81	3.89	35.68	100	0	Peak
2	2366.00	29.08	-24.92	54.00	29.06	31.81	3.89	35.68	100	11	Average
3 @	2462.00	96.00			95.72	31.95	4.02	35.69	100	11	Average
4 X	2462.00	104.03			103.75	31.95	4.02	35.69	100	0	Peak
5	2485.37	48.41	-25.59	74.00	48.33	31.83	3.92	35.68	100	0	Peak
6	2485.37	35.82	-18.18	54.00	35.74	31.83	3.92	35.68	100	11	Average
7	8661.00	53.51	-20.49	74.00	46.48	36.03	7.39	36.39	100	0	Peak
8	8661.00	42.34	-11.66	54.00	35.31	36.03	7.39	36.39	100	213	Average
9	9846.00	39.02	-34.98	74.00	77.38	-9.63	8.04	36.77	100	0	Peak

Remark: #3 and #4 are Fundamental Signals.

- Polarization : Vertical (30MHz-1GHz)

The test that passed at minimum margin was marked by the boldface in the following table.

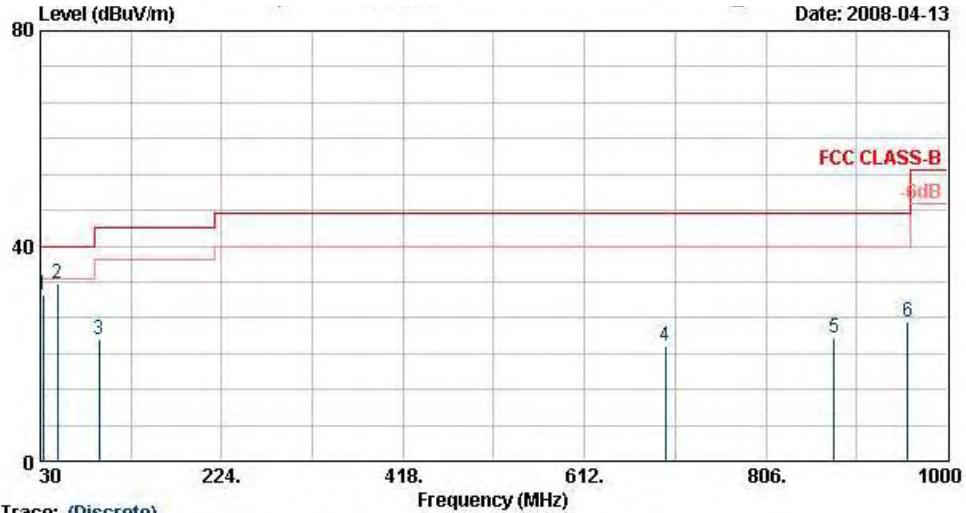

Trace: (Discrete)
 Site : 03CH06-HY
 Condition : FCC CLASS-B 3m LF-ANT(951121) VERTICAL
 EUT : Smart Phone WCDMA/GSM/GPRS/EDGE
 Power : 120Vac/60Hz
 Model : FR 832620
 Memo : 11b Tx_Ch11 ; 2462MHz + Adaptor
 Data Rate :
 Plane :
 TMEI : 35755901003041301

	Freq	Level	Over	Limit	Read	Antenna	Cable	Preamp	Ant	Table	Remark
	MHz	dBUV/m	Limit	Line	Level	Factor	Loss	Factor	Pos	Pos	
			dB	dBUV/m	dBuV	dB/m	dB	dB	cm	deg	
1	33.24	30.91	-9.09	40.00	46.45	17.54	0.30	33.38	---	---	Peak
2	48.63	33.11	-6.89	40.00	56.89	9.06	0.30	33.14	100	119	Peak
3	92.64	22.54	-20.96	43.50	45.76	9.62	0.50	33.33	---	---	Peak
4	698.30	21.40	-24.60	46.00	34.58	18.88	1.10	33.16	---	---	Peak
5	878.90	23.01	-22.99	46.00	34.08	20.38	1.30	32.75	---	---	Peak
6	957.30	25.86	-20.14	46.00	36.03	20.94	1.27	32.38	---	---	Peak

- Polarization : Vertical (1GHz-25GHz)

The test that passed at minimum margin was marked by the boldface in the following table.

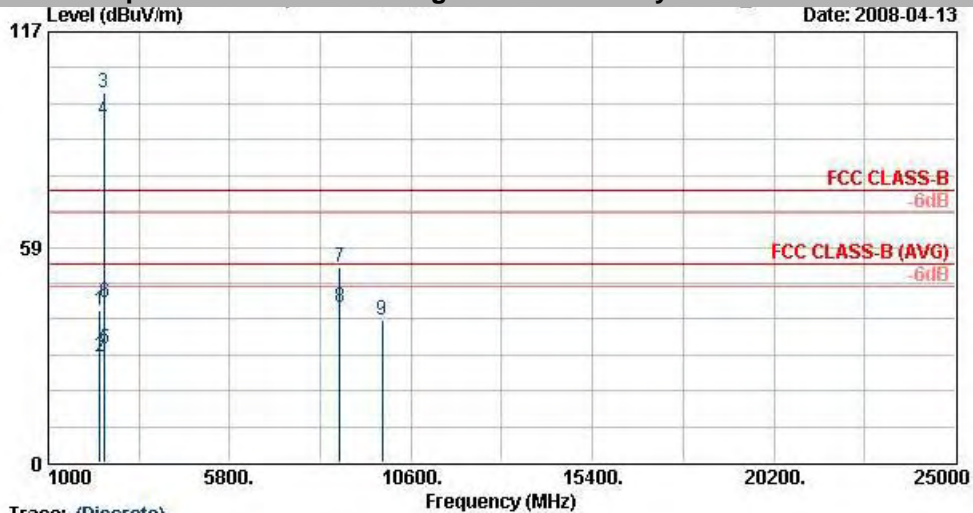

Trace: (Discrete)
 Site : 03CH06-HY
 Condition : FCC CLASS-B 3m SHF-EHF HORN HORIZONTAL
 EUT : Smart Phone WCDMA/GSM/GPRS/EDGE
 Power : 120Vac/60Hz
 Model : FR 832620
 Memo : 11b Tx_Ch11 ; 2462MHz + Adaptor
 Data Rate :
 Plane : H
 TMET : 35755801003041301

	Freq	Level	Over Limit	Limit Line	Read Level	Antenna Factor	Cable Loss	Preamp Factor	Ant Pos	Table Pos	Remark
	MHz	dBuV/m	dB	dBuV/m	dBuV	dB/m	dB	dB	cm	deg	
1	2364.00	41.20	-32.80	74.00	41.18	31.81	3.89	35.67	100	0	Peak
2	2364.00	28.62	-25.38	54.00	28.60	31.81	3.89	35.67	129	130	Average
3 X	2462.00	100.68			100.40	31.95	4.02	35.69	100	0	Peak
4 @	2462.00	92.99			92.71	31.95	4.02	35.69	129	130	Average
5	2484.61	31.02	-22.98	54.00	30.69	31.98	4.05	35.70	129	130	Average
6	2484.61	43.46	-30.54	74.00	43.13	31.98	4.05	35.70	100	0	Peak
7	8721.00	53.24	-20.76	74.00	46.09	36.10	7.48	36.44	100	0	Peak
8	8721.00	42.28	-11.72	54.00	35.13	36.10	7.48	36.44	100	95	Average
9	9846.00	38.83	-35.17	74.00	77.19	-9.63	8.04	36.77	100	0	Peak

Remark: #3 and #4 are Fundamental Signals.

- Test Mode : Mode 4
- Polarization : Horizontal (30MHz-1GHz)

The test that passed at minimum margin was marked by the boldface in the following table.

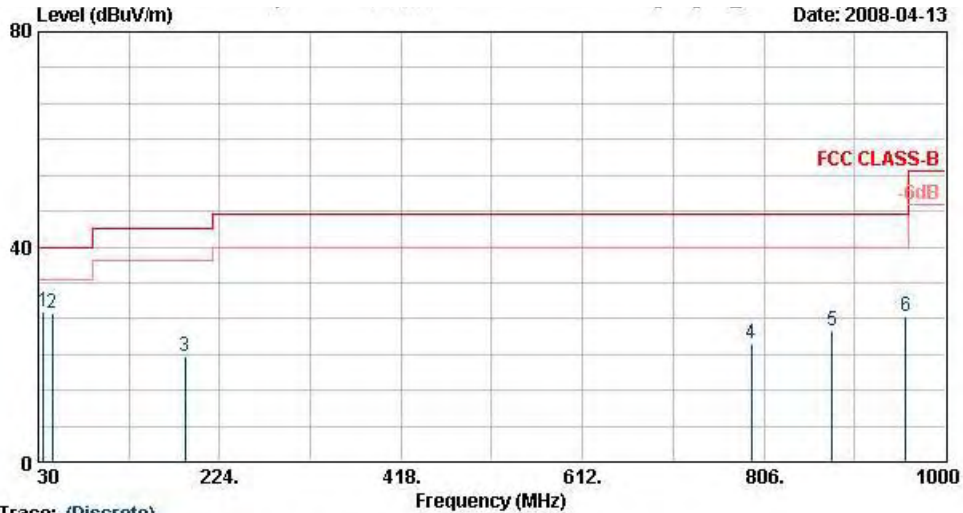

Trace: (Discrete)
 Site : 03CH06-HY
 Condition : FCC CLASS-B 3m LF-ANT(951121) HORIZONTAL
 EUT : Smart Phone WCDMA/GSM/GPRS/EDGE
 Power : 120Vac/60Hz
 Model : FR 832620
 Memo : 11g Tx_Ch01 ; 2412MHz + Adaptor
 Data Rate :
 Plane :
 IMEI : 35755901003041301

	Freq	Level	Over	Limit	Read	Antenna	Cable	Preamp	Ant	Table	Remark
	MHz	dBuV/m	dB	dBuV/m	dBuV	dB/m	dB	dB	cm	deg	
1 @	35.94	27.91	-12.09	40.00	45.28	15.61	0.30	33.28	100	121	Peak
2 @	45.39	27.64	-12.36	40.00	49.93	10.53	0.30	33.12	---	---	Peak
3	187.14	19.48	-24.02	43.50	42.99	9.39	0.60	33.49	---	---	Peak
4	792.80	21.96	-24.04	46.00	33.62	19.75	1.20	32.61	---	---	Peak
5	878.90	24.34	-21.66	46.00	35.41	20.38	1.30	32.75	---	---	Peak
6	957.30	27.07	-18.93	46.00	37.24	20.94	1.27	32.38	---	---	Peak

- Polarization : Horizontal (1GHz-25GHz)

The test that passed at minimum margin was marked by the boldface in the following table.

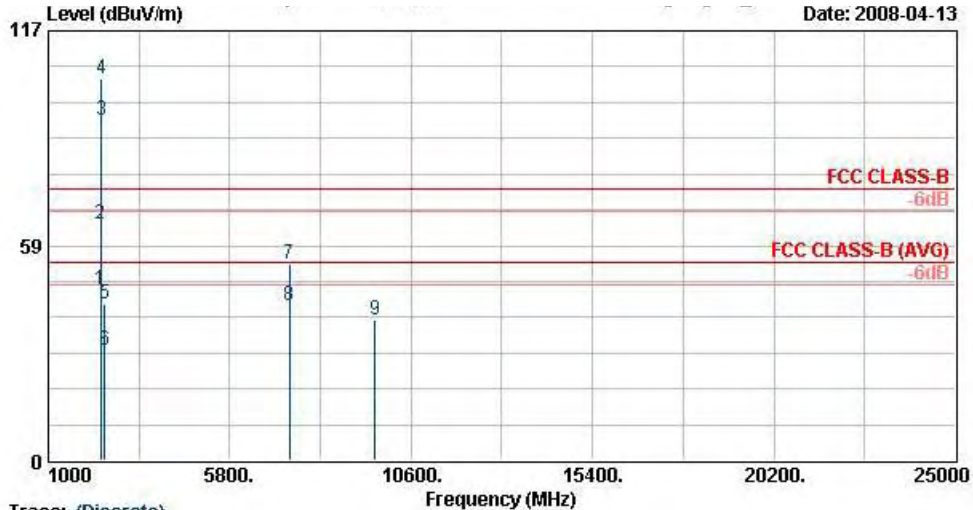

Trace: (Discrete)
 Site : 03CH06-HY
 Condition : FCC CLASS-B 3m SHF-EHF HORN HORIZONTAL
 EUT : Smart Phone WCDMA/GSM/GPRS/EDGE
 Power : 120Vac/60Hz
 Model : FR 832620
 Memo : 11g Tx_Ch01 ; 2412MHz + Adaptor
 Data Rate :
 Plane : H
 TMET : 35755901003041301

	Freq	Level	Over Limit	Limit Line	Read Level	Antenna Factor	Cable Loss	Preamp Factor	Ant Pos	Table Pos	Remark
	MHz	dBUV/m	dB	dBUV/m	dBUV	dB/m	dB	dB	cm	deg	
1 @	2390.00	46.41	-7.59	54.00	46.31	31.86	3.92	35.68	131	50	Average
2 @	2390.00	64.24	-9.76	74.00	64.14	31.86	3.92	35.68	100	0	Peak
3 @	2412.00	92.47			92.32	31.88	3.95	35.68	131	50	Average
4 @	2412.00	104.08			103.93	31.88	3.95	35.68	100	0	Peak
5	2500.00	42.65	-31.35	74.00	42.30	32.00	4.05	35.70	100	0	Peak
6	2500.00	29.93	-24.07	54.00	29.58	32.00	4.05	35.70	131	50	Average
7	7386.00	53.41	-20.59	74.00	46.70	35.64	7.23	36.15	100	0	Peak
8 @	7386.00	42.26	-11.74	54.00	35.54	35.64	7.23	36.15	100	213	Average
9	9642.00	38.35	-35.65	74.00	77.23	-10.09	7.94	36.73	100	0	Peak

Remark: #3 and #4 are Fundamental Signals.

- Polarization : Vertical (30MHz-1GHz)

The test that passed at minimum margin was marked by the boldface in the following table.

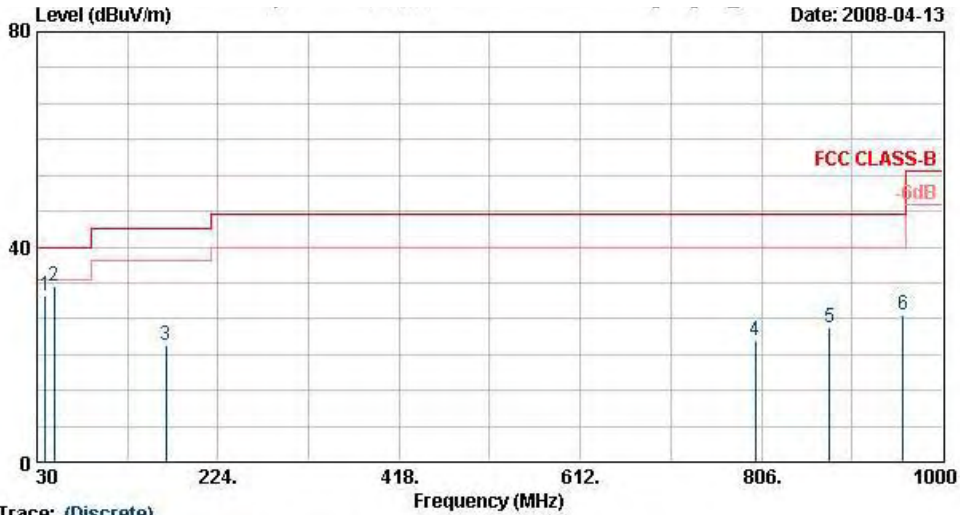

Trace: (Discrete)
 Site : 03CH06-HY
 Condition : FCC CLASS-B 3m LF-ANT(951121) VERTICAL
 EUT : Smart Phone WCDMA/GSM/GPRS/EDGE
 Power : 120Vac/60Hz
 Model : FR 832620
 Memo : 11g Tx_Ch01 ; 2412MHz + Adaptor
 Data Rate :
 Plane :
 IMET : 35755901003041301

	Freq	Level	Over	Limit	ReadAntenna	Cable	Preamp	Ant	Table	Remark
	MHz	dBuV/m	dB	dBuV/m	dBuV	dB	dB	cm	deg	
1 @	39.18	30.96	-9.04	40.00	49.85	14.03	0.30	33.22	---	Peak
2 @	48.63	32.84	-7.16	40.00	56.62	9.06	0.30	33.14	100	57 Peak
3	168.24	21.85	-21.65	43.50	44.74	9.94	0.60	33.44	---	Peak
4	799.80	22.68	-23.32	46.00	34.22	19.82	1.20	32.56	---	Peak
5	878.90	24.86	-21.14	46.00	35.93	20.38	1.30	32.75	---	Peak
6	957.30	27.44	-18.56	46.00	37.62	20.94	1.27	32.38	---	Peak

- Polarization :Vertical (1GHz-25GHz)

The test that passed at minimum margin was marked by the boldface in the following table.

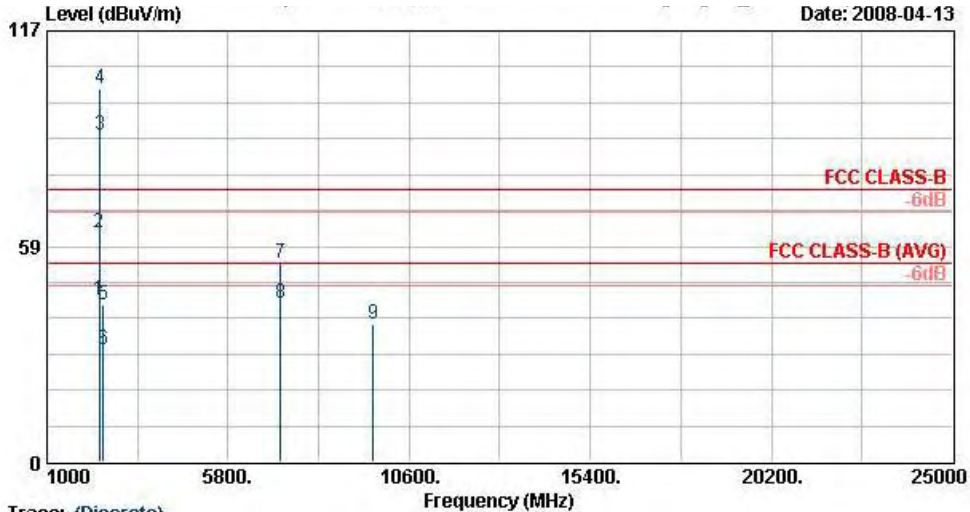

Trace: (Discrete)
 Site : D3CH06-HY
 Condition : FCC CLASS-B 3m SHF-EHF HORN VERTICAL
 EUT : Smart Phone WCDMA/GSM/GPRS/EDGE
 Power : 120Vac/60Hz
 Model : FR 832620
 Memo : 11g Tx_Ch01 ; 2412MHz + Adaptor
 Data Rate :
 Plane : H
 IMET : 35755901003041301

	Freq	Level	Over	Limit	Read	Antenna	Cable	Preamp	Ant	Table	Remark
	MHz	dBuV/m	dB	dBuV/m	dBuV	dB/m	dB	dB	cm	deg	
1 @	2390.00	43.72	-10.28	54.00	43.62	31.86	3.92	35.68	120	64	Average
2 @	2390.00	62.33	-11.67	74.00	62.23	31.86	3.92	35.68	100	0	Peak
3 @	2412.00	88.76			88.61	31.88	3.95	35.68	120	64	Average
4 @	2412.00	101.26			101.11	31.88	3.95	35.68	100	0	Peak
5	2494.00	42.62	-31.38	74.00	42.27	32.00	4.05	35.70	100	0	Peak
6	2494.00	30.60	-23.40	54.00	30.25	32.00	4.05	35.70	120	64	Average
7	7182.00	53.87	-20.13	74.00	47.06	35.72	7.16	36.07	100	0	Peak
8 @	7182.00	42.95	-11.05	54.00	36.14	35.72	7.16	36.07	100	116	Average
9	9642.00	37.49	-36.51	74.00	76.37	-10.09	7.94	36.73	100	0	Peak

Remark: #3 and #4 are Fundamental Signals.

- Test Mode : Mode 5
- Polarization : Horizontal (30MHz-1GHz)

The test that passed at minimum margin was marked by the boldface in the following table.

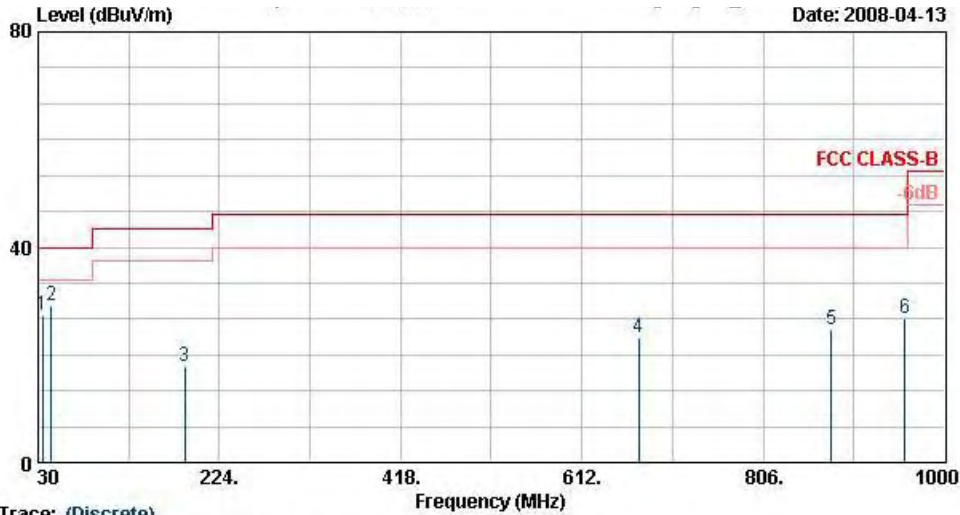

Trace: (Discrete)
 Site : 03CH06-HY
 Condition : FCC CLASS-B 3m LF-ANT(851121) HORIZONTAL
 EUT : Smart Phone WCDMA/GSM/GPRS/EDGE
 Power : 120Vac/60Hz
 Model : FR 832620
 Memo : 11g Tx_Ch06 ; 2437MHz + Adaptor
 Data Rate :
 Plane :
 TMET : 35755901003041301

	Freq	Level	Over Limit	Limit Line	ReadAntenna Level	Antenna Factor	Cable Loss	Preamp Factor	Ant Pos	Table Pos	Remark
	MHz	dBuV/m	dB	dBuV/m	dBuV	dB/m	dB	dB	cm	deg	
1	35.13	27.30	-12.70	40.00	44.17	16.13	0.30	33.30	---	---	Peak
2	44.04	29.09	-10.91	40.00	50.40	11.52	0.30	33.13	100	146	Peak
3	187.14	17.83	-25.67	43.50	41.33	9.39	0.60	33.49	---	---	Peak
4	672.40	23.06	-22.94	46.00	36.35	18.77	1.02	33.08	---	---	Peak
5	878.90	24.60	-21.40	46.00	35.67	20.38	1.30	32.75	---	---	Peak
6	957.30	26.65	-19.35	46.00	36.82	20.94	1.27	32.38	---	---	Peak

- Polarization : Horizontal (1GHz-25GHz)

The test that passed at minimum margin was marked by the boldface in the following table.

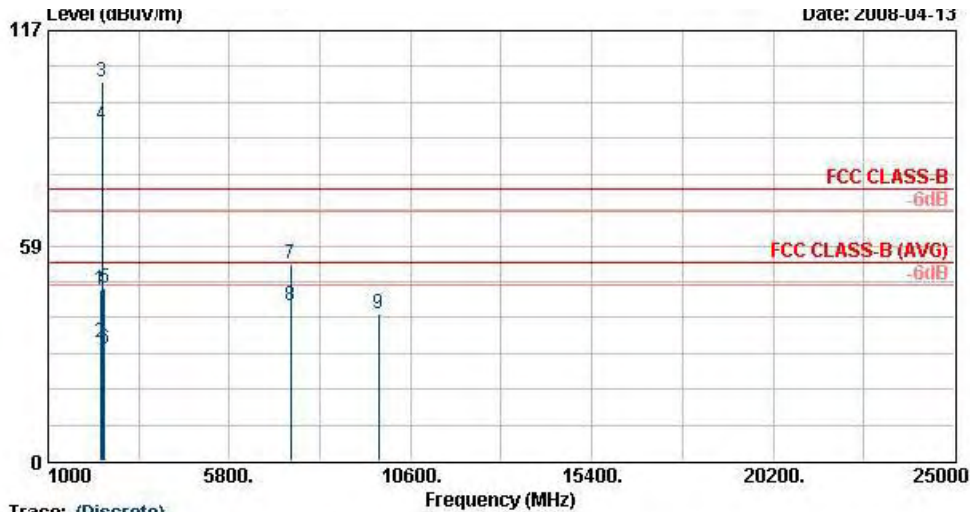

Trace: (Discrete)
 Site : 03CH06-HY
 Condition : FCC CLASS-B 3m SHF-EHF HORN HORIZONTAL
 EUT : Smart Phone WCDMA/GSM/GPRS/EDGE
 Power : 120Vac/60Hz
 Model : FR 832620
 Memo : 11g Tx_Ch06 ; 2437MHz + Adaptor
 Data Rate :
 Plane : H
 TMEI : 35755901003041301

	Freq	Level	Over	Limit	Read	Antenna	Cable	Preamp	Ant	Table	Remark
	MHz	dBuV/m	Limit	Line	Level	Factor	Loss	Factor	Pos	Pos	
			dB	dBuV/m	dBuV	dB/m	dB	dB	cm	deg	
1	2390.00	46.43	-27.57	74.00	46.33	31.86	3.92	35.68	100	0	Peak
2	2390.00	32.02	-21.98	54.00	31.92	31.86	3.92	35.68	100	35	Average
3 X	2437.00	102.98			102.76	31.93	3.99	35.69	100	0	Peak
4 @	2437.00	91.40			91.17	31.93	3.99	35.69	100	35	Average
5	2484.00	47.08	-26.92	74.00	46.75	31.98	4.05	35.70	100	0	Peak
6	2484.00	30.39	-23.61	54.00	30.06	31.98	4.05	35.70	100	35	Average
7	7416.00	53.49	-20.51	74.00	46.79	35.63	7.24	36.17	100	0	Peak
8	7416.00	42.32	-11.68	54.00	35.62	35.63	7.24	36.17	100	182	Average
9	9747.00	39.97	-34.03	74.00	78.59	-9.85	7.98	36.75	100	0	Peak

Remark: #3 and #4 are Fundamental Signals.

- Polarization : Vertivcal (30MHz-1GHz)

The test that passed at minimum margin is marked by the boldface in the following table.

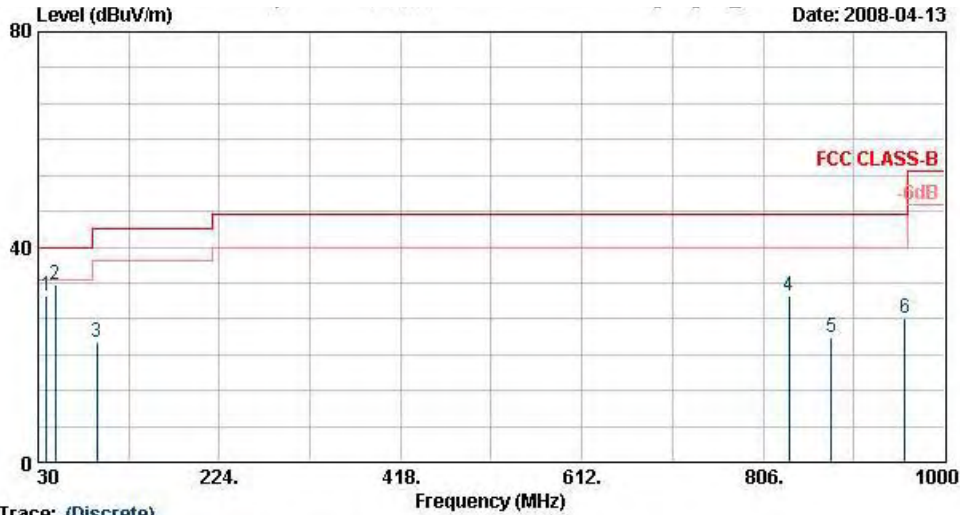

Trace: (Discrete)

Site : 03CH06-HY
 Condition : FCC CLASS-B 3m LF-ANT(951121) VERTICAL
 EUT : Smart Phone WCDMA/GSM/GPRS/EDGE
 Power : 120Vac/60Hz
 Model : FR 832620
 Memo : 11g Tx_Ch06 ; 2437MHz + Adaptor
 Data Rate :
 Plane :
 TMEI : 35755001003041301

	Freq	Level	Over	Limit	ReadAntenna	Cable	Preamp	Ant	Table	Remark
	MHz	dBuV/m	Limit	Line	Level	Loss	Factor	Pos	Pos	
			dB	dBuV/m	dBuV	dB	dB	cm	deg	
1	39.18	30.86	-9.14	40.00	49.75	14.03	0.30	33.22	---	Peak
2	48.09	33.01	-6.99	40.00	56.79	9.06	0.30	33.14	100	205 Peak
3	92.64	22.44	-21.06	43.50	45.66	9.62	0.50	33.33	---	Peak
4	833.40	30.86	-15.14	46.00	42.24	20.05	1.20	32.64	---	Peak
5	878.90	23.19	-22.81	46.00	34.26	20.38	1.30	32.75	---	Peak
6	957.30	26.68	-19.32	46.00	36.85	20.94	1.27	32.38	---	Peak

- Polarization : Vertical (1GHz-25GHz)

The test that passed at minimum margin is marked by the boldface in the following table.

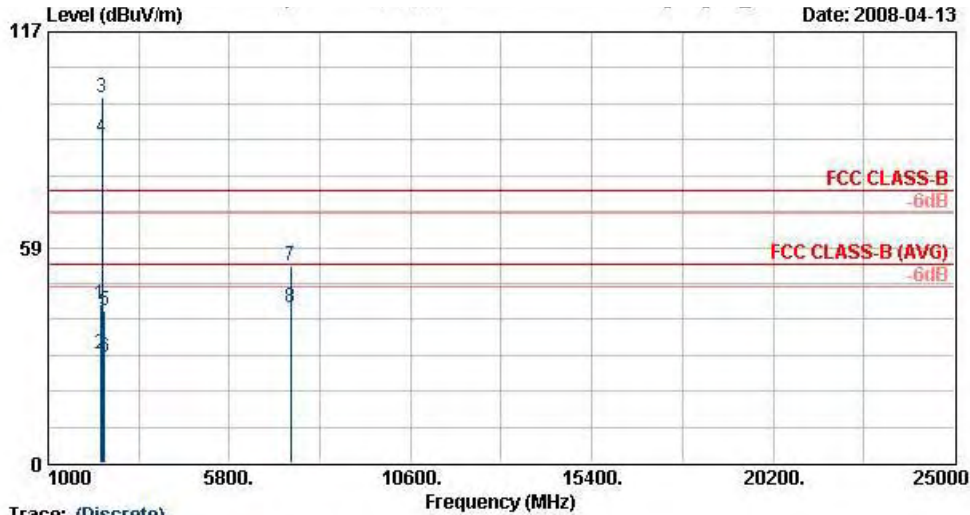

Trace: (Discrete)
 Site : 03CH06-HY
 Condition : FCC CLASS-B 3m SHF-EHF HORN VERTICAL
 EUT : Smart Phone WCDMA/GSM/GPRS/EDGE
 Power : 120Vac/60Hz
 Model : FR 832620
 Memo : 11g Tx_Ch06 : 2437MHz + Adaptor
 Data Rate :
 Plane : H
 TMET : 35755901003041301

	Freq	Level	Over	Limit	Read	Antenna	Cable	Preamp	Ant	Table	Remark
	MHz	dBuV/m	Limit	Line	Level	Factor	Loss	Factor	Pos	Pos	
			dB	dBuV/m	dBuV	dB/m	dB	dB	cm	deg	
1	2390.00	42.87	-31.13	74.00	42.78	31.86	3.92	35.68	100	0	Peak
2	2390.00	29.68	-24.32	54.00	29.58	31.86	3.92	35.68	102	130	Average
3 X	2437.00	99.33			99.10	31.93	3.99	35.69	100	0	Peak
4 X	2437.00	88.14			87.91	31.93	3.99	35.69	102	130	Average
5	2484.00	41.36	-32.64	74.00	41.03	31.98	4.05	35.70	100	0	Peak
6	2484.00	28.63	-25.37	54.00	28.30	31.98	4.05	35.70	102	130	Average
7	7422.00	53.41	-20.59	74.00	46.71	35.63	7.24	36.17	100	0	Peak
8	7422.00	42.31	-11.69	54.00	35.61	35.63	7.24	36.17	100	111	Average

Remark: #3 and #4 are Fundamental Signals.

- Test Mode : Mode 6
- Polarization : Horizontal (30MHz-1GHz)

The test that passed at minimum margin was marked by the boldface in the following table.

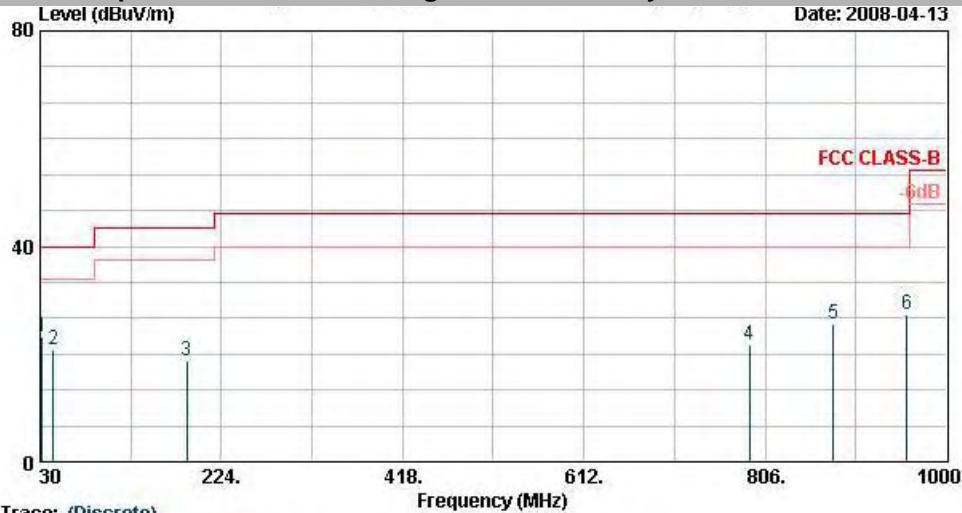

Trace: (Discrete)

Site : 03CH06-HY
 Condition : FCC CLASS-B 3m LF-ANT(051121) HORIZONTAL
 EUT : Smart Phone WCDMA/GSM/GPRS/EDGE
 Power : 120Vac/60Hz
 Model : FR 832620
 Memo : 11g Tx_Ch11 ; 2462MHz + Adaptor
 Data Rate :
 Plane :
 TMET : 35755901003041301

	Freq	Level	Over Limit	Limit Line	Read Level	Antenna Factor	Cable Loss	Preamp Factor	Ant Pos	Table Pos	Remark
	MHz	dBuV/m	dB	dBuV/m	dBuV	dB/m	dB	dB	cm	deg	
1	31.89	23.21	-16.79	40.00	38.08	18.25	0.30	33.42	100	213	Peak
2	44.04	20.90	-19.10	40.00	42.21	11.52	0.30	33.13	---	---	Peak
3	187.14	18.69	-24.81	43.50	42.19	9.39	0.60	33.49	---	---	Peak
4	789.30	21.56	-24.44	46.00	33.27	19.72	1.20	32.63	---	---	Peak
5	878.90	25.56	-20.44	46.00	36.63	20.38	1.30	32.75	---	---	Peak
6	957.30	27.28	-18.72	46.00	37.45	20.94	1.27	32.38	---	---	Peak

- Polarization : Horizontal (1GHz-25GHz)

The test that passed at minimum margin was marked by the boldface in the following table.

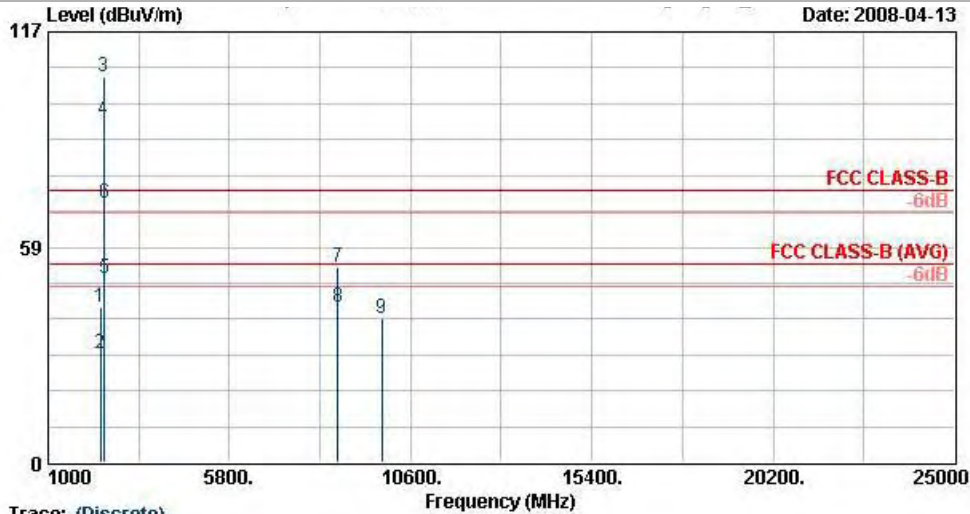

Trace: (Discrete)
 Site : 03CH06-HY
 Condition : FCC CLASS-B 3m SHF-EHF HORN HORIZONTAL
 EUT : Smart Phone WCDMA/GSM/GPRS/EDGE
 Power : 120Vac/60Hz
 Model : FR 832620
 Memo : 11g Tx_Ch11 ; 2462MHz + Adaptor
 Data Rate :
 Plane : H
 TMET : 35755901003041301

	Freq	Level	Over	Limit	Read	Antenna	Cable	Preamp	Ant	Table	Remark
	MHz	dBuV/m	Limit	Line	Level	Factor	Loss	Factor	Pos	Pos	
			dB	dBuV/m	dBuV	dB/m	dB	dB	cm	deg	
1	2388.00	42.37	-31.63	74.00	42.27	31.86	3.92	35.68	100	0	Peak
2	2388.00	29.42	-24.58	54.00	29.32	31.86	3.92	35.68	100	13	Average
3 X	2462.00	104.76			104.48	31.95	4.02	35.69	100	0	Peak
4 @	2462.00	93.08			92.80	31.95	4.02	35.69	100	13	Average
5 !	2483.50	49.90	-4.10	54.00	49.57	31.98	4.05	35.70	100	13	Average
6 !	2483.50	70.50	-3.50	74.00	70.17	31.98	4.05	35.70	100	0	Peak
7	8667.00	53.22	-20.78	74.00	46.21	36.03	7.39	36.41	100	0	Peak
8	8667.00	42.16	-11.85	54.00	35.14	36.03	7.39	36.41	100	129	Average
9	9846.00	39.19	-34.81	74.00	77.55	-9.63	8.04	36.77	100	0	Peak

Remark: #3 and #4 are Fundamental Signals.

- Polarization : Vertical (30MHz-1GHz)

The test that passed at minimum margin was marked by the boldface in the following table.

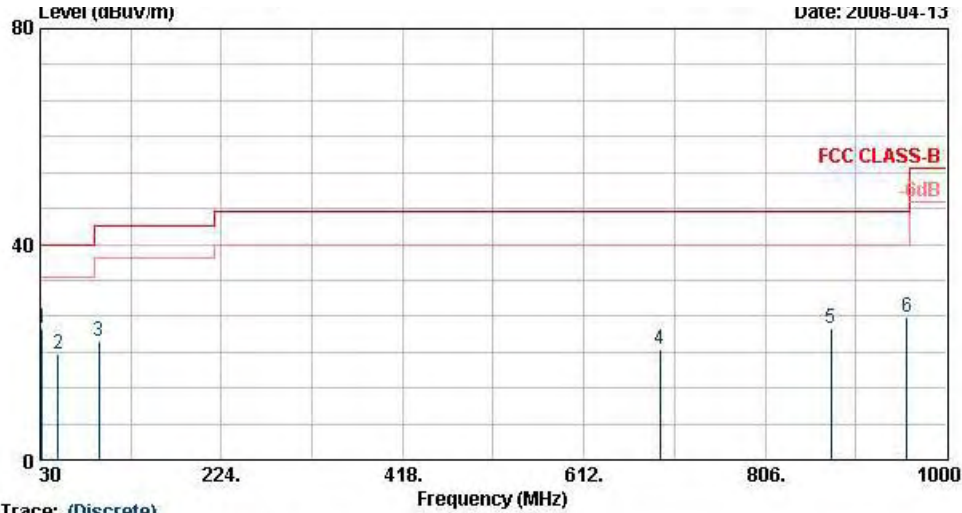

Trace: (Discrete)

Site : 03CH06-HY
 Condition : FCC CLASS-B 3m LF-ANT(951121) VERTICAL
 EUT : Smart Phone WCDMA/GSM/GPRS/EDGE
 Power : 120Vac/60Hz
 Model : FR 832620
 Memo : I1g Tx_Ch11 ; 2462MHz + Adaptor
 Data Rate :
 Plane :
 TMEI : 35755001003041301

	Freq	Level	Over	Limit	ReadAntenna	Cable	Preamp	Ant	Table	Remark
	MHz	dBuV/m	Limit	Line	Level	Loss	Factor	Pos	Pos	
			dB	dBuV/m	dBuV	dB	dB	cm	deg	
1	32.43	24.47	-15.53	40.00	40.01	17.54	0.30	33.38	100	182 Peak
2	49.44	19.57	-20.43	40.00	43.84	8.57	0.30	33.14	---	Peak
3	92.64	21.95	-21.55	43.50	45.16	9.62	0.50	33.33	---	Peak
4	693.40	20.55	-25.45	46.00	33.74	18.86	1.10	33.15	---	Peak
5	876.80	24.32	-21.68	46.00	35.40	20.36	1.30	32.74	---	Peak
6	957.30	26.52	-19.48	46.00	36.69	20.94	1.27	32.38	---	Peak

- Polarization : Vertical (1GHz-25GHz)

The test that passed at minimum margin was marked by the boldface in the following table.

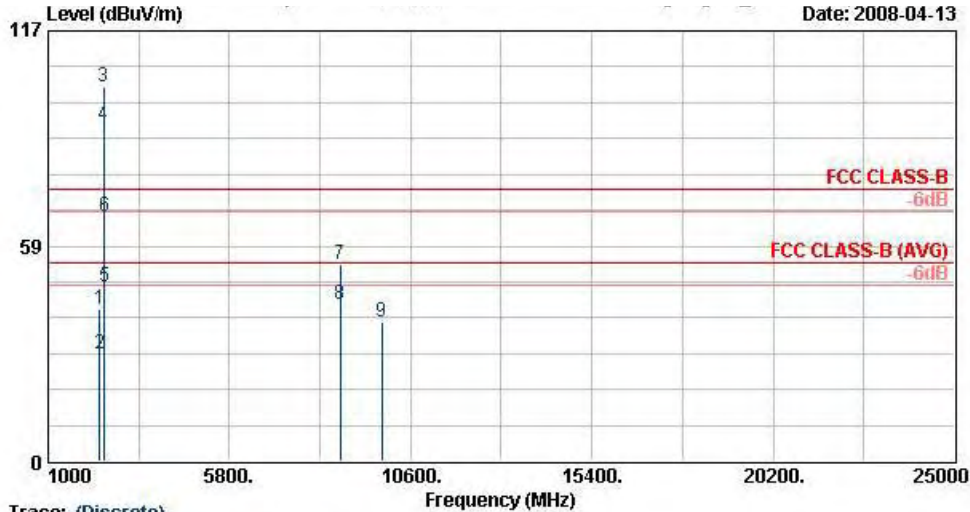

Trace: (Discrete)
 Site : 03CH06-HY
 Condition : FCC CLASS-B 3m SHF-EHF HORN VERTICAL
 EUT : Smart Phone WCDMA/GSM/GPRS/EDGE
 Power : 120Vac/60Hz
 Model : FR 832620
 Memo : 11g Tx_Ch11 ; 2462MHz + Adaptor
 Data Rate :
 Plane : H
 TMET : 35755901003041301

	Freq	Level	Over	Limit	Read	Antenna	Cable	Preamp	Ant	Table	Remark
	MHz	dBuV/m	Limit	Line	Level	Factor	Loss	Factor	Pos	Pos	
			dB	dBuV/m	dBuV	dB/m	dB	dB	cm	deg	
1	2364.00	41.47	-32.53	74.00	41.45	31.81	3.89	35.67	100	0	Peak
2	2364.00	29.05	-24.95	54.00	29.03	31.81	3.89	35.67	120	65	Average
3 X	2462.00	101.65			101.37	31.95	4.02	35.69	100	0	Peak
4 X	2462.00	91.18			90.90	31.95	4.02	35.69	120	65	Average
5	2483.50	47.58	-6.42	54.00	47.25	31.98	4.05	35.70	120	65	Average
6	2483.50	66.36	-7.64	74.00	66.03	31.98	4.05	35.70	100	0	Peak
7	8736.00	53.67	-20.33	74.00	46.50	36.13	7.48	36.44	100	0	Peak
8	8736.00	42.59	-11.41	54.00	35.42	36.13	7.48	36.44	100	312	Average
9	9846.00	37.62	-36.38	74.00	75.99	-9.63	8.04	36.77	100	0	Peak

Remark: #3 and #4 are Fundamental Signals.

5.8 Antenna Requirements

5.8.1 Standard Applicable

For intentional device, according to FCC 47 CFR Section 15.203, an intentional radiator shall be designed to ensure that no other antenna except assembled by the responsible party shall be used with the device.

And according to FCC 47 CFR Section 15.247 (b), if directional gain of transmitting antennas is greater than 6dBi, the power shall be reduced by the same level in dB comparing to gain minus 6dBi.

5.8.2 Antenna Connected Construction

The antenna used in this product is PIFA Antenna for WLAN without connector and it is considered to meet antenna requirement of FCC.

5.8.3 Antenna Gain

The antenna gain of EUT is less than 6 dBi. Therefore, it is not necessary to reduce maximum peak output power limit.

6. List of Measuring Equipments

Instrument	Manufacturer	Model No.	Serial No.	Characteristics	Calibration Date	Due Date	Remark
EMC Receiver	R&S	ESCS 30	100359	9kHz – 2.75GHz	Mar. 03, 2008	Mar. 02, 2009	Conduction (CO04-HY)
LISN	MessTec	NNB-2/16Z	99079	9kHz – 30MHz	Mar. 31, 2008	Mar. 29, 2009	Conduction (CO04-HY)
LISN (Support Unit)	EMCO	3810/2NM	9703-1839	9kHz – 30MHz	Mar. 22, 2008	Mar. 21, 2009	Conduction (CO04-HY)
RF Cable-CON	UTIFLEX	3102-26886-4	CB049	9kHz – 30MHz	Apr. 20, 2008	Apr. 19, 2009	Conduction (CO04-HY)
ISN	SCHAFFNER	ISN T400	21653	9kHz –30MHz	Mar. 27, 2008	Mar. 26, 2009	Conduction (CO04-HY)
EMI Filter	LINDGREN	LRE-2030	2651	< 450 Hz	N/A	N/A	Conduction (CO04-HY)
Spectrum Analyzer	Agilent	E4408B	MY44211028	9KHz-26.5GHz	Oct. 17, 2007	Oct. 16, 2008	Radiation (03CH06-HY)
EMI Test Receiver	R&S	ESCS30	100356	9KHz-2.75GHz	Jul. 26, 2007	Jul. 25, 2008	Radiation (03CH06-HY)
Bilog Antenna	SCHAFFNER	CBL6112B	2885	30MHz -2GHz	Dec. 01, 2007	Nov. 30, 2008	Radiation (03CH06-HY)
Double Ridge Horn Antenna	Com-Power	AH118	071025	1G~18G	Jun. 04, 2007	Jun. 03, 2008	Radiation (03CH06-HY)
SHF-EHF Horn	SCHWARZBECK	BBHA 9170	9170-251	14G - 40G	Oct. 17, 2007	Oct. 16, 2008	Radiation (03CH06-HY)
Pre Amplifier	Agilent	8449B	3008A01917	1G - 26.5G	Nov. 22, 2007	Nov. 21, 2008	Radiation (03CH06-HY)
Pre Amplifier	EMEC	PA303	PA303-SMA-059	100K~3GHz	Nov. 26, 2007	Nov. 25, 2008	Radiation (03CH06-HY)
Base Station Simulator	R & S	CMU200	103937	Third-Band	Oct. 19, 2007	Oct. 18, 2008	Radiation (03CH06-HY)

7. Uncertainty Evaluation

Uncertainty of Conducted Emission Measurement (150 KHz ~ 30 MHz)

Contribution	Uncertainty of x_i		$u(x_i)$
	dB	Probability Distribution	
Receiver reading	0.10	Normal(k=2)	0.05
Cable loss	0.10	Normal(k=2)	0.05
AMN insertion loss	2.50	Rectangular	0.63
Receiver Spec	1.50	Rectangular	0.43
Site imperfection	1.39	Rectangular	0.80
Mismatch	+0.34/-0.35	U-shape	0.24
Combined standard uncertainty Uc(y)	1.13		
Measuring uncertainty for a level of confidence of 95% U=2Uc(y)	2.26		

Uncertainty of Radiated Emission Measurement (30 MHz ~ 1000 MHz)

Contribution	Uncertainty of x_i		$u(x_i)$
	dB	Probability Distribution	
Receiver reading	0.11	Normal(k=2)	0.06
Antenna factor calibration	0.91	Normal(k=2)	0.46
Cable loss calibration	0.12	Normal(k=2)	0.06
Pre Amplifier Gain calibration	0.15	Normal(k=2)	0.08
RCV/SPA specification	2.50	Rectangular	0.72
Antenna Factor Interpolation for Frequency	1.00	Rectangular	0.29
Site imperfection	1.52	Rectangular	0.88
Mismatch	+0.45/-0.48	U-shaped	0.33
Combined standard uncertainty Uc(y)	1.30		
Measuring uncertainty for a level of confidence of 95% U=2Uc(y)	2.60		

Uncertainty of Radiated Emission Measurement (1 GHz ~ 40 GHz)

Contribution	Uncertainty of x_i		$u(x_i)$	C_i	$C_i * u(x_i)$
	dB	Probability Distribution			
Receiver reading	±0.10	Normal(k=1)	0.10	1	0.10
Antenna factor calibration	±1.70	Normal(k=2)	0.85	1	0.85
Cable loss calibration	±0.50	Normal(k=2)	0.25	1	0.25
Receiver Correction	±2.00	Rectangular	1.15	1	1.15
Antenna Factor Directional	±1.50	Rectangular	0.87	1	0.87
Site imperfection	±2.80	Triangular	1.14	1	1.14
Mismatch Receiver VSWR $\Gamma_1 = 0.197$ Antenna VSWR $\Gamma_2 = 0.194$ Uncertainty = $20 \log(1 - \Gamma_1 * \Gamma_2 * \Gamma_3)$	+0.34/-0.35	U-shaped	0.244	1	0.244
Combined standard uncertainty $U_c(y)$	2.36				
Measuring uncertainty for a level of confidence of 95% $U = 2U_c(y)$	4.72				

The measured result is : y dBuV $\pm U$ dB
for a level of confidence of approximately 95% , ($k = 2$)



Appendix A. Photographs of EUT

Please refer to Sporton report number EP832620 as below.