



Calibration Laboratory of Schmid & Partner Engineering AG, Zeughausstrasse 43, 8004 Zurich, Switzerland



S Schweizerischer Kalibrierdienst, Service suisse d'étalonnage, Servizio svizzero di taratura, S Swiss Calibration Service

Accredited by the Swiss Federal Office of Metrology and Accreditation. The Swiss Accreditation Service is one of the signatories to the EA Multilateral Agreement for the recognition of calibration certificates

Accreditation No.: SCS 108

Client Sporton (Auden)

Certificate No: D1900V2-5d041\_Mar08

CALIBRATION CERTIFICATE

Object: D1900V2 - SN: 5d041
Calibration procedure(s): QA CAL-05.v7, Calibration procedure for dipole validation kits
Calibration date: March 18, 2008
Condition of the calibrated item: In Tolerance

This calibration certificate documents the traceability to national standards, which realize the physical units of measurements (SI). The measurements and the uncertainties with confidence probability are given on the following pages and are part of the certificate.

All calibrations have been conducted in the closed laboratory facility; environment temperature (22 ± 3)°C and humidity < 70%.

Calibration Equipment used (M&TE critical for calibration)

Table with 4 columns: Primary Standards, ID #, Cal Date (Calibrated by, Certificate No.), Scheduled Calibration. Includes items like Power meter EPM-442A, Power sensor HP 8481A, Reference 20 dB Attenuator, etc.

Calibrated by: Marcel Fehr, Laboratory Technician
Approved by: Katja Pokovic, Technical Manager

Issued: March 18, 2008

This calibration certificate shall not be reproduced except in full without written approval of the laboratory.

**Calibration Laboratory of  
Schmid & Partner  
Engineering AG**  
Zeughausstrasse 43, 8004 Zurich, Switzerland



**S** Schweizerischer Kalibrierdienst  
**S** Service suisse d'étalonnage  
**C** Servizio svizzero di taratura  
**S** Swiss Calibration Service

Accredited by the Swiss Federal Office of Metrology and Accreditation  
The Swiss Accreditation Service is one of the signatories to the EA  
Multilateral Agreement for the recognition of calibration certificates

Accreditation No.: **SCS 108**

**Glossary:**

TSL tissue simulating liquid  
ConvF sensitivity in TSL / NORM x,y,z  
N/A not applicable or not measured

**Calibration is Performed According to the Following Standards:**

- IEEE Std 1528-2003, "IEEE Recommended Practice for Determining the Peak Spatial-Averaged Specific Absorption Rate (SAR) in the Human Head from Wireless Communications Devices: Measurement Techniques", December 2003
- CENELEC EN 50361, "Basic standard for the measurement of Specific Absorption Rate related to human exposure to electromagnetic fields from mobile phones (300 MHz - 3 GHz), July 2001
- Federal Communications Commission Office of Engineering & Technology (FCC OET), "Evaluating Compliance with FCC Guidelines for Human Exposure to Radiofrequency Electromagnetic Fields; Additional Information for Evaluating Compliance of Mobile and Portable Devices with FCC Limits for Human Exposure to Radiofrequency Emissions", Supplement C (Edition 01-01) to Bulletin 65

**Additional Documentation:**

- DASY4 System Handbook

**Methods Applied and Interpretation of Parameters:**

- Measurement Conditions:** Further details are available from the Validation Report at the end of the certificate. All figures stated in the certificate are valid at the frequency indicated.
- Antenna Parameters with TSL:** The dipole is mounted with the spacer to position its feed point exactly below the center marking of the flat phantom section, with the arms oriented parallel to the body axis.
- Feed Point Impedance and Return Loss:** These parameters are measured with the dipole positioned under the liquid filled phantom. The impedance stated is transformed from the measurement at the SMA connector to the feed point. The Return Loss ensures low reflected power. No uncertainty required.
- Electrical Delay:** One-way delay between the SMA connector and the antenna feed point. No uncertainty required.
- SAR measured:** SAR measured at the stated antenna input power.
- SAR normalized:** SAR as measured, normalized to an input power of 1 W at the antenna connector.
- SAR for nominal TSL parameters:** The measured TSL parameters are used to calculate the nominal SAR result.

**Measurement Conditions**

DASY system configuration, as far as not given on page 1.

DASY Version	DASY4	V4.7
Extrapolation	Advanced Extrapolation	
Phantom	Modular Flat Phantom V5.0	
Distance Dipole Center - TSL	10 mm	with Spacer
Zoom Scan Resolution	dx, dy, dz = 5 mm	
Frequency	1900 MHz ± 1 MHz	

**Head TSL parameters**

The following parameters and calculations were applied.

	Temperature	Permittivity	Conductivity
Nominal Head TSL parameters	22.0 °C	40.0	1.40 mho/m
Measured Head TSL parameters	(22.0 ± 0.2) °C	40.2 ± 6 %	1.47 mho/m ± 6 %
Head TSL temperature during test	(21.1 ± 0.2) °C	---	---

**SAR result with Head TSL**

SAR averaged over 1 cm <sup>3</sup> (1 g) of Head TSL	condition	
SAR measured	250 mW input power	10.1 mW / g
SAR normalized	normalized to 1W	40.4 mW / g
SAR for nominal Head TSL parameters <sup>1</sup>	normalized to 1W	<b>39.5 mW / g ± 17.0 % (k=2)</b>

SAR averaged over 10 cm <sup>3</sup> (10 g) of Head TSL	Condition	
SAR measured	250 mW input power	5.20 mW / g
SAR normalized	normalized to 1W	20.8 mW / g
SAR for nominal Head TSL parameters <sup>1</sup>	normalized to 1W	<b>20.6 mW / g ± 16.5 % (k=2)</b>

<sup>1</sup> Correction to nominal TSL parameters according to d), chapter "SAR Sensitivities"

**Body TSL parameters**

The following parameters and calculations were applied.

	Temperature	Permittivity	Conductivity
Nominal Body TSL parameters	22.0 °C	53.3	1.52 mho/m
Measured Body TSL parameters	(22.0 ± 0.2) °C	51.6 ± 6 %	1.57 mho/m ± 6 %
Body TSL temperature during test	(21.4 ± 0.2) °C	----	----

**SAR result with Body TSL**

SAR averaged over 1 cm <sup>3</sup> (1 g) of Body TSL	Condition	
SAR measured	250 mW input power	10.4 mW / g
SAR normalized	normalized to 1W	41.6 mW / g
SAR for nominal Body TSL parameters <sup>2</sup>	normalized to 1W	<b>40.1 mW / g ± 17.0 % (k=2)</b>

SAR averaged over 10 cm <sup>3</sup> (10 g) of Body TSL	condition	
SAR measured	250 mW input power	5.44 mW / g
SAR normalized	normalized to 1W	21.8 mW / g
SAR for nominal Body TSL parameters <sup>2</sup>	normalized to 1W	<b>21.3 mW / g ± 16.5 % (k=2)</b>

<sup>2</sup> Correction to nominal TSL parameters according to d), chapter "SAR Sensitivities"



**Appendix**

**Antenna Parameters with Head TSL**

Impedance, transformed to feed point	54.0 $\Omega$ + 5.1 $j\Omega$
Return Loss	- 24.2 dB

**Antenna Parameters with Body TSL**

Impedance, transformed to feed point	48.0 $\Omega$ + 6.1 $j\Omega$
Return Loss	- 23.6 dB

**General Antenna Parameters and Design**

Electrical Delay (one direction)	1.199 ns
----------------------------------	----------

After long term use with 100W radiated power, only a slight warming of the dipole near the feedpoint can be measured.

The dipole is made of standard semirigid coaxial cable. The center conductor of the feeding line is directly connected to the second arm of the dipole. The antenna is therefore short-circuited for DC-signals.

No excessive force must be applied to the dipole arms, because they might bend or the soldered connections near the feedpoint may be damaged.

**Additional EUT Data**

Manufactured by	SPEAG
Manufactured on	July 04, 2003

**DASY4 Validation Report for Head TSL**

Date/Time: 18.03.2008 12:05:10

Test Laboratory: SPEAG, Zurich, Switzerland

**DUT: Dipole 1900 MHz; Type: D1900V2; Serial: D1900V2 - SN:5d041**

Communication System: CW; Frequency: 1900 MHz; Duty Cycle: 1:1

Medium: HSL U10 BB;

Medium parameters used:  $f = 1900$  MHz;  $\sigma = 1.47$  mho/m;  $\epsilon_r = 40.2$ ;  $\rho = 1000$  kg/m<sup>3</sup>

Phantom section: Flat Section

Measurement Standard: DASY4 (High Precision Assessment)

**DASY4 Configuration:**

- Probe: ES3DV2 - SN3025; ConvF(4.9, 4.9, 4.9); Calibrated: 01.03.2008
- Sensor-Surface: 3.4mm (Mechanical Surface Detection)
- Electronics: DAE4 Sn909; Calibrated: 03.09.2007
- Phantom: Flat Phantom 5.0 (front); Type: QD000P50AA; ;
- Measurement SW: DASY4, V4.7 Build 55; Postprocessing SW: SEMCAD, V1.8 Build 172

**Pin = 250 mW; d = 10 mm/Zoom Scan (7x7x7)/Cube 0:**

Measurement grid: dx=5mm, dy=5mm, dz=5mm

Reference Value = 91.7 V/m; Power Drift = 0.013 dB

Peak SAR (extrapolated) = 19.1 W/kg

**SAR(1 g) = 10.1 mW/g; SAR(10 g) = 5.2 mW/g**

Maximum value of SAR (measured) = 11.8 mW/g

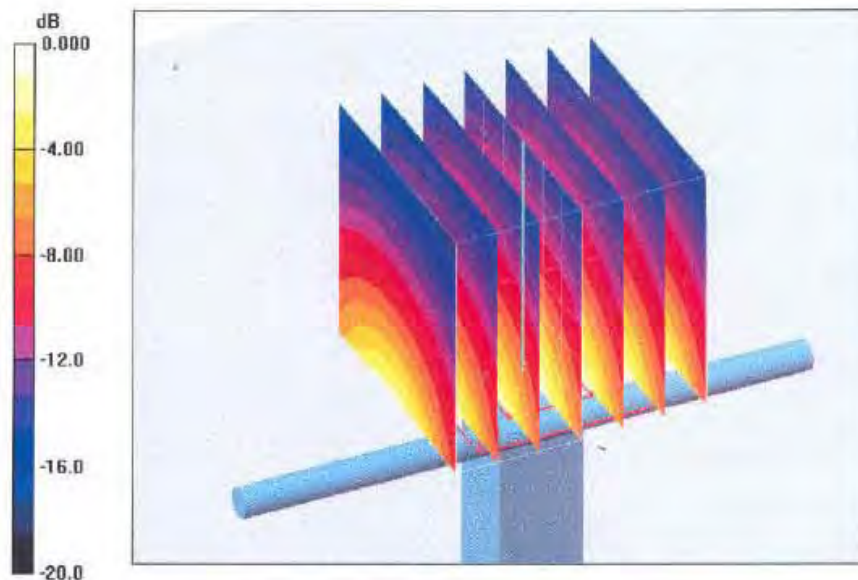

0 dB = 11.8mW/g



### Impedance Measurement Plot for Head TSL

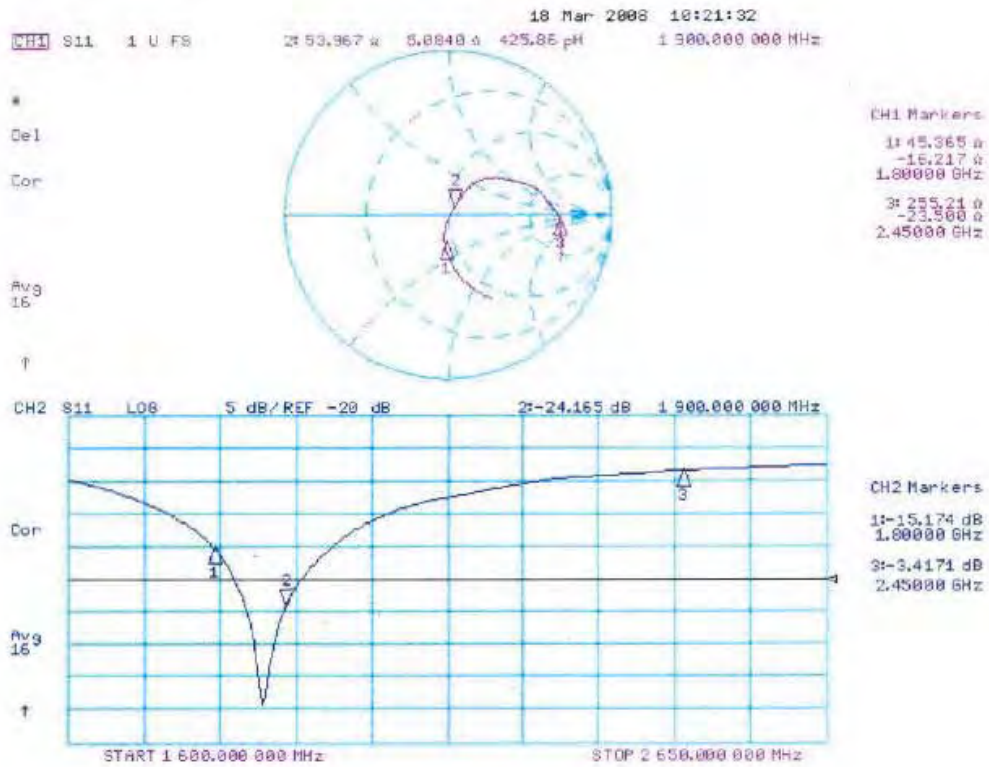

**DASY4 Validation Report for Body TSL**

Date/Time: 14.03.2008 13:22:24

Test Laboratory: SPEAG, Zurich, Switzerland

**DUT: Dipole 1900 MHz; Type: D1900V2; Serial: D1900V2 - SN:5d041**

Communication System: CW; Frequency: 1900 MHz; Duty Cycle: 1:1

Medium: MSL U10 BB;

Medium parameters used:  $f = 1900$  MHz;  $\sigma = 1.57$  mho/m;  $\epsilon_r = 51.7$ ;  $\rho = 1000$  kg/m<sup>3</sup>

Phantom section: Flat Section

Measurement Standard: DASY4 (High Precision Assessment)

**DASY4 Configuration:**

- Probe: ES3DV2 - SN3025; ConvF(4.5, 4.5, 4.5); Calibrated: 01.03.2008
- Sensor-Surface: 3.4mm (Mechanical Surface Detection)
- Electronics: DAE4 Sn909; Calibrated: 03.09.2007
- Phantom: Flat Phantom 5.0 (front); Type: QD000P50AA; ;
- Measurement SW: DASY4, V4.7 Build 55; Postprocessing SW: SEMCAD, V1.8 Build 172

**Pin = 250 mW; d = 10 mm/Zoom Scan (7x7x7)/Cube 0:**

Measurement grid: dx=5mm, dy=5mm, dz=5mm

Reference Value = 89.7 V/m; Power Drift = 0.004 dB

Peak SAR (extrapolated) = 18.6 W/kg

**SAR(1 g) = 10.4 mW/g; SAR(10 g) = 5.44 mW/g**

Maximum value of SAR (measured) = 12.0 mW/g

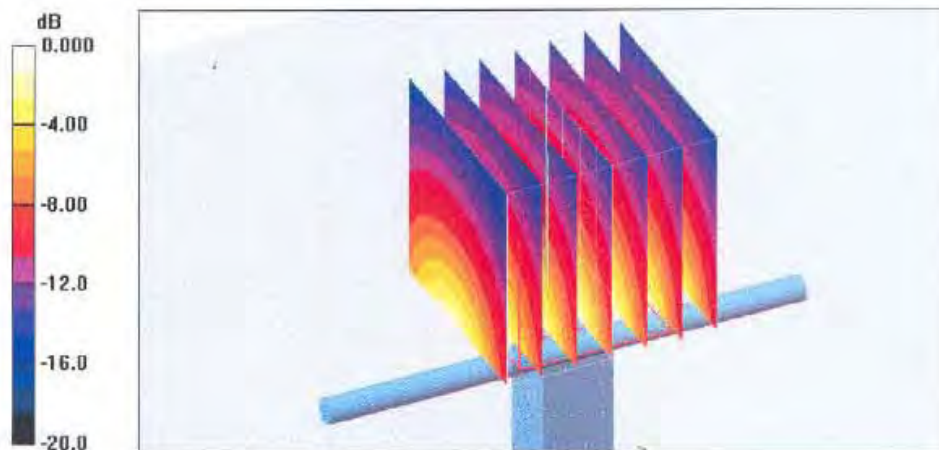

0 dB = 12.0mW/g





Impedance Measurement Plot for Body TSL

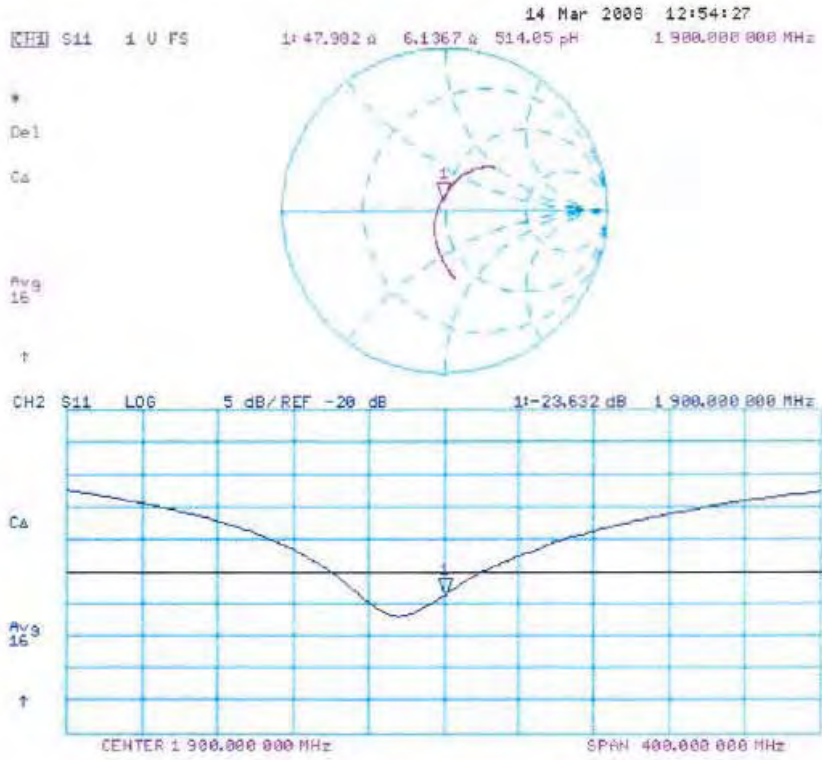



Calibration Laboratory of Schmid & Partner Engineering AG Zeughausstrasse 43, 8004 Zurich, Switzerland



S Schweizerischer Kalibrierdienst
C Service suisse d'etalonnage
S Servizio svizzero di taratura
S Swiss Calibration Service

Accredited by the Swiss Federal Office of Metrology and Accreditation The Swiss Accreditation Service is one of the signatories to the EA Multilateral Agreement for the recognition of calibration certificates

Accreditation No.: SCS 108

Client Sporton (Auelen)

Certificate No: DAE4-778\_Sep07

CALIBRATION CERTIFICATE

Object: DAE4 - SD 000 D04 BG - SN: 778
Calibration procedure(s): QA CAL-06.v12 Calibration procedure for the data acquisition electronics (DAE)
Calibration date: September 17, 2007
Condition of the calibrated item: In Tolerance

This calibration certificate documents the traceability to national standards, which realize the physical units of measurements (SI). The measurements and the uncertainties with confidence probability are given on the following pages and are part of the certificate.

All calibrations have been conducted in the closed laboratory facility: environment temperature (22 ± 3)°C and humidity < 70%.

Calibration Equipment used (M&TE critical for calibration)

Table with 4 columns: Primary Standards, ID #, Cal Date (Calibrated by, Certificate No.), Scheduled Calibration. Includes entries for Fluke Process Calibrator Type 702 and Keithley Multimeter Type 2001.

Table with 4 columns: Secondary Standards, ID #, Check Date (in house), Scheduled Check. Includes entry for Calibrator Box V1.1.

Calibrated by: Dominique Steffen, Technician
Approved by: Fin Bornholt, R&D Director

Issued: September 17, 2007

This calibration certificate shall not be reproduced except in full without written approval of the laboratory.

**Calibration Laboratory of  
Schmid & Partner  
Engineering AG**  
Zeughausstrasse 43, 8004 Zurich, Switzerland



**S** Schweizerischer Kalibrierdienst  
**C** Service suisse d'étalonnage  
**S** Servizio svizzero di taratura  
**S** Swiss Calibration Service

Accredited by the Swiss Federal Office of Metrology and Accreditation  
The Swiss Accreditation Service is one of the signatories to the EA  
Multilateral Agreement for the recognition of calibration certificates

Accreditation No.: **SCS 108**

### Glossary

**DAE** data acquisition electronics  
**Connector angle** information used in DASY system to align probe sensor X to the robot coordinate system.

### Methods Applied and Interpretation of Parameters

- **DC Voltage Measurement:** Calibration Factor assessed for use in DASY system by comparison with a calibrated instrument traceable to national standards. The figure given corresponds to the full scale range of the voltmeter in the respective range.
- **Connector angle:** The angle of the connector is assessed measuring the angle mechanically by a tool inserted. Uncertainty is not required.
- The following parameters contain technical information as a result from the performance test and require no uncertainty.
- **DC Voltage Measurement Linearity:** Verification of the Linearity at +10% and -10% of the nominal calibration voltage. Influence of offset voltage is included in this measurement.
- **Common mode sensitivity:** Influence of a positive or negative common mode voltage on the differential measurement.
- **Channel separation:** Influence of a voltage on the neighbor channels not subject to an input voltage.
- **AD Converter Values with inputs shorted:** Values on the internal AD converter corresponding to zero input voltage
- **Input Offset Measurement:** Output voltage and statistical results over a large number of zero voltage measurements.
- **Input Offset Current:** Typical value for information; Maximum channel input offset current, not considering the input resistance.
- **Input resistance:** DAE input resistance at the connector, during internal auto-zeroing and during measurement.
- **Low Battery Alarm Voltage:** Typical value for information. Below this voltage, a battery alarm signal is generated.
- **Power consumption:** Typical value for information. Supply currents in various operating modes.



**DC Voltage Measurement**

A/D - Converter Resolution nominal

High Range: 1LSB = 6.1µV , full range = -100...+300 mV

Low Range: 1LSB = 61nV , full range = -1.....+3mV

DASY measurement parameters: Auto Zero Time: 3 sec; Measuring time: 3 sec

Calibration Factors	X	Y	Z
High Range	404.715 ± 0.1% (k=2)	403.520 ± 0.1% (k=2)	405.065 ± 0.1% (k=2)
Low Range	3.99539 ± 0.7% (k=2)	3.96323 ± 0.7% (k=2)	3.97102 ± 0.7% (k=2)

**Connector Angle**

Connector Angle to be used in DASY system	309 ° ± 1 °
---	-------------

Appendix

1. DC Voltage Linearity

High Range	Input ( $\mu\text{V}$ )	Reading ( $\mu\text{V}$ )	Error (%)
Channel X + Input	200000	199999.5	0.00
Channel X + Input	20000	20004.41	0.02
Channel X - Input	20000	-20002.56	0.01
Channel Y + Input	200000	200000.3	0.00
Channel Y + Input	20000	20003.87	0.02
Channel Y - Input	20000	-20003.41	0.02
Channel Z + Input	200000	200000.3	0.00
Channel Z + Input	20000	20002.49	0.01
Channel Z - Input	20000	-20006.25	0.03

Low Range	Input ( $\mu\text{V}$ )	Reading ( $\mu\text{V}$ )	Error (%)
Channel X + Input	2000	1999.9	0.00
Channel X + Input	200	199.47	-0.26
Channel X - Input	200	-200.56	0.28
Channel Y + Input	2000	2000.1	0.00
Channel Y + Input	200	199.15	-0.43
Channel Y - Input	200	-200.77	0.39
Channel Z + Input	2000	2000	0.00
Channel Z + Input	200	199.22	-0.39
Channel Z - Input	200	-201.39	0.69

2. Common mode sensitivity

DASY measurement parameters: Auto Zero Time: 3 sec; Measuring time: 3 sec

	Common mode Input Voltage (mV)	High Range Average Reading ( $\mu\text{V}$ )	Low Range Average Reading ( $\mu\text{V}$ )
Channel X	200	-6.00	-6.42
	-200	7.17	6.60
Channel Y	200	-2.49	-2.64
	-200	2.04	1.25
Channel Z	200	-10.83	-10.80
	-200	9.19	8.80

3. Channel separation

DASY measurement parameters: Auto Zero Time: 3 sec; Measuring time: 3 sec

	Input Voltage (mV)	Channel X ( $\mu\text{V}$ )	Channel Y ( $\mu\text{V}$ )	Channel Z ( $\mu\text{V}$ )
Channel X	200	-	2.57	0.15
Channel Y	200	0.11	-	4.08
Channel Z	200	-1.80	1.03	-

**4. AD-Converter Values with inputs shorted**

DASY measurement parameters: Auto Zero Time: 3 sec; Measuring time: 3 sec

	High Range (LSB)	Low Range (LSB)
Channel X	16068	16321
Channel Y	16180	16239
Channel Z	16405	16167

**5. Input Offset Measurement**

DASY measurement parameters: Auto Zero Time: 3 sec; Measuring time: 3 sec

Input 10MΩ

	Average (μV)	min. Offset (μV)	max. Offset (μV)	Std. Deviation (μV)
Channel X	-0.14	-1.23	0.61	0.34
Channel Y	-0.85	-2.24	0.48	0.49
Channel Z	-1.24	-2.43	0.38	0.51

**6. Input Offset Current**

Nominal Input circuitry offset current on all channels: <25fA

**7. Input Resistance**

	Zeroing (MOhm)	Measuring (MOhm)
Channel X	0.2000	201.7
Channel Y	0.2000	201.7
Channel Z	0.1999	202.5

**8. Low Battery Alarm Voltage** (verified during pre test)

Typical values	Alarm Level (VDC)
Supply (+ Vcc)	+7.9
Supply (- Vcc)	-7.6

**9. Power Consumption** (verified during pre test)

Typical values	Switched off (mA)	Stand by (mA)	Transmitting (mA)
Supply (+ Vcc)	+0.0	+6	+14
Supply (- Vcc)	-0.01	-8	-9



Calibration Laboratory of Schmid & Partner Engineering AG, Zeughausstrasse 43, 8004 Zurich, Switzerland



S Schweizerischer Kalibrierdienst, C Service suisse d'etalonnage, S Servizio svizzero di taratura, S Swiss Calibration Service

Accredited by the Swiss Federal Office of Metrology and Accreditation. The Swiss Accreditation Service is one of the signatories to the EA Multilateral Agreement for the recognition of calibration certificates

Accreditation No.: SCS 108

Client Sporton (Auden)

Certificate No: ET3-1787\_Aug07

CALIBRATION CERTIFICATE

Object: ET3DV6 - SN:1787
Calibration procedure(s): QA CAL-01.v6
Calibration procedure for dosimetric E-field probes
Calibration date: August 28, 2007
Condition of the calibrated item: In Tolerance

This calibration certificate documents the traceability to national standards, which realize the physical units of measurements (SI). The measurements and the uncertainties with confidence probability are given on the following pages and are part of the certificate.

All calibrations have been conducted in the closed laboratory facility: environment temperature (22 ± 3)°C and humidity < 70%.

Calibration Equipment used (M&TE critical for calibration)

Table with 4 columns: Primary Standards, ID #, Cal Date (Calibrated by, Certificate No.), Scheduled Calibration. Lists various power meters, sensors, and attenuators with their respective IDs and calibration dates.

Table with 4 columns: Secondary Standards, ID #, Check Date (in house), Scheduled Check. Lists RF generator and Network Analyzer with their IDs and check dates.

Calibrated by: Katja Pokovic, Technical Manager
Approved by: Niels Kuster, Quality Manager

Issued: August 28, 2007

This calibration certificate shall not be reproduced except in full without written approval of the laboratory.

**Calibration Laboratory of**  
 Schmid & Partner  
 Engineering AG  
 Zeughausstrasse 43, 8004 Zurich, Switzerland



S Schweizerischer Kalibrierdienst  
 C Service suisse d'étalonnage  
 S Servizio svizzero di taratura  
 S Swiss Calibration Service

Accredited by the Swiss Federal Office of Metrology and Accreditation  
 The Swiss Accreditation Service is one of the signatories to the EA  
 Multilateral Agreement for the recognition of calibration certificates

Accreditation No.: SCS 108

**Glossary:**

TSL tissue simulating liquid  
 NORM<sub>x,y,z</sub> sensitivity in free space  
 ConF sensitivity in TSL / NORM<sub>x,y,z</sub>  
 DCP diode compression point  
 Polarization  $\phi$   $\phi$  rotation around probe axis  
 Polarization  $\vartheta$   $\vartheta$  rotation around an axis that is in the plane normal to probe axis (at measurement center), i.e.,  $\vartheta = 0$  is normal to probe axis

**Calibration is Performed According to the Following Standards:**

- a) IEEE Std 1528-2003, "IEEE Recommended Practice for Determining the Peak Spatial-Averaged Specific Absorption Rate (SAR) in the Human Head from Wireless Communications Devices: Measurement Techniques", December 2003
- b) IEC 62209-1, "Procedure to measure the Specific Absorption Rate (SAR) for hand-held devices used in close proximity to the ear (frequency range of 300 MHz to 3 GHz)", February 2005

**Methods Applied and Interpretation of Parameters:**

- **NORM<sub>x,y,z</sub>:** Assessed for E-field polarization  $\vartheta = 0$  ( $f \leq 900$  MHz in TEM-cell;  $f > 1800$  MHz: R22 waveguide). NORM<sub>x,y,z</sub> are only intermediate values, i.e., the uncertainties of NORM<sub>x,y,z</sub> does not effect the E<sup>2</sup>-field uncertainty inside TSL (see below *ConvF*).
- **NORM(f)<sub>x,y,z</sub> = NORM<sub>x,y,z</sub> \* frequency\_response** (see Frequency Response Chart). This linearization is implemented in DASY4 software versions later than 4.2. The uncertainty of the frequency response is included in the stated uncertainty of *ConvF*.
- **DCP<sub>x,y,z</sub>:** DCP are numerical linearization parameters assessed based on the data of power sweep (no uncertainty required). DCP does not depend on frequency nor media.
- **ConvF and Boundary Effect Parameters:** Assessed in flat phantom using E-field (or Temperature Transfer Standard for  $f \leq 800$  MHz) and inside waveguide using analytical field distributions based on power measurements for  $f > 800$  MHz. The same setups are used for assessment of the parameters applied for boundary compensation (alpha, depth) of which typical uncertainty values are given. These parameters are used in DASY4 software to improve probe accuracy close to the boundary. The sensitivity in TSL corresponds to NORM<sub>x,y,z</sub> \* *ConvF* whereby the uncertainty corresponds to that given for *ConvF*. A frequency dependent *ConvF* is used in DASY version 4.4 and higher which allows extending the validity from  $\pm 50$  MHz to  $\pm 100$  MHz.
- **Spherical isotropy (3D deviation from isotropy):** in a field of low gradients realized using a flat phantom exposed by a patch antenna.
- **Sensor Offset:** The sensor offset corresponds to the offset of virtual measurement center from the probe tip (on probe axis). No tolerance required.





ET3DV6 SN:1787

August 28, 2007

# Probe ET3DV6

## SN:1787

Manufactured:	May 28, 2003
Last calibrated:	May 31, 2006
Recalibrated:	August 28, 2007

Calibrated for DASY Systems

(Note: non-compatible with DASY2 system!)



ET3DV6 SN:1787

August 28, 2007

DASY - Parameters of Probe: ET3DV6 SN:1787

Sensitivity in Free Space<sup>A</sup>

Diode Compression<sup>B</sup>

NormX	1.63 ± 10.1%	μV/(V/m) <sup>2</sup>	DCP X	92 mV
NormY	1.66 ± 10.1%	μV/(V/m) <sup>2</sup>	DCP Y	96 mV
NormZ	2.08 ± 10.1%	μV/(V/m) <sup>2</sup>	DCP Z	91 mV

Sensitivity in Tissue Simulating Liquid (Conversion Factors)

Please see Page 8.

Boundary Effect

TSL	900 MHz	Typical SAR gradient: 5 % per mm		
	Sensor Center to Phantom Surface Distance		3.7 mm	4.7 mm
	SAR <sub>be</sub> [%] Without Correction Algorithm		4.7	2.0
	SAR <sub>be</sub> [%] With Correction Algorithm		0.1	0.0

TSL	1810 MHz	Typical SAR gradient: 10 % per mm		
	Sensor Center to Phantom Surface Distance		3.7 mm	4.7 mm
	SAR <sub>be</sub> [%] Without Correction Algorithm		11.8	7.0
	SAR <sub>be</sub> [%] With Correction Algorithm		0.2	0.4

Sensor Offset

Probe Tip to Sensor Center	2.7 mm
----------------------------	--------

The reported uncertainty of measurement is stated as the standard uncertainty of measurement multiplied by the coverage factor k=2, which for a normal distribution corresponds to a coverage probability of approximately 95%.

<sup>A</sup> The uncertainties of NormX,Y,Z do not affect the E<sup>2</sup>-field uncertainty inside TSL (see Page 8).

<sup>B</sup> Numerical linearization parameter: uncertainty not required.

ET3DV6 SN:1787

August 28, 2007

### Frequency Response of E-Field

(TEM-Cell:ifi110 EXX, Waveguide: R22)

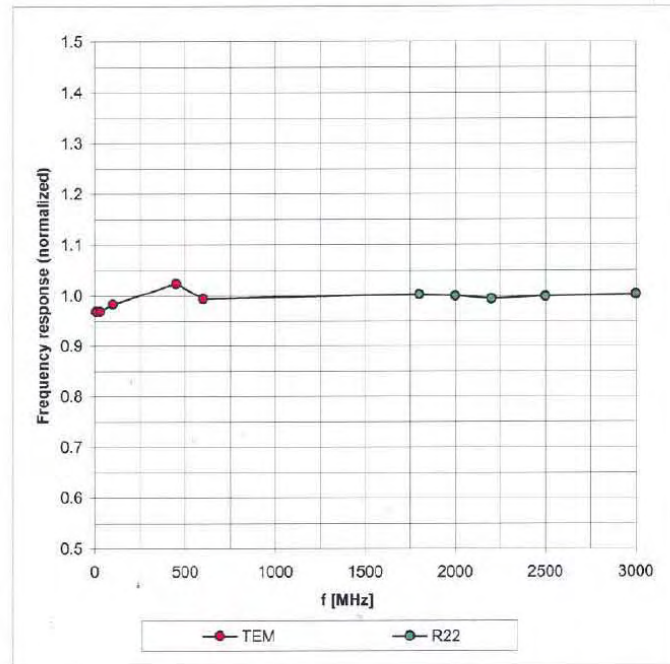

Uncertainty of Frequency Response of E-field:  $\pm 6.3\%$  (k=2)



ET3DV6 SN:1787

August 28, 2007

### Receiving Pattern ( $\phi$ ), $\theta = 0^\circ$

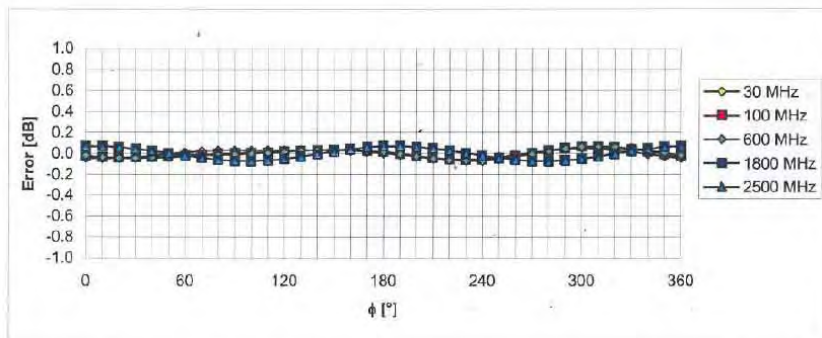
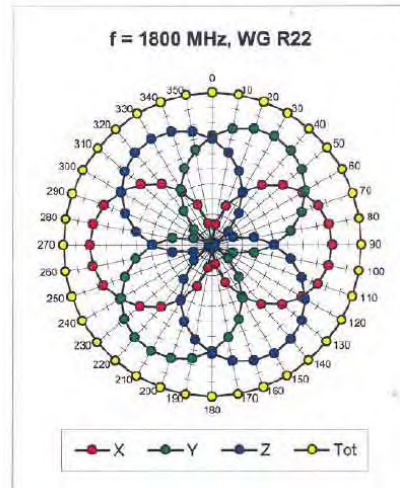
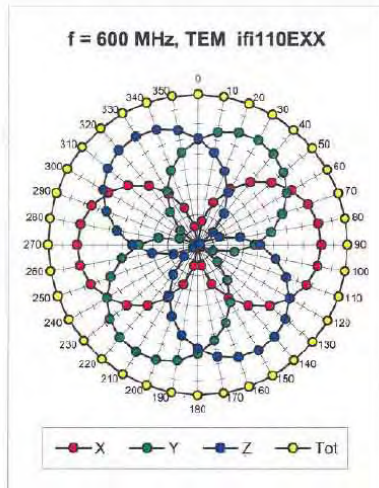

Uncertainty of Axial Isotropy Assessment:  $\pm 0.5\%$  ( $k=2$ )



ET3DV6 SN:1787

August 28, 2007

### Dynamic Range f(SAR<sub>head</sub>) (Waveguide R22, f = 1800 MHz)

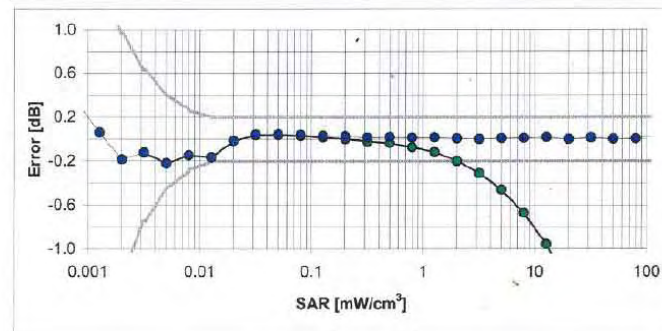
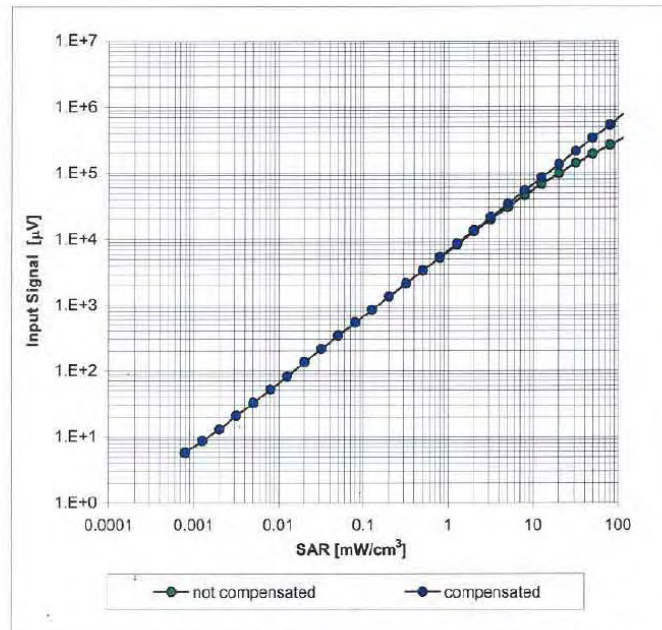

Uncertainty of Linearity Assessment:  $\pm 0.6\%$  (k=2)

ET3DV6 SN:1787

August 28, 2007

### Conversion Factor Assessment

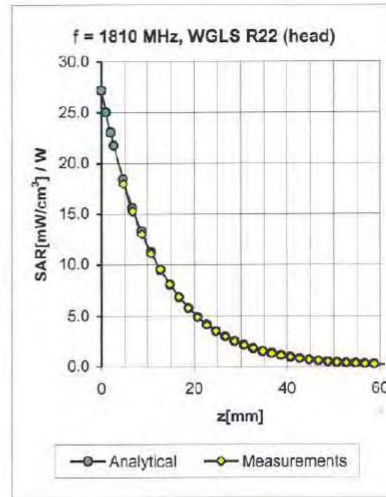
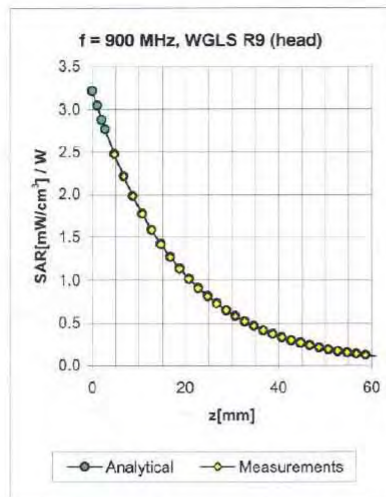

f [MHz]	Validity [MHz] <sup>c</sup>	TSL	Permittivity	Conductivity	Alpha	Depth	ConvF Uncertainty
900	± 50 / ± 100	Head	41.5 ± 5%	0.97 ± 5%	0.32	2.42	6.58 ± 11.0% (k=2)
1810	± 50 / ± 100	Head	40.0 ± 5%	1.40 ± 5%	0.50	2.61	5.16 ± 11.0% (k=2)
2000	± 50 / ± 100	Head	40.0 ± 5%	1.40 ± 5%	0.55	2.45	4.80 ± 11.0% (k=2)
2450	± 50 / ± 100	Head	39.2 ± 5%	1.80 ± 5%	0.67	1.81	4.50 ± 11.8% (k=2)
900	± 50 / ± 100	Body	55.0 ± 5%	1.05 ± 5%	0.36	2.52	6.10 ± 11.0% (k=2)
1810	± 50 / ± 100	Body	53.3 ± 5%	1.52 ± 5%	0.61	2.56	4.68 ± 11.0% (k=2)
2000	± 50 / ± 100	Body	53.3 ± 5%	1.52 ± 5%	0.60	2.40	4.30 ± 11.0% (k=2)
2450	± 50 / ± 100	Body	52.7 ± 5%	1.95 ± 5%	0.65	2.15	4.02 ± 11.8% (k=2)

<sup>c</sup> The validity of ± 100 MHz only applies for DASY v4.4 and higher (see Page 2). The uncertainty is the RSS of the ConvF uncertainty at calibration frequency and the uncertainty for the indicated frequency band.



ET3DV6 SN:1787

August 28, 2007

### Deviation from Isotropy in HSL

Error ( $\phi$ ,  $\theta$ ),  $f = 900$  MHz

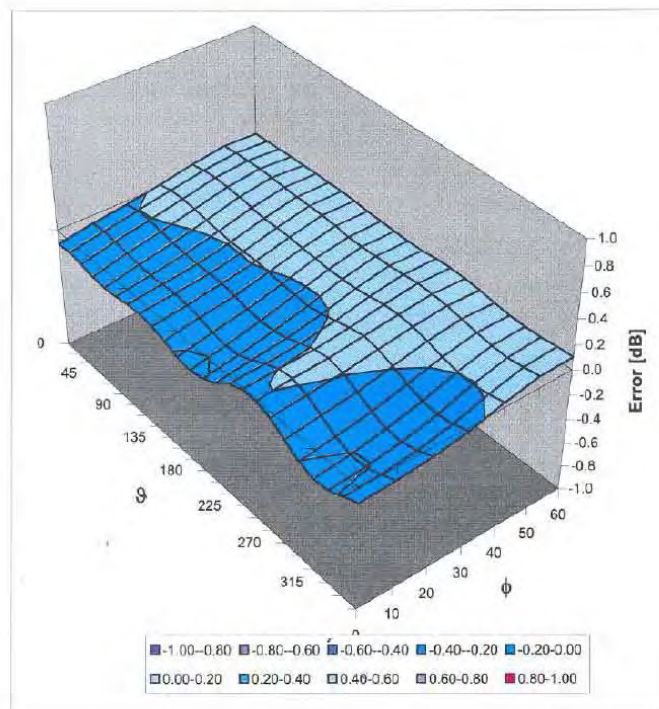

Uncertainty of Spherical Isotropy Assessment:  $\pm 2.6\%$  ( $k=2$ )

## Appendix D - WCDMA Test Mode

### Conducted Output Power

The EUT's WCDMA and HSPA function is Release 6 version. A detailed analysis of the output power for all WCDMA modes is provided in the table below. The EUT supports DPDCH1 and HSDPA with several of data rates, such as 12.2Kbps, 64kbps, 144Kbps and 384Kbps.

Mode	Symbol Rates (Kbps)	SF	K	Data	Reference Channel Type (Data Rates)	Band II			Band V		
						Ch 9262	Ch 9400	Ch 9538	Ch 4132	Ch 4182	Ch 4233
						1852.4	1880.0	1907.6	826.4	836.4	846.6
DPDCH1	60	64	2	40	RMC 12.2 Kbps	22.55	22.65	22.46	23.48	23.68	23.50
	240	16	4	160	RMC 64 Kbps	22.60	22.54	22.33	23.60	23.73	23.60
	480	8	5	320	RMC 144 Kbps	22.57	22.72	22.40	23.61	23.78	23.61
	960	4	6	640	RMC 384 Kbps	22.59	22.74	22.43	23.61	23.57	23.63
HSDPA	60	64	2	40	RMC 12.2 Kbps	21.74	21.99	21.85	22.85	22.86	22.88

Data: Bits/Slot; SF: Spreading Factor; K: Number of bits per uplink DPDCH slot.

**Table 1 Conducted output power**

Mode	Band	WCDMA II -1900			WCDMA V -850		
	Channel	9262	9400	9538	4132	4182	4233
HSUPA	$\beta(11/15)$	19.16	19.40	22.18	23.14	23.35	23.12
	$\beta(6/15)$	22.85	23.07	22.80	23.79	24.00	23.69
	$\beta(15/9)$	22.25	22.61	22.44	23.28	23.64	23.29
	$\beta(2/15)$	22.86	23.27	22.95	23.96	24.25	23.86
	$\beta(15/15)$	22.51	22.68	22.46	23.33	23.50	23.29

**Table 2 Conducted output power for HSUPA**

Followed by FCC suggestions [1]:

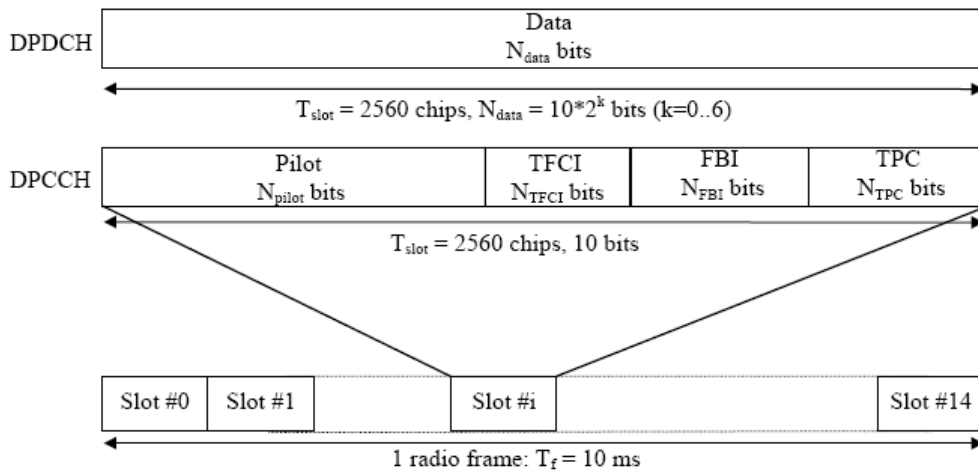

**Frame structure for uplink DPDCH/DPCCH**





The parameter K in the figure determines the number of bits per uplink DPDCH slot. It is related to the spreading factor SF of the DPDCH as  $SF = 256/2^k$ . The DPDCH spreading factor may range from 256 down to 4. The spreading factor of the uplink DPCCH is always equal to 256, i.e. there are 10 bits per uplink DPCCH slot.

	Channel Bit Rate (kbps)	Channel Symbol Rate (ksps)	Spreading Factor	Spreading Code Number	Bits/Slot
DPCCH	15	15	256	0	10
DPDCH <sub>1</sub>	15	15	256	64	10
	30	30	128	32	20
	60	60	64	16	40
	120	120	32	8	80
	240	240	16	4	160
	480	480	8	2	320
	960	960	4	1	640
DPDCH <sub>n</sub>	960	960	4	1, 2, 3	640

Table 2 DPCCH and DPDCH

There is only one DPCCH per radio link. Data rates, channelization codes and spread factor information for DPCCH and DPDCH<sub>n</sub> are indicated in the following Table. Spreading Rate (SF) \* Symbol Rate = 3.84 Mcps.

### WCDMA Setup Configuration

- a. The EUT was connected to Base Station. Refer to the drawing of Setup Configuration.
- b. The RF path losses were compensated into the measurements.
- c. A call was established between EUT and Base Station with following setting
  - i. Data rates: Varied RMC for each measurement.
  - ii. TPC with All Up
- d. The transmitted maximum output power was recorded.

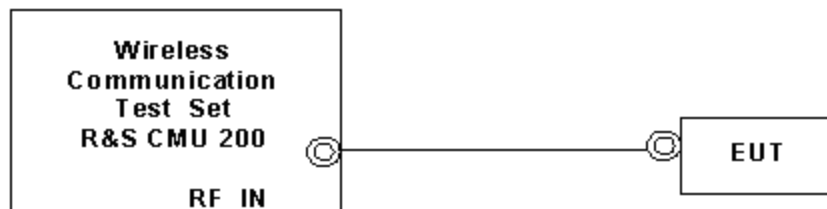

**Setup Configuration**

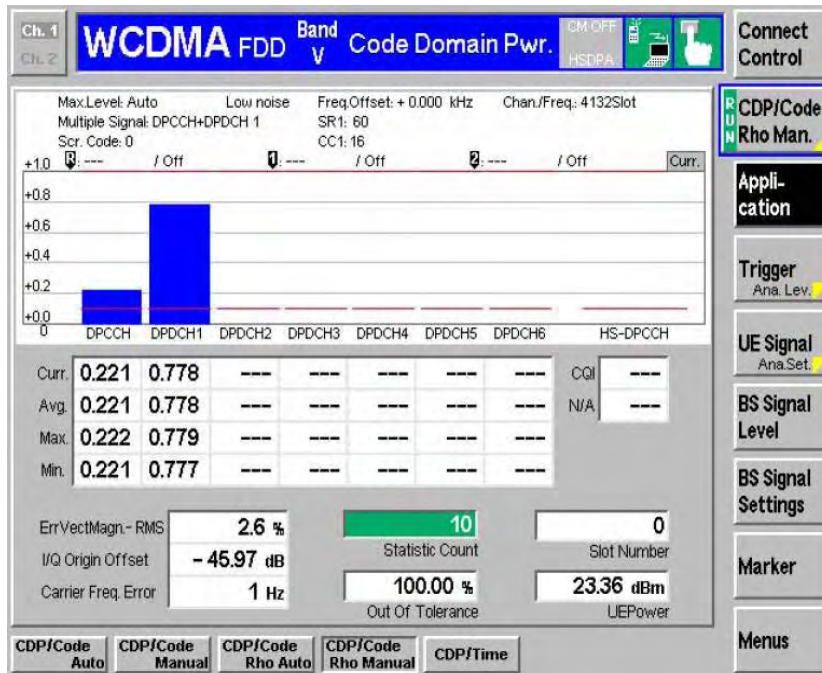

Single DPCCH with only one DPDCH at RMC 12.2Kbps (Symbol Rate 60 Kbps)

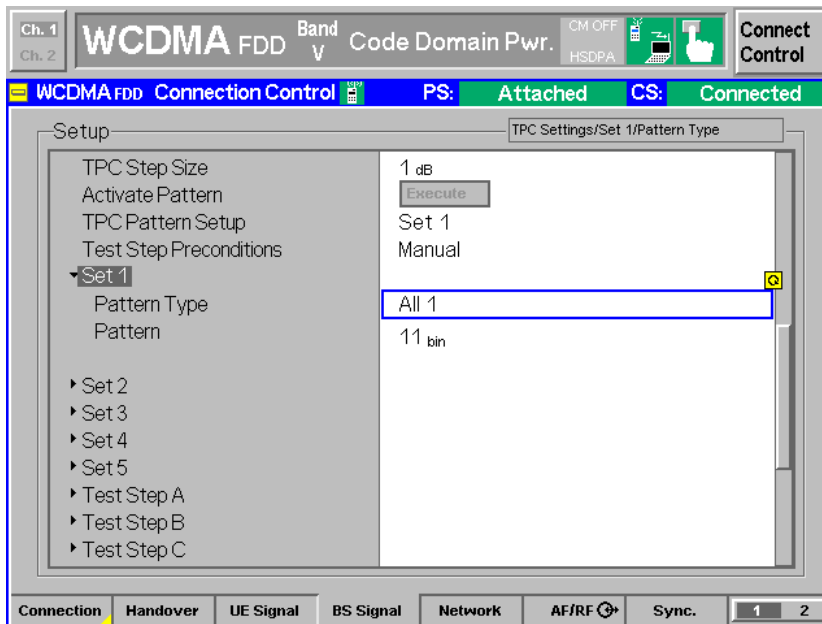

TPC with All "1" (Continuous transmitting)

### HSDPA Setup Configuration

- a. The EUT was connected to Spectrum Analyzer and Base Station via power splitter. Refer to the drawing of Setup Configuration.
- b. The RF path losses were compensated into the measurements.
- c. A call was established between EUT and Base Station with following setting:
  - i. Set RMC12.2Kbps with HSDPA mode.
  - ii. TPC with All Up with H-set.
- d. The transmitted maximum output power was recorded.

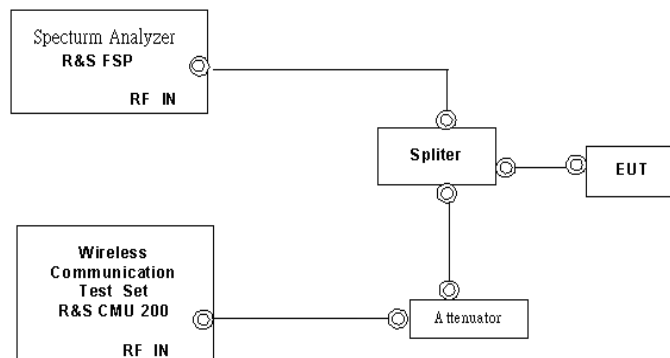

### Setup Configuration

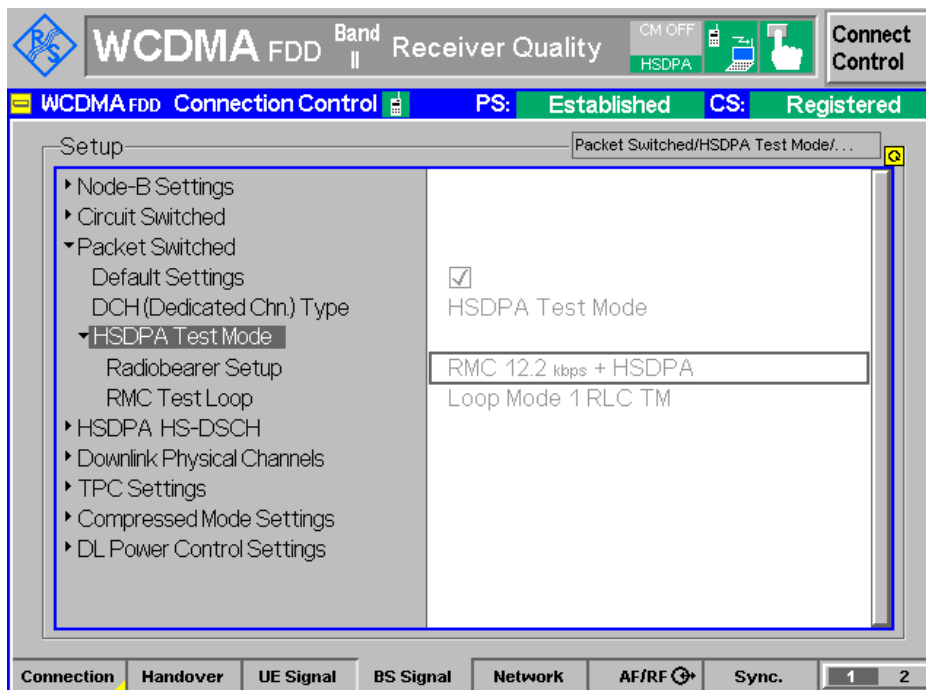

RMC 12.2Kbps with HSDPA function



**Reference:**

- [1.] SAR Measurement Procedures for 3G Devices CDMA 2000/Ev-Do/WCDMA/HSDPA June 2006 Laboratory Division Office of Engineering and Technology Federal Communications Commission
- [2.] TS 34.121 Universal Mobile Telecommunications System (UMTS); Terminal Conformance Specification, Radio Transmission and Reception (FDD)