

FCC RF Test Report

APPLICANT : HTC Corporation
EQUIPMENT : Smart Phone
MODEL NAME : CDMA__HTI12
FCC ID : NM8CDMAHTI12
STANDARD : 47 CFR Part 2, 27(M)
CLASSIFICATION : PCS Licensed Transmitter Held to Ear (PCE)
TX FREQUENCY RANGE : 2496 MHz ~ 2690 MHz
Rx FREQUENCY RANGE : 2496 MHz ~ 2690 MHz
MAX. EIRP POWER : 0.06 W (QPSK, BW 5MHz)
0.06 W (QPSK, BW 10MHz)
0.05 W (16QAM, BW 5MHz)
0.06 W (16QAM, BW 10MHz)
EMISSION DESIGNATOR : 4M50G7D (QPSK, BW 5MHz)
9M36G7D (QPSK, BW 10MHz)
4M50W7D (16QAM, BW 5MHz)
9M36W7D (16QAM, BW 10MHz)

The product was received on Jun. 15, 2011 and completely tested on Jul. 03, 2011. We, SPORTON INTERNATIONAL INC., would like to declare that the tested sample has been evaluated in accordance with the procedures given in ANSI C63.4-2003 and 47 CFR FCC Part 27 Subpart M and shown compliance with the applicable technical standards.

The test results in this report apply exclusively to the tested model / sample. Without written approval of SPORTON INTERNATIONAL INC., the test report shall not be reproduced except in full.

Reviewed by:



Jones Tsai / Manager



SPORTON INTERNATIONAL INC.

No. 52, Hwa Ya 1st Rd., Hwa Ya Technology Park, Kwei-Shan Hsiang, Tao Yuan Hsien, Taiwan, R.O.C.

SPORTON INTERNATIONAL INC.

TEL : 886-3-327-3456

FAX : 886-3-328-4978

FCC ID : NM8CDMAHTI12

Page Number : 1 of 52

Report Issued Date : Jul. 21, 2011

Report Version : Rev. 01



TABLE OF CONTENTS

REVISION HISTORY..... 3

SUMMARY OF TEST RESULT 4

1 GENERAL DESCRIPTION 5

 1.1 Applicant 5

 1.2 Manufacturer 5

 1.3 Feature of Equipment Under Test 5

 1.4 Testing Site 6

 1.5 Applied Standards 6

 1.6 Ancillary Equipment List 6

2 TEST CONFIGURATION OF EQUIPMENT UNDER TEST 7

 2.1 Test Mode 7

 2.2 Connection Diagram of Test System 9

3 TEST RESULT 10

 3.1 Maximum Output Power, Band Edge, and Effective Isotropic Radiated Power Measurement 10

 3.2 Emission Bandwidth 19

 3.3 Conducted Spurious Emission Measurement 24

 3.4 Radiated Emissions Measurement 37

 3.5 Frequency Stability Measurement 47

4 LIST OF MEASURING EQUIPMENTS..... 51

5 UNCERTAINTY OF EVALUATION 52

APPENDIX A. SETUP PHOTOGRAPHS



SUMMARY OF TEST RESULT

Report Section	FCC Rule	Description	Limit	Result	Remark
3.1	§2.1033 §2.1046 §27.50	Maximum Output Power	< 2 Watts	PASS	-
3.1	§2.1033 §2.1046 §27.50	Band Edge Emissions	< 5.5MHz: -13 dBm ≥5.5MHz: -25 dBm	PASS	-
3.1	§27.50	Equivalent Isotropic Radiated Power	< 2 Watts	PASS	-
3.2	§2.1049 §27.53	Emissions Bandwidth	N/A	PASS	-
3.3	§2.1051 §27.53	Conducted Spurious Emissions	< 55+10log ₁₀ (P[Watts])	PASS	-
3.4	§2.1053 §27.53	Field Strength of Spurious Radiation	< 55+10log ₁₀ (P[Watts])	PASS	Under limit 5.77 dB at 7779 MHz
3.5	§2.1055 §27.54	Frequency Stability for Temperature & Voltage	2.5 ppm	PASS	-



1 General Description

1.1 Applicant

HTC Corporation
1F., No. 6-3, Baoqiang Rd., Xindian City, Taipei, Taiwan

1.2 Manufacturer

HTC Corporation
1F., No. 6-3, Baoqiang Rd., Xindian City, Taipei, Taiwan

1.3 Feature of Equipment Under Test

Product Feature & Specification	
Equipment	Smart Phone
Model Name	CDMA__HTI12
FCC ID	NM8CDMAHTI12
Tx Frequency	2496 MHz ~ 2690 MHz
Rx Frequency	2496 MHz ~ 2690 MHz
Channel Bandwidth	5MHz / 10MHz
Maximum Output Power to Antenna	23.94 dBm (QPSK, BW 5MHz) 23.58 dBm (QPSK, BW 10MHz) 23.83 dBm (16QAM, BW 5MHz) 23.53 dBm (16QAM, BW 10MHz)
Maximum EIRP	0.06 W (17.50 dBm) (QPSK, BW 5MHz) 0.06 W (17.69 dBm) (QPSK, BW 10MHz) 0.05 W (17.40 dBm) (16QAM, BW 5MHz) 0.06 W (17.67 dBm) (16QAM, BW 10MHz)
Antenna Type	PIFA Antenna
Type of Modulation	Uplink : OFDMA (QPSK / 16QAM / 64QAM)
Type of Emission	4M50G7D (QPSK, BW 5MHz) 9M36G7D (QPSK, BW 10MHz) 4M50W7D (16QAM, BW 5MHz) 9M36W7D (16QAM, BW 10MHz)
EUT Stage	Production Unit

Remark:

1. For other wireless features of this EUT, the test report will be issued separately.
2. This test report recorded only product characteristics and test results of PCS Licensed Transmitter Held to Ear (PCE).
3. The above EUT's information was declared by manufacturer. Please refer to the specifications or user's manual for more detailed description.



1.4 Testing Site

Test Site	SPORTON INTERNATIONAL INC.		
Test Site Location	No. 52, Hwa Ya 1 st Rd., Hwa Ya Technology Park, Kwei-Shan Hsiang, Tao Yuan Hsien, Taiwan, R.O.C. TEL: +886-3-327-3456 FAX: +886-3-328-4978		
Test Site No.	Sporton Site No.		FCC / IC Registration No.
	TH02-HY	03CH05-HY	722060/4086B-1

1.5 Applied Standards

According to the specifications of the manufacturer, the EUT must comply with the requirements of the following standards:

- 47 CFR Part 2, 27(M)
- ANSI C63.4-2003
- ANSI TIA-603-C-2004

Remark:

1. All test items were verified and recorded according to the standards and without any deviation during the test.
2. This EUT has also been tested and complied with the requirements of FCC Part 15, Subpart B (DoC), recorded in a separate test report.

1.6 Ancillary Equipment List

Item	Equipment	Trade Name	Model No.	FCC ID	Data Cable	Power Cord
1.	VSG (System Simulator)	Agilent	E6651A	N/A	N/A	Unshielded, 1.8 m

2 Test Configuration of Equipment Under Test

2.1 Test Mode

Preliminary tests were performed in different data rate to find the worst radiated emission. The data rate shown in the table below is the worst-case rate with respect to the specific test item. Investigation has been done on all the possible configurations for searching the worst cases. The following table is a list of the test modes shown in this test report. The spurious emission measurements were carried out in semi-anechoic chamber with 3-meter test range.

Test Modes		
Band	Radiated TCs	Conducted TCs
802.16e (Modulation : OFDMA)	<ul style="list-style-type: none"> ■ QPSK, BW 5MHz Link ■ QPSK, BW 10MHz Link ■ 16QAM, BW 5MHz Link ■ 16QAM, BW 10MHz Link 	<ul style="list-style-type: none"> ■ QPSK, BW 5MHz Link ■ QPSK, BW 10MHz Link ■ 16QAM, BW 5MHz Link ■ 16QAM, BW 10MHz Link

Note: The maximum average power levels are on PUSC and coding rate, 1/2 mode for QPSK, BW 5MHz, QPSK, BW 10MHz, 16QAM, BW 5MHz, and 16QAM, BW 10MHz Link ; only these modes were used for all tests.

The conducted power tables are as follows:

Zone Type	Modulation	Coding Rate	Channel	Main Antenna			Aux. Antenna		
				Peak Power	Average Power	PAPR	Peak Power	Average Power	PAPR
PUSC	QPSK (BW 5MHz)	1/2	Low	31.78	23.90	7.88	31.90	23.94	7.96
			Middle	31.58	23.34	8.24	31.38	23.34	8.04
			High	30.97	23.29	7.68	30.97	23.29	7.68
		3/4	Low	31.85	23.89	7.96	31.83	23.87	7.96
			Middle	31.41	23.21	8.20	31.29	23.25	8.04
			High	30.93	23.25	7.68	30.96	23.28	7.68
	16QAM (BW 5MHz)	1/2	Low	31.87	23.83	8.04	31.86	23.82	8.04
			Middle	31.31	23.11	8.20	31.14	23.18	7.96
			High	30.85	23.05	7.80	30.92	23.20	7.72
		3/4	Low	31.92	23.76	8.16	31.97	23.81	8.16
			Middle	31.24	23.00	8.24	31.11	23.07	8.04
			High	30.80	22.92	7.88	30.83	22.99	7.84
	QPSK (BW 10MHz)	1/2	Low	31.74	23.42	8.32	31.90	23.58	8.32
			Middle	31.22	22.90	8.32	31.33	23.09	8.24
			High	31.28	23.16	8.12	31.14	23.22	7.92
		3/4	Low	31.67	23.35	8.32	31.83	23.47	8.36
			Middle	31.22	22.86	8.36	31.40	23.08	8.32
			High	31.08	23.00	8.08	31.18	23.22	7.96
	16QAM (BW 10MHz)	1/2	Low	31.64	23.36	8.28	31.81	23.53	8.28
			Middle	31.31	22.99	8.32	31.45	23.17	8.28
			High	31.08	23.00	8.08	31.27	23.27	8.00
		3/4	Low	31.57	23.25	8.32	31.77	23.45	8.32
			Middle	31.09	22.77	8.32	31.28	22.96	8.32
			High	30.93	22.85	8.08	31.06	23.06	8.00

Note: PAPR = Peak to Average Power Ratio

2.2 Connection Diagram of Test System

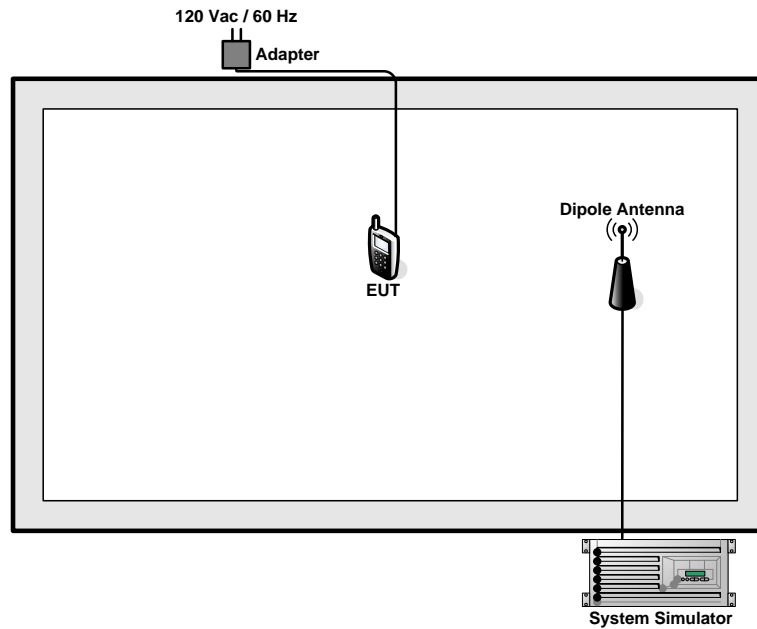

3 Test Result

3.1 Maximum Output Power, Band Edge, and Effective Isotropic Radiated Power Measurement

3.1.1 Limit

For mobile and other user stations, mobile stations are limited to 2.0 watts EIRP and all user stations are limited to 2.0 watts transmitter output power. The power of any emission outside of the authorized operating frequency ranges must be attenuated below the transmitting power (p) by a factor of mobile digital stations, the attenuation factor shall be not less than $43 + 10 \log (p)$ dB at the channel edge and $55 + 10 \log (p)$ dB at 5.5 MHz from the channel edges.

3.1.2 Measuring Instruments

See list of measuring instruments of this test report.

3.1.3 Test Procedures

For Conducted Power and Band Edge Measurement:

The RF output of the transmitter was connected to the input of the spectrum analyzer through sufficient attenuation.

For Effective Isotropic Radiated Power Measurement:

1. The EUT was placed on an non-conductive rotating platform with 0.8 meter height in a semi-anechoic chamber. The radiated emission at the fundamental frequency was measured at 3 m.
2. During the measurement, the EUT was enforced in maximum power. The highest emission was recorded from analyzer power level (LVL) from the 360 degrees rotation of the turntable and the test antenna raised and lowered over a range from 1 to 4 meters in both horizontally and vertically polarized orientations.
3. Effective Isotropic Radiated Power (EIRP) was measured by substitution method according to TIA/EIA-603-C. The EUT was replaced by dipole antenna (substitution antenna) at same location, and then a known power from S.G. was applied into the dipole antenna through a Tx cable, and then recorded the maximum Analyzer reading through raised and lowered the test antenna. The correction factor (in dB) = S.G. - Tx Cable loss + Substitution antenna gain - Analyzer reading. Then the EUT's EIRP was calculated with the correction factor, $EIRP = LVL + \text{Correction factor}$.

3.1.4 Test Setup

<Conducted Power and Band Edge Measurement>

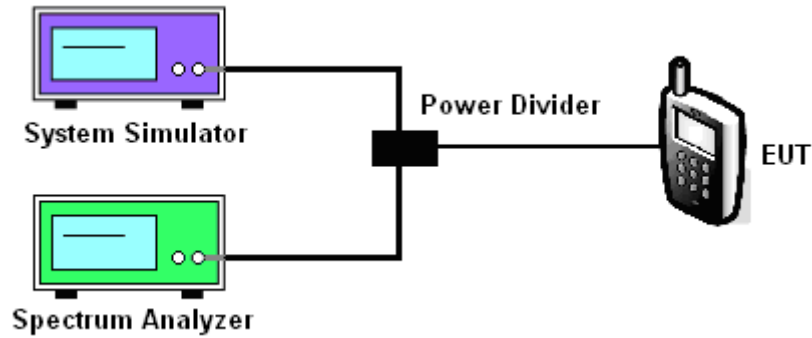

<Effective Isotropic Radiated Power Measurement>

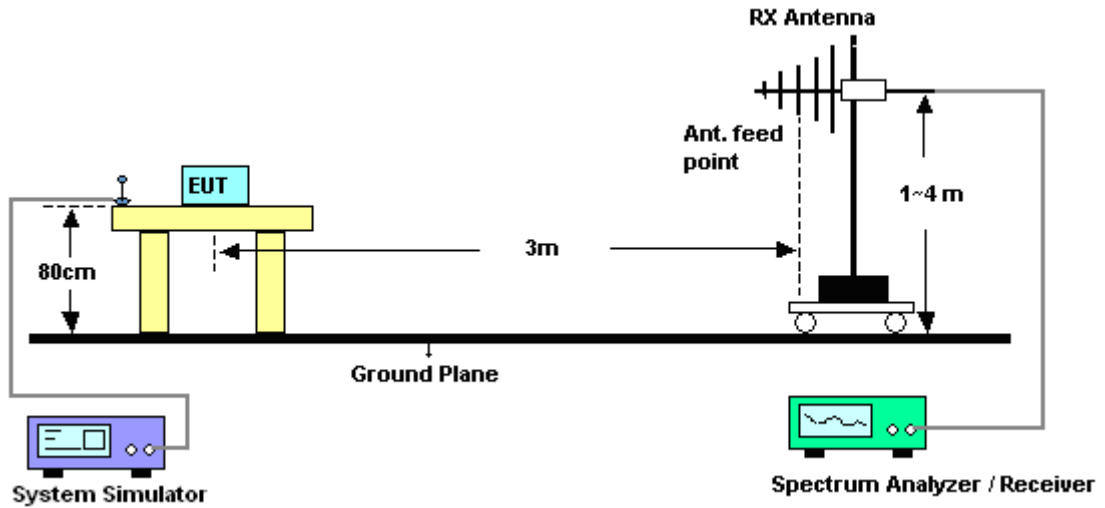



3.1.5 Test Result of Maximum Output Power

Channel	Modulation Type	Zone Type	Coding Rate	5MHz Bandwidth			10MHz Bandwidth		
				Peak Power	Average Power	PAR	Peak Power	Average Power	PAR
Low	QPSK	PUSC	1/2	31.90	23.94	7.96	31.90	23.58	8.32
Middle	QPSK	PUSC	1/2	31.38	23.34	8.04	31.33	23.09	8.24
High	QPSK	PUSC	1/2	30.97	23.29	7.68	31.14	23.22	7.92

Note: PAR = Peak to Average Ratio

Channel	Modulation Type	Zone Type	Coding Rate	5MHz Bandwidth			10MHz Bandwidth		
				Peak Power	Average Power	PAR	Peak Power	Average Power	PAR
Low	16QAM	PUSC	1/2	31.87	23.83	8.04	31.81	23.53	8.28
Middle	16QAM	PUSC	1/2	31.31	23.11	8.20	31.45	23.17	8.28
High	16QAM	PUSC	1/2	30.85	23.05	7.80	31.27	23.27	8.00

Note: PAR = Peak to Average Ratio

3.1.6 Test Result of Band Edge Measurement

Band :	802.16e	Power Stage :	High
Test Mode :	QPSK, BW 5MHz		

Band Edge Plot on Low Channel

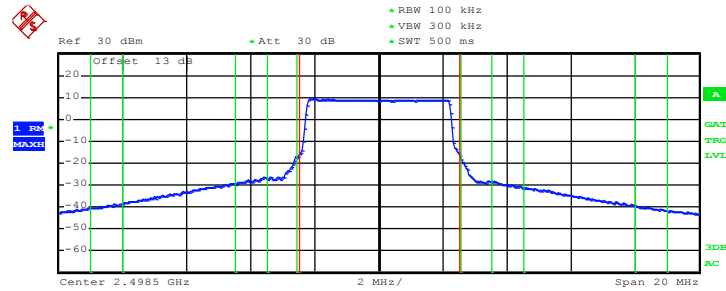

Tx Channel	Bandwidth	5 MHz	Power	24.94 dBm
Adjacent Channel	Bandwidth	50 kHz	Lower	-20.62 dBm
	Spacing	2.525 MHz		
Alternate Channel	Bandwidth	1 MHz	Lower	-18.29 dBm
	Spacing	4 MHz	- -	
2nd Alternate Channel	Bandwidth	1 MHz	Lower	-29.95 dBm
	Spacing	8.5 MHz		

Bandedge limit: -13dBm

Bandedge limit: -13dBm

Bandedge limit: -25dBm

Date: 13.JUL.2011 06:17:28

Band Edge Plot on High Channel

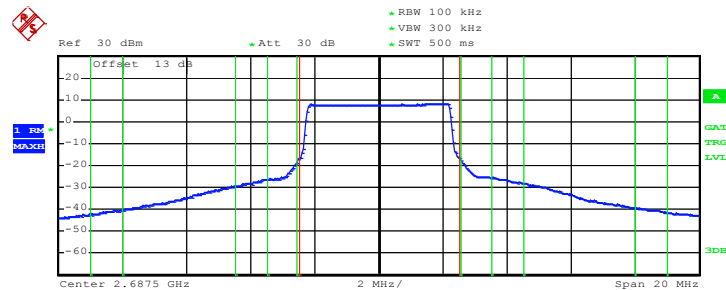

Tx Channel	Bandwidth	5 MHz	Power	23.87 dBm
Adjacent Channel	Bandwidth	50 kHz	Upper	-19.94 dBm
	Spacing	2.525 MHz		
Alternate Channel	Bandwidth	1 MHz	Upper	-17.10 dBm
	Spacing	4 MHz		
2nd Alternate Channel	Bandwidth	1 MHz	Upper	-30.68 dBm
	Spacing	8.5 MHz		

Bandedge limit: -13dBm

Bandedge limit: -13dBm

Bandedge limit: -25dBm

Date: 24.JUN.2011 17:57:08



Band :	802.16e	Power Stage :	High
Test Mode :	QPSK, BW 10MHz		

Edge Plot on Low Channel

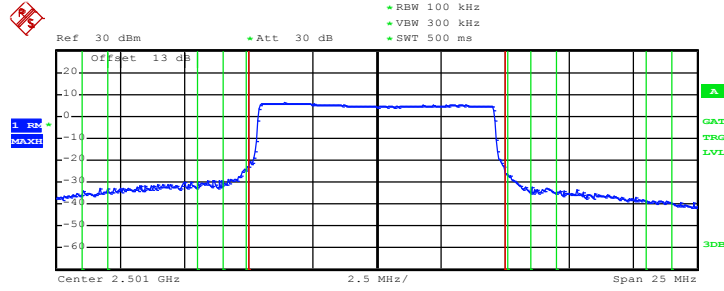

Tx Channel	Bandwidth	10 MHz	Power	24.33 dBm
Adjacent Channel	Bandwidth	100 kHz	Lower	-23.74 dBm
	Spacing	5.05 MHz		
Alternate Channel	Bandwidth	1 MHz	Lower	-20.93 dBm
	Spacing	6.5 MHz		
2nd Alternate Channel	Bandwidth	1 MHz	Lower	-25.24 dBm
	Spacing	11 MHz		

Bandedge limit: -13dBm
 Bandedge limit: -13dBm
 Bandedge limit: -25dBm

Date: 13.JUL.2011 15:33:41

Band Edge Plot on High Channel

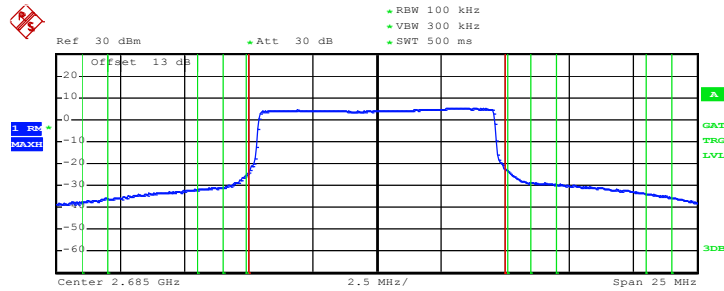

Tx Channel	Bandwidth	10 MHz	Power	23.55 dBm
Adjacent Channel	Bandwidth	100 kHz	Upper	-23.32 dBm
	Spacing	5.05 MHz		
Alternate Channel	Bandwidth	1 MHz	Upper	-19.54 dBm
	Spacing	6.5 MHz		
2nd Alternate Channel	Bandwidth	1 MHz	Upper	-25.06 dBm
	Spacing	11 MHz		

Bandedge limit: -13dBm
 Bandedge limit: -13dBm
 Bandedge limit: -25dBm

Date: 24.JUN.2011 17:41:38



Band :	802.16e	Power Stage :	High
Test Mode :	16QAM, BW 5MHz		

Band Edge Plot on Low Channel

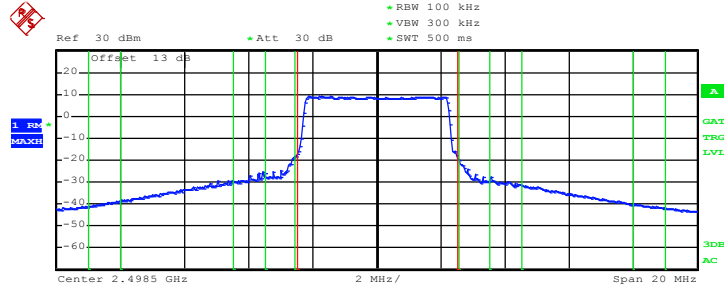

Tx Channel	Bandwidth 5 MHz	Power 24.68 dBm	
Adjacent Channel	Bandwidth 50 kHz Spacing 2.525 MHz	Lower -21.40 dBm	Bandedge limit: -13dBm
Alternate Channel	Bandwidth 1 MHz Spacing 4 MHz	Lower -18.82 dBm	Bandedge limit: -13dBm
2nd Alternate Channel	Bandwidth 1 MHz Spacing 8.5 MHz	Lower -30.27 dBm	Bandedge limit: -25dBm

Date: 13.JUL.2011 06:18:43

Band Edge Plot on High Channel

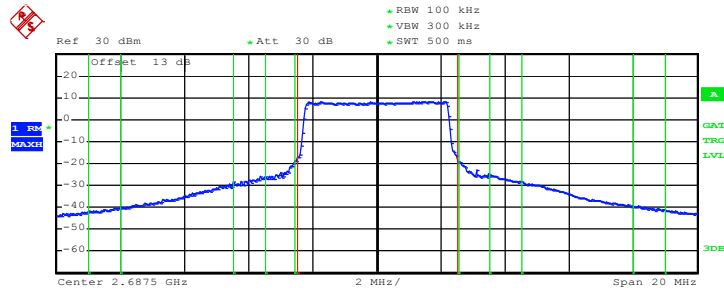

Tx Channel	Bandwidth 5 MHz	Power 23.75 dBm	
Adjacent Channel	Bandwidth 50 kHz Spacing 2.525 MHz	Upper -20.96 dBm	Bandedge limit: -13dBm
Alternate Channel	Bandwidth 1 MHz Spacing 4 MHz	Upper -17.34 dBm	Bandedge limit: -13dBm
2nd Alternate Channel	Bandwidth 1 MHz Spacing 8.5 MHz	Upper -30.79 dBm	Bandedge limit: -25dBm

Date: 24.JUN.2011 17:58:17



Band :	802.16e	Power Stage :	High
Test Mode :	16QAM, BW 10MHz		

Band Edge Plot on Low Channel

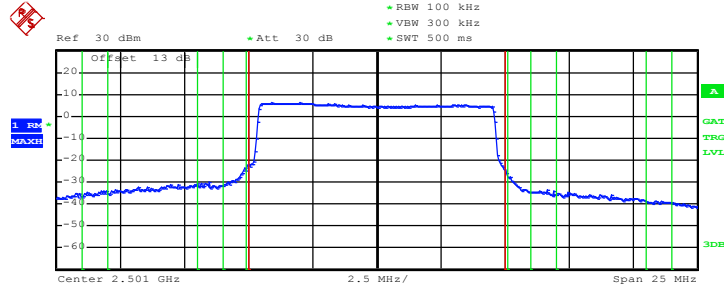

Tx Channel	Bandwidth	10 MHz	Power	24.33 dBm
Adjacent Channel	Bandwidth	100 kHz	Lower	-23.04 dBm
	Spacing	5.05 MHz		
Alternate Channel	Bandwidth	1 MHz	Lower	-21.76 dBm
	Spacing	6.5 MHz		
2nd Alternate Channel	Bandwidth	1 MHz	Lower	-25.47 dBm
	Spacing	11 MHz		

Bandedge limit: -13dBm
 Bandedge limit: -13dBm
 Bandedge limit: -25dBm

Date: 13.JUL.2011 15:33:00

Band Edge Plot on High Channel

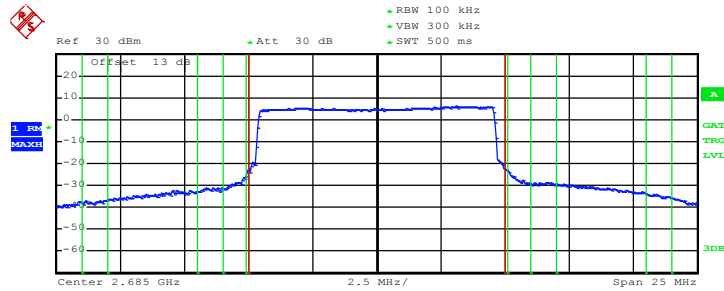

Tx Channel	Bandwidth	10 MHz	Power	24.29 dBm
Adjacent Channel	Bandwidth	100 kHz	Upper	-23.35 dBm
	Spacing	5.05 MHz		
Alternate Channel	Bandwidth	1 MHz	Upper	-19.51 dBm
	Spacing	6.5 MHz		
2nd Alternate Channel	Bandwidth	1 MHz	Upper	-25.14 dBm
	Spacing	11 MHz		

Bandedge limit: -13dBm
 Bandedge limit: -13dBm
 Bandedge limit: -25dBm

Date: 13.JUL.2011 15:35:18

3.1.7 Test Result of Effective Isotropic Radiated Power

802.16e (QPSK, BW 5MHz) Radiated Power (EIRP)				
Horizontal Polarization				
Channel	LVL (dBm)	Correction Factor (dB)	EIRP (dBm)	EIRP (W)
Low	-26.35	43.85	17.50	0.06
Middle	-26.80	44.06	17.26	0.05
High	-33.98	44.26	10.28	0.01
Vertical Polarization				
Channel	LVL (dBm)	Correction Factor (dB)	EIRP (dBm)	EIRP (W)
Low	-29.19	45.55	16.36	0.04
Middle	-30.22	46.72	16.50	0.04
High	-37.75	45.48	7.73	0.01

802.16e (QPSK, BW 10MHz) Radiated Power (EIRP)				
Horizontal Polarization				
Channel	LVL (dBm)	Correction Factor (dB)	EIRP (dBm)	EIRP (W)
Low	-26.57	43.85	17.28	0.05
Middle	-26.37	44.06	17.69	0.06
High	-34.04	44.26	10.22	0.01
Vertical Polarization				
Channel	LVL (dBm)	Correction Factor (dB)	EIRP (dBm)	EIRP (W)
Low	-29.87	45.55	15.68	0.04
Middle	-30.23	46.72	16.49	0.04
High	-37.62	45.48	7.86	0.01



802.16e (16QAM, BW 5MHz) Radiated Power (EIRP)				
Horizontal Polarization				
Channel	LVL (dBm)	Correction Factor (dB)	EIRP (dBm)	EIRP (W)
Low	-26.53	43.85	17.32	0.05
Middle	-26.66	44.06	17.40	0.05
High	-34.11	44.26	10.15	0.01
Vertical Polarization				
Channel	LVL (dBm)	Correction Factor (dB)	EIRP (dBm)	EIRP (W)
Low	-29.31	45.55	16.24	0.04
Middle	-29.90	46.72	16.82	0.05
High	-38.00	45.48	7.48	0.01

802.16e (16QAM, BW 10MHz) Radiated Power (EIRP)				
Horizontal Polarization				
Channel	LVL (dBm)	Correction Factor (dB)	EIRP (dBm)	EIRP (W)
Low	-26.48	43.85	17.37	0.05
Middle	-26.39	44.06	17.67	0.06
High	-34.08	44.26	10.18	0.01
Vertical Polarization				
Channel	LVL (dBm)	Correction Factor (dB)	EIRP (dBm)	EIRP (W)
Low	-29.86	45.55	15.69	0.04
Middle	-30.19	46.72	16.53	0.04
High	-37.61	45.48	7.87	0.01

3.2 Emission Bandwidth

3.2.1 Description of Emission Bandwidth Measurement

The emission bandwidth is defined as the width of the signal between two points, located at the 2 sides of the carrier frequency, outside of which all emissions are attenuated at least 26 dB below the transmitter power. The designated emission bandwidth using a resolution bandwidth of at least 1% of the emission bandwidth of the fundamental emission and a video bandwidth is more than resolution bandwidth.

3.2.2 Measuring Instruments

See list of measuring instruments of this test report.

3.2.3 Test Procedures

1. The EUT was connected to Spectrum Analyzer and System Simulator via power divider.
2. The 99% and 26 dB occupied bandwidth (BW) of the middle channel for the highest RF powers were measured.

3.2.4 Test Setup

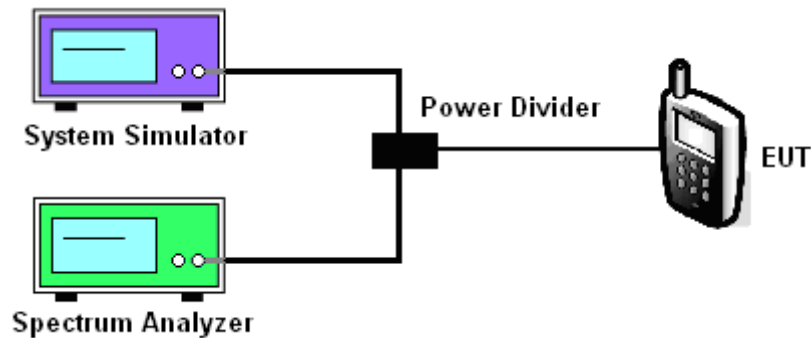

3.2.5 Test Result of Emission Bandwidth

Band :	802.16e	Power Stage :	High
Test Mode :	QPSK, BW 5MHz		

99% Occupied Bandwidth Plot on Middle Channel

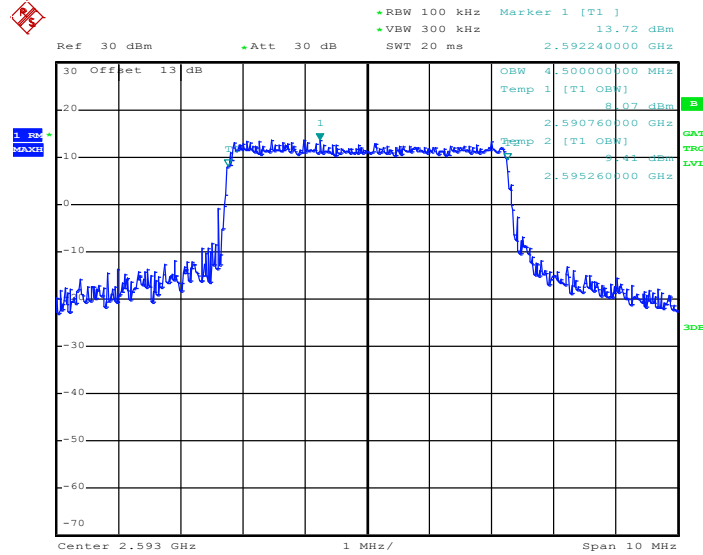

Date: 24.JUN.2011 15:59:10

26dB Bandwidth Plot on Middle Channel

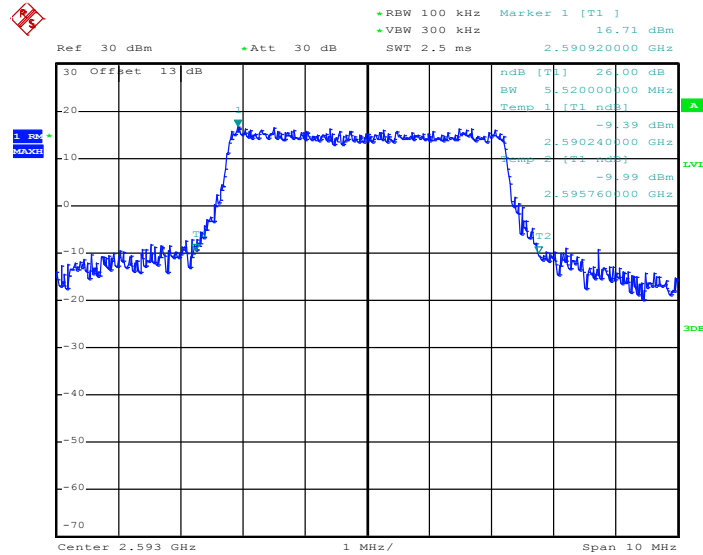

Date: 24.JUN.2011 17:02:27



Band :	802.16e	Power Stage :	High
Test Mode :	QPSK, BW 10MHz		

99% Occupied Bandwidth Plot on Middle Channel

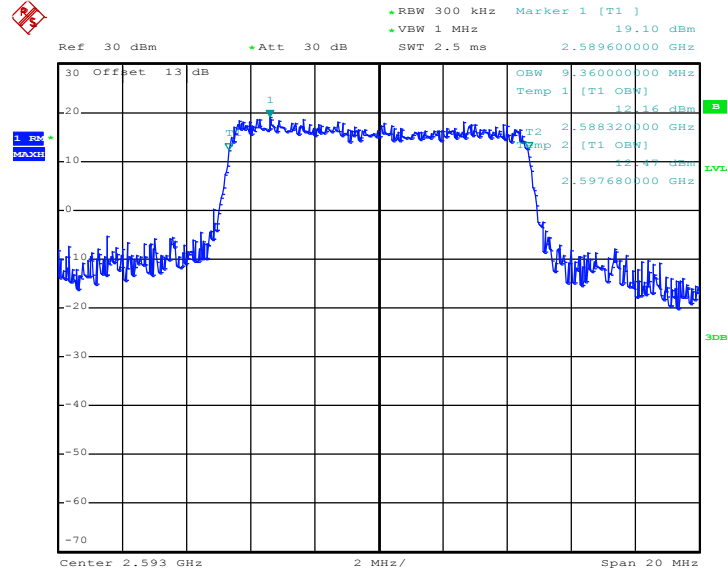

Date: 24.JUN.2011 16:42:08

26dB Bandwidth Plot on Middle Channel

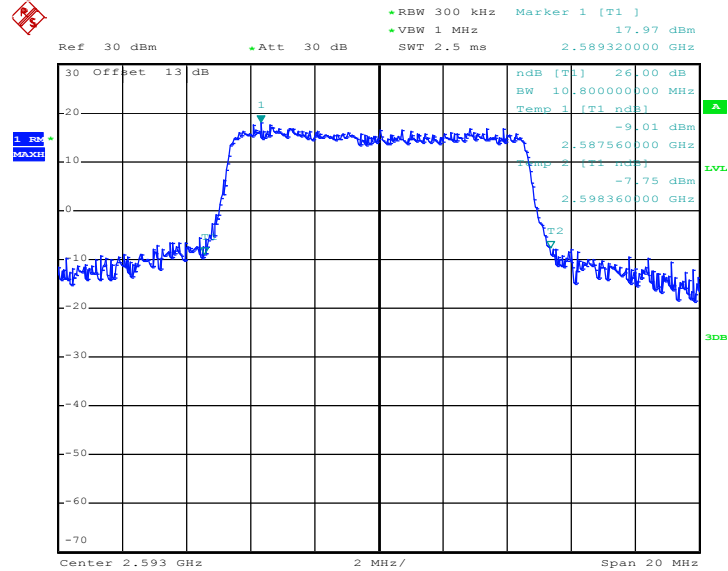

Date: 24.JUN.2011 16:53:51



Band :	802.16e	Power Stage :	High
Test Mode :	16QAM, BW 5MHz		

99% Occupied Bandwidth Plot on Middle Channel

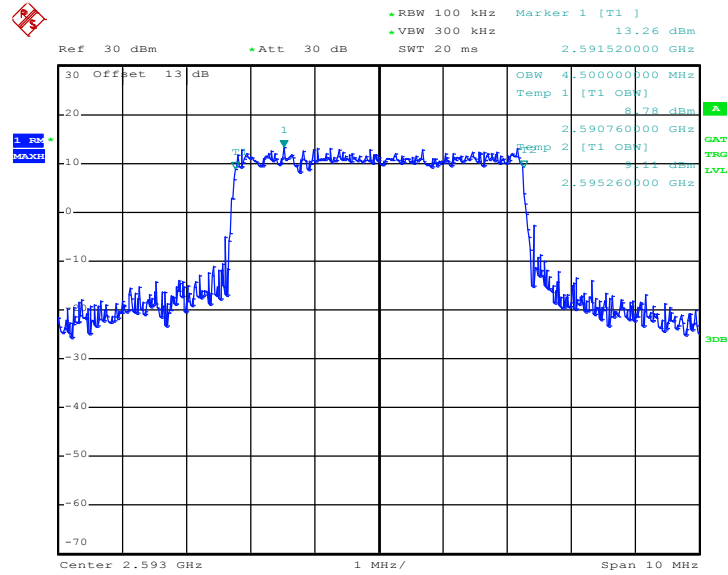

Date: 24.JUN.2011 14:59:00

26dB Bandwidth Plot on Middle Channel

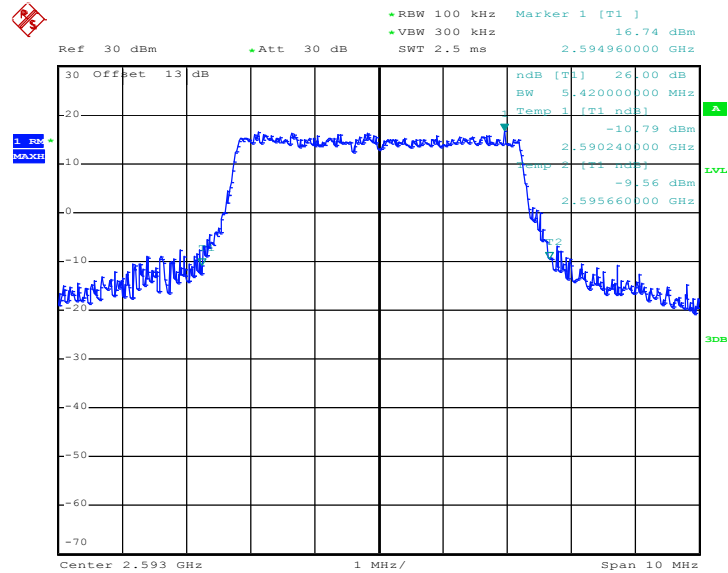

Date: 29.JUN.2011 10:53:34



Band :	802.16e	Power Stage :	High
Test Mode :	16QAM, BW 10MHz		

99% Occupied Bandwidth Plot on Middle Channel

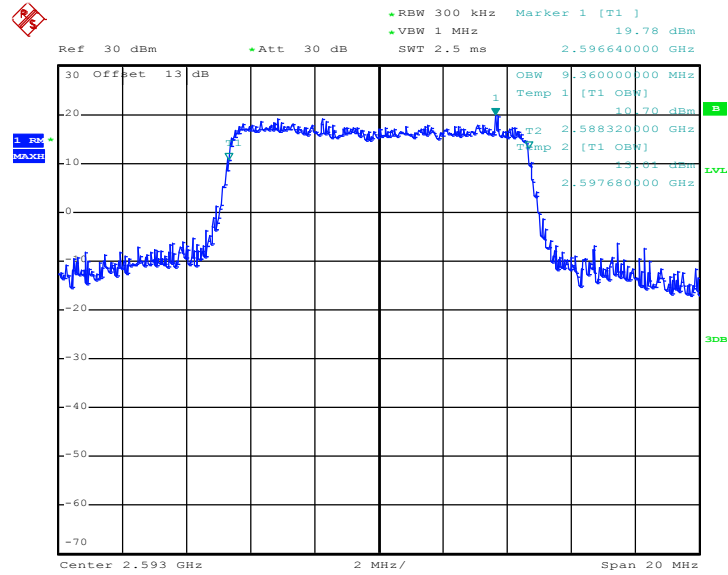

Date: 24.JUN.2011 16:39:51

26dB Bandwidth Plot on Middle Channel

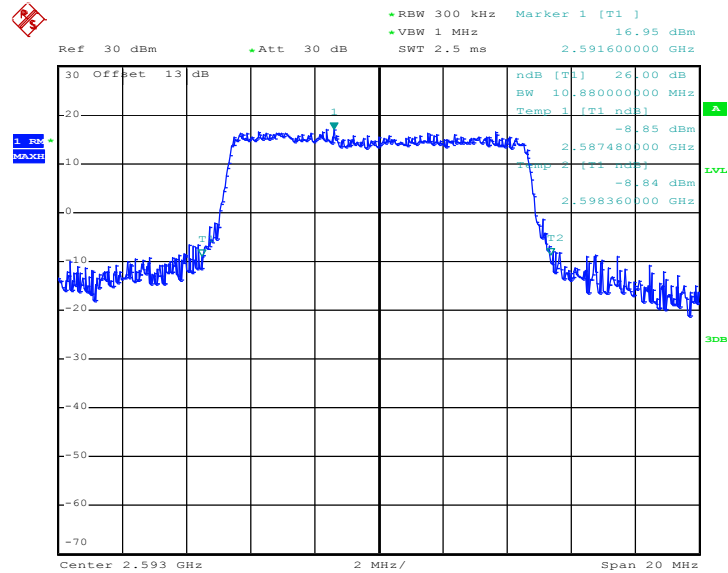

Date: 24.JUN.2011 16:57:03

3.3 Conducted Spurious Emission Measurement

3.3.1 Description of Conducted Spurious Emission Measurement

The power of any emission outside of the authorized operating frequency ranges must be lower than the transmitter power (P) by a factor of mobile digital stations, the attenuation factor shall be not less than $43 + 10 \log (P)$ dB at the channel edge and $55 + 10 \log (P)$ dB at 5.5 MHz from the channel edges. It is measured by means of a calibrated spectrum analyzer and scanned from 30 MHz up to a frequency including its 10th harmonic.

3.3.2 Measuring Instruments

See list of measuring instruments of this test report.

3.3.3 Test Procedures

1. The EUT was connected to spectrum analyzer and System Simulator via power divider.
2. The conducted spurious emission for the whole frequency range was taken.

3.3.4 Test Setup

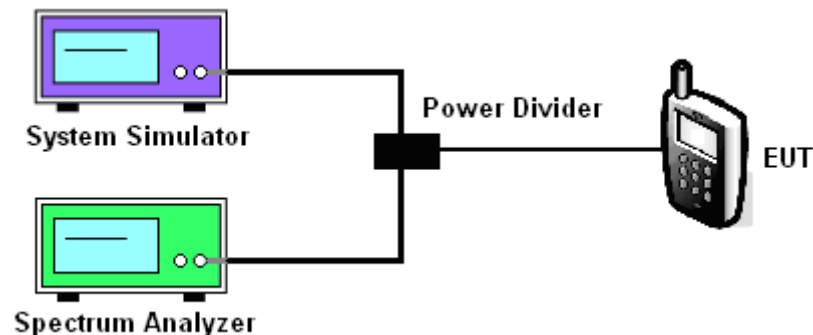

3.3.5 Test Plots of Spurious Emission

Band :	802.16e	Power Stage :	High
Test Mode :	QPSK, BW 5MHz	Channel :	Low

Conducted Spurious Emission Plot between 30MHz ~ 1GHz

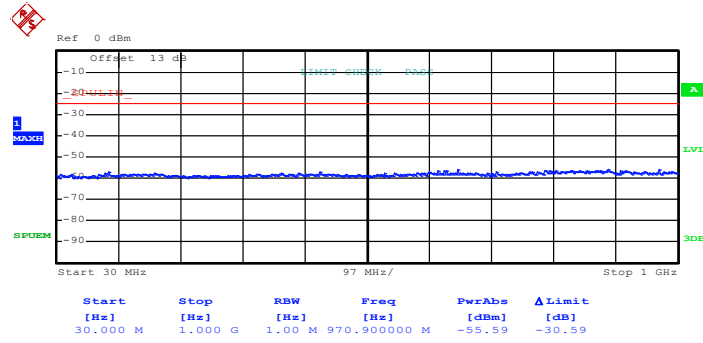

Date: 24.JUN.2011 15:19:21

Conducted Spurious Emission Plot between 1GHz ~ 27GHz

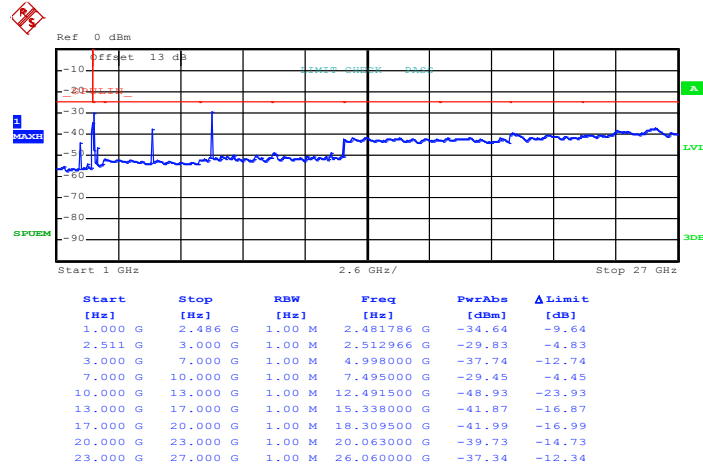

Date: 24.JUN.2011 15:44:17



Band :	802.16e	Power Stage :	High
Test Mode :	QPSK, BW 5MHz	Channel :	Middle

Conducted Spurious Emission Plot between 30MHz ~ 1GHz

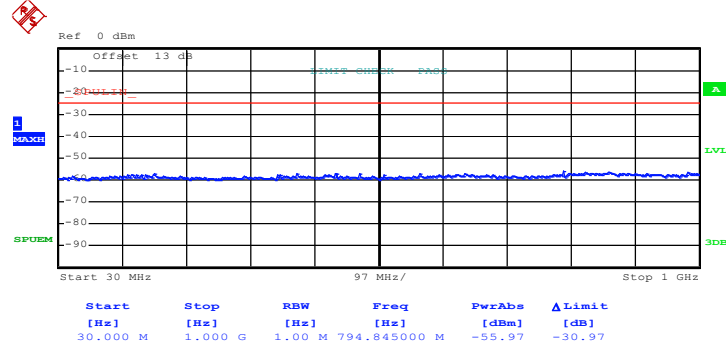

Date: 24.JUN.2011 15:20:09

Conducted Spurious Emission Plot between 1GHz ~ 27GHz

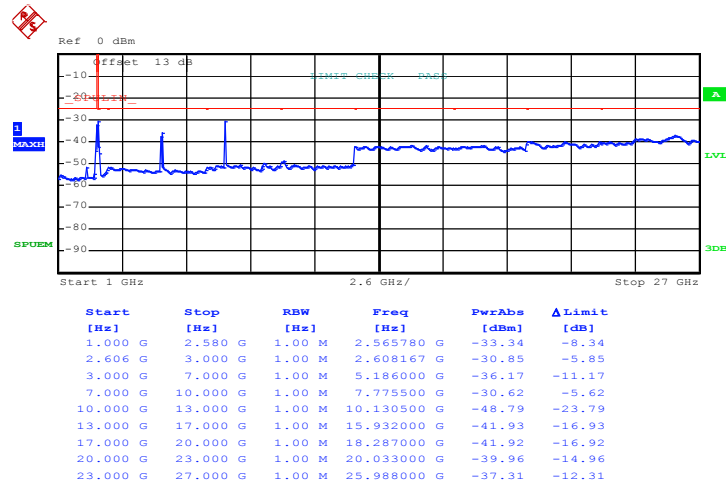

Date: 24.JUN.2011 15:50:47



Band :	802.16e	Power Stage :	High
Test Mode :	QPSK, BW 5MHz	Channel :	High

Conducted Spurious Emission Plot between 30MHz ~ 1GHz

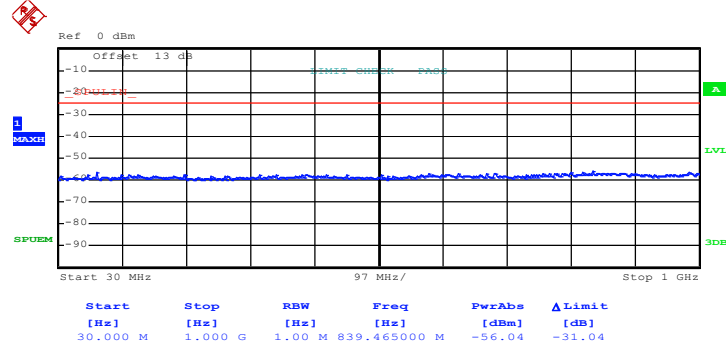

Date: 24.JUN.2011 15:17:35

Conducted Spurious Emission Plot between 1GHz ~ 27GHz

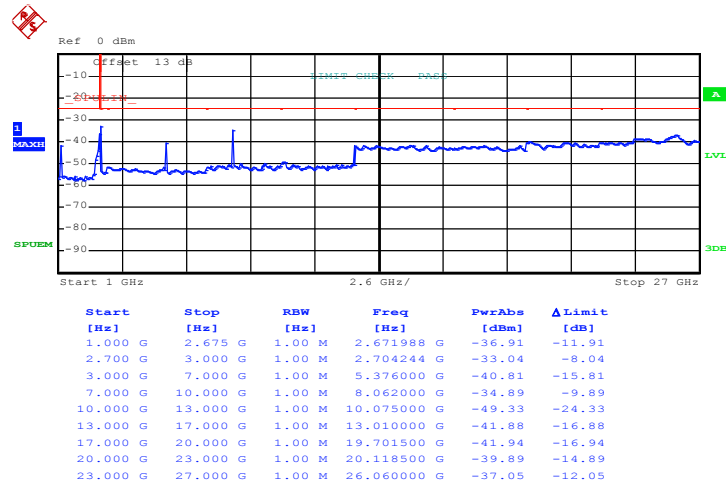

Date: 24.JUN.2011 15:47:37



Band :	802.16e	Power Stage :	High
Test Mode :	QPSK, BW 10MHz	Channel :	Low

Conducted Spurious Emission Plot between 30MHz ~ 1GHz

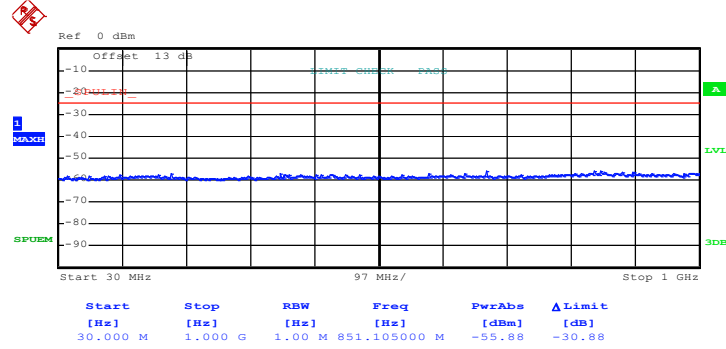

Date: 24.JUN.2011 15:14:34

Conducted Spurious Emission Plot between 1GHz ~ 27GHz

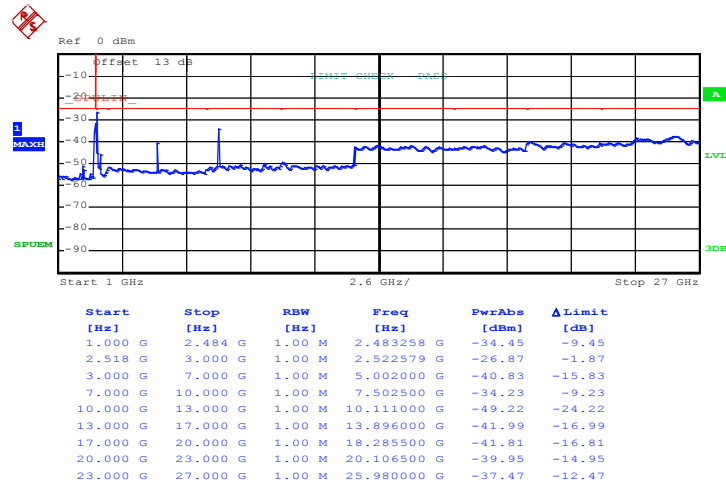

Date: 24.JUN.2011 16:38:57



Band :	802.16e	Power Stage :	High
Test Mode :	QPSK, BW 10MHz	Channel :	Middle

Conducted Spurious Emission Plot between 30MHz ~ 1GHz

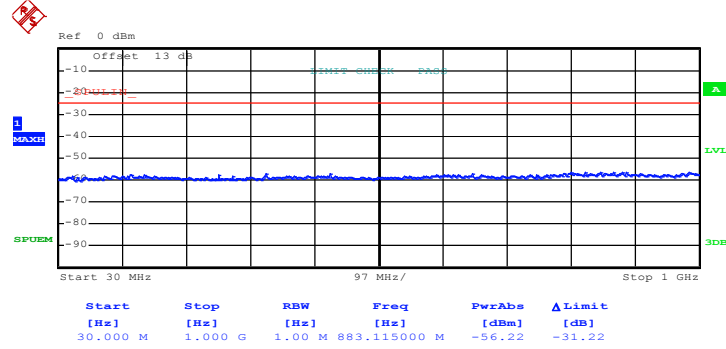

Date: 24.JUN.2011 15:13:45

Conducted Spurious Emission Plot between 1GHz ~ 27GHz

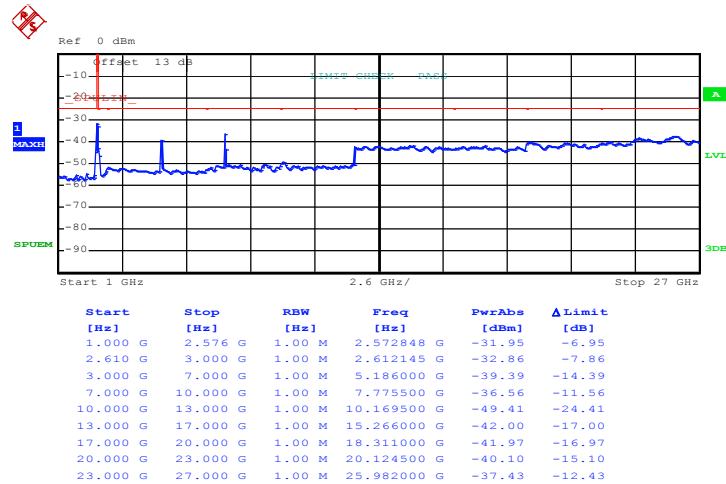

Date: 24.JUN.2011 16:33:12



Band :	802.16e	Power Stage :	High
Test Mode :	QPSK, BW 10MHz	Channel :	High

Conducted Spurious Emission Plot between 30MHz ~ 1GHz

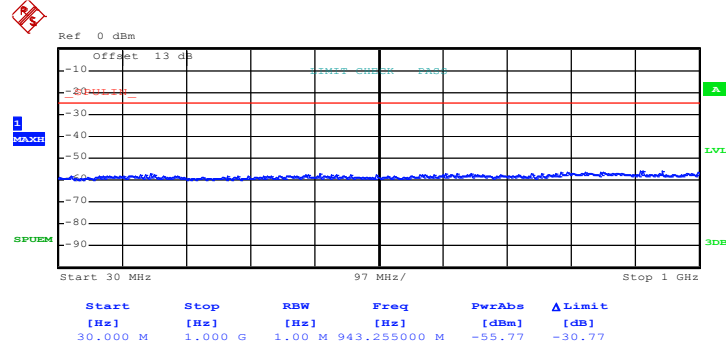

Date: 24.JUN.2011 15:16:09

Conducted Spurious Emission Plot between 1GHz ~ 27GHz

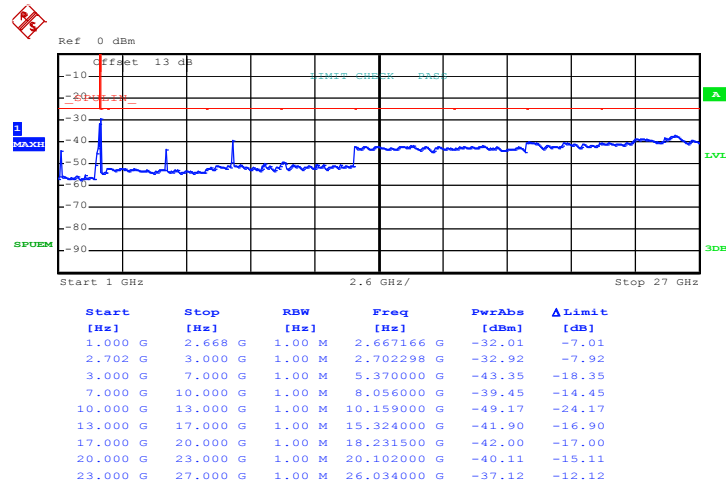

Date: 24.JUN.2011 16:35:36



Band :	802.16e	Power Stage :	High
Test Mode :	16QAM, BW 5MHz	Channel :	Low

Conducted Spurious Emission Plot between 30MHz ~ 1GHz

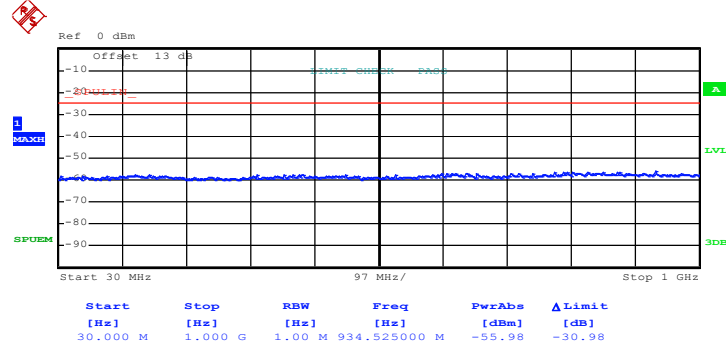

Date: 24.JUN.2011 15:18:50

Conducted Spurious Emission Plot between 1GHz ~ 27GHz

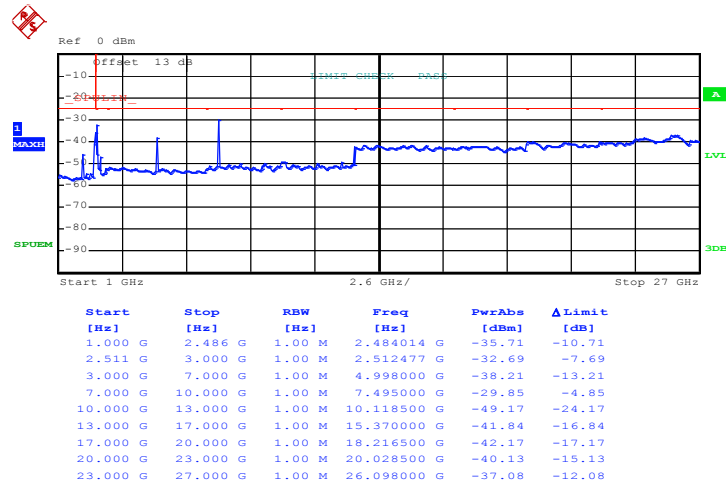

Date: 24.JUN.2011 15:45:13



Band :	802.16e	Power Stage :	High
Test Mode :	16QAM, BW 5MHz	Channel :	Middle

Conducted Spurious Emission Plot between 30MHz ~ 1GHz

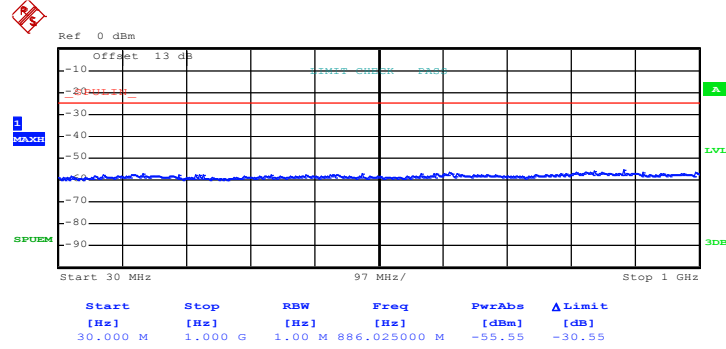

Date: 24.JUN.2011 15:20:40

Conducted Spurious Emission Plot between 1GHz ~ 27GHz

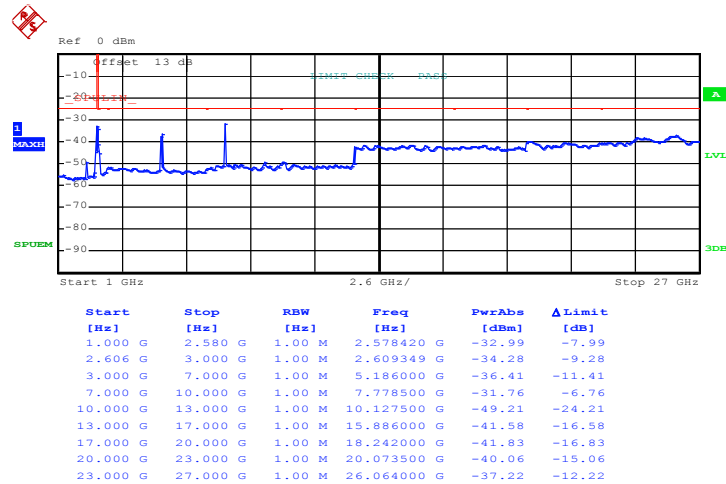

Date: 24.JUN.2011 15:49:58



Band :	802.16e	Power Stage :	High
Test Mode :	16QAM, BW 5MHz	Channel :	High

Conducted Spurious Emission Plot between 30MHz ~ 1GHz

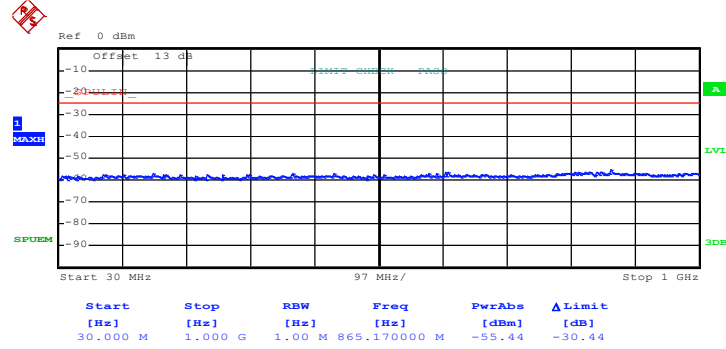

Date: 24.JUN.2011 15:18:04

Conducted Spurious Emission Plot between 1GHz ~ 27GHz

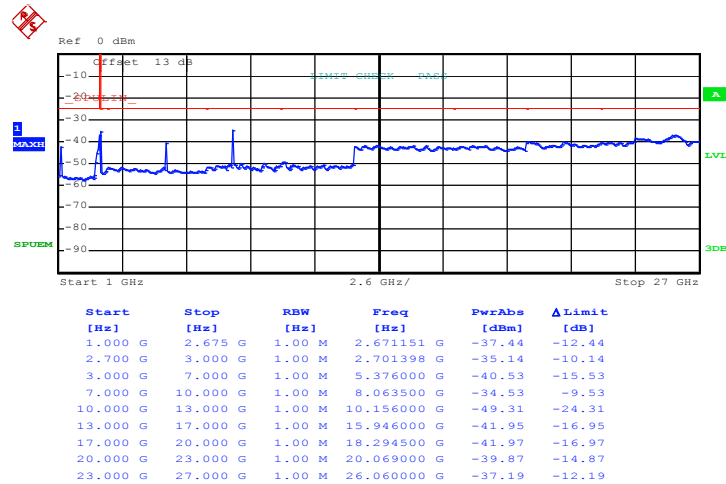

Date: 24.JUN.2011 15:48:25



Band :	802.16e	Power Stage :	High
Test Mode :	16QAM, BW 10MHz	Channel :	Low

Conducted Spurious Emission Plot between 30MHz ~ 1GHz

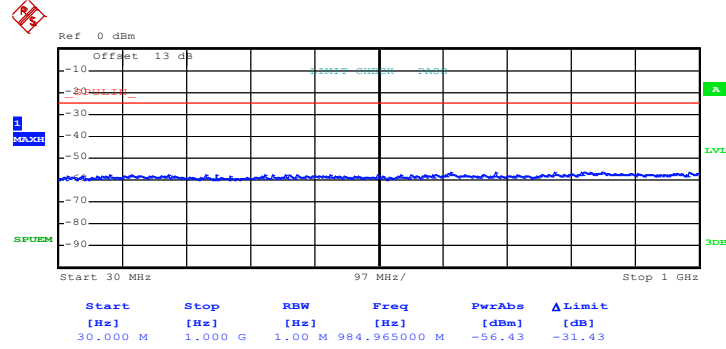

Date: 24.JUN.2011 15:14:59

Conducted Spurious Emission Plot between 1GHz ~ 27GHz

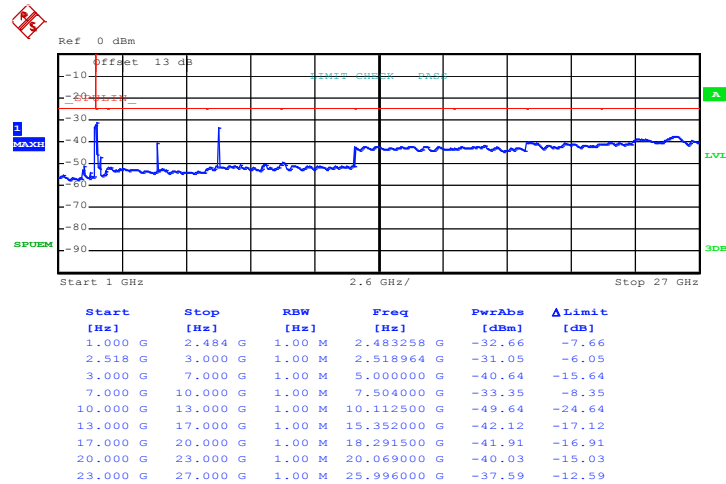

Date: 24.JUN.2011 16:38:11



Band :	802.16e	Power Stage :	High
Test Mode :	16QAM, BW 10MHz	Channel :	Middle

Conducted Spurious Emission Plot between 30MHz ~ 1GHz

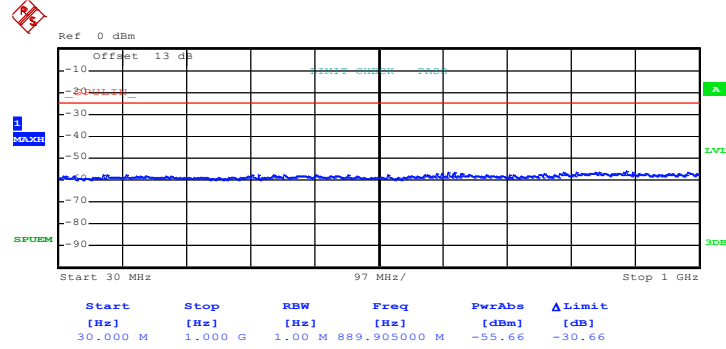

Date: 24.JUN.2011 15:13:04

Conducted Spurious Emission Plot between 1GHz ~ 27GHz

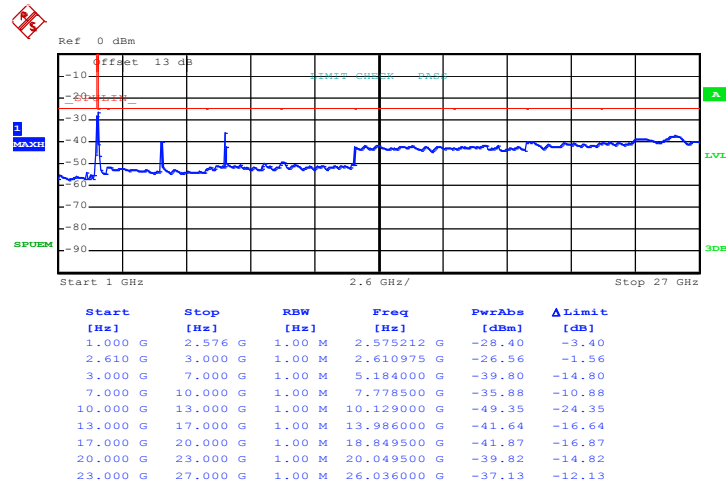

Date: 24.JUN.2011 16:12:05



Band :	802.16e	Power Stage :	High
Test Mode :	16QAM, BW 10MHz	Channel :	High

Conducted Spurious Emission Plot between 30MHz ~ 1GHz

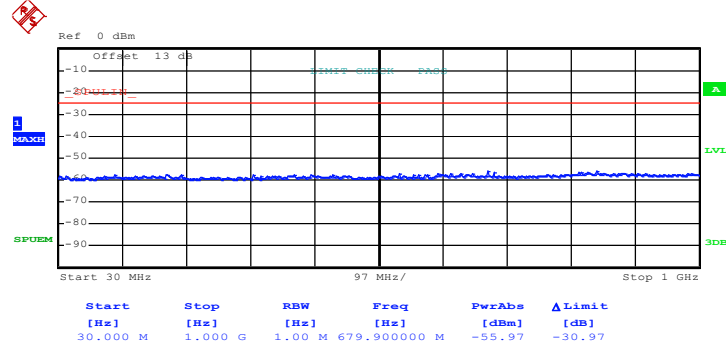

Date: 24.JUN.2011 15:15:46

Conducted Spurious Emission Plot between 1GHz ~ 27GHz

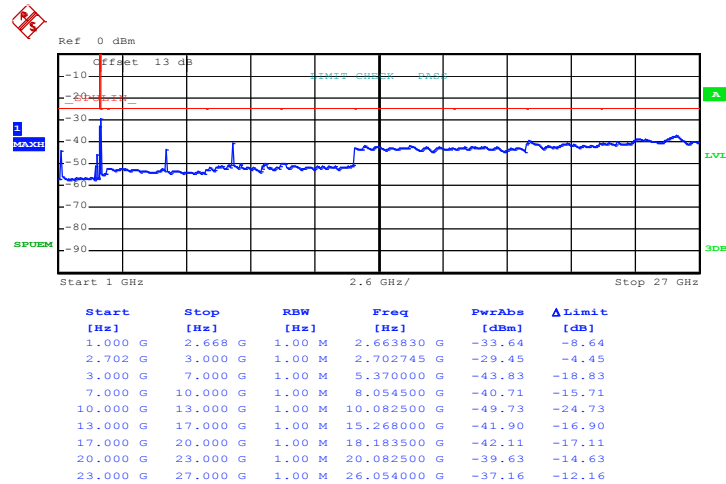

Date: 24.JUN.2011 16:36:37



3.4 Radiated Emissions Measurement

3.4.1 Description of Radiated Emissions Measurement

The power of any emission outside of the authorized operating frequency ranges must be lower than the transmitter power (P) by a factor of mobile digital stations, the attenuation factor shall be not less than $43 + 10 \log (P)$ dB at the channel edge and $55 + 10 \log (P)$ dB at 5.5 MHz from the channel edges. It is measured by means of a calibrated spectrum analyzer and scanned from 30 MHz up to a frequency including its 10th harmonic.

3.4.2 Measuring Instruments

See list of measuring instruments of this test report.

3.4.3 Test Procedures

1. The EUT was placed on a rotatable wooden table with 0.8 meter about ground.
2. The EUT was set 3 meters from the receiving antenna, which was mounted on the antenna tower.
3. The table was rotated 360 degrees to determine the position of the highest spurious emission.
4. The height of the receiving antenna is varied between one meter and four meters to search the maximum spurious emission for both horizontal and vertical polarizations.
5. Make the measurement with the spectrum analyzer's RBW = 1MHz, VBW = 1MHz, Sweep = 500ms, Taking the record of maximum spurious emission.
6. A horn antenna was substituted in place of the EUT and was driven by a signal generator.
7. Tune the output power of signal generator to the same emission level with EUT maximum spurious emission.
8. Taking the record of output power at antenna port.
9. Repeat step 7 to step 8 for another polarization.
10. Emission level (dBm) = output power + substitution Gain.

3.4.4 Test Setup

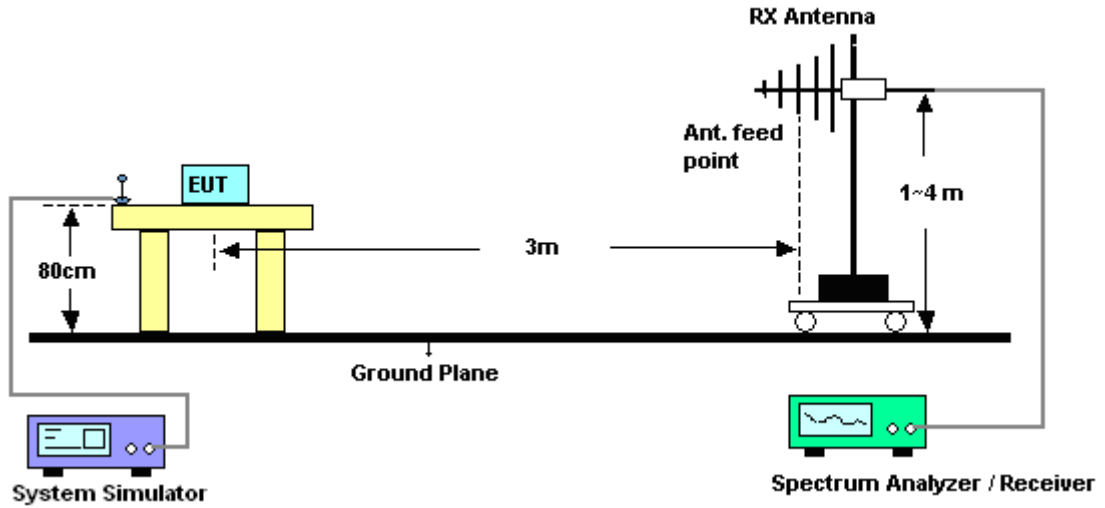



3.4.5 Test Result of Radiated Emissions

Band :	802.16e	Temperature :	23~24°C
Test Mode :	QPSK, BW 5MHz, Middle Ch (2593MHz)	Relative Humidity :	46~47%
Test Engineer :	Kai Wang	Polarization :	Horizontal

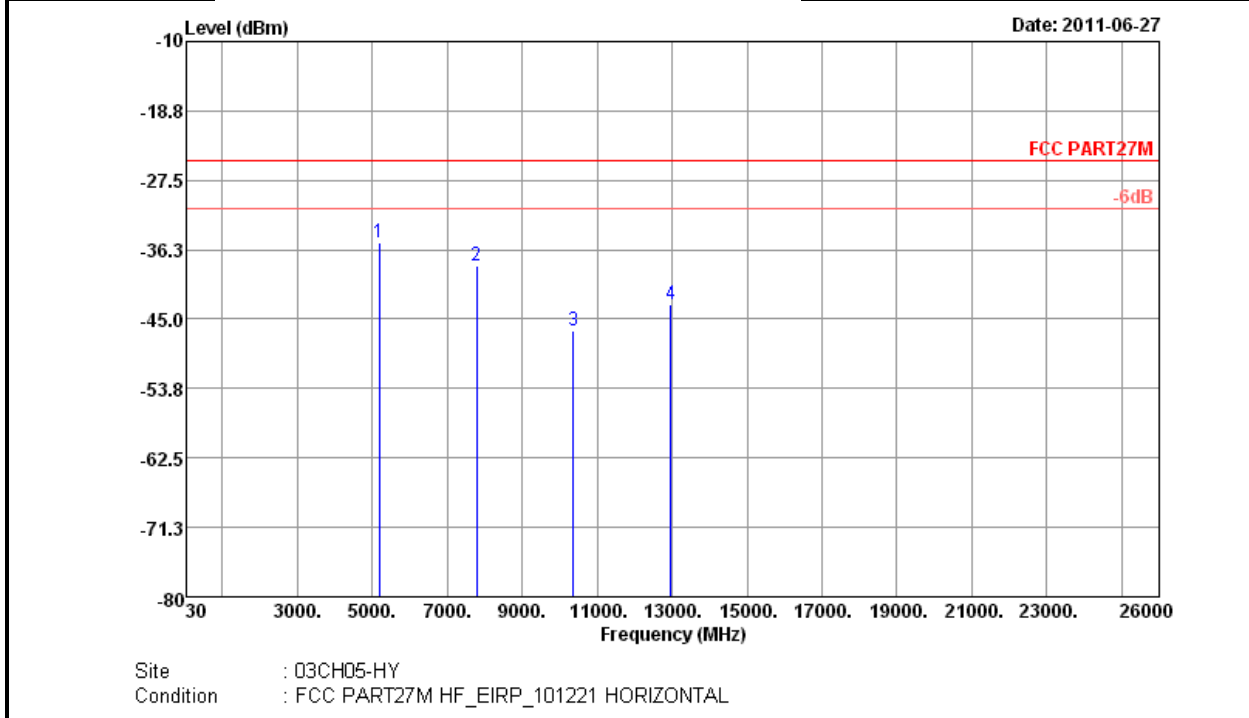

Frequency (MHz)	EIRP (dBm)	Limit (dBm)	Over Limit (dB)	SPA Reading (dBm)	S.G. Power (dBm)	TX Cable loss (dB)	TX Antenna Gain (dBi)	Polarization (H/V)	Result
5186	-35.31	-25	-10.31	-53.95	-44.65	1.27	10.61	H	Pass
7779	-38.20	-25	-13.20	-61.5	-48.75	1.65	12.20	H	Pass
10372	-46.45	-25	-21.45	-73.29	-57.01	2.61	13.17	H	Pass
12965	-43.06	-25	-18.06	-74.01	-53.12	3.13	13.19	H	Pass



Band :	802.16e	Temperature :	23~24°C
Test Mode :	QPSK, BW 5MHz, Middle Ch (2593MHz)	Relative Humidity :	46~47%
Test Engineer :	Kai Wang	Polarization :	Vertical

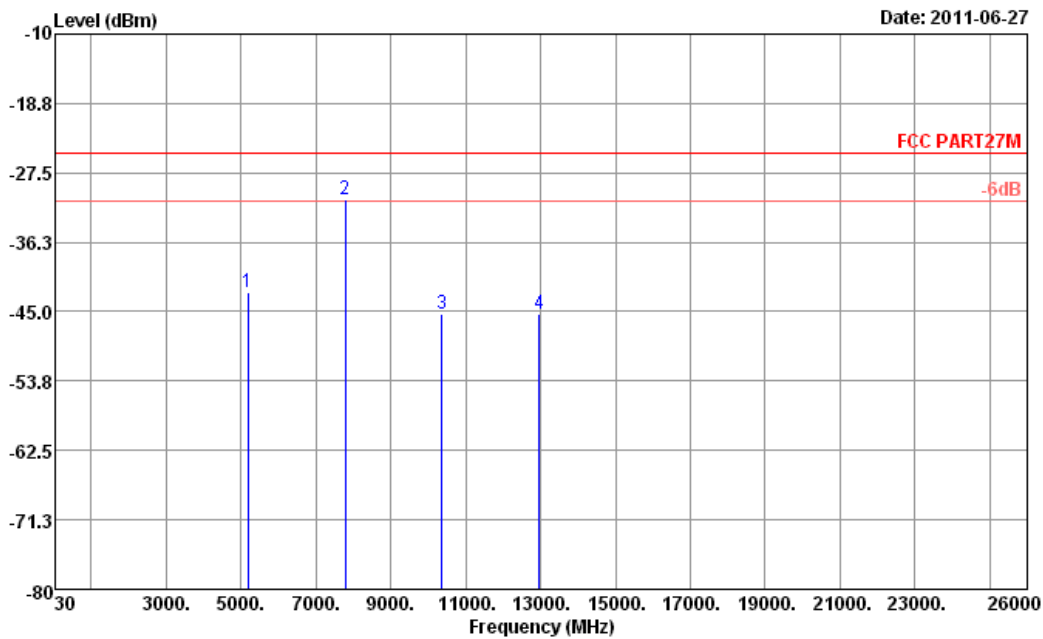

Site : 03CH05-HY
 Condition : FCC PART27M HF_EIRP_101221 VERTICAL

Frequency (MHz)	EIRP (dBm)	Limit (dBm)	Over Limit (dB)	SPA Reading (dBm)	S.G. Power (dBm)	TX Cable loss (dB)	TX Antenna Gain (dBi)	Polarization (H/V)	Result
5186	-42.50	-25	-17.50	-61.15	-51.84	1.27	10.61	V	Pass
7779	-30.77	-25	-5.77	-54.07	-41.32	1.65	12.20	V	Pass
10372	-45.30	-25	-20.30	-72.17	-55.86	2.61	13.17	V	Pass
12965	-45.20	-25	-20.20	-76.25	-55.27	3.76	13.83	V	Pass



Band :	802.16e	Temperature :	23~24°C
Test Mode :	QPSK, BW 10MHz, Middle Ch (2593MHz)	Relative Humidity :	46~47%
Test Engineer :	Kai Wang	Polarization :	Horizontal

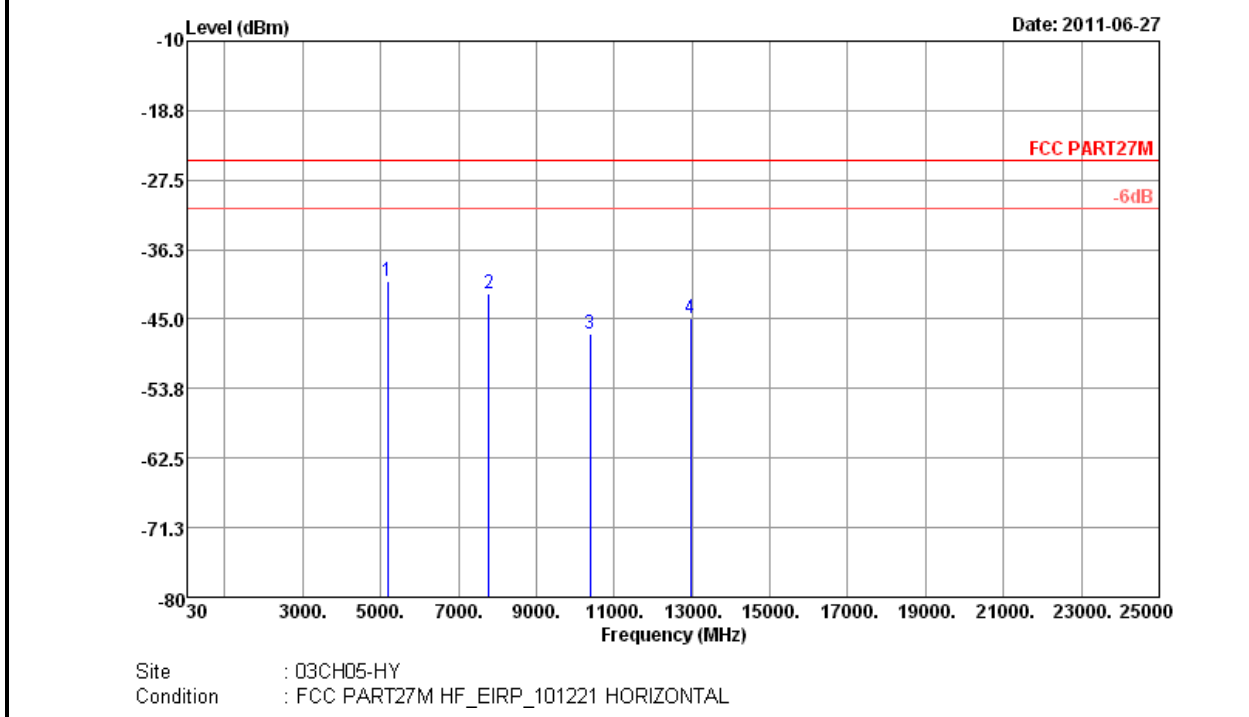

Frequency (MHz)	EIRP (dBm)	Limit (dBm)	Over Limit (dB)	SPA Reading (dBm)	S.G. Power (dBm)	TX Cable loss (dB)	TX Antenna Gain (dBi)	Polarization (H/V)	Result
5186	-40.23	-25	-15.23	-58.9	-49.57	1.27	10.61	H	Pass
7779	-41.72	-25	-16.72	-65.02	-52.27	1.65	12.20	H	Pass
10372	-46.79	-25	-21.79	-73.62	-57.35	2.61	13.17	H	Pass
12965	-44.95	-25	-19.95	-75.98	-55.01	3.13	13.19	H	Pass



Band :	802.16e	Temperature :	23~24°C
Test Mode :	QPSK, BW 10MHz, Middle Ch (2593MHz)	Relative Humidity :	46~47%
Test Engineer :	Kai Wang	Polarization :	Vertical

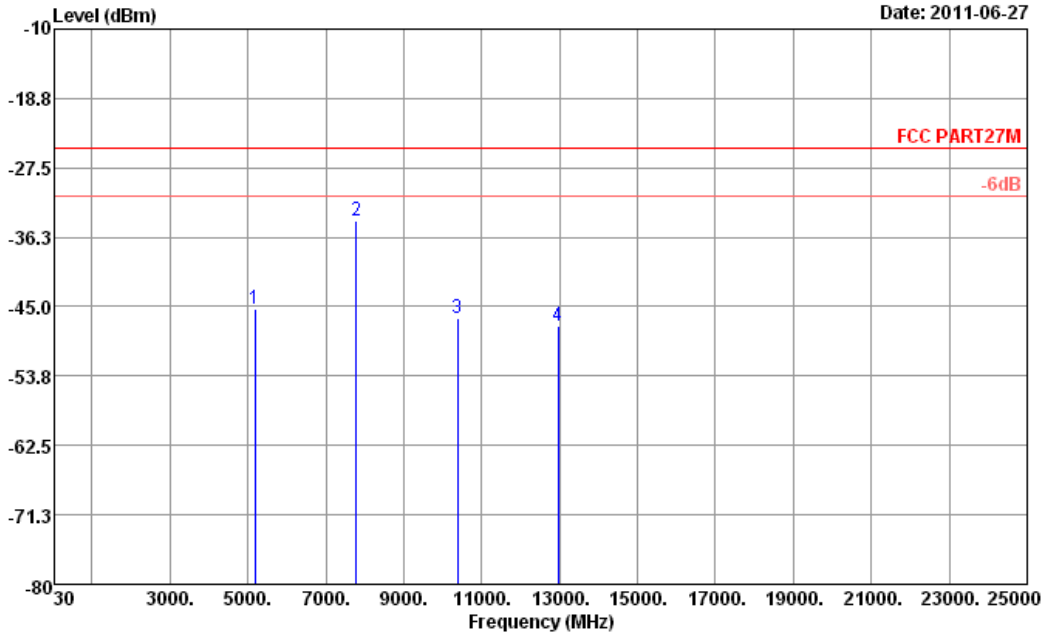

Site : D3CH05-HY
 Condition : FCC PART27M HF_EIRP_101221 VERTICAL

Frequency (MHz)	EIRP (dBm)	Limit (dBm)	Over Limit (dB)	SPA Reading (dBm)	S.G. Power (dBm)	TX Cable loss (dB)	TX Antenna Gain (dBi)	Polarization (H/V)	Result
5186	-45.30	-25	-20.30	-63.84	-54.64	1.27	10.61	V	Pass
7779	-34.16	-25	-9.16	-57.49	-44.71	1.65	12.20	V	Pass
10372	-46.46	-25	-21.46	-73.33	-57.02	2.61	13.17	V	Pass
12965	-47.47	-25	-22.47	-78.47	-57.54	3.76	13.83	V	Pass



Band :	802.16e	Temperature :	23~24°C
Test Mode :	16QAM, BW 5MHz, Middle Ch (2593MHz)	Relative Humidity :	46~47%
Test Engineer :	Kai Wang	Polarization :	Horizontal

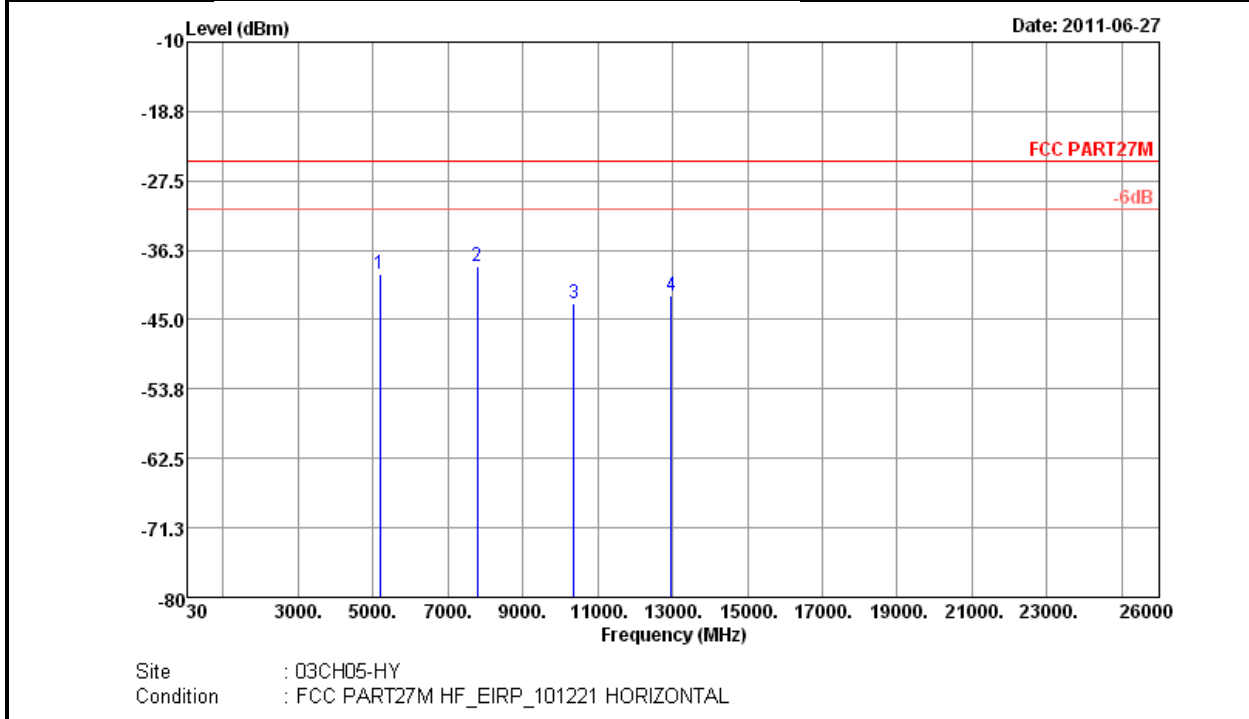

Frequency (MHz)	EIRP (dBm)	Limit (dBm)	Over Limit (dB)	SPA Reading (dBm)	S.G. Power (dBm)	TX Cable loss (dB)	TX Antenna Gain (dBi)	Polarization (H/V)	Result
5186	-39.20	-25	-14.20	-58.06	-48.54	1.27	10.61	H	Pass
7779	-38.31	-25	-13.31	-61.32	-48.86	1.65	12.20	H	Pass
10372	-42.90	-25	-17.90	-70.31	-53.46	2.61	13.17	H	Pass
12965	-42.06	-25	-17.06	-73.43	-52.12	3.13	13.19	H	Pass



Band :	802.16e	Temperature :	23~24°C
Test Mode :	16QAM, BW 5MHz, Middle Ch (2593MHz)	Relative Humidity :	46~47%
Test Engineer :	Kai Wang	Polarization :	Vertical

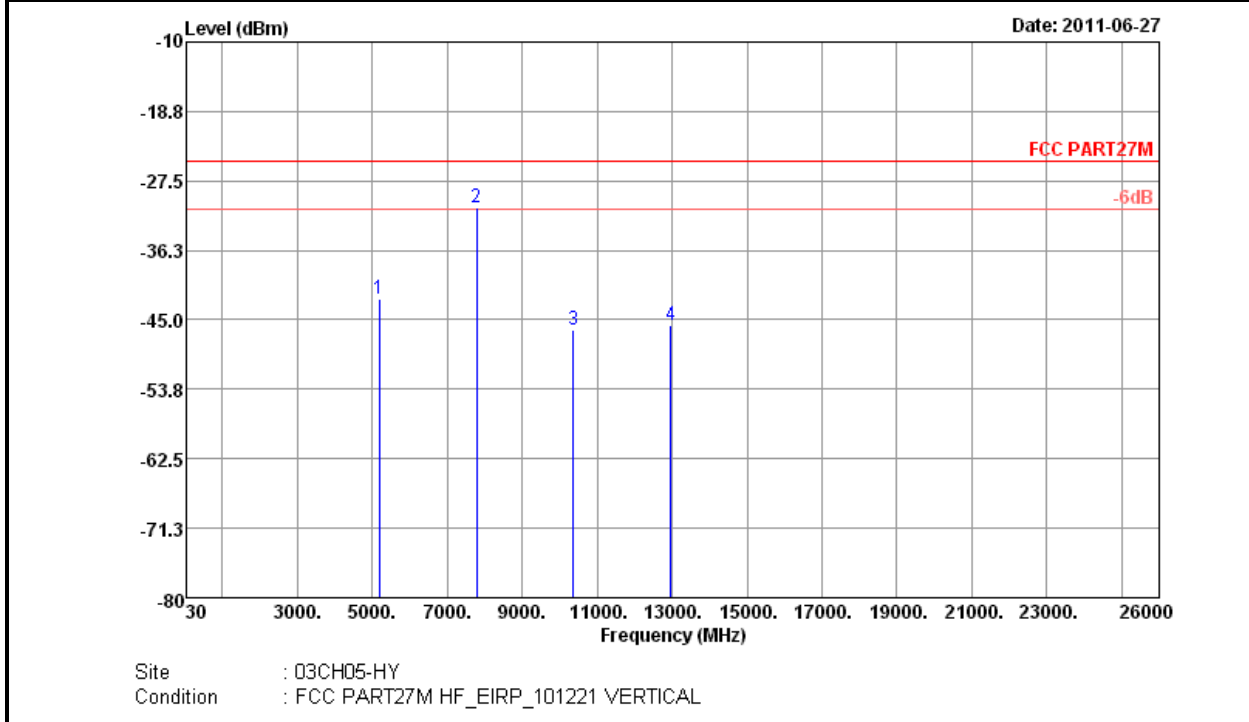

Frequency (MHz)	EIRP (dBm)	Limit (dBm)	Over Limit (dB)	SPA Reading (dBm)	S.G. Power (dBm)	TX Cable loss (dB)	TX Antenna Gain (dBi)	Polarization (H/V)	Result
5186	-42.40	-25	-17.40	-61.08	-51.74	1.27	10.61	V	Pass
7779	-30.81	-25	-5.81	-54.09	-41.36	1.65	12.20	V	Pass
10372	-46.32	-25	-21.32	-73.2	-56.88	2.61	13.17	V	Pass
12965	-45.75	-25	-20.75	-76.96	-55.82	3.76	13.83	V	Pass



Band :	802.16e	Temperature :	23~24°C
Test Mode :	16QAM, BW 10MHz, Middle Ch (2593MHz)	Relative Humidity :	46~47%
Test Engineer :	Kai Wang	Polarization :	Horizontal

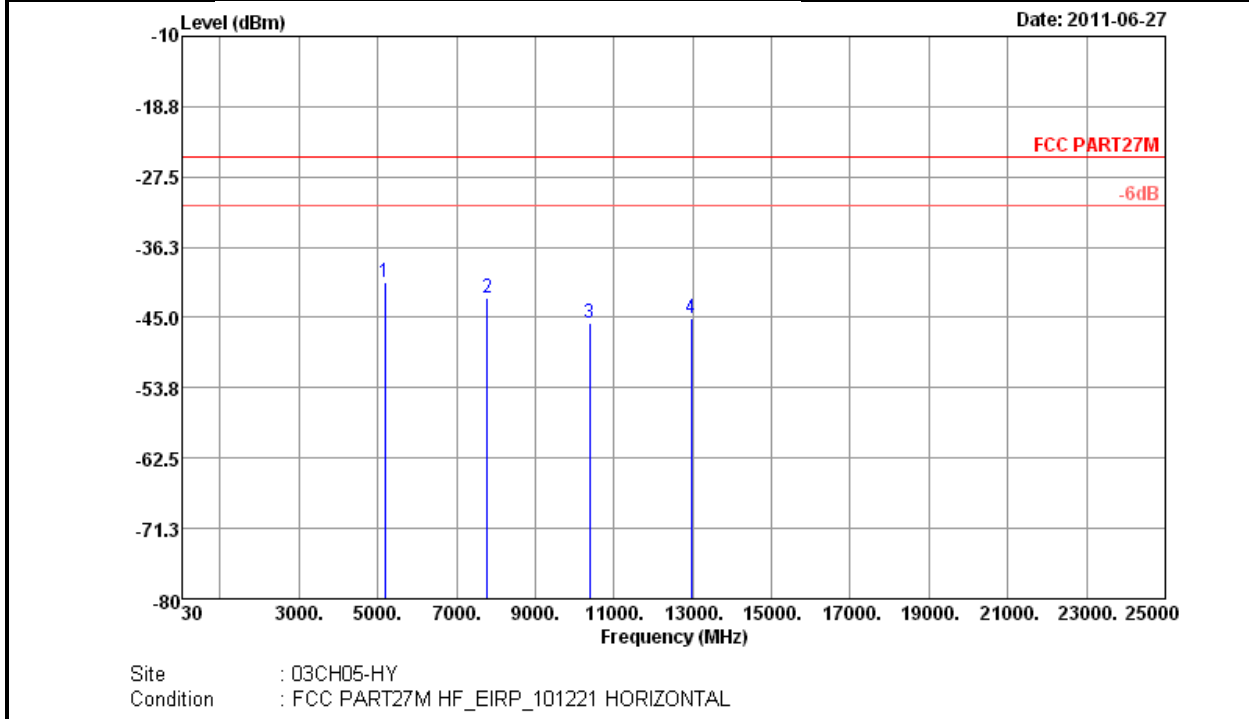

Frequency (MHz)	EIRP (dBm)	Limit (dBm)	Over Limit (dB)	SPA Reading (dBm)	S.G. Power (dBm)	TX Cable loss (dB)	TX Antenna Gain (dBi)	Polarization (H/V)	Result
5186	-40.68	-25	-15.68	-59.25	-50.02	1.27	10.61	H	Pass
7779	-42.55	-25	-17.55	-65.85	-53.10	1.65	12.20	H	Pass
10372	-45.63	-25	-20.63	-72.48	-56.19	2.61	13.17	H	Pass
12965	-45.07	-25	-20.07	-76.07	-55.13	3.13	13.19	H	Pass



Band :	802.16e	Temperature :	23~24°C
Test Mode :	16QAM, BW 10MHz, Middle Ch (2593MHz)	Relative Humidity :	46~47%
Test Engineer :	Kai Wang	Polarization :	Vertical

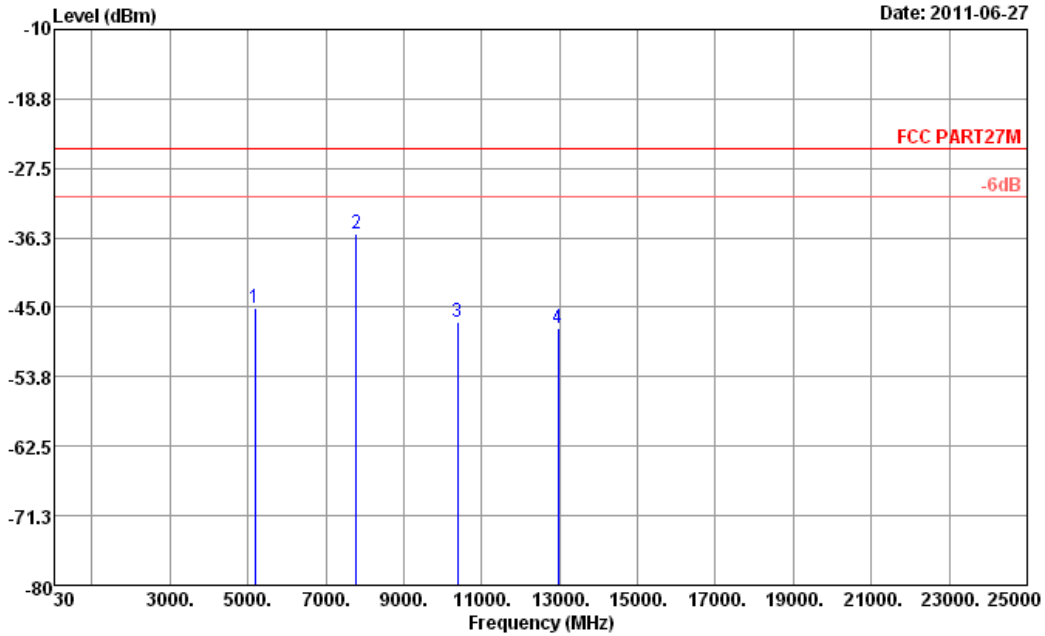

Site : 03CH05-HY
 Condition : FCC PART27M HF_EIRP_101221 VERTICAL

Frequency (MHz)	EIRP (dBm)	Limit (dBm)	Over Limit (dB)	SPA Reading (dBm)	S.G. Power (dBm)	TX Cable loss (dB)	TX Antenna Gain (dBi)	Polarization (H/V)	Result
5186	-45.08	-25	-20.08	-63.66	-54.42	1.27	10.61	V	Pass
7779	-35.70	-25	-10.70	-58.96	-46.25	1.65	12.20	V	Pass
10372	-46.76	-25	-21.76	-73.61	-57.32	2.61	13.17	V	Pass
12965	-47.57	-25	-22.57	-78.56	-57.64	3.76	13.83	V	Pass

3.5 Frequency Stability Measurement

3.5.1 Description of Frequency Stability Measurement

The frequency stability shall be sufficient to ensure that the fundamental emissions stay within the authorized frequency band. For equipment authorization purposes, this is a reporting requirement only.

3.5.2 Measuring Instruments

See list of measuring instruments of this test report.

3.5.3 Test Procedures for Temperature Variation

1. The EUT was set up in the thermal chamber and connected with the System Simulator.
2. With power OFF, the temperature was decreased to -30°C and the EUT was stabilized for three hours. Power was applied and the maximum change in frequency was recorded within one minute.
3. With power OFF, the temperature was raised in 10°C step up to 60°C . The EUT was stabilized at each step for at least half an hour. Power was applied and the maximum frequency change was recorded within one minute.
4. If the EUT can not be turned on at -30°C , the testing lowest temperature will be raised in 10°C step until the EUT can be turned on.

3.5.4 Test Procedures for Voltage Variation

1. The EUT was placed in a temperature chamber at $25\pm 5^{\circ}\text{C}$ and connected with the System Simulator.
2. The power supply voltage to the EUT was varied from BEP to 115% of the nominal value measured at the input to the EUT.
3. The variation in frequency was measured for the worst case.

3.5.5 Test Setup

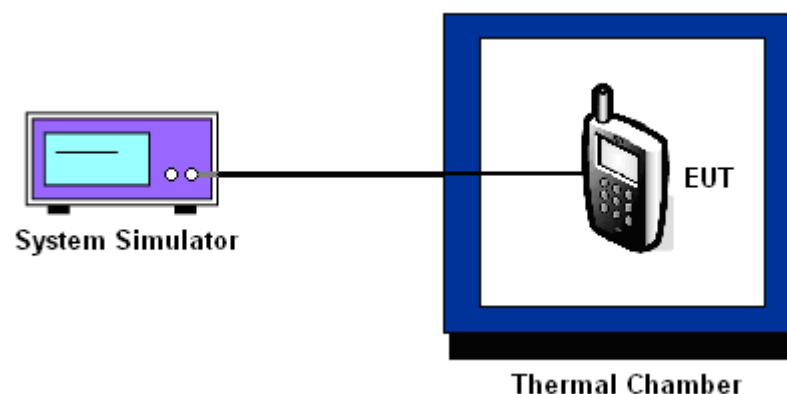

3.5.6 Test Result of Temperature Variation

Band :	802.16e	Channel :	Middle (2593MHz)
Limit (ppm) :	2.5		

Temperature (°C)	QPSK, BW 5MHz		QPSK, BW 10MHz		Result
	Freq. Dev. (Hz)	Deviation (ppm)	Freq. Dev. (Hz)	Deviation (ppm)	
-30	-29.13	-0.0112	-20.48	-0.0079	PASS
-20	-28.66	-0.0111	-12.93	-0.0050	
-10	-26.04	-0.0100	-16.47	-0.0064	
0	-27.62	-0.0107	-21.2	-0.0082	
10	-23.53	-0.0091	-17.56	-0.0068	
20	70.63	0.0272	80.61	0.0311	
30	76.41	0.0295	84.9	0.0327	
40	71.29	0.0275	76.4	0.0295	
50	74.62	0.0288	75.17	0.0290	
60	76.83	0.0296	82.69	0.0319	

Note: The manufacturer declared that the EUT could work properly between temperatures -30°C~60°C.



Band :	802.16e	Channel :	Middle (2593MHz)
Limit (ppm) :	2.5		

Temperature (°C)	16QAM, BW 5MHz		16QAM, BW 10MHz		Result
	Freq. Dev. (Hz)	Deviation (ppm)	Freq. Dev. (Hz)	Deviation (ppm)	
-30	-28.06	-0.0108	-20.48	-0.0079	PASS
-20	-26.56	-0.0102	-12.93	-0.0050	
-10	-26.99	-0.0104	-16.47	-0.0064	
0	-22.45	-0.0087	-21.20	-0.0082	
10	-26.04	-0.0100	-17.56	-0.0068	
20	65.78	0.0254	80.61	0.0311	
30	66.32	0.0256	84.90	0.0327	
40	78.71	0.0304	76.40	0.0295	
50	72.13	0.0278	75.17	0.0290	
60	75.09	0.0290	82.69	0.0319	

Note: The manufacturer declared that the EUT could work properly between temperatures -30°C~60°C.

3.5.7 Test Result of Voltage Variation

Band & Channel	Mode	Voltage (Volt)	Freq. Dev. (Hz)	Deviation (ppm)	Result
802.16e Middle (2593MHz)	QPSK, BW 5MHz	3.8	66.32	0.0256	PASS
		BEP	69.25	0.0267	
		4.2	73.2	0.0282	
	QPSK, BW 10MHz	3.8	63.83	0.0246	PASS
		BEP	67.54	0.0260	
		4.2	59.92	0.0231	
	16QAM, BW 5MHz	3.8	63.12	0.0243	PASS
		BEP	64.19	0.0248	
		4.2	75.21	0.0290	
	16QAM, BW 10MHz	3.8	74.53	0.0287	PASS
		BEP	78.86	0.0304	
		4.2	72.94	0.0281	

Note:

1. Normal Voltage = 3.8V.
2. Battery End Point (BEP) = 3.6 V.

4 List of Measuring Equipments

Instrument	Manufacturer	Model No.	Serial No.	Characteristics	Calibration Date	Due Date	Remark
System Simulator	R&S	CMU200	117995	N/A	Aug. 11, 2010	Aug.10, 2011	Conducted (TH02-HY)
Spectrum Analyzer	R&S	FSP30	101329	9kHz~30GHz	May 03, 2011	May 02, 2012	Conducted (TH02-HY)
Power Meter	Anritsu	ML2495A	0932001	N/A	Sep. 13, 2010	Sep. 12, 2011	Conducted (TH02-HY)
Power Sensor	Anritsu	MA2411B	0846202	N/A	Sep. 14, 2010	Sep. 13, 2011	Conducted (TH02-HY)
Power Meter	Agilent	E4416A	GB41292344	N/A	Feb. 18, 2011	Feb. 17, 2012	Conducted (TH02-HY)
Power Sensor	Agilent	E9327A	US40441548	N/A	Feb. 18, 2011	Feb. 17, 2012	Conducted (TH02-HY)
Thermal Chamber	Ten Billion	TTH-D35P	TBN-930701	N/A	Jul. 30, 2010	Jul. 29, 2011	Conducted (TH02-HY)
Spectrum Analyzer	R&S	FSP30	101352	9KHz-40GHz	Nov. 03, 2010	Nov. 02, 2011	Radiation (03CH05-HY)
Amplifier	COM-POWER	PA-103	161075	1KHz - 1GHz	Mar. 29, 2011	Mar. 28, 2012	Radiation (03CH05-HY)
Bilog Antenna	SCHAFFNER	CBL6111C	2725	30MHz ~ 1GHz	Nov. 06, 2010	Nov. 05, 2011	Radiation (03CH05-HY)
SHF-EHF Horn Antenna	SCHWARZBECK	BBHA 9170	BBHA917025 1	15GHz- 40GHz	Oct. 18, 2010	Oct. 17, 2011	Radiation (03CH05-HY)
Pre Amplifier	Agilent	8449B	3008A01917	1GHz- 26.5GHz	Apr. 14, 2011	Apr. 13, 2012	Radiation (03CH05-HY)
Turn Table	HD	Deis HD 2000	420/611	0 - 360 degree	N/A	N/A	Radiation (03CH05-HY)
Antenna Mast	HD	MA 240	240/666	1 m - 4 m	N/A	N/A	Radiation (03CH05-HY)
Horn Antenna	ESCO	3117	00066584	1GHz ~ 18GHz	Aug. 05, 2010	Aug. 04, 2011	Radiation (03CH05-HY)
Loop Antenna	R&S	HFH2-Z2	860004/001	9 kHz~30 MHz	Jul. 29, 2010	Jul. 28, 2011	Radiation (03CH05-HY)
WiMAX Base Station (System Simulator)	Agilent	E6651A	N/A	N/A	N/A	N/A	Radiation (03CH05-HY)

5 Uncertainty of Evaluation

Uncertainty of Radiated Emission Measurement (30 MHz ~ 1000 MHz)

Contribution	Uncertainty of X_i		$u(X_i)$
	dB	Probability Distribution	
Receiver Reading	0.41	Normal (k=2)	0.21
Antenna Factor Calibration	0.83	Normal (k=2)	0.42
Cable Loss Calibration	0.25	Normal (k=2)	0.13
Pre-Amplifier Gain Calibration	0.27	Normal (k=2)	0.14
RCV/SPA Specification	2.50	Rectangular	0.72
Antenna Factor Interpolation for Frequency	1.00	Rectangular	0.29
Site Imperfection	1.43	Rectangular	0.83
Mismatch	+0.39 / -0.41	U-Shape	0.28
Combined Standard Uncertainty $U_c(y)$	1.27		
Measuring Uncertainty for a Level of Confidence of 95% ($U = 2U_c(y)$)	2.54		

Uncertainty of Radiated Emission Measurement (1 GHz ~ 40 GHz)

Contribution	Uncertainty of X_i		$u(X_i)$	C_i	$C_i * u(X_i)$
	dB	Probability Distribution			
Receiver Reading	± 0.10	Normal (k=2)	0.10	1	0.10
Antenna Factor Calibration	± 1.70	Normal (k=2)	0.85	1	0.85
Cable Loss Calibration	± 0.50	Normal (k=2)	0.25	1	0.25
Receiver Correction	± 2.00	Rectangular	1.15	1	1.15
Antenna Factor Directional	± 1.50	Rectangular	0.87	1	0.87
Site Imperfection	± 2.80	Triangular	1.14	1	1.14
Mismatch Receiver VSWR $\Gamma_1 = 0.197$ Antenna VSWR $\Gamma_2 = 0.194$ Uncertainty = $20\text{Log}(1-\Gamma_1*\Gamma_2)$	+0.34 / -0.35	U-Shape	0.244	1	0.244
Combined Standard Uncertainty $U_c(y)$	2.36				
Measuring Uncertainty for a Level of Confidence of 95% ($U = 2U_c(y)$)	4.72				