



# FCC TEST REPORT

## (Part 24)

**REPORT NO.:** RF960330L04  
**MODEL NO.:** CAVA100  
**RECEIVED:** Mar. 30, 2007  
**TESTED:** Apr. 02 ~ Apr. 13, 2007  
**ISSUED:** Apr. 18, 2007

**APPLICANT:** High Tech Computer Corp.

**ADDRESS:** 23, Hsin-Hua Rd., Taoyuan, 330, Taiwan, R.O.C.

**ISSUED BY:** Advance Data Technology Corporation

**LAB ADDRESS:** No. 47, 14th Ling, Chia Pau Tsuen, Lin Kou Hsiang  
244, Taipei Hsien, Taiwan, R.O.C.

**TEST LOCATION:** No. 19, Hwa Ya 2<sup>nd</sup> Rd., Wen Hwa Tsuen, Kwei  
Shan Hsiang, Taoyuan Hsien 333, Taiwan, R.O.C.

This test report consists of 80 pages in total. It may be duplicated completely for legal use with the approval of the applicant. It should not be reproduced except in full, without the written approval of our laboratory. The client should not use it to claim product endorsement by CNLA, A2LA or any government agencies. The test results in the report only apply to the tested sample.





## TABLE OF CONTENTS

1	CERTIFICATION .....	4
2	SUMMARY OF TEST RESULTS.....	5
2.1	MEASUREMENT UNCERTAINTY .....	6
3	GENERAL INFORMATION .....	7
3.1	GENERAL DESCRIPTION OF EUT .....	7
3.2	DESCRIPTION OF TEST MODES .....	10
3.2.1	CONFIGURATION OF SYSTEM UNDER TEST .....	11
3.2.2	TEST MODE APPLICABILITY AND TESTED CHANNEL DETAIL .....	12
3.3	GENERAL DESCRIPTION OF APPLIED STANDARDS .....	17
3.4	DESCRIPTION OF SUPPORT UNITS.....	17
4	TEST TYPES AND RESULTS.....	18
4.1	OUTPUT POWER MEASUREMENT .....	18
4.1.1	LIMITS OF OUTPUT POWER MEASUREMENT .....	18
4.1.2	TEST INSTRUMENTS.....	19
4.1.3	TEST PROCEDURES .....	20
4.1.4	TEST SETUP .....	21
4.1.5	EUT OPERATING CONDITIONS.....	22
4.1.6	TEST RESULTS .....	23
4.2	FREQUENCY STABILITY MEASUREMENT .....	28
4.2.1	LIMITS OF FREQUENCY STABILITY MEASUREMENT .....	28
4.2.2	TEST INSTRUMENTS.....	28
4.2.3	TEST PROCEDURE.....	29
4.2.4	TEST SETUP .....	29
4.2.5	TEST RESULTS .....	30
4.3	OCCUPIED BANDWIDTH MEASUREMENT .....	34
4.3.1	LIMITS OF OCCUPIED BANDWIDTH MEASUREMENT .....	34
4.3.2	TEST INSTRUMENTS.....	34
4.3.3	TEST SETUP .....	34
4.3.4	TEST PROCEDURES .....	35
4.3.5	EUT OPERATING CONDITION.....	35
4.3.6	TEST RESULTS .....	35
4.4	BAND EDGE MEASUREMENT .....	44
4.4.1	LIMITS OF BAND EDGE MEASUREMENT .....	44
4.4.2	TEST INSTRUMENTS.....	44
4.4.3	TEST SETUP .....	44
4.4.4	TEST PROCEDURES .....	45
4.4.5	EUT OPERATING CONDITION.....	45
4.4.6	TEST RESULTS .....	46
4.5	CONDUCTED SPURIOUS EMISSIONS.....	50
4.5.1	LIMITS OF CONDUCTED SPURIOUS EMISSIONS MEASUREMENT .....	50
4.5.2	TEST INSTRUMENTS.....	50
4.5.3	TEST PROCEDURE.....	51
4.5.4	TEST SETUP .....	51



4.5.5	EUT OPERATING CONDITIONS.....	51
4.5.6	TEST RESULTS .....	52
4.6	RADIATED EMISSION MEASUREMENT (BELOW 1GHz).....	64
4.6.1	LIMITS OF RADIATED EMISSION MEASUREMENT .....	64
4.6.2	TEST INSTRUMENTS.....	65
4.6.3	TEST PROCEDURES .....	66
4.6.4	DEVIATION FROM TEST STANDARD .....	66
4.6.5	TEST SETUP .....	67
4.6.6	EUT OPERATING CONDITIONS.....	67
4.6.7	TEST RESULTS .....	68
4.7	EFFECTIVE RADIATED POWER MEASUREMENT (ABOVE 1GHz) .....	70
4.7.1	LIMITS OF RADIATED EMISSION MEASUREMENT .....	70
4.7.2	TEST INSTRUMENTS.....	71
4.7.3	TEST PROCEDURES .....	72
4.7.4	DEVIATION FROM TEST STANDARD .....	72
4.7.5	TEST SETUP .....	73
4.7.6	EUT OPERATING CONDITIONS.....	73
4.7.7	TEST RESULTS .....	74
5	INFORMATION ON THE TESTING LABORATORIES .....	80



## 1 CERTIFICATION

**PRODUCT :** Smart Phone  
**MODEL :** CAVA100  
**APPLICANT :** High Tech Computer Corp.  
**TESTED :** Apr. 02 ~ Apr. 13, 2007  
**TEST SAMPLE :** ENGINEERING SAMPLE  
**TEST STANDARDS :** **FCC Part 24, Subpart E**  
ANSI C63.4-2003

The above equipment (model: CAVA100) has been tested by **Advance Data Technology Corporation**, and found compliance with the requirement of the above standards. The test record, data evaluation & Equipment Under Test (EUT) configurations represented herein are true and accurate accounts of the measurements of the sample's EMC characteristics under the conditions specified in this report.

**PREPARED BY :** Rennie Wang , **DATE:** Apr. 18, 2007  
Rennie Wang

**TECHNICAL**  
**ACCEPTANCE :** Long Chen , **DATE:** Apr. 18, 2007  
Responsible for RF Long Chen

**APPROVED BY :** Gary Chang , **DATE:** Apr. 18, 2007  
Gary Chang / Supervisor

## 2 SUMMARY OF TEST RESULTS

The EUT has been tested according to the following specifications:

<b>APPLIED STANDARD: FCC Part 24 &amp; Part 2 / IC RSS-133</b>			
<b>STANDARD SECTION</b>	<b>TEST TYPE AND LIMIT</b>	<b>RESULT</b>	<b>REMARK</b>
2.1047(d)	Modulation Characteristics	PASS	Meet the requirement of limit.
2.1046 24.232	Maximum Peak Output Power Limit: max. 2 watts e.i.r.p peak power	PASS	Meet the requirement of limit. Minimum passing margin is 29.04dBm at 1850.20MHz.
2.1055 24.235	Frequency Stability AFC Freq. Error vs. Voltage AFC Freq. Error vs. Temperature Limit: max. $\pm 2.5$ ppm	PASS	Meet the requirement of limit.
2.1049 24.238(b)	Occupied Bandwidth	PASS	Meet the requirement of limit.
24.238(b)	Band Edge Measurements	PASS	Meet the requirement of limit.
2.1051 24.238	Conducted Spurious Emissions	PASS	Meet the requirement of limit.
2.1053 24.238	Radiated Spurious Emissions	PASS	Meet the requirement of limit. Minimum passing margin is $-48.38$ dB at 935.94MHz.

## 2.1 MEASUREMENT UNCERTAINTY

Where relevant, the following measurement uncertainty levels have been estimated for tests performed on the EUT as specified in CISPR 16-4:

MEASUREMENT	FREQUENCY	UNCERTAINTY
Conducted emissions	9kHz ~ 30MHz	2.44 dB
Radiated emissions	30MHz ~ 200MHz	3.71 dB
	200MHz ~ 1000MHz	3.73 dB
	1GHz ~ 18GHz	2.26 dB
	18GHz ~ 40GHz	1.94 dB

This uncertainty represents an expanded uncertainty expressed at approximately the 95% confidence level using a coverage factor of  $k=2$ .



### 3 GENERAL INFORMATION

#### 3.1 GENERAL DESCRIPTION OF EUT

<b>PRODUCT</b>	Smart Phone
<b>MODEL NO.</b>	CAVA100
<b>FCC ID</b>	NM8CAVA100
<b>POWER SUPPLY</b>	3.7Vdc from rechargeable lithium battery 5.0Vdc from power adapter 5.0Vdc from host equipment
<b>MODULATION TYPE</b>	GMSK / 8PSK / QPSK / BPSK
<b>FREQUENCY RANGE</b>	Tx Frequency: 1850.2MHz ~ 1909.8MHz (PCS band) Rx Frequency: 1930.2MHz ~ 1989.8MHz (PCS band) Tx Frequency: 1850MHz ~ 1910MHz (WCDMA band) Rx Frequency: 1930MHz ~ 1990MHz (WCDMA band)
<b>NUMBER OF CHANNEL</b>	299 (GSM band) / 277 (WCDMA band)
<b>MAX. CONDUCTED PEAK OUTPUT POWER</b>	GSM Mode: 29.60dBm (0.912Watts) GPRS Mode: 29.30dBm (0.851Watts) E-GPRS Mode: 28.30dBm (0.676Watts) WCDMA Mode: 23.18dBm (0.208Watts)
<b>MAX. EIRP POWER</b>	GSM Mode: 29.04dBm (0.802Watts) GPRS Mode: 28.83dBm (0.764Watts) E-GPRS Mode: 27.92dBm (0.619Watts) WCDMA Mode: 23.86dBm (0.243Watts)
<b>ANTENNA TYPE</b>	Monopole antenna with 1dBi gain for PCS band Monopole antenna with 1dBi gain for WCDMA band
<b>DATA CABLE</b>	1.0m shielded USB cable without core
<b>I/O PORTS</b>	Refer to user's manual
<b>ASSOCIATED DEVICES</b>	Adapter*2, Battery*2, Earpiece (1.6m), Holster, LCD Panel
<b>EUT EXTREME VOL. RANGE</b>	3.7Vdc to 4.2Vdc

**NOTE:**

1. The applicant defined the normal working voltage of the battery is from 3.7Vdc to 4.2Vdc.
2. The EUT is a GSM850/PCS1900/WCDMA850/WCDMA1900/GPRS/E-GPRS Smart Phone with wireless LAN and bluetooth functions. This report is only covered the functions of PCS1900/WCDMA1900. The wireless LAN and bluetooth functions are covered in another test report, which standard used is FCC Part 15. And the GSM850/WCDMA850 mobile phone function is covered in another test report, which standard used is FCC Part 22.



3. The communicated functions of EUT listed as below:

		GSM850MHz	PCS1900MHz	WCDMA850MHz	WCDMA1900MHz	With 802.11b/g & bluetooth
2G	GPRS	√	√			
	Edge	√	√			
3G	HSDPA			√	√	

4. The EUT has two lithium batteries listed as below:

STANDARD BATTERY 1:	
<b>MANUFACTURER:</b>	Simplo Technology Co., Ltd.
<b>MODEL:</b>	LIBR160
<b>RATING:</b>	3.7Vdc, 1050mAh

STANDARD BATTERY 2:	
<b>MANUFACTURER:</b>	SANYO
<b>MODEL:</b>	LIBR160
<b>RATING:</b>	3.7Vdc, 1050mAh

\*\*Battery 1 was the worst case for final test.

5. The EUT was operated with following power adapters:

ADAPTER 1:	
<b>BRAND:</b>	PHIHONG
<b>MODEL:</b>	PSAA05A-050
<b>INPUT:</b>	100-240Vac, 50-60Hz, 200mA, 13-20VA
<b>OUTPUT:</b>	5Vdc, 1A
<b>POWER LINE:</b>	1.8m non-shielded cable without core

ADAPTER 2:	
<b>BRAND:</b>	DELTA ELECTRONICS, INC.
<b>MODEL:</b>	ADP-5FH B
<b>INPUT:</b>	100-240Vac, 50-60Hz, 0.2A
<b>OUTPUT:</b>	5.0Vdc, 1A
<b>POWER LINE:</b>	1.8m non-shielded cable without core





6. The following accessories are specified to use in this EUT.

PRODUCT	BRAND	MODEL
Holster	New Tech	HTC-372
Earpiece	Cotron	CHM-60STV07002
LCD Panel	Sony	ACX362AKM-8
	TOPPOLY	TD025THED1

\*\*TOPPOLY LCD Panel was the worst case for final test.

7. IMEI Code: 352131 01\*\*\*\*\*.

8. The above EUT information was declared by manufacturer and for more detailed features description, please refer to the manufacturer's specifications or User's Manual.

### 3.2 DESCRIPTION OF TEST MODES

#### FOR PCS BAND:

299 channels are provided to this EUT in the PCS1900 band. Therefore, the low, middle and high channels are chosen for testing.

	CHANNEL	FREQUENCY	TX MODE
LOW	512	1850.2 MHz	GSM, GPRS, E-GPRS
MIDDLE	661	1880.0 MHz	GSM, GPRS, E-GPRS
HIGH	810	1909.8 MHz	GSM, GPRS, E-GPRS

#### NOTE:

1. Below 1 GHz, the channel 512, 661, and 810 were pre-tested in chamber. The channel 512 was chosen for final test.
2. Above 1 GHz, the channel 512, 661, and 810 were tested individually.
3. The worst case for final test is chosen when the power control level set 0.
4. The channel space is 0.2MHz.
5. Since the EUT is considered a portable unit, it was pre-tested on the positioned of each 3 axis. The worst case was found when positioned on Y-plane. Therefore only the test data of this Y-plane was used for radiated emission measurement test.
6. The EUT is a GPRS class 10 device (Multislot class: 10, Mobile Terminal B), which provide 2 up-link. The up-link with 1 time slot has been chosen for the worst case to do the final output power, frequency stability, occupied bandwidth, band edge test and recorded.
7. The EUT is an E-GPRS class 10 device (Multislot class: 10, Mobile Terminal B), which provide 2 up-link. The up-link with 1 time slot has been chosen for the worst case to do the final output power, frequency stability, occupied bandwidth, band edge test and recorded.
8. The EUT has GSM, GPRS, E-GPRS functions. After pre-testing, GSM function is the worst case for all the emission tests.

### FOR WCDMA BAND:

277 channels are provided to this EUT in the WCDMA1900 band. Therefore, the low, middle and high channels are chosen for testing.

	CHANNEL	FREQUENCY	TX MODE
LOW	9262	1852.4 MHz	WCDMA
MIDDLE	9400	1880.0 MHz	WCDMA
HIGH	9538	1907.6 MHz	WCDMA

#### NOTE:

1. Below 1 GHz, the channel 9262, 9400 and 9538 were pre-tested in chamber. The channel 9262 was chosen for final test.
2. Above 1 GHz, the channel 9262, 9400 and 9538 were tested individually.
3. The channel space is 0.2MHz.
4. Since the EUT is considered a portable unit, it was pre-tested on the positioned of each 3 axis. The worst case was found when positioned on Y-plane. Therefore only the test data of this Y-plane was used for radiated emission measurement test.
5. (RMC, HSDPA Inactive) mode has been chosen for the worst case to do the final test and record.

### 3.2.1 CONFIGURATION OF SYSTEM UNDER TEST

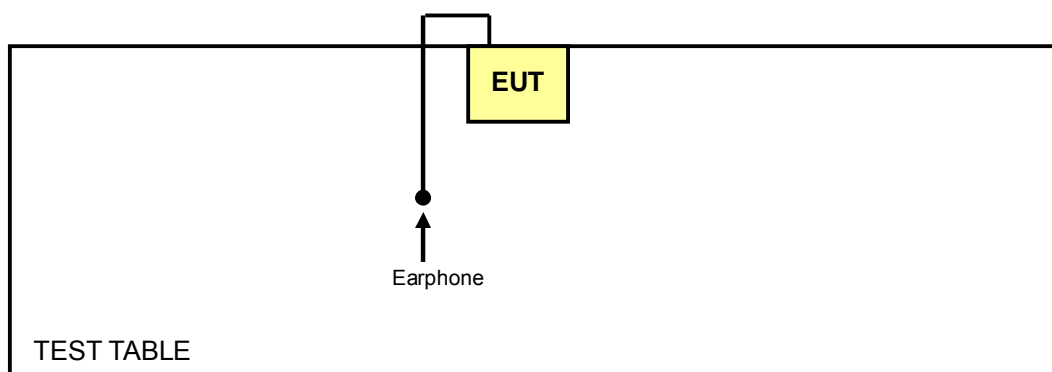

### 3.2.2 TEST MODE APPLICABILITY AND TESTED CHANNEL DETAIL

#### FOR PCS BAND:

EUT CONFIGURE MODE	APPLICABLE TO							DESCRIPTION
	OP	FS	OB	BE	CE	RE<1G	RE <sup>3</sup> 1G	
-	√	√	√	√	√	√	√	-

Where **OP**: Output power  
**OB**: Occupied bandwidth  
**CE**: Conducted spurious emissions  
**RE<sup>3</sup>1G**: Radiated emission above 1GHz  
**FS**: Frequency stability  
**BE**: Band edge  
**RE<1G**: Radiated emission below 1GHz

#### OUTPUT POWER MEASUREMENT:

- Pre-Scan has been conducted to determine the worst-case mode from all possible combinations between available modulations, data rates, xyz axis and antenna ports (if EUT with antenna diversity architecture).
- Following channel(s) was (were) selected for the final test as listed below.

AVAILABLE CHANNEL	TESTED CHANNEL	MODULATION TECHNOLOGY	AXIS
512 to 810	512, 661, 810	PCS, GPRS, EGPRS	Y

#### FREQUENCY STABILITY MEASUREMENT:

- Pre-Scan has been conducted to determine the worst-case mode from all possible combinations between available modulations, data rates, and antenna ports (if EUT with antenna diversity architecture).
- Following channel(s) was (were) selected for the final test as listed below.

AVAILABLE CHANNEL	TESTED CHANNEL	MODULATION TECHNOLOGY
512 to 810	512	PCS, GPRS, EGPRS



**OCCUPIED BANDWIDTH MEASUREMENT:**

Pre-Scan has been conducted to determine the worst-case mode from all possible combinations between available modulations, data rates, and antenna ports (if EUT with antenna diversity architecture).

Following channel(s) was (were) selected for the final test as listed below.

AVAILABLE CHANNEL	TESTED CHANNEL	MODULATION TECHNOLOGY
512 to 810	512, 661, 810	PCS, GPRS, EGPRS

**BAND EDGE MEASUREMENT:**

Pre-Scan has been conducted to determine the worst-case mode from all possible combinations between available modulations, data rates, and antenna ports (if EUT with antenna diversity architecture).

Following channel(s) was (were) selected for the final test as listed below.

AVAILABLE CHANNEL	TESTED CHANNEL	MODULATION TECHNOLOGY
512 to 810	512, 810	PCS, GPRS, EGPRS

**CONDUCTED SPURIOUS EMISSIONS MEASUREMENT:**

Pre-Scan has been conducted to determine the worst-case mode from all possible combinations between available modulations, data rates, and antenna ports (if EUT with antenna diversity architecture).

Following channel(s) was (were) selected for the final test as listed below.

AVAILABLE CHANNEL	TESTED CHANNEL	MODULATION TECHNOLOGY
512 to 810	512, 661, 810	PCS



**RADIATED EMISSION MEASUREMENT (BELOW 1 GHz):**

- Pre-Scan has been conducted to determine the worst-case mode from all possible combinations between available modulations, data rates, xyz axis and antenna ports (if EUT with antenna diversity architecture).
- Following channel(s) was (were) selected for the final test as listed below.

AVAILABLE CHANNEL	TESTED CHANNEL	MODULATION TECHNOLOGY	AXIS
512 to 810	512	PCS	Y

**RADIATED EMISSION MEASUREMENT (ABOVE 1 GHz):**

- Pre-Scan has been conducted to determine the worst-case mode from all possible combinations between available modulations, data rates, xyz axis and antenna ports (if EUT with antenna diversity architecture).
- Following channel(s) was (were) selected for the final test as listed below.

AVAILABLE CHANNEL	TESTED CHANNEL	MODULATION TECHNOLOGY	AXIS
512 to 810	512, 661, 810	PCS	Y



### FOR WCDMA BAND:

EUT CONFIGURE MODE	APPLICABLE TO							DESCRIPTION
	OP	FS	OB	BE	CE	RE<1G	RE <sup>3</sup> 1G	
-	√	√	√	√	√	√	√	-

Where **OP**: Output power **FS**: Frequency stability  
**OB**: Occupied bandwidth **BE**: Band edge  
**CE**: Conducted spurious emissions **RE<1G**: Radiated emission below 1GHz  
**RE<sup>3</sup>1G**: Radiated emission above 1GHz

### OUTPUT POWER MEASUREMENT:

- Pre-Scan has been conducted to determine the worst-case mode from all possible combinations between available modulations, data rates, xyz axis and antenna ports (if EUT with antenna diversity architecture).
- Following channel(s) was (were) selected for the final test as listed below.

AVAILABLE CHANNEL	TESTED CHANNEL	MODULATION TECHNOLOGY	AXIS
9262 to 9538	9262, 9400, 9538	WCDMA	Y

### FREQUENCY STABILITY MEASUREMENT:

- Pre-Scan has been conducted to determine the worst-case mode from all possible combinations between available modulations, data rates, and antenna ports (if EUT with antenna diversity architecture).
- Following channel(s) was (were) selected for the final test as listed below.

AVAILABLE CHANNEL	TESTED CHANNEL	MODULATION TECHNOLOGY
9262 to 9538	9262	WCDMA

### OCCUPIED BANDWIDTH MEASUREMENT:

- Pre-Scan has been conducted to determine the worst-case mode from all possible combinations between available modulations, data rates, and antenna ports (if EUT with antenna diversity architecture).
- Following channel(s) was (were) selected for the final test as listed below.

AVAILABLE CHANNEL	TESTED CHANNEL	MODULATION TECHNOLOGY
9262 to 9538	9262, 9400, 9538	WCDMA



**BAND EDGE MEASUREMENT:**

- Pre-Scan has been conducted to determine the worst-case mode from all possible combinations between available modulations, data rates, and antenna ports (if EUT with antenna diversity architecture).
- Following channel(s) was (were) selected for the final test as listed below.

AVAILABLE CHANNEL	TESTED CHANNEL	MODULATION TECHNOLOGY
9262 to 9538	9262, 9538	WCDMA

**CONDUCTED SPURIOUS EMISSIONS MEASUREMENT:**

- Pre-Scan has been conducted to determine the worst-case mode from all possible combinations between available modulations, data rates, and antenna ports (if EUT with antenna diversity architecture).
- Following channel(s) was (were) selected for the final test as listed below.

AVAILABLE CHANNEL	TESTED CHANNEL	MODULATION TECHNOLOGY
9262 to 9538	9262, 9400, 9538	WCDMA

**RADIATED EMISSION MEASUREMENT (BELOW 1 GHz):**

- Pre-Scan has been conducted to determine the worst-case mode from all possible combinations between available modulations, data rates, xyz axis and antenna ports (if EUT with antenna diversity architecture).
- Following channel(s) was (were) selected for the final test as listed below.

AVAILABLE CHANNEL	TESTED CHANNEL	MODULATION TECHNOLOGY	AXIS
9262 to 9538	9262	WCDMA	Y

**RADIATED EMISSION MEASUREMENT (ABOVE 1 GHz):**

- Pre-Scan has been conducted to determine the worst-case mode from all possible combinations between available modulations, data rates, xyz axis and antenna ports (if EUT with antenna diversity architecture).
- Following channel(s) was (were) selected for the final test as listed below.

AVAILABLE CHANNEL	TESTED CHANNEL	MODULATION TECHNOLOGY	AXIS
9262 to 9538	9262, 9400, 9538	WCDMA	Y





### 3.3 GENERAL DESCRIPTION OF APPLIED STANDARDS

The EUT is a RF product. According to the specifications of the manufacturer, it must comply with the requirements of the following standards:

**FCC 47 CFR Part 2**

**FCC 47 CFR Part 24**

**IC RSS-133**

**ANSI C63.4-2003**

**NOTE:** All test items have been performed and recorded as per the above standards.

### 3.4 DESCRIPTION OF SUPPORT UNITS

The EUT has been tested as an independent unit together with other necessary accessories or support units. The following support units or accessories were used to form a representative test configuration during the tests.

NO.	PRODUCT	BRAND	MODEL NO.	SERIAL NO.	CAL. DATE
1	Universal Radio Communication Tester	R&S	CMU200	101095	Apr. 11, 2008
2	NJZ-2000 (GSM+WCDMA simulator)	JRC	NJZ-2000	ET00054	Sep. 05, 2007

NO.	SIGNAL CABLE DESCRIPTION OF THE ABOVE SUPPORT UNITS
1	NA
2	NA

**NOTE:** All power cords of the above support units are non shielded (1.8m).



## **4 TEST TYPES AND RESULTS**

### **4.1 OUTPUT POWER MEASUREMENT**

#### **4.1.1 LIMITS OF OUTPUT POWER MEASUREMENT**

The radiated peak output power shall be according to the specific rule Part 24.232(b) that “Mobile / Portable station are limited to 2 watts e.i.r.p” and 24.232(c) specific that “Peak transmit power must be measure over any interval of continuous transmission using instrumentation calibration in terms of rms-equivalent voltage.”



#### 4.1.2 TEST INSTRUMENTS

DESCRIPTION & MANUFACTURER	MODEL NO.	SERIAL NO.	CALIBRATED UNTIL
Test Receiver ROHDE & SCHWARZ	ESI7	100033	May 22, 2007
Spectrum Analyzer ROHDE & SCHWARZ	FSP40	100025	Oct. 05, 2007
BILOG Antenna SCHWARZBECK	VULB9168	9168-160	May 31, 2007
HORN Antenna SCHWARZBECK	9120D	9120D-209	Jun. 27, 2007
HORN Antenna SCHWARZBECK	BBHA 9170	BBHA9170243	Dec. 28, 2007
Preamplifier Agilent	8447D	2944A10633	Oct. 26, 2007
Preamplifier Agilent	8449B	3008A01964	Oct. 26, 2007
RF signal cable HUBER+SUHNNER	SUCOFLEX 104	238137/4	Dec. 11, 2007
RF signal cable HUBER+SUHNNER	SUCOFLEX 104	233233/4	Nov. 14, 2007
Software ADT.	ADT_Radiated_V7.6	NA	NA
Antenna Tower inn-co GmbH	MA 4000	013303	NA
Antenna Tower Controller inn-co GmbH	CO2000	017303	NA
Turn Table ADT.	TT100.	TT93021703	NA
Turn Table Controller ADT.	SC100.	SC93021703	NA

- NOTE:**
1. The calibration interval of the above test instruments is 12 months and the calibrations are traceable to NML/ROC and NIST/USA.
  2. The test was performed in HwaYa Chamber 3.
  3. The horn antenna and HP preamplifier (model: 8449B) are used only for the measurement of emission frequency above 1GHz if tested.
  4. The VCCI Site Registration No. is R-237.
  5. The IC Site Registration No. is IC3789B-3.



### 4.1.3 TEST PROCEDURES

- a. The EUT was set up for the maximum peak power with GSM / WCDMA link data modulation. The power was measured with R&S Spectrum Analyzer. All measurements were done at 3 channels, 512, 661 and 810 / 9262, 9400 and 9538 (low, middle and high operational frequency range.)
- b. The conducted peak output power used the power splitter via EUT RF power connector between simulation base station and spectrum analyzer. The path loss included the splitter loss, cable loss and 20dB pad loss. The spectrum set RB/VB 3MHz (GSM) and 5MHz (WCDMA), then read peak power value and record to the test. (All transmitted path loss shall be considered in the test report data.)
- c. E.I.R.P peak power measurement. In the fully anechoic chamber, EUT placed on the 1.5m height of Turn Table, rotated the table around 360 degrees to search the maximum radiation power and receiver antenna shall be rotated vertical and horizontal polarization to find the maximum polar radiated power. The "Read Value" is the spectrum reading the maximum power value.
- d. The substitution horn antenna is substituted for EUT at the same position and signal generator export the CW signal to the calibration antenna. Rotated the Turn Table to find the maximum radiation power. "Raw" is the spectrum reading value, "SG" is signal generator export power, "TX Gain" is calibration antenna isotropic gain value, "TX cable" is the transmitted cable loss between the calibration antenna and signal generator. The "Factor" means that the transmission path loss is equal to "SG" - "TX cable" + "TX Gain" - "Raw".
- e. Actually the real E.I.R.P peak power is equal to "Read Value" + "Factor"
- f. E.R.P power can be calculated form E.I.R.P power by subtracting the gain of dipole,  
E.R.P power = E.I.P.R power - 2.15dBi.

**NOTE:** The resolution bandwidth and video bandwidth of test receiver/spectrum analyzer is 3MHz for Peak detection (PK)

#### 4.1.4 TEST SETUP

##### EIRP POWER MEASUREMENT:

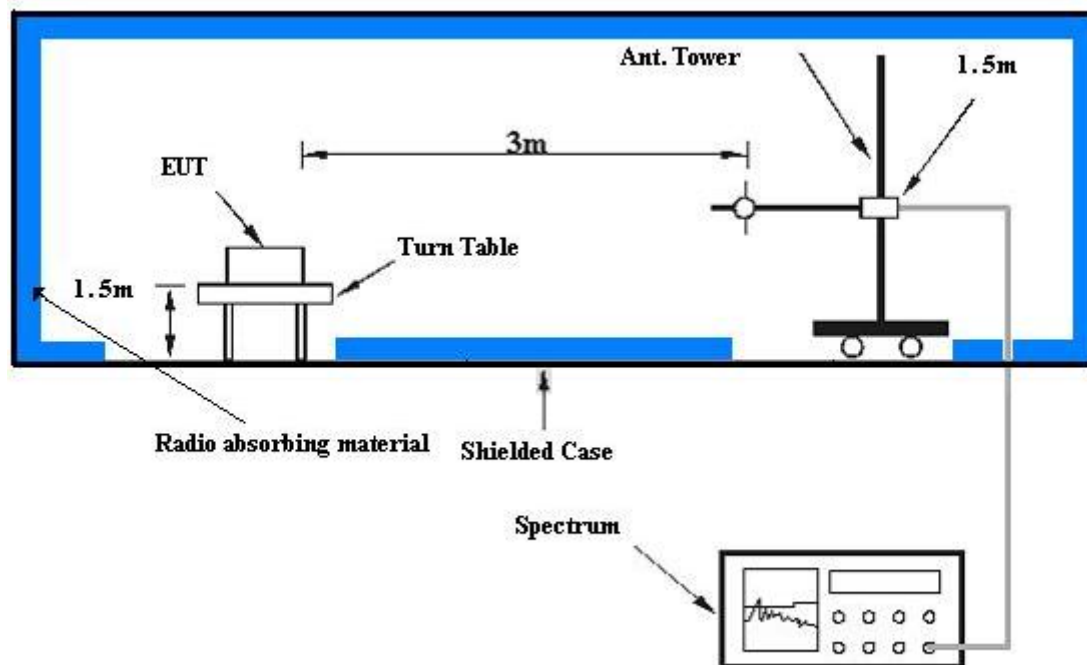

For the actual test configuration, please refer to the attached file (Test Setup Photo).

##### CONDUCTED POWER MEASUREMENT:

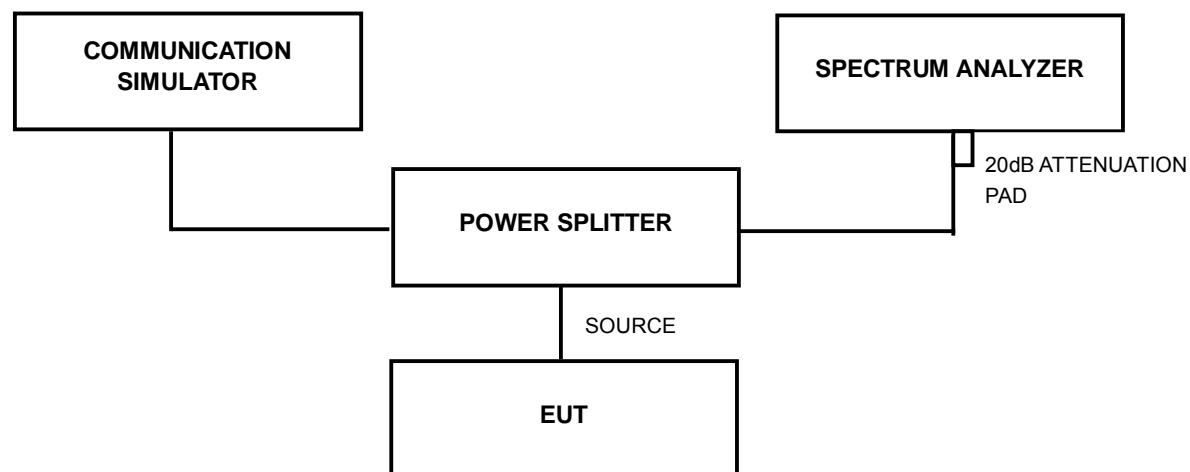

For the actual test configuration, please refer to the related item – Photographs of the Test Configuration.



#### 4.1.5 EUT OPERATING CONDITIONS

- a. The EUT makes a phone call to the communication simulator.
- b. The communication simulator station system controlled an EUT to export maximum output power under transmission mode and specific channel frequency.



#### 4.1.6 TEST RESULTS

##### FOR PCS BAND:

<b>MODE</b>	TX connected	<b>POWER CONTROL LEVEL</b>	0
<b>INPUT POWER (SYSTEM)</b>	120Vac, 60 Hz	<b>DETECTOR FUNCTION</b>	Peak
<b>ENVIRONMENTAL CONDITIONS</b>	22deg. C, 60%RH, 991hPa	<b>TESTED BY</b>	Match Tsui

##### FOR GSM MODE (UP-LINK WITH 1 TIME SLOT)

CONDUCTED PEAK OUTPUT POWER					
CHANNEL NO.	FREQUENCY (MHz)	RAW VALUE (dBm)	CORRECTION FACTOR (dB)	PEAK OUTPUT POWER	
				dBm	Watt
512	1850.2	23.60	6.00	29.60	0.912
661	1880.0	23.30	6.00	29.30	0.851
810	1909.8	23.10	6.00	29.10	0.813

##### FOR GPRS MODE (UP-LINK WITH 1 TIME SLOT)

CONDUCTED PEAK OUTPUT POWER					
CHANNEL NO.	FREQUENCY (MHz)	RAW VALUE (dBm)	CORRECTION FACTOR (dB)	PEAK OUTPUT POWER	
				dBm	Watt
512	1850.2	23.30	6.00	29.30	0.851
661	1880.0	23.20	6.00	29.20	0.832
810	1909.8	23.00	6.00	29.00	0.794

##### FOR E-GPRS MODE (UP-LINK WITH 1 TIME SLOT)

CONDUCTED PEAK OUTPUT POWER					
CHANNEL NO.	FREQUENCY (MHz)	RAW VALUE (dBm)	CORRECTION FACTOR (dB)	PEAK OUTPUT POWER	
				dBm	Watt
512	1850.2	22.30	6.00	28.30	0.676
661	1880.0	22.10	6.00	28.10	0.646
810	1909.8	22.00	6.00	28.00	0.631

**REMARKS:** 1. Peak Output Power (dBm) = Raw Value (dBm) + Correction Factor (dB).  
 2. Correction Factor (dB) = Power Splitter Loss (dB) + Cable Loss (dB).



<b>MODE</b>	TX connected	<b>POWER CONTROL LEVEL</b>	0
<b>INPUT POWER (SYSTEM)</b>	120Vac, 60 Hz	<b>DETECTOR FUNCTION</b>	Peak
<b>ENVIRONMENTAL CONDITIONS</b>	22deg. C, 60%RH, 991hPa	<b>TESTED BY</b>	Match Tsui

**FOR GSM MODE (UP-LINK WITH 1 TIME SLOT)**

EIRP POWER					
CHANNEL NO.	FREQUENCY (MHz)	RAW VALUE (dBm)	CORRECTION FACTOR (dB)	PEAK OUTPUT POWER	
				dBm	Watt
512	1850.2	-10.99	40.03	29.04	0.802
661	1880.0	-12.32	40.32	28.00	0.631
810	1909.8	-12.71	40.62	27.91	0.618

**FOR GPRS MODE (UP-LINK WITH 1 TIME SLOT)**

EIRP POWER					
CHANNEL NO.	FREQUENCY (MHz)	RAW VALUE (dBm)	CORRECTION FACTOR (dB)	PEAK OUTPUT POWER	
				dBm	Watt
512	1850.2	-11.20	40.03	28.83	0.764
661	1880.0	-12.57	40.32	27.75	0.596
810	1909.8	-12.96	40.62	27.66	0.583

**FOR E-GPRS MODE (UP-LINK WITH 1 TIME SLOT)**

EIRP POWER					
CHANNEL NO.	FREQUENCY (MHz)	RAW VALUE (dBm)	CORRECTION FACTOR (dB)	PEAK OUTPUT POWER	
				dBm	Watt
512	1850.2	-12.11	40.03	27.92	0.619
661	1880.0	-13.50	40.32	26.82	0.481
810	1909.8	-14.02	40.62	26.60	0.457

- REMARKS:** 1. Peak Output Power (dBm) = Raw Value (dBm) + Correction Factor (dB).  
 2. Correction Factor (dB) = Receiver Antenna Gain (dBi) + Cable Loss (dB) + Free Space Loss (dB).





### **FOR WCDMA BAND:**

The following procedures were followed according to FCC “SAR Measurement Procedures Devices”, June 2006.

#### Output Power Verification

Maximum output power is verified on the High, Middle and Low channels according to the general descriptions in section 5.2 of 3GPP TS 34.121, using the appropriate RMC or AMR with TPC (transmit power control) set to all “1s” . Results for all applicable physical channel configurations (DPCCH, DPDCH<sub>n</sub> and spreading codes) should be tabulated in the test report. All configurations that are not supported by the DUT or cannot be measured due to technical or equipment limitations should be clearly identified



<b>MODE</b>	TX connected	<b>POWER CONTROL LEVEL</b>	0
<b>INPUT POWER (SYSTEM)</b>	120Vac, 60 Hz	<b>DETECTOR FUNCTION</b>	Peak
<b>ENVIRONMENTAL CONDITIONS</b>	22deg. C, 60%RH, 991hPa	<b>TESTED BY</b>	Match Tsui

CONDUCTED PEAK OUTPUT POWER (RMC, HSDPA INACTIVE)					
CHANNEL NO.	FREQUENCY (MHz)	RAW VALUE (dBm)	CORRECTION FACTOR (dB)	PEAK OUTPUT POWER	
				dBm	Watt
9262	1852.40	17.14	6.00	23.14	0.206
9400	1880.00	17.18	6.00	23.18	0.208
9538	1907.60	16.71	6.00	22.71	0.187

CONDUCTED PEAK OUTPUT POWER (AMR, HSDPA INACTIVE)					
CHANNEL NO.	FREQUENCY (MHz)	RAW VALUE (dBm)	CORRECTION FACTOR (dB)	PEAK OUTPUT POWER	
				dBm	Watt
9262	1852.40	17.11	6.00	23.11	0.205
9400	1880.00	17.15	6.00	23.15	0.207
9538	1907.60	16.73	6.00	22.73	0.187

CONDUCTED PEAK OUTPUT POWER (RMC, HSDPA ACTIVE)					
CHANNEL NO.	FREQUENCY (MHz)	RAW VALUE (dBm)	CORRECTION FACTOR (dB)	PEAK OUTPUT POWER	
				dBm	Watt
9262	1852.40	17.08	6.00	23.08	0.203
9400	1880.00	17.10	6.00	23.10	0.204
9538	1907.60	16.58	6.00	22.58	0.181

**REMARKS:** 1. Peak Output Power (dBm) = Raw Value (dBm) + Correction Factor (dB).  
 2. Correction Factor (dB) = Power Splitter Loss (dB) + Cable Loss (dB).



<b>MODE</b>	TX connected	<b>POWER CONTROL LEVEL</b>	0
<b>INPUT POWER (SYSTEM)</b>	120Vac, 60 Hz	<b>DETECTOR FUNCTION</b>	Peak
<b>ENVIRONMENTAL CONDITIONS</b>	22deg. C, 60%RH, 991hPa	<b>TESTED BY</b>	Match Tsui

EIRP POWER (RMC, HSDPA INACTIVE)					
CHANNEL NO.	FREQUENCY (MHz)	RAW VALUE (dBm)	CORRECTION FACTOR (dB)	PEAK OUTPUT POWER	
				dBm	Watt
9262	1852.40	-16.24	40.03	23.79	0.239
9400	1880.00	-16.46	40.32	23.86	0.243
9538	1907.60	-17.46	40.62	23.16	0.207

**REMARKS:** 1. Peak Output Power (dBm) = Raw Value (dBm) + Correction Factor (dB).  
 2. Correction Factor (dB) = Receiver Antenna Gain (dBi) + Cable Loss (dB) + Free Space Loss (dB).



## 4.2 FREQUENCY STABILITY MEASUREMENT

### 4.2.1 LIMITS OF FREQUENCY STABILITY MEASUREMENT

According to the FCC part 2.4235 shall be tested the frequency stability. The rule is defined that "The frequency stability shall be sufficient to ensure that the fundamental emission stays within the authorized frequency block." The frequency error rate is according to the JTC standard that the frequency error rate shall be accurate to within 2.5ppm of the received frequency from the base station. The test extreme voltage is according to the 2.1055(d)(1) Vary primary supply voltage from 85 to 115 percent of the nominal value for other than hand carried battery equipment and the extreme temperature rule is comply with the 2.1055(a)(1)  $-30^{\circ}\text{C} \sim 50^{\circ}\text{C}$ .

### 4.2.2 TEST INSTRUMENTS

DESCRIPTION & MANUFACTURER	MODEL NO.	SERIAL NO.	CALIBRATED UNTIL
* Hewlett Packard RF cable	8120-6192	01428251	NA
* Suhner RF cable	Sucoflex104	204850/4	NA
* WIT Standard Temperature & Humidity Chamber	TH-4S-C	W981030	Jul. 10, 2007

- NOTE:**
1. The calibration interval of the above test instruments is 12 months. And the calibrations are traceable to NML/ROC and NIST/USA.
  2. "\*" = These equipments are used for the final measurement.
  3. The test was performed in ADT RF OVEN room.

### 4.2.3 TEST PROCEDURE

- a. Because of the measure the carrier frequency under the condition of the AFC lock, it shall be used the mobile station in the GSM / WCDMA link mode. This is accomplished with the use of the R&S CMU200 / JRC NJZ-2000 simulator station. The oven room could control the temperatures and humidity. The GSM link channel is the 661 and the WCDMA link channel is the 9538.
- b. Power must be removed when changing from one temperature to another or one voltage to another voltage. Power warm up is at least 15 min and power applied should perform before recording frequency error.
- c. EUT is connected the external power supply to control the DC input power. The various Volts from the minimum 3.7 Volts to 4.2 Volts. Each step shall be record the frequency error rate.
- d. The temperature range step is 10 degrees in this test items. All temperature levels shall be hold the  $\pm 0.5^{\circ}\text{C}$  during the measurement testing.
- e. The each temperature step shall be at least 0.5 hours, consider the EUT could be test under the stability condition.

**NOTE:** The frequency error was recorded frequency error from the GSM simulator.

### 4.2.4 TEST SETUP

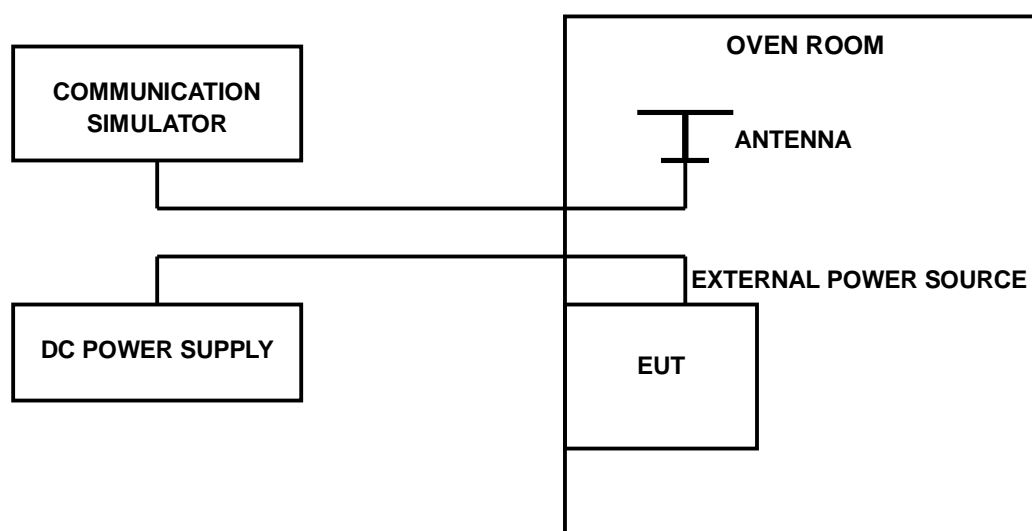



#### 4.2.5 TEST RESULTS

##### FOR PCS BAND:

<b>MODE</b>	TX channel 661	<b>POWER CONTROL LEVEL</b>	0
<b>INPUT POWER (SYSTEM)</b>	120Vac, 60 Hz	<b>ENVIRONMENTAL CONDITIONS</b>	22deg. C, 60%RH, 991hPa
<b>TESTED BY</b>	Match Tsui		

##### FOR GSM MODE (UP-LINK WITH 1 TIME SLOT)

AFC FREQUENCY ERROR vs. VOLTAGE			
VOLTAGE (Volts)	FREQUENCY ERROR (Hz)	FREQUENCY ERROR (ppm)	LIMIT (ppm)
3.7	9	0.0047872340	2.5
4.2	11	0.0058510638	2.5

**NOTE:** The applicant defined the normal working voltage of the battery is from 3.7Vdc to 4.2Vdc.

##### FOR GPRS MODE (UP-LINK WITH 1 TIME SLOT)

AFC FREQUENCY ERROR vs. VOLTAGE			
VOLTAGE (Volts)	FREQUENCY ERROR (Hz)	FREQUENCY ERROR (ppm)	LIMIT (ppm)
3.7	8	0.0042553191	2.5
4.2	10	0.0053191489	2.5

**NOTE:** The applicant defined the normal working voltage of the battery is from 3.7Vdc to 4.2Vdc.

##### FOR E-GPRS MODE (UP-LINK WITH 1 TIME SLOT)

AFC FREQUENCY ERROR vs. VOLTAGE			
VOLTAGE (Volts)	FREQUENCY ERROR (Hz)	FREQUENCY ERROR (ppm)	LIMIT (ppm)
3.7	9	0.0047872340	2.5
4.2	11	0.0058510638	2.5

**NOTE:** The applicant defined the normal working voltage of the battery is from 3.7Vdc to 4.2Vdc.



<b>MODE</b>	TX channel 661	<b>POWER CONTROL LEVEL</b>	0
<b>INPUT POWER (SYSTEM)</b>	120Vac, 60 Hz	<b>ENVIRONMENTAL CONDITIONS</b>	22deg. C, 60%RH, 991hPa
<b>TESTED BY</b>	Match Tsui		

**FOR GSM MODE (UP-LINK WITH 1 TIME SLOT)**

<b>AFC FREQUENCY ERROR vs. TEMP.</b>			
<b>TEMP. (°C)</b>	<b>FREQUENCY ERROR (Hz)</b>	<b>FREQUENCY ERROR (ppm)</b>	<b>LIMIT (ppm)</b>
50	14	0.0074468085	2.5
40	13	0.0069148936	2.5
30	7	0.0037234043	2.5
20	4	0.0021276596	2.5
10	5	0.0026595745	2.5
0	8	0.0042553191	2.5
-10	11	0.0058510638	2.5
-20	13	0.0069148936	2.5
-30	15	0.0079787234	2.5

**FOR GPRS MODE (UP-LINK WITH 1 TIME SLOT)**

<b>AFC FREQUENCY ERROR vs. TEMP.</b>			
<b>TEMP. (°C)</b>	<b>FREQUENCY ERROR (Hz)</b>	<b>FREQUENCY ERROR (ppm)</b>	<b>LIMIT (ppm)</b>
50	15	0.0079787234	2.5
40	14	0.0074468085	2.5
30	9	0.0047872340	2.5
20	6	0.0031914894	2.5
10	5	0.0026595745	2.5
0	5	0.0026595745	2.5
-10	7	0.0037234043	2.5
-20	11	0.0058510638	2.5
-30	14	0.0074468085	2.5

**FOR E-GPRS MODE (UP-LINK WITH 1 TIME SLOT)**

<b>AFC FREQUENCY ERROR vs. TEMP.</b>			
<b>TEMP. (°C)</b>	<b>FREQUENCY ERROR (Hz)</b>	<b>FREQUENCY ERROR (ppm)</b>	<b>LIMIT (ppm)</b>
50	15	0.0079787234	2.5
40	14	0.0074468085	2.5
30	10	0.0053191489	2.5
20	7	0.0037234043	2.5
10	5	0.0026595745	2.5
0	6	0.0031914894	2.5
-10	8	0.0042553191	2.5
-20	11	0.0058510638	2.5
-30	14	0.0074468085	2.5





**FOR WCDMA BAND:**

<b>MODE</b>	TX channel 9538	<b>POWER CONTROL LEVEL</b>	0
<b>INPUT POWER (SYSTEM)</b>	120Vac, 60 Hz	<b>ENVIRONMENTAL CONDITIONS</b>	22deg. C, 60%RH, 991hPa
<b>TESTED BY</b>	Match Tsui		

<b>AFC FREQUENCY ERROR vs. VOLTAGE</b>			
<b>VOLTAGE (Volts)</b>	<b>FREQUENCY ERROR (Hz)</b>	<b>FREQUENCY ERROR (ppm)</b>	<b>LIMIT (ppm)</b>
3.7	9	0.0047872340	2.5
4.2	10	0.0053191489	2.5

**NOTE:** The applicant defined the normal working voltage of the battery is from 3.7Vdc to 4.2Vdc.

<b>AFC FREQUENCY ERROR vs. TEMP.</b>			
<b>TEMP. (°C)</b>	<b>FREQUENCY ERROR (Hz)</b>	<b>FREQUENCY ERROR (ppm)</b>	<b>LIMIT (ppm)</b>
50	14	0.0074468085	2.5
40	14	0.0074468085	2.5
30	12	0.0063829787	2.5
20	7	0.0037234043	2.5
10	5	0.0026595745	2.5
0	7	0.0037234043	2.5
-10	9	0.0047872340	2.5
-20	11	0.0058510638	2.5
-30	15	0.0079787234	2.5



### 4.3 OCCUPIED BANDWIDTH MEASUREMENT

#### 4.3.1 LIMITS OF OCCUPIED BANDWIDTH MEASUREMENT

According to FCC 24.238(b) specified that emission bandwidth is defined as the width of the signal between two points, one below the carrier center frequency and one above the carrier center frequency, outside of which all emissions are attenuated at least 26 dB below the transmitter power.

#### 4.3.2 TEST INSTRUMENTS

DESCRIPTION & MANUFACTURER	MODEL NO.	SERIAL NO.	CALIBRATED UNTIL
* ROHDE & SCHWARZ Spectrum Analyzer	FSP40	100035	Mar. 25, 2008
* Mini-Circuits Power Splitter	ZAPD-4	400005	NA
* Hewlett Packard RF cable	8120-6192	01428251	NA
* JFW 20dB attenuation	50HF-020-SMA	NA	NA
* Suhner RF cable	Sucoflex104	204850/4	NA

**NOTE:** 1. The calibration interval of the above test instruments is 12 months. And the calibrations are traceable to NML/ROC and NIST/USA.

2. "\*" = These equipments are used for the final measurement.

#### 4.3.3 TEST SETUP

Same as Item 4.2.4 (Conducted Power Setup)

#### 4.3.4 TEST PROCEDURES

- a. The EUT was set up for the maximum peak power with GSM / WCDMA link data modulation. The power was measured with R&S Spectrum Analyzer. All measurements were done at 3 channels, 512, 661 and 810 / 9262, 9400 and 9538 (low, middle and high operational frequency range.)
- b. The conducted occupied bandwidth used the power splitter via EUT RF power connector between simulation base station and spectrum analyzer. This splitter loss and cable loss are the worst loss 6dB (PCS band) / 4.5dB (WCDMA band) in the transmitted path track.
- c. FCC 24.238(b) required a measurement bandwidth is the fundamental emission below 26dB bandwidth.

#### 4.3.5 EUT OPERATING CONDITION

- a. The EUT makes a phone call to the communication simulator.
- b. The communication simulator station system controlled a EUT to export maximum and minimum output power under transmission mode and specific channel frequency.

#### 4.3.6 TEST RESULTS

##### FOR PCS BAND:

##### FOR GSM MODE (UP-LINK WITH 1 TIME SLOT)

FREQUENCY (MHz)	MAX. OUTPUT POWER -26 dBc BANDWIDTH (kHz)
1850.2	314
1880.0	316
1909.8	316

### CH 512 MAX. POWER

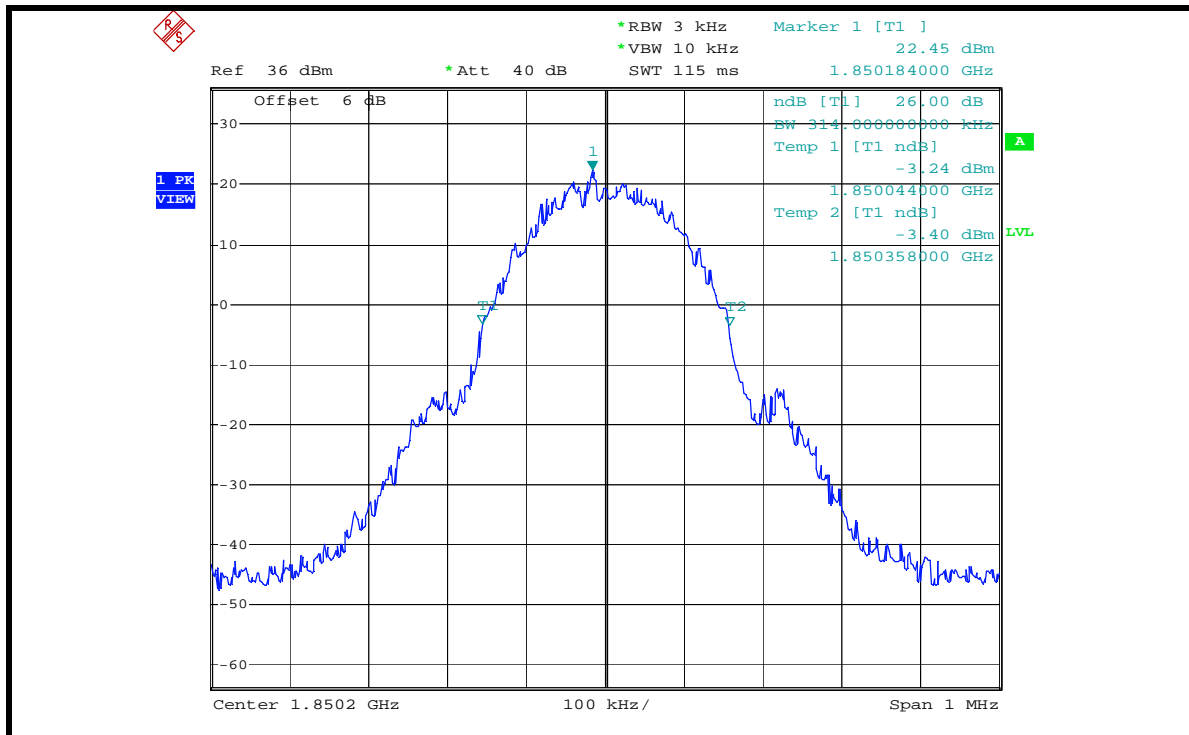

### CH 661 MAX. POWER

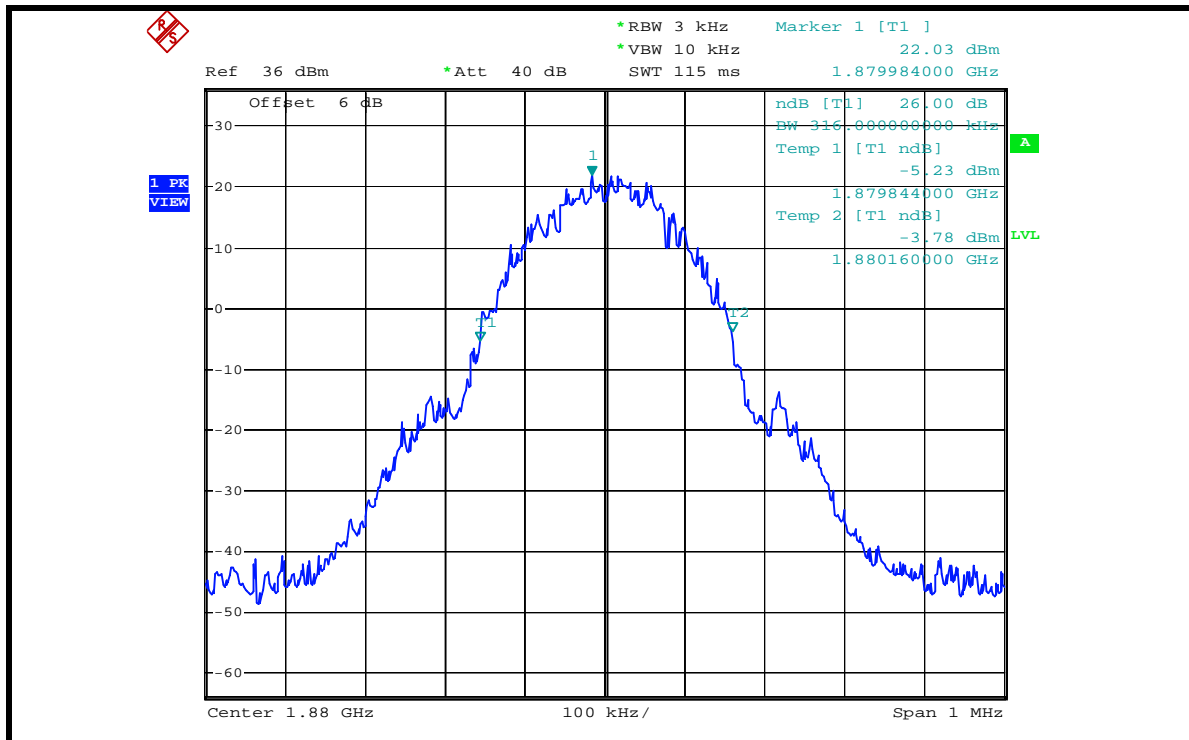

### CH 810 MAX. POWER

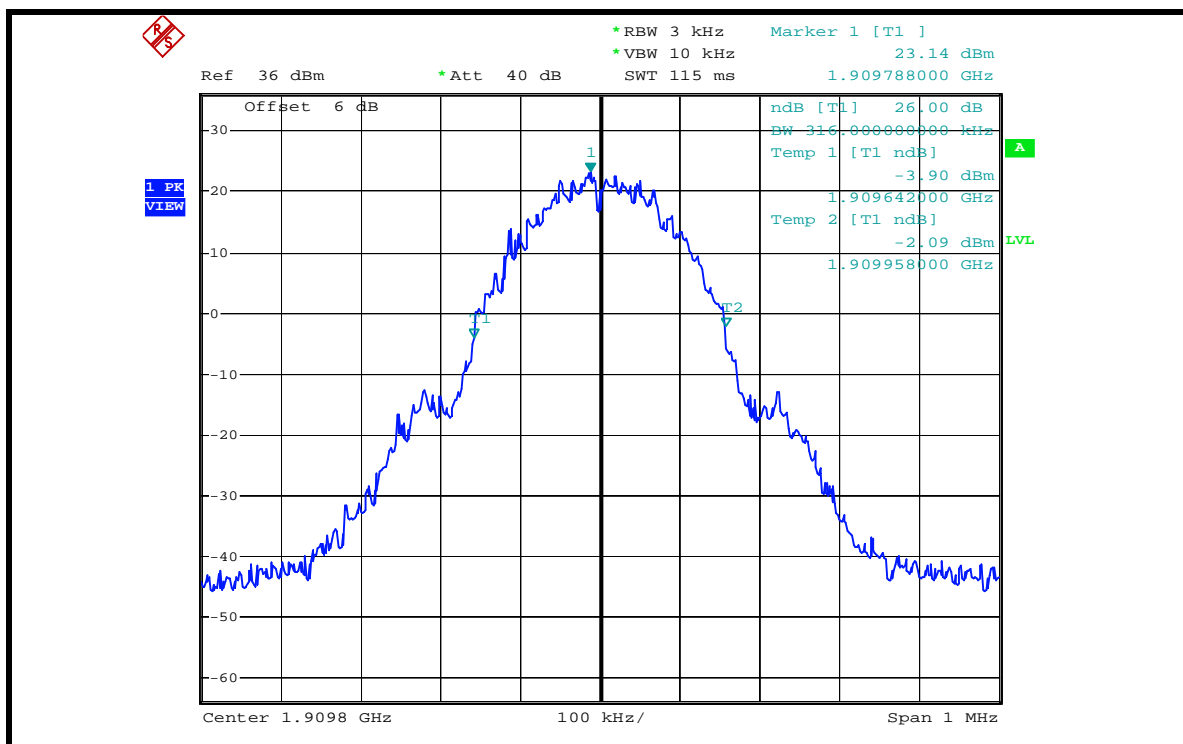

**FOR GPRS MODE (UP-LINK WITH 1 TIME SLOT)**

FREQUENCY (MHz)	MAX. OUTPUT POWER -26 dBc BANDWIDTH (kHz)
1850.2	320
1880.0	318
1909.8	312

**CH 512 MAX. POWER**

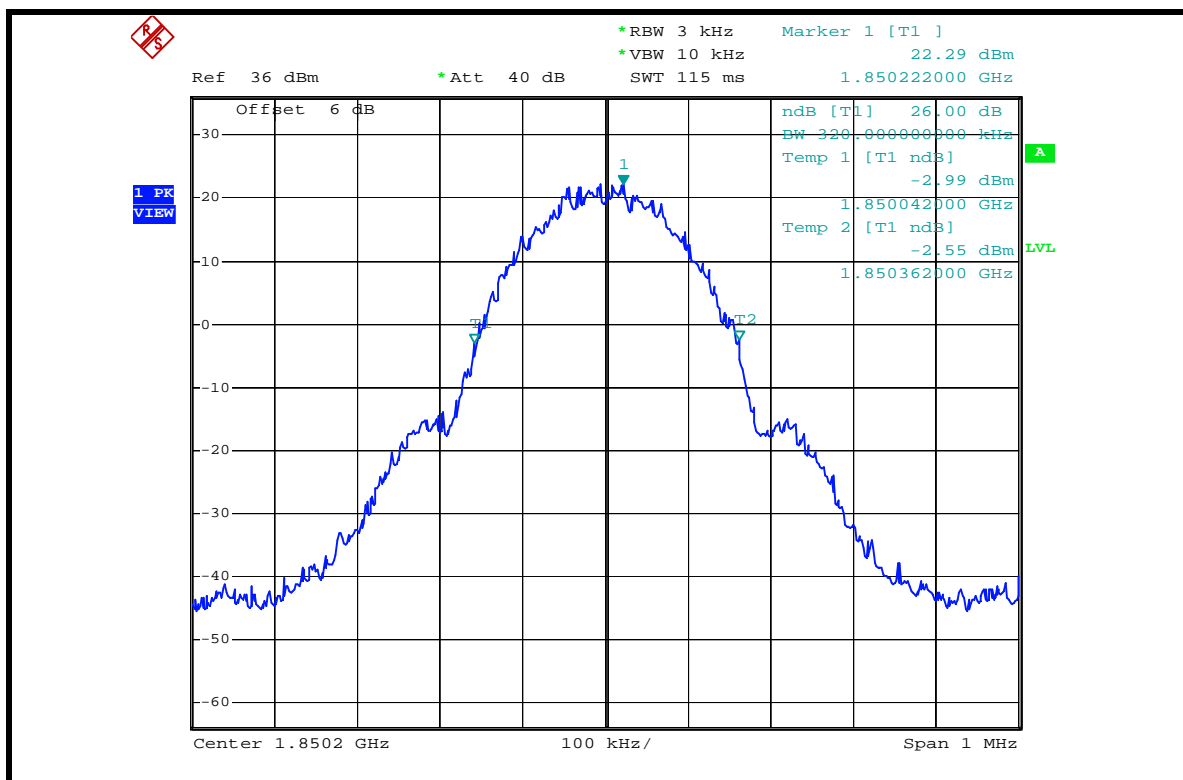

### CH 661 MAX. POWER

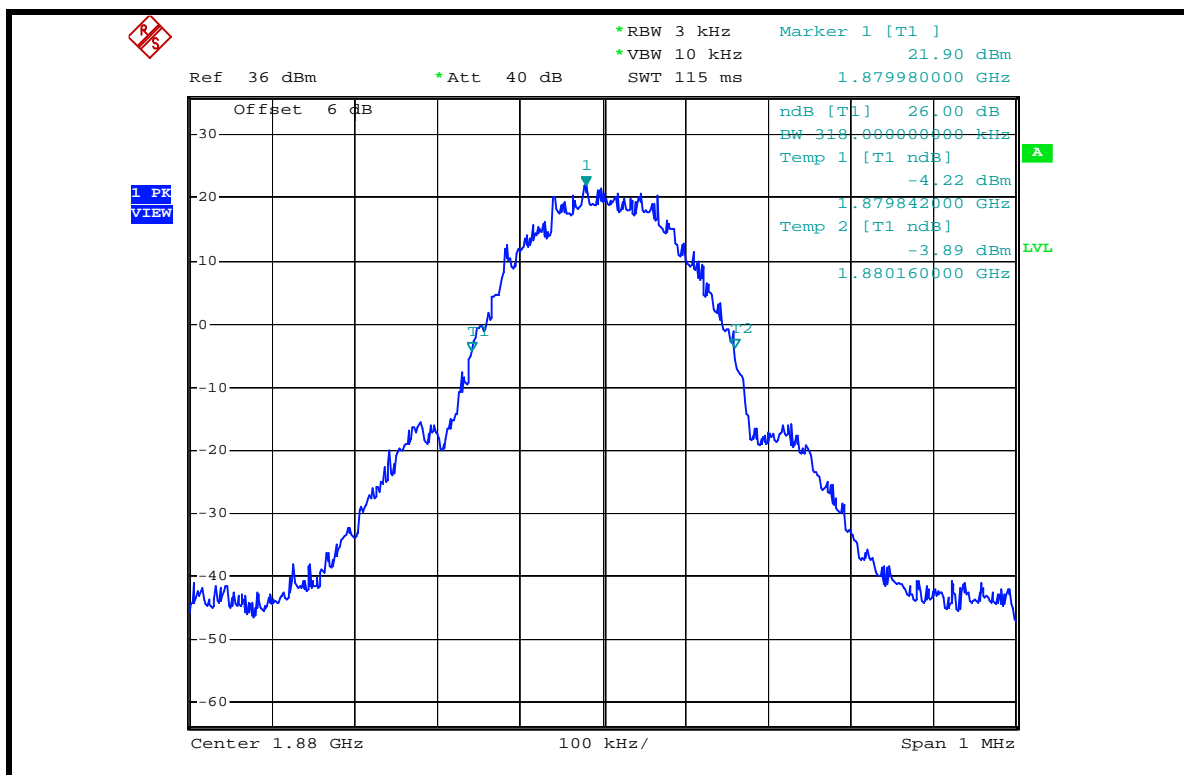

### CH 810 MAX. POWER

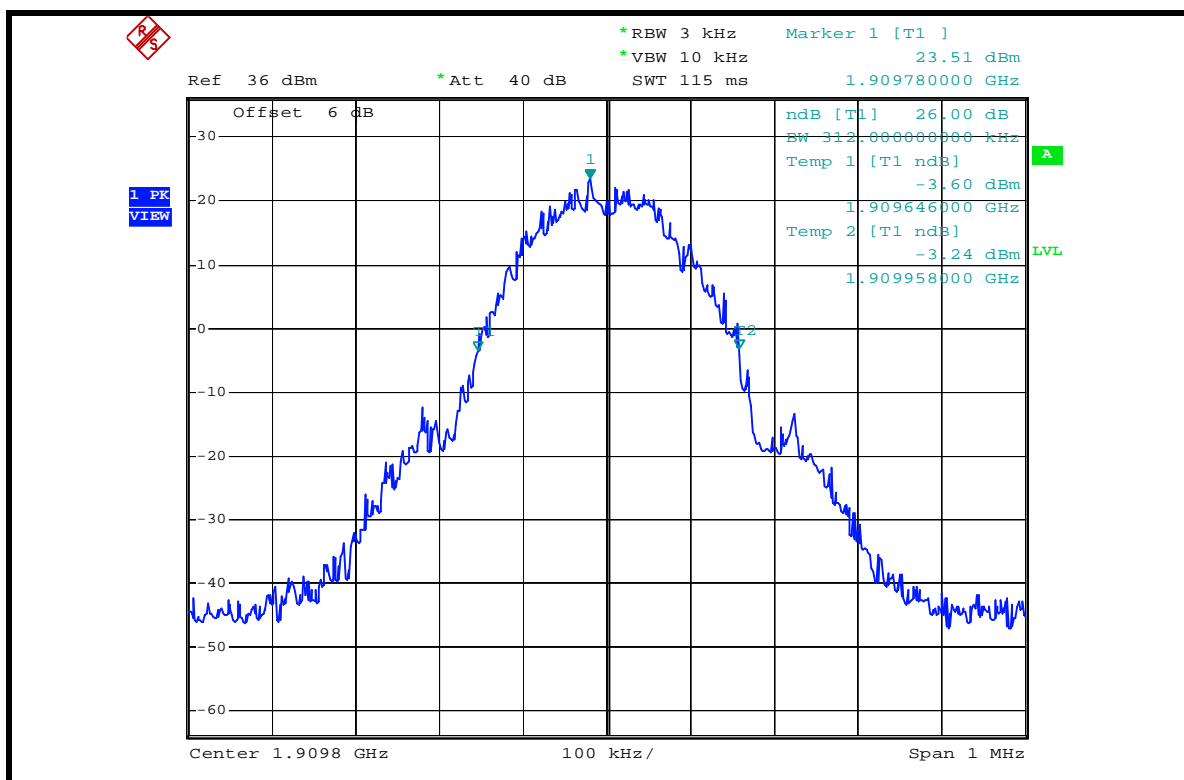

**FOR E-GPRS MODE (UP-LINK WITH 1 TIME SLOT)**

FREQUENCY (MHz)	MAX. OUTPUT POWER -26 dBc BANDWIDTH (kHz)
1850.2	316
1880.0	312
1909.8	314

**CH 512 MAX. POWER**

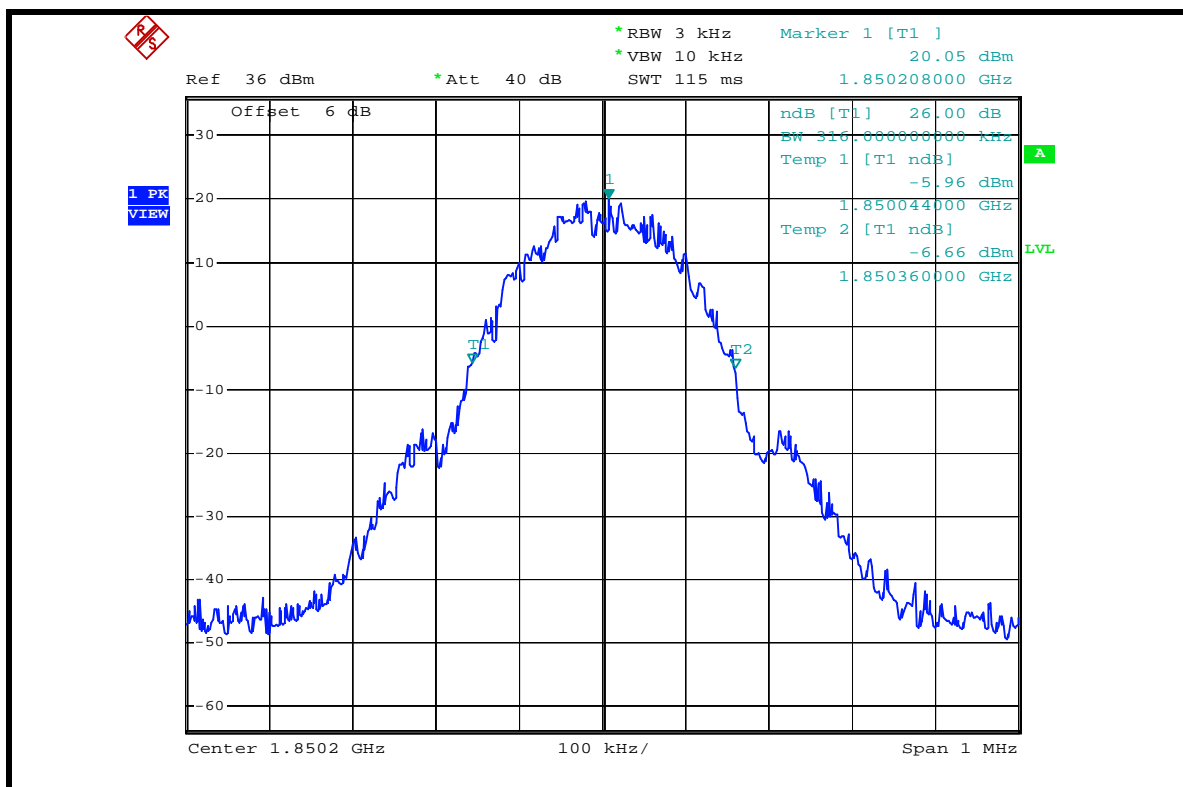





### CH 661 MAX. POWER

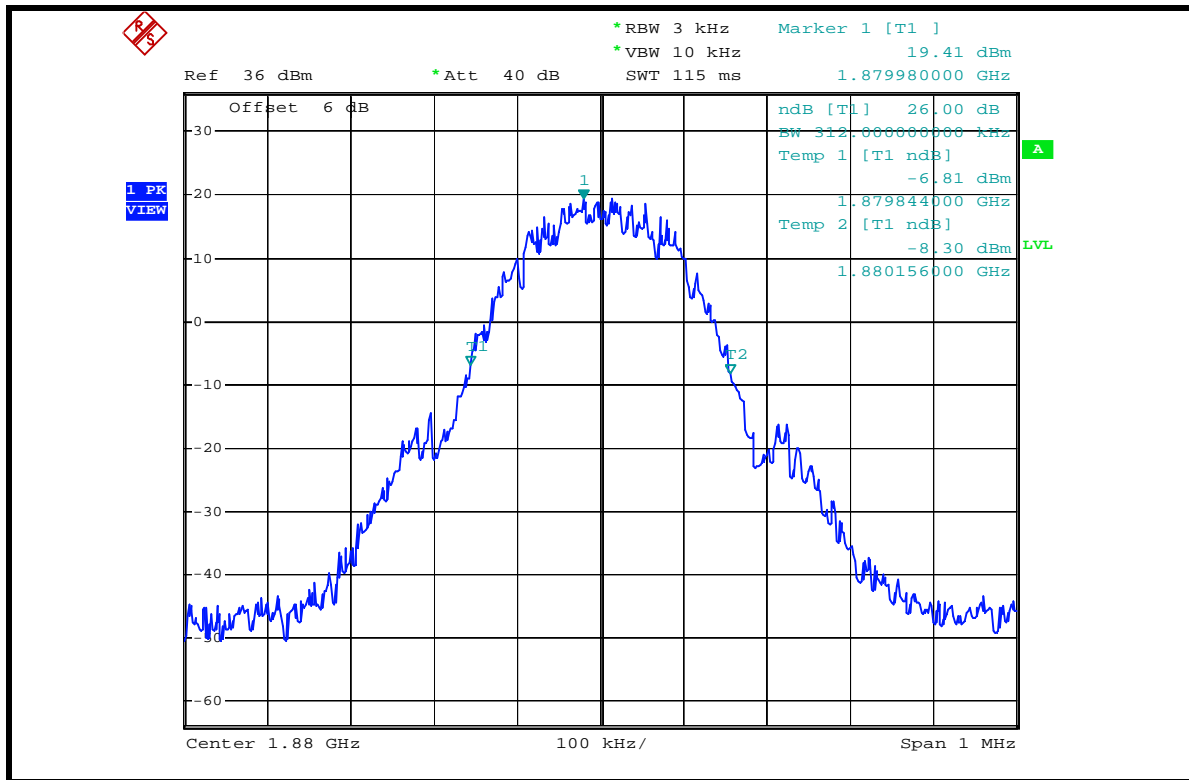

### CH 810 MAX. POWER

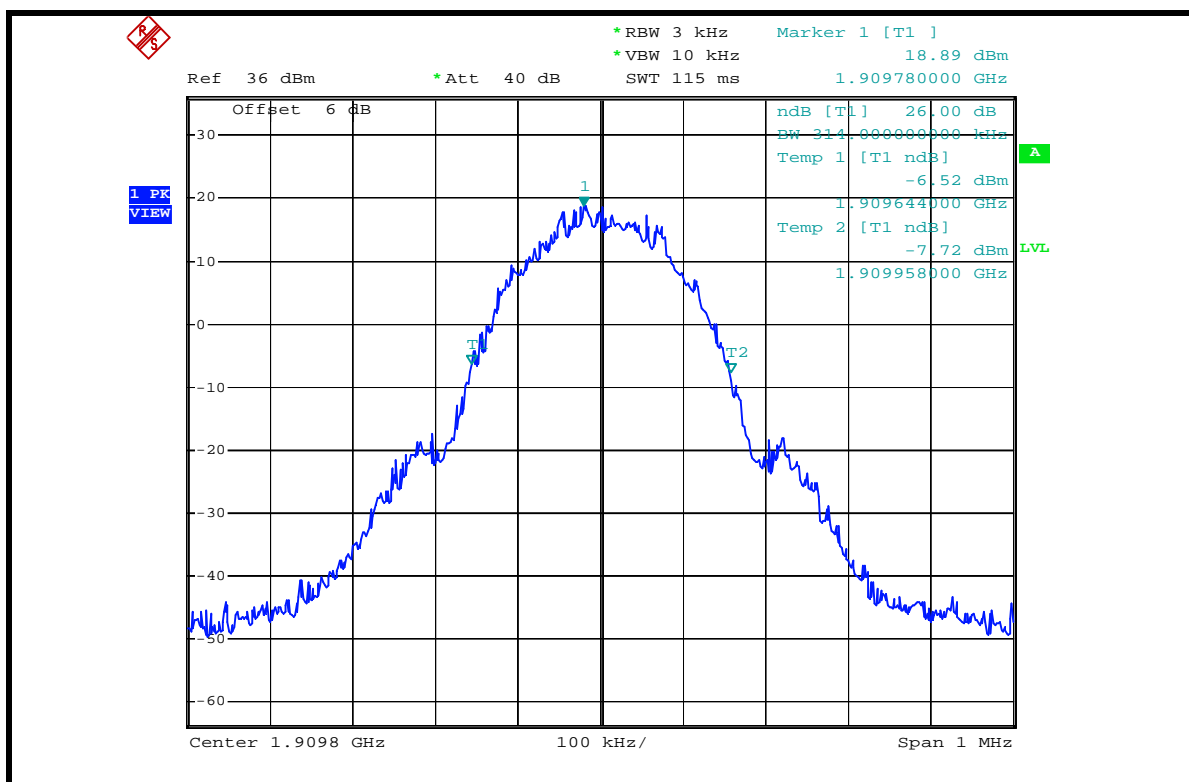

**FOR WCDMA BAND:**

FREQUENCY (MHz)	MAX. OUTPUT POWER -26 dBc BANDWIDTH (MHz)
1852.40	4.68
1880.00	4.70
1907.60	4.70

**CH 9262 MAX. POWER**

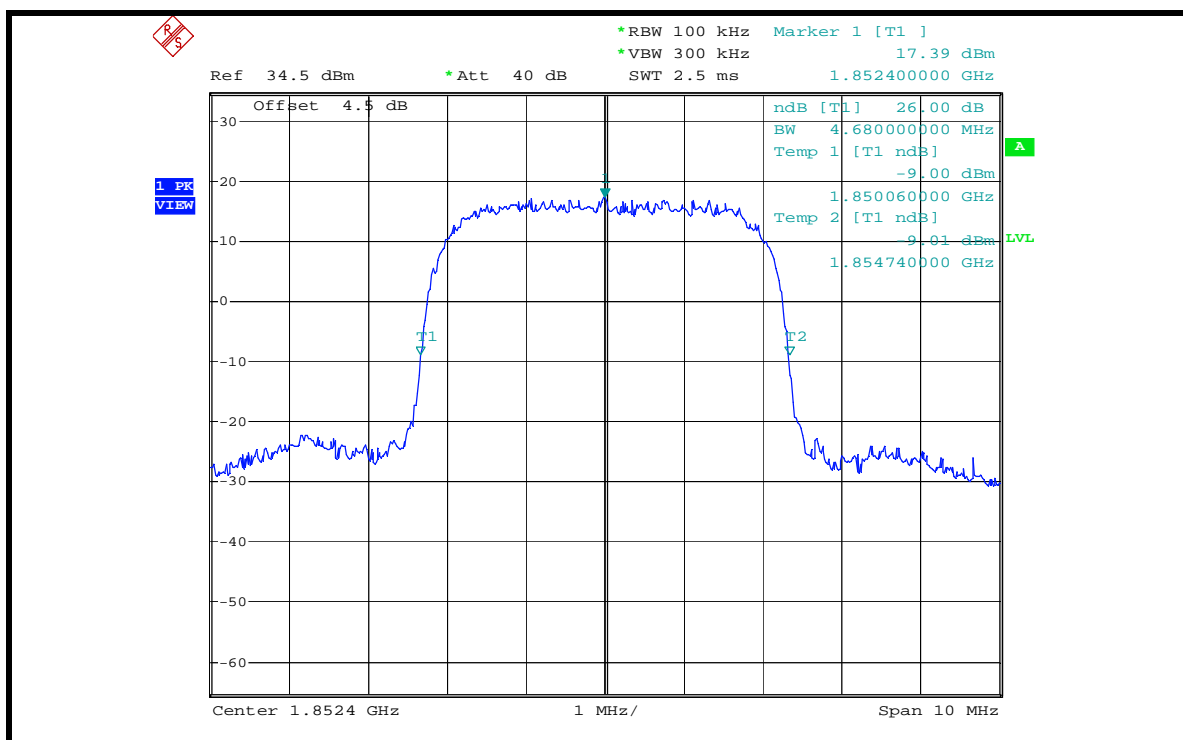



### CH 9400 MAX. POWER

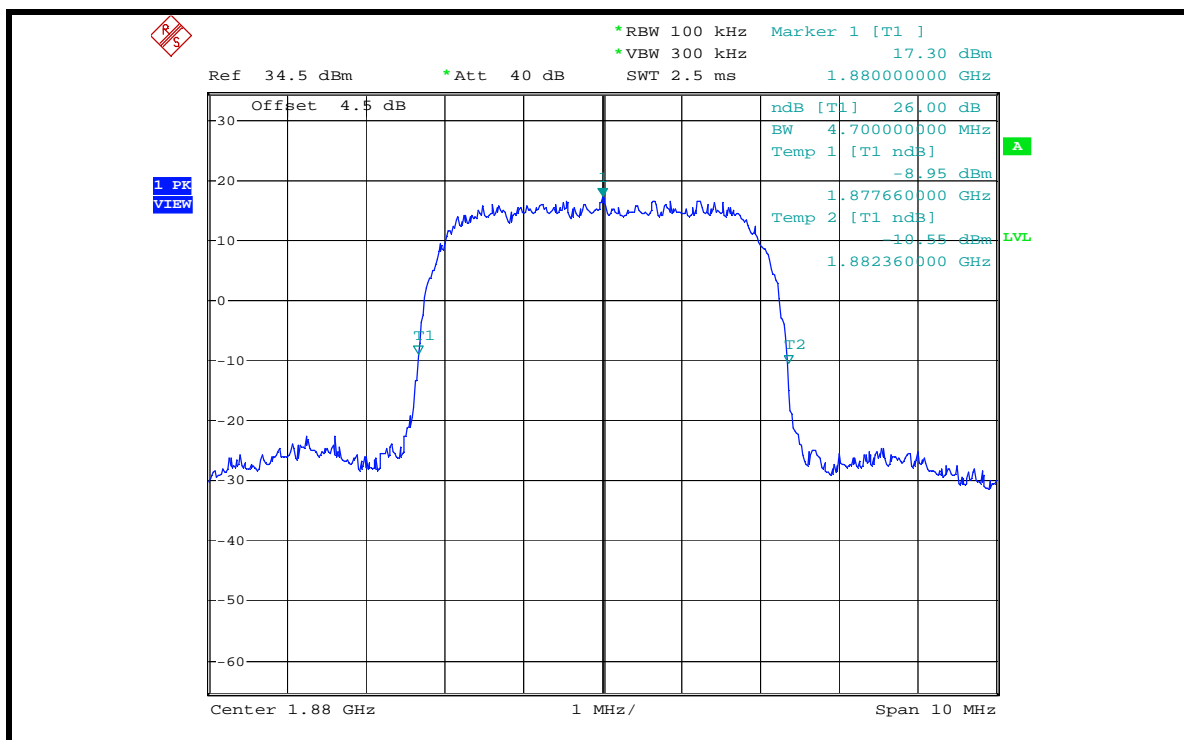

### CH 9538 MAX. POWER

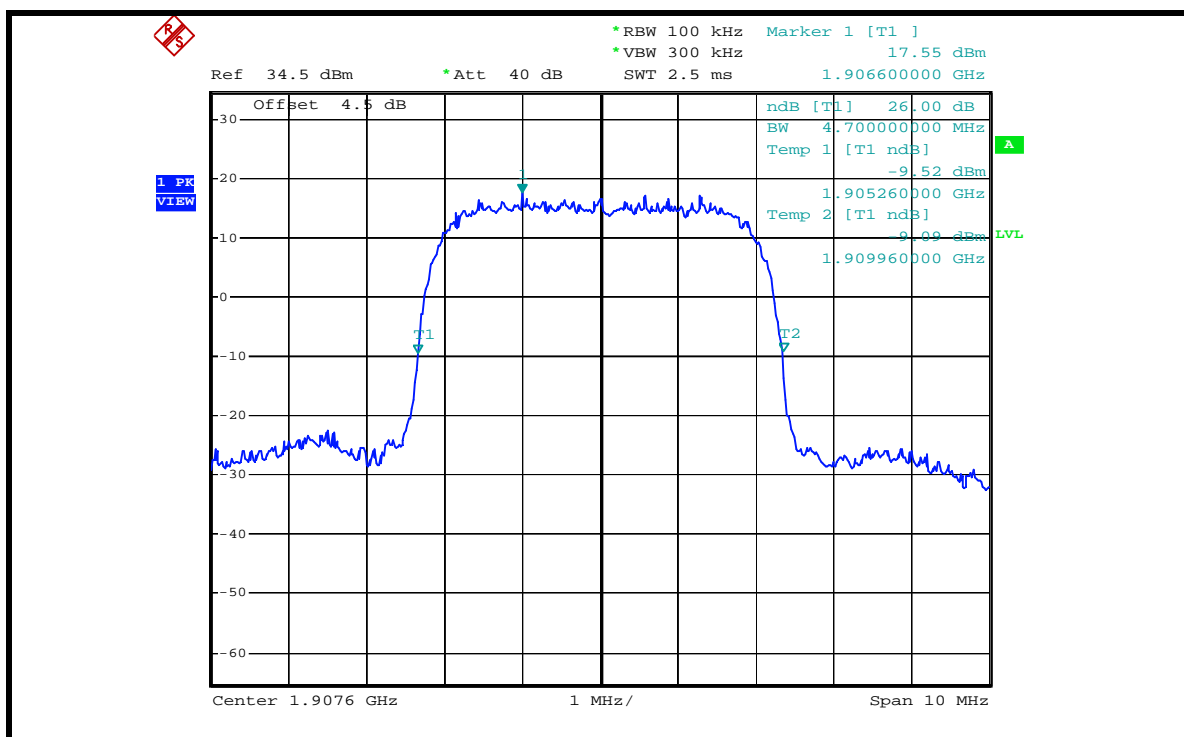



## 4.4 BAND EDGE MEASUREMENT

### 4.4.1 LIMITS OF BAND EDGE MEASUREMENT

The PCS frequency bands refer to the FCC 24.229 rule. According to FCC 24.238(a) specified that power of any emission outside of the authorized operating frequency ranges must be attenuated below the transmitting power (P) by a factor of at least  $43 + 10 \log(P)$  dB. In the 1 MHz bands immediately outside and adjacent to the frequency block a resolution bandwidth of at least one percent of the emission bandwidth of the fundamental emission of the transmitter may be employed.

### 4.4.2 TEST INSTRUMENTS

DESCRIPTION & MANUFACTURER	MODEL NO.	SERIAL NO.	CALIBRATED UNTIL
* ROHDE & SCHWARZ Spectrum Analyzer	FSP40	100035	Mar. 25, 2008
* Mini-Circuits Power Splitter	ZAPD-4	400005	NA
* Hewlett Packard RF cable	8120-6192	01428251	NA
* JFW 20dB attenuation	50HF-020-SMA	NA	NA
* Suhner RF cable	Sucoflex104	204850/4	NA

**NOTE:** 1. The calibration interval of the above test instruments is 12 months. And the calibrations are traceable to NML/ROC and NIST/USA.

2. "\*" = These equipments are used for the final measurement.

### 4.4.3 TEST SETUP

Same as Item 4.2.4 (Conducted Power Setup)

#### 4.4.4 TEST PROCEDURES

- a. The EUT was set up for the maximum peak power with GSM / WCDMA link data modulation. The power was measured with R&S Spectrum Analyzer. All measurements were done at 2 channels, 512 and 810 / 9262 and 9538 (low and high operational frequency range.)
- b. The band edge measurement used the power splitter via EUT RF power connector between simulation base station and spectrum analyzer. This splitter loss and cable loss are the worst loss 6dB (PCS band) / 4.5dB (WCDMA band) in the transmitted path track.
- c. The center frequency of spectrum is the band edge frequency and span is 1.5 MHz. RB of the spectrum is 3kHz and VB of the spectrum is 10kHz (for PCS band).
- d. The center frequency of spectrum is the band edge frequency and span is 10 MHz. RB of the spectrum is 100kHz and VB of the spectrum is 300kHz (for WCDMA band).
- e. Record the max trace plot into the test report.

#### 4.4.5 EUT OPERATING CONDITION

- a. The EUT makes a phone call to the communication simulator.
- b. The communication simulator station system controlled an EUT to export maximum output power under transmission mode and specific channel frequency.

#### 4.4.6 TEST RESULTS

**FOR PCS BAND:**

**FOR GSM MODE (UP-LINK WITH 1 TIME SLOT)**

**LOWER BAND EDGE**

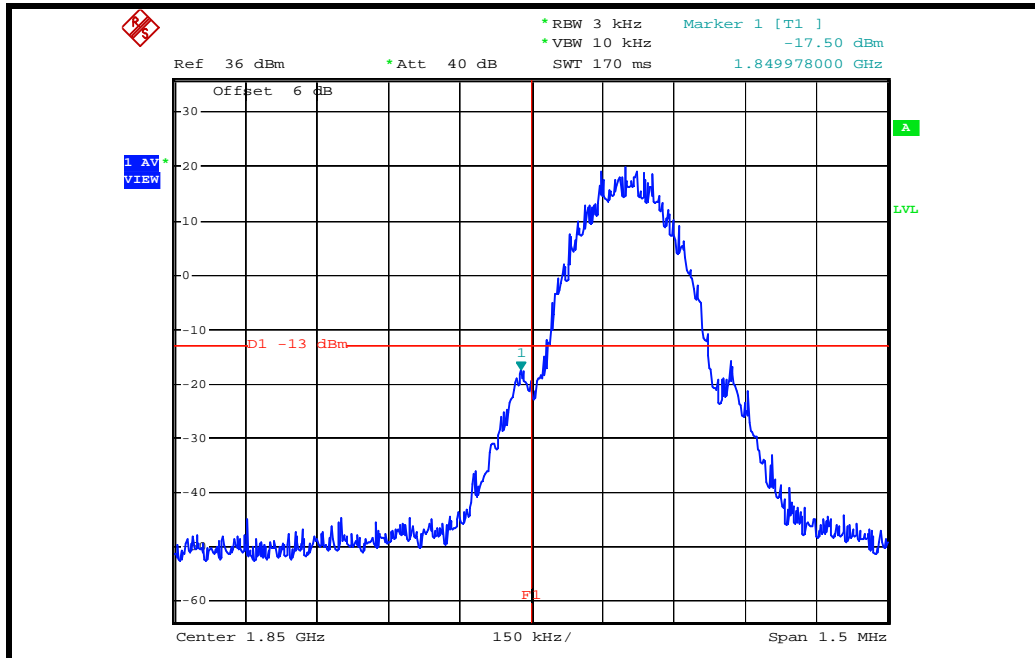

**HIGHER BAND EDGE**

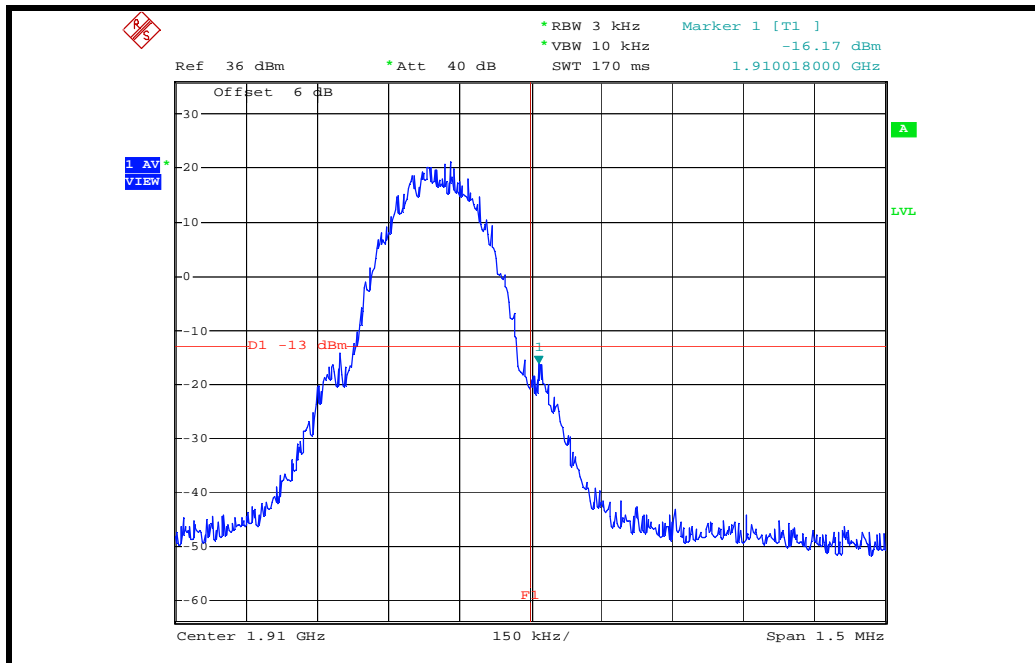

**FOR GPRS MODE (UP-LINK WITH 1 TIME SLOT)**  
**LOWER BAND EDGE**

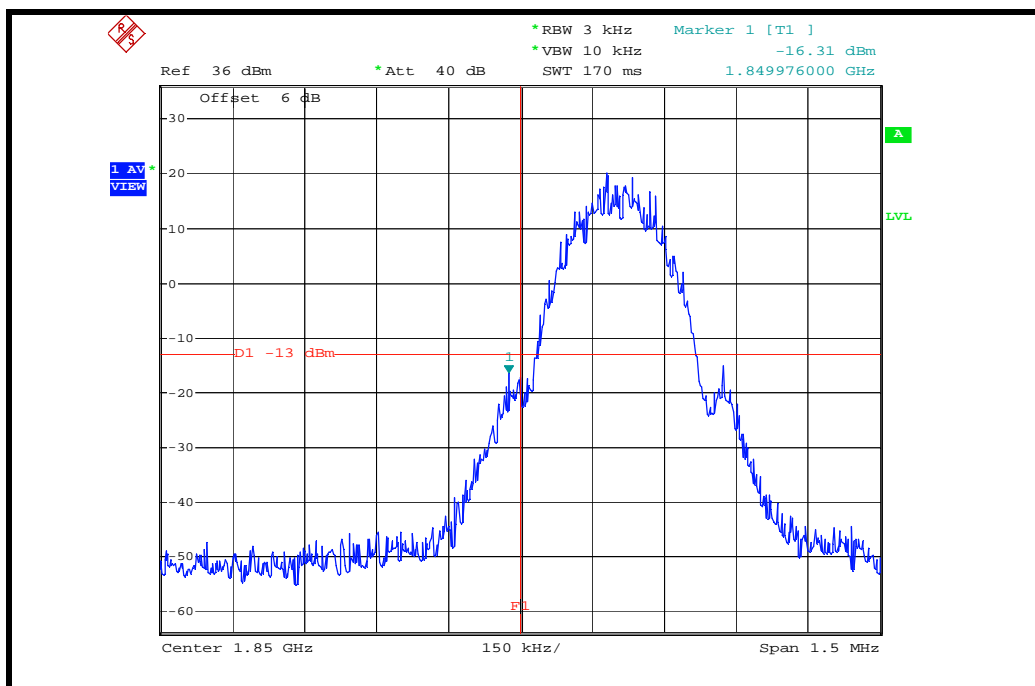

**HIGHER BAND EDGE**

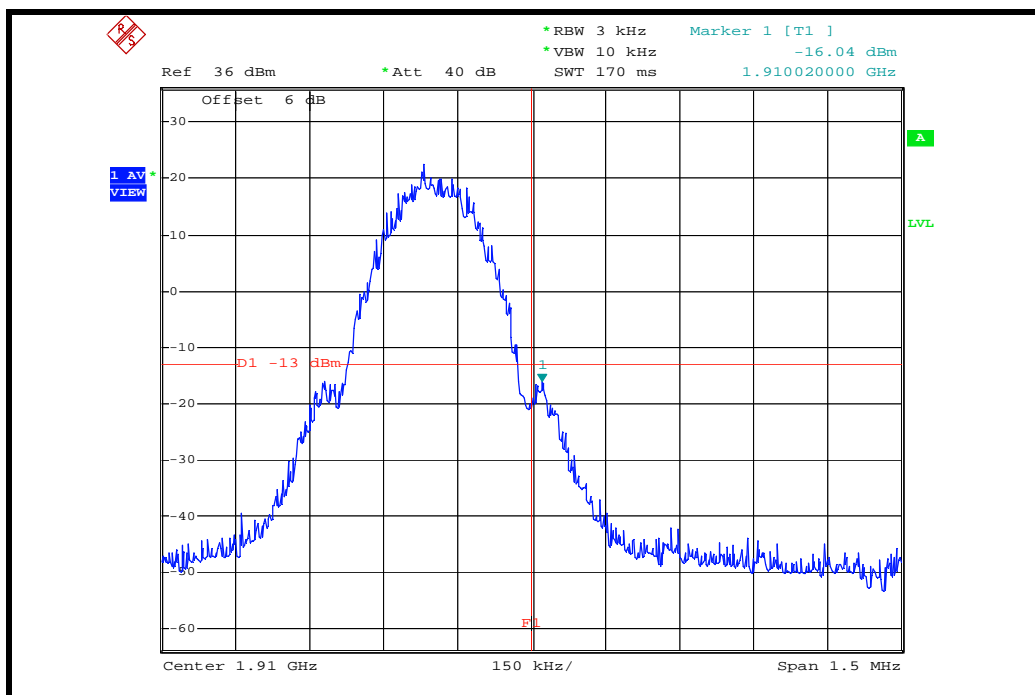

### FOR E-GPRS MODE (UP-LINK WITH 1 TIME SLOT)

#### LOWER BAND EDGE

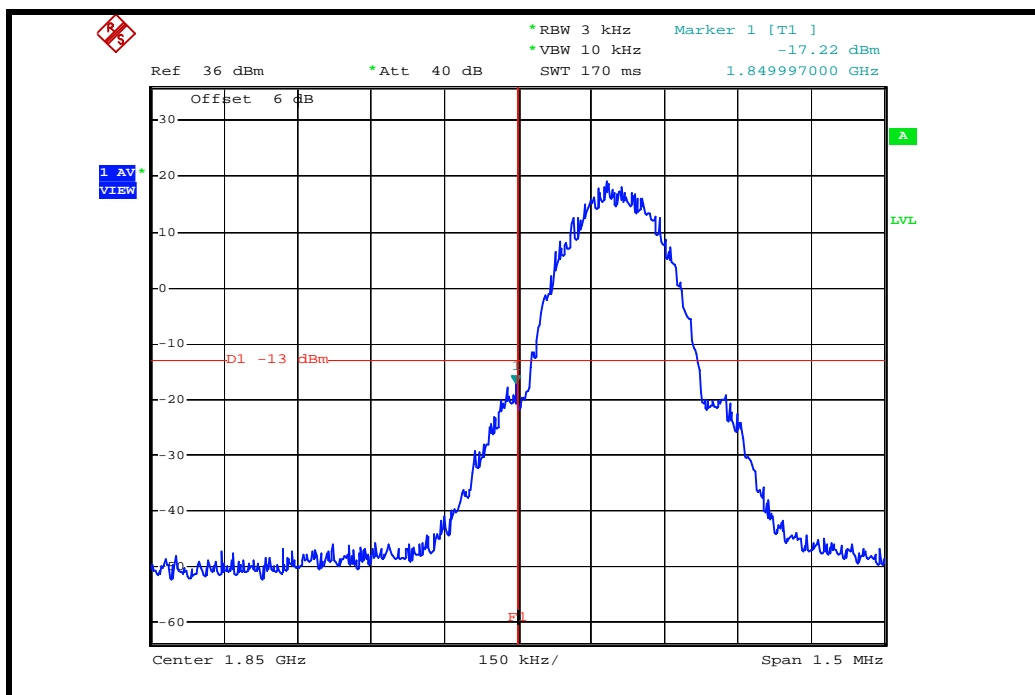

#### HIGHER BAND EDGE

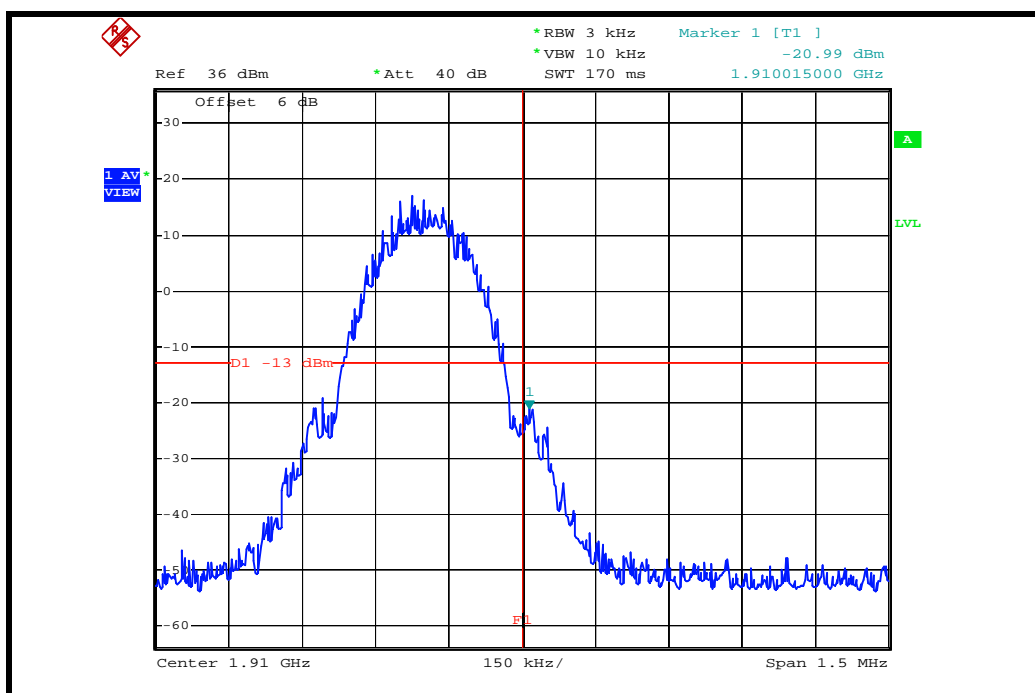



### FOR WCDMA BAND: LOWER BAND EDGE

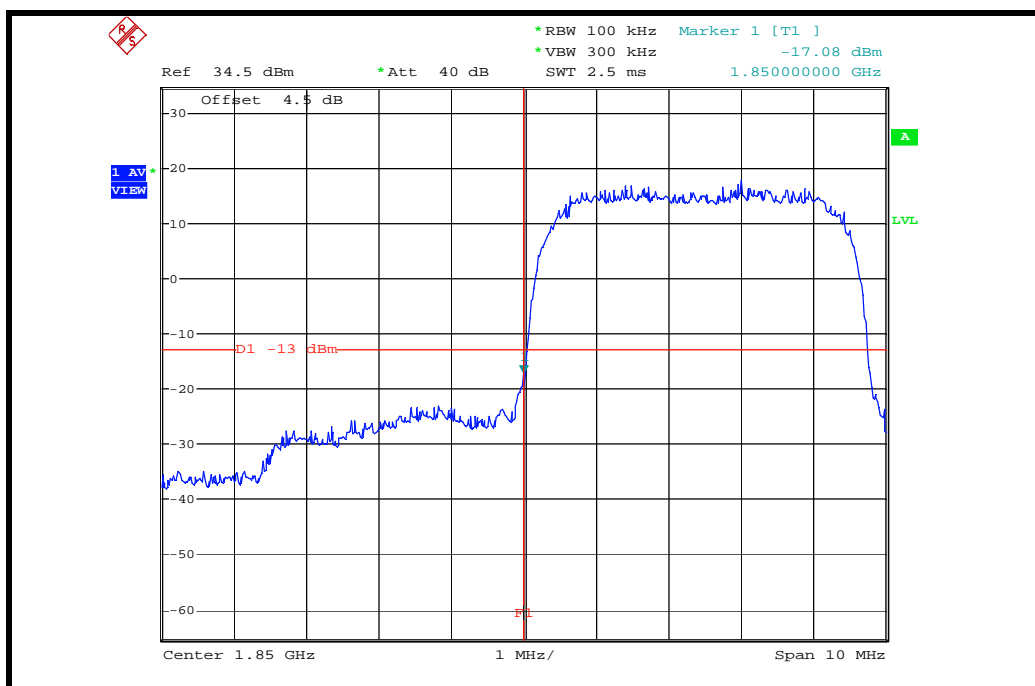

### HIGHER BAND EDGE

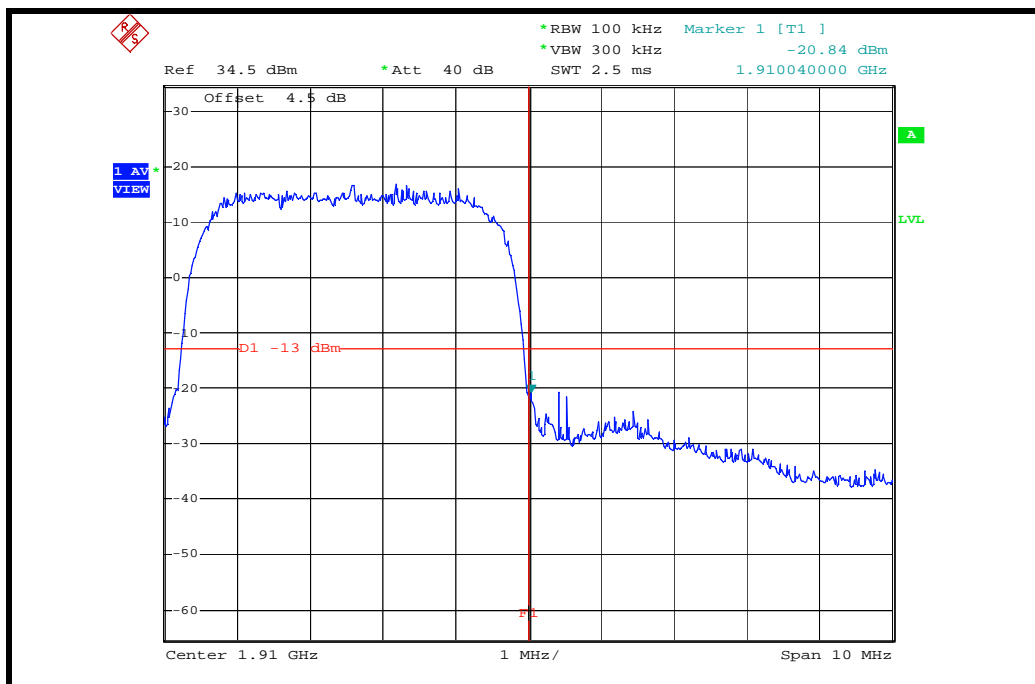



## 4.5 CONDUCTED SPURIOUS EMISSIONS

### 4.5.1 LIMITS OF CONDUCTED SPURIOUS EMISSIONS MEASUREMENT

In the FCC 24.238(a), On any frequency outside a licensee's frequency block within USPCS spectrum, the power of any emission shall be attenuated below the transmitter power (P) by at least  $43 + 10 \log (P)$  dB. The specified minimum attenuation becomes 43dB and the limit of emission equal to  $-13\text{dBm}$ .

### 4.5.2 TEST INSTRUMENTS

DESCRIPTION & MANUFACTURER	MODEL NO.	SERIAL NO.	CALIBRATED UNTIL
* ROHDE & SCHWARZ Spectrum Analyzer	FSP40	100035	Mar. 25, 2008
* Wainwright Instruments Band Reject Filter	WRCG1850/1910-18 30/1930-60/10SS	SN1	NA
* Wainwright Instruments High Pass Filter	WHK3.1/18G-10SS	SN1	NA
* Mini-Circuits Power Splitter	ZAPD-4	400005	NA
* Hewlett Packard RF cable	8120-6192	01428251	NA
* JFW 20dB attenuation	50HF-020-SMA	NA	NA
* Suhner RF cable	Sucoflex104	204850/4	NA

- NOTE:**
1. The calibration interval of the above test instruments is 12 months. And the calibrations are traceable to NML/ROC and NIST/USA.
  2. "\*" = These equipments are used for the final measurement.

### 4.5.3 TEST PROCEDURE

- a. The EUT was set up for the maximum peak power with GSM / WCDMA link data modulation. The power was measured with R&S Spectrum Analyzer. All measurements were done at 3 channels, 512, 661 and 810 / 9262, 9400 and 9538 (low, middle and high operational frequency range.)
- b. The conducted spurious emission used the power splitter via EUT RF power connector between simulation base station and spectrum analyzer. This splitter loss and cable loss are the worst loss 6dB (PCS band) / 4.5dB (WCDMA band) in the transmitted path track.
- c. When the spectrum scanned from 9kHz to 3GHz, it shall be connected to the band reject filter attenuated the carried frequency. The spectrum set RB=1MHz, VB=3MHz (GSM band) / RB=1MHz, VB=1MHz (WCDMA band).
- d. When the spectrum scanned from 3kHz to 20GHz, it shall be connected to the high pass filter attenuated the carried frequency. The spectrum set set RB=1MHz, VB=3MHz (GSM band) / RB=1MHz, VB=1MHz (WCDMA band).

### 4.5.4 TEST SETUP

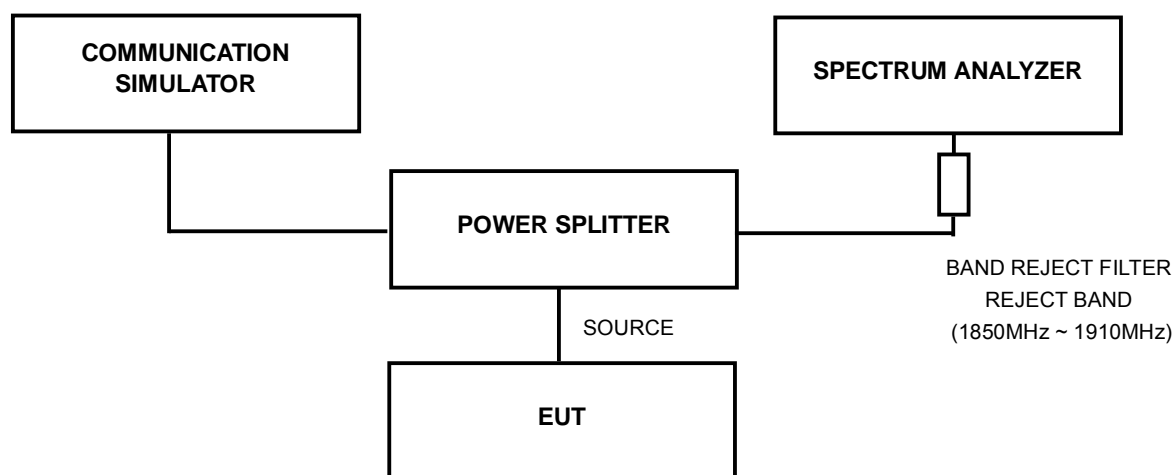

### 4.5.5 EUT OPERATING CONDITIONS

- a. The EUT makes a phone call to the communication simulator.
- b. The communication simulator station system controlled an EUT to export maximum output power under transmission mode and specific channel frequency.

## 4.5.6 TEST RESULTS

**FOR PCS BAND:**

**FOR GSM MODE (UP-LINK WITH 1 TIME SLOT)**

**CH 512: 9kHz ~ 3GHz**

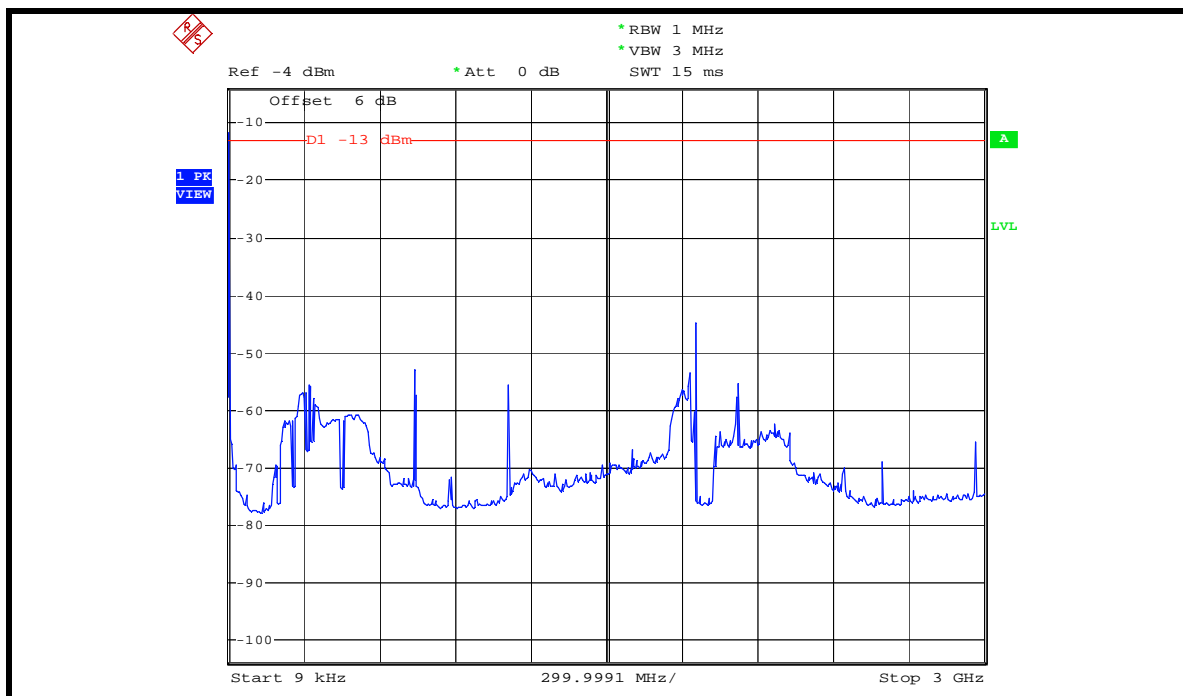

**3GHz ~ 10GHz**

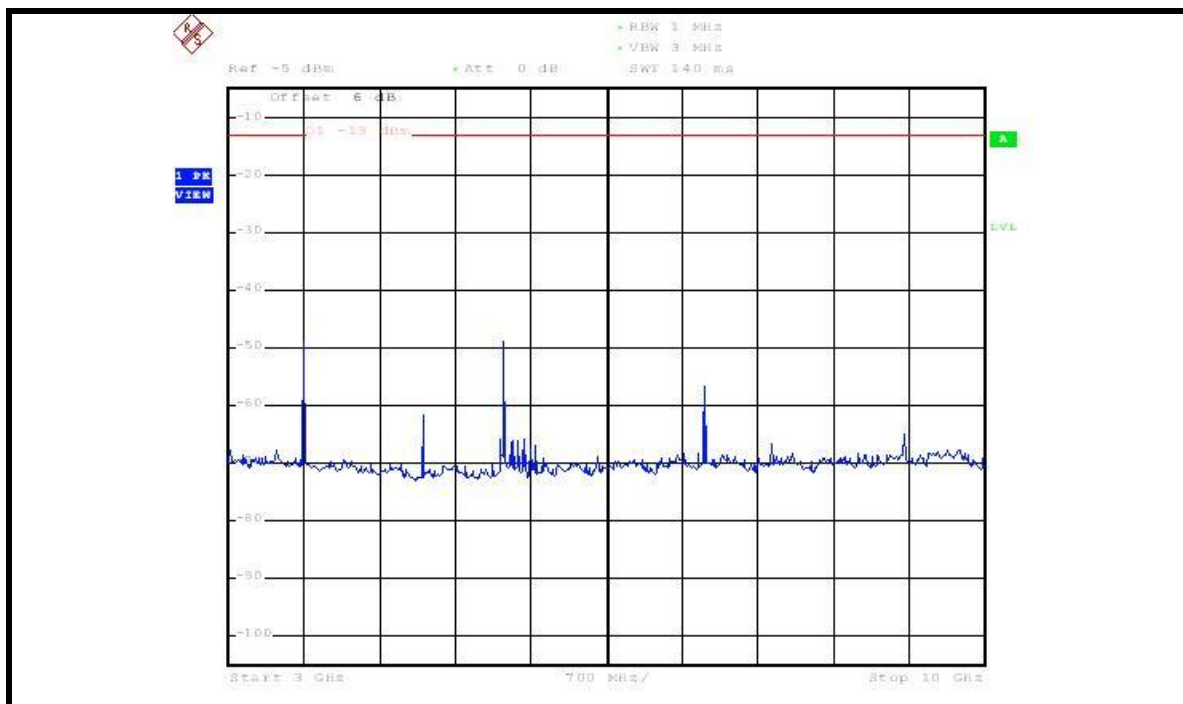

**10GHz ~ 20GHz**

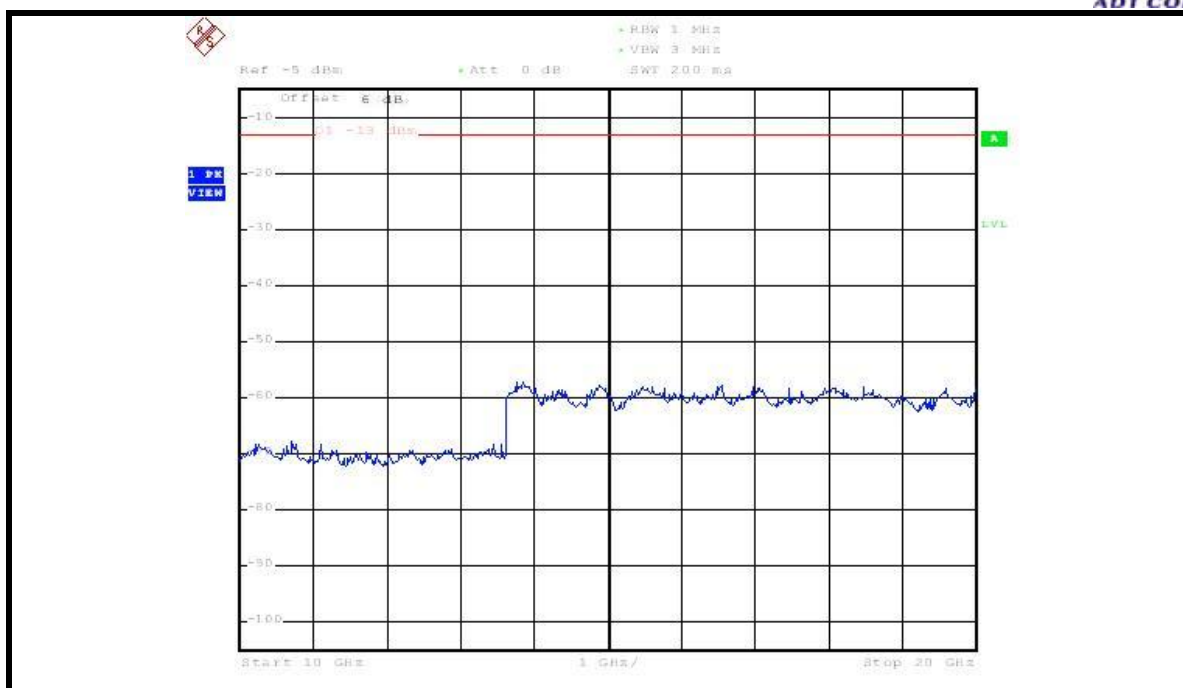

### CH 661: 9kHz ~ 3GHz

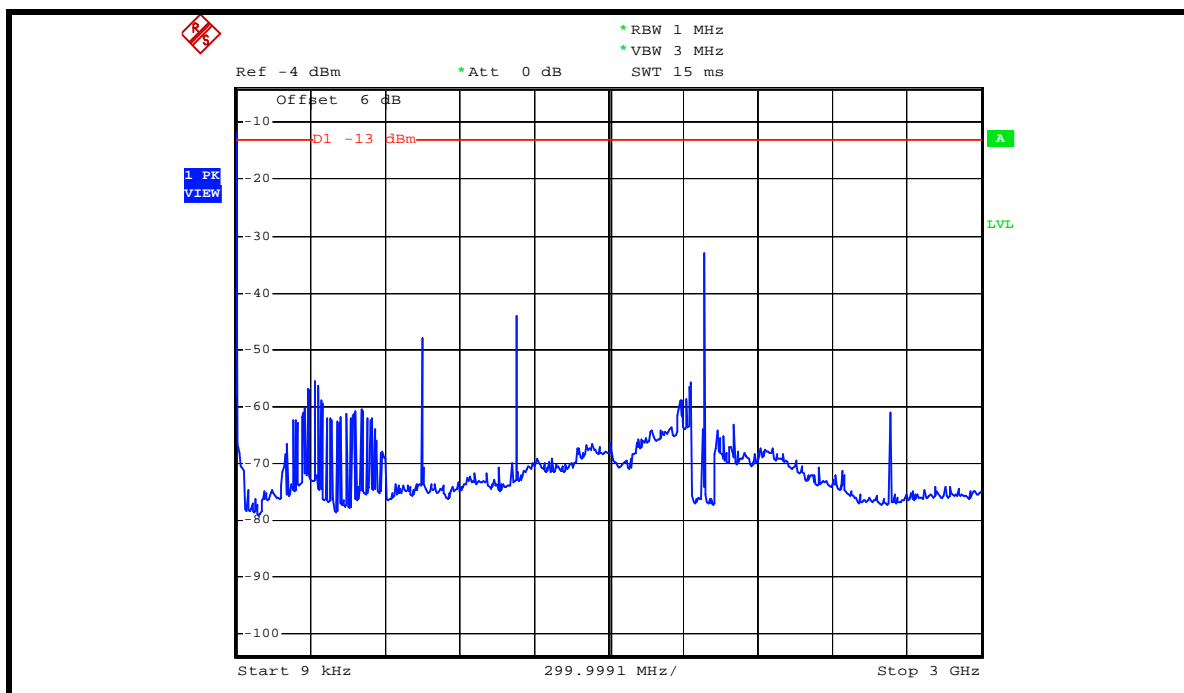

### 3GHz ~ 10GHz

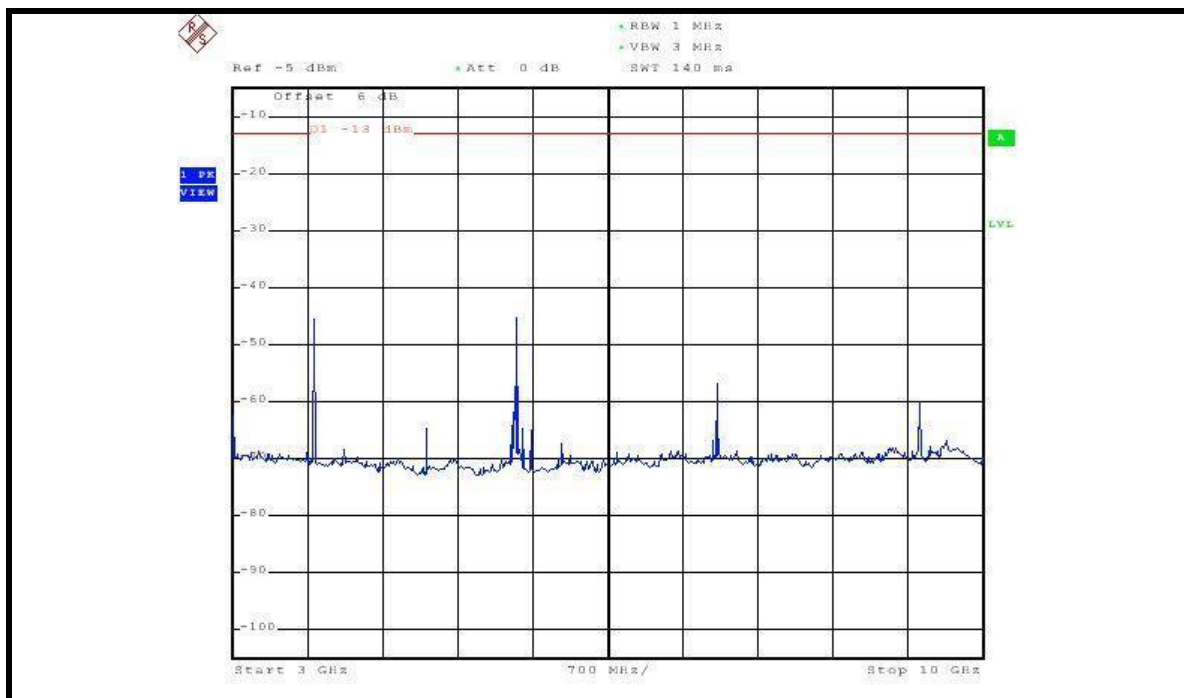

10GHz ~ 20GHz

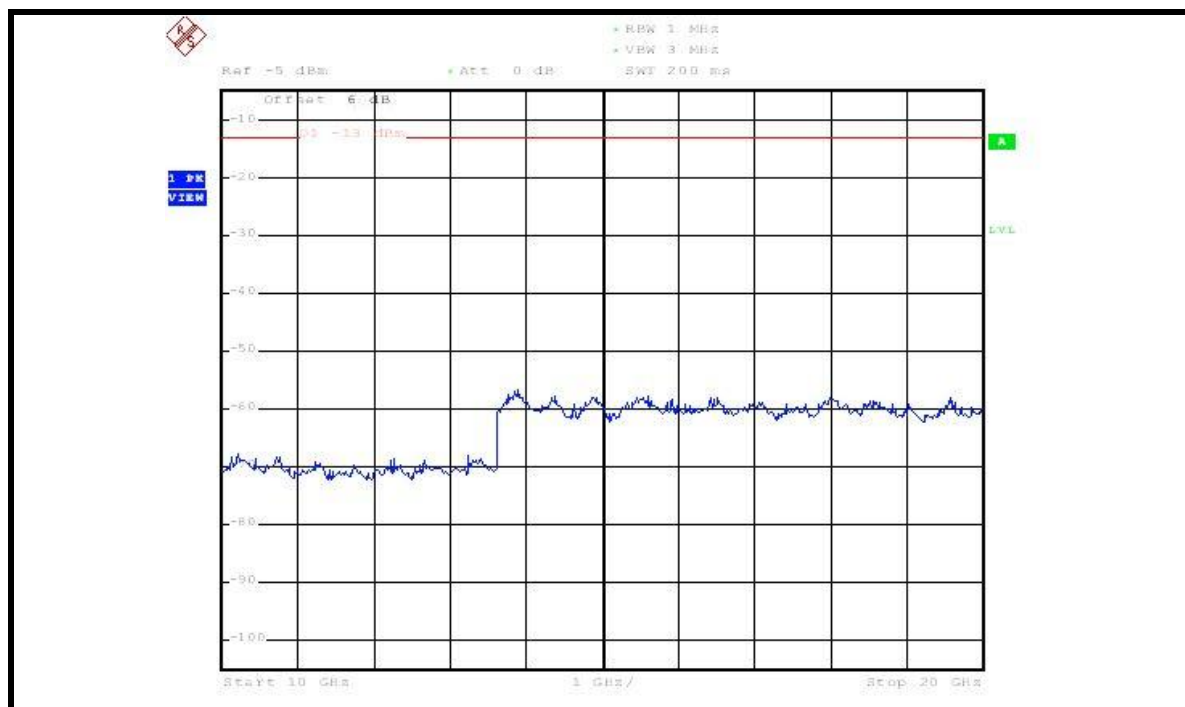

### CH 810: 9kHz ~ 3GHz

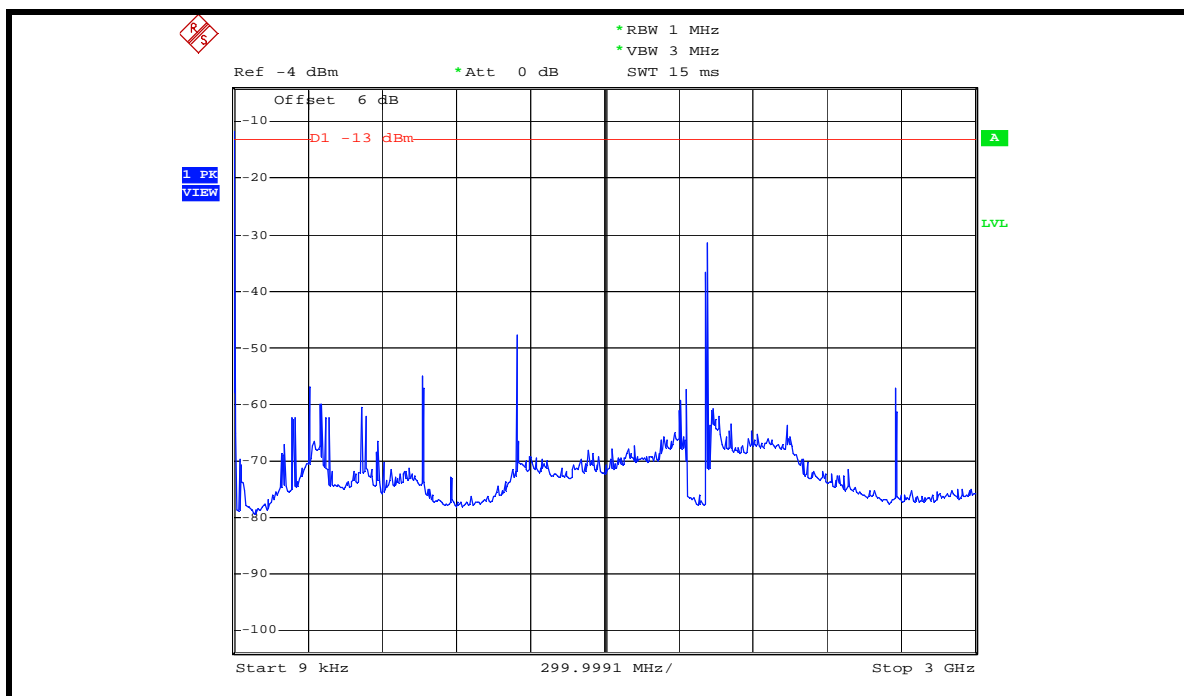

### 3GHz ~ 10GHz

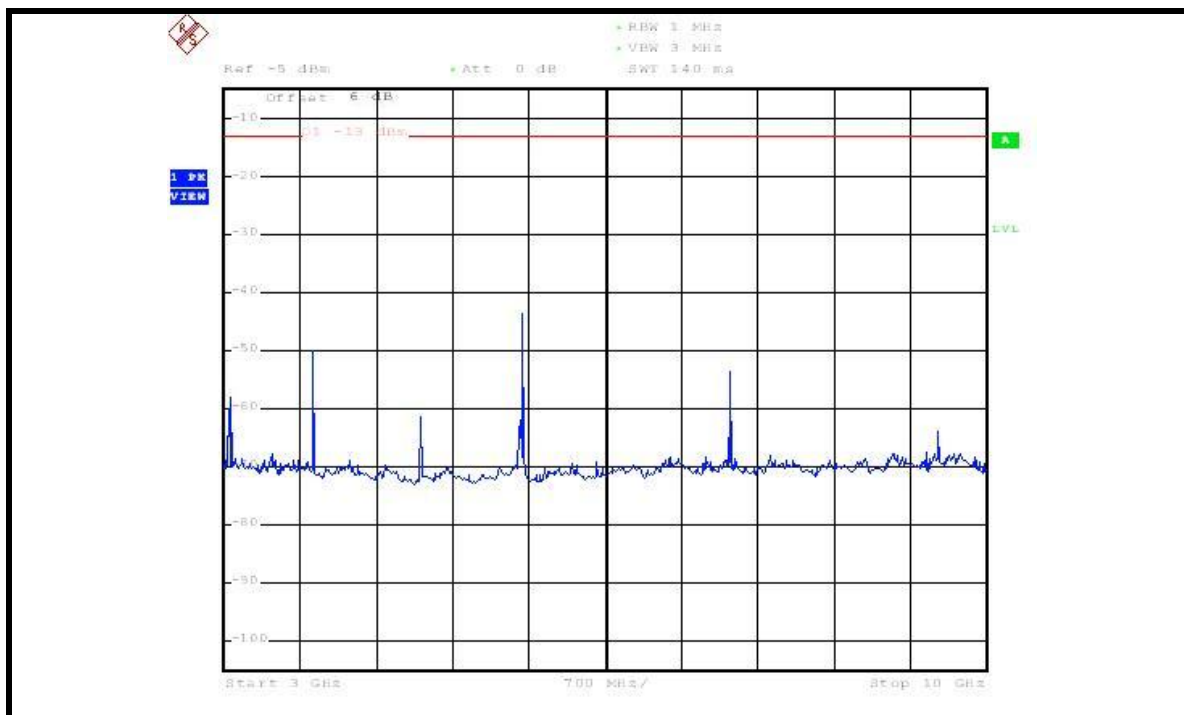



10GHz ~ 20GHz

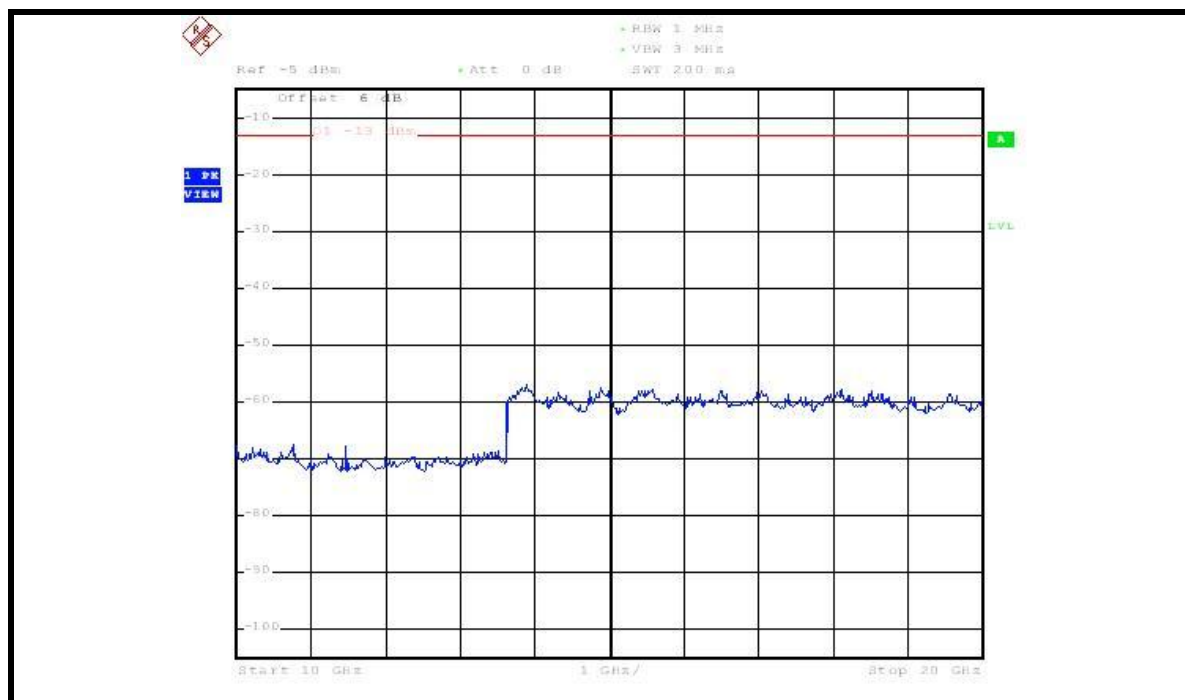

**FOR WCDMA BAND:**

**CH 9262: 9kHz ~ 3GHz**

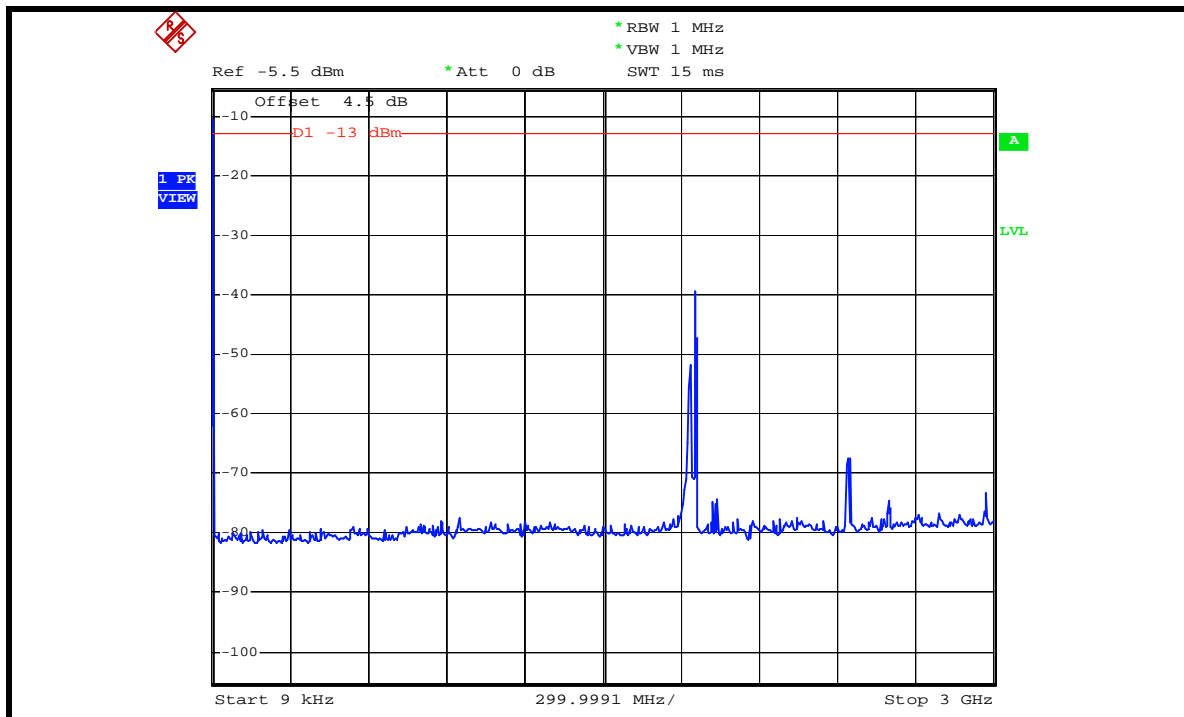

**3GHz ~ 10GHz**

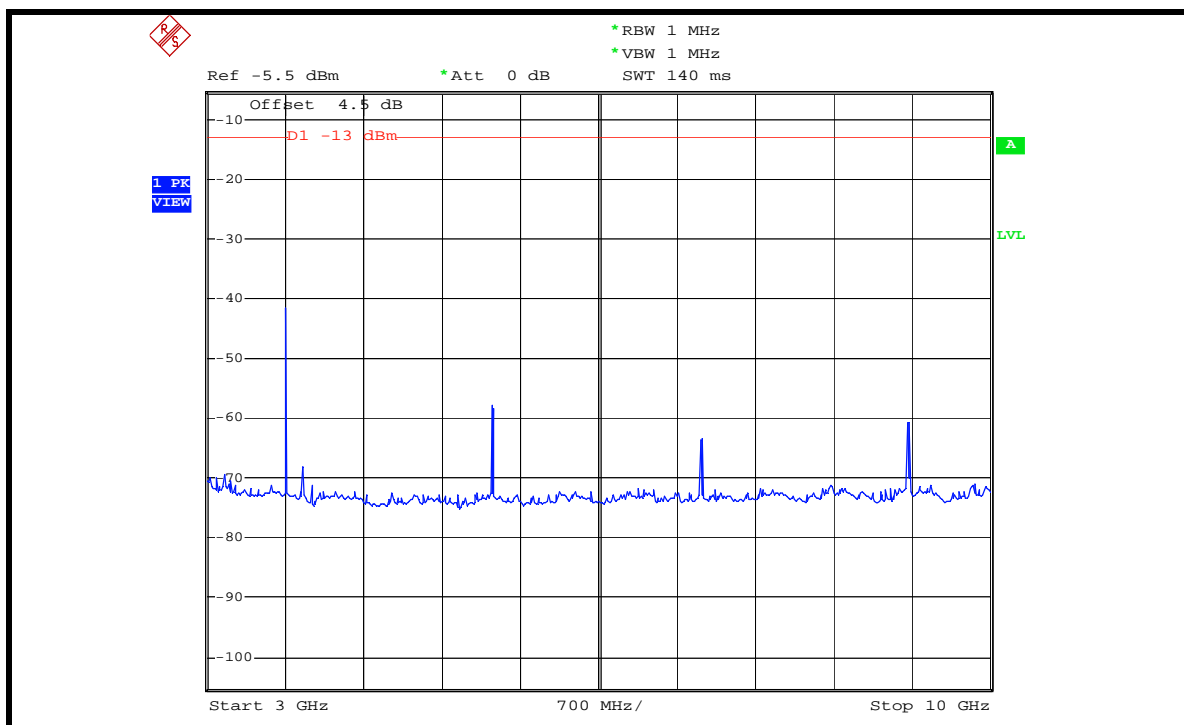

# 10GHz ~ 20GHz

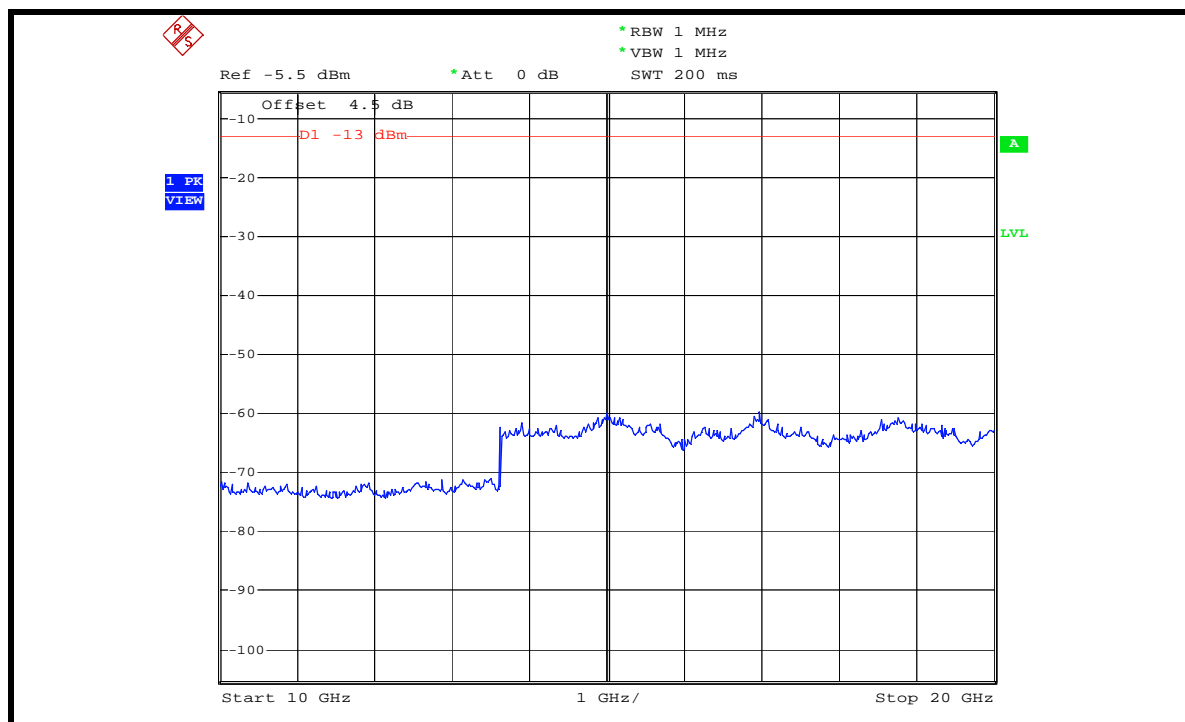

### CH 9400: 9kHz ~ 3GHz

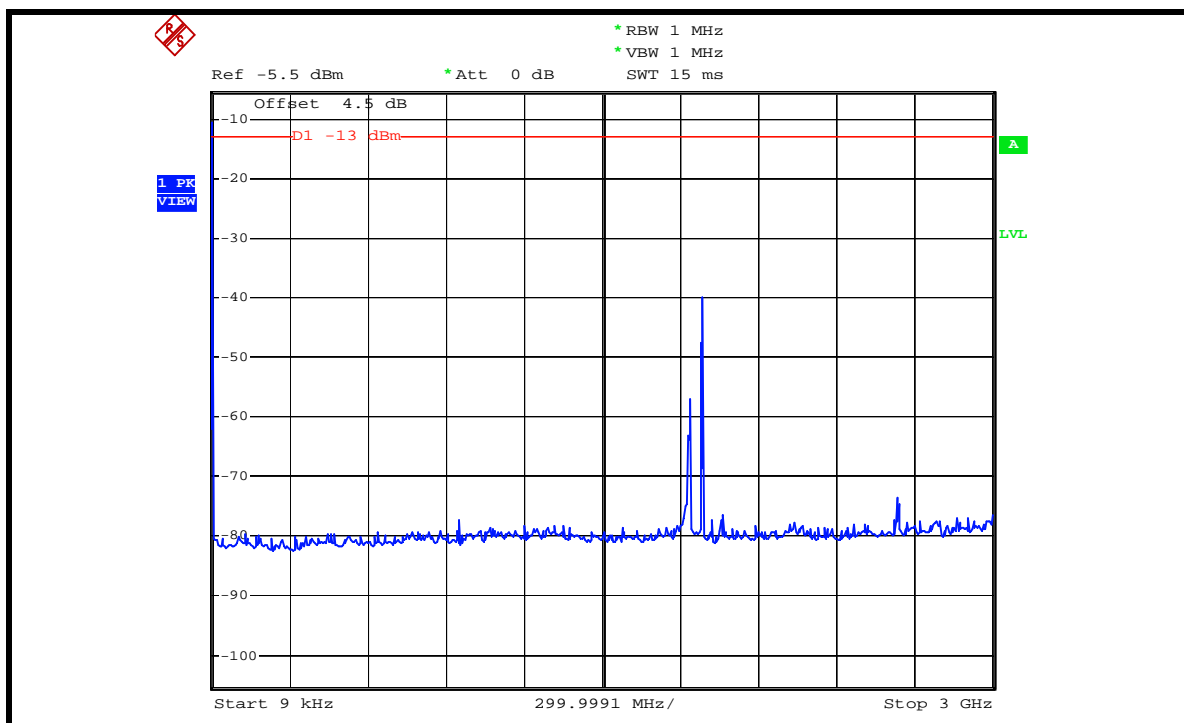

### 3GHz ~ 10GHz

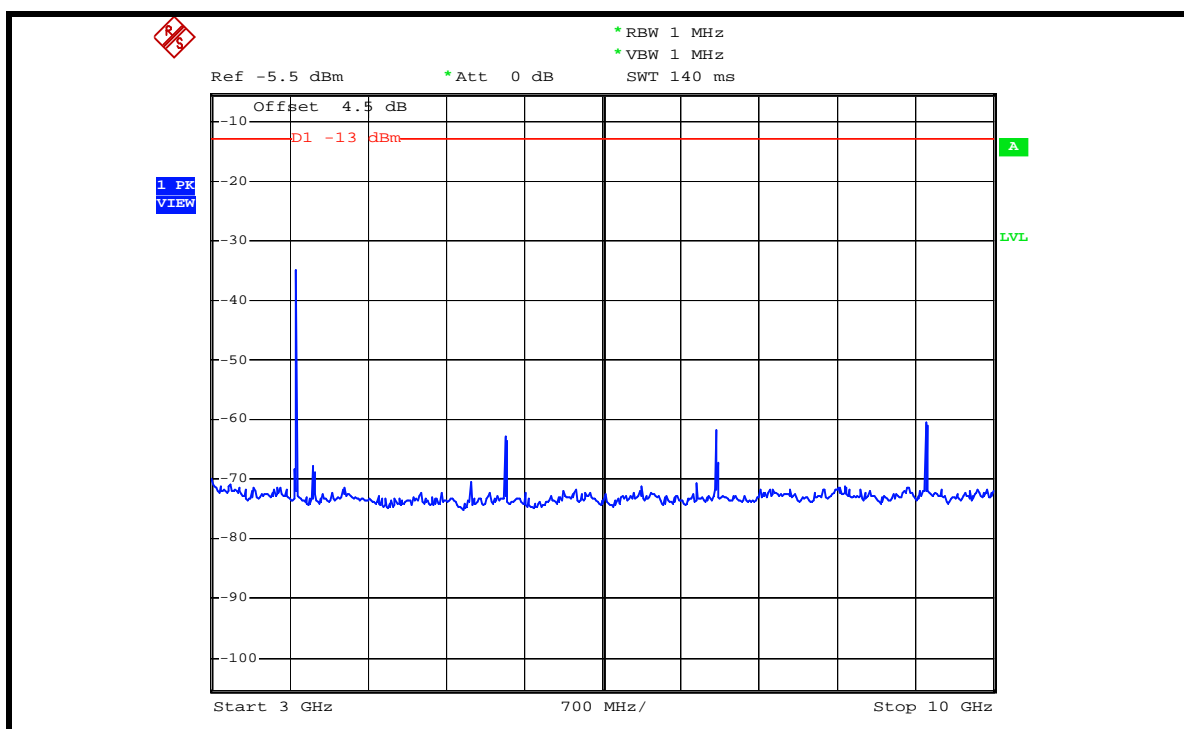

10GHz ~ 20GHz

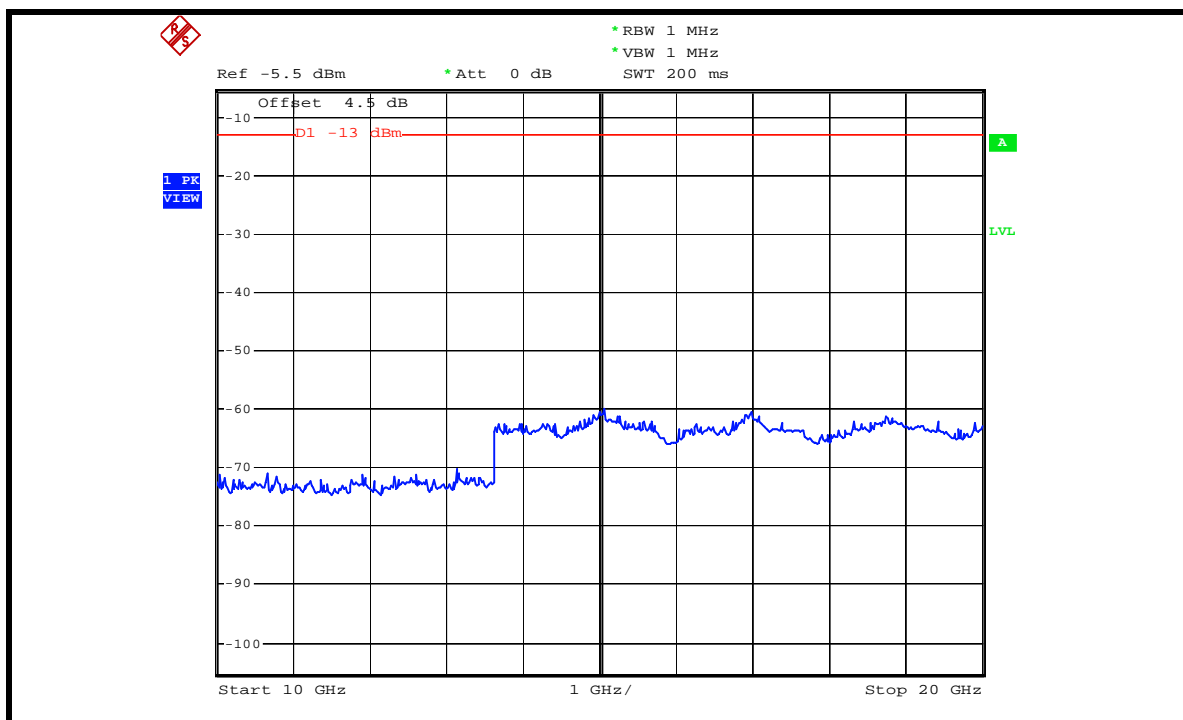

### CH 9538: 9kHz ~ 3GHz

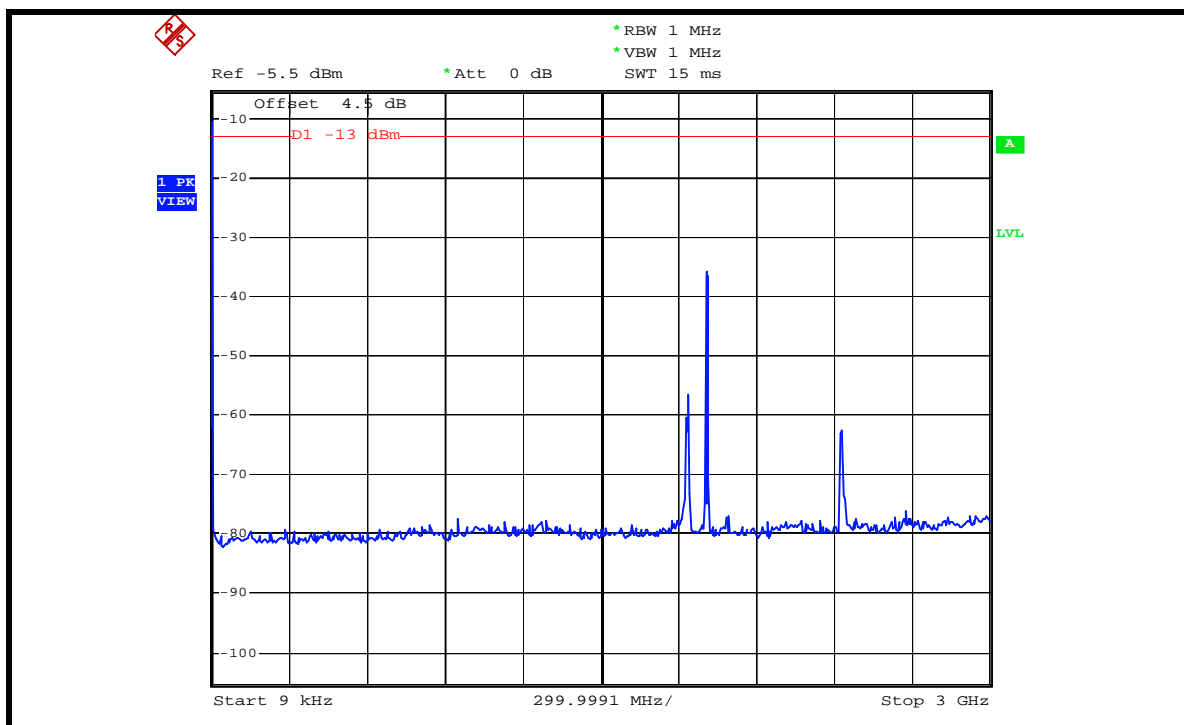

### 3GHz ~ 10GHz

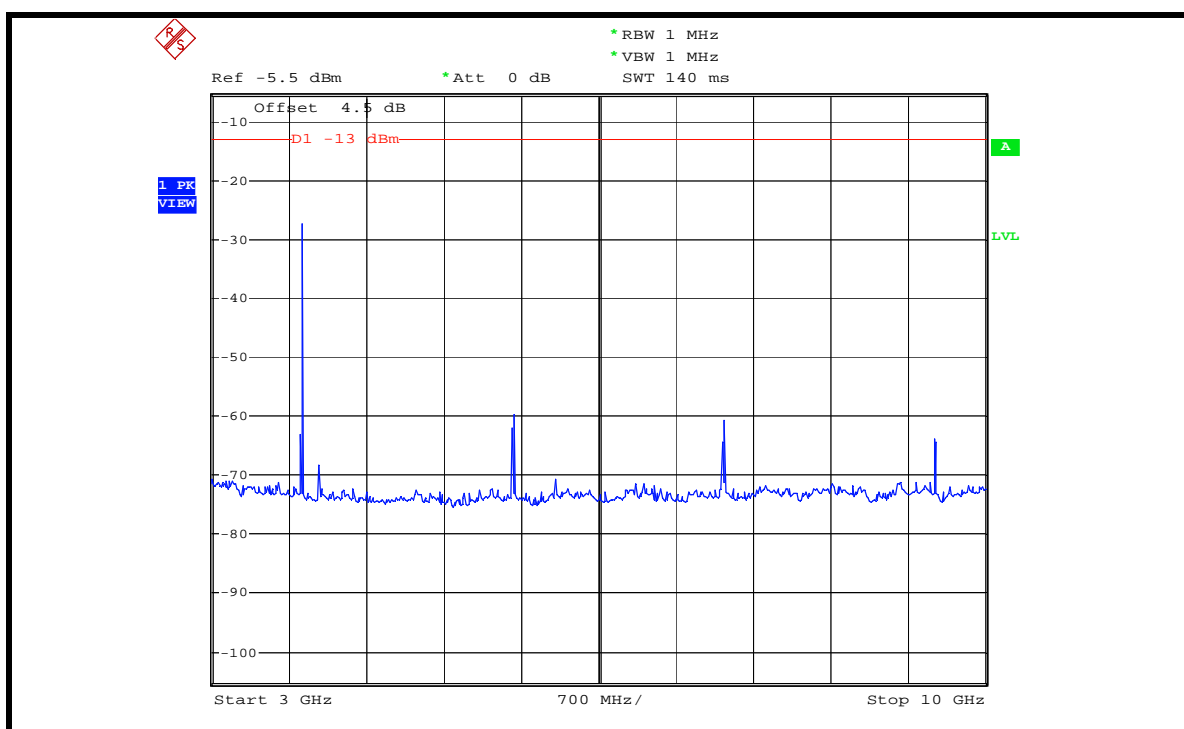

10GHz ~ 20GHz

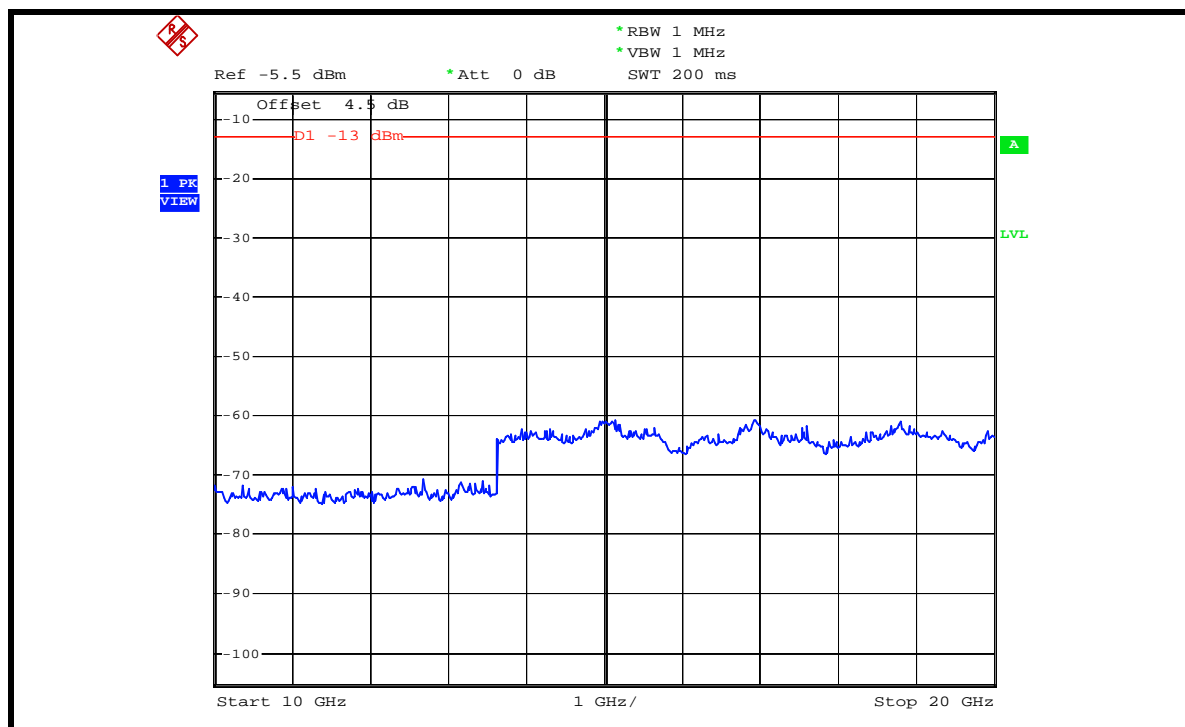



## 4.6 RADIATED EMISSION MEASUREMENT (BELOW 1GHz)

### 4.6.1 LIMITS OF RADIATED EMISSION MEASUREMENT

In the FCC 24.238(a), On any frequency outside a licensee's frequency block within USPCS spectrum, the power of any emission shall be attenuated below the transmitter power (P) by at least  $43 + 10 \log (P)$  dB. The specified minimum attenuation becomes 43dB and the emission of limit equal to  $-13$ dBm. So the limit of emission is the same absolute specified line.

LIMIT (dBm)	EQUIVALENT FIELD STRENGTH AT 3m (dBuV/m) (NOTE)
-13	82.22

**NOTE:** The following formula is used to convert the equipment radiated power to field strength.

$$E = [1000000\sqrt{(30P)}] / 3 \text{ uV/m, where P is Watts.}$$





#### 4.6.2 TEST INSTRUMENTS

DESCRIPTION & MANUFACTURER	MODEL NO.	SERIAL NO.	CALIBRATED UNTIL
Test Receiver ROHDE & SCHWARZ	ESI7	100033	May 22, 2007
Spectrum Analyzer ROHDE & SCHWARZ	FSP40	100025	Oct. 05, 2007
BILOG Antenna SCHWARZBECK	VULB9168	9168-160	May 31, 2007
HORN Antenna SCHWARZBECK	9120D	9120D-209	Jun. 27, 2007
HORN Antenna SCHWARZBECK	BBHA 9170	BBHA9170243	Dec. 28, 2007
Preamplifier Agilent	8447D	2944A10633	Oct. 26, 2007
Preamplifier Agilent	8449B	3008A01964	Oct. 26, 2007
RF signal cable HUBER+SUHNNER	SUCOFLEX 104	238137/4	Dec. 11, 2007
RF signal cable HUBER+SUHNNER	SUCOFLEX 104	233233/4	Nov. 14, 2007
Software ADT.	ADT_Radiated_V7.6	NA	NA
Antenna Tower inn-co GmbH	MA 4000	013303	NA
Antenna Tower Controller inn-co GmbH	CO2000	017303	NA
Turn Table ADT.	TT100.	TT93021703	NA
Turn Table Controller ADT.	SC100.	SC93021703	NA
Signal Generator Agilent	E8257C	MY43320668	Dec. 28, 2007

- NOTE:**
1. The calibration interval of the above test instruments is 12 months and the calibrations are traceable to NML/ROC and NIST/USA.
  2. The test was performed in HwaYa Chamber 3.
  3. The horn antenna and HP preamplifier (model: 8449B) are used only for the measurement of emission frequency above 1GHz if tested.
  4. The VCCI Site Registration No. is R-237.
  5. The IC Site Registration No. is IC3789B-3.



#### 4.6.3 TEST PROCEDURES

- a. The EUT was placed on the top of a rotating table 0.8 meters above the ground. The table was rotated 360 degrees to determine the position of the highest radiation.
- b. The EUT was set 3 meters away from the receiving antenna, which was mounted on antenna tower and its position at 0.8 m above the ground.
- c. For each suspected emission, the EUT was arranged to its worst case and the rotatable table was turned from 0 degrees to 360 degrees to find the maximum reading and recorded the value.
- d. Repeat step a ~ c for horizontal polarization.

**NOTE:** The resolution bandwidth of spectrum analyzer is 1 MHz and the video bandwidth is 1 MHz.

#### 4.6.4 DEVIATION FROM TEST STANDARD

No deviation

#### 4.6.5 TEST SETUP

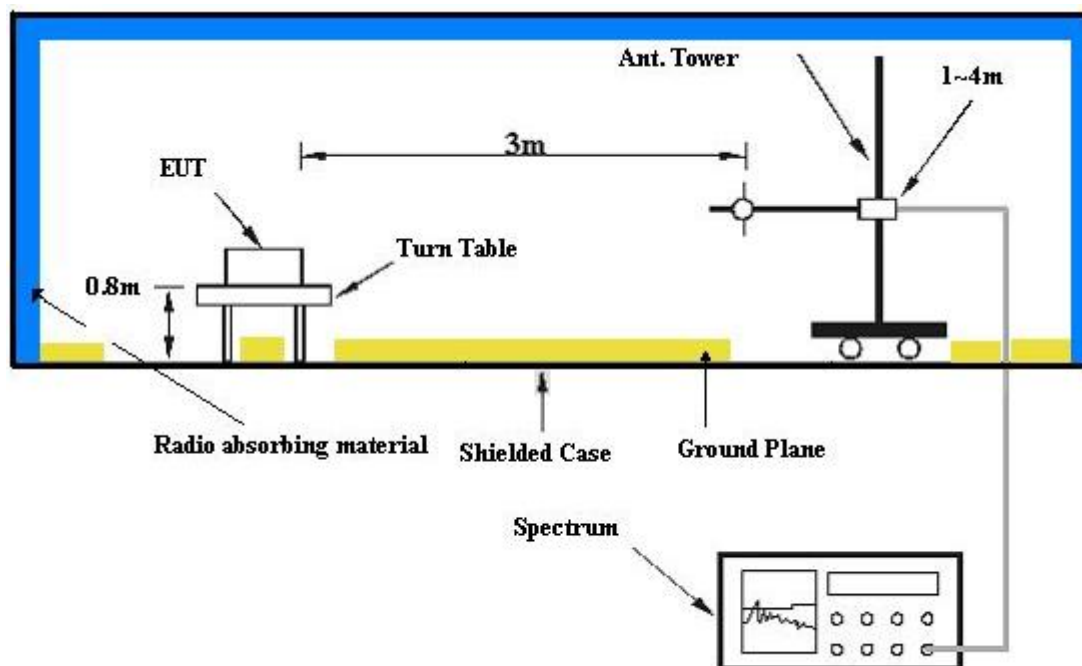

For the actual test configuration, please refer to the attached file (Test Setup Photo).

#### 4.6.6 EUT OPERATING CONDITIONS

- a. The EUT makes a phone call to the communication simulator.
- b. The communication simulator station system controlled an EUT to export maximum output power under transmission mode and specific channel frequency.

#### 4.6.7 TEST RESULTS

#### FOR PCS BAND:

#### FOR GSM MODE (UP-LINK WITH 1 TIME SLOT)

<b>MODE</b>	TX channel 512	<b>DETECTOR FUNCTION</b>	Quasi-Peak
<b>FREQUENCY RANGE</b>	Below 1000 MHz	<b>INPUT POWER (SYSTEM)</b>	120Vac, 60 Hz
<b>ENVIRONMENTAL CONDITIONS</b>	22deg. C, 60%RH, 991hPa	<b>TESTED BY</b>	Dean Wang

ANTENNA POLARITY & TEST DISTANCE: HORIZONTAL AT 3 M								
No.	Freq. (MHz)	Emission Level (dBuV/m)	Limit (dBuV/m)	Margin (dB)	Antenna Height (m)	Table Angle (Degree)	Raw Value (dBuV)	Correction Factor (dB/m)
1	239.88	28.75 QP	82.22	-53.47	1.00 H	349.00	15.71	13.04
2	265.16	30.12 QP	82.22	-52.10	1.00 H	340.00	16.10	14.01
3	399.31	30.03 QP	82.22	-52.19	1.00 H	10.00	12.41	17.62
4	702.62	25.25 QP	82.22	-56.97	1.00 H	289.00	0.97	24.27
5	725.96	26.56 QP	82.22	-55.66	1.50 H	283.00	1.61	24.95
6	780.40	28.85 QP	82.22	-53.37	1.00 H	259.00	3.06	25.79
7	797.89	26.03 QP	82.22	-56.19	1.00 H	10.00	0.16	25.87
8	852.33	26.99 QP	82.22	-55.23	1.00 H	37.00	0.00	26.99
9	885.39	28.47 QP	82.22	-53.75	1.00 H	256.00	1.06	27.41
10	918.44	27.76 QP	82.22	-54.46	1.00 H	10.00	-0.10	27.86

ANTENNA POLARITY & TEST DISTANCE: VERTICAL AT 3 M								
No.	Freq. (MHz)	Emission Level (dBuV/m)	Limit (dBuV/m)	Margin (dB)	Antenna Height (m)	Table Angle (Degree)	Raw Value (dBuV)	Correction Factor (dB/m)
1	218.50	23.14 QP	82.22	-59.08	1.00 V	220.00	11.06	12.08
2	265.16	24.43 QP	82.22	-57.79	2.00 V	292.00	10.41	14.01
3	397.37	22.94 QP	82.22	-59.28	2.50 V	4.00	5.36	17.58
4	702.62	27.69 QP	82.22	-54.53	1.00 V	325.00	3.42	24.27
5	725.96	27.21 QP	82.22	-55.01	1.00 V	322.00	2.26	24.95
6	780.40	28.73 QP	82.22	-53.49	1.50 V	151.00	2.94	25.79
7	801.78	25.75 QP	82.22	-56.47	1.50 V	58.00	-0.17	25.92
8	829.00	26.69 QP	82.22	-55.53	2.50 V	262.00	0.19	26.51
9	867.89	27.14 QP	82.22	-55.08	1.50 V	325.00	-0.05	27.19
10	953.44	28.77 QP	82.22	-53.45	2.00 V	46.00	0.42	28.34

#### NOTE:

1. Emission level (dBuV/m) = Raw Value (dBuV) + Correction Factor (dB).
2. Correction Factor (dB/m) = Antenna Factor (dB/m) + Cable Factor (dB).
3. The other emission levels were very low against the limit.
4. Margin value = Emission level – Limit value.
5. This is valid for all 3 channels.



**FOR WCDMA BAND:**

<b>MODE</b>	TX channel 9262	<b>DETECTOR FUNCTION</b>	Quasi-Peak
<b>FREQUENCY RANGE</b>	Below 1000 MHz	<b>INPUT POWER (SYSTEM)</b>	120Vac, 60 Hz
<b>ENVIRONMENTAL CONDITIONS</b>	22deg. C, 60%RH, 991hPa	<b>TESTED BY</b>	Dean Wang

<b>ANTENNA POLARITY &amp; TEST DISTANCE: HORIZONTAL AT 3 M</b>								
No.	Freq. (MHz)	Emission Level (dBuV/m)	Limit (dBuV/m)	Margin (dB)	Antenna Height (m)	Table Angle (Degree)	Raw Value (dBuV)	Correction Factor (dB/m)
1	218.50	25.37 QP	82.22	-56.85	1.50 H	184.00	13.28	12.08
2	265.16	24.70 QP	82.22	-57.52	2.00 H	304.00	10.69	14.01
3	399.31	22.35 QP	82.22	-59.87	2.50 H	307.00	4.73	17.62
4	702.62	27.06 QP	82.22	-55.16	1.00 H	322.00	2.78	24.27
5	725.96	26.97 QP	82.22	-55.25	1.50 H	130.00	2.02	24.95
6	780.40	28.09 QP	82.22	-54.13	1.50 H	154.00	2.30	25.79
7	829.00	26.74 QP	82.22	-55.48	2.00 H	34.00	0.23	26.51
8	873.72	26.93 QP	82.22	-55.29	1.50 H	310.00	-0.33	27.26
9	<b>935.94</b>	<b>33.84 QP</b>	<b>82.22</b>	<b>-48.38</b>	<b>1.50 H</b>	<b>328.00</b>	<b>5.72</b>	<b>28.12</b>
10	957.33	28.57 QP	82.22	-53.65	1.00 H	31.00	0.20	28.37

<b>ANTENNA POLARITY &amp; TEST DISTANCE: VERTICAL AT 3 M</b>								
No.	Freq. (MHz)	Emission Level (dBuV/m)	Limit (dBuV/m)	Margin (dB)	Antenna Height (m)	Table Angle (Degree)	Raw Value (dBuV)	Correction Factor (dB/m)
1	239.88	27.92 QP	82.22	-54.30	1.50 V	334.00	14.88	13.04
2	265.16	30.07 QP	82.22	-52.15	1.50 V	346.00	16.06	14.01
3	399.31	30.25 QP	82.22	-51.97	1.00 V	10.00	12.62	17.62
4	702.62	25.47 QP	82.22	-56.75	1.00 V	310.00	1.20	24.27
5	725.96	26.41 QP	82.22	-55.81	1.00 V	211.00	1.45	24.95
6	780.40	27.94 QP	82.22	-54.28	1.00 V	256.00	2.15	25.79
7	801.78	25.40 QP	82.22	-56.82	1.00 V	7.00	-0.52	25.92
8	836.78	26.54 QP	82.22	-55.68	1.50 V	217.00	-0.13	26.67
9	902.89	27.29 QP	82.22	-54.93	1.50 V	241.00	-0.35	27.64
10	935.94	28.52 QP	82.22	-53.70	1.00 V	10.00	0.40	28.12

**NOTE:**

1. Emission level (dBuV/m) = Raw Value (dBuV) + Correction Factor (dB).
2. Correction Factor (dB/m) = Antenna Factor (dB/m) + Cable Factor (dB).
3. The other emission levels were very low against the limit.
4. Margin value = Emission level – Limit value.
5. This is valid for all 3 channels.



## **4.7 EFFECTIVE RADIATED POWER MEASUREMENT (ABOVE 1GHz)**

### **4.7.1 LIMITS OF RADIATED EMISSION MEASUREMENT**

In the FCC 24.238(a), On any frequency outside a licensee's frequency block within USPCS spectrum, the power of any emission shall be attenuated below the transmitter power (P) by at least  $43 + 10 \log (P)$  dB. The specified minimum attenuation becomes 43dB and the limit of emission equal to  $-13\text{dBm}$ .



#### 4.7.2 TEST INSTRUMENTS

DESCRIPTION & MANUFACTURER	MODEL NO.	SERIAL NO.	CALIBRATED UNTIL
Test Receiver ROHDE & SCHWARZ	ESI7	100033	May 22, 2007
Spectrum Analyzer ROHDE & SCHWARZ	FSP40	100025	Oct. 05, 2007
BILOG Antenna SCHWARZBECK	VULB9168	9168-160	May 31, 2007
HORN Antenna SCHWARZBECK	9120D	9120D-209	Jun. 27, 2007
HORN Antenna SCHWARZBECK	BBHA 9170	BBHA9170243	Dec. 28, 2007
Preamplifier Agilent	8447D	2944A10633	Oct. 26, 2007
Preamplifier Agilent	8449B	3008A01964	Oct. 26, 2007
RF signal cable HUBER+SUHNNER	SUCOFLEX 104	238137/4	Dec. 11, 2007
RF signal cable HUBER+SUHNNER	SUCOFLEX 104	233233/4	Nov. 14, 2007
Software ADT.	ADT_Radiated_V7.6	NA	NA
Antenna Tower inn-co GmbH	MA 4000	013303	NA
Antenna Tower Controller inn-co GmbH	CO2000	017303	NA
Turn Table ADT.	TT100.	TT93021703	NA
Turn Table Controller ADT.	SC100.	SC93021703	NA

- NOTE:**
1. The calibration interval of the above test instruments is 12 months and the calibrations are traceable to NML/ROC and NIST/USA.
  2. The test was performed in HwaYa Chamber 3.
  3. The horn antenna and HP preamplifier (model: 8449B) are used only for the measurement of emission frequency above 1GHz if tested.
  4. The VCCI Site Registration No. is R-237.
  5. The IC Site Registration No. is IC3789B-3.

#### 4.7.3 TEST PROCEDURES

- a. The EUT was placed on the top of a rotating table 0.8 meters above the ground. The table was rotated 360 degrees to determine the position of the highest radiation.
- b. The EUT was set 3 meters away from the receiving antenna, which was mounted on antenna tower and its position at 0.8 m above the ground.
- c. For each suspected emission, the EUT was arranged to its worst case and the rotatable table was turned from 0 degrees to 360 degrees to find the maximum reading and recorded the value.
- d. The EUT is replaced by a horn antenna connected to a signal generator tuned to the frequency of emission.
- e. The signal generator level has to be adjusted to have the same emission nature.
- f. The radiated power can be calculated via the factor and antenna gain.
- g. Repeat step a ~ f for horizontal polarization.

**NOTE:** The resolution bandwidth of spectrum analyzer is 1 MHz and the video bandwidth is 1 MHz.

#### 4.7.4 DEVIATION FROM TEST STANDARD

No deviation



#### 4.7.5 TEST SETUP

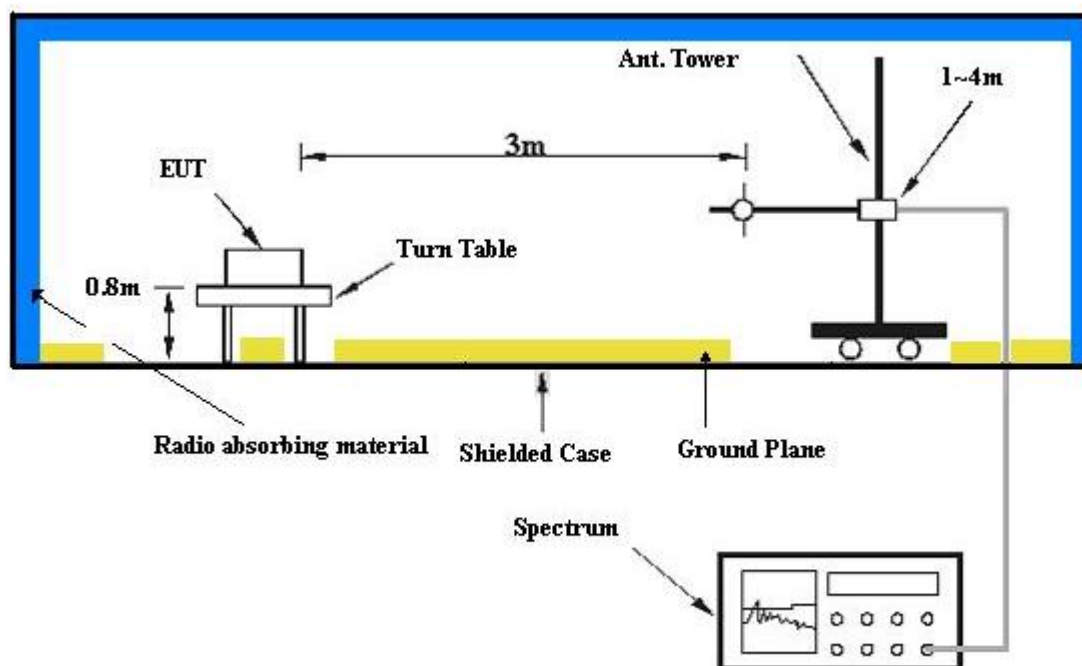

For the actual test configuration, please refer to the attached file (Test Setup Photo).

#### 4.7.6 EUT OPERATING CONDITIONS

- a. The EUT makes a phone call to the communication simulator.
- b. The communication simulator station system controlled an EUT to export maximum output power under transmission mode and specific channel frequency.



#### 4.7.7 TEST RESULTS

#### FOR PCS BAND:

#### FOR GSM MODE (UP-LINK WITH 1 TIME SLOT)

<b>MODE</b>	TX channel 512	<b>DETECTOR FUNCTION</b>	Above 1000 MHz
<b>FREQUENCY RANGE</b>	Below 1000 MHz	<b>INPUT POWER (SYSTEM)</b>	120Vac, 60 Hz
<b>ENVIRONMENTAL CONDITIONS</b>	23deg. C, 67%RH, 991hPa	<b>TESTED BY</b>	Brad Wu

ANTENNA POLARITY & TEST DISTANCE: HORIZONTAL AT 3 M						
No.	Freq. (MHz)	Emission Level (dBuV)	Limit (dBm)	S.G Power Value (dBm)	Correction Factor (dB)	Power Value (dBm)
1	3700.40	50.54	-13.00	-54.81	10.12	-44.69
2	5550.60	51.99	-13.00	-54.73	11.49	-43.24

ANTENNA POLARITY & TEST DISTANCE: VERTICAL AT 3 M						
No.	Freq. (MHz)	Emission Level (dBuV)	Limit (dBm)	S.G Power Value (dBm)	Correction Factor (dB)	Power Value (dBm)
1	3700.40	50.86	-13.00	-54.49	10.12	-44.37
2	5550.60	54.77	-13.00	-51.95	11.49	-40.46

**NOTE:** Power Value (dBum) = S.G Power Value (dBm) + Correction Factor (dB).



<b>MODE</b>	TX channel 661	<b>DETECTOR FUNCTION</b>	Above 1000 MHz
<b>FREQUENCY RANGE</b>	Below 1000 MHz	<b>INPUT POWER (SYSTEM)</b>	120Vac, 60 Hz
<b>ENVIRONMENTAL CONDITIONS</b>	23deg. C, 67%RH, 991hPa	<b>TESTED BY</b>	Brad Wu

<b>ANTENNA POLARITY &amp; TEST DISTANCE: HORIZONTAL AT 3 M</b>						
No.	Freq. (MHz)	Emission Level (dBUV)	Limit (dBm)	S.G Power Value (dBm)	Correction Factor (dB)	Power Value (dBm)
1	3760.00	50.21	-13.00	-55.14	10.12	-45.02
2	5640.00	52.38	-13.00	-54.34	11.49	-42.85

<b>ANTENNA POLARITY &amp; TEST DISTANCE: VERTICAL AT 3 M</b>						
No.	Freq. (MHz)	Emission Level (dBUV)	Limit (dBm)	S.G Power Value (dBm)	Correction Factor (dB)	Power Value (dBm)
1	3760.00	51.62	-13.00	-53.73	10.12	-43.61
2	5640.00	55.19	-13.00	-51.53	11.49	-40.04

**NOTE:** Power Value (dBum) = S.G Power Value (dBm) + Correction Factor (dB).



<b>MODE</b>	TX channel 810	<b>DETECTOR FUNCTION</b>	Above 1000 MHz
<b>FREQUENCY RANGE</b>	Below 1000 MHz	<b>INPUT POWER (SYSTEM)</b>	120Vac, 60 Hz
<b>ENVIRONMENTAL CONDITIONS</b>	23deg. C, 67%RH, 991hPa	<b>TESTED BY</b>	Brad Wu

<b>ANTENNA POLARITY &amp; TEST DISTANCE: HORIZONTAL AT 3 M</b>						
No.	Freq. (MHz)	Emission Level (dBUV)	Limit (dBm)	S.G Power Value (dBm)	Correction Factor (dB)	Power Value (dBm)
1	3819.60	51.06	-13.00	-53.75	10.12	-43.63
2	5729.40	53.14	-13.00	-53.81	11.49	-42.32

<b>ANTENNA POLARITY &amp; TEST DISTANCE: VERTICAL AT 3 M</b>						
No.	Freq. (MHz)	Emission Level (dBUV)	Limit (dBm)	S.G Power Value (dBm)	Correction Factor (dB)	Power Value (dBm)
1	3819.60	52.49	-13.00	-52.32	10.12	-42.20
2	5729.40	56.08	-13.00	-50.87	11.49	-39.38

**NOTE:** Power Value (dBum) = S.G Power Value (dBm) + Correction Factor (dB).



**FOR WCDMA BAND:**

<b>MODE</b>	TX channel 9262	<b>DETECTOR FUNCTION</b>	Above 1000 MHz
<b>FREQUENCY RANGE</b>	Below 1000 MHz	<b>INPUT POWER (SYSTEM)</b>	120Vac, 60 Hz
<b>ENVIRONMENTAL CONDITIONS</b>	23deg. C, 67%RH, 991hPa	<b>TESTED BY</b>	Brad Wu

<b>ANTENNA POLARITY &amp; TEST DISTANCE: HORIZONTAL AT 3 M</b>						
No.	Freq. (MHz)	Emission Level (dBuV)	Limit (dBm)	S.G Power Value (dBm)	Correction Factor (dB)	Power Value (dBm)
1	3704.80	40.97	-13.00	-64.38	10.12	-54.26
2	5557.20	45.06	-13.00	-61.66	11.49	-50.17

<b>ANTENNA POLARITY &amp; TEST DISTANCE: VERTICAL AT 3 M</b>						
No.	Freq. (MHz)	Emission Level (dBuV)	Limit (dBm)	S.G Power Value (dBm)	Correction Factor (dB)	Power Value (dBm)
1	3704.80	39.86	-13.00	-65.49	10.12	-55.37
2	5557.20	44.15	-13.00	-62.57	11.49	-51.08

**NOTE:** Power Value (dBum) = S.G Power Value (dBm) + Correction Factor (dB).



<b>MODE</b>	TX channel 9400	<b>DETECTOR FUNCTION</b>	Above 1000 MHz
<b>FREQUENCY RANGE</b>	Below 1000 MHz	<b>INPUT POWER (SYSTEM)</b>	120Vac, 60 Hz
<b>ENVIRONMENTAL CONDITIONS</b>	23deg. C, 67%RH, 991hPa	<b>TESTED BY</b>	Brad Wu

<b>ANTENNA POLARITY &amp; TEST DISTANCE: HORIZONTAL AT 3 M</b>						
No.	Freq. (MHz)	Emission Level (dBUV)	Limit (dBm)	S.G Power Value (dBm)	Correction Factor (dB)	Power Value (dBm)
1	3760.00	41.56	-13.00	-63.79	10.12	-53.67
2	5640.00	45.64	-13.00	-61.08	11.49	-49.59

<b>ANTENNA POLARITY &amp; TEST DISTANCE: VERTICAL AT 3 M</b>						
No.	Freq. (MHz)	Emission Level (dBUV)	Limit (dBm)	S.G Power Value (dBm)	Correction Factor (dB)	Power Value (dBm)
1	3760.00	40.25	-13.00	-65.10	10.12	-54.98
2	5640.00	44.59	-13.00	-62.13	11.49	-50.64

**NOTE:** Power Value (dBum) = S.G Power Value (dBm) + Correction Factor (dB).



<b>MODE</b>	TX channel 9538	<b>DETECTOR FUNCTION</b>	Above 1000 MHz
<b>FREQUENCY RANGE</b>	Below 1000 MHz	<b>INPUT POWER (SYSTEM)</b>	120Vac, 60 Hz
<b>ENVIRONMENTAL CONDITIONS</b>	23deg. C, 67%RH, 991hPa	<b>TESTED BY</b>	Brad Wu

<b>ANTENNA POLARITY &amp; TEST DISTANCE: HORIZONTAL AT 3 M</b>						
No.	Freq. (MHz)	Emission Level (dBuV)	Limit (dBm)	S.G Power Value (dBm)	Correction Factor (dB)	Power Value (dBm)
1	3815.20	41.62	-13.00	-63.73	10.12	-53.61
2	5722.80	45.93	-13.00	-60.79	11.49	-49.30

<b>ANTENNA POLARITY &amp; TEST DISTANCE: VERTICAL AT 3 M</b>						
No.	Freq. (MHz)	Emission Level (dBuV)	Limit (dBm)	S.G Power Value (dBm)	Correction Factor (dB)	Power Value (dBm)
1	3815.20	40.96	-13.00	-64.39	10.12	-54.27
2	5722.80	45.12	-13.00	-61.60	11.49	-50.11

**NOTE:** Power Value (dBum) = S.G Power Value (dBm) + Correction Factor (dB).



## 5 INFORMATION ON THE TESTING LABORATORIES

We, ADT Corp., were founded in 1988 to provide our best service in EMC, Radio, Telecom and Safety consultation. Our laboratories are accredited and approved by the following approval agencies according to ISO/IEC 17025.

<b>USA</b>	FCC, UL, A2LA
<b>GERMANY</b>	TUV Rheinland
<b>JAPAN</b>	VCCI
<b>NORWAY</b>	NEMKO
<b>CANADA</b>	INDUSTRY CANADA , CSA
<b>R.O.C.</b>	CNLA, BSMI, NCC
<b>NETHERLANDS</b>	Telefication
<b>SINGAPORE</b>	PSB , GOST-ASIA (MOU)
<b>RUSSIA</b>	CERTIS (MOU)

Copies of accreditation certificates of our laboratories obtained from approval agencies can be downloaded from our web site: [www.adt.com.tw/index.5/phtml](http://www.adt.com.tw/index.5/phtml).  
If you have any comments, please feel free to contact us at the following:

**Linko EMC/RF Lab:**  
Tel: 886-2-26052180  
Fax: 886-2-26051924

**Hsin Chu EMC/RF Lab:**  
Tel: 886-3-5935343  
Fax: 886-3-5935342

**Hwa Ya EMC/RF/Safety/Telecom Lab:**  
Tel: 886-3-3183232  
Fax: 886-3-3185050

**Web Site:** [www.adt.com.tw](http://www.adt.com.tw)

The address and road map of all our labs can be found in our web site also.