



Test Laboratory: Sporton International Inc. SAR Testing Lab

Date/Time: 4/18/2007 11:48:32 PM

**Body\_802.11b Ch11\_Keypad Down With 1.5cm Gap\_20070418\_without VT Camera\_BT On**

**DUT: 731703**

Communication System: 802.11b ; Frequency: 2462 MHz;Duty Cycle: 1:1

Medium: MSL\_2450 Medium parameters used:  $f = 2462$  MHz;  $\sigma = 1.98$  mho/m;  $\epsilon_r = 53.3$ ;  $\rho = 1000$  kg/m<sup>3</sup>

Ambient Temperature : 23.0 °C; Liquid Temperature : 21.9 °C

DASY4 Configuration:

- Probe: ET3DV6 - SN1788; ConvF(4.11, 4.11, 4.11); Calibrated: 9/19/2006
- Sensor-Surface: 4mm (Mechanical Surface Detection)
- Electronics: DAE3 Sn577; Calibrated: 11/21/2006
- Phantom: SAM-A; Type: QD 000 P40 C; Serial: TP-1303
- Measurement SW: DASY4, V4.7 Build 53; Postprocessing SW: SEMCAD, V1.8 Build 172

**Ch11/Area Scan (81x111x1):** Measurement grid: dx=15mm, dy=15mm

Maximum value of SAR (interpolated) = 0.078 mW/g

**Ch11/Zoom Scan (5x5x7)/Cube 0:** Measurement grid: dx=8mm, dy=8mm, dz=5mm

Reference Value = 3.26 V/m; Power Drift = -0.113 dB

Peak SAR (extrapolated) = 0.155 W/kg

**SAR(1 g) = 0.073 mW/g; SAR(10 g) = 0.037 mW/g**

Maximum value of SAR (measured) = 0.078 mW/g

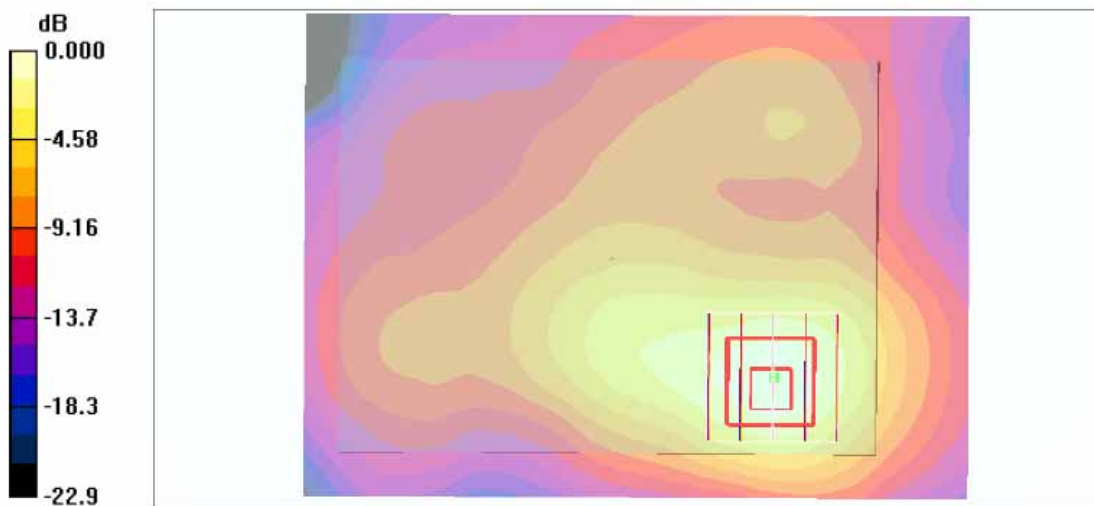

0 dB = 0.078mW/g



Test Laboratory: Sporton International Inc. SAR Testing Lab

Date/Time: 3/30/2007 11:20:40 PM

**Body\_GSM850 Ch128\_Keypad Down With 1.5cm Gap\_20070330\_GPRS10\_2D**

**DUT: 731703**

Communication System: GSM850; Frequency: 824.2 MHz; Duty Cycle: 1:4

Medium: MSL\_850 Medium parameters used :  $f = 824.2$  MHz;  $\sigma = 0.956$  mho/m;  $\epsilon_r = 54.3$ ;  $\rho = 1000$  kg/m<sup>3</sup>

Ambient Temperature : 22.3 °C ; Liquid Temperature : 21.0 °C

DASY4 Configuration:

- Probe: ET3DV6 - SN1788; ConvF(6.33, 6.33, 6.33); Calibrated: 9/19/2006
- Sensor-Surface: 4mm (Mechanical Surface Detection)
- Electronics: DAE3 Sn577; Calibrated: 11/21/2006
- Phantom: SAM-A; Type: QD 000 P40 C; Serial: TP-1303
- Measurement SW: DASY4, V4.7 Build 53; Postprocessing SW: SEMCAD, V1.8 Build 172

**Ch128/Area Scan (81x111x1):** Measurement grid: dx=15mm, dy=15mm

Maximum value of SAR (interpolated) = 0.417 mW/g

**Ch128/Zoom Scan (5x5x7)/Cube 0:** Measurement grid: dx=8mm, dy=8mm, dz=5mm

Reference Value = 17.9 V/m; Power Drift = -0.040 dB

Peak SAR (extrapolated) = 0.567 W/kg

**SAR(1 g) = 0.380 mW/g; SAR(10 g) = 0.252 mW/g**

Maximum value of SAR (measured) = 0.411 mW/g

**Ch128/Zoom Scan (5x5x7)/Cube 1:** Measurement grid: dx=8mm, dy=8mm, dz=5mm

Reference Value = 17.9 V/m; Power Drift = -0.040 dB

Peak SAR (extrapolated) = 0.343 W/kg

**SAR(1 g) = 0.280 mW/g; SAR(10 g) = 0.221 mW/g**

Maximum value of SAR (measured) = 0.293 mW/g

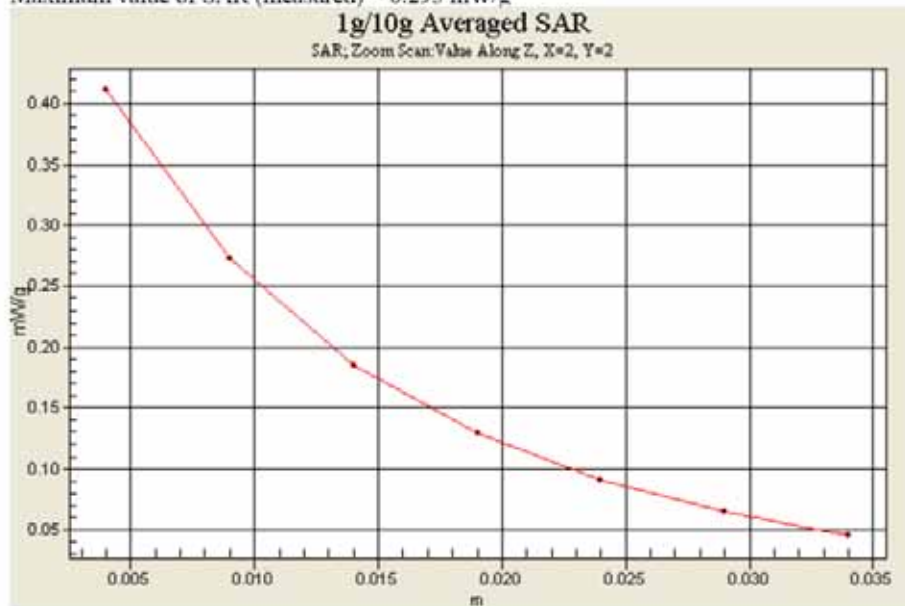



Test Laboratory: Sporton International Inc. SAR Testing Lab

Date/Time: 3/31/2007 9:01:43 AM

**Body\_PCS Ch512\_Keypad Down With 1.5cm Gap\_20070330\_GPRS10\_Bluetooth\_2D**

**DUT: 731703**

Communication System: PCS; Frequency: 1850.2 MHz; Duty Cycle: 1:4

Medium: MSL\_1900 Medium parameters used :  $f = 1850.2$  MHz;  $\sigma = 1.48$  mho/m;  $\epsilon_r = 52.8$ ;  $\rho = 1000$  kg/m<sup>3</sup>

Ambient Temperature : 22.3 °C; Liquid Temperature : 21.2 °C

DASY4 Configuration:

- Probe: ET3DV6 - SN1788; ConvF(4.67, 4.67, 4.67); Calibrated: 9/19/2006
- Sensor-Surface: 4mm (Mechanical Surface Detection)
- Electronics: DAE3 Sn577; Calibrated: 11/21/2006
- Phantom: SAM-B; Type: QD 000 P40 C; Serial: TP-1383
- Measurement SW: DASY4, V4.7 Build 53; Postprocessing SW: SEMCAD, V1.8 Build 172

**Ch512/Area Scan (81x111x1):** Measurement grid: dx=15mm, dy=15mm

Maximum value of SAR (interpolated) = 0.423 mW/g

**Ch512/Zoom Scan (5x5x7)/Cube 0:** Measurement grid: dx=8mm, dy=8mm, dz=5mm

Reference Value = 10.5 V/m; Power Drift = 0.043 dB

Peak SAR (extrapolated) = 0.614 W/kg

**SAR(1 g) = 0.382 mW/g; SAR(10 g) = 0.210 mW/g**

Maximum value of SAR (measured) = 0.434 mW/g

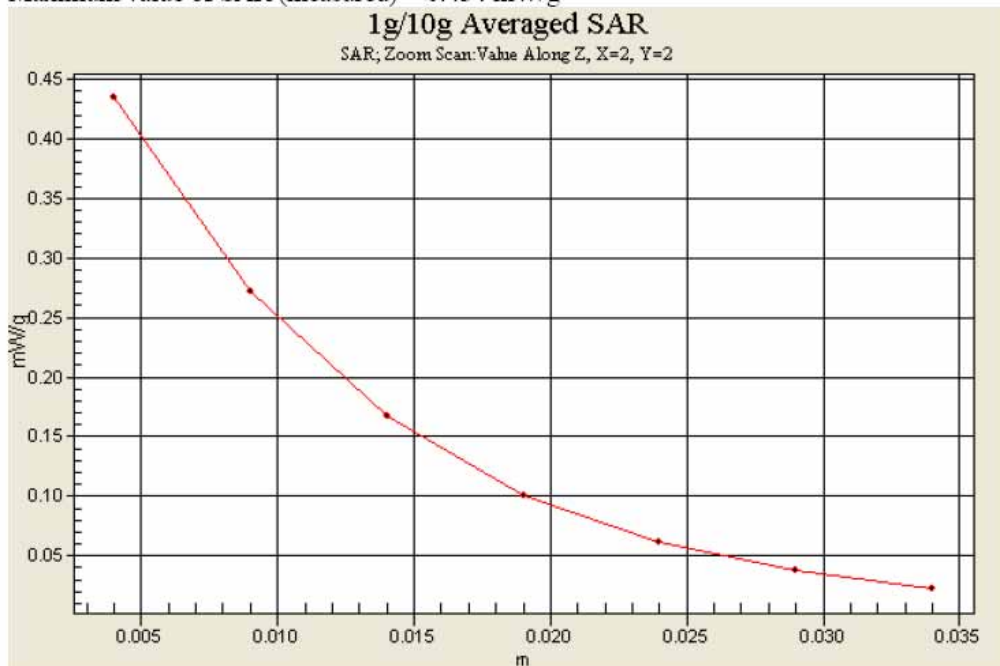



Test Laboratory: Sporton International Inc. SAR Testing Lab

Date/Time: 3/31/2007 8:24:31 PM

**Body\_WCDMA Ch4182\_Keypad Down With 1.5cm Gap\_20070330\_RMC 64k\_Bluetooth\_2D**

**DUT: 731703**

Communication System: WCDMA; Frequency: 836.4 MHz; Duty Cycle: 1:1

Medium: MSL\_850 Medium parameters used :  $f = 836.4$  MHz;  $\sigma = 0.969$  mho/m;  $\epsilon_r = 54.1$ ;  $\rho = 1000$  kg/m<sup>3</sup>

Ambient Temperature : 22.9 °C; Liquid Temperature : 21.0 °C

DASY4 Configuration:

- Probe: ET3DV6 - SN1788; ConvF(6.33, 6.33, 6.33); Calibrated: 9/19/2006
- Sensor-Surface: 4mm (Mechanical Surface Detection)
- Electronics: DAE3 Sn577; Calibrated: 11/21/2006
- Phantom: SAM-A; Type: QD 000 P40 C; Serial: TP-1303
- Measurement SW: DASY4, V4.7 Build 53; Postprocessing SW: SEMCAD, V1.8 Build 172

**Ch4182/Area Scan (81x111x1):** Measurement grid: dx=15mm, dy=15mm

Maximum value of SAR (interpolated) = 0.310 mW/g

**Ch4182/Zoom Scan (5x5x7)/Cube 0:** Measurement grid: dx=8mm, dy=8mm, dz=5mm

Reference Value = 12.6 V/m; Power Drift = -0.130 dB

Peak SAR (extrapolated) = 0.408 W/kg

**SAR(1 g) = 0.267 mW/g; SAR(10 g) = 0.171 mW/g**

Maximum value of SAR (measured) = 0.287 mW/g

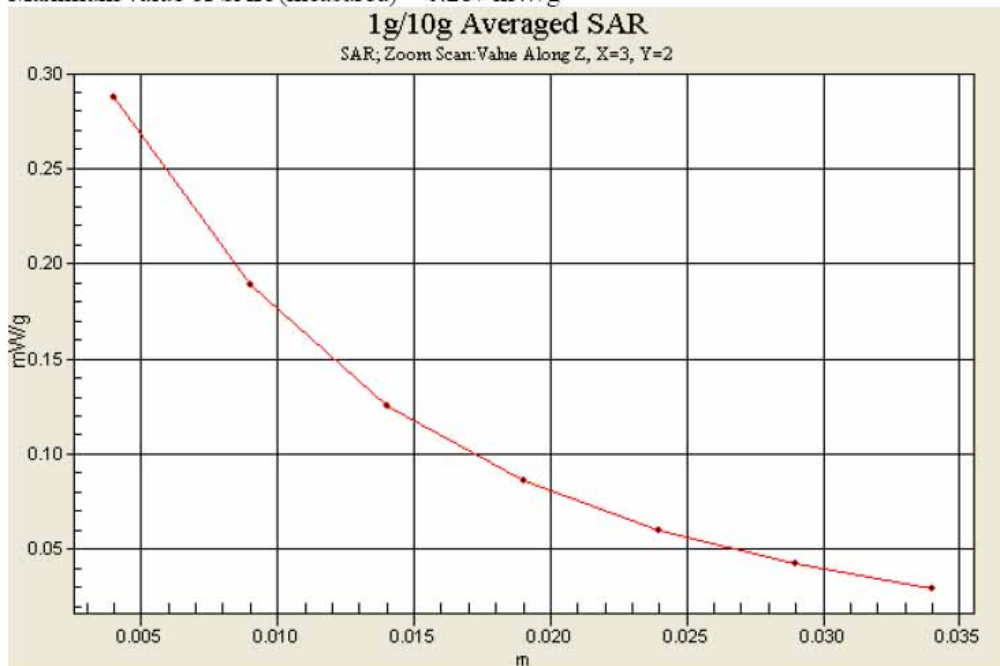





Test Laboratory: Sporton International Inc. SAR Testing Lab

Date/Time: 3/31/2007 5:00:38 AM

**Body\_WCDMA Ch9538\_Keypad Down With 1.5cm Gap\_20070330\_RMC 64k\_Bluetooth\_2D**

**DUT: 731703**

Communication System: WCDMA; Frequency: 1907.6 MHz; Duty Cycle: 1:1

Medium: MSL\_1900 Medium parameters used:  $f = 1908$  MHz;  $\sigma = 1.56$  mho/m;  $\epsilon_r = 52.5$ ;  $\rho = 1000$  kg/m<sup>3</sup>

Ambient Temperature : 22.3 °C; Liquid Temperature : 21.2 °C

DASY4 Configuration:

- Probe: ET3DV6 - SN1788; ConvF(4.67, 4.67, 4.67); Calibrated: 9/19/2006
- Sensor-Surface: 4mm (Mechanical Surface Detection)
- Electronics: DAE3 Sn577; Calibrated: 11/21/2006
- Phantom: SAM-B; Type: QD 000 P40 C; Serial: TP-1383
- Measurement SW: DASY4, V4.7 Build 53; Postprocessing SW: SEMCAD, V1.8 Build 172

**Ch9538/Area Scan (81x111x1):** Measurement grid: dx=15mm, dy=15mm

Maximum value of SAR (interpolated) = 0.563 mW/g

**Ch9538/Zoom Scan (5x5x7)/Cube 0:** Measurement grid: dx=8mm, dy=8mm, dz=5mm

Reference Value = 10.3 V/m; Power Drift = 0.016 dB

Peak SAR (extrapolated) = 0.786 W/kg

**SAR(1 g) = 0.482 mW/g; SAR(10 g) = 0.263 mW/g**

Maximum value of SAR (measured) = 0.548 mW/g

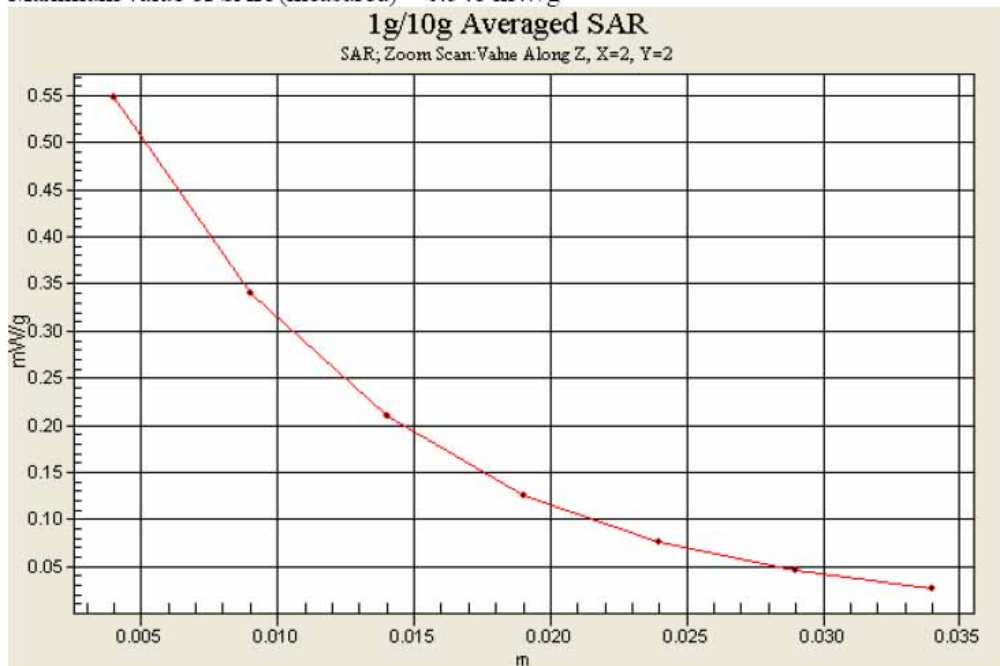



Test Laboratory: Sporton International Inc. SAR Testing Lab

Date/Time: 4/18/2007 8:19:10 PM

**Body\_GSM850 Ch128\_Keypad Down With 1.5cm Gap\_20070418\_without VT Camera\_GPRS10\_2D**

DUT: 731703

Communication System: GSM850; Frequency: 824.2 MHz; Duty Cycle: 1:4

Medium: MSL\_850 Medium parameters used :  $f = 824.2$  MHz;  $\sigma = 0.956$  mho/m;  $\epsilon_r = 54.3$ ;  $\rho = 1000$  kg/m<sup>3</sup>

Ambient Temperature : 23.3 °C; Liquid Temperature : 22.1 °C

DASY4 Configuration:

- Probe: ET3DV6 - SN1788; ConvF(6.33, 6.33, 6.33); Calibrated: 9/19/2006
- Sensor-Surface: 4mm (Mechanical Surface Detection)
- Electronics: DAE3 Sn577; Calibrated: 11/21/2006
- Phantom: SAM-A; Type: QD 000 P40 C; Serial: TP-1303
- Measurement SW: DASY4, V4.7 Build 53; Postprocessing SW: SEMCAD, V1.8 Build 172

**Ch128/Area Scan (81x111x1):** Measurement grid: dx=15mm, dy=15mm

Maximum value of SAR (interpolated) = 0.460 mW/g

**Ch128/Zoom Scan (5x5x7)/Cube 0:** Measurement grid: dx=8mm, dy=8mm, dz=5mm

Reference Value = 17.8 V/m; Power Drift = -0.107 dB

Peak SAR (extrapolated) = 0.644 W/kg

SAR(1 g) = 0.427 mW/g; SAR(10 g) = 0.277 mW/g

Maximum value of SAR (measured) = 0.465 mW/g

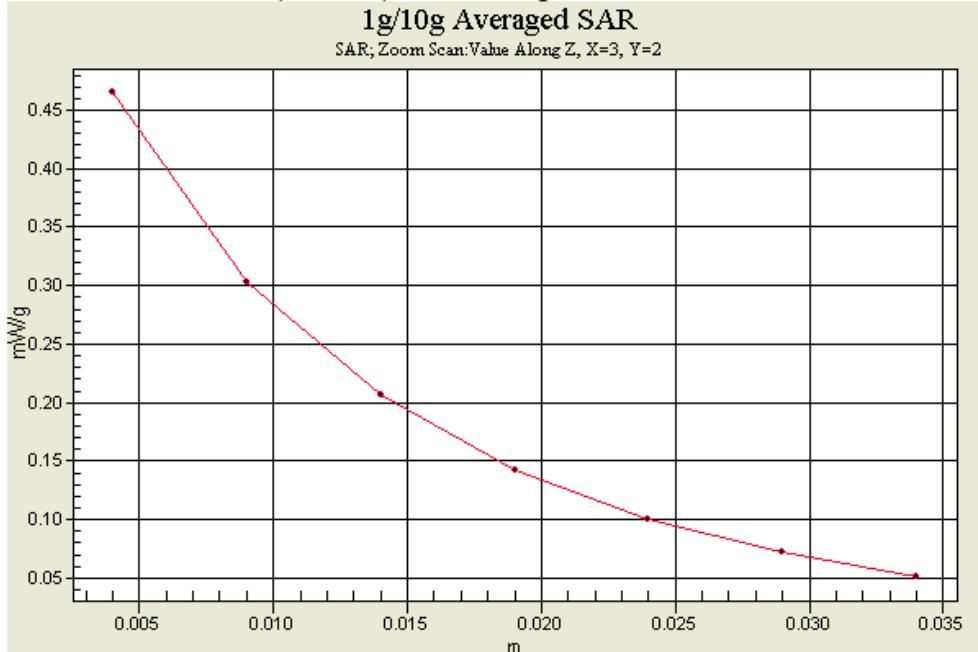



Test Laboratory: Sporton International Inc. SAR Testing Lab

Date/Time: 4/18/2007 10:43:37 PM

**Body\_PCS Ch512\_Keypad Down With 1.5cm Gap\_20070418\_without VT Camera\_GPRS10\_BT On\_2D**

DUT: 731703

Communication System: PCS; Frequency: 1850.2 MHz; Duty Cycle: 1:4

Medium: MSL\_1900 Medium parameters used :  $f = 1850.2$  MHz;  $\sigma = 1.48$  mho/m;  $\epsilon_r = 52.8$ ;  $\rho = 1000$  kg/m<sup>3</sup>

Ambient Temperature : 22.9 °C; Liquid Temperature : 21.7 °C

DASY4 Configuration:

- Probe: ET3DV6 - SN1788; ConvF(4.67, 4.67, 4.67); Calibrated: 9/19/2006
- Sensor-Surface: 4mm (Mechanical Surface Detection)
- Electronics: DAE3 Sn577; Calibrated: 11/21/2006
- Phantom: SAM-B; Type: QD 000 P40 C; Serial: TP-1383
- Measurement SW: DASY4, V4.7 Build 53; Postprocessing SW: SEMCAD, V1.8 Build 172

**Ch512/Area Scan (81x111x1):** Measurement grid: dx=15mm, dy=15mm

Maximum value of SAR (interpolated) = 0.535 mW/g

**Ch512/Zoom Scan (5x5x7)/Cube 0:** Measurement grid: dx=8mm, dy=8mm, dz=5mm

Reference Value = 10.8 V/m; Power Drift = -0.158 dB

Peak SAR (extrapolated) = 0.726 W/kg

SAR(1 g) = 0.444 mW/g; SAR(10 g) = 0.242 mW/g

Maximum value of SAR (measured) = 0.498 mW/g

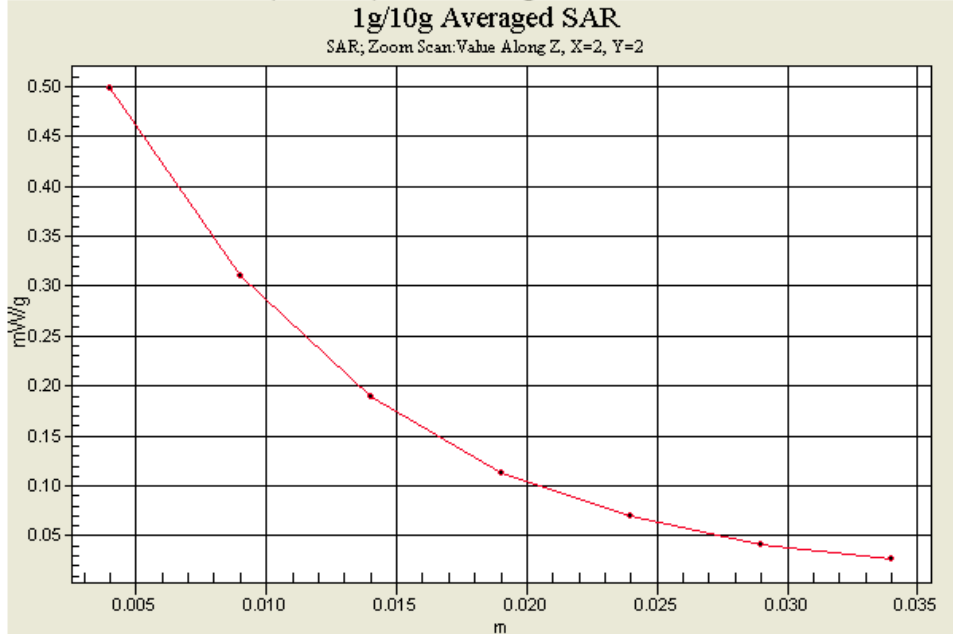



Test Laboratory: Sporton International Inc. SAR Testing Lab

Date/Time: 4/18/2007 9:35:35 PM

**Body\_WCDMA Ch4182\_Keypad Down With 1.5cm Gap\_20070418\_without VT Camera\_RMC 64k\_BT On\_2D**

DUT: 731703

Communication System: WCDMA; Frequency: 836.4 MHz; Duty Cycle: 1:1

Medium: MSL\_850 Medium parameters used :  $f = 836.4$  MHz;  $\sigma = 0.969$  mho/m;  $\epsilon_r = 54.1$ ;  $\rho = 1000$  kg/m<sup>3</sup>

Ambient Temperature : 22.9 °C ; Liquid Temperature : 22.1 °C

DASY4 Configuration:

- Probe: ET3DV6 - SN1788; ConvF(6.33, 6.33, 6.33); Calibrated: 9/19/2006
- Sensor-Surface: 4mm (Mechanical Surface Detection)
- Electronics: DAE3 Sn577; Calibrated: 11/21/2006
- Phantom: SAM-A; Type: QD 000 P40 C; Serial: TP-1303
- Measurement SW: DASY4, V4.7 Build 53; Postprocessing SW: SEMCAD, V1.8 Build 172

**Ch4182/Area Scan (81x111x1):** Measurement grid: dx=15mm, dy=15mm

Maximum value of SAR (interpolated) = 0.291 mW/g

**Ch4182/Zoom Scan (5x5x7)/Cube 0:** Measurement grid: dx=8mm, dy=8mm, dz=5mm

Reference Value = 13.0 V/m; Power Drift = 0.049 dB

Peak SAR (extrapolated) = 0.395 W/kg

SAR(1 g) = 0.261 mW/g; SAR(10 g) = 0.169 mW/g

Maximum value of SAR (measured) = 0.284 mW/g

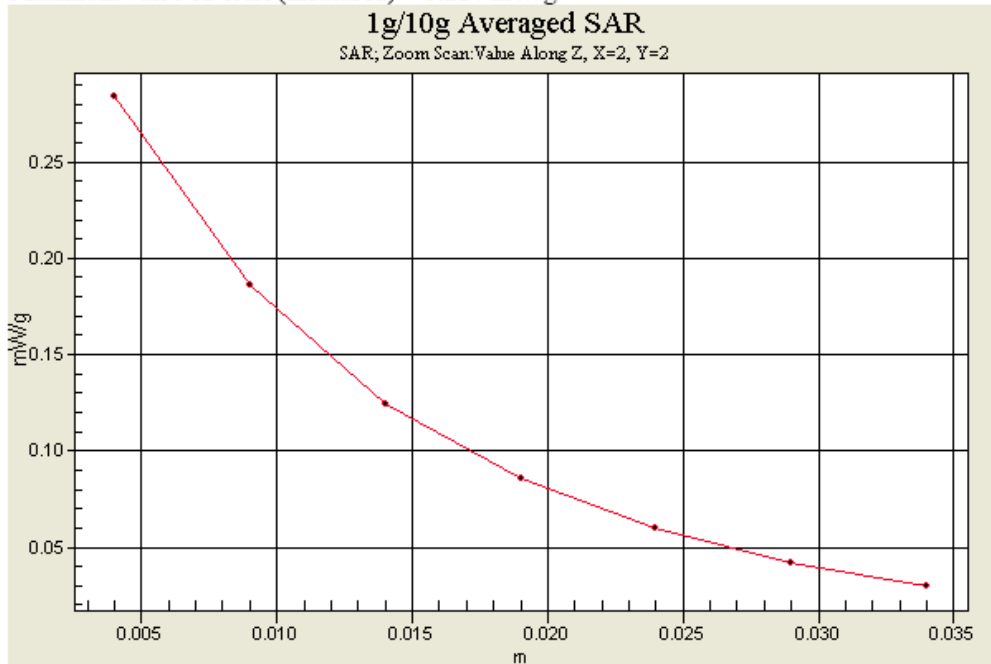





Test Laboratory: Sporton International Inc. SAR Testing Lab

Date/Time: 4/18/2007 10:06:47 PM

**Body\_WCDMA Ch9538\_Keypad Down With 1.5cm Gap\_20070418\_without VT Camera\_RMC 64k\_BT On\_2D**

DUT: 731703

Communication System: WCDMA; Frequency: 1907.6 MHz; Duty Cycle: 1:1

Medium: MSL\_1900 Medium parameters used:  $f = 1908$  MHz;  $\sigma = 1.56$  mho/m;  $\epsilon_r = 52.5$ ;  $\rho = 1000$  kg/m<sup>3</sup>

Ambient Temperature : 22.9 °C; Liquid Temperature : 21.7 °C

DASY4 Configuration:

- Probe: ET3DV6 - SN1788; ConvF(4.67, 4.67, 4.67); Calibrated: 9/19/2006

- Sensor-Surface: 4mm (Mechanical Surface Detection)

- Electronics: DAE3 Sn577; Calibrated: 11/21/2006

- Phantom: SAM-B; Type: QD 000 P40 C; Serial: TP-1383

- Measurement SW: DASY4, V4.7 Build 53; Postprocessing SW: SEMCAD, V1.8 Build 172

**Ch9538/Area Scan (81x111x1):** Measurement grid: dx=15mm, dy=15mm

Maximum value of SAR (interpolated) = 0.614 mW/g

**Ch9538/Zoom Scan (5x5x7)/Cube 0:** Measurement grid: dx=8mm, dy=8mm, dz=5mm

Reference Value = 11.4 V/m; Power Drift = -0.140 dB

Peak SAR (extrapolated) = 0.860 W/kg

SAR(1 g) = 0.520 mW/g; SAR(10 g) = 0.283 mW/g

Maximum value of SAR (measured) = 0.582 mW/g

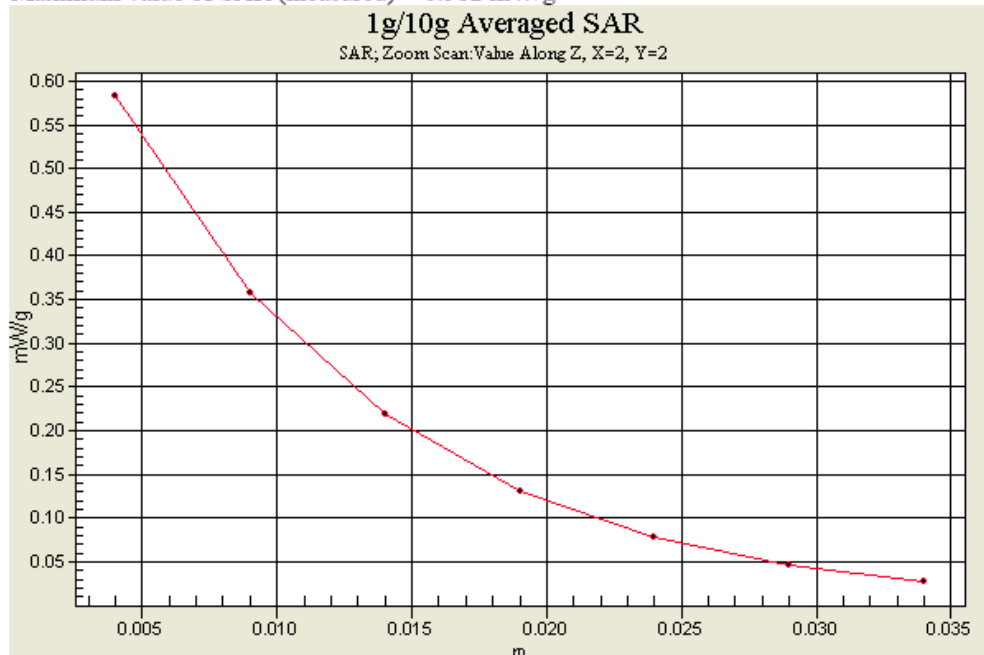



Test Laboratory: Sporton International Inc. SAR Testing Lab

Date/Time: 4/12/2007 2:29:31 PM

**Body\_802.11b Ch11\_Keypad Down With 1.5cm Gap\_20070412\_Bluetooth\_2D**

**DUT: 731703**

Communication System: 802.11b ; Frequency: 2462 MHz;Duty Cycle: 1:1

Medium: MSL\_2450 Medium parameters used:  $f = 2462$  MHz;  $\sigma = 1.98$  mho/m;  $\epsilon_r = 53.3$ ;  $\rho = 1000$  kg/m<sup>3</sup>

Ambient Temperature : 22.3 °C; Liquid Temperature : 22.0 °C

**DASY4 Configuration:**

- Probe: ET3DV6 - SN1788; ConvF(4.11, 4.11, 4.11); Calibrated: 9/19/2006
- Sensor-Surface: 4mm (Mechanical Surface Detection)
- Electronics: DAE3 Sn577; Calibrated: 11/21/2006
- Phantom: SAM-B; Type: QD 000 P40 C; Serial: TP-1383
- Measurement SW: DASY4, V4.7 Build 53; Postprocessing SW: SEMCAD, V1.8 Build 172

**Ch11/Area Scan (81x111x1):** Measurement grid: dx=15mm, dy=15mm

Maximum value of SAR (interpolated) = 0.090 mW/g

**Ch11/Zoom Scan (5x5x7)/Cube 0:** Measurement grid: dx=8mm, dy=8mm, dz=5mm

Reference Value = 2.65 V/m; Power Drift = -0.108 dB

Peak SAR (extrapolated) = 0.196 W/kg

**SAR(1 g) = 0.088 mW/g; SAR(10 g) = 0.045 mW/g**

Maximum value of SAR (measured) = 0.092 mW/g

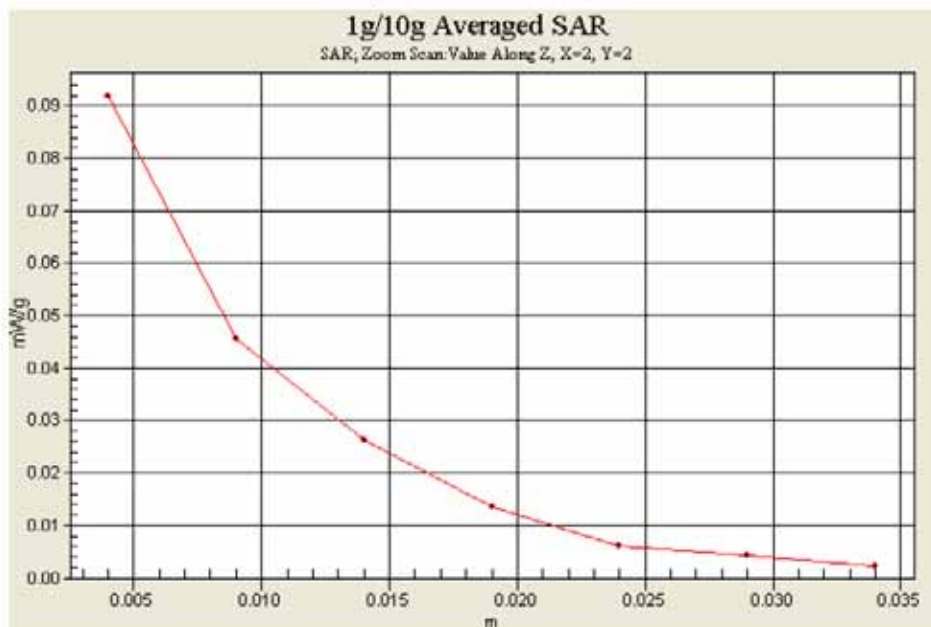



Test Laboratory: Sporton International Inc. SAR Testing Lab

Date/Time: 4/18/2007 11:48:32 PM

**Body\_802.11b Ch11\_Keypad Down With 1.5cm Gap\_20070418\_without VT Camera\_BT On\_2D**

**DUT: 731703**

Communication System: 802.11b ; Frequency: 2462 MHz;Duty Cycle: 1:1

Medium: MSL\_2450 Medium parameters used:  $f = 2462$  MHz;  $\sigma = 1.98$  mho/m;  $\epsilon_r = 53.3$ ;  $\rho = 1000$  kg/m<sup>3</sup>

Ambient Temperature : 23.0 °C; Liquid Temperature : 21.9 °C

DASY4 Configuration:

- Probe: ET3DV6 - SN1788; ConvF(4.11, 4.11, 4.11); Calibrated: 9/19/2006
- Sensor-Surface: 4mm (Mechanical Surface Detection)
- Electronics: DAE3 Sn577; Calibrated: 11/21/2006
- Phantom: SAM-A; Type: QD 000 P40 C; Serial: TP-1303
- Measurement SW: DASY4, V4.7 Build 53; Postprocessing SW: SEMCAD, V1.8 Build 172

**Ch11/Area Scan (81x111x1):** Measurement grid: dx=15mm, dy=15mm

Maximum value of SAR (interpolated) = 0.078 mW/g

**Ch11/Zoom Scan (5x5x7)/Cube 0:** Measurement grid: dx=8mm, dy=8mm, dz=5mm

Reference Value = 3.26 V/m; Power Drift = -0.113 dB

Peak SAR (extrapolated) = 0.155 W/kg

SAR(1 g) = 0.073 mW/g; SAR(10 g) = 0.037 mW/g

Maximum value of SAR (measured) = 0.078 mW/g





Appendix C – Calibration Data

Calibration Laboratory of Schmid & Partner Engineering AG Zoughausstrasse 43, 8004 Zurich, Switzerland



S Schweizerischer Kalibrierdienst
C Service suisse d'etalonnage
S Servizio svizzero di taratura
S Swiss Calibration Service

Accredited by the Swiss Federal Office of Metrology and Accreditation The Swiss Accreditation Service is one of the signatories to the EA Multilateral Agreement for the recognition of calibration certificates

Accreditation No.: SCS 108

Client Sporton (Auden)

Certificate No: D835V2-499\_Mar06

CALIBRATION CERTIFICATE

Object: D835V2 - SN: 499
Calibration procedure(s): QA CAL-05.v6 Calibration procedure for dipole validation kits
Calibration date: March 15, 2006
Condition of the calibrated item: In Tolerance

This calibration certificate documents the traceability to national standards, which realize the physical units of measurements (SI). The measurements and the uncertainties with confidence probability are given on the following pages and are part of the certificate.

All calibrations have been conducted in the closed laboratory facility: environment temperature (22 ± 3)°C and humidity < 70%.

Calibration Equipment used (M&TE critical for calibration)

Table with 4 columns: Primary Standards, ID #, Cal Date (Calibrated by, Certificate No.), Scheduled Calibration. Lists equipment like Power meter EPM-442A, Power sensor HP B481A, Reference 20 dB Attenuator, etc.

Table with 4 columns: Secondary Standards, ID #, Check Date (in house), Scheduled Check. Lists equipment like Power sensor HP B481A, RF generator Agilent E4421B, Network Analyzer HP B753E.

Signature block with Name, Function, and Signature for Judith Müller (Laboratory Technician) and Katja Pokovic (Technical Manager).

Issued: March 16, 2006

This calibration certificate shall not be reproduced except in full without written approval of the laboratory.





Calibration Laboratory of  
Schmid & Partner  
Engineering AG  
Zeughausstrasse 43, 8004 Zurich, Switzerland



S Schweizerischer Kalibrierdienst  
C Service suisse d'étalonnage  
S Servizio svizzero di taratura  
S Swiss Calibration Service

Accredited by the Swiss Federal Office of Metrology and Accreditation  
The Swiss Accreditation Service is one of the signatories to the EA  
Multilateral Agreement for the recognition of calibration certificates

Accreditation No.: SCS 108

**Glossary:**

TSL tissue simulating liquid  
ConvF sensitivity in TSL / NORM x,y,z  
N/A not applicable or not measured

**Calibration is Performed According to the Following Standards:**

- a) IEEE Std 1528-2003, "IEEE Recommended Practice for Determining the Peak Spatial-Averaged Specific Absorption Rate (SAR) in the Human Head from Wireless Communications Devices: Measurement Techniques", December 2003
- b) CENELEC EN 50361, "Basic standard for the measurement of Specific Absorption Rate related to human exposure to electromagnetic fields from mobile phones (300 MHz - 3 GHz), July 2001
- c) Federal Communications Commission Office of Engineering & Technology (FCC OET), "Evaluating Compliance with FCC Guidelines for Human Exposure to Radiofrequency Electromagnetic Fields; Additional Information for Evaluating Compliance of Mobile and Portable Devices with FCC Limits for Human Exposure to Radiofrequency Emissions", Supplement C (Edition 01-01) to Bulletin 65

**Additional Documentation:**

- d) DASY4 System Handbook

**Methods Applied and Interpretation of Parameters:**

- *Measurement Conditions:* Further details are available from the Validation Report at the end of the certificate. All figures stated in the certificate are valid at the frequency indicated.
- *Antenna Parameters with TSL:* The dipole is mounted with the spacer to position its feed point exactly below the center marking of the flat phantom section, with the arms oriented parallel to the body axis.
- *Feed Point Impedance and Return Loss:* These parameters are measured with the dipole positioned under the liquid filled phantom. The impedance stated is transformed from the measurement at the SMA connector to the feed point. The Return Loss ensures low reflected power. No uncertainty required.
- *Electrical Delay:* One-way delay between the SMA connector and the antenna feed point. No uncertainty required.
- *SAR measured:* SAR measured at the stated antenna input power.
- *SAR normalized:* SAR as measured, normalized to an input power of 1 W at the antenna connector.
- *SAR for nominal TSL parameters:* The measured TSL parameters are used to calculate the nominal SAR result.





Measurement Conditions

DASY system configuration, as far as not given on page 1.

DASY Version	DASY4	V4.7
Extrapolation	Advanced Extrapolation	
Phantom	Modular Flat Phantom V4.9	
Distance Dipole Center - TSL	15 mm	with Spacer
Area Scan resolution	dx, dy = 15 mm	
Zoom Scan Resolution	dx, dy, dz = 5 mm	
Frequency	835 MHz ± 1 MHz	

Head TSL parameters

The following parameters and calculations were applied.

	Temperature	Permittivity	Conductivity
Nominal Head TSL parameters	22.0 °C	41.5	0.90 mho/m
Measured Head TSL parameters	(22.0 ± 0.2) °C	42.1 ± 6 %	0.94mho/m ± 6 %
Head TSL temperature during test	(22.2 ± 0.2) °C	---	---

SAR result with Head TSL

SAR averaged over 1 cm <sup>3</sup> (1 g) of Head TSL	condition	
SAR measured	250 mW input power	2.35 mW / g
SAR normalized	normalized to 1W	9.40 mW / g
SAR for nominal Head TSL parameters <sup>1</sup>	normalized to 1W	<b>9.24 mW / g ± 17.0 % (k=2)</b>

SAR averaged over 10 cm <sup>3</sup> (10 g) of Head TSL	condition	
SAR measured	250 mW input power	1.53 mW / g
SAR normalized	normalized to 1W	6.12 mW / g
SAR for nominal Head TSL parameters <sup>1</sup>	normalized to 1W	<b>6.07 mW / g ± 16.5 % (k=2)</b>

<sup>1</sup> Correction to nominal TSL parameters according to d), chapter "SAR Sensitivities"



**Body TSL parameters**

The following parameters and calculations were applied.

	Temperature	Permittivity	Conductivity
Nominal Body TSL parameters	22.0 °C	55.2	0.97 mho/m
Measured Body TSL parameters	(22.0 ± 0.2) °C	56.8 ± 6 %	0.98 mho/m ± 6 %
Body TSL temperature during test	(21.4 ± 0.2) °C	---	---

**SAR result with Body TSL**

SAR averaged over 1 cm <sup>3</sup> (1 g) of Body TSL	condition	
SAR measured	250 mW input power	2.45 mW / g
SAR normalized	normalized to 1W	9.80 mW / g
SAR for nominal Body TSL parameters <sup>2</sup>	normalized to 1W	<b>9.91 mW / g ± 17.0 % (k=2)</b>

SAR averaged over 10 cm <sup>3</sup> (10 g) of Body TSL	condition	
SAR measured	250 mW input power	1.62 mW / g
SAR normalized	normalized to 1W	6.48 mW / g
SAR for nominal Body TSL parameters <sup>2</sup>	normalized to 1W	<b>6.55 mW / g ± 16.5 % (k=2)</b>

<sup>2</sup> Correction to nominal TSL parameters according to d), chapter "SAR Sensitivities"



**Appendix**

**Antenna Parameters with Head TSL**

Impedance, transformed to feed point	52.1 $\Omega$ - 2.9 j $\Omega$
Return Loss	-29.1 dB

**Antenna Parameters with Body TSL**

Impedance, transformed to feed point	47.9 $\Omega$ - 5.1 j $\Omega$
Return Loss	-24.9 dB

**General Antenna Parameters and Design**

Electrical Delay (one direction)	1.391ns
----------------------------------	---------

After long term use with 100W radiated power, only a slight warming of the dipole near the feedpoint can be measured.

The dipole is made of standard semirigid coaxial cable. The center conductor of the feeding line is directly connected to the second arm of the dipole. The antenna is therefore short-circuited for DC-signals.

No excessive force must be applied to the dipole arms, because they might bend or the soldered connections near the feedpoint may be damaged.

**Additional EUT Data**

Manufactured by	SPEAG
Manufactured on	July 10, 2003



**DASY4 Validation Report for Head TSL**

Date/Time: 15.03.2006 12:51:44

Test Laboratory: SPEAG, Zurich, Switzerland

**DUT: Dipole 835 MHz; Type: D835V2; Serial: D835V2 - SN:499**

Communication System: CW; Frequency: 835 MHz; Duty Cycle: 1:1

Medium: HSL U10 BB;

Medium parameters used:  $f = 835 \text{ MHz}$ ;  $\sigma = 0.942 \text{ mho/m}$ ;  $\epsilon_r = 42.1$ ;  $\rho = 1000 \text{ kg/m}^3$

Phantom section: Flat Section

Measurement Standard: DASY4 (High Precision Assessment)

DASY4 Configuration:

- Probe: ET3DV6 - SN1507 (HF); ConvF(6.09, 6.09, 6.09); Calibrated: 28.10.2005
- Sensor-Surface: 4mm (Mechanical Surface Detection)
- Electronics: DAE4 Sn601; Calibrated: 15.12.2005
- Phantom: Flat Phantom 4.9L; Type: QD000P49AA; ;
- Measurement SW: DASY4, V4.7 Build 14; Postprocessing SW: SEMCAD, V1.8 Build 165

**Pin = 250 mW; d = 10 mm/Area Scan (71x81x1):** Measurement grid: dx=15mm, dy=15mm  
Maximum value of SAR (interpolated) = 2.54 mW/g

**Pin = 250 mW; d = 10 mm/Zoom Scan (7x7x7)/Cube 0:** Measurement grid: dx=5mm, dy=5mm, dz=5mm  
Reference Value = 53.7 V/m; Power Drift = -0.008 dB  
Peak SAR (extrapolated) = 3.53 W/kg  
**SAR(1 g) = 2.35 mW/g; SAR(10 g) = 1.53 mW/g**  
Maximum value of SAR (measured) = 2.55 mW/g

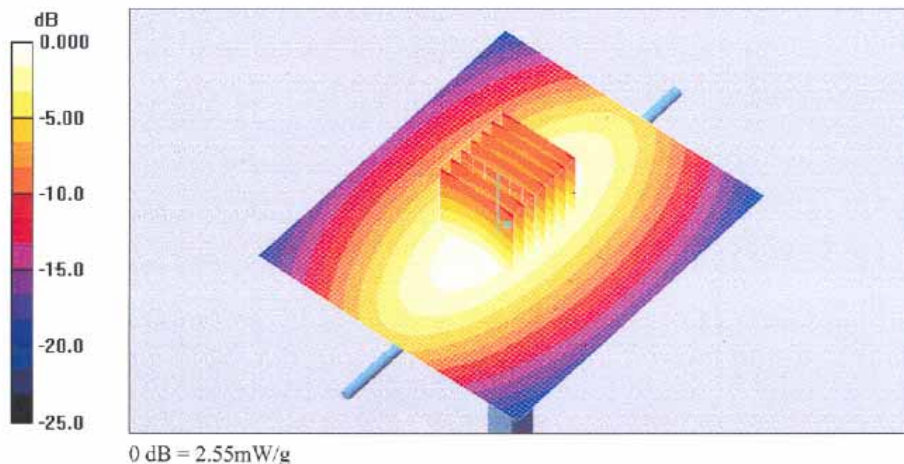



Impedance Measurement Plot for Head TSL

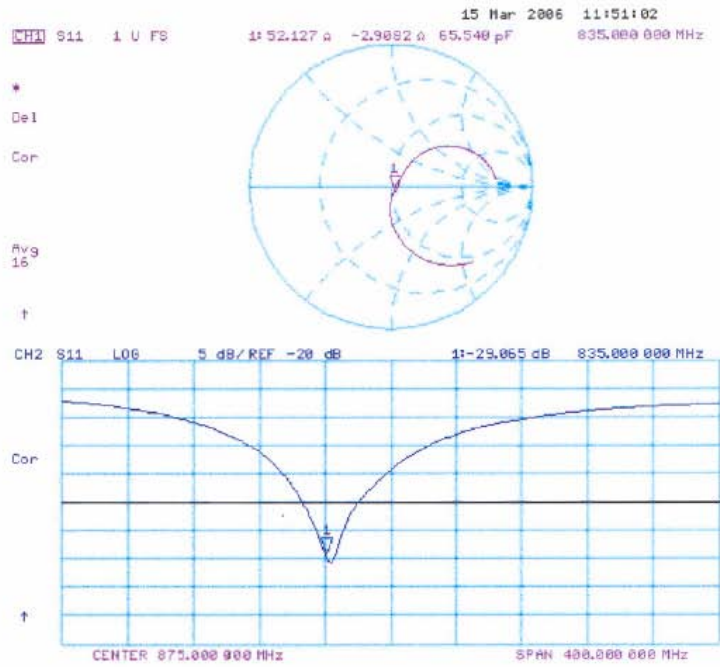





**DASY4 Validation Report for Body TSL**

Date/Time: 14.03.2006 12:37:15

Test Laboratory: SPEAG, Zurich, Switzerland

**DUT: Dipole 835 MHz; Type: D835V2; Serial: D835V2 - SN:499**

Communication System: CW; Frequency: 835 MHz; Duty Cycle: 1:1

Medium: MSL U10;

Medium parameters used:  $f = 835 \text{ MHz}$ ;  $\sigma = 0.972 \text{ mho/m}$ ;  $\epsilon_r = 56.9$ ;  $\rho = 1000 \text{ kg/m}^3$

Phantom section: Flat Section

Measurement Standard: DASY4 (High Precision Assessment)

DASY4 Configuration:

- Probe: ET3DV6 - SN1507 (HF); ConvF(5.84, 5.84, 5.84); Calibrated: 28.10.2005
- Sensor-Surface: 4mm (Mechanical Surface Detection)
- Electronics: DAE4 Sn601; Calibrated: 15.12.2005
- Phantom: Flat Phantom 4.9L; Type: QD000P49AA; ;
- Measurement SW: DASY4, V4.7 Build 14; Postprocessing SW: SEMCAD, V1.8 Build 165

**Pin = 250 mW; d = 10 mm/Area Scan (71x81x1):** Measurement grid: dx=15mm, dy=15mm  
Maximum value of SAR (interpolated) = 2.63 mW/g

**Pin = 250 mW; d = 10 mm/Zoom Scan (7x7x7)/Cube 0:** Measurement grid: dx=5mm, dy=5mm, dz=5mm

Reference Value = 53.3 V/m; Power Drift = 0.026 dB

Peak SAR (extrapolated) = 3.51 W/kg

**SAR(1 g) = 2.45 mW/g; SAR(10 g) = 1.62 mW/g**

Maximum value of SAR (measured) = 2.65 mW/g

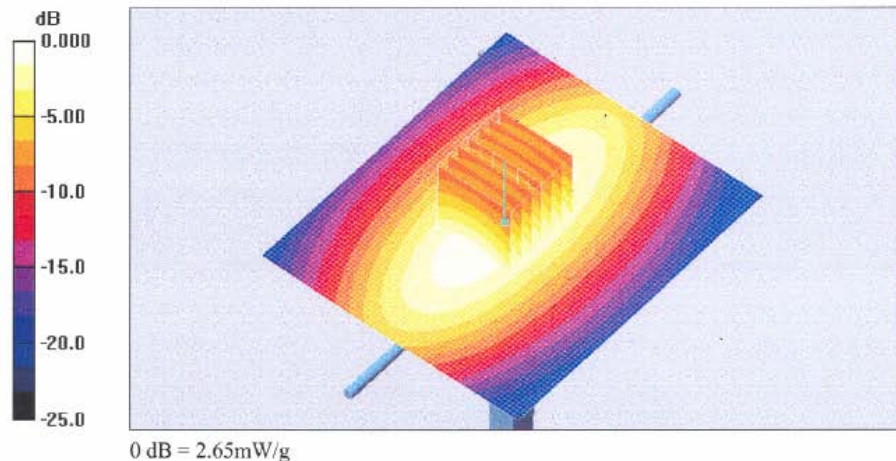



Impedance Measurement Plot Body TSL

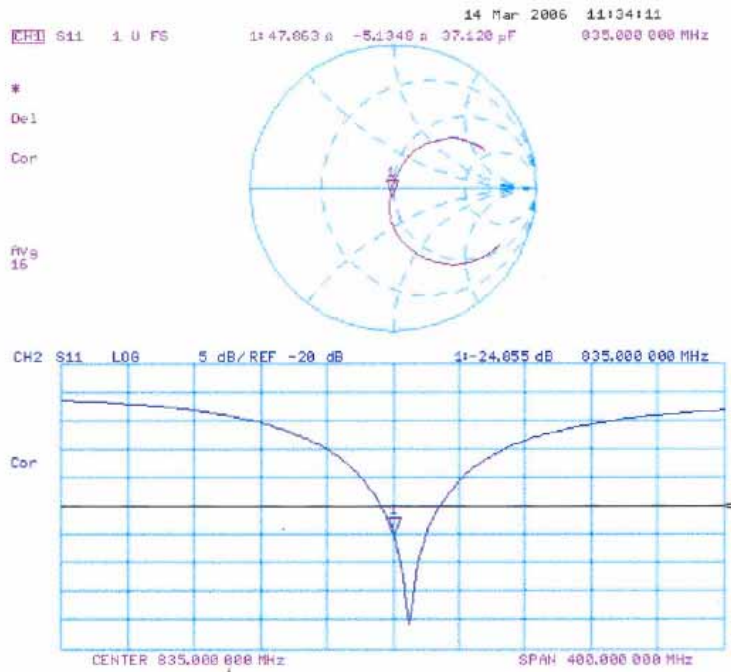



Calibration Laboratory of  
Schmid & Partner  
Engineering AG  
Zeughausstrasse 43, 8004 Zurich, Switzerland



S Schweizerischer Kalibrierdienst  
C Service suisse d'étalonnage  
S Servizio svizzero di taratura  
S Swiss Calibration Service

Accredited by the Swiss Federal Office of Metrology and Accreditation  
The Swiss Accreditation Service is one of the signatories to the EA  
Multilateral Agreement for the recognition of calibration certificates

Accreditation No.: SCS 108

Client Sporton (Auden)

Certificate No: D1900V2-5d041\_Mar06

**CALIBRATION CERTIFICATE**

Object D1900V2 - SN: 5d041  
Calibration procedure(s) QA CAL-05.v6  
Calibration procedure for dipole validation kits  
Calibration date: March 21, 2006  
Condition of the calibrated item In Tolerance

This calibration certificate documents the traceability to national standards, which realize the physical units of measurements (SI).  
The measurements and the uncertainties with confidence probability are given on the following pages and are part of the certificate.

All calibrations have been conducted in the closed laboratory facility: environment temperature (22 ± 3)°C and humidity < 70%.

Calibration Equipment used (M&TE critical for calibration)

Primary Standards	ID #	Cal Date (Calibrated by, Certificate No.)	Scheduled Calibration
Power meter EPM-442A	GB37480704	04-Oct-05 (METAS, No. 251-00516)	Oct-06
Power sensor HP 8481A	US37292783	04-Oct-05 (METAS, No. 251-00516)	Oct-08
Reference 20 dB Attenuator	SN: 5086 (20g)	11-Aug-05 (METAS, No 251-00498)	Aug-06
Reference 10 dB Attenuator	SN: 5047.2 (10r)	11-Aug-05 (METAS, No 251-00498)	Aug-06
Reference Probe ET3DV6	SN: 1507	28-Oct-05 (SPEAG, No. ET3-1507_Oct05)	Oct-08
DAE4	SN: 601	15-Dec-05 (SPEAG, No. DAE4-601_Dec05)	Dec-06
Secondary Standards	ID #	Check Date (in house)	Scheduled Check
Power sensor HP 8481A	MY41092317	18-Oct-02 (SPEAG, in house check Oct-05)	In house check: Oct-07
RF generator Agilent E4421B	MY41000675	11-May-05 (SPEAG, in house check Nov-05)	In house check: Nov-07
Network Analyzer HP 8753E	US37390585 S4206	18-Oct-01 (SPEAG, in house check Nov-05)	In house check: Nov-06

	Name	Function	Signature
Calibrated by:	Judith Müller	Laboratory Technician	
Approved by:	Katja Pokovic	Technical Manager	

Issued: March 22, 2006

This calibration certificate shall not be reproduced except in full without written approval of the laboratory.



Calibration Laboratory of  
Schmid & Partner  
Engineering AG  
Zeughausstrasse 43, 8004 Zurich, Switzerland



S Schweizerischer Kalibrierdienst  
C Service suisse d'étalonnage  
S Servizio svizzero di taratura  
S Swiss Calibration Service

Accredited by the Swiss Federal Office of Metrology and Accreditation  
The Swiss Accreditation Service is one of the signatories to the EA  
Multilateral Agreement for the recognition of calibration certificates

Accreditation No.: SCS 108

**Glossary:**

TSL tissue simulating liquid  
ConvF sensitivity in TSL / NORM x,y,z  
N/A not applicable or not measured

**Calibration is Performed According to the Following Standards:**

- a) IEEE Std 1528-2003, "IEEE Recommended Practice for Determining the Peak Spatial-Averaged Specific Absorption Rate (SAR) in the Human Head from Wireless Communications Devices: Measurement Techniques", December 2003
- b) CENELEC EN 50361, "Basic standard for the measurement of Specific Absorption Rate related to human exposure to electromagnetic fields from mobile phones (300 MHz - 3 GHz), July 2001
- c) Federal Communications Commission Office of Engineering & Technology (FCC OET), "Evaluating Compliance with FCC Guidelines for Human Exposure to Radiofrequency Electromagnetic Fields; Additional Information for Evaluating Compliance of Mobile and Portable Devices with FCC Limits for Human Exposure to Radiofrequency Emissions", Supplement C (Edition 01-01) to Bulletin 65

**Additional Documentation:**

- d) DASY4 System Handbook

**Methods Applied and Interpretation of Parameters:**

- *Measurement Conditions:* Further details are available from the Validation Report at the end of the certificate. All figures stated in the certificate are valid at the frequency indicated.
- *Antenna Parameters with TSL:* The dipole is mounted with the spacer to position its feed point exactly below the center marking of the flat phantom section, with the arms oriented parallel to the body axis.
- *Feed Point Impedance and Return Loss:* These parameters are measured with the dipole positioned under the liquid filled phantom. The impedance stated is transformed from the measurement at the SMA connector to the feed point. The Return Loss ensures low reflected power. No uncertainty required.
- *Electrical Delay:* One-way delay between the SMA connector and the antenna feed point. No uncertainty required.
- *SAR measured:* SAR measured at the stated antenna input power.
- *SAR normalized:* SAR as measured, normalized to an input power of 1 W at the antenna connector.
- *SAR for nominal TSL parameters:* The measured TSL parameters are used to calculate the nominal SAR result.





Measurement Conditions

DASY system configuration, as far as not given on page 1.

DASY Version	DASY4	V4.7
Extrapolation	Advanced Extrapolation	
Phantom	Modular Flat Phantom V5.0	
Distance Dipole Center - TSL	10 mm	with Spacer
Area Scan resolution	dx, dy = 15 mm	
Zoom Scan Resolution	dx, dy, dz = 5 mm	
Frequency	1900 MHz ± 1 MHz	

Head TSL parameters

The following parameters and calculations were applied.

	Temperature	Permittivity	Conductivity
Nominal Head TSL parameters	22.0 °C	40.0	1.40 mho/m
Measured Head TSL parameters	(22.0 ± 0.2) °C	39.4 ± 6 %	1.42 mho/m ± 6 %
Head TSL temperature during test	(21.5 ± 0.2) °C	---	---

SAR result with Head TSL

SAR averaged over 1 cm <sup>3</sup> (1 g) of Head TSL	condition	
SAR measured	250 mW input power	9.75 mW / g
SAR normalized	normalized to 1W	39.0 mW / g
SAR for nominal Head TSL parameters <sup>1</sup>	normalized to 1W	<b>38.4 mW / g ± 17.0 % (k=2)</b>

SAR averaged over 10 cm <sup>3</sup> (10 g) of Head TSL	Condition	
SAR measured	250 mW input power	5.17 mW / g
SAR normalized	normalized to 1W	20.7 mW / g
SAR for nominal Head TSL parameters <sup>1</sup>	normalized to 1W	<b>20.5 mW / g ± 16.5 % (k=2)</b>

<sup>1</sup> Correction to nominal TSL parameters according to d), chapter "SAR Sensitivities"





**Body TSL parameters**

The following parameters and calculations were applied.

	Temperature	Permittivity	Conductivity
Nominal Body TSL parameters	22.0 °C	53.3	1.52 mho/m
Measured Body TSL parameters	(22.0 ± 0.2) °C	54.7 ± 6 %	1.54 mho/m ± 6 %
Body TSL temperature during test	(21.6 ± 0.2) °C	----	----

**SAR result with Body TSL**

SAR averaged over 1 cm <sup>3</sup> (1 g) of Body TSL	Condition	
SAR measured	250 mW input power	10.2 mW / g
SAR normalized	normalized to 1W	40.8 mW / g
SAR for nominal Body TSL parameters <sup>2</sup>	normalized to 1W	<b>41.1 mW / g ± 17.0 % (k=2)</b>

SAR averaged over 10 cm <sup>3</sup> (10 g) of Body TSL	condition	
SAR measured	250 mW Input power	5.40 mW / g
SAR normalized	normalized to 1W	21.6 mW / g
SAR for nominal Body TSL parameters <sup>2</sup>	normalized to 1W	<b>21.8 mW / g ± 16.5 % (k=2)</b>

<sup>2</sup> Correction to nominal TSL parameters according to d), chapter "SAR Sensitivities"



**Appendix**

**Antenna Parameters with Head TSL**

Impedance, transformed to feed point	53.5 $\Omega$ + 5.1 j $\Omega$
Return Loss	- 24.8 dB

**Antenna Parameters with Body TSL**

Impedance, transformed to feed point	47.9 $\Omega$ + 6.3 j $\Omega$
Return Loss	- 23.4 dB

**General Antenna Parameters and Design**

Electrical Delay (one direction)	1.200 ns
----------------------------------	----------

After long term use with 100W radiated power, only a slight warming of the dipole near the feedpoint can be measured.

The dipole is made of standard semirigid coaxial cable. The center conductor of the feeding line is directly connected to the second arm of the dipole. The antenna is therefore short-circuited for DC-signals.

No excessive force must be applied to the dipole arms, because they might bend or the soldered connections near the feedpoint may be damaged.

**Additional EUT Data**

Manufactured by	SPEAG
Manufactured on	July 4, 2003



DASY4 Validation Report for Head TSL

Date/Time: 14.03.2006 16:18:53

Test Laboratory: SPEAG, Zurich, Switzerland

DUT: Dipole 1900 MHz; Type: D1900V2; Serial: D1900V2 - SN:5d041

Communication System: CW; Frequency: 1900 MHz; Duty Cycle: 1:1

Medium: HSL U10 BB;

Medium parameters used:  $f = 1900$  MHz;  $\sigma = 1.42$  mho/m;  $\epsilon_r = 39.4$ ;  $\rho = 1000$  kg/m<sup>3</sup>

Phantom section: Flat Section

Measurement Standard: DASY4 (High Precision Assessment)

DASY4 Configuration:

- Probe: ET3DV6 - SN1507 (HF); ConvF(4.74, 4.74, 4.74); Calibrated: 28.10.2005
- Sensor-Surface: 4mm (Mechanical Surface Detection)
- Electronics: DAE4 Sn601; Calibrated: 15.12.2005
- Phantom: Flat Phantom 5.0 (front); Type: QD000P50AA; ;
- Measurement SW: DASY4, V4.7 Build 14; Postprocessing SW: SEMCAD, V1.8 Build 165

Pin = 250 mW; d = 10 mm/Area Scan (71x71x1): Measurement grid: dx=15mm, dy=15mm

Maximum value of SAR (interpolated) = 11.7 mW/g

Pin = 250 mW; d = 10 mm/Zoom Scan (7x7x7)/Cube 0: Measurement grid: dx=5mm, dy=5mm, dz=5mm

Reference Value = 90.9 V/m; Power Drift = -0.093 dB

Peak SAR (extrapolated) = 16.6 W/kg

SAR(1 g) = 9.75 mW/g; SAR(10 g) = 5.17 mW/g

Maximum value of SAR (measured) = 11.1 mW/g

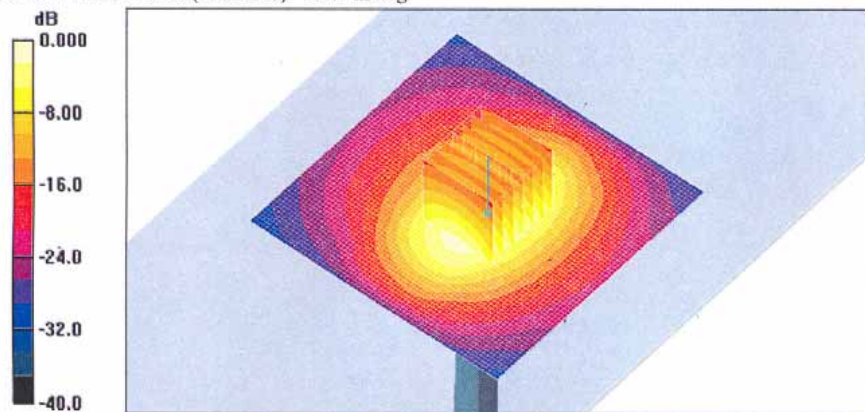

0 dB = 11.1 mW/g



Impedance Measurement Plot for Head TSL

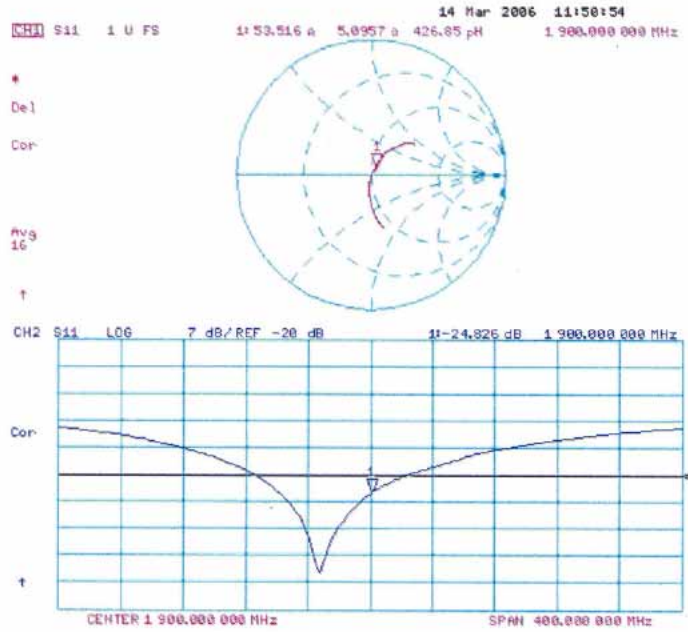



DASY4 Validation Report for Body TSL

Date/Time: 21.03.2006 13:59:55

Test Laboratory: SPEAG, Zurich, Switzerland

DUT: Dipole 1900 MHz; Type: D1900V2; Serial: D1900V2 - SN:5d041

Communication System: CW; Frequency: 1900 MHz; Duty Cycle: 1:1

Medium: MSL U10;

Medium parameters used:  $f = 1900$  MHz;  $\sigma = 1.54$  mho/m;  $\epsilon_r = 54.7$ ;  $\rho = 1000$  kg/m<sup>3</sup>

Phantom section: Flat Section

Measurement Standard: DASY4 (High Precision Assessment)

DASY4 Configuration:

- Probe: ET3DV6 - SN1507 (HF); ConvF(4.3, 4.3, 4.3); Calibrated: 28.10.2005
- Sensor-Surface: 4mm (Mechanical Surface Detection)
- Electronics: DAE4 Sn601; Calibrated: 15.12.2005
- Phantom: Flat Phantom 5.0 (front); Type: QD000P50AA; ;
- Measurement SW: DASY4, V4.6 Build 23; Postprocessing SW: SEMCAD, V1.8 Build 161

Pin = 250 mW; d = 10 mm/Area Scan (71x71x1); Measurement grid: dx=15mm, dy=15mm  
Maximum value of SAR (interpolated) = 11.8 mW/g

Pin = 250 mW; d = 10 mm/Zoom Scan (7x7x7)/Cube 0; Measurement grid: dx=5mm, dy=5mm, dz=5mm

Reference Value = 89.3 V/m; Power Drift = 0.045 dB

Peak SAR (extrapolated) = 17.4 W/kg

SAR(1 g) = 10.2 mW/g; SAR(10 g) = 5.4 mW/g

Maximum value of SAR (measured) = 11.6 mW/g

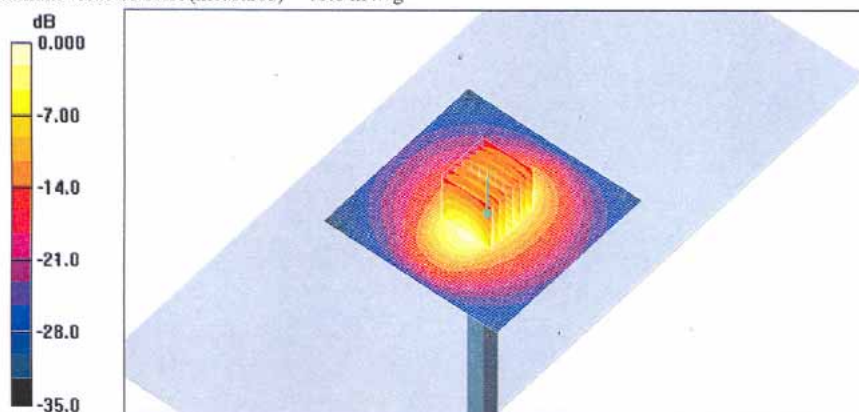

0 dB = 11.6mW/g





Impedance Measurement Plot for Body TSL

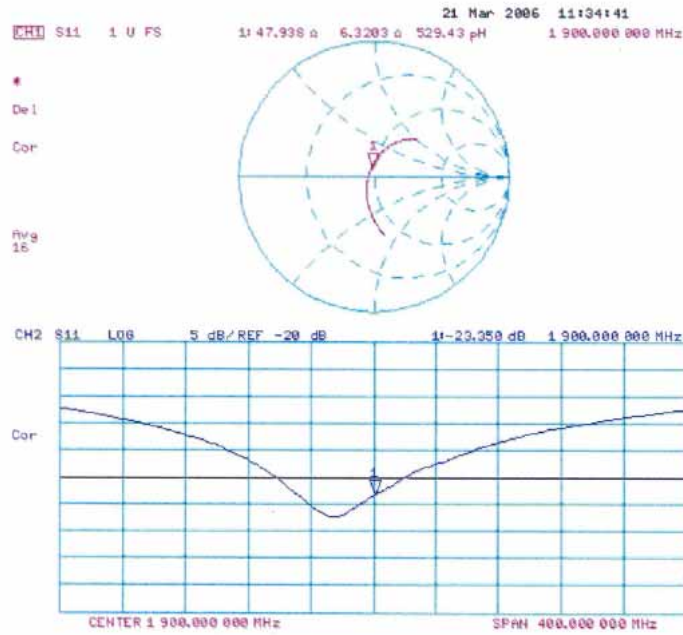



Calibration Laboratory of Schmid & Partner Engineering AG



S Schweizerischer Kalibrierdienst
C Service suisse d'etalonnage
S Servizio svizzero di taratura
S Swiss Calibration Service

Accredited by the Swiss Federal Office of Metrology and Accreditation
The Swiss Accreditation Service is one of the signatories to the EA Multilateral Agreement for the recognition of calibration certificates

Accreditation No.: SCS 108

Client Sporton (Auden)

Certificate No: D2450V2-736\_Jul05

CALIBRATION CERTIFICATE

Object: D2450V2 - SN: 736
Calibration procedure(s): QA CAL-05.v6
Calibration procedure for dipole validation kits
Calibration date: July 12, 2005
Condition of the calibrated item: In Tolerance

This calibration certificate documents the traceability to national standards, which realize the physical units of measurements (SI).

All calibrations have been conducted in the closed laboratory facility: environment temperature (22 ± 3)°C and humidity < 70%.

Calibration Equipment used (M&TE critical for calibration)

Table with 4 columns: Primary Standards, ID #, Cal Date (Calibrated by, Certificate No.), Scheduled Calibration. Lists equipment like Power meter EPM E442, Power sensor HP 8481A, etc.

Table with 4 columns: Secondary Standards, ID #, Check Date (in house), Scheduled Check. Lists equipment like Power sensor HP 8481A, RF generator R&S SML-03, etc.

Calibrated by: Name: Mike Meli, Function: Laboratory Technician, Signature: [Handwritten]

Approved by: Name: Katja Pokovic, Function: Technical Manager, Signature: [Handwritten]

Issued: July 12, 2005

This calibration certificate shall not be reproduced except in full without written approval of the laboratory.



Calibration Laboratory of  
Schmid & Partner  
Engineering AG  
Zaughausstrasse 43, 8004 Zurich, Switzerland



S Schweizerischer Kalibrierdienst  
C Service suisse d'étalonnage  
S Servizio svizzero di taratura  
S Swiss Calibration Service

Accredited by the Swiss Federal Office of Metrology and Accreditation  
The Swiss Accreditation Service is one of the signatories to the EA  
Multilateral Agreement for the recognition of calibration certificates

Accreditation No.: SCS 108

**Glossary:**

TSL tissue simulating liquid  
ConvF sensitivity in TSL / NORM x,y,z  
N/A not applicable or not measured

**Calibration is Performed According to the Following Standards:**

- a) IEEE Std 1528-2003, "IEEE Recommended Practice for Determining the Peak Spatial-Averaged Specific Absorption Rate (SAR) in the Human Head from Wireless Communications Devices: Measurement Techniques", December 2003
- b) CENELEC EN 50361, "Basic standard for the measurement of Specific Absorption Rate related to human exposure to electromagnetic fields from mobile phones (300 MHz - 3 GHz), July 2001
- c) Federal Communications Commission Office of Engineering & Technology (FCC OET), "Evaluating Compliance with FCC Guidelines for Human Exposure to Radiofrequency Electromagnetic Fields; Additional Information for Evaluating Compliance of Mobile and Portable Devices with FCC Limits for Human Exposure to Radiofrequency Emissions", Supplement C (Edition 01-01) to Bulletin 65

**Additional Documentation:**

- d) DASY4 System Handbook

**Methods Applied and Interpretation of Parameters:**

- *Measurement Conditions:* Further details are available from the Validation Report at the end of the certificate. All figures stated in the certificate are valid at the frequency indicated.
- *Antenna Parameters with TSL:* The dipole is mounted with the spacer to position its feed point exactly below the center marking of the flat phantom section, with the arms oriented parallel to the body axis.
- *Feed Point Impedance and Return Loss:* These parameters are measured with the dipole positioned under the liquid filled phantom. The impedance stated is transformed from the measurement at the SMA connector to the feed point. The Return Loss ensures low reflected power. No uncertainty required.
- *Electrical Delay:* One-way delay between the SMA connector and the antenna feed point. No uncertainty required.
- *SAR measured:* SAR measured at the stated antenna input power.
- *SAR normalized:* SAR as measured, normalized to an input power of 1 W at the antenna connector.
- *SAR for nominal TSL parameters:* The measured TSL parameters are used to calculate the nominal SAR result.



Measurement Conditions

DASY system configuration, as far as not given on page 1.

DASY Version	DASY4	V4.6
Extrapolation	Advanced Extrapolation	
Phantom	Modular Flat Phantom V5.0	
Distance Dipole Center - TSL	10 mm	with Spacer
Area Scan resolution	dx, dy = 15 mm	
Zoom Scan Resolution	dx, dy, dz = 5 mm	
Frequency	2450 MHz ± 1 MHz	

Head TSL parameters

The following parameters and calculations were applied.

	Temperature	Permittivity	Conductivity
Nominal Head TSL parameters	22.0 °C	39.2	1.80 mho/m
Measured Head TSL parameters	(22.0 ± 0.2) °C	38.5 ± 6 %	1.73 mho/m ± 6 %
Head TSL temperature during test	(22.0 ± 0.2) °C	----	----

SAR result with Head TSL

SAR averaged over 1 cm <sup>3</sup> (1 g) of Head TSL	condition	
SAR measured	250 mW input power	13.1 mW / g
SAR normalized	normalized to 1W	52.4 mW / g
SAR for nominal Head TSL parameters <sup>1</sup>	normalized to 1W	<b>52.8 mW / g ± 17.0 % (k=2)</b>

SAR averaged over 10 cm <sup>3</sup> (10 g) of Head TSL	condition	
SAR measured	250 mW input power	6.13 mW / g
SAR normalized	normalized to 1W	24.5 mW / g
SAR for nominal Head TSL parameters <sup>1</sup>	normalized to 1W	<b>24.7 mW / g ± 16.5 % (k=2)</b>

<sup>1</sup> Correction to nominal TSL parameters according to d), chapter "SAR Sensitivities"



**Body TSL parameters**

The following parameters and calculations were applied.

	Temperature	Permittivity	Conductivity
Nominal Body TSL parameters	22.0 °C	52.7	1.95 mho/m
Measured Body TSL parameters	(22.2 ± 0.2) °C	52.5 ± 6 %	2.02 mho/m ± 8 %
Body TSL temperature during test	(22.2 ± 0.2) °C	----	----

**SAR result with Body TSL**

SAR averaged over 1 cm <sup>3</sup> (1 g) of Body TSL	condition	
SAR measured	250 mW input power	13.5 mW / g
SAR normalized	normalized to 1W	54.0 mW / g
SAR for nominal Body TSL parameters <sup>2</sup>	normalized to 1W	<b>52.8 mW / g ± 17.0 % (k=2)</b>

SAR averaged over 10 cm <sup>3</sup> (10 g) of Body TSL	condition	
SAR measured	250 mW input power	6.26 mW / g
SAR normalized	normalized to 1W	25.0 mW / g
SAR for nominal Body TSL parameters <sup>2</sup>	normalized to 1W	<b>24.5 mW / g ± 16.5 % (k=2)</b>

<sup>2</sup> Correction to nominal TSL parameters according to d), chapter "SAR Sensitivities"





**Appendix**

**Antenna Parameters with Head TSL**

Impedance, transformed to feed point	53.6 $\Omega$ + 3.7 j $\Omega$
Return Loss	-26.0 dB

**Antenna Parameters with Body TSL**

Impedance, transformed to feed point	49.9 $\Omega$ + 5.3 j $\Omega$
Return Loss	- 25.5 dB

**General Antenna Parameters and Design**

Electrical Delay (one direction)	1.157 ns
----------------------------------	----------

After long term use with 100W radiated power, only a slight warming of the dipole near the feedpoint can be measured.

The dipole is made of standard semirigid coaxial cable. The center conductor of the feeding line is directly connected to the second arm of the dipole. The antenna is therefore short-circuited for DC-signals. No excessive force must be applied to the dipole arms, because they might bend or the soldered connections near the feedpoint may be damaged.

**Additional EUT Data**

Manufactured by	SPEAG
Manufactured on	August 26, 2003



**DASY4 Validation Report for Head TSL**

Date/Time: 12.07.2005 12:53:00

Test Laboratory: SPEAG, Zurich, Switzerland

**DUT: Dipole 2450 MHz; Type: D2450V2; Serial: D2450V2 - SN736**

Communication System: CW-2450; Frequency: 2450 MHz; Duty Cycle: 1:1

Medium: HSL U10 BB

Medium parameters used:  $f = 2450$  MHz;  $\sigma = 1.73$  mho/m;  $\epsilon_r = 38.5$ ;  $\rho = 1000$  kg/m<sup>3</sup>

Phantom section: Flat Section

Measurement Standard: DASY4 (High Precision Assessment)

**DASY4 Configuration:**

- Probe: ES3DV2 - SN3025; ConvF(4.4, 4.4, 4.4); Calibrated: 29.10.2004
- Sensor-Surface: 4mm (Mechanical Surface Detection)
- Electronics: DA14 Sn601; Calibrated: 22.07.2004
- Phantom: Flat Phantom 5.0 (front); Type: QD000P50AA
- Measurement SW: DASY4, V4.5 Build 30; Postprocessing SW: SEMCAD, V1.8 Build 149

**Pin = 250 mW; d = 10 mm 2/Area Scan (41x61x1):**

Measurement grid: dx=15mm, dy=15mm

Maximum value of SAR (interpolated) = 16.6 mW/g

**Pin = 250 mW; d = 10 mm 2/Zoom Scan (7x7x7)/Cube 0:**

Measurement grid: dx=5mm, dy=5mm, dz=5mm

Reference Value = 91.6 V/m; Power Drift = 0.077 dB

Peak SAR (extrapolated) = 27.0 W/kg

**SAR(1 g) = 13.1 mW/g; SAR(10 g) = 6.13 mW/g**

Maximum value of SAR (measured) = 15.0 mW/g

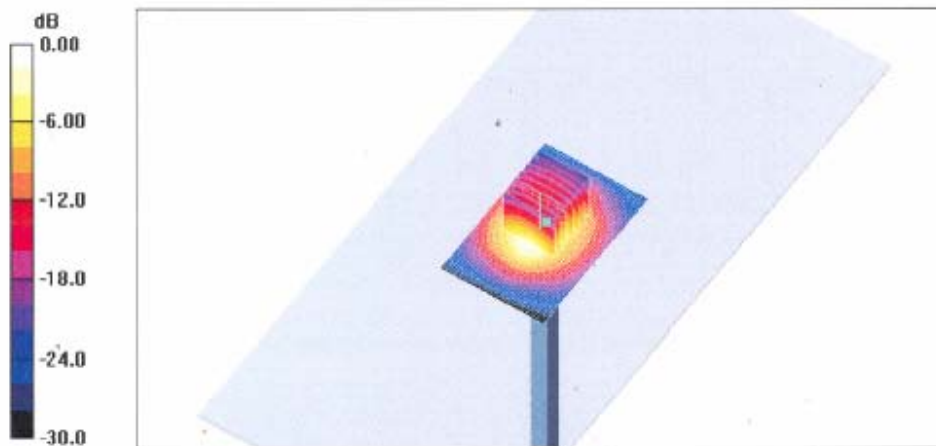



Impedance Measurement Plot for Head TSL

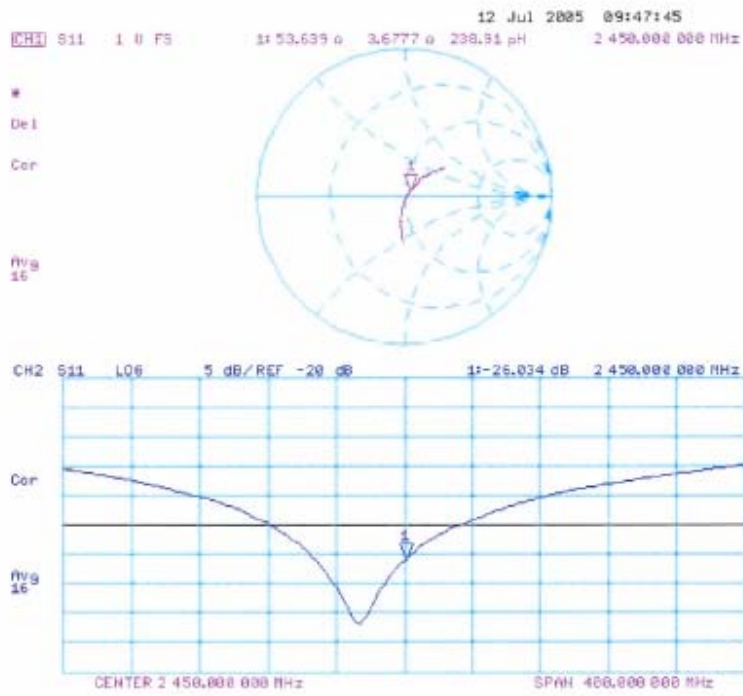



DASY4 Validation Report for Body TSL

Date/Time: 11.07.2005 17:33:35

Test Laboratory: SPEAG, Zurich, Switzerland

DUT: Dipole 2450 MHz; Type: D2450V2; Serial: D2450V2 - SN736

Communication System: CW-2450; Frequency: 2450 MHz; Duty Cycle: 1:1

Medium: MSL 2450

Medium parameters used:  $f = 2450$  MHz;  $\sigma = 2.02$  mho/m;  $\epsilon_r = 52.5$ ;  $\rho = 1000$  kg/m<sup>3</sup>

Phantom section: Flat Section

Measurement Standard: DASY4 (High Precision Assessment)

DASY4 Configuration:

- Probe: ES3DV2 - SN3025; ConvF(4.13, 4.13, 4.13); Calibrated: 29.10.2004
- Sensor-Surface: 4mm (Mechanical Surface Detection)
- Electronics: DAE4 Sn601; Calibrated: 22.07.2004
- Phantom: Flat Phantom 5.0 (front); Type: QD000P50AA
- Measurement SW: DASY4, V4.6 Build 4; Postprocessing SW: SEMCAD, V1.8 Build 149

Pin = 250 mW; d = 10 mm/Area Scan (81x81x1):

Measurement grid: dx=15mm, dy=15mm

Maximum value of SAR (interpolated) = 15.8 mW/g

Pin = 250 mW; d = 10 mm/Zoom Scan (7x7x7)/Cube 0:

Measurement grid: dx=5mm, dy=5mm, dz=5mm

Reference Value = 85.9 V/m; Power Drift = 0.160 dB

Peak SAR (extrapolated) = 27.6 W/kg

SAR(1 g) = 13.5 mW/g; SAR(10 g) = 6.26 mW/g

Maximum value of SAR (measured) = 15.5 mW/g

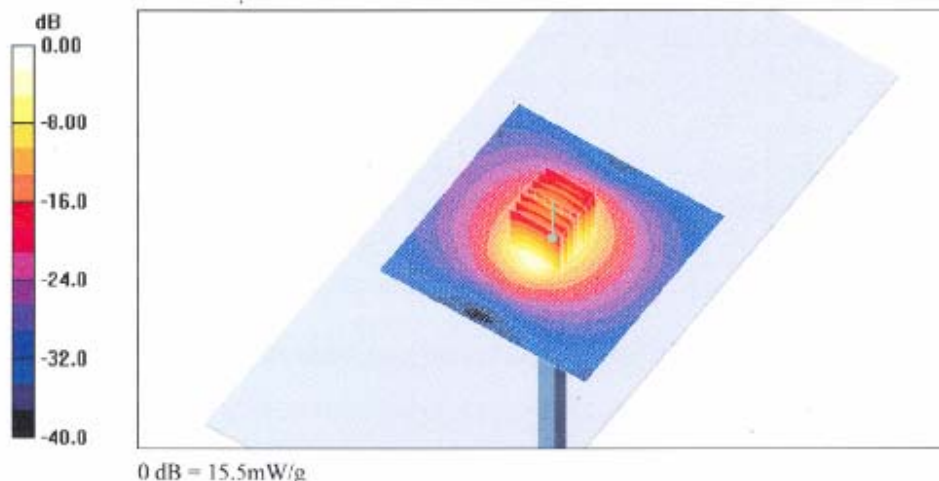



Impedance Measurement Plot for Body TSL

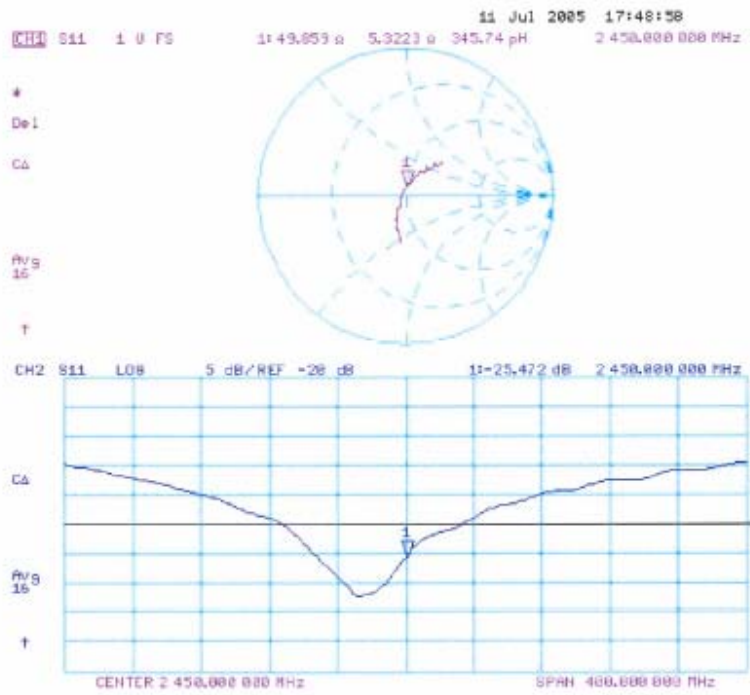





Calibration Laboratory of Schmid & Partner Engineering AG



S Schweizerischer Kalibrierdienst
C Service suisse d'etalonnage
S Servizio svizzero di taratura
S Swiss Calibration Service

Accredited by the Swiss Federal Office of Metrology and Accreditation
The Swiss Accreditation Service is one of the signatories to the EA Multilateral Agreement for the recognition of calibration certificates

Accreditation No.: SCS 108

Client Sporton (Auden)

Certificate No: ET3-1788\_Sep06

CALIBRATION CERTIFICATE

Object: ET3DV6 - SN:1788
Calibration procedure(s): QA CAL-01.v5
Calibration procedure for dosimetric E-field probes
Calibration date: September 19, 2006
Condition of the calibrated item: In Tolerance

This calibration certificate documents the traceability to national standards, which realize the physical units of measurements (SI).

All calibrations have been conducted in the closed laboratory facility; environment temperature (22 ± 3)°C and humidity < 70%.

Calibration Equipment used (M&TE critical for calibration)

Table with 4 columns: Primary Standards, ID #, Cal Date (Calibrated by, Certificate No.), Scheduled Calibration. Lists equipment like Power meter E4419B, Reference 3 dB Attenuator, etc.

Table with 4 columns: Secondary Standards, ID #, Check Date (in house), Scheduled Check. Lists equipment like RF generator HP 8645C, Network Analyzer HP 8753E.

Calibrated by: Katja Pokovic, Technical Manager
Approved by: Niels Kuster, Quality Manager

Issued: September 19, 2006

This calibration certificate shall not be reproduced except in full without written approval of the laboratory.



Calibration Laboratory of  
Schmid & Partner  
Engineering AG  
Zeughausstrasse 43, 8004 Zurich, Switzerland



S Schweizerischer Kalibrierdienst  
C Service suisse d'étalonnage  
S Servizio svizzero di taratura  
S Swiss Calibration Service

Accredited by the Swiss Federal Office of Metrology and Accreditation  
The Swiss Accreditation Service is one of the signatories to the EA  
Multilateral Agreement for the recognition of calibration certificates

Accreditation No.: SCS 108

**Glossary:**

TSL	tissue simulating liquid
NORM <sub>x,y,z</sub>	sensitivity in free space
ConvF	sensitivity in TSL / NORM <sub>x,y,z</sub>
DCP	diode compression point
Polarization $\varphi$	$\varphi$ rotation around probe axis
Polarization $\vartheta$	$\vartheta$ rotation around an axis that is in the plane normal to probe axis (at measurement center), i.e., $\vartheta = 0$ is normal to probe axis

**Calibration is Performed According to the Following Standards:**

- a) IEEE Std 1528-2003, "IEEE Recommended Practice for Determining the Peak Spatial-Averaged Specific Absorption Rate (SAR) in the Human Head from Wireless Communications Devices: Measurement Techniques", December 2003
- b) CENELEC EN 50361, "Basic standard for the measurement of Specific Absorption Rate related to human exposure to electromagnetic fields from mobile phones (300 MHz - 3 GHz), July 2001

**Methods Applied and Interpretation of Parameters:**

- **NORM<sub>x,y,z</sub>**: Assessed for E-field polarization  $\vartheta = 0$  ( $f \leq 900$  MHz in TEM-cell;  $f > 1800$  MHz: R22 waveguide). NORM<sub>x,y,z</sub> are only intermediate values, i.e., the uncertainties of NORM<sub>x,y,z</sub> does not effect the E<sup>2</sup>-field uncertainty inside TSL (see below ConvF).
- **NORM(f)<sub>x,y,z</sub>** = NORM<sub>x,y,z</sub> \* frequency\_response (see Frequency Response Chart). This linearization is implemented in DASY4 software versions later than 4.2. The uncertainty of the frequency response is included in the stated uncertainty of ConvF.
- **DCP<sub>x,y,z</sub>**: DCP are numerical linearization parameters assessed based on the data of power sweep (no uncertainty required). DCP does not depend on frequency nor media.
- **ConvF and Boundary Effect Parameters**: Assessed in flat phantom using E-field (or Temperature Transfer Standard for  $f \leq 800$  MHz) and inside waveguide using analytical field distributions based on power measurements for  $f > 800$  MHz. The same setups are used for assessment of the parameters applied for boundary compensation (alpha, depth) of which typical uncertainty values are given. These parameters are used in DASY4 software to improve probe accuracy close to the boundary. The sensitivity in TSL corresponds to NORM<sub>x,y,z</sub> \* ConvF whereby the uncertainty corresponds to that given for ConvF. A frequency dependent ConvF is used in DASY version 4.4 and higher which allows extending the validity from  $\pm 50$  MHz to  $\pm 100$  MHz.
- **Spherical isotropy (3D deviation from isotropy)**: in a field of low gradients realized using a flat phantom exposed by a patch antenna.
- **Sensor Offset**: The sensor offset corresponds to the offset of virtual measurement center from the probe tip (on probe axis). No tolerance required.



ET3DV6 SN:1788

September 19, 2006

# Probe ET3DV6

## SN:1788

Manufactured:	May 28, 2003
Last calibrated:	September 30, 2004
Recalibrated:	September 19, 2006

Calibrated for DASY Systems

(Note: non-compatible with DASY2 system!)



ET3DV6 SN:1788

September 19, 2006

DASY - Parameters of Probe: ET3DV6 SN:1788

Sensitivity in Free Space<sup>A</sup>

Diode Compression<sup>B</sup>

NormX	1.73 ± 10.1%	μV/(V/m) <sup>2</sup>	DCP X	95 mV
NormY	1.67 ± 10.1%	μV/(V/m) <sup>2</sup>	DCP Y	101 mV
NormZ	1.70 ± 10.1%	μV/(V/m) <sup>2</sup>	DCP Z	93 mV

Sensitivity in Tissue Simulating Liquid (Conversion Factors)

Please see Page 8.

Boundary Effect

TSL 900 MHz Typical SAR gradient: 5 % per mm

Sensor Center to Phantom Surface Distance		3.7 mm	4.7 mm
SAR <sub>tsa</sub> [%]	Without Correction Algorithm	7.9	4.3
SAR <sub>tsa</sub> [%]	With Correction Algorithm	0.1	0.3

TSL 1810 MHz Typical SAR gradient: 10 % per mm

Sensor Center to Phantom Surface Distance		3.7 mm	4.7 mm
SAR <sub>tsa</sub> [%]	Without Correction Algorithm	11.8	7.0
SAR <sub>tsa</sub> [%]	With Correction Algorithm	0.2	0.4

Sensor Offset

Probe Tip to Sensor Center 2.7 mm

The reported uncertainty of measurement is stated as the standard uncertainty of measurement multiplied by the coverage factor k=2, which for a normal distribution corresponds to a coverage probability of approximately 95%.

<sup>A</sup> The uncertainties of NormX,Y,Z do not affect the E<sup>2</sup>-field uncertainty inside TSL (see Page 8).

<sup>B</sup> Numerical linearization parameter; uncertainty not required.



ET3DV6 SN:1788

September 19, 2006

### Frequency Response of E-Field

(TEM-Cell:ifi110 EXX, Waveguide: R22)

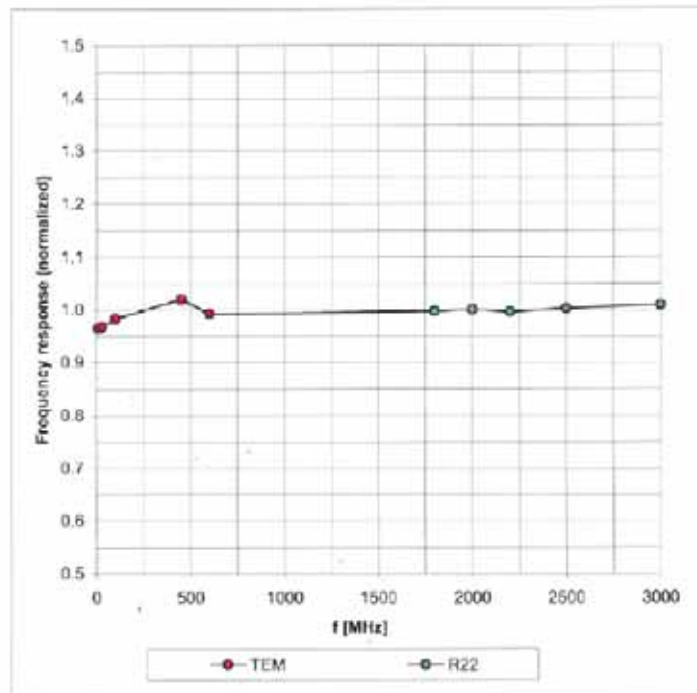

Uncertainty of Frequency Response of E-field:  $\pm 6.3\%$  (k=2)





ET3DV6 SN:1788

September 19, 2006

### Receiving Pattern ( $\phi$ ), $\theta = 0^\circ$

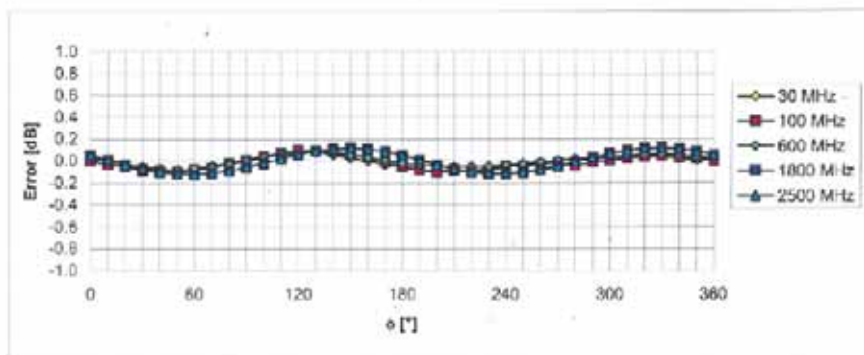
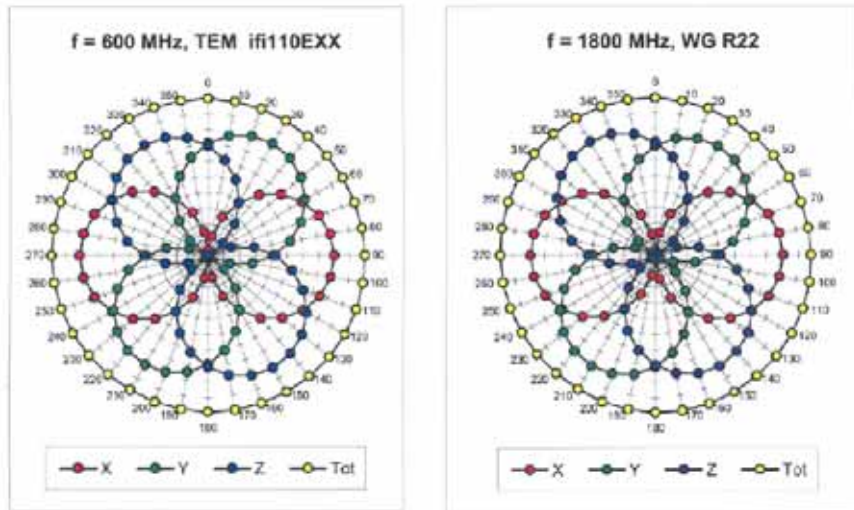

Uncertainty of Axial Isotropy Assessment:  $\pm 0.5\%$  ( $k=2$ )



ET3DV6 SN:1788

September 19, 2006

### Dynamic Range f(SAR<sub>head</sub>) (Waveguide R22, f = 1800 MHz)

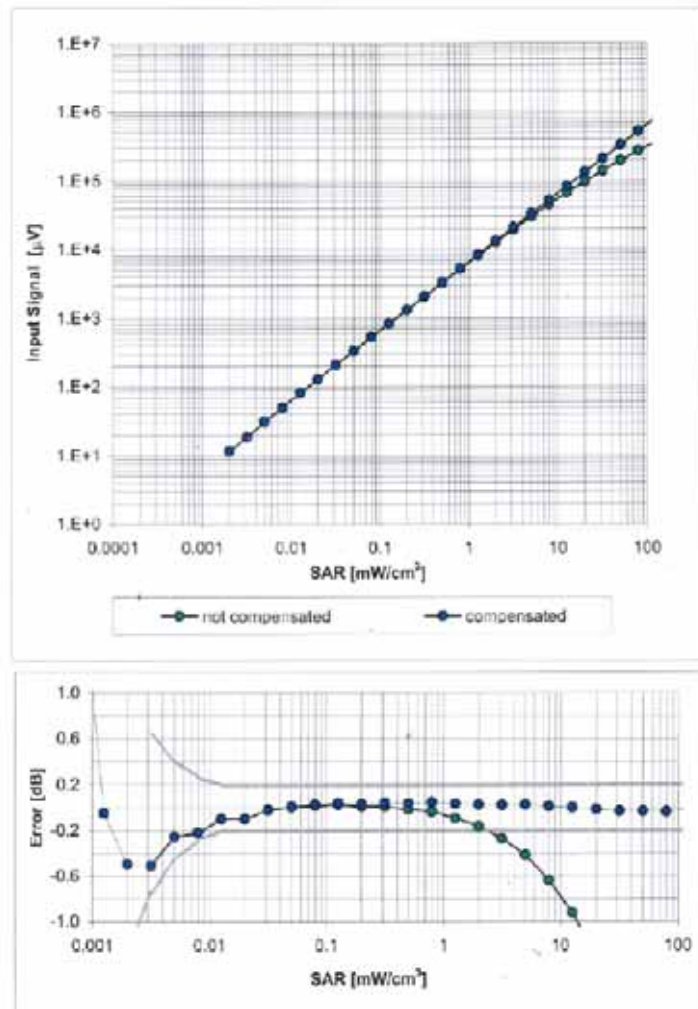

Uncertainty of Linearity Assessment: ± 0.6% (k=2)



ET3DV6 SN:1788

September 19, 2006

### Conversion Factor Assessment

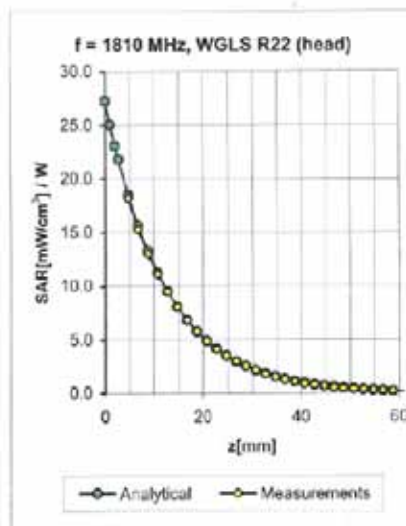
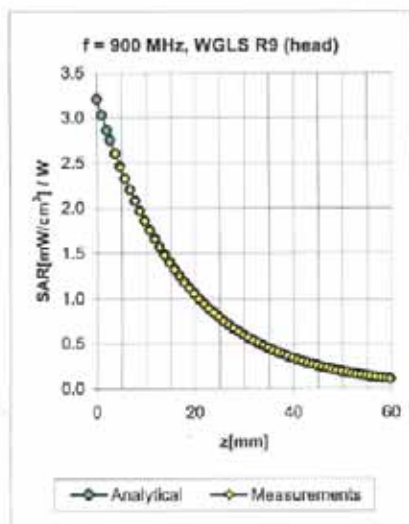

f [MHz]	Validity [MHz] <sup>6</sup>	TSL	Permittivity	Conductivity	Alpha	Depth	ConvF	Uncertainty
900	± 50 / ± 100	Head	41.5 ± 5%	0.97 ± 5%	0.49	1.94	6.60	± 11.0% (k=2)
1810	± 50 / ± 100	Head	40.0 ± 5%	1.40 ± 5%	0.48	2.74	5.30	± 11.0% (k=2)
2000	± 50 / ± 100	Head	40.0 ± 5%	1.40 ± 5%	0.53	2.75	5.00	± 11.0% (k=2)
2450	± 50 / ± 100	Head	39.2 ± 5%	1.80 ± 5%	0.68	1.96	4.66	± 11.8% (k=2)
900	± 50 / ± 100	Body	55.0 ± 5%	1.05 ± 5%	0.45	2.12	6.33	± 11.0% (k=2)
1810	± 50 / ± 100	Body	53.3 ± 5%	1.52 ± 5%	0.59	2.89	4.67	± 11.0% (k=2)
2000	± 50 / ± 100	Body	53.3 ± 5%	1.52 ± 5%	0.56	2.79	4.50	± 11.0% (k=2)
2450	± 50 / ± 100	Body	52.7 ± 5%	1.95 ± 5%	0.60	1.70	4.11	± 11.8% (k=2)

<sup>6</sup> The validity of ± 100 MHz only applies for DASY v4.4 and higher (see Page 2). The uncertainty is the RSS of the ConvF uncertainty at calibration frequency and the uncertainty for the indicated frequency band.



ET3DV6 SN:1788

September 19, 2006

### Deviation from Isotropy in HSL

Error ( $\phi, \theta$ ),  $f = 900$  MHz

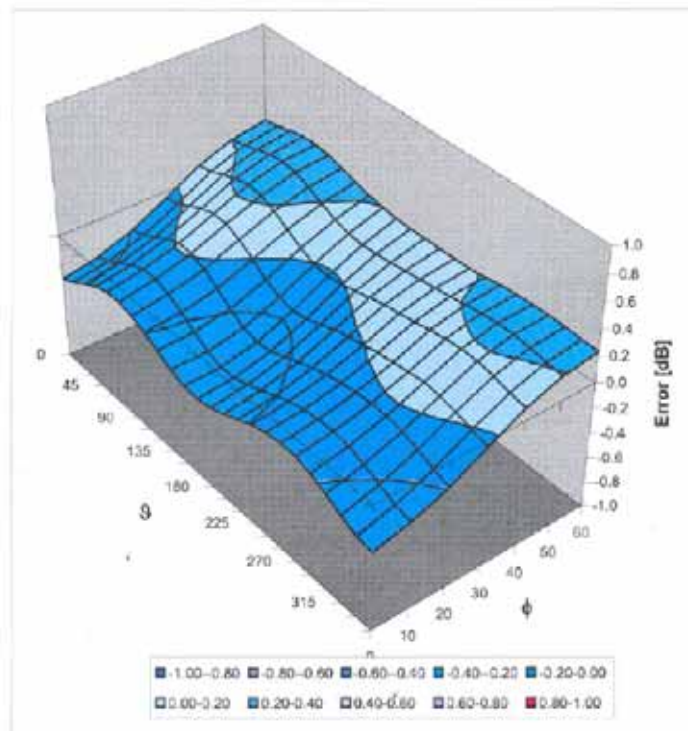

Uncertainty of Spherical Isotropy Assessment:  $\pm 2.6\%$  ( $k=2$ )



Calibration Laboratory of  
Schmid & Partner  
Engineering AG  
Zeughausstrasse 43, 8004 Zurich, Switzerland



S Schweizerischer Kalibrierdienst  
C Service suisse d'étalonnage  
S Servizio svizzero di taratura  
S Swiss Calibration Service

Accredited by the Swiss Federal Office of Metrology and Accreditation  
The Swiss Accreditation Service is one of the signatories to the EA  
Multilateral Agreement for the recognition of calibration certificates

Accreditation No.: SCS 108

Client Sporton (Auden)

Certificate No: DAE3-577\_Nov06

**CALIBRATION CERTIFICATE**

Object: DAE3 - SD 000 D03 AA - SN: 577

Calibration procedure(s): QA CAL-06.v12  
Calibration procedure for the data acquisition electronics (DAE)

Calibration date: November 21, 2006

Condition of the calibrated item: In Tolerance

This calibration certificate documents the traceability to national standards, which realize the physical units of measurements (SI). The measurements and the uncertainties with confidence probability are given on the following pages and are part of the certificate.

All calibrations have been conducted in the closed laboratory facility: environment temperature (22 ± 3)°C and humidity < 70%.

Calibration Equipment used (M&TE critical for calibration)

Primary Standards	ID #	Cal Date (Calibrated by, Certificate No.)	Scheduled Calibration
Fuke Process Calibrator Type 702	SN: 6295503	13-Oct-06 (Eical AG, No: 5492)	Oct-07
Kelthley Multimeter Type 2001	SN: 0810278	03-Oct-06 (Eical AG, No: 5478)	Oct-07
Secondary Standards	ID #	Check Date (in house)	Scheduled Check
Calibrator Box VI.1	SE UMS 006 AB 1002	15-Jun-06 (SPEAG, in house check)	In house check Jun-07

	Name	Function	Signature
Calibrated by:	Eric Hainfeld	Technician	
Approved by:	Fin Bornhoff	R&D Director	

Issued: November 21, 2006

This calibration certificate shall not be reproduced except in full without written approval of the laboratory.





Calibration Laboratory of  
Schmid & Partner  
Engineering AG  
Zeughausstrasse 43, 8004 Zurich, Switzerland



S Schweizerischer Kalibrierdienst  
C Service suisse d'étalonnage  
S Servizio svizzero di taratura  
S Swiss Calibration Service

Accredited by the Swiss Federal Office of Metrology and Accreditation  
The Swiss Accreditation Service is one of the signatories to the EA  
Multilateral Agreement for the recognition of calibration certificates

Accreditation No.: SCS 108

### Glossary

DAE data acquisition electronics  
Connector angle information used in DASY system to align probe sensor X to the robot coordinate system.

### Methods Applied and Interpretation of Parameters

- **DC Voltage Measurement:** Calibration Factor assessed for use in DASY system by comparison with a calibrated instrument traceable to national standards. The figure given corresponds to the full scale range of the voltmeter in the respective range.
- **Connector angle:** The angle of the connector is assessed measuring the angle mechanically by a tool inserted. Uncertainty is not required.
- The following parameters contain technical information as a result from the performance test and require no uncertainty.
- **DC Voltage Measurement Linearity:** Verification of the Linearity at +10% and -10% of the nominal calibration voltage. Influence of offset voltage is included in this measurement.
- **Common mode sensitivity:** Influence of a positive or negative common mode voltage on the differential measurement.
- **Channel separation:** Influence of a voltage on the neighbor channels not subject to an input voltage.
- **AD Converter Values with Inputs shorted:** Values on the internal AD converter corresponding to zero input voltage
- **Input Offset Measurement:** Output voltage and statistical results over a large number of zero voltage measurements.
- **Input Offset Current:** Typical value for information; Maximum channel input offset current, not considering the input resistance.
- **Input resistance:** DAE input resistance at the connector, during internal auto-zeroing and during measurement.
- **Low Battery Alarm Voltage:** Typical value for information. Below this voltage, a battery alarm signal is generated.
- **Power consumption:** Typical value for information. Supply currents in various operating modes.



**DC Voltage Measurement**

A/D - Converter Resolution nominal

High Range: 1LSB = 6.1µV, full range = -100...+300 mV  
Low Range: 1LSB = 81mV, full range = -1.....+3mV

DASY measurement parameters: Auto Zero Time: 3 sec; Measuring time: 3 sec

Calibration Factors	X	Y	Z
High Range	404.355 ± 0.1% (k=2)	403.806 ± 0.1% (k=2)	404.276 ± 0.1% (k=2)
Low Range	3.92854 ± 0.7% (k=2)	3.93862 ± 0.7% (k=2)	3.93591 ± 0.7% (k=2)

**Connector Angle**

Connector Angle to be used in DASY system	268 ° ± 1 °
---	-------------



Appendix

1. DC Voltage Linearity

High Range	Input (µV)	Reading (µV)	Error (%)
Channel X + Input	200000	199999.5	0.00
Channel X + Input	20000	20005.07	0.03
Channel X - Input	20000	-19998.71	-0.01
Channel Y + Input	200000	200000	0.00
Channel Y + Input	20000	20004.22	0.02
Channel Y - Input	20000	-20003.23	0.02
Channel Z + Input	200000	200000.8	0.00
Channel Z + Input	20000	20005.24	0.03
Channel Z - Input	20000	-20001.80	0.01

Low Range	Input (µV)	Reading (µV)	Error (%)
Channel X + Input	2000	1999.9	0.00
Channel X + Input	200	200.27	0.13
Channel X - Input	200	-200.73	0.36
Channel Y + Input	2000	2000.1	0.00
Channel Y + Input	200	199.22	-0.39
Channel Y - Input	200	-200.86	0.43
Channel Z + Input	2000	1999.9	0.00
Channel Z + Input	200	199.28	-0.36
Channel Z - Input	200	-200.94	0.47

2. Common mode sensitivity

DASY measurement parameters: Auto Zero Time: 3 sec; Measuring time: 3 sec

	Common mode Input Voltage (mV)	High Range Average Reading (µV)	Low Range Average Reading (µV)
Channel X	200	14.24	12.49
	-200	-12.13	-12.62
Channel Y	200	-6.51	-7.06
	-200	6.05	5.81
Channel Z	200	1.09	0.86
	-200	-2.86	-2.63

3. Channel separation

DASY measurement parameters: Auto Zero Time: 3 sec; Measuring time: 3 sec

	Input Voltage (mV)	Channel X (µV)	Channel Y (µV)	Channel Z (µV)
Channel X	200	-	2.51	0.09
Channel Y	200	0.43	-	3.37
Channel Z	200	-0.55	0.98	-



4. AD-Converter Values with inputs shorted

DASY measurement parameters: Auto Zero Time: 3 sec; Measuring time: 3 sec

	High Range (LSB)	Low Range (LSB)
Channel X	15970	16306
Channel Y	15851	16305
Channel Z	16208	17088

5. Input Offset Measurement

DASY measurement parameters: Auto Zero Time: 3 sec; Measuring time: 3 sec

Input 10MΩ

	Average (μV)	min. Offset (μV)	max. Offset (μV)	Std. Deviation (μV)
Channel X	-0.51	-1.55	0.47	0.50
Channel Y	-2.06	-4.32	-0.65	0.60
Channel Z	-1.63	-2.56	-0.15	0.35

6. Input Offset Current

Nominal input circuitry offset current on all channels: <25fA

7. Input Resistance

	Zeroing (MOhm)	Measuring (MOhm)
Channel X	0.2000	199.8
Channel Y	0.2000	200.7
Channel Z	0.2000	199.8

8. Low Battery Alarm Voltage (verified during pre test)

Typical values	Alarm Level (VDC)
Supply (+ Vcc)	+7.9
Supply (- Vcc)	-7.6

9. Power Consumption (verified during pre test)

Typical values	Switched off (mA)	Stand by (mA)	Transmitting (mA)
Supply (+ Vcc)	+0.0	+6	+14
Supply (- Vcc)	-0.01	-6	-9



## Appendix D - WCDMA Test Mode

### 1. Conducted Output Power

RMC 144 kbps is the main WCDMA test mode for both EMC and SAR reports. A detailed analysis of the output power for all WCDMA modes is provided in the table below. The EUT supports DPDCH1 and HSDPA with a various of data rates, such as 12.2Kbps, 64kbps, 144Kbps and 384Kbps.

Mode	Symbol Rates (Kbps)	SF	K	Data	Reference Channel Type (Data Rates)	Band II			Band V		
						Ch 9262	Ch 9400	Ch 9538	Ch 4132	Ch 4182	Ch 4233
						1852.4	1880.0	1907.6	826.4	836.4	846.6
DPDCH1	60	64	2	40	RMC 12.2 Kbps	23.12	23.36	23.63	23.91	23.87	23.94
	240	16	4	160	RMC 64 Kbps	22.94	23.49	23.59	23.91	23.92	23.89
	480	8	5	320	RMC 144 Kbps	23.10	23.15	23.68	23.93	23.81	23.96
	960	4	6	640	RMC 384 Kbps	23.28	23.13	23.47	23.92	23.81	23.88
HSDPA	60	64	2	40	RMC 12.2 Kbps	23.16	23.11	23.41	23.32	23.80	23.41

Data : Bits/Slot ; SF : Spreading Factor ; K : Number of bits per uplink DPDCH slot.

**Table 1 Conducted output power**

Followed by FCC suggestions[1]:

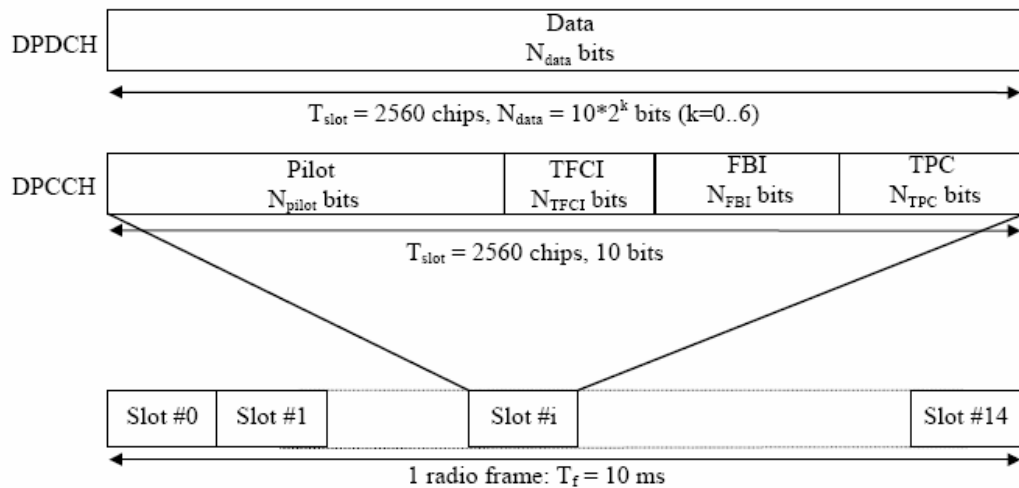

**Frame structure for uplink DPDCH/DPCCH**

The parameter K in the figure determines the number of bits per uplink DPDCH slot. It is related to the spreading factor SF of the DPDCH as  $SF = 256/2^k$ . The DPDCH spreading factor may range from 256 down to 4. The spreading factor of the uplink DPCCH is always equal to 256, i.e. there are 10 bits per uplink DPCCH slot.





	Channel Bit Rate (kbps)	Channel Symbol Rate (ksps)	Spreading Factor	Spreading Code Number	Bits/Slot
DPCCH	15	15	256	0	10
DPDCH <sub>1</sub>	15	15	256	64	10
	30	30	128	32	20
	60	60	64	16	40
	120	120	32	8	80
	240	240	16	4	160
	480	480	8	2	320
	960	960	4	1	640
DPDCH <sub>n</sub>	960	960	4	1, 2, 3	640

**Table 2 DPCCH and DPDCH**

There is only one DPCCH per radio link. Data rates, channelization codes and spread factor information for DPCCH and DPDCH<sub>n</sub> are indicated in the following Table. Spreading Rate (SF) \* Symbol Rate = 3.84 Mcps.



## 2. WCDMA Setup Configuration

- I. The EUT was connected to Spectrum Analyzer and Base Station via power splitter. Refer to the drawing of Setup Configuration.
- II. The RF path losses was compensated into the measurements.
- III. A call was established between EUT and Base Station with following setting
  - a. Data rates : Varied RMC for each measurements.
  - b. TPC with All Up
- IV. The transmitted maximum output power was recorded.

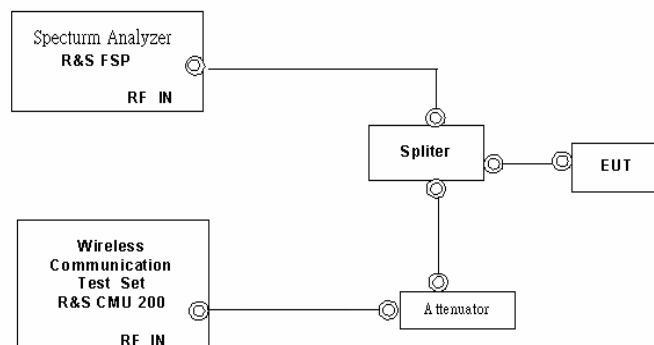

**Setup Configuration**

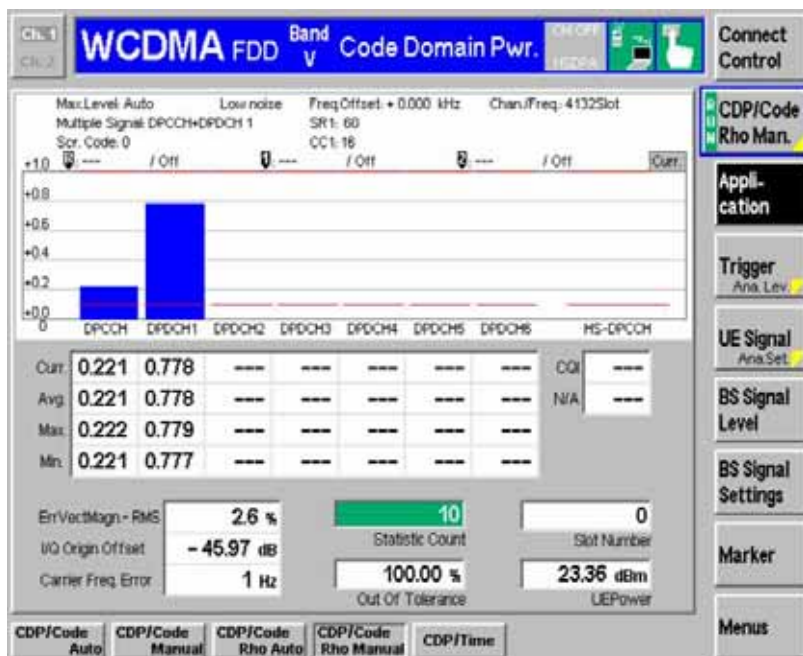

Single DPCH with only one DPDCH at RMC 12.2Kbps (Symbol Rate 60 Kbps)

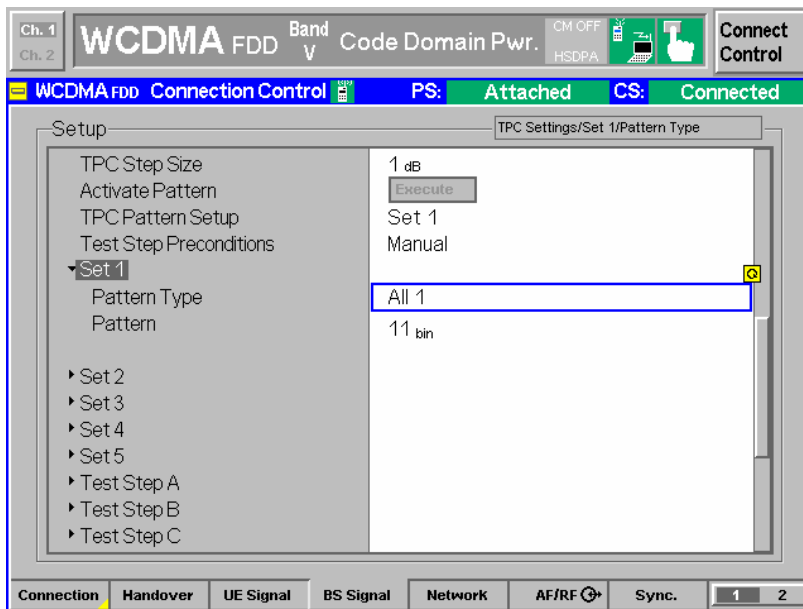

TPC with All "1" (Continuous transmitting)

### 3. HSDPA Setup Configuration

- I. The EUT was connected to Spectrum Analyzer and Base Station via power splitter. Refer to the drawing of Setup Configuration.
- II. The RF path losses was compensated into the measurements.
- III. A call was established between EUT and Base Station with following setting:
  - a. Set RMC12.2Kbps with HSDPA mode.
  - b. TPC with All Up with H-set.
- IV. The transmitted maximum output power was recorded.

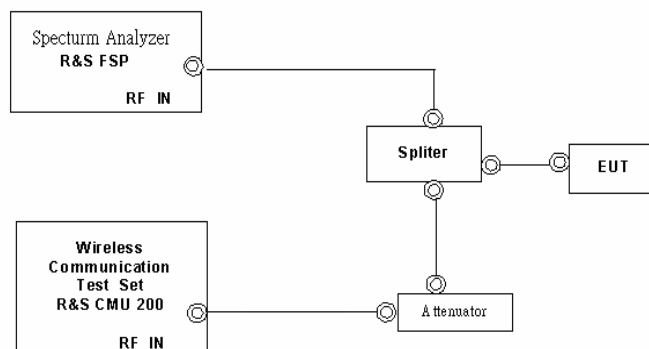

**Setup Configuration**

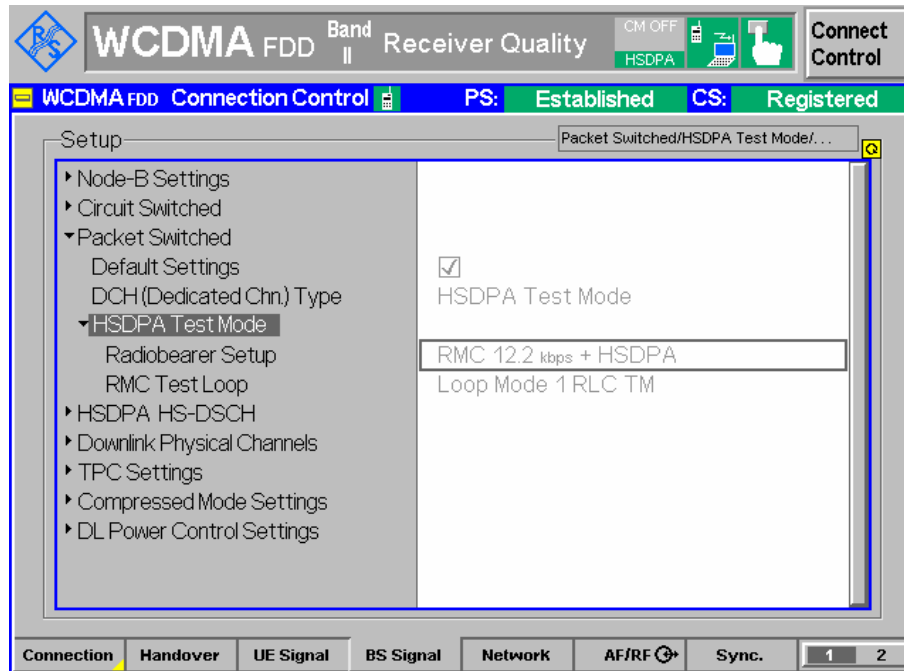

RMC 12.2Kbps with HSDPA function

**Reference:**

- [1.] SAR Measurement Procedures for 3G Devices CDMA 2000/Ev-Do/WCDMA/HSDPA June 2006 Laboratory Division Office of Engineering and Technology Federal Communications Commission
- [2.] TS 34.121 Universal Mobile Telecommunications System (UMTS); Terminal Conformance Specification, Radio Transmission and Reception (FDD)