

## DFS Test Report

**Report No.:** RF171218C14-4

**FCC ID:** NM82Q55200

**Model:** 2Q55200

**Received Date:** Dec. 18, 2017

**Test Date:** Jan. 11 ~ Jan. 26, 2018

**Issued Date:** Jan. 29, 2018

**Applicant:** HTC Corporation

**Address:** 88 Section 3, Zhongxing Road, Xindian District, New Taipei City 231, Taiwan

**Issued By:** Bureau Veritas Consumer Products Services (H.K.) Ltd., Taoyuan Branch

**Lab Address:** No. 47-2, 14th Ling, Chia Pau Vil., Lin Kou Dist., New Taipei City, Taiwan

**Test Location:** No. 19, Hwa Ya 2nd Rd., Wen Hwa Vil., Kwei Shan Dist., Taoyuan City  
33383, TAIWAN (R.O.C.)



This report is for your exclusive use. Any copying or replication of this report to or for any other person or entity, or use of our name or trademark, is permitted only with our prior written permission. This report sets forth our findings solely with respect to the test samples identified herein. The results set forth in this report are not indicative or representative of the quality or characteristics of the lot from which a test sample was taken or any similar or identical product unless specifically and expressly noted. Our report includes all of the tests requested by you and the results thereof based upon the information that you provided to us. You have 60 days from date of issuance of this report to notify us of any material error or omission caused by our negligence, provided, however, that such notice shall be in writing and shall specifically address the issue you wish to raise. A failure to raise such issue within the prescribed time shall constitute your unqualified acceptance of the completeness of this report, the tests conducted and the correctness of the report contents. Unless specific mention, the uncertainty of measurement has been explicitly taken into account to declare the compliance or non-compliance to the specification. The report must not be used by the client to claim product certification, approval, or endorsement by TAF or any government agencies.

## Table of Contents

<b>Release Control Record</b> .....	<b>3</b>
<b>1 Certificate of Conformity</b> .....	<b>4</b>
<b>2 EUT Information</b> .....	<b>5</b>
2.1 Operating Frequency Bands and Mode of EUT.....	5
2.2 EUT Hardware, Software and Firmware Version.....	5
2.3 Description of Available Antennas to the EUT.....	5
2.4 EUT Maximum Conducted Power.....	6
2.5 EUT Maximum E.I.R.P. Power.....	7
2.6 Transmit Power Control (TPC).....	8
2.7 Statement of Manufacturer.....	8
<b>3. U-NII DFS Rule Requirements</b> .....	<b>9</b>
3.1 Working Modes and Required Test Items.....	9
3.2 Test Limits and Radar Signal Parameters.....	10
<b>4. Test &amp; Support Equipment List</b> .....	<b>13</b>
4.1 Test Instruments.....	13
4.2 Description of Support Units.....	13
<b>5. Test Procedure</b> .....	<b>14</b>
5.1 DFS Measurement System.....	14
5.2 Calibration of DFS Detection Threshold Level.....	15
5.3 Deviation from Test Standard.....	16
5.4 Radiated Test Setup Configuration.....	16
5.4.1 Client without Radar Detection Mode.....	16
<b>6. Test Results</b> .....	<b>17</b>
6.1 Summary of Test Results.....	17
6.2 Test Results.....	18
6.2.1 Test Mode: Device Operating In Client without Radar Detection Mode.....	18
6.2.2 Channel Closing Transmission and Channel Move Time.....	19
6.2.3 Non-Occupancy Period.....	22
6.2.4 Non-Associated Test.....	23
6.2.5 Non-Co-Channel Test.....	23
<b>7. Information on the Testing Laboratories</b> .....	<b>24</b>

### Release Control Record

Issue No.	Description	Date Issued
RF171218C14-4	Original release.	Jan. 26, 2018

## 1 Certificate of Conformity

**Product:** Smartphone

**Brand:** HTC

**Model Name:** 2Q55200

**Sample Status:** Production Unit

**Applicant:** HTC Corporation

**Test Date:** Jan. 11 ~ Jan. 26, 2018

**Standards:** FCC Part 15, Subpart E (Section 15.407)

KDB 905462 D03 UNII Clients Without Radar Detection New Rules v01r02

The above equipment has been tested by **Bureau Veritas Consumer Products Services (H.K.) Ltd., Taoyuan Branch**, and found compliance with the requirement of the above standards. The test record, data evaluation & Equipment Under Test (EUT) configurations represented herein are true and accurate accounts of the measurements of the sample's EMC characteristics under the conditions specified in this report.

**Prepared by :**  , **Date:** Jan. 29, 2018  
Pettie Chen / Senior Specialist

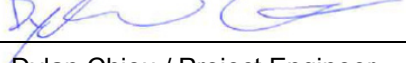
**Approved by :**  , **Date:** Jan. 29, 2018  
Dylan Chiou / Project Engineer

## 2 EUT Information

### 2.1 Operating Frequency Bands and Mode of EUT

TABLE 1: Operating Frequency Bands and Mode of EUT

Operational Mode	Operating Frequency Range	
	5250~5350MHz	5470~5725MHz
Client without radar detection and ad hoc function	✓	✓

### 2.2 EUT Hardware, Software and Firmware Version

Table 2: The EUT Hardware/Software/Firmware Version

No.	Product	Model	Hardware/Software/Firmware Version
1	Smartphone	2Q55200	Android version: 8.0.0 Baseband version: Unknown Kernel version: <a href="#">4.6.60-g0cacdd1-dirtyand@AABM #1</a> SMP PREEMPT Base version: sdm845-003911-1712012239 Build number: 0.55.401.2 10.0_g CL1099484 test-keys Software number: 0.55.401.2

### 2.3 Description of Available Antennas to the EUT

Table 3: Antenna List

ANT No.	Antenna Type	Operation Frequency Range (MHz)	Gain (dBi)
1	PIFA	5250-5350 MHz	-1.40
1	PIFA	5470-5725 MHz	-1.60
2	PIFA	5250-5350 MHz	-3.60
2	PIFA	5470-5725 MHz	-3.30

## 2.4 EUT Maximum Conducted Power

Table 4: The Measured Conducted Output Power

### 802.11a

ANT No.	Frequency Band (MHz)	MAX. Power	
		Output Power(dBm)	Output Power(mW)
1	5250~5350	18.49	70.632
1	5470~5725	18.49	70.632

### 802.11n HT20

ANT No.	Frequency Band (MHz)	MAX. Power	
		Output Power(dBm)	Output Power(mW)
1	5250~5350	21.44	139.439
1	5470~5725	21.49	140.795

### 802.11n HT40

ANT No.	Frequency Band (MHz)	MAX. Power	
		Output Power(dBm)	Output Power(mW)
1	5250~5350	21.39	137.763
1	5470~5725	21.46	139.831

### 802.11ac VHT80

ANT No.	Frequency Band (MHz)	MAX. Power	
		Output Power(dBm)	Output Power(mW)
1	5250~5350	17.92	61.901
1	5470~5725	21.41	138.445

## 2.5 EUT Maximum E.I.R.P. Power

Table 5: The EIRP Output Power List

### 802.11a

ANT No.	Frequency Band (MHz)	MAX. Power	
		Output Power(dBm)	Output Power(mW)
1	5250~5350	17.09	51.168
1	5470~5725	16.89	48.865

### 802.11n HT20

ANT No.	Frequency Band (MHz)	MAX. Power	
		Output Power(dBm)	Output Power(mW)
1	5250~5350	20.04	100.925
1	5470~5725	19.89	97.499

### 802.11n HT40

ANT No.	Frequency Band (MHz)	MAX. Power	
		Output Power(dBm)	Output Power(mW)
1	5250~5350	19.99	99.770
1	5470~5725	19.86	96.828

### 802.11ac VHT80

ANT No.	Frequency Band (MHz)	MAX. Power	
		Output Power(dBm)	Output Power(mW)
1	5250~5350	16.52	44.875
1	5470~5725	19.81	95.719

## 2.6 Transmit Power Control (TPC)

U-NII devices operating in the 5.25-5.35 GHz band and the 5.47-5.725 GHz band shall employ a TPC mechanism. The U-NII device is required to have the capability to operate at least 6 dB below the mean EIRP value of 30 dBm. A TPC mechanism is not required for systems with an e.i.r.p. of less than 500 mW.

Maximum EIRP of this device is 100.925mW which less than 500mW, therefore it's not require TPC function.

## 2.7 Statement of Manufacturer

Manufacturer statement confirming that information regarding the parameters of the detected Radar Waveforms is not available to the end user. **And the device doesn't have Ad Hoc mode on DFS frequency band.**



### 3. U-NII DFS Rule Requirements

#### 3.1 Working Modes and Required Test Items

The manufacturer shall state whether the UUT is capable of operating as a Master and/or a Client. If the UUT is capable of operating in more than one operating mode then each operating mode shall be tested separately. See tables 6 and 7 for the applicability of DFS requirements for each of the operational modes.

Table 6: Applicability of DFS Requirements Prior To Use a Channel

Requirement	Operational Mode		
	Master	Client without radar detection	Client with radar detection
Non-Occupancy Period	✓	Not required	✓
DFS Detection Threshold	✓	Not required	✓
Channel Availability Check Time	✓	Not required	Not required
U-NII Detection Bandwidth	✓	Not required	✓

Note: Regarding KDB 905462 D03 Client Without DFS New Rules v01r02 section (b)(5/6), If the client moves with the master, the device is considered compliant if nothing appears in the client non-occupancy period test. For devices that shut down (rather than moving channels), no beacons should appear. An analyzer plot that contains a single 30-minute sweep on the original channel.

Table 7: Applicability of DFS Requirements during Normal Operation.

Requirement	Operational Mode	
	Master or Client with radar detection	Client without radar detection
DFS Detection Threshold	✓	Not required
Channel Closing Transmission Time	✓	✓
Channel Move Time	✓	✓
U-NII Detection Bandwidth	✓	Not required

Additional requirements for devices with multiple bandwidth modes	Master or Client with radar detection	Client without radar detection
U-NII Detection Bandwidth and Statistical Performance Check	All BW modes must be tested	Not required
Channel Move Time and Channel Closing Transmission Time	Test using widest BW mode available	Test using the widest BW mode available for the link
All other tests	Any single BW mode	Not required

Note: Frequencies selected for statistical performance check (Section 7.8.4) should include several frequencies within the radar detection bandwidth and frequencies near the edge of the radar detection bandwidth. For 802.11 devices it is suggested to select frequencies in each of the bonded 20 MHz channels and the channel center frequency.

### 3.2 Test Limits and Radar Signal Parameters

#### Detection Threshold Values

Table 8: DFS Detection Thresholds for Master Devices And Client Devices With Radar Detection

Maximum Transmit Power	Value (See Notes 1, 2, and 3)
EIRP $\geq$ 200 milliwatt	-64 dBm
EIRP < 200 milliwatt and power spectral density < 10 dBm/MHz	-62 dBm
EIRP < 200 milliwatt that do not meet the power spectral density requirement	-64 dBm

Note 1: This is the level at the input of the receiver assuming a 0 dBi receive antenna.  
 Note 2: Throughout these test procedures an additional 1 dB has been added to the amplitude of the test transmission waveforms to account for variations in measurement equipment. This will ensure that the test signal is at or above the detection threshold level to trigger a DFS response.  
 Note3: EIRP is based on the highest antenna gain. For MIMO devices refer to KDB Publication 662911 D01.

Table 9: DFS Response Requirement Values

Parameter	Value
Non-occupancy period	Minimum 30 minutes
Channel Availability Check Time	60 seconds
Channel Move Time	10 seconds See Note 1.
Channel Closing Transmission Time	200 milliseconds + an aggregate of 60 milliseconds over remaining 10 second period. See Notes 1 and 2.
U-NII Detection Bandwidth	Minimum 100% of the U-NII 99% transmission power bandwidth. See Note 3

Note 1: Channel Move Time and the Channel Closing Transmission Time should be performed with Radar Type 0. The measurement timing begins at the end of the Radar Type 0 burst.  
 Note 2: The Channel Closing Transmission Time is comprised of 200 milliseconds starting at the beginning of the Channel Move Time plus any additional intermittent control signals required to facilitate a Channel move (an aggregate of 60 milliseconds) during the remainder of the 10 second period. The aggregate duration of control signals will not count quiet periods in between transmissions.  
 Note 3: During the U-NII Detection Bandwidth detection test, radar type 0 should be used. For each frequency step the minimum percentage of detection is 90 percent. Measurements are performed with no data traffic.

### Parameters of DFS Test Signals

Step intervals of 0.1 microsecond for Pulse Width, 1 microsecond for PRI, 1 MHz for chirp width and 1 for the number of pulses will be utilized for the random determination of specific test waveforms.

Table 10: Short Pulse Radar Test Waveforms

Radar Type	Pulse Width (μsec)	PRI (μsec)	Number of Pulses	Minimum Percentage of Successful Detection	Minimum Number of Trials
0	1	1428	18	See Note 1	See Note 1
1	1	Test A: 15 unique PRI values randomly selected from the list of 23 PRI values in Table 5a	$\text{Roundup} \left\{ \begin{array}{l} \left( \frac{1}{360} \right) \cdot \\ \left( \frac{19 \cdot 10^6}{\text{PRI}_{\mu\text{sec}}} \right) \end{array} \right\}$	60%	30
		Test B: 15 unique PRI values randomly selected within the range of 518-3066 μ sec, with a minimum increment of 1 μ sec, excluding PRI values selected in Test A			
2	1-5	150-230	23-29	60%	30
3	6-10	200-500	16-18	60%	30
4	11-20	200-500	12-16	60%	30
Aggregate (Radar Types 1-4)				80%	120
Note 1: Short Pulse Radar Type 0 should be used for the detection bandwidth test, channel move time, and channel closing time tests.					

**Table 11: Long Pulse Radar Test Waveform**

Radar Type	Pulse Width (μsec)	Chirp Width (MHz)	PRI (μsec)	Number Of Pulses Per Burst	Number Of Bursts	Minimum Percentage Of Successful Detection	Minimum Number Of Trials
5	50-100	5-20	1000-2000	1-3	8-20	80%	30

Three subsets of trials will be performed with a minimum of ten trials per subset. The subset of trials differ in where the Long Pulse Type 5 Signal is tuned in frequency.

- a) the Channel center frequency
- b) tuned frequencies such that 90% of the Long Pulse Type 5 frequency modulation is within the low edge of the UUT Occupied Bandwidth
- c) tuned frequencies such that 90% of the Long Pulse Type 5 frequency modulation is within the high edge of the UUT Occupied Bandwidth

It include 10 trails for every subset, the formula as below,

For subset case 1: the center frequency of the signal generator will remain fixed at the center of the UUT Channel.

For subset case 2: to retain 90% frequency overlap between the radar signal and the UUT Occupied Bandwidth, the center frequency of the signal generator will vary for each of the ten trials in subset case 2. The center frequency of the signal generator for each trial is calculated by:

$$FL+(0.4*Chirp\ Width\ [in\ MHz])$$

For subset case 3: to retain 90% frequency overlap between the radar signal and the UUT Occupied Bandwidth, the center frequency of the signal generator will vary for each of the ten trials in subset case 3. The center frequency of the signal generator for each trial is calculated by:

$$FH-(0.4*Chirp\ Width\ [in\ MHz])$$

**Table 12: Frequency Hopping Radar Test Waveform**

Radar Type	Pulse Width (μsec)	PRI (μsec)	Pulses per Hop	Hopping Rate (kHz)	Hopping Sequence Length (msec)	Minimum Percentage Of Successful Detection	Minimum Number Of Trials
6	1	333	9	0.333	300	70%	30

#### 4. Test & Support Equipment List

##### 4.1 Test Instruments

Table 13: Test Instruments List

Description	Model No.	Brand	Date Of Calibration	Due Date Of Calibration
Spectrum analyzer	ESR	R&S	2017/02/20	2018/02/19
Signal generator	8645A	Agilent	2017/08/11	2018/08/10
Horn antenna	BBHA 9120 D	Schwarzbeck	2017/12/14	2018/12/13
RF coaxial cable	CA3501-3501-G.90(3m) & CA3501-3501-F.90(2m)	INFINET	2017/08/21	2018/08/20

##### 4.2 Description of Support Units

Table 14: Support Unit Information.

No.	Product	Brand	Model No.	FCC ID	Spec.
1	Router	NETGEAR	R7800	PY315100319	5G Ant gain : 1.61dBi Maximum EIRP : 25.47dBm

**NOTE:** This device was functioned as a  Master  Slave device during the DFS test.

Table 15: Software/Firmware Information.

No.	Product	Model No.	Software/Firmware Version
1	Router	R7800	V1.0.1.30

## 5. Test Procedure

### 5.1 DFS Measurement System

A complete DFS Measurement System consists of two subsystems: (1) the Radar Signal Generating Subsystem and (2) the Traffic Monitoring Subsystem. The control PC is necessary for generating the Radar waveforms in Table 10, 11 and 12. The traffic monitoring subsystem is specified to the type of unit under test (UUT).

#### Radiated Setup Configuration of DFS Measurement System

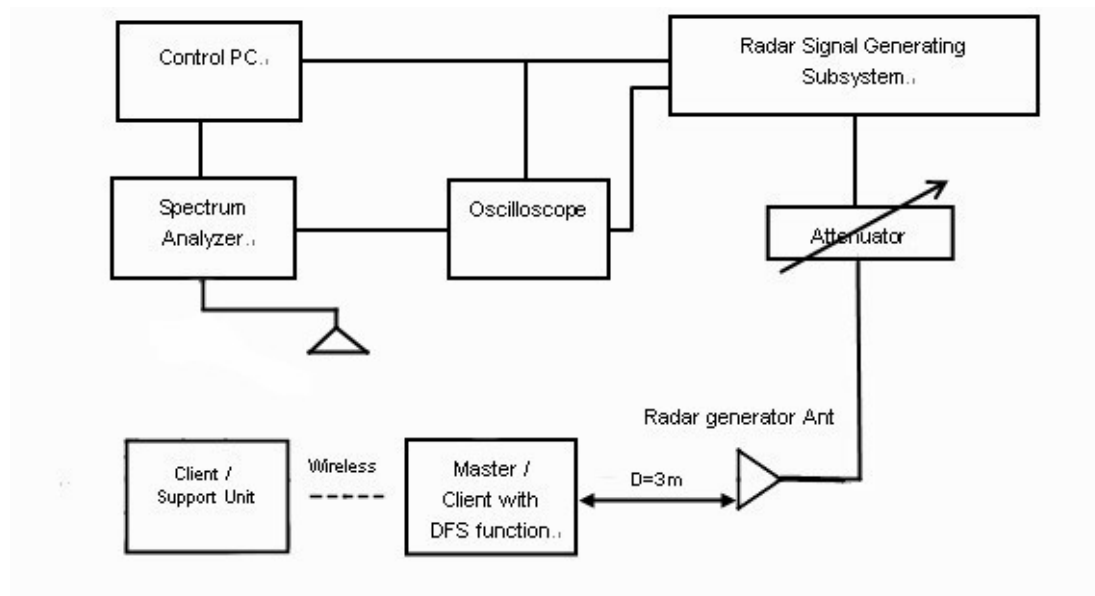

System testing will be performed with channel-loading using means appropriate to the data types that are used by the unlicensed device. The following requirements apply:

	a) The data file must be of a type that is typical for the device (i.e., MPEG-2, MPEG-4, WAV, MP3, MP4, AVI, etc.) and must generally be transmitting in a streaming mode.
	b) Software to ping the client is permitted to simulate data transfer but must have random ping intervals.
V	c) Timing plots are required with calculations demonstrating a minimum channel loading of approximately 17% or greater.
	d) Unicast or Multicast protocols are preferable but other protocols may be used. The appropriate protocol used must be described in the test procedures.

## Wireless Traffic Loading Duty Cycle

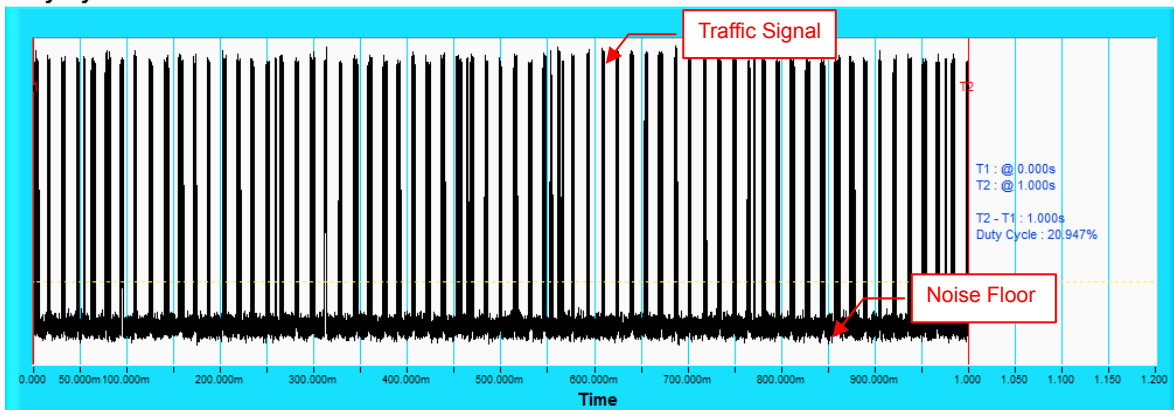

### 5.2 Calibration of DFS Detection Threshold Level

The measured channel is 5500MHz, 5510MHz and 5530MHz. The radar signal was the same as transmitted channels, and injected into the antenna of AP (master) or Client Device with Radar Detection, measured the channel closing transmission time and channel move time. The calibrated detection threshold level is set to -64dBm. The tested level is lower than required level hence it provides margin to the limit.

### Radiated setup configuration of Calibration of DFS Detection Threshold Level

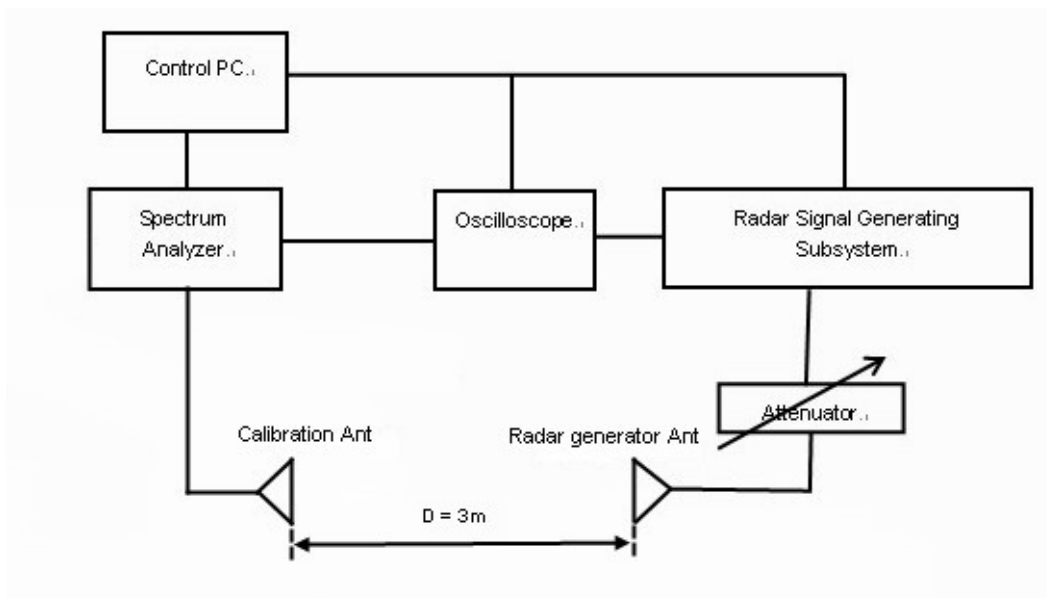

### 5.3 Deviation from Test Standard

No deviation.

### 5.4 Radiated Test Setup Configuration

#### 5.4.1 Client without Radar Detection Mode

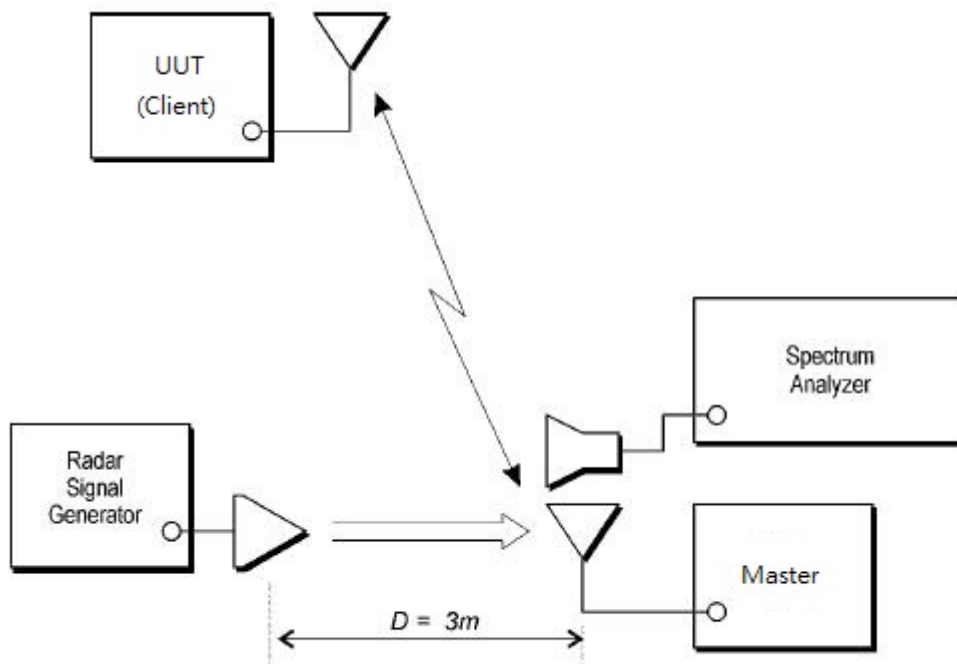

The UUT is a U-NII Device operating in Client mode without radar detection. The radar test signals are injected into the Master Device.



## 6. Test Results

### 6.1 Summary of Test Results

Clause	Test Parameter	Remarks	Pass/Fail
15.407	DFS Detection Threshold	Not Applicable	NA
15.407	Channel Availability Check Time	Not Applicable	NA
15.407	Channel Move Time	Applicable	Pass
15.407	Channel Closing Transmission Time	Applicable	Pass
15.407	Non-Occupancy Period	Applicable	Pass
15.407	Uniform Spreading	Not Applicable	NA
15.407	U-NII Detection Bandwidth	Not Applicable	NA
15.407	Non-associated test	Applicable	Pass
15.407	Non-Co-Channel test	Applicable	Pass

## 6.2 Test Results

6.2.1 Test Mode: Device Operating In Client without Radar Detection Mode.

Client with injection at the Master. (The radar test signals are injected into the Master Device)

### DFS Detection Threshold

For a detection threshold level of -64dBm, the required signal strength at EUT antenna location is -64dBm. The tested level is lower than required level hence it provides margin to the limit.

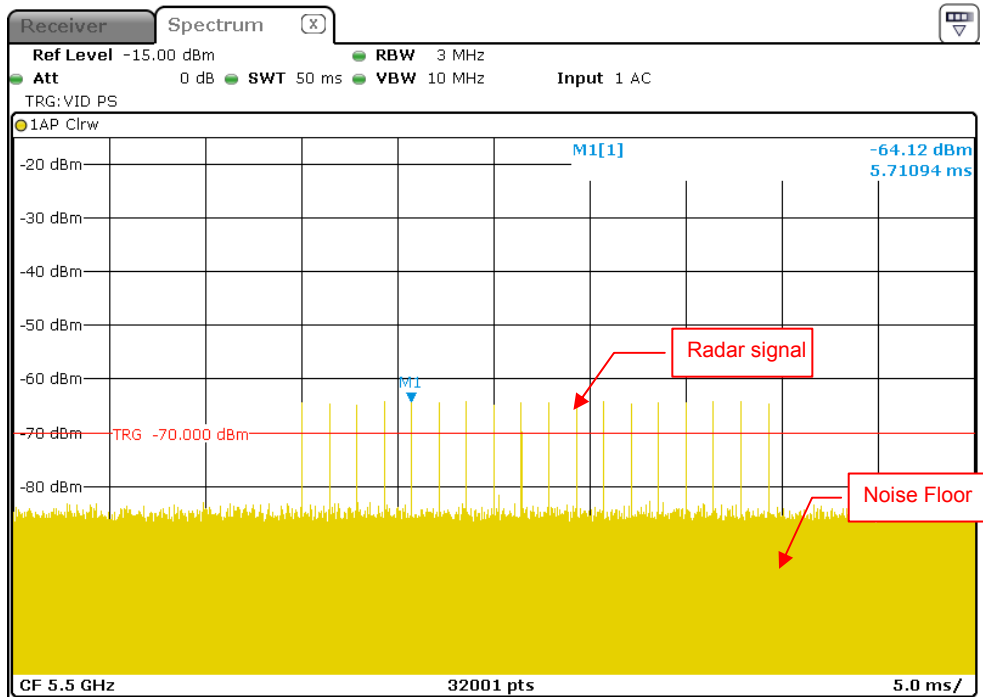

Radar Signal 0

## 6.2.2 Channel Closing Transmission and Channel Move Time

### Radar Signal 0

802.11n HT20

#### Channel Closing Transmission Time & Channel Move Time

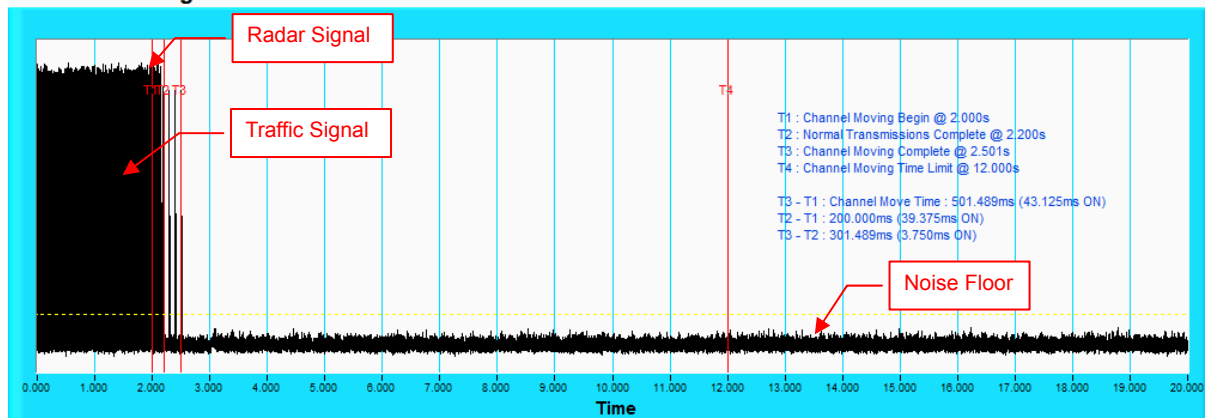

**NOTE:** T1 denotes the start of Channel Move Time upon the end of the last Radar burst. T2 denotes the data transmission time of 200ms from T1. T3 denotes the end of Channel Move Time. T4 denotes the 10 second from T1 to observe the aggregate duration of transmissions.

#### Channel Closing Transmission Time & Channel Move Time

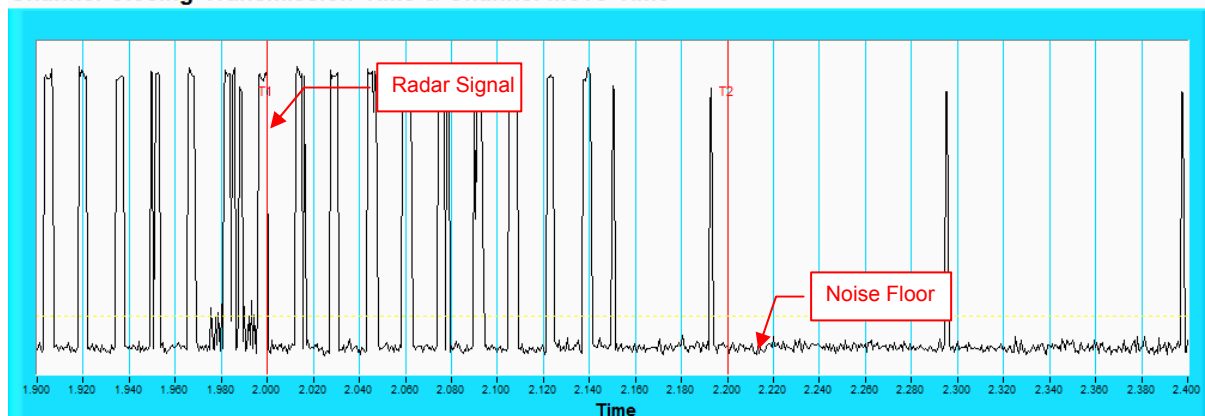

**NOTE:** An expanded plot for the device vacates the channel in the required 500ms.

## Radar Signal 0

802.11n HT40

### Channel Closing Transmission Time & Channel Move Time

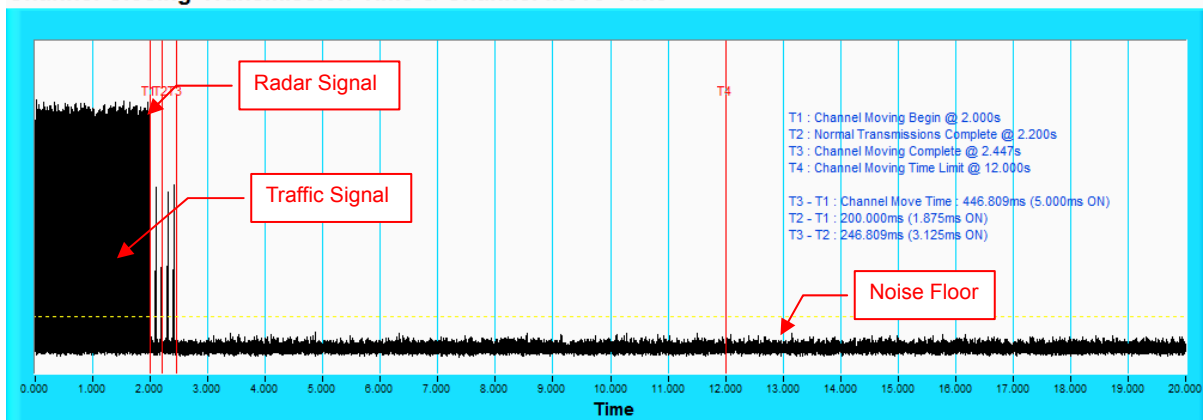

**NOTE:** T1 denotes the start of Channel Move Time upon the end of the last Radar burst. T2 denotes the data transmission time of 200ms from T1. T3 denotes the end of Channel Move Time. T4 denotes the 10 second from T1 to observe the aggregate duration of transmissions.

### Channel Closing Transmission Time & Channel Move Time

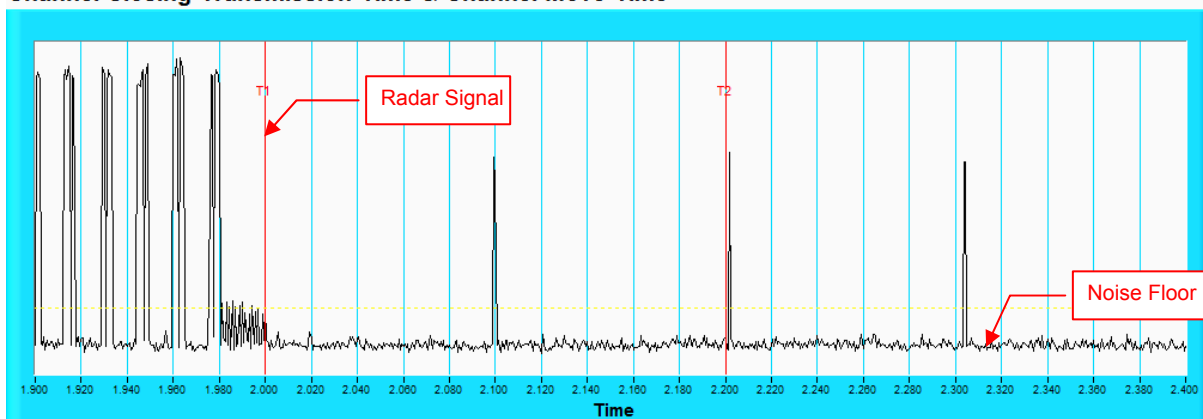

**NOTE:** An expanded plot for the device vacates the channel in the required 500ms.

## Radar Signal 0 802.11ac VHT80

### Channel Closing Transmission Time & Channel Move Time

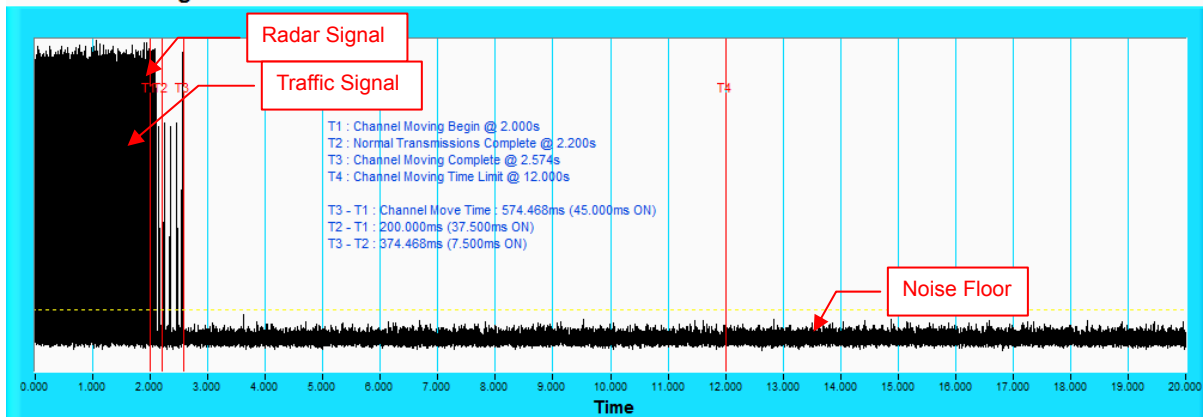

**NOTE:** T1 denotes the start of Channel Move Time upon the end of the last Radar burst. T2 denotes the data transmission time of 200ms from T1. T3 denotes the end of Channel Move Time. T4 denotes the 10 second from T1 to observe the aggregate duration of transmissions.

### Channel Closing Transmission Time & Channel Move Time

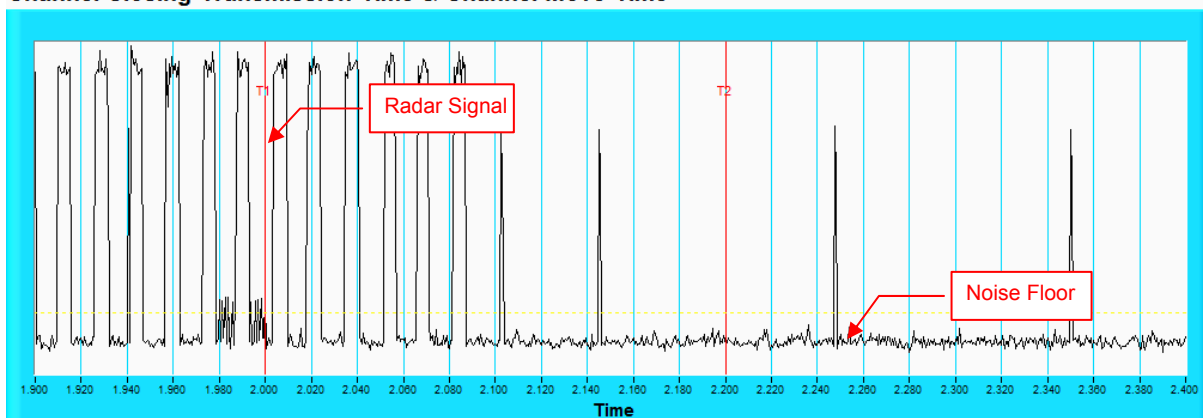

**NOTE:** An expanded plot for the device vacates the channel in the required 500ms.

### 6.2.3 Non-Occupancy Period

#### Associate test:

During the 30 minutes observation time, UUT did not make any transmissions on a channel after a radar signal was detected on that channel by either the Channel Availability Check or the In-Service Monitoring.

- 1) EUT (Client) links with master on 5500MHz.

Waveform of EUT links up with Master

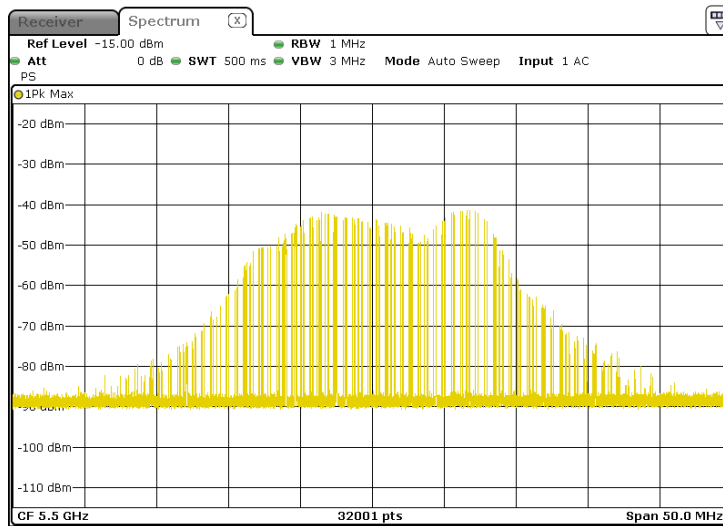

- 2) Client plays specified files via master.

Waveform of transmission

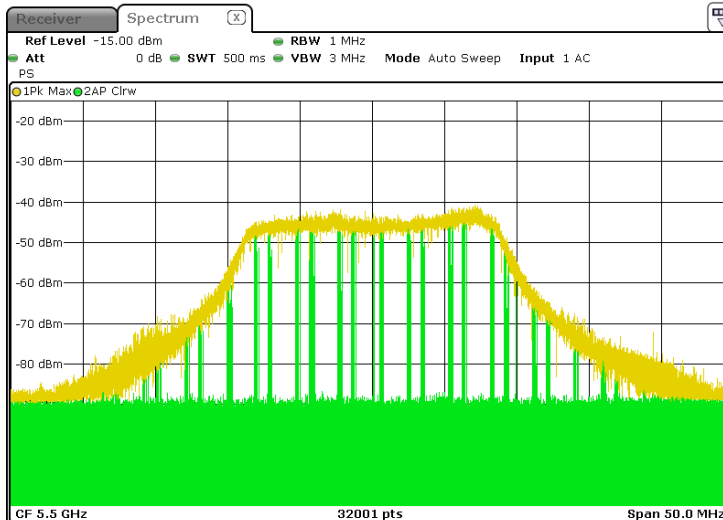

3) Radar signal 0 is applied to the Master device and WiFi traffic signal stop immediately.

Radar signal applied to the master and traffic stopped as described in section 6.2.2.

4) 5500MHz has been monitored in 30 minutes period. In this period, no any transmission occurs.

Plot of 30minutes period

**802.11n HT20**

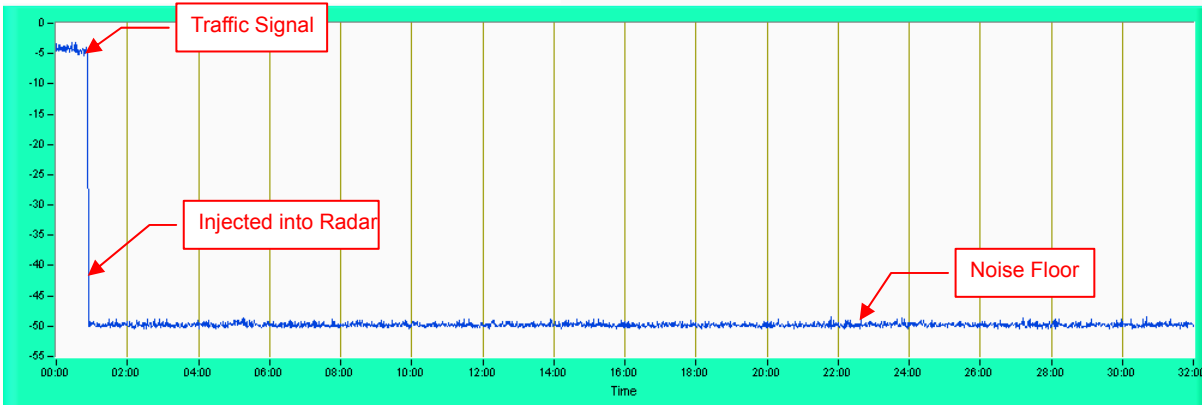

**NOTE:** Test setup are shown on Test set up photo.pdf

**6.2.4 Non-Associated Test**

Master was off.

During the 30 minutes observation time, The UUT did not make any transmissions in the DFS band after UUT power up.

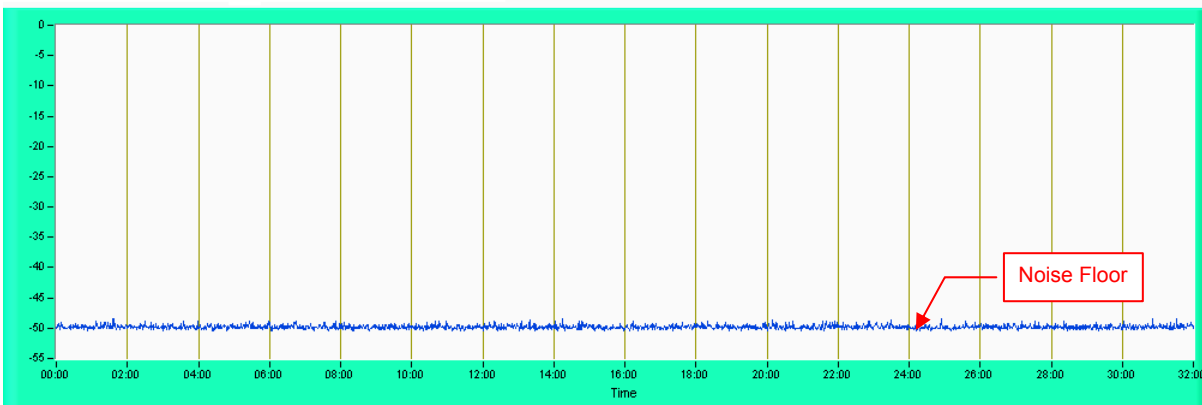

**6.2.5 Non-Co-Channel Test**

The UUT was investigated after radar was detected and confirmed that no co-channel operation with radars.

## 7. Information on the Testing Laboratories

We, Bureau Veritas Consumer Products Services (H.K.) Ltd., Taoyuan Branch, were founded in 1988 to provide our best service in EMC, Radio, Telecom and Safety consultation. Our laboratories are accredited and approved according to ISO/IEC 17025.

If you have any comments, please feel free to contact us at the following:

**Linko EMC/RF Lab**

Tel: 886-2-26052180

Fax: 886-2-26051924

**Hsin Chu EMC/RF/Telecom Lab**

Tel: 886-3-6668565

Fax: 886-3-6668323

**Hwa Ya EMC/RF/Safety Lab**

Tel: 886-3-3183232

Fax: 886-3-3270892

**Email:** [service.adt@tw.bureauveritas.com](mailto:service.adt@tw.bureauveritas.com)

**Web Site:** [www.bureauveritas-adt.com](http://www.bureauveritas-adt.com)

The address and road map of all our labs can be found in our web site also.

--- END ---