

System Check_Head_5750MHz

DUT: D5GHzV2-1006

Communication System: CW; Frequency: 5750 MHz; Duty Cycle: 1:1
Medium: HSL_5G_170614 Medium parameters used: $f = 5750$ MHz; $\sigma = 5.087$ S/m; $\epsilon_r = 36.729$; $\rho = 1000$ kg/m³
Ambient Temperature : 23.5 °C; Liquid Temperature : 22.5 °C

DASY5 Configuration:

- Probe: EX3DV4 - SN3925; ConvF(4.87, 4.87, 4.87); Calibrated: 2017/5/24;
- Sensor-Surface: 1.4mm (Mechanical Surface Detection)
- Electronics: DAE3 Sn495; Calibrated: 2017/5/22
- Phantom: SAM_Left; Type: QD000P40CD; Serial: TP:1431
- Measurement SW: DASY52, Version 52.8 (8); SEMCAD X Version 14.6.10 (7373)

Pin=100mW/Area Scan (71x71x1): Interpolated grid: dx=1.000 mm, dy=1.000 mm
Maximum value of SAR (interpolated) = 18.9 W/kg

Pin=100mW/Zoom Scan (7x7x7)/Cube 0: Measurement grid: dx=4mm, dy=4mm, dz=1.4mm
Reference Value = 67.28 V/m; Power Drift = 0.06 dB
Peak SAR (extrapolated) = 33.4 W/kg
SAR(1 g) = 7.61 W/kg; SAR(10 g) = 2.11 W/kg
Maximum value of SAR (measured) = 19.2 W/kg

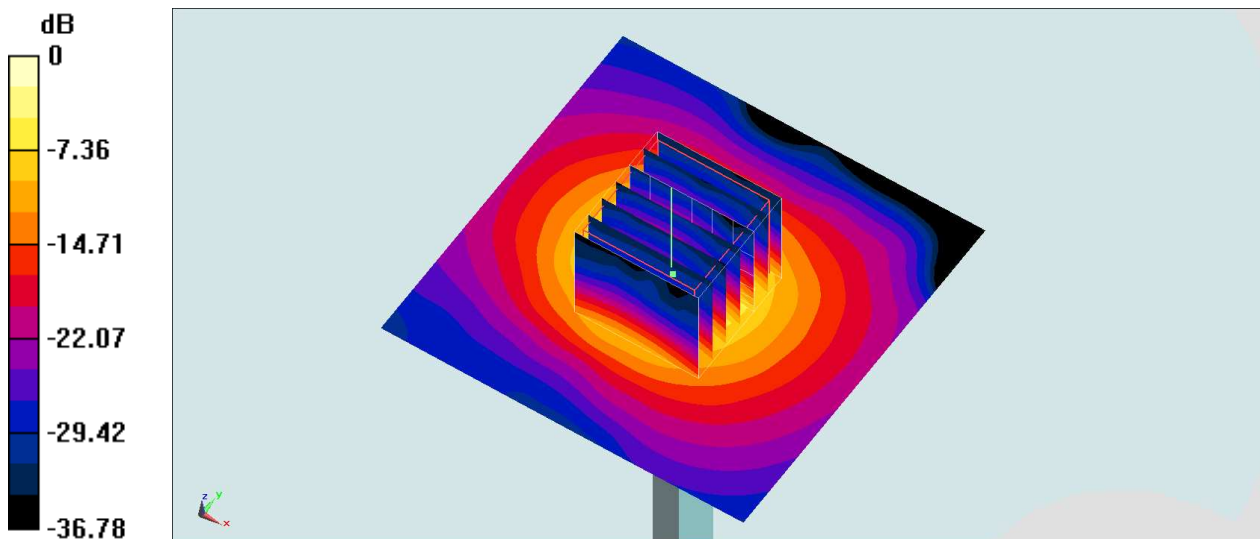

0 dB = 19.2 W/kg = 12.83 dBW/kg

System Check_Body_5750MHz

DUT: D5GHzV2-1006

Communication System: CW ; Frequency: 5750 MHz;Duty Cycle: 1:1

Medium: MSL_5G_170615 Medium parameters used: $f = 5750$ MHz; $\sigma = 6.17$ S/m; $\epsilon_r = 46.916$; $\rho = 1000$ kg/m³

Ambient Temperature : 23.4 °C ; Liquid Temperature : 22.4 °C

DASY5 Configuration:

- Probe: EX3DV4 - SN3925; ConvF(4.14, 4.14, 4.14); Calibrated: 2017/5/24;
- Sensor-Surface: 1.4mm (Mechanical Surface Detection)
- Electronics: DAE3 Sn495; Calibrated: 2017/5/22
- Phantom: SAM-Right; Type: SAM; Serial: TP-1303
- Measurement SW: DASY52, Version 52.8 (8);SEMCAD X Version 14.6.10 (7373)

Pin=100mW/Area Scan (71x71x1): Interpolated grid: dx=1.000 mm, dy=1.000 mm

Maximum value of SAR (interpolated) = 20.0 W/kg

Pin=100mW/Zoom Scan (7x7x7)/Cube 0: Measurement grid: dx=4mm, dy=4mm, dz=1.4mm

Reference Value = 59.98 V/m; Power Drift = 0.11 dB

Peak SAR (extrapolated) = 37.1 W/kg

SAR(1 g) = 7.86 W/kg; SAR(10 g) = 2.12 W/kg

Maximum value of SAR (measured) = 20.5 W/kg

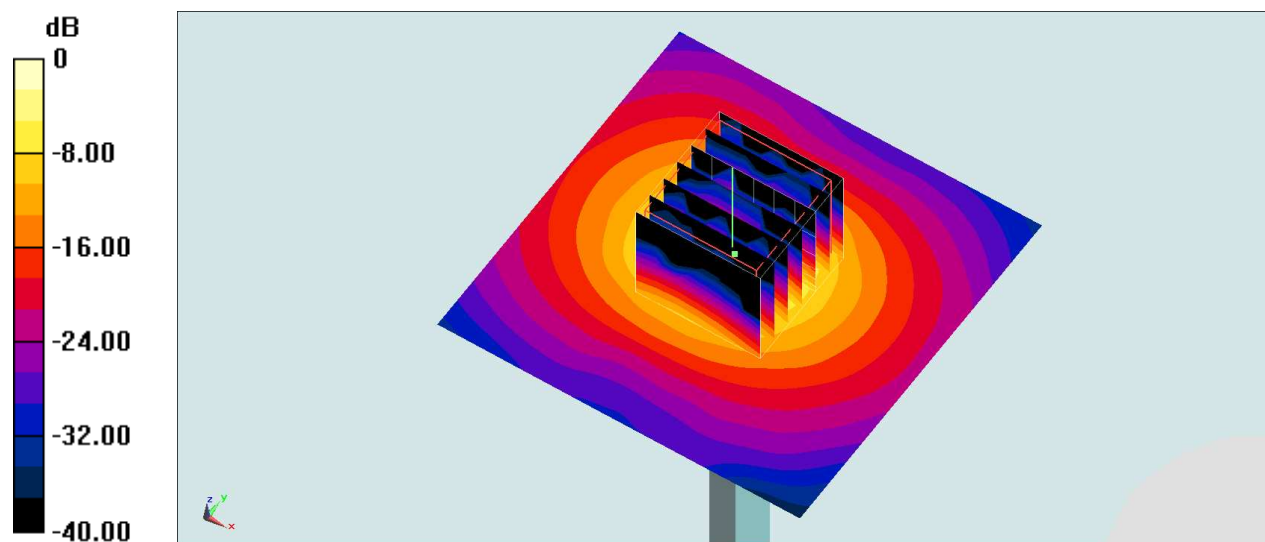

0 dB = 20.5 W/kg = 13.12 dBW/kg



Appendix B. Plots of SAR Measurement

The plots are shown as follows.

#01_GSM850_GPRS(4 Tx slots)_Left Cheek_Ch251

Communication System: GSM850 ; Frequency: 848.8 MHz;Duty Cycle: 1:2.08
Medium: HSL_850_170612 Medium parameters used: $f = 849$ MHz; $\sigma = 0.914$ S/m; $\epsilon_r = 42.975$; $\rho = 1000$ kg/m³
Ambient Temperature : 23.2 °C; Liquid Temperature : 22.2 °C

DASY5 Configuration:

- Probe: ES3DV3 - SN3169; ConvF(5.99, 5.99, 5.99); Calibrated: 2017/5/11;
- Sensor-Surface: 3mm (Mechanical Surface Detection)
- Electronics: DAE4 Sn1399; Calibrated: 2016/11/17
- Phantom: SAM_Left; Type: QD000P40CD; Serial: TP:1431
- Measurement SW: DASY52, Version 52.8 (8);SEMCAD X Version 14.6.10 (7373)

Area Scan (71x121x1): Interpolated grid: dx=1.500 mm, dy=1.500 mm
Maximum value of SAR (interpolated) = 0.153 W/kg

Zoom Scan (5x5x7)/Cube 0: Measurement grid: dx=8mm, dy=8mm, dz=5mm
Reference Value = 13.10 V/m; Power Drift = 0.04 dB
Peak SAR (extrapolated) = 0.174 W/kg
SAR(1 g) = 0.140 W/kg; SAR(10 g) = 0.108 W/kg
Maximum value of SAR (measured) = 0.153 W/kg

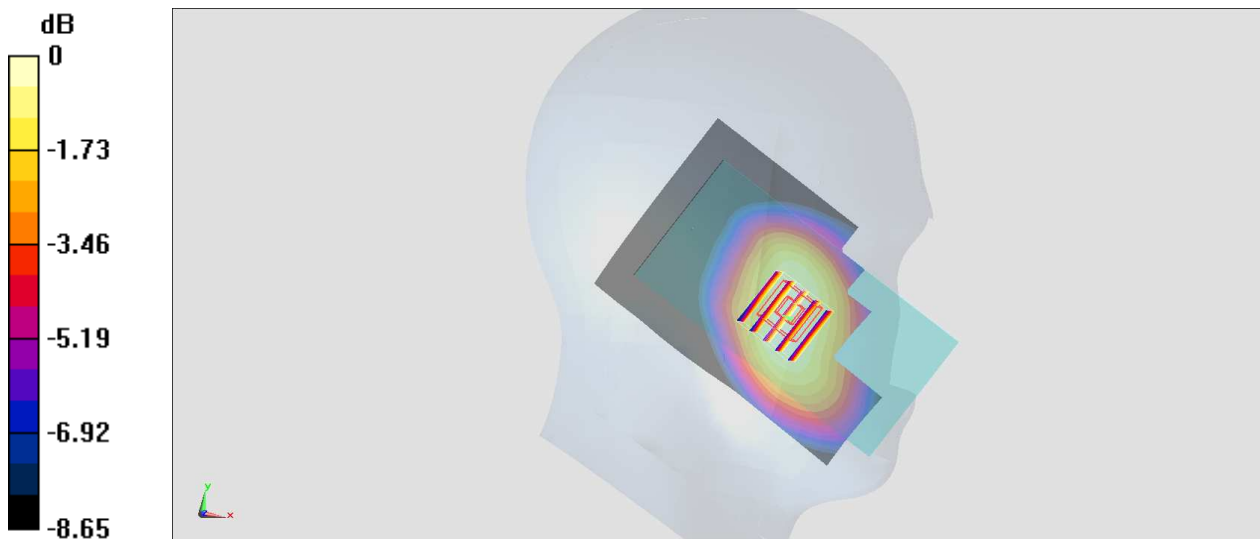

0 dB = 0.153 W/kg = -8.15 dBW/kg

#02_GSM1900_GPRS(4 Tx slots)_Left Cheek_Ch512

Communication System: PCS ; Frequency: 1850.2 MHz;Duty Cycle: 1:2.08

Medium: HSL_1900_170612 Medium parameters used : $f = 1850.2$ MHz; $\sigma = 1.4$ S/m; $\epsilon_r = 41.898$;

$\rho = 1000$ kg/m³

Ambient Temperature : 23.2 °C; Liquid Temperature : 22.2 °C

DASY5 Configuration:

- Probe: ES3DV3 - SN3169; ConvF(5.03, 5.03, 5.03); Calibrated: 2017/5/11;
- Sensor-Surface: 3mm (Mechanical Surface Detection)
- Electronics: DAE4 Sn1399; Calibrated: 2016/11/17
- Phantom: SAM_Left; Type: QD000P40CD; Serial: TP:1431
- Measurement SW: DASY52, Version 52.8 (8);SEMCAD X Version 14.6.10 (7373)

Area Scan (71x121x1): Interpolated grid: dx=1.500 mm, dy=1.500 mm

Maximum value of SAR (interpolated) = 0.382 W/kg

Zoom Scan (5x5x7)/Cube 0: Measurement grid: dx=8mm, dy=8mm, dz=5mm

Reference Value = 15.20 V/m; Power Drift = -0.04 dB

Peak SAR (extrapolated) = 0.501 W/kg

SAR(1 g) = 0.318 W/kg; SAR(10 g) = 0.192 W/kg

Maximum value of SAR (measured) = 0.368 W/kg

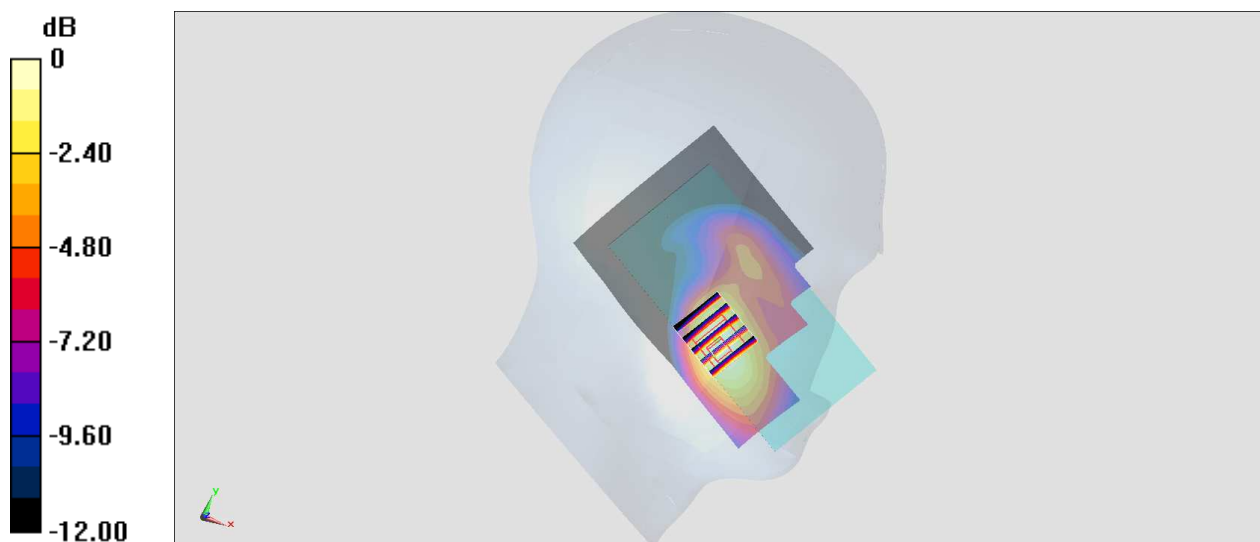

0 dB = 0.368 W/kg = -4.34 dBW/kg

#03_WCDMA II_RMC 12.2Kbps_Left Cheek_Ch9262

Communication System: WCDMA ; Frequency: 1852.4 MHz;Duty Cycle: 1:1
Medium: HSL_1900_170612 Medium parameters used : $f = 1852.4$ MHz; $\sigma = 1.402$ S/m; $\epsilon_r = 41.889$; $\rho = 1000$ kg/m³
Ambient Temperature : 23.2 °C; Liquid Temperature : 22.2 °C

DASY5 Configuration:

- Probe: ES3DV3 - SN3169; ConvF(5.03, 5.03, 5.03); Calibrated: 2017/5/11;
- Sensor-Surface: 3mm (Mechanical Surface Detection)
- Electronics: DAE4 Sn1399; Calibrated: 2016/11/17
- Phantom: SAM_Left; Type: QD000P40CD; Serial: TP:1431
- Measurement SW: DASY52, Version 52.8 (8);SEMCAD X Version 14.6.10 (7373)

Area Scan (71x121x1): Interpolated grid: dx=1.500 mm, dy=1.500 mm
Maximum value of SAR (interpolated) = 0.245 W/kg

Zoom Scan (5x5x7)/Cube 0: Measurement grid: dx=8mm, dy=8mm, dz=5mm
Reference Value = 11.54 V/m; Power Drift = 0.11 dB
Peak SAR (extrapolated) = 0.327 W/kg
SAR(1 g) = 0.205 W/kg; SAR(10 g) = 0.124 W/kg
Maximum value of SAR (measured) = 0.237 W/kg

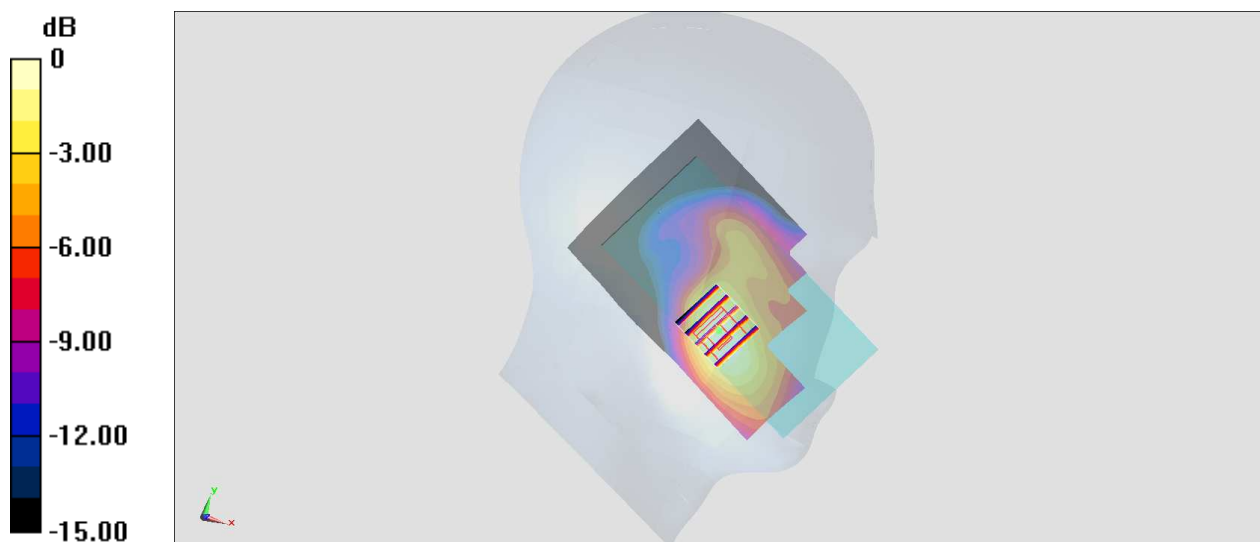

0 dB = 0.237 W/kg = -6.25 dBW/kg

#04_WCDMA IV_RMC 12.2Kbps_Left Cheek_Ch1513

Communication System: WCDMA ; Frequency: 1752.6 MHz;Duty Cycle: 1:1
Medium: HSL_1750_170612 Medium parameters used: $f = 1753$ MHz; $\sigma = 1.392$ S/m; $\epsilon_r = 39.599$;
 $\rho = 1000$ kg/m³
Ambient Temperature : 23.2 °C; Liquid Temperature : 22.2 °C

DASY5 Configuration:

- Probe: ES3DV3 - SN3169; ConvF(5.33, 5.33, 5.33); Calibrated: 2017/5/11;
- Sensor-Surface: 3mm (Mechanical Surface Detection)
- Electronics: DAE4 Sn1399; Calibrated: 2016/11/17
- Phantom: SAM_Left; Type: QD000P40CD; Serial: TP:1431
- Measurement SW: DASY52, Version 52.8 (8);SEMCAD X Version 14.6.10 (7373)

Area Scan (71x121x1): Interpolated grid: dx=1.500 mm, dy=1.500 mm
Maximum value of SAR (interpolated) = 0.270 W/kg

Zoom Scan (5x5x7)/Cube 0: Measurement grid: dx=8mm, dy=8mm, dz=5mm
Reference Value = 12.15 V/m; Power Drift = 0.10 dB
Peak SAR (extrapolated) = 0.352 W/kg
SAR(1 g) = 0.254 W/kg; SAR(10 g) = 0.143 W/kg
Maximum value of SAR (measured) = 0.270 W/kg

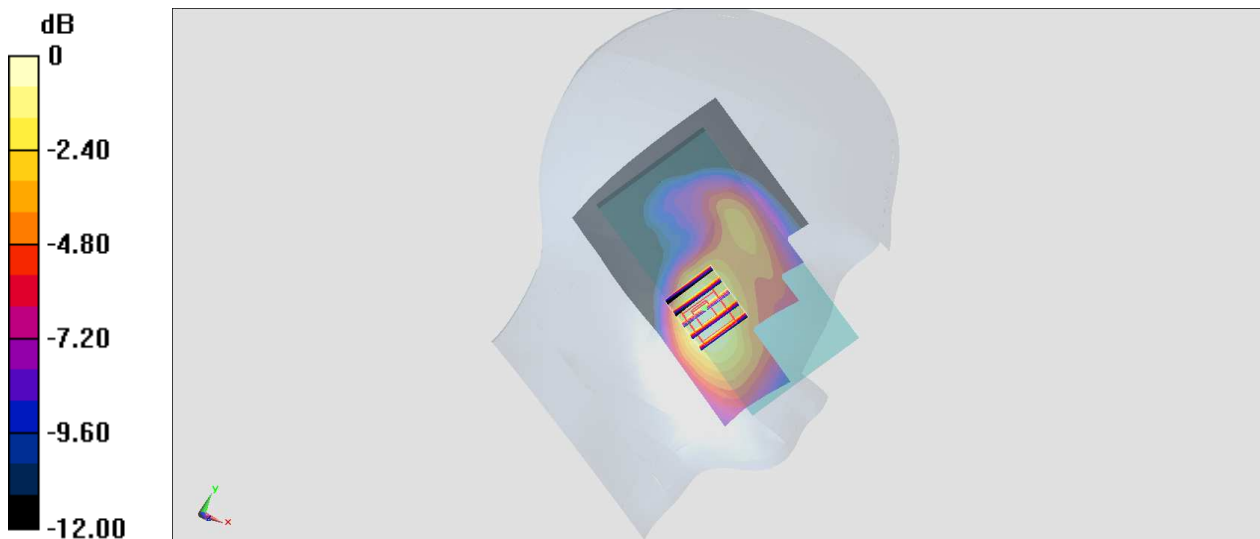

0 dB = 0.270 W/kg = -5.69 dBW/kg

#05_WCDMA V_RMC 12.2Kbps_Left Cheek_Ch4233

Communication System: WCDMA ; Frequency: 846.6 MHz;Duty Cycle: 1:1
Medium: HSL_850_170612 Medium parameters used: $f = 847 \text{ MHz}$; $\sigma = 0.912 \text{ S/m}$; $\epsilon_r = 42.999$; $\rho = 1000 \text{ kg/m}^3$
Ambient Temperature : $23.2 \text{ }^\circ\text{C}$; Liquid Temperature : $22.2 \text{ }^\circ\text{C}$

DASY5 Configuration:

- Probe: ES3DV3 - SN3169; ConvF(5.99, 5.99, 5.99); Calibrated: 2017/5/11;
- Sensor-Surface: 3mm (Mechanical Surface Detection)
- Electronics: DAE4 Sn1399; Calibrated: 2016/11/17
- Phantom: SAM_Left; Type: QD000P40CD; Serial: TP:1431
- Measurement SW: DASY52, Version 52.8 (8);SEMCAD X Version 14.6.10 (7373)

Area Scan (71x121x1): Interpolated grid: $dx=1.500 \text{ mm}$, $dy=1.500 \text{ mm}$
Maximum value of SAR (interpolated) = 0.0819 W/kg

Zoom Scan (5x5x7)/Cube 0: Measurement grid: $dx=8\text{mm}$, $dy=8\text{mm}$, $dz=5\text{mm}$
Reference Value = 9.671 V/m ; Power Drift = 0.06 dB
Peak SAR (extrapolated) = 0.0960 W/kg
SAR(1 g) = 0.076 W/kg ; SAR(10 g) = 0.059 W/kg
Maximum value of SAR (measured) = 0.0832 W/kg

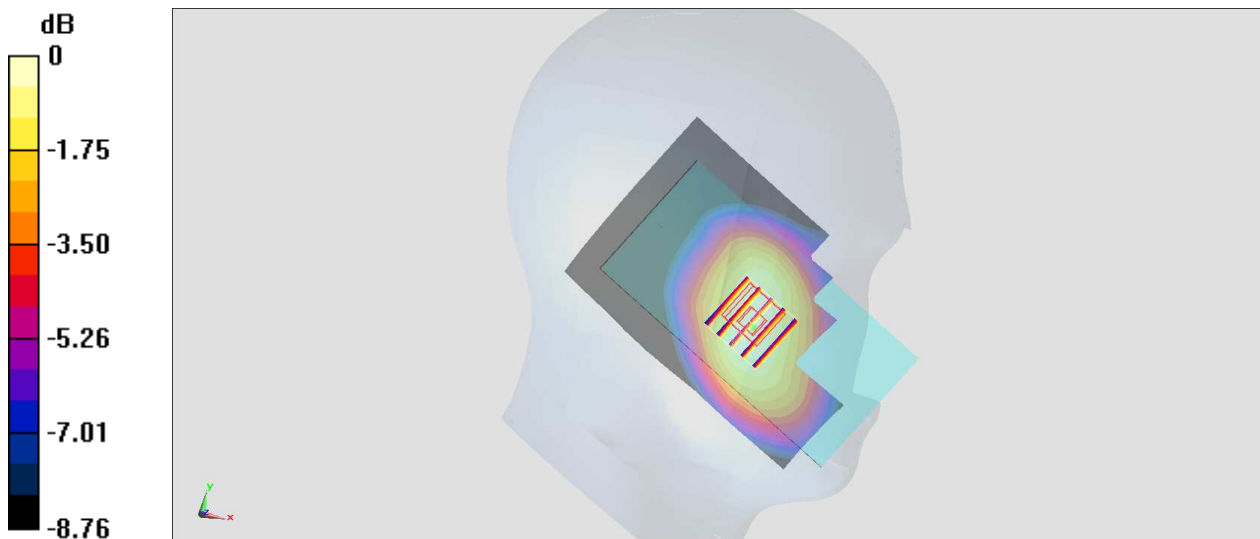

0 dB = 0.0832 W/kg = -10.80 dBW/kg

#06_LTE Band 2_20M_QPSK_1_0_Left Cheek_Ch18700

Communication System: LTE ; Frequency: 1860 MHz;Duty Cycle: 1:1
Medium: HSL_1900_170612 Medium parameters used: $f = 1860$ MHz; $\sigma = 1.411$ S/m; $\epsilon_r = 41.858$;
 $\rho = 1000$ kg/m³
Ambient Temperature : 23.2 °C; Liquid Temperature : 22.2 °C

DASY5 Configuration:

- Probe: ES3DV3 - SN3169; ConvF(5.03, 5.03, 5.03); Calibrated: 2017/5/11;
- Sensor-Surface: 3mm (Mechanical Surface Detection)
- Electronics: DAE4 Sn1399; Calibrated: 2016/11/17
- Phantom: SAM_Left; Type: QD000P40CD; Serial: TP:1431
- Measurement SW: DASY52, Version 52.8 (8);SEMCAD X Version 14.6.10 (7373)

Area Scan (71x121x1): Interpolated grid: dx=1.500 mm, dy=1.500 mm
Maximum value of SAR (interpolated) = 0.222 W/kg

Zoom Scan (5x5x7)/Cube 0: Measurement grid: dx=8mm, dy=8mm, dz=5mm
Reference Value = 10.99 V/m; Power Drift = 0.03 dB
Peak SAR (extrapolated) = 0.313 W/kg
SAR(1 g) = 0.189 W/kg; SAR(10 g) = 0.114 W/kg
Maximum value of SAR (measured) = 0.224 W/kg

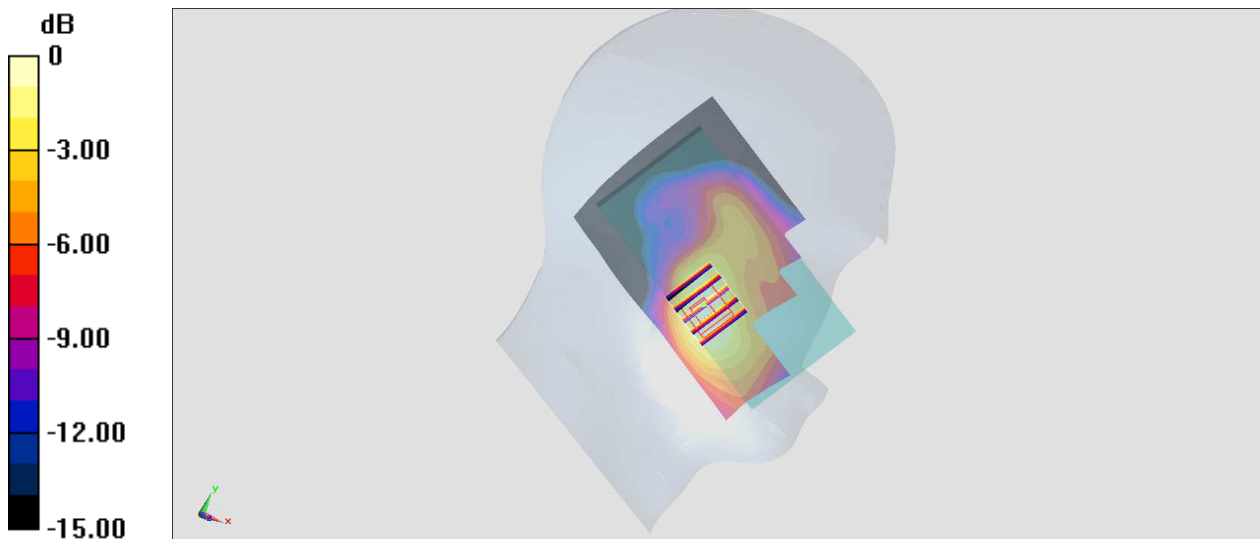

#07_LTE Band 5_10M_QPSK_1_0_Left Cheek_Ch20525

Communication System: LTE ; Frequency: 836.5 MHz;Duty Cycle: 1:1
Medium: HSL_850_170612 Medium parameters used : $f = 836.5$ MHz; $\sigma = 0.903$ S/m; $\epsilon_r = 43.13$; $\rho = 1000$ kg/m³
Ambient Temperature : 23.2 °C; Liquid Temperature : 22.2 °C

DASY5 Configuration:

- Probe: ES3DV3 - SN3169; ConvF(5.99, 5.99, 5.99); Calibrated: 2017/5/11;
- Sensor-Surface: 3mm (Mechanical Surface Detection)
- Electronics: DAE4 Sn1399; Calibrated: 2016/11/17
- Phantom: SAM_Left; Type: QD000P40CD; Serial: TP:1431
- Measurement SW: DASY52, Version 52.8 (8);SEMCAD X Version 14.6.10 (7373)

Area Scan (71x121x1): Interpolated grid: dx=1.500 mm, dy=1.500 mm
Maximum value of SAR (interpolated) = 0.0571 W/kg

Zoom Scan (5x5x7)/Cube 0: Measurement grid: dx=8mm, dy=8mm, dz=5mm
Reference Value = 8.100 V/m; Power Drift = 0.01 dB
Peak SAR (extrapolated) = 0.0700 W/kg
SAR(1 g) = 0.054 W/kg; SAR(10 g) = 0.041 W/kg
Maximum value of SAR (measured) = 0.0592 W/kg

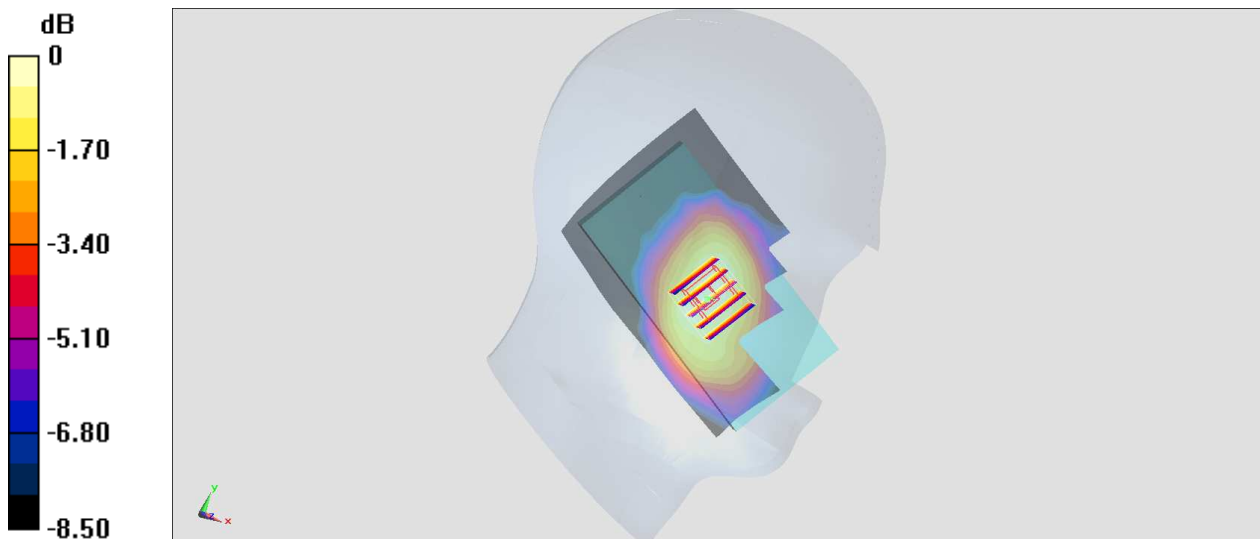

0 dB = 0.0592 W/kg = -12.28 dBW/kg

#08_LTE Band 7_20M_QPSK_1_0_Right Cheek_Ch21350

Communication System: LTE ; Frequency: 2560 MHz;Duty Cycle: 1:1

Medium: HSL_2600_170607 Medium parameters used: $f = 2560$ MHz; $\sigma = 1.966$ S/m; $\epsilon_r = 38.093$; $\rho = 1000$ kg/m³

Ambient Temperature : 23.2 °C ; Liquid Temperature : 22.2 °C

DASY5 Configuration:

- Probe: ES3DV3 - SN3270; ConvF(4.37, 4.37, 4.37); Calibrated: 2016/8/26;
- Sensor-Surface: 3mm (Mechanical Surface Detection)
- Electronics: DAE4 Sn778; Calibrated: 2017/5/22
- Phantom: SAM_Right; Type: QD000P40CD; Serial: 1884
- Measurement SW: DASY52, Version 52.8 (8);SEMCAD X Version 14.6.10 (7331)

Area Scan (81x141x1): Interpolated grid: dx=1.200 mm, dy=1.200 mm

Maximum value of SAR (interpolated) = 0.491 W/kg

Zoom Scan (8x8x7)/Cube 0: Measurement grid: dx=5mm, dy=5mm, dz=5mm

Reference Value = 4.374 V/m; Power Drift = 0.15 dB

Peak SAR (extrapolated) = 0.709 W/kg

SAR(1 g) = 0.393 W/kg; SAR(10 g) = 0.222 W/kg

Maximum value of SAR (measured) = 0.473 W/kg

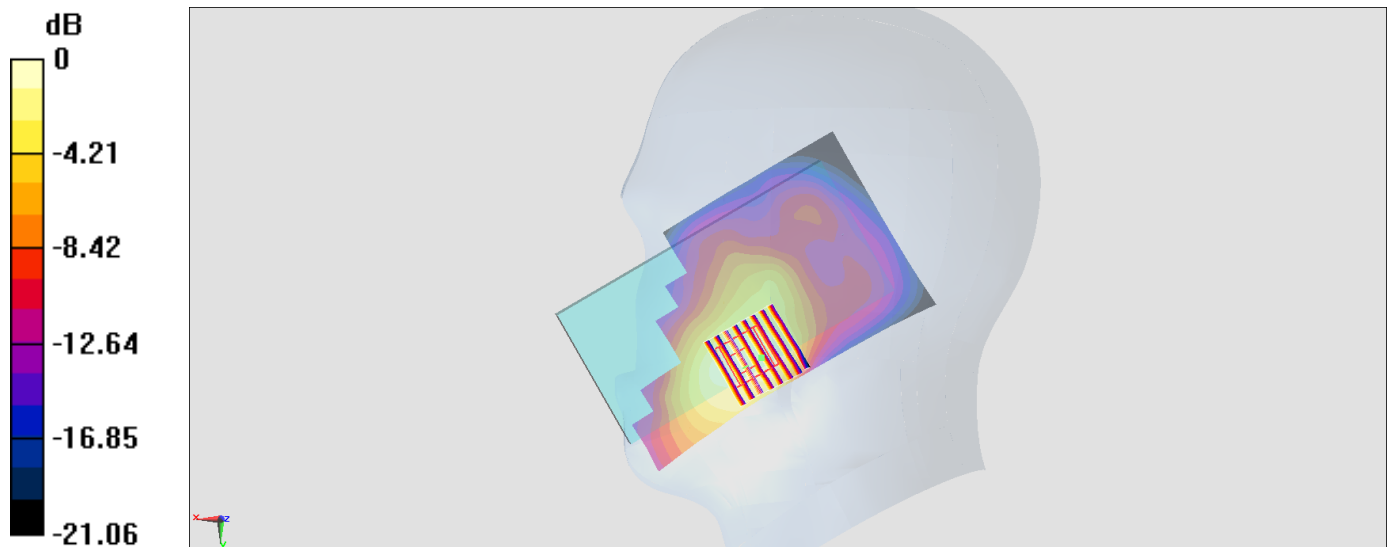

0 dB = 0.473 W/kg = -3.25 dBW/kg

#09_LTE Band 12_10M_QPSK_1_49_Left Cheek_Ch23095

Communication System: LTE ; Frequency: 707.5 MHz;Duty Cycle: 1:1
 Medium: HSL_750_170613 Medium parameters used: $f = 707.5$ MHz; $\sigma = 0.858$ S/m; $\epsilon_r = 41.432$;
 $\rho = 1000$ kg/m³
 Ambient Temperature : 23.7 °C; Liquid Temperature : 22.7 °C

DASY5 Configuration:

- Probe: ES3DV3 - SN3169; ConvF(6.07, 6.07, 6.07); Calibrated: 2017/5/11;
- Sensor-Surface: 3mm (Mechanical Surface Detection)
- Electronics: DAE4 Sn1399; Calibrated: 2016/11/17
- Phantom: SAM_Left; Type: QD000P40CD; Serial: TP:1431
- Measurement SW: DASY52, Version 52.8 (8);SEMCAD X Version 14.6.10 (7373)

Area Scan (71x121x1): Interpolated grid: dx=1.500 mm, dy=1.500 mm
 Maximum value of SAR (interpolated) = 0.0739 W/kg

Zoom Scan (6x6x7)/Cube 0: Measurement grid: dx=8mm, dy=8mm, dz=5mm
 Reference Value = 9.282 V/m; Power Drift = 0.09 dB
 Peak SAR (extrapolated) = 0.0870 W/kg
SAR(1 g) = 0.067 W/kg; SAR(10 g) = 0.053 W/kg
 Maximum value of SAR (measured) = 0.0736 W/kg

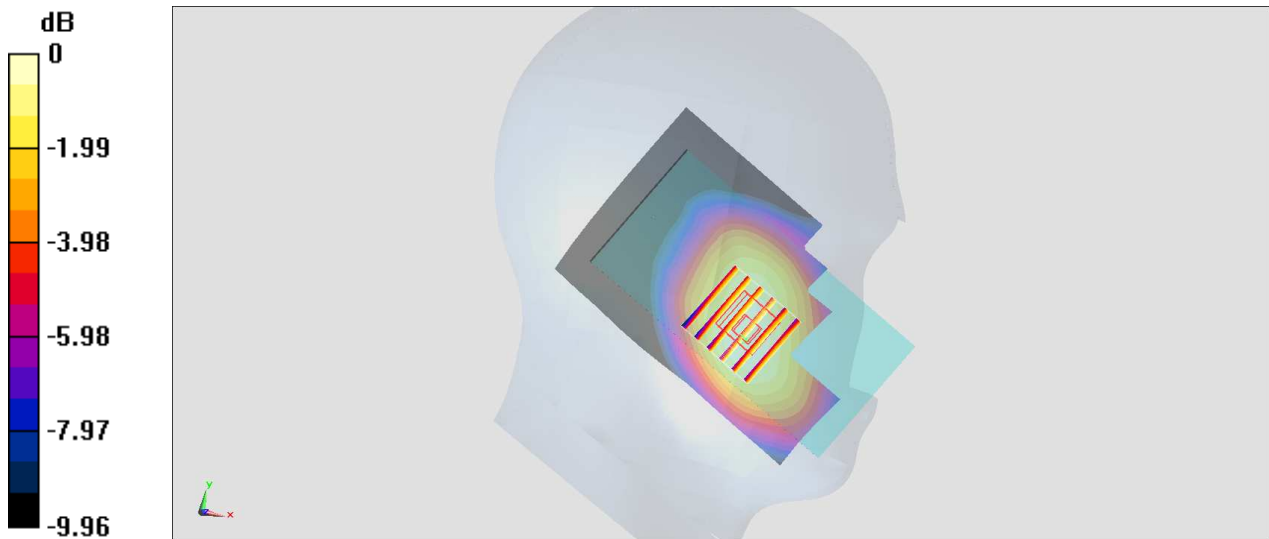

0 dB = 0.0736 W/kg = -11.33 dBW/kg

#10_LTE Band 13_10M_QPSK_1_49_Left Cheek_Ch23230

Communication System: LTE ; Frequency: 782 MHz;Duty Cycle: 1:1

Medium: HSL_750_170613 Medium parameters used: $f = 782 \text{ MHz}$; $\sigma = 0.928 \text{ S/m}$; $\epsilon_r = 40.474$; $\rho = 1000 \text{ kg/m}^3$

Ambient Temperature : $23.7 \text{ }^\circ\text{C}$; Liquid Temperature : $22.7 \text{ }^\circ\text{C}$

DASY5 Configuration:

- Probe: ES3DV3 - SN3169; ConvF(6.07, 6.07, 6.07); Calibrated: 2017/5/11;
- Sensor-Surface: 3mm (Mechanical Surface Detection)
- Electronics: DAE4 Sn1399; Calibrated: 2016/11/17
- Phantom: SAM_Left; Type: QD000P40CD; Serial: TP:1431
- Measurement SW: DASY52, Version 52.8 (8);SEMCAD X Version 14.6.10 (7373)

Area Scan (71x121x1): Interpolated grid: $dx=1.500 \text{ mm}$, $dy=1.500 \text{ mm}$

Maximum value of SAR (interpolated) = 0.0524 W/kg

Zoom Scan (6x6x7)/Cube 0: Measurement grid: $dx=8\text{mm}$, $dy=8\text{mm}$, $dz=5\text{mm}$

Reference Value = 7.683 V/m ; Power Drift = 0.09 dB

Peak SAR (extrapolated) = 0.0660 W/kg

SAR(1 g) = 0.059 W/kg ; SAR(10 g) = 0.039 W/kg

Maximum value of SAR (measured) = 0.0539 W/kg

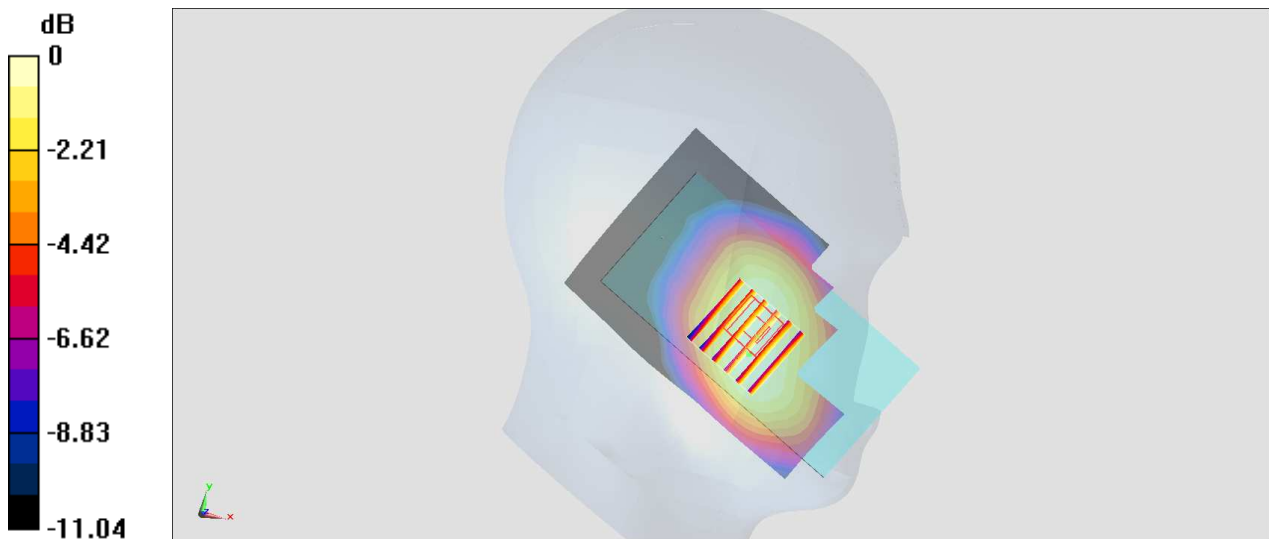

0 dB = $0.0539 \text{ W/kg} = -12.68 \text{ dBW/kg}$

#11_LTE Band 66_20M_QPSK_1_0_Left Cheek_Ch132572

Communication System: LTE ; Frequency: 1770 MHz;Duty Cycle: 1:1

Medium: HSL_1750_170607 Medium parameters used: $f = 1770$ MHz; $\sigma = 1.373$ S/m; $\epsilon_r = 41.476$; $\rho = 1000$ kg/m³

Ambient Temperature : 23.2 °C ; Liquid Temperature : 22.2 °C

DASY5 Configuration:

- Probe: ES3DV3 - SN3270; ConvF(5.21, 5.21, 5.21); Calibrated: 2016/8/26;
- Sensor-Surface: 3mm (Mechanical Surface Detection)
- Electronics: DAE4 Sn916; Calibrated: 2016/12/15
- Phantom: SAM_Right; Type: QD000P40CD; Serial: 1884
- Measurement SW: DASY52, Version 52.8 (8);SEMCAD X Version 14.6.10 (7331)

Area Scan (71x121x1): Interpolated grid: dx=1.500 mm, dy=1.500 mm

Maximum value of SAR (interpolated) = 0.220 W/kg

Zoom Scan (5x5x7)/Cube 0: Measurement grid: dx=8mm, dy=8mm, dz=5mm

Reference Value = 12.26 V/m; Power Drift = -0.07 dB

Peak SAR (extrapolated) = 0.272 W/kg

SAR(1 g) = 0.192 W/kg; SAR(10 g) = 0.128 W/kg

Maximum value of SAR (measured) = 0.218 W/kg

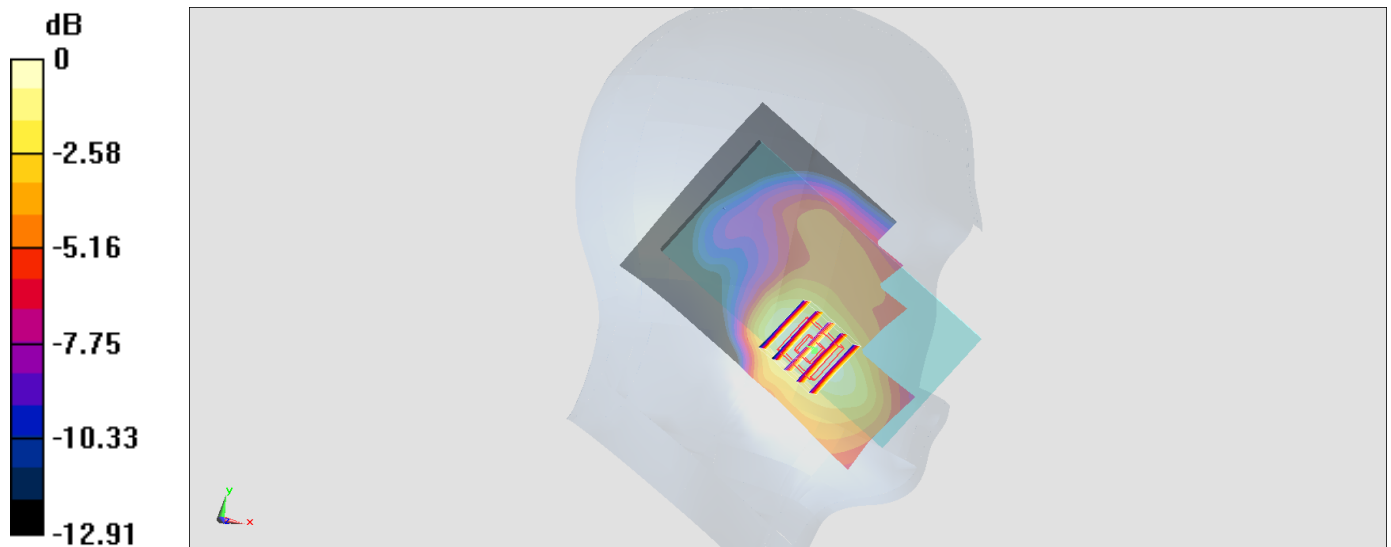

0 dB = 0.218 W/kg = -6.62 dBW/kg

#12_WLAN2.4GHz_802.11b 1Mbps_Left Cheek_Ch11

Communication System: 802.11b ; Frequency: 2462 MHz;Duty Cycle: 1:1
Medium: HSL_2450_170615 Medium parameters used: $f = 2462$ MHz; $\sigma = 1.822$ S/m; $\epsilon_r = 40.443$;
 $\rho = 1000$ kg/m³
Ambient Temperature : 23.2 °C ; Liquid Temperature : 22.2 °C

DASY5 Configuration:

- Probe: EX3DV4 - SN3925; ConvF(7.85, 7.85, 7.85); Calibrated: 2017/5/24;
- Sensor-Surface: 1.4mm (Mechanical Surface Detection)
- Electronics: DAE3 Sn495; Calibrated: 2017/5/22
- Phantom: SAM_Left; Type: QD000P40CD; Serial: TP:1431
- Measurement SW: DASY52, Version 52.8 (8);SEMCAD X Version 14.6.10 (7373)

Area Scan (81x151x1): Interpolated grid: dx=1.200 mm, dy=1.200 mm
Maximum value of SAR (interpolated) = 0.442 W/kg

Zoom Scan (7x7x7)/Cube 0: Measurement grid: dx=5mm, dy=5mm, dz=5mm
Reference Value = 11.84 V/m; Power Drift = 0.05 dB
Peak SAR (extrapolated) = 0.577 W/kg
SAR(1 g) = 0.231 W/kg; SAR(10 g) = 0.093 W/kg
Maximum value of SAR (measured) = 0.429 W/kg

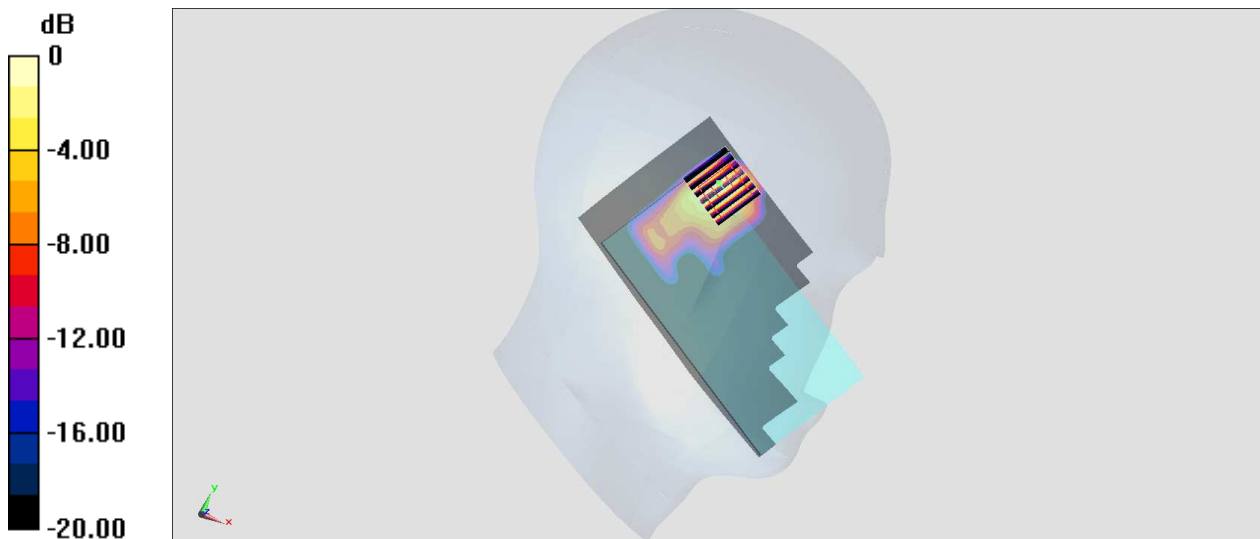

0 dB = 0.429 W/kg = -3.68 dBW/kg

#13_WLAN5GHz_802.11ac-VHT80 MCS0_Left Cheek_Ch58

Communication System: 802.11ac ; Frequency: 5290 MHz;Duty Cycle: 1:1.174
Medium: HSL_5G_170614 Medium parameters used: $f = 5290$ MHz; $\sigma = 4.587$ S/m; $\epsilon_r = 37.386$; $\rho = 1000$ kg/m³
Ambient Temperature : 23.5 °C; Liquid Temperature : 22.5 °C

DASY5 Configuration:

- Probe: EX3DV4 - SN3925; ConvF(5.36, 5.36, 5.36); Calibrated: 2017/5/24;
- Sensor-Surface: 1.4mm (Mechanical Surface Detection)
- Electronics: DAE3 Sn495; Calibrated: 2017/5/22
- Phantom: SAM_Left; Type: QD000P40CD; Serial: TP:1431
- Measurement SW: DASY52, Version 52.8 (8);SEMCAD X Version 14.6.10 (7373)

Area Scan (101x181x1): Interpolated grid: dx=1.000 mm, dy=1.000 mm
Maximum value of SAR (interpolated) = 0.0750 W/kg

Zoom Scan (7x7x7)/Cube 0: Measurement grid: dx=4mm, dy=4mm, dz=1.4mm
Reference Value = 3.693 V/m; Power Drift = 0.08 dB
Peak SAR (extrapolated) = 0.285 W/kg
SAR(1 g) = 0.00956 W/kg; SAR(10 g) = 0.00103 W/kg
Maximum value of SAR (measured) = 0.0464 W/kg

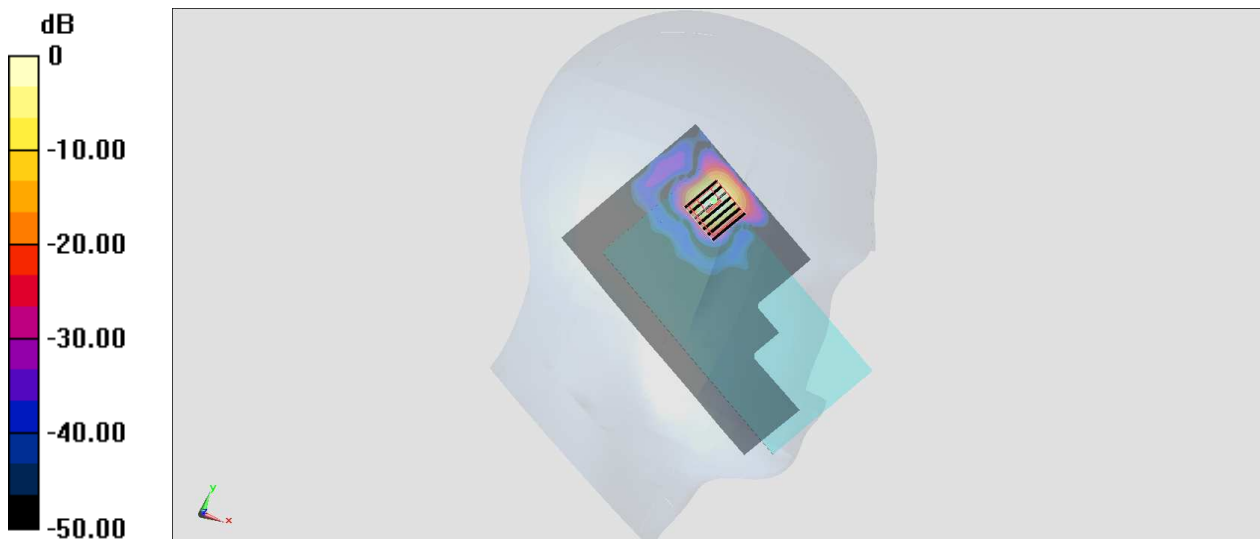

0 dB = 0.0464 W/kg = -13.33 dBW/kg

#14_WLAN5GHz_802.11ac-VHT80 MCS0_Left Cheek_Ch106

Communication System: 802.11ac; Frequency: 5530 MHz; Duty Cycle: 1:1.174

Medium: HSL_5G_170614 Medium parameters used: $f = 5530$ MHz; $\sigma = 4.842$ S/m; $\epsilon_r = 37.022$; $\rho = 1000$ kg/m³

Ambient Temperature : 23.5 °C; Liquid Temperature : 22.5 °C

DASY5 Configuration:

- Probe: EX3DV4 - SN3925; ConvF(4.72, 4.72, 4.72); Calibrated: 2017/5/24;
- Sensor-Surface: 1.4mm (Mechanical Surface Detection)
- Electronics: DAE3 Sn495; Calibrated: 2017/5/22
- Phantom: SAM_Left; Type: QD000P40CD; Serial: TP:1431
- Measurement SW: DASY52, Version 52.8 (8); SEMCAD X Version 14.6.10 (7373)

Area Scan (101x91x1): Interpolated grid: dx=1.000 mm, dy=1.000 mm

Maximum value of SAR (interpolated) = 0.249 W/kg

Zoom Scan (8x8x7)/Cube 0: Measurement grid: dx=4mm, dy=4mm, dz=1.4mm

Reference Value = 9.026 V/m; Power Drift = 0.02 dB

Peak SAR (extrapolated) = 0.523 W/kg

SAR(1 g) = 0.107 W/kg; SAR(10 g) = 0.027 W/kg

Maximum value of SAR (measured) = 0.303 W/kg

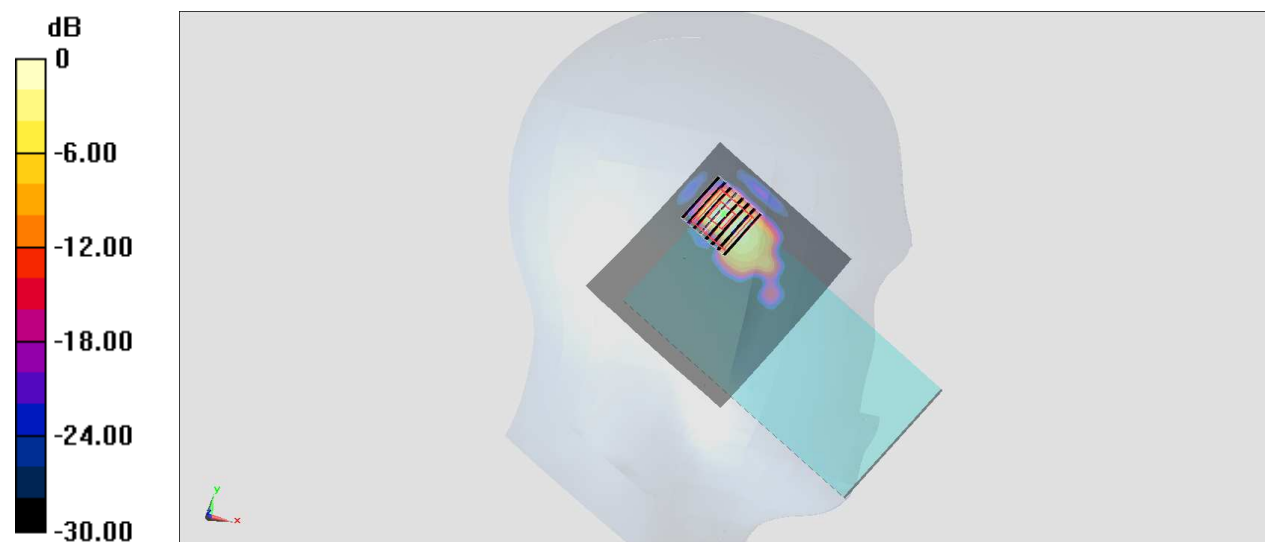

0 dB = 0.303 W/kg = -5.19 dBW/kg

#15_WLAN5GHz_802.11ac-VHT80 MCS0_Right Cheek_Ch155

Communication System: 802.11ac; Frequency: 5775 MHz; Duty Cycle: 1:1.174
Medium: HSL_5G_170614 Medium parameters used: $f = 5775$ MHz; $\sigma = 5.123$ S/m; $\epsilon_r = 36.809$; $\rho = 1000$ kg/m³
Ambient Temperature : 23.5 °C; Liquid Temperature : 22.5 °C

DASY5 Configuration:

- Probe: EX3DV4 - SN3925; ConvF(4.87, 4.87, 4.87); Calibrated: 2017/5/24;
- Sensor-Surface: 1.4mm (Mechanical Surface Detection)
- Electronics: DAE3 Sn495; Calibrated: 2017/5/22
- Phantom: SAM_Left; Type: QD000P40CD; Serial: TP:1431
- Measurement SW: DASY52, Version 52.8 (8); SEMCAD X Version 14.6.10 (7373)

Area Scan (101x181x1): Interpolated grid: dx=1.000 mm, dy=1.000 mm
Maximum value of SAR (interpolated) = 0.213 W/kg

Zoom Scan (8x8x7)/Cube 0: Measurement grid: dx=4mm, dy=4mm, dz=1.4mm
Reference Value = 7.842 V/m; Power Drift = -0.08 dB
Peak SAR (extrapolated) = 0.584 W/kg
SAR(1 g) = 0.176 W/kg; SAR(10 g) = 0.032 W/kg
Maximum value of SAR (measured) = 0.373 W/kg

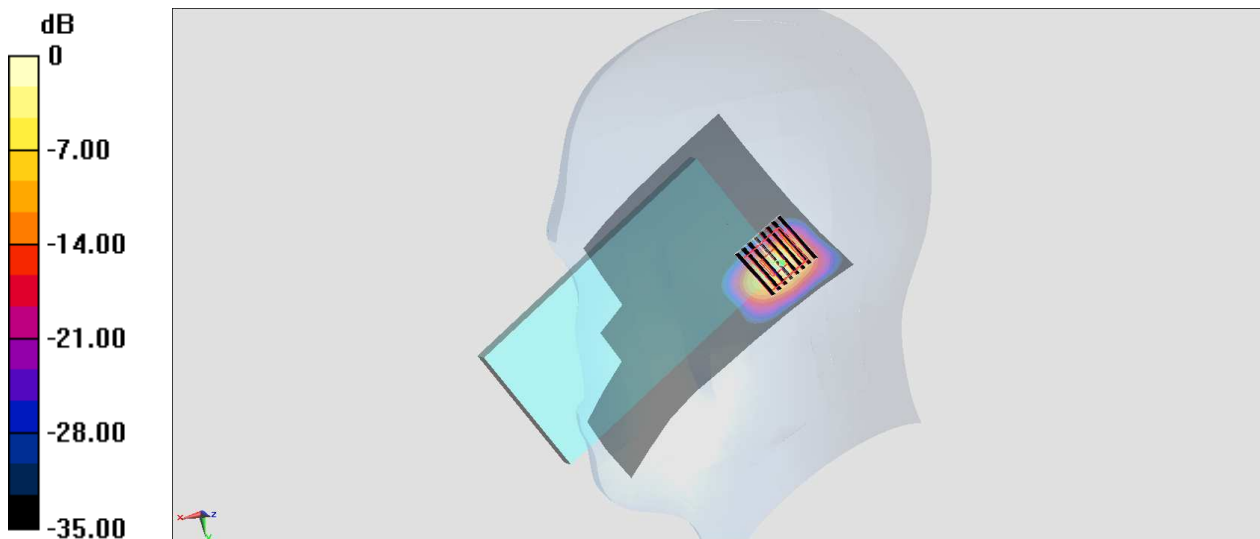

0 dB = 0.373 W/kg = -4.28 dBW/kg

#16_Bluetooth_1Mbps_Left Cheek_Ch78

Communication System: Bluetooth ; Frequency: 2480 MHz;Duty Cycle: 1:1.297
Medium: HSL_2450_170616 Medium parameters used: $f = 2480$ MHz; $\sigma = 1.88$ S/m; $\epsilon_r = 40.539$; $\rho = 1000$ kg/m³
Ambient Temperature : 23.4 °C; Liquid Temperature : 22.4 °C

DASY5 Configuration:

- Probe: EX3DV4 - SN3925; ConvF(7.85, 7.85, 7.85); Calibrated: 2017/5/24;
- Sensor-Surface: 1.4mm (Mechanical Surface Detection)
- Electronics: DAE3 Sn495; Calibrated: 2017/5/22
- Phantom: SAM-Right; Type: SAM; Serial: TP-1503
- Measurement SW: DASY52, Version 52.8 (8);SEMCAD X Version 14.6.10 (7373)

Area Scan (71x151x1): Interpolated grid: dx=1.200 mm, dy=1.200 mm
Maximum value of SAR (interpolated) = 0.0166 W/kg

Zoom Scan (7x7x7)/Cube 0: Measurement grid: dx=5mm, dy=5mm, dz=5mm
Reference Value = 1.037 V/m; Power Drift = -0.08 dB
Peak SAR (extrapolated) = 0.0410 W/kg
SAR(1 g) = 0.0066 W/kg; SAR(10 g) = 0.00153 W/kg
Maximum value of SAR (measured) = 0.0207 W/kg

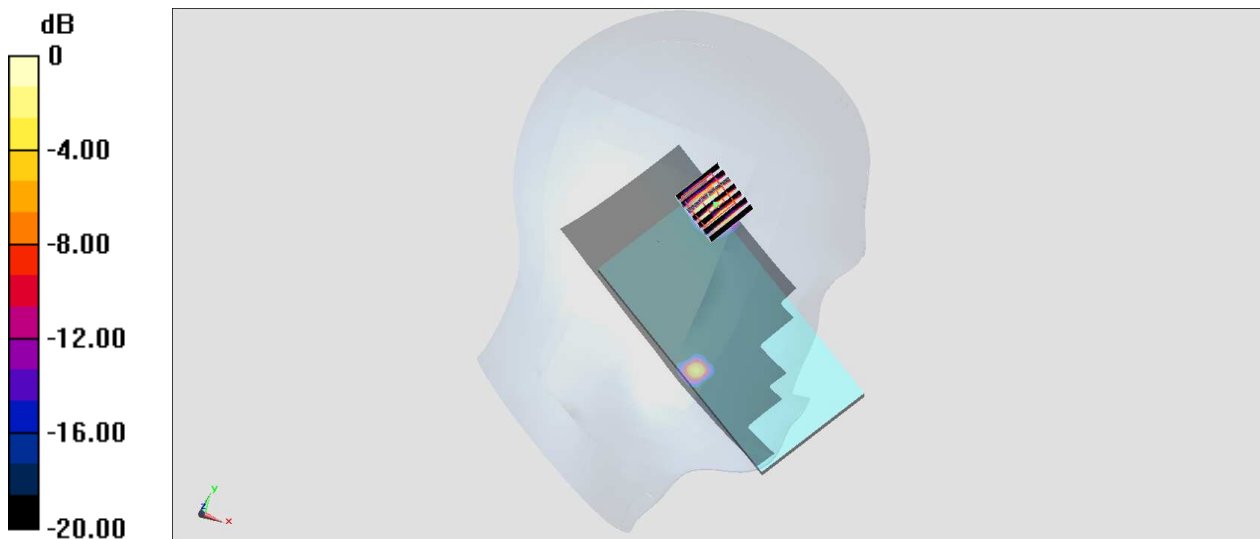

0 dB = 0.0207 W/kg = -16.84 dBW/kg

#17_GSM850_GPRS(4 Tx slots)_Back_10mm_Ch251

Communication System: GSM850; Frequency: 848.8 MHz; Duty Cycle: 1:2.08

Medium: MSL_850_170609 Medium parameters used: $f = 849$ MHz; $\sigma = 0.974$ S/m; $\epsilon_r = 55.107$; $\rho = 1000$ kg/m³

Ambient Temperature : 23.5 °C; Liquid Temperature : 22.5 °C

DASY5 Configuration:

- Probe: ES3DV3 - SN3270; ConvF(6.01, 6.01, 6.01); Calibrated: 2016/8/26;
- Sensor-Surface: 3mm (Mechanical Surface Detection)
- Electronics: DAE4 Sn778; Calibrated: 2017/5/22
- Phantom: SAM-Left; Type: QD 000 P40 C; Serial: TP-1446
- Measurement SW: DASY52, Version 52.8 (8); SEMCAD X Version 14.6.10 (7331)

Area Scan (61x121x1): Interpolated grid: dx=1.500 mm, dy=1.500 mm

Maximum value of SAR (interpolated) = 0.284 W/kg

Zoom Scan (5x5x7)/Cube 0: Measurement grid: dx=8mm, dy=8mm, dz=5mm

Reference Value = 16.27 V/m; Power Drift = 0.03 dB

Peak SAR (extrapolated) = 0.401 W/kg

SAR(1 g) = 0.237 W/kg; SAR(10 g) = 0.149 W/kg

Maximum value of SAR (measured) = 0.270 W/kg

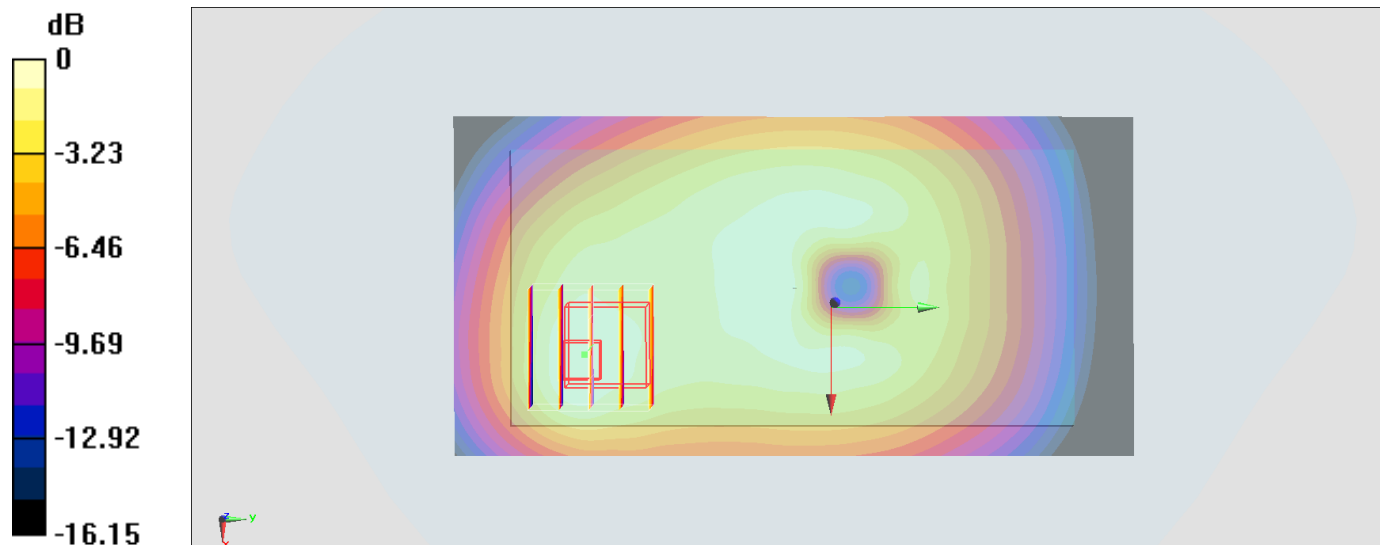

0 dB = 0.270 W/kg = -5.69 dBW/kg

#18_GSM1900_GPRS(4 Tx slots)_Back_10mm_Ch810

Communication System: PCS; Frequency: 1909.8 MHz; Duty Cycle: 1:2.08

Medium: MSL_1900_170608 Medium parameters used: $f = 1910$ MHz; $\sigma = 1.531$ S/m; $\epsilon_r = 55.384$; $\rho = 1000$ kg/m³

Ambient Temperature : 23.6 °C ; Liquid Temperature : 22.6 °C

DASY5 Configuration:

- Probe: ES3DV3 - SN3270; ConvF(4.7, 4.7, 4.7); Calibrated: 2016/8/26;
- Sensor-Surface: 3mm (Mechanical Surface Detection)
- Electronics: DAE4 Sn916; Calibrated: 2016/12/15
- Phantom: SAM-Left; Type: QD 000 P40 C; Serial: TP-1446
- Measurement SW: DASY52, Version 52.8 (8); SEMCAD X Version 14.6.10 (7331)

Area Scan (61x121x1): Interpolated grid: dx=1.500 mm, dy=1.500 mm

Maximum value of SAR (interpolated) = 1.13 W/kg

Zoom Scan (5x5x7)/Cube 0: Measurement grid: dx=8mm, dy=8mm, dz=5mm

Reference Value = 20.42 V/m; Power Drift = -0.01 dB

Peak SAR (extrapolated) = 1.61 W/kg

SAR(1 g) = 0.905 W/kg; SAR(10 g) = 0.476 W/kg

Maximum value of SAR (measured) = 1.19 W/kg

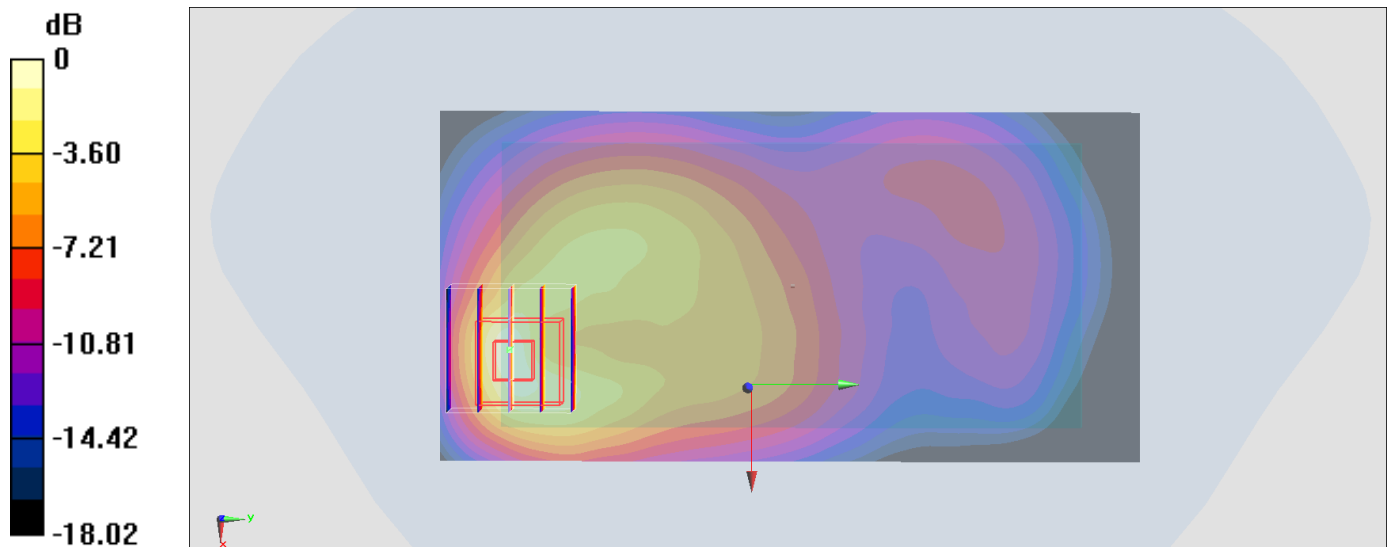

0 dB = 1.19 W/kg = 0.76 dBW/kg

#19_WCDMA II_RMC 12.2Kbps_Back_10mm_Ch9538

Communication System: WCDMA; Frequency: 1907.6 MHz; Duty Cycle: 1:1

Medium: MSL_1900_170608 Medium parameters used: $f = 1908 \text{ MHz}$; $\sigma = 1.529 \text{ S/m}$; $\epsilon_r = 55.391$; $\rho = 1000 \text{ kg/m}^3$

Ambient Temperature : $23.6 \text{ }^\circ\text{C}$; Liquid Temperature : $22.6 \text{ }^\circ\text{C}$

DASY5 Configuration:

- Probe: ES3DV3 - SN3270; ConvF(4.7, 4.7, 4.7); Calibrated: 2016/8/26;
- Sensor-Surface: 3mm (Mechanical Surface Detection)
- Electronics: DAE4 Sn916; Calibrated: 2016/12/15
- Phantom: SAM-Left; Type: QD 000 P40 C; Serial: TP-1446
- Measurement SW: DASY52, Version 52.8 (8); SEMCAD X Version 14.6.10 (7331)

Area Scan (61x121x1): Interpolated grid: $dx=1.500 \text{ mm}$, $dy=1.500 \text{ mm}$

Maximum value of SAR (interpolated) = 0.727 W/kg

Zoom Scan (5x5x7)/Cube 0: Measurement grid: $dx=8\text{mm}$, $dy=8\text{mm}$, $dz=5\text{mm}$

Reference Value = 16.60 V/m ; Power Drift = -0.12 dB

Peak SAR (extrapolated) = 1.04 W/kg

SAR(1 g) = 0.577 W/kg ; SAR(10 g) = 0.290 W/kg

Maximum value of SAR (measured) = 0.719 W/kg

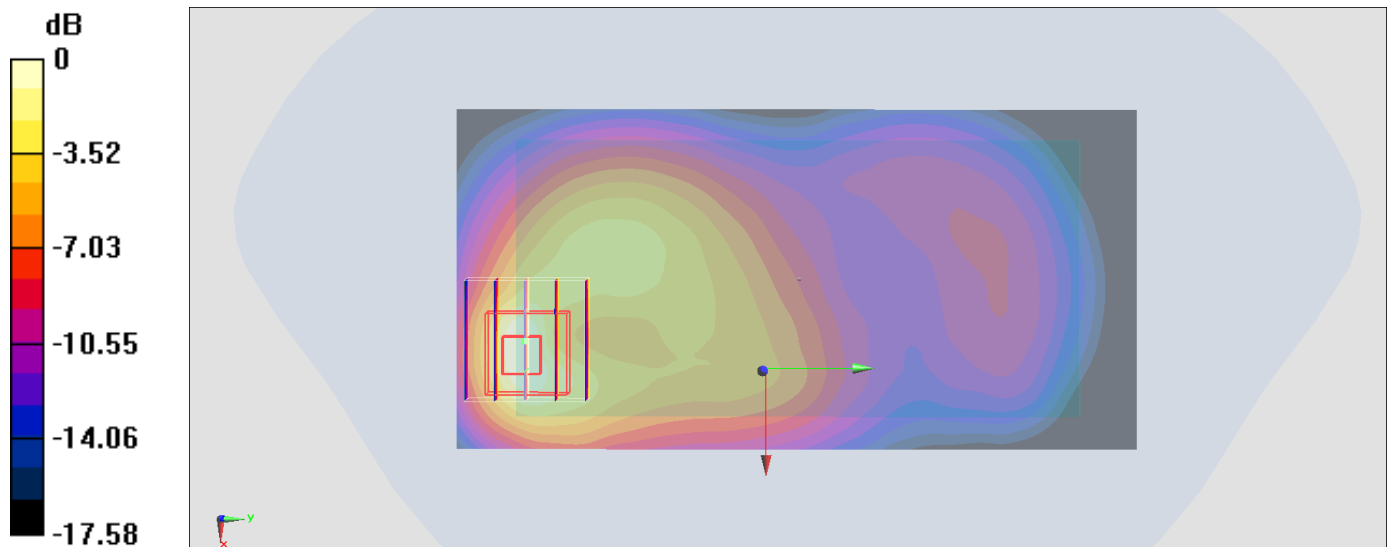

0 dB = $0.719 \text{ W/kg} = -1.43 \text{ dBW/kg}$

#20_WCDMA IV_RMC 12.2Kbps_Back_10mm_Ch1513

Communication System: WCDMA; Frequency: 1752.6 MHz; Duty Cycle: 1:1

Medium: MSL_1750_170608 Medium parameters used: $f = 1753$ MHz; $\sigma = 1.464$ S/m; $\epsilon_r = 55.056$; $\rho = 1000$ kg/m³

Ambient Temperature : 23.6 °C ; Liquid Temperature : 22.6 °C

DASY5 Configuration:

- Probe: ES3DV3 - SN3270; ConvF(4.95, 4.95, 4.95); Calibrated: 2016/8/26;
- Sensor-Surface: 3mm (Mechanical Surface Detection)
- Electronics: DAE4 Sn916; Calibrated: 2016/12/15
- Phantom: SAM-Left; Type: QD 000 P40 C; Serial: TP-1446
- Measurement SW: DASY52, Version 52.8 (8); SEMCAD X Version 14.6.10 (7331)

Area Scan (61x121x1): Interpolated grid: dx=1.500 mm, dy=1.500 mm

Maximum value of SAR (interpolated) = 0.524 W/kg

Zoom Scan (5x5x7)/Cube 0: Measurement grid: dx=8mm, dy=8mm, dz=5mm

Reference Value = 16.67 V/m; Power Drift = 0.00 dB

Peak SAR (extrapolated) = 0.692 W/kg

SAR(1 g) = 0.486 W/kg; SAR(10 g) = 0.252 W/kg

Maximum value of SAR (measured) = 0.531 W/kg

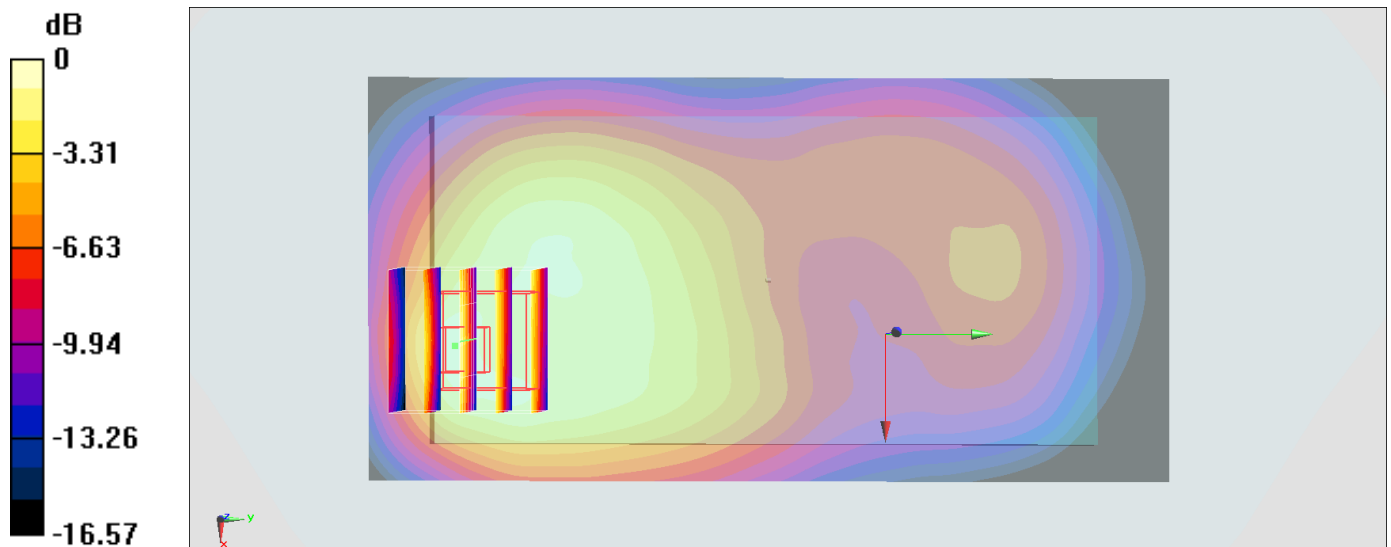

0 dB = 0.531 W/kg = -2.75 dBW/kg

#21_WCDMA V_RMC 12.2Kbps_Back_10mm_Ch4233

Communication System: WCDMA; Frequency: 846.6 MHz; Duty Cycle: 1:1

Medium: MSL_850_170609 Medium parameters used: $f = 847$ MHz; $\sigma = 0.972$ S/m; $\epsilon_r = 55.122$; $\rho = 1000$ kg/m³

Ambient Temperature : 23.5 °C; Liquid Temperature : 22.5 °C

DASY5 Configuration:

- Probe: ES3DV3 - SN3270; ConvF(6.01, 6.01, 6.01); Calibrated: 2016/8/26;
- Sensor-Surface: 3mm (Mechanical Surface Detection)
- Electronics: DAE4 Sn778; Calibrated: 2017/5/22
- Phantom: SAM-Left; Type: QD 000 P40 C; Serial: TP-1446
- Measurement SW: DASY52, Version 52.8 (8); SEMCAD X Version 14.6.10 (7331)

Area Scan (61x121x1): Interpolated grid: dx=1.500 mm, dy=1.500 mm

Maximum value of SAR (interpolated) = 0.146 W/kg

Zoom Scan (5x5x7)/Cube 0: Measurement grid: dx=8mm, dy=8mm, dz=5mm

Reference Value = 11.34 V/m; Power Drift = -0.01 dB

Peak SAR (extrapolated) = 0.210 W/kg

SAR(1 g) = 0.121 W/kg; SAR(10 g) = 0.076 W/kg

Maximum value of SAR (measured) = 0.142 W/kg

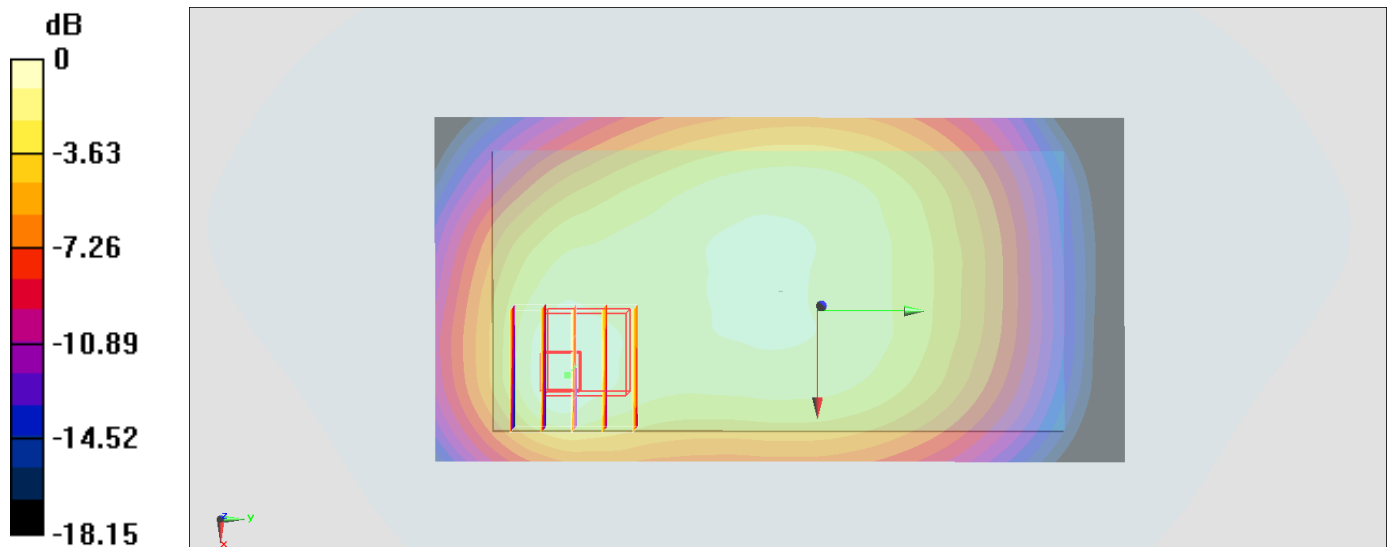

0 dB = 0.142 W/kg = -8.48 dBW/kg

#22_LTE Band 2_20M_QPSK_1_0_Back_10mm_Ch19100

Communication System: LTE; Frequency: 1900 MHz; Duty Cycle: 1:1

Medium: MSL_1900_170608 Medium parameters used: $f = 1900$ MHz; $\sigma = 1.521$ S/m; $\epsilon_r = 55.414$; $\rho = 1000$ kg/m³

Ambient Temperature : 23.6 °C ; Liquid Temperature : 22.6 °C

DASY5 Configuration:

- Probe: ES3DV3 - SN3270; ConvF(4.7, 4.7, 4.7); Calibrated: 2016/8/26;
- Sensor-Surface: 3mm (Mechanical Surface Detection)
- Electronics: DAE4 Sn916; Calibrated: 2016/12/15
- Phantom: SAM-Left; Type: QD 000 P40 C; Serial: TP-1446
- Measurement SW: DASY52, Version 52.8 (8); SEMCAD X Version 14.6.10 (7331)

Area Scan (61x121x1): Interpolated grid: dx=1.500 mm, dy=1.500 mm

Maximum value of SAR (interpolated) = 0.470 W/kg

Zoom Scan (5x5x7)/Cube 0: Measurement grid: dx=8mm, dy=8mm, dz=5mm

Reference Value = 13.85 V/m; Power Drift = 0.14 dB

Peak SAR (extrapolated) = 0.679 W/kg

SAR(1 g) = 0.418 W/kg; SAR(10 g) = 0.193 W/kg

Maximum value of SAR (measured) = 0.465 W/kg

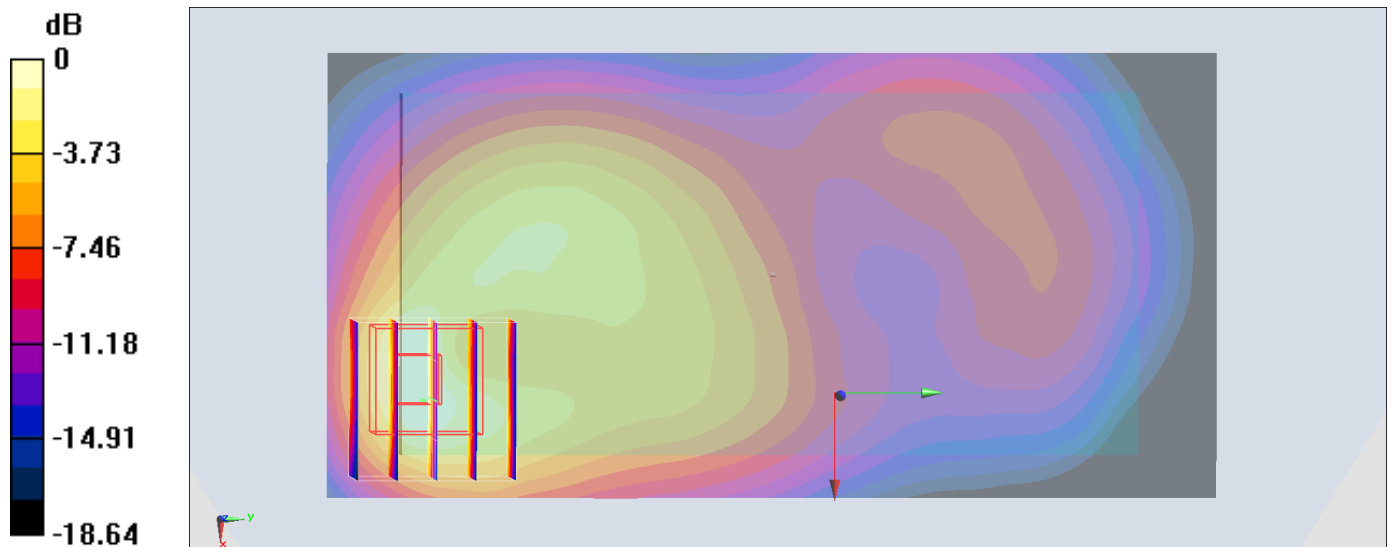

0 dB = 0.465 W/kg = -3.33 dBW/kg

#23_LTE Band 5_10M_QPSK_1_0_Back_10mm_Ch20525

Communication System: LTE; Frequency: 836.5 MHz; Duty Cycle: 1:1

Medium: MSL_850_170609 Medium parameters used: $f = 836.5$ MHz; $\sigma = 0.962$ S/m; $\epsilon_r = 55.222$; $\rho = 1000$ kg/m³

Ambient Temperature : 23.5 °C; Liquid Temperature : 22.5 °C

DASY5 Configuration:

- Probe: ES3DV3 - SN3270; ConvF(6.01, 6.01, 6.01); Calibrated: 2016/8/26;
- Sensor-Surface: 3mm (Mechanical Surface Detection)
- Electronics: DAE4 Sn778; Calibrated: 2017/5/22
- Phantom: SAM-Left; Type: QD 000 P40 C; Serial: TP-1446
- Measurement SW: DASY52, Version 52.8 (8); SEMCAD X Version 14.6.10 (7331)

Area Scan (61x121x1): Interpolated grid: dx=1.500 mm, dy=1.500 mm

Maximum value of SAR (interpolated) = 0.119 W/kg

Zoom Scan (5x5x7)/Cube 0: Measurement grid: dx=8mm, dy=8mm, dz=5mm

Reference Value = 10.10 V/m; Power Drift = -0.03 dB

Peak SAR (extrapolated) = 0.168 W/kg

SAR(1 g) = 0.096 W/kg; SAR(10 g) = 0.060 W/kg

Maximum value of SAR (measured) = 0.114 W/kg

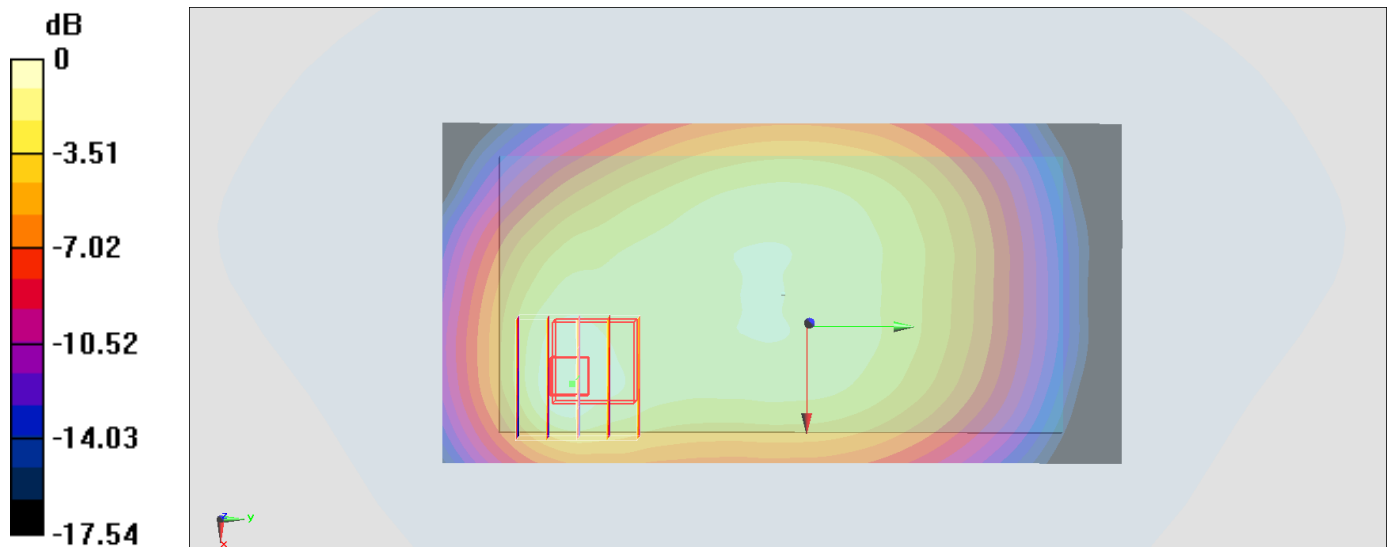

0 dB = 0.114 W/kg = -9.43 dBW/kg

#24_LTE Band 7_20M_QPSK_1_0_Back_10mm_Ch21350

Communication System: LTE; Frequency: 2560 MHz; Duty Cycle: 1:1

Medium: MSL_2600_170609 Medium parameters used: $f = 2560$ MHz; $\sigma = 2.104$ S/m; $\epsilon_r = 52.835$; $\rho = 1000$ kg/m³

Ambient Temperature : 23.5 °C; Liquid Temperature : 22.5 °C

DASY5 Configuration:

- Probe: ES3DV3 - SN3270; ConvF(4.12, 4.12, 4.12); Calibrated: 2016/8/26;
- Sensor-Surface: 3mm (Mechanical Surface Detection)
- Electronics: DAE4 Sn778; Calibrated: 2017/5/22
- Phantom: SAM_Right; Type: QD000P40CD; Serial: 1884
- Measurement SW: DASY52, Version 52.8 (8); SEMCAD X Version 14.6.10 (7331)

Area Scan (81x151x1): Interpolated grid: dx=1.200 mm, dy=1.200 mm

Maximum value of SAR (interpolated) = 0.542 W/kg

Zoom Scan (7x7x7)/Cube 0: Measurement grid: dx=5mm, dy=5mm, dz=5mm

Reference Value = 4.043 V/m; Power Drift = -0.07 dB

Peak SAR (extrapolated) = 0.916 W/kg

SAR(1 g) = 0.459 W/kg; SAR(10 g) = 0.227 W/kg

Maximum value of SAR (measured) = 0.587 W/kg

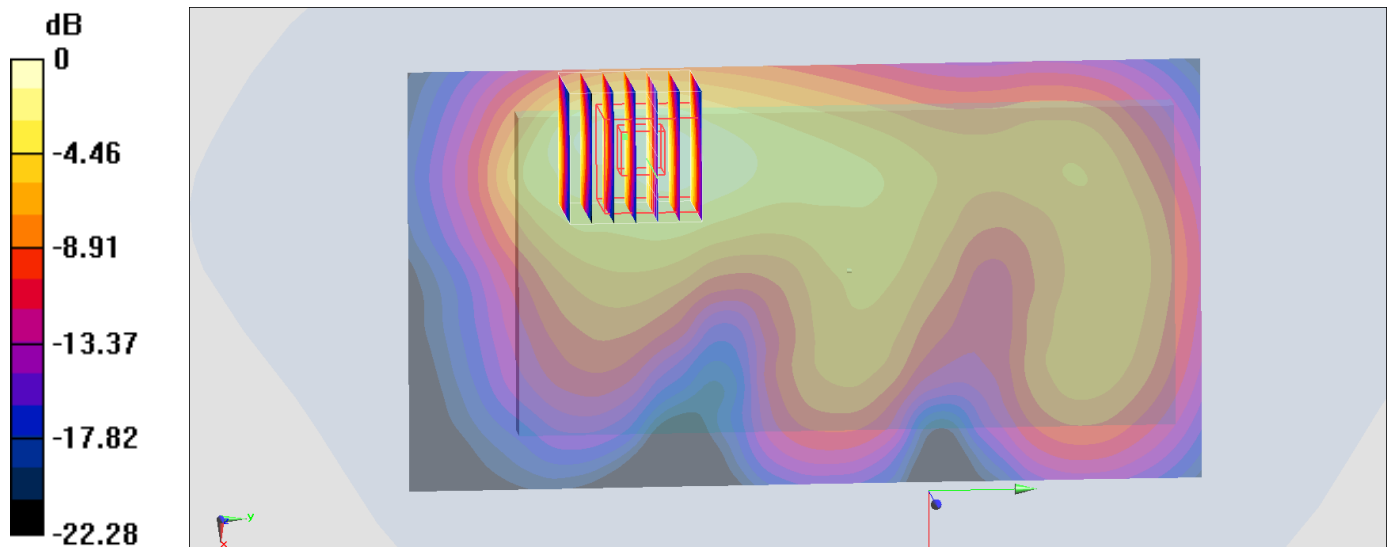

0 dB = 0.587 W/kg = -2.31 dBW/kg

#25_LTE Band 12_10M_QPSK_1_49_Back_10mm_Ch23095

Communication System: LTE; Frequency: 707.5 MHz; Duty Cycle: 1:1

Medium: MSL_750_170611 Medium parameters used: $f = 707.5$ MHz; $\sigma = 0.919$ S/m; $\epsilon_r = 55.919$; $\rho = 1000$ kg/m³

Ambient Temperature : 23.4 °C; Liquid Temperature : 22.4 °C

DASY5 Configuration:

- Probe: ES3DV3 - SN3270; ConvF(6.09, 6.09, 6.09); Calibrated: 2016/8/26;
- Sensor-Surface: 3mm (Mechanical Surface Detection)
- Electronics: DAE4 Sn778; Calibrated: 2017/5/22
- Phantom: SAM-Left; Type: QD 000 P40 C; Serial: TP-1446
- Measurement SW: DASY52, Version 52.8 (8); SEMCAD X Version 14.6.10 (7331)

Area Scan (61x121x1): Interpolated grid: dx=1.500 mm, dy=1.500 mm

Maximum value of SAR (interpolated) = 0.156 W/kg

Zoom Scan (6x7x7)/Cube 0: Measurement grid: dx=8mm, dy=8mm, dz=5mm

Reference Value = 12.47 V/m; Power Drift = -0.03 dB

Peak SAR (extrapolated) = 0.204 W/kg

SAR(1 g) = 0.129 W/kg; SAR(10 g) = 0.092 W/kg

Maximum value of SAR (measured) = 0.148 W/kg

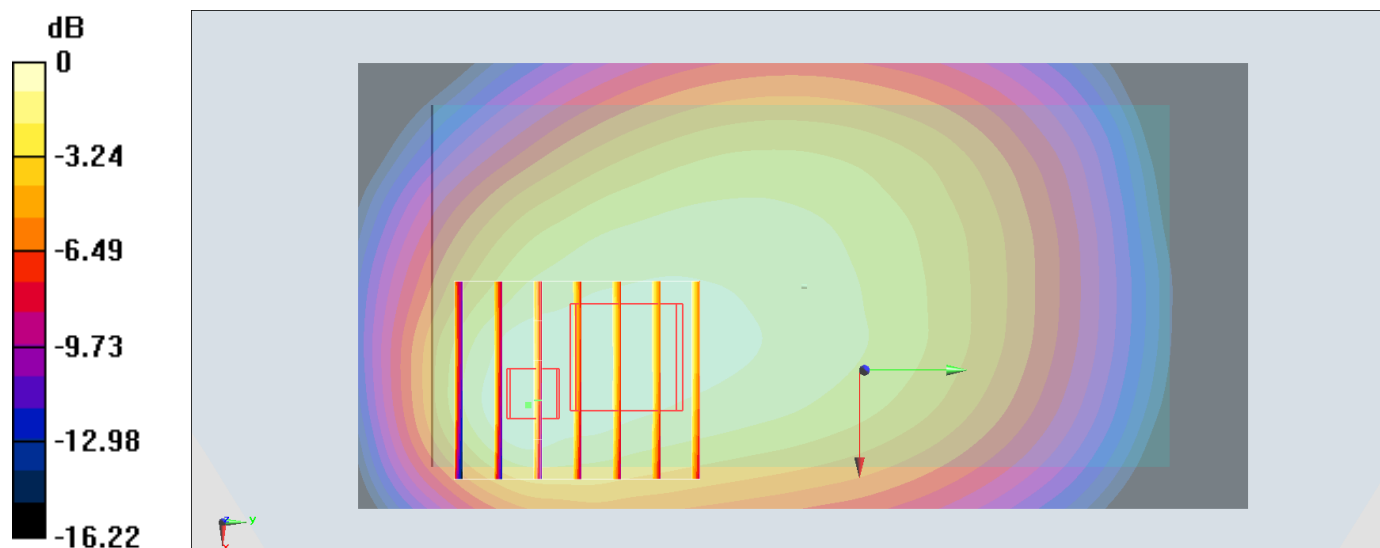

0 dB = 0.148 W/kg = -8.30 dBW/kg

#26_LTE Band 13_10M_QPSK_1_49_Back_10mm_Ch23230

Communication System: LTE; Frequency: 782 MHz; Duty Cycle: 1:1

Medium: MSL_750_170611 Medium parameters used: $f = 782 \text{ MHz}$; $\sigma = 0.993 \text{ S/m}$; $\epsilon_r = 55.133$; $\rho = 1000 \text{ kg/m}^3$

Ambient Temperature : $23.4 \text{ }^\circ\text{C}$; Liquid Temperature : $22.4 \text{ }^\circ\text{C}$

DASY5 Configuration:

- Probe: ES3DV3 - SN3270; ConvF(6.09, 6.09, 6.09); Calibrated: 2016/8/26;
- Sensor-Surface: 3mm (Mechanical Surface Detection)
- Electronics: DAE4 Sn778; Calibrated: 2017/5/22
- Phantom: SAM-Left; Type: QD 000 P40 C; Serial: TP-1446
- Measurement SW: DASY52, Version 52.8 (8); SEMCAD X Version 14.6.10 (7331)

Area Scan (61x121x1): Interpolated grid: $dx=1.500 \text{ mm}$, $dy=1.500 \text{ mm}$

Maximum value of SAR (interpolated) = 0.110 W/kg

Zoom Scan (6x5x7)/Cube 0: Measurement grid: $dx=8\text{mm}$, $dy=8\text{mm}$, $dz=5\text{mm}$

Reference Value = 10.37 V/m ; Power Drift = 0.00 dB

Peak SAR (extrapolated) = 0.126 W/kg

SAR(1 g) = 0.112 W/kg ; SAR(10 g) = 0.079 W/kg

Maximum value of SAR (measured) = 0.109 W/kg

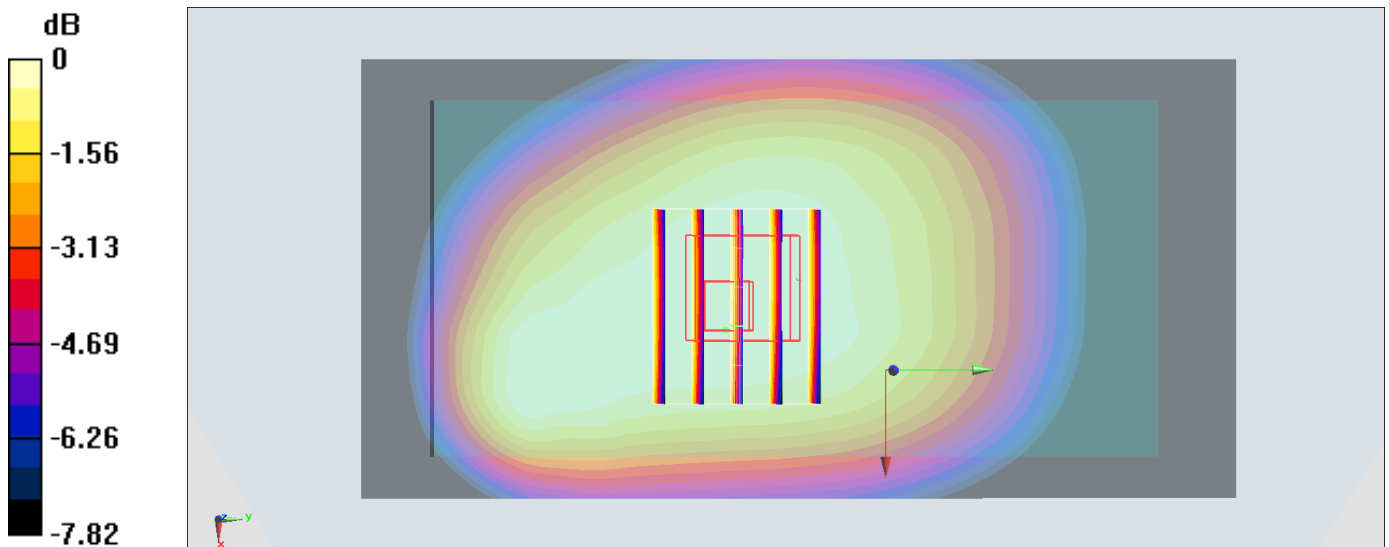

0 dB = 0.109 W/kg = -9.63 dBW/kg

#27_LTE Band 66_20M_QPSK_1_0_Back_10mm_Ch132572

Communication System: LTE; Frequency: 1770 MHz; Duty Cycle: 1:1

Medium: MSL_1750_170608 Medium parameters used: $f = 1770$ MHz; $\sigma = 1.483$ S/m; $\epsilon_r = 55.01$; $\rho = 1000$ kg/m³

Ambient Temperature : 23.6 °C ; Liquid Temperature : 22.6 °C

DASY5 Configuration:

- Probe: ES3DV3 - SN3270; ConvF(4.95, 4.95, 4.95); Calibrated: 2016/8/26;
- Sensor-Surface: 3mm (Mechanical Surface Detection)
- Electronics: DAE4 Sn916; Calibrated: 2016/12/15
- Phantom: SAM-Left; Type: QD 000 P40 C; Serial: TP-1446
- Measurement SW: DASY52, Version 52.8 (8); SEMCAD X Version 14.6.10 (7331)

Area Scan (61x121x1): Interpolated grid: dx=1.500 mm, dy=1.500 mm

Maximum value of SAR (interpolated) = 0.418 W/kg

Zoom Scan (5x5x7)/Cube 0: Measurement grid: dx=8mm, dy=8mm, dz=5mm

Reference Value = 15.73 V/m; Power Drift = 0.04 dB

Peak SAR (extrapolated) = 0.546 W/kg

SAR(1 g) = 0.365 W/kg; SAR(10 g) = 0.197 W/kg

Maximum value of SAR (measured) = 0.406 W/kg

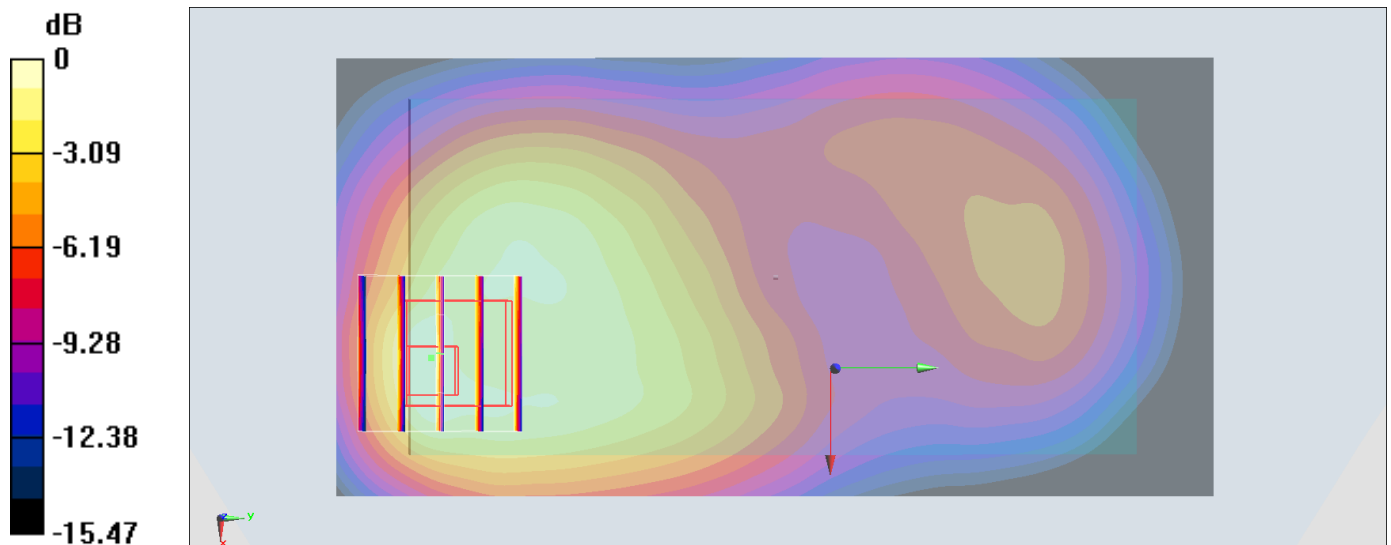

0 dB = 0.406 W/kg = -3.91 dBW/kg

#28_WLAN2.4GHz_802.11b 1Mbps_Back_10mm_Ch11

Communication System: 802.11b ; Frequency: 2462 MHz;Duty Cycle: 1:1
Medium: MSL_2450_170615 Medium parameters used: $f = 2462$ MHz; $\sigma = 2.006$ S/m; $\epsilon_r = 54.529$;
 $\rho = 1000$ kg/m³
Ambient Temperature : 23.2 °C ; Liquid Temperature : 22.2 °C

DASY5 Configuration:

- Probe: EX3DV4 - SN3925; ConvF(7.94, 7.94, 7.94); Calibrated: 2017/5/24;
- Sensor-Surface: 1.4mm (Mechanical Surface Detection)
- Electronics: DAE3 Sn495; Calibrated: 2017/5/22
- Phantom: SAM_Left; Type: QD000P40CD; Serial: TP:1431
- Measurement SW: DASY52, Version 52.8 (8);SEMCAD X Version 14.6.10 (7373)

Area Scan (81x141x1): Interpolated grid: dx=1.200 mm, dy=1.200 mm
Maximum value of SAR (interpolated) = 0.411 W/kg

Zoom Scan (7x7x7)/Cube 0: Measurement grid: dx=5mm, dy=5mm, dz=5mm
Reference Value = 4.290 V/m; Power Drift = -0.09 dB
Peak SAR (extrapolated) = 0.552 W/kg
SAR(1 g) = 0.250 W/kg; SAR(10 g) = 0.094 W/kg
Maximum value of SAR (measured) = 0.438 W/kg

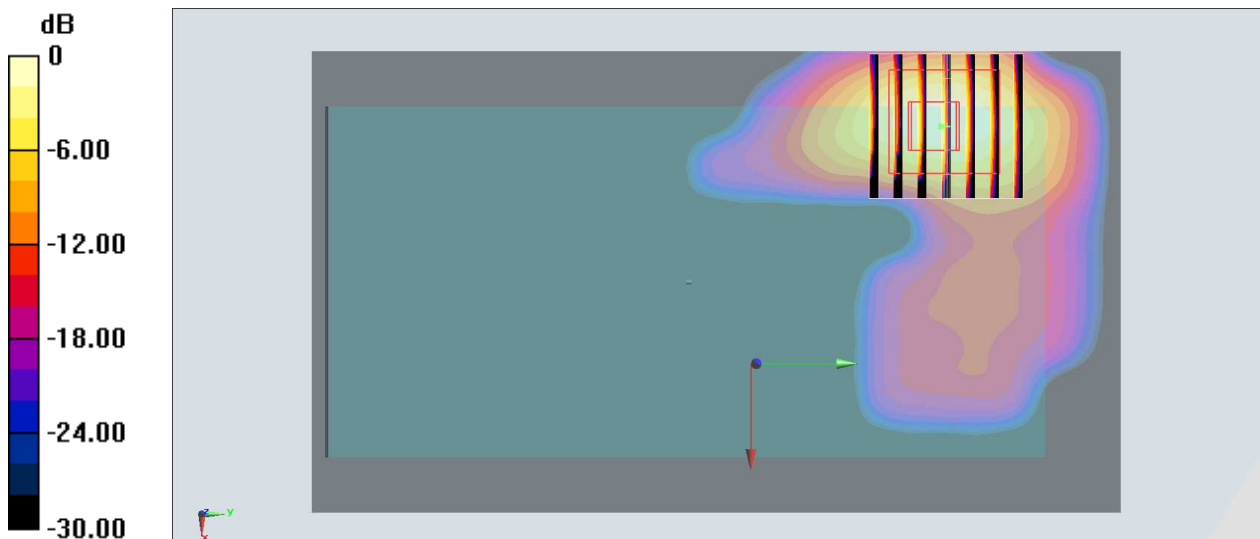

0 dB = 0.438 W/kg = -3.59 dBW/kg

#29_WLAN5GHz_802.11ac-VHT80 MCS0_Back_10mm_Ch42

Communication System: 802.11ac; Frequency: 5210 MHz; Duty Cycle: 1:1.174
Medium: MSL_5G_170615 Medium parameters used: $f = 5210$ MHz; $\sigma = 5.436$ S/m; $\epsilon_r = 47.905$; $\rho = 1000$ kg/m³
Ambient Temperature : 23.4 °C; Liquid Temperature : 22.4 °C

DASY5 Configuration:

- Probe: EX3DV4 - SN3925; ConvF(4.59, 4.59, 4.59); Calibrated: 2017/5/24;
- Sensor-Surface: 1.4mm (Mechanical Surface Detection)
- Electronics: DAE3 Sn495; Calibrated: 2017/5/22
- Phantom: SAM-Right; Type: SAM; Serial: TP-1303
- Measurement SW: DASY52, Version 52.8 (8); SEMCAD X Version 14.6.10 (7373)

Area Scan (101x91x1): Interpolated grid: dx=1.000 mm, dy=1.000 mm
Maximum value of SAR (interpolated) = 0.0569 W/kg

Zoom Scan (7x7x7)/Cube 0: Measurement grid: dx=4mm, dy=4mm, dz=1.4mm
Reference Value = 3.452 V/m; Power Drift = 0.04 dB
Peak SAR (extrapolated) = 0.366 W/kg
SAR(1 g) = 0.051 W/kg; SAR(10 g) = 0.00359 W/kg
Maximum value of SAR (measured) = 0.0571 W/kg

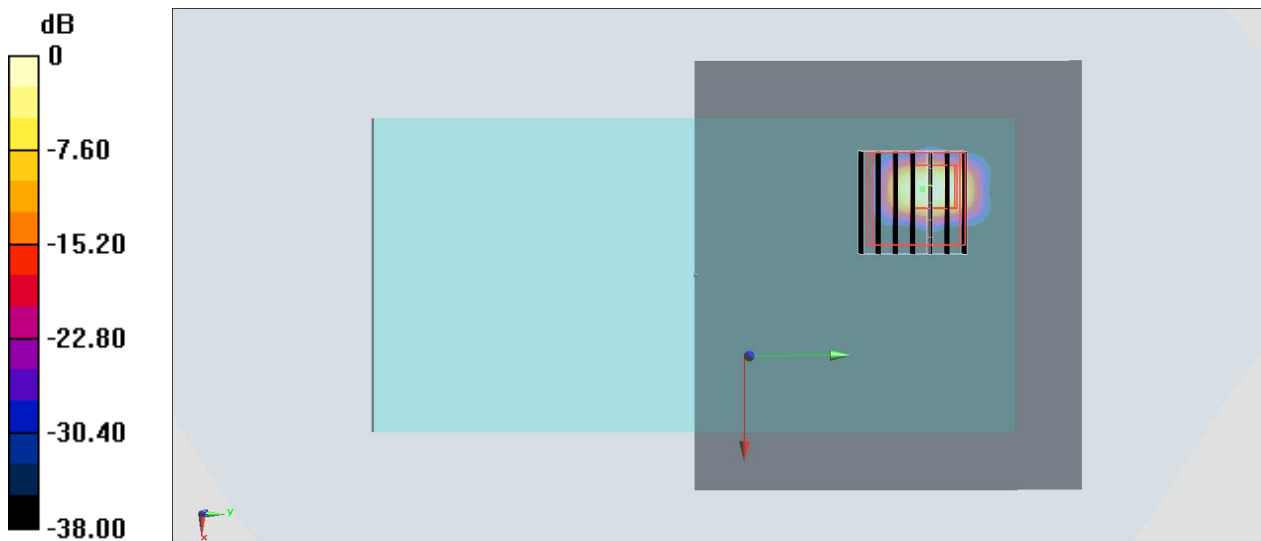

0 dB = 0.0571 W/kg = -12.43 dBW/kg

#30_GSM850_GPRS(4 Tx slots)_Back_10mm_Ch251

Communication System: GSM850; Frequency: 848.8 MHz; Duty Cycle: 1:2.08

Medium: MSL_850_170609 Medium parameters used: $f = 849$ MHz; $\sigma = 0.974$ S/m; $\epsilon_r = 55.107$; $\rho = 1000$ kg/m³

Ambient Temperature : 23.5 °C ; Liquid Temperature : 22.5 °C

DASY5 Configuration:

- Probe: ES3DV3 - SN3270; ConvF(6.01, 6.01, 6.01); Calibrated: 2016/8/26;
- Sensor-Surface: 3mm (Mechanical Surface Detection)
- Electronics: DAE4 Sn778; Calibrated: 2017/5/22
- Phantom: SAM-Left; Type: QD 000 P40 C; Serial: TP-1446
- Measurement SW: DASY52, Version 52.8 (8); SEMCAD X Version 14.6.10 (7331)

Area Scan (61x121x1): Interpolated grid: dx=1.500 mm, dy=1.500 mm

Maximum value of SAR (interpolated) = 0.284 W/kg

Zoom Scan (5x5x7)/Cube 0: Measurement grid: dx=8mm, dy=8mm, dz=5mm

Reference Value = 16.27 V/m; Power Drift = 0.03 dB

Peak SAR (extrapolated) = 0.401 W/kg

SAR(1 g) = 0.237 W/kg; SAR(10 g) = 0.149 W/kg

Maximum value of SAR (measured) = 0.270 W/kg

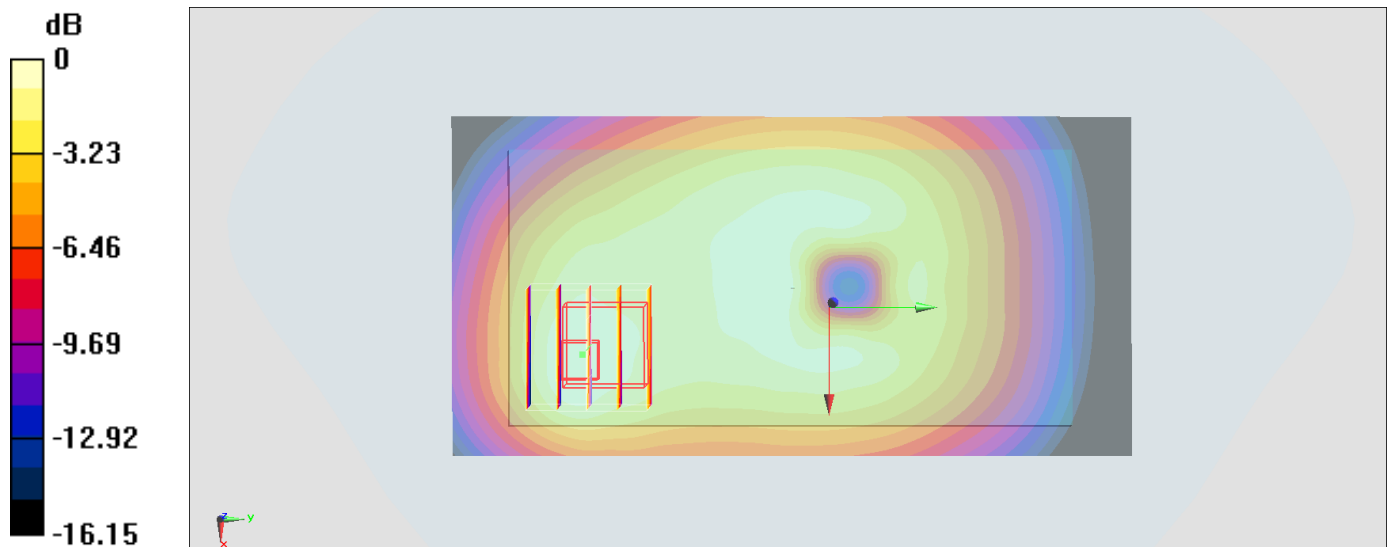

0 dB = 0.270 W/kg = -5.69 dBW/kg

#31_GSM1900_GPRS(4 Tx slots)_Back_10mm_Ch810

Communication System: PCS; Frequency: 1909.8 MHz; Duty Cycle: 1:2.08

Medium: MSL_1900_170608 Medium parameters used: $f = 1910 \text{ MHz}$; $\sigma = 1.531 \text{ S/m}$; $\epsilon_r = 55.384$; $\rho = 1000 \text{ kg/m}^3$

Ambient Temperature : $23.6 \text{ }^\circ\text{C}$; Liquid Temperature : $22.6 \text{ }^\circ\text{C}$

DASY5 Configuration:

- Probe: ES3DV3 - SN3270; ConvF(4.7, 4.7, 4.7); Calibrated: 2016/8/26;
- Sensor-Surface: 3mm (Mechanical Surface Detection)
- Electronics: DAE4 Sn916; Calibrated: 2016/12/15
- Phantom: SAM-Left; Type: QD 000 P40 C; Serial: TP-1446
- Measurement SW: DASY52, Version 52.8 (8); SEMCAD X Version 14.6.10 (7331)

Area Scan (61x121x1): Interpolated grid: $dx=1.500 \text{ mm}$, $dy=1.500 \text{ mm}$

Maximum value of SAR (interpolated) = 1.13 W/kg

Zoom Scan (5x5x7)/Cube 0: Measurement grid: $dx=8\text{mm}$, $dy=8\text{mm}$, $dz=5\text{mm}$

Reference Value = 20.42 V/m ; Power Drift = -0.01 dB

Peak SAR (extrapolated) = 1.61 W/kg

SAR(1 g) = 0.905 W/kg ; SAR(10 g) = 0.476 W/kg

Maximum value of SAR (measured) = 1.19 W/kg

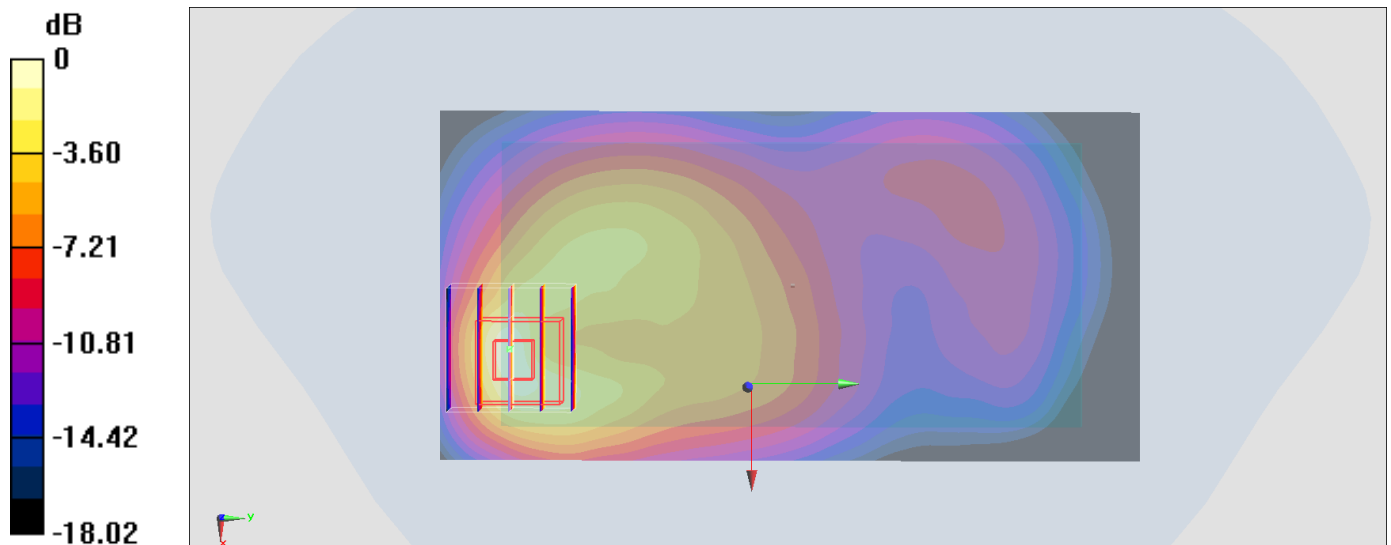

0 dB = $1.19 \text{ W/kg} = 0.76 \text{ dBW/kg}$

#32_WCDMA II_RMC 12.2Kbps_Back_10mm_Ch9538

Communication System: WCDMA; Frequency: 1907.6 MHz; Duty Cycle: 1:1

Medium: MSL_1900_170608 Medium parameters used: $f = 1908 \text{ MHz}$; $\sigma = 1.529 \text{ S/m}$; $\epsilon_r = 55.391$; $\rho = 1000 \text{ kg/m}^3$

Ambient Temperature : $23.6 \text{ }^\circ\text{C}$; Liquid Temperature : $22.6 \text{ }^\circ\text{C}$

DASY5 Configuration:

- Probe: ES3DV3 - SN3270; ConvF(4.7, 4.7, 4.7); Calibrated: 2016/8/26;
- Sensor-Surface: 3mm (Mechanical Surface Detection)
- Electronics: DAE4 Sn916; Calibrated: 2016/12/15
- Phantom: SAM-Left; Type: QD 000 P40 C; Serial: TP-1446
- Measurement SW: DASY52, Version 52.8 (8); SEMCAD X Version 14.6.10 (7331)

Area Scan (61x121x1): Interpolated grid: $dx=1.500 \text{ mm}$, $dy=1.500 \text{ mm}$

Maximum value of SAR (interpolated) = 0.727 W/kg

Zoom Scan (5x5x7)/Cube 0: Measurement grid: $dx=8\text{mm}$, $dy=8\text{mm}$, $dz=5\text{mm}$

Reference Value = 16.60 V/m ; Power Drift = -0.12 dB

Peak SAR (extrapolated) = 1.04 W/kg

SAR(1 g) = 0.577 W/kg ; SAR(10 g) = 0.290 W/kg

Maximum value of SAR (measured) = 0.719 W/kg

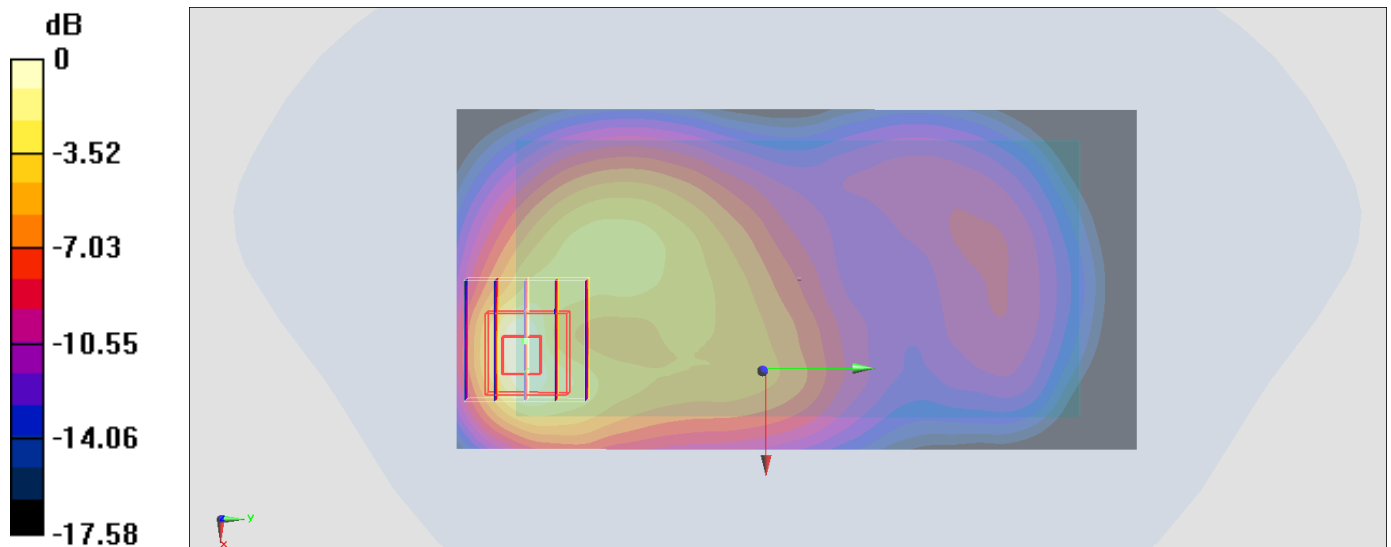

0 dB = $0.719 \text{ W/kg} = -1.43 \text{ dBW/kg}$

#33_WCDMA IV_RMC 12.2Kbps_Back_10mm_Ch1513

Communication System: WCDMA; Frequency: 1752.6 MHz; Duty Cycle: 1:1

Medium: MSL_1750_170608 Medium parameters used: $f = 1753$ MHz; $\sigma = 1.464$ S/m; $\epsilon_r = 55.056$; $\rho = 1000$ kg/m³

Ambient Temperature : 23.6 °C ; Liquid Temperature : 22.6 °C

DASY5 Configuration:

- Probe: ES3DV3 - SN3270; ConvF(4.95, 4.95, 4.95); Calibrated: 2016/8/26;
- Sensor-Surface: 3mm (Mechanical Surface Detection)
- Electronics: DAE4 Sn916; Calibrated: 2016/12/15
- Phantom: SAM-Left; Type: QD 000 P40 C; Serial: TP-1446
- Measurement SW: DASY52, Version 52.8 (8); SEMCAD X Version 14.6.10 (7331)

Area Scan (61x121x1): Interpolated grid: dx=1.500 mm, dy=1.500 mm

Maximum value of SAR (interpolated) = 0.524 W/kg

Zoom Scan (5x5x7)/Cube 0: Measurement grid: dx=8mm, dy=8mm, dz=5mm

Reference Value = 16.67 V/m; Power Drift = 0.00 dB

Peak SAR (extrapolated) = 0.692 W/kg

SAR(1 g) = 0.486 W/kg; SAR(10 g) = 0.252 W/kg

Maximum value of SAR (measured) = 0.531 W/kg

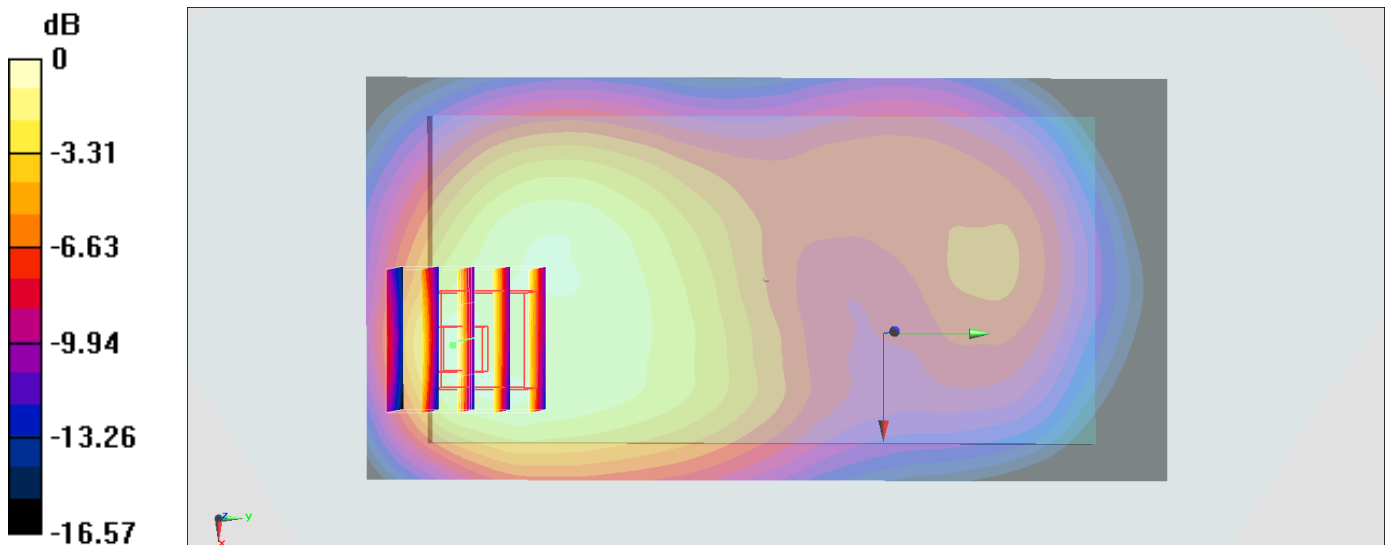

0 dB = 0.531 W/kg = -2.75 dBW/kg

#34_WCDMA V_RMC 12.2Kbps_Back_10mm_Ch4233

Communication System: WCDMA; Frequency: 846.6 MHz; Duty Cycle: 1:1

Medium: MSL_850_170609 Medium parameters used: $f = 847$ MHz; $\sigma = 0.972$ S/m; $\epsilon_r = 55.122$; $\rho = 1000$ kg/m³

Ambient Temperature : 23.5 °C; Liquid Temperature : 22.5 °C

DASY5 Configuration:

- Probe: ES3DV3 - SN3270; ConvF(6.01, 6.01, 6.01); Calibrated: 2016/8/26;
- Sensor-Surface: 3mm (Mechanical Surface Detection)
- Electronics: DAE4 Sn778; Calibrated: 2017/5/22
- Phantom: SAM-Left; Type: QD 000 P40 C; Serial: TP-1446
- Measurement SW: DASY52, Version 52.8 (8); SEMCAD X Version 14.6.10 (7331)

Area Scan (61x121x1): Interpolated grid: dx=1.500 mm, dy=1.500 mm

Maximum value of SAR (interpolated) = 0.146 W/kg

Zoom Scan (5x5x7)/Cube 0: Measurement grid: dx=8mm, dy=8mm, dz=5mm

Reference Value = 11.34 V/m; Power Drift = -0.01 dB

Peak SAR (extrapolated) = 0.210 W/kg

SAR(1 g) = 0.121 W/kg; SAR(10 g) = 0.076 W/kg

Maximum value of SAR (measured) = 0.142 W/kg

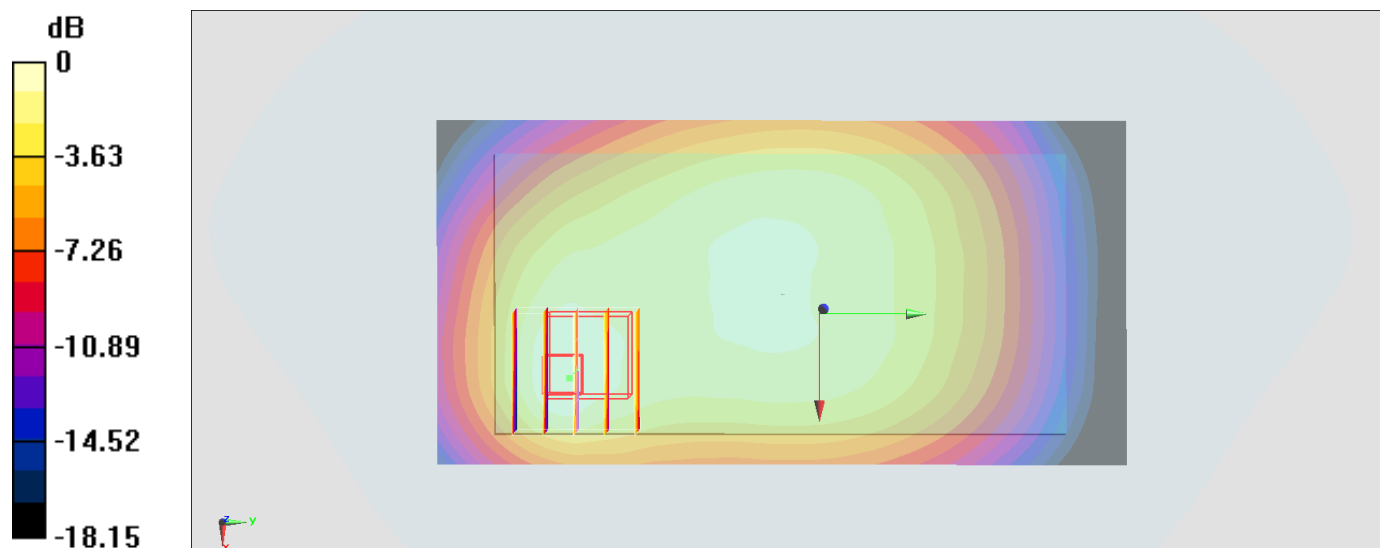

0 dB = 0.142 W/kg = -8.48 dBW/kg

#35_LTE Band 2_20M_QPSK_1_0_Back_10mm_Ch19100

Communication System: LTE; Frequency: 1900 MHz; Duty Cycle: 1:1

Medium: MSL_1900_170608 Medium parameters used: $f = 1900$ MHz; $\sigma = 1.521$ S/m; $\epsilon_r = 55.414$; $\rho = 1000$ kg/m³

Ambient Temperature : 23.6 °C; Liquid Temperature : 22.6 °C

DASY5 Configuration:

- Probe: ES3DV3 - SN3270; ConvF(4.7, 4.7, 4.7); Calibrated: 2016/8/26;
- Sensor-Surface: 3mm (Mechanical Surface Detection)
- Electronics: DAE4 Sn916; Calibrated: 2016/12/15
- Phantom: SAM-Left; Type: QD 000 P40 C; Serial: TP-1446
- Measurement SW: DASY52, Version 52.8 (8); SEMCAD X Version 14.6.10 (7331)

Area Scan (61x121x1): Interpolated grid: dx=1.500 mm, dy=1.500 mm

Maximum value of SAR (interpolated) = 0.470 W/kg

Zoom Scan (5x5x7)/Cube 0: Measurement grid: dx=8mm, dy=8mm, dz=5mm

Reference Value = 13.85 V/m; Power Drift = 0.14 dB

Peak SAR (extrapolated) = 0.679 W/kg

SAR(1 g) = 0.418 W/kg; SAR(10 g) = 0.193 W/kg

Maximum value of SAR (measured) = 0.465 W/kg

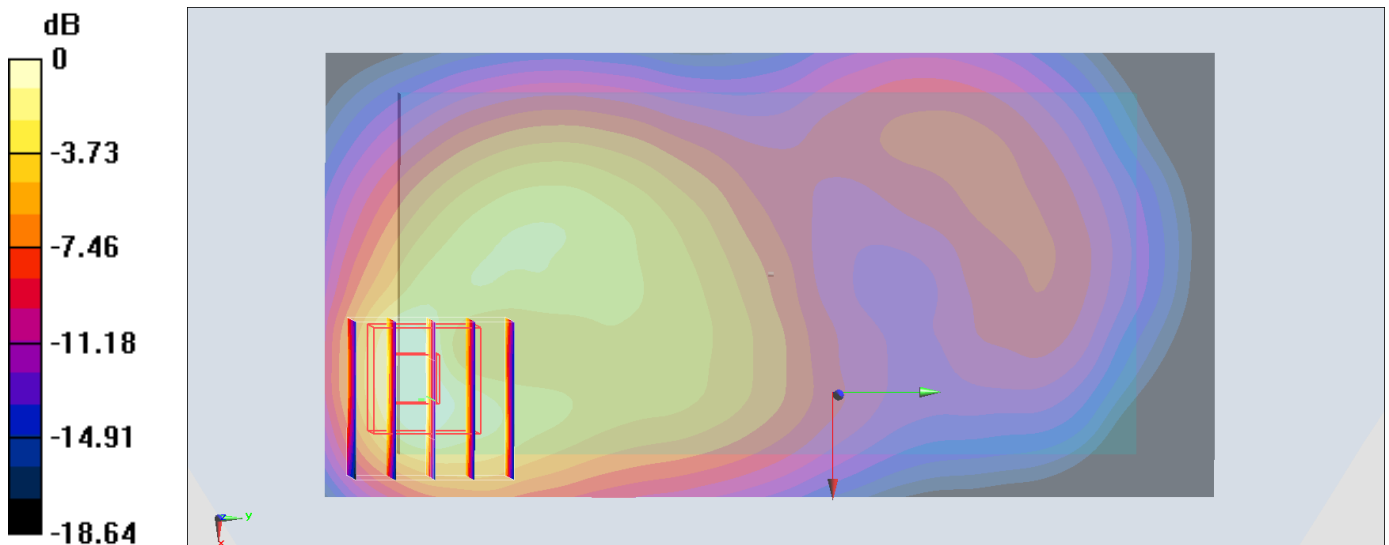

0 dB = 0.465 W/kg = -3.33 dBW/kg

#36_LTE Band 5_10M_QPSK_1_0_Back_10mm_Ch20525

Communication System: LTE; Frequency: 836.5 MHz; Duty Cycle: 1:1

Medium: MSL_850_170609 Medium parameters used: $f = 836.5$ MHz; $\sigma = 0.962$ S/m; $\epsilon_r = 55.222$; $\rho = 1000$ kg/m³

Ambient Temperature : 23.5 °C; Liquid Temperature : 22.5 °C

DASY5 Configuration:

- Probe: ES3DV3 - SN3270; ConvF(6.01, 6.01, 6.01); Calibrated: 2016/8/26;
- Sensor-Surface: 3mm (Mechanical Surface Detection)
- Electronics: DAE4 Sn778; Calibrated: 2017/5/22
- Phantom: SAM-Left; Type: QD 000 P40 C; Serial: TP-1446
- Measurement SW: DASY52, Version 52.8 (8); SEMCAD X Version 14.6.10 (7331)

Area Scan (61x121x1): Interpolated grid: dx=1.500 mm, dy=1.500 mm

Maximum value of SAR (interpolated) = 0.119 W/kg

Zoom Scan (5x5x7)/Cube 0: Measurement grid: dx=8mm, dy=8mm, dz=5mm

Reference Value = 10.10 V/m; Power Drift = -0.03 dB

Peak SAR (extrapolated) = 0.168 W/kg

SAR(1 g) = 0.096 W/kg; SAR(10 g) = 0.060 W/kg

Maximum value of SAR (measured) = 0.114 W/kg

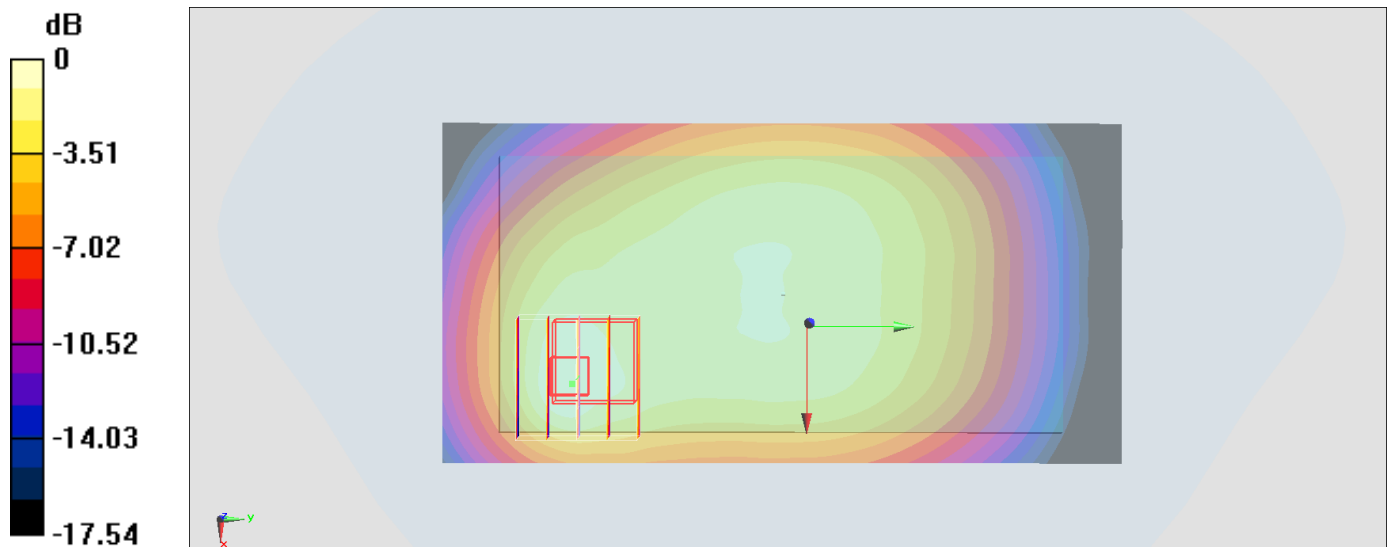

0 dB = 0.114 W/kg = -9.43 dBW/kg

#37_LTE Band 7_20M_QPSK_1_0_Back_10mm_Ch21350

Communication System: LTE; Frequency: 2560 MHz; Duty Cycle: 1:1

Medium: MSL_2600_170609 Medium parameters used: $f = 2560$ MHz; $\sigma = 2.104$ S/m; $\epsilon_r = 52.835$; $\rho = 1000$ kg/m³

Ambient Temperature : 23.5 °C ; Liquid Temperature : 22.5 °C

DASY5 Configuration:

- Probe: ES3DV3 - SN3270; ConvF(4.12, 4.12, 4.12); Calibrated: 2016/8/26;
- Sensor-Surface: 3mm (Mechanical Surface Detection)
- Electronics: DAE4 Sn778; Calibrated: 2017/5/22
- Phantom: SAM_Right; Type: QD000P40CD; Serial: 1884
- Measurement SW: DASY52, Version 52.8 (8); SEMCAD X Version 14.6.10 (7331)

Area Scan (81x151x1): Interpolated grid: dx=1.200 mm, dy=1.200 mm

Maximum value of SAR (interpolated) = 0.542 W/kg

Zoom Scan (7x7x7)/Cube 0: Measurement grid: dx=5mm, dy=5mm, dz=5mm

Reference Value = 4.043 V/m; Power Drift = -0.07 dB

Peak SAR (extrapolated) = 0.916 W/kg

SAR(1 g) = 0.459 W/kg; SAR(10 g) = 0.227 W/kg

Maximum value of SAR (measured) = 0.587 W/kg

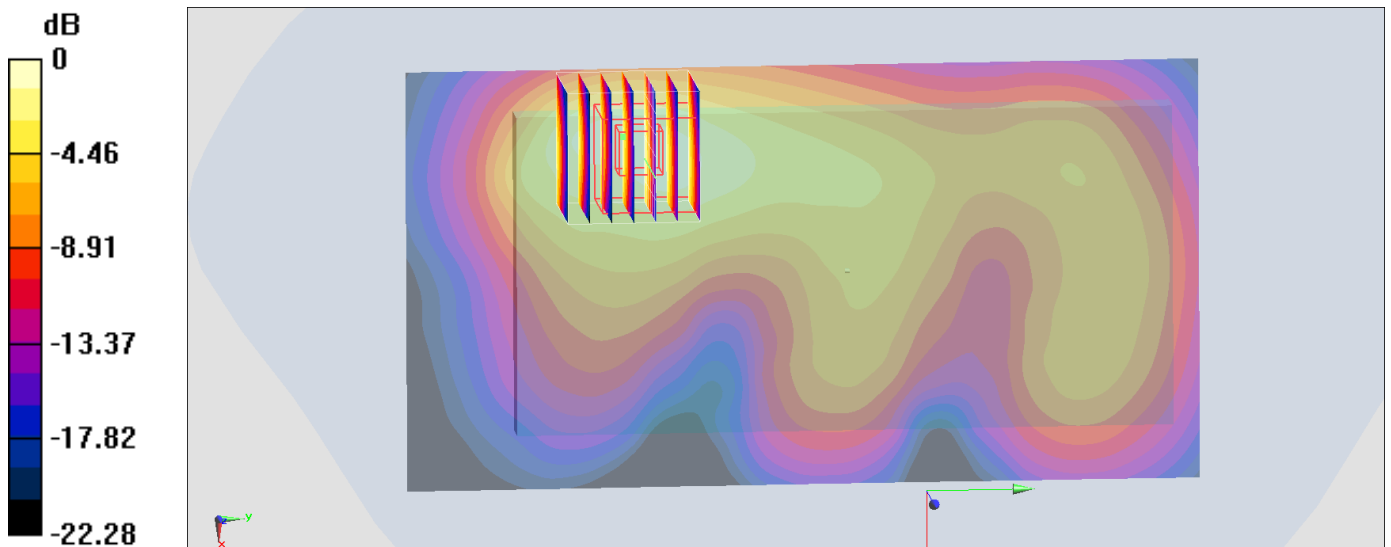

0 dB = 0.587 W/kg = -2.31 dBW/kg

#38_LTE Band 12_10M_QPSK_1_49_Back_10mm_Ch23095

Communication System: LTE; Frequency: 707.5 MHz; Duty Cycle: 1:1

Medium: MSL_750_170611 Medium parameters used: $f = 707.5$ MHz; $\sigma = 0.919$ S/m; $\epsilon_r = 55.919$; $\rho = 1000$ kg/m³

Ambient Temperature : 23.4 °C; Liquid Temperature : 22.4 °C

DASY5 Configuration:

- Probe: ES3DV3 - SN3270; ConvF(6.09, 6.09, 6.09); Calibrated: 2016/8/26;
- Sensor-Surface: 3mm (Mechanical Surface Detection)
- Electronics: DAE4 Sn778; Calibrated: 2017/5/22
- Phantom: SAM-Left; Type: QD 000 P40 C; Serial: TP-1446
- Measurement SW: DASY52, Version 52.8 (8); SEMCAD X Version 14.6.10 (7331)

Area Scan (61x121x1): Interpolated grid: dx=1.500 mm, dy=1.500 mm

Maximum value of SAR (interpolated) = 0.156 W/kg

Zoom Scan (6x7x7)/Cube 0: Measurement grid: dx=8mm, dy=8mm, dz=5mm

Reference Value = 12.47 V/m; Power Drift = -0.03 dB

Peak SAR (extrapolated) = 0.204 W/kg

SAR(1 g) = 0.129 W/kg; SAR(10 g) = 0.092 W/kg

Maximum value of SAR (measured) = 0.148 W/kg

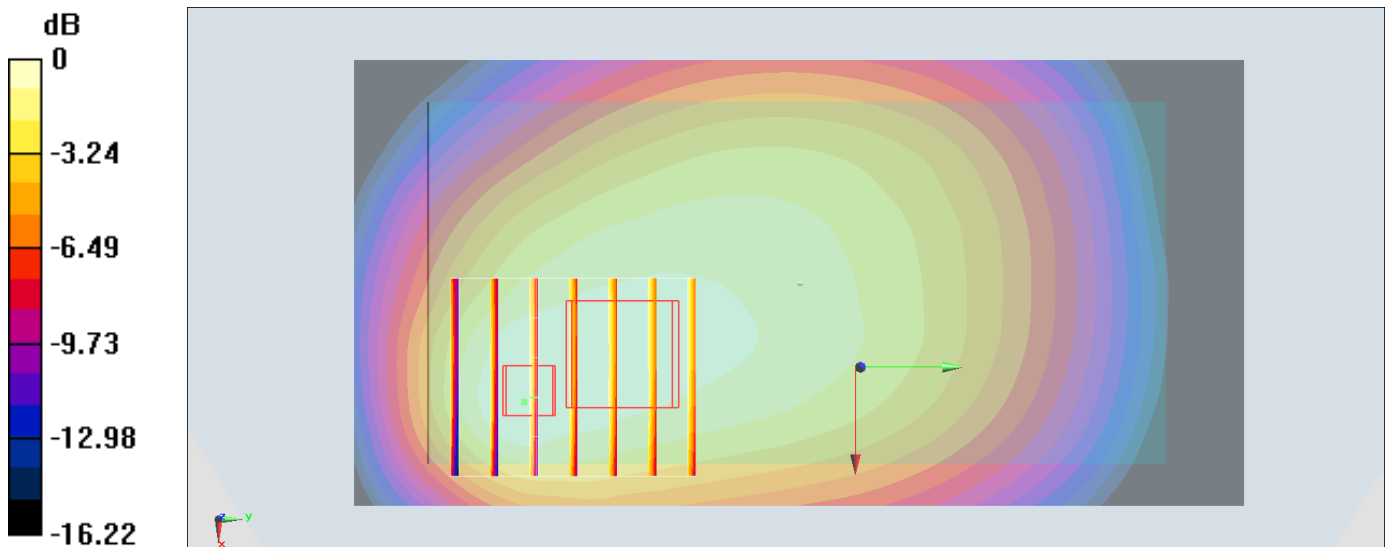

0 dB = 0.148 W/kg = -8.30 dBW/kg

#39_LTE Band 13_10M_QPSK_1_49_Back_10mm_Ch23230

Communication System: LTE; Frequency: 782 MHz; Duty Cycle: 1:1

Medium: MSL_750_170611 Medium parameters used: $f = 782 \text{ MHz}$; $\sigma = 0.993 \text{ S/m}$; $\epsilon_r = 55.133$; $\rho = 1000 \text{ kg/m}^3$

Ambient Temperature : $23.4 \text{ }^\circ\text{C}$; Liquid Temperature : $22.4 \text{ }^\circ\text{C}$

DASY5 Configuration:

- Probe: ES3DV3 - SN3270; ConvF(6.09, 6.09, 6.09); Calibrated: 2016/8/26;
- Sensor-Surface: 3mm (Mechanical Surface Detection)
- Electronics: DAE4 Sn778; Calibrated: 2017/5/22
- Phantom: SAM-Left; Type: QD 000 P40 C; Serial: TP-1446
- Measurement SW: DASY52, Version 52.8 (8); SEMCAD X Version 14.6.10 (7331)

Area Scan (61x121x1): Interpolated grid: $dx=1.500 \text{ mm}$, $dy=1.500 \text{ mm}$

Maximum value of SAR (interpolated) = 0.110 W/kg

Zoom Scan (6x5x7)/Cube 0: Measurement grid: $dx=8\text{mm}$, $dy=8\text{mm}$, $dz=5\text{mm}$

Reference Value = 10.37 V/m ; Power Drift = 0.00 dB

Peak SAR (extrapolated) = 0.126 W/kg

SAR(1 g) = 0.112 W/kg ; SAR(10 g) = 0.079 W/kg

Maximum value of SAR (measured) = 0.109 W/kg

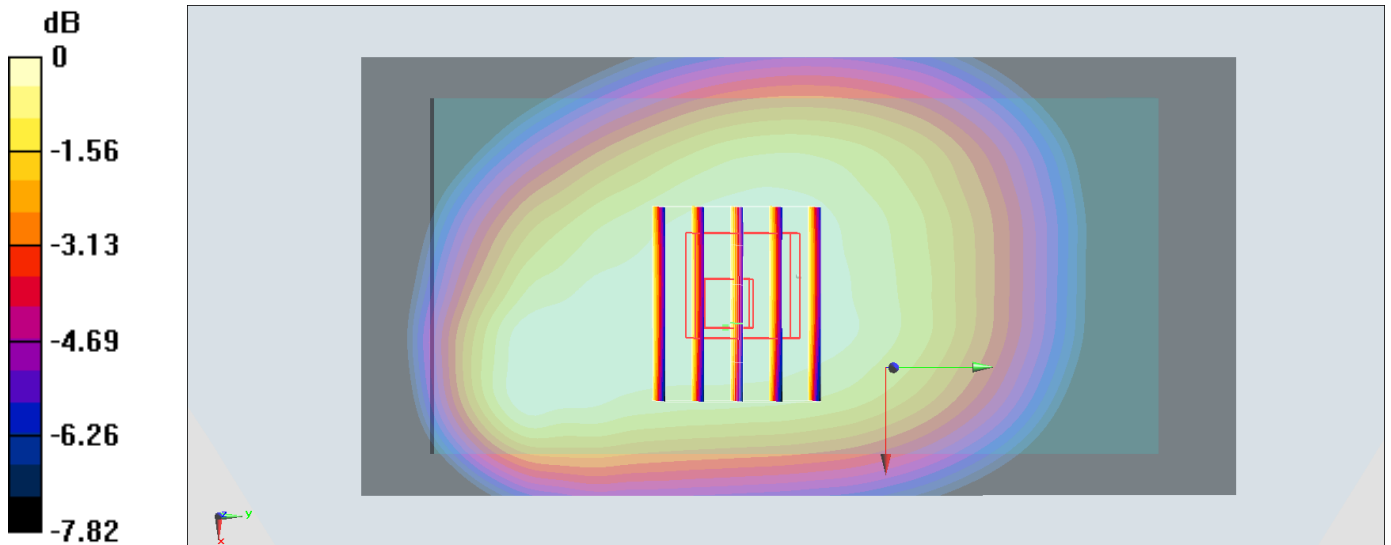

0 dB = 0.109 W/kg = -9.63 dBW/kg

#40_LTE Band 66_20M_QPSK_1_0_Back_10mm_Ch132572

Communication System: LTE; Frequency: 1770 MHz; Duty Cycle: 1:1

Medium: MSL_1750_170608 Medium parameters used: $f = 1770$ MHz; $\sigma = 1.483$ S/m; $\epsilon_r = 55.01$; $\rho = 1000$ kg/m³

Ambient Temperature : 23.6 °C ; Liquid Temperature : 22.6 °C

DASY5 Configuration:

- Probe: ES3DV3 - SN3270; ConvF(4.95, 4.95, 4.95); Calibrated: 2016/8/26;
- Sensor-Surface: 3mm (Mechanical Surface Detection)
- Electronics: DAE4 Sn916; Calibrated: 2016/12/15
- Phantom: SAM-Left; Type: QD 000 P40 C; Serial: TP-1446
- Measurement SW: DASY52, Version 52.8 (8); SEMCAD X Version 14.6.10 (7331)

Area Scan (61x121x1): Interpolated grid: dx=1.500 mm, dy=1.500 mm

Maximum value of SAR (interpolated) = 0.418 W/kg

Zoom Scan (5x5x7)/Cube 0: Measurement grid: dx=8mm, dy=8mm, dz=5mm

Reference Value = 15.73 V/m; Power Drift = 0.04 dB

Peak SAR (extrapolated) = 0.546 W/kg

SAR(1 g) = 0.365 W/kg; SAR(10 g) = 0.197 W/kg

Maximum value of SAR (measured) = 0.406 W/kg

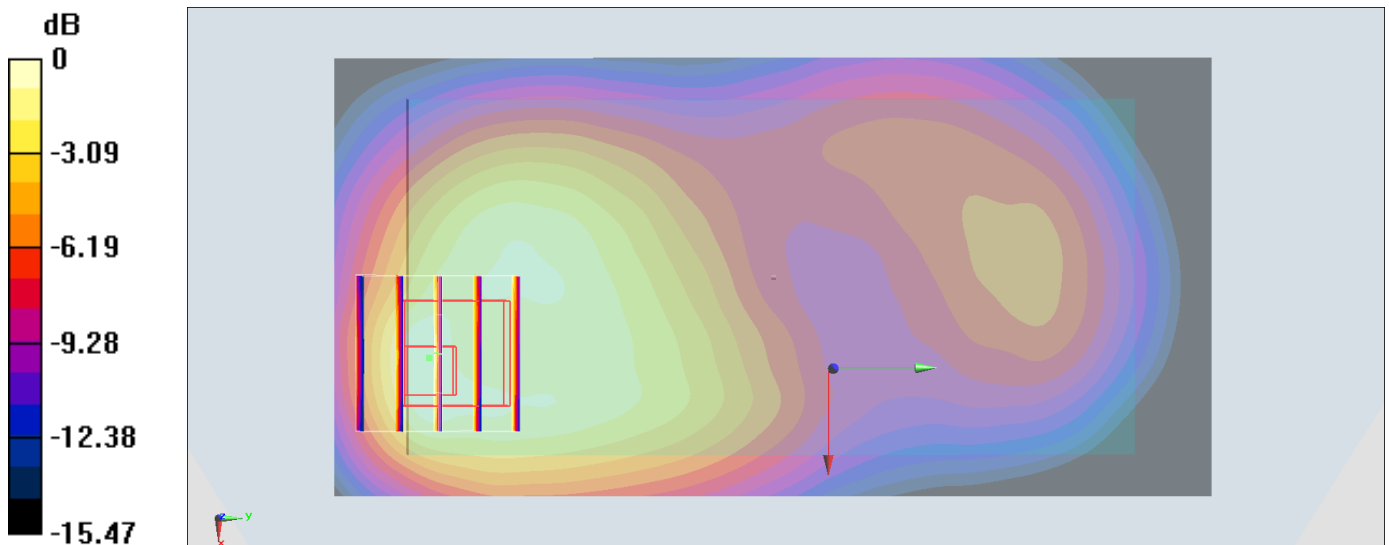

0 dB = 0.406 W/kg = -3.91 dBW/kg

#41_WLAN2.4GHz_802.11b 1Mbps_Back_10mm_Ch11

Communication System: 802.11b ; Frequency: 2462 MHz;Duty Cycle: 1:1
Medium: MSL_2450_170615 Medium parameters used: $f = 2462$ MHz; $\sigma = 2.006$ S/m; $\epsilon_r = 54.529$;
 $\rho = 1000$ kg/m³
Ambient Temperature : 23.2 °C ; Liquid Temperature : 22.2 °C

DASY5 Configuration:

- Probe: EX3DV4 - SN3925; ConvF(7.94, 7.94, 7.94); Calibrated: 2017/5/24;
- Sensor-Surface: 1.4mm (Mechanical Surface Detection)
- Electronics: DAE3 Sn495; Calibrated: 2017/5/22
- Phantom: SAM_Left; Type: QD000P40CD; Serial: TP:1431
- Measurement SW: DASY52, Version 52.8 (8);SEMCAD X Version 14.6.10 (7373)

Area Scan (81x141x1): Interpolated grid: dx=1.200 mm, dy=1.200 mm
Maximum value of SAR (interpolated) = 0.411 W/kg

Zoom Scan (7x7x7)/Cube 0: Measurement grid: dx=5mm, dy=5mm, dz=5mm
Reference Value = 4.290 V/m; Power Drift = -0.09 dB
Peak SAR (extrapolated) = 0.552 W/kg
SAR(1 g) = 0.250 W/kg; SAR(10 g) = 0.094 W/kg
Maximum value of SAR (measured) = 0.438 W/kg

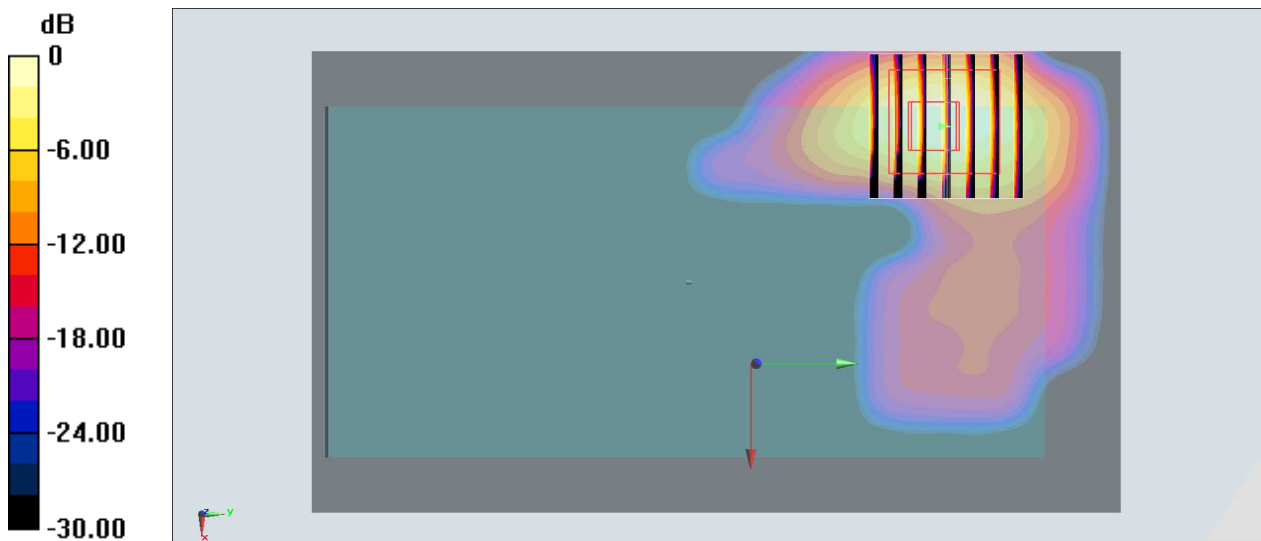

0 dB = 0.438 W/kg = -3.59 dBW/kg

#42_WLAN5GHz_802.11ac-VHT80 MCS0_Back_10mm_Ch58

Communication System: 802.11ac; Frequency: 5290 MHz; Duty Cycle: 1:1.174
Medium: MSL_5G_170615 Medium parameters used: $f = 5290$ MHz; $\sigma = 5.538$ S/m; $\epsilon_r = 47.712$; $\rho = 1000$ kg/m³
Ambient Temperature : 23.4 °C; Liquid Temperature : 22.4 °C

DASY5 Configuration:

- Probe: EX3DV4 - SN3925; ConvF(4.59, 4.59, 4.59); Calibrated: 2017/5/24;
- Sensor-Surface: 1.4mm (Mechanical Surface Detection)
- Electronics: DAE3 Sn495; Calibrated: 2017/5/22
- Phantom: SAM-Right; Type: SAM; Serial: TP-1303
- Measurement SW: DASY52, Version 52.8 (8); SEMCAD X Version 14.6.10 (7373)

Area Scan (101x101x1): Interpolated grid: dx=1.000 mm, dy=1.000 mm
Maximum value of SAR (interpolated) = 0.0369 W/kg

Zoom Scan (7x7x7)/Cube 0: Measurement grid: dx=4mm, dy=4mm, dz=1.4mm
Reference Value = 3.026 V/m; Power Drift = -0.03 dB
Peak SAR (extrapolated) = 0.151 W/kg
SAR(1 g) = 0.00158 W/kg; SAR(10 g) = 0.000158 W/kg
Maximum value of SAR (measured) = 0.0457 W/kg

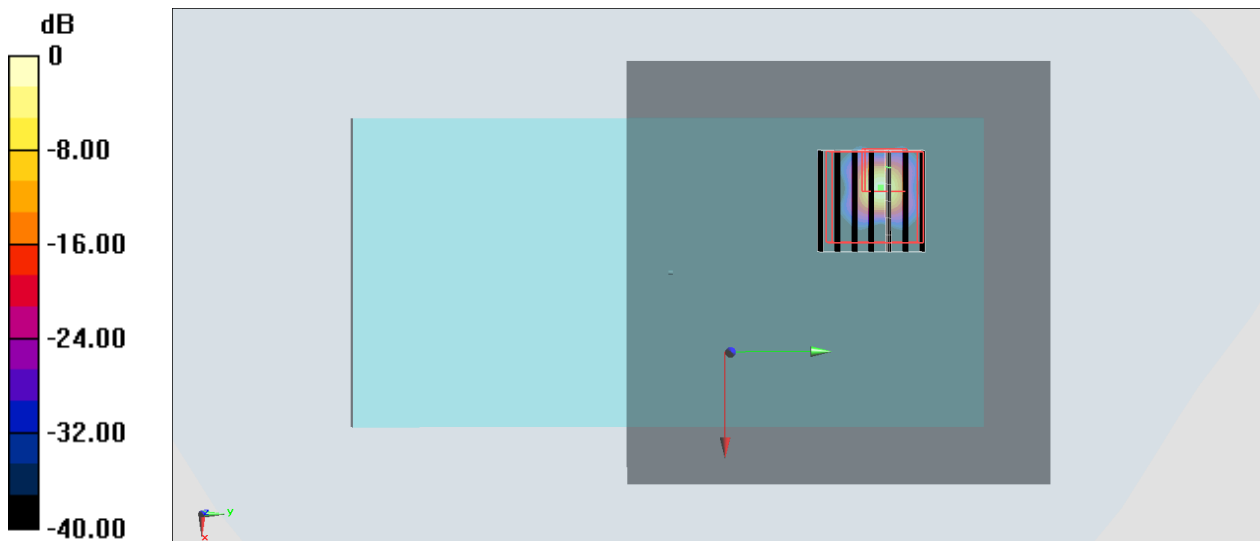

0 dB = 0.0457 W/kg = -13.40 dBW/kg



Appendix C. DASYS Calibration Certificate

The DASYS calibration certificates are shown as follows.



Accredited by the Swiss Accreditation Service (SAS)
The Swiss Accreditation Service is one of the signatories to the EA
Multilateral Agreement for the recognition of calibration certificates

Accreditation No.: **SCS 0108**

Client **Sporton (Auden)**

Certificate No: **D750V3-1012_May17**

CALIBRATION CERTIFICATE

Object **D750V3 - SN:1012**

Calibration procedure(s) **QA CAL-05.v9
Calibration procedure for dipole validation kits above 700 MHz**

Calibration date: **May 22, 2017**

This calibration certificate documents the traceability to national standards, which realize the physical units of measurements (SI).
The measurements and the uncertainties with confidence probability are given on the following pages and are part of the certificate.

All calibrations have been conducted in the closed laboratory facility: environment temperature (22 ± 3)°C and humidity < 70%.

Calibration Equipment used (M&TE critical for calibration)

Primary Standards	ID #	Cal Date (Certificate No.)	Scheduled Calibration
Power meter NRP	SN: 104778	04-Apr-17 (No. 217-02521/02522)	Apr-18
Power sensor NRP-Z91	SN: 103244	04-Apr-17 (No. 217-02521)	Apr-18
Power sensor NRP-Z91	SN: 103245	04-Apr-17 (No. 217-02522)	Apr-18
Reference 20 dB Attenuator	SN: 5058 (20k)	07-Apr-17 (No. 217-02528)	Apr-18
Type-N mismatch combination	SN: 5047.2 / 06327	07-Apr-17 (No. 217-02529)	Apr-18
Reference Probe EX3DV4	SN: 7460	19-May-17 (No. EX3-7460_May17)	May-18
DAE4	SN: 601	28-Mar-17 (No. DAE4-601_Mar17)	Mar-18

Secondary Standards	ID #	Check Date (in house)	Scheduled Check
Power meter EPM-442A	SN: GB37480704	07-Oct-15 (in house check Oct-16)	In house check: Oct-18
Power sensor HP 8481A	SN: US37292783	07-Oct-15 (in house check Oct-16)	In house check: Oct-18
Power sensor HP 8481A	SN: MY41092317	07-Oct-15 (in house check Oct-16)	In house check: Oct-18
RF generator R&S SMT-06	SN: 100972	15-Jun-15 (in house check Oct-16)	In house check: Oct-18
Network Analyzer HP 8753E	SN: US37390585	18-Oct-01 (in house check Oct-16)	In house check: Oct-17

	Name	Function	Signature
Calibrated by:	Leif Klysner	Laboratory Technician	
Approved by:	Katja Pokovic	Technical Manager	

Issued: May 30, 2017

This calibration certificate shall not be reproduced except in full without written approval of the laboratory.



Accredited by the Swiss Accreditation Service (SAS)

The Swiss Accreditation Service is one of the signatories to the EA Multilateral Agreement for the recognition of calibration certificates

Accreditation No.: **SCS 0108**

Glossary:

TSL	tissue simulating liquid
ConvF	sensitivity in TSL / NORM x,y,z
N/A	not applicable or not measured

Calibration is Performed According to the Following Standards:

- IEEE Std 1528-2013, "IEEE Recommended Practice for Determining the Peak Spatial-Averaged Specific Absorption Rate (SAR) in the Human Head from Wireless Communications Devices: Measurement Techniques", June 2013
- IEC 62209-1, "Procedure to measure the Specific Absorption Rate (SAR) for hand-held devices used in close proximity to the ear (frequency range of 300 MHz to 3 GHz)", February 2005
- IEC 62209-2, "Procedure to determine the Specific Absorption Rate (SAR) for wireless communication devices used in close proximity to the human body (frequency range of 30 MHz to 6 GHz)", March 2010
- KDB 865664, "SAR Measurement Requirements for 100 MHz to 6 GHz"

Additional Documentation:

- DASY4/5 System Handbook

Methods Applied and Interpretation of Parameters:

- Measurement Conditions:** Further details are available from the Validation Report at the end of the certificate. All figures stated in the certificate are valid at the frequency indicated.
- Antenna Parameters with TSL:** The dipole is mounted with the spacer to position its feed point exactly below the center marking of the flat phantom section, with the arms oriented parallel to the body axis.
- Feed Point Impedance and Return Loss:** These parameters are measured with the dipole positioned under the liquid filled phantom. The impedance stated is transformed from the measurement at the SMA connector to the feed point. The Return Loss ensures low reflected power. No uncertainty required.
- Electrical Delay:** One-way delay between the SMA connector and the antenna feed point. No uncertainty required.
- SAR measured:** SAR measured at the stated antenna input power.
- SAR normalized:** SAR as measured, normalized to an input power of 1 W at the antenna connector.
- SAR for nominal TSL parameters:** The measured TSL parameters are used to calculate the nominal SAR result.

The reported uncertainty of measurement is stated as the standard uncertainty of measurement multiplied by the coverage factor $k=2$, which for a normal distribution corresponds to a coverage probability of approximately 95%.

Measurement Conditions

DASY system configuration, as far as not given on page 1.

DASY Version	DASY5	V52.10.0
Extrapolation	Advanced Extrapolation	
Phantom	Modular Flat Phantom	
Distance Dipole Center - TSL	15 mm	with Spacer
Zoom Scan Resolution	dx, dy, dz = 5 mm	
Frequency	750 MHz ± 1 MHz	

Head TSL parameters

The following parameters and calculations were applied.

	Temperature	Permittivity	Conductivity
Nominal Head TSL parameters	22.0 °C	41.9	0.89 mho/m
Measured Head TSL parameters	(22.0 ± 0.2) °C	41.0 ± 6 %	0.91 mho/m ± 6 %
Head TSL temperature change during test	< 0.5 °C	----	----

SAR result with Head TSL

SAR averaged over 1 cm ³ (1 g) of Head TSL	Condition	
SAR measured	250 mW input power	2.10 W/kg
SAR for nominal Head TSL parameters	normalized to 1W	8.22 W/kg ± 17.0 % (k=2)

SAR averaged over 10 cm ³ (10 g) of Head TSL	condition	
SAR measured	250 mW input power	1.36 W/kg
SAR for nominal Head TSL parameters	normalized to 1W	5.35 W/kg ± 16.5 % (k=2)

Body TSL parameters

The following parameters and calculations were applied.

	Temperature	Permittivity	Conductivity
Nominal Body TSL parameters	22.0 °C	55.5	0.96 mho/m
Measured Body TSL parameters	(22.0 ± 0.2) °C	55.3 ± 6 %	0.96 mho/m ± 6 %
Body TSL temperature change during test	< 0.5 °C	----	----

SAR result with Body TSL

SAR averaged over 1 cm ³ (1 g) of Body TSL	Condition	
SAR measured	250 mW input power	2.18 W/kg
SAR for nominal Body TSL parameters	normalized to 1W	8.71 W/kg ± 17.0 % (k=2)

SAR averaged over 10 cm ³ (10 g) of Body TSL	condition	
SAR measured	250 mW input power	1.43 W/kg
SAR for nominal Body TSL parameters	normalized to 1W	5.72 W/kg ± 16.5 % (k=2)

Appendix (Additional assessments outside the scope of SCS 0108)

Antenna Parameters with Head TSL

Impedance, transformed to feed point	55.2 Ω + 1.4 j Ω
Return Loss	- 25.8 dB

Antenna Parameters with Body TSL

Impedance, transformed to feed point	50.6 Ω - 2.3 j Ω
Return Loss	- 32.6 dB

General Antenna Parameters and Design

Electrical Delay (one direction)	1.035 ns
----------------------------------	----------

After long term use with 100W radiated power, only a slight warming of the dipole near the feedpoint can be measured.

The dipole is made of standard semirigid coaxial cable. The center conductor of the feeding line is directly connected to the second arm of the dipole. The antenna is therefore short-circuited for DC-signals. On some of the dipoles, small end caps are added to the dipole arms in order to improve matching when loaded according to the position as explained in the "Measurement Conditions" paragraph. The SAR data are not affected by this change. The overall dipole length is still according to the Standard.

No excessive force must be applied to the dipole arms, because they might bend or the soldered connections near the feedpoint may be damaged.

Additional EUT Data

Manufactured by	SPEAG
Manufactured on	September 29, 2009

DASY5 Validation Report for Head TSL

Date: 22.05.2017

Test Laboratory: SPEAG, Zurich, Switzerland

DUT: Dipole 750 MHz; Type: D750V3; Serial: D750V3 - SN:1012

Communication System: UID 0 - CW; Frequency: 750 MHz

Medium parameters used: $f = 750$ MHz; $\sigma = 0.91$ S/m; $\epsilon_r = 41$; $\rho = 1000$ kg/m³

Phantom section: Flat Section

Measurement Standard: DASY5 (IEEE/IEC/ANSI C63.19-2011)

DASY52 Configuration:

- Probe: EX3DV4 - SN7460; ConvF(10.05, 10.05, 10.05); Calibrated: 19.05.2017;
- Sensor-Surface: 1.4mm (Mechanical Surface Detection)
- Electronics: DAE4 Sn601; Calibrated: 28.03.2017
- Phantom: Flat Phantom 4.9 (front); Type: QD 00L P49 AA; Serial: 1001
- DASY52 52.10.0(1446); SEMCAD X 14.6.10(7417)

Dipole Calibration for Head Tissue/Pin=250 mW, d=15mm/Zoom Scan (7x7x7)/Cube 0:

Measurement grid: dx=5mm, dy=5mm, dz=5mm

Reference Value = 59.26 V/m; Power Drift = -0.02 dB

Peak SAR (extrapolated) = 3.23 W/kg

SAR(1 g) = 2.1 W/kg; SAR(10 g) = 1.36 W/kg

Maximum value of SAR (measured) = 2.85 W/kg

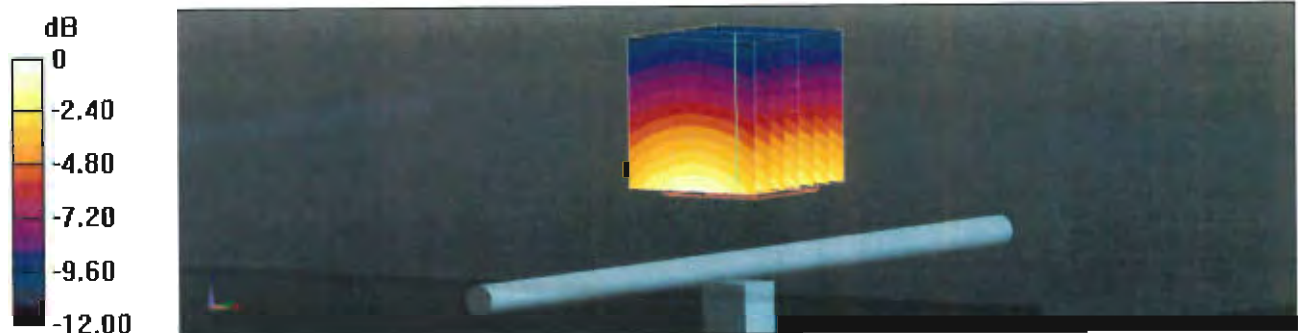

0 dB = 2.85 W/kg = 4.55 dBW/kg

Impedance Measurement Plot for Head TSL

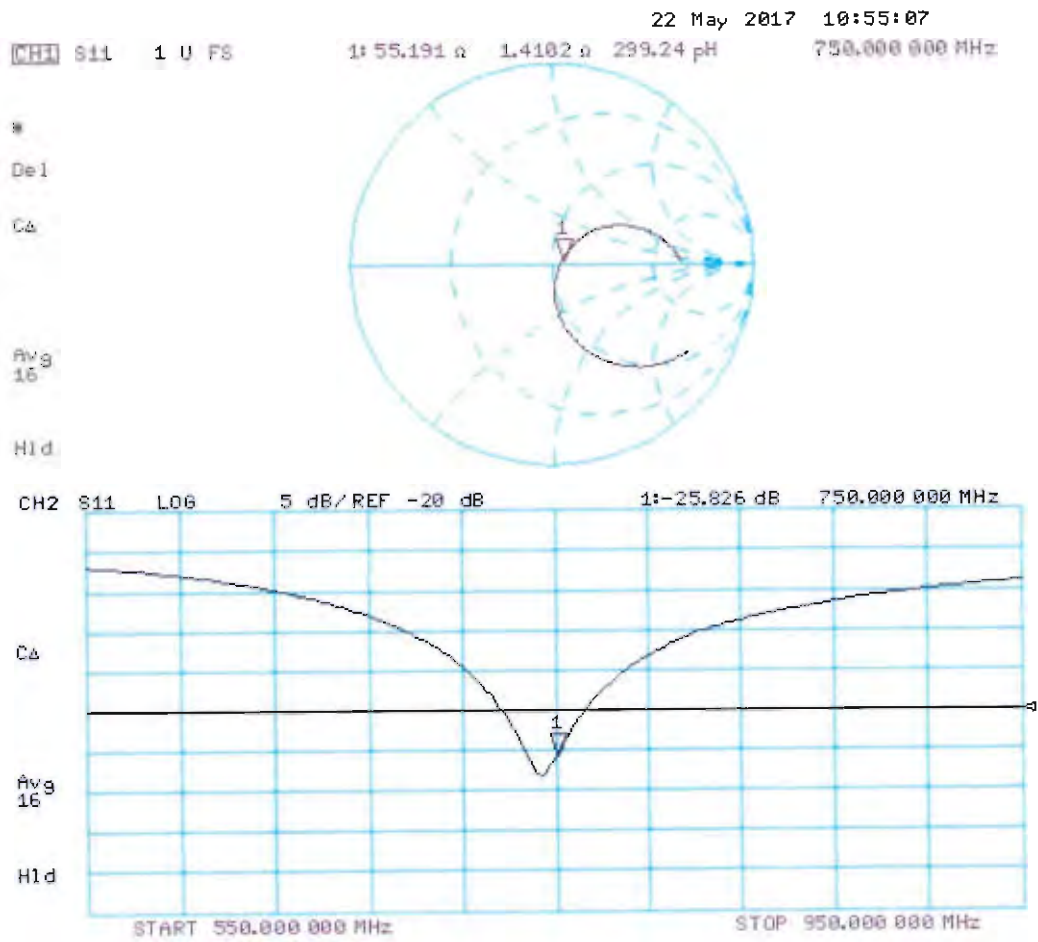

DASY5 Validation Report for Body TSL

Date: 22.05.2017

Test Laboratory: SPEAG, Zurich, Switzerland

DUT: Dipole 750 MHz; Type: D750V3; Serial: D750V3 - SN:1012

Communication System: UID 0 - CW; Frequency: 750 MHz

Medium parameters used: $f = 750$ MHz; $\sigma = 0.96$ S/m; $\epsilon_r = 55.3$; $\rho = 1000$ kg/m³

Phantom section: Flat Section

Measurement Standard: DASY5 (IEEE/IEC/ANSI C63.19-2011)

DASY52 Configuration:

- Probe: EX3DV4 - SN7460; ConvF(9.81, 9.81, 9.81); Calibrated: 19.05.2017;
- Sensor-Surface: 1.4mm (Mechanical Surface Detection)
- Electronics: DAE4 Sn601; Calibrated: 28.03.2017
- Phantom: Flat Phantom 4.9 (Back); Type: QD 00R P49 AA; Serial: 1005
- DASY52 52.10.0(1446); SEMCAD X 14.6.10(7417)

Dipole Calibration for Body Tissue/Pin=250 mW, d=15mm/Zoom Scan (7x7x7)/Cube 0:

Measurement grid: dx=5mm, dy=5mm, dz=5mm

Reference Value = 57.73 V/m; Power Drift = -0.04 dB

Peak SAR (extrapolated) = 3.27 W/kg

SAR(1 g) = 2.18 W/kg; SAR(10 g) = 1.43 W/kg

Maximum value of SAR (measured) = 2.86 W/kg

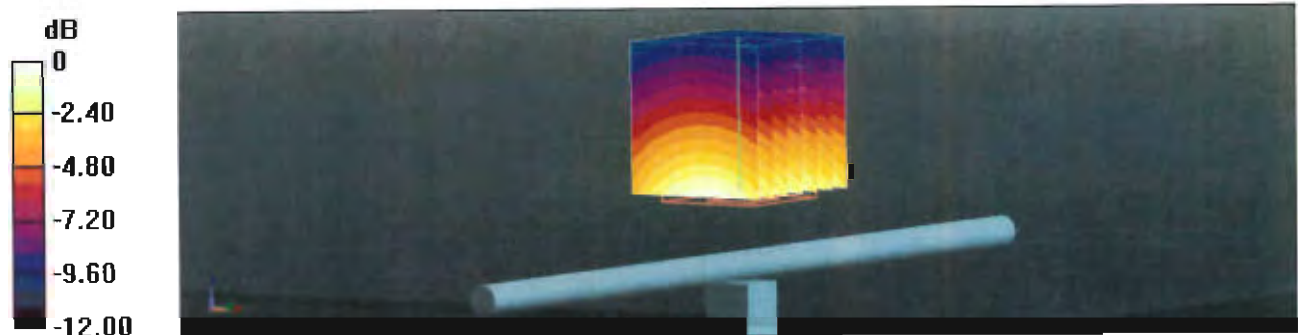

Impedance Measurement Plot for Body TSL

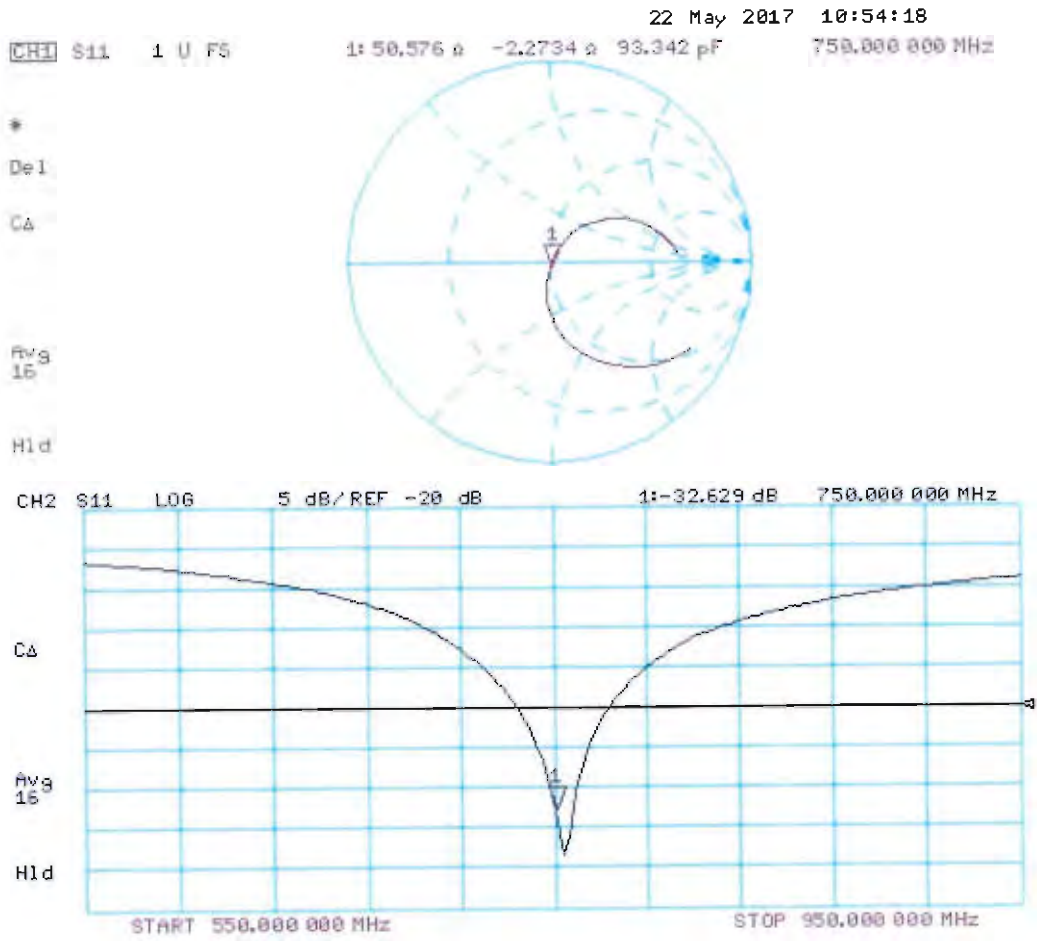



Accredited by the Swiss Accreditation Service (SAS)
The Swiss Accreditation Service is one of the signatories to the EA
Multilateral Agreement for the recognition of calibration certificates

Accreditation No.: **SCS 0108**

Client **Sporton-TW (Auden)**

Certificate No: **D835V2-499_Mar17**

CALIBRATION CERTIFICATE

Object **D835V2 - SN:499**

Calibration procedure(s) **QA CAL-05.v9
Calibration procedure for dipole validation kits above 700 MHz**

Calibration date: **March 21, 2017**

This calibration certificate documents the traceability to national standards, which realize the physical units of measurements (SI).
The measurements and the uncertainties with confidence probability are given on the following pages and are part of the certificate.

All calibrations have been conducted in the closed laboratory facility: environment temperature (22 ± 3)°C and humidity < 70%.

Calibration Equipment used (M&TE critical for calibration)

Primary Standards	ID #	Cal Date (Certificate No.)	Scheduled Calibration
Power meter NRP	SN: 104778	06-Apr-16 (No. 217-02288/02289)	Apr-17
Power sensor NRP-Z91	SN: 103244	06-Apr-16 (No. 217-02288)	Apr-17
Power sensor NRP-Z91	SN: 103245	06-Apr-16 (No. 217-02289)	Apr-17
Reference 20 dB Attenuator	SN: 5058 (20k)	05-Apr-16 (No. 217-02292)	Apr-17
Type-N mismatch combination	SN: 5047.2 / 06327	05-Apr-16 (No. 217-02295)	Apr-17
Reference Probe EX3DV4	SN: 7349	31-Dec-16 (No. EX3-7349_Dec16)	Dec-17
DAE4	SN: 601	04-Jan-17 (No. DAE4-601_Jan17)	Jan-18

Secondary Standards	ID #	Check Date (in house)	Scheduled Check
Power meter EPM-442A	SN: GB37480704	07-Oct-15 (in house check Oct-16)	In house check: Oct-18
Power sensor HP 8481A	SN: US37292783	07-Oct-15 (in house check Oct-16)	In house check: Oct-18
Power sensor HP 8481A	SN: MY41092317	07-Oct-15 (in house check Oct-16)	In house check: Oct-18
RF generator R&S SMT-06	SN: 100972	15-Jun-15 (in house check Oct-16)	In house check: Oct-18
Network Analyzer HP 8753E	SN: US37390585	18-Oct-01 (in house check Oct-16)	In house check: Oct-17

	Name	Function	Signature
Calibrated by:	Leif Klynsner	Laboratory Technician	
Approved by:	Katja Pokovic	Technical Manager	

Issued: March 23, 2017

This calibration certificate shall not be reproduced except in full without written approval of the laboratory.



Accredited by the Swiss Accreditation Service (SAS)

The Swiss Accreditation Service is one of the signatories to the EA Multilateral Agreement for the recognition of calibration certificates

Accreditation No.: **SCS 0108**

Glossary:

TSL	tissue simulating liquid
ConvF	sensitivity in TSL / NORM x,y,z
N/A	not applicable or not measured

Calibration is Performed According to the Following Standards:

- IEEE Std 1528-2013, "IEEE Recommended Practice for Determining the Peak Spatial-Averaged Specific Absorption Rate (SAR) in the Human Head from Wireless Communications Devices: Measurement Techniques", June 2013
- IEC 62209-1, "Procedure to measure the Specific Absorption Rate (SAR) for hand-held devices used in close proximity to the ear (frequency range of 300 MHz to 3 GHz)", February 2005
- IEC 62209-2, "Procedure to determine the Specific Absorption Rate (SAR) for wireless communication devices used in close proximity to the human body (frequency range of 30 MHz to 6 GHz)", March 2010
- KDB 865664, "SAR Measurement Requirements for 100 MHz to 6 GHz"

Additional Documentation:

- DASY4/5 System Handbook

Methods Applied and Interpretation of Parameters:

- Measurement Conditions:** Further details are available from the Validation Report at the end of the certificate. All figures stated in the certificate are valid at the frequency indicated.
- Antenna Parameters with TSL:** The dipole is mounted with the spacer to position its feed point exactly below the center marking of the flat phantom section, with the arms oriented parallel to the body axis.
- Feed Point Impedance and Return Loss:** These parameters are measured with the dipole positioned under the liquid filled phantom. The impedance stated is transformed from the measurement at the SMA connector to the feed point. The Return Loss ensures low reflected power. No uncertainty required.
- Electrical Delay:** One-way delay between the SMA connector and the antenna feed point. No uncertainty required.
- SAR measured:** SAR measured at the stated antenna input power.
- SAR normalized:** SAR as measured, normalized to an input power of 1 W at the antenna connector.
- SAR for nominal TSL parameters:** The measured TSL parameters are used to calculate the nominal SAR result.

The reported uncertainty of measurement is stated as the standard uncertainty of measurement multiplied by the coverage factor $k=2$, which for a normal distribution corresponds to a coverage probability of approximately 95%.

Measurement Conditions

DASY system configuration, as far as not given on page 1.

DASY Version	DASY5	V52.8.8
Extrapolation	Advanced Extrapolation	
Phantom	Modular Flat Phantom	
Distance Dipole Center - TSL	15 mm	with Spacer
Zoom Scan Resolution	dx, dy, dz = 5 mm	
Frequency	835 MHz \pm 1 MHz	

Head TSL parameters

The following parameters and calculations were applied.

	Temperature	Permittivity	Conductivity
Nominal Head TSL parameters	22.0 °C	41.5	0.90 mho/m
Measured Head TSL parameters	(22.0 \pm 0.2) °C	40.7 \pm 6 %	0.94 mho/m \pm 6 %
Head TSL temperature change during test	< 0.5 °C	----	----

SAR result with Head TSL

SAR averaged over 1 cm ³ (1 g) of Head TSL	Condition	
SAR measured	250 mW input power	2.45 W/kg
SAR for nominal Head TSL parameters	normalized to 1W	9.45 W/kg \pm 17.0 % (k=2)

SAR averaged over 10 cm ³ (10 g) of Head TSL	condition	
SAR measured	250 mW input power	1.58 W/kg
SAR for nominal Head TSL parameters	normalized to 1W	6.14 W/kg \pm 16.5 % (k=2)

Body TSL parameters

The following parameters and calculations were applied.

	Temperature	Permittivity	Conductivity
Nominal Body TSL parameters	22.0 °C	55.2	0.97 mho/m
Measured Body TSL parameters	(22.0 \pm 0.2) °C	54.4 \pm 6 %	1.01 mho/m \pm 6 %
Body TSL temperature change during test	< 0.5 °C	----	----

SAR result with Body TSL

SAR averaged over 1 cm ³ (1 g) of Body TSL	Condition	
SAR measured	250 mW input power	2.50 W/kg
SAR for nominal Body TSL parameters	normalized to 1W	9.67 W/kg \pm 17.0 % (k=2)

SAR averaged over 10 cm ³ (10 g) of Body TSL	condition	
SAR measured	250 mW input power	1.63 W/kg
SAR for nominal Body TSL parameters	normalized to 1W	6.35 W/kg \pm 16.5 % (k=2)

Appendix (Additional assessments outside the scope of SCS 0108)

Antenna Parameters with Head TSL

Impedance, transformed to feed point	52.0 Ω - 4.9 j Ω
Return Loss	- 25.7 dB

Antenna Parameters with Body TSL

Impedance, transformed to feed point	47.5 Ω - 7.0 j Ω
Return Loss	- 22.4 dB

General Antenna Parameters and Design

Electrical Delay (one direction)	1.390 ns
----------------------------------	----------

After long term use with 100W radiated power, only a slight warming of the dipole near the feedpoint can be measured.

The dipole is made of standard semirigid coaxial cable. The center conductor of the feeding line is directly connected to the second arm of the dipole. The antenna is therefore short-circuited for DC-signals. On some of the dipoles, small end caps are added to the dipole arms in order to improve matching when loaded according to the position as explained in the "Measurement Conditions" paragraph. The SAR data are not affected by this change. The overall dipole length is still according to the Standard.

No excessive force must be applied to the dipole arms, because they might bend or the soldered connections near the feedpoint may be damaged.

Additional EUT Data

Manufactured by	SPEAG
Manufactured on	July 10, 2003

DASY5 Validation Report for Head TSL

Date: 21.03.2017

Test Laboratory: SPEAG, Zurich, Switzerland

DUT: Dipole 835 MHz; Type: D835V2; Serial: D835V2 - SN:499

Communication System: UID 0 - CW; Frequency: 835 MHz

Medium parameters used: $f = 835$ MHz; $\sigma = 0.94$ S/m; $\epsilon_r = 40.7$; $\rho = 1000$ kg/m³

Phantom section: Flat Section

Measurement Standard: DASY5 (IEEE/IEC/ANSI C63.19-2011)

DASY52 Configuration:

- Probe: EX3DV4 - SN7349; ConvF(9.72, 9.72, 9.72); Calibrated: 31.12.2016;
- Sensor-Surface: 1.4mm (Mechanical Surface Detection)
- Electronics: DAE4 Sn601; Calibrated: 04.01.2017
- Phantom: Flat Phantom 4.9 (front); Type: QD 00L P49 AA; Serial: 1001
- DASY52 52.8.8(1258); SEMCAD X 14.6.10(7372)

Dipole Calibration for Head Tissue/Pin=250 mW, d=15mm/Zoom Scan (7x7x7)/Cube 0:

Measurement grid: dx=5mm, dy=5mm, dz=5mm

Reference Value = 63.11 V/m; Power Drift = -0.04 dB

Peak SAR (extrapolated) = 3.69 W/kg

SAR(1 g) = 2.45 W/kg; SAR(10 g) = 1.58 W/kg

Maximum value of SAR (measured) = 3.29 W/kg

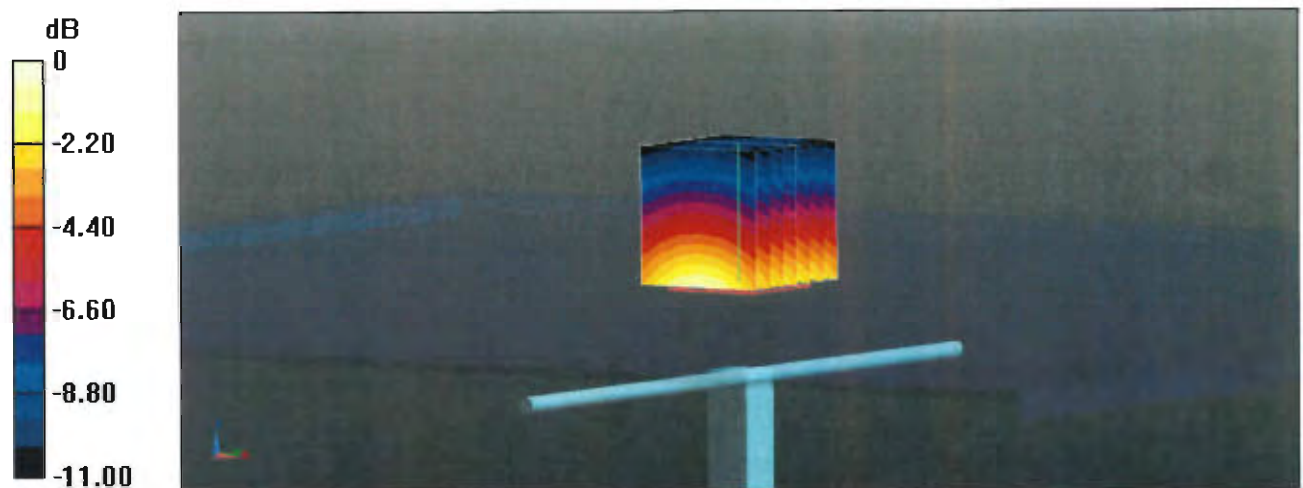

0 dB = 3.29 W/kg = 5.17 dBW/kg

Impedance Measurement Plot for Head TSL

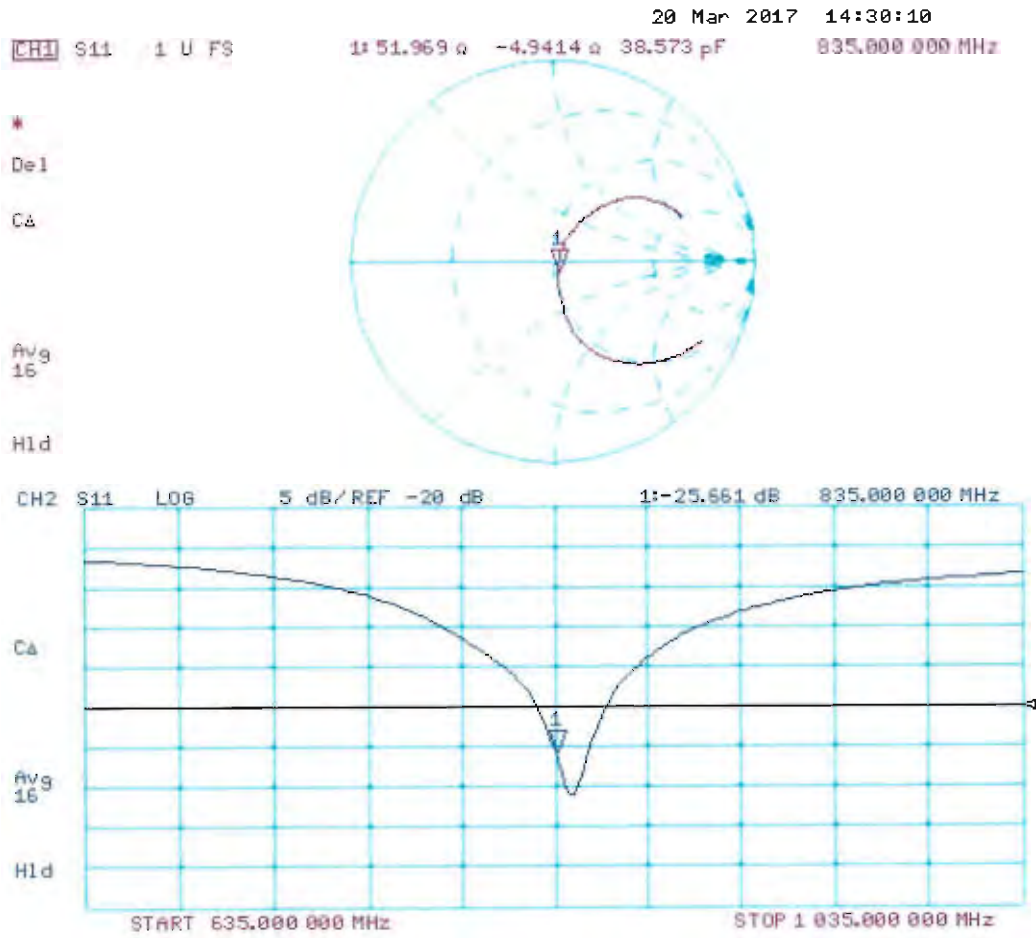

DASY5 Validation Report for Body TSL

Date: 20.03.2017

Test Laboratory: SPEAG, Zurich, Switzerland

DUT: Dipole 835 MHz; Type: D835V2; Serial: D835V2 - SN:499

Communication System: UID 0 - CW; Frequency: 835 MHz

Medium parameters used: $f = 835$ MHz; $\sigma = 1.01$ S/m; $\epsilon_r = 54.4$; $\rho = 1000$ kg/m³

Phantom section: Flat Section

Measurement Standard: DASY5 (IEEE/IEC/ANSI C63.19-2011)

DASY52 Configuration:

- Probe: EX3DV4 - SN7349; ConvF(9.73, 9.73, 9.73); Calibrated: 31.12.2016;
- Sensor-Surface: 1.4mm (Mechanical Surface Detection)
- Electronics: DAE4 Sn601; Calibrated: 04.01.2017
- Phantom: Flat Phantom 4.9 (Back); Type: QD 00R P49 AA; Serial: 1005
- DASY52 52.8.8(1258); SEMCAD X 14.6.10(7372)

Dipole Calibration for Body Tissue/Pin=250 mW, d=15mm/Zoom Scan (7x7x7)/Cube 0:

Measurement grid: dx=5mm, dy=5mm, dz=5mm

Reference Value = 61.02 V/m; Power Drift = -0.05 dB

Peak SAR (extrapolated) = 3.74 W/kg

SAR(1 g) = 2.5 W/kg; SAR(10 g) = 1.63 W/kg

Maximum value of SAR (measured) = 3.32 W/kg

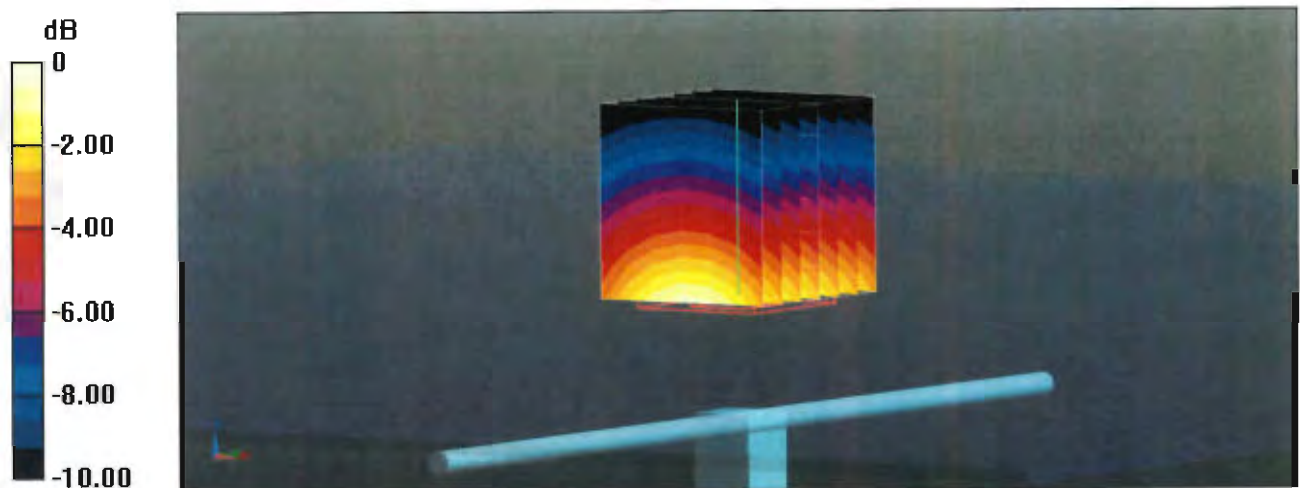

0 dB = 3.32 W/kg = 5.21 dBW/kg

Impedance Measurement Plot for Body TSL

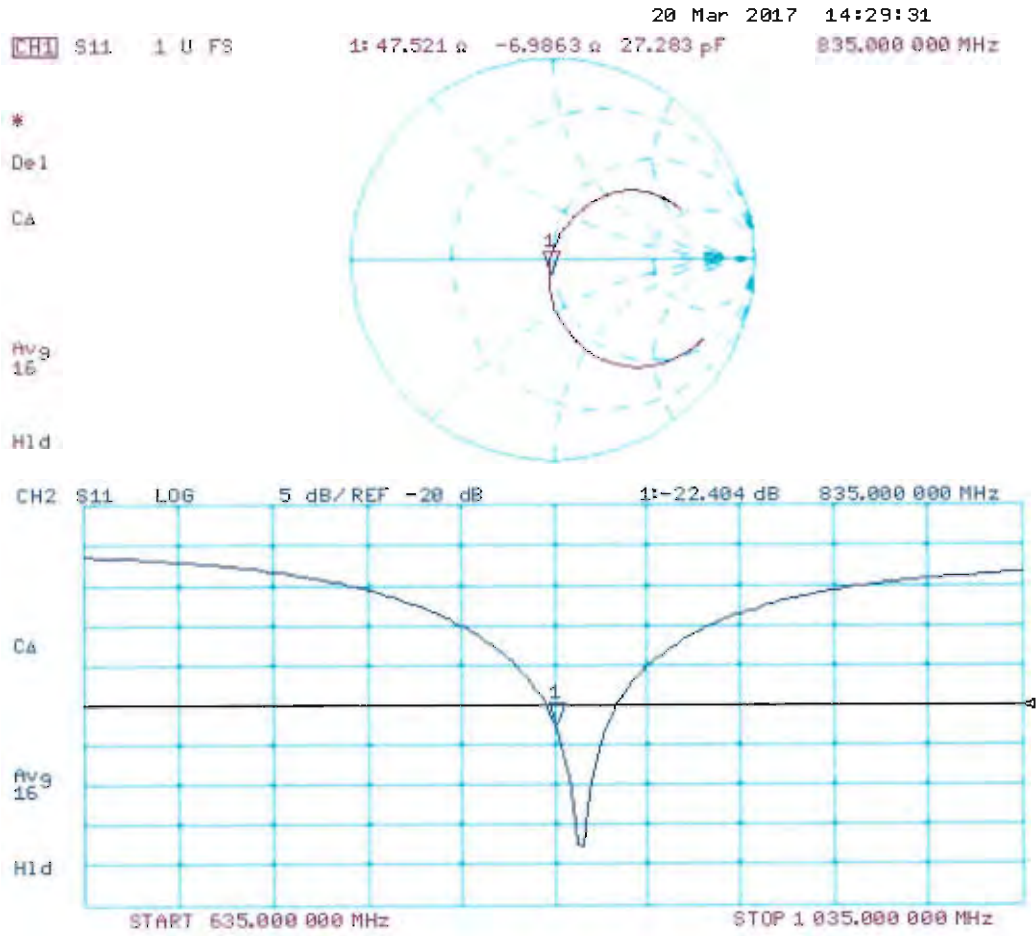



Accredited by the Swiss Accreditation Service (SAS)
The Swiss Accreditation Service is one of the signatories to the EA
Multilateral Agreement for the recognition of calibration certificates

Accreditation No.: **SCS 0108**

Client **Sporton-TW (Auden)**

Certificate No: **D1750V2-1068_Nov16**

CALIBRATION CERTIFICATE

Object **D1750V2 - SN:1068**

Calibration procedure(s) **QA CAL-05.v9
Calibration procedure for dipole validation kits above 700 MHz**

Calibration date: **November 16, 2016**

This calibration certificate documents the traceability to national standards, which realize the physical units of measurements (SI).
The measurements and the uncertainties with confidence probability are given on the following pages and are part of the certificate.

All calibrations have been conducted in the closed laboratory facility: environment temperature (22 ± 3)°C and humidity < 70%.

Calibration Equipment used (M&TE critical for calibration)

Primary Standards	ID #	Cal Date (Certificate No.)	Scheduled Calibration
Power meter NRP	SN: 104778	06-Apr-16 (No. 217-02288/02289)	Apr-17
Power sensor NRP-Z91	SN: 103244	06-Apr-16 (No. 217-02288)	Apr-17
Power sensor NRP-Z91	SN: 103245	06-Apr-16 (No. 217-02289)	Apr-17
Reference 20 dB Attenuator	SN: 5058 (20k)	05-Apr-16 (No. 217-02292)	Apr-17
Type-N mismatch combination	SN: 5047.2 / 06327	05-Apr-16 (No. 217-02295)	Apr-17
Reference Probe EX3DV4	SN: 7349	15-Jun-16 (No. EX3-7349_Jun16)	Jun-17
DAE4	SN: 601	30-Dec-15 (No. DAE4-601_Dec15)	Dec-16

Secondary Standards	ID #	Check Date (in house)	Scheduled Check
Power meter EPM-442A	SN: GB37480704	07-Oct-15 (in house check Oct-16)	In house check: Oct-18
Power sensor HP 8481A	SN: US37292783	07-Oct-15 (in house check Oct-16)	In house check: Oct-18
Power sensor HP 8481A	SN: MY41092317	07-Oct-15 (in house check Oct-16)	In house check: Oct-18
RF generator R&S SMT-06	SN: 100972	15-Jun-15 (in house check Oct-16)	In house check: Oct-18
Network Analyzer HP 8753E	SN: US37390585	18-Oct-01 (in house check Oct-16)	In house check: Oct-17

Calibrated by: **Claudio Leubler** Name: Claudio Leubler Function: Laboratory Technician

Approved by: **Katja Pokovic** Name: Katja Pokovic Function: Technical Manager

Signature

Issued: November 17, 2016

This calibration certificate shall not be reproduced except in full without written approval of the laboratory.



Accredited by the Swiss Accreditation Service (SAS)

Accreditation No.: **SCS 0108**

The Swiss Accreditation Service is one of the signatories to the EA Multilateral Agreement for the recognition of calibration certificates

Glossary:

TSL	tissue simulating liquid
ConvF	sensitivity in TSL / NORM x,y,z
N/A	not applicable or not measured

Calibration is Performed According to the Following Standards:

- a) IEEE Std 1528-2013, "IEEE Recommended Practice for Determining the Peak Spatial-Averaged Specific Absorption Rate (SAR) in the Human Head from Wireless Communications Devices: Measurement Techniques", June 2013
- b) IEC 62209-1, "Procedure to measure the Specific Absorption Rate (SAR) for hand-held devices used in close proximity to the ear (frequency range of 300 MHz to 3 GHz)", February 2005
- c) IEC 62209-2, "Procedure to determine the Specific Absorption Rate (SAR) for wireless communication devices used in close proximity to the human body (frequency range of 30 MHz to 6 GHz)", March 2010
- d) KDB 865664, "SAR Measurement Requirements for 100 MHz to 6 GHz"

Additional Documentation:

- e) DASY4/5 System Handbook

Methods Applied and Interpretation of Parameters:

- *Measurement Conditions:* Further details are available from the Validation Report at the end of the certificate. All figures stated in the certificate are valid at the frequency indicated.
- *Antenna Parameters with TSL:* The dipole is mounted with the spacer to position its feed point exactly below the center marking of the flat phantom section, with the arms oriented parallel to the body axis.
- *Feed Point Impedance and Return Loss:* These parameters are measured with the dipole positioned under the liquid filled phantom. The impedance stated is transformed from the measurement at the SMA connector to the feed point. The Return Loss ensures low reflected power. No uncertainty required.
- *Electrical Delay:* One-way delay between the SMA connector and the antenna feed point. No uncertainty required.
- *SAR measured:* SAR measured at the stated antenna input power.
- *SAR normalized:* SAR as measured, normalized to an input power of 1 W at the antenna connector.
- *SAR for nominal TSL parameters:* The measured TSL parameters are used to calculate the nominal SAR result.

The reported uncertainty of measurement is stated as the standard uncertainty of measurement multiplied by the coverage factor $k=2$, which for a normal distribution corresponds to a coverage probability of approximately 95%.

Measurement Conditions

DASY system configuration, as far as not given on page 1.

DASY Version	DASY5	V52.8.8
Extrapolation	Advanced Extrapolation	
Phantom	Modular Flat Phantom	
Distance Dipole Center - TSL	10 mm	with Spacer
Zoom Scan Resolution	dx, dy, dz = 5 mm	
Frequency	1750 MHz \pm 1 MHz	

Head TSL parameters

The following parameters and calculations were applied.

	Temperature	Permittivity	Conductivity
Nominal Head TSL parameters	22.0 °C	40.1	1.37 mho/m
Measured Head TSL parameters	(22.0 \pm 0.2) °C	39.1 \pm 6 %	1.37 mho/m \pm 6 %
Head TSL temperature change during test	< 0.5 °C	----	----

SAR result with Head TSL

SAR averaged over 1 cm ³ (1 g) of Head TSL	Condition	
SAR measured	250 mW input power	9.20 W/kg
SAR for nominal Head TSL parameters	normalized to 1W	36.6 W/kg \pm 17.0 % (k=2)

SAR averaged over 10 cm ³ (10 g) of Head TSL	condition	
SAR measured	250 mW input power	4.88 W/kg
SAR for nominal Head TSL parameters	normalized to 1W	19.5 W/kg \pm 16.5 % (k=2)

Body TSL parameters

The following parameters and calculations were applied.

	Temperature	Permittivity	Conductivity
Nominal Body TSL parameters	22.0 °C	53.4	1.49 mho/m
Measured Body TSL parameters	(22.0 \pm 0.2) °C	53.7 \pm 6 %	1.49 mho/m \pm 6 %
Body TSL temperature change during test	< 0.5 °C	----	----

SAR result with Body TSL

SAR averaged over 1 cm ³ (1 g) of Body TSL	Condition	
SAR measured	250 mW input power	9.04 W/kg
SAR for nominal Body TSL parameters	normalized to 1W	36.2 W/kg \pm 17.0 % (k=2)

SAR averaged over 10 cm ³ (10 g) of Body TSL	condition	
SAR measured	250 mW input power	4.85 W/kg
SAR for nominal Body TSL parameters	normalized to 1W	19.4 W/kg \pm 16.5 % (k=2)

Appendix (Additional assessments outside the scope of SCS 0108)

Antenna Parameters with Head TSL

Impedance, transformed to feed point	51.4 Ω + 3.9 j Ω
Return Loss	- 27.9 dB

Antenna Parameters with Body TSL

Impedance, transformed to feed point	47.1 Ω + 2.7 j Ω
Return Loss	- 27.8 dB

General Antenna Parameters and Design

Electrical Delay (one direction)	1.221 ns
----------------------------------	----------

After long term use with 100W radiated power, only a slight warming of the dipole near the feedpoint can be measured.

The dipole is made of standard semirigid coaxial cable. The center conductor of the feeding line is directly connected to the second arm of the dipole. The antenna is therefore short-circuited for DC-signals. On some of the dipoles, small end caps are added to the dipole arms in order to improve matching when loaded according to the position as explained in the "Measurement Conditions" paragraph. The SAR data are not affected by this change. The overall dipole length is still according to the Standard.

No excessive force must be applied to the dipole arms, because they might bend or the soldered connections near the feedpoint may be damaged.

Additional EUT Data

Manufactured by	SPEAG
Manufactured on	June 15, 2010

DASY5 Validation Report for Head TSL

Date: 16.11.2016

Test Laboratory: SPEAG, Zurich, Switzerland

DUT: Dipole 1750 MHz; Type: D1750V2; Serial: D1750V2 - SN:1068

Communication System: UID 0 - CW; Frequency: 1750 MHz

Medium parameters used: $f = 1750$ MHz; $\sigma = 1.37$ S/m; $\epsilon_r = 39.1$; $\rho = 1000$ kg/m³

Phantom section: Flat Section

Measurement Standard: DASY5 (IEEE/IEC/ANSI C63.19-2011)

DASY52 Configuration:

- Probe: EX3DV4 - SN7349; ConvF(8.46, 8.46, 8.46); Calibrated: 15.06.2016;
- Sensor-Surface: 1.4mm (Mechanical Surface Detection)
- Electronics: DAE4 Sn601; Calibrated: 30.12.2015
- Phantom: Flat Phantom 5.0 (front); Type: QD000P50AA; Serial: 1001
- DASY52 52.8.8(1258); SEMCAD X 14.6.10(7372)

Dipole Calibration for Head Tissue/Pin=250 mW, d=10mm/Zoom Scan (7x7x7)/Cube 0:

Measurement grid: dx=5mm, dy=5mm, dz=5mm

Reference Value = 103.4 V/m; Power Drift = 0.01 dB

Peak SAR (extrapolated) = 16.8 W/kg

SAR(1 g) = 9.2 W/kg; SAR(10 g) = 4.88 W/kg

Maximum value of SAR (measured) = 14.0 W/kg

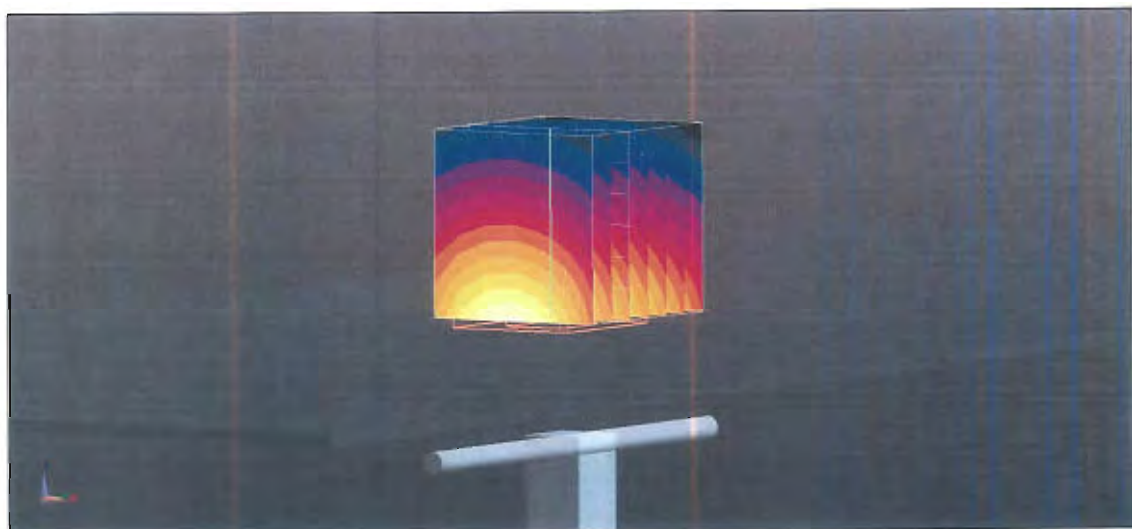
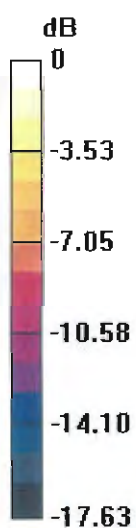

0 dB = 14.0 W/kg = 11.46 dBW/kg

Impedance Measurement Plot for Head TSL

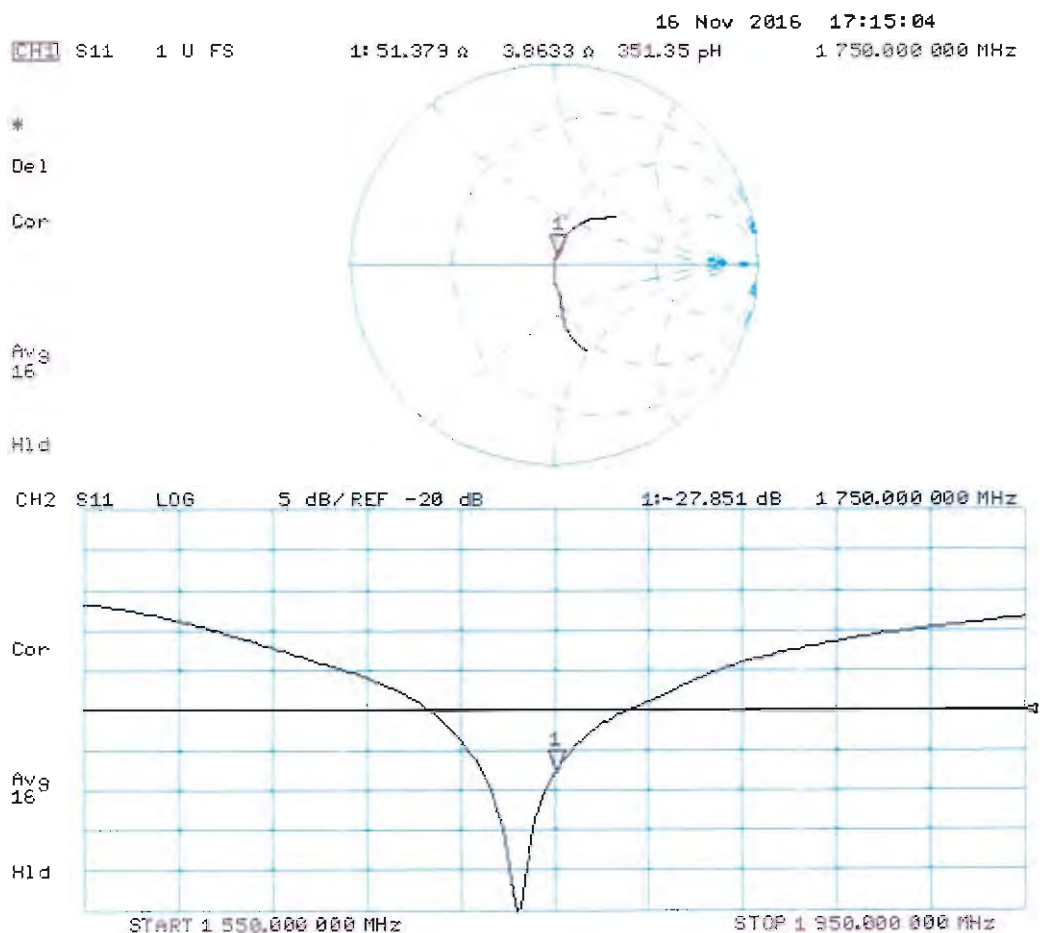

DASY5 Validation Report for Body TSL

Date: 16.11.2016

Test Laboratory: SPEAG, Zurich, Switzerland

DUT: Dipole 1750 MHz; Type: D1750V2; Serial: D1750V2 - SN:1068

Communication System: UID 0 - CW; Frequency: 1750 MHz

Medium parameters used: $f = 1750$ MHz; $\sigma = 1.49$ S/m; $\epsilon_r = 53.7$; $\rho = 1000$ kg/m³

Phantom section: Flat Section

Measurement Standard: DASY5 (IEEE/IEC/ANSI C63.19-2011)

DASY52 Configuration:

- Probe: EX3DV4 - SN7349; ConvF(8.25, 8.25, 8.25); Calibrated: 15.06.2016;
- Sensor-Surface: 1.4mm (Mechanical Surface Detection)
- Electronics: DAE4 Sn601; Calibrated: 30.12.2015
- Phantom: Flat Phantom 5.0 (back); Type: QD000P50AA; Serial: 1002
- DASY52 52.8.8(1258); SEMCAD X 14.6.10(7372)

Dipole Calibration for Body Tissue/Pin=250 mW, d=10mm/Zoom Scan (7x7x7)/Cube 0:

Measurement grid: dx=5mm, dy=5mm, dz=5mm

Reference Value = 99.57 V/m; Power Drift = -0.06 dB

Peak SAR (extrapolated) = 15.8 W/kg

SAR(1 g) = 9.04 W/kg; SAR(10 g) = 4.85 W/kg

Maximum value of SAR (measured) = 13.5 W/kg

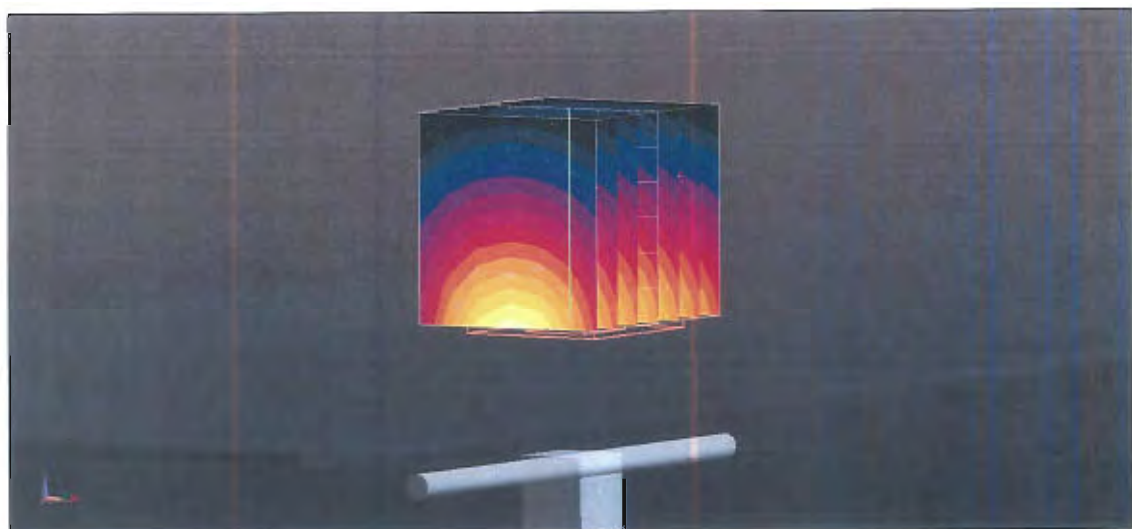
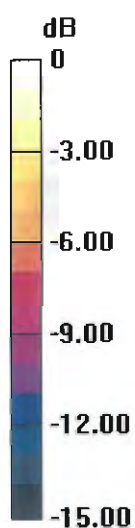

0 dB = 13.5 W/kg = 11.30 dBW/kg

Impedance Measurement Plot for Body TSL

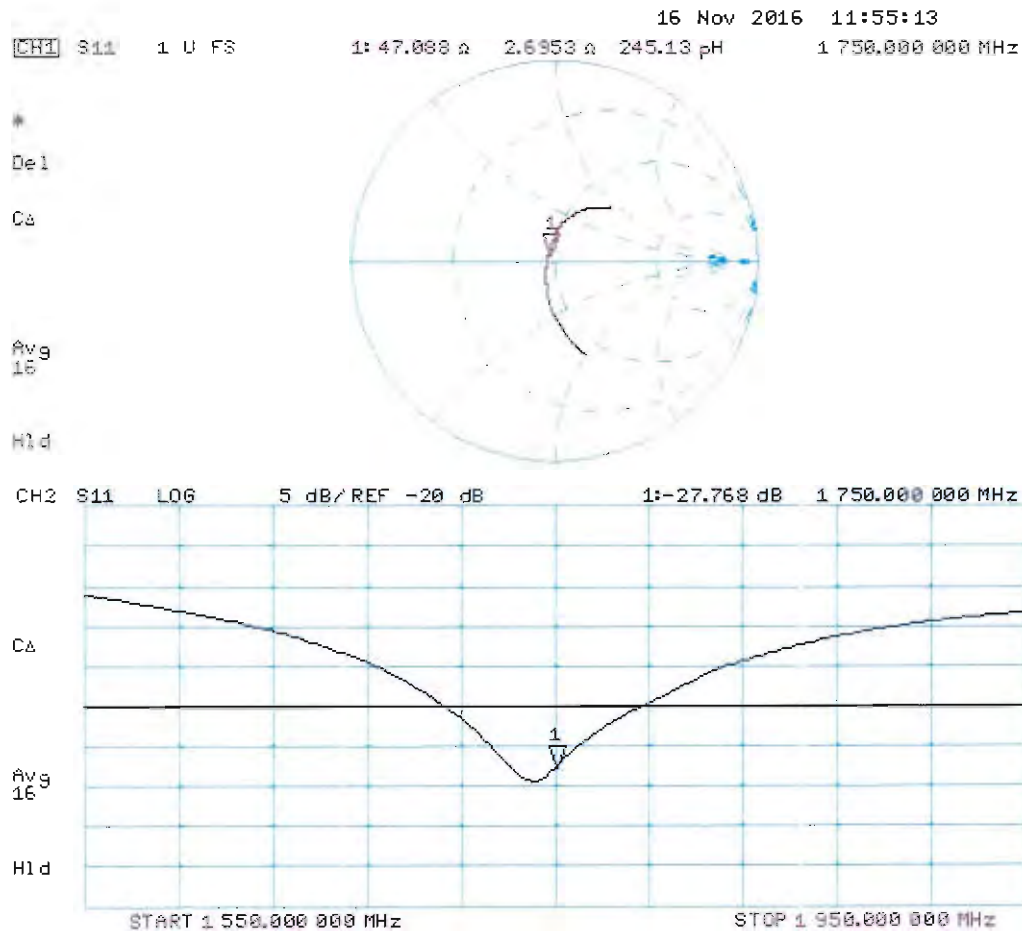



Accredited by the Swiss Accreditation Service (SAS)
The Swiss Accreditation Service is one of the signatories to the EA
Multilateral Agreement for the recognition of calibration certificates

Accreditation No.: **SCS 0108**

Client **Sporton-TW (Auden)**

Certificate No: **D1900V2-5d041_Sep16**

CALIBRATION CERTIFICATE

Object **D1900V2 - SN:5d041**

Calibration procedure(s) **QA CAL-05.v9**
Calibration procedure for dipole validation kits above 700 MHz

Calibration date: **September 30, 2016**

This calibration certificate documents the traceability to national standards, which realize the physical units of measurements (SI).
The measurements and the uncertainties with confidence probability are given on the following pages and are part of the certificate.

All calibrations have been conducted in the closed laboratory facility: environment temperature (22 ± 3)°C and humidity < 70%.

Calibration Equipment used (M&TE critical for calibration)

Primary Standards	ID #	Cal Date (Certificate No.)	Scheduled Calibration
Power meter NRP	SN: 104778	06-Apr-16 (No. 217-02288/02289)	Apr-17
Power sensor NRP-Z91	SN: 103244	06-Apr-16 (No. 217-02288)	Apr-17
Power sensor NRP-Z91	SN: 103245	06-Apr-16 (No. 217-02289)	Apr-17
Reference 20 dB Attenuator	SN: 5058 (20k)	05-Apr-16 (No. 217-02292)	Apr-17
Type-N mismatch combination	SN: 5047.2 / 06327	05-Apr-16 (No. 217-02295)	Apr-17
Reference Probe EX3DV4	SN: 7349	15-Jun-16 (No. EX3-7349_Jun16)	Jun-17
DAE4	SN: 601	30-Dec-15 (No. DAE4-601_Dec15)	Dec-16
Secondary Standards	ID #	Check Date (in house)	Scheduled Check
Power meter EPM-442A	SN: GB37480704	07-Oct-15 (No. 217-02222)	In house check: Oct-16
Power sensor HP 8481A	SN: US37292783	07-Oct-15 (No. 217-02222)	In house check: Oct-16
Power sensor HP 8481A	SN: MY41092317	07-Oct-15 (No. 217-02223)	In house check: Oct-16
RF generator R&S SMT-06	SN: 100972	15-Jun-15 (in house check Jun-15)	In house check: Oct-16
Network Analyzer HP 8753E	SN: US37390585	18-Oct-01 (in house check Oct-15)	In house check: Oct-16

Calibrated by: **Jeton Kastrati** Name: **Jeton Kastrati** Function: **Laboratory Technician**

Approved by: **Katja Pokovic** Name: **Katja Pokovic** Function: **Technical Manager**

Signature

Issued: September 30, 2016

This calibration certificate shall not be reproduced except in full without written approval of the laboratory.



Accredited by the Swiss Accreditation Service (SAS)

Accreditation No.: **SCS 0108**

The Swiss Accreditation Service is one of the signatories to the EA
Multilateral Agreement for the recognition of calibration certificates

Glossary:

TSL	tissue simulating liquid
ConvF	sensitivity in TSL / NORM x,y,z
N/A	not applicable or not measured

Calibration is Performed According to the Following Standards:

- IEEE Std 1528-2013, "IEEE Recommended Practice for Determining the Peak Spatial-Averaged Specific Absorption Rate (SAR) in the Human Head from Wireless Communications Devices: Measurement Techniques", June 2013
- IEC 62209-1, "Procedure to measure the Specific Absorption Rate (SAR) for hand-held devices used in close proximity to the ear (frequency range of 300 MHz to 3 GHz)", February 2005
- IEC 62209-2, "Procedure to determine the Specific Absorption Rate (SAR) for wireless communication devices used in close proximity to the human body (frequency range of 30 MHz to 6 GHz)", March 2010
- KDB 865664, "SAR Measurement Requirements for 100 MHz to 6 GHz"

Additional Documentation:

- DASY4/5 System Handbook

Methods Applied and Interpretation of Parameters:

- Measurement Conditions:** Further details are available from the Validation Report at the end of the certificate. All figures stated in the certificate are valid at the frequency indicated.
- Antenna Parameters with TSL:** The dipole is mounted with the spacer to position its feed point exactly below the center marking of the flat phantom section, with the arms oriented parallel to the body axis.
- Feed Point Impedance and Return Loss:** These parameters are measured with the dipole positioned under the liquid filled phantom. The impedance stated is transformed from the measurement at the SMA connector to the feed point. The Return Loss ensures low reflected power. No uncertainty required.
- Electrical Delay:** One-way delay between the SMA connector and the antenna feed point. No uncertainty required.
- SAR measured:** SAR measured at the stated antenna input power.
- SAR normalized:** SAR as measured, normalized to an input power of 1 W at the antenna connector.
- SAR for nominal TSL parameters:** The measured TSL parameters are used to calculate the nominal SAR result.

The reported uncertainty of measurement is stated as the standard uncertainty of measurement multiplied by the coverage factor $k=2$, which for a normal distribution corresponds to a coverage probability of approximately 95%.

Measurement Conditions

DASY system configuration, as far as not given on page 1.

DASY Version	DASY5	V52.8.8
Extrapolation	Advanced Extrapolation	
Phantom	Modular Flat Phantom	
Distance Dipole Center - TSL	10 mm	with Spacer
Zoom Scan Resolution	dx, dy, dz = 5 mm	
Frequency	1900 MHz \pm 1 MHz	

Head TSL parameters

The following parameters and calculations were applied.

	Temperature	Permittivity	Conductivity
Nominal Head TSL parameters	22.0 °C	40.0	1.40 mho/m
Measured Head TSL parameters	(22.0 \pm 0.2) °C	40.5 \pm 6 %	1.40 mho/m \pm 6 %
Head TSL temperature change during test	< 0.5 °C	----	----

SAR result with Head TSL

SAR averaged over 1 cm³ (1 g) of Head TSL	Condition	
SAR measured	250 mW input power	10.1 W/kg
SAR for nominal Head TSL parameters	normalized to 1W	40.5 W/kg \pm 17.0 % (k=2)

SAR averaged over 10 cm³ (10 g) of Head TSL	condition	
SAR measured	250 mW input power	5.33 W/kg
SAR for nominal Head TSL parameters	normalized to 1W	21.4 W/kg \pm 16.5 % (k=2)

Body TSL parameters

The following parameters and calculations were applied.

	Temperature	Permittivity	Conductivity
Nominal Body TSL parameters	22.0 °C	53.3	1.52 mho/m
Measured Body TSL parameters	(22.0 \pm 0.2) °C	53.6 \pm 6 %	1.49 mho/m \pm 6 %
Body TSL temperature change during test	< 0.5 °C	----	----

SAR result with Body TSL

SAR averaged over 1 cm³ (1 g) of Body TSL	Condition	
SAR measured	250 mW input power	9.58 W/kg
SAR for nominal Body TSL parameters	normalized to 1W	38.8 W/kg \pm 17.0 % (k=2)

SAR averaged over 10 cm³ (10 g) of Body TSL	condition	
SAR measured	250 mW input power	5.10 W/kg
SAR for nominal Body TSL parameters	normalized to 1W	20.6 W/kg \pm 16.5 % (k=2)

Appendix (Additional assessments outside the scope of SCS 0108)

Antenna Parameters with Head TSL

Impedance, transformed to feed point	52.5 Ω + 8.0 j Ω
Return Loss	- 21.8 dB

Antenna Parameters with Body TSL

Impedance, transformed to feed point	48.7 Ω + 7.6 j Ω
Return Loss	- 22.1 dB

General Antenna Parameters and Design

Electrical Delay (one direction)	1.199 ns
----------------------------------	----------

After long term use with 100W radiated power, only a slight warming of the dipole near the feedpoint can be measured.

The dipole is made of standard semirigid coaxial cable. The center conductor of the feeding line is directly connected to the second arm of the dipole. The antenna is therefore short-circuited for DC-signals. On some of the dipoles, small end caps are added to the dipole arms in order to improve matching when loaded according to the position as explained in the "Measurement Conditions" paragraph. The SAR data are not affected by this change. The overall dipole length is still according to the Standard.

No excessive force must be applied to the dipole arms, because they might bend or the soldered connections near the feedpoint may be damaged.

Additional EUT Data

Manufactured by	SPEAG
Manufactured on	July 04, 2003

DASY5 Validation Report for Head TSL

Date: 28.09.2016

Test Laboratory: SPEAG, Zurich, Switzerland

DUT: Dipole 1900 MHz; Type: D1900V2; Serial: D1900V2 - SN:5d041

Communication System: UID 0 - CW; Frequency: 1900 MHz

Medium parameters used: $f = 1900$ MHz; $\sigma = 1.4$ S/m; $\epsilon_r = 40.5$; $\rho = 1000$ kg/m³

Phantom section: Flat Section

Measurement Standard: DASY5 (IEEE/IEC/ANSI C63.19-2011)

DASY52 Configuration:

- Probe: EX3DV4 - SN7349; ConvF(7.99, 7.99, 7.99); Calibrated: 15.06.2016;
- Sensor-Surface: 1.4mm (Mechanical Surface Detection)
- Electronics: DAE4 Sn601; Calibrated: 30.12.2015
- Phantom: Flat Phantom 5.0 (front); Type: QD000P50AA; Serial: 1001
- DASY52 52.8.8(1258); SEMCAD X 14.6.10(7372)

Dipole Calibration for Head Tissue/Pin=250 mW, d=10mm/Zoom Scan (7x7x7)/Cube 0:

Measurement grid: dx=5mm, dy=5mm, dz=5mm

Reference Value = 108.5 V/m; Power Drift = -0.02 dB

Peak SAR (extrapolated) = 19.0 W/kg

SAR(1 g) = 10.1 W/kg; SAR(10 g) = 5.33 W/kg

Maximum value of SAR (measured) = 15.7 W/kg

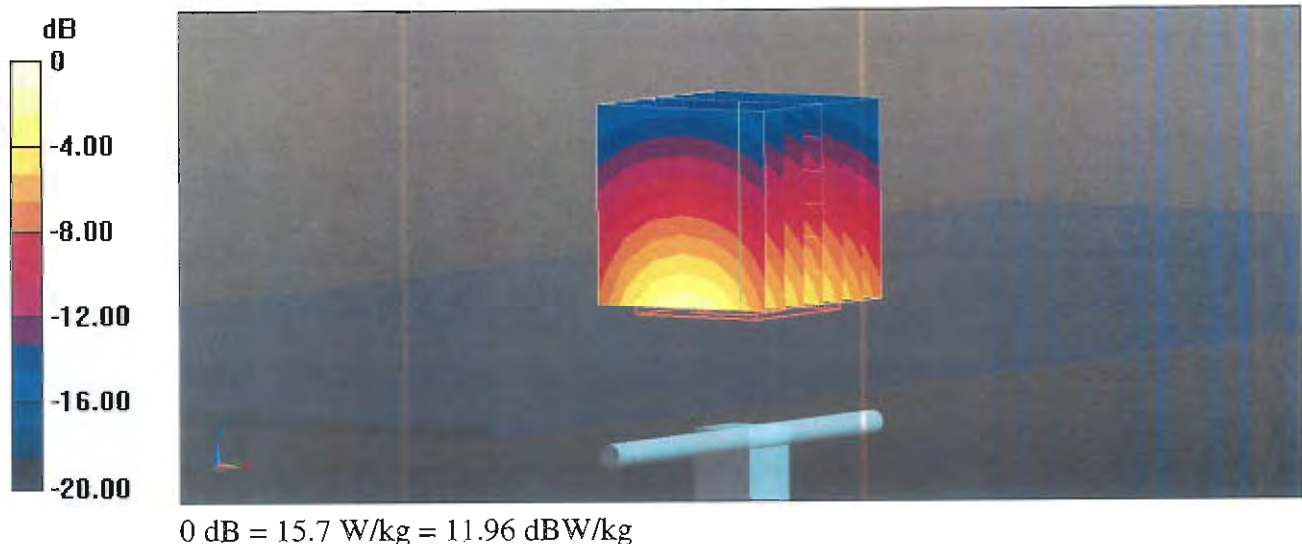

Impedance Measurement Plot for Head TSL

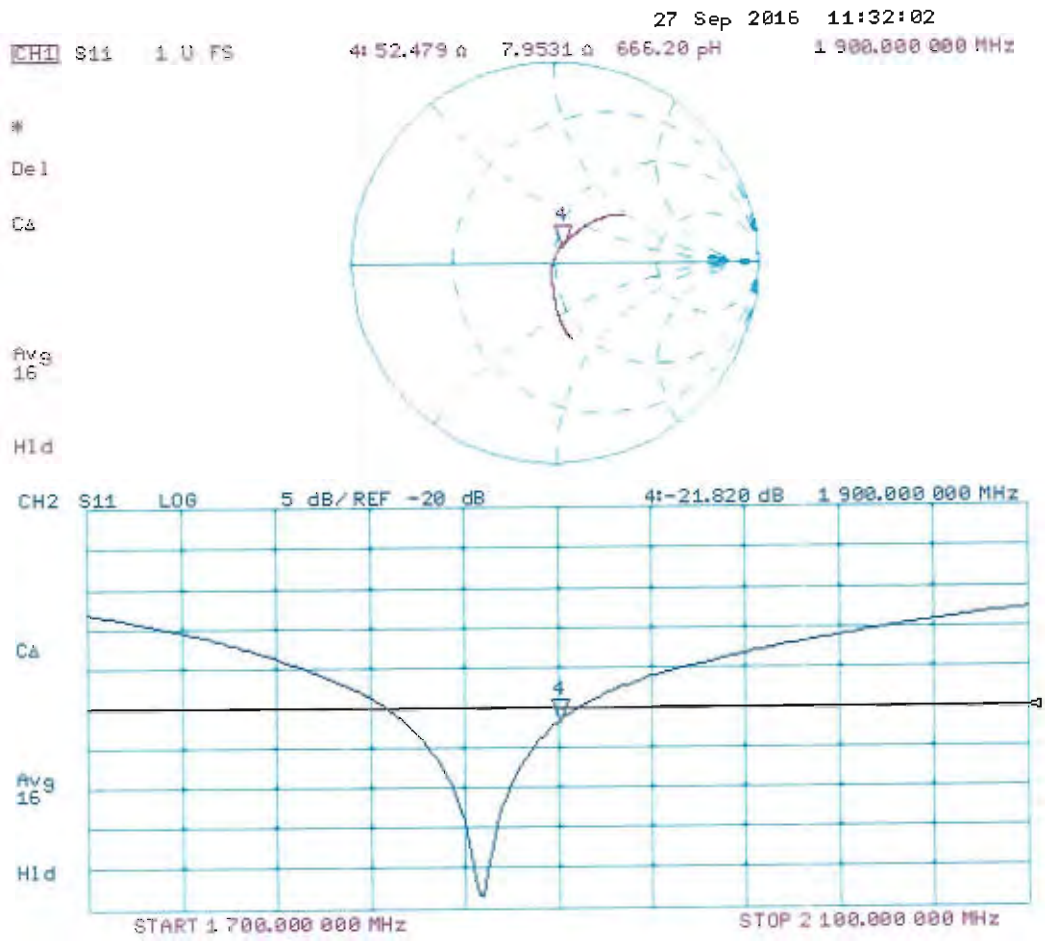

DASY5 Validation Report for Body TSL

Date: 30.09.2016

Test Laboratory: SPEAG, Zurich, Switzerland

DUT: Dipole 1900 MHz; Type: D1900V2; Serial: D1900V2 - SN:5d041

Communication System: UID 0 - CW; Frequency: 1900 MHz

Medium parameters used: $f = 1900$ MHz; $\sigma = 1.49$ S/m; $\epsilon_r = 53.6$; $\rho = 1000$ kg/m³

Phantom section: Flat Section

Measurement Standard: DASY5 (IEEE/IEC/ANSI C63.19-2011)

DASY52 Configuration:

- Probe: EX3DV4 - SN7349; ConvF(8.03, 8.03, 8.03); Calibrated: 15.06.2016;
- Sensor-Surface: 1.4mm (Mechanical Surface Detection)
- Electronics: DAE4 Sn601; Calibrated: 30.12.2015
- Phantom: Flat Phantom 5.0 (back); Type: QD000P50AA; Serial: 1002
- DASY52 52.8.8(1258); SEMCAD X 14.6.10(7372)

Dipole Calibration for Body Tissue/Pin=250 mW, d=10mm/Zoom Scan (7x7x7)/Cube 0:

Measurement grid: dx=5mm, dy=5mm, dz=5mm

Reference Value = 102.7 V/m; Power Drift = -0.03 dB

Peak SAR (extrapolated) = 16.7 W/kg

SAR(1 g) = 9.58 W/kg; SAR(10 g) = 5.1 W/kg

Maximum value of SAR (measured) = 14.3 W/kg

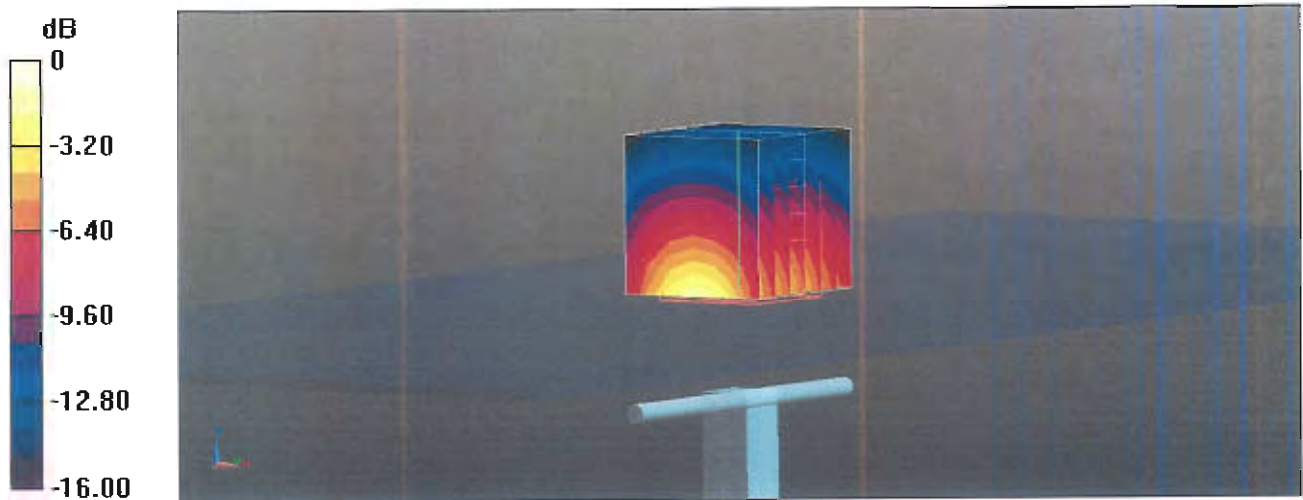

0 dB = 14.3 W/kg = 11.55 dBW/kg

Impedance Measurement Plot for Body TSL

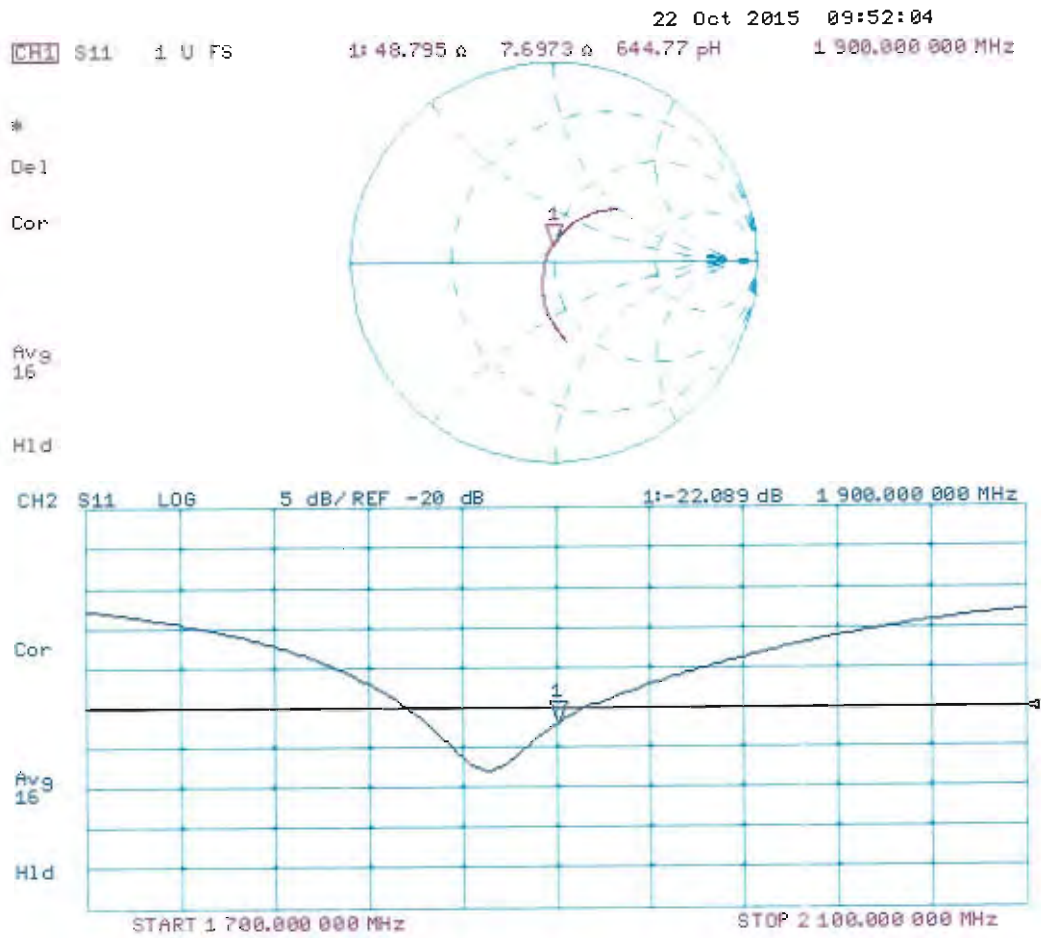



Accredited by the Swiss Accreditation Service (SAS)
The Swiss Accreditation Service is one of the signatories to the EA
Multilateral Agreement for the recognition of calibration certificates

Accreditation No.: **SCS 0108**

Client **Sporton-TW (Auden)**

Certificate No: **D2450V2-926_Jul16**

CALIBRATION CERTIFICATE

Object **D2450V2 - SN:926**

Calibration procedure(s) **QA CAL-05.v9
Calibration procedure for dipole validation kits above 700 MHz**

Calibration date: **July 25, 2016**

This calibration certificate documents the traceability to national standards, which realize the physical units of measurements (SI).
The measurements and the uncertainties with confidence probability are given on the following pages and are part of the certificate.

All calibrations have been conducted in the closed laboratory facility: environment temperature (22 ± 3)°C and humidity < 70%.

Calibration Equipment used (M&TE critical for calibration)

Primary Standards	ID #	Cal Date (Certificate No.)	Scheduled Calibration
Power meter NRP	SN: 104778	06-Apr-16 (No. 217-02288/02289)	Apr-17
Power sensor NRP-Z91	SN: 103244	06-Apr-16 (No. 217-02288)	Apr-17
Power sensor NRP-Z91	SN: 103245	06-Apr-16 (No. 217-02289)	Apr-17
Reference 20 dB Attenuator	SN: 5058 (20k)	05-Apr-16 (No. 217-02292)	Apr-17
Type-N mismatch combination	SN: 5047.2 / 06327	05-Apr-16 (No. 217-02295)	Apr-17
Reference Probe EX3DV4	SN: 7349	15-Jun-16 (No. EX3-7349_Jun16)	Jun-17
DAE4	SN: 601	30-Dec-15 (No. DAE4-601_Dec15)	Dec-16

Secondary Standards	ID #	Check Date (in house)	Scheduled Check
Power meter EPM-442A	SN: GB37480704	07-Oct-15 (No. 217-02222)	In house check: Oct-16
Power sensor HP 8481A	SN: US37292783	07-Oct-15 (No. 217-02222)	In house check: Oct-16
Power sensor HP 8481A	SN: MY41092317	07-Oct-15 (No. 217-02223)	In house check: Oct-16
RF generator R&S SMT-06	SN: 100972	15-Jun-15 (in house check Jun-15)	In house check: Oct-16
Network Analyzer HP 8753E	SN: US37390585	18-Oct-01 (in house check Oct-15)	In house check: Oct-16

Calibrated by: **Michael Weber** Name: Michael Weber Function: Laboratory Technician

Signature

Approved by: **Katja Pokovic** Name: Katja Pokovic Function: Technical Manager

Issued: July 26, 2016

This calibration certificate shall not be reproduced except in full without written approval of the laboratory.



Accredited by the Swiss Accreditation Service (SAS)

The Swiss Accreditation Service is one of the signatories to the EA
Multilateral Agreement for the recognition of calibration certificates

Accreditation No.: **SCS 0108**

Glossary:

TSL	tissue simulating liquid
ConvF	sensitivity in TSL / NORM x,y,z
N/A	not applicable or not measured

Calibration is Performed According to the Following Standards:

- IEEE Std 1528-2013, "IEEE Recommended Practice for Determining the Peak Spatial-Averaged Specific Absorption Rate (SAR) in the Human Head from Wireless Communications Devices: Measurement Techniques", June 2013
- IEC 62209-1, "Procedure to measure the Specific Absorption Rate (SAR) for hand-held devices used in close proximity to the ear (frequency range of 300 MHz to 3 GHz)", February 2005
- IEC 62209-2, "Procedure to determine the Specific Absorption Rate (SAR) for wireless communication devices used in close proximity to the human body (frequency range of 30 MHz to 6 GHz)", March 2010
- KDB 865664, "SAR Measurement Requirements for 100 MHz to 6 GHz"

Additional Documentation:

- DASY4/5 System Handbook

Methods Applied and Interpretation of Parameters:

- Measurement Conditions:** Further details are available from the Validation Report at the end of the certificate. All figures stated in the certificate are valid at the frequency indicated.
- Antenna Parameters with TSL:** The dipole is mounted with the spacer to position its feed point exactly below the center marking of the flat phantom section, with the arms oriented parallel to the body axis.
- Feed Point Impedance and Return Loss:** These parameters are measured with the dipole positioned under the liquid filled phantom. The impedance stated is transformed from the measurement at the SMA connector to the feed point. The Return Loss ensures low reflected power. No uncertainty required.
- Electrical Delay:** One-way delay between the SMA connector and the antenna feed point. No uncertainty required.
- SAR measured:** SAR measured at the stated antenna input power.
- SAR normalized:** SAR as measured, normalized to an input power of 1 W at the antenna connector.
- SAR for nominal TSL parameters:** The measured TSL parameters are used to calculate the nominal SAR result.

The reported uncertainty of measurement is stated as the standard uncertainty of measurement multiplied by the coverage factor $k=2$, which for a normal distribution corresponds to a coverage probability of approximately 95%.

Measurement Conditions

DASY system configuration, as far as not given on page 1.

DASY Version	DASY5	V52.8.8
Extrapolation	Advanced Extrapolation	
Phantom	Modular Flat Phantom	
Distance Dipole Center - TSL	10 mm	with Spacer
Zoom Scan Resolution	dx, dy, dz = 5 mm	
Frequency	2450 MHz ± 1 MHz	

Head TSL parameters

The following parameters and calculations were applied.

	Temperature	Permittivity	Conductivity
Nominal Head TSL parameters	22.0 °C	39.2	1.80 mho/m
Measured Head TSL parameters	(22.0 ± 0.2) °C	38.0 ± 6 %	1.86 mho/m ± 6 %
Head TSL temperature change during test	< 0.5 °C	----	----

SAR result with Head TSL

SAR averaged over 1 cm³ (1 g) of Head TSL	Condition	
SAR measured	250 mW input power	13.5 W/kg
SAR for nominal Head TSL parameters	normalized to 1W	52.8 W/kg ± 17.0 % (k=2)

SAR averaged over 10 cm³ (10 g) of Head TSL	condition	
SAR measured	250 mW input power	6.22 W/kg
SAR for nominal Head TSL parameters	normalized to 1W	24.5 W/kg ± 16.5 % (k=2)

Body TSL parameters

The following parameters and calculations were applied.

	Temperature	Permittivity	Conductivity
Nominal Body TSL parameters	22.0 °C	52.7	1.95 mho/m
Measured Body TSL parameters	(22.0 ± 0.2) °C	51.8 ± 6 %	2.03 mho/m ± 6 %
Body TSL temperature change during test	< 0.5 °C	----	----

SAR result with Body TSL

SAR averaged over 1 cm³ (1 g) of Body TSL	Condition	
SAR measured	250 mW input power	13.1 W/kg
SAR for nominal Body TSL parameters	normalized to 1W	51.2 W/kg ± 17.0 % (k=2)

SAR averaged over 10 cm³ (10 g) of Body TSL	condition	
SAR measured	250 mW input power	6.07 W/kg
SAR for nominal Body TSL parameters	normalized to 1W	24.0 W/kg ± 16.5 % (k=2)

Appendix (Additional assessments outside the scope of SCS 0108)

Antenna Parameters with Head TSL

Impedance, transformed to feed point	$54.3 \Omega + 3.7 j\Omega$
Return Loss	- 25.3 dB

Antenna Parameters with Body TSL

Impedance, transformed to feed point	$50.3 \Omega + 5.0 j\Omega$
Return Loss	- 26.0 dB

General Antenna Parameters and Design

Electrical Delay (one direction)	1.155 ns
----------------------------------	----------

After long term use with 100W radiated power, only a slight warming of the dipole near the feedpoint can be measured.

The dipole is made of standard semirigid coaxial cable. The center conductor of the feeding line is directly connected to the second arm of the dipole. The antenna is therefore short-circuited for DC-signals. On some of the dipoles, small end caps are added to the dipole arms in order to improve matching when loaded according to the position as explained in the "Measurement Conditions" paragraph. The SAR data are not affected by this change. The overall dipole length is still according to the Standard.

No excessive force must be applied to the dipole arms, because they might bend or the soldered connections near the feedpoint may be damaged.

Additional EUT Data

Manufactured by	SPEAG
Manufactured on	September 26, 2013

DASY5 Validation Report for Head TSL

Date: 25.07.2016

Test Laboratory: SPEAG, Zurich, Switzerland

DUT: Dipole 2450 MHz D2450V2; Type: D2450V2; Serial: D2450V2 - SN:926

Communication System: UID 0 - CW; Frequency: 2450 MHz

Medium parameters used: $f = 2450$ MHz; $\sigma = 1.86$ S/m; $\epsilon_r = 38$; $\rho = 1000$ kg/m³

Phantom section: Flat Section

Measurement Standard: DASY5 (IEEE/IEC/ANSI C63.19-2011)

DASY52 Configuration:

- Probe: EX3DV4 - SN7349; ConvF(7.72, 7.72, 7.72); Calibrated: 15.06.2016;
- Sensor-Surface: 1.4mm (Mechanical Surface Detection)
- Electronics: DAE4 Sn601; Calibrated: 30.12.2015
- Phantom: Flat Phantom 5.0 (front); Type: QD000P50AA; Serial: 1001
- DASY52 52.8.8(1258); SEMCAD X 14.6.10(7372)

Dipole Calibration for Head Tissue/Pin=250 mW, d=10mm/Zoom Scan (7x7x7)/Cube 0:

Measurement grid: dx=5mm, dy=5mm, dz=5mm

Reference Value = 114.2 V/m; Power Drift = 0.01 dB

Peak SAR (extrapolated) = 27.6 W/kg

SAR(1 g) = 13.5 W/kg; SAR(10 g) = 6.22 W/kg

Maximum value of SAR (measured) = 22.3 W/kg

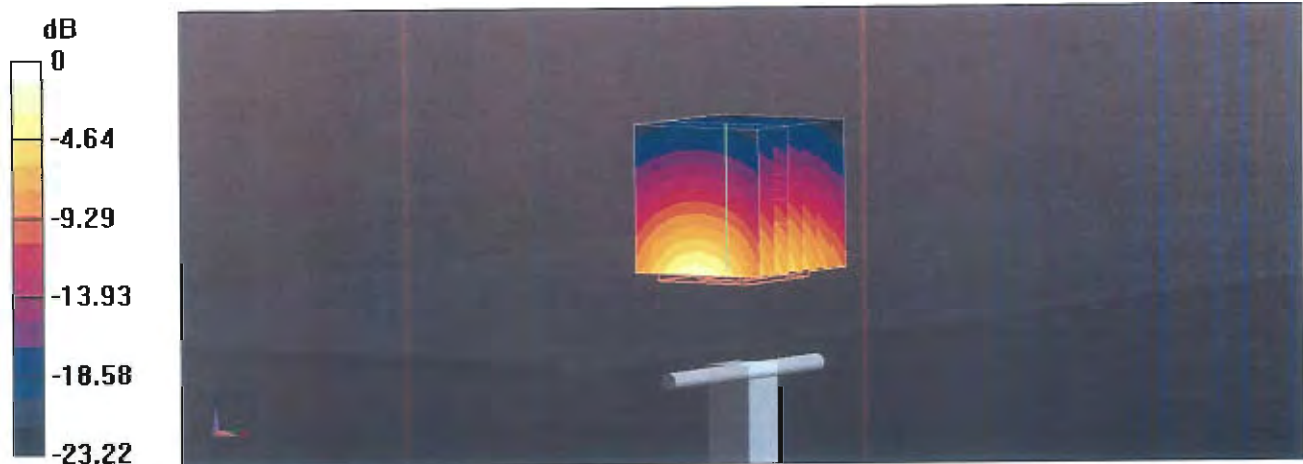

Impedance Measurement Plot for Head TSL

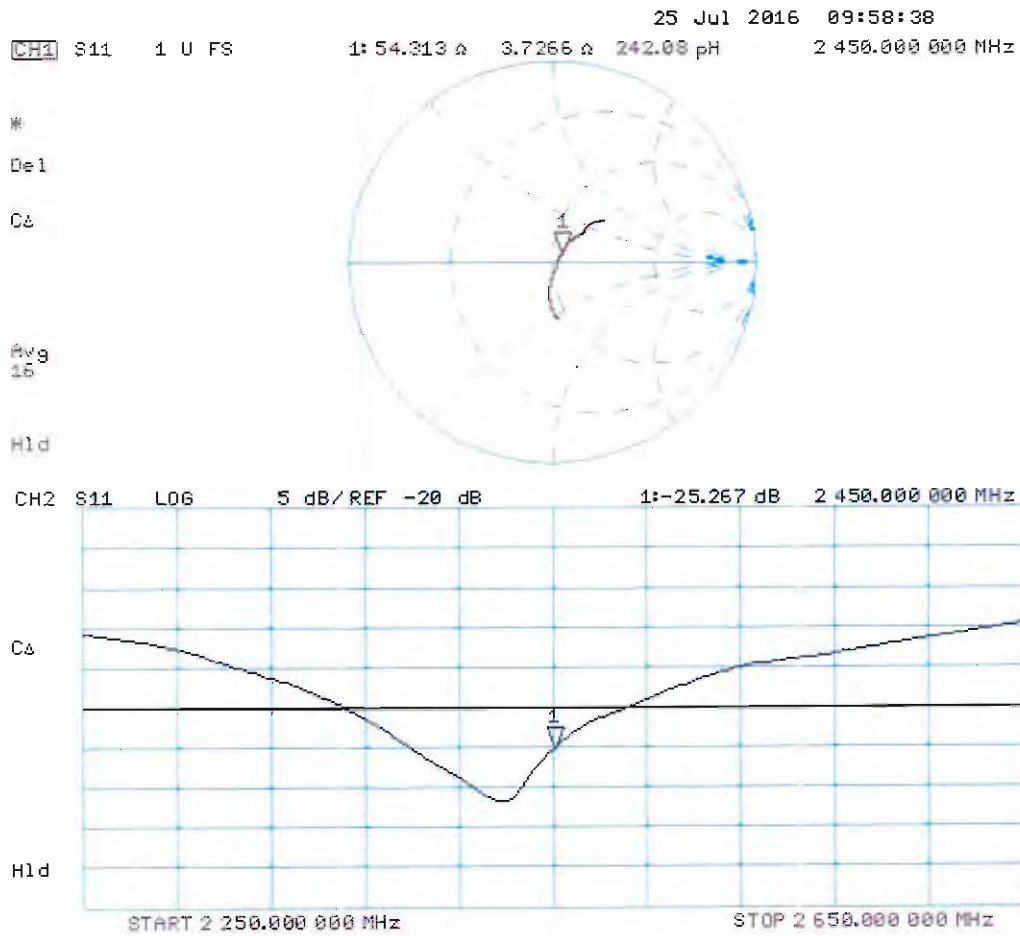

DASY5 Validation Report for Body TSL

Date: 25.07.2016

Test Laboratory: SPEAG, Zurich, Switzerland

DUT: Dipole 2450 MHz D2450V2; Type: D2450V2; Serial: D2450V2 - SN:926

Communication System: UID 0 - CW; Frequency: 2450 MHz

Medium parameters used: $f = 2450$ MHz; $\sigma = 2.03$ S/m; $\epsilon_r = 51.8$; $\rho = 1000$ kg/m³

Phantom section: Flat Section

Measurement Standard: DASY5 (IEEE/IEC/ANSI C63.19-2011)

DASY52 Configuration:

- Probe: EX3DV4 - SN7349; ConvF(7.79, 7.79, 7.79); Calibrated: 15.06.2016;
- Sensor-Surface: 1.4mm (Mechanical Surface Detection)
- Electronics: DAE4 Sn601; Calibrated: 30.12.2015
- Phantom: Flat Phantom 5.0 (back); Type: QD000P50AA; Serial: 1002
- DASY52 52.8.8(1258); SEMCAD X 14.6.10(7372)

Dipole Calibration for Body Tissue/Pin=250 mW, d=10mm/Zoom Scan (7x7x7)/Cube 0:

Measurement grid: dx=5mm, dy=5mm, dz=5mm

Reference Value = 107.2 V/m; Power Drift = -0.04 dB

Peak SAR (extrapolated) = 26.3 W/kg

SAR(1 g) = 13.1 W/kg; SAR(10 g) = 6.07 W/kg

Maximum value of SAR (measured) = 21.4 W/kg

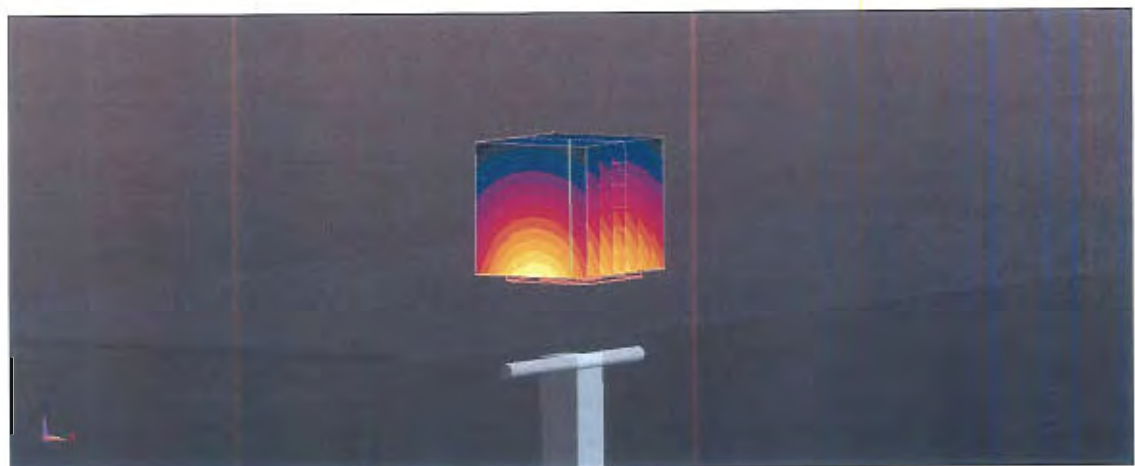
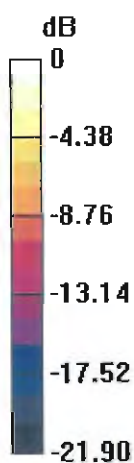

0 dB = 21.4 W/kg = 13.30 dBW/kg

Impedance Measurement Plot for Body TSL

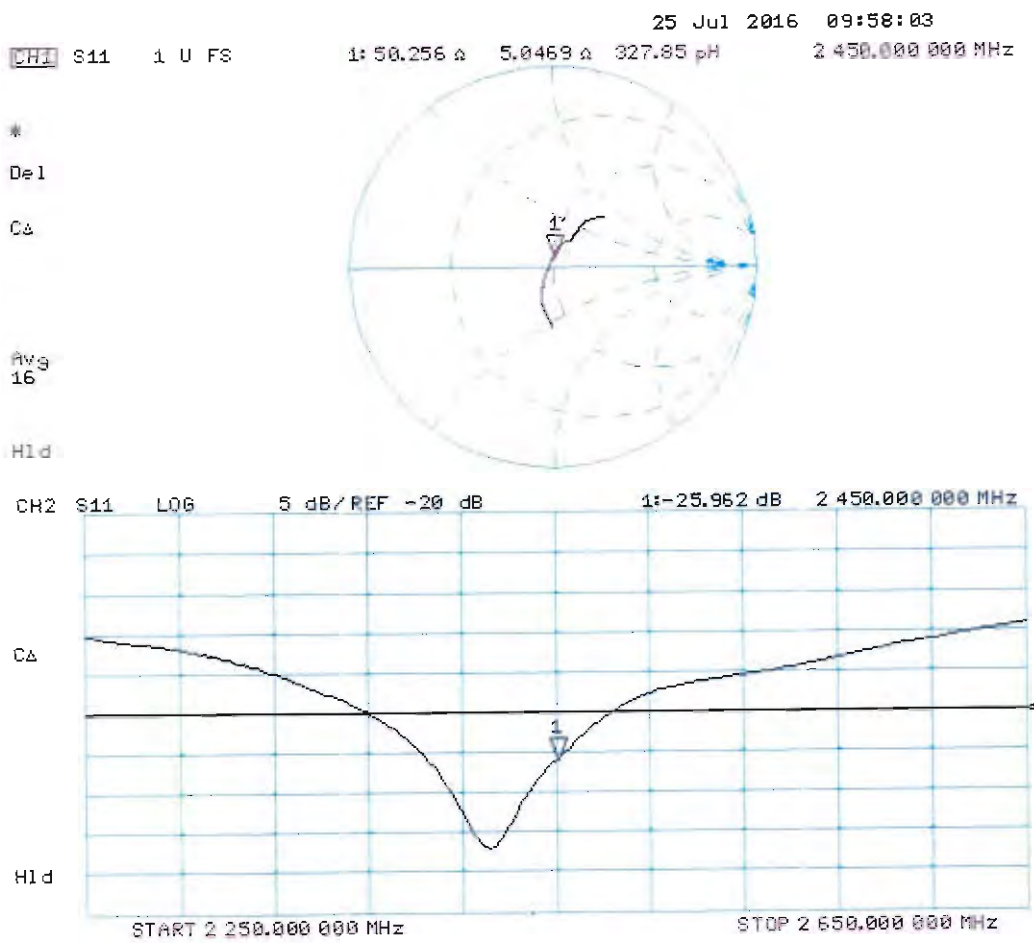



In Collaboration with
s p e a g
 CALIBRATION LABORATORY



中国认可
 国际互认
 校准
 CALIBRATION
 CNAS L0570

Add: No.51 Xueyuan Road, Haidian District, Beijing, 100191, China
 Tel: +86-10-62304633-2079 Fax: +86-10-62304633-2504
 E-mail: cttl@chinattl.com [Http://www.chinattl.cn](http://www.chinattl.cn)

Client **Sporton_TW**

Certificate No: **Z16-97132**

CALIBRATION CERTIFICATE

Object **D2600V2 - SN: 1008**

Calibration Procedure(s) **FD-Z11-2-003-01**
 Calibration Procedures for dipole validation kits

Calibration date: **August 30, 2016**

This calibration Certificate documents the traceability to national standards, which realize the physical units of measurements(SI). The measurements and the uncertainties with confidence probability are given on the following pages and are part of the certificate.

All calibrations have been conducted in the closed laboratory facility: environment temperature(22±3)°C and humidity<70%.

Calibration Equipment used (M&TE critical for calibration)

Primary Standards	ID #	Cal Date(Calibrated by, Certificate No.)	Scheduled Calibration
Power Meter NRP2	101919	01-Jul-15 (CTTL, No.J15X04256)	Jun-16
Power sensor NRP-Z91	101547	01-Jul-15 (CTTL, No.J15X04256)	Jun-16
Reference Probe EX3DV4	SN 3801	29-Jun-16(SPEAG,No.EX3-3801_Jun16)	Jun-17
DAE4	SN 777	22-Aug-16(CTTL-SPEAG,No.Z16-97138)	Aug-17
Secondary Standards	ID #	Cal Date(Calibrated by, Certificate No.)	Scheduled Calibration
Signal Generator E4438C	MY49071430	01-Feb-16 (CTTL, No.J16X00893)	Jan-17
Network Analyzer E5071C	MY46110673	26-Jan-16 (CTTL, No.J16X00894)	Jan-17

	Name	Function	Signature
Calibrated by:	Zhao Jing	SAR Test Engineer	
Reviewed by:	Qi Dianyuan	SAR Project Leader	
Approved by:	Lu Bingsong	Deputy Director of the laboratory	

Issued: September 1, 2016

This calibration certificate shall not be reproduced except in full without written approval of the laboratory.



Glossary:

TSL	tissue simulating liquid
ConvF	sensitivity in TSL / NORM _{x,y,z}
N/A	not applicable or not measured

Calibration is Performed According to the Following Standards:

- IEEE Std 1528-2013, "IEEE Recommended Practice for Determining the Peak Spatial-Averaged Specific Absorption Rate (SAR) in the Human Head from Wireless Communications Devices: Measurement Techniques", June 2013
- IEC 62209-1, "Procedure to measure the Specific Absorption Rate (SAR) For hand-held devices used in close proximity to the ear (frequency range of 300MHz to 3GHz)", February 2005
- IEC 62209-2, "Procedure to measure the Specific Absorption Rate (SAR) For wireless communication devices used in close proximity to the human body (frequency range of 30MHz to 6GHz)", March 2010
- KDB865664, SAR Measurement Requirements for 100 MHz to 6 GHz

Additional Documentation:

- DASY4/5 System Handbook

Methods Applied and Interpretation of Parameters:

- Measurement Conditions:* Further details are available from the Validation Report at the end of the certificate. All figures stated in the certificate are valid at the frequency indicated.
- Antenna Parameters with TSL:* The dipole is mounted with the spacer to position its feed point exactly below the center marking of the flat phantom section, with the arms oriented parallel to the body axis.
- Feed Point Impedance and Return Loss:* These parameters are measured with the dipole positioned under the liquid filled phantom. The impedance stated is transformed from the measurement at the SMA connector to the feed point. The Return Loss ensures low reflected power. No uncertainty required.
- Electrical Delay:* One-way delay between the SMA connector and the antenna feed point. No uncertainty required.
- SAR measured:* SAR measured at the stated antenna input power.
- SAR normalized:* SAR as measured, normalized to an input power of 1 W at the antenna connector.
- SAR for nominal TSL parameters:* The measured TSL parameters are used to calculate the nominal SAR result.

The reported uncertainty of measurement is stated as the standard uncertainty of Measurement multiplied by the coverage factor $k=2$, which for a normal distribution Corresponds to a coverage probability of approximately 95%.



Measurement Conditions

DASY system configuration, as far as not given on page 1.

DASY Version	DASY52	52.8.8.1258
Extrapolation	Advanced Extrapolation	
Phantom	Triple Flat Phantom 5.1C	
Distance Dipole Center - TSL	10 mm	with Spacer
Zoom Scan Resolution	dx, dy, dz = 5 mm	
Frequency	2600 MHz \pm 1 MHz	

Head TSL parameters

The following parameters and calculations were applied.

	Temperature	Permittivity	Conductivity
Nominal Head TSL parameters	22.0 °C	39.0	1.96 mho/m
Measured Head TSL parameters	(22.0 \pm 0.2) °C	39.4 \pm 6 %	1.97 mho/m \pm 6 %
Head TSL temperature change during test	<1.0 °C	---	---

SAR result with Head TSL

SAR averaged over 1 cm³ (1 g) of Head TSL	Condition	
SAR measured	250 mW input power	14.2 mW / g
SAR for nominal Head TSL parameters	normalized to 1W	56.8 mW / g \pm 20.8 % (k=2)
SAR averaged over 10 cm³ (10 g) of Head TSL	Condition	
SAR measured	250 mW input power	6.40 mW / g
SAR for nominal Head TSL parameters	normalized to 1W	25.6 mW / g \pm 20.4 % (k=2)

Body TSL parameters

The following parameters and calculations were applied.

	Temperature	Permittivity	Conductivity
Nominal Body TSL parameters	22.0 °C	52.5	2.16 mho/m
Measured Body TSL parameters	(22.0 \pm 0.2) °C	52.2 \pm 6 %	2.18 mho/m \pm 6 %
Body TSL temperature change during test	<1.0 °C	---	---

SAR result with Body TSL

SAR averaged over 1 cm³ (1 g) of Body TSL	Condition	
SAR measured	250 mW input power	13.9 mW / g
SAR for nominal Body TSL parameters	normalized to 1W	55.2 mW / g \pm 20.8 % (k=2)
SAR averaged over 10 cm³ (10 g) of Body TSL	Condition	
SAR measured	250 mW input power	6.28 mW / g
SAR for nominal Body TSL parameters	normalized to 1W	25.0 mW / g \pm 20.4 % (k=2)



Add: No.51 Xueyuan Road, Haidian District, Beijing, 100191, China
Tel: +86-10-62304633-2079 Fax: +86-10-62304633-2504
E-mail: cttl@chinattl.com | Http://www.chinattl.cn

Appendix

Antenna Parameters with Head TSL

Impedance, transformed to feed point	48.3Ω- 1.82jΩ
Return Loss	- 31.8dB

Antenna Parameters with Body TSL

Impedance, transformed to feed point	45.8Ω- 1.91jΩ
Return Loss	- 26.4dB

General Antenna Parameters and Design

Electrical Delay (one direction)	1.046 ns
----------------------------------	----------

After long term use with 100W radiated power, only a slight warming of the dipole near the feedpoint can be measured.

The dipole is made of standard semirigid coaxial cable. The center conductor of the feeding line is directly connected to the second arm of the dipole. The antenna is therefore short-circuited for DC-signals. On some of the dipoles, small end caps are added to the dipole arms in order to improve matching when loaded according to the position as explained in the "Measurement Conditions" paragraph. The SAR data are not affected by this change. The overall dipole length is still according to the Standard.

No excessive force must be applied to the dipole arms, because they might bend or the soldered connections near the feedpoint may be damaged.

Additional EUT Data

Manufactured by	SPEAG
-----------------	-------



Add: No.51 Xueyuan Road, Haidian District, Beijing, 100191, China
Tel: +86-10-62304633-2079 Fax: +86-10-62304633-2504
E-mail: cttl@chinattl.com Http://www.chinattl.cn

DASY5 Validation Report for Head TSL

Date: 08.30.2016

Test Laboratory: CTTL, Beijing, China

DUT: Dipole 2600 MHz; Type: D2600V2; Serial: D2600V2 - SN: 1008

Communication System: UID 0, CW; Frequency: 2600 MHz; Duty Cycle: 1:1

Medium parameters used: $f = 2600$ MHz; $\sigma = 1.974$ S/m; $\epsilon_r = 39.43$; $\rho = 1000$ kg/m³

Phantom section: Right Section

Measurement Standard: DASY5 (IEEE/IEC/ANSI C63.19-2007)

DASY5 Configuration:

- Probe: EX3DV4 - SN3801; ConvF(6.64, 6.64, 6.64); Calibrated: 6/29/2016;
- Sensor-Surface: 2mm (Mechanical Surface Detection)
- Electronics: DAE4 Sn777; Calibrated: 8/22/2016
- Phantom: Triple Flat Phantom 5.1C; Type: QD 000 P51 CA; Serial: 1161/1
- Measurement SW: DASY52, Version 52.8 (8); SEMCAD X Version 14.6.10 (7372)

Dipole Calibration/Zoom Scan (7x7x7) (7x7x7)/Cube 0: Measurement grid: dx=5mm, dy=5mm, dz=5mm

Reference Value = 107.4 V/m; Power Drift = 0.02 dB

Peak SAR (extrapolated) = 30.0 W/kg

SAR(1 g) = 14.2 W/kg; SAR(10 g) = 6.4 W/kg

Maximum value of SAR (measured) = 22.1 W/kg

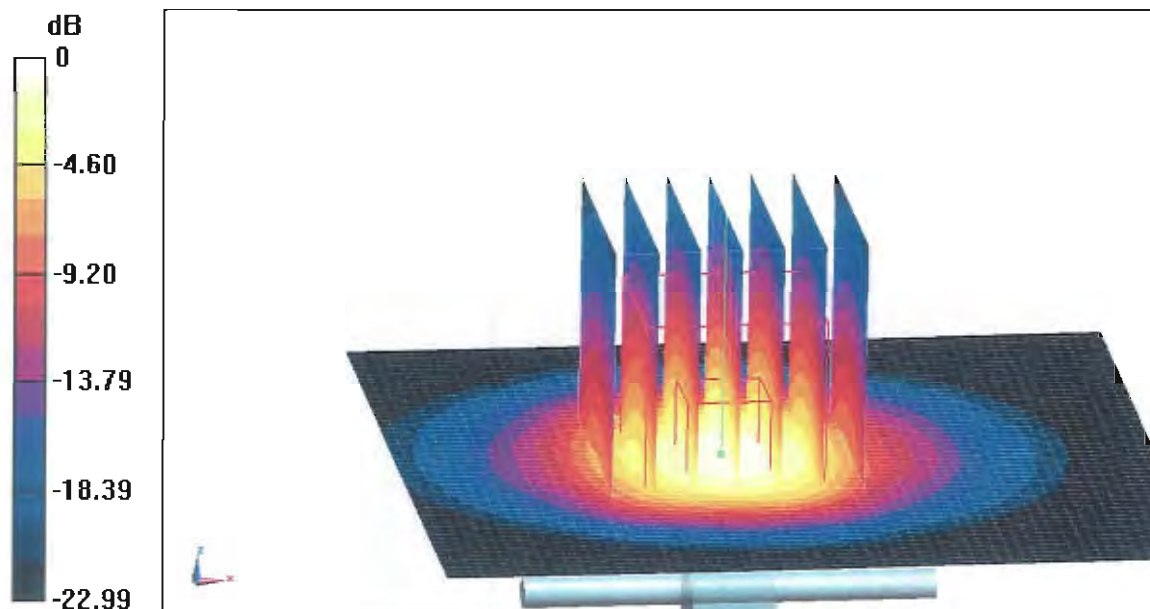

0 dB = 22.1 W/kg = 13.44 dBW/kg



Add: No.51 Xueyuan Road, Haidian District, Beijing, 100191, China
Tel: +86-10-62304633-2079 Fax: +86-10-62304633-2504
E-mail: cttl@chinattl.com Http://www.chinattl.cn

Impedance Measurement Plot for Head TSL

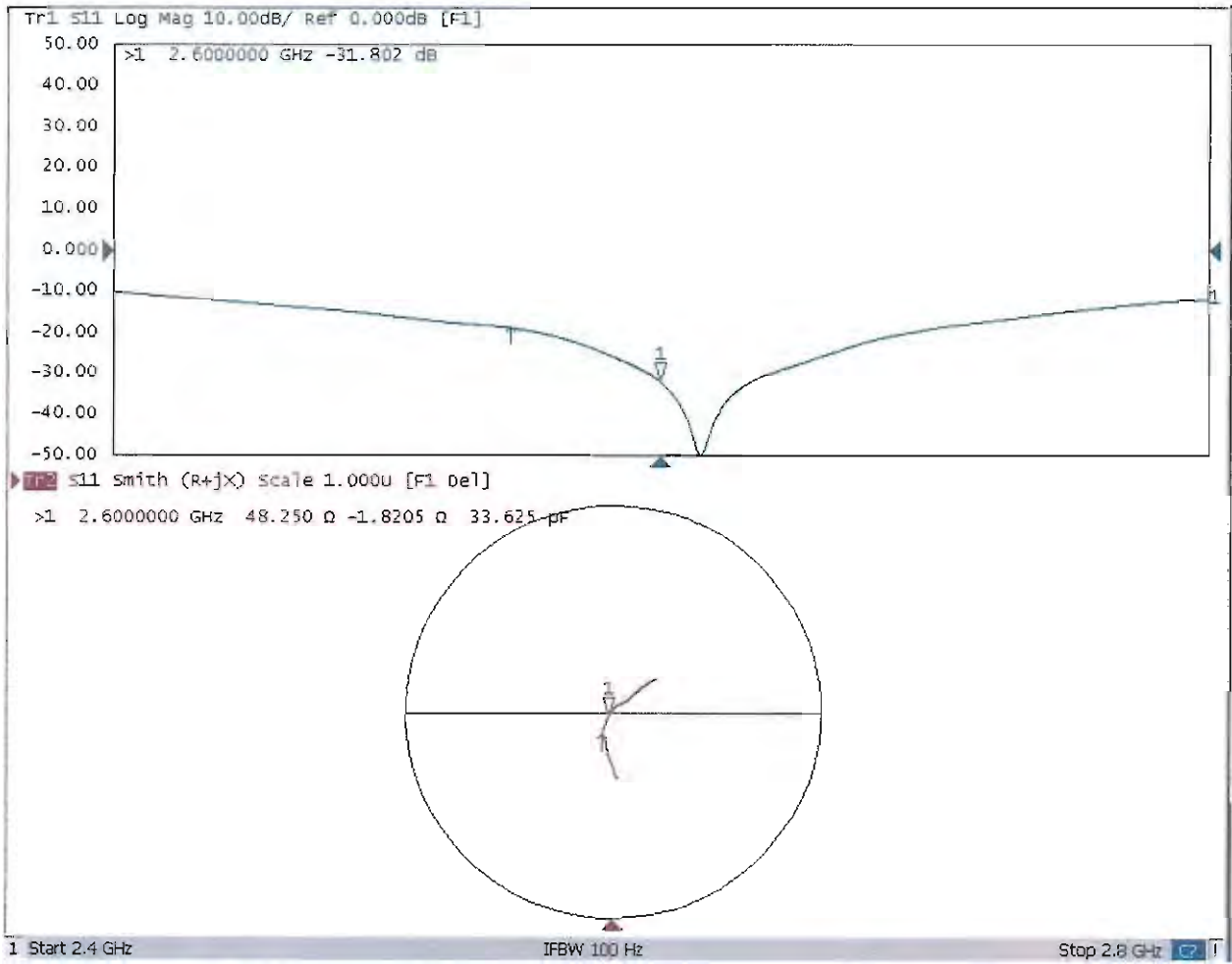



Add: No.51 Xueyuan Road, Haidian District, Beijing, 100191, China
Tel: +86-10-62304633-2079 Fax: +86-10-62304633-2504
E-mail: cttl@chinattl.com Http://www.chinattl.cn

DASY5 Validation Report for Body TSL

Date: 08.30.2016

Test Laboratory: CTTL, Beijing, China

DUT: Dipole 2600 MHz; Type: D2600V2; Serial: D2600V2 - SN: 1008

Communication System: UID 0, CW; Frequency: 2600 MHz; Duty Cycle: 1:1

Medium parameters used: $f = 2600$ MHz; $\sigma = 2.184$ S/m; $\epsilon_r = 52.15$; $\rho = 1000$ kg/m³

Phantom section: Left Section

Measurement Standard: DASY5 (IEEE/IEC/ANSI C63.19-2007)

DASY5 Configuration:

- Probe: EX3DV4 - SN3801; ConvF(6.7, 6.7,6.7); Calibrated: 6/29/2016;
- Sensor-Surface: 2mm (Mechanical Surface Detection)
- Electronics: DAE4 Sn777; Calibrated: 8/22/2016
- Phantom: Triple Flat Phantom 5.1C; Type: QD 000 P51 CA; Serial: 1161/1
- Measurement SW: DASY52, Version 52.8 (8); SEMCAD X Version 14.6.10 (7372)

Dipole Calibration/Zoom Scan (7x7x7) (7x7x7)/Cube 0: Measurement grid: dx=5mm, dy=5mm, dz=5mm

Reference Value = 94.70 V/m; Power Drift = -0.00 dB

Peak SAR (extrapolated) = 28.8 W/kg

SAR(1 g) = 13.9 W/kg; SAR(10 g) = 6.28 W/kg

Maximum value of SAR (measured) = 21.3 W/kg

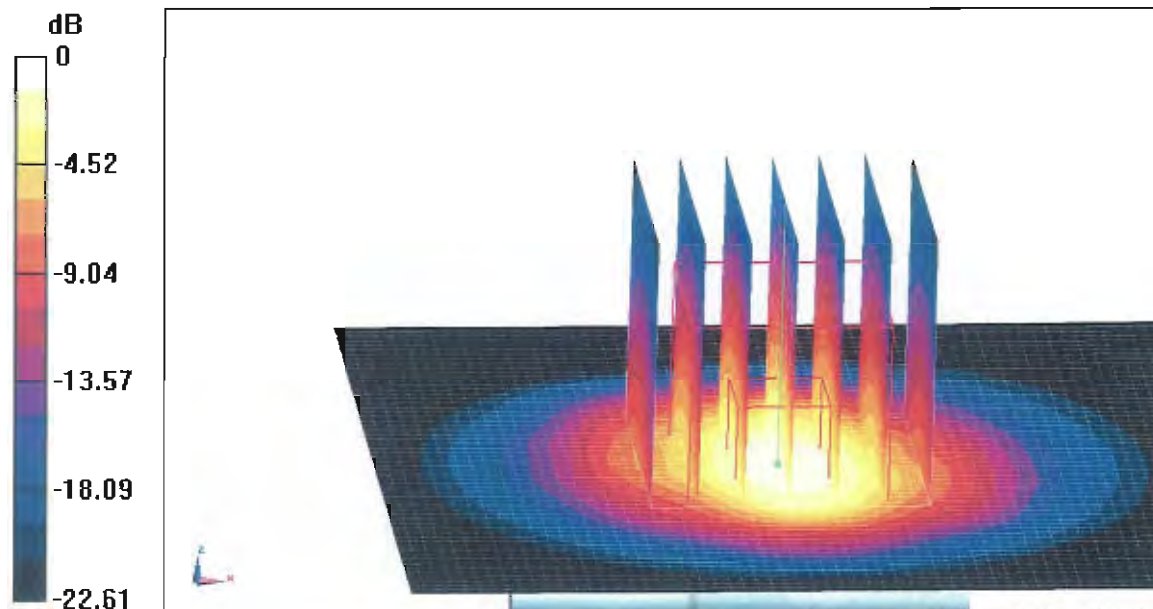

0 dB = 21.3 W/kg = 13.28 dBW/kg



Add: No.51 Xueyuan Road, Haidian District, Beijing, 100191, China
Tel: +86-10-62304633-2079 Fax: +86-10-62304633-2504
E-mail: cttl@chinattl.com Http://www.chinattl.cn

Impedance Measurement Plot for Body TSL

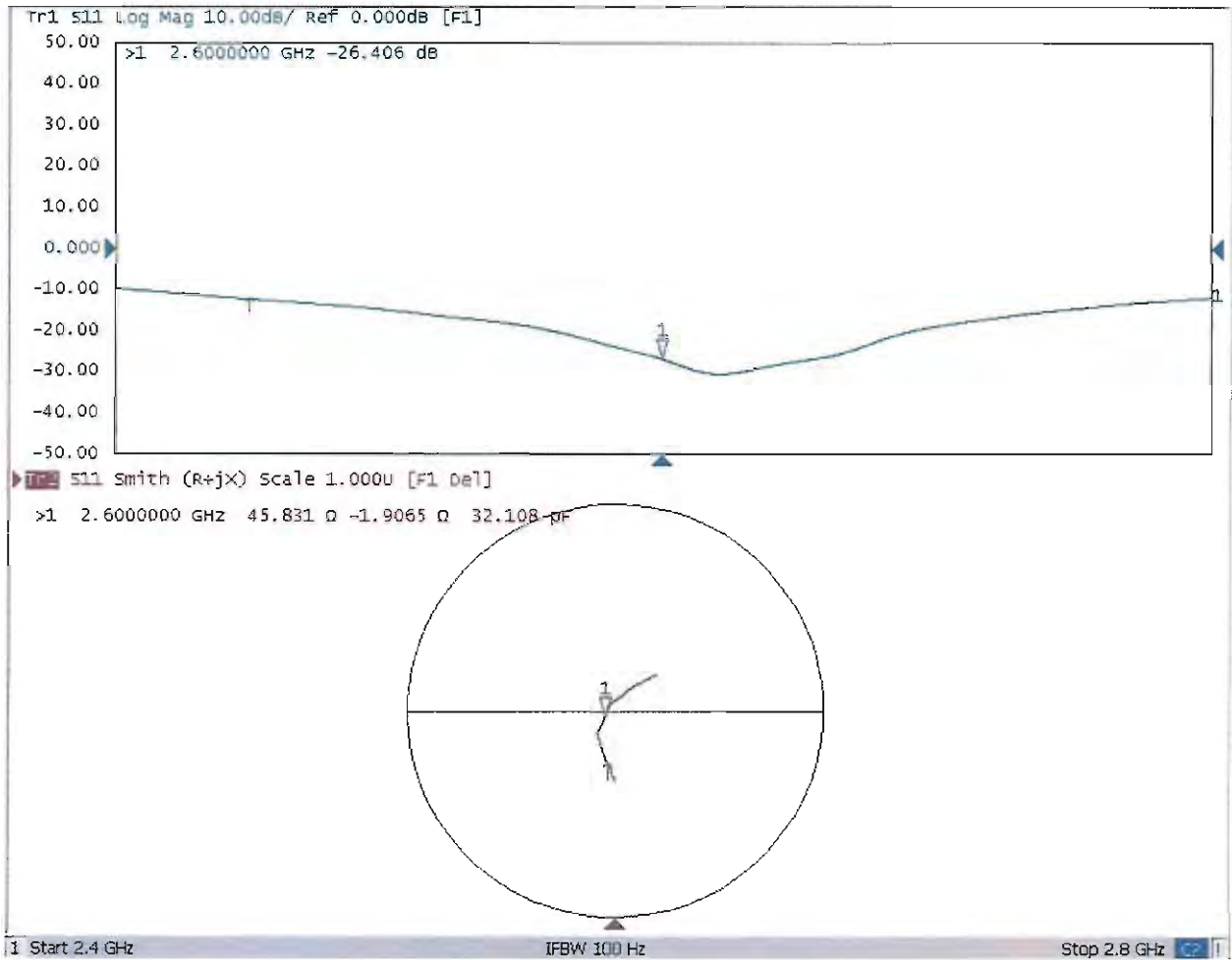



In Collaboration with
s p e a g
 CALIBRATION LABORATORY



中国认可
 国际互认
 校准
 CALIBRATION
 CNAS L0570

Add: No.51 Xueyuan Road, Haidian District, Beijing, 100191, China
 Tel: +86-10-62304633-2079 Fax: +86-10-62304633-2504
 E-mail: cttl@chinattl.com [Http://www.chinattl.cn](http://www.chinattl.cn)

Client

Sporton_TW

Certificate No: **Z16-97131**

CALIBRATION CERTIFICATE

Object: D2600V2 - SN: 1113

Calibration Procedure(s):
 FD-Z11-2-003-01
 Calibration Procedures for dipole validation kits

Calibration date: August 30, 2016

This calibration Certificate documents the traceability to national standards, which realize the physical units of measurements(SI). The measurements and the uncertainties with confidence probability are given on the following pages and are part of the certificate.

All calibrations have been conducted in the closed laboratory facility: environment temperature(22±3)°C and humidity<70%.

Calibration Equipment used (M&TE critical for calibration)

Primary Standards	ID #	Cal Date(Calibrated by, Certificate No.)	Scheduled Calibration
Power Meter NRP2	101919	01-Jul-15 (CTTL, No.J15X04256)	Jun-16
Power sensor NRP-Z91	101547	01-Jul-15 (CTTL, No.J15X04256)	Jun-16
Reference Probe EX3DV4	SN 3801	29-Jun-16(SPEAG,No.EX3-3801_Jun16)	Jun-17
DAE4	SN 777	22-Aug-16(CTTL-SPEAG,No.Z16-97138)	Aug-17
Secondary Standards	ID #	Cal Date(Calibrated by, Certificate No.)	Scheduled Calibration
Signal Generator E4438C	MY49071430	01-Feb-16 (CTTL, No.J16X00893)	Jan-17
Network Analyzer E5071C	MY46110673	26-Jan-16 (CTTL, No.J16X00894)	Jan-17

	Name	Function	Signature
Calibrated by:	Zhao Jing	SAR Test Engineer	
Reviewed by:	Qi Dianyuan	SAR Project Leader	
Approved by:	Lu Bingsong	Deputy Director of the laboratory	

Issued: September 1, 2016

This calibration certificate shall not be reproduced except in full without written approval of the laboratory.



In Collaboration with

s p e a q
CALIBRATION LABORATORY

Add: No.51 Xueyuan Road, Haidian District, Beijing, 100191, China

Tel: +86-10-62304633-2079

Fax: +86-10-62304633-2504

E-mail: cttl@chinattl.com

Http://www.chinattl.cn

Glossary:

TSL	tissue simulating liquid
ConvF	sensitivity in TSL / NORM _{x,y,z}
N/A	not applicable or not measured

Calibration is Performed According to the Following Standards:

- IEEE Std 1528-2013, "IEEE Recommended Practice for Determining the Peak Spatial-Averaged Specific Absorption Rate (SAR) in the Human Head from Wireless Communications Devices: Measurement Techniques", June 2013
- IEC 62209-1, "Procedure to measure the Specific Absorption Rate (SAR) For hand-held devices used in close proximity to the ear (frequency range of 300MHz to 3GHz)", February 2005
- IEC 62209-2, "Procedure to measure the Specific Absorption Rate (SAR) For wireless communication devices used in close proximity to the human body (frequency range of 30MHz to 6GHz)", March 2010
- KDB865664, SAR Measurement Requirements for 100 MHz to 6 GHz

Additional Documentation:

- DASY4/5 System Handbook

Methods Applied and Interpretation of Parameters:

- Measurement Conditions:** Further details are available from the Validation Report at the end of the certificate. All figures stated in the certificate are valid at the frequency indicated.
- Antenna Parameters with TSL:** The dipole is mounted with the spacer to position its feed point exactly below the center marking of the flat phantom section, with the arms oriented parallel to the body axis.
- Feed Point Impedance and Return Loss:** These parameters are measured with the dipole positioned under the liquid filled phantom. The impedance stated is transformed from the measurement at the SMA connector to the feed point. The Return Loss ensures low reflected power. No uncertainty required.
- Electrical Delay:** One-way delay between the SMA connector and the antenna feed point. No uncertainty required.
- SAR measured:** SAR measured at the stated antenna input power.
- SAR normalized:** SAR as measured, normalized to an input power of 1 W at the antenna connector.
- SAR for nominal TSL parameters:** The measured TSL parameters are used to calculate the nominal SAR result.

The reported uncertainty of measurement is stated as the standard uncertainty of Measurement multiplied by the coverage factor $k=2$, which for a normal distribution Corresponds to a coverage probability of approximately 95%.



Add: No.51 Xueyuan Road, Haidian District, Beijing, 100191, China
 Tel: +86-10-62304633-2079 Fax: +86-10-62304633-2504
 E-mail: cttl@chinattl.com Http://www.chinattl.cn

Measurement Conditions

DASY system configuration, as far as not given on page 1.

DASY Version	DASY52	52.8.8.1258
Extrapolation	Advanced Extrapolation	
Phantom	Triple Flat Phantom 5.1C	
Distance Dipole Center - TSL	10 mm	with Spacer
Zoom Scan Resolution	dx, dy, dz = 5 mm	
Frequency	2600 MHz ± 1 MHz	

Head TSL parameters

The following parameters and calculations were applied.

	Temperature	Permittivity	Conductivity
Nominal Head TSL parameters	22.0 °C	39.0	1.96 mho/m
Measured Head TSL parameters	(22.0 ± 0.2) °C	39.4 ± 6 %	1.97 mho/m ± 6 %
Head TSL temperature change during test	<1.0 °C	---	---

SAR result with Head TSL

SAR averaged over 1 cm³ (1 g) of Head TSL	Condition	
SAR measured	250 mW input power	14.2 mW / g
SAR for nominal Head TSL parameters	normalized to 1W	56.8 mW / g ± 20.8 % (k=2)
SAR averaged over 10 cm³ (10 g) of Head TSL	Condition	
SAR measured	250 mW input power	6.41 mW / g
SAR for nominal Head TSL parameters	normalized to 1W	25.6 mW / g ± 20.4 % (k=2)

Body TSL parameters

The following parameters and calculations were applied.

	Temperature	Permittivity	Conductivity
Nominal Body TSL parameters	22.0 °C	52.5	2.16 mho/m
Measured Body TSL parameters	(22.0 ± 0.2) °C	52.2 ± 6 %	2.18 mho/m ± 6 %
Body TSL temperature change during test	<1.0 °C	---	---

SAR result with Body TSL

SAR averaged over 1 cm³ (1 g) of Body TSL	Condition	
SAR measured	250 mW input power	14.0 mW / g
SAR for nominal Body TSL parameters	normalized to 1W	55.6 mW / g ± 20.8 % (k=2)
SAR averaged over 10 cm³ (10 g) of Body TSL	Condition	
SAR measured	250 mW input power	6.34 mW / g
SAR for nominal Body TSL parameters	normalized to 1W	25.3 mW / g ± 20.4 % (k=2)



Add: No.51 Xucyuan Road, Haidian District, Beijing, 100191, China
Tel: +86-10-62304633-2079 Fax: +86-10-62304633-2504
E-mail: cttl@chinattl.com Http://www.chinattl.cn

Appendix

Antenna Parameters with Head TSL

Impedance, transformed to feed point	46.5Ω- 7.32jΩ
Return Loss	- 21.5dB

Antenna Parameters with Body TSL

Impedance, transformed to feed point	45.0Ω- 6.71jΩ
Return Loss	- 21.1dB

General Antenna Parameters and Design

Electrical Delay (one direction)	1.045 ns
----------------------------------	----------

After long term use with 100W radiated power, only a slight warming of the dipole near the feedpoint can be measured.

The dipole is made of standard semirigid coaxial cable. The center conductor of the feeding line is directly connected to the second arm of the dipole. The antenna is therefore short-circuited for DC-signals. On some of the dipoles, small end caps are added to the dipole arms in order to improve matching when loaded according to the position as explained in the "Measurement Conditions" paragraph. The SAR data are not affected by this change. The overall dipole length is still according to the Standard. No excessive force must be applied to the dipole arms, because they might bend or the soldered connections near the feedpoint may be damaged.

Additional EUT Data

Manufactured by	SPEAG
-----------------	-------



Add: No.51 Xueyuan Road, Haidian District, Beijing, 100191, China
Tel: +86-10-62304633-2079 Fax: +86-10-62304633-2504
E-mail: cttl@chinattl.com Http://www.chinattl.cn

DASY5 Validation Report for Head TSL

Date: 08.30.2016

Test Laboratory: CTTL, Beijing, China

DUT: Dipole 2600 MHz; Type: D2600V2; Serial: D2600V2 - SN: 1113

Communication System: UID 0, CW; Frequency: 2600 MHz; Duty Cycle: 1:1

Medium parameters used: $f = 2600$ MHz; $\sigma = 1.974$ S/m; $\epsilon_r = 39.43$; $\rho = 1000$ kg/m³

Phantom section: Right Section

Measurement Standard: DASY5 (IEEE/IEC/ANSI C63.19-2007)

DASY5 Configuration:

- Probe: EX3DV4 - SN3801; ConvF(6.64, 6.64, 6.64); Calibrated: 6/29/2016;
- Sensor-Surface: 2mm (Mechanical Surface Detection)
- Electronics: DAE4 Sn777; Calibrated: 8/22/2016
- Phantom: Triple Flat Phantom 5.1C; Type: QD 000 P51 CA; Serial: 1161/1
- Measurement SW: DASY52, Version 52.8 (8); SEMCAD X Version 14.6.10 (7372)

Dipole Calibration/Zoom Scan (7x7x7) (7x7x7)/Cube 0: Measurement grid: dx=5mm, dy=5mm, dz=5mm

Reference Value = 106.7 V/m; Power Drift = -0.01 dB

Peak SAR (extrapolated) = 30.0 W/kg

SAR(1 g) = 14.2 W/kg; SAR(10 g) = 6.41 W/kg

Maximum value of SAR (measured) = 22.0 W/kg

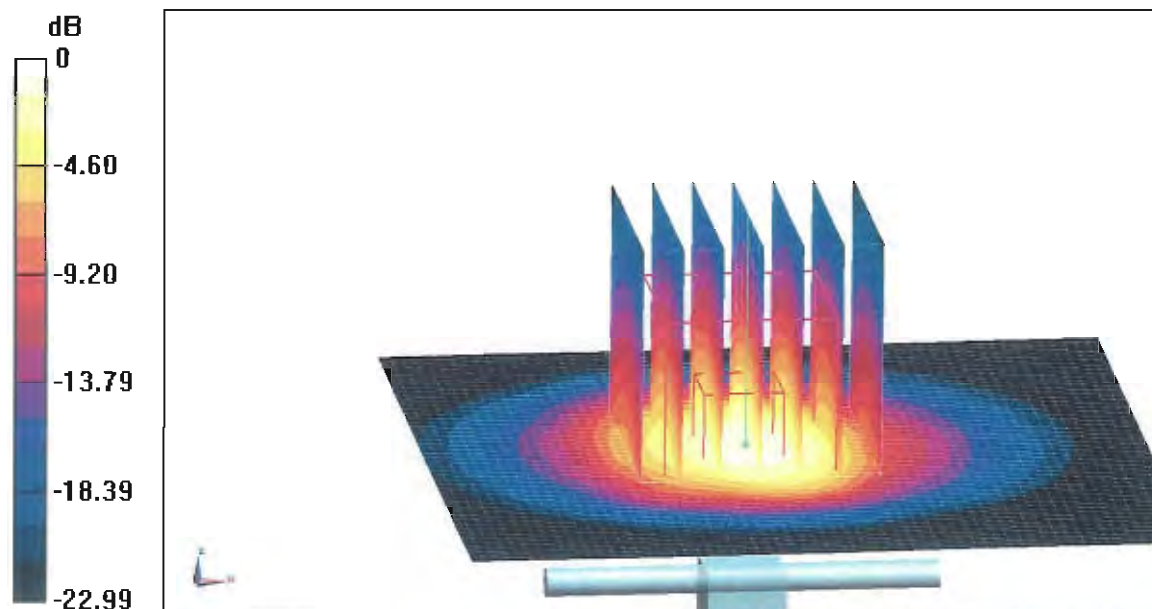

0 dB = 22.0 W/kg = 13.42 dBW/kg



Add: No.51 Xueyuan Road, Haidian District, Beijing, 100191, China
Tel: +86-10-62304633-2079 Fax: +86-10-62304633-2504
E-mail: cttl@chinattl.com Http://www.chinattl.cn

Impedance Measurement Plot for Head TSL

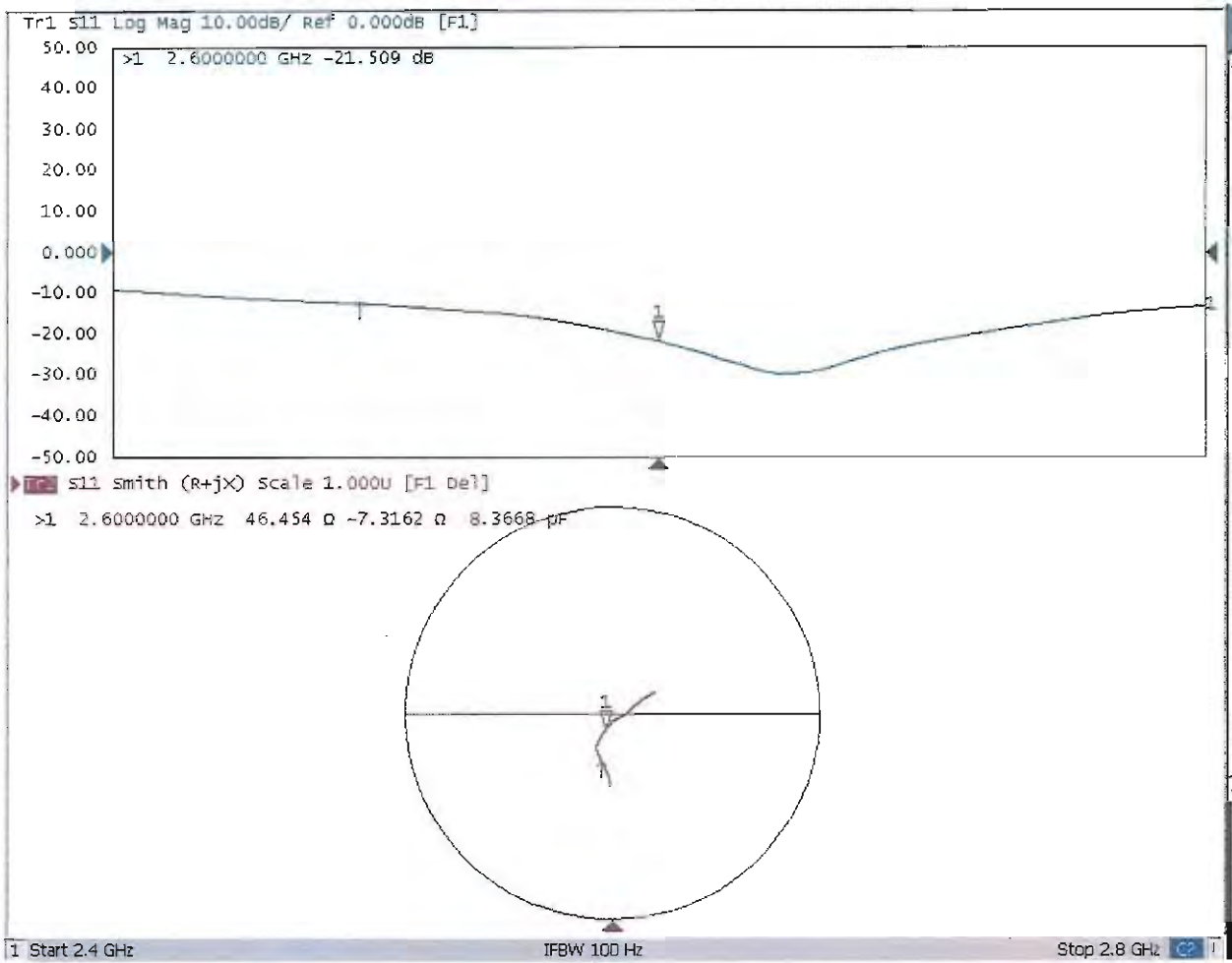



Add: No.51 Xueyuan Road, Haidian District, Beijing, 100191, China
Tel: +86-10-62304633-2079 Fax: +86-10-62304633-2504
E-mail: cttl@chinattl.com Http://www.chinattl.cn

DASY5 Validation Report for Body TSL

Date: 08.30.2016

Test Laboratory: CTTL, Beijing, China

DUT: Dipole 2600 MHz; Type: D2600V2; Serial: D2600V2 - SN: 1113

Communication System: UID 0, CW; Frequency: 2600 MHz; Duty Cycle: 1:1

Medium parameters used: $f = 2600$ MHz; $\sigma = 2.184$ S/m; $\epsilon_r = 52.15$; $\rho = 1000$ kg/m³

Phantom section: Center Section

Measurement Standard: DASY5 (IEEE/IEC/ANSI C63.19-2007)

DASY5 Configuration:

- Probe: EX3DV4 - SN3801; ConvF(6.7, 6.7,6.7); Calibrated: 6/29/2016;
- Sensor-Surface: 2mm (Mechanical Surface Detection)
- Electronics: DAE4 Sn777; Calibrated: 8/22/2016
- Phantom: Triple Flat Phantom 5.1C; Type: QD 000 P51 CA; Serial: 1161/1
- Measurement SW: DASY52, Version 52.8 (8); SEMCAD X Version 14.6.10 (7372)

Dipole Calibration/Zoom Scan (7x7x7) (7x7x7)/Cube 0: Measurement grid: dx=5mm, dy=5mm, dz=5mm

Reference Value = 94.87 V/m; Power Drift = -0.04 dB

Peak SAR (extrapolated) = 29.1 W/kg

SAR(1 g) = 14 W/kg; SAR(10 g) = 6.34 W/kg

Maximum value of SAR (measured) = 21.5 W/kg

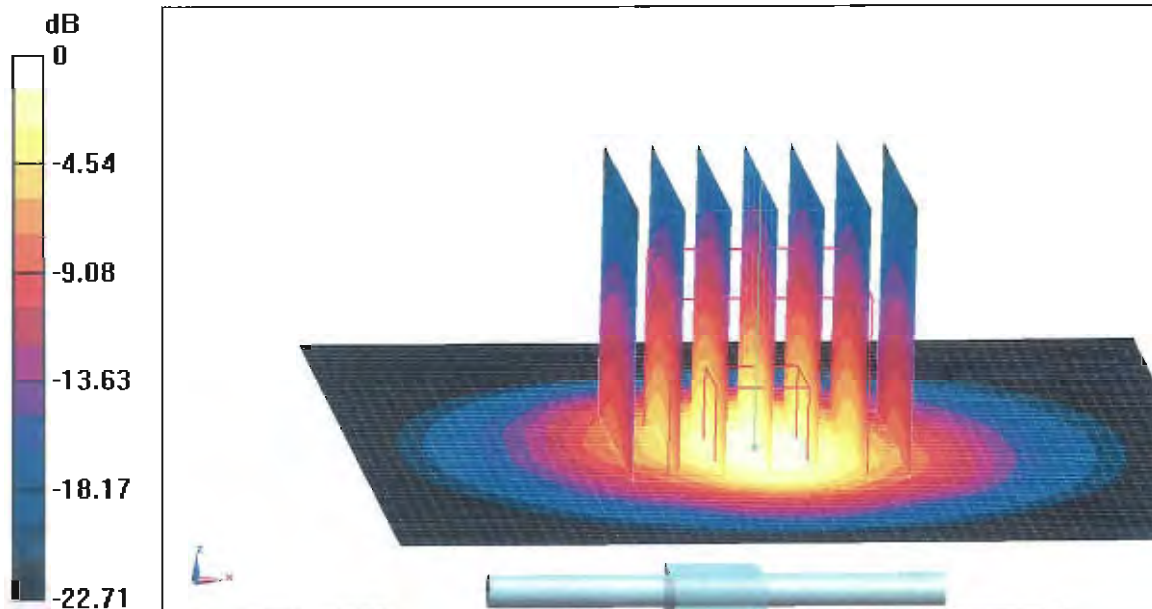

0 dB = 21.5 W/kg = 13.32 dBW/kg



Add: No.51 Xueyuan Road, Haidian District, Beijing, 100191, China
Tel: +86-10-62304633-2079 Fax: +86-10-62304633-2504
E-mail: cttl@chinattl.com Http://www.chinattl.cn

Impedance Measurement Plot for Body TSL

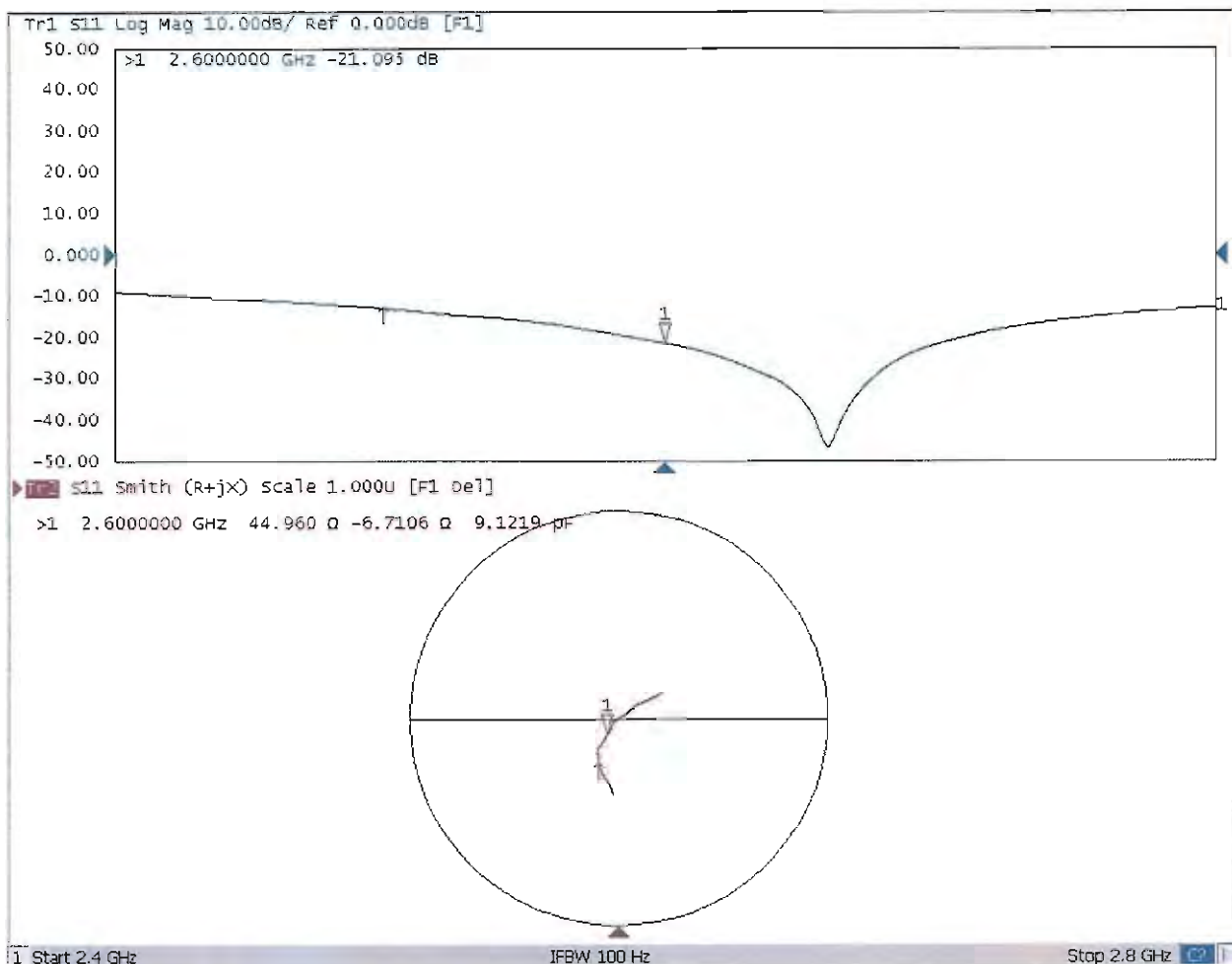



Accredited by the Swiss Accreditation Service (SAS)
The Swiss Accreditation Service is one of the signatories to the EA
Multilateral Agreement for the recognition of calibration certificates

Accreditation No.: **SCS 0108**

Client **Sporton-TW (Auden)**

Certificate No: **D5GHzV2-1006_Sep16**

CALIBRATION CERTIFICATE

Object **D5GHzV2 - SN:1006**

Calibration procedure(s) **QA CAL-22.v2**
Calibration procedure for dipole validation kits between 3-6 GHz

Calibration date: **September 27, 2016**

This calibration certificate documents the traceability to national standards, which realize the physical units of measurements (SI).
The measurements and the uncertainties with confidence probability are given on the following pages and are part of the certificate.

All calibrations have been conducted in the closed laboratory facility: environment temperature (22 ± 3)°C and humidity < 70%.

Calibration Equipment used (M&TE critical for calibration)

Primary Standards	ID #	Cal Date (Certificate No.)	Scheduled Calibration
Power meter NRP	SN: 104778	06-Apr-16 (No. 217-02288/02289)	Apr-17
Power sensor NRP-Z91	SN: 103244	06-Apr-16 (No. 217-02288)	Apr-17
Power sensor NRP-Z91	SN: 103245	06-Apr-16 (No. 217-02289)	Apr-17
Reference 20 dB Attenuator	SN: 5058 (20k)	05-Apr-16 (No. 217-02292)	Apr-17
Type-N mismatch combination	SN: 5047.2 / 06327	05-Apr-16 (No. 217-02295)	Apr-17
Reference Probe EX3DV4	SN: 3503	30-Jun-16 (No. EX3-3503_Jun16)	Jun-17
DAE4	SN: 601	30-Dec-15 (No. DAE4-601_Dec15)	Dec-16

Secondary Standards	ID #	Check Date (in house)	Scheduled Check
Power meter EPM-442A	SN: GB37480704	07-Oct-15 (No. 217-02222)	In house check: Oct-16
Power sensor HP 8481A	SN: US37292783	07-Oct-15 (No. 217-02222)	In house check: Oct-16
Power sensor HP 8481A	SN: MY41092317	07-Oct-15 (No. 217-02223)	In house check: Oct-16
RF generator R&S SMT-06	SN: 100972	15-Jun-15 (in house check Jun-15)	In house check: Oct-16
Network Analyzer HP 8753E	SN: US37390585	18-Oct-01 (in house check Oct-15)	In house check: Oct-16

Calibrated by: **Claudio Leubler** Name: Claudio Leubler Function: Laboratory Technician

Approved by: **Katja Pokovic** Name: Katja Pokovic Function: Technical Manager

Signature

Issued: September 27, 2016

This calibration certificate shall not be reproduced except in full without written approval of the laboratory.



Accredited by the Swiss Accreditation Service (SAS)
The Swiss Accreditation Service is one of the signatories to the EA
Multilateral Agreement for the recognition of calibration certificates

Accreditation No.: **SCS 0108**

Glossary:

TSL	tissue simulating liquid
ConvF	sensitivity in TSL / NORM x,y,z
N/A	not applicable or not measured

Calibration is Performed According to the Following Standards:

- IEEE Std 1528-2013, "IEEE Recommended Practice for Determining the Peak Spatial-Averaged Specific Absorption Rate (SAR) in the Human Head from Wireless Communications Devices: Measurement Techniques", June 2013
- IEC 62209-2, "Procedure to determine the Specific Absorption Rate (SAR) for wireless communication devices used in close proximity to the human body (frequency range of 30 MHz to 6 GHz)", March 2010
- KDB 865664, "SAR Measurement Requirements for 100 MHz to 6 GHz"

Additional Documentation:

- DASY4/5 System Handbook

Methods Applied and Interpretation of Parameters:

- Measurement Conditions:* Further details are available from the Validation Report at the end of the certificate. All figures stated in the certificate are valid at the frequency indicated.
- Antenna Parameters with TSL:* The dipole is mounted with the spacer to position its feed point exactly below the center marking of the flat phantom section, with the arms oriented parallel to the body axis.
- Feed Point Impedance and Return Loss:* These parameters are measured with the dipole positioned under the liquid filled phantom. The impedance stated is transformed from the measurement at the SMA connector to the feed point. The Return Loss ensures low reflected power. No uncertainty required.
- Electrical Delay:* One-way delay between the SMA connector and the antenna feed point. No uncertainty required.
- SAR measured:* SAR measured at the stated antenna input power.
- SAR normalized:* SAR as measured, normalized to an input power of 1 W at the antenna connector.
- SAR for nominal TSL parameters:* The measured TSL parameters are used to calculate the nominal SAR result.

The reported uncertainty of measurement is stated as the standard uncertainty of measurement multiplied by the coverage factor $k=2$, which for a normal distribution corresponds to a coverage probability of approximately 95%.

Measurement Conditions

DASY system configuration, as far as not given on page 1.

DASY Version	DASY5	V52.8.8
Extrapolation	Advanced Extrapolation	
Phantom	Modular Flat Phantom V5.0	
Distance Dipole Center - TSL	10 mm	with Spacer
Zoom Scan Resolution	dx, dy = 4.0 mm, dz = 1.4 mm	Graded Ratio = 1.4 (Z direction)
Frequency	5250 MHz ± 1 MHz 5600 MHz ± 1 MHz 5750 MHz ± 1 MHz	

Head TSL parameters at 5250 MHz

The following parameters and calculations were applied.

	Temperature	Permittivity	Conductivity
Nominal Head TSL parameters	22.0 °C	35.9	4.71 mho/m
Measured Head TSL parameters	(22.0 ± 0.2) °C	34.5 ± 6 %	4.59 mho/m ± 6 %
Head TSL temperature change during test	< 0.5 °C	----	----

SAR result with Head TSL at 5250 MHz

SAR averaged over 1 cm³ (1 g) of Head TSL	Condition	
SAR measured	100 mW input power	8.13 W/kg
SAR for nominal Head TSL parameters	normalized to 1W	80.6 W/kg ± 19.9 % (k=2)

SAR averaged over 10 cm³ (10 g) of Head TSL	condition	
SAR measured	100 mW input power	2.32 W/kg
SAR for nominal Head TSL parameters	normalized to 1W	22.9 W/kg ± 19.5 % (k=2)

Head TSL parameters at 5600 MHz

The following parameters and calculations were applied.

	Temperature	Permittivity	Conductivity
Nominal Head TSL parameters	22.0 °C	35.5	5.07 mho/m
Measured Head TSL parameters	(22.0 ± 0.2) °C	34.0 ± 6 %	4.93 mho/m ± 6 %
Head TSL temperature change during test	< 0.5 °C	----	----

SAR result with Head TSL at 5600 MHz

SAR averaged over 1 cm³ (1 g) of Head TSL	Condition	
SAR measured	100 mW input power	8.47 W/kg
SAR for nominal Head TSL parameters	normalized to 1W	83.8 W / kg ± 19.9 % (k=2)

SAR averaged over 10 cm³ (10 g) of Head TSL	condition	
SAR measured	100 mW input power	2.40 W/kg
SAR for nominal Head TSL parameters	normalized to 1W	23.7 W/kg ± 19.5 % (k=2)

Head TSL parameters at 5750 MHz

The following parameters and calculations were applied.

	Temperature	Permittivity	Conductivity
Nominal Head TSL parameters	22.0 °C	35.4	5.22 mho/m
Measured Head TSL parameters	(22.0 ± 0.2) °C	33.8 ± 6 %	5.08 mho/m ± 6 %
Head TSL temperature change during test	< 0.5 °C	----	----

SAR result with Head TSL at 5750 MHz

SAR averaged over 1 cm ³ (1 g) of Head TSL	Condition	
SAR measured	100 mW input power	8.14 W/kg
SAR for nominal Head TSL parameters	normalized to 1W	80.5 W/kg ± 19.9 % (k=2)

SAR averaged over 10 cm ³ (10 g) of Head TSL	condition	
SAR measured	100 mW input power	2.30 W/kg
SAR for nominal Head TSL parameters	normalized to 1W	22.7 W/kg ± 19.5 % (k=2)

Body TSL parameters at 5250 MHz

The following parameters and calculations were applied.

	Temperature	Permittivity	Conductivity
Nominal Body TSL parameters	22.0 °C	48.9	5.36 mho/m
Measured Body TSL parameters	(22.0 ± 0.2) °C	47.4 ± 6 %	5.52 mho/m ± 6 %
Body TSL temperature change during test	< 0.5 °C	----	----

SAR result with Body TSL at 5250 MHz

SAR averaged over 1 cm ³ (1 g) of Body TSL	Condition	
SAR measured	100 mW input power	7.59 W/kg
SAR for nominal Body TSL parameters	normalized to 1W	75.5 W/kg ± 19.9 % (k=2)

SAR averaged over 10 cm ³ (10 g) of Body TSL	condition	
SAR measured	100 mW input power	2.13 W/kg
SAR for nominal Body TSL parameters	normalized to 1W	21.2 W/kg ± 19.5 % (k=2)

Body TSL parameters at 5600 MHz

The following parameters and calculations were applied.

	Temperature	Permittivity	Conductivity
Nominal Body TSL parameters	22.0 °C	48.5	5.77 mho/m
Measured Body TSL parameters	(22.0 ± 0.2) °C	46.8 ± 6 %	6.00 mho/m ± 6 %
Body TSL temperature change during test	< 0.5 °C	----	----

SAR result with Body TSL at 5600 MHz

SAR averaged over 1 cm ³ (1 g) of Body TSL	Condition	
SAR measured	100 mW input power	7.90 W/kg
SAR for nominal Body TSL parameters	normalized to 1W	78.6 W/kg ± 19.9 % (k=2)

SAR averaged over 10 cm ³ (10 g) of Body TSL	condition	
SAR measured	100 mW input power	2.22 W/kg
SAR for nominal Body TSL parameters	normalized to 1W	22.0 W/kg ± 19.5 % (k=2)

Body TSL parameters at 5750 MHz

The following parameters and calculations were applied.

	Temperature	Permittivity	Conductivity
Nominal Body TSL parameters	22.0 °C	48.3	5.94 mho/m
Measured Body TSL parameters	(22.0 ± 0.2) °C	46.5 ± 6 %	6.21 mho/m ± 6 %
Body TSL temperature change during test	< 0.5 °C	----	----

SAR result with Body TSL at 5750 MHz

SAR averaged over 1 cm ³ (1 g) of Body TSL	Condition	
SAR measured	100 mW input power	7.50 W/kg
SAR for nominal Body TSL parameters	normalized to 1W	74.6 W/kg ± 19.9 % (k=2)

SAR averaged over 10 cm ³ (10 g) of Body TSL	condition	
SAR measured	100 mW input power	2.10 W/kg
SAR for nominal Body TSL parameters	normalized to 1W	20.8 W/kg ± 19.5 % (k=2)

Appendix (Additional assessments outside the scope of SCS 0108)

Antenna Parameters with Head TSL at 5250 MHz

Impedance, transformed to feed point	55.6 Ω - 6.5 j Ω
Return Loss	- 21.8 dB

Antenna Parameters with Head TSL at 5600 MHz

Impedance, transformed to feed point	57.5 Ω - 4.7 j Ω
Return Loss	- 21.7 dB

Antenna Parameters with Head TSL at 5750 MHz

Impedance, transformed to feed point	59.2 Ω + 5.8 j Ω
Return Loss	- 20.1 dB

Antenna Parameters with Body TSL at 5250 MHz

Impedance, transformed to feed point	55.5 Ω - 3.4 j Ω
Return Loss	- 24.2 dB

Antenna Parameters with Body TSL at 5600 MHz

Impedance, transformed to feed point	59.3 Ω - 1.9 j Ω
Return Loss	- 21.2 dB

Antenna Parameters with Body TSL at 5750 MHz

Impedance, transformed to feed point	58.8 Ω + 8.9 j Ω
Return Loss	- 18.8 dB

General Antenna Parameters and Design

Electrical Delay (one direction)	1.201 ns
----------------------------------	----------

After long term use with 100W radiated power, only a slight warming of the dipole near the feedpoint can be measured.

The dipole is made of standard semirigid coaxial cable. The center conductor of the feeding line is directly connected to the second arm of the dipole. The antenna is therefore short-circuited for DC-signals. On some of the dipoles, small end caps are added to the dipole arms in order to improve matching when loaded according to the position as explained in the "Measurement Conditions" paragraph. The SAR data are not affected by this change. The overall dipole length is still according to the Standard.

No excessive force must be applied to the dipole arms, because they might bend or the soldered connections near the feedpoint may be damaged.

Additional EUT Data

Manufactured by	SPEAG
Manufactured on	August 28, 2003

Test Laboratory: SPEAG, Zurich, Switzerland

DUT: Dipole D5GHzV2; Type: D5GHzV2; Serial: D5GHzV2 - SN:1006

Communication System: UID 0 - CW; Frequency: 5250 MHz, Frequency: 5600 MHz, Frequency: 5750 MHz

Medium parameters used: $f = 5250$ MHz; $\sigma = 4.59$ S/m; $\epsilon_r = 34.5$; $\rho = 1000$ kg/m³

Medium parameters used: $f = 5600$ MHz; $\sigma = 4.93$ S/m; $\epsilon_r = 34.0$; $\rho = 1000$ kg/m³

Medium parameters used: $f = 5750$ MHz; $\sigma = 5.08$ S/m; $\epsilon_r = 33.8$; $\rho = 1000$ kg/m³

Phantom section: Flat Section

Measurement Standard: DASY5 (IEEE/IEC/ANSI C63.19-2011)

DASY52 Configuration:

- Probe: EX3DV4 - SN3503; ConvF(5.42, 5.42, 5.42); Calibrated: 30.06.2016, ConvF(4.89, 4.89, 4.89); Calibrated: 30.06.2016, ConvF(4.85, 4.85, 4.85); Calibrated: 30.06.2016;
- Sensor-Surface: 1.4mm (Mechanical Surface Detection)
- Electronics: DAE4 Sn601; Calibrated: 30.12.2015
- Phantom: Flat Phantom 5.0 (front); Type: QD000P50AA; Serial: 1001
- DASY52 52.8.8(1258); SEMCAD X 14.6.10(7372)

Dipole Calibration for Head Tissue/Pin=100mW, dist=10mm, f=5250 MHz/Zoom Scan, dist=1.4mm (8x8x7)/Cube 0: Measurement grid: dx=4mm, dy=4mm, dz=1.4mm

Reference Value = 72.67 V/m; Power Drift = 0.03 dB

Peak SAR (extrapolated) = 29.4 W/kg

SAR(1 g) = 8.13 W/kg; SAR(10 g) = 2.32 W/kg

Maximum value of SAR (measured) = 18.2 W/kg

Dipole Calibration for Head Tissue/Pin=100mW, dist=10mm, f=5600 MHz/Zoom Scan, dist=1.4mm (8x8x7)/Cube 0: Measurement grid: dx=4mm, dy=4mm, dz=1.4mm

Reference Value = 72.60 V/m; Power Drift = 0.04 dB

Peak SAR (extrapolated) = 33.1 W/kg

SAR(1 g) = 8.47 W/kg; SAR(10 g) = 2.4 W/kg

Maximum value of SAR (measured) = 19.7 W/kg

Dipole Calibration for Head Tissue/Pin=100mW, dist=10mm, f=5750 MHz/Zoom Scan, dist=1.4mm (8x8x7)/Cube 0: Measurement grid: dx=4mm, dy=4mm, dz=1.4mm

Reference Value = 70.56 V/m; Power Drift = 0.03 dB

Peak SAR (extrapolated) = 33.0 W/kg

SAR(1 g) = 8.14 W/kg; SAR(10 g) = 2.3 W/kg

Maximum value of SAR (measured) = 19.2 W/kg

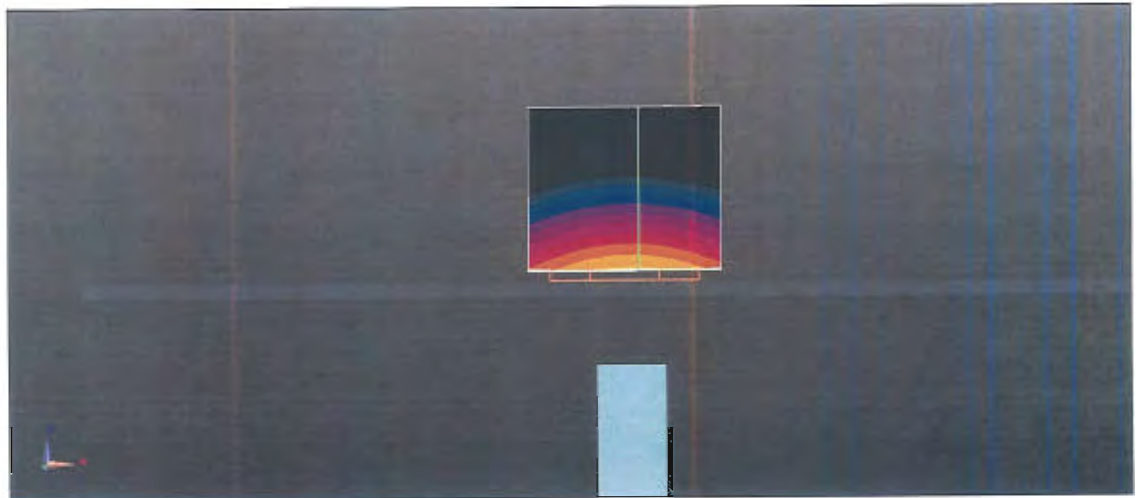
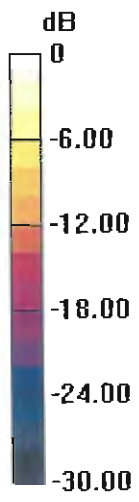

0 dB = 19.2 W/kg = 12.83 dBW/kg

Impedance Measurement Plot for Head TSL

27 Sep 2016 13:52:19

CH1 S11 1 U FS

1: 55.643 Ω -6.4844 Ω 4.6751 pF

5 250.000 000 MHz

De1
Cor
Avg
16
H1d

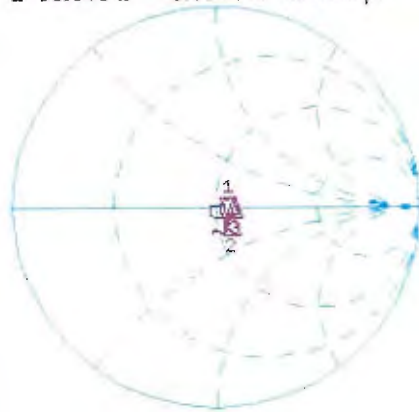

CH1 Markers

2: 57.496 Ω
-4.6836 Ω
5.60000 GHz
3: 59.191 Ω
5.8047 Ω
5.75000 GHz

CH2 S11 LOG 5 dB/REF -20 dB 1:-21.809 dB 5 250.000 000 MHz

Cor
Avg
16
H1d

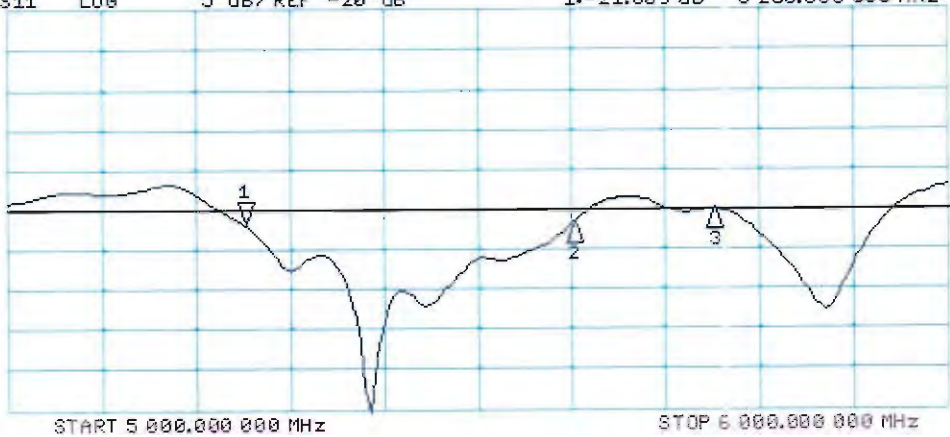

CH2 Markers

2:-21.707 dB
5.60000 GHz
3:-20.051 dB
5.75000 GHz

Test Laboratory: SPEAG, Zurich, Switzerland

DUT: Dipole D5GHzV2; Type: D5GHzV2; Serial: D5GHzV2 - SN:1006

Communication System: UID 0 - CW; Frequency: 5250 MHz, Frequency: 5600 MHz, Frequency: 5750 MHz

Medium parameters used: $f = 5250$ MHz; $\sigma = 5.52$ S/m; $\epsilon_r = 47.4$; $\rho = 1000$ kg/m³

Medium parameters used: $f = 5600$ MHz; $\sigma = 6.00$ S/m; $\epsilon_r = 46.8$; $\rho = 1000$ kg/m³

Medium parameters used: $f = 5750$ MHz; $\sigma = 6.21$ S/m; $\epsilon_r = 46.5$; $\rho = 1000$ kg/m³

Phantom section: Flat Section

Measurement Standard: DASY5 (IEEE/IEC/ANSI C63.19-2011)

DASY52 Configuration:

- Probe: EX3DV4 - SN3503; ConvF(4.85, 4.85, 4.85); Calibrated: 30.06.2016, ConvF(4.35, 4.35, 4.35); Calibrated: 30.06.2016, ConvF(4.3, 4.3, 4.3); Calibrated: 30.06.2016;
- Sensor-Surface: 1.4mm (Mechanical Surface Detection)
- Electronics: DAE4 Sn601; Calibrated: 30.12.2015
- Phantom: Flat Phantom 5.0 (back); Type: QD000P50AA; Serial: 1002
- DASY52 52.8.8(1258); SEMCAD X 14.6.10(7372)

Dipole Calibration for Body Tissue/Pin=100mW, dist=10mm, f=5250 MHz/Zoom Scan, dist=1.4mm (8x8x7)/Cube 0: Measurement grid: dx=4mm, dy=4mm, dz=1.4mm

Reference Value = 66.79 V/m; Power Drift = -0.07 dB

Peak SAR (extrapolated) = 28.8 W/kg

SAR(1 g) = 7.59 W/kg; SAR(10 g) = 2.13 W/kg

Maximum value of SAR (measured) = 17.9 W/kg

Dipole Calibration for Body Tissue/Pin=100mW, dist=10mm, f=5600 MHz/Zoom Scan, dist=1.4mm (8x8x7)/Cube 0: Measurement grid: dx=4mm, dy=4mm, dz=1.4mm

Reference Value = 67.00 V/m; Power Drift = -0.07 dB

Peak SAR (extrapolated) = 32.5 W/kg

SAR(1 g) = 7.9 W/kg; SAR(10 g) = 2.22 W/kg

Maximum value of SAR (measured) = 19.0 W/kg

Dipole Calibration for Body Tissue/Pin=100mW, dist=10mm, f=5750 MHz/Zoom Scan, dist=1.4mm (8x8x7)/Cube 0: Measurement grid: dx=4mm, dy=4mm, dz=1.4mm

Reference Value = 64.64 V/m; Power Drift = -0.03 dB

Peak SAR (extrapolated) = 32.2 W/kg

SAR(1 g) = 7.5 W/kg; SAR(10 g) = 2.1 W/kg

Maximum value of SAR (measured) = 18.5 W/kg

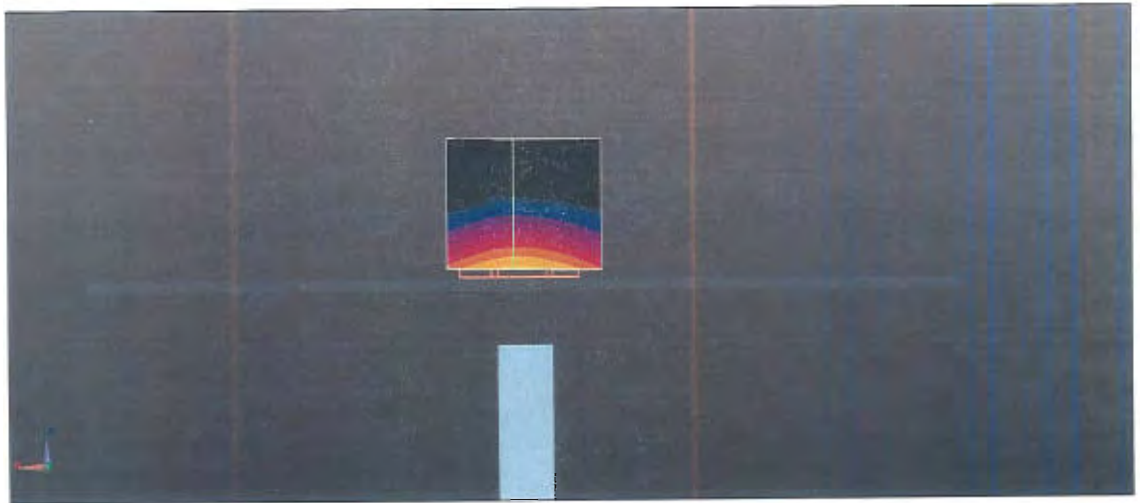
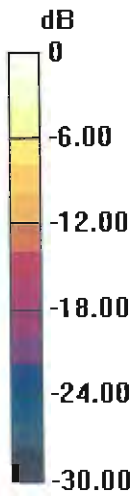

0 dB = 18.5 W/kg = 12.67 dBW/kg

Impedance Measurement Plot for Body TSL

26 Sep 2016 07:46:17

CH1 S11 1 U FS

1: 55.521 Ω -3.4188 Ω 8.8694 pF

5 250.000 000 MHz

*
Del
Cor
Avg
16
H1d

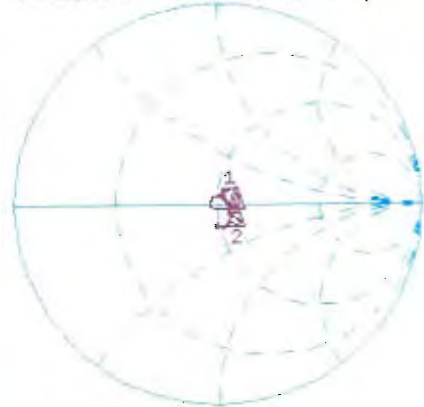

CH1 Markers
2: 59.314 Ω
-1.8555 Ω
5.60000 GHz
3: 58.801 Ω
8.8986 Ω
5.75000 GHz

CH2 S11 LOG 5 dB/REF -20 dB 1:-24.217 dB 5 250.000 000 MHz

Cor
Avg
16
H1d

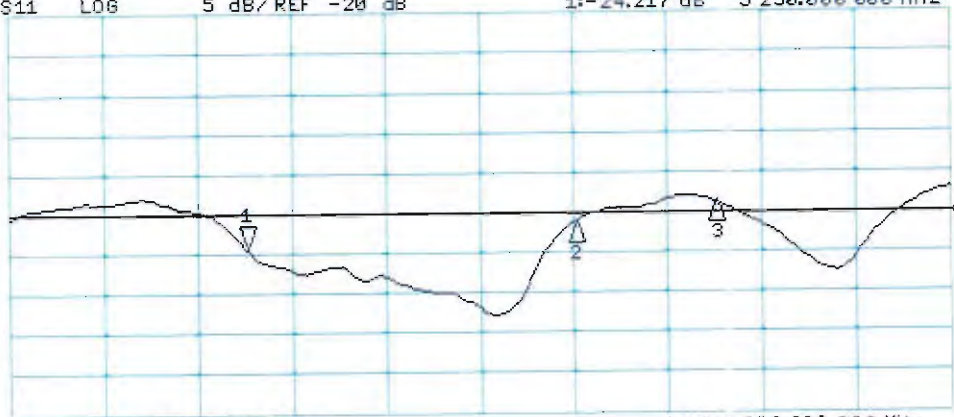

CH2 Markers
2:-21.221 dB
5.60000 GHz
3:-18.815 dB
5.75000 GHz

START 5 000.000 000 MHz

STOP 6 000.000 000 MHz



Accredited by the Swiss Accreditation Service (SAS)
The Swiss Accreditation Service is one of the signatories to the EA
Multilateral Agreement for the recognition of calibration certificates

Accreditation No.: **SCS 0108**

Client **Sporton (Auden)**

Certificate No: **DAE3-495_May17**

CALIBRATION CERTIFICATE

Object **DAE3 - SD 000 D03 AD - SN: 495**

Calibration procedure(s) **QA CAL-06.v29
Calibration procedure for the data acquisition electronics (DAE)**

Calibration date: **May 22, 2017**

This calibration certificate documents the traceability to national standards, which realize the physical units of measurements (SI).
The measurements and the uncertainties with confidence probability are given on the following pages and are part of the certificate.

All calibrations have been conducted in the closed laboratory facility: environment temperature (22 ± 3)°C and humidity < 70%.

Calibration Equipment used (M&TE critical for calibration)

Primary Standards	ID #	Cal Date (Certificate No.)	Scheduled Calibration
Keithley Multimeter Type 2001	SN: 0810278	09-Sep-16 (No:19065)	Sep-17
Secondary Standards	ID #	Check Date (in house)	Scheduled Check
Auto DAE Calibration Unit	SE UWS 053 AA 1001	05-Jan-17 (in house check)	In house check: Jan-18
Calibrator Box V2.1	SE UMS 006 AA 1002	05-Jan-17 (in house check)	In house check: Jan-18

Calibrated by:	Name Adrian Gehring	Function Technician	Signature
Approved by:	Name Fin Bomholt	Function Deputy Technical Manager	Signature

Issued: May 22, 2017

This calibration certificate shall not be reproduced except in full without written approval of the laboratory.



Accredited by the Swiss Accreditation Service (SAS)
The Swiss Accreditation Service is one of the signatories to the EA
Multilateral Agreement for the recognition of calibration certificates

Accreditation No.: **SCS 0108**

Glossary

DAE data acquisition electronics
Connector angle information used in DASY system to align probe sensor X to the robot coordinate system.

Methods Applied and Interpretation of Parameters

- *DC Voltage Measurement*: Calibration Factor assessed for use in DASY system by comparison with a calibrated instrument traceable to national standards. The figure given corresponds to the full scale range of the voltmeter in the respective range.
- *Connector angle*: The angle of the connector is assessed measuring the angle mechanically by a tool inserted. Uncertainty is not required.
- The following parameters as documented in the Appendix contain technical information as a result from the performance test and require no uncertainty.
 - *DC Voltage Measurement Linearity*: Verification of the Linearity at +10% and -10% of the nominal calibration voltage. Influence of offset voltage is included in this measurement.
 - *Common mode sensitivity*: Influence of a positive or negative common mode voltage on the differential measurement.
 - *Channel separation*: Influence of a voltage on the neighbor channels not subject to an input voltage.
 - *AD Converter Values with inputs shorted*: Values on the internal AD converter corresponding to zero input voltage
 - *Input Offset Measurement*: Output voltage and statistical results over a large number of zero voltage measurements.
 - *Input Offset Current*: Typical value for information; Maximum channel input offset current, not considering the input resistance.
 - *Input resistance*: Typical value for information: DAE input resistance at the connector, during internal auto-zeroing and during measurement.
 - *Low Battery Alarm Voltage*: Typical value for information. Below this voltage, a battery alarm signal is generated.
 - *Power consumption*: Typical value for information. Supply currents in various operating modes.

DC Voltage Measurement

A/D - Converter Resolution nominal

High Range: 1LSB = 6.1 μ V, full range = -100...+300 mV

Low Range: 1LSB = 61nV, full range = -1.....+3mV

DASY measurement parameters: Auto Zero Time: 3 sec; Measuring time: 3 sec

Calibration Factors	X	Y	Z
High Range	404.410 \pm 0.02% (k=2)	405.390 \pm 0.02% (k=2)	405.754 \pm 0.02% (k=2)
Low Range	3.95327 \pm 1.50% (k=2)	3.99222 \pm 1.50% (k=2)	3.96688 \pm 1.50% (k=2)

Connector Angle

Connector Angle to be used in DASY system	73.0 \pm 1 $^{\circ}$
---	-------------------------

Appendix (Additional assessments outside the scope of SCS0108)

1. DC Voltage Linearity

High Range	Reading (μV)	Difference (μV)	Error (%)
Channel X + Input	200036.32	-0.53	-0.00
Channel X + Input	20006.90	1.96	0.01
Channel X - Input	-20002.74	3.21	-0.02
Channel Y + Input	200037.97	0.48	0.00
Channel Y + Input	20003.40	-1.56	-0.01
Channel Y - Input	-20003.25	2.58	-0.01
Channel Z + Input	200036.42	-2.51	-0.00
Channel Z + Input	20006.90	2.06	0.01
Channel Z - Input	-20001.84	4.23	-0.02

Low Range	Reading (μV)	Difference (μV)	Error (%)
Channel X + Input	2001.22	0.30	0.02
Channel X + Input	200.83	-0.07	-0.04
Channel X - Input	-198.44	0.59	-0.29
Channel Y + Input	2000.13	-0.67	-0.03
Channel Y + Input	200.76	-0.02	-0.01
Channel Y - Input	-199.54	-0.36	0.18
Channel Z + Input	2000.82	0.09	0.00
Channel Z + Input	198.88	-1.81	-0.90
Channel Z - Input	-200.61	-1.37	0.69

2. Common mode sensitivity

DASY measurement parameters: Auto Zero Time: 3 sec; Measuring time: 3 sec

	Common mode Input Voltage (mV)	High Range Average Reading (μV)	Low Range Average Reading (μV)
Channel X	200	4.95	3.15
	- 200	-1.85	-3.32
Channel Y	200	-0.13	0.16
	- 200	-1.11	-1.51
Channel Z	200	1.66	1.87
	- 200	-4.35	-4.69

3. Channel separation

DASY measurement parameters: Auto Zero Time: 3 sec; Measuring time: 3 sec

	Input Voltage (mV)	Channel X (μV)	Channel Y (μV)	Channel Z (μV)
Channel X	200	-	-1.04	-2.16
Channel Y	200	8.07	-	-0.61
Channel Z	200	5.90	6.18	-

4. AD-Converter Values with inputs shorted

DASY measurement parameters: Auto Zero Time: 3 sec; Measuring time: 3 sec

	High Range (LSB)	Low Range (LSB)
Channel X	15813	17008
Channel Y	15760	16933
Channel Z	15907	17415

5. Input Offset Measurement

DASY measurement parameters: Auto Zero Time: 3 sec; Measuring time: 3 sec

Input 10M Ω

	Average (μ V)	min. Offset (μ V)	max. Offset (μ V)	Std. Deviation (μ V)
Channel X	-0.31	-1.54	1.33	0.59
Channel Y	1.19	-0.39	3.04	0.63
Channel Z	-1.55	-3.60	0.02	0.66

6. Input Offset Current

Nominal Input circuitry offset current on all channels: <25fA

7. Input Resistance (Typical values for information)

	Zeroing (kOhm)	Measuring (MOhm)
Channel X	200	200
Channel Y	200	200
Channel Z	200	200

8. Low Battery Alarm Voltage (Typical values for information)

Typical values	Alarm Level (VDC)
Supply (+ Vcc)	+7.9
Supply (- Vcc)	-7.6

9. Power Consumption (Typical values for information)

Typical values	Switched off (mA)	Stand by (mA)	Transmitting (mA)
Supply (+ Vcc)	+0.01	+6	+14
Supply (- Vcc)	-0.01	-8	-9



Accredited by the Swiss Accreditation Service (SAS)
 The Swiss Accreditation Service is one of the signatories to the EA
 Multilateral Agreement for the recognition of calibration certificates

Accreditation No.: **SCS 0108**

Client **Auden**

Certificate No: **DAE4-916_Dec16**

CALIBRATION CERTIFICATE

Object **DAE4 - SD 000 D04 BK - SN: 916**

Calibration procedure(s) **QA CAL-06.v29**
Calibration procedure for the data acquisition electronics (DAE)

Calibration date: **December 15, 2016**

This calibration certificate documents the traceability to national standards, which realize the physical units of measurements (SI).
 The measurements and the uncertainties with confidence probability are given on the following pages and are part of the certificate.

All calibrations have been conducted in the closed laboratory facility: environment temperature (22 ± 3)°C and humidity < 70%.

Calibration Equipment used (M&TE critical for calibration)

Primary Standards	ID #	Cal Date (Certificate No.)	Scheduled Calibration
Keithley Multimeter Type 2001	SN: 0810278	09-Sep-16 (No:19065)	Sep-17
Secondary Standards	ID #	Check Date (in house)	Scheduled Check
Auto DAE Calibration Unit	SE UWS 053 AA 1001	05-Jan-16 (in house check)	In house check: Jan-17
Calibrator Box V2.1	SE UMS 006 AA 1002	05-Jan-16 (in house check)	In house check: Jan-17

Calibrated by:	Name Adrian Gehring	Function Technician	Signature
Approved by:	Fin Bomholt	Deputy Technical Manager	

Issued: December 15, 2016

This calibration certificate shall not be reproduced except in full without written approval of the laboratory.



Accredited by the Swiss Accreditation Service (SAS)
The Swiss Accreditation Service is one of the signatories to the EA
Multilateral Agreement for the recognition of calibration certificates

Accreditation No.: **SCS 0108**

Glossary

DAE data acquisition electronics
Connector angle information used in DASY system to align probe sensor X to the robot coordinate system.

Methods Applied and Interpretation of Parameters

- *DC Voltage Measurement:* Calibration Factor assessed for use in DASY system by comparison with a calibrated instrument traceable to national standards. The figure given corresponds to the full scale range of the voltmeter in the respective range.
- *Connector angle:* The angle of the connector is assessed measuring the angle mechanically by a tool inserted. Uncertainty is not required.
- The following parameters as documented in the Appendix contain technical information as a result from the performance test and require no uncertainty.
 - *DC Voltage Measurement Linearity:* Verification of the Linearity at +10% and -10% of the nominal calibration voltage. Influence of offset voltage is included in this measurement.
 - *Common mode sensitivity:* Influence of a positive or negative common mode voltage on the differential measurement.
 - *Channel separation:* Influence of a voltage on the neighbor channels not subject to an input voltage.
 - *AD Converter Values with inputs shorted:* Values on the internal AD converter corresponding to zero input voltage
 - *Input Offset Measurement:* Output voltage and statistical results over a large number of zero voltage measurements.
 - *Input Offset Current:* Typical value for information; Maximum channel input offset current, not considering the input resistance.
 - *Input resistance:* Typical value for information: DAE input resistance at the connector, during internal auto-zeroing and during measurement.
 - *Low Battery Alarm Voltage:* Typical value for information. Below this voltage, a battery alarm signal is generated.
 - *Power consumption:* Typical value for information. Supply currents in various operating modes.

DC Voltage Measurement

A/D - Converter Resolution nominal

High Range: 1LSB = 6.1 μ V, full range = -100...+300 mV

Low Range: 1LSB = 61nV, full range = -1.....+3mV

DASY measurement parameters: Auto Zero Time: 3 sec; Measuring time: 3 sec

Calibration Factors	X	Y	Z
High Range	403.882 \pm 0.02% (k=2)	403.668 \pm 0.02% (k=2)	403.797 \pm 0.02% (k=2)
Low Range	3.97364 \pm 1.50% (k=2)	3.98713 \pm 1.50% (k=2)	3.98098 \pm 1.50% (k=2)

Connector Angle

Connector Angle to be used in DASY system	238.0 $^{\circ}$ \pm 1 $^{\circ}$
---	-------------------------------------

Appendix (Additional assessments outside the scope of SCS0108)

1. DC Voltage Linearity

High Range	Reading (μV)	Difference (μV)	Error (%)
Channel X + Input	200031.81	-1.22	-0.00
Channel X + Input	20007.13	2.51	0.01
Channel X - Input	-20002.69	2.85	-0.01
Channel Y + Input	200029.98	-2.72	-0.00
Channel Y + Input	20006.28	1.71	0.01
Channel Y - Input	-20005.88	-0.17	0.00
Channel Z + Input	200030.72	-2.46	-0.00
Channel Z + Input	20004.72	0.25	0.00
Channel Z - Input	-20007.38	-1.48	0.01

Low Range	Reading (μV)	Difference (μV)	Error (%)
Channel X + Input	2000.95	0.20	0.01
Channel X + Input	200.73	-0.09	-0.05
Channel X - Input	-199.18	-0.10	0.05
Channel Y + Input	2000.61	-0.06	-0.00
Channel Y + Input	200.03	-0.76	-0.38
Channel Y - Input	-200.51	-1.26	0.63
Channel Z + Input	2001.22	0.58	0.03
Channel Z + Input	199.16	-1.53	-0.76
Channel Z - Input	-200.72	-1.37	0.69

2. Common mode sensitivity

DASY measurement parameters: Auto Zero Time: 3 sec; Measuring time: 3 sec

	Common mode Input Voltage (mV)	High Range Average Reading (μV)	Low Range Average Reading (μV)
Channel X	200	3.76	2.39
	- 200	-1.64	-3.85
Channel Y	200	-16.60	-16.77
	- 200	15.75	15.23
Channel Z	200	-23.25	-22.87
	- 200	20.50	20.71

3. Channel separation

DASY measurement parameters: Auto Zero Time: 3 sec; Measuring time: 3 sec

	Input Voltage (mV)	Channel X (μV)	Channel Y (μV)	Channel Z (μV)
Channel X	200	-	-0.82	-3.02
Channel Y	200	5.35	-	0.36
Channel Z	200	8.41	2.98	-

4. AD-Converter Values with inputs shorted

DASY measurement parameters: Auto Zero Time: 3 sec; Measuring time: 3 sec

	High Range (LSB)	Low Range (LSB)
Channel X	15873	13890
Channel Y	16099	15731
Channel Z	15951	14368

5. Input Offset Measurement

DASY measurement parameters: Auto Zero Time: 3 sec; Measuring time: 3 sec

Input 10M Ω

	Average (μ V)	min. Offset (μ V)	max. Offset (μ V)	Std. Deviation (μ V)
Channel X	0.27	-0.60	1.03	0.34
Channel Y	0.15	-0.84	0.90	0.36
Channel Z	-0.38	-1.92	0.87	0.46

6. Input Offset Current

Nominal Input circuitry offset current on all channels: <25fA

7. Input Resistance (Typical values for information)

	Zeroing (kOhm)	Measuring (MOhm)
Channel X	200	200
Channel Y	200	200
Channel Z	200	200

8. Low Battery Alarm Voltage (Typical values for information)

Typical values	Alarm Level (VDC)
Supply (+ Vcc)	+7.9
Supply (- Vcc)	-7.6

9. Power Consumption (Typical values for information)

Typical values	Switched off (mA)	Stand by (mA)	Transmitting (mA)
Supply (+ Vcc)	+0.01	+6	+14
Supply (- Vcc)	-0.01	-8	-9



Accredited by the Swiss Accreditation Service (SAS)
The Swiss Accreditation Service is one of the signatories to the EA
Multilateral Agreement for the recognition of calibration certificates

Accreditation No.: **SCS 0108**

Client **Sporton-TW (Auden)**

Certificate No: **DAE4-1399_Nov16**

CALIBRATION CERTIFICATE

Object **DAE4 - SD 000 D04 BM - SN: 1399**

Calibration procedure(s) **QA CAL-06.v29**
Calibration procedure for the data acquisition electronics (DAE)

Calibration date: **November 17, 2016**

This calibration certificate documents the traceability to national standards, which realize the physical units of measurements (SI).
The measurements and the uncertainties with confidence probability are given on the following pages and are part of the certificate.

All calibrations have been conducted in the closed laboratory facility: environment temperature (22 ± 3)°C and humidity < 70%.

Calibration Equipment used (M&TE critical for calibration)

Primary Standards	ID #	Cal Date (Certificate No.)	Scheduled Calibration
Keithley Multimeter Type 2001	SN: 0810278	09-Sep-16 (No:19065)	Sep-17
Secondary Standards	ID #	Check Date (in house)	Scheduled Check
Auto DAE Calibration Unit	SE UWS 053 AA 1001	05-Jan-16 (in house check)	In house check: Jan-17
Calibrator Box V2.1	SE UMS 006 AA 1002	05-Jan-16 (in house check)	In house check: Jan-17

	Name	Function	Signature
Calibrated by:	Dominique Steffen	Technician	
Approved by:	Fin Bomholt	Deputy Technical Manager	

Issued: November 17, 2016

This calibration certificate shall not be reproduced except in full without written approval of the laboratory.



Accredited by the Swiss Accreditation Service (SAS)
The Swiss Accreditation Service is one of the signatories to the EA
Multilateral Agreement for the recognition of calibration certificates

Glossary

DAE data acquisition electronics
Connector angle information used in DASY system to align probe sensor X to the robot coordinate system.

Methods Applied and Interpretation of Parameters

- *DC Voltage Measurement:* Calibration Factor assessed for use in DASY system by comparison with a calibrated instrument traceable to national standards. The figure given corresponds to the full scale range of the voltmeter in the respective range.
- *Connector angle:* The angle of the connector is assessed measuring the angle mechanically by a tool inserted. Uncertainty is not required.
- The following parameters as documented in the Appendix contain technical information as a result from the performance test and require no uncertainty.
 - *DC Voltage Measurement Linearity:* Verification of the Linearity at +10% and -10% of the nominal calibration voltage. Influence of offset voltage is included in this measurement.
 - *Common mode sensitivity:* Influence of a positive or negative common mode voltage on the differential measurement.
 - *Channel separation:* Influence of a voltage on the neighbor channels not subject to an input voltage.
 - *AD Converter Values with inputs shorted:* Values on the internal AD converter corresponding to zero input voltage
 - *Input Offset Measurement:* Output voltage and statistical results over a large number of zero voltage measurements.
 - *Input Offset Current:* Typical value for information; Maximum channel input offset current, not considering the input resistance.
 - *Input resistance:* Typical value for information: DAE input resistance at the connector, during internal auto-zeroing and during measurement.
 - *Low Battery Alarm Voltage:* Typical value for information. Below this voltage, a battery alarm signal is generated.
 - *Power consumption:* Typical value for information. Supply currents in various operating modes.

DC Voltage Measurement

A/D - Converter Resolution nominal

High Range: 1LSB = 6.1 μ V, full range = -100...+300 mV

Low Range: 1LSB = 61nV, full range = -1.....+3mV

DASY measurement parameters: Auto Zero Time: 3 sec; Measuring time: 3 sec

Calibration Factors	X	Y	Z
High Range	403.601 \pm 0.02% (k=2)	403.860 \pm 0.02% (k=2)	403.715 \pm 0.02% (k=2)
Low Range	3.98192 \pm 1.50% (k=2)	3.99210 \pm 1.50% (k=2)	3.98028 \pm 1.50% (k=2)

Connector Angle

Connector Angle to be used in DASY system	302.5 $^{\circ}$ \pm 1 $^{\circ}$
---	-------------------------------------

Appendix (Additional assessments outside the scope of SCS0108)

1. DC Voltage Linearity

High Range	Reading (μV)	Difference (μV)	Error (%)
Channel X + Input	199995.88	1.05	0.00
Channel X + Input	20002.28	0.87	0.00
Channel X - Input	-19998.50	2.29	-0.01
Channel Y + Input	199993.59	-1.44	-0.00
Channel Y + Input	20000.11	-1.26	-0.01
Channel Y - Input	-20001.82	-0.91	0.00
Channel Z + Input	199995.29	-0.07	-0.00
Channel Z + Input	19998.72	-2.63	-0.01
Channel Z - Input	-20002.93	-1.99	0.01

Low Range	Reading (μV)	Difference (μV)	Error (%)
Channel X + Input	2001.09	-0.18	-0.01
Channel X + Input	201.99	0.26	0.13
Channel X - Input	-197.66	0.46	-0.23
Channel Y + Input	2001.13	-0.06	-0.00
Channel Y + Input	200.58	-0.99	-0.49
Channel Y - Input	-198.74	-0.44	0.22
Channel Z + Input	2001.38	0.15	0.01
Channel Z + Input	200.84	-0.68	-0.34
Channel Z - Input	-199.07	-0.83	0.42

2. Common mode sensitivity

DASY measurement parameters: Auto Zero Time: 3 sec; Measuring time: 3 sec

	Common mode Input Voltage (mV)	High Range Average Reading (μV)	Low Range Average Reading (μV)
Channel X	200	-4.94	-6.62
	- 200	8.38	6.51
Channel Y	200	-6.22	-6.54
	- 200	5.04	4.27
Channel Z	200	-6.68	-6.74
	- 200	4.86	5.05

3. Channel separation

DASY measurement parameters: Auto Zero Time: 3 sec; Measuring time: 3 sec

	Input Voltage (mV)	Channel X (μV)	Channel Y (μV)	Channel Z (μV)
Channel X	200	-	4.65	-1.72
Channel Y	200	9.38	-	6.88
Channel Z	200	8.80	6.72	-

4. AD-Converter Values with inputs shorted

DASY measurement parameters: Auto Zero Time: 3 sec; Measuring time: 3 sec

	High Range (LSB)	Low Range (LSB)
Channel X	15826	16053
Channel Y	16118	16526
Channel Z	15887	15918

5. Input Offset Measurement

DASY measurement parameters: Auto Zero Time: 3 sec; Measuring time: 3 sec

Input 10M Ω

	Average (μ V)	min. Offset (μ V)	max. Offset (μ V)	Std. Deviation (μ V)
Channel X	0.11	-0.73	0.73	0.27
Channel Y	-0.19	-1.32	1.76	0.44
Channel Z	-0.78	-2.06	0.51	0.41

6. Input Offset Current

Nominal Input circuitry offset current on all channels: <25fA

7. Input Resistance (Typical values for information)

	Zeroing (kOhm)	Measuring (MOhm)
Channel X	200	200
Channel Y	200	200
Channel Z	200	200

8. Low Battery Alarm Voltage (Typical values for information)

Typical values	Alarm Level (VDC)
Supply (+ Vcc)	+7.9
Supply (- Vcc)	-7.6

9. Power Consumption (Typical values for information)

Typical values	Switched off (mA)	Stand by (mA)	Transmitting (mA)
Supply (+ Vcc)	+0.01	+6	+14
Supply (- Vcc)	-0.01	-8	-9



Accredited by the Swiss Accreditation Service (SAS)
The Swiss Accreditation Service is one of the signatories to the EA
Multilateral Agreement for the recognition of calibration certificates

Accreditation No.: **SCS 0108**

Client **Sporton (Auden)**

Certificate No: **DAE4-778_May17**

CALIBRATION CERTIFICATE

Object **DAE4 - SD 000 D04 BM - SN: 778**

Calibration procedure(s) **QA CAL-06.v29
Calibration procedure for the data acquisition electronics (DAE)**

Calibration date: **May 22, 2017**

This calibration certificate documents the traceability to national standards, which realize the physical units of measurements (SI).
The measurements and the uncertainties with confidence probability are given on the following pages and are part of the certificate.

All calibrations have been conducted in the closed laboratory facility: environment temperature (22 ± 3)°C and humidity < 70%.

Calibration Equipment used (M&TE critical for calibration)

Primary Standards	ID #	Cal Date (Certificate No.)	Scheduled Calibration
Keithley Multimeter Type 2001	SN: 0810278	09-Sep-16 (No:19065)	Sep-17
Secondary Standards	ID #	Check Date (in house)	Scheduled Check
Auto DAE Calibration Unit	SE UWS 053 AA 1001	05-Jan-17 (in house check)	In house check: Jan-18
Calibrator Box V2.1	SE UMS 006 AA 1002	05-Jan-17 (in house check)	In house check: Jan-18

Calibrated by:	Name Adrian Gehring	Function Technician	Signature
Approved by:	Name Fin Bornholt	Function Deputy Technical Manager	Signature

Issued: May 22, 2017

This calibration certificate shall not be reproduced except in full without written approval of the laboratory.



Accredited by the Swiss Accreditation Service (SAS)
The Swiss Accreditation Service is one of the signatories to the EA
Multilateral Agreement for the recognition of calibration certificates

Accreditation No.: **SCS 0108**

Glossary

DAE data acquisition electronics
Connector angle information used in DASY system to align probe sensor X to the robot coordinate system.

Methods Applied and Interpretation of Parameters

- *DC Voltage Measurement*: Calibration Factor assessed for use in DASY system by comparison with a calibrated instrument traceable to national standards. The figure given corresponds to the full scale range of the voltmeter in the respective range.
- *Connector angle*: The angle of the connector is assessed measuring the angle mechanically by a tool inserted. Uncertainty is not required.
- The following parameters as documented in the Appendix contain technical information as a result from the performance test and require no uncertainty.
 - *DC Voltage Measurement Linearity*: Verification of the Linearity at +10% and -10% of the nominal calibration voltage. Influence of offset voltage is included in this measurement.
 - *Common mode sensitivity*: Influence of a positive or negative common mode voltage on the differential measurement.
 - *Channel separation*: Influence of a voltage on the neighbor channels not subject to an input voltage.
 - *AD Converter Values with inputs shorted*: Values on the internal AD converter corresponding to zero input voltage
 - *Input Offset Measurement*: Output voltage and statistical results over a large number of zero voltage measurements.
 - *Input Offset Current*: Typical value for information; Maximum channel input offset current, not considering the input resistance.
 - *Input resistance*: Typical value for information: DAE input resistance at the connector, during internal auto-zeroing and during measurement.
 - *Low Battery Alarm Voltage*: Typical value for information. Below this voltage, a battery alarm signal is generated.
 - *Power consumption*: Typical value for information. Supply currents in various operating modes.

DC Voltage Measurement

A/D - Converter Resolution nominal

High Range: 1LSB = 6.1 μ V, full range = -100...+300 mV

Low Range: 1LSB = 61nV, full range = -1.....+3mV

DASY measurement parameters: Auto Zero Time: 3 sec; Measuring time: 3 sec

Calibration Factors	X	Y	Z
High Range	404.717 \pm 0.02% (k=2)	403.514 \pm 0.02% (k=2)	405.071 \pm 0.02% (k=2)
Low Range	3.98763 \pm 1.50% (k=2)	3.96503 \pm 1.50% (k=2)	4.00094 \pm 1.50% (k=2)

Connector Angle

Connector Angle to be used in DASY system	270.0 $^{\circ}$ \pm 1 $^{\circ}$
---	-------------------------------------

Appendix (Additional assessments outside the scope of SCS0108)

1. DC Voltage Linearity

High Range	Reading (μV)	Difference (μV)	Error (%)
Channel X + Input	199994.64	-1.22	-0.00
Channel X + Input	20002.84	1.48	0.01
Channel X - Input	-19998.43	2.86	-0.01
Channel Y + Input	199993.51	-2.70	-0.00
Channel Y + Input	20002.24	0.88	0.00
Channel Y - Input	-19999.71	1.54	-0.01
Channel Z + Input	199996.74	0.89	0.00
Channel Z + Input	19998.38	-2.84	-0.01
Channel Z - Input	-20005.15	-3.75	0.02

Low Range	Reading (μV)	Difference (μV)	Error (%)
Channel X + Input	2001.64	0.53	0.03
Channel X + Input	200.99	-0.35	-0.17
Channel X - Input	-199.14	-0.59	0.30
Channel Y + Input	2000.89	-0.14	-0.01
Channel Y + Input	201.17	-0.12	-0.06
Channel Y - Input	-199.26	-0.60	0.30
Channel Z + Input	2000.81	-0.14	-0.01
Channel Z + Input	199.84	-1.33	-0.66
Channel Z - Input	-199.58	-0.90	0.45

2. Common mode sensitivity

DASY measurement parameters: Auto Zero Time: 3 sec; Measuring time: 3 sec

	Common mode Input Voltage (mV)	High Range Average Reading (μV)	Low Range Average Reading (μV)
Channel X	200	-4.36	-6.06
	- 200	6.36	4.97
Channel Y	200	-1.03	-1.77
	- 200	0.28	-0.17
Channel Z	200	-12.38	-12.25
	- 200	9.83	10.04

3. Channel separation

DASY measurement parameters: Auto Zero Time: 3 sec; Measuring time: 3 sec

	Input Voltage (mV)	Channel X (μV)	Channel Y (μV)	Channel Z (μV)
Channel X	200	-	-0.44	-2.21
Channel Y	200	8.52	-	0.05
Channel Z	200	3.63	7.19	-

4. AD-Converter Values with inputs shorted

DASY measurement parameters: Auto Zero Time: 3 sec; Measuring time: 3 sec

	High Range (LSB)	Low Range (LSB)
Channel X	16052	16464
Channel Y	16192	17676
Channel Z	16439	15882

5. Input Offset Measurement

DASY measurement parameters: Auto Zero Time: 3 sec; Measuring time: 3 sec

Input 10M Ω

	Average (μ V)	min. Offset (μ V)	max. Offset (μ V)	Std. Deviation (μ V)
Channel X	0.36	-0.69	1.24	0.39
Channel Y	-0.04	-1.05	1.13	0.50
Channel Z	-0.69	-2.03	0.82	0.54

6. Input Offset Current

Nominal Input circuitry offset current on all channels: <25fA

7. Input Resistance (Typical values for information)

	Zeroing (kOhm)	Measuring (MOhm)
Channel X	200	200
Channel Y	200	200
Channel Z	200	200

8. Low Battery Alarm Voltage (Typical values for information)

Typical values	Alarm Level (VDC)
Supply (+ Vcc)	+7.9
Supply (- Vcc)	-7.6

9. Power Consumption (Typical values for information)

Typical values	Switched off (mA)	Stand by (mA)	Transmitting (mA)
Supply (+ Vcc)	+0.01	+6	+14
Supply (- Vcc)	-0.01	-8	-9



Accredited by the Swiss Accreditation Service (SAS)
The Swiss Accreditation Service is one of the signatories to the EA
Multilateral Agreement for the recognition of calibration certificates

Accreditation No.: **SCS 0108**

Client **Sporton - ICC (Auden)**

Certificate No: **DAE4-1424_Feb17**

CALIBRATION CERTIFICATE

Object **DAE4 - SD 000 D04 BM - SN: 1424**

Calibration procedure(s) **QA CAL-06.v29
Calibration procedure for the data acquisition electronics (DAE)**

Calibration date: **February 16, 2017**

This calibration certificate documents the traceability to national standards, which realize the physical units of measurements (SI).
The measurements and the uncertainties with confidence probability are given on the following pages and are part of the certificate.

All calibrations have been conducted in the closed laboratory facility: environment temperature (22 ± 3)°C and humidity < 70%.

Calibration Equipment used (M&TE critical for calibration)

Primary Standards	ID #	Cal Date (Certificate No.)	Scheduled Calibration
Keithley Multimeter Type 2001	SN: 0810278	09-Sep-16 (No:19065)	Sep-17
Secondary Standards	ID #	Check Date (in house)	Scheduled Check
Auto DAE Calibration Unit	SE UWS 053 AA 1001	05-Jan-17 (in house check)	In house check: Jan-18
Calibrator Box V2.1	SE UMS 006 AA 1002	05-Jan-17 (in house check)	In house check: Jan-18

Calibrated by:	Name Adrian Gehring	Function Technician	Signature
Approved by:	Fin Bornholt	Deputy Technical Manager	

Issued: February 16, 2017

This calibration certificate shall not be reproduced except in full without written approval of the laboratory.



Accredited by the Swiss Accreditation Service (SAS)
The Swiss Accreditation Service is one of the signatories to the EA
Multilateral Agreement for the recognition of calibration certificates

Glossary

DAE	data acquisition electronics
Connector angle	information used in DASY system to align probe sensor X to the robot coordinate system.

Methods Applied and Interpretation of Parameters

- *DC Voltage Measurement:* Calibration Factor assessed for use in DASY system by comparison with a calibrated instrument traceable to national standards. The figure given corresponds to the full scale range of the voltmeter in the respective range.
- *Connector angle:* The angle of the connector is assessed measuring the angle mechanically by a tool inserted. Uncertainty is not required.
- The following parameters as documented in the Appendix contain technical information as a result from the performance test and require no uncertainty.
 - *DC Voltage Measurement Linearity:* Verification of the Linearity at +10% and -10% of the nominal calibration voltage. Influence of offset voltage is included in this measurement.
 - *Common mode sensitivity:* Influence of a positive or negative common mode voltage on the differential measurement.
 - *Channel separation:* Influence of a voltage on the neighbor channels not subject to an input voltage.
 - *AD Converter Values with inputs shorted:* Values on the internal AD converter corresponding to zero input voltage
 - *Input Offset Measurement:* Output voltage and statistical results over a large number of zero voltage measurements.
 - *Input Offset Current:* Typical value for information; Maximum channel input offset current, not considering the input resistance.
 - *Input resistance:* Typical value for information: DAE input resistance at the connector, during internal auto-zeroing and during measurement.
 - *Low Battery Alarm Voltage:* Typical value for information. Below this voltage, a battery alarm signal is generated.
 - *Power consumption:* Typical value for information. Supply currents in various operating modes.

DC Voltage Measurement

A/D - Converter Resolution nominal

High Range: 1LSB = 6.1 μ V, full range = -100...+300 mV

Low Range: 1LSB = 61nV, full range = -1.....+3mV

DASY measurement parameters: Auto Zero Time: 3 sec; Measuring time: 3 sec

Calibration Factors	X	Y	Z
High Range	403.134 \pm 0.02% (k=2)	403.619 \pm 0.02% (k=2)	403.192 \pm 0.02% (k=2)
Low Range	3.96929 \pm 1.50% (k=2)	3.99683 \pm 1.50% (k=2)	3.98424 \pm 1.50% (k=2)

Connector Angle

Connector Angle to be used in DASY system	358.0 $^{\circ}$ \pm 1 $^{\circ}$
---	-------------------------------------

Appendix (Additional assessments outside the scope of SCS0108)

1. DC Voltage Linearity

High Range		Reading (μV)	Difference (μV)	Error (%)
Channel X	+ Input	200030.67	-2.60	-0.00
Channel X	+ Input	20005.85	1.13	0.01
Channel X	- Input	-20002.78	2.30	-0.01
Channel Y	+ Input	200031.94	-1.24	-0.00
Channel Y	+ Input	20003.46	-1.30	-0.01
Channel Y	- Input	-20006.16	-1.09	0.01
Channel Z	+ Input	200032.25	-1.01	-0.00
Channel Z	+ Input	20004.24	-0.48	-0.00
Channel Z	- Input	-20006.86	-1.71	0.01

Low Range		Reading (μV)	Difference (μV)	Error (%)
Channel X	+ Input	2001.70	0.52	0.03
Channel X	+ Input	201.06	-0.00	-0.00
Channel X	- Input	-198.66	0.27	-0.13
Channel Y	+ Input	2001.37	0.26	0.01
Channel Y	+ Input	199.96	-1.04	-0.52
Channel Y	- Input	-199.87	-0.90	0.45
Channel Z	+ Input	2000.87	-0.15	-0.01
Channel Z	+ Input	199.84	-1.10	-0.55
Channel Z	- Input	-200.34	-1.29	0.65

2. Common mode sensitivity

DASY measurement parameters: Auto Zero Time: 3 sec; Measuring time: 3 sec

	Common mode Input Voltage (mV)	High Range Average Reading (μV)	Low Range Average Reading (μV)
Channel X	200	-0.52	-2.04
	- 200	2.53	1.37
Channel Y	200	-13.45	-13.66
	- 200	11.80	11.67
Channel Z	200	-9.10	-8.91
	- 200	6.53	6.23

3. Channel separation

DASY measurement parameters: Auto Zero Time: 3 sec; Measuring time: 3 sec

	Input Voltage (mV)	Channel X (μV)	Channel Y (μV)	Channel Z (μV)
Channel X	200	-	2.89	-3.75
Channel Y	200	8.71	-	4.32
Channel Z	200	9.71	6.36	-

4. AD-Converter Values with inputs shorted

DASY measurement parameters: Auto Zero Time: 3 sec; Measuring time: 3 sec

	High Range (LSB)	Low Range (LSB)
Channel X	15953	15468
Channel Y	15877	15900
Channel Z	15869	13329

5. Input Offset Measurement

DASY measurement parameters: Auto Zero Time: 3 sec; Measuring time: 3 sec

Input 10M Ω

	Average (μ V)	min. Offset (μ V)	max. Offset (μ V)	Std. Deviation (μ V)
Channel X	0.70	-0.82	2.12	0.47
Channel Y	-0.67	-2.05	0.88	0.54
Channel Z	-1.55	-2.34	-0.03	0.37

6. Input Offset Current

Nominal Input circuitry offset current on all channels: <25fA

7. Input Resistance (Typical values for information)

	Zeroing (kOhm)	Measuring (MOhm)
Channel X	200	200
Channel Y	200	200
Channel Z	200	200

8. Low Battery Alarm Voltage (Typical values for information)

Typical values	Alarm Level (VDC)
Supply (+ Vcc)	+7.9
Supply (- Vcc)	-7.6

9. Power Consumption (Typical values for information)

Typical values	Switched off (mA)	Stand by (mA)	Transmitting (mA)
Supply (+ Vcc)	+0.01	+6	+14
Supply (- Vcc)	-0.01	-8	-9



In Collaboration with
s p e a g
CALIBRATION LABORATORY



中国认可
国际互认
校准
CALIBRATION
CNAS L0570

Add: No.51 Xueyuan Road, Haidian District, Beijing, 100191, China
Tel: +86-10-62304633-2218 Fax: +86-10-62304633-2209
E-mail: cttl@chinattl.com [Http://www.chinattl.cn](http://www.chinattl.cn)

Client : **sporton**

Certificate No: **Z17-97055**

CALIBRATION CERTIFICATE

Object: **DAE4 - SN: 854**

Calibration Procedure(s): **FF-Z11-002-01**
Calibration Procedure for the Data Acquisition Electronics (DAEx)

Calibration date: **May 02, 2017**

This calibration Certificate documents the traceability to national standards, which realize the physical units of measurements(SI). The measurements and the uncertainties with confidence probability are given on the following pages and are part of the certificate.

All calibrations have been conducted in the closed laboratory facility: environment temperature(22±3)°C and humidity<70%.

Calibration Equipment used (M&TE critical for calibration)

Primary Standards	ID #	Cal Date(Calibrated by, Certificate No.)	Scheduled Calibration
Process Calibrator 753	1971018	27-June-16 (CTTL, No:J16X04778)	June-17

	Name	Function	Signature
Calibrated by:	Yu Zongying	SAR Test Engineer	
Reviewed by:	Lin Hao	SAR Test Engineer	
Approved by:	Qi Dianyuan	SAR Project Leader	

Issued: May 03, 2017

This calibration certificate shall not be reproduced except in full without written approval of the laboratory.



In Collaboration with

s p e a g

CALIBRATION LABORATORY

Add: No.51 Xueyuan Road, Haidian District, Beijing, 100191, China

Tel: +86-10-62304633-2218

Fax: +86-10-62304633-2209

E-mail: ctl@chinattl.com

[Http://www.chinattl.cn](http://www.chinattl.cn)

Glossary:

DAE data acquisition electronics
Connector angle information used in DASY system to align probe sensor X to the robot coordinate system.

Methods Applied and Interpretation of Parameters:

- *DC Voltage Measurement*: Calibration Factor assessed for use in DASY system by comparison with a calibrated instrument traceable to national standards. The figure given corresponds to the full scale range of the voltmeter in the respective range.
- *Connector angle*: The angle of the connector is assessed measuring the angle mechanically by a tool inserted. Uncertainty is not required.
- The report provide only calibration results for DAE, it does not contain other performance test results.



Add: No.51 Xueyuan Road, Haidian District, Beijing, 100191, China
 Tel: +86-10-62304633-2218 Fax: +86-10-62304633-2209
 E-mail: cttl@chinattl.com Http://www.chinattl.cn

DC Voltage Measurement

A/D - Converter Resolution nominal

High Range: 1LSB = 6.1μV, full range = -100...+300 mV

Low Range: 1LSB = 61nV, full range = -1.....+3mV

DASY measurement parameters: Auto Zero Time: 3 sec; Measuring time: 3 sec

Calibration Factors	X	Y	Z
High Range	405.005 ± 0.15% (k=2)	404.208 ± 0.15% (k=2)	405.318 ± 0.15% (k=2)
Low Range	3.96053 ± 0.7% (k=2)	3.94760 ± 0.7% (k=2)	3.96516 ± 0.7% (k=2)

Connector Angle

Connector Angle to be used in DASY system	325.5° ± 1 °
---	--------------



Accredited by the Swiss Accreditation Service (SAS)
The Swiss Accreditation Service is one of the signatories to the EA
Multilateral Agreement for the recognition of calibration certificates

Accreditation No.: **SCS 0108**

Client **Sporton-ICC (Auden)**

Certificate No: **EX3-3976_Feb17**

CALIBRATION CERTIFICATE

Object **EX3DV4 - SN:3976**

Calibration procedure(s) **QA CAL-01.v9, QA CAL-14.v4, QA CAL-23.v5, QA CAL-25.v6
Calibration procedure for dosimetric E-field probes**

Calibration date: **February 21, 2017**

This calibration certificate documents the traceability to national standards, which realize the physical units of measurements (SI).
The measurements and the uncertainties with confidence probability are given on the following pages and are part of the certificate.

All calibrations have been conducted in the closed laboratory facility: environment temperature $(22 \pm 3)^\circ\text{C}$ and humidity $< 70\%$.

Calibration Equipment used (M&TE critical for calibration)

Primary Standards	ID	Cal Date (Certificate No.)	Scheduled Calibration
Power meter NRP	SN: 104778	06-Apr-16 (No. 217-02288/02289)	Apr-17
Power sensor NRP-Z91	SN: 103244	06-Apr-16 (No. 217-02288)	Apr-17
Power sensor NRP-Z91	SN: 103245	06-Apr-16 (No. 217-02289)	Apr-17
Reference 20 dB Attenuator	SN: S5277 (20x)	05-Apr-16 (No. 217-02293)	Apr-17
Reference Probe ES3DV2	SN: 3013	31-Dec-16 (No. ES3-3013_Dec16)	Dec-17
DAE4	SN: 660	7-Dec-16 (No. DAE4-660_Dec16)	Dec-17
Secondary Standards	ID	Check Date (in house)	Scheduled Check
Power meter E4419B	SN: GB41293874	06-Apr-16 (in house check Jun-16)	In house check: Jun-18
Power sensor E4412A	SN: MY41498087	06-Apr-16 (in house check Jun-16)	In house check: Jun-18
Power sensor E4412A	SN: 000110210	06-Apr-16 (in house check Jun-16)	In house check: Jun-18
RF generator HP 8648C	SN: US3642U01700	04-Aug-99 (in house check Jun-16)	In house check: Jun-18
Network Analyzer HP 8753E	SN: US37390585	18-Oct-01 (in house check Oct-16)	In house check: Oct-17

Calibrated by:	Name Claudio Leubler	Function Laboratory Technician	Signature
Approved by:	Katja Pokovic	Technical Manager	
			Issued: February 27, 2017
This calibration certificate shall not be reproduced except in full without written approval of the laboratory.			



Accredited by the Swiss Accreditation Service (SAS)

Accreditation No.: **SCS 0108**

The Swiss Accreditation Service is one of the signatories to the EA
Multilateral Agreement for the recognition of calibration certificates

Glossary:

TSL	tissue simulating liquid
NORM _{x,y,z}	sensitivity in free space
ConvF	sensitivity in TSL / NORM _{x,y,z}
DCP	diode compression point
CF	crest factor (1/duty_cycle) of the RF signal
A, B, C, D	modulation dependent linearization parameters
Polarization φ	φ rotation around probe axis
Polarization ϑ	ϑ rotation around an axis that is in the plane normal to probe axis (at measurement center), i.e., $\vartheta = 0$ is normal to probe axis
Connector Angle	information used in DASY system to align probe sensor X to the robot coordinate system

Calibration is Performed According to the Following Standards:

- a) IEEE Std 1528-2013, "IEEE Recommended Practice for Determining the Peak Spatial-Averaged Specific Absorption Rate (SAR) in the Human Head from Wireless Communications Devices: Measurement Techniques", June 2013
- b) IEC 62209-1, "Procedure to measure the Specific Absorption Rate (SAR) for hand-held devices used in close proximity to the ear (frequency range of 300 MHz to 3 GHz)", February 2005
- c) IEC 62209-2, "Procedure to determine the Specific Absorption Rate (SAR) for wireless communication devices used in close proximity to the human body (frequency range of 30 MHz to 6 GHz)", March 2010
- d) KDB 865664, "SAR Measurement Requirements for 100 MHz to 6 GHz"

Methods Applied and Interpretation of Parameters:

- *NORM_{x,y,z}*: Assessed for E-field polarization $\vartheta = 0$ ($f \leq 900$ MHz in TEM-cell; $f > 1800$ MHz: R22 waveguide). *NORM_{x,y,z}* are only intermediate values, i.e., the uncertainties of *NORM_{x,y,z}* does not affect the E^2 -field uncertainty inside TSL (see below *ConvF*).
- *NORM(f)_{x,y,z} = NORM_{x,y,z} * frequency_response* (see Frequency Response Chart). This linearization is implemented in DASY4 software versions later than 4.2. The uncertainty of the frequency response is included in the stated uncertainty of *ConvF*.
- *DCP_{x,y,z}*: DCP are numerical linearization parameters assessed based on the data of power sweep with CW signal (no uncertainty required). DCP does not depend on frequency nor media.
- *PAR*: PAR is the Peak to Average Ratio that is not calibrated but determined based on the signal characteristics
- *A_{x,y,z}; B_{x,y,z}; C_{x,y,z}; D_{x,y,z}; VR_{x,y,z}*: A, B, C, D are numerical linearization parameters assessed based on the data of power sweep for specific modulation signal. The parameters do not depend on frequency nor media. VR is the maximum calibration range expressed in RMS voltage across the diode.
- *ConvF and Boundary Effect Parameters*: Assessed in flat phantom using E-field (or Temperature Transfer Standard for $f \leq 800$ MHz) and inside waveguide using analytical field distributions based on power measurements for $f > 800$ MHz. The same setups are used for assessment of the parameters applied for boundary compensation (alpha, depth) of which typical uncertainty values are given. These parameters are used in DASY4 software to improve probe accuracy close to the boundary. The sensitivity in TSL corresponds to *NORM_{x,y,z} * ConvF* whereby the uncertainty corresponds to that given for *ConvF*. A frequency dependent *ConvF* is used in DASY version 4.4 and higher which allows extending the validity from ± 50 MHz to ± 100 MHz.
- *Spherical isotropy (3D deviation from isotropy)*: in a field of low gradients realized using a flat phantom exposed by a patch antenna.
- *Sensor Offset*: The sensor offset corresponds to the offset of virtual measurement center from the probe tip (on probe axis). No tolerance required.
- *Connector Angle*: The angle is assessed using the information gained by determining the *NORM_x* (no uncertainty required).

Probe EX3DV4

SN:3976

Manufactured: November 5, 2013
Calibrated: February 21, 2017

Calibrated for DASY/EASY Systems
(Note: non-compatible with DASY2 system!)

DASY/EASY - Parameters of Probe: EX3DV4 - SN:3976

Basic Calibration Parameters

	Sensor X	Sensor Y	Sensor Z	Unc (k=2)
Norm ($\mu\text{V}/(\text{V}/\text{m})^2$) ^A	0.48	0.49	0.54	$\pm 10.1 \%$
DCP (mV) ^B	102.3	101.2	103.1	

Modulation Calibration Parameters

UID	Communication System Name		A dB	B dB $\sqrt{\mu\text{V}}$	C	D dB	VR mV	Unc ^E (k=2)
0	CW	X	0.0	0.0	1.0	0.00	173.0	$\pm 3.0 \%$
		Y	0.0	0.0	1.0		186.1	
		Z	0.0	0.0	1.0		174.0	

The reported uncertainty of measurement is stated as the standard uncertainty of measurement multiplied by the coverage factor k=2, which for a normal distribution corresponds to a coverage probability of approximately 95%.

^A The uncertainties of Norm X,Y,Z do not affect the E²-field uncertainty inside TSL (see Pages 5 and 6).

^B Numerical linearization parameter: uncertainty not required.

^E Uncertainty is determined using the max. deviation from linear response applying rectangular distribution and is expressed for the square of the field value.

DASY/EASY - Parameters of Probe: EX3DV4 - SN:3976

Calibration Parameter Determined in Head Tissue Simulating Media

f (MHz) ^C	Relative Permittivity ^F	Conductivity (S/m) ^F	ConvF X	ConvF Y	ConvF Z	Alpha ^G	Depth ^G (mm)	Unc (k=2)
750	41.9	0.89	10.96	10.96	10.96	0.38	0.95	± 12.0 %
835	41.5	0.90	10.43	10.43	10.43	0.46	0.80	± 12.0 %
900	41.5	0.97	10.28	10.28	10.28	0.49	0.80	± 12.0 %
1750	40.1	1.37	8.93	8.93	8.93	0.33	0.80	± 12.0 %
1900	40.0	1.40	8.62	8.62	8.62	0.39	0.80	± 12.0 %
2000	40.0	1.40	8.61	8.61	8.61	0.29	0.80	± 12.0 %
2450	39.2	1.80	7.83	7.83	7.83	0.32	0.88	± 12.0 %
2600	39.0	1.96	7.60	7.60	7.60	0.36	0.87	± 12.0 %
3700	37.7	3.12	7.60	7.60	7.60	0.25	1.20	± 13.1 %
5250	35.9	4.71	5.56	5.56	5.56	0.35	1.80	± 13.1 %
5600	35.5	5.07	4.98	4.98	4.98	0.40	1.80	± 13.1 %
5750	35.4	5.22	5.16	5.16	5.16	0.40	1.80	± 13.1 %

^C Frequency validity above 300 MHz of ± 100 MHz only applies for DASY v4.4 and higher (see Page 2), else it is restricted to ± 50 MHz. The uncertainty is the RSS of the ConvF uncertainty at calibration frequency and the uncertainty for the indicated frequency band. Frequency validity below 300 MHz is ± 10, 25, 40, 50 and 70 MHz for ConvF assessments at 30, 64, 128, 150 and 220 MHz respectively. Above 5 GHz frequency validity can be extended to ± 110 MHz.

^F At frequencies below 3 GHz, the validity of tissue parameters (ϵ and σ) can be relaxed to ± 10% if liquid compensation formula is applied to measured SAR values. At frequencies above 3 GHz, the validity of tissue parameters (ϵ and σ) is restricted to ± 5%. The uncertainty is the RSS of the ConvF uncertainty for indicated target tissue parameters.

^G Alpha/Depth are determined during calibration. SPEAG warrants that the remaining deviation due to the boundary effect after compensation is always less than ± 1% for frequencies below 3 GHz and below ± 2% for frequencies between 3-6 GHz at any distance larger than half the probe tip diameter from the boundary.

DASY/EASY - Parameters of Probe: EX3DV4 - SN:3976

Calibration Parameter Determined in Body Tissue Simulating Media

f (MHz) ^C	Relative Permittivity ^F	Conductivity (S/m) ^F	ConvF X	ConvF Y	ConvF Z	Alpha ^G	Depth ^G (mm)	Unc (k=2)
750	55.5	0.96	10.68	10.68	10.68	0.51	0.80	± 12.0 %
835	55.2	0.97	10.41	10.41	10.41	0.48	0.80	± 12.0 %
1750	53.4	1.49	8.57	8.57	8.57	0.37	0.80	± 12.0 %
1900	53.3	1.52	8.31	8.31	8.31	0.41	0.80	± 12.0 %
2450	52.7	1.95	7.93	7.93	7.93	0.30	0.92	± 12.0 %
2600	52.5	2.16	7.59	7.59	7.59	0.28	0.92	± 12.0 %
3700	51.0	3.55	6.84	6.84	6.84	0.30	1.20	± 13.1 %
5250	48.9	5.36	4.87	4.87	4.87	0.40	1.90	± 13.1 %
5600	48.5	5.77	4.03	4.03	4.03	0.50	1.90	± 13.1 %
5750	48.3	5.94	4.33	4.33	4.33	0.50	1.90	± 13.1 %

^C Frequency validity above 300 MHz of ± 100 MHz only applies for DASY v4.4 and higher (see Page 2), else it is restricted to ± 50 MHz. The uncertainty is the RSS of the ConvF uncertainty at calibration frequency and the uncertainty for the indicated frequency band. Frequency validity below 300 MHz is ± 10, 25, 40, 50 and 70 MHz for ConvF assessments at 30, 64, 128, 150 and 220 MHz respectively. Above 5 GHz frequency validity can be extended to ± 110 MHz.

^F At frequencies below 3 GHz, the validity of tissue parameters (ϵ and σ) can be relaxed to ± 10% if liquid compensation formula is applied to measured SAR values. At frequencies above 3 GHz, the validity of tissue parameters (ϵ and σ) is restricted to ± 5%. The uncertainty is the RSS of the ConvF uncertainty for indicated target tissue parameters.

^G Alpha/Depth are determined during calibration. SPEAG warrants that the remaining deviation due to the boundary effect after compensation is always less than ± 1% for frequencies below 3 GHz and below ± 2% for frequencies between 3-6 GHz at any distance larger than half the probe tip diameter from the boundary.

Frequency Response of E-Field (TEM-Cell:ifi110 EXX, Waveguide: R22)

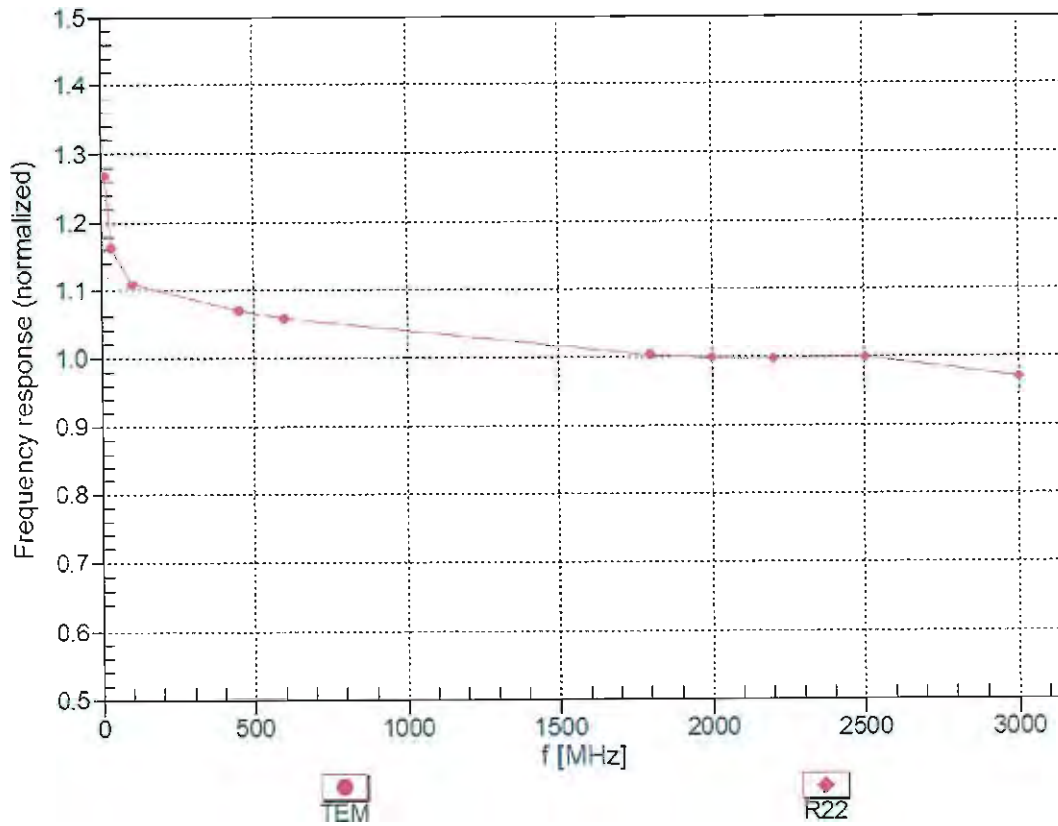

Uncertainty of Frequency Response of E-field: $\pm 6.3\%$ (k=2)

Receiving Pattern (ϕ), $\theta = 0^\circ$

f=600 MHz, TEM

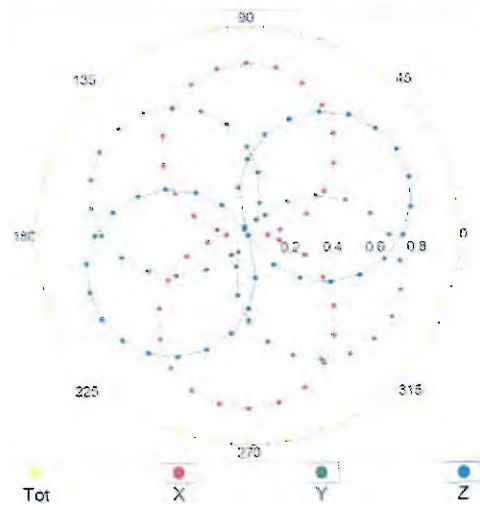

f=1800 MHz, R22

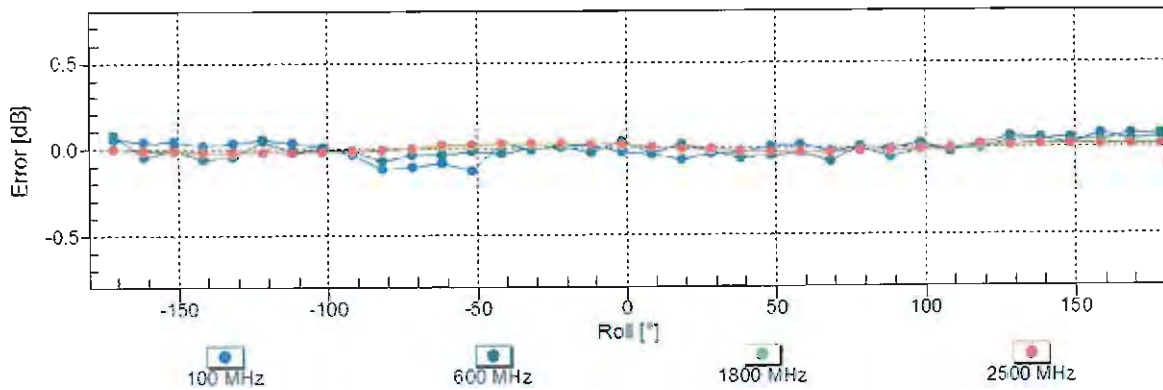
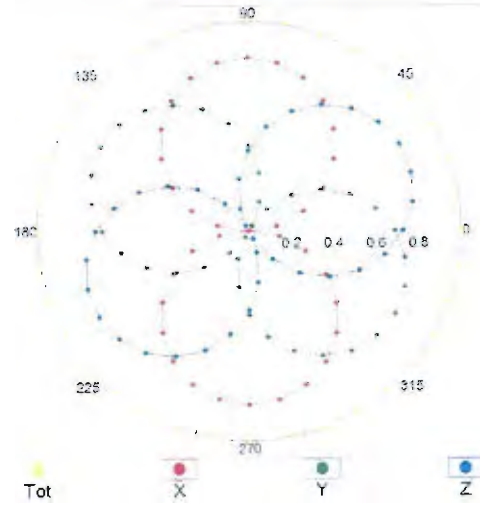

Uncertainty of Axial Isotropy Assessment: $\pm 0.5\%$ (k=2)

Dynamic Range f(SAR_{head}) (TEM cell , f_{eval}= 1900 MHz)

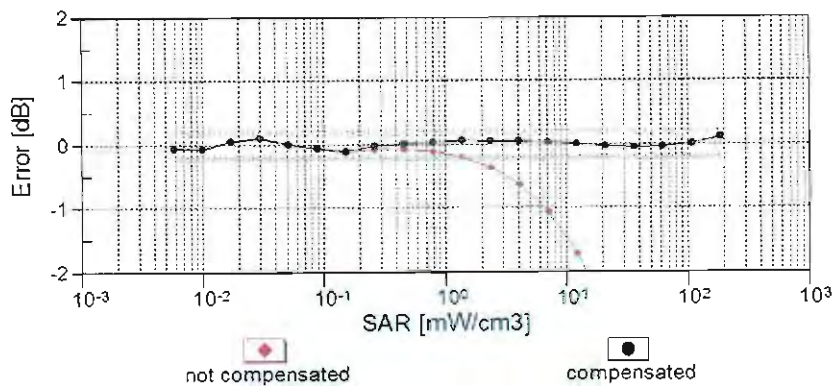
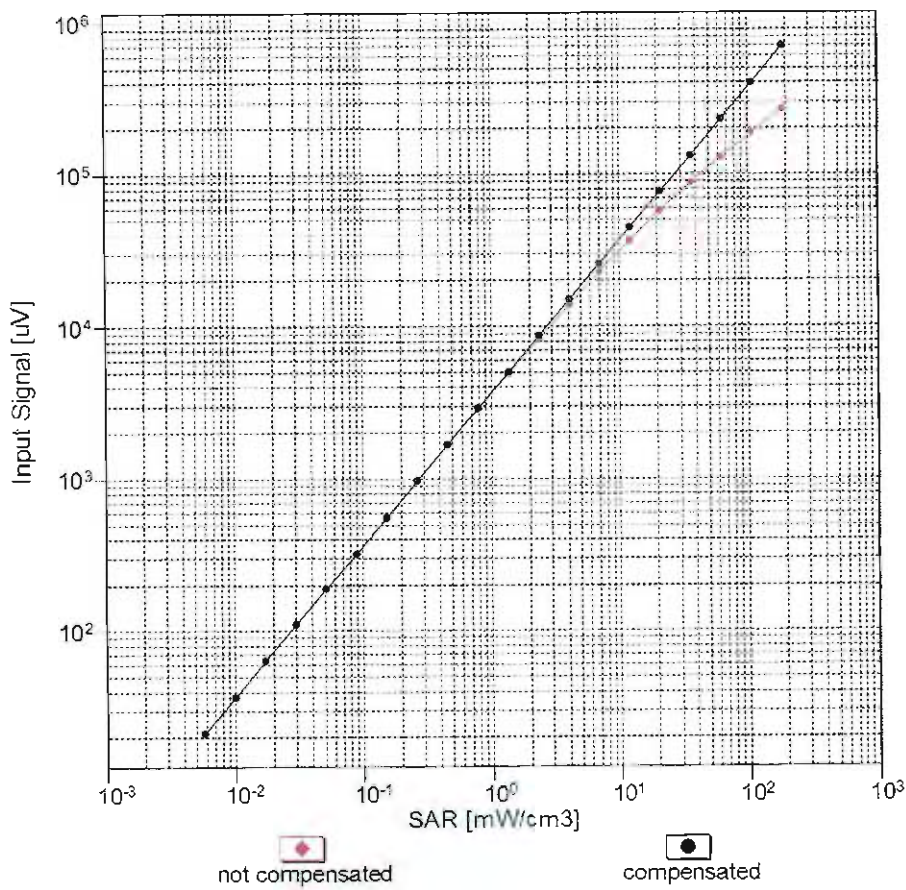

Uncertainty of Linearity Assessment: ± 0.6% (k=2)

Conversion Factor Assessment

f = 835 MHz, WGLS R9 (H_convF)

f = 1900 MHz, WGLS R22 (H_convF)

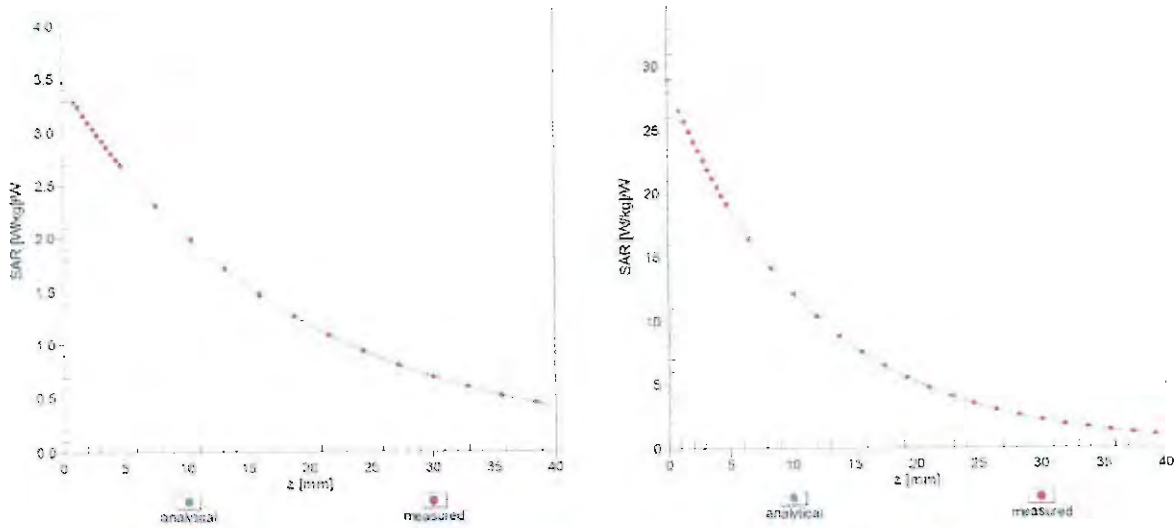

Deviation from Isotropy in Liquid Error (ϕ, ϑ), f = 900 MHz

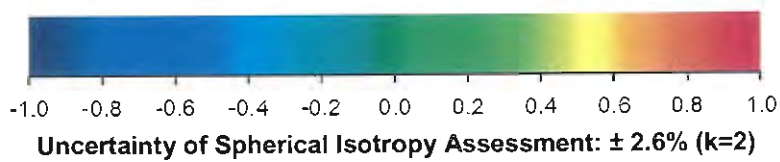
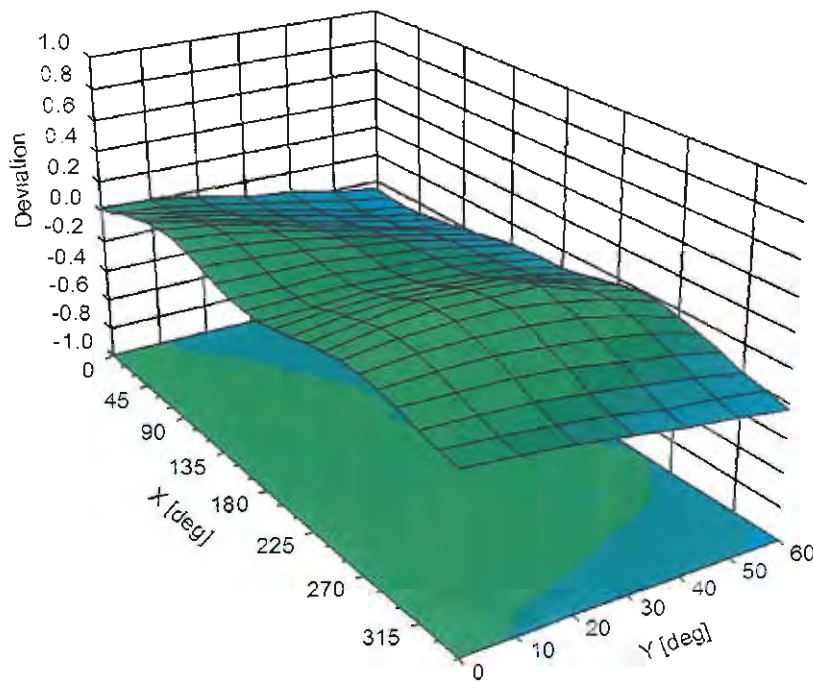

DASY/EASY - Parameters of Probe: EX3DV4 - SN:3976

Other Probe Parameters

Sensor Arrangement	Triangular
Connector Angle (°)	-1.6
Mechanical Surface Detection Mode	enabled
Optical Surface Detection Mode	disabled
Probe Overall Length	337 mm
Probe Body Diameter	10 mm
Tip Length	9 mm
Tip Diameter	2.5 mm
Probe Tip to Sensor X Calibration Point	1 mm
Probe Tip to Sensor Y Calibration Point	1 mm
Probe Tip to Sensor Z Calibration Point	1 mm
Recommended Measurement Distance from Surface	1.4 mm



Accredited by the Swiss Accreditation Service (SAS)
The Swiss Accreditation Service is one of the signatories to the EA
Multilateral Agreement for the recognition of calibration certificates

Accreditation No.: **SCS 0108**

Client **Sporton (Auden)**

Certificate No: **EX3-7306_Jul17**

CALIBRATION CERTIFICATE

Object **EX3DV4 - SN:7306**

Calibration procedure(s) **A CAL-01.v9, QA CAL-14.v4, QA CAL-23.v5, QA CAL-25.v6
Calibration procedure for dosimetric E-field probes**

Calibration date: **July 24, 2017**

This calibration certificate documents the traceability to national standards, which realize the physical units of measurements (SI).
The measurements and the uncertainties with confidence probability are given on the following pages and are part of the certificate.

All calibrations have been conducted in the closed laboratory facility: environment temperature (22 ± 3)°C and humidity < 70%.

Calibration Equipment used (M&TE critical for calibration)

Primary Standards	ID	Cal Date (Certificate No.)	Scheduled Calibration
Power meter NRP	SN: 104778	04-Apr-17 (No. 217-02521/02522)	Apr-18
Power sensor NRP-Z91	SN: 103244	04-Apr-17 (No. 217-02521)	Apr-18
Power sensor NRP-Z91	SN: 103245	04-Apr-17 (No. 217-02525)	Apr-18
Reference 20 dB Attenuator	SN: S5277 (20x)	07-Apr-17 (No. 217-02528)	Apr-18
Reference Probe ES3DV2	SN: 3013	31-Dec-16 (No. ES3-3013_Dec16)	Dec-17
DAE4	SN: 660	7-Dec-16 (No. DAE4-660_Dec16)	Dec-17
Secondary Standards	ID	Check Date (in house)	Scheduled Check
Power meter E4419B	SN: GB41293874	06-Apr-16 (in house check Jun-16)	In house check: Jun-18
Power sensor E4412A	SN: MY41498087	06-Apr-16 (in house check Jun-16)	In house check: Jun-18
Power sensor E4412A	SN: 000110210	06-Apr-16 (in house check Jun-16)	In house check: Jun-18
RF generator HP 8648C	SN: US3642U01700	04-Aug-99 (in house check Jun-16)	In house check: Jun-18
Network Analyzer HP 8753E	SN: US37390585	18-Oct-01 (in house check Oct-16)	In house check: Oct-17

	Name	Function	Signature
Calibrated by:	Michael Weber	Laboratory Technician	
Approved by:	Katja Pokovic	Technical Manager	

Issued: July 25, 2017

This calibration certificate shall not be reproduced except in full without written approval of the laboratory.



Accredited by the Swiss Accreditation Service (SAS)
The Swiss Accreditation Service is one of the signatories to the EA
Multilateral Agreement for the recognition of calibration certificates

Accreditation No.: **SCS 0108**

Glossary:

TSL	tissue simulating liquid
NORM _{x,y,z}	sensitivity in free space
ConvF	sensitivity in TSL / NORM _{x,y,z}
DCP	diode compression point
CF	crest factor (1/duty_cycle) of the RF signal
A, B, C, D	modulation dependent linearization parameters
Polarization φ	φ rotation around probe axis
Polarization ϑ	ϑ rotation around an axis that is in the plane normal to probe axis (at measurement center), i.e., $\vartheta = 0$ is normal to probe axis
Connector Angle	information used in DASY system to align probe sensor X to the robot coordinate system

Calibration is Performed According to the Following Standards:

- a) IEEE Std 1528-2013, "IEEE Recommended Practice for Determining the Peak Spatial-Averaged Specific Absorption Rate (SAR) in the Human Head from Wireless Communications Devices: Measurement Techniques", June 2013
- b) IEC 62209-1, "Measurement procedure for the assessment of Specific Absorption Rate (SAR) from hand-held and body-mounted devices used next to the ear (frequency range of 300 MHz to 6 GHz)", July 2016
- c) IEC 62209-2, "Procedure to determine the Specific Absorption Rate (SAR) for wireless communication devices used in close proximity to the human body (frequency range of 30 MHz to 6 GHz)", March 2010
- d) KDB 865664, "SAR Measurement Requirements for 100 MHz to 6 GHz"

Methods Applied and Interpretation of Parameters:

- **NORM_{x,y,z}**: Assessed for E-field polarization $\vartheta = 0$ ($f \leq 900$ MHz in TEM-cell; $f > 1800$ MHz: R22 waveguide). NORM_{x,y,z} are only intermediate values, i.e., the uncertainties of NORM_{x,y,z} does not affect the E²-field uncertainty inside TSL (see below *ConvF*).
- **NORM(f)_{x,y,z}** = NORM_{x,y,z} * *frequency_response* (see Frequency Response Chart). This linearization is implemented in DASY4 software versions later than 4.2. The uncertainty of the frequency response is included in the stated uncertainty of *ConvF*.
- **DCP_{x,y,z}**: DCP are numerical linearization parameters assessed based on the data of power sweep with CW signal (no uncertainty required). DCP does not depend on frequency nor media.
- **PAR**: PAR is the Peak to Average Ratio that is not calibrated but determined based on the signal characteristics
- **A_{x,y,z}; B_{x,y,z}; C_{x,y,z}; D_{x,y,z}; VR_{x,y,z}**: A, B, C, D are numerical linearization parameters assessed based on the data of power sweep for specific modulation signal. The parameters do not depend on frequency nor media. VR is the maximum calibration range expressed in RMS voltage across the diode.
- **ConvF and Boundary Effect Parameters**: Assessed in flat phantom using E-field (or Temperature Transfer Standard for $f \leq 800$ MHz) and inside waveguide using analytical field distributions based on power measurements for $f > 800$ MHz. The same setups are used for assessment of the parameters applied for boundary compensation (alpha, depth) of which typical uncertainty values are given. These parameters are used in DASY4 software to improve probe accuracy close to the boundary. The sensitivity in TSL corresponds to NORM_{x,y,z} * ConvF whereby the uncertainty corresponds to that given for ConvF. A frequency dependent ConvF is used in DASY version 4.4 and higher which allows extending the validity from ± 50 MHz to ± 100 MHz.
- **Spherical isotropy (3D deviation from isotropy)**: in a field of low gradients realized using a flat phantom exposed by a patch antenna.
- **Sensor Offset**: The sensor offset corresponds to the offset of virtual measurement center from the probe tip (on probe axis). No tolerance required.
- **Connector Angle**: The angle is assessed using the information gained by determining the NORM_x (no uncertainty required).

Probe EX3DV4

SN:7306

Manufactured:	March 11, 2014
Repaired:	July 17, 2017
Calibrated:	July 24, 2017

Calibrated for DASY/EASY Systems
(Note: non-compatible with DASY2 system!)

DASY/EASY - Parameters of Probe: EX3DV4 - SN:7306

Basic Calibration Parameters

	Sensor X	Sensor Y	Sensor Z	Unc (k=2)
Norm ($\mu\text{V}/(\text{V}/\text{m})^2$) ^A	0.49	0.58	0.46	$\pm 10.1 \%$
DCP (mV) ^B	99.6	93.5	97.4	

Modulation Calibration Parameters

UID	Communication System Name		A dB	B dB $\sqrt{\mu\text{V}}$	C	D dB	VR mV	Unc ^E (k=2)
0	CW	X	0.0	0.0	1.0	0.00	142.9	$\pm 3.5 \%$
		Y	0.0	0.0	1.0		146.1	
		Z	0.0	0.0	1.0		142.3	

The reported uncertainty of measurement is stated as the standard uncertainty of measurement multiplied by the coverage factor k=2, which for a normal distribution corresponds to a coverage probability of approximately 95%.

^A The uncertainties of Norm X,Y,Z do not affect the E²-field uncertainty inside TSL (see Pages 5 and 6).

^B Numerical linearization parameter: uncertainty not required.

^E Uncertainty is determined using the max. deviation from linear response applying rectangular distribution and is expressed for the square of the field value.

DASY/EASY - Parameters of Probe: EX3DV4 - SN:7306

Calibration Parameter Determined in Head Tissue Simulating Media

f (MHz) ^C	Relative Permittivity ^F	Conductivity (S/m) ^F	ConvF X	ConvF Y	ConvF Z	Alpha ^G	Depth ^G (mm)	Unc (k=2)
750	41.9	0.89	9.96	9.96	9.96	0.48	0.80	± 12.0 %
835	41.5	0.90	9.79	9.79	9.79	0.45	0.80	± 12.0 %
900	41.5	0.97	9.50	9.50	9.50	0.34	0.98	± 12.0 %
1750	40.1	1.37	8.64	8.64	8.64	0.36	0.80	± 12.0 %
1900	40.0	1.40	8.34	8.34	8.34	0.32	0.80	± 12.0 %
2000	40.0	1.40	8.32	8.32	8.32	0.35	0.86	± 12.0 %
2450	39.2	1.80	7.49	7.49	7.49	0.36	0.80	± 12.0 %
2600	39.0	1.96	7.36	7.36	7.36	0.37	0.80	± 12.0 %
5250	35.9	4.71	5.58	5.58	5.58	0.35	1.80	± 13.1 %
5600	35.5	5.07	4.73	4.73	4.73	0.40	1.80	± 13.1 %
5750	35.4	5.22	5.10	5.10	5.10	0.40	1.80	± 13.1 %

^C Frequency validity above 300 MHz of ± 100 MHz only applies for DASY v4.4 and higher (see Page 2), else it is restricted to ± 50 MHz. The uncertainty is the RSS of the ConvF uncertainty at calibration frequency and the uncertainty for the indicated frequency band. Frequency validity below 300 MHz is ± 10, 25, 40, 50 and 70 MHz for ConvF assessments at 30, 64, 128, 150 and 220 MHz respectively. Above 5 GHz frequency validity can be extended to ± 110 MHz.

^F At frequencies below 3 GHz, the validity of tissue parameters (ϵ and σ) can be relaxed to ± 10% if liquid compensation formula is applied to measured SAR values. At frequencies above 3 GHz, the validity of tissue parameters (ϵ and σ) is restricted to ± 5%. The uncertainty is the RSS of the ConvF uncertainty for indicated target tissue parameters.

^G Alpha/Depth are determined during calibration. SPEAG warrants that the remaining deviation due to the boundary effect after compensation is always less than ± 1% for frequencies below 3 GHz and below ± 2% for frequencies between 3-6 GHz at any distance larger than half the probe tip diameter from the boundary.

DASY/EASY - Parameters of Probe: EX3DV4 - SN:7306

Calibration Parameter Determined in Body Tissue Simulating Media

f (MHz) ^C	Relative Permittivity ^F	Conductivity (S/m) ^F	ConvF X	ConvF Y	ConvF Z	Alpha ^G	Depth (mm) ^G	Unc (k=2)
750	55.5	0.96	10.09	10.09	10.09	0.47	0.84	± 12.0 %
835	55.2	0.97	9.85	9.85	9.85	0.42	0.80	± 12.0 %
1750	53.4	1.49	8.29	8.29	8.29	0.44	0.80	± 12.0 %
1900	53.3	1.52	7.98	7.98	7.98	0.43	0.80	± 12.0 %
2450	52.7	1.95	7.73	7.73	7.73	0.32	0.90	± 12.0 %
2600	52.5	2.16	7.46	7.46	7.46	0.26	0.96	± 12.0 %
5250	48.9	5.36	5.05	5.05	5.05	0.35	1.90	± 13.1 %
5600	48.5	5.77	4.29	4.29	4.29	0.40	1.90	± 13.1 %
5750	48.3	5.94	4.47	4.47	4.47	0.45	1.90	± 13.1 %

^C Frequency validity above 300 MHz of ± 100 MHz only applies for DASY v4.4 and higher (see Page 2), else it is restricted to ± 50 MHz. The uncertainty is the RSS of the ConvF uncertainty at calibration frequency and the uncertainty for the indicated frequency band. Frequency validity below 300 MHz is ± 10, 25, 40, 50 and 70 MHz for ConvF assessments at 30, 64, 128, 150 and 220 MHz respectively. Above 5 GHz frequency validity can be extended to ± 110 MHz.

^F At frequencies below 3 GHz, the validity of tissue parameters (ϵ and σ) can be relaxed to ± 10% if liquid compensation formula is applied to measured SAR values. At frequencies above 3 GHz, the validity of tissue parameters (ϵ and σ) is restricted to ± 5%. The uncertainty is the RSS of the ConvF uncertainty for indicated target tissue parameters.

^G Alpha/Depth are determined during calibration. SPEAG warrants that the remaining deviation due to the boundary effect after compensation is always less than ± 1% for frequencies below 3 GHz and below ± 2% for frequencies between 3-6 GHz at any distance larger than half the probe tip diameter from the boundary.

Frequency Response of E-Field (TEM-Cell:ifi110 EXX, Waveguide: R22)

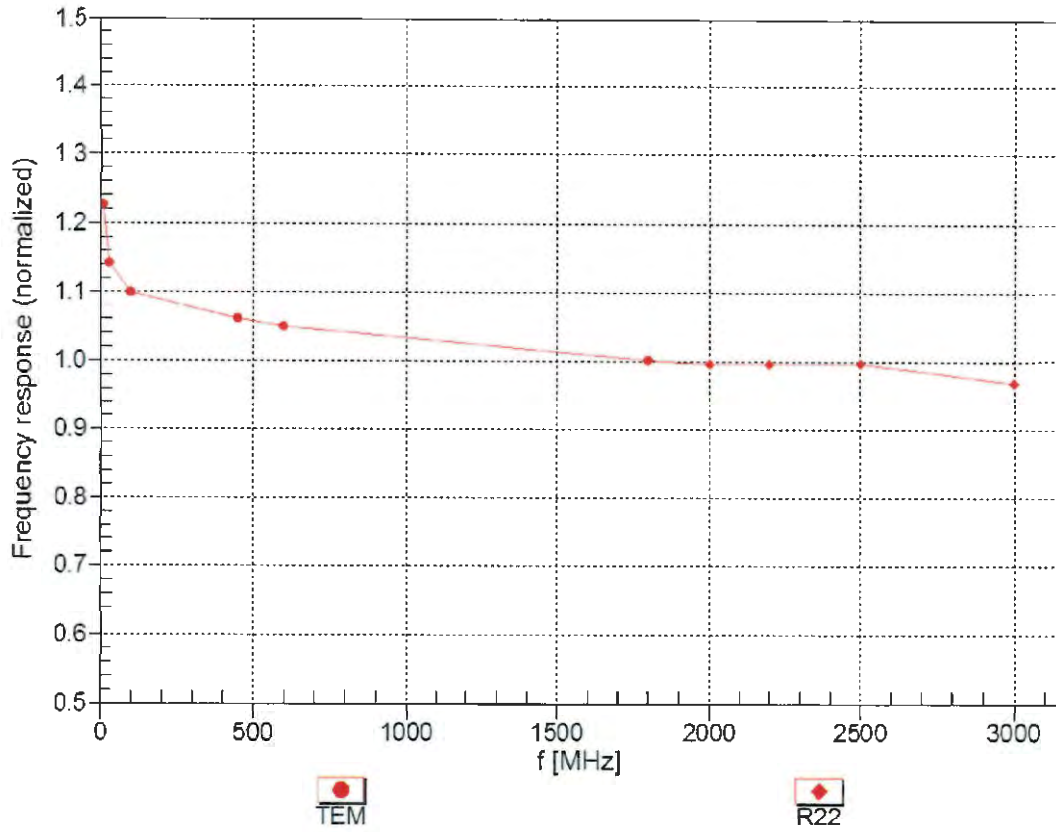

Uncertainty of Frequency Response of E-field: $\pm 6.3\%$ (k=2)

Receiving Pattern (ϕ), $\theta = 0^\circ$

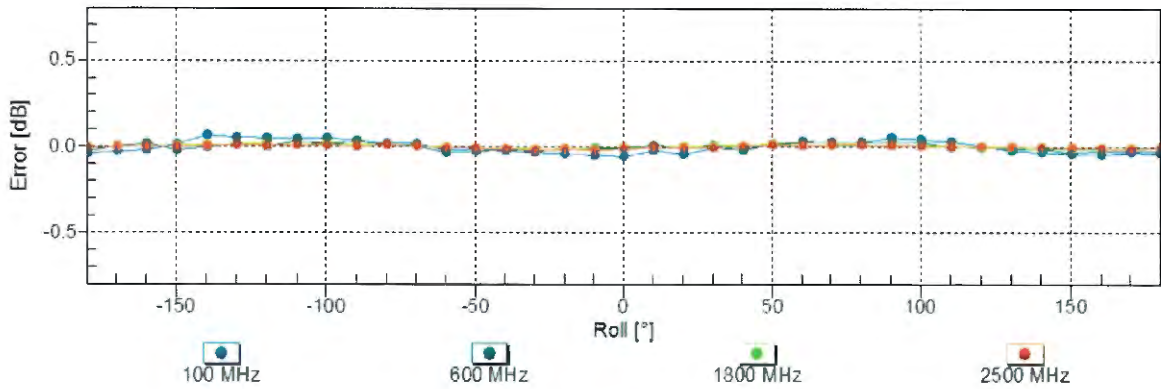
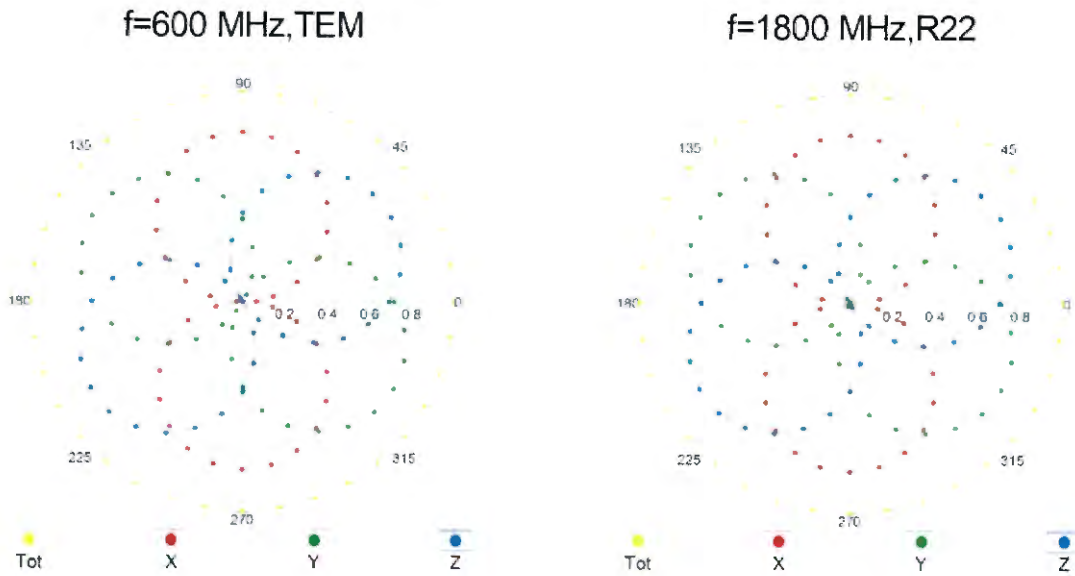

Uncertainty of Axial Isotropy Assessment: $\pm 0.5\%$ ($k=2$)