

FCC SAR Test Report

APPLICANT : HTC Corporation
EQUIPMENT : Smartphone
MODEL NAME : 2Q3F300
FCC ID : NM82Q3F300
STANDARD : FCC 47 CFR Part 2 (2.1093)
ANSI/IEEE C95.1-1992
IEEE 1528-2013

We, SPORTON INTERNATIONAL INC., would like to declare that the tested sample has been evaluated in accordance with the procedures and had been in compliance with the applicable technical standards.

The test results in this report apply exclusively to the tested model / sample. Without written approval of SPORTON INTERNATIONAL INC., the test report shall not be reproduced except in full.

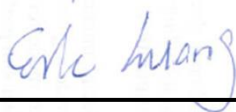

Reviewed by: Eric Huang / Manager



Approved by: Jones Tsai / Manager



SPORTON INTERNATIONAL INC.

No.52, Hwa Ya 1st Rd., Hwa Ya Technology Park, Kwei-Shan District, Taoyuan City, Taiwan (R.O.C.)



Table of Contents

1. Statement of Compliance 4
2. Administration Data 5
3. Guidance Applied..... 5
4. Equipment Under Test (EUT) Information..... 6
4.1 General Information 6
4.2 General LTE SAR Test and Reporting Considerations 8
5. RF Exposure Limits.....10
5.1 Uncontrolled Environment.....10
5.2 Controlled Environment.....10
6. Specific Absorption Rate (SAR).....11
6.1 Introduction 11
6.2 SAR Definition..... 11
7. System Description and Setup12
7.1 E-Field Probe13
7.2 Data Acquisition Electronics (DAE)13
7.3 Phantom.....14
7.4 Device Holder.....15
8. Measurement Procedures16
8.1 Spatial Peak SAR Evaluation16
8.2 Power Reference Measurement.....17
8.3 Area Scan17
8.4 Zoom Scan.....18
8.5 Volume Scan Procedures.....18
8.6 Power Drift Monitoring.....18
9. Test Equipment List19
10. System Verification20
10.1 Tissue Simulating Liquids.....20
10.2 Tissue Verification21
10.3 System Performance Check Results.....23
11. RF Exposure Positions24
11.1 Ear and handset reference point24
11.2 Definition of the cheek position.....25
11.3 Definition of the tilt position.....26
11.4 Body Worn Accessory27
11.5 Wireless Router.....27
12. Conducted RF Output Power (Unit: dBm).....28
13. Exclusions Applied57
14. Antenna Location58
15. SAR Test Results59
15.1 Head SAR61
15.2 Hotspot SAR67
15.3 Body Worn Accessory SAR.....73
15.4 Repeated SAR Measurement76
16. Simultaneous Transmission Analysis.....77
16.1 Head Exposure Conditions78
16.2 Hotspot Exposure Conditions.....80
16.3 Body-Worn Accessory Exposure Conditions84
17. Uncertainty Assessment86
18. References.....89
Appendix A. Plots of System Performance Check
Appendix B. Plots of High SAR Measurement
Appendix C. DASYS Calibration Certificate
Appendix D. Test Setup Photos



1. Statement of Compliance

The maximum results of Specific Absorption Rate (SAR) found during testing for HTC Corporation, Smartphone, 2Q3F300, are as follows.

Equipment Class	Frequency Band	Highest SAR Summary			Highest Simultaneous Transmission 1g SAR (W/kg)
		Head (Separation 0mm)	Body-worn (Separation 10mm)	Hotspot (Separation 10mm)	
		1g SAR (W/kg)			
Licensed	GSM850	0.16	0.28	0.28	1.31
	GSM1900	0.35	1.00	1.00	
	WCDMA II	0.27	0.70	0.70	
	WCDMA IV	0.30	0.58	0.58	
	WCDMA V	0.12	0.19	0.19	
	LTE Band 2	0.26	0.55	0.55	
	LTE Band 5	0.07	0.13	0.13	
	LTE Band 7	0.59	0.69	0.69	
	LTE Band 12 / 17	0.09	0.18	0.18	
	LTE Band 13	0.08	0.15	0.15	
LTE Band 4 / 66	0.24	0.46	0.46		
DTS	2.4GHz WLAN	0.29	0.31	0.31	1.31
NII	5GHz WLAN	0.33	< 0.01	0.09	1.09
DSS	Bluetooth	0.01			1.13
Date of Testing:		2017/6/7 ~ 2017/8/23			
Remark :					
This device supports both LTE B4, B12, B17 and B66. Since the supported frequency span for LTE B4 and B17 falls completely within the supported frequency span for LTE B66 and B17, both LTE bands have the same target power, and both LTE bands share the same transmission path; therefore, SAR was only assessed for LTE B66 and B12.					

This device is in compliance with Specific Absorption Rate (SAR) for general population/uncontrolled exposure limits (1.6 W/kg) specified in FCC 47 CFR part 2 (2.1093) and ANSI/IEEE C95.1-1992, and had been tested in accordance with the measurement methods and procedures specified in IEEE 1528-2013 and FCC KDB publications

2. Administration Data

Testing Laboratory	
Test Site	SPORTON INTERNATIONAL INC.
Test Site Location	No.52, Hwa Ya 1st Rd., Hwa Ya Technology Park, Kwei-Shan District, Taoyuan City, Taiwan (R.O.C.) TEL: +886-3-327-3456 FAX: +886-3-328-4978

Applicant	
Company Name	HTC Corporation
Address	No.23, Xinghua Rd., Taoyuan District, Taoyuan City, Taiwan 330

Manufacturer	
Company Name	HTC Corporation
Address	No.23, Xinghua Rd., Taoyuan District, Taoyuan City, Taiwan 330

3. Guidance Applied

The Specific Absorption Rate (SAR) testing specification, method, and procedure for this device is in accordance with the following standards:

- FCC 47 CFR Part 2 (2.1093)
- ANSI/IEEE C95.1-1992
- IEEE 1528-2013
- FCC KDB 865664 D01 SAR Measurement 100 MHz to 6 GHz v01r04
- FCC KDB 865664 D02 SAR Reporting v01r02
- FCC KDB 447498 D01 General RF Exposure Guidance v06
- FCC KDB 648474 D04 SAR Evaluation Considerations for Wireless Handsets v01r03
- FCC KDB 248227 D01 802.11 Wi-Fi SAR v02r02
- FCC KDB 941225 D01 3G SAR Procedures v03r01
- FCC KDB 941225 D05 SAR for LTE Devices v02r05
- FCC KDB 941225 D05A Rel.10 LTE SAR Test Guidance v01r02
- FCC KDB 941225 D06 Hotspot Mode SAR v02r01



4. Equipment Under Test (EUT) Information

4.1 General Information

Product Feature & Specification	
Equipment Name	Smartphone
Model Name	2Q3F300
FCC ID	NM82Q3F300
IMEI	Main: 358722080011775 2nd: 358722080017731
Wireless Technology and Frequency Range	GSM850: 824.2 MHz ~ 848.8 MHz GSM1900: 1850.2 MHz ~ 1909.8 MHz WCDMA Band II: 1852.4 MHz ~ 1907.6 MHz WCDMA Band IV: 1712.4 MHz ~ 1752.6 MHz WCDMA Band V: 826.4 MHz ~ 846.6 MHz LTE Band 2: 1850.7 MHz ~ 1909.3 MHz LTE Band 4: 1710.7 MHz ~ 1754.3 MHz LTE Band 5: 824.7 MHz ~ 848.3 MHz LTE Band 7: 2502.5 MHz ~ 2567.5 MHz LTE Band 12: 699.7 MHz ~ 715.3 MHz LTE Band 13: 779.5 MHz ~ 784.5 MHz LTE Band 17: 706.5 MHz ~ 713.5 MHz LTE Band 66: 1710.7 MHz ~ 1779.3 MHz WLAN 2.4GHz Band: 2412 MHz ~ 2462 MHz WLAN 5.2GHz Band: 5180 MHz ~ 5240 MHz WLAN 5.3GHz Band: 5260 MHz ~ 5320 MHz WLAN 5.5GHz Band: 5500 MHz ~ 5700 MHz WLAN 5.8GHz Band: 5745 MHz ~ 5825 MHz Bluetooth: 2402 MHz ~ 2480 MHz NFC : 13.56 MHz ANT+ : 2402 MHz ~ 2480 MHz
Mode	GSM/GPRS/EGPRS RMC/AMR 12.2Kbps HSDPA HSUPA DC-HSDPA LTE: QPSK, 16QAM WLAN 2.4GHz : 802.11b/g/n HT20/HT40 WLAN 5GHz : 802.11a/n/ac HT20/HT40/VHT20/VHT40/VHT80 Bluetooth BR/EDR/LE/BT5.0 NFC:ASK ANT+: GFSK
GSM / (E)GPRS Transfer mode	Class B – EUT cannot support Packet Switched and Circuit Switched Network simultaneously but can automatically switch between Packet and Circuit Switched Network.
EUT Stage	Production Unit
Remark:	
<ol style="list-style-type: none"> This device WLAN 2.4GHz / 5.2GHz / 5.8GHz supports Hotspot operation and Bluetooth support tethering applications. There are 1st PCB and 2nd PCB, the hardware change are USB board, antenna board and speaker module. Regarding the differences, perform full WWAN SAR testing on sample 1 and sample 3, and the WLAN/BT was perform on the sample1, due to the change was not affect WLAN/BT performance, sample2 spot check worse case found in sample1 and sample3. For the LTE setting which controlled by software, there are two Skus of device. Sku 1 supports LTE category 9(up to 450 Mbps), and Sku 2 support category 11(up to 600 Mbps) and 256QAM downlink. Since the differences. 	



Sample Information	
Sample 1	EUT with battery 1 and 1st PCB
Sample 2	EUT with battery 2 and 1st PCB
Sample 3	EUT with battery 1 and 2nd PCB

Accessories Information		
Battery 1	Brand Name	HTC
	Manufacturer	WTE
	Model Name	B2Q3F100
Battery 2	Brand Name	HTC
	Manufacturer	WTE
	Model Name	B2Q3F100
Earphone 1	Brand Name	HTC
	Model Name	MAX 320



4.2 General LTE SAR Test and Reporting Considerations

Summarized necessary items addressed in KDB 941225 D05 v02r05																																							
FCC ID	NM82Q3F300																																						
Equipment Name	Smartphone																																						
Operating Frequency Range of each LTE transmission band	LTE Band 2: 1850.7 MHz ~ 1909.3 MHz LTE Band 4: 1710.7 MHz ~ 1754.3 MHz LTE Band 5: 824.7 MHz ~ 848.3 MHz LTE Band 7: 2502.5 MHz ~ 2567.5 MHz LTE Band 12: 699.7 MHz ~ 715.3 MHz LTE Band 13: 779.5 MHz ~ 784.5 MHz LTE Band 17: 706.5 MHz ~ 713.5 MHz LTE Band 66: 1710.7 MHz ~ 1779.3 MHz																																						
Channel Bandwidth	LTE Band 02: 1.4MHz, 3MHz, 5MHz, 10MHz, 15MHz, 20MHz LTE Band 04: 1.4MHz, 3MHz, 5MHz, 10MHz, 15MHz, 20MHz LTE Band 05: 1.4MHz, 3MHz, 5MHz, 10MHz LTE Band 07: 5MHz, 10MHz, 15MHz, 20MHz LTE Band 12: 1.4MHz, 3MHz, 5MHz, 10MHz LTE Band 13: 5MHz, 10MHz LTE Band 17: 5MHz, 10MHz LTE Band 66: 1.4MHz, 3MHz, 5MHz, 10MHz, 15MHz, 20MHz																																						
uplink modulations used	QPSK / 16QAM																																						
LTE Voice / Data requirements	Voice and Data																																						
LTE MPR permanently built-in by design	<p align="center">Table 6.2.3-1: Maximum Power Reduction (MPR) for Power Class 3</p> <table border="1"> <thead> <tr> <th rowspan="2">Modulation</th> <th colspan="6">Channel bandwidth / Transmission bandwidth (RB)</th> <th rowspan="2">MPR (dB)</th> </tr> <tr> <th>1.4 MHz</th> <th>3.0 MHz</th> <th>5 MHz</th> <th>10 MHz</th> <th>15 MHz</th> <th>20 MHz</th> </tr> </thead> <tbody> <tr> <td>QPSK</td> <td>> 5</td> <td>> 4</td> <td>> 8</td> <td>> 12</td> <td>> 16</td> <td>> 18</td> <td>≤ 1</td> </tr> <tr> <td>16 QAM</td> <td>≤ 5</td> <td>≤ 4</td> <td>≤ 8</td> <td>≤ 12</td> <td>≤ 16</td> <td>≤ 18</td> <td>≤ 1</td> </tr> <tr> <td>16 QAM</td> <td>> 5</td> <td>> 4</td> <td>> 8</td> <td>> 12</td> <td>> 16</td> <td>> 18</td> <td>≤ 2</td> </tr> </tbody> </table>	Modulation	Channel bandwidth / Transmission bandwidth (RB)						MPR (dB)	1.4 MHz	3.0 MHz	5 MHz	10 MHz	15 MHz	20 MHz	QPSK	> 5	> 4	> 8	> 12	> 16	> 18	≤ 1	16 QAM	≤ 5	≤ 4	≤ 8	≤ 12	≤ 16	≤ 18	≤ 1	16 QAM	> 5	> 4	> 8	> 12	> 16	> 18	≤ 2
Modulation	Channel bandwidth / Transmission bandwidth (RB)						MPR (dB)																																
	1.4 MHz	3.0 MHz	5 MHz	10 MHz	15 MHz	20 MHz																																	
QPSK	> 5	> 4	> 8	> 12	> 16	> 18	≤ 1																																
16 QAM	≤ 5	≤ 4	≤ 8	≤ 12	≤ 16	≤ 18	≤ 1																																
16 QAM	> 5	> 4	> 8	> 12	> 16	> 18	≤ 2																																
LTE A-MPR	In the base station simulator configuration, Network Setting value is set to NS_01 to disable A-MPR during SAR testing and the LTE SAR tests was transmitting on all TTI frames (Maximum TTI)																																						
Spectrum plots for RB configuration	A properly configured base station simulator was used for the SAR and power measurement; therefore, spectrum plots for each RB allocation and offset configuration are not included in the SAR report.																																						
LTE Carrier Aggregation Combinations	Inter-Band and Intra-Band possible combinations as below page and the detail power verification please refer to section 12.																																						
LTE Carrier Aggregation Additional Information	This device does not support full CA features on 3GPP Release 11. It supports a maximum of 2 carriers in the downlink only. All uplink communications are identical to the Release 8 Specifications. Uplink communications are done on the PCC. The following LTE Release features are not supported: Relay, HetNet, Enhanced MIMO, eICI, WiFi Offloading, MDH, eMBMA, Cross-Carrier Scheduling, Enhanced SC-FDMA.																																						



Transmission (H, M, L) channel numbers and frequencies in each LTE band																
LTE Band 2																
	Bandwidth 1.4 MHz		Bandwidth 3 MHz		Bandwidth 5 MHz		Bandwidth 10 MHz		Bandwidth 15 MHz		Bandwidth 20 MHz					
	Ch. #	Freq. (MHz)	Ch. #	Freq. (MHz)	Ch. #	Freq. (MHz)	Ch. #	Freq. (MHz)	Ch. #	Freq. (MHz)	Ch. #	Freq. (MHz)				
L	18607	1850.7	18615	1851.5	18625	1852.5	18650	1855	18675	1857.5	18700	1860				
M	18900	1880	18900	1880	18900	1880	18900	1880	18900	1880	18900	1880				
H	19193	1909.3	19185	1908.5	19175	1907.5	19150	1905	19125	1902.5	19100	1900				
LTE Band 4																
	Bandwidth 1.4 MHz		Bandwidth 3 MHz		Bandwidth 5 MHz		Bandwidth 10 MHz		Bandwidth 15 MHz		Bandwidth 20 MHz					
	Ch. #	Freq. (MHz)	Ch. #	Freq. (MHz)	Ch. #	Freq. (MHz)	Ch. #	Freq. (MHz)	Ch. #	Freq. (MHz)	Ch. #	Freq. (MHz)				
L	19957	1710.7	19965	1711.5	19975	1712.5	20000	1715	20025	1717.5	20050	1720				
M	20175	1732.5	20175	1732.5	20175	1732.5	20175	1732.5	20175	1732.5	20175	1732.5				
H	20393	1754.3	20385	1753.5	20375	1752.5	20350	1750	20325	1747.5	20300	1745				
LTE Band 5																
	Bandwidth 1.4 MHz		Bandwidth 3 MHz		Bandwidth 5 MHz		Bandwidth 10 MHz		Bandwidth 15 MHz		Bandwidth 20 MHz					
	Ch. #	Freq. (MHz)	Ch. #	Freq. (MHz)	Ch. #	Freq. (MHz)	Ch. #	Freq. (MHz)	Ch. #	Freq. (MHz)	Ch. #	Freq. (MHz)				
L	20407	824.7	20415	825.5	20425	826.5	20450	829	20450	829	20450	829				
M	20525	836.5	20525	836.5	20525	836.5	20525	836.5	20525	836.5	20525	836.5				
H	20643	848.3	20635	847.5	20625	846.5	20600	844	20600	844	20600	844				
LTE Band 7																
	Bandwidth 5 MHz		Bandwidth 10 MHz		Bandwidth 15 MHz		Bandwidth 20 MHz		Bandwidth 15 MHz		Bandwidth 20 MHz					
	Ch. #	Freq. (MHz)	Ch. #	Freq. (MHz)	Ch. #	Freq. (MHz)	Ch. #	Freq. (MHz)	Ch. #	Freq. (MHz)	Ch. #	Freq. (MHz)				
L	20775	2502.5	20800	2505	20825	2507.5	20850	2510	20850	2510	20850	2510				
M	21100	2535	21100	2535	21100	2535	21100	2535	21100	2535	21100	2535				
H	21425	2567.5	21400	2565	21375	2562.5	21350	2560	21350	2560	21350	2560				
LTE Band 12																
	Bandwidth 1.4 MHz		Bandwidth 3 MHz		Bandwidth 5 MHz		Bandwidth 10 MHz		Bandwidth 15 MHz		Bandwidth 20 MHz					
	Ch. #	Freq. (MHz)	Ch. #	Freq. (MHz)	Ch. #	Freq. (MHz)	Ch. #	Freq. (MHz)	Ch. #	Freq. (MHz)	Ch. #	Freq. (MHz)				
L	23017	699.7	23025	700.5	23035	701.5	23060	704	23060	704	23060	704				
M	23095	707.5	23095	707.5	23095	707.5	23095	707.5	23095	707.5	23095	707.5				
H	23173	715.3	23165	714.5	23155	713.5	23130	711	23130	711	23130	711				
LTE Band 13																
	Bandwidth 5 MHz				Bandwidth 10 MHz				Bandwidth 15 MHz				Bandwidth 20 MHz			
	Channel #		Freq.(MHz)		Channel #		Freq.(MHz)		Channel #		Freq.(MHz)		Channel #		Freq.(MHz)	
L	23205		779.5		23230		782		23255		784.5		23280		787	
M	23230		782		23255		784.5		23280		787		23305		789.5	
H	23255		784.5		23280		787		23305		789.5		23330		792	
LTE Band 17																
	Bandwidth 5 MHz				Bandwidth 10 MHz				Bandwidth 15 MHz				Bandwidth 20 MHz			
	Channel #		Freq.(MHz)		Channel #		Freq.(MHz)		Channel #		Freq.(MHz)		Channel #		Freq.(MHz)	
L	23755		706.5		23780		709		23805		712		23830		715	
M	23790		710		23815		713		23840		716		23865		719	
H	23825		713.5		23850		716.5		23875		719.5		23900		722.5	
LTE Band 66																
	Bandwidth 1.4 MHz		Bandwidth 3 MHz		Bandwidth 5 MHz		Bandwidth 10 MHz		Bandwidth 15 MHz		Bandwidth 20 MHz					
	Ch. #	Freq. (MHz)	Ch. #	Freq. (MHz)	Ch. #	Freq. (MHz)	Ch. #	Freq. (MHz)	Ch. #	Freq. (MHz)	Ch. #	Freq. (MHz)				
L	131979	1710.7	131987	1711.5	131997	1712.5	132022	1715	132047	1717.5	132072	1720				
M	132322	1745	132322	1745	132322	1745	132322	1745	132322	1745	132322	1745				
H	132665	1779.3	132657	1778.5	132647	1777.5	132622	1775	132597	1772.5	132572	1770				



5. RF Exposure Limits

5.1 Uncontrolled Environment

Uncontrolled Environments are defined as locations where there is the exposure of individuals who have no knowledge or control of their exposure. The general population/uncontrolled exposure limits are applicable to situations in which the general public may be exposed or in which persons who are exposed as a consequence of their employment may not be made fully aware of the potential for exposure or cannot exercise control over their exposure. Members of the general public would come under this category when exposure is not employment-related; for example, in the case of a wireless transmitter that exposes persons in its vicinity.

5.2 Controlled Environment

Controlled Environments are defined as locations where there is exposure that may be incurred by persons who are aware of the potential for exposure, (i.e. as a result of employment or occupation). In general, occupational/controlled exposure limits are applicable to situations in which persons are exposed as a consequence of their employment, who have been made fully aware of the potential for exposure and can exercise control over their exposure. The exposure category is also applicable when the exposure is of a transient nature due to incidental passage through a location where the exposure levels may be higher than the general population/uncontrolled limits, but the exposed person is fully aware of the potential for exposure and can exercise control over his or her exposure by leaving the area or by some other appropriate means.

Limits for Occupational/Controlled Exposure (W/kg)

Whole-Body	Partial-Body	Hands, Wrists, Feet and Ankles
0.4	8.0	20.0

Limits for General Population/Uncontrolled Exposure (W/kg)

Whole-Body	Partial-Body	Hands, Wrists, Feet and Ankles
0.08	1.6	4.0

1. Whole-Body SAR is averaged over the entire body, partial-body SAR is averaged over any 1gram of tissue defined as a tissue volume in the shape of a cube. SAR for hands, wrists, feet and ankles is averaged over any 10 grams of tissue defined as a tissue volume in the shape of a cube.



6. Specific Absorption Rate (SAR)

6.1 Introduction

SAR is related to the rate at which energy is absorbed per unit mass in an object exposed to a radio field. The SAR distribution in a biological body is complicated and is usually carried out by experimental techniques or numerical modeling. The standard recommends limits for two tiers of groups, occupational/controlled and general population/uncontrolled, based on a person's awareness and ability to exercise control over his or her exposure. In general, occupational/controlled exposure limits are higher than the limits for general population/uncontrolled.

6.2 SAR Definition

The SAR definition is the time derivative (rate) of the incremental energy (dW) absorbed by (dissipated in) an incremental mass (dm) contained in a volume element (dv) of a given density (ρ). The equation description is as below:

$$SAR = \frac{d}{dt} \left(\frac{dW}{dm} \right) = \frac{d}{dt} \left(\frac{dW}{\rho dv} \right)$$

SAR is expressed in units of Watts per kilogram (W/kg)

$$SAR = \frac{\sigma |E|^2}{\rho}$$

Where: σ is the conductivity of the tissue, ρ is the mass density of the tissue and E is the RMS electrical field strength.

7. System Description and Setup

The DASY system used for performing compliance tests consists of the following items:

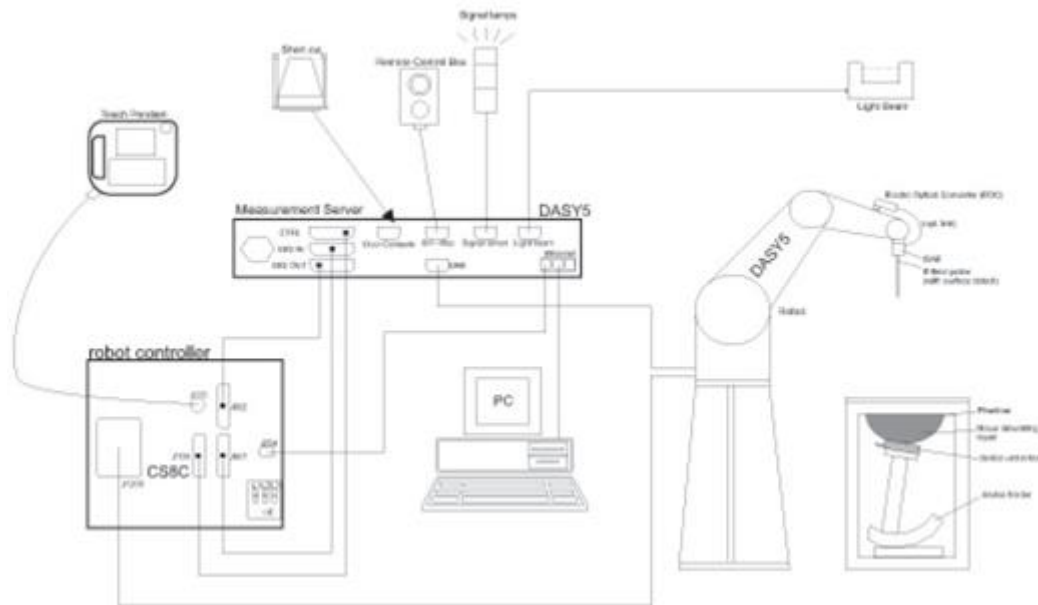

- A standard high precision 6-axis robot with controller, teach pendant and software. An arm extension for accommodating the data acquisition electronics (DAE).
- An isotropic Field probe optimized and calibrated for the targeted measurement.
- A data acquisition electronics (DAE) which performs the signal amplification, signal multiplexing, AD-conversion, offset measurements, mechanical surface detection, collision detection, etc. The unit is battery powered with standard or rechargeable batteries. The signal is optically transmitted to the EOC.
- The Electro-optical converter (EOC) performs the conversion from optical to electrical signals for the digital communication to the DAE. To use optical surface detection, a special version of the EOC is required. The EOC signal is transmitted to the measurement server.
- The function of the measurement server is to perform the time critical tasks such as signal filtering, control of the robot operation and fast movement interrupts.
- The Light Beam used is for probe alignment. This improves the (absolute) accuracy of the probe positioning.
- A computer running WinXP or Win7 and the DASY5 software.
- Remote control and teach pendant as well as additional circuitry for robot safety such as warning lamps, etc.
- The phantom, the device holder and other accessories according to the targeted measurement.

7.1 E-Field Probe

The SAR measurement is conducted with the dosimetric probe (manufactured by SPEAG). The probe is specially designed and calibrated for use in liquid with high permittivity. The dosimetric probe has special calibration in liquid at different frequency. This probe has a built in optical surface detection system to prevent from collision with phantom.

<ES3DV3 Probe>

Construction	Symmetric design with triangular core Interleaved sensors Built-in shielding against static charges PEEK enclosure material (resistant to organic solvents, e.g., DGBE)	
Frequency	10 MHz – 4 GHz; Linearity: ± 0.2 dB (30 MHz – 4 GHz)	
Directivity	± 0.2 dB in TSL (rotation around probe axis) ± 0.3 dB in TSL (rotation normal to probe axis)	
Dynamic Range	5 μ W/g – >100 mW/g; Linearity: ± 0.2 dB	
Dimensions	Overall length: 337 mm (tip: 20 mm) Tip diameter: 3.9 mm (body: 12 mm) Distance from probe tip to dipole centers: 3.0 mm	

<EX3DV4 Probe>

Construction	Symmetric design with triangular core Built-in shielding against static charges PEEK enclosure material (resistant to organic solvents, e.g., DGBE)	
Frequency	10 MHz – >6 GHz Linearity: ± 0.2 dB (30 MHz – 6 GHz)	
Directivity	± 0.3 dB in TSL (rotation around probe axis) ± 0.5 dB in TSL (rotation normal to probe axis)	
Dynamic Range	10 μ W/g – >100 mW/g Linearity: ± 0.2 dB (noise: typically <1 μ W/g)	
Dimensions	Overall length: 337 mm (tip: 20 mm) Tip diameter: 2.5 mm (body: 12 mm) Typical distance from probe tip to dipole centers: 1 mm	

7.2 Data Acquisition Electronics (DAE)

The data acquisition electronics (DAE) consists of a highly sensitive electrometer-grade preamplifier with auto-zeroing, a channel and gain-switching multiplexer, a fast 16 bit AD-converter and a command decoder and control logic unit. Transmission to the measurement server is accomplished through an optical downlink for data and status information as well as an optical uplink for commands and the clock.

The input impedance of the DAE is 200 MOhm; the inputs are symmetrical and floating. Common mode rejection is above 80 dB.



Fig 5.1 Photo of DAE

7.3 Phantom

<SAM Twin Phantom>

Shell Thickness	2 ± 0.2 mm; Center ear point: 6 ± 0.2 mm	
Filling Volume	Approx. 25 liters	
Dimensions	Length: 1000 mm; Width: 500 mm; Height: adjustable feet	
Measurement Areas	Left Hand, Right Hand, Flat Phantom	

The bottom plate contains three pair of bolts for locking the device holder. The device holder positions are adjusted to the standard measurement positions in the three sections. A white cover is provided to tap the phantom during off-periods to prevent water evaporation and changes in the liquid parameters. On the phantom top, three reference markers are provided to identify the phantom position with respect to the robot.

<ELI Phantom>

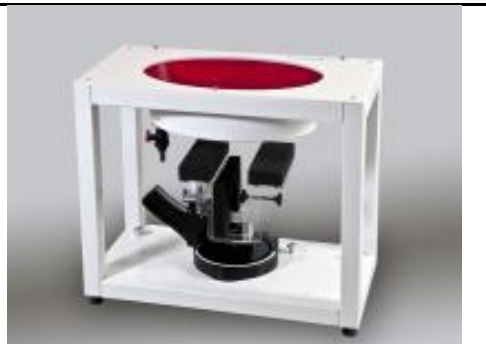
Shell Thickness	2 ± 0.2 mm (sagging: <1%)	
Filling Volume	Approx. 30 liters	
Dimensions	Major ellipse axis: 600 mm Minor axis: 400 mm	

The ELI phantom is intended for compliance testing of handheld and body-mounted wireless devices in the frequency range of 30 MHz to 6 GHz. ELI4 is fully compatible with standard and all known tissue simulating liquids.

7.4 Device Holder

<Mounting Device for Hand-Held Transmitter>

In combination with the Twin SAM V5.0/V5.0c or ELI phantoms, the Mounting Device for Hand-Held Transmitters enables rotation of the mounted transmitter device to specified spherical coordinates. At the heads, the rotation axis is at the ear opening. Transmitter devices can be easily and accurately positioned according to IEC 62209-1, IEEE 1528, FCC, or other specifications. The device holder can be locked for positioning at different phantom sections (left head, right head, flat). And upgrade kit to Mounting Device to enable easy mounting of wider devices like big smart-phones, e-books, small tablets, etc. It holds devices with width up to 140 mm.



Mounting Device for Hand-Held Transmitters



Mounting Device Adaptor for Wide-Phones

<Mounting Device for Laptops and other Body-Worn Transmitters>

The extension is lightweight and made of POM, acrylic glass and foam. It fits easily on the upper part of the mounting device in place of the phone positioned. The extension is fully compatible with the SAM Twin and ELI phantoms.



Mounting Device for Laptops



8. Measurement Procedures

The measurement procedures are as follows:

<Conducted power measurement>

- (a) For WWAN power measurement, use base station simulator to configure EUT WWAN transmission in conducted connection with RF cable, at maximum power in each supported wireless interface and frequency band.
- (b) Read the WWAN RF power level from the base station simulator.
- (c) For WLAN/BT power measurement, use engineering software to configure EUT WLAN/BT continuously transmission, at maximum RF power in each supported wireless interface and frequency band
- (d) Connect EUT RF port through RF cable to the power meter, and measure WLAN/BT output power

<SAR measurement>

- (a) Use base station simulator to configure EUT WWAN transmission in radiated connection, and engineering software to configure EUT WLAN/BT continuously transmission, at maximum RF power, in the highest power channel.
- (b) Place the EUT in the positions as Appendix D demonstrates.
- (c) Set scan area, grid size and other setting on the DASY software.
- (d) Measure SAR results for the highest power channel on each testing position.
- (e) Find out the largest SAR result on these testing positions of each band
- (f) Measure SAR results for other channels in worst SAR testing position if the reported SAR of highest power channel is larger than 0.8 W/kg

According to the test standard, the recommended procedure for assessing the peak spatial-average SAR value consists of the following steps:

- (a) Power reference measurement
- (b) Area scan
- (c) Zoom scan
- (d) Power drift measurement

8.1 Spatial Peak SAR Evaluation

The procedure for spatial peak SAR evaluation has been implemented according to the test standard. It can be conducted for 1g and 10g, as well as for user-specific masses. The DASY software includes all numerical procedures necessary to evaluate the spatial peak SAR value.

The base for the evaluation is a "cube" measurement. The measured volume must include the 1g and 10g cubes with the highest averaged SAR values. For that purpose, the center of the measured volume is aligned to the interpolated peak SAR value of a previously performed area scan.

The entire evaluation of the spatial peak values is performed within the post-processing engine (SEMCAD). The system always gives the maximum values for the 1g and 10g cubes. The algorithm to find the cube with highest averaged SAR is divided into the following stages:

- (a) Extraction of the measured data (grid and values) from the Zoom Scan
- (b) Calculation of the SAR value at every measurement point based on all stored data (A/D values and measurement parameters)
- (c) Generation of a high-resolution mesh within the measured volume
- (d) Interpolation of all measured values from the measurement grid to the high-resolution grid
- (e) Extrapolation of the entire 3-D field distribution to the phantom surface over the distance from sensor to surface
- (f) Calculation of the averaged SAR within masses of 1g and 10g

8.2 Power Reference Measurement

The Power Reference Measurement and Power Drift Measurements are for monitoring the power drift of the device under test in the batch process. The minimum distance of probe sensors to surface determines the closest measurement point to phantom surface. This distance cannot be smaller than the distance of sensor calibration points to probe tip as defined in the probe properties.

8.3 Area Scan

The area scan is used as a fast scan in two dimensions to find the area of high field values, before doing a fine measurement around the hot spot. The sophisticated interpolation routines implemented in DASY software can find the maximum found in the scanned area, within a range of the global maximum. The range (in dB0 is specified in the standards for compliance testing. For example, a 2 dB range is required in IEEE standard 1528 and IEC 62209 standards, whereby 3 dB is a requirement when compliance is assessed in accordance with the ARIB standard (Japan), if only one zoom scan follows the area scan, then only the absolute maximum will be taken as reference. For cases where multiple maximums are detected, the number of zoom scans has to be increased accordingly.

Area scan parameters extracted from FCC KDB 865664 D01v01r04 SAR measurement 100 MHz to 6 GHz.

	≤ 3 GHz	> 3 GHz
Maximum distance from closest measurement point (geometric center of probe sensors) to phantom surface	5 ± 1 mm	$\frac{1}{2} \cdot \delta \cdot \ln(2) \pm 0.5$ mm
Maximum probe angle from probe axis to phantom surface normal at the measurement location	30° ± 1°	20° ± 1°
Maximum area scan spatial resolution: $\Delta x_{Area}, \Delta y_{Area}$	≤ 2 GHz: ≤ 15 mm 2 – 3 GHz: ≤ 12 mm	3 – 4 GHz: ≤ 12 mm 4 – 6 GHz: ≤ 10 mm
	When the x or y dimension of the test device, in the measurement plane orientation, is smaller than the above, the measurement resolution must be ≤ the corresponding x or y dimension of the test device with at least one measurement point on the test device.	

8.4 Zoom Scan

Zoom scans are used assess the peak spatial SAR values within a cubic averaging volume containing 1 gram and 10 gram of simulated tissue. The zoom scan measures points (refer to table below) within a cube shoes base faces are centered on the maxima found in a preceding area scan job within the same procedure. When the measurement is done, the zoom scan evaluates the averaged SAR for 1 gram and 10 gram and displays these values next to the job's label.

Zoom scan parameters extracted from FCC KDB 865664 D01v01r04 SAR measurement 100 MHz to 6 GHz.

		≤ 3 GHz	> 3 GHz	
Maximum zoom scan spatial resolution: $\Delta x_{Zoom}, \Delta y_{Zoom}$		≤ 2 GHz: ≤ 8 mm 2 – 3 GHz: ≤ 5 mm*	3 – 4 GHz: ≤ 5 mm* 4 – 6 GHz: ≤ 4 mm*	
Maximum zoom scan spatial resolution, normal to phantom surface	uniform grid: $\Delta z_{Zoom}(n)$	≤ 5 mm	3 – 4 GHz: ≤ 4 mm 4 – 5 GHz: ≤ 3 mm 5 – 6 GHz: ≤ 2 mm	
	graded grid	$\Delta z_{Zoom}(1)$: between 1 st two points closest to phantom surface	≤ 4 mm	3 – 4 GHz: ≤ 3 mm 4 – 5 GHz: ≤ 2.5 mm 5 – 6 GHz: ≤ 2 mm
		$\Delta z_{Zoom}(n>1)$: between subsequent points	$\leq 1.5 \cdot \Delta z_{Zoom}(n-1)$	
Minimum zoom scan volume	x, y, z	≥ 30 mm	3 – 4 GHz: ≥ 28 mm 4 – 5 GHz: ≥ 25 mm 5 – 6 GHz: ≥ 22 mm	
Note: δ is the penetration depth of a plane-wave at normal incidence to the tissue medium; see draft standard IEEE P1528-2011 for details. * When zoom scan is required and the <i>reported</i> SAR from the <i>area scan based 1-g SAR estimation</i> procedures of KDB 447498 is ≤ 1.4 W/kg, ≤ 8 mm, ≤ 7 mm and ≤ 5 mm zoom scan resolution may be applied, respectively, for 2 GHz to 3 GHz, 3 GHz to 4 GHz and 4 GHz to 6 GHz.				

8.5 Volume Scan Procedures

The volume scan is used for assess overlapping SAR distributions for antennas transmitting in different frequency bands. It is equivalent to an oversized zoom scan used in standalone measurements. The measurement volume will be used to enclose all the simultaneous transmitting antennas. For antennas transmitting simultaneously in different frequency bands, the volume scan is measured separately in each frequency band. In order to sum correctly to compute the 1g aggregate SAR, the EUT remain in the same test position for all measurements and all volume scan use the same spatial resolution and grid spacing. When all volume scan were completed, the software, SEMCAD postprocessor can combine and subsequently superpose these measurement data to calculating the multiband SAR.

8.6 Power Drift Monitoring

All SAR testing is under the EUT install full charged battery and transmit maximum output power. In DASy measurement software, the power reference measurement and power drift measurement procedures are used for monitoring the power drift of EUT during SAR test. Both these procedures measure the field at a specified reference position before and after the SAR testing. The software will calculate the field difference in dB. If the power drifts more than 5%, the SAR will be retested.



9. Test Equipment List

Manufacturer	Name of Equipment	Type/Model	Serial Number	Calibration	
				Last Cal.	Due Date
SPEAG	750MHz System Validation Kit	D750V3	1012	May. 22, 2017	May. 21, 2018
SPEAG	835MHz System Validation Kit	D835V2	499	Mar. 21, 2017	Mar. 20, 2018
SPEAG	1750MHz System Validation Kit	D1750V2	1068	Nov. 16, 2016	Nov. 15, 2017
SPEAG	1900MHz System Validation Kit	D1900V2	5d041	Sep. 30, 2016	Sep. 29, 2017
SPEAG	2450MHz System Validation Kit	D2450V2	926	Jul. 25, 2016	Jul. 24, 2017
SPEAG	2600MHz System Validation Kit	D2600V2	1008	Aug. 30, 2016	Aug. 29, 2017
SPEAG	2600MHz System Validation Kit	D2600V2	1113	Aug. 30, 2016	Aug. 29, 2017
SPEAG	5GHz System Validation Kit	D5GHZV2	1006	Sep. 27, 2016	Sep. 26, 2017
SPEAG	Data Acquisition Electronics	DAE3	495	May. 22, 2017	May. 21, 2018
SPEAG	Data Acquisition Electronics	DAE4	916	Dec. 15, 2016	Dec. 14, 2017
SPEAG	Data Acquisition Electronics	DAE4	1399	Nov. 17, 2016	Nov. 16, 2017
SPEAG	Data Acquisition Electronics	DAE4	778	May. 22, 2017	May. 21, 2018
SPEAG	Data Acquisition Electronics	DAE4	1424	Feb. 16, 2017	Feb. 15, 2018
SPEAG	Data Acquisition Electronics	DAE4	854	May. 02, 2017	May. 01, 2018
SPEAG	Dosimetric E-Field Probe	EX3DV4	3976	Feb. 21, 2017	Feb. 20, 2018
SPEAG	Dosimetric E-Field Probe	EX3DV4	7306	Jul. 24, 2017	Jul. 23, 2018
SPEAG	Dosimetric E-Field Probe	EX3DV4	3925	May. 24, 2017	May. 23, 2018
SPEAG	Dosimetric E-Field Probe	ES3DV3	3270	Aug. 26, 2016	Aug. 25, 2017
SPEAG	Dosimetric E-Field Probe	ES3DV3	3169	May. 11, 2017	May. 10, 2018
WonDer	Thermometer	WD-5016	TM560-1	Mar. 17, 2017	Mar. 16, 2018
WonDer	Thermometer	WD-5016	TM560-2	Mar. 17, 2017	Mar. 16, 2018
TECPEL	Thermometer	UL-A03	TM225-1	Mar. 21, 2017	Mar. 20, 2018
WonDer	Thermometer	WD-5016	TM281-2	Mar. 17, 2017	Mar. 16, 2018
WonDer	Thermometer	WD-5016	TM281-1	Mar. 17, 2017	Mar. 16, 2018
Anritsu	Radio Communication Analyzer	MT8821C	6201341950	Apr. 20, 2017	Apr. 19, 2018
Agilent	Wireless Communication Test Set	E5515C	GB46311322	Mar. 13, 2017	Mar. 12, 2018
R&S	BT Base Station	CBT32	100522	Mar. 14, 2017	Mar. 13, 2018
SPEAG	Device Holder	N/A	N/A	N/A	N/A
Anritsu	Signal Generator	MG3710A	6201502524	Dec. 09, 2016	Dec. 08, 2017
Agilent	ENA Network Analyzer	E5071C	MY46316648	Jan. 04, 2017	Jan. 03, 2018
SPEAG	Dielectric Probe Kit	DAK-3.5	1126	Jul. 19, 2016	Jul. 18, 2017
SPEAG	Dielectric Probe Kit	DAK-3.5	1146	Jul. 18, 2017	Jul. 17, 2018
LINE SEIKI	Digital Thermometer	LKMelectronic	DTM3000SPEZIAL	Sep. 05, 2016	Sep. 04, 2017
Anritsu	Power Meter	ML2495A	1438002	Dec. 06, 2016	Dec. 05, 2017
Anritsu	Power Sensor	MA2411B	1339195	Dec. 06, 2016	Dec. 05, 2017
Agilent	Spectrum Analyzer	E4408B	MY44211028	Aug. 22, 2016	Aug. 21, 2017
Anritsu	Spectrum Analyzer	MS2830A	6201396378	Jun. 26, 2017	Jun. 25, 2018
Mini-Circuits	Power Amplifier	ZVE-8G+	D120604	Mar. 09, 2017	Mar. 08, 2018
Mini-Circuits	Power Amplifier	ZHL-42W+	QA1344002	Mar. 09, 2017	Mar. 08, 2018
ATM	Dual Directional Coupler	C122H-10	P610410z-02	Note 1	
Woken	Attenuator 1	WK0602-XX	N/A	Note 1	
PE	Attenuator 2	PE7005-10	N/A	Note 1	
PE	Attenuator 3	PE7005- 3	N/A	Note 1	

General Note:

1. Prior to system verification and validation, the path loss from the signal generator to the system check source and the power meter, which includes the amplifier, cable, attenuator and directional coupler, was measured by the network analyzer. The reading of the power meter was offset by the path loss difference between the path to the power meter and the path to the system check source to monitor the actual power level fed to the system check source.

10. System Verification

10.1 Tissue Simulating Liquids

For the measurement of the field distribution inside the SAM phantom with DASY, the phantom must be filled with around 25 liters of homogeneous body tissue simulating liquid. For head SAR testing, the liquid height from the ear reference point (ERP) of the phantom to the liquid top surface is larger than 15 cm, which is shown in Fig. 10.1. For body SAR testing, the liquid height from the center of the flat phantom to the liquid top surface is larger than 15 cm, which is shown in Fig. 10.2.

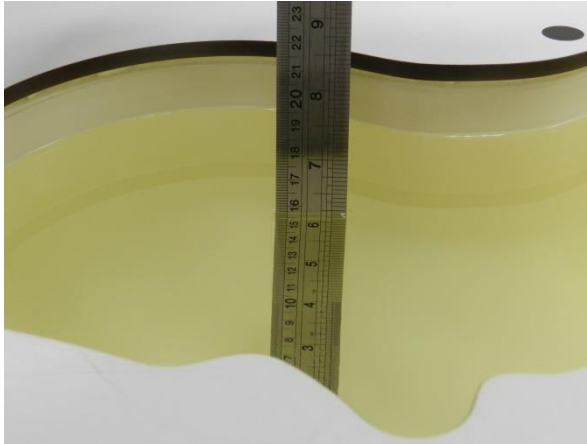

Fig 10.1 Photo of Liquid Height for Head SAR

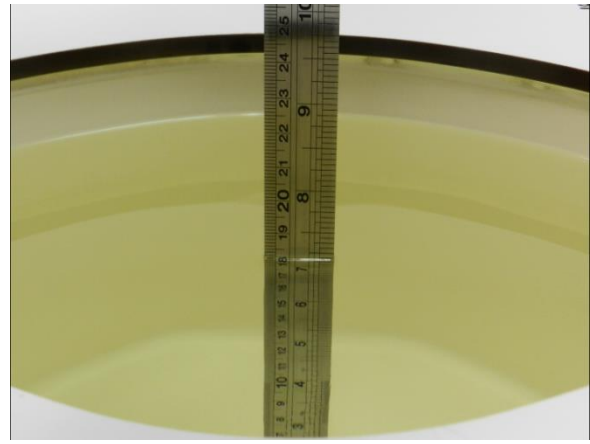

Fig 10.2 Photo of Liquid Height for Body SAR



10.2 Tissue Verification

The following tissue formulations are provided for reference only as some of the parameters have not been thoroughly verified. The composition of ingredients may be modified accordingly to achieve the desired target tissue parameters required for routine SAR evaluation.

Frequency (MHz)	Water (%)	Sugar (%)	Cellulose (%)	Salt (%)	Preventol (%)	DGBE (%)	Conductivity (σ)	Permittivity (εr)
For Head								
750	41.1	57.0	0.2	1.4	0.2	0	0.89	41.9
835	40.3	57.9	0.2	1.4	0.2	0	0.90	41.5
900	40.3	57.9	0.2	1.4	0.2	0	0.97	41.5
1800, 1900, 2000	55.2	0	0	0.3	0	44.5	1.40	40.0
2450	55.0	0	0	0	0	45.0	1.80	39.2
2600	54.8	0	0	0.1	0	45.1	1.96	39.0
For Body								
750	51.7	47.2	0	0.9	0.1	0	0.96	55.5
835	50.8	48.2	0	0.9	0.1	0	0.97	55.2
900	50.8	48.2	0	0.9	0.1	0	1.05	55.0
1800, 1900, 2000	70.2	0	0	0.4	0	29.4	1.52	53.3
2450	68.6	0	0	0	0	31.4	1.95	52.7
2600	68.1	0	0	0.1	0	31.8	2.16	52.5

Simulating Liquid for 5GHz, Manufactured by SPEAG

Ingredients	(% by weight)
Water	64~78%
Mineral oil	11~18%
Emulsifiers	9~15%
Additives and Salt	2~3%



<Tissue Dielectric Parameter Check Results>

Frequency (MHz)	Tissue Type	Liquid Temp. (°C)	Conductivity (σ)	Permittivity (ε _r)	Conductivity Target (σ)	Permittivity Target (ε _r)	Delta (σ) (%)	Delta (ε _r) (%)	Limit (%)	Date
750	HSL	22.7	0.898	40.872	0.89	41.90	0.90	-2.45	±5	2017/6/13
750	HSL	22.7	0.900	40.782	0.89	41.90	1.12	-2.67	±5	2017/8/22
750	MSL	22.4	0.960	55.486	0.96	55.50	0.00	-0.03	±5	2017/6/11
750	MSL	22.6	0.973	54.274	0.96	55.50	1.35	-2.21	±5	2017/8/19
835	HSL	22.2	0.901	43.151	0.90	41.50	0.11	3.98	±5	2017/6/12
835	HSL	22.2	0.913	42.632	0.90	41.50	1.44	2.73	±5	2017/8/22
835	MSL	22.5	0.960	55.236	0.97	55.20	-1.03	0.07	±5	2017/6/9
835	MSL	22.6	0.967	55.584	0.97	55.20	-0.31	0.70	±5	2017/8/18
1750	HSL	22.2	1.355	41.553	1.37	40.10	-1.09	3.62	±5	2017/6/7
1750	HSL	22.2	1.389	39.608	1.37	40.10	1.39	-1.23	±5	2017/6/12
1750	HSL	22.3	1.409	40.898	1.37	40.10	2.85	1.99	±5	2017/8/23
1750	MSL	22.6	1.460	55.067	1.49	53.40	-2.01	3.12	±5	2017/6/8
1750	MSL	22.9	1.473	55.484	1.49	53.40	-1.14	3.90	±5	2017/8/18
1900	HSL	22.2	1.424	40.526	1.40	40.00	1.71	1.32	±5	2017/6/7
1900	HSL	22.2	1.450	41.676	1.40	40.00	3.57	4.19	±5	2017/6/12
1900	HSL	22.6	1.405	40.394	1.40	40.00	0.36	0.98	±5	2017/8/23
1900	MSL	22.6	1.521	55.414	1.52	53.30	0.07	3.97	±5	2017/6/8
1900	MSL	22.9	1.573	54.426	1.52	53.30	3.49	2.11	±5	2017/8/17
2450	HSL	22.2	1.809	40.475	1.80	39.20	0.50	3.25	±5	2017/6/15
2450	HSL	22.4	1.845	40.648	1.80	39.20	2.50	3.69	±5	2017/6/16
2450	MSL	22.2	1.991	54.566	1.95	52.70	2.10	3.54	±5	2017/6/15
2600	HSL	22.2	2.012	37.953	1.96	39.00	2.65	-2.68	±5	2017/6/7
2600	HSL	22.5	1.939	38.027	1.96	39.00	-1.07	-2.49	±5	2017/8/22
2600	MSL	22.5	2.162	52.714	2.16	52.50	0.09	0.41	±5	2017/6/9
2600	MSL	22.9	2.183	54.420	2.16	52.50	1.06	3.66	±5	2017/8/18
5250	HSL	22.5	4.561	37.502	4.71	35.95	-3.16	4.32	±5	2017/6/14
5250	MSL	22.4	5.480	47.824	5.36	48.95	2.24	-2.30	±5	2017/6/15
5600	HSL	22.5	4.890	36.976	5.07	35.50	-3.55	4.16	±5	2017/6/14
5600	MSL	22.4	5.955	47.205	5.77	48.50	3.21	-2.67	±5	2017/6/15
5750	HSL	22.5	5.087	36.729	5.22	35.35	-2.55	3.90	±5	2017/6/14
5750	MSL	22.4	6.170	46.916	5.94	48.28	3.87	-2.83	±5	2017/6/15

10.3 System Performance Check Results

Comparing to the original SAR value provided by SPEAG, the verification data should be within its specification of 10 %. Below table shows the target SAR and measured SAR after normalized to 1W input power. The table below indicates the system performance check can meet the variation criterion and the plots can be referred to Appendix A of this report.

Date	Frequency (MHz)	Tissue Type	Input Power (mW)	Dipole S/N	Probe S/N	DAE S/N	Measured 1g SAR (W/kg)	Targeted 1g SAR (W/kg)	Normalized 1g SAR (W/kg)	Deviation (%)
2017/6/13	750	HSL	250	D750V3-1012	ES3DV3 - SN3169	DAE4 Sn1399	2.17	8.22	8.68	5.60
2017/8/22	750	HSL	250	D750V3-1012	ES3DV3 - SN3169	DAE4 Sn1399	2.16	8.22	8.64	5.11
2017/6/11	750	MSL	250	D750V3-1012	ES3DV3 - SN3270	DAE4 Sn778	2.27	8.71	9.08	4.25
2017/8/19	750	MSL	250	D750V3-1012	ES3DV3 - SN3169	DAE4 Sn1399	2.27	8.71	9.08	4.25
2017/6/12	835	HSL	250	D835V2-499	ES3DV3 - SN3169	DAE4 Sn1399	2.39	9.45	9.56	1.16
2017/8/22	835	HSL	250	D835V2-499	EX3DV4 - SN3976	DAE4 Sn1424	2.32	9.45	9.28	-1.80
2017/6/9	835	MSL	250	D835V2-499	ES3DV3 - SN3270	DAE4 Sn778	2.35	9.67	9.40	-2.79
2017/8/18	835	MSL	250	D835V2-499	ES3DV3 - SN3169	DAE4 Sn1399	2.28	9.67	9.12	-5.69
2017/6/7	1750	HSL	250	D1750V2-1068	ES3DV3 - SN3270	DAE4 Sn916	8.86	36.60	35.44	-3.17
2017/6/12	1750	HSL	250	D1750V2-1068	ES3DV3 - SN3169	DAE4 Sn1399	8.70	36.60	34.80	-4.92
2017/8/23	1750	HSL	250	D1750V2-1068	EX3DV4 - SN7306	DAE4 Sn854	9.37	36.60	37.48	2.40
2017/6/8	1750	MSL	250	D1750V2-1068	ES3DV3 - SN3270	DAE4 Sn916	8.61	36.20	34.44	-4.86
2017/8/18	1750	MSL	250	D1750V2-1068	ES3DV3 - SN3169	DAE4 Sn1399	9.44	36.20	37.76	4.31
2017/6/7	1900	HSL	250	D1900V2-5d041	ES3DV3 - SN3270	DAE4 Sn916	10.40	40.50	41.60	2.72
2017/6/12	1900	HSL	250	D1900V2-5d041	ES3DV3 - SN3169	DAE4 Sn1399	10.00	40.50	40.00	-1.23
2017/8/23	1900	HSL	250	D1900V2-5d041	ES3DV3 - SN3169	DAE4 Sn1399	9.72	40.50	38.88	-4.00
2017/6/8	1900	MSL	250	D1900V2-5d041	ES3DV3 - SN3270	DAE4 Sn916	10.10	38.80	40.40	4.12
2017/8/17	1900	MSL	250	D1900V2-5d041	ES3DV3 - SN3169	DAE4 Sn1399	10.00	38.80	40.00	3.09
2017/6/15	2450	HSL	250	D2450V2-926	EX3DV4 - SN3925	DAE3 Sn495	12.60	52.80	50.40	-4.55
2017/6/16	2450	HSL	250	D2450V2-926	EX3DV4 - SN3925	DAE3 Sn495	13.40	52.80	53.60	1.52
2017/6/15	2450	MSL	250	D2450V2-926	EX3DV4 - SN3925	DAE3 Sn495	12.60	51.20	50.40	-1.56
2017/6/7	2600	HSL	250	D2600V2-1008	ES3DV3 - SN3270	DAE4 Sn778	14.50	56.80	58.00	2.11
2017/8/22	2600	HSL	250	D2600V2-1113	ES3DV3 - SN3169	DAE4 Sn1399	14.30	56.80	57.20	0.70
2017/6/9	2600	MSL	250	D2600V2-1008	ES3DV3 - SN3270	DAE4 Sn778	14.30	55.20	57.20	3.62
2017/8/18	2600	MSL	250	D2600V2-1113	ES3DV3 - SN3169	DAE4 Sn1399	13.80	55.60	55.20	-0.72
2017/6/14	5250	HSL	100	D5GHzV2-1006	EX3DV4 - SN3925	DAE3 Sn495	7.56	80.60	75.60	-6.20
2017/6/15	5250	MSL	100	D5GHzV2-1006	EX3DV4 - SN3925	DAE3 Sn495	7.80	75.50	78.00	3.31
2017/6/14	5600	HSL	100	D5GHzV2-1006	EX3DV4 - SN3925	DAE3 Sn495	8.45	83.80	84.50	0.84
2017/6/15	5600	MSL	100	D5GHzV2-1006	EX3DV4 - SN3925	DAE3 Sn495	8.17	78.60	81.70	3.94
2017/6/14	5750	HSL	100	D5GHzV2-1006	EX3DV4 - SN3925	DAE3 Sn495	7.61	80.50	76.10	-5.47
2017/6/15	5750	MSL	100	D5GHzV2-1006	EX3DV4 - SN3925	DAE3 Sn495	7.86	74.60	78.60	5.36

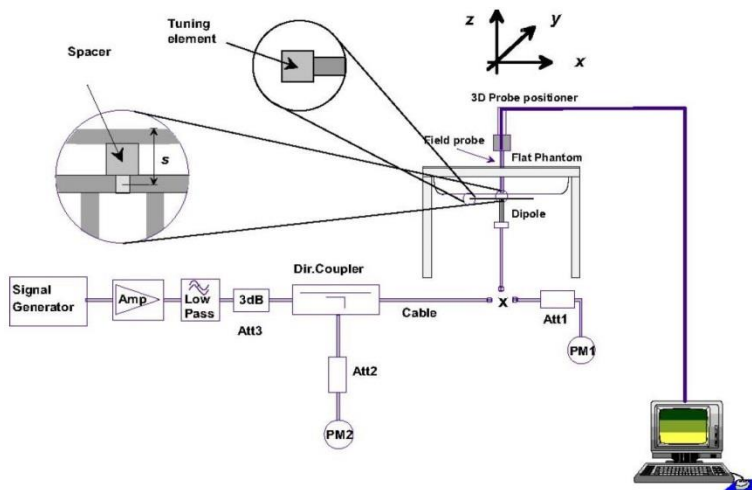

Fig 8.3.1 System Performance Check Setup



Fig 8.3.2 Setup Photo

11. RF Exposure Positions

11.1 Ear and handset reference point

Figure 9.1.1 shows the front, back, and side views of the SAM phantom. The center-of-mouth reference point is labeled “M,” the left ear reference point (ERP) is marked “LE,” and the right ERP is marked “RE.” Each ERP is 15 mm along the B-M (back-mouth) line behind the entrance-to-ear-canal (EEC) point, as shown in Figure 9.1.2 The Reference Plane is defined as passing through the two ear reference points and point M. The line N-F (neck-front), also called the reference pivoting line, is normal to the Reference Plane and perpendicular to both a line passing through RE and LE and the B-M line (see Figure 9.1.3). Both N-F and B-M lines should be marked on the exterior of the phantom shell to facilitate handset positioning. Posterior to the N-F line the ear shape is a flat surface with 6 mm thickness at each ERP, and forward of the N-F line the ear is truncated, as illustrated in Figure 9.1.2. The ear truncation is introduced to preclude the ear lobe from interfering with handset tilt, which could lead to unstable positioning at the cheek.

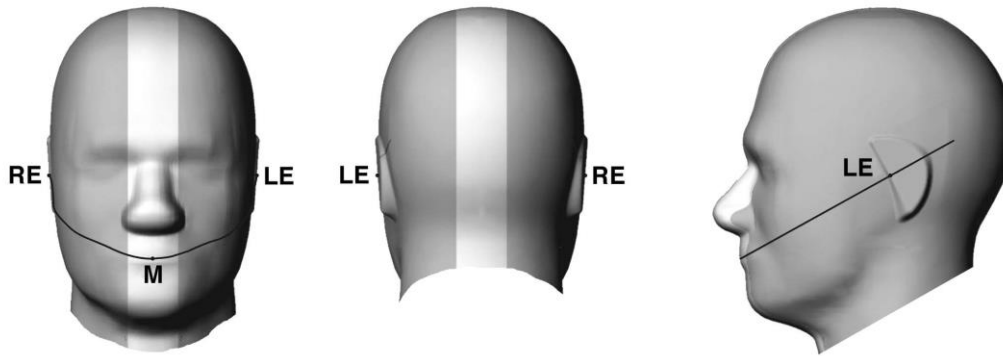

Fig 9.1.1 Front, back, and side views of SAM twin phantom

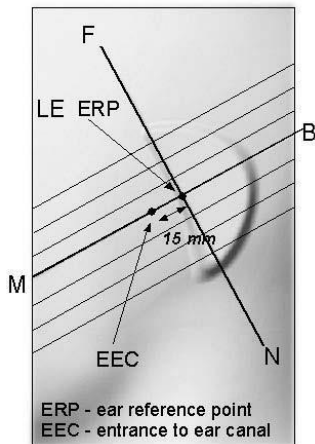

Fig 9.1.2 Close-up side view of phantom showing the ear region.

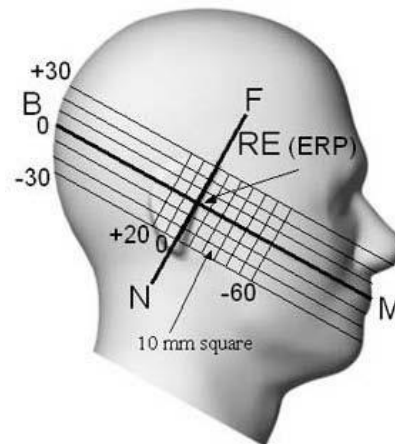

Fig 9.1.3 Side view of the phantom showing relevant markings and seven cross-sectional plane locations

11.2 Definition of the cheek position

1. Ready the handset for talk operation, if necessary. For example, for handsets with a cover piece (flip cover), open the cover. If the handset can transmit with the cover closed, both configurations must be tested.
2. Define two imaginary lines on the handset—the vertical centerline and the horizontal line. The vertical centerline passes through two points on the front side of the handset—the midpoint of the width w_t of the handset at the level of the acoustic output (point A in Figure 9.2.1 and Figure 9.2.2), and the midpoint of the width w_b of the bottom of the handset (point B). The horizontal line is perpendicular to the vertical centerline and passes through the center of the acoustic output (see Figure 9.2.1). The two lines intersect at point A. Note that for many handsets, point A coincides with the center of the acoustic output; however, the acoustic output may be located elsewhere on the horizontal line. Also note that the vertical centerline is not necessarily parallel to the front face of the handset (see Figure 9.2.2), especially for clamshell handsets, handsets with flip covers, and other irregularly-shaped handsets.
3. Position the handset close to the surface of the phantom such that point A is on the (virtual) extension of the line passing through points RE and LE on the phantom (see Figure 9.2.3), such that the plane defined by the vertical centerline and the horizontal line of the handset is approximately parallel to the sagittal plane of the phantom.
4. Translate the handset towards the phantom along the line passing through RE and LE until handset point A touches the pinna at the ERP.
5. While maintaining the handset in this plane, rotate it around the LE-RE line until the vertical centerline is in the plane normal to the plane containing B-M and N-F lines, i.e., the Reference Plane.
6. Rotate the handset around the vertical centerline until the handset (horizontal line) is parallel to the N-F line.
7. While maintaining the vertical centerline in the Reference Plane, keeping point A on the line passing through RE and LE, and maintaining the handset contact with the pinna, rotate the handset about the N-F line until any point on the handset is in contact with a phantom point below the pinna on the cheek. See Figure 9.2.3. The actual rotation angles should be documented in the test report.

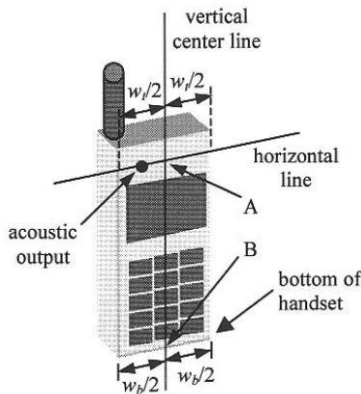

Fig 9.2.1 Handset vertical and horizontal reference lines—“fixed case”

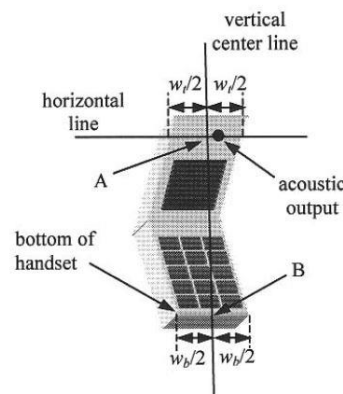

Fig 9.2.2 Handset vertical and horizontal reference lines—“clam-shell case”

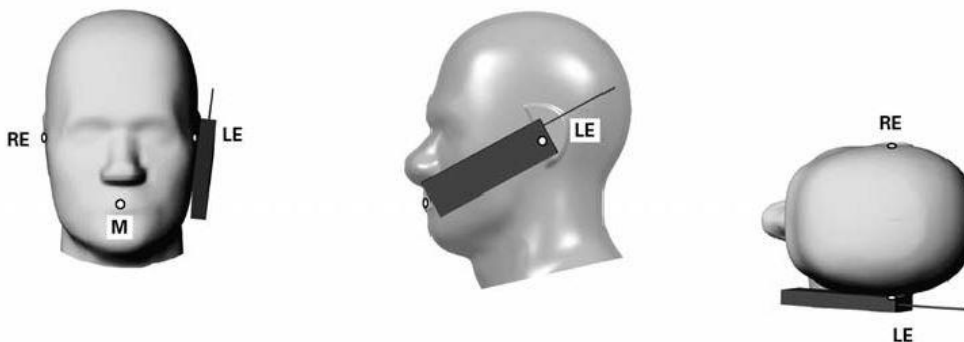

Fig 9.2.3 cheek or touch position. The reference points for the right ear (RE), left ear (LE), and mouth (M), which establish the Reference Plane for handset positioning, are indicated.

11.3 Definition of the tilt position

1. Ready the handset for talk operation, if necessary. For example, for handsets with a cover piece (flip cover), open the cover. If the handset can transmit with the cover closed, both configurations must be tested.
2. While maintaining the orientation of the handset, move the handset away from the pinna along the line passing through RE and LE far enough to allow a rotation of the handset away from the cheek by 15°.
3. Rotate the handset around the horizontal line by 15°.
4. While maintaining the orientation of the handset, move the handset towards the phantom on the line passing through RE and LE until any part of the handset touches the ear. The tilt position is obtained when the contact point is on the pinna. See Figure 9.3.1. If contact occurs at any location other than the pinna, e.g., the antenna at the back of the phantom head, the angle of the handset should be reduced. In this case, the tilt position is obtained if any point on the handset is in contact with the pinna and a second point

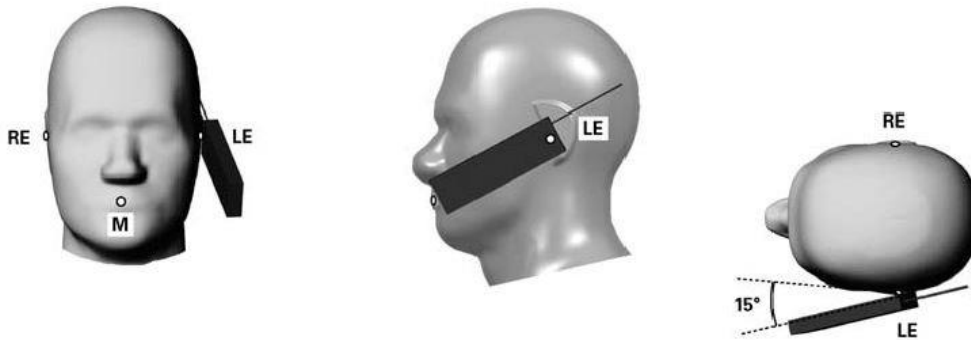

Fig 9.3.1 Tilt position. The reference points for the right ear (RE), left ear (LE), and mouth (M), which define the Reference Plane for handset positioning, are indicated.

11.4 Body Worn Accessory

Body-worn operating configurations are tested with the belt-clips and holsters attached to the device and positioned against a flat phantom in a normal use configuration (see Figure 9.4). Per KDB648474 D04v01r03, body-worn accessory exposure is typically related to voice mode operations when handsets are carried in body-worn accessories. The body-worn accessory procedures in FCC KDB 447498 D01v06 should be used to test for body-worn accessory SAR compliance, without a headset connected to it. This enables the test results for such configuration to be compatible with that required for hotspot mode when the body-worn accessory test separation distance is greater than or equal to that required for hotspot mode, when applicable. When the reported SAR for body-worn accessory, measured without a headset connected to the handset is > 1.2 W/kg, the highest reported SAR configuration for that wireless mode and frequency band should be repeated for that body-worn accessory with a headset attached to the handset.

Accessories for body-worn operation configurations are divided into two categories: those that do not contain metallic components and those that do contain metallic components. When multiple accessories that do not contain metallic components are supplied with the device, the device is tested with only the accessory that dictates the closest spacing to the body. Then multiple accessories that contain metallic components are test with the device with each accessory. If multiple accessories share an identical metallic component (i.e. the same metallic belt-clip used with different holsters with no other metallic components) only the accessory that dictates the closest spacing to the body is tested.

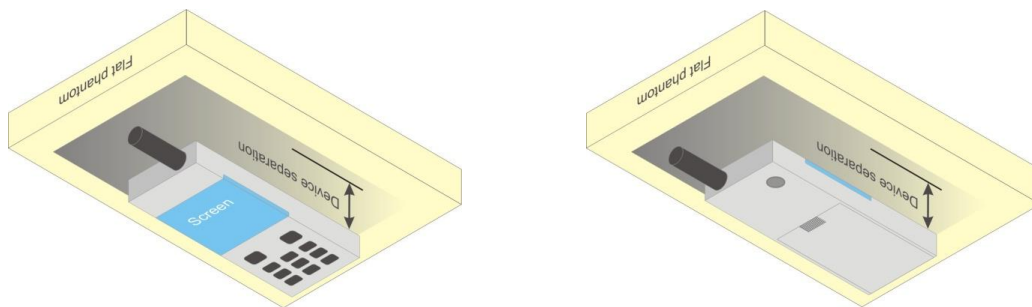

Fig 9.4 Body Worn Position

11.5 Wireless Router

Some battery-operated handsets have the capability to transmit and receive user through simultaneous transmission of WIFI simultaneously with a separate licensed transmitter. The FCC has provided guidance in FCC KDB Publication 941225 D06 v02r01 where SAR test considerations for handsets (L x W ≥ 9 cm x 5 cm) are based on a composite test separation distance of 10mm from the front, back and edges of the device containing transmitting antennas within 2.5cm of their edges, determined from general mixed use conditions for this type of devices. Since the hotspot SAR results may overlap with the body-worn accessory SAR requirements, the more conservative configurations can be considered, thus excluding some body-worn accessory SAR tests.

When the user enables the personal wireless router functions for the handset, actual operations include simultaneous transmission of both the WIFI transmitter and another licensed transmitter. Both transmitters often do not transmit at the same transmitting frequency and thus cannot be evaluated for SAR under actual use conditions due to the limitations of the SAR assessment probes. Therefore, SAR must be evaluated for each frequency transmission and mode separately and spatially summed with the WIFI transmitter according to FCC KDB Publication 447498 D01v06 publication procedures. The "Portable Hotspot" feature on the handset was NOT activated during SAR assessments, to ensure the SAR measurements were evaluated for a single transmission frequency RF signal at a time.



12. Conducted RF Output Power (Unit: dBm)

<GSM Conducted Power>

1. Per KDB 447498 D01v06, the maximum output power channel is used for SAR testing and for further SAR test reduction.
2. Per KDB 941225 D01v03r01, for SAR test reduction for GSM / GPRS / EDGE modes is determined by the source-based time-averaged output power including tune-up tolerance. The mode with highest specified time-averaged output power should be tested for SAR compliance in the applicable exposure conditions. For modes with the same specified maximum output power and tolerance, the higher number time-slot configuration should be tested. Therefore, the GPRS (4Tx slots) for GSM850/GSM1900 is considered as the primary mode.
3. Other configurations of GSM / GPRS / EDGE are considered as secondary modes. The 3G SAR test reduction procedure is applied, when the maximum output power and tune-up tolerance specified for production units in a secondary mode is $\leq \frac{1}{4}$ dB higher than the primary mode, SAR measurement is not required for the secondary mode

GSM850 TX Channel	Burst Average Power (dBm)			Tune-up Limit (dBm)	Frame-Average Power (dBm)			Tune-up Limit (dBm)
	128	189	251		128	189	251	
Frequency (MHz)	824.2	836.4	848.8		824.2	836.4	848.8	
GSM 1 Tx slot	33.07	33.21	32.88	33.50	24.07	24.21	23.88	24.50
GPRS 1 Tx slot	33.19	33.31	32.90	33.50	24.19	24.31	23.90	24.50
GPRS 2 Tx slots	31.44	31.50	31.00	32.00	25.44	25.50	25.00	26.00
GPRS 3 Tx slots	30.46	30.47	30.38	31.00	26.20	26.21	26.12	26.74
GPRS 4 Tx slots	29.73	29.37	29.35	30.00	26.73	26.37	26.35	27.00
EDGE 1 Tx slot	27.46	27.40	27.33	27.50	18.46	18.40	18.33	18.50
EDGE 2 Tx slots	26.94	26.97	26.87	27.00	20.94	20.97	20.87	21.00
EDGE 3 Tx slots	26.56	26.44	26.33	27.00	22.30	22.18	22.07	22.74
EDGE 4 Tx slots	24.88	24.82	24.68	25.00	21.88	21.82	21.68	22.00

GSM1900 TX Channel	Burst Average Power (dBm)			Tune-up Limit (dBm)	Frame-Average Power (dBm)			Tune-up Limit (dBm)
	512	661	810		512	661	810	
Frequency (MHz)	1850.2	1880	1909.8		1850.2	1880	1909.8	
GSM 1 Tx slot	29.97	30.40	30.49	30.50	20.97	21.40	21.49	21.50
GPRS 1 Tx slot	29.98	30.39	30.50	30.50	20.98	21.39	21.50	21.50
GPRS 2 Tx slots	28.90	28.85	28.96	29.50	22.90	22.85	22.96	23.50
GPRS 3 Tx slots	28.84	28.76	28.87	29.00	24.58	24.50	24.61	24.74
GPRS 4 Tx slots	27.53	27.54	27.57	28.00	24.53	24.54	24.57	25.00
EDGE 1 Tx slot	26.35	26.23	26.17	26.50	17.35	17.23	17.17	17.50
EDGE 2 Tx slots	25.92	25.80	25.69	26.00	19.92	19.80	19.69	20.00
EDGE 3 Tx slots	25.00	24.81	24.66	25.00	20.74	20.55	20.40	20.74
EDGE 4 Tx slots	24.00	23.77	23.62	24.00	21.00	20.77	20.62	21.00

<WCDMA Conducted Power>

1. The following tests were conducted according to the test requirements outlines in 3GPP TS 34.121 specification.
2. The procedures in KDB 941225 D01v03r01 are applied for 3GPP Rel. 6 HSPA to configure the device in the required sub-test mode(s) to determine SAR test exclusion.
3. For DC-HSDPA, the device was configured according to the H-Set 12, Fixed Reference Channel (FRC) configuration in Table C.8.1.12 of 3GPP TS 34.121-1, with the primary and the secondary serving HS-DSCH Cell enabled during the power measurement.

A summary of these settings are illustrated below:

HSDPA Setup Configuration:

- a. The EUT was connected to Base Station Agilent E5515C referred to the Setup Configuration.
- b. The RF path losses were compensated into the measurements.
- c. A call was established between EUT and Base Station with following setting:
 - i. Set Gain Factors (β_c and β_d) and parameters were set according to each
 - ii. Specific sub-test in the following table, C10.1.4, quoted from the TS 34.121
 - iii. Set RMC 12.2Kbps + HSDPA mode.
 - iv. Set Cell Power = -86 dBm
 - v. Set HS-DSCH Configuration Type to FRC (H-set 1, QPSK)
 - vi. Select HSDPA Uplink Parameters
 - vii. Set Delta ACK, Delta NACK and Delta CQI = 8
 - viii. Set Ack-Nack Repetition Factor to 3
 - ix. Set CQI Feedback Cycle (k) to 4 ms
 - x. Set CQI Repetition Factor to 2
 - xi. Power Ctrl Mode = All Up bits
- d. The transmitted maximum output power was recorded.

Table C.10.1.4: β values for transmitter characteristics tests with HS-DPCCH

Sub-test	β_c	β_d	β_d (SF)	β_c/β_d	β_{HS} (Note 1, Note 2)	CM (dB) (Note 3)	MPR (dB) (Note 3)
1	2/15	15/15	64	2/15	4/15	0.0	0.0
2	12/15 (Note 4)	15/15 (Note 4)	64	12/15 (Note 4)	24/15	1.0	0.0
3	15/15	8/15	64	15/8	30/15	1.5	0.5
4	15/15	4/15	64	15/4	30/15	1.5	0.5

Note 1: $\Delta_{ACK}, \Delta_{NACK}$ and $\Delta_{CQI} = 30/15$ with $\beta_{HS} = 30/15 * \beta_c$.

Note 2: For the HS-DPCCH power mask requirement test in clause 5.2C, 5.7A, and the Error Vector Magnitude (EVM) with HS-DPCCH test in clause 5.13.1A, and HSDPA EVM with phase discontinuity in clause 5.13.1AA, Δ_{ACK} and $\Delta_{NACK} = 30/15$ with $\beta_{HS} = 30/15 * \beta_c$, and $\Delta_{CQI} = 24/15$ with $\beta_{HS} = 24/15 * \beta_c$.

Note 3: CM = 1 for $\beta_c/\beta_d = 12/15, \beta_{HS}/\beta_c = 24/15$. For all other combinations of DPCCH, DPDCCH and HS-DPCCH the MPR is based on the relative CM difference. This is applicable for only UEs that support HSDPA in release 6 and later releases.

Note 4: For subtest 2 the β_c/β_d ratio of 12/15 for the TFC during the measurement period (TF1, TF0) is achieved by setting the signalled gain factors for the reference TFC (TF1, TF1) to $\beta_c = 11/15$ and $\beta_d = 15/15$.

Setup Configuration

HSUPA Setup Configuration:

- a. The EUT was connected to Base Station Agilent E5515C referred to the Setup Configuration.
- b. The RF path losses were compensated into the measurements.
- c. A call was established between EUT and Base Station with following setting * :
 - i. Call Configs = 5.2B, 5.9B, 5.10B, and 5.13.2B with QPSK
 - ii. Set the Gain Factors (β_c and β_d) and parameters (AG Index) were set according to each specific sub-test in the following table, C11.1.3, quoted from the TS 34.121
 - iii. Set Cell Power = -86 dBm
 - iv. Set Channel Type = 12.2k + HSPA
 - v. Set UE Target Power
 - vi. Power Ctrl Mode= Alternating bits
 - vii. Set and observe the E-TFCl
 - viii. Confirm that E-TFCl is equal to the target E-TFCl of 75 for sub-test 1, and other subtest's E-TFCl
- d. The transmitted maximum output power was recorded.

Table C.11.1.3: β values for transmitter characteristics tests with HS-DPCCH and E-DCH

Sub-test	β_c	β_d	β_d (SF)	β_c/β_d	β_{HS} (Note1)	β_{ec}	β_{ed} (Note 4) (Note 5)	β_{ed} (SF)	β_{ed} (Codes)	CM (dB) (Note 2)	MPR (dB) (Note 2) (Note 6)	AG Index (Note 5)	E-TFCl
1	11/15 (Note 3)	15/15 (Note 3)	64	11/15 (Note 3)	22/15	209/25	1309/225	4	1	1.0	0.0	20	75
2	6/15	15/15	64	6/15	12/15	12/15	94/75	4	1	3.0	2.0	12	67
3	15/15	9/15	64	15/9	30/15	30/15	$\beta_{ed1}: 47/15$ $\beta_{ed2}: 47/15$	4 4	2	2.0	1.0	15	92
4	2/15	15/15	64	2/15	4/15	2/15	56/75	4	1	3.0	2.0	17	71
5	15/15	0	-	-	5/15	5/15	47/15	4	1	1.0	0.0	12	67

Note 1: For sub-test 1 to 4, Δ_{ACK} , Δ_{NACK} and $\Delta_{CQI} = 30/15$ with $\beta_{hs} = 30/15 * \beta_c$. For sub-test 5, Δ_{ACK} , Δ_{NACK} and $\Delta_{CQI} = 5/15$ with $\beta_{hs} = 5/15 * \beta_c$.

Note 2: CM = 1 for $\beta_c/\beta_d = 12/15$, $\beta_{hs}/\beta_c = 24/15$. For all other combinations of DPDCH, DPCCH, HS-DPCCH, E-DPDCH and E-DPCCH the MPR is based on the relative CM difference.

Note 3: For subtest 1 the β_c/β_d ratio of 11/15 for the TFC during the measurement period (TF1, TF0) is achieved by setting the signalled gain factors for the reference TFC (TF1, TF1) to $\beta_c = 10/15$ and $\beta_d = 15/15$.

Note 4: In case of testing by UE using E-DPDCH Physical Layer category 1, Sub-test 3 is omitted according to TS25.306 Table 5.1g.

Note 5: β_{ed} can not be set directly; it is set by Absolute Grant Value.

Note 6: For subtests 2, 3 and 4, UE may perform E-DPDCH power scaling at max power which could results in slightly smaller MPR values.

Setup Configuration

DC-HSDPA 3GPP release 8 Setup Configuration:

- a. The EUT was connected to Base Station Agilent E5515C referred to the Setup Configuration below
- b. The RF path losses were compensated into the measurements.
- c. A call was established between EUT and Base Station with following setting:
 - i. Set RMC 12.2Kbps + HSDPA mode.
 - ii. Set Cell Power = -25 dBm
 - iii. Set HS-DSCH Configuration Type to FRC (H-set 12, QPSK)
 - iv. Select HSDPA Uplink Parameters
 - v. Set Gain Factors (β_c and β_d) and parameters were set according to each Specific sub-test in the following table, C10.1.4, quoted from the TS 34.121
 - a). Subtest 1: $\beta_c/\beta_d=2/15$
 - b). Subtest 2: $\beta_c/\beta_d=12/15$
 - c). Subtest 3: $\beta_c/\beta_d=15/8$
 - d). Subtest 4: $\beta_c/\beta_d=15/4$
 - vi. Set Delta ACK, Delta NACK and Delta CQI = 8
 - vii. Set Ack-Nack Repetition Factor to 3
 - viii. Set CQI Feedback Cycle (k) to 4 ms
 - ix. Set CQI Repetition Factor to 2
 - x. Power Ctrl Mode = All Up bits
- d. The transmitted maximum output power was recorded.

The following tests were conducted according to the test requirements outlines in 3GPP TS 34.121 specification. A summary of these settings are illustrated below:

C.8.1.12 Fixed Reference Channel Definition H-Set 12

Table C.8.1.12: Fixed Reference Channel H-Set 12

Parameter	Unit	Value
Nominal Avg. Inf. Bit Rate	kbps	60
Inter-TTI Distance	TTI's	1
Number of HARQ Processes	Processes	6
Information Bit Payload (N_{INF})	Bits	120
Number Code Blocks	Blocks	1
Binary Channel Bits Per TTI	Bits	960
Total Available SML's in UE	SML's	19200
Number of SML's per HARQ Proc.	SML's	3200
Coding Rate		0.15
Number of Physical Channel Codes	Codes	1
Modulation		QPSK
Note 1: The RMC is intended to be used for DC-HSDPA mode and both cells shall transmit with identical parameters as listed in the table. Note 2: Maximum number of transmission is limited to 1, i.e., retransmission is not allowed. The redundancy and constellation version 0 shall be used.		

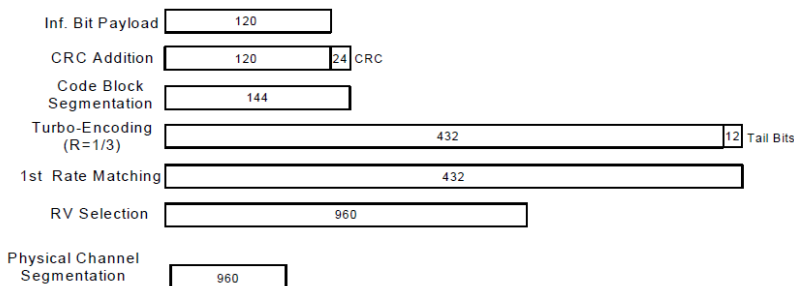

Figure C.8.19: Coding rate for Fixed reference Channel H-Set 12 (QPSK)

Setup Configuration



<WCDMA Conducted Power>

General Note:

1. Per KDB 941225 D01v03r01, for SAR testing is measured using a 12.2 kbps RMC with TPC bits configured to all "1's".
2. Per KDB 941225 D01v03r01, RMC 12.2kbps setting is used to evaluate SAR. The maximum output power and tune-up tolerance specified for production units in HSDPA / HSUPA / DC-HSDPA is $\leq \frac{1}{4}$ dB higher than RMC 12.2Kbps or when the highest reported SAR of the RMC12.2Kbps is scaled by the ratio of specified maximum output power and tune-up tolerance of HSDPA / HSUPA / DC-HSDPA to RMC12.2Kbps and the adjusted SAR is ≤ 1.2 W/kg, SAR measurement is not required for HSDPA / HSUPA / DC-HSDPA, and according to the following RF output power, the output power results of the secondary modes (HSUPA, HSDPA, DC-HSDPA) are less than $\frac{1}{4}$ dB higher than the primary modes; therefore, SAR measurement is not required for HSDPA / HSUPA / DC-HSDPA.

Band		WCDMA II			Tune-up Limit (dBm)	WCDMA IV			Tune-up Limit (dBm)	WCDMA V			Tune-up Limit (dBm)
TX Channel		9262	9400	9538		1312	1413	1513		4132	4182	4233	
Rx Channel		9662	9800	9938		1537	1638	1738		4357	4407	4458	
Frequency (MHz)		1852.4	1880	1907.6		1712.4	1732.6	1752.6		826.4	836.4	846.6	
3GPP Rel 99	AMR 12.2Kbps	23.21	23.58	23.62	24.50	23.58	23.80	23.70	24.50	22.91	22.93	22.61	24.50
3GPP Rel 99	RMC 12.2Kbps	23.24	23.62	23.69	24.50	23.60	23.82	23.72	24.50	22.97	22.98	22.66	24.50
3GPP Rel 6	HSDPA Subtest-1	22.56	22.71	22.69	24.50	22.59	22.87	22.70	24.50	22.00	21.98	21.66	24.50
3GPP Rel 6	HSDPA Subtest-2	22.55	22.64	22.73	24.50	22.58	22.81	22.78	24.50	22.05	22.00	21.72	24.50
3GPP Rel 6	HSDPA Subtest-3	22.11	22.15	22.23	24.00	22.13	22.30	22.28	24.00	21.56	21.51	21.23	24.00
3GPP Rel 6	HSDPA Subtest-4	22.09	22.14	22.20	24.00	22.11	22.32	22.28	24.00	21.56	21.53	21.22	24.00
3GPP Rel 8	DC-HSDPA Subtest-1	22.52	22.61	22.59	24.50	22.52	22.77	22.60	24.50	21.92	21.88	21.56	24.50
3GPP Rel 8	DC-HSDPA Subtest-2	22.51	22.57	22.52	24.50	22.51	22.71	22.66	24.50	21.91	21.90	21.61	24.50
3GPP Rel 8	DC-HSDPA Subtest-3	22.03	22.03	22.13	24.00	22.06	22.20	22.18	24.00	21.46	21.41	21.14	24.00
3GPP Rel 8	DC-HSDPA Subtest-4	22.02	22.04	22.11	24.00	22.07	22.21	22.15	24.00	21.44	21.39	21.12	24.00
3GPP Rel 6	HSUPA Subtest-1	22.54	22.60	22.68	24.50	22.54	22.79	22.77	24.50	22.01	21.98	21.67	24.50
3GPP Rel 6	HSUPA Subtest-2	20.56	20.61	20.70	22.50	20.59	20.80	20.78	22.50	20.03	20.00	19.68	22.50
3GPP Rel 6	HSUPA Subtest-3	21.58	21.61	21.65	23.50	21.50	21.73	21.71	23.50	21.00	20.98	21.65	23.50
3GPP Rel 6	HSUPA Subtest-4	20.54	20.60	20.67	22.50	20.51	20.60	20.57	22.50	20.04	20.10	19.65	22.50
3GPP Rel 6	HSUPA Subtest-5	22.51	22.58	22.61	24.50	22.51	22.75	22.73	24.50	22.00	21.91	21.36	24.50



<LTE Conducted Power>

General Note:

1. Anritsu MT8820C base station simulator was used to setup the connection with EUT; the frequency band, channel bandwidth, RB allocation configuration, modulation type are set in the base station simulator to configure EUT transmitting at maximum power and at different configurations which are requested to be reported to FCC, for conducted power measurement and SAR testing.
2. Per KDB 941225 D05v02r05, when a properly configured base station simulator is used for the SAR and power measurements, spectrum plots for each RB allocation and offset configuration is not required.
3. Per KDB 941225 D05v02r05, start with the largest channel bandwidth and measure SAR for QPSK with 1 RB allocation, using the RB offset and required test channel combination with the highest maximum output power for RB offsets at the upper edge, middle and lower edge of each required test channel.
4. Per KDB 941225 D05v02r05, 50% RB allocation for QPSK SAR testing follows 1RB QPSK allocation procedure.
5. Per KDB 941225 D05v02r05, For QPSK with 100% RB allocation, SAR is not required when the highest maximum output power for 100 % RB allocation is less than the highest maximum output power in 50% and 1 RB allocations and the highest reported SAR for 1 RB and 50% RB allocation are ≤ 0.8 W/kg. Otherwise, SAR is measured for the highest output power channel; and if the reported SAR is > 1.45 W/kg, the remaining required test channels must also be tested.
6. Per KDB 941225 D05v02r05, 16QAM output power for each RB allocation configuration is $>$ not $\frac{1}{2}$ dB higher than the same configuration in QPSK and the reported SAR for the QPSK configuration is ≤ 1.45 W/kg; Per KDB 941225 D05v02r05, 16QAM SAR testing is not required.
7. Per KDB 941225 D05v02r05, Smaller bandwidth output power for each RB allocation configuration is $>$ not $\frac{1}{2}$ dB higher than the same configuration in the largest supported bandwidth, and the reported SAR for the largest supported bandwidth is ≤ 1.45 W/kg; Per KDB 941225 D05v02r05, smaller bandwidth SAR testing is not required.
8. For LTE B12 / B5 the maximum bandwidth does not support three non-overlapping channels, per KDB 941225 D05v02r05, when a device supports overlapping channel assignment in a channel bandwidth configuration, the middle channel of the group of overlapping channels should be selected for testing.
9. LTE band 4 / 17 SAR test was covered by Band 66 / 12; according to April 2015 TCB workshop, SAR test for overlapping LTE bands can be reduced if
 - a. the maximum output power, including tolerance, for the smaller band is \leq the larger band to qualify for the SAR test exclusion
 - b. the channel bandwidth and other operating parameters for the smaller band are fully supported by the larger band



<LTE Band 2>

BW [MHz]	Modulation	RB Size	RB Offset	Power Low Ch. / Freq.	Power Middle Ch. / Freq.	Power High Ch. / Freq.	Tune-up limit (dBm)	MPR (dB)
Channel				18700	18900	19100		
Frequency (MHz)				1860	1880	1900		
20	QPSK	1	0	22.65	22.74	22.80	24	0
20	QPSK	1	49	22.50	22.59	22.65		
20	QPSK	1	99	22.42	22.66	22.72		
20	QPSK	50	0	21.65	21.77	21.91	23	1
20	QPSK	50	24	21.59	21.73	21.84		
20	QPSK	50	50	21.56	21.75	21.90		
20	QPSK	100	0	21.52	21.69	21.77		
20	16QAM	1	0	21.82	21.85	21.94	23	1
20	16QAM	1	49	21.71	21.79	21.90		
20	16QAM	1	99	21.67	21.90	21.91		
20	16QAM	50	0	20.63	20.80	20.91	22	2
20	16QAM	50	24	20.66	20.73	20.84		
20	16QAM	50	50	20.59	20.65	20.82		
20	16QAM	100	0	20.53	20.76	20.85		
Channel				18675	18900	19125		
Frequency (MHz)				1857.5	1880	1902.5		
15	QPSK	1	0	22.45	22.57	22.61	24	0
15	QPSK	1	37	22.30	22.45	22.53		
15	QPSK	1	74	22.37	22.59	22.67		
15	QPSK	36	0	21.45	21.66	21.75	23	1
15	QPSK	36	20	21.40	21.63	21.67		
15	QPSK	36	39	21.48	21.58	21.79		
15	QPSK	75	0	21.42	21.67	21.71		
15	16QAM	1	0	21.82	21.88	21.91	23	1
15	16QAM	1	37	21.59	21.65	21.76		
15	16QAM	1	74	21.76	21.84	21.91		
15	16QAM	36	0	20.45	20.62	20.70	22	2
15	16QAM	36	20	20.44	20.66	20.69		
15	16QAM	36	39	20.48	20.55	20.74		
15	16QAM	75	0	20.38	20.45	20.64		
Channel				18650	18900	19150		
Frequency (MHz)				1855	1880	1905		
10	QPSK	1	0	22.66	22.57	22.63	24	0
10	QPSK	1	25	22.67	22.48	22.68		
10	QPSK	1	49	22.62	22.48	22.64		
10	QPSK	25	0	21.44	21.63	21.67	23	1
10	QPSK	25	12	21.45	21.59	21.78		
10	QPSK	25	25	21.39	21.57	21.74		
10	QPSK	50	0	21.43	21.61	21.77		
10	16QAM	1	0	21.76	21.80	21.87	23	1
10	16QAM	1	25	21.68	21.69	21.90		
10	16QAM	1	49	21.69	21.69	21.89		
10	16QAM	25	0	20.40	20.58	20.69	22	2
10	16QAM	25	12	20.43	20.60	20.74		
10	16QAM	25	25	20.36	20.54	20.73		
10	16QAM	50	0	20.41	20.60	20.80		



Channel				18625	18900	19175	Tune-up limit (dBm)	MPR (dB)
Frequency (MHz)				1852.5	1880	1907.5		
5	QPSK	1	0	22.49	22.76	22.69	24	0
5	QPSK	1	12	22.36	22.75	22.66		
5	QPSK	1	24	22.39	22.71	22.63		
5	QPSK	12	0	21.43	21.62	21.74	23	1
5	QPSK	12	7	21.38	21.65	21.73		
5	QPSK	12	13	21.36	21.58	21.71		
5	QPSK	25	0	21.41	21.61	21.76		
5	16QAM	1	0	21.61	21.94	21.92	23	1
5	16QAM	1	12	21.60	21.85	21.88		
5	16QAM	1	24	21.59	21.82	21.91		
5	16QAM	12	0	20.41	20.57	20.70	22	2
5	16QAM	12	7	20.46	20.61	20.76		
5	16QAM	12	13	20.41	20.62	20.76		
5	16QAM	25	0	20.40	20.54	20.72		
Channel				18615	18900	19185	Tune-up limit (dBm)	MPR (dB)
Frequency (MHz)				1851.5	1880	1908.5		
3	QPSK	1	0	22.32	22.50	22.65	24	0
3	QPSK	1	8	22.27	22.47	22.62		
3	QPSK	1	14	22.30	22.44	22.63		
3	QPSK	8	0	21.36	21.61	21.70	23	1
3	QPSK	8	4	21.38	21.62	21.76		
3	QPSK	8	7	21.40	21.59	21.73		
3	QPSK	15	0	21.38	21.55	21.76		
3	16QAM	1	0	21.54	21.72	21.92	23	1
3	16QAM	1	8	21.48	21.73	21.87		
3	16QAM	1	14	21.52	21.69	21.85		
3	16QAM	8	0	20.48	20.65	20.82	22	2
3	16QAM	8	4	20.50	20.66	20.84		
3	16QAM	8	7	20.43	20.66	20.79		
3	16QAM	15	0	20.40	20.63	20.76		
Channel				18607	18900	19193	Tune-up limit (dBm)	MPR (dB)
Frequency (MHz)				1850.7	1880	1909.3		
1.4	QPSK	1	0	22.18	22.46	22.67	24	0
1.4	QPSK	1	3	22.29	22.52	22.59		
1.4	QPSK	1	5	22.21	22.44	22.66		
1.4	QPSK	3	0	22.26	22.57	22.61		
1.4	QPSK	3	1	22.29	22.60	22.67		
1.4	QPSK	3	3	22.27	22.55	22.61		
1.4	QPSK	6	0	21.29	21.53	21.63	23	1
1.4	16QAM	1	0	21.54	21.69	21.90	23	1
1.4	16QAM	1	3	21.59	21.76	22.00		
1.4	16QAM	1	5	21.50	21.69	21.93		
1.4	16QAM	3	0	21.32	21.58	21.66		
1.4	16QAM	3	1	21.37	21.62	21.69		
1.4	16QAM	3	3	21.31	21.56	21.63		
1.4	16QAM	6	0	20.35	20.58	20.76	22	2



<LTE Band 4>

BW [MHz]	Modulation	RB Size	RB Offset	Power Low Ch. / Freq.	Power Middle Ch. / Freq.	Power High Ch. / Freq.	Tune-up limit (dBm)	MPR (dB)
Channel				20050	20175	20300		
Frequency (MHz)				1720	1732.5	1745		
20	QPSK	1	0	22.74	22.87	22.83	24	0
20	QPSK	1	49	22.64	22.74	22.83		
20	QPSK	1	99	22.67	22.75	22.85		
20	QPSK	50	0	21.85	21.99	21.96	23	1
20	QPSK	50	24	21.82	21.89	21.98		
20	QPSK	50	50	21.81	21.95	21.94		
20	QPSK	100	0	21.77	21.94	21.87		
20	16QAM	1	0	21.99	21.95	21.97	23	1
20	16QAM	1	49	21.91	22.00	21.98		
20	16QAM	1	99	21.96	21.93	21.92		
20	16QAM	50	0	20.88	20.97	20.95	22	2
20	16QAM	50	24	20.84	20.88	20.97		
20	16QAM	50	50	20.73	20.93	20.94		
20	16QAM	100	0	20.85	20.91	20.92		
Channel				20025	20175	20325		
Frequency (MHz)				1717.5	1732.5	1747.5		
15	QPSK	1	0	22.56	22.74	22.79	24	0
15	QPSK	1	37	22.49	22.60	22.69		
15	QPSK	1	74	22.51	22.71	22.80		
15	QPSK	36	0	21.59	21.79	21.92	23	1
15	QPSK	36	20	21.65	21.78	21.83		
15	QPSK	36	39	21.61	21.72	21.89		
15	QPSK	75	0	21.70	21.79	21.91		
15	16QAM	1	0	21.82	21.97	21.92	23	1
15	16QAM	1	37	21.75	21.80	21.92		
15	16QAM	1	74	21.79	21.92	21.91		
15	16QAM	36	0	20.59	20.82	20.90	22	2
15	16QAM	36	20	20.72	20.77	20.91		
15	16QAM	36	39	20.62	20.71	20.89		
15	16QAM	75	0	20.71	20.81	20.91		
Channel				20000	20175	20350		
Frequency (MHz)				1715	1732.5	1750		
10	QPSK	1	0	22.60	22.78	22.84	24	0
10	QPSK	1	25	22.46	22.67	22.86		
10	QPSK	1	49	22.55	22.67	22.84		
10	QPSK	25	0	21.63	21.79	21.88	23	1
10	QPSK	25	12	21.56	21.76	21.94		
10	QPSK	25	25	21.66	21.74	21.90		
10	QPSK	50	0	21.58	21.76	21.99		
10	16QAM	1	0	21.77	21.93	21.97	23	1
10	16QAM	1	25	21.69	21.87	21.94		
10	16QAM	1	49	21.80	21.86	21.92		
10	16QAM	25	0	20.60	20.83	20.86	22	2
10	16QAM	25	12	20.60	20.80	20.96		
10	16QAM	25	25	20.64	20.73	20.91		
10	16QAM	50	0	20.59	20.75	20.98		



Channel				19975	20175	20375	Tune-up limit (dBm)	MPR (dB)
Frequency (MHz)				1712.5	1732.5	1752.5		
5	QPSK	1	0	22.51	22.70	22.79	24	0
5	QPSK	1	12	22.50	22.68	22.83		
5	QPSK	1	24	22.46	22.65	22.84		
5	QPSK	12	0	21.58	21.78	21.99	23	1
5	QPSK	12	7	21.60	21.77	21.99		
5	QPSK	12	13	21.55	21.77	21.92		
5	QPSK	25	0	21.58	21.73	21.94	23	1
5	16QAM	1	0	21.73	21.90	21.93		
5	16QAM	1	12	21.67	21.84	21.94		
5	16QAM	1	24	21.70	21.89	21.88	22	2
5	16QAM	12	0	20.57	20.76	20.96		
5	16QAM	12	7	20.64	20.76	20.99		
5	16QAM	12	13	20.60	20.77	20.92	22	2
5	16QAM	25	0	20.58	20.74	20.95		
Channel				19965	20175	20385	Tune-up limit (dBm)	MPR (dB)
Frequency (MHz)				1711.5	1732.5	1753.5		
3	QPSK	1	0	22.49	22.68	22.76	24	0
3	QPSK	1	8	22.52	22.68	22.82		
3	QPSK	1	14	22.48	22.64	22.8		
3	QPSK	8	0	21.6	21.78	21.93	23	1
3	QPSK	8	4	21.61	21.76	21.99		
3	QPSK	8	7	21.56	21.74	21.89		
3	QPSK	15	0	21.56	21.76	21.91	23	1
3	16QAM	1	0	21.74	21.9	21.96		
3	16QAM	1	8	21.71	21.86	21.97		
3	16QAM	1	14	21.71	21.89	21.94	22	2
3	16QAM	8	0	20.65	20.82	20.95		
3	16QAM	8	4	20.66	20.85	20.94		
3	16QAM	8	7	20.62	20.79	20.91	22	2
3	16QAM	15	0	20.6	20.78	20.99		
Channel				19957	20175	20393	Tune-up limit (dBm)	MPR (dB)
Frequency (MHz)				1710.7	1732.5	1754.3		
1.4	QPSK	1	0	22.37	22.59	22.73	24	0
1.4	QPSK	1	3	22.48	22.62	22.83		
1.4	QPSK	1	5	22.35	22.55	22.77		
1.4	QPSK	3	0	22.49	22.75	22.85		
1.4	QPSK	3	1	22.48	22.79	22.82		
1.4	QPSK	3	3	22.50	22.82	22.86		
1.4	QPSK	6	0	21.47	21.68	21.89	23	1
1.4	16QAM	1	0	21.59	21.82	21.94	23	1
1.4	16QAM	1	3	21.65	21.87	21.98		
1.4	16QAM	1	5	21.61	21.80	21.91		
1.4	16QAM	3	0	21.42	21.64	21.85		
1.4	16QAM	3	1	21.54	21.68	21.88		
1.4	16QAM	3	3	21.42	21.63	21.83		
1.4	16QAM	6	0	20.55	20.74	20.96	22	2



<LTE Band 5>

BW [MHz]	Modulation	RB Size	RB Offset	Power Low Ch. / Freq.	Power Middle Ch. / Freq.	Power High Ch. / Freq.	Tune-up limit (dBm)	MPR (dB)
Channel				20450	20525	20600		
Frequency (MHz)				829	836.5	844		
10	QPSK	1	0	22.82	22.63	22.51	24	0
10	QPSK	1	25	22.76	22.51	22.37		
10	QPSK	1	49	22.56	22.44	22.29		
10	QPSK	25	0	21.87	21.63	21.46	23	1
10	QPSK	25	12	21.80	21.61	21.45		
10	QPSK	25	25	21.69	21.60	21.40		
10	QPSK	50	0	21.79	21.68	21.42		
10	16QAM	1	0	21.93	21.81	21.70	23	1
10	16QAM	1	25	21.94	21.71	21.56		
10	16QAM	1	49	21.77	21.64	21.45		
10	16QAM	25	0	20.85	20.63	20.45	22	2
10	16QAM	25	12	20.82	20.62	20.41		
10	16QAM	25	25	20.68	20.58	20.38		
10	16QAM	50	0	20.79	20.59	20.42		
Channel				20425	20525	20625		
Frequency (MHz)				826.5	836.5	846.5		
5	QPSK	1	0	22.77	22.57	22.34	24	0
5	QPSK	1	12	22.77	22.52	22.33		
5	QPSK	1	24	22.71	22.51	22.31		
5	QPSK	12	0	21.83	21.66	21.40	23	1
5	QPSK	12	7	21.88	21.64	21.41		
5	QPSK	12	13	21.83	21.57	21.41		
5	QPSK	25	0	21.82	21.62	21.43		
5	16QAM	1	0	21.94	21.80	21.60	23	1
5	16QAM	1	12	21.99	21.73	21.52		
5	16QAM	1	24	21.91	21.73	21.54		
5	16QAM	12	0	20.85	20.59	20.46	22	2
5	16QAM	12	7	20.90	20.63	20.46		
5	16QAM	12	13	20.83	20.60	20.35		
5	16QAM	25	0	20.84	20.60	20.42		
Channel				20415	20525	20635		
Frequency (MHz)				825.5	836.5	847.5		
3	QPSK	1	0	22.80	22.58	22.33	24	0
3	QPSK	1	8	22.76	22.52	22.34		
3	QPSK	1	14	22.73	22.54	22.29		
3	QPSK	8	0	21.88	21.60	21.41	23	1
3	QPSK	8	4	21.86	21.67	21.45		
3	QPSK	8	7	21.82	21.57	21.42		
3	QPSK	15	0	21.86	21.58	21.39		
3	16QAM	1	0	22.00	21.79	21.55	23	1
3	16QAM	1	8	21.95	21.79	21.54		
3	16QAM	1	14	21.97	21.74	21.53		
3	16QAM	8	0	20.95	20.74	20.45	22	2
3	16QAM	8	4	20.91	20.74	20.53		
3	16QAM	8	7	20.89	20.64	20.52		
3	16QAM	15	0	20.89	20.62	20.45		



Channel				20407	20525	20643	Tune-up limit (dBm)	MPR (dB)
Frequency (MHz)				824.7	836.5	848.3		
1.4	QPSK	1	0	22.72	22.47	22.20	24	0
1.4	QPSK	1	3	22.79	22.47	22.27		
1.4	QPSK	1	5	22.72	22.42	22.21		
1.4	QPSK	3	0	22.77	22.58	22.37		
1.4	QPSK	3	1	22.78	22.61	22.39		
1.4	QPSK	3	3	22.75	22.59	22.36		
1.4	QPSK	6	0	21.81	21.53	21.35	23	1
1.4	16QAM	1	0	21.98	21.68	21.45	23	1
1.4	16QAM	1	3	22.00	21.76	21.56		
1.4	16QAM	1	5	22.00	21.71	21.43		
1.4	16QAM	3	0	21.81	21.54	21.28		
1.4	16QAM	3	1	21.84	21.56	21.31		
1.4	16QAM	3	3	21.78	21.53	21.29		
1.4	16QAM	6	0	20.88	20.62	20.39	22	2



<LTE Band 7>

BW [MHz]	Modulation	RB Size	RB Offset	Power Low Ch. / Freq.	Power Middle Ch. / Freq.	Power High Ch. / Freq.	Tune-up limit (dBm)	MPR (dB)
Channel				20850	21100	21350		
Frequency (MHz)				2510	2535	2560		
20	QPSK	1	0	22.48	22.28	22.25	24	0
20	QPSK	1	49	22.44	22.26	22.18		
20	QPSK	1	99	22.39	22.25	22.22		
20	QPSK	50	0	21.50	21.46	21.37	23	1
20	QPSK	50	24	21.49	21.40	21.29		
20	QPSK	50	50	21.44	21.42	21.36		
20	QPSK	100	0	21.47	21.38	21.20		
20	16QAM	1	0	21.51	21.46	21.41	23	1
20	16QAM	1	49	21.73	21.66	21.46		
20	16QAM	1	99	21.70	21.58	21.45		
20	16QAM	50	0	20.42	20.39	20.28	22	2
20	16QAM	50	24	20.53	20.43	20.24		
20	16QAM	50	50	20.50	20.44	20.21		
20	16QAM	100	0	20.43	20.40	20.18		
Channel				20825	21100	21375		
Frequency (MHz)				2507.5	2535	2562.5		
15	QPSK	1	0	22.42	22.24	22.22	24	0
15	QPSK	1	37	22.41	22.35	22.21		
15	QPSK	1	74	22.42	22.38	22.27		
15	QPSK	36	0	21.44	21.34	21.19	23	1
15	QPSK	36	20	21.56	21.44	21.29		
15	QPSK	36	39	21.55	21.43	21.34		
15	QPSK	75	0	21.48	21.44	21.26		
15	16QAM	1	0	21.70	21.56	21.52	23	1
15	16QAM	1	37	21.79	21.60	21.39		
15	16QAM	1	74	21.74	21.69	21.46		
15	16QAM	36	0	20.46	20.36	20.16	22	2
15	16QAM	36	20	20.58	20.49	20.33		
15	16QAM	36	39	20.50	20.40	20.31		
15	16QAM	75	0	20.52	20.40	20.23		
Channel				20800	21100	21400		
Frequency (MHz)				2505	2535	2565		
10	QPSK	1	0	22.42	22.25	22.13	24	0
10	QPSK	1	25	22.43	22.35	22.22		
10	QPSK	1	49	22.39	22.31	22.19		
10	QPSK	25	0	21.47	21.35	21.25	23	1
10	QPSK	25	12	21.49	21.43	21.30		
10	QPSK	25	25	21.51	21.42	21.31		
10	QPSK	50	0	21.45	21.37	21.25		
10	16QAM	1	0	21.67	21.56	21.35	23	1
10	16QAM	1	25	21.74	21.61	21.44		
10	16QAM	1	49	21.71	21.64	21.41		
10	16QAM	25	0	20.50	20.37	20.18	22	2
10	16QAM	25	12	20.51	20.41	20.24		
10	16QAM	25	25	20.52	20.42	20.28		
10	16QAM	50	0	20.50	20.39	20.21		



Channel				20775	21100	21425	Tune-up limit (dBm)	MPR (dB)
Frequency (MHz)				2502.5	2535	2567.5		
5	QPSK	1	0	22.44	22.26	22.12	24	0
5	QPSK	1	12	22.44	22.31	22.18		
5	QPSK	1	24	22.44	22.30	22.14		
5	QPSK	12	0	21.48	21.39	21.17	23	1
5	QPSK	12	7	21.56	21.43	21.25		
5	QPSK	12	13	21.51	21.38	21.25		
5	QPSK	25	0	21.49	21.38	21.21		
5	16QAM	1	0	21.71	21.56	21.40	23	1
5	16QAM	1	12	21.72	21.57	21.37		
5	16QAM	1	24	21.74	21.63	21.44		
5	16QAM	12	0	20.56	20.37	20.18	22	2
5	16QAM	12	7	20.59	20.48	20.29		
5	16QAM	12	13	20.55	20.44	20.25		
5	16QAM	25	0	20.51	20.36	20.20		



<LTE Band 12>

BW [MHz]	Modulation	RB Size	RB Offset	Power Low Ch. / Freq.	Power Middle Ch. / Freq.	Power High Ch. / Freq.	Tune-up limit (dBm)	MPR (dB)
Channel				23060	23095	23130		
Frequency (MHz)				704	707.5	711		
10	QPSK	1	0	22.53	22.38	22.43	24	0
10	QPSK	1	25	22.58	22.50	22.48		
10	QPSK	1	49	22.55	22.59	22.58		
10	QPSK	25	0	21.59	21.53	21.51	23	1
10	QPSK	25	12	21.70	21.51	21.59		
10	QPSK	25	25	21.63	21.57	21.57		
10	QPSK	50	0	21.55	21.56	21.48		
10	16QAM	1	0	21.75	21.54	21.66	23	1
10	16QAM	1	25	21.78	21.69	21.67		
10	16QAM	1	49	21.77	21.73	21.76	22	2
10	16QAM	25	0	20.58	20.51	20.48		
10	16QAM	25	12	20.69	20.52	20.61		
10	16QAM	25	25	20.63	20.53	20.58		
10	16QAM	50	0	20.67	20.54	20.49		
Channel				23035	23095	23155		
Frequency (MHz)				701.5	707.5	713.5		
5	QPSK	1	0	22.44	22.44	22.47	24	0
5	QPSK	1	12	22.41	22.44	22.45		
5	QPSK	1	24	22.50	22.47	22.56		
5	QPSK	12	0	21.51	21.54	21.60	23	1
5	QPSK	12	7	21.54	21.53	21.60		
5	QPSK	12	13	21.54	21.52	21.67		
5	QPSK	25	0	21.52	21.50	21.58	23	1
5	16QAM	1	0	21.72	21.68	21.72		
5	16QAM	1	12	21.63	21.68	21.62		
5	16QAM	1	24	21.77	21.71	21.75		
5	16QAM	12	0	20.52	20.51	20.53	22	2
5	16QAM	12	7	20.54	20.57	20.54		
5	16QAM	12	13	20.51	20.54	20.60		
5	16QAM	25	0	20.41	20.44	20.50		
Channel				23025	23095	23165		
Frequency (MHz)				700.5	707.5	714.5		
3	QPSK	1	0	22.58	22.44	22.47	24	0
3	QPSK	1	8	22.53	22.44	22.57		
3	QPSK	1	14	22.53	22.43	22.55		
3	QPSK	8	0	21.61	21.49	21.59	23	1
3	QPSK	8	4	21.67	21.59	21.69		
3	QPSK	8	7	21.65	21.53	21.62		
3	QPSK	15	0	21.63	21.51	21.58		
3	16QAM	1	0	21.80	21.73	21.64	23	1
3	16QAM	1	8	21.79	21.71	21.78		
3	16QAM	1	14	21.78	21.67	21.74		
3	16QAM	8	0	20.64	20.60	20.67	22	2
3	16QAM	8	4	20.70	20.61	20.76		
3	16QAM	8	7	20.67	20.56	20.71		
3	16QAM	8	7	20.67	20.56	20.71		
3	16QAM	15	0	20.63	20.52	20.72		



Channel				23017	23095	23173	Tune-up limit (dBm)	MPR (dB)
Frequency (MHz)				699.7	707.5	715.3		
1.4	QPSK	1	0	22.52	22.41	22.41	24	0
1.4	QPSK	1	3	22.54	22.46	22.44		
1.4	QPSK	1	5	22.49	22.41	22.41		
1.4	QPSK	3	0	22.60	22.53	22.62		
1.4	QPSK	3	1	22.68	22.57	22.64		
1.4	QPSK	3	3	22.65	22.53	22.63		
1.4	QPSK	6	0	21.54	21.48	21.57	23	1
1.4	16QAM	1	0	21.84	21.64	21.63	23	1
1.4	16QAM	1	3	21.87	21.71	21.76		
1.4	16QAM	1	5	21.81	21.66	21.61		
1.4	16QAM	3	0	21.58	21.44	21.47		
1.4	16QAM	3	1	21.59	21.51	21.55		
1.4	16QAM	3	3	21.54	21.45	21.45		
1.4	16QAM	6	0	20.68	20.52	20.59	22	2



<LTE Band 13>

BW [MHz]	Modulation	RB Size	RB Offset	Power Low Ch. / Freq.	Power Middle Ch. / Freq.	Power High Ch. / Freq.	Tune-up limit (dBm)	MPR (dB)
Channel				23230				
Frequency (MHz)				782				
10	QPSK	1	0	22.57			24	0
10	QPSK	1	25	22.59				
10	QPSK	1	49	22.65				
10	QPSK	25	0	21.53			23	1
10	QPSK	25	12	21.69				
10	QPSK	25	25	21.74				
10	QPSK	50	0	21.66				
10	16QAM	1	0	21.78			23	1
10	16QAM	1	25	21.80				
10	16QAM	1	49	21.79				
10	16QAM	25	0	20.55			22	2
10	16QAM	25	12	20.67				
10	16QAM	25	25	20.69				
10	16QAM	50	0	20.67				
Channel				23205	23230	23255	Tune-up limit (dBm)	MPR (dB)
Frequency (MHz)				779.5	782	784.5		
5	QPSK	1	0	22.64	22.47	22.61	24	0
5	QPSK	1	12	22.61	22.57	22.63		
5	QPSK	1	24	22.60	22.53	22.60		
5	QPSK	12	0	21.74	21.70	21.61	23	1
5	QPSK	12	7	21.68	21.72	21.77		
5	QPSK	12	13	21.76	21.67	21.73		
5	QPSK	25	0	21.65	21.63	21.71		
5	16QAM	1	0	21.94	21.71	21.85	23	1
5	16QAM	1	12	21.79	21.79	21.85		
5	16QAM	1	24	21.91	21.80	21.83		
5	16QAM	12	0	20.70	20.67	20.63	22	2
5	16QAM	12	7	20.70	20.68	20.76		
5	16QAM	12	13	20.75	20.67	20.73		
5	16QAM	12	13	20.75	20.67	20.73		
5	16QAM	25	0	20.68	20.63	20.70		



<LTE Band 17>

BW [MHz]	Modulation	RB Size	RB Offset	Power Low Ch. / Freq.	Power Middle Ch. / Freq.	Power High Ch. / Freq.	Tune-up limit (dBm)	MPR (dB)
Channel				23780	23790	23800		
Frequency (MHz)				709	710	711		
10	QPSK	1	0	22.31	22.31	22.42		
10	QPSK	1	25	22.42	22.38	22.47	24	0
10	QPSK	1	49	22.57	22.58	22.57		
10	QPSK	25	0	21.47	21.45	21.48		
10	QPSK	25	12	21.51	21.51	21.50	23	1
10	QPSK	25	25	21.57	21.65	21.65		
10	QPSK	50	0	21.47	21.57	21.56		
10	16QAM	1	0	21.52	21.49	21.59	23	1
10	16QAM	1	25	21.58	21.58	21.63		
10	16QAM	1	49	21.76	21.74	21.75		
10	16QAM	25	0	20.45	20.48	20.47	22	2
10	16QAM	25	12	20.49	20.49	20.49		
10	16QAM	25	25	20.56	20.65	20.66		
10	16QAM	50	0	20.55	20.58	20.57		
Channel				23755	23790	23825	Tune-up limit (dBm)	MPR (dB)
Frequency (MHz)				706.5	710	713.5		
5	QPSK	1	0	22.30	22.39	22.45	24	0
5	QPSK	1	12	22.42	22.38	22.56		
5	QPSK	1	24	22.41	22.48	22.54		
5	QPSK	12	0	21.37	21.46	21.59	23	1
5	QPSK	12	7	21.52	21.49	21.68		
5	QPSK	12	13	21.50	21.62	21.68		
5	QPSK	25	0	21.52	21.48	21.66	23	1
5	16QAM	1	0	21.53	21.64	21.64		
5	16QAM	1	12	21.64	21.58	21.70		
5	16QAM	1	24	21.65	21.66	21.74	22	2
5	16QAM	12	0	20.37	20.51	20.50		
5	16QAM	12	7	20.58	20.55	20.62		
5	16QAM	12	13	20.58	20.63	20.59		
5	16QAM	25	0	20.51	20.47	20.67		



<LTE Band 66>

BW [MHz]	Modulation	RB Size	RB Offset	Power Low Ch. / Freq.	Power Middle Ch. / Freq.	Power High Ch. / Freq.	Tune-up limit (dBm)	MPR (dB)
Channel				132072	132322	132572		
Frequency (MHz)				1720	1745	1770		
20	QPSK	1	0	22.68	22.89	22.96	24	0
20	QPSK	1	49	22.57	22.82	22.90		
20	QPSK	1	99	22.61	22.77	22.75		
20	QPSK	50	0	21.81	21.96	21.98	23	1
20	QPSK	50	24	21.76	21.97	21.95		
20	QPSK	50	50	21.79	21.94	21.92		
20	QPSK	100	0	21.68	21.95	21.97		
20	16QAM	1	0	21.84	21.95	21.99	23	1
20	16QAM	1	49	21.82	21.84	21.92		
20	16QAM	1	99	21.89	21.96	21.93		
20	16QAM	50	0	20.80	20.89	20.95	22	2
20	16QAM	50	24	20.78	20.99	20.88		
20	16QAM	50	50	20.76	20.89	20.96		
20	16QAM	100	0	20.78	20.82	20.89		
Channel				132047	132322	132597		
Frequency (MHz)				1717.5	1745	1772.5		
15	QPSK	1	0	22.67	22.88	22.95	24	0
15	QPSK	1	37	22.50	22.85	22.80		
15	QPSK	1	74	22.62	22.82	22.83		
15	QPSK	36	0	21.71	21.91	21.96	23	1
15	QPSK	36	20	21.67	21.99	21.95		
15	QPSK	36	39	21.73	21.91	21.96		
15	QPSK	75	0	21.72	21.92	21.94		
15	16QAM	1	0	21.93	21.96	21.98	23	1
15	16QAM	1	37	21.77	21.88	21.84		
15	16QAM	1	74	21.88	21.89	21.91		
15	16QAM	36	0	20.70	20.92	20.90	22	2
15	16QAM	36	20	20.74	20.99	20.94		
15	16QAM	36	39	20.73	20.92	20.96		
15	16QAM	75	0	20.72	20.98	21.04		
Channel				132022	132322	132622		
Frequency (MHz)				1715	1745	1775		
10	QPSK	1	0	22.61	22.96	22.62	24	0
10	QPSK	1	25	22.54	22.87	22.48		
10	QPSK	1	49	22.52	22.86	22.59		
10	QPSK	25	0	21.69	22.00	21.94	23	1
10	QPSK	25	12	21.65	21.97	21.96		
10	QPSK	25	25	21.61	21.92	21.99		
10	QPSK	50	0	21.69	22.00	21.93		
10	16QAM	1	0	21.88	22.00	21.95	23	1
10	16QAM	1	25	21.80	21.93	21.87		
10	16QAM	1	49	21.75	21.94	21.99		
10	16QAM	25	0	20.66	20.99	20.95	22	2
10	16QAM	25	12	20.70	20.91	20.92		
10	16QAM	25	25	20.66	20.92	20.94		
10	16QAM	50	0	20.68	21.00	20.99		



Channel				131997	132322	132647	Tune-up limit (dBm)	MPR (dB)
Frequency (MHz)				1712.5	1745	1777.5		
5	QPSK	1	0	22.60	22.90	22.98	24	0
5	QPSK	1	12	22.54	22.88	23.00		
5	QPSK	1	24	22.54	22.84	22.93		
5	QPSK	12	0	21.68	22.00	21.95	23	1
5	QPSK	12	7	21.70	21.97	21.91		
5	QPSK	12	13	21.67	21.94	22.00		
5	QPSK	25	0	21.66	21.96	21.94		
5	16QAM	1	0	21.81	21.94	21.89	23	1
5	16QAM	1	12	21.71	21.86	21.93		
5	16QAM	1	24	21.84	21.89	21.91		
5	16QAM	12	0	20.70	20.99	20.88	22	2
5	16QAM	12	7	20.66	20.82	20.86		
5	16QAM	12	13	20.63	20.93	20.93		
5	16QAM	25	0	20.61	20.96	20.91		
Channel				131987	132322	132657	Tune-up limit (dBm)	MPR (dB)
Frequency (MHz)				1711.5	1745	1778.5		
3	QPSK	1	0	22.58	22.86	22.96	24	0
3	QPSK	1	8	22.55	22.88	22.91		
3	QPSK	1	14	22.58	22.85	22.92		
3	QPSK	8	0	21.68	21.98	21.95	23	1
3	QPSK	8	4	21.67	21.97	21.91		
3	QPSK	8	7	21.69	21.94	21.93		
3	QPSK	15	0	21.67	21.93	21.93		
3	16QAM	1	0	21.81	21.93	21.93	23	1
3	16QAM	1	8	21.92	21.98	21.89		
3	16QAM	1	14	21.92	21.99	21.85		
3	16QAM	8	0	20.73	20.96	20.92	22	2
3	16QAM	8	4	20.76	20.94	20.89		
3	16QAM	8	7	20.71	20.93	20.86		
3	16QAM	15	0	20.70	20.91	20.88		
Channel				131979	132322	132665	Tune-up limit (dBm)	MPR (dB)
Frequency (MHz)				1710.7	1745	1779.3		
1.4	QPSK	1	0	22.50	22.76	22.71	24	0
1.4	QPSK	1	3	22.61	22.86	22.78		
1.4	QPSK	1	5	22.48	22.78	22.71		
1.4	QPSK	3	0	22.64	22.98	22.81		
1.4	QPSK	3	1	22.68	22.83	22.90		
1.4	QPSK	3	3	22.65	22.98	22.82		
1.4	QPSK	6	0	21.66	21.89	21.88	23	1
1.4	16QAM	1	0	21.69	21.82	21.87	23	1
1.4	16QAM	1	3	21.74	21.87	21.86		
1.4	16QAM	1	5	21.69	21.81	21.99		
1.4	16QAM	3	0	21.66	21.90	21.91		
1.4	16QAM	3	1	21.70	21.94	21.98		
1.4	16QAM	3	3	21.64	21.89	21.91		
1.4	16QAM	6	0	20.63	20.93	20.98	22	2



<LTE Carrier Aggregation>

General Note:

1. This device supports Carrier Aggregation on downlink only for inter and intra band, Uplink CA is not supported. For the device supports bands and bandwidths and configurations are provided as follow table was according to 3GPP.
2. All permutations exist. No restrictions on Pcell & Scell combinations.

<Inter-Band Two Carrier combination>

E-UTRA CA Configuration	E-UTRA Bands	1.4 MHz	3 MHz	5 MHz	10 MHz	15 MHz	20 MHz	Maximum aggregated bandwidth [MHz]	Bandwidth combination set
CA_2A-4A	2	Yes	Yes	Yes	Yes	Yes	Yes	40	0
	4			Yes	Yes	Yes	Yes		
CA_2A-4A	2			Yes	Yes			20	1
	4			Yes	Yes				
CA_2A-4A	2			Yes	Yes	Yes	Yes	40	2
	4			Yes	Yes	Yes	Yes		
CA_2A-5A	2			Yes	Yes	Yes	Yes	30	0
	5			Yes	Yes				
CA_2A-5A	2			Yes	Yes			20	1
	5			Yes	Yes				
CA_2A-12A	2			Yes	Yes	Yes	Yes	30	0
	12			Yes	Yes				
CA_2A-12A	2			Yes	Yes	Yes	Yes	30	1
	12		Yes	Yes	Yes				
CA_2A-12A	2			Yes	Yes			20	2
	12			Yes	Yes				
CA_2A-66A	2	Yes	Yes	Yes	Yes	Yes	Yes	40	0
	66			Yes	Yes	Yes	Yes		
CA_2A-66A	2			Yes	Yes			20	1
	66			Yes	Yes				
CA_2A-66A	2			Yes	Yes	Yes	Yes	40	2
	66			Yes	Yes	Yes	Yes		
CA_4A-5A	4			Yes	Yes			20	0
	5			Yes	Yes				
CA_4A-5A	4			Yes	Yes	Yes	Yes	30	1
	5			Yes	Yes				
CA_4A-12A	4	Yes	Yes	Yes	Yes			20	0
	12			Yes	Yes				
CA_4A-12A	4	Yes	Yes	Yes	Yes	Yes	Yes	30	1
	12			Yes	Yes				
CA_4A-12A	4			Yes	Yes	Yes	Yes	30	2
	12		Yes	Yes	Yes				
CA_4A-12A	4			Yes	Yes			20	3
	12			Yes	Yes				
CA_4A-12A	4			Yes	Yes	Yes	Yes	30	4
	12			Yes	Yes				
CA_4A-12A	4			Yes	Yes	Yes		20	5
	12			Yes					
CA_12A-66A	12			Yes	Yes			20	0
	66	Yes	Yes	Yes	Yes				
CA_12A-66A	12			Yes	Yes			30	1
	66	Yes	Yes	Yes	Yes	Yes	Yes		
CA_12A-66A	12		Yes	Yes	Yes			30	2
	66			Yes	Yes	Yes	Yes		



CA_12A-66A	12			Yes	Yes			20	3
	66			Yes	Yes				
CA_12A-66A	12			Yes	Yes			30	4
	66			Yes	Yes	Yes	Yes		
CA_12A-66A	12			Yes				20	5
	66			Yes	Yes	Yes			

<Inter-Band Three Carrier combination>

E-UTRA CA Configuration	E-UTRA Bands	1.4 MHz	3 MHz	5 MHz	10 MHz	15 MHz	20 MHz	Maximum aggregated bandwidth [MHz]	Bandwidth combination set
CA_2A-2A-4A	2	See CA_2A-2A Bandwidth Combination Set 0 in Table 5.4.2A.1-3						60	0
	4			Yes	Yes	Yes	Yes		
CA_2A-2A-12A	2	See CA_2A-2A Bandwidth Combination Set 0 in Table 5.4.2A.1-3						50	0
	12			Yes	Yes				
CA_2A-4A-12A	2			Yes	Yes	Yes	Yes	50	0
	4			Yes	Yes	Yes	Yes		
	12			Yes	Yes				
CA_2A-4A-4A	2			Yes	Yes	Yes	Yes	60	0
	4	See CA_4A-4A Bandwidth Combination Set 0 in Table 5.4.2A.1-3							
CA_2A-66C	2			Yes	Yes	Yes	Yes	60	0
	66	See CA_66C Bandwidth Combination Set 0 in Table 5.4.2A.1-1							
CA_2A-66A-66A	2			Yes	Yes	Yes	Yes	60	0
	66	See CA_66A-66A Bandwidth Combination Set 0 in Table 5.4.2A.1-3							
CA_2A-12A-66A	2			Yes	Yes	Yes	Yes	50	0
	12			Yes	Yes				
	66			Yes	Yes	Yes	Yes		
	2			Yes	Yes				
CA_2A-12A-66A	12			Yes	Yes			40	0
	66			Yes	Yes	Yes	Yes		
	2			Yes	Yes				
CA_4A-4A-12A	4	See CA_4A-4A Bandwidth Combination Set 0 in Table 5.4.2A.1-3						50	0
	12			Yes	Yes				
CA_12A-66C	12			Yes	Yes			50	0
	66	See CA_66C Bandwidth combination set 0 in Table 5.4.2A.1-1							
CA_12A-66A-66A	12			Yes	Yes			50	0
	66	See CA_66A-66A Bandwidth combination set 0 in Table 5.4.2A.1-3							
CA_2C-12A	2	See CA_2C Bandwidth combination set 0 in Table 5.4.2A.1-1						50	0
	12			Yes	Yes				
CA_2A-2A-66A	2	See CA_2A-2A Bandwidth Combination Set 0 in Table 5.4.2A.1-3						60	0
	66			Yes	Yes	Yes	Yes		

<Intra-Band Carrier combination>

E-UTRA CA Configuration	Channel bandwidths for carrier [MHz]	Channel bandwidths for carrier [MHz]	Channel bandwidths for carrier [MHz]	Channel bandwidths for carrier [MHz]	Maximum aggregated bandwidth [MHz]	Bandwidth combination set
CA_2C	5	20			40	0
	10	15,20				
	15	10,15,20				
	20	5,10,15,20				
CA_2A-2A	5,10,15,20	5,10,15,20			40	0
CA_4A-4A	5,10,15,20	5,10,15,20			40	0
	5,10	5,10			20	1
CA_66C	5	20			40	0
	10	15, 20				
	15	10, 15, 20				
	20	5, 10, 15, 20				
CA_66A-66A	5, 10, 15, 20	5, 10, 15, 20			40	0
CA_66B	5	5, 10, 15			20	0
	10	5, 10				
	15	5				

<LTE Carrier Aggregation Power verification>

General Note:

- i. According to KDB941225 D05A v01r02, Uplink maximum output power measurement with downlink carrier aggregation active should be measured, using the highest output channel measured without downlink carrier aggregation, to confirm that uplink maximum output power with downlink carrier aggregation active remains within the specified tune-up tolerance limits and not more than ¼ dB higher than the maximum output measured without downlink carrier aggregation active.
- ii. Uplink maximum output power with downlink carrier aggregation active does not show more than ¼ dB higher than the maximum output power without downlink carrier aggregation active, therefore SAR evaluation with downlink carrier aggregation active can be excluded.
- iii. The device supports downlink carrier aggregation only. Uplink carrier aggregation is not supported. For power measurement were control and acknowledge data is sent on uplink channels that operate identical to specifications when downlink carrier aggregation is inactive.
- iv. Selected highest measured power when downlink carrier aggregation is inactive for conducted power comparison with downlink carrier aggregation is active, to confirm that when downlink carrier aggregation is active uplink maximum output power remains within the specified tune-up tolerance limits and not more than ¼ dB higher than the maximum output power measured when downlink carrier aggregation inactive.
- v. For non-contiguous intra-band CA, the SCC selected to provide maximum separation from the PCC and must remain fully within the downlink transmission band.
- vi. For inter-band CA, the SCC selected highest bandwidth and near the middle of its transmission band.
- vii. For Intra-band, contiguous CA, the downlink channels selected to perform the uplink power measurement must satisfy 3GPP channel spacing (5.4.1A of 3GPP TS 36.521 or equivalent) and channel bandwidth (5.4.2A) requirements.

$$\text{Nominal channel spacing} = \left\lfloor \frac{BW_{\text{Channel}(1)} + BW_{\text{Channel}(2)} - 0.1|BW_{\text{Channel}(1)} - BW_{\text{Channel}(2)}|}{0.6} \right\rfloor 0.3 \text{ [MHz]}$$

<Maximum output power for Two Carrier power verification>

Configure	PCC							SCC				Power		
	LTE Band	BW (MHz)	UL Freq. (MHz)	UL Channel	Mod.	UL# RB	UL RB Offset	LTE Band	BW (MHz)	DL Freq. (MHz)	DL Channel	With CA Tx.Power (dBm)	W/O CA Tx.Power (dBm)	
Inter-Band	Band 2	20	1900	19100	QPSK	1	0	Band 4	20	2132.5	2175	22.78	22.80	
	Band 4	20	1732.5	20175	QPSK	1	0	Band 2	20	1960	900	22.80	22.87	
	Band 2	20	1900	19100	QPSK	1	0	Band 5	10	881.5	2525	22.76	22.80	
	Band 5	10	829	20450	QPSK	1	0	Band 2	20	1960	900	22.77	22.82	
	Band 2	20	1900	19100	QPSK	1	0	Band 12	10	737.5	5095	22.74	22.80	
	Band 12	10	707.5	23095	QPSK	1	49	Band 2	20	1960	900	22.58	22.59	
	Band 2	20	1900	19100	QPSK	1	0	Band 66	20	2145	66786	22.72	22.80	
	Band 66	20	1770	132572	QPSK	1	0	Band 2	20	1960	900	22.89	22.96	
	Band 4	20	1732.5	20175	QPSK	1	0	Band 5	10	881.5	2525	22.86	22.87	
	Band 5	10	829	20450	QPSK	1	0	Band 4	20	2132.5	2175	22.77	22.82	
	Band 4	20	1732.5	20175	QPSK	1	0	Band 12	10	737.5	5095	22.79	22.87	
	Band 12	10	707.5	23095	QPSK	1	49	Band 4	20	2132.5	2175	22.49	22.59	
	Band 12	10	707.5	23095	QPSK	1	49	Band 66	20	2145	66786	22.55	22.59	
	Band 66	20	1770	132572	QPSK	1	0	Band 12	10	737.5	5095	22.91	22.96	
Intra-Band	Non-Contiguous	Band 2	20	1900	19100	QPSK	1	0	Band 2	5	1932.5	625	22.72	22.80
		Band 4	20	1732.5	20175	QPSK	1	0	Band 4	5	2152.5	2375	22.83	22.87
		Band 66	20	1770	132572	QPSK	1	0	Band 66	5	2112.5	66461	22.90	22.96
	Contiguous	Band 2	20	1900	19100	QPSK	1	0	Band 2	20	1960.2	902	22.80	22.80
		Band 66	20	1770	132572	QPSK	1	0	Band 66	20	2189.8	67234	22.95	22.96
		Band 66	5	1777.5	132647	QPSK	1	12	Band 66	15	2168.2	67018	22.93	23.00



<Maximum output power for Three Carrier power verification>

Configure	PCC							SCC1				SCC2				Power	
	LTE Band	BW (MHz)	UL Freq. (MHz)	UL CH.	Mod.	UL# RB	UL RB Offset	LTE Band	BW (MHz)	DL Freq. (MHz)	DL CH.	LTE Band	BW (MHz)	DL Freq. (MHz)	DL CH.	With CA Tx.Power (dBm)	W/O CA Tx.Power (dBm)
Inter-Band	Band 2	20	1900	19100	QPSK	1	0	Band 4	20	2132.5	2175	Band 12	10	737.5	5095	22.74	22.80
	Band 4	20	1732.5	20175	QPSK	1	0	Band 2	20	1960	900	Band 12	10	737.5	5095	22.80	22.87
	Band 12	10	707.5	23095	QPSK	1	49	Band 2	20	1960	900	Band 4	20	2132.5	2175	22.54	22.59
	Band 2	20	1900	19100	QPSK	1	0	Band 12	10	737.5	5095	Band 66	20	2155	66886	22.75	22.80
	Band 12	10	707.5	23095	QPSK	1	49	Band 2	20	1960	900	Band 66	20	2155	66886	22.57	22.59
	Band 66	20	1770	132572	QPSK	1	0	Band 2	20	1960	900	Band 12	10	737.5	5095	22.90	22.96
	Band 2	20	1900	19100	QPSK	1	0	Band 2	20	1960.2	902	Band 12	10	737.5	5095	22.72	22.80
	Band 12	10	707.5	23095	QPSK	1	49	Band 2	20	1960	900	Band 2	20	1979.8	1098	22.56	22.59
	Band 4	20	1732.5	20175	QPSK	1	0	Band 4	5	2152.5	2375	Band 12	10	737.5	5095	22.77	22.87
	Band 12	10	707.5	23095	QPSK	1	49	Band 4	20	2132.5	2175	Band 4	5	2152.5	2375	22.50	22.59
	Band 2	20	1900	19100	QPSK	1	0	Band 2	5	1932.5	625	Band 12	10	737.5	5095	22.73	22.80
	Band 12	10	707.5	23095	QPSK	1	49	Band 2	20	1960	900	Band 2	5	1987.5	1175	22.55	22.59
	Band 2	20	1900	19100	QPSK	1	0	Band 4	20	2132.5	2175	Band 4	5	2152.5	2375	22.71	22.80
	Band 4	20	1732.5	20175	QPSK	1	0	Band 4	5	2152.5	2375	Band 2	20	1960	900	22.80	22.87
	Band 2	20	1900	19100	QPSK	1	0	Band 2	5	1932.5	625	Band 4	20	2132.5	2175	22.78	22.80
	Band 4	20	1732.5	20175	QPSK	1	0	Band 2	20	1960	900	Band 2	5	1987.5	1175	22.79	22.87
	Band 2	20	1900	19100	QPSK	1	0	Band 66	20	2155	66886	Band 66	5	2112.5	66461	22.71	22.80
	Band 66	20	1770	132572	QPSK	1	0	Band 66	5	2112.5	66461	Band 2	20	1960	900	22.90	22.96
	Band 12	10	707.5	23095	QPSK	1	49	Band 66	20	2155	66886	Band 66	5	2112.5	66461	22.52	22.59
	Band 66	20	1770	132572	QPSK	1	0	Band 66	5	2112.5	66461	Band 12	10	737.5	5095	22.96	22.96
	Band 2	20	1900	19100	QPSK	1	0	Band 66	20	2155	66886	Band 66	20	2174.8	67084	22.75	22.80
	Band 66	20	1770	132572	QPSK	1	0	Band 66	20	2189.8	67234	Band 2	20	1960	900	22.95	22.96
	Band 12	10	707.5	23095	QPSK	1	49	Band 66	20	2155	66886	Band 66	20	2174.8	67084	22.58	22.59
	Band 66	20	1770	132572	QPSK	1	0	Band 66	20	2189.8	67234	Band 12	10	737.5	5095	22.92	22.96
	Band 2	20	1900	19100	QPSK	1	0	Band 2	5	1932.5	625	Band 66	20	2155	66886	22.72	22.80
	Band 66	20	1770	132572	QPSK	1	0	Band 2	20	1960	900	Band 2	5	1987.5	1175	22.93	22.96

**<WLAN Conducted Power>****General Note:**

1. Per KDB 248227 D01v02r02, SAR test reduction is determined according to 802.11 transmission mode configurations and certain exposure conditions with multiple test positions. In the 2.4 GHz band, separate SAR procedures are applied to DSSS and OFDM configurations to simplify DSSS test requirements. For OFDM, in both 2.4 and 5 GHz bands, an initial test configuration must be determined for each standalone and aggregated frequency band, according to the transmission mode configuration with the highest maximum output power specified for production units to perform SAR measurements. If the same highest maximum output power applies to different combinations of channel bandwidths, modulations and data rates, additional procedures are applied to determine which test configurations require SAR measurement. When applicable, an initial test position may be applied to reduce the number of SAR measurements required for next to the ear, UMPC mini-tablet or hotspot mode configurations with multiple test positions.
2. For 2.4 GHz 802.11b DSSS, either the initial test position procedure for multiple exposure test positions or the DSSS procedure for fixed exposure position is applied; these are mutually exclusive. For 2.4 GHz and 5 GHz OFDM configurations, the initial test configuration is applied to measure SAR using either the initial test position procedure for multiple exposure test position configurations or the initial test configuration procedures for fixed exposure test conditions. Based on the reported SAR of the measured configurations and maximum output power of the transmission mode configurations that are not included in the initial test configuration, the subsequent test configuration and initial test position procedures are applied to determine if SAR measurements are required for the remaining OFDM transmission configurations. In general, the number of test channels that require SAR measurement is minimized based on maximum output power measured for the test sample(s).
3. For OFDM transmission configurations in the 2.4 GHz and 5 GHz bands, When the same maximum power is specified for multiple transmission modes in a frequency band, the largest channel bandwidth, lowest order modulation, lowest data rate and lowest order 802.11a/g/n/ac mode is used for SAR measurement, on the highest measured output power channel for each frequency band.
4. DSSS and OFDM configurations are considered separately according to the required SAR procedures. SAR is measured in the initial test position using the 802.11 transmission mode configuration required by the DSSS procedure or initial test configuration and subsequent test configuration(s) according to the OFDM procedures.¹⁸ The initial test position procedure is described in the following:
 - a. When the reported SAR of the initial test position is ≤ 0.4 W/kg, further SAR measurement is not required for the other test positions in that exposure configuration and 802.11 transmission mode combinations within the frequency band or aggregated band.
 - b. When the reported SAR of the test position is > 0.4 W/kg, SAR is repeated for the 802.11 transmission mode configuration tested in the initial test position to measure the subsequent next closet/smallest test separation distance and maximum coupling test position on the highest maximum output power channel, until the report SAR is ≤ 0.8 W/kg or all required test position are tested.
 - c. For all positions/configurations, when the reported SAR is > 0.8 W/kg, SAR is measured for these test positions/configurations on the subsequent next highest measured output power channel(s) until the reported SAR is ≤ 1.2 W/kg or all required channels are tested.



<2.4GHz WLAN>

	Mode	Channel	Frequency (MHz)	Average power (dBm)	Tune-Up Limit	Duty Cycle %
2.4GHz WLAN	802.11b 1Mbps	1	2412	18.10	19.00	100.00
		6	2437	17.03	19.00	
		11	2462	18.01	19.00	
	802.11g 6Mbps	1	2412	15.84	18.50	93.43
		6	2437	15.96	18.50	
		11	2462	15.97	18.50	
	802.11n-HT20 MCS0	1	2412	15.87	18.50	93.02
		6	2437	15.98	18.50	
		11	2462	15.99	18.50	
	802.11n-HT40 MCS0	3	2422	15.70	18.00	87.41
		6	2437	15.88	18.00	
		9	2452	15.63	18.00	

<5GHz WLAN>

	Mode	Channel	Frequency (MHz)	Average power (dBm)	Tune-Up Limit	Duty Cycle %
5.2GHz WLAN	802.11a 6Mbps	36	5180	15.94	18.50	93.48
		40	5200	15.85	18.50	
		44	5220	15.79	18.50	
		48	5240	15.77	18.50	
	802.11n-HT20 MCS0	36	5180	15.97	18.50	93.41
		40	5200	15.90	18.50	
		44	5220	15.85	18.50	
		48	5240	15.80	18.50	
	802.11n-HT40 MCS0	38	5190	15.78	18.50	87.41
		46	5230	15.98	18.50	
	802.11ac-VHT20 MCS0	36	5180	15.95	18.50	93.80
		40	5200	15.88	18.50	
		44	5220	15.83	18.50	
		48	5240	15.78	18.50	
	802.11ac-VHT40 MCS0	38	5190	15.73	18.50	89.47
		46	5230	15.96	18.50	
802.11ac-VHT80 MCS0	42	5210	16.53	18.50	85.19	



5.3GHz WLAN	Mode	Channel	Frequency (MHz)	Average power (dBm)	Tune-Up Limit	Duty Cycle %
	802.11a 6Mbps	52	5260	15.88	18.50	93.48
		56	5280	15.90	18.50	
		60	5300	15.91	18.50	
		64	5320	15.94	18.50	
	802.11n-HT20 MCS0	52	5260	15.90	18.50	93.41
		56	5280	15.91	18.50	
		60	5300	15.93	18.50	
		64	5320	15.99	18.50	
	802.11n-HT40 MCS0	54	5270	15.88	18.50	87.41
62		5310	15.90	18.50		
802.11ac-VHT20 MCS0	52	5260	15.89	18.50	93.80	
	56	5280	15.90	18.50		
	60	5300	15.92	18.50		
	64	5320	15.98	18.50		
802.11ac-VHT40 MCS0	54	5270	15.78	18.50	89.47	
	62	5310	15.81	18.50		
802.11ac-VHT80 MCS0	58	5290	16.50	18.50	85.19	

5.5GHz WLAN	Mode	Channel	Frequency (MHz)	Average power (dBm)	Tune-Up Limit	Duty Cycle %
	802.11a 6Mbps	100	5500	15.95	18.50	93.48
		116	5580	15.79	18.50	
		124	5620	15.77	18.50	
		132	5660	15.75	18.50	
		140	5700	15.74	18.50	
	802.11n-HT20 MCS0	100	5500	15.97	18.50	93.41
		116	5580	15.94	18.50	
		124	5620	15.90	18.50	
		132	5660	15.85	18.50	
		140	5700	15.80	18.50	
	802.11n-HT40 MCS0	102	5510	15.83	18.50	87.41
		110	5550	15.71	18.50	
		126	5630	15.70	18.50	
		134	5670	15.68	18.50	
	802.11ac-VHT20 MCS0	100	5500	15.96	18.50	93.80
		116	5580	15.88	18.50	
		124	5620	15.85	18.50	
132		5660	15.80	18.50		
140		5700	15.78	18.50		
802.11ac-VHT40 MCS0	102	5510	15.72	18.50	89.47	
	110	5550	15.68	18.50		
	126	5630	15.66	18.50		
	134	5670	15.65	18.50		
802.11ac-VHT80 MCS0	106	5530	16.61	18.50	85.19	
	122	5610	16.59	18.50		

5.8GHz WLAN	Mode	Channel	Frequency (MHz)	Average power (dBm)	Tune-Up Limit	Duty Cycle %
	802.11a MCS0	149	5745	15.97	18.50	93.48
		157	5785	15.96	18.50	
		165	5825	15.95	18.50	
	802.11n-HT20 MCS0	149	5745	15.99	18.50	93.41
		157	5785	15.98	18.50	
		165	5825	15.97	18.50	
	802.11n-HT40 MCS0	151	5755	15.98	18.50	87.41
		159	5795	15.99	18.50	
802.11ac-VHT20 MCS0	149	5745	15.98	18.50	93.80	
	157	5785	15.97	18.50		
	165	5825	15.96	18.50		
802.11ac-VHT40 MCS0	151	5755	15.91	18.50	89.47	
	159	5795	15.98	18.50		
802.11ac-VHT80 MCS0	155	5775	16.52	18.50	85.19	

<2.4GHz Bluetooth>

Mode	Channel	Frequency (MHz)	Average power (dBm)		
			1Mbps	2Mbps	3Mbps
BR / EDR	CH 00	2402	7.34	4.92	5.05
	CH 39	2441	5.64	2.54	2.50
	CH 78	2480	6.81	4.49	4.48
Tune-up Limit			7.5	5.5	5.5

Mode	Channel	Frequency (MHz)	Average power (dBm)
			GFSK
LE	CH 00	2402	2.91
	CH 19	2440	0.83
	CH 39	2480	3.29
Tune-up Limit			3.5

Mode	Channel	Frequency (MHz)	Average power (dBm)
			GFSK
BT5.0	CH 00	2402	1.28
	CH 19	2440	-1.11
	CH 39	2480	1.24
Tune-up Limit			1.5

General Note:

1. For 2.4GHz Bluetooth SAR testing was selected 1Mbps, due to its highest average power.
2. The Bluetooth duty cycle is 77.13%, according to 2016 Oct. TCB workshop for Bluetooth SAR scaling need further consideration and the theoretical duty cycle is 83.3%, therefore the actual duty cycle will be scaled up to the theoretical value of Bluetooth reported SAR calculation



13. Exclusions Applied

<2.4GHz ANT+>

Max Average power(dBm)	
ANT+	GFSK
	-6

Note:

- Per KDB 447498 D01v06, the 1-g and 10-g SAR test exclusion thresholds for 100 MHz to 6 GHz at *test separation distances* ≤ 50 mm are determined by:

$$[(max. power of channel, including tune-up tolerance, mW)/(min. test separation distance, mm)] \cdot [\sqrt{f(GHz)}] \leq 3.0$$
for 1-g SAR and ≤ 7.5 for 10-g extremity SAR
 - f(GHz) is the RF channel transmit frequency in GHz
 - Power and distance are rounded to the nearest mW and mm before calculation
 - The result is rounded to one decimal place for comparison

ANT+ Max Power (dBm)	Separation Distance (mm)	Frequency (GHz)	exclusion thresholds
-6	< 5	2.48	0.00

Note:

Per KDB 447498 D01v06, when the minimum test separation distance is < 5 mm, a distance of 5 mm is applied to determine SAR test exclusion. The test exclusion threshold is 0 which is ≤ 3, SAR testing is not required.

14. Antenna Location

<Mobile Phone>

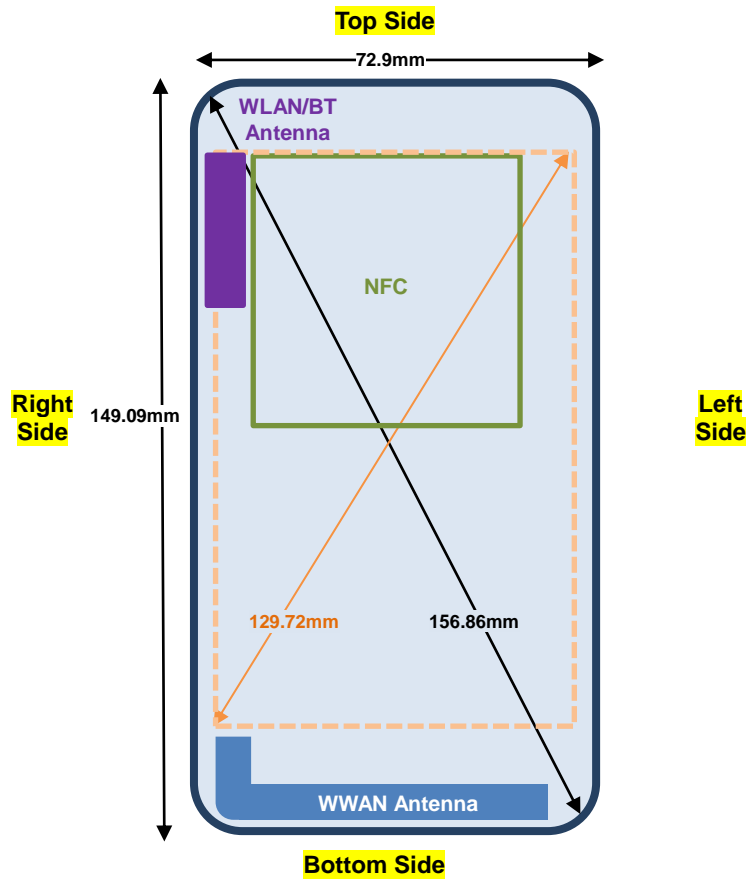

Back View

Overall diagonal	156.86 mm
Display diagonal	129.72 mm

Distance of the Antenna to the EUT surface/edge						
Antennas	Back	Front	Top Side	Bottom Side	Right Side	Left Side
WWAN Main	≤ 25mm	≤ 25mm	>25mm	≤ 25mm	≤ 25mm	≤ 25mm
BT&WLAN	≤ 25mm	≤ 25mm	≤ 25mm	>25mm	≤ 25mm	>25mm

Positions for SAR tests; Hotspot mode						
Antennas	Back	Front	Top Side	Bottom Side	Right Side	Left Side
WWAN Main	Yes	Yes	No	Yes	Yes	Yes
BT&WLAN	Yes	Yes	Yes	No	Yes	No

General Note:

- Referring to KDB 941225 D06 v02r01, when the overall device length and width are ≥ 9cm*5cm, the test distance is 10 mm. SAR must be measured for all sides and surfaces with a transmitting antenna located within 25mm from that surface or edge



15. SAR Test Results

General Note:

1. Per KDB 447498 D01v06, the reported SAR is the measured SAR value adjusted for maximum tune-up tolerance.
 - a. Tune-up scaling Factor = tune-up limit power (mW) / EUT RF power (mW), where tune-up limit is the maximum rated power among all production units.
 - b. For SAR testing of WLAN signal with non-100% duty cycle, the measured SAR is scaled-up by the duty cycle scaling factor which is equal to "1/(duty cycle)"
 - c. For WWAN: Reported SAR(W/kg)= Measured SAR(W/kg)*Tune-up Scaling Factor
 - d. For WLAN/Bluetooth: Reported SAR(W/kg)= Measured SAR(W/kg)* Duty Cycle scaling factor * Tune-up scaling factor
2. Per KDB 447498 D01v06, for each exposure position, testing of other required channels within the operating mode of a frequency band is not required when the *reported* 1-g or 10-g SAR for the mid-band or highest output power channel is:
 - ≤ 0.8 W/kg or 2.0 W/kg, for 1-g or 10-g respectively, when the transmission band is ≤ 100 MHz
 - ≤ 0.6 W/kg or 1.5 W/kg, for 1-g or 10-g respectively, when the transmission band is between 100 MHz and 200 MHz
 - ≤ 0.4 W/kg or 1.0 W/kg, for 1-g or 10-g respectively, when the transmission band is ≥ 200 MHz
3. Per KDB 865664 D01v01r04, for each frequency band, repeated SAR measurement is required only when the measured SAR is ≥ 0.8 W/kg.
4. Per KDB 648474 D04v01r03, when the reported SAR for a body-worn accessory measured without a headset connected to the handset is ≤ 1.2 W/kg, SAR testing with a headset connected to the handset is not required.

GSM Note:

1. Per KDB 941225 D01v03r01, for SAR test reduction for GSM / GPRS / EDGE modes is determined by the source-based time-averaged output power including tune-up tolerance. The mode with highest specified time-averaged output power should be tested for SAR compliance in the applicable exposure conditions. For modes with the same specified maximum output power and tolerance, the higher number time-slot configuration should be tested. Therefore, the GPRS (4Tx slots) for GSM850/GSM1900 is considered as the primary mode.
2. Other configurations of GSM / GPRS / EDGE are considered as secondary modes. The 3G SAR test reduction procedure is applied, when the maximum output power and tune-up tolerance specified for production units in a secondary mode is $\leq 1/4$ dB higher than the primary mode, SAR measurement is not required for the secondary mode.

UMTS Note:

1. Per KDB 941225 D01v03r01, for SAR testing is measured using a 12.2 kbps RMC with TPC bits configured to all "1's".
2. Per KDB 941225 D01v03r01, RMC 12.2kbps setting is used to evaluate SAR. The maximum output power and tune-up tolerance specified for production units in HSDPA / HSUPA / DC-HSDPA is $\leq 1/4$ dB higher than RMC 12.2Kbps or when the highest reported SAR of the RMC12.2Kbps is scaled by the ratio of specified maximum output power and tune-up tolerance of HSDPA / HSUPA / DC-HSDPA to RMC12.2Kbps and the adjusted SAR is ≤ 1.2 W/kg, SAR measurement is not required for HSDPA / HSUPA / DC-HSDPA, and according to the following RF output power, the output power results of the secondary modes (HSUPA, HSDPA, DC-HSDPA) are less than $1/4$ dB higher than the primary modes; therefore, SAR measurement is not required for HSDPA / HSUPA / DC-HSDPA.

**LTE Note:**

1. Per KDB 941225 D05v02r05, start with the largest channel bandwidth and measure SAR for QPSK with 1 RB allocation, using the RB offset and required test channel combination with the highest maximum output power for RB offsets at the upper edge, middle and lower edge of each required test channel.
2. Per KDB 941225 D05v02r05, 50% RB allocation for QPSK SAR testing follows 1RB QPSK allocation procedure.
3. Per KDB 941225 D05v02r05, For QPSK with 100% RB allocation, SAR is not required when the highest maximum output power for 100 % RB allocation is less than the highest maximum output power in 50% and 1 RB allocations and the highest reported SAR for 1 RB and 50% RB allocation are ≤ 0.8 W/kg. Otherwise, SAR is measured for the highest output power channel; and if the reported SAR is > 1.45 W/kg, the remaining required test channels must also be tested.
4. Per KDB 941225 D05v02r05, 16QAM output power for each RB allocation configuration is $>$ not $\frac{1}{2}$ dB higher than the same configuration in QPSK and the reported SAR for the QPSK configuration is ≤ 1.45 W/kg; Per KDB 941225 D05v02r05, 16QAM SAR testing is not required.
5. Per KDB 941225 D05v02r05, Smaller bandwidth output power for each RB allocation configuration is $>$ not $\frac{1}{2}$ dB higher than the same configuration in the largest supported bandwidth, and the reported SAR for the largest supported bandwidth is ≤ 1.45 W/kg; Per KDB 941225 D05v02r05, smaller bandwidth SAR testing is not required.
6. For LTE B12 / B5 the maximum bandwidth does not support three non-overlapping channels, per KDB 941225 D05v02r05, when a device supports overlapping channel assignment in a channel bandwidth configuration, the middle channel of the group of overlapping channels should be selected for testing.
7. LTE band 4 / 17 SAR test was covered by Band 66 / 12; according to April 2015 TCB workshop, SAR test for overlapping LTE bands can be reduced if
 - a. The maximum output power, including tolerance, for the smaller band is \leq the larger band to qualify for the SAR test exclusion.
 - b. The channel bandwidth and other operating parameters for the smaller band are fully supported by the larger band.

WLAN Note:

1. Per KDB 248227 D01v02r02, for 2.4GHz 802.11g/n SAR testing is not required when the highest reported SAR for DSSS is adjusted by the ratio of OFDM to DSSS specified maximum output power and the adjusted SAR is ≤ 1.2 W/kg.
2. Per KDB 248227 D01v02r02, U-NII-1 SAR testing is not required when the U-NII-2A band highest reported SAR for a test configuration is ≤ 1.2 W/kg, SAR is not required for U-NII-1 band.
3. When the reported SAR of the test position is > 0.4 W/kg, SAR is repeated for the 802.11 transmission mode configuration tested in the initial test position to measure the subsequent next closet/smallest test separation distance and maximum coupling test position on the highest maximum output power channel, until the report SAR is ≤ 0.8 W/kg or all required test position are tested.
4. For all positions / configurations, when the reported SAR is > 0.8 W/kg, SAR is measured for these test positions / configurations on the subsequent next highest measured output power channel(s) until the reported SAR is ≤ 1.2 W/kg or all required channels are tested.
5. During SAR testing the WLAN transmission was verified using a spectrum analyzer.



15.1 Head SAR

<GSM SAR>

Plot No.	Band	Mode	Test Position	Gap (mm)	Sample	Battery	Ch.	Freq. (MHz)	Average Power (dBm)	Tune-Up Limit (dBm)	Tune-up Scaling Factor	Power Drift (dB)	Measured 1g SAR (W/kg)	Reported 1g SAR (W/kg)
	GSM850	GPRS(4 Tx slots)	Right Cheek	0mm	1	1	128	824.2	29.73	30.00	1.064	0.03	0.084	0.089
	GSM850	GPRS(4 Tx slots)	Right Tilted	0mm	1	1	128	824.2	29.73	30.00	1.064	0.12	0.052	0.055
	GSM850	GPRS(4 Tx slots)	Left Cheek	0mm	1	1	128	824.2	29.73	30.00	1.064	0.05	0.090	0.096
	GSM850	GPRS(4 Tx slots)	Left Cheek	0mm	1	1	189	836.4	29.37	30.00	1.156	0.05	0.117	0.135
01	GSM850	GPRS(4 Tx slots)	Left Cheek	0mm	1	1	251	848.8	29.35	30.00	1.161	0.04	0.140	0.163
	GSM850	GPRS(4 Tx slots)	Left Cheek	0mm	2	2	251	848.8	29.35	30.00	1.161	-0.09	0.104	0.121
	GSM850	GPRS(4 Tx slots)	Left Tilted	0mm	1	1	128	824.2	29.73	30.00	1.064	0.07	0.037	0.039
	GSM850	GPRS (4 Tx slots)	Right Cheek	0mm	3	1	128	824.2	29.73	30.00	1.064	-0.12	0.104	0.111
	GSM850	GPRS (4 Tx slots)	Right Cheek	0mm	3	1	189	836.4	29.37	30.00	1.156	0.12	0.107	0.124
	GSM850	GPRS (4 Tx slots)	Right Cheek	0mm	3	1	251	848.8	29.35	30.00	1.161	-0.03	0.132	0.153
	GSM850	GPRS (4 Tx slots)	Right Tilted	0mm	3	1	128	824.2	29.73	30.00	1.064	0.12	0.061	0.065
	GSM850	GPRS (4 Tx slots)	Left Cheek	0mm	3	1	128	824.2	29.73	30.00	1.064	0.11	0.097	0.103
	GSM850	GPRS (4 Tx slots)	Left Tilted	0mm	3	1	128	824.2	29.73	30.00	1.064	0.12	0.064	0.068
	GSM850	GPRS (4 Tx slots)	Right Cheek	0mm	3	1	128	824.2	29.73	30.00	1.064	-0.12	0.104	0.111
	GSM1900	GPRS(4 Tx slots)	Right Cheek	0mm	1	1	810	1909.8	27.57	28.00	1.104	0.02	0.114	0.126
	GSM1900	GPRS(4 Tx slots)	Right Tilted	0mm	1	1	810	1909.8	27.57	28.00	1.104	0.09	0.056	0.062
	GSM1900	GPRS(4 Tx slots)	Left Cheek	0mm	1	1	810	1909.8	27.57	28.00	1.104	-0.06	0.281	0.310
02	GSM1900	GPRS(4 Tx slots)	Left Cheek	0mm	1	1	512	1850.2	27.53	28.00	1.114	-0.04	0.318	0.354
	GSM1900	GPRS(4 Tx slots)	Left Cheek	0mm	1	2	512	1850.2	27.53	28.00	1.114	0	0.184	0.205
	GSM1900	GPRS(4 Tx slots)	Left Cheek	0mm	1	1	661	1880	27.54	28.00	1.112	0.12	0.285	0.317
	GSM1900	GPRS(4 Tx slots)	Left Tilted	0mm	1	1	810	1909.8	27.57	28.00	1.104	0.17	0.078	0.086
	GSM1900	GPRS(4 Tx slots)	Right Cheek	0mm	3	1	810	1909.8	27.57	28.00	1.104	0.05	0.053	0.059
	GSM1900	GPRS(4 Tx slots)	Right Tilted	0mm	3	1	810	1909.8	27.57	28.00	1.104	-0.18	0.032	0.035
	GSM1900	GPRS(4 Tx slots)	Left Cheek	0mm	3	1	810	1909.8	27.57	28.00	1.104	0.14	0.080	0.088
	GSM1900	GPRS(4 Tx slots)	Left Cheek	0mm	3	1	512	1850.2	27.53	28.00	1.114	0.18	0.132	0.147
	GSM1900	GPRS(4 Tx slots)	Left Cheek	0mm	3	1	661	1909.8	27.54	28.00	1.112	0.18	0.124	0.138
	GSM1900	GPRS(4 Tx slots)	Left Tilted	0mm	3	1	810	1909.8	27.57	28.00	1.104	-0.01	0.033	0.036



<WCDMA SAR>

Plot No.	Band	Mode	Test Position	Cap (mm)	Sample	Battery	Ch.	Freq. (MHz)	Average Power (dBm)	Tune-Up Limit (dBm)	Tune-up Scaling Factor	Power Drift (dB)	Measured 1g SAR (W/kg)	Reported 1g SAR (W/kg)
	WCDMA II	RMC 12.2Kbps	Right Cheek	0mm	1	1	9538	1907.6	23.69	24.50	1.205	0.17	0.100	0.121
	WCDMA II	RMC 12.2Kbps	Right Tilted	0mm	1	1	9538	1907.6	23.69	24.50	1.205	0.14	0.053	0.064
	WCDMA II	RMC 12.2Kbps	Left Cheek	0mm	1	1	9538	1907.6	23.69	24.50	1.205	-0.03	0.152	0.183
03	WCDMA II	RMC 12.2Kbps	Left Cheek	0mm	1	1	9262	1852.4	23.24	24.50	1.337	0.11	0.205	0.274
	WCDMA II	RMC 12.2Kbps	Left Cheek	0mm	2	2	9262	1852.4	23.24	24.50	1.337	-0.03	0.201	0.269
	WCDMA II	RMC 12.2Kbps	Left Cheek	0mm	1	1	9400	1880	23.62	24.50	1.225	0.13	0.165	0.202
	WCDMA II	RMC 12.2Kbps	Left Tilted	0mm	1	1	9538	1907.6	23.69	24.50	1.205	0.11	0.041	0.049
	WCDMA II	RMC 12.2Kbps	Right Cheek	0mm	3	1	9538	1907.6	23.69	24.50	1.205	0.1	0.059	0.071
	WCDMA II	RMC 12.2Kbps	Right Tilted	0mm	3	1	9538	1907.6	23.69	24.50	1.205	-0.04	0.028	0.034
	WCDMA II	RMC 12.2Kbps	Left Cheek	0mm	3	1	9538	1907.6	23.69	24.50	1.205	0.15	0.084	0.101
	WCDMA II	RMC 12.2Kbps	Left Cheek	0mm	3	1	9262	1852.4	23.24	24.50	1.337	0.06	0.122	0.163
	WCDMA II	RMC 12.2Kbps	Left Cheek	0mm	3	1	9400	1880	23.62	24.50	1.225	0.08	0.110	0.135
	WCDMA II	RMC 12.2Kbps	Left Tilted	0mm	3	1	9538	1907.6	23.69	24.50	1.205	0.14	0.022	0.027
	WCDMA IV	RMC 12.2Kbps	Right Cheek	0mm	1	1	1413	1732.6	23.82	24.50	1.169	0.1	0.141	0.165
	WCDMA IV	RMC 12.2Kbps	Right Tilted	0mm	1	1	1413	1732.6	23.82	24.50	1.169	0.14	0.057	0.067
	WCDMA IV	RMC 12.2Kbps	Left Cheek	0mm	1	1	1413	1732.6	23.82	24.50	1.169	-0.15	0.206	0.241
	WCDMA IV	RMC 12.2Kbps	Left Cheek	0mm	1	1	1312	1712.4	23.60	24.50	1.230	0.16	0.219	0.269
04	WCDMA IV	RMC 12.2Kbps	Left Cheek	0mm	1	1	1513	1752.6	23.72	24.50	1.197	0.1	0.254	0.304
	WCDMA IV	RMC 12.2Kbps	Left Cheek	0mm	2	2	1513	1752.6	23.72	24.50	1.197	0.1	0.229	0.274
	WCDMA IV	RMC 12.2Kbps	Left Tilted	0mm	1	1	1413	1732.6	23.82	24.50	1.169	0.02	0.077	0.090
	WCDMA IV	RMC 12.2Kbps	Right Cheek	0mm	3	1	1413	1732.6	23.82	24.50	1.169	0.14	0.122	0.143
	WCDMA IV	RMC 12.2Kbps	Right Tilted	0mm	3	1	1413	1732.6	23.82	24.50	1.169	0.01	0.040	0.047
	WCDMA IV	RMC 12.2Kbps	Left Cheek	0mm	3	1	1413	1732.6	23.82	24.50	1.169	0.07	0.188	0.220
	WCDMA IV	RMC 12.2Kbps	Left Cheek	0mm	3	1	1312	1712.4	23.60	24.50	1.230	0.01	0.140	0.172
	WCDMA IV	RMC 12.2Kbps	Left Cheek	0mm	3	1	1513	1752.6	23.72	24.50	1.197	0.14	0.159	0.190
	WCDMA IV	RMC 12.2Kbps	Left Tilted	0mm	3	1	1413	1732.6	23.82	24.50	1.169	-0.1	0.046	0.054
	WCDMA V	RMC 12.2Kbps	Right Cheek	0mm	1	1	4182	836.4	22.98	24.50	1.419	0.07	0.058	0.082
	WCDMA V	RMC 12.2Kbps	Right Tilted	0mm	1	1	4182	836.4	22.98	24.50	1.419	-0.13	0.025	0.035
	WCDMA V	RMC 12.2Kbps	Left Cheek	0mm	1	1	4182	836.4	22.98	24.50	1.419	0.15	0.062	0.088
	WCDMA V	RMC 12.2Kbps	Left Cheek	0mm	1	1	4132	826.4	22.97	24.50	1.422	0.15	0.050	0.071
05	WCDMA V	RMC 12.2Kbps	Left Cheek	0mm	1	1	4233	846.6	22.66	24.50	1.528	0.06	0.076	0.116
	WCDMA V	RMC 12.2Kbps	Left Cheek	0mm	2	2	4233	846.6	22.66	24.50	1.528	-0.11	0.054	0.082
	WCDMA V	RMC 12.2Kbps	Left Tilted	0mm	1	1	4182	836.4	22.98	24.50	1.419	0.16	0.029	0.041
	WCDMA V	RMC 12.2Kbps	Right Cheek	0mm	3	1	4182	836.4	22.98	24.50	1.419	-0.01	0.077	0.109
	WCDMA V	RMC 12.2Kbps	Right Cheek	0mm	3	1	4132	826.4	22.97	24.50	1.422	-0.01	0.062	0.088
	WCDMA V	RMC 12.2Kbps	Right Cheek	0mm	3	1	4233	846.6	22.66	24.50	1.528	0.1	0.076	0.116
	WCDMA V	RMC 12.2Kbps	Right Tilted	0mm	3	1	4182	836.4	22.98	24.50	1.419	0.19	0.041	0.058
	WCDMA V	RMC 12.2Kbps	Left Cheek	0mm	3	1	4182	836.4	22.98	24.50	1.419	-0.05	0.071	0.101
	WCDMA V	RMC 12.2Kbps	Left Tilted	0mm	3	1	4182	836.4	22.98	24.50	1.419	0.09	0.041	0.058



<LTE SAR>

Plot No.	Band	BW (MHz)	Modulation	RB Size	RB offset	Test Position	Gap (mm)	Sample	Battery	Ch.	Freq. (MHz)	Average Power (dBm)	Tune-Up Limit (dBm)	Tune-up Scaling Factor	Power Drift (dB)	Measured 1g SAR (W/kg)	Reported 1g SAR (W/kg)
	LTE Band 2	20M	QPSK	1	0	Right Cheek	0mm	1	1	19100	1900	22.80	24.00	1.318	0	0.087	0.115
	LTE Band 2	20M	QPSK	50	0	Right Cheek	0mm	1	1	19100	1900	21.91	23.00	1.285	0.04	0.067	0.086
	LTE Band 2	20M	QPSK	1	0	Right Tilted	0mm	1	1	19100	1900	22.80	24.00	1.318	0.05	0.034	0.045
	LTE Band 2	20M	QPSK	50	0	Right Tilted	0mm	1	1	19100	1900	21.91	23.00	1.285	0.04	0.024	0.031
	LTE Band 2	20M	QPSK	1	0	Left Cheek	0mm	1	1	19100	1900	22.80	24.00	1.318	0.04	0.140	0.185
06	LTE Band 2	20M	QPSK	1	0	Left Cheek	0mm	1	1	18700	1860	22.65	24.00	1.365	0.03	0.189	0.258
	LTE Band 2	20M	QPSK	1	0	Left Cheek	0mm	2	2	18700	1860	22.65	24.00	1.365	-0.07	0.148	0.202
	LTE Band 2	20M	QPSK	1	0	Left Cheek	0mm	1	1	18900	1880	22.74	24.00	1.337	-0.06	0.171	0.229
	LTE Band 2	20M	QPSK	50	0	Left Cheek	0mm	1	1	19100	1900	21.91	23.00	1.285	0.06	0.108	0.139
	LTE Band 2	20M	QPSK	1	0	Left Tilted	0mm	1	1	19100	1900	22.80	24.00	1.318	0.07	0.042	0.055
	LTE Band 2	20M	QPSK	50	0	Left Tilted	0mm	1	1	19100	1900	21.91	23.00	1.285	0.14	0.033	0.042
	LTE Band 2	20M	QPSK	1	0	Right Cheek	0mm	3	1	19100	1900	22.80	24.00	1.318	0.12	0.051	0.067
	LTE Band 2	20M	QPSK	50	0	Right Cheek	0mm	3	1	19100	1900	21.91	23.00	1.285	0.15	0.040	0.051
	LTE Band 2	20M	QPSK	1	0	Right Tilted	0mm	3	1	19100	1900	22.80	24.00	1.318	0.11	0.025	0.033
	LTE Band 2	20M	QPSK	50	0	Right Tilted	0mm	3	1	19100	1900	21.91	23.00	1.285	-0.18	0.020	0.026
	LTE Band 2	20M	QPSK	1	0	Left Cheek	0mm	3	1	19100	1900	22.80	24.00	1.318	0.02	0.077	0.102
	LTE Band 2	20M	QPSK	1	0	Left Cheek	0mm	3	1	18700	1860	22.65	24.00	1.365	0.15	0.099	0.135
	LTE Band 2	20M	QPSK	1	0	Left Cheek	0mm	3	1	18900	1880	22.74	24.00	1.337	0.17	0.096	0.128
	LTE Band 2	20M	QPSK	50	0	Left Cheek	0mm	3	1	19100	1900	21.91	23.00	1.285	0.05	0.064	0.082
	LTE Band 2	20M	QPSK	1	0	Left Tilted	0mm	3	1	19100	1900	22.80	24.00	1.318	0.01	0.018	0.024
	LTE Band 2	20M	QPSK	50	0	Left Tilted	0mm	3	1	19100	1900	21.91	23.00	1.285	0.12	0.014	0.018
	LTE Band 5	10M	QPSK	1	0	Right Cheek	0mm	1	1	20525	836.5	22.63	24.00	1.371	0.16	0.042	0.058
	LTE Band 5	10M	QPSK	25	0	Right Cheek	0mm	1	1	20525	836.5	21.63	23.00	1.371	0.16	0.035	0.048
	LTE Band 5	10M	QPSK	1	0	Right Tilted	0mm	1	1	20525	836.5	22.63	24.00	1.371	0.13	0.025	0.034
	LTE Band 5	10M	QPSK	25	0	Right Tilted	0mm	1	1	20525	836.5	21.63	23.00	1.371	0.08	0.021	0.029
07	LTE Band 5	10M	QPSK	1	0	Left Cheek	0mm	1	1	20525	836.5	22.63	24.00	1.371	0.01	0.054	0.074
	LTE Band 5	10M	QPSK	1	0	Left Cheek	0mm	2	2	20525	836.5	22.63	24.00	1.371	-0.14	0.037	0.051
	LTE Band 5	10M	QPSK	25	0	Left Cheek	0mm	1	1	20525	836.5	21.63	23.00	1.371	0.12	0.044	0.060
	LTE Band 5	10M	QPSK	1	0	Left Tilted	0mm	1	1	20525	836.5	22.63	24.00	1.371	0.12	0.033	0.045
	LTE Band 5	10M	QPSK	25	0	Left Tilted	0mm	1	1	20525	836.5	21.63	23.00	1.371	0.06	0.027	0.037
	LTE Band 5	10M	QPSK	1	0	Right Cheek	0mm	3	1	20525	836.5	22.63	24.00	1.371	-0.03	0.050	0.069
	LTE Band 5	10M	QPSK	25	0	Right Cheek	0mm	3	1	20525	836.5	21.63	23.00	1.371	-0.13	0.042	0.058
	LTE Band 5	10M	QPSK	1	0	Right Tilted	0mm	3	1	20525	836.5	22.63	24.00	1.371	0.01	0.027	0.037
	LTE Band 5	10M	QPSK	25	0	Right Tilted	0mm	3	1	20525	836.5	21.63	23.00	1.371	0.07	0.026	0.036
	LTE Band 5	10M	QPSK	1	0	Left Cheek	0mm	3	1	20525	836.5	22.63	24.00	1.371	0.04	0.049	0.067
	LTE Band 5	10M	QPSK	25	0	Left Cheek	0mm	3	1	20525	836.5	21.63	23.00	1.371	0.07	0.043	0.059
	LTE Band 5	10M	QPSK	1	0	Left Tilted	0mm	3	1	20525	836.5	22.63	24.00	1.371	0.05	0.033	0.045
	LTE Band 5	10M	QPSK	25	0	Left Tilted	0mm	3	1	20525	836.5	21.63	23.00	1.371	0.07	0.027	0.037



Plot No.	Band	BW (MHz)	Modulation	RB Size	RB offset	Test Position	Gap (mm)	Sample	Battery	Ch.	Freq. (MHz)	Average Power (dBm)	Tune-Up Limit (dBm)	Tune-up Scaling Factor	Power Drift (dB)	Measured 1g SAR (W/kg)	Reported 1g SAR (W/kg)
	LTE Band 7	20M	QPSK	1	0	Right Cheek	0mm	1	1	20850	2510	22.48	24.00	1.419	0.12	0.280	0.397
	LTE Band 7	20M	QPSK	1	0	Right Cheek	0mm	1	1	21100	2535	22.28	24.00	1.486	0.11	0.371	0.551
08	LTE Band 7	20M	QPSK	1	0	Right Cheek	0mm	1	1	21350	2560	22.25	24.00	1.496	0.15	0.393	0.588
	LTE Band 7	20M	QPSK	1	0	Right Cheek	0mm	2	2	21350	2560	22.25	24.00	1.496	0.09	0.354	0.530
	LTE Band 7	20M	QPSK	50	0	Right Cheek	0mm	1	1	20850	2510	21.50	23.00	1.413	0.19	0.245	0.346
	LTE Band 7	20M	QPSK	1	0	Right Tilted	0mm	1	1	20850	2510	22.48	24.00	1.419	0.05	0.050	0.071
	LTE Band 7	20M	QPSK	50	0	Right Tilted	0mm	1	1	20850	2510	21.50	23.00	1.413	0.15	0.042	0.059
	LTE Band 7	20M	QPSK	1	0	Left Cheek	0mm	1	1	20850	2510	22.48	24.00	1.419	0.14	0.138	0.196
	LTE Band 7	20M	QPSK	50	0	Left Cheek	0mm	1	1	20850	2510	21.50	23.00	1.413	0.15	0.114	0.161
	LTE Band 7	20M	QPSK	1	0	Left Tilted	0mm	1	1	20850	2510	22.48	24.00	1.419	0.03	0.123	0.175
	LTE Band 7	20M	QPSK	50	0	Left Tilted	0mm	1	1	20850	2510	21.50	23.00	1.413	-0.02	0.100	0.141
	LTE Band 7	20M	QPSK	1	0	Right Cheek	0mm	3	1	20850	2510	22.48	24.00	1.419	0.19	0.167	0.237
	LTE Band 7	20M	QPSK	1	0	Right Cheek	0mm	3	1	21100	2535	22.28	24.00	1.486	-0.04	0.215	0.319
	LTE Band 7	20M	QPSK	1	0	Right Cheek	0mm	3	1	21350	2560	22.25	24.00	1.496	0.11	0.173	0.259
	LTE Band 7	20M	QPSK	50	0	Right Cheek	0mm	3	1	20850	2510	21.50	23.00	1.413	0.12	0.161	0.227
	LTE Band 7	20M	QPSK	1	0	Right Tilted	0mm	3	1	20850	2510	22.48	24.00	1.419	0.05	0.059	0.084
	LTE Band 7	20M	QPSK	50	0	Right Tilted	0mm	3	1	20850	2510	21.50	23.00	1.413	0.05	0.050	0.071
	LTE Band 7	20M	QPSK	1	0	Left Cheek	0mm	3	1	20850	2510	22.48	24.00	1.419	0.01	0.110	0.156
	LTE Band 7	20M	QPSK	50	0	Left Cheek	0mm	3	1	20850	2510	21.50	23.00	1.413	0.03	0.087	0.123
	LTE Band 7	20M	QPSK	1	0	Left Tilted	0mm	3	1	20850	2510	22.48	24.00	1.419	0.1	0.089	0.126
	LTE Band 7	20M	QPSK	50	0	Left Tilted	0mm	3	1	20850	2510	21.50	23.00	1.413	-0.07	0.070	0.099
	LTE Band 12	10M	QPSK	1	49	Right Cheek	0mm	1	1	23095	707.5	22.59	24.00	1.384	0.06	0.049	0.068
	LTE Band 12	10M	QPSK	25	12	Right Cheek	0mm	1	1	23095	707.5	21.51	23.00	1.409	0.09	0.038	0.054
	LTE Band 12	10M	QPSK	1	49	Right Tilted	0mm	1	1	23095	707.5	21.51	23.00	1.409	0.09	0.025	0.035
	LTE Band 12	10M	QPSK	25	12	Right Tilted	0mm	1	1	23095	707.5	22.59	24.00	1.384	0.14	0.020	0.028
09	LTE Band 12	10M	QPSK	1	49	Left Cheek	0mm	1	1	23095	707.5	22.59	24.00	1.384	0.09	0.067	0.093
	LTE Band 12	10M	QPSK	1	49	Left Cheek	0mm	2	2	23095	707.5	22.59	24.00	1.384	-0.07	0.038	0.053
	LTE Band 12	10M	QPSK	25	12	Left Cheek	0mm	1	1	23095	707.5	21.51	23.00	1.409	0.06	0.048	0.068
	LTE Band 12	10M	QPSK	1	49	Left Tilted	0mm	1	1	23095	707.5	22.59	24.00	1.384	0.07	0.026	0.036
	LTE Band 12	10M	QPSK	25	12	Left Tilted	0mm	1	1	23095	707.5	21.51	23.00	1.409	0.06	0.018	0.025
	LTE Band 12	10M	QPSK	1	49	Right Cheek	0mm	3	1	23095	707.5	22.59	24.00	1.384	0.18	0.026	0.036
	LTE Band 12	10M	QPSK	25	12	Right Cheek	0mm	3	1	23095	707.5	21.51	23.00	1.409	0.11	0.018	0.025
	LTE Band 12	10M	QPSK	1	49	Right Tilted	0mm	3	1	23095	707.5	22.59	24.00	1.384	0.12	0.019	0.026
	LTE Band 12	10M	QPSK	25	12	Right Tilted	0mm	3	1	23095	707.5	21.51	23.00	1.409	0.12	0.014	0.020
	LTE Band 12	10M	QPSK	1	49	Left Cheek	0mm	3	1	23095	707.5	22.59	24.00	1.384	0.1	0.035	0.048
	LTE Band 12	10M	QPSK	25	12	Left Cheek	0mm	3	1	23095	707.5	21.51	23.00	1.409	0.15	0.027	0.038
	LTE Band 12	10M	QPSK	1	49	Left Tilted	0mm	3	1	23095	707.5	22.59	24.00	1.384	0.12	0.020	0.028
	LTE Band 12	10M	QPSK	25	12	Left Tilted	0mm	3	1	23095	707.5	21.51	23.00	1.409	0.13	0.016	0.023



Plot No.	Band	BW (MHz)	Modulation	RB Size	RB offset	Test Position	Gap (mm)	Sample	Battery	Ch.	Freq. (MHz)	Average Power (dBm)	Tune-Up Limit (dBm)	Tune-up Scaling Factor	Power Drift (dB)	Measured 1g SAR (W/kg)	Reported 1g SAR (W/kg)
	LTE Band 13	10M	QPSK	1	49	Right Cheek	0mm	1	1	23230	782	22.65	24.00	1.365	0.03	0.047	0.064
	LTE Band 13	10M	QPSK	25	25	Right Cheek	0mm	1	1	23230	782	21.74	23.00	1.337	0.02	0.040	0.053
	LTE Band 13	10M	QPSK	1	49	Right Tilted	0mm	1	1	23230	782	22.65	24.00	1.365	-0.11	0.021	0.029
	LTE Band 13	10M	QPSK	25	25	Right Tilted	0mm	1	1	23230	782	21.74	23.00	1.337	0.04	0.018	0.024
10	LTE Band 13	10M	QPSK	1	49	Left Cheek	0mm	1	1	23230	782	22.65	24.00	1.365	0.09	0.059	0.081
	LTE Band 13	10M	QPSK	1	49	Left Cheek	0mm	2	2	23230	782	22.65	24.00	1.365	-0.06	0.050	0.068
	LTE Band 13	10M	QPSK	25	25	Left Cheek	0mm	1	1	23230	782	21.74	23.00	1.337	0.02	0.042	0.056
	LTE Band 13	10M	QPSK	1	49	Left Tilted	0mm	1	1	23230	782	22.65	24.00	1.365	0.16	0.019	0.026
	LTE Band 13	10M	QPSK	25	25	Left Tilted	0mm	1	1	23230	782	21.74	23.00	1.337	-0.03	0.017	0.023
	LTE Band 13	10M	QPSK	1	49	Right Cheek	0mm	3	1	23230	782	22.65	24.00	1.365	0.06	0.055	0.075
	LTE Band 13	10M	QPSK	25	25	Right Cheek	0mm	3	1	23230	782	21.74	23.00	1.337	0.03	0.046	0.061
	LTE Band 13	10M	QPSK	1	49	Right Tilted	0mm	3	1	23230	782	22.65	24.00	1.365	-0.15	0.048	0.065
	LTE Band 13	10M	QPSK	25	25	Right Tilted	0mm	3	1	23230	782	21.74	23.00	1.337	0.1	0.040	0.053
	LTE Band 13	10M	QPSK	1	49	Left Cheek	0mm	3	1	23230	782	22.65	24.00	1.365	0.13	0.060	0.082
	LTE Band 13	10M	QPSK	25	25	Left Cheek	0mm	3	1	23230	782	21.74	23.00	1.337	0.16	0.038	0.051
	LTE Band 13	10M	QPSK	1	49	Left Tilted	0mm	3	1	23230	782	22.65	24.00	1.365	0.08	0.051	0.070
	LTE Band 13	10M	QPSK	25	25	Left Tilted	0mm	3	1	23230	782	21.74	23.00	1.337	0.08	0.042	0.056
	LTE Band 66	20M	QPSK	1	0	Right Cheek	0mm	1	1	132572	1770	22.96	24.00	1.271	0.08	0.117	0.149
	LTE Band 66	20M	QPSK	50	0	Right Cheek	0mm	1	1	132572	1770	21.98	23.00	1.265	0.04	0.092	0.116
	LTE Band 66	20M	QPSK	1	0	Right Tilted	0mm	1	1	132572	1770	22.96	24.00	1.271	0.04	0.052	0.066
	LTE Band 66	20M	QPSK	50	0	Right Tilted	0mm	1	1	132572	1770	21.98	24.00	1.592	0.06	0.036	0.057
11	LTE Band 66	20M	QPSK	1	0	Left Cheek	0mm	1	1	132572	1770	22.96	24.00	1.271	-0.07	0.192	0.244
	LTE Band 66	20M	QPSK	1	0	Left Cheek	0mm	2	2	132572	1770	22.96	24.00	1.271	0.06	0.183	0.233
	LTE Band 66	20M	QPSK	1	0	Left Cheek	0mm	1	1	132072	1720	22.68	24.00	1.355	-0.1	0.171	0.232
	LTE Band 66	20M	QPSK	1	0	Left Cheek	0mm	1	1	132322	1745	22.89	24.00	1.291	-0.04	0.178	0.230
	LTE Band 66	20M	QPSK	50	0	Left Cheek	0mm	1	1	132572	1770	21.98	23.00	1.265	0.04	0.148	0.187
	LTE Band 66	20M	QPSK	1	0	Left Tilted	0mm	1	1	132572	1770	22.96	24.00	1.271	0.06	0.054	0.069
	LTE Band 66	20M	QPSK	50	0	Left Tilted	0mm	1	1	132572	1770	21.98	23.00	1.265	0.09	0.043	0.054
	LTE Band 66	20M	QPSK	1	0	Right Cheek	0mm	3	1	132572	1770	22.96	24.00	1.271	0.14	0.087	0.111
	LTE Band 66	20M	QPSK	50	0	Right Cheek	0mm	3	1	132572	1770	21.98	23.00	1.265	0.12	0.066	0.083
	LTE Band 66	20M	QPSK	1	0	Right Tilted	0mm	3	1	132572	1770	22.96	24.00	1.271	-0.01	0.039	0.050
	LTE Band 66	20M	QPSK	50	0	Right Tilted	0mm	3	1	132572	1770	21.98	23.00	1.265	0.15	0.029	0.037
	LTE Band 66	20M	QPSK	1	0	Left Cheek	0mm	3	1	132572	1770	22.96	24.00	1.271	0.09	0.144	0.183
	LTE Band 66	20M	QPSK	1	0	Left Cheek	0mm	3	1	132322	1745	22.89	24.00	1.291	-0.02	0.145	0.187
	LTE Band 66	20M	QPSK	1	0	Left Cheek	0mm	3	1	132072	1720	22.68	24.00	1.355	0.1	0.133	0.180
	LTE Band 66	20M	QPSK	50	0	Left Cheek	0mm	3	1	132572	1770	21.98	23.00	1.265	0.14	0.110	0.139
	LTE Band 66	20M	QPSK	1	0	Left Tilted	0mm	3	1	132572	1770	22.96	24.00	1.271	0.17	0.028	0.036
	LTE Band 66	20M	QPSK	50	0	Left Tilted	0mm	3	1	132572	1770	21.98	23.00	1.265	0.18	0.022	0.028



<WLAN SAR>

Plot No.	Band	Mode	Test Position	Gap (mm)	Sample	Battery	Ch.	Freq. (MHz)	Average Power (dBm)	Tune-Up Limit (dBm)	Tune-up Scaling Factor	Duty Cycle %	Duty Cycle Scaling Factor	Power Drift (dB)	Measured 1g SAR (W/kg)	Reported 1g SAR (W/kg)
	WLAN2.4GHz	802.11b 1Mbps	Right Cheek	0mm	1	1	1	2412	18.10	19.00	1.230	100	1.000	0.07	0.075	0.092
	WLAN2.4GHz	802.11b 1Mbps	Right Tilted	0mm	1	1	1	2412	18.10	19.00	1.230	100	1.000	0.01	0.083	0.102
	WLAN2.4GHz	802.11b 1Mbps	Left Cheek	0mm	1	1	1	2412	18.10	19.00	1.230	100	1.000	0.03	0.196	0.241
	WLAN2.4GHz	802.11b 1Mbps	Left Cheek	0mm	1	1	6	2437	17.03	19.00	1.574	100	1.000	0.1	0.134	0.211
12	WLAN2.4GHz	802.11b 1Mbps	Left Cheek	0mm	1	1	11	2462	18.01	19.00	1.256	100	1.000	0.05	0.231	0.290
	WLAN2.4GHz	802.11b 1Mbps	Left Cheek	0mm	2	2	11	2462	18.01	19.00	1.256	100	1.000	0.18	0.099	0.124
	WLAN2.4GHz	802.11b 1Mbps	Left Tilted	0mm	1	1	1	2412	18.10	19.00	1.230	100	1.000	0.07	0.117	0.144
	WLAN5GHz	802.11ac-VHT80 MCS0	Right Cheek	0mm	1	1	58	5290	16.50	18.50	1.585	85.19	1.174	0	0.001	0.002
	WLAN5GHz	802.11ac-VHT80 MCS0	Right Tilted	0mm	1	1	58	5290	16.50	18.50	1.585	85.19	1.174	0	0.001	0.002
13	WLAN5GHz	802.11ac-VHT80 MCS0	Left Cheek	0mm	1	1	58	5290	16.50	18.50	1.585	85.19	1.174	0.08	0.010	0.018
	WLAN5GHz	802.11ac-VHT80 MCS0	Left Tilted	0mm	1	1	58	5290	16.50	18.50	1.585	85.19	1.174	0.05	0.001	0.002
	WLAN5GHz	802.11ac-VHT80 MCS0	Right Cheek	0mm	1	1	106	5530	16.61	18.50	1.547	85.19	1.174	-0.1	0.105	0.191
	WLAN5GHz	802.11ac-VHT80 MCS0	Right Tilted	0mm	1	1	106	5530	16.61	18.50	1.547	85.19	1.174	-0.02	0.095	0.172
14	WLAN5GHz	802.11ac-VHT80 MCS0	Left Cheek	0mm	1	1	106	5530	16.61	18.50	1.547	85.19	1.174	0.02	0.107	0.194
	WLAN5GHz	802.11ac-VHT80 MCS0	Left Tilted	0mm	1	1	106	5530	16.61	18.50	1.547	85.19	1.174	0.03	0.078	0.142
15	WLAN5GHz	802.11ac-VHT80 MCS0	Right Cheek	0mm	1	1	155	5775	16.52	18.50	1.578	85.19	1.174	-0.08	0.176	0.326
	WLAN5GHz	802.11ac-VHT80 MCS0	Right Cheek	0mm	2	2	155	5775	16.52	18.50	1.578	85.19	1.174	-0.04	0.125	0.232
	WLAN5GHz	802.11ac-VHT80 MCS0	Right Tilted	0mm	1	1	155	5775	16.52	18.50	1.578	85.19	1.174	-0.14	0.123	0.228
	WLAN5GHz	802.11ac-VHT80 MCS0	Left Cheek	0mm	1	1	155	5775	16.52	18.50	1.578	85.19	1.174	0.01	0.115	0.213
	WLAN5GHz	802.11ac-VHT80 MCS0	Left Tilted	0mm	1	1	155	5775	16.52	18.50	1.578	85.19	1.174	0.03	0.096	0.178

<Bluetooth SAR>

Plot No.	Band	Mode	Test Position	Gap (mm)	Sample	Battery	Ch.	Freq. (MHz)	Average Power (dBm)	Tune-Up Limit (dBm)	Tune-up Scaling Factor	Duty Cycle %	Duty Cycle Scaling Factor	Power Drift (dB)	Measured 1g SAR (W/kg)	Reported 1g SAR (W/kg)
	Bluetooth	1Mbps	Right Cheek	0mm	1	1	0	2402	7.34	7.50	1.038	77.13	1.080	0.01	0.001	0.001
	Bluetooth	1Mbps	Right Tilted	0mm	1	1	0	2402	7.34	7.50	1.038	77.13	1.080	0.06	0.001	0.001
	Bluetooth	1Mbps	Left Cheek	0mm	1	1	0	2402	7.34	7.50	1.038	77.13	1.080	-0.08	0.003	0.004
	Bluetooth	1Mbps	Left Cheek	0mm	1	1	39	2441	5.64	7.50	1.535	77.13	1.080	-0.09	0.002	0.004
16	Bluetooth	1Mbps	Left Cheek	0mm	1	1	78	2480	6.81	7.50	1.172	77.13	1.080	-0.08	0.007	0.008
	Bluetooth	1Mbps	Left Cheek	0mm	2	2	78	2480	6.81	7.50	1.172	77.13	1.080	-0.18	0.003	0.003
	Bluetooth	1Mbps	Left Tilted	0mm	1	1	0	2402	7.34	7.50	1.038	77.13	1.080	0.06	0.001	0.001



15.2 Hotspot SAR

<GSM SAR>

Plot No.	Band	Mode	Test Position	Gap (mm)	Sample	Battery	Ch.	Freq. (MHz)	Average Power (dBm)	Tune-Up Limit (dBm)	Tune-up Scaling Factor	Power Drift (dB)	Measured 1g SAR (W/kg)	Reported 1g SAR (W/kg)
	GSM850	GPRS(4 Tx slots)	Front	10mm	1	1	128	824.2	29.73	30.00	1.064	-0.01	0.128	0.136
	GSM850	GPRS(4 Tx slots)	Back	10mm	1	1	128	824.2	29.73	30.00	1.064	-0.06	0.176	0.187
	GSM850	GPRS(4 Tx slots)	Back	10mm	1	1	189	836.4	29.37	30.00	1.156	0.01	0.212	0.245
17	GSM850	GPRS(4 Tx slots)	Back	10mm	1	1	251	848.8	29.35	30.00	1.161	0.03	0.237	0.275
	GSM850	GPRS(4 Tx slots)	Back	10mm	2	2	251	848.8	29.35	30.00	1.161	-0.17	0.211	0.245
	GSM850	GPRS(4 Tx slots)	Left Side	10mm	1	1	128	824.2	29.73	30.00	1.064	0.07	0.153	0.163
	GSM850	GPRS(4 Tx slots)	Right Side	10mm	1	1	128	824.2	29.73	30.00	1.064	0.01	0.115	0.122
	GSM850	GPRS(4 Tx slots)	Bottom Side	10mm	1	1	128	824.2	29.73	30.00	1.064	0.02	0.037	0.039
	GSM850	GPRS (4 Tx slots)	Front	10mm	3	1	128	824.2	29.73	30.00	1.064	-0.08	0.142	0.151
	GSM850	GPRS (4 Tx slots)	Back	10mm	3	1	128	824.2	29.73	30.00	1.064	0.08	0.178	0.189
	GSM850	GPRS (4 Tx slots)	Back	10mm	3	1	189	836.4	29.37	30.00	1.156	-0.06	0.166	0.192
	GSM850	GPRS (4 Tx slots)	Back	10mm	3	1	251	848.8	29.35	30.00	1.161	-0.09	0.182	0.211
	GSM850	GPRS (4 Tx slots)	Left Side	10mm	3	1	128	824.2	29.73	30.00	1.064	-0.11	0.146	0.155
	GSM850	GPRS (4 Tx slots)	Right Side	10mm	3	1	128	824.2	29.73	30.00	1.064	-0.13	0.140	0.149
	GSM850	GPRS (4 Tx slots)	Bottom Side	10mm	3	1	128	824.2	29.73	30.00	1.064	0.14	0.042	0.045
	GSM1900	GPRS(4 Tx slots)	Front	10mm	1	1	810	1909.8	27.57	28.00	1.104	0.16	0.566	0.625
18	GSM1900	GPRS(4 Tx slots)	Back	10mm	1	1	810	1909.8	27.57	28.00	1.104	-0.01	0.905	0.999
	GSM1900	GPRS(4 Tx slots)	Back	10mm	2	2	810	1909.8	27.57	28.00	1.104	-0.08	0.434	0.479
	GSM1900	GPRS(4 Tx slots)	Back	10mm	1	1	512	1850.2	27.53	28.00	1.114	0	0.688	0.767
	GSM1900	GPRS(4 Tx slots)	Back	10mm	1	1	661	1880	27.54	28.00	1.112	-0.05	0.792	0.880
	GSM1900	GPRS(4 Tx slots)	Left Side	10mm	1	1	810	1909.8	27.57	28.00	1.104	-0.03	0.128	0.141
	GSM1900	GPRS(4 Tx slots)	Right Side	10mm	1	1	810	1909.8	27.57	28.00	1.104	-0.04	0.067	0.074
	GSM1900	GPRS(4 Tx slots)	Bottom Side	10mm	1	1	810	1909.8	27.57	28.00	1.104	0.07	0.455	0.502
	GSM1900	GPRS(4 Tx slots)	Front	10mm	3	1	810	1909.8	27.57	28.00	1.104	0.04	0.156	0.172
	GSM1900	GPRS(4 Tx slots)	Back	10mm	3	1	810	1909.8	27.57	28.00	1.104	-0.03	0.267	0.295
	GSM1900	GPRS(4 Tx slots)	Back	10mm	3	1	512	1850.2	27.53	28.00	1.114	-0.01	0.305	0.340
	GSM1900	GPRS(4 Tx slots)	Back	10mm	3	1	661	1880	27.54	28.00	1.112	-0.03	0.288	0.320
	GSM1900	GPRS(4 Tx slots)	Left Side	10mm	3	1	810	1909.8	27.57	28.00	1.104	-0.06	0.054	0.060
	GSM1900	GPRS(4 Tx slots)	Right Side	10mm	3	1	810	1909.8	27.57	28.00	1.104	0.03	0.032	0.035
	GSM1900	GPRS(4 Tx slots)	Bottom Side	10mm	3	1	810	1909.8	27.57	28.00	1.104	-0.05	0.136	0.150



<WCDMA SAR>

Plot No.	Band	Mode	Test Position	Gap (mm)	Sample	Battery	Ch.	Freq. (MHz)	Average Power (dBm)	Tune-Up Limit (dBm)	Tune-up Scaling Factor	Power Drift (dB)	Measured 1g SAR (W/kg)	Reported 1g SAR (W/kg)
	WCDMA II	RMC 12.2Kbps	Front	10mm	1	1	9538	1907.6	23.69	24.50	1.205	0	0.299	0.360
19	WCDMA II	RMC 12.2Kbps	Back	10mm	1	1	9538	1907.6	23.69	24.50	1.205	-0.12	0.577	0.695
	WCDMA II	RMC 12.2Kbps	Back	10mm	2	2	9538	1907.6	23.69	24.50	1.205	-0.03	0.574	0.692
	WCDMA II	RMC 12.2Kbps	Back	10mm	1	1	9262	1852.4	23.24	24.50	1.337	-0.01	0.447	0.597
	WCDMA II	RMC 12.2Kbps	Back	10mm	1	1	9400	1880	23.62	24.50	1.225	-0.01	0.434	0.531
	WCDMA II	RMC 12.2Kbps	Left Side	10mm	1	1	9538	1907.6	23.69	24.50	1.205	-0.02	0.138	0.166
	WCDMA II	RMC 12.2Kbps	Right Side	10mm	1	1	9538	1907.6	23.69	24.50	1.205	-0.03	0.071	0.086
	WCDMA II	RMC 12.2Kbps	Bottom Side	10mm	1	1	9538	1907.6	23.69	24.50	1.205	0.13	0.238	0.287
	WCDMA II	RMC 12.2Kbps	Front	10mm	3	1	9538	1907.6	23.69	24.50	1.205	-0.07	0.182	0.219
	WCDMA II	RMC 12.2Kbps	Back	10mm	3	1	9538	1907.6	23.69	24.50	1.205	-0.12	0.308	0.371
	WCDMA II	RMC 12.2Kbps	Back	10mm	3	1	9262	1852.4	23.24	24.50	1.337	-0.01	0.356	0.476
	WCDMA II	RMC 12.2Kbps	Back	10mm	3	1	9400	1880	23.62	24.50	1.225	0.01	0.346	0.424
	WCDMA II	RMC 12.2Kbps	Left Side	10mm	3	1	9538	1907.6	23.69	24.50	1.205	0.13	0.035	0.042
	WCDMA II	RMC 12.2Kbps	Right Side	10mm	3	1	9538	1907.6	23.69	24.50	1.205	0.12	0.009	0.011
	WCDMA II	RMC 12.2Kbps	Bottom Side	10mm	3	1	9538	1907.6	23.69	24.50	1.205	0.01	0.175	0.211
	WCDMA IV	RMC 12.2Kbps	Front	10mm	1	1	1413	1732.6	23.82	24.50	1.169	-0.01	0.327	0.382
	WCDMA IV	RMC 12.2Kbps	Back	10mm	1	1	1413	1732.6	23.82	24.50	1.169	0.01	0.404	0.472
	WCDMA IV	RMC 12.2Kbps	Back	10mm	1	1	1312	1712.4	23.60	24.50	1.230	-0.02	0.395	0.486
20	WCDMA IV	RMC 12.2Kbps	Back	10mm	1	1	1513	1752.6	23.72	24.50	1.197	0	0.486	0.582
	WCDMA IV	RMC 12.2Kbps	Back	10mm	2	2	1513	1752.6	23.72	24.50	1.197	-0.15	0.427	0.511
	WCDMA IV	RMC 12.2Kbps	Left Side	10mm	1	1	1413	1732.6	23.82	24.50	1.169	0.01	0.175	0.205
	WCDMA IV	RMC 12.2Kbps	Right Side	10mm	1	1	1413	1732.6	23.82	24.50	1.169	0.04	0.069	0.081
	WCDMA IV	RMC 12.2Kbps	Bottom Side	10mm	1	1	1413	1732.6	23.82	24.50	1.169	0.07	0.205	0.240
	WCDMA IV	RMC 12.2Kbps	Front	10mm	3	1	1413	1732.6	23.82	24.50	1.169	-0.1	0.238	0.278
	WCDMA IV	RMC 12.2Kbps	Back	10mm	3	1	1413	1732.6	23.82	24.50	1.169	0.01	0.363	0.425
	WCDMA IV	RMC 12.2Kbps	Back	10mm	3	1	1312	1712.4	23.60	24.50	1.230	-0.18	0.321	0.395
	WCDMA IV	RMC 12.2Kbps	Back	10mm	3	1	1513	1752.6	23.72	24.50	1.197	-0.1	0.328	0.393
	WCDMA IV	RMC 12.2Kbps	Left Side	10mm	3	1	1413	1732.6	23.82	24.50	1.169	-0.01	0.093	0.109
	WCDMA IV	RMC 12.2Kbps	Right Side	10mm	3	1	1413	1732.6	23.82	24.50	1.169	-0.06	0.045	0.053
	WCDMA IV	RMC 12.2Kbps	Bottom Side	10mm	3	1	1413	1732.6	23.82	24.50	1.169	-0.03	0.223	0.261
	WCDMA V	RMC 12.2Kbps	Front	10mm	1	1	4182	836.4	22.98	24.50	1.419	0.05	0.076	0.108
	WCDMA V	RMC 12.2Kbps	Back	10mm	1	1	4182	836.4	22.98	24.50	1.419	0.02	0.111	0.158
	WCDMA V	RMC 12.2Kbps	Back	10mm	1	1	4132	826.4	22.97	24.50	1.422	-0.06	0.098	0.139
21	WCDMA V	RMC 12.2Kbps	Back	10mm	1	1	4233	846.6	22.66	24.50	1.528	-0.01	0.121	0.185
	WCDMA V	RMC 12.2Kbps	Back	10mm	2	2	4233	846.6	22.66	24.50	1.528	-0.03	0.118	0.180
	WCDMA V	RMC 12.2Kbps	Left Side	10mm	1	1	4182	836.4	22.98	24.50	1.419	0.01	0.086	0.122
	WCDMA V	RMC 12.2Kbps	Right Side	10mm	1	1	4182	836.4	22.98	24.50	1.419	-0.01	0.075	0.106
	WCDMA V	RMC 12.2Kbps	Bottom Side	10mm	1	1	4182	836.4	22.98	24.50	1.419	0	0.026	0.037
	WCDMA V	RMC 12.2Kbps	Front	10mm	3	1	4182	836.4	22.98	24.50	1.419	0.01	0.090	0.128
	WCDMA V	RMC 12.2Kbps	Back	10mm	3	1	4182	836.4	22.98	24.50	1.419	-0.03	0.118	0.167
	WCDMA V	RMC 12.2Kbps	Back	10mm	3	1	4132	826.4	22.97	24.50	1.422	0.04	0.107	0.152
	WCDMA V	RMC 12.2Kbps	Back	10mm	3	1	4233	846.6	22.66	24.50	1.528	-0.04	0.116	0.177
	WCDMA V	RMC 12.2Kbps	Left Side	10mm	3	1	4182	836.4	22.98	24.50	1.419	-0.02	0.087	0.123
	WCDMA V	RMC 12.2Kbps	Right Side	10mm	3	1	4182	836.4	22.98	24.50	1.419	-0.04	0.087	0.123
	WCDMA V	RMC 12.2Kbps	Bottom Side	10mm	3	1	4182	836.4	22.98	24.50	1.419	0.04	0.028	0.040



<LTE SAR>

Plot No.	Band	BW (MHz)	Modulation	RB Size	RB offset	Test Position	Gap (mm)	Sample	Battery	Ch.	Freq. (MHz)	Average Power (dBm)	Tune-Up Limit (dBm)	Tune-up Scaling Factor	Power Drift (dB)	Measured 1g SAR (W/kg)	Reported 1g SAR (W/kg)
	LTE Band 2	20M	QPSK	1	0	Front	10mm	1	1	19100	1900	22.80	24.00	1.318	0.02	0.251	0.331
	LTE Band 2	20M	QPSK	50	0	Front	10mm	1	1	19100	1900	21.91	23.00	1.285	-0.02	0.202	0.260
22	LTE Band 2	20M	QPSK	1	0	Back	10mm	1	1	19100	1900	22.80	24.00	1.318	0.14	0.418	0.551
	LTE Band 2	20M	QPSK	1	0	Back	10mm	2	2	19100	1900	22.80	24.00	1.318	-0.17	0.382	0.504
	LTE Band 2	20M	QPSK	1	0	Back	10mm	1	1	18700	1860	22.65	24.00	1.365	0	0.362	0.494
	LTE Band 2	20M	QPSK	1	0	Back	10mm	1	1	18900	1880	22.74	24.00	1.337	0.06	0.349	0.466
	LTE Band 2	20M	QPSK	50	0	Back	10mm	1	1	19100	1900	21.91	23.00	1.285	0.09	0.295	0.379
	LTE Band 2	20M	QPSK	1	0	Left Side	10mm	1	1	19100	1900	22.80	24.00	1.318	0.04	0.112	0.148
	LTE Band 2	20M	QPSK	50	0	Left Side	10mm	1	1	19100	1900	21.91	23.00	1.285	0.03	0.087	0.112
	LTE Band 2	20M	QPSK	1	0	Right Side	10mm	1	1	19100	1900	22.80	24.00	1.318	-0.03	0.050	0.066
	LTE Band 2	20M	QPSK	50	0	Right Side	10mm	1	1	19100	1900	21.91	23.00	1.285	-0.02	0.038	0.049
	LTE Band 2	20M	QPSK	1	0	Bottom Side	10mm	1	1	19100	1900	22.80	24.00	1.318	0.08	0.181	0.239
	LTE Band 2	20M	QPSK	50	0	Bottom Side	10mm	1	1	19100	1900	21.91	23.00	1.285	0.16	0.165	0.212
	LTE Band 2	20M	QPSK	1	0	Front	10mm	3	1	19100	1900	22.80	24.00	1.318	-0.12	0.154	0.203
	LTE Band 2	20M	QPSK	50	0	Front	10mm	3	1	19100	1900	21.91	23.00	1.285	-0.03	0.115	0.148
	LTE Band 2	20M	QPSK	1	0	Back	10mm	3	1	19100	1900	22.80	24.00	1.318	0.02	0.266	0.351
	LTE Band 2	20M	QPSK	1	0	Back	10mm	3	1	18700	1860	22.65	24.00	1.365	0	0.298	0.407
	LTE Band 2	20M	QPSK	1	0	Back	10mm	3	1	18900	1880	22.74	24.00	1.337	0.02	0.284	0.380
	LTE Band 2	20M	QPSK	50	0	Back	10mm	3	1	19100	1900	21.91	23.00	1.285	0	0.208	0.267
	LTE Band 2	20M	QPSK	1	0	Left Side	10mm	3	1	19100	1900	22.80	24.00	1.318	0.08	0.031	0.041
	LTE Band 2	20M	QPSK	50	0	Left Side	10mm	3	1	19100	1900	21.91	23.00	1.285	0.11	0.023	0.030
	LTE Band 2	20M	QPSK	1	0	Right Side	10mm	3	1	19100	1900	22.80	24.00	1.318	0.18	0.008	0.010
	LTE Band 2	20M	QPSK	50	0	Right Side	10mm	3	1	19100	1900	21.91	23.00	1.285	0.13	0.005	0.006
	LTE Band 2	20M	QPSK	1	0	Bottom Side	10mm	3	1	19100	1900	22.80	24.00	1.318	0.07	0.173	0.228
	LTE Band 2	20M	QPSK	50	0	Bottom Side	10mm	3	1	19100	1900	21.91	23.00	1.285	-0.02	0.135	0.174
	LTE Band 5	10M	QPSK	1	0	Front	10mm	1	1	20525	836.5	22.63	24.00	1.371	0.02	0.063	0.086
	LTE Band 5	10M	QPSK	25	0	Front	10mm	1	1	20525	836.5	21.63	23.00	1.371	0.05	0.052	0.071
23	LTE Band 5	10M	QPSK	1	0	Back	10mm	1	1	20525	836.5	22.63	24.00	1.371	-0.03	0.096	0.132
	LTE Band 5	10M	QPSK	1	0	Back	10mm	2	2	20525	836.5	22.63	24.00	1.371	-0.06	0.085	0.117
	LTE Band 5	10M	QPSK	25	0	Back	10mm	1	1	20525	836.5	21.63	23.00	1.371	-0.02	0.079	0.108
	LTE Band 5	10M	QPSK	1	0	Left Side	10mm	1	1	20525	836.5	22.63	24.00	1.371	-0.03	0.080	0.110
	LTE Band 5	10M	QPSK	25	0	Left Side	10mm	1	1	20525	836.5	21.63	23.00	1.371	0.06	0.064	0.088
	LTE Band 5	10M	QPSK	1	0	Right Side	10mm	1	1	20525	836.5	22.63	24.00	1.371	-0.01	0.065	0.089
	LTE Band 5	10M	QPSK	25	0	Right Side	10mm	1	1	20525	836.5	21.63	23.00	1.371	-0.03	0.053	0.073
	LTE Band 5	10M	QPSK	1	0	Bottom Side	10mm	1	1	20525	836.5	22.63	24.00	1.371	0.09	0.022	0.030
	LTE Band 5	10M	QPSK	25	0	Bottom Side	10mm	1	1	20525	836.5	21.63	23.00	1.371	-0.09	0.019	0.026
	LTE Band 5	10M	QPSK	1	0	Front	10mm	3	1	20525	836.5	22.63	24.00	1.371	0	0.073	0.100
	LTE Band 5	10M	QPSK	25	0	Front	10mm	3	1	20525	836.5	21.63	23.00	1.371	-0.08	0.061	0.084
	LTE Band 5	10M	QPSK	1	0	Back	10mm	3	1	20525	836.5	22.63	24.00	1.371	-0.05	0.088	0.121
	LTE Band 5	10M	QPSK	25	0	Back	10mm	3	1	20525	836.5	21.63	23.00	1.371	0.07	0.079	0.108
	LTE Band 5	10M	QPSK	1	0	Left Side	10mm	3	1	20525	836.5	22.63	24.00	1.371	-0.07	0.071	0.097
	LTE Band 5	10M	QPSK	25	0	Left Side	10mm	3	1	20525	836.5	21.63	23.00	1.371	0.03	0.058	0.080
	LTE Band 5	10M	QPSK	1	0	Right Side	10mm	3	1	20525	836.5	22.63	24.00	1.371	0.04	0.071	0.097
	LTE Band 5	10M	QPSK	25	0	Right Side	10mm	3	1	20525	836.5	21.63	23.00	1.371	-0.02	0.058	0.080
	LTE Band 5	10M	QPSK	1	0	Bottom Side	10mm	3	1	20525	836.5	22.63	24.00	1.371	0.05	0.023	0.032
	LTE Band 5	10M	QPSK	25	0	Bottom Side	10mm	3	1	20525	836.5	21.63	23.00	1.371	0.14	0.018	0.025



Plot No.	Band	BW (MHz)	Modulation	RB Size	RB offset	Test Position	Gap (mm)	Sample	Battery	Ch.	Freq. (MHz)	Average Power (dBm)	Tune-Up Limit (dBm)	Tune-up Scaling Factor	Power Drift (dB)	Measured 1g SAR (W/kg)	Reported 1g SAR (W/kg)
	LTE Band 7	20M	QPSK	1	0	Front	10mm	1	1	20850	2510	22.48	24.00	1.419	0.01	0.216	0.307
	LTE Band 7	20M	QPSK	50	0	Front	10mm	1	1	20850	2510	21.50	23.00	1.413	0.08	0.179	0.253
	LTE Band 7	20M	QPSK	1	0	Back	10mm	1	1	20850	2510	22.48	24.00	1.419	0.12	0.393	0.558
	LTE Band 7	20M	QPSK	1	0	Back	10mm	1	1	21100	2535	22.28	24.00	1.486	0	0.433	0.643
24	LTE Band 7	20M	QPSK	1	0	Back	10mm	1	1	21350	2560	22.25	24.00	1.496	-0.07	0.459	0.687
	LTE Band 7	20M	QPSK	1	0	Back	10mm	2	2	21350	2560	22.25	24.00	1.496	-0.11	0.352	0.527
	LTE Band 7	20M	QPSK	50	0	Back	10mm	1	1	20850	2510	21.50	23.00	1.413	-0.12	0.318	0.449
	LTE Band 7	20M	QPSK	1	0	Left Side	10mm	1	1	20850	2510	22.48	24.00	1.419	-0.15	0.018	0.026
	LTE Band 7	20M	QPSK	50	0	Left Side	10mm	1	1	20850	2510	21.50	23.00	1.413	0	0.015	0.021
	LTE Band 7	20M	QPSK	1	0	Right Side	10mm	1	1	20850	2510	22.48	24.00	1.419	0.04	0.212	0.301
	LTE Band 7	20M	QPSK	50	0	Right Side	10mm	1	1	20850	2510	21.50	23.00	1.413	-0.03	0.174	0.246
	LTE Band 7	20M	QPSK	1	0	Bottom Side	10mm	1	1	20850	2510	22.48	24.00	1.419	-0.06	0.066	0.094
	LTE Band 7	20M	QPSK	50	0	Bottom Side	10mm	1	1	20850	2510	21.50	23.00	1.413	0.03	0.053	0.075
	LTE Band 7	20M	QPSK	1	0	Front	10mm	3	1	20850	2510	22.48	24.00	1.419	-0.01	0.142	0.202
	LTE Band 7	20M	QPSK	50	0	Front	10mm	3	1	20850	2510	21.50	23.00	1.413	-0.07	0.120	0.170
	LTE Band 7	20M	QPSK	1	0	Back	10mm	3	1	20850	2510	22.48	24.00	1.419	0.01	0.269	0.382
	LTE Band 7	20M	QPSK	1	0	Back	10mm	3	1	21100	2535	22.28	24.00	1.486	0	0.212	0.315
	LTE Band 7	20M	QPSK	1	0	Back	10mm	3	1	21350	2560	22.25	24.00	1.496	-0.04	0.180	0.269
	LTE Band 7	20M	QPSK	50	0	Back	10mm	3	1	20850	2510	21.50	23.00	1.413	-0.02	0.198	0.280
	LTE Band 7	20M	QPSK	1	0	Left Side	10mm	3	1	20850	2510	22.48	24.00	1.419	0.13	0.008	0.011
	LTE Band 7	20M	QPSK	50	0	Left Side	10mm	3	1	20850	2510	21.50	23.00	1.413	-0.13	0.005	0.008
	LTE Band 7	20M	QPSK	1	0	Right Side	10mm	3	1	20850	2510	22.48	24.00	1.419	0.03	0.182	0.258
	LTE Band 7	20M	QPSK	50	0	Right Side	10mm	3	1	20850	2510	21.50	23.00	1.413	0.04	0.142	0.201
	LTE Band 7	20M	QPSK	1	0	Bottom Side	10mm	3	1	20850	2510	22.48	24.00	1.419	0.03	0.050	0.071
	LTE Band 7	20M	QPSK	50	0	Bottom Side	10mm	3	1	20850	2510	21.50	23.00	1.413	0.07	0.037	0.052
	LTE Band 12	10M	QPSK	1	49	Front	10mm	1	1	23095	707.5	22.59	24.00	1.384	0.01	0.080	0.111
	LTE Band 12	10M	QPSK	25	12	Front	10mm	1	1	23095	707.5	21.51	23.00	1.409	0.03	0.062	0.087
25	LTE Band 12	10M	QPSK	1	49	Back	10mm	1	1	23095	707.5	22.59	24.00	1.384	-0.03	0.129	0.178
	LTE Band 12	10M	QPSK	1	49	Back	10mm	2	2	23095	707.5	22.59	24.00	1.384	-0.09	0.085	0.118
	LTE Band 12	10M	QPSK	25	12	Back	10mm	1	1	23095	707.5	21.51	23.00	1.409	-0.05	0.098	0.138
	LTE Band 12	10M	QPSK	1	49	Left Side	10mm	1	1	23095	707.5	22.59	24.00	1.384	0.02	0.078	0.108
	LTE Band 12	10M	QPSK	25	12	Left Side	10mm	1	1	23095	707.5	21.51	23.00	1.409	0	0.058	0.082
	LTE Band 12	10M	QPSK	1	49	Right Side	10mm	1	1	23095	707.5	22.59	24.00	1.384	0	0.039	0.054
	LTE Band 12	10M	QPSK	25	12	Right Side	10mm	1	1	23095	707.5	21.51	23.00	1.409	0.03	0.029	0.041
	LTE Band 12	10M	QPSK	1	49	Bottom Side	10mm	1	1	23095	707.5	22.59	24.00	1.384	0.11	0.019	0.026
	LTE Band 12	10M	QPSK	25	12	Bottom Side	10mm	1	1	23095	707.5	21.51	23.00	1.409	-0.01	0.015	0.021
	LTE Band 12	10M	QPSK	1	49	Front	10mm	3	1	23095	707.5	22.59	24.00	1.384	-0.13	0.042	0.058
	LTE Band 12	10M	QPSK	25	12	Front	10mm	3	1	23095	707.5	21.51	23.00	1.409	0.02	0.029	0.041
	LTE Band 12	10M	QPSK	1	49	Back	10mm	3	1	23095	707.5	22.59	24.00	1.384	0.02	0.062	0.086
	LTE Band 12	10M	QPSK	25	12	Back	10mm	3	1	23095	707.5	21.51	23.00	1.409	-0.04	0.046	0.065
	LTE Band 12	10M	QPSK	1	49	Left Side	10mm	3	1	23095	707.5	22.59	24.00	1.384	0.05	0.041	0.057
	LTE Band 12	10M	QPSK	25	12	Left Side	10mm	3	1	23095	707.5	21.51	23.00	1.409	0.03	0.033	0.047
	LTE Band 12	10M	QPSK	1	49	Right Side	10mm	3	1	23095	707.5	22.59	24.00	1.384	-0.01	0.020	0.028
	LTE Band 12	10M	QPSK	25	12	Right Side	10mm	3	1	23095	707.5	21.51	23.00	1.409	0.09	0.015	0.021
	LTE Band 12	10M	QPSK	1	49	Bottom Side	10mm	3	1	23095	707.5	22.59	24.00	1.384	0.17	0.009	0.013
	LTE Band 12	10M	QPSK	25	12	Bottom Side	10mm	3	1	23095	707.5	21.51	23.00	1.409	0.1	0.007	0.009



Plot No.	Band	BW (MHz)	Modulation	RB Size	RB offset	Test Position	Gap (mm)	Sample	Battery	Ch.	Freq. (MHz)	Average Power (dBm)	Tune-Up Limit (dBm)	Tune-up Scaling Factor	Power Drift (dB)	Measured 1g SAR (W/kg)	Reported 1g SAR (W/kg)
	LTE Band 13	10M	QPSK	1	49	Front	10mm	1	1	23230	782	22.65	24.00	1.365	0	0.072	0.098
	LTE Band 13	10M	QPSK	25	25	Front	10mm	1	1	23230	782	21.74	23.00	1.337	0	0.060	0.080
26	LTE Band 13	10M	QPSK	1	49	Back	10mm	1	1	23230	782	22.65	24.00	1.365	0	0.112	0.153
	LTE Band 13	10M	QPSK	1	49	Back	10mm	2	2	23230	782	22.65	24.00	1.365	-0.06	0.100	0.136
	LTE Band 13	10M	QPSK	25	25	Back	10mm	1	1	23230	782	21.74	23.00	1.337	0.01	0.084	0.112
	LTE Band 13	10M	QPSK	1	49	Left Side	10mm	1	1	23230	782	22.65	24.00	1.365	0	0.097	0.132
	LTE Band 13	10M	QPSK	25	25	Left Side	10mm	1	1	23230	782	21.74	23.00	1.337	-0.01	0.082	0.110
	LTE Band 13	10M	QPSK	1	49	Right Side	10mm	1	1	23230	782	22.65	24.00	1.365	0.02	0.068	0.093
	LTE Band 13	10M	QPSK	25	25	Right Side	10mm	1	1	23230	782	21.74	23.00	1.337	0	0.057	0.076
	LTE Band 13	10M	QPSK	1	49	Bottom Side	10mm	1	1	23230	782	22.65	24.00	1.365	0.01	0.019	0.026
	LTE Band 13	10M	QPSK	25	25	Bottom Side	10mm	1	1	23230	782	21.74	23.00	1.337	0.01	0.016	0.021
	LTE Band 13	10M	QPSK	1	49	Front	10mm	3	1	23230	782	22.65	24.00	1.365	-0.03	0.096	0.131
	LTE Band 13	10M	QPSK	25	25	Front	10mm	3	1	23230	782	21.74	23.00	1.337	0.1	0.079	0.106
	LTE Band 13	10M	QPSK	1	49	Back	10mm	3	1	23230	782	22.65	24.00	1.365	0.01	0.107	0.146
	LTE Band 13	10M	QPSK	25	25	Back	10mm	3	1	23230	782	21.74	23.00	1.337	0.03	0.104	0.139
	LTE Band 13	10M	QPSK	1	49	Left Side	10mm	3	1	23230	782	22.65	24.00	1.365	-0.11	0.105	0.143
	LTE Band 13	10M	QPSK	25	25	Left Side	10mm	3	1	23230	782	21.74	23.00	1.337	-0.05	0.094	0.126
	LTE Band 13	10M	QPSK	1	49	Right Side	10mm	3	1	23230	782	22.65	24.00	1.365	0	0.092	0.126
	LTE Band 13	10M	QPSK	25	25	Right Side	10mm	3	1	23230	782	21.74	23.00	1.337	0.03	0.075	0.100
	LTE Band 13	10M	QPSK	1	49	Bottom Side	10mm	3	1	23230	782	22.65	24.00	1.365	0.04	0.022	0.030
	LTE Band 13	10M	QPSK	25	25	Bottom Side	10mm	3	1	23230	782	21.74	23.00	1.337	0.08	0.018	0.024
	LTE Band 66	20M	QPSK	1	0	Front	10mm	1	1	132572	1770	22.96	24.00	1.271	0.01	0.275	0.349
	LTE Band 66	20M	QPSK	50	0	Front	10mm	1	1	132572	1770	21.98	23.00	1.265	0	0.228	0.288
27	LTE Band 66	20M	QPSK	1	0	Back	10mm	1	1	132572	1770	22.96	24.00	1.271	0.04	0.365	0.464
	LTE Band 66	20M	QPSK	1	0	Back	10mm	2	2	132572	1770	22.96	24.00	1.271	-0.16	0.336	0.427
	LTE Band 66	20M	QPSK	1	0	Back	10mm	1	1	132072	1720	22.68	24.00	1.355	0.01	0.285	0.386
	LTE Band 66	20M	QPSK	1	0	Back	10mm	1	1	132322	1745	22.89	24.00	1.291	0.02	0.307	0.396
	LTE Band 66	20M	QPSK	50	0	Back	10mm	1	1	132572	1770	21.98	23.00	1.265	-0.02	0.268	0.339
	LTE Band 66	20M	QPSK	1	0	Left Side	10mm	1	1	132572	1770	22.96	24.00	1.271	0	0.126	0.160
	LTE Band 66	20M	QPSK	50	0	Left Side	10mm	1	1	132572	1770	21.98	23.00	1.265	0.03	0.104	0.132
	LTE Band 66	20M	QPSK	1	0	Right Side	10mm	1	1	132572	1770	22.96	24.00	1.271	0.03	0.050	0.064
	LTE Band 66	20M	QPSK	50	0	Right Side	10mm	1	1	132572	1770	21.98	23.00	1.265	0.06	0.041	0.052
	LTE Band 66	20M	QPSK	1	0	Bottom Side	10mm	1	1	132572	1770	22.96	24.00	1.271	0.06	0.166	0.211
	LTE Band 66	20M	QPSK	50	0	Bottom Side	10mm	1	1	132572	1770	21.98	23.00	1.265	0.04	0.155	0.196
	LTE Band 66	20M	QPSK	1	0	Front	10mm	3	1	132572	1770	22.96	24.00	1.271	-0.07	0.182	0.231
	LTE Band 66	20M	QPSK	50	0	Front	10mm	3	1	132572	1770	21.98	23.00	1.265	0	0.136	0.172
	LTE Band 66	20M	QPSK	1	0	Back	10mm	3	1	132572	1770	22.96	24.00	1.271	-0.1	0.283	0.360
	LTE Band 66	20M	QPSK	1	0	Back	10mm	3	1	132072	1720	22.68	24.00	1.355	-0.06	0.280	0.379
	LTE Band 66	20M	QPSK	1	0	Back	10mm	3	1	132322	1745	22.89	24.00	1.291	0.05	0.278	0.359
	LTE Band 66	20M	QPSK	50	0	Back	10mm	3	1	132572	1770	21.98	23.00	1.265	0.02	0.242	0.306
	LTE Band 66	20M	QPSK	1	0	Left Side	10mm	3	1	132572	1770	22.96	24.00	1.271	0.05	0.072	0.091
	LTE Band 66	20M	QPSK	50	0	Left Side	10mm	3	1	132572	1770	21.98	23.00	1.265	-0.03	0.059	0.075
	LTE Band 66	20M	QPSK	1	0	Right Side	10mm	3	1	132572	1770	22.96	24.00	1.271	-0.04	0.037	0.047
	LTE Band 66	20M	QPSK	50	0	Right Side	10mm	3	1	132572	1770	21.98	23.00	1.265	-0.16	0.029	0.037
	LTE Band 66	20M	QPSK	1	0	Bottom Side	10mm	3	1	132572	1770	22.96	24.00	1.271	0.04	0.161	0.205
	LTE Band 66	20M	QPSK	50	0	Bottom Side	10mm	3	1	132572	1770	21.98	23.00	1.265	0.04	0.132	0.167



<WLAN SAR>

Plot No.	Band	Mode	Test Position	Gap (mm)	Sample	Battery	Ch.	Freq. (MHz)	Average Power (dBm)	Tune-Up Limit (dBm)	Tune-up Scaling Factor	Duty Cycle %	Duty Cycle Scaling Factor	Power Drift (dB)	Measured 1g SAR (W/kg)	Reported 1g SAR (W/kg)
	WLAN2.4GHz	802.11b 1Mbps	Front	10mm	1	1	1	2412	18.10	19.00	1.230	100	1.000	0.14	0.015	0.018
	WLAN2.4GHz	802.11b 1Mbps	Back	10mm	1	1	1	2412	18.10	19.00	1.230	100	1.000	-0.04	0.143	0.176
	WLAN2.4GHz	802.11b 1Mbps	Back	10mm	1	1	6	2437	17.03	19.00	1.574	100	1.000	-0.1	0.158	0.249
28	WLAN2.4GHz	802.11b 1Mbps	Back	10mm	1	1	11	2462	18.01	19.00	1.256	100	1.000	-0.09	0.250	0.314
	WLAN2.4GHz	802.11b 1Mbps	Back	10mm	2	2	11	2462	18.01	19.00	1.256	100	1.000	-0.19	0.176	0.221
	WLAN2.4GHz	802.11b 1Mbps	Right Side	10mm	1	1	1	2412	18.10	19.00	1.230	100	1.000	0.11	0.072	0.089
	WLAN2.4GHz	802.11b 1Mbps	Top Side	10mm	1	1	1	2412	18.10	19.00	1.230	100	1.000	0.08	0.004	0.005
	WLAN5GHz	802.11ac-VHT80 MCS0	Front	10mm	1	1	42	5210	16.53	18.50	1.575	85.19	1.174	0	< 0.001	< 0.001
29	WLAN5GHz	802.11ac-VHT80 MCS0	Back	10mm	1	1	42	5210	16.53	18.50	1.575	85.19	1.174	0.04	0.051	0.094
	WLAN5GHz	802.11ac-VHT80 MCS0	Back	10mm	1	1	42	5210	16.53	18.50	1.575	85.19	1.174	0.15	0.022	0.041
	WLAN5GHz	802.11ac-VHT80 MCS0	Right Side	10mm	1	1	42	5210	16.53	18.50	1.575	85.19	1.174	0	< 0.001	< 0.001
	WLAN5GHz	802.11ac-VHT80 MCS0	Top Side	10mm	1	1	42	5210	16.53	18.50	1.575	85.19	1.174	0	< 0.001	< 0.001
	WLAN5GHz	802.11ac-VHT80 MCS0	Front	10mm	1	1	155	5775	16.52	18.50	1.578	85.19	1.174	0	< 0.001	< 0.001
	WLAN5GHz	802.11ac-VHT80 MCS0	Back	10mm	1	1	155	5775	16.52	18.50	1.578	85.19	1.174	0	< 0.001	< 0.001
	WLAN5GHz	802.11ac-VHT80 MCS0	Right Side	10mm	1	1	155	5775	16.52	18.50	1.578	85.19	1.174	0	< 0.001	< 0.001
	WLAN5GHz	802.11ac-VHT80 MCS0	Top Side	10mm	1	1	155	5775	16.52	18.50	1.578	85.19	1.174	0	< 0.001	< 0.001



15.3 Body Worn Accessory SAR

<GSM SAR>

Plot No.	Band	Mode	Test Position	Gap (mm)	Sample	Battery	Ch.	Freq. (MHz)	Average Power (dBm)	Tune-Up Limit (dBm)	Tune-up Scaling Factor	Power Drift (dB)	Measured 1g SAR (W/kg)	Reported 1g SAR (W/kg)
	GSM850	GPRS(4 Tx slots)	Front	10mm	1	1	128	824.2	29.73	30.00	1.064	-0.01	0.128	0.136
	GSM850	GPRS(4 Tx slots)	Back	10mm	1	1	128	824.2	29.73	30.00	1.064	-0.06	0.176	0.187
	GSM850	GPRS(4 Tx slots)	Back	10mm	1	1	189	836.4	29.37	30.00	1.156	0.01	0.212	0.245
30	GSM850	GPRS(4 Tx slots)	Back	10mm	1	1	251	848.8	29.35	30.00	1.161	0.03	0.237	0.275
	GSM850	GPRS(4 Tx slots)	Back	10mm	2	2	251	848.8	29.35	30.00	1.161	-0.17	0.211	0.245
	GSM850	GPRS (4 Tx slots)	Front	10mm	3	1	128	824.2	29.73	30.00	1.064	-0.08	0.142	0.151
	GSM850	GPRS (4 Tx slots)	Back	10mm	3	1	128	824.2	29.73	30.00	1.064	0.08	0.178	0.189
	GSM850	GPRS (4 Tx slots)	Back	10mm	3	1	189	836.4	29.37	30.00	1.156	-0.06	0.166	0.192
	GSM850	GPRS (4 Tx slots)	Back	10mm	3	1	251	848.8	29.35	30.00	1.161	-0.09	0.182	0.211
	GSM1900	GPRS(4 Tx slots)	Front	10mm	1	1	810	1909.8	27.57	28.00	1.104	0.16	0.566	0.625
31	GSM1900	GPRS(4 Tx slots)	Back	10mm	1	1	810	1909.8	27.57	28.00	1.104	-0.01	0.905	0.999
	GSM1900	GPRS(4 Tx slots)	Back	10mm	2	2	810	1909.8	27.57	28.00	1.104	-0.08	0.434	0.479
	GSM1900	GPRS(4 Tx slots)	Back	10mm	1	1	512	1850.2	27.53	28.00	1.114	0	0.688	0.767
	GSM1900	GPRS(4 Tx slots)	Back	10mm	1	1	661	1880	27.54	28.00	1.112	-0.05	0.792	0.880
	GSM1900	GPRS(4 Tx slots)	Front	10mm	3	1	810	1909.8	27.57	28.00	1.104	0.04	0.156	0.172
	GSM1900	GPRS(4 Tx slots)	Back	10mm	3	1	810	1909.8	27.57	28.00	1.104	-0.03	0.267	0.295
	GSM1900	GPRS(4 Tx slots)	Back	10mm	3	1	512	1850.2	27.53	28.00	1.114	-0.01	0.305	0.340
	GSM1900	GPRS(4 Tx slots)	Back	10mm	3	1	661	1880	27.54	28.00	1.112	-0.03	0.288	0.320

<WCDMA SAR>

Plot No.	Band	Mode	Test Position	Gap (mm)	Sample	Battery	Ch.	Freq. (MHz)	Average Power (dBm)	Tune-Up Limit (dBm)	Tune-up Scaling Factor	Power Drift (dB)	Measured 1g SAR (W/kg)	Reported 1g SAR (W/kg)
	WCDMA II	RMC 12.2Kbps	Front	10mm	1	1	9538	1907.6	23.69	24.50	1.205	0	0.299	0.360
32	WCDMA II	RMC 12.2Kbps	Back	10mm	1	1	9538	1907.6	23.69	24.50	1.205	-0.12	0.577	0.695
	WCDMA II	RMC 12.2Kbps	Back	10mm	2	2	9538	1907.6	23.69	24.50	1.205	-0.03	0.574	0.692
	WCDMA II	RMC 12.2Kbps	Back	10mm	1	1	9262	1852.4	23.24	24.50	1.337	-0.01	0.447	0.597
	WCDMA II	RMC 12.2Kbps	Back	10mm	1	1	9400	1880	23.62	24.50	1.225	-0.01	0.434	0.531
	WCDMA II	RMC 12.2Kbps	Front	10mm	3	1	9538	1907.6	23.69	24.50	1.205	-0.07	0.182	0.219
	WCDMA II	RMC 12.2Kbps	Back	10mm	3	1	9538	1907.6	23.69	24.50	1.205	-0.12	0.308	0.371
	WCDMA II	RMC 12.2Kbps	Back	10mm	3	1	9262	1852.4	23.24	24.50	1.337	-0.01	0.356	0.476
	WCDMA II	RMC 12.2Kbps	Back	10mm	3	1	9400	1880	23.62	24.50	1.225	0.01	0.346	0.424
	WCDMA IV	RMC 12.2Kbps	Front	10mm	1	1	1413	1732.6	23.82	24.50	1.169	-0.01	0.327	0.382
	WCDMA IV	RMC 12.2Kbps	Back	10mm	1	1	1413	1732.6	23.82	24.50	1.169	0.01	0.404	0.472
	WCDMA IV	RMC 12.2Kbps	Back	10mm	1	1	1312	1712.4	23.60	24.50	1.230	-0.02	0.395	0.486
33	WCDMA IV	RMC 12.2Kbps	Back	10mm	1	1	1513	1752.6	23.72	24.50	1.197	0	0.486	0.582
	WCDMA IV	RMC 12.2Kbps	Back	10mm	2	2	1513	1752.6	23.72	24.50	1.197	-0.15	0.427	0.511
	WCDMA IV	RMC 12.2Kbps	Front	10mm	3	1	1413	1732.6	23.82	24.50	1.169	-0.1	0.238	0.278
	WCDMA IV	RMC 12.2Kbps	Back	10mm	3	1	1413	1732.6	23.82	24.50	1.169	0.01	0.363	0.425
	WCDMA IV	RMC 12.2Kbps	Back	10mm	3	1	1312	1712.4	23.60	24.50	1.230	-0.18	0.321	0.395
	WCDMA IV	RMC 12.2Kbps	Back	10mm	3	1	1513	1752.6	23.72	24.50	1.197	-0.1	0.328	0.393
	WCDMA V	RMC 12.2Kbps	Front	10mm	1	1	4182	836.4	22.98	24.50	1.419	0.05	0.076	0.108
	WCDMA V	RMC 12.2Kbps	Back	10mm	1	1	4182	836.4	22.98	24.50	1.419	0.02	0.111	0.158
	WCDMA V	RMC 12.2Kbps	Back	10mm	1	1	4132	826.4	22.97	24.50	1.422	-0.06	0.098	0.139
34	WCDMA V	RMC 12.2Kbps	Back	10mm	1	1	4233	846.6	22.66	24.50	1.528	-0.01	0.121	0.185
	WCDMA V	RMC 12.2Kbps	Back	10mm	2	2	4233	846.6	22.66	24.50	1.528	-0.03	0.118	0.180
	WCDMA V	RMC 12.2Kbps	Front	10mm	3	1	4182	836.4	22.98	24.50	1.419	0.01	0.090	0.128
	WCDMA V	RMC 12.2Kbps	Back	10mm	3	1	4182	836.4	22.98	24.50	1.419	-0.03	0.118	0.167
	WCDMA V	RMC 12.2Kbps	Back	10mm	3	1	4132	826.4	22.97	24.50	1.422	0.04	0.107	0.152
	WCDMA V	RMC 12.2Kbps	Back	10mm	3	1	4233	846.6	22.66	24.50	1.528	-0.04	0.116	0.177



<LTE SAR>

Plot No.	Band	BW (MHz)	Modulation	RB Size	RB offset	Test Position	Gap (mm)	Sample	Battery	Ch.	Freq. (MHz)	Average Power (dBm)	Tune-Up Limit (dBm)	Tune-up Scaling Factor	Power Drift (dB)	Measured 1g SAR (W/kg)	Reported 1g SAR (W/kg)
	LTE Band 2	20M	QPSK	1	0	Front	10mm	1	1	19100	1900	22.80	24.00	1.318	0.02	0.251	0.331
	LTE Band 2	20M	QPSK	50	0	Front	10mm	1	1	19100	1900	21.91	23.00	1.285	-0.02	0.202	0.260
35	LTE Band 2	20M	QPSK	1	0	Back	10mm	1	1	19100	1900	22.80	24.00	1.318	0.14	0.418	0.551
	LTE Band 2	20M	QPSK	1	0	Back	10mm	2	2	19100	1900	22.80	24.00	1.318	-0.17	0.382	0.504
	LTE Band 2	20M	QPSK	1	0	Back	10mm	1	1	18700	1860	22.65	24.00	1.365	0	0.362	0.494
	LTE Band 2	20M	QPSK	1	0	Back	10mm	1	1	18900	1880	22.74	24.00	1.337	0.06	0.349	0.466
	LTE Band 2	20M	QPSK	50	0	Back	10mm	1	1	19100	1900	21.91	23.00	1.285	0.09	0.295	0.379
	LTE Band 2	20M	QPSK	1	0	Front	10mm	3	1	19100	1900	22.80	24.00	1.318	-0.12	0.154	0.203
	LTE Band 2	20M	QPSK	50	0	Front	10mm	3	1	19100	1900	21.91	23.00	1.285	-0.03	0.115	0.148
	LTE Band 2	20M	QPSK	1	0	Back	10mm	3	1	19100	1900	22.80	24.00	1.318	0.02	0.266	0.351
	LTE Band 2	20M	QPSK	1	0	Back	10mm	3	1	18700	1860	22.65	24.00	1.365	0	0.298	0.407
	LTE Band 2	20M	QPSK	1	0	Back	10mm	3	1	18900	1880	22.74	24.00	1.337	0.02	0.284	0.380
	LTE Band 2	20M	QPSK	50	0	Back	10mm	3	1	19100	1900	21.91	23.00	1.285	0	0.208	0.267
	LTE Band 5	10M	QPSK	1	0	Front	10mm	1	1	20525	836.5	22.63	24.00	1.371	0.02	0.063	0.086
	LTE Band 5	10M	QPSK	25	0	Front	10mm	1	1	20525	836.5	21.63	23.00	1.371	0.05	0.052	0.071
36	LTE Band 5	10M	QPSK	1	0	Back	10mm	1	1	20525	836.5	22.63	24.00	1.371	-0.03	0.096	0.132
	LTE Band 5	10M	QPSK	1	0	Back	10mm	2	2	20525	836.5	22.63	24.00	1.371	-0.06	0.085	0.117
	LTE Band 5	10M	QPSK	25	0	Back	10mm	1	1	20525	836.5	21.63	23.00	1.371	-0.02	0.079	0.108
	LTE Band 5	10M	QPSK	1	0	Front	10mm	3	1	20525	836.5	22.63	24.00	1.371	0	0.073	0.100
	LTE Band 5	10M	QPSK	25	0	Front	10mm	3	1	20525	836.5	21.63	23.00	1.371	-0.08	0.061	0.084
	LTE Band 5	10M	QPSK	1	0	Back	10mm	3	1	20525	836.5	22.63	24.00	1.371	-0.05	0.088	0.121
	LTE Band 5	10M	QPSK	25	0	Back	10mm	3	1	20525	836.5	21.63	23.00	1.371	0.07	0.079	0.108
	LTE Band 7	20M	QPSK	1	0	Front	10mm	1	1	20850	2510	22.48	24.00	1.419	0.01	0.216	0.307
	LTE Band 7	20M	QPSK	50	0	Front	10mm	1	1	20850	2510	21.50	23.00	1.413	0.08	0.179	0.253
	LTE Band 7	20M	QPSK	1	0	Back	10mm	1	1	20850	2510	22.48	24.00	1.419	0.12	0.393	0.558
	LTE Band 7	20M	QPSK	1	0	Back	10mm	1	1	21100	2535	22.28	24.00	1.486	0	0.433	0.643
37	LTE Band 7	20M	QPSK	1	0	Back	10mm	1	1	21350	2560	22.25	24.00	1.496	-0.07	0.459	0.687
	LTE Band 7	20M	QPSK	1	0	Back	10mm	2	2	21350	2560	22.25	24.00	1.496	-0.11	0.352	0.527
	LTE Band 7	20M	QPSK	50	0	Back	10mm	1	1	20850	2510	21.50	23.00	1.413	-0.12	0.318	0.449
	LTE Band 7	20M	QPSK	1	0	Front	10mm	3	1	20850	2510	22.48	24.00	1.419	-0.01	0.142	0.202
	LTE Band 7	20M	QPSK	50	0	Front	10mm	3	1	20850	2510	21.50	23.00	1.413	-0.07	0.120	0.170
	LTE Band 7	20M	QPSK	1	0	Back	10mm	3	1	20850	2510	22.48	24.00	1.419	0.01	0.269	0.382
	LTE Band 7	20M	QPSK	1	0	Back	10mm	3	1	21100	2535	22.28	24.00	1.486	0	0.212	0.315
	LTE Band 7	20M	QPSK	1	0	Back	10mm	3	1	21350	2560	22.25	24.00	1.496	-0.04	0.180	0.269
	LTE Band 7	20M	QPSK	50	0	Back	10mm	3	1	20850	2510	21.50	23.00	1.413	-0.02	0.198	0.280



Plot No.	Band	BW (MHz)	Modulation	RB Size	RB offset	Test Position	Gap (mm)	Sample	Battery	Ch.	Freq. (MHz)	Average Power (dBm)	Tune-Up Limit (dBm)	Tune-up Scaling Factor	Power Drift (dB)	Measured 1g SAR (W/kg)	Reported 1g SAR (W/kg)
	LTE Band 12	10M	QPSK	1	49	Front	10mm	1	1	23095	707.5	22.59	24.00	1.384	0.01	0.080	0.111
	LTE Band 12	10M	QPSK	25	12	Front	10mm	1	1	23095	707.5	21.51	23.00	1.409	0.03	0.062	0.087
38	LTE Band 12	10M	QPSK	1	49	Back	10mm	1	1	23095	707.5	22.59	24.00	1.384	-0.03	0.129	0.178
	LTE Band 12	10M	QPSK	1	49	Back	10mm	2	2	23095	707.5	22.59	24.00	1.384	-0.09	0.085	0.118
	LTE Band 12	10M	QPSK	25	12	Back	10mm	1	1	23095	707.5	21.51	23.00	1.409	-0.05	0.098	0.138
	LTE Band 12	10M	QPSK	1	49	Front	10mm	3	1	23095	707.5	22.59	24.00	1.384	-0.13	0.042	0.058
	LTE Band 12	10M	QPSK	25	12	Front	10mm	3	1	23095	707.5	21.51	23.00	1.409	0.02	0.029	0.041
	LTE Band 12	10M	QPSK	1	49	Back	10mm	3	1	23095	707.5	22.59	24.00	1.384	0.02	0.062	0.086
	LTE Band 12	10M	QPSK	25	12	Back	10mm	3	1	23095	707.5	21.51	23.00	1.409	-0.04	0.046	0.065
	LTE Band 13	10M	QPSK	1	49	Front	10mm	1	1	23230	782	22.65	24.00	1.365	0	0.072	0.098
	LTE Band 13	10M	QPSK	25	25	Front	10mm	1	1	23230	782	21.74	23.00	1.337	0	0.060	0.080
39	LTE Band 13	10M	QPSK	1	49	Back	10mm	1	1	23230	782	22.65	24.00	1.365	0	0.112	0.153
	LTE Band 13	10M	QPSK	1	49	Back	10mm	2	2	23230	782	22.65	24.00	1.365	-0.06	0.100	0.136
	LTE Band 13	10M	QPSK	25	25	Back	10mm	1	1	23230	782	21.74	23.00	1.337	0.01	0.084	0.112
	LTE Band 13	10M	QPSK	1	49	Front	10mm	3	1	23230	782	22.65	24.00	1.365	-0.03	0.096	0.131
	LTE Band 13	10M	QPSK	25	25	Front	10mm	3	1	23230	782	21.74	23.00	1.337	0.1	0.079	0.106
	LTE Band 13	10M	QPSK	1	49	Back	10mm	3	1	23230	782	22.65	24.00	1.365	0.01	0.107	0.146
	LTE Band 13	10M	QPSK	25	25	Back	10mm	3	1	23230	782	21.74	23.00	1.337	0.03	0.104	0.139
	LTE Band 66	20M	QPSK	1	0	Front	10mm	1	1	132572	1770	22.96	24.00	1.271	0.01	0.275	0.349
	LTE Band 66	20M	QPSK	50	0	Front	10mm	1	1	132572	1770	21.98	23.00	1.265	0	0.228	0.288
40	LTE Band 66	20M	QPSK	1	0	Back	10mm	1	1	132572	1770	22.96	24.00	1.271	0.04	0.365	0.464
	LTE Band 66	20M	QPSK	1	0	Back	10mm	2	2	132572	1770	22.96	24.00	1.271	-0.16	0.336	0.427
	LTE Band 66	20M	QPSK	1	0	Back	10mm	1	1	132072	1720	22.68	24.00	1.355	0.01	0.285	0.386
	LTE Band 66	20M	QPSK	1	0	Back	10mm	1	1	132322	1745	22.89	24.00	1.291	0.02	0.307	0.396
	LTE Band 66	20M	QPSK	50	0	Back	10mm	1	1	132572	1770	21.98	23.00	1.265	-0.02	0.268	0.339
	LTE Band 66	20M	QPSK	1	0	Front	10mm	3	1	132572	1770	22.96	24.00	1.271	-0.07	0.182	0.231
	LTE Band 66	20M	QPSK	50	0	Front	10mm	3	1	132572	1770	21.98	23.00	1.265	0	0.136	0.172
	LTE Band 66	20M	QPSK	1	0	Back	10mm	3	1	132572	1770	22.96	24.00	1.271	-0.1	0.283	0.360
	LTE Band 66	20M	QPSK	1	0	Back	10mm	3	1	132072	1720	22.68	24.00	1.355	-0.06	0.280	0.379
	LTE Band 66	20M	QPSK	1	0	Back	10mm	3	1	132322	1745	22.89	24.00	1.291	0.05	0.278	0.359
	LTE Band 66	20M	QPSK	50	0	Back	10mm	3	1	132572	1770	21.98	23.00	1.265	0.02	0.242	0.306



<WLAN SAR>

Plot No.	Band	Mode	Test Position	Gap (mm)	Sample	Battery	Ch.	Freq. (MHz)	Average Power (dBm)	Tune-Up Limit (dBm)	Tune-up Scaling Factor	Duty Cycle %	Duty Cycle Scaling Factor	Power Drift (dB)	Measured 1g SAR (W/kg)	Reported 1g SAR (W/kg)
	WLAN2.4GHz	802.11b 1Mbps	Front	10mm	1	1	1	2412	18.10	19.00	1.230	100	1.000	0.14	0.015	0.018
	WLAN2.4GHz	802.11b 1Mbps	Back	10mm	1	1	1	2412	18.10	19.00	1.230	100	1.000	-0.04	0.143	0.176
	WLAN2.4GHz	802.11b 1Mbps	Back	10mm	1	1	6	2437	17.03	19.00	1.574	100	1.000	-0.1	0.158	0.249
41	WLAN2.4GHz	802.11b 1Mbps	Back	10mm	1	1	11	2462	18.01	19.00	1.256	100	1.000	-0.09	0.250	0.314
	WLAN2.4GHz	802.11b 1Mbps	Back	10mm	2	2	11	2462	18.01	19.00	1.256	100	1.000	-0.19	0.176	0.221
	WLAN5GHz	802.11ac-VHT80 MCS0	Front	10mm	1	1	58	5290	16.50	18.50	1.585	85.19	1.174	0	0.001	0.001
42	WLAN5GHz	802.11ac-VHT80 MCS0	Back	10mm	1	1	58	5290	16.50	18.50	1.585	85.19	1.174	-0.03	0.002	0.003
	WLAN5GHz	802.11ac-VHT80 MCS0	Front	10mm	1	1	106	5530	16.61	18.50	1.547	85.19	1.174	0	< 0.001	< 0.001
	WLAN5GHz	802.11ac-VHT80 MCS0	Back	10mm	1	1	106	5530	16.61	18.50	1.547	85.19	1.174	0	< 0.001	< 0.001
	WLAN5GHz	802.11ac-VHT80 MCS0	Front	10mm	1	1	155	5775	16.52	18.50	1.578	85.19	1.174	0	< 0.001	< 0.001
	WLAN5GHz	802.11ac-VHT80 MCS0	Back	10mm	1	1	155	5775	16.52	18.50	1.578	85.19	1.174	0	< 0.001	< 0.001

15.4 Repeated SAR Measurement

No.	Band	Mode	Test Position	Gap (mm)	Sample	Battery	Ch.	Freq. (MHz)	Average Power (dBm)	Tune-Up Limit (dBm)	Tune-up Scaling Factor	Power Drift (dB)	Measured 1g SAR (W/kg)	Ratio	Reported 1g SAR (W/kg)
1st	GSM1900	GPRS(4 Tx slots)	Back	10mm	1	1	810	1909.8	27.57	28.00	1.104	-0.01	0.905		0.999
2nd	GSM1900	GPRS(4 Tx slots)	Back	10mm	1	1	810	1909.8	27.57	28.00	1.104	0.13	0.865	1.05	0.955

General Note:

1. Per KDB 865664 D01v01r04, for each frequency band, repeated SAR measurement is required only when the measured SAR is $\geq 0.8W/kg$.
2. Per KDB 865664 D01v01r04, if the ratio among the repeated measurement is ≤ 1.2 and the measured SAR $< 1.45W/kg$, only one repeated measurement is required.
3. The ratio is the difference in percentage between original and repeated *measured SAR*.
4. All measurement SAR result is scaled-up to account for tune-up tolerance and is compliant.

16. Simultaneous Transmission Analysis

NO.	Simultaneous Transmission Configurations	Portable Handset		
		Head	Body-worn	Hotspot
1.	GSM Voice + WLAN2.4GHz	Yes	Yes	
2.	GPRS/EDGE + WLAN2.4GHz	Yes	Yes	Yes
3.	WCDMA + WLAN2.4GHz	Yes	Yes	Yes
4.	LTE + WLAN2.4GHz	Yes	Yes	Yes
5.	GSM Voice + Bluetooth	Yes	Yes	
6.	GPRS/EDGE + Bluetooth	Yes	Yes	Yes
7.	WCDMA+ Bluetooth	Yes	Yes	Yes
8.	LTE + Bluetooth	Yes	Yes	Yes
9.	GSM Voice + WLAN5GHz	Yes	Yes	
10.	GPRS/EDGE + WLAN5GHz	Yes	Yes	Yes
11.	WCDMA + WLAN5GHz	Yes	Yes	Yes
12.	LTE + WLAN5GHz	Yes	Yes	Yes

General Note:

- This device WLAN 2.4GHz / 5.2GHz / 5.8GHz supports Hotspot operation and Bluetooth support tethering applications.
- WLAN and Bluetooth share the same antenna, and cannot transmit simultaneously.
- EUT will choose either WLAN 2.4GHz or WLAN 5GHz according to the network signal condition; therefore, 2.4GHz WLAN and 5GHz WLAN will not operate simultaneously at any moment.
- The Scaled SAR summation is calculated based on the same configuration and test position.
- Per KDB 447498 D01v06, simultaneous transmission SAR is compliant if,
 - Scalar SAR summation < 1.6W/kg.
 - $SPLSR = (SAR1 + SAR2)^{1.5} / (\text{min. separation distance, mm})$, and the peak separation distance is determined from the square root of $[(x1-x2)^2 + (y1-y2)^2 + (z1-z2)^2]$, where (x1, y1, z1) and (x2, y2, z2) are the coordinates of the extrapolated peak SAR locations in the zoom scan.
 - If $SPLSR \leq 0.04$, simultaneously transmission SAR measurement is not necessary.
 - Simultaneously transmission SAR measurement, and the reported multi-band SAR < 1.6W/kg.
- For simultaneous transmission analysis, Bluetooth SAR is estimated per KDB 447498 D01v06 based on the formula below.
 - $(\text{max. power of channel, including tune-up tolerance, mW}) / (\text{min. test separation distance, mm}) \cdot [\sqrt{f(\text{GHz})} / x] \text{ W/kg}$ for test separation distances $\leq 50 \text{ mm}$; where $x = 7.5$ for 1-g SAR, and $x = 18.75$ for 10-g SAR.
 - When the minimum separation distance is < 5mm, the distance is used 5mm to determine SAR test exclusion.
 - 0.4 W/kg for 1-g SAR and 1.0 W/kg for 10-g SAR, when the test separation distances is > 50 mm.

Bluetooth Max Power	Exposure Position	Hotspot	Body worn
	Test separation	10 mm	10 mm
7.5dBm	Estimated SAR (W/kg)	0.126 W/kg	0.126 W/kg



16.1 Head Exposure Conditions

<Sample 1>

WWAN Band		Exposure Position	1	2	3	4	1+2 Summed 1g SAR (W/kg)	1+3 Summed 1g SAR (W/kg)	1+4 Summed 1g SAR (W/kg)
			WWAN 1g SAR (W/kg)	2.4GHz WLAN 1g SAR (W/kg)	5GHz WLAN 1g SAR (W/kg)	Bluetooth 1g SAR (W/kg)			
GSM	GSM850	Right Cheek	0.089	0.092	0.326	0.001	0.181	0.415	0.090
		Right Tilted	0.055	0.102	0.228	0.001	0.157	0.283	0.056
		Left Cheek	0.163	0.290	0.213	0.008	0.453	0.376	0.171
		Left Tilted	0.039	0.144	0.178	0.001	0.183	0.217	0.040
	GSM1900	Right Cheek	0.126	0.092	0.326	0.001	0.218	0.452	0.127
		Right Tilted	0.062	0.102	0.228	0.001	0.164	0.290	0.063
		Left Cheek	0.354	0.290	0.213	0.008	0.644	0.567	0.362
		Left Tilted	0.086	0.144	0.178	0.001	0.230	0.264	0.087
WCDMA	WCDMA II	Right Cheek	0.121	0.092	0.326	0.001	0.213	0.447	0.122
		Right Tilted	0.064	0.102	0.228	0.001	0.166	0.292	0.065
		Left Cheek	0.274	0.290	0.213	0.008	0.564	0.487	0.282
		Left Tilted	0.049	0.144	0.178	0.001	0.193	0.227	0.050
	WCDMA IV	Right Cheek	0.165	0.092	0.326	0.001	0.257	0.491	0.166
		Right Tilted	0.067	0.102	0.228	0.001	0.169	0.295	0.068
		Left Cheek	0.304	0.290	0.213	0.008	0.594	0.517	0.312
		Left Tilted	0.090	0.144	0.178	0.001	0.234	0.268	0.091
	WCDMA V	Right Cheek	0.082	0.092	0.326	0.001	0.174	0.408	0.083
		Right Tilted	0.035	0.102	0.228	0.001	0.137	0.263	0.036
		Left Cheek	0.116	0.290	0.213	0.008	0.406	0.329	0.124
		Left Tilted	0.041	0.144	0.178	0.001	0.185	0.219	0.042
LTE	LTE Band 2	Right Cheek	0.115	0.092	0.326	0.001	0.207	0.441	0.116
		Right Tilted	0.045	0.102	0.228	0.001	0.147	0.273	0.046
		Left Cheek	0.258	0.290	0.213	0.008	0.548	0.471	0.266
		Left Tilted	0.055	0.144	0.178	0.001	0.199	0.233	0.056
	LTE Band 5	Right Cheek	0.058	0.092	0.326	0.001	0.150	0.384	0.059
		Right Tilted	0.034	0.102	0.228	0.001	0.136	0.262	0.035
		Left Cheek	0.074	0.290	0.213	0.008	0.364	0.287	0.082
		Left Tilted	0.045	0.144	0.178	0.001	0.189	0.223	0.046
	LTE Band 7	Right Cheek	0.588	0.092	0.326	0.001	0.680	0.914	0.589
		Right Tilted	0.071	0.102	0.228	0.001	0.173	0.299	0.072
		Left Cheek	0.196	0.290	0.213	0.008	0.486	0.409	0.204
		Left Tilted	0.175	0.144	0.178	0.001	0.319	0.353	0.176
	LTE Band 12	Right Cheek	0.068	0.092	0.326	0.001	0.160	0.394	0.069
		Right Tilted	0.035	0.102	0.228	0.001	0.137	0.263	0.036
		Left Cheek	0.093	0.290	0.213	0.008	0.383	0.306	0.101
		Left Tilted	0.036	0.144	0.178	0.001	0.180	0.214	0.037
	LTE Band 13	Right Cheek	0.064	0.092	0.326	0.001	0.156	0.390	0.065
		Right Tilted	0.029	0.102	0.228	0.001	0.131	0.257	0.030
		Left Cheek	0.081	0.290	0.213	0.008	0.371	0.294	0.089
		Left Tilted	0.026	0.144	0.178	0.001	0.170	0.204	0.027
	LTE Band 66	Right Cheek	0.149	0.092	0.326	0.001	0.241	0.475	0.150
		Right Tilted	0.066	0.102	0.228	0.001	0.168	0.294	0.067
		Left Cheek	0.244	0.290	0.213	0.008	0.534	0.457	0.252
		Left Tilted	0.069	0.144	0.178	0.001	0.213	0.247	0.070



<Sample 3>

WWAN Band		Exposure Position	1	2	3	4	1+2 Summed 1g SAR (W/kg)	1+3 Summed 1g SAR (W/kg)	1+4 Summed 1g SAR (W/kg)
			WWAN	2.4GHz WLAN	5GHz WLAN	Bluetooth			
			1g SAR (W/kg)	1g SAR (W/kg)	1g SAR (W/kg)	1g SAR (W/kg)			
GSM	GSM850	Right Cheek	0.153	0.092	0.326	0.001	0.245	0.479	0.154
		Right Tilted	0.065	0.102	0.228	0.001	0.167	0.293	0.066
		Left Cheek	0.103	0.290	0.213	0.008	0.393	0.316	0.111
		Left Tilted	0.068	0.144	0.178	0.001	0.212	0.246	0.069
	GSM1900	Right Cheek	0.059	0.092	0.326	0.001	0.151	0.385	0.060
		Right Tilted	0.035	0.102	0.228	0.001	0.137	0.263	0.036
		Left Cheek	0.147	0.290	0.213	0.008	0.437	0.360	0.155
		Left Tilted	0.036	0.144	0.178	0.001	0.180	0.214	0.037
WCDMA	WCDMA II	Right Cheek	0.071	0.092	0.326	0.001	0.163	0.397	0.072
		Right Tilted	0.034	0.102	0.228	0.001	0.136	0.262	0.035
		Left Cheek	0.163	0.290	0.213	0.008	0.453	0.376	0.171
		Left Tilted	0.027	0.144	0.178	0.001	0.171	0.205	0.028
	WCDMA IV	Right Cheek	0.143	0.092	0.326	0.001	0.235	0.469	0.144
		Right Tilted	0.047	0.102	0.228	0.001	0.149	0.275	0.048
		Left Cheek	0.220	0.290	0.213	0.008	0.510	0.433	0.228
		Left Tilted	0.054	0.144	0.178	0.001	0.198	0.232	0.055
	WCDMA V	Right Cheek	0.116	0.092	0.326	0.001	0.208	0.442	0.117
		Right Tilted	0.058	0.102	0.228	0.001	0.160	0.286	0.059
		Left Cheek	0.101	0.290	0.213	0.008	0.391	0.314	0.109
		Left Tilted	0.058	0.144	0.178	0.001	0.202	0.236	0.059
LTE	LTE Band 2	Right Cheek	0.067	0.092	0.326	0.001	0.159	0.393	0.068
		Right Tilted	0.033	0.102	0.228	0.001	0.135	0.261	0.034
		Left Cheek	0.135	0.290	0.213	0.008	0.425	0.348	0.143
		Left Tilted	0.024	0.144	0.178	0.001	0.168	0.202	0.025
	LTE Band 5	Right Cheek	0.069	0.092	0.326	0.001	0.161	0.395	0.070
		Right Tilted	0.037	0.102	0.228	0.001	0.139	0.265	0.038
		Left Cheek	0.067	0.290	0.213	0.008	0.357	0.280	0.075
		Left Tilted	0.045	0.144	0.178	0.001	0.189	0.223	0.046
	LTE Band 7	Right Cheek	0.319	0.092	0.326	0.001	0.411	0.645	0.320
		Right Tilted	0.084	0.102	0.228	0.001	0.186	0.312	0.085
		Left Cheek	0.156	0.290	0.213	0.008	0.446	0.369	0.164
		Left Tilted	0.126	0.144	0.178	0.001	0.270	0.304	0.127
	LTE Band 12	Right Cheek	0.036	0.092	0.326	0.001	0.128	0.362	0.037
		Right Tilted	0.026	0.102	0.228	0.001	0.128	0.254	0.027
		Left Cheek	0.048	0.290	0.213	0.008	0.338	0.261	0.056
		Left Tilted	0.028	0.144	0.178	0.001	0.172	0.206	0.029
	LTE Band 13	Right Cheek	0.075	0.092	0.326	0.001	0.167	0.401	0.076
		Right Tilted	0.065	0.102	0.228	0.001	0.167	0.293	0.066
		Left Cheek	0.082	0.290	0.213	0.008	0.372	0.295	0.090
		Left Tilted	0.070	0.144	0.178	0.001	0.214	0.248	0.071
	LTE Band 66	Right Cheek	0.111	0.092	0.326	0.001	0.203	0.437	0.112
		Right Tilted	0.050	0.102	0.228	0.001	0.152	0.278	0.051
		Left Cheek	0.187	0.290	0.213	0.008	0.477	0.400	0.195
		Left Tilted	0.036	0.144	0.178	0.001	0.180	0.214	0.037



16.2 Hotspot Exposure Conditions

<Sample 1>

WWAN Band		Exposure Position	1	2	3	4	1+2 Summed 1g SAR (W/kg)	1+3 Summed 1g SAR (W/kg)	1+4 Summed 1g SAR (W/kg)
			WWAN 1g SAR (W/kg)	2.4GHz WLAN 1g SAR (W/kg)	5GHz WLAN 1g SAR (W/kg)	Bluetooth Estimated 1g SAR (W/kg)			
GSM	GSM850	Front	0.136	0.018	0.001	0.126	0.154	0.137	0.262
		Back	0.275	0.314	0.094	0.126	0.589	0.369	0.401
		Left side	0.163			0.126	0.163	0.163	0.289
		Right side	0.122	0.089	0.001	0.126	0.211	0.123	0.248
		Top side		0.005	0.001	0.126	0.005	0.001	0.126
		Bottom side	0.039			0.126	0.039	0.039	0.165
	GSM1900	Front	0.625	0.018	0.001	0.126	0.643	0.626	0.751
		Back	0.999	0.314	0.094	0.126	1.313	1.093	1.125
		Left side	0.141			0.126	0.141	0.141	0.267
		Right side	0.074	0.089	0.001	0.126	0.163	0.075	0.200
		Top side		0.005	0.001	0.126	0.005	0.001	0.126
		Bottom side	0.502			0.126	0.502	0.502	0.628
WCDMA	WCDMA II	Front	0.360	0.018	0.001	0.126	0.378	0.361	0.486
		Back	0.695	0.314	0.094	0.126	1.009	0.789	0.821
		Left side	0.166			0.126	0.166	0.166	0.292
		Right side	0.086	0.089	0.001	0.126	0.175	0.087	0.212
		Top side		0.005	0.001	0.126	0.005	0.001	0.126
		Bottom side	0.287			0.126	0.287	0.287	0.413
	WCDMA IV	Front	0.382	0.018	0.001	0.126	0.400	0.383	0.508
		Back	0.582	0.314	0.094	0.126	0.896	0.676	0.708
		Left side	0.205			0.126	0.205	0.205	0.331
		Right side	0.081	0.089	0.001	0.126	0.170	0.082	0.207
		Top side		0.005	0.001	0.126	0.005	0.001	0.126
		Bottom side	0.240			0.126	0.240	0.240	0.366
	WCDMA V	Front	0.108	0.018	0.001	0.126	0.126	0.109	0.234
		Back	0.185	0.314	0.094	0.126	0.499	0.279	0.311
		Left side	0.122			0.126	0.122	0.122	0.248
		Right side	0.106	0.089	0.001	0.126	0.195	0.107	0.232
		Top side		0.005	0.001	0.126	0.005	0.001	0.126
		Bottom side	0.037			0.126	0.037	0.037	0.163



WWAN Band	Exposure Position	1	2	3	4	1+2 Summed 1g SAR (W/kg)	1+3 Summed 1g SAR (W/kg)	1+4 Summed 1g SAR (W/kg)	
		WWAN	2.4GHz WLAN	5GHz WLAN	Bluetooth				
		1g SAR (W/kg)	1g SAR (W/kg)	1g SAR (W/kg)	Estimated 1g SAR (W/kg)				
LTE	LTE Band 2	Front	0.331	0.018	0.001	0.126	0.349	0.332	0.457
		Back	0.551	0.314	0.094	0.126	0.865	0.645	0.677
		Left side	0.148			0.126	0.148	0.148	0.274
		Right side	0.066	0.089	0.001	0.126	0.155	0.067	0.192
		Top side		0.005	0.001	0.126	0.005	0.001	0.126
		Bottom side	0.239			0.126	0.239	0.239	0.365
	LTE Band 5	Front	0.086	0.018	0.001	0.126	0.104	0.087	0.212
		Back	0.132	0.314	0.094	0.126	0.446	0.226	0.258
		Left side	0.110			0.126	0.110	0.110	0.236
		Right side	0.089	0.089	0.001	0.126	0.178	0.090	0.215
		Top side		0.005	0.001	0.126	0.005	0.001	0.126
		Bottom side	0.030			0.126	0.030	0.030	0.156
	LTE Band 7	Front	0.307	0.018	0.001	0.126	0.325	0.308	0.433
		Back	0.687	0.314	0.094	0.126	1.001	0.781	0.813
		Left side	0.026			0.126	0.026	0.026	0.152
		Right side	0.301	0.089	0.001	0.126	0.390	0.302	0.427
		Top side		0.005	0.001	0.126	0.005	0.001	0.126
		Bottom side	0.094			0.126	0.094	0.094	0.220
	LTE Band 12	Front	0.111	0.018	0.001	0.126	0.129	0.112	0.237
		Back	0.178	0.314	0.094	0.126	0.492	0.272	0.304
		Left side	0.108			0.126	0.108	0.108	0.234
		Right side	0.054	0.089	0.001	0.126	0.143	0.055	0.180
		Top side		0.005	0.001	0.126	0.005	0.001	0.126
		Bottom side	0.026			0.126	0.026	0.026	0.152
	LTE Band 13	Front	0.098	0.018	0.001	0.126	0.116	0.099	0.224
		Back	0.153	0.314	0.094	0.126	0.467	0.247	0.279
		Left side	0.132			0.126	0.132	0.132	0.258
		Right side	0.093	0.089	0.001	0.126	0.182	0.094	0.219
		Top side		0.005	0.001	0.126	0.005	0.001	0.126
		Bottom side	0.026			0.126	0.026	0.026	0.152
LTE Band 66	Front	0.349	0.018	0.001	0.126	0.367	0.350	0.475	
	Back	0.464	0.314	0.094	0.126	0.778	0.558	0.590	
	Left side	0.160			0.126	0.160	0.160	0.286	
	Right side	0.064	0.089	0.001	0.126	0.153	0.065	0.190	
	Top side		0.005	0.001	0.126	0.005	0.001	0.126	
	Bottom side	0.211			0.126	0.211	0.211	0.337	



<Sample 3>

WWAN Band	Exposure Position	1	2	3	4	1+2 Summed 1g SAR (W/kg)	1+3 Summed 1g SAR (W/kg)	1+4 Summed 1g SAR (W/kg)	
		WWAN	2.4GHz WLAN	5GHz WLAN	Bluetooth				
		1g SAR (W/kg)	1g SAR (W/kg)	1g SAR (W/kg)	1g SAR (W/kg)				
GSM	GSM850	Front	0.151	0.018	0.001	0.126	0.169	0.152	0.277
		Back	0.211	0.314	0.094	0.126	0.525	0.305	0.337
		Left side	0.155			0.126	0.155	0.155	0.281
		Right side	0.149	0.089	0.001	0.126	0.238	0.150	0.275
		Top side		0.005	0.001	0.126	0.005	0.001	0.126
		Bottom side	0.045			0.126	0.045	0.045	0.171
	GSM1900	Front	0.172	0.018	0.001	0.126	0.190	0.173	0.298
		Back	0.340	0.314	0.094	0.126	0.654	0.434	0.466
		Left side	0.060			0.126	0.060	0.060	0.186
		Right side	0.035	0.089	0.001	0.126	0.124	0.036	0.161
		Top side		0.005	0.001	0.126	0.005	0.001	0.126
		Bottom side	0.150			0.126	0.150	0.150	0.276
WCDMA	WCDMA II	Front	0.219	0.018	0.001	0.126	0.237	0.220	0.345
		Back	0.476	0.314	0.094	0.126	0.790	0.570	0.602
		Left side	0.042			0.126	0.042	0.042	0.168
		Right side	0.011	0.089	0.001	0.126	0.100	0.012	0.137
		Top side		0.005	0.001	0.126	0.005	0.001	0.126
		Bottom side	0.211			0.126	0.211	0.211	0.337
	WCDMA IV	Front	0.278	0.018	0.001	0.126	0.296	0.279	0.404
		Back	0.425	0.314	0.094	0.126	0.739	0.519	0.551
		Left side	0.109			0.126	0.109	0.109	0.235
		Right side	0.053	0.089	0.001	0.126	0.142	0.054	0.179
		Top side		0.005	0.001	0.126	0.005	0.001	0.126
		Bottom side	0.261			0.126	0.261	0.261	0.387
	WCDMA V	Front	0.128	0.018	0.001	0.126	0.146	0.129	0.254
		Back	0.177	0.314	0.094	0.126	0.491	0.271	0.303
		Left side	0.123			0.126	0.123	0.123	0.249
		Right side	0.123	0.089	0.001	0.126	0.212	0.124	0.249
		Top side		0.005	0.001	0.126	0.005	0.001	0.126
		Bottom side	0.040			0.126	0.040	0.040	0.166



WWAN Band		Exposure Position	1	2	3	4	1+2 Summed 1g SAR (W/kg)	1+3 Summed 1g SAR (W/kg)	1+4 Summed 1g SAR (W/kg)
			WWAN	2.4GHz WLAN	5GHz WLAN	Bluetooth			
			1g SAR (W/kg)	1g SAR (W/kg)	1g SAR (W/kg)	1g SAR (W/kg)			
LTE	LTE Band 2	Front	0.203	0.018	0.001	0.126	0.221	0.204	0.329
		Back	0.407	0.314	0.094	0.126	0.721	0.501	0.533
		Left side	0.041			0.126	0.041	0.041	0.167
		Right side	0.010	0.089	0.001	0.126	0.099	0.011	0.136
		Top side		0.005	0.001	0.126	0.005	0.001	0.126
		Bottom side	0.228			0.126	0.228	0.228	0.354
	LTE Band 5	Front	0.100	0.018	0.001	0.126	0.118	0.101	0.226
		Back	0.121	0.314	0.094	0.126	0.435	0.215	0.247
		Left side	0.097			0.126	0.097	0.097	0.223
		Right side	0.097	0.089	0.001	0.126	0.186	0.098	0.223
		Top side		0.005	0.001	0.126	0.005	0.001	0.126
		Bottom side	0.032			0.126	0.032	0.032	0.158
	LTE Band 7	Front	0.202	0.018	0.001	0.126	0.220	0.203	0.328
		Back	0.382	0.314	0.094	0.126	0.696	0.476	0.508
		Left side	0.011			0.126	0.011	0.011	0.137
		Right side	0.258	0.089	0.001	0.126	0.347	0.259	0.384
		Top side		0.005	0.001	0.126	0.005	0.001	0.126
		Bottom side	0.071			0.126	0.071	0.071	0.197
	LTE Band 12	Front	0.058	0.018	0.001	0.126	0.076	0.059	0.184
		Back	0.086	0.314	0.094	0.126	0.400	0.180	0.212
		Left side	0.057			0.126	0.057	0.057	0.183
		Right side	0.028	0.089	0.001	0.126	0.117	0.029	0.154
		Top side		0.005	0.001	0.126	0.005	0.001	0.126
		Bottom side	0.013			0.126	0.013	0.013	0.139
	LTE Band 13	Front	0.131	0.018	0.001	0.126	0.149	0.132	0.257
		Back	0.146	0.314	0.094	0.126	0.460	0.240	0.272
		Left side	0.143			0.126	0.143	0.143	0.269
		Right side	0.126	0.089	0.001	0.126	0.215	0.127	0.252
		Top side		0.005	0.001	0.126	0.005	0.001	0.126
		Bottom side	0.030			0.126	0.030	0.030	0.156
LTE Band 66	Front	0.231	0.018	0.001	0.126	0.249	0.232	0.357	
	Back	0.379	0.314	0.094	0.126	0.693	0.473	0.505	
	Left side	0.091			0.126	0.091	0.091	0.217	
	Right side	0.047	0.089	0.001	0.126	0.136	0.048	0.173	
	Top side		0.005	0.001	0.126	0.005	0.001	0.126	
	Bottom side	0.205			0.126	0.205	0.205	0.331	

16.3 Body-Worn Accessory Exposure Conditions

<Sample 1>

WWAN Band		Exposure Position	1	2	3	4	1+2 Summed 1g SAR (W/kg)	1+3 Summed 1g SAR (W/kg)	1+4 Summed 1g SAR (W/kg)
			WWAN 1g SAR (W/kg)	2.4GHz WLAN 1g SAR (W/kg)	5GHz WLAN 1g SAR (W/kg)	Bluetooth Estimated 1g SAR (W/kg)			
GSM	GSM850	Front	0.136	0.018	0.001	0.126	0.154	0.137	0.262
		Back	0.275	0.314	0.003	0.126	0.589	0.278	0.401
	GSM1900	Front	0.625	0.018	0.001	0.126	0.643	0.626	0.751
		Back	0.999	0.314	0.003	0.126	1.313	1.002	1.125
WCDMA	WCDMA II	Front	0.360	0.018	0.001	0.126	0.378	0.361	0.486
		Back	0.695	0.314	0.003	0.126	1.009	0.698	0.821
	WCDMA IV	Front	0.382	0.018	0.001	0.126	0.400	0.383	0.508
		Back	0.582	0.314	0.003	0.126	0.896	0.585	0.708
	WCDMA V	Front	0.108	0.018	0.001	0.126	0.126	0.109	0.234
		Back	0.185	0.314	0.003	0.126	0.499	0.188	0.311
LTE	LTE Band 2	Front	0.331	0.018	0.001	0.126	0.349	0.332	0.457
		Back	0.551	0.314	0.003	0.126	0.865	0.554	0.677
	LTE Band 5	Front	0.086	0.018	0.001	0.126	0.104	0.087	0.212
		Back	0.132	0.314	0.003	0.126	0.446	0.135	0.258
	LTE Band 7	Front	0.307	0.018	0.001	0.126	0.325	0.308	0.433
		Back	0.687	0.314	0.003	0.126	1.001	0.690	0.813
	LTE Band 12	Front	0.111	0.018	0.001	0.126	0.129	0.112	0.237
		Back	0.178	0.314	0.003	0.126	0.492	0.181	0.304
	LTE Band 13	Front	0.098	0.018	0.001	0.126	0.116	0.099	0.224
		Back	0.153	0.314	0.003	0.126	0.467	0.156	0.279
	LTE Band 66	Front	0.349	0.018	0.001	0.126	0.367	0.350	0.475
		Back	0.464	0.314	0.003	0.126	0.778	0.467	0.590



<Sample 3>

WWAN Band		Exposure Position	1	2	3	4	1+2 Summed 1g SAR (W/kg)	1+3 Summed 1g SAR (W/kg)	1+4 Summed 1g SAR (W/kg)
			WWAN	2.4GHz WLAN	5GHz WLAN	Bluetooth			
			1g SAR (W/kg)	1g SAR (W/kg)	1g SAR (W/kg)	1g SAR (W/kg)			
GSM	GSM850	Front	0.151	0.018	0.001	0.126	0.169	0.152	0.277
		Back	0.211	0.314	0.094	0.126	0.525	0.305	0.337
	GSM1900	Front	0.172	0.018	0.001	0.126	0.190	0.173	0.298
		Back	0.340	0.314	0.094	0.126	0.654	0.434	0.466
WCDMA	WCDMA II	Front	0.219	0.018	0.001	0.126	0.237	0.220	0.345
		Back	0.476	0.314	0.094	0.126	0.790	0.570	0.602
	WCDMA IV	Front	0.278	0.018	0.001	0.126	0.296	0.279	0.404
		Back	0.425	0.314	0.094	0.126	0.739	0.519	0.551
	WCDMA V	Front	0.128	0.018	0.001	0.126	0.146	0.129	0.254
		Back	0.177	0.314	0.094	0.126	0.491	0.271	0.303
LTE	LTE Band 2	Front	0.203	0.018	0.001	0.126	0.221	0.204	0.329
		Back	0.407	0.314	0.094	0.126	0.721	0.501	0.533
	LTE Band 5	Front	0.100	0.018	0.001	0.126	0.118	0.101	0.226
		Back	0.121	0.314	0.094	0.126	0.435	0.215	0.247
	LTE Band 7	Front	0.202	0.018	0.001	0.126	0.220	0.203	0.328
		Back	0.382	0.314	0.094	0.126	0.696	0.476	0.508
	LTE Band 12	Front	0.058	0.018	0.001	0.126	0.076	0.059	0.184
		Back	0.086	0.314	0.094	0.126	0.400	0.180	0.212
	LTE Band 13	Front	0.131	0.018	0.001	0.126	0.149	0.132	0.257
		Back	0.146	0.314	0.094	0.126	0.460	0.240	0.272
	LTE Band 66	Front	0.231	0.018	0.001	0.126	0.249	0.232	0.357
		Back	0.379	0.314	0.094	0.126	0.693	0.473	0.505

Test Engineer : Wilson Lin Steven Chang Tommy Chen and Iran Wang

17. Uncertainty Assessment

The component of uncertainty may generally be categorized according to the methods used to evaluate them. The evaluation of uncertainty by the statistical analysis of a series of observations is termed a Type A evaluation of uncertainty. The evaluation of uncertainty by means other than the statistical analysis of a series of observation is termed a Type B evaluation of uncertainty. Each component of uncertainty, however evaluated, is represented by an estimated standard deviation, termed standard uncertainty, which is determined by the positive square root of the estimated variance.

A Type A evaluation of standard uncertainty may be based on any valid statistical method for treating data. This includes calculating the standard deviation of the mean of a series of independent observations; using the method of least squares to fit a curve to the data in order to estimate the parameter of the curve and their standard deviations; or carrying out an analysis of variance in order to identify and quantify random effects in certain kinds of measurement.

A type B evaluation of standard uncertainty is typically based on scientific judgment using all of the relevant information available. These may include previous measurement data, experience, and knowledge of the behavior and properties of relevant materials and instruments, manufacture’s specification, data provided in calibration reports and uncertainties assigned to reference data taken from handbooks. Broadly speaking, the uncertainty is either obtained from an outdoor source or obtained from an assumed distribution, such as the normal distribution, rectangular or triangular distributions indicated in table below.

Uncertainty Distributions	Normal	Rectangular	Triangular	U-Shape
Multi-plying Factor ^(a)	1/k ^(b)	1/√3	1/√6	1/√2

(a) standard uncertainty is determined as the product of the multiplying factor and the estimated range of variations in the measured quantity

(b) κ is the coverage factor

Table 17.1. Standard Uncertainty for Assumed Distribution

The combined standard uncertainty of the measurement result represents the estimated standard deviation of the result. It is obtained by combining the individual standard uncertainties of both Type A and Type B evaluation using the usual “root-sum-squares” (RSS) methods of combining standard deviations by taking the positive square root of the estimated variances.

Expanded uncertainty is a measure of uncertainty that defines an interval about the measurement result within which the measured value is confidently believed to lie. It is obtained by multiplying the combined standard uncertainty by a coverage factor. Typically, the coverage factor ranges from 2 to 3. Using a coverage factor allows the true value of a measured quantity to be specified with a defined probability within the specified uncertainty range. For purpose of this document, a coverage factor two is used, which corresponds to confidence interval of about 95 %. The DASY uncertainty Budget is shown in the following tables.



Error Description	Uncertainty Value (±%)	Probability	Divisor	(Ci) 1g	(Ci) 10g	Standard Uncertainty (1g) (±%)	Standard Uncertainty (10g) (±%)
Measurement System							
Probe Calibration	6.00	N	1	1	1	6.0	6.0
Axial Isotropy	4.70	R	1.732	0.7	0.7	1.9	1.9
Hemispherical Isotropy	9.60	R	1.732	0.7	0.7	3.9	3.9
Boundary Effects	1.00	R	1.732	1	1	0.6	0.6
Linearity	4.70	R	1.732	1	1	2.7	2.7
System Detection Limits	1.00	R	1.732	1	1	0.6	0.6
Modulation Response	4.68	R	1.732	1	1	2.7	2.7
Readout Electronics	0.30	N	1	1	1	0.3	0.3
Response Time	0.00	R	1.732	1	1	0.0	0.0
Integration Time	2.60	R	1.732	1	1	1.5	1.5
RF Ambient Noise	3.00	R	1.732	1	1	1.7	1.7
RF Ambient Reflections	3.00	R	1.732	1	1	1.7	1.7
Probe Positioner	0.40	R	1.732	1	1	0.2	0.2
Probe Positioning	2.90	R	1.732	1	1	1.7	1.7
Max. SAR Eval.	2.00	R	1.732	1	1	1.2	1.2
Test Sample Related							
Device Positioning	3.03	N	1	1	1	3.0	3.0
Device Holder	3.60	N	1	1	1	3.6	3.6
Power Drift	5.00	R	1.732	1	1	2.9	2.9
Power Scaling	0.00	R	1.732	1	1	0.0	0.0
Phantom and Setup							
Phantom Uncertainty	6.10	R	1.732	1	1	3.5	3.5
SAR correction	0.00	R	1.732	1	0.84	0.0	0.0
Liquid Conductivity Repeatability	0.03	N	1	0.78	0.71	0.0	0.0
Liquid Conductivity (target)	5.00	R	1.732	0.78	0.71	2.3	2.0
Liquid Conductivity (mea.)	2.50	R	1.732	0.78	0.71	1.1	1.0
Temp. unc. - Conductivity	3.68	R	1.732	0.78	0.71	1.7	1.5
Liquid Permittivity Repeatability	0.02	N	1	0.23	0.26	0.0	0.0
Liquid Permittivity (target)	5.00	R	1.732	0.23	0.26	0.7	0.8
Liquid Permittivity (mea.)	2.50	R	1.732	0.23	0.26	0.3	0.4
Temp. unc. - Permittivity	0.84	R	1.732	0.23	0.26	0.1	0.1
Combined Std. Uncertainty						11.6%	11.6%
Coverage Factor for 95 %						K=2	K=2
Expanded STD Uncertainty						23.2%	23.1%

Table 17.2. Uncertainty Budget for frequency range 300 MHz to 3 GHz



Error Description	Uncertainty Value (±%)	Probability	Divisor	(Ci) 1g	(Ci) 10g	Standard Uncertainty (1g) (±%)	Standard Uncertainty (10g) (±%)
Measurement System							
Probe Calibration	6.55	N	1	1	1	6.6	6.6
Axial Isotropy	4.70	R	1.732	0.7	0.7	1.9	1.9
Hemispherical Isotropy	9.60	R	1.732	0.7	0.7	3.9	3.9
Boundary Effects	2.00	R	1.732	1	1	1.2	1.2
Linearity	4.70	R	1.732	1	1	2.7	2.7
System Detection Limits	1.00	R	1.732	1	1	0.6	0.6
Modulation Response	4.68	R	1.732	1	1	2.7	2.7
Readout Electronics	0.30	N	1	1	1	0.3	0.3
Response Time	0.00	R	1.732	1	1	0.0	0.0
Integration Time	2.60	R	1.732	1	1	1.5	1.5
RF Ambient Noise	3.00	R	1.732	1	1	1.7	1.7
RF Ambient Reflections	3.00	R	1.732	1	1	1.7	1.7
Probe Positioner	0.40	R	1.732	1	1	0.2	0.2
Probe Positioning	6.70	R	1.732	1	1	3.9	3.9
Max. SAR Eval.	4.00	R	1.732	1	1	2.3	2.3
Test Sample Related							
Device Positioning	3.03	N	1	1	1	3.0	3.0
Device Holder	3.60	N	1	1	1	3.6	3.6
Power Drift	5.00	R	1.732	1	1	2.9	2.9
Power Scaling	0.00	R	1.732	1	1	0.0	0.0
Phantom and Setup							
Phantom Uncertainty	6.60	R	1.732	1	1	3.8	3.8
SAR correction	0.00	R	1.732	1	0.84	0.0	0.0
Liquid Conductivity Repeatability	0.03	N	1	0.78	0.71	0.0	0.0
Liquid Conductivity (target)	5.00	R	1.732	0.78	0.71	2.3	2.0
Liquid Conductivity (mea.)	2.50	R	1.732	0.78	0.71	1.1	1.0
Temp. unc. - Conductivity	3.68	R	1.732	0.78	0.71	1.7	1.5
Liquid Permittivity Repeatability	0.02	N	1	0.23	0.26	0.0	0.0
Liquid Permittivity (target)	5.00	R	1.732	0.23	0.26	0.7	0.8
Liquid Permittivity (mea.)	2.50	R	1.732	0.23	0.26	0.3	0.4
Temp. unc. - Permittivity	0.84	R	1.732	0.23	0.26	0.1	0.1
Combined Std. Uncertainty						12.7%	12.6%
Coverage Factor for 95 %						K=2	K=2
Expanded STD Uncertainty						25.4%	25.3%

Table 17.3. Uncertainty Budget for frequency range 3 GHz to 6 GHz



18. References

- [1] FCC 47 CFR Part 2 “Frequency Allocations and Radio Treaty Matters; General Rules and Regulations”
- [2] ANSI/IEEE Std. C95.1-1992, “IEEE Standard for Safety Levels with Respect to Human Exposure to Radio Frequency Electromagnetic Fields, 3 kHz to 300 GHz”, September 1992
- [3] IEEE Std. 1528-2013, “IEEE Recommended Practice for Determining the Peak Spatial-Average Specific Absorption Rate (SAR) in the Human Head from Wireless Communications Devices: Measurement Techniques”, Sep 2013
- [4] SPEAG DASY System Handbook
- [5] FCC KDB 248227 D01 v02r02, “SAR Guidance for IEEE 802.11 (WiFi) Transmitters”, Oct 2015.
- [6] FCC KDB 447498 D01 v06, “Mobile and Portable Device RF Exposure Procedures and Equipment Authorization Policies”, Oct 2015
- [7] FCC KDB 648474 D04 v01r03, “SAR Evaluation Considerations for Wireless Handsets”, Oct 2015.
- [8] FCC KDB 941225 D01 v03r01, “3G SAR MEAUREMENT PROCEDURES”, Oct 2015
- [9] FCC KDB 941225 D05 v02r05, “SAR Evaluation Considerations for LTE Devices”, Dec 2015
- [10] FCC KDB 941225 D05A v01r02, “Rel. 10 LTE SAR Test Guidance and KDB Inquiries”, Oct 2015
- [11] FCC KDB 941225 D06 v02r01, "SAR Evaluation Procedures for Portable Devices with Wireless Router Capabilities", Oct 2015.
- [12] FCC KDB 865664 D01 v01r04, "SAR Measurement Requirements for 100 MHz to 6 GHz", Aug 2015.
- [13] FCC KDB 865664 D02 v01r02, “RF Exposure Compliance Reporting and Documentation Considerations” Oct 2015.



Appendix A. Plots of System Performance Check

The plots are shown as follows.

System Check_Head_750MHz

DUT: D750V3-1012

Communication System: CW; Frequency: 750 MHz; Duty Cycle: 1:1

Medium: HSL_750_170613 Medium parameters used: $f = 750 \text{ MHz}$; $\sigma = 0.898 \text{ S/m}$; $\epsilon_r = 40.872$; $\rho = 1000 \text{ kg/m}^3$

Ambient Temperature : $23.7 \text{ }^\circ\text{C}$; Liquid Temperature : $22.7 \text{ }^\circ\text{C}$

DASY5 Configuration:

- Probe: ES3DV3 - SN3169; ConvF(6.07, 6.07, 6.07); Calibrated: 2017/5/11;
- Sensor-Surface: 3mm (Mechanical Surface Detection)
- Electronics: DAE4 Sn1399; Calibrated: 2016/11/17
- Phantom: SAM_Left; Type: QD000P40CD; Serial: TP:1431
- Measurement SW: DASY52, Version 52.8 (8); SEMCAD X Version 14.6.10 (7373)

Pin=250mW/Area Scan (61x61x1): Interpolated grid: $dx=1.500 \text{ mm}$, $dy=1.500 \text{ mm}$

Maximum value of SAR (interpolated) = 2.84 W/kg

Pin=250mW/Zoom Scan (5x5x7)/Cube 0: Measurement grid: $dx=8\text{mm}$, $dy=8\text{mm}$, $dz=5\text{mm}$

Reference Value = 59.10 V/m ; Power Drift = 0.00 dB

Peak SAR (extrapolated) = 3.63 W/kg

SAR(1 g) = 2.17 W/kg ; SAR(10 g) = 1.42 W/kg

Maximum value of SAR (measured) = 2.83 W/kg

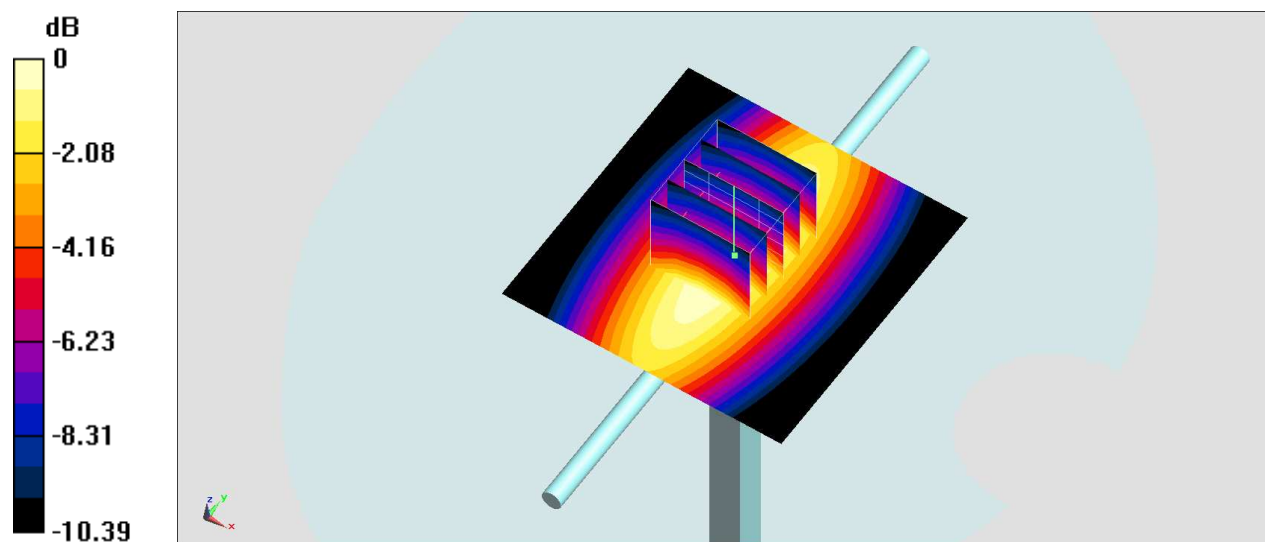

0 dB = 2.83 W/kg = 4.52 dBW/kg

System Check_Head_750MHz

DUT: D750V3-1012

Communication System: CW; Frequency: 750 MHz; Duty Cycle: 1:1

Medium: HSL_750_170822 Medium parameters used: $f = 750$ MHz; $\sigma = 0.9$ S/m; $\epsilon_r = 40.782$; $\rho = 1000$ kg/m³

Ambient Temperature : 23.7 °C; Liquid Temperature : 22.7 °C

DASY5 Configuration:

- Probe: ES3DV3 - SN3169; ConvF(6.07, 6.07, 6.07); Calibrated: 2017/5/11;
- Sensor-Surface: 3mm (Mechanical Surface Detection)
- Electronics: DAE4 Sn1399; Calibrated: 2016/11/17
- Phantom: SAM-Left; Type: QD 000 P40 C; Serial: TP-1446
- Measurement SW: DASY52, Version 52.8 (8); SEMCAD X Version 14.6.10 (7331)

Pin=250mW/Area Scan (61x61x1): Interpolated grid: dx=1.500 mm, dy=1.500 mm

Maximum value of SAR (interpolated) = 2.81 W/kg

Pin=250mW/Zoom Scan (5x5x7)/Cube 0: Measurement grid: dx=8mm, dy=8mm, dz=5mm

Reference Value = 58.61 V/m; Power Drift = -0.00 dB

Peak SAR (extrapolated) = 3.58 W/kg

SAR(1 g) = 2.16 W/kg; SAR(10 g) = 1.41 W/kg

Maximum value of SAR (measured) = 2.82 W/kg

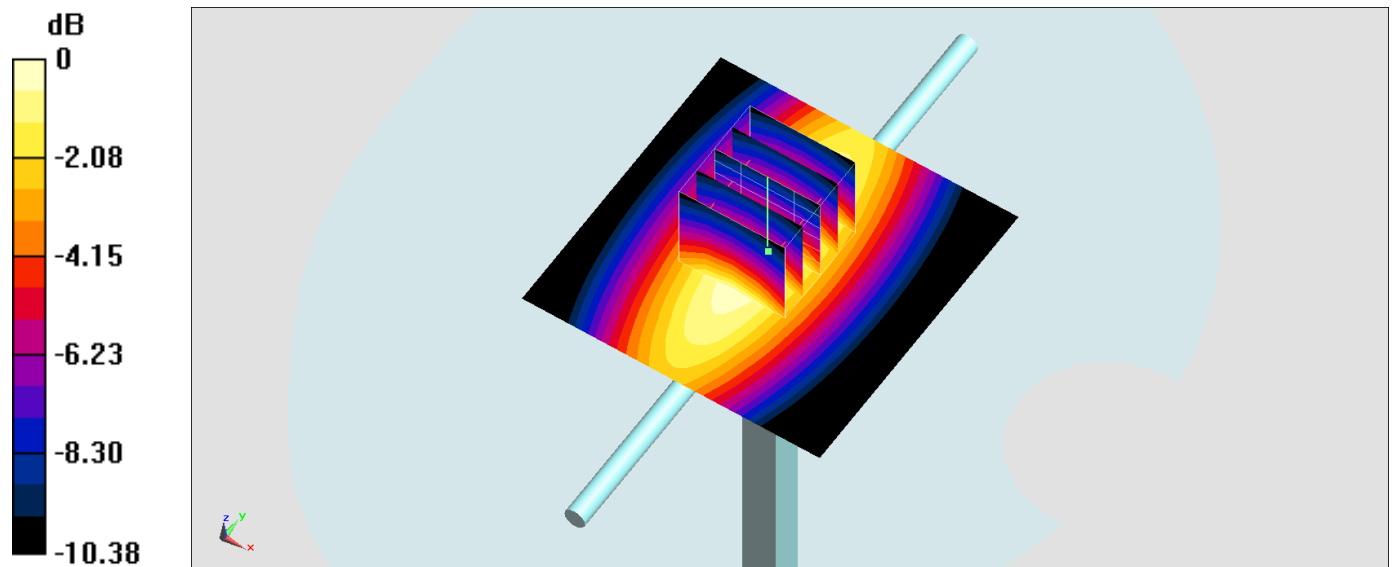

0 dB = 2.82 W/kg = 4.50 dBW/kg

System Check_Body_750MHz

DUT: D750V3-1012

Communication System: CW; Frequency: 750 MHz; Duty Cycle: 1:1

Medium: MSL_750_170611 Medium parameters used: $f = 750$ MHz; $\sigma = 0.96$ S/m; $\epsilon_r = 55.486$; $\rho = 1000$ kg/m³

Ambient Temperature : 23.4 °C ; Liquid Temperature : 22.4 °C

DASY5 Configuration:

- Probe: ES3DV3 - SN3270; ConvF(6.09, 6.09, 6.09); Calibrated: 2016/8/26;
- Sensor-Surface: 3mm (Mechanical Surface Detection)
- Electronics: DAE4 Sn778; Calibrated: 2017/5/22
- Phantom: SAM-Left; Type: QD 000 P40 C; Serial: TP-1446
- Measurement SW: DASY52, Version 52.8 (8); SEMCAD X Version 14.6.10 (7331)

Pin=250mW/Area Scan (61x61x1): Interpolated grid: dx=1.500 mm, dy=1.500 mm

Maximum value of SAR (interpolated) = 2.61 W/kg

Pin=250mW/Zoom Scan (5x5x7)/Cube 0: Measurement grid: dx=8mm, dy=8mm, dz=5mm

Reference Value = 53.61 V/m; Power Drift = -0.06 dB

Peak SAR (extrapolated) = 3.32 W/kg

SAR(1 g) = 2.27 W/kg; SAR(10 g) = 1.53 W/kg

Maximum value of SAR (measured) = 2.64 W/kg

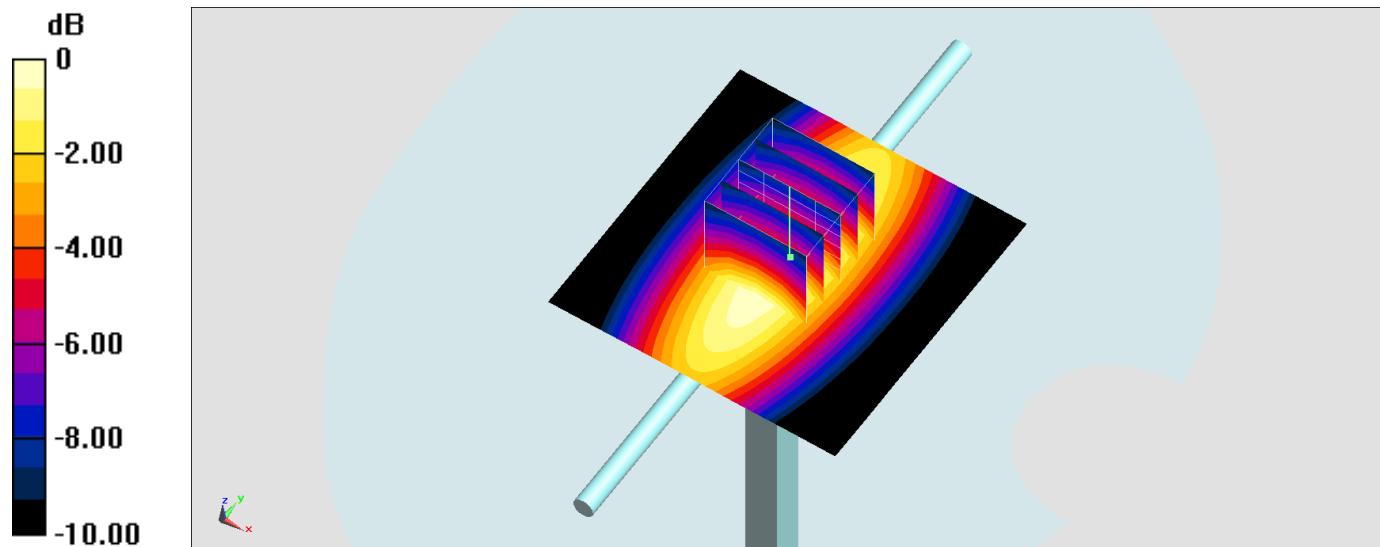

System Check_Body_750MHz

DUT: D750V3-1012

Communication System: CW; Frequency: 750 MHz; Duty Cycle: 1:1

Medium: MSL_750_170819 Medium parameters used: $f = 750 \text{ MHz}$; $\sigma = 0.973 \text{ S/m}$; $\epsilon_r = 54.274$; $\rho = 1000 \text{ kg/m}^3$

Ambient Temperature : $23.6 \text{ }^\circ\text{C}$; Liquid Temperature : $22.6 \text{ }^\circ\text{C}$

DASY5 Configuration:

- Probe: ES3DV3 - SN3169; ConvF(6.31, 6.31, 6.31); Calibrated: 2017/5/11;
- Sensor-Surface: 3mm (Mechanical Surface Detection)
- Electronics: DAE4 Sn1399; Calibrated: 2016/11/17
- Phantom: SAM_Right; Type: QD000P40CD; Serial: 1884
- Measurement SW: DASY52, Version 52.8 (8); SEMCAD X Version 14.6.10 (7331)

Pin=250mW/Area Scan (61x61x1): Interpolated grid: $dx=1.500 \text{ mm}$, $dy=1.500 \text{ mm}$

Maximum value of SAR (interpolated) = 2.70 W/kg

Pin=250mW/Zoom Scan (5x5x7)/Cube 0: Measurement grid: $dx=8\text{mm}$, $dy=8\text{mm}$, $dz=5\text{mm}$

Reference Value = 53.28 V/m ; Power Drift = -0.09 dB

Peak SAR (extrapolated) = 3.32 W/kg

SAR(1 g) = 2.27 W/kg ; SAR(10 g) = 1.53 W/kg

Maximum value of SAR (measured) = 2.63 W/kg

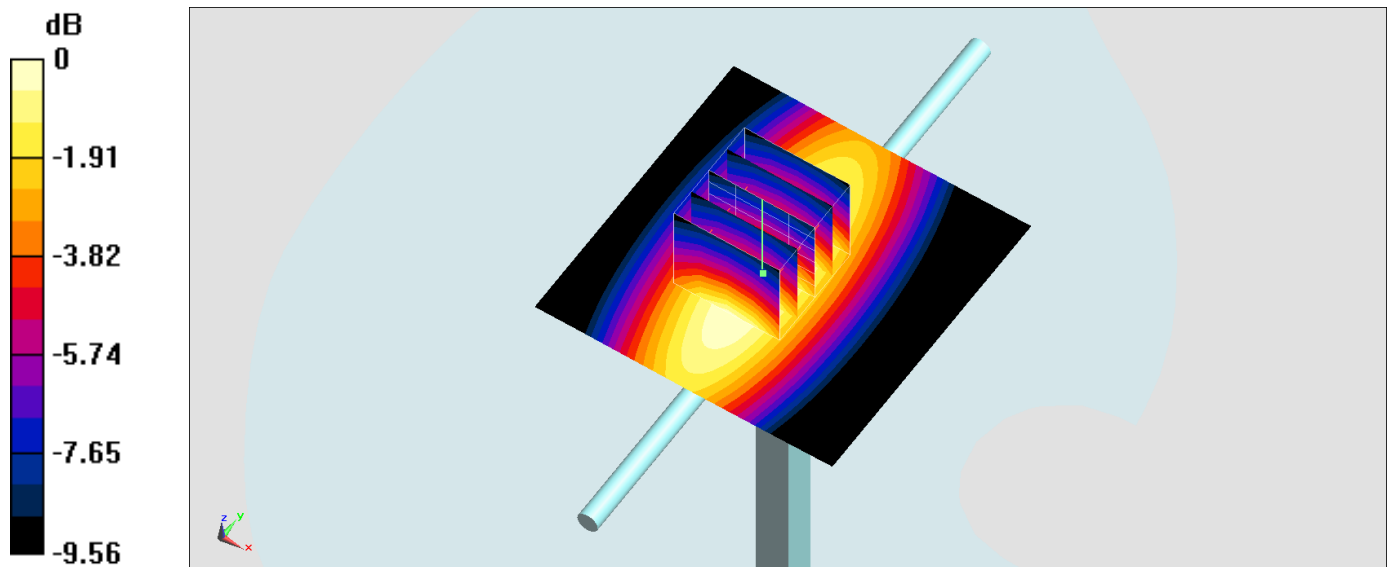

0 dB = $2.63 \text{ W/kg} = 4.20 \text{ dBW/kg}$

System Check_Head_835MHz

DUT: D835V2-499

Communication System: CW; Frequency: 835 MHz; Duty Cycle: 1:1

Medium: HSL_850_170612 Medium parameters used: $f = 835 \text{ MHz}$; $\sigma = 0.901 \text{ S/m}$; $\epsilon_r = 43.151$; $\rho = 1000 \text{ kg/m}^3$

Ambient Temperature : $23.2 \text{ }^\circ\text{C}$; Liquid Temperature : $22.2 \text{ }^\circ\text{C}$

DASY5 Configuration:

- Probe: ES3DV3 - SN3169; ConvF(5.99, 5.99, 5.99); Calibrated: 2017/5/11;
- Sensor-Surface: 3mm (Mechanical Surface Detection)
- Electronics: DAE4 Sn1399; Calibrated: 2016/11/17
- Phantom: SAM_Left; Type: QD000P40CD; Serial: TP:1431
- Measurement SW: DASY52, Version 52.8 (8); SEMCAD X Version 14.6.10 (7373)

Pin=250mW/Area Scan (61x61x1): Interpolated grid: $dx=1.500 \text{ mm}$, $dy=1.500 \text{ mm}$

Maximum value of SAR (interpolated) = 2.81 W/kg

Pin=250mW/Zoom Scan (5x5x7)/Cube 0: Measurement grid: $dx=8\text{mm}$, $dy=8\text{mm}$, $dz=5\text{mm}$

Reference Value = 57.09 V/m ; Power Drift = 0.01 dB

Peak SAR (extrapolated) = 3.57 W/kg

SAR(1 g) = 2.39 W/kg ; SAR(10 g) = 1.58 W/kg

Maximum value of SAR (measured) = 2.78 W/kg

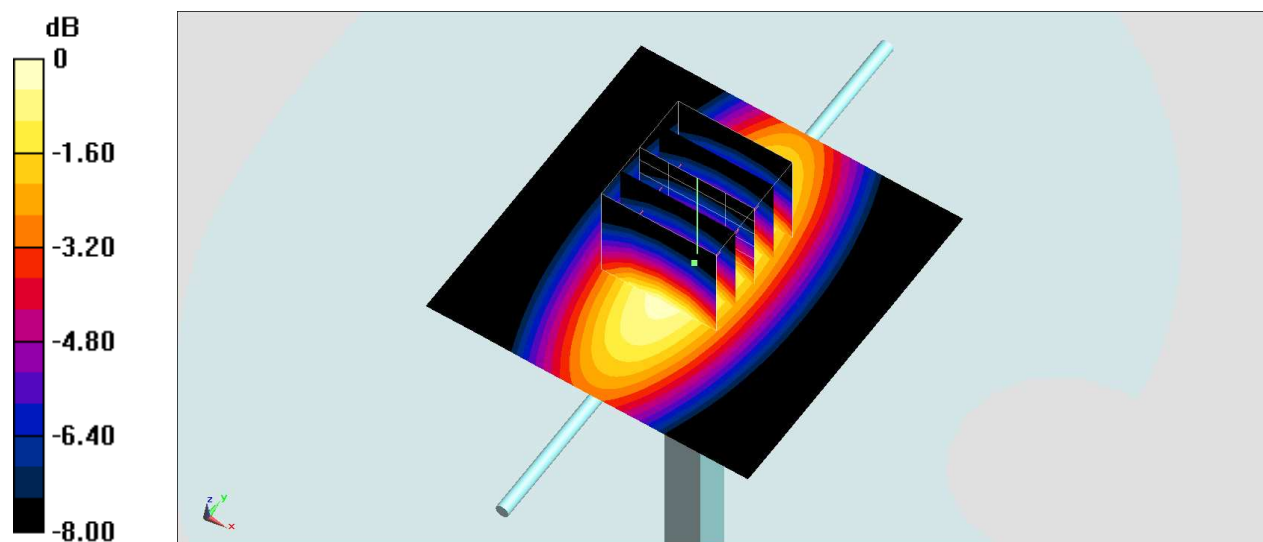

0 dB = $2.78 \text{ W/kg} = 4.44 \text{ dBW/kg}$

System Check_Head_835MHz

DUT: D835V2-499

Communication System: CW; Frequency: 835 MHz; Duty Cycle: 1:1

Medium: HSL_850_170822 Medium parameters used: $f = 835 \text{ MHz}$; $\sigma = 0.913 \text{ S/m}$; $\epsilon_r = 42.632$; $\rho = 1000 \text{ kg/m}^3$

Ambient Temperature : $23.2 \text{ }^\circ\text{C}$; Liquid Temperature : $22.2 \text{ }^\circ\text{C}$

DASY5 Configuration:

- Probe: EX3DV4 - SN3976; ConvF(10.43, 10.43, 10.43); Calibrated: 2017/2/21;
- Sensor-Surface: 1.4mm (Mechanical Surface Detection)
- Electronics: DAE4 Sn1424; Calibrated: 2017/2/16
- Phantom: SAM_Left; Type: QD000P40CD; Serial: TP:1431
- Measurement SW: DASY52, Version 52.8 (8); SEMCAD X Version 14.6.10 (7373)

Pin=250mW/Area Scan (61x61x1): Interpolated grid: $dx=1.500 \text{ mm}$, $dy=1.500 \text{ mm}$

Maximum value of SAR (interpolated) = 3.08 W/kg

Pin=250mW/Zoom Scan (5x5x7)/Cube 0: Measurement grid: $dx=8\text{mm}$, $dy=8\text{mm}$, $dz=5\text{mm}$

Reference Value = 60.86 V/m ; Power Drift = -0.05 dB

Peak SAR (extrapolated) = 3.47 W/kg

SAR(1 g) = 2.32 W/kg ; SAR(10 g) = 1.53 W/kg

Maximum value of SAR (measured) = 3.08 W/kg

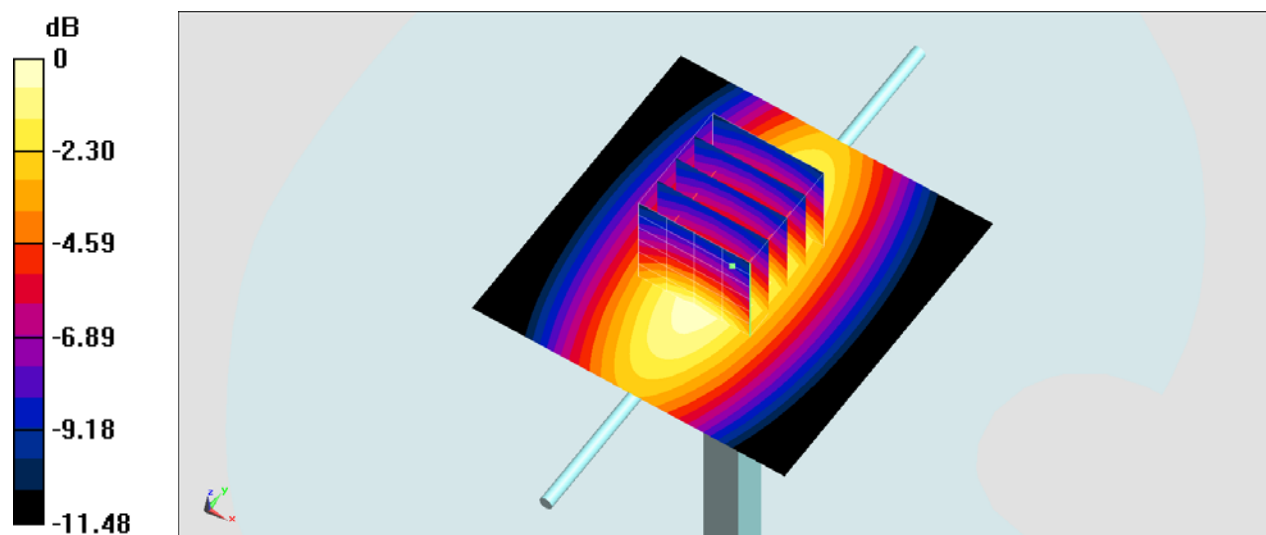

0 dB = $3.08 \text{ W/kg} = 4.89 \text{ dBW/kg}$

System Check_Body_835MHz

DUT: D835V2-499

Communication System: CW; Frequency: 835 MHz; Duty Cycle: 1:1

Medium: MSL_850_170609 Medium parameters used: $f = 835$ MHz; $\sigma = 0.96$ S/m; $\epsilon_r = 55.236$; $\rho = 1000$ kg/m³

Ambient Temperature : 23.5 °C ; Liquid Temperature : 22.5 °C

DASY5 Configuration:

- Probe: ES3DV3 - SN3270; ConvF(6.01, 6.01, 6.01); Calibrated: 2016/8/26;
- Sensor-Surface: 3mm (Mechanical Surface Detection)
- Electronics: DAE4 Sn778; Calibrated: 2017/5/22
- Phantom: SAM-Left; Type: QD 000 P40 C; Serial: TP-1446
- Measurement SW: DASY52, Version 52.8 (8); SEMCAD X Version 14.6.10 (7331)

Pin=250mW/Area Scan (61x61x1): Interpolated grid: dx=1.500 mm, dy=1.500 mm

Maximum value of SAR (interpolated) = 2.73 W/kg

Pin=250mW/Zoom Scan (5x5x7)/Cube 0: Measurement grid: dx=8mm, dy=8mm, dz=5mm

Reference Value = 55.09 V/m; Power Drift = -0.00 dB

Peak SAR (extrapolated) = 3.39 W/kg

SAR(1 g) = 2.35 W/kg; SAR(10 g) = 1.56 W/kg

Maximum value of SAR (measured) = 2.72 W/kg

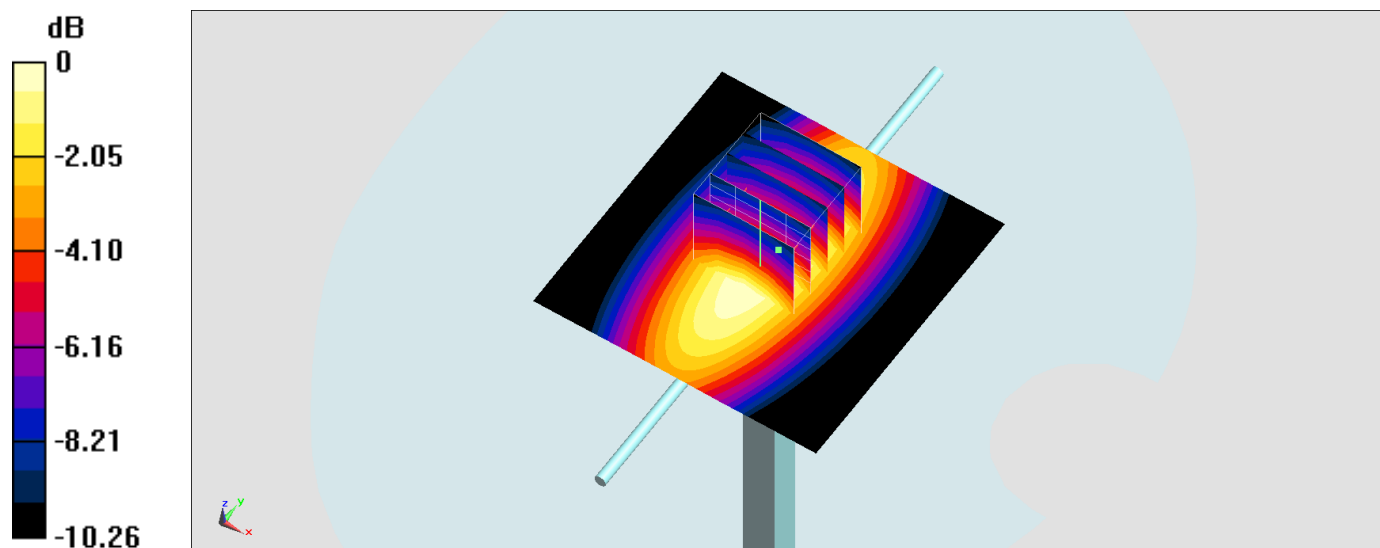

0 dB = 2.72 W/kg = 4.35 dBW/kg

System Check_Body_835MHz

DUT: D835V2-499

Communication System: CW; Frequency: 835 MHz; Duty Cycle: 1:1

Medium: MSL_850_170818 Medium parameters used: $f = 835$ MHz; $\sigma = 0.967$ S/m; $\epsilon_r = 55.584$; $\rho = 1000$ kg/m³

Ambient Temperature : 23.6 °C; Liquid Temperature : 22.6 °C

DASY5 Configuration:

- Probe: ES3DV3 - SN3169; ConvF(6.05, 6.05, 6.05); Calibrated: 2017/5/11;
- Sensor-Surface: 3mm (Mechanical Surface Detection)
- Electronics: DAE4 Sn1399; Calibrated: 2016/11/17
- Phantom: SAM_Right; Type: QD000P40CD; Serial: 1884
- Measurement SW: DASY52, Version 52.8 (8); SEMCAD X Version 14.6.10 (7331)

Pin=250mW/Area Scan (61x61x1): Interpolated grid: dx=1.500 mm, dy=1.500 mm

Maximum value of SAR (interpolated) = 2.53 W/kg

Pin=250mW/Zoom Scan (5x5x7)/Cube 0: Measurement grid: dx=8mm, dy=8mm, dz=5mm

Reference Value = 52.81 V/m; Power Drift = 0.12 dB

Peak SAR (extrapolated) = 3.20 W/kg

SAR(1 g) = 2.28 W/kg; SAR(10 g) = 1.52 W/kg

Maximum value of SAR (measured) = 2.64 W/kg

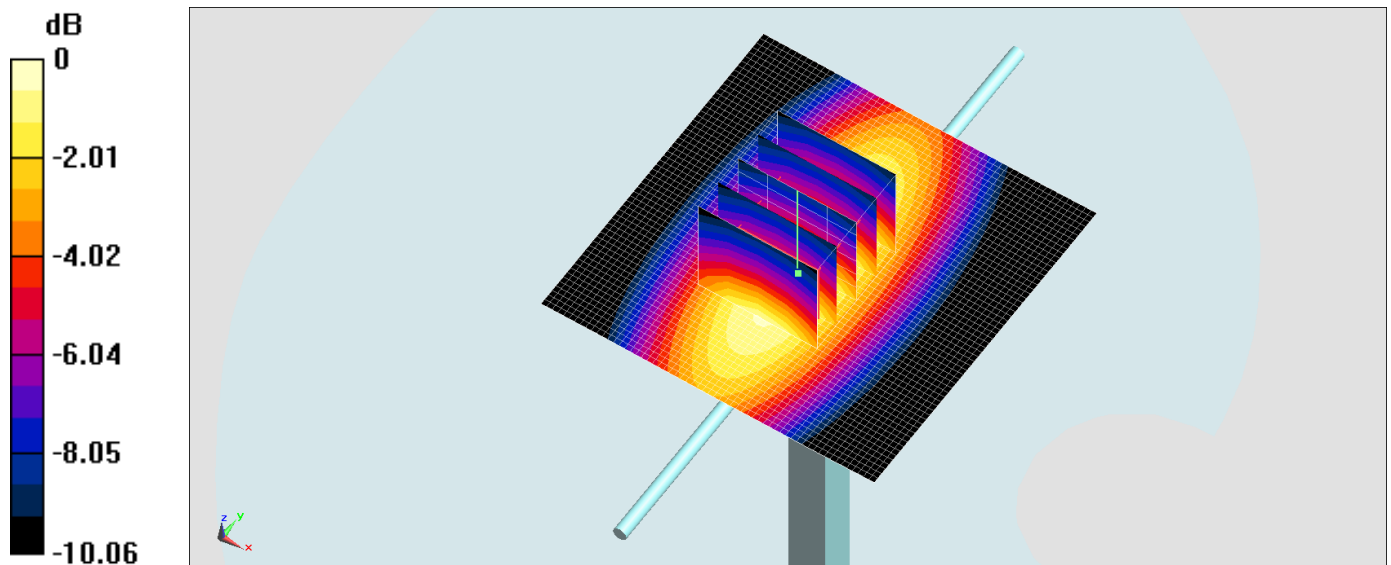

System Check_Head_1750MHz

DUT: **D1750V2-1068**

Communication System: CW; Frequency: 1750 MHz; Duty Cycle: 1:1

Medium: HSL_1750_170607 Medium parameters used: $f = 1750$ MHz; $\sigma = 1.355$ S/m; $\epsilon_r = 41.553$; $\rho = 1000$ kg/m³

Ambient Temperature : 23.2 °C; Liquid Temperature : 22.2 °C

DASY5 Configuration:

- Probe: ES3DV3 - SN3270; ConvF(5.21, 5.21, 5.21); Calibrated: 2016/8/26;
- Sensor-Surface: 3mm (Mechanical Surface Detection)
- Electronics: DAE4 Sn916; Calibrated: 2016/12/15
- Phantom: SAM_Right; Type: QD000P40CD; Serial: 1884
- Measurement SW: DASY52, Version 52.8 (8); SEMCAD X Version 14.6.10 (7331)

Pin=250mW/Area Scan (61x61x1): Interpolated grid: dx=1.500 mm, dy=1.500 mm

Maximum value of SAR (interpolated) = 11.3 W/kg

Pin=250mW/Zoom Scan (5x5x7)/Cube 0: Measurement grid: dx=8mm, dy=8mm, dz=5mm

Reference Value = 92.54 V/m; Power Drift = -0.07 dB

Peak SAR (extrapolated) = 15.0 W/kg

SAR(1 g) = 8.86 W/kg; SAR(10 g) = 4.85 W/kg

Maximum value of SAR (measured) = 10.8 W/kg

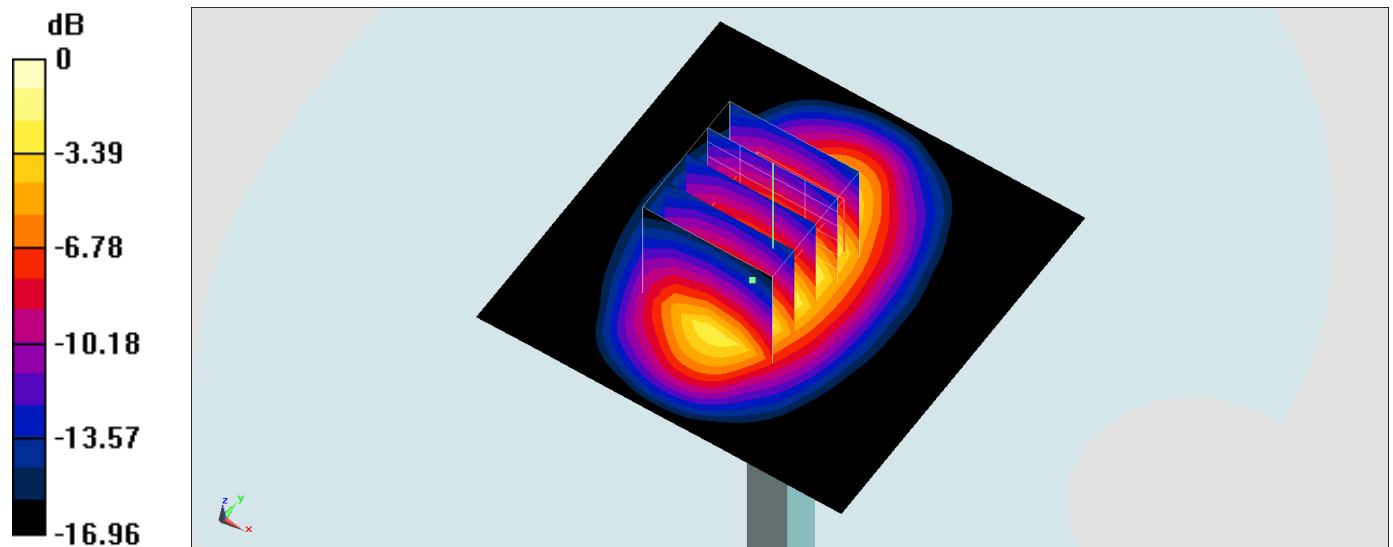

0 dB = 10.8 W/kg = 10.33 dBW/kg

System Check_Head_1750MHz

DUT: D1750V2-1068

Communication System: CW; Frequency: 1750 MHz; Duty Cycle: 1:1
Medium: HSL_1750_170612 Medium parameters used: $f = 1750$ MHz; $\sigma = 1.389$ S/m; $\epsilon_r = 39.608$;
 $\rho = 1000$ kg/m³
Ambient Temperature : 23.2 °C; Liquid Temperature : 22.2 °C

DASY5 Configuration:

- Probe: ES3DV3 - SN3169; ConvF(5.33, 5.33, 5.33); Calibrated: 2017/5/11;
- Sensor-Surface: 3mm (Mechanical Surface Detection)
- Electronics: DAE4 Sn1399; Calibrated: 2016/11/17
- Phantom: SAM_Left; Type: QD000P40CD; Serial: TP:1431
- Measurement SW: DASY52, Version 52.8 (8); SEMCAD X Version 14.6.10 (7373)

Pin=250mW/Area Scan (61x61x1): Interpolated grid: dx=1.500 mm, dy=1.500 mm
Maximum value of SAR (interpolated) = 11.2 W/kg

Pin=250mW/Zoom Scan (5x5x7)/Cube 0: Measurement grid: dx=8mm, dy=8mm, dz=5mm
Reference Value = 90.07 V/m; Power Drift = -0.07 dB
Peak SAR (extrapolated) = 15.0 W/kg
SAR(1 g) = 8.7 W/kg; SAR(10 g) = 4.75 W/kg
Maximum value of SAR (measured) = 10.6 W/kg

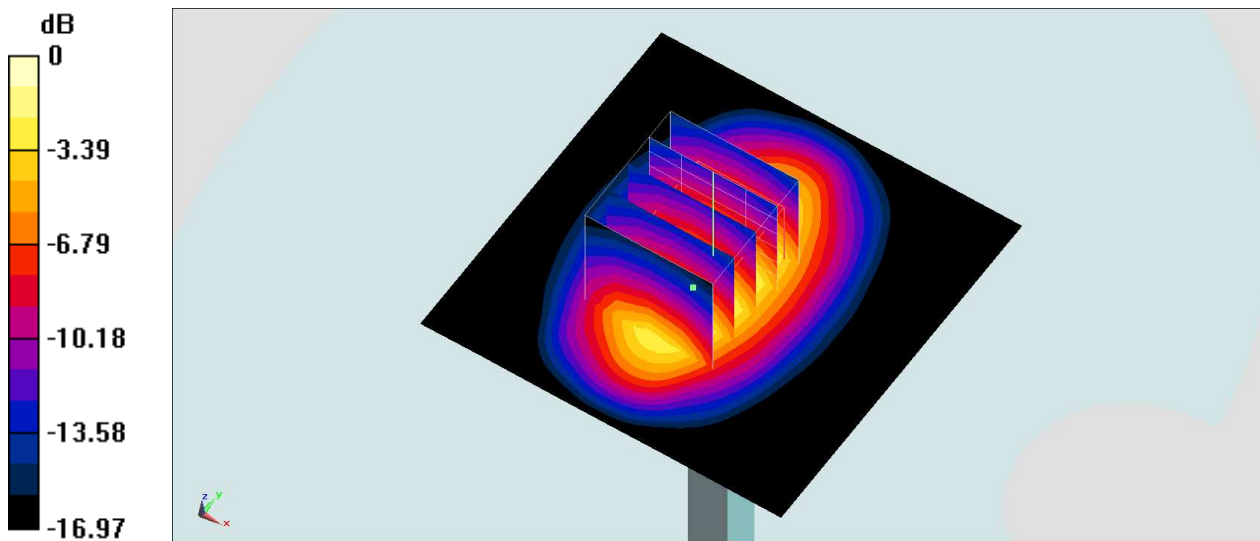

0 dB = 10.6 W/kg = 10.25 dBW/kg

System Check_Head_1750MHz

DUT: D1750V2-1068

Communication System: CW; Frequency: 1750 MHz; Duty Cycle: 1:1
Medium: HSL_1750_170823 Medium parameters used: $f = 1750 \text{ MHz}$; $\sigma = 1.409 \text{ S/m}$; $\epsilon_r = 40.898$;
 $\rho = 1000 \text{ kg/m}^3$
Ambient Temperature : $23.3 \text{ }^\circ\text{C}$; Liquid Temperature : $22.3 \text{ }^\circ\text{C}$

DASY5 Configuration:

- Probe: EX3DV4 - SN7306; ConvF(8.64, 8.64, 8.64); Calibrated: 2017/7/24;
- Sensor-Surface: 1.4mm (Mechanical Surface Detection)
- Electronics: DAE4 Sn854; Calibrated: 2017/5/2
- Phantom: SAM_Left; Type: QD000P40CD; Serial: TP:1431
- Measurement SW: DASY52, Version 52.8 (8); SEMCAD X Version 14.6.10 (7373)

Pin=250mW/Area Scan (61x61x1): Interpolated grid: $dx=1.500 \text{ mm}$, $dy=1.500 \text{ mm}$
Maximum value of SAR (interpolated) = 13.9 W/kg

Pin=250mW/Zoom Scan (5x5x7)/Cube 0: Measurement grid: $dx=8\text{mm}$, $dy=8\text{mm}$, $dz=5\text{mm}$
Reference Value = 96.97 V/m ; Power Drift = 0.08 dB
Peak SAR (extrapolated) = 16.6 W/kg
SAR(1 g) = 9.37 W/kg ; SAR(10 g) = 4.97 W/kg
Maximum value of SAR (measured) = 14.1 W/kg

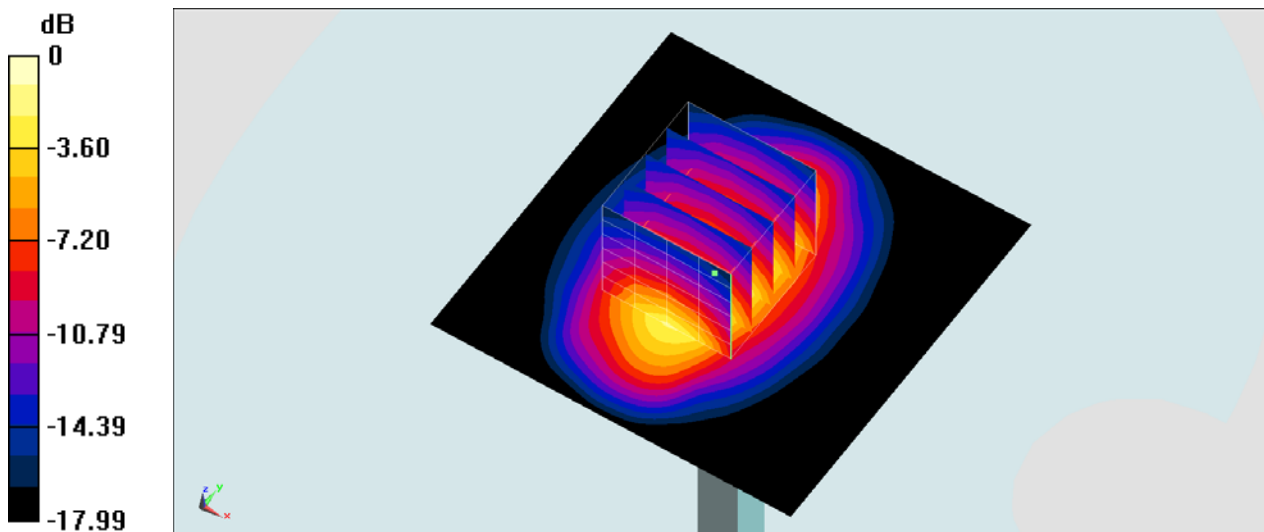

0 dB = $14.1 \text{ W/kg} = 11.49 \text{ dBW/kg}$

System Check_Body_1750MHz

DUT: **D1750V2-1068**

Communication System: CW; Frequency: 1750 MHz; Duty Cycle: 1:1

Medium: MSL_1750_170608 Medium parameters used: $f = 1750$ MHz; $\sigma = 1.46$ S/m; $\epsilon_r = 55.067$; $\rho = 1000$ kg/m³

Ambient Temperature : 23.6 °C; Liquid Temperature : 22.6 °C

DASY5 Configuration:

- Probe: ES3DV3 - SN3270; ConvF(4.95, 4.95, 4.95); Calibrated: 2016/8/26;
- Sensor-Surface: 3mm (Mechanical Surface Detection)
- Electronics: DAE4 Sn916; Calibrated: 2016/12/15
- Phantom: SAM-Left; Type: QD 000 P40 C; Serial: TP-1446
- Measurement SW: DASY52, Version 52.8 (8); SEMCAD X Version 14.6.10 (7331)

Pin=250mW/Area Scan (61x61x1): Interpolated grid: dx=1.500 mm, dy=1.500 mm

Maximum value of SAR (interpolated) = 12.3 W/kg

Pin=250mW/Zoom Scan (5x5x7)/Cube 0: Measurement grid: dx=8mm, dy=8mm, dz=5mm

Reference Value = 99.78 V/m; Power Drift = -0.10 dB

Peak SAR (extrapolated) = 15.6 W/kg

SAR(1 g) = 8.61 W/kg; SAR(10 g) = 4.61 W/kg

Maximum value of SAR (measured) = 12.2 W/kg

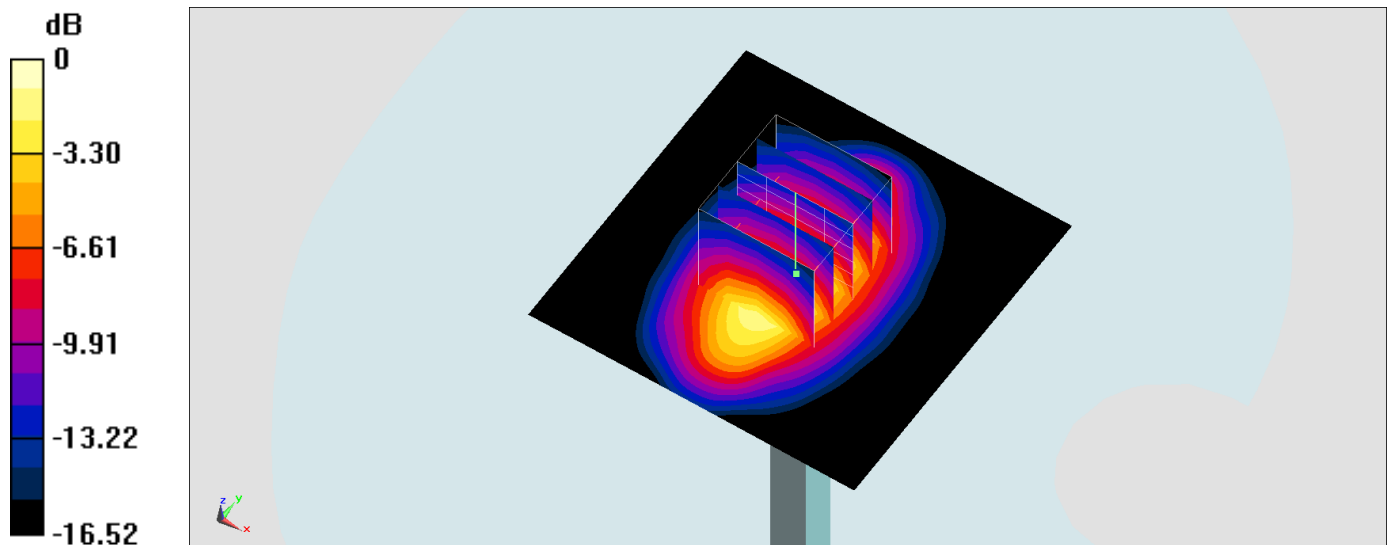

0 dB = 12.2 W/kg = 10.86 dBW/kg

System Check_Body_1750MHz

DUT: D1750V2-1068

Communication System: CW; Frequency: 1750 MHz; Duty Cycle: 1:1

Medium: MSL_1750_170818 Medium parameters used: $f = 1750$ MHz; $\sigma = 1.473$ S/m; $\epsilon_r = 55.484$; $\rho = 1000$ kg/m³

Ambient Temperature : 23.9 °C; Liquid Temperature : 22.9 °C

DASY5 Configuration:

- Probe: ES3DV3 - SN3169; ConvF(4.95, 4.95, 4.95); Calibrated: 2017/5/11;
- Sensor-Surface: 3mm (Mechanical Surface Detection)
- Electronics: DAE4 Sn1399; Calibrated: 2016/11/17
- Phantom: SAM-Left; Type: QD 000 P40 C; Serial: TP-1446
- Measurement SW: DASY52, Version 52.8 (8); SEMCAD X Version 14.6.10 (7331)

Pin=250mW/Area Scan (61x61x1): Interpolated grid: dx=1.500 mm, dy=1.500 mm

Maximum value of SAR (interpolated) = 12.4 W/kg

Pin=250mW/Zoom Scan (5x5x7)/Cube 0: Measurement grid: dx=8mm, dy=8mm, dz=5mm

Reference Value = 90.31 V/m; Power Drift = 0.08 dB

Peak SAR (extrapolated) = 16.0 W/kg

SAR(1 g) = 9.44 W/kg; SAR(10 g) = 5.17 W/kg

Maximum value of SAR (measured) = 11.5 W/kg

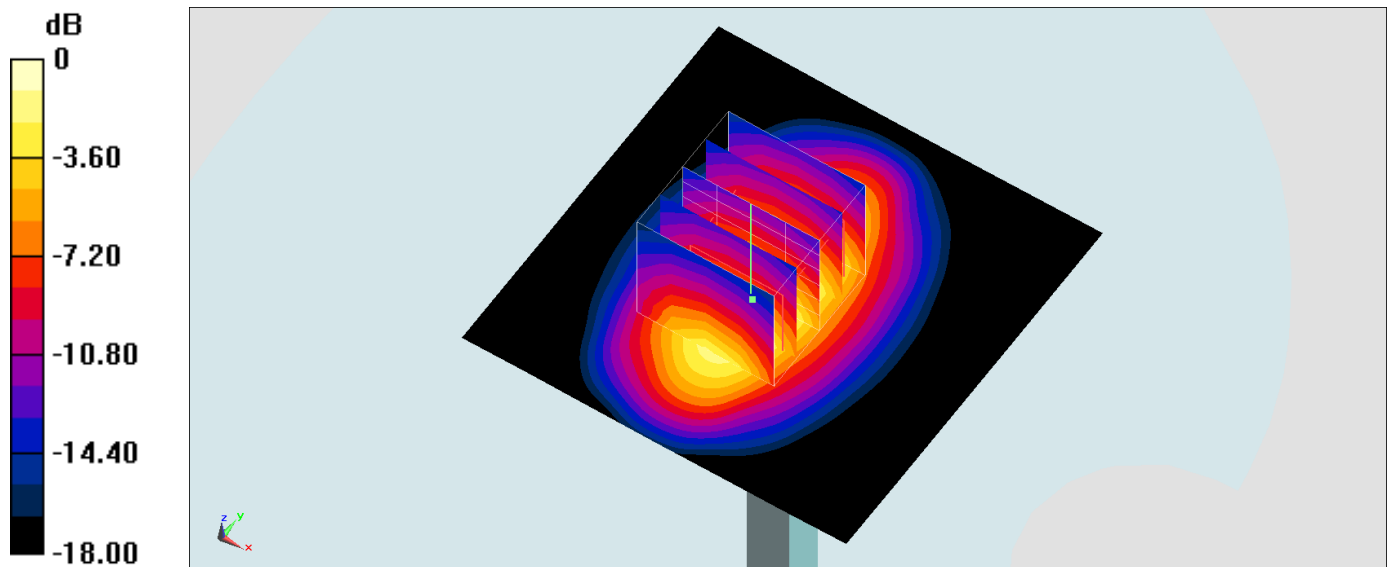

0 dB = 11.5 W/kg = 10.61 dBW/kg

System Check_Head_1900MHz

DUT: D1900V2-5d041

Communication System: CW; Frequency: 1900 MHz; Duty Cycle: 1:1

Medium: HSL_1900_170607 Medium parameters used: $f = 1900$ MHz; $\sigma = 1.424$ S/m; $\epsilon_r = 40.526$; $\rho = 1000$ kg/m³

Ambient Temperature : 23.2 °C; Liquid Temperature : 22.2 °C

DASY5 Configuration:

- Probe: ES3DV3 - SN3270; ConvF(5.08, 5.08, 5.08); Calibrated: 2016/8/26;
- Sensor-Surface: 3mm (Mechanical Surface Detection)
- Electronics: DAE4 Sn916; Calibrated: 2016/12/15
- Phantom: SAM_Right; Type: QD000P40CD; Serial: 1884
- Measurement SW: DASY52, Version 52.8 (8); SEMCAD X Version 14.6.10 (7331)

Pin=250mW/Area Scan (61x61x1): Interpolated grid: dx=1.500 mm, dy=1.500 mm

Maximum value of SAR (interpolated) = 13.7 W/kg

Pin=250mW/Zoom Scan (5x5x7)/Cube 0: Measurement grid: dx=8mm, dy=8mm, dz=5mm

Reference Value = 100.4 V/m; Power Drift = 0.04 dB

Peak SAR (extrapolated) = 18.6 W/kg

SAR(1 g) = 10.4 W/kg; SAR(10 g) = 5.47 W/kg

Maximum value of SAR (measured) = 13.0 W/kg

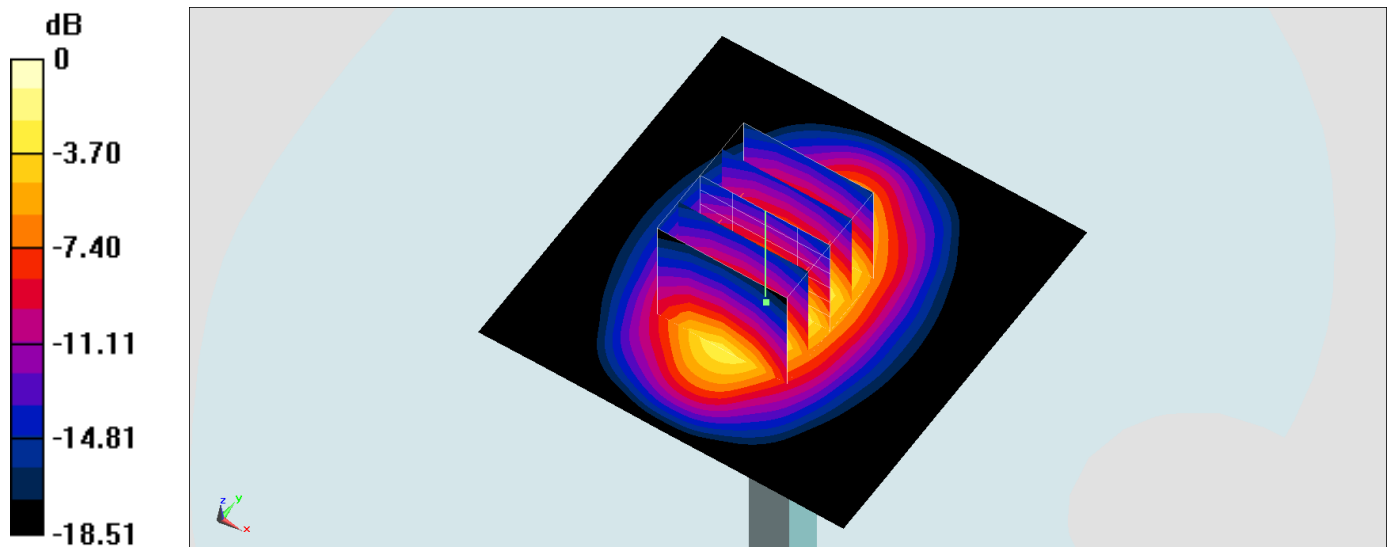

0 dB = 13.0 W/kg = 11.14 dBW/kg

System Check_Head_1900MHz

DUT: D1900V2-5d041

Communication System: CW; Frequency: 1900 MHz; Duty Cycle: 1:1

Medium: HSL_1900_170612 Medium parameters used: $f = 1900 \text{ MHz}$; $\sigma = 1.45 \text{ S/m}$; $\epsilon_r = 41.676$; $\rho = 1000 \text{ kg/m}^3$

Ambient Temperature : 23.2 °C; Liquid Temperature : 22.2 °C

DASY5 Configuration:

- Probe: ES3DV3 - SN3169; ConvF(5.03, 5.03, 5.03); Calibrated: 2017/5/11;
- Sensor-Surface: 3mm (Mechanical Surface Detection)
- Electronics: DAE4 Sn1399; Calibrated: 2016/11/17
- Phantom: SAM_Left; Type: QD000P40CD; Serial: TP:1431
- Measurement SW: DASY52, Version 52.8 (8); SEMCAD X Version 14.6.10 (7373)

Pin=250mW/Area Scan (61x61x1): Interpolated grid: $dx=1.500 \text{ mm}$, $dy=1.500 \text{ mm}$

Maximum value of SAR (interpolated) = 13.1 W/kg

Pin=250mW/Zoom Scan (5x5x7)/Cube 0: Measurement grid: $dx=8\text{mm}$, $dy=8\text{mm}$, $dz=5\text{mm}$

Reference Value = 96.48 V/m; Power Drift = -0.02 dB

Peak SAR (extrapolated) = 17.9 W/kg

SAR(1 g) = 10 W/kg; SAR(10 g) = 5.33 W/kg

Maximum value of SAR (measured) = 12.3 W/kg

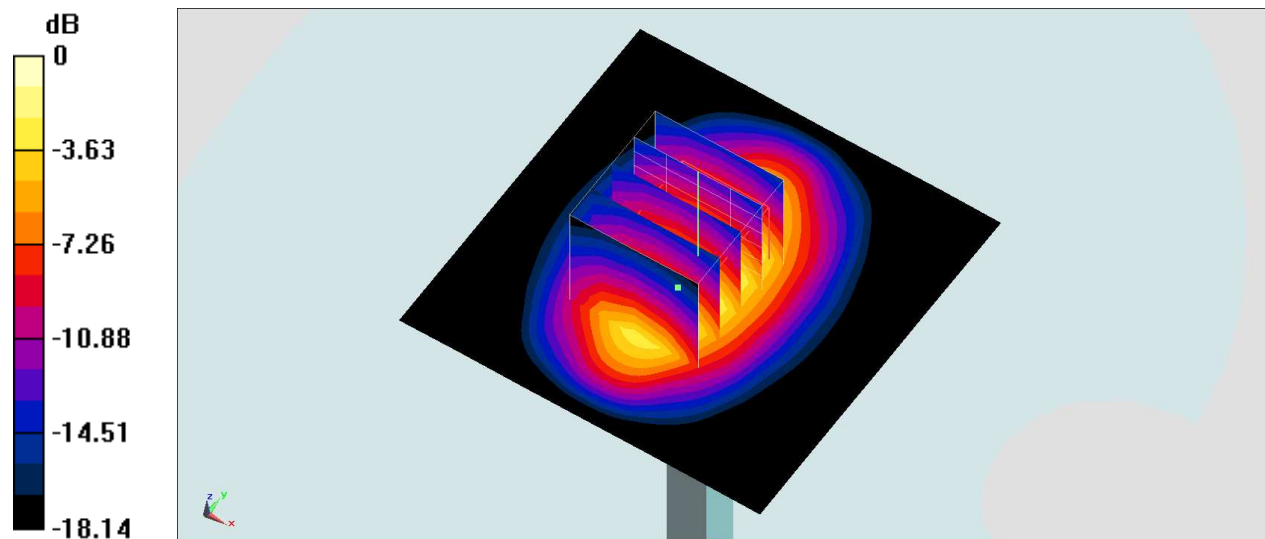

0 dB = 12.3 W/kg = 10.90 dBW/kg

System Check_Head_1900MHz

DUT: D1900V2-5d041

Communication System: CW; Frequency: 1900 MHz; Duty Cycle: 1:1

Medium: HSL_1900_170823 Medium parameters used: $f = 1900$ MHz; $\sigma = 1.405$ S/m; $\epsilon_r = 40.394$; $\rho = 1000$ kg/m³

Ambient Temperature : 23.6 °C; Liquid Temperature : 22.6 °C

DASY5 Configuration:

- Probe: ES3DV3 - SN3169; ConvF(5.03, 5.03, 5.03); Calibrated: 2017/5/11;
- Sensor-Surface: 3mm (Mechanical Surface Detection)
- Electronics: DAE4 Sn1399; Calibrated: 2016/11/17
- Phantom: SAM_Right; Type: QD000P40CD; Serial: 1884
- Measurement SW: DASY52, Version 52.8 (8); SEMCAD X Version 14.6.10 (7331)

Pin=250mW/Area Scan (61x61x1): Interpolated grid: dx=1.500 mm, dy=1.500 mm
Maximum value of SAR (interpolated) = 12.7 W/kg

Pin=250mW/Zoom Scan (5x5x7)/Cube 0: Measurement grid: dx=8mm, dy=8mm, dz=5mm

Reference Value = 96.48 V/m; Power Drift = -0.02 dB

Peak SAR (extrapolated) = 17.3 W/kg

SAR(1 g) = 9.72 W/kg; SAR(10 g) = 5.17 W/kg

Maximum value of SAR (measured) = 11.9 W/kg

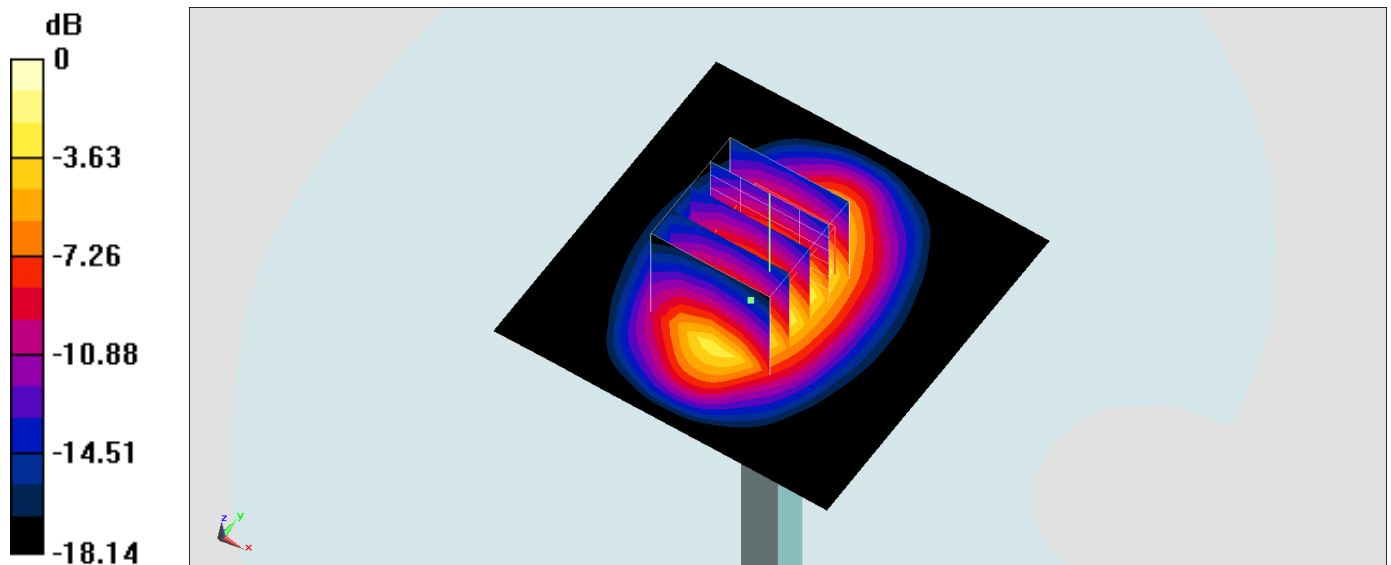

0 dB = 11.9 W/kg = 10.76 dBW/kg

System Check_Body_1900MHz

DUT: D1900V2-5d041

Communication System: CW; Frequency: 1900 MHz; Duty Cycle: 1:1

Medium: MSL_1900_170608 Medium parameters used: $f = 1900$ MHz; $\sigma = 1.521$ S/m; $\epsilon_r = 55.414$; $\rho = 1000$ kg/m³

Ambient Temperature : 23.6 °C ; Liquid Temperature : 22.6 °C

DASY5 Configuration:

- Probe: ES3DV3 - SN3270; ConvF(4.7, 4.7, 4.7); Calibrated: 2016/8/26;
- Sensor-Surface: 3mm (Mechanical Surface Detection)
- Electronics: DAE4 Sn916; Calibrated: 2016/12/15
- Phantom: SAM-Left; Type: QD 000 P40 C; Serial: TP-1446
- Measurement SW: DASY52, Version 52.8 (8); SEMCAD X Version 14.6.10 (7331)

Pin=250mW/Area Scan (61x61x1): Interpolated grid: dx=1.500 mm, dy=1.500 mm

Maximum value of SAR (interpolated) = 13.2 W/kg

Pin=250mW/Zoom Scan (5x5x7)/Cube 0: Measurement grid: dx=8mm, dy=8mm, dz=5mm

Reference Value = 91.95 V/m; Power Drift = -0.00 dB

Peak SAR (extrapolated) = 17.2 W/kg

SAR(1 g) = 10.1 W/kg; SAR(10 g) = 5.37 W/kg

Maximum value of SAR (measured) = 12.2 W/kg

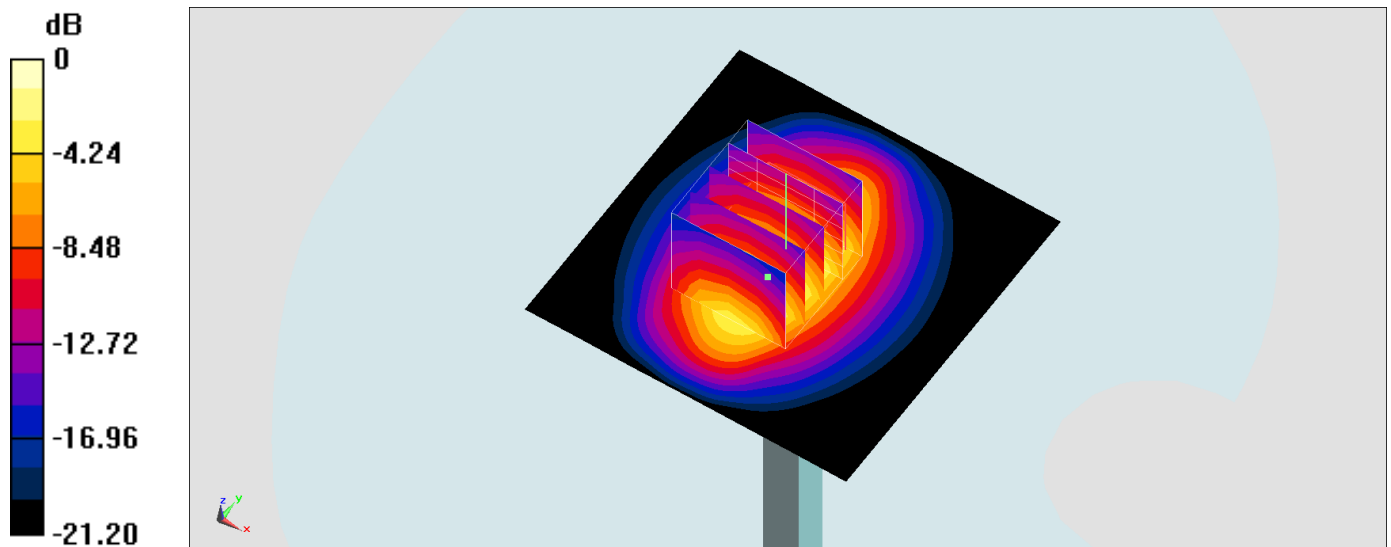

0 dB = 12.2 W/kg = 10.86 dBW/kg

System Check_Body_1900MHz

DUT: D1900V2-5d041

Communication System: CW; Frequency: 1900 MHz; Duty Cycle: 1:1

Medium: MSL_1900_170817 Medium parameters used: $f = 1900$ MHz; $\sigma = 1.573$ S/m; $\epsilon_r = 54.426$; $\rho = 1000$ kg/m³

Ambient Temperature : 23.9 °C; Liquid Temperature : 22.9 °C

DASY5 Configuration:

- Probe: ES3DV3 - SN3169; ConvF(4.72, 4.72, 4.72); Calibrated: 2017/5/11;
- Sensor-Surface: 3mm (Mechanical Surface Detection)
- Electronics: DAE4 Sn1399; Calibrated: 2016/11/17
- Phantom: SAM-Left; Type: QD 000 P40 C; Serial: TP-1446
- Measurement SW: DASY52, Version 52.8 (8); SEMCAD X Version 14.6.10 (7331)

Pin=250mW/Area Scan (61x61x1): Interpolated grid: dx=1.500 mm, dy=1.500 mm

Maximum value of SAR (interpolated) = 13.5 W/kg

Pin=250mW/Zoom Scan (5x5x7)/Cube 0: Measurement grid: dx=8mm, dy=8mm, dz=5mm

Reference Value = 87.77 V/m; Power Drift = 0.02 dB

Peak SAR (extrapolated) = 17.7 W/kg

SAR(1 g) = 10 W/kg; SAR(10 g) = 5.27 W/kg

Maximum value of SAR (measured) = 12.3 W/kg

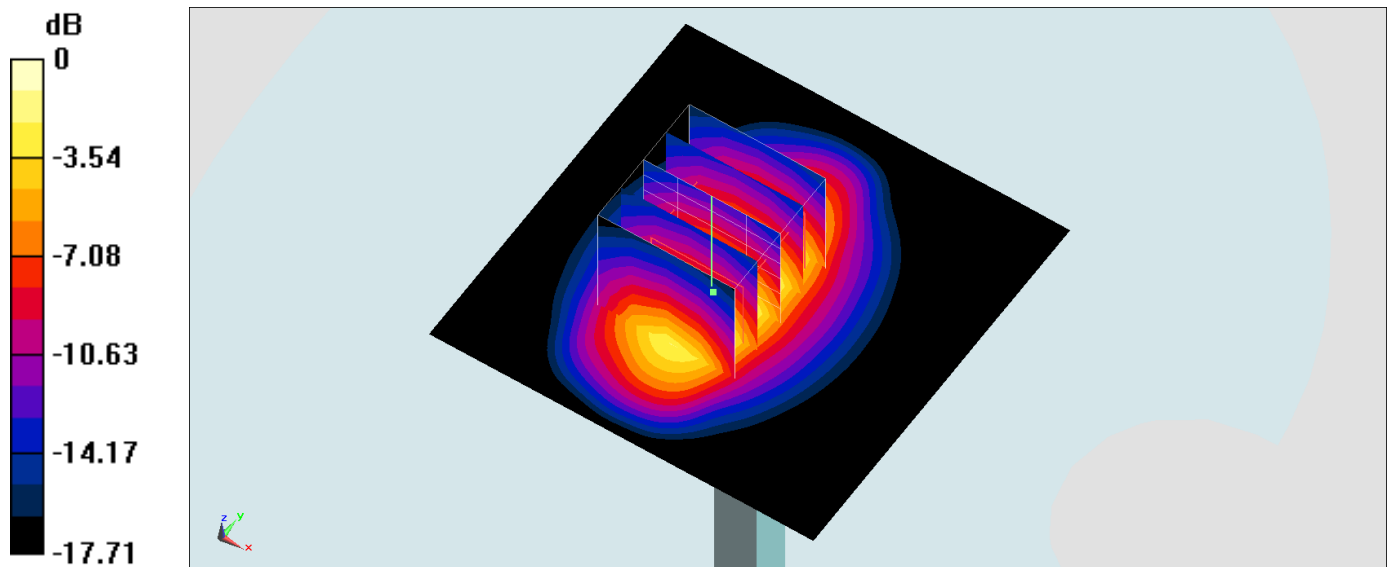

0 dB = 12.3 W/kg = 10.90 dBW/kg

System Check_Head_2450MHz

DUT: D2450V2-926

Communication System: CW ; Frequency: 2450 MHz;Duty Cycle: 1:1
Medium: HSL_2450_170615 Medium parameters used: $f = 2450$ MHz; $\sigma = 1.809$ S/m; $\epsilon_r = 40.475$;
 $\rho = 1000$ kg/m³
Ambient Temperature : 23.2 °C ; Liquid Temperature : 22.2 °C

DASY5 Configuration:

- Probe: EX3DV4 - SN3925; ConvF(7.85, 7.85, 7.85); Calibrated: 2017/5/24;
- Sensor-Surface: 1.4mm (Mechanical Surface Detection)
- Electronics: DAE3 Sn495; Calibrated: 2017/5/22
- Phantom: SAM_Left; Type: QD000P40CD; Serial: TP:1431
- Measurement SW: DASY52, Version 52.8 (8);SEMCAD X Version 14.6.10 (7373)

Pin=250mW/Area Scan (61x61x1): Interpolated grid: dx=1.200 mm, dy=1.200 mm
Maximum value of SAR (interpolated) = 19.4 W/kg

Pin=250mW/Zoom Scan (7x7x7)/Cube 0: Measurement grid: dx=5mm, dy=5mm, dz=5mm
Reference Value = 104.9 V/m; Power Drift = 0.01 dB
Peak SAR (extrapolated) = 26.0 W/kg
SAR(1 g) = 12.6 W/kg; SAR(10 g) = 5.84 W/kg
Maximum value of SAR (measured) = 19.4 W/kg

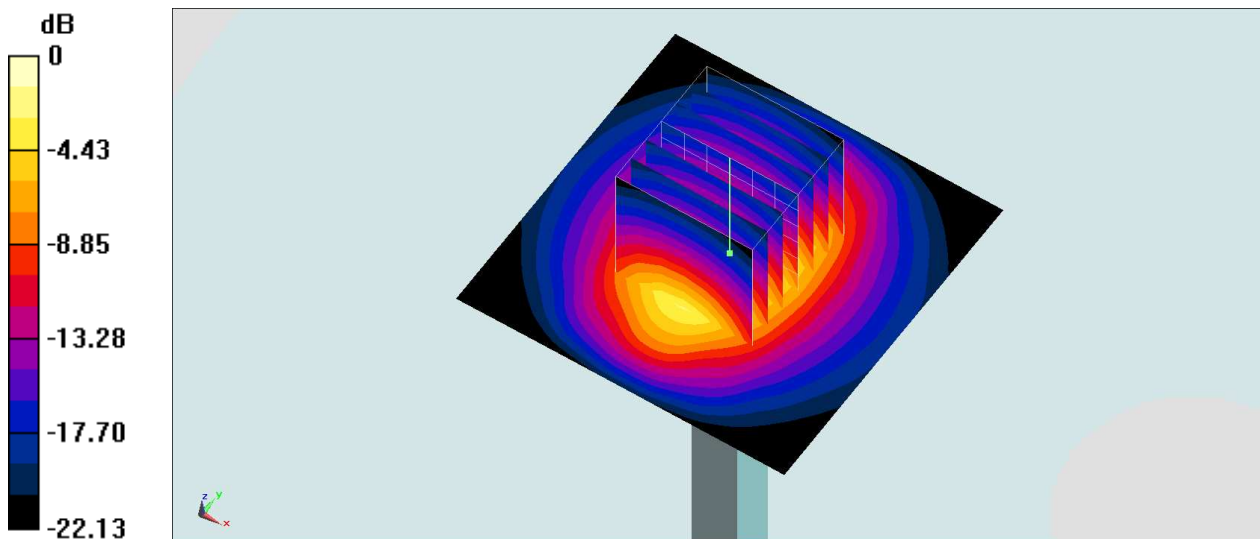

0 dB = 19.4 W/kg = 12.88 dBW/kg

System Check_Head_2450MHz

DUT: D2450V2-926

Communication System: CW ; Frequency: 2450 MHz;Duty Cycle: 1:1
Medium: HSL_2450_170616 Medium parameters used: $f = 2450$ MHz; $\sigma = 1.845$ S/m; $\epsilon_r = 40.648$;
 $\rho = 1000$ kg/m³
Ambient Temperature : 23.4 °C ; Liquid Temperature : 22.4 °C

DASY5 Configuration:

- Probe: EX3DV4 - SN3925; ConvF(7.85, 7.85, 7.85); Calibrated: 2017/5/24;
- Sensor-Surface: 1.4mm (Mechanical Surface Detection)
- Electronics: DAE3 Sn495; Calibrated: 2017/5/22
- Phantom: SAM-Right; Type: SAM; Serial: TP-1503
- Measurement SW: DASY52, Version 52.8 (8);SEMCAD X Version 14.6.10 (7373)

Pin=250mW/Area Scan (61x61x1): Interpolated grid: dx=1.200 mm, dy=1.200 mm
Maximum value of SAR (interpolated) = 22.4 W/kg

Pin=250mW/Zoom Scan (7x7x7)/Cube 0: Measurement grid: dx=5mm, dy=5mm, dz=5mm
Reference Value = 105.6 V/m; Power Drift = 0.01 dB
Peak SAR (extrapolated) = 29.1 W/kg
SAR(1 g) = 13.4 W/kg; SAR(10 g) = 6.19 W/kg
Maximum value of SAR (measured) = 20.6 W/kg

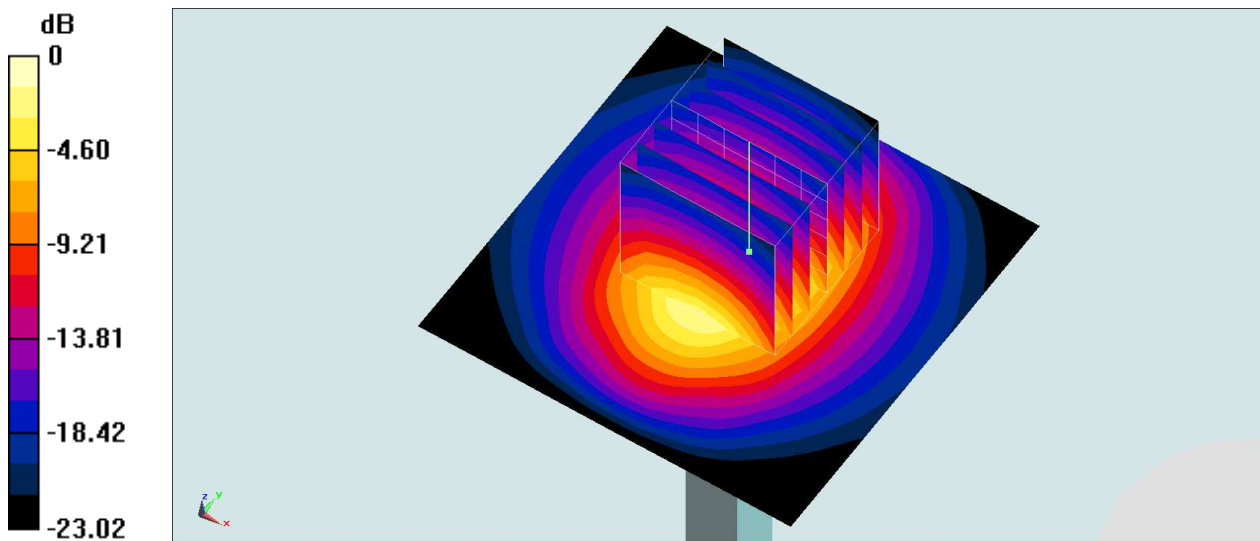

0 dB = 20.6 W/kg = 13.14 dBW/kg

System Check_Body_2450MHz

DUT: D2450V2-926

Communication System: CW; Frequency: 2450 MHz; Duty Cycle: 1:1
Medium: MSL_2450_170615 Medium parameters used: $f = 2450$ MHz; $\sigma = 1.991$ S/m; $\epsilon_r = 54.566$;
 $\rho = 1000$ kg/m³
Ambient Temperature : 23.2 °C; Liquid Temperature : 22.2 °C

DASY5 Configuration:

- Probe: EX3DV4 - SN3925; ConvF(7.94, 7.94, 7.94); Calibrated: 2017/5/24;
- Sensor-Surface: 1.4mm (Mechanical Surface Detection)
- Electronics: DAE3 Sn495; Calibrated: 2017/5/22
- Phantom: SAM_Left; Type: QD000P40CD; Serial: TP:1431
- Measurement SW: DASY52, Version 52.8 (8); SEMCAD X Version 14.6.10 (7373)

Pin=250mW/Area Scan (61x61x1): Interpolated grid: dx=1.200 mm, dy=1.200 mm
Maximum value of SAR (interpolated) = 20.0 W/kg

Pin=250mW/Zoom Scan (7x7x7)/Cube 0: Measurement grid: dx=5mm, dy=5mm, dz=5mm
Reference Value = 102.7 V/m; Power Drift = 0.10 dB
Peak SAR (extrapolated) = 24.7 W/kg
SAR(1 g) = 12.6 W/kg; SAR(10 g) = 6 W/kg
Maximum value of SAR (measured) = 20.4 W/kg

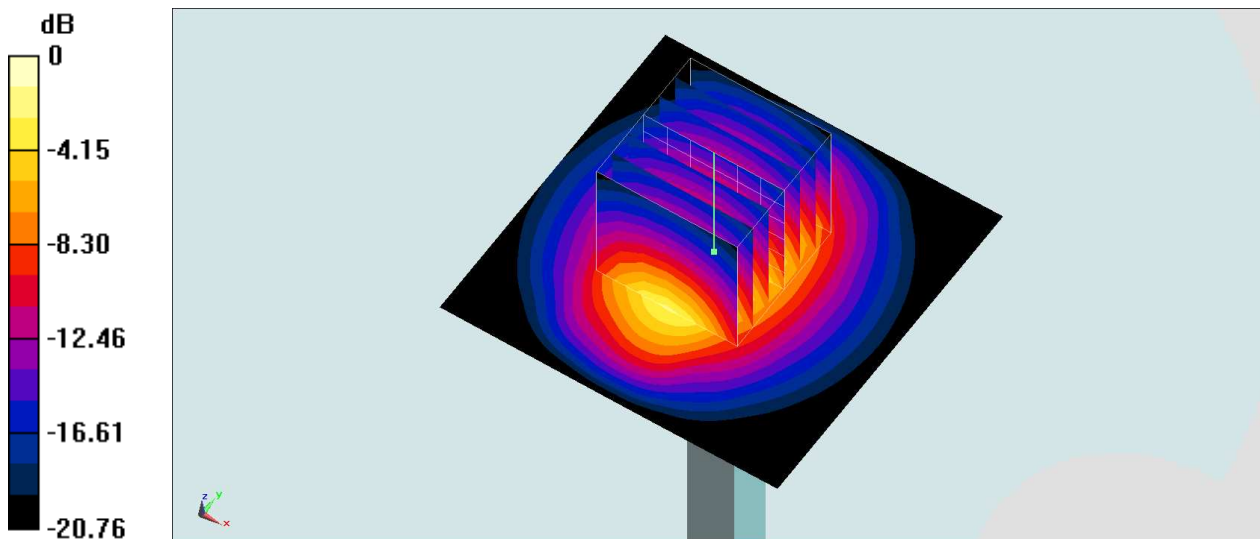

0 dB = 20.4 W/kg = 13.10 dBW/kg

System Check_Head_2600MHz

DUT: D2600V2-1008

Communication System: CW; Frequency: 2600 MHz; Duty Cycle: 1:1

Medium: HSL_2600_170607 Medium parameters used: $f = 2600$ MHz; $\sigma = 2.012$ S/m; $\epsilon_r = 37.953$; $\rho = 1000$ kg/m³

Ambient Temperature : 23.2 °C ; Liquid Temperature : 22.2 °C

DASY5 Configuration:

- Probe: ES3DV3 - SN3270; ConvF(4.37, 4.37, 4.37); Calibrated: 2016/8/26;
- Sensor-Surface: 3mm (Mechanical Surface Detection)
- Electronics: DAE4 Sn778; Calibrated: 2017/5/22
- Phantom: SAM_Right; Type: QD000P40CD; Serial: 1884
- Measurement SW: DASY52, Version 52.8 (8); SEMCAD X Version 14.6.10 (7331)

Pin=250mW/Area Scan (81x81x1): Interpolated grid: dx=1.200 mm, dy=1.200 mm

Maximum value of SAR (interpolated) = 22.7 W/kg

Pin=250mW/Zoom Scan (7x7x7)/Cube 0: Measurement grid: dx=5mm, dy=5mm, dz=5mm

Reference Value = 113.9 V/m; Power Drift = 0.15 dB

Peak SAR (extrapolated) = 31.5 W/kg

SAR(1 g) = 14.5 W/kg; SAR(10 g) = 6.48 W/kg

Maximum value of SAR (measured) = 22.8 W/kg

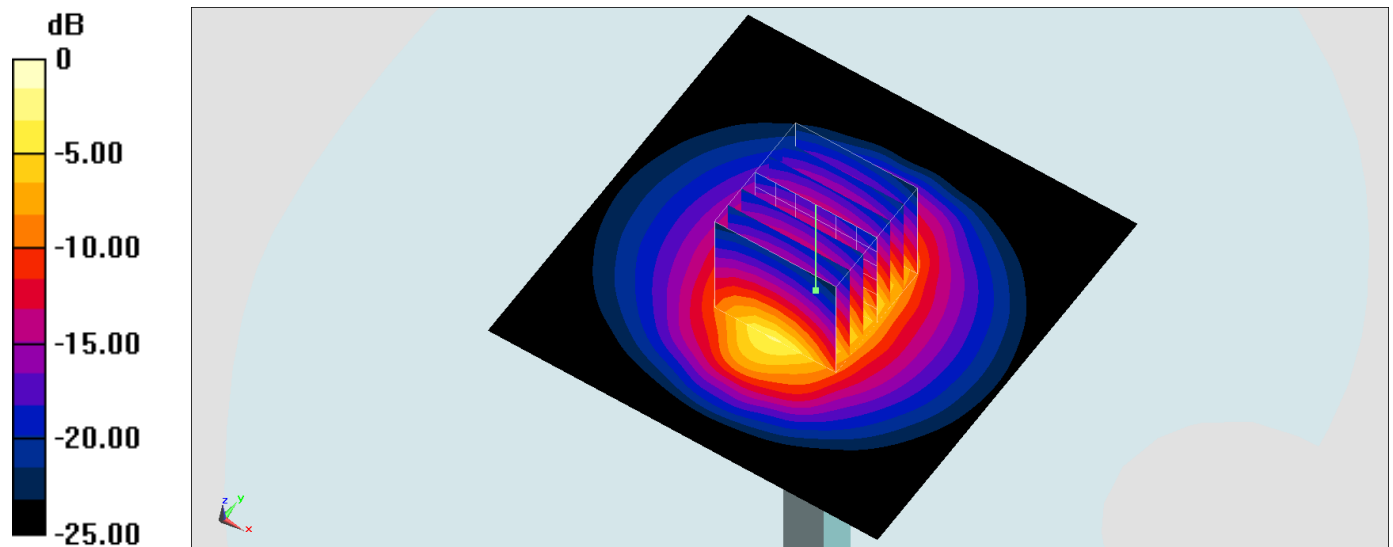

0 dB = 22.8 W/kg = 13.58 dBW/kg

System Check_Head_2600MHz

DUT: D2600V2-1113

Communication System: CW; Frequency: 2600 MHz; Duty Cycle: 1:1

Medium: HSL_2600_170822 Medium parameters used: $f = 2600$ MHz; $\sigma = 1.939$ S/m; $\epsilon_r = 38.027$; $\rho = 1000$ kg/m³

Ambient Temperature : 23.5 °C; Liquid Temperature : 22.5 °C

DASY5 Configuration:

- Probe: ES3DV3 - SN3169; ConvF(4.47, 4.47, 4.47); Calibrated: 2017/5/11;
- Sensor-Surface: 3mm (Mechanical Surface Detection)
- Electronics: DAE4 Sn1399; Calibrated: 2016/11/17
- Phantom: SAM_Right; Type: QD000P40CD; Serial: 1884
- Measurement SW: DASY52, Version 52.8 (8); SEMCAD X Version 14.6.10 (7331)

Pin=250mW/Area Scan (81x81x1): Interpolated grid: dx=1.200 mm, dy=1.200 mm

Maximum value of SAR (interpolated) = 19.7 W/kg

Pin=250mW/Zoom Scan (7x7x7)/Cube 0: Measurement grid: dx=5mm, dy=5mm, dz=5mm

Reference Value = 100.6 V/m; Power Drift = -0.05 dB

Peak SAR (extrapolated) = 31.4 W/kg

SAR(1 g) = 14.3 W/kg; SAR(10 g) = 6.43 W/kg

Maximum value of SAR (measured) = 19.2 W/kg

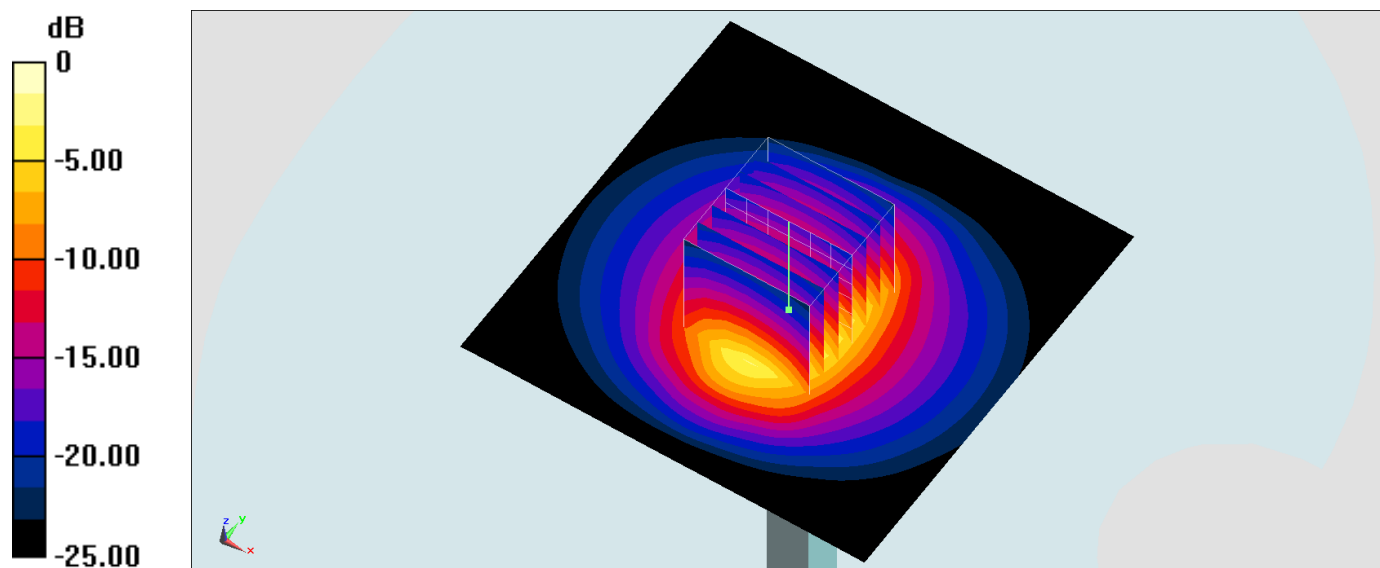

0 dB = 19.2 W/kg = 12.83 dBW/kg

System Check_Body_2600MHz

DUT: D2600V2-1008

Communication System: CW; Frequency: 2600 MHz; Duty Cycle: 1:1

Medium: MSL_2600_170609 Medium parameters used: $f = 2600$ MHz; $\sigma = 2.162$ S/m; $\epsilon_r = 52.714$; $\rho = 1000$ kg/m³

Ambient Temperature : 23.5 °C ; Liquid Temperature : 22.5 °C

DASY5 Configuration:

- Probe: ES3DV3 - SN3270; ConvF(4.12, 4.12, 4.12); Calibrated: 2016/8/26;
- Sensor-Surface: 3mm (Mechanical Surface Detection)
- Electronics: DAE4 Sn778; Calibrated: 2017/5/22
- Phantom: SAM_Right; Type: QD000P40CD; Serial: 1884
- Measurement SW: DASY52, Version 52.8 (8); SEMCAD X Version 14.6.10 (7331)

Pin=250mW/Area Scan (71x71x1): Interpolated grid: dx=1.200 mm, dy=1.200 mm

Maximum value of SAR (interpolated) = 19.9 W/kg

Pin=250mW/Zoom Scan (7x7x7)/Cube 0: Measurement grid: dx=5mm, dy=5mm, dz=5mm

Reference Value = 97.52 V/m; Power Drift = -0.05 dB

Peak SAR (extrapolated) = 30.2 W/kg

SAR(1 g) = 14.3 W/kg; SAR(10 g) = 6.39 W/kg

Maximum value of SAR (measured) = 19.1 W/kg

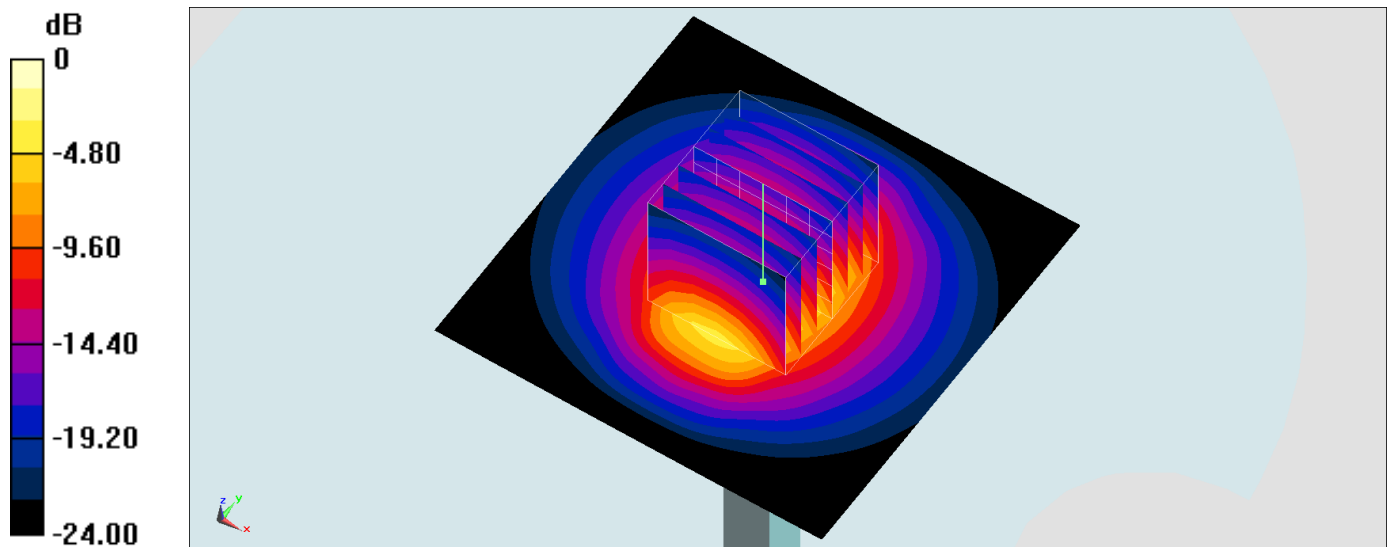

0 dB = 19.1 W/kg = 12.81 dBW/kg

System Check_Body_2600MHz

DUT: D2600V2-1113

Communication System: CW; Frequency: 2600 MHz; Duty Cycle: 1:1

Medium: MSL_2600_170818 Medium parameters used: $f = 2600$ MHz; $\sigma = 2.183$ S/m; $\epsilon_r = 54.42$; $\rho = 1000$ kg/m³

Ambient Temperature : 23.9 °C; Liquid Temperature : 22.9 °C

DASY5 Configuration:

- Probe: ES3DV3 - SN3169; ConvF(4.17, 4.17, 4.17); Calibrated: 2017/5/11;
- Sensor-Surface: 3mm (Mechanical Surface Detection)
- Electronics: DAE4 Sn1399; Calibrated: 2016/11/17
- Phantom: SAM_Right; Type: QD000P40CD; Serial: 1884
- Measurement SW: DASY52, Version 52.8 (8); SEMCAD X Version 14.6.10 (7331)

Pin=250mW/Area Scan (61x61x1): Interpolated grid: dx=1.200 mm, dy=1.200 mm
Maximum value of SAR (interpolated) = 19.6 W/kg

Pin=250mW/Zoom Scan (7x7x7)/Cube 0: Measurement grid: dx=5mm, dy=5mm, dz=5mm
Reference Value = 92.76 V/m; Power Drift = 0.06 dB
Peak SAR (extrapolated) = 28.3 W/kg
SAR(1 g) = 13.8 W/kg; SAR(10 g) = 6.2 W/kg
Maximum value of SAR (measured) = 18.1 W/kg

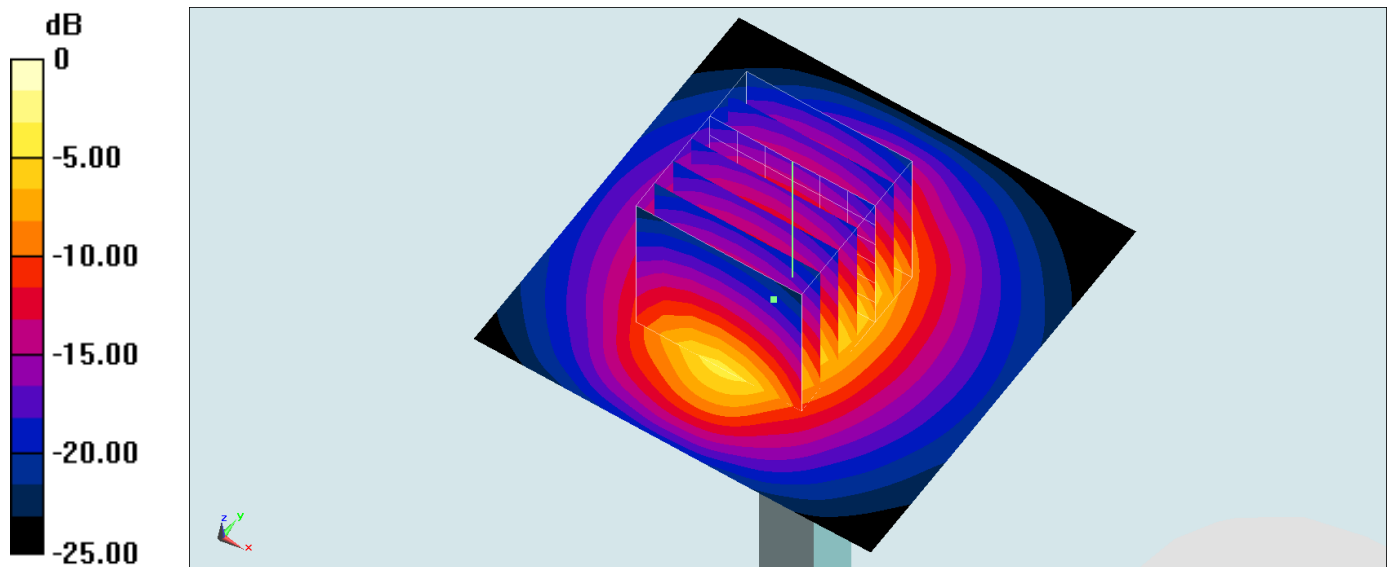

0 dB = 18.1 W/kg = 12.58 dBW/kg

System Check_Head_5250MHz

DUT: D5GHzV2-1006

Communication System: CW ; Frequency: 5250 MHz;Duty Cycle: 1:1
Medium: HSL_5G_170614 Medium parameters used: $f = 5250$ MHz; $\sigma = 4.561$ S/m; $\epsilon_r = 37.502$; $\rho = 1000$ kg/m³
Ambient Temperature : 23.5 °C ; Liquid Temperature : 22.5 °C

DASY5 Configuration:

- Probe: EX3DV4 - SN3925; ConvF(5.36, 5.36, 5.36); Calibrated: 2017/5/24;
- Sensor-Surface: 1.4mm (Mechanical Surface Detection)
- Electronics: DAE3 Sn495; Calibrated: 2017/5/22
- Phantom: SAM_Left; Type: QD000P40CD; Serial: TP:1431
- Measurement SW: DASY52, Version 52.8 (8);SEMCAD X Version 14.6.10 (7373)

Pin=100mW/Area Scan (71x71x1): Interpolated grid: dx=1.000 mm, dy=1.000 mm
Maximum value of SAR (interpolated) = 17.4 W/kg

Pin=100mW/Zoom Scan (7x7x7)/Cube 0: Measurement grid: dx=4mm, dy=4mm, dz=1.4mm
Reference Value = 70.18 V/m; Power Drift = -0.01 dB
Peak SAR (extrapolated) = 32.0 W/kg
SAR(1 g) = 7.56 W/kg; SAR(10 g) = 2.11 W/kg
Maximum value of SAR (measured) = 18.5 W/kg

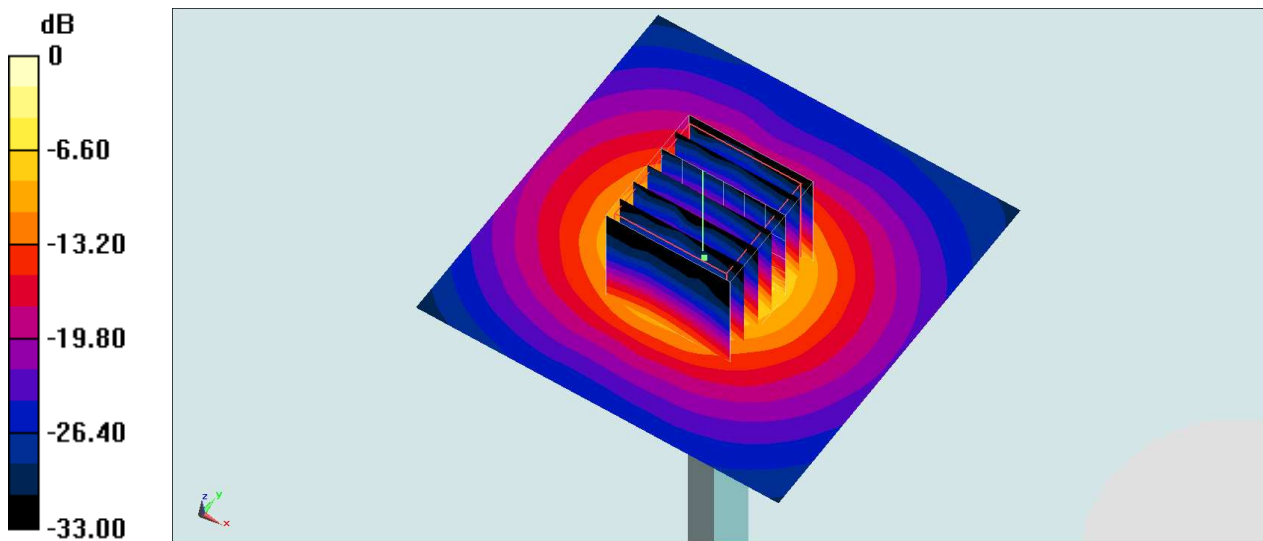

0 dB = 18.5 W/kg = 12.67 dBW/kg

System Check_Body_5250MHz

DUT: D5GHzV2-1006

Communication System: CW ; Frequency: 5250 MHz;Duty Cycle: 1:1

Medium: MSL_5G_170615 Medium parameters used: $f = 5250$ MHz; $\sigma = 5.48$ S/m; $\epsilon_r = 47.824$; $\rho = 1000$ kg/m³

Ambient Temperature : 23.4 °C ; Liquid Temperature : 22.4 °C

DASY5 Configuration:

- Probe: EX3DV4 - SN3925; ConvF(4.59, 4.59, 4.59); Calibrated: 2017/5/24;
- Sensor-Surface: 1.4mm (Mechanical Surface Detection)
- Electronics: DAE3 Sn495; Calibrated: 2017/5/22
- Phantom: SAM-Right; Type: SAM; Serial: TP-1303
- Measurement SW: DASY52, Version 52.8 (8);SEMCAD X Version 14.6.10 (7373)

Pin=100mW/Area Scan (71x71x1): Interpolated grid: dx=1.000 mm, dy=1.000 mm

Maximum value of SAR (interpolated) = 19.9 W/kg

Pin=100mW/Zoom Scan (7x7x7)/Cube 0: Measurement grid: dx=4mm, dy=4mm, dz=1.4mm

Reference Value = 68.83 V/m; Power Drift = -0.11 dB

Peak SAR (extrapolated) = 35.1 W/kg

SAR(1 g) = 7.8 W/kg; SAR(10 g) = 2.09 W/kg

Maximum value of SAR (measured) = 20.0 W/kg

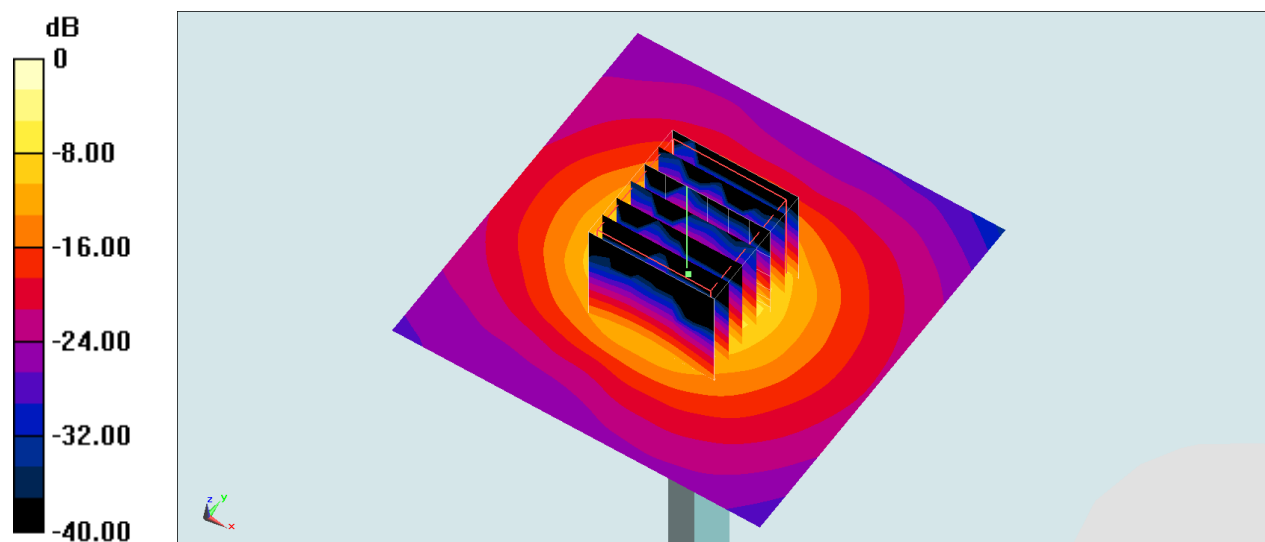

0 dB = 20.0 W/kg = 13.01 dBW/kg

System Check_Head_5600MHz

DUT: D5GHzV2-1006

Communication System: CW ; Frequency: 5600 MHz;Duty Cycle: 1:1

Medium: HSL_5G_170614 Medium parameters used: $f = 5600$ MHz; $\sigma = 4.89$ S/m; $\epsilon_r = 36.976$; $\rho = 1000$ kg/m³

Ambient Temperature : 23.5 °C ; Liquid Temperature : 22.5 °C

DASY5 Configuration:

- Probe: EX3DV4 - SN3925; ConvF(4.72, 4.72, 4.72); Calibrated: 2017/5/24;
- Sensor-Surface: 1.4mm (Mechanical Surface Detection)
- Electronics: DAE3 Sn495; Calibrated: 2017/5/22
- Phantom: SAM_Left; Type: QD000P40CD; Serial: TP:1431
- Measurement SW: DASY52, Version 52.8 (8);SEMCAD X Version 14.6.10 (7373)

Pin=100mW/Area Scan (71x71x1): Interpolated grid: dx=1.000 mm, dy=1.000 mm

Maximum value of SAR (interpolated) = 20.9 W/kg

Pin=100mW/Zoom Scan (7x7x7)/Cube 0: Measurement grid: dx=4mm, dy=4mm, dz=1.4mm

Reference Value = 70.82 V/m; Power Drift = 0.14 dB

Peak SAR (extrapolated) = 36.7 W/kg

SAR(1 g) = 8.45 W/kg; SAR(10 g) = 2.31 W/kg

Maximum value of SAR (measured) = 21.7 W/kg

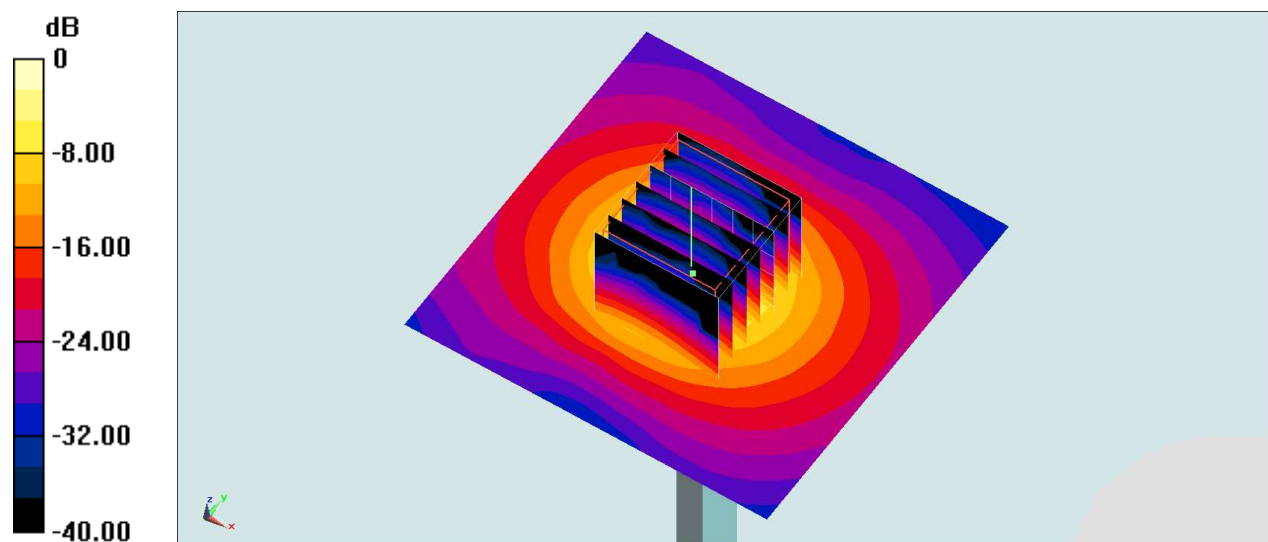

0 dB = 21.7 W/kg = 13.36 dBW/kg

System Check_Body_5600MHz

DUT: D5GHzV2-1006

Communication System: CW ; Frequency: 5600 MHz;Duty Cycle: 1:1

Medium: MSL_5G_170615 Medium parameters used: $f = 5600$ MHz; $\sigma = 5.955$ S/m; $\epsilon_r = 47.205$; $\rho = 1000$ kg/m³

Ambient Temperature : 23.4 °C ; Liquid Temperature : 22.4 °C

DASY5 Configuration:

- Probe: EX3DV4 - SN3925; ConvF(4.17, 4.17, 4.17); Calibrated: 2017/5/24;
- Sensor-Surface: 1.4mm (Mechanical Surface Detection)
- Electronics: DAE3 Sn495; Calibrated: 2017/5/22
- Phantom: SAM-Right; Type: SAM; Serial: TP-1303
- Measurement SW: DASY52, Version 52.8 (8);SEMCAD X Version 14.6.10 (7373)

Pin=100mW/Area Scan (71x71x1): Interpolated grid: dx=1.000 mm, dy=1.000 mm

Maximum value of SAR (interpolated) = 20.9 W/kg

Pin=100mW/Zoom Scan (7x7x7)/Cube 0: Measurement grid: dx=4mm, dy=4mm, dz=1.4mm

Reference Value = 68.22 V/m; Power Drift = 0.13 dB

Peak SAR (extrapolated) = 37.4 W/kg

SAR(1 g) = 8.17 W/kg; SAR(10 g) = 2.21 W/kg

Maximum value of SAR (measured) = 20.8 W/kg

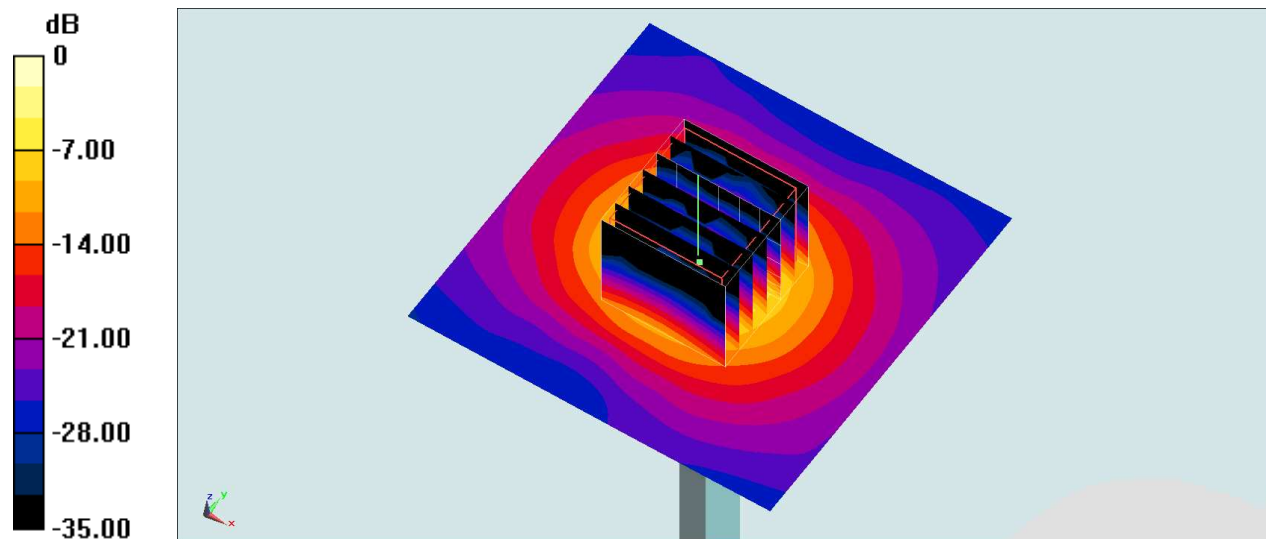

0 dB = 20.8 W/kg = 13.18 dBW/kg