



---

**Appendix B. Plots of SAR Measurement**

The plots are shown as follows.

## #01\_GSM850\_GPRS (4 Tx slots)\_Left Cheek\_Ch128

Communication System: GSM850; Frequency: 824.2 MHz; Duty Cycle: 1:2.08

Medium: HSL\_850\_170112 Medium parameters used:  $f = 824.2$  MHz;  $\sigma = 0.87$  S/m;  $\epsilon_r = 41.327$ ;  $\rho = 1000$  kg/m<sup>3</sup>

Ambient Temperature : 23.3 °C; Liquid Temperature : 22.3 °C

DASY5 Configuration:

- Probe: ES3DV3 - SN3270; ConvF(6.03, 6.03, 6.03); Calibrated: 2016/8/26;
- Sensor-Surface: 3mm (Mechanical Surface Detection)
- Electronics: DAE4 Sn778; Calibrated: 2016/5/12
- Phantom: SAM\_Left; Type: QD000P40CD; Serial: TP:1644
- Measurement SW: DASY52, Version 52.8 (8); SEMCAD X Version 14.6.10 (7331)

**Area Scan (71x131x1):** Interpolated grid: dx=1.500 mm, dy=1.500 mm

Maximum value of SAR (interpolated) = 0.0837 W/kg

**Zoom Scan (5x5x7)/Cube 0:** Measurement grid: dx=8mm, dy=8mm, dz=5mm

Reference Value = 9.766 V/m; Power Drift = 0.09 dB

Peak SAR (extrapolated) = 0.0980 W/kg

**SAR(1 g) = 0.077 W/kg; SAR(10 g) = 0.060 W/kg**

Maximum value of SAR (measured) = 0.0835 W/kg

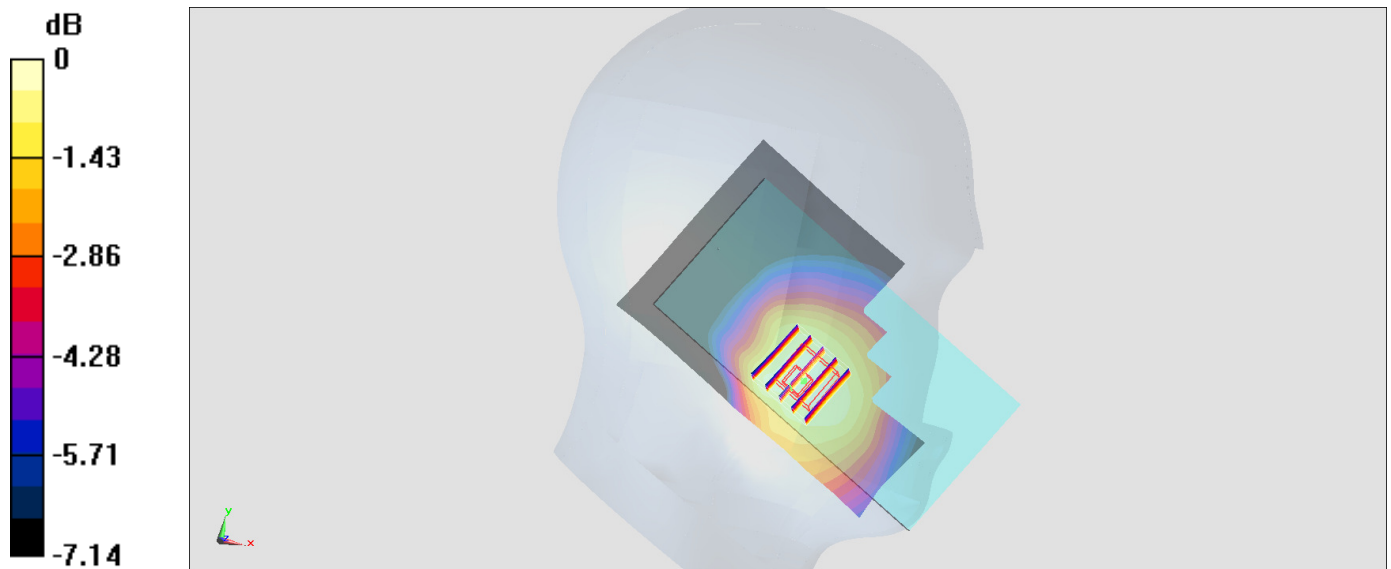

0 dB = 0.0835 W/kg = -10.78 dBW/kg

## #02\_GSM1900\_GPRS (3 Tx slots)\_Right Cheek\_Ch512

Communication System: PCS ; Frequency: 1850.2 MHz; Duty Cycle: 1:2.77

Medium: HSL\_1900\_170111 Medium parameters used:  $f = 1850.2$  MHz;  $\sigma = 1.351$  S/m;  $\epsilon_r = 41.358$ ;

$\rho = 1000$  kg/m<sup>3</sup>

Ambient Temperature : 23.8 °C ; Liquid Temperature : 22.8 °C

DASY5 Configuration:

- Probe: ES3DV3 - SN3270; ConvF(5.08, 5.08, 5.08); Calibrated: 2016/8/26;
- Sensor-Surface: 3mm (Mechanical Surface Detection)
- Electronics: DAE4 Sn778; Calibrated: 2016/5/12
- Phantom: SAM\_Left; Type: QD000P40CD; Serial: TP:1644
- Measurement SW: DASY52, Version 52.8 (8); SEMCAD X Version 14.6.10 (7331)

**Area Scan (71x131x1):** Interpolated grid: dx=1.500 mm, dy=1.500 mm

Maximum value of SAR (interpolated) = 0.0414 W/kg

**Zoom Scan (5x5x7)/Cube 0:** Measurement grid: dx=8mm, dy=8mm, dz=5mm

Reference Value = 4.935 V/m; Power Drift = -0.10 dB

Peak SAR (extrapolated) = 0.0500 W/kg

**SAR(1 g) = 0.034 W/kg; SAR(10 g) = 0.023 W/kg**

Maximum value of SAR (measured) = 0.0384 W/kg

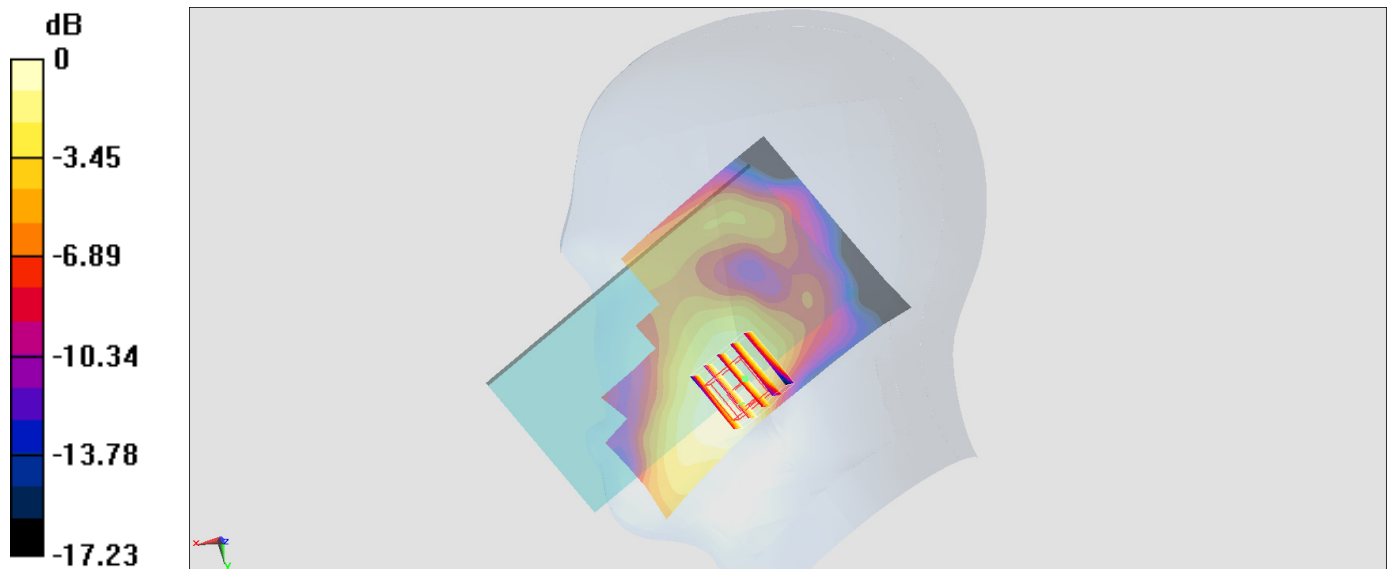

0 dB = 0.0384 W/kg = -14.16 dBW/kg

### #03\_WCDMA II\_RMC 12.2Kbps\_Right Cheek\_Ch9262

Communication System: WCDMA ; Frequency: 1852.4 MHz; Duty Cycle: 1:1

Medium: HSL\_1900\_170111 Medium parameters used:  $f = 1852.4$  MHz;  $\sigma = 1.353$  S/m;  $\epsilon_r = 41.353$ ;

$\rho = 1000$  kg/m<sup>3</sup>

Ambient Temperature : 23.8 °C ; Liquid Temperature : 22.8 °C

DASY5 Configuration:

- Probe: ES3DV3 - SN3270; ConvF(5.08, 5.08, 5.08); Calibrated: 2016/8/26;
- Sensor-Surface: 3mm (Mechanical Surface Detection)
- Electronics: DAE4 Sn778; Calibrated: 2016/5/12
- Phantom: SAM\_Left; Type: QD000P40CD; Serial: TP:1644
- Measurement SW: DASY52, Version 52.8 (8); SEMCAD X Version 14.6.10 (7331)

**Area Scan (71x131x1):** Interpolated grid: dx=1.500 mm, dy=1.500 mm

Maximum value of SAR (interpolated) = 0.0410 W/kg

**Zoom Scan (5x5x7)/Cube 0:** Measurement grid: dx=8mm, dy=8mm, dz=5mm

Reference Value = 4.866 V/m; Power Drift = -0.13 dB

Peak SAR (extrapolated) = 0.0490 W/kg

**SAR(1 g) = 0.034 W/kg; SAR(10 g) = 0.023 W/kg**

Maximum value of SAR (measured) = 0.0397 W/kg

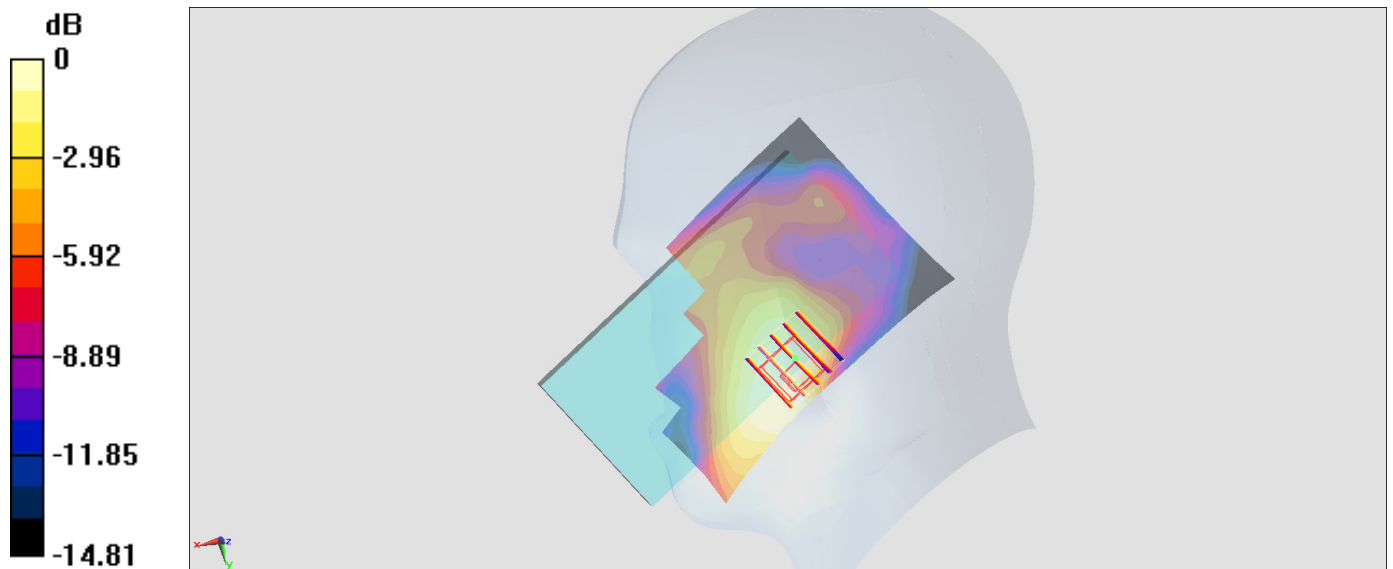

0 dB = 0.0397 W/kg = -14.01 dBW/kg

**#04\_WCDMA IV\_RMC 12.2Kbps\_Left Cheek\_Ch1413**

Communication System: WCDMA; Frequency: 1732.6 MHz; Duty Cycle: 1:1

Medium: HSL\_1750\_170103 Medium parameters used:  $f = 1733$  MHz;  $\sigma = 1.327$  S/m;  $\epsilon_r = 39.724$ ;  $\rho = 1000$  kg/m<sup>3</sup>

Ambient Temperature : 23.4 °C; Liquid Temperature : 22.4 °C

**DASY5 Configuration**

- Probe: EX3DV4 - SN3931; ConvF(8.68, 8.68, 8.68); Calibrated: 2016/10/3;
- Sensor-Surface: 1.4mm (Mechanical Surface Detection)
- Electronics: DAE3 Sn577; Calibrated: 2016/9/28
- Phantom: SAM\_Left; Type: QD000P40CD; Serial: S/N:1796
- Measurement SW: DASY52, Version 52.8 (8); SEMCAD X Version 14.6.10 (7373)

**Area Scan (71x131x1):** Interpolated grid: dx=1.500 mm, dy=1.500 mm

Maximum value of SAR (interpolated) = 0.0816 W/kg

**Zoom Scan (5x5x7)/Cube 0:** Measurement grid: dx=8mm, dy=8mm, dz=5mm

Reference Value = 7.640 V/m; Power Drift = -0.00 dB

Peak SAR (extrapolated) = 0.0820 W/kg

**SAR(1 g) = 0.055 W/kg; SAR(10 g) = 0.036 W/kg**

Maximum value of SAR (measured) = 0.0722 W/kg

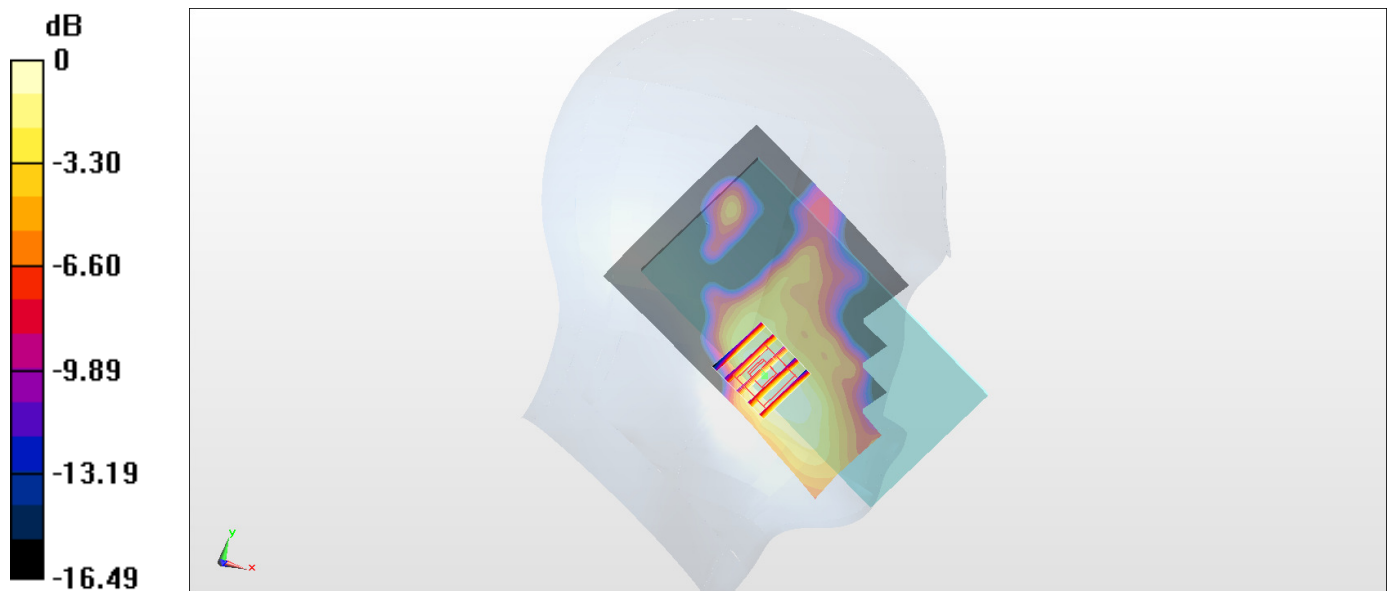

0 dB = 0.0722 W/kg = -11.41 dBW/kg

## #05\_WCDMA V\_RMC 12.2Kbps\_Left Cheek\_Ch4132

Communication System: WCDMA; Frequency: 826.4 MHz; Duty Cycle: 1:1

Medium: HSL\_850\_161229 Medium parameters used:  $f = 826.4$  MHz;  $\sigma = 0.86$  S/m;  $\epsilon_r = 41.358$ ;  $\rho = 1000$  kg/m<sup>3</sup>

Ambient Temperature : 23.6 °C; Liquid Temperature : 22.6 °C

### DASY5 Configuration

- Probe: EX3DV4 - SN3931; ConvF(10.35, 10.35, 10.35); Calibrated: 2016/10/3;
- Sensor-Surface: 1.4mm (Mechanical Surface Detection)
- Electronics: DAE3 Sn577; Calibrated: 2016/9/28
- Phantom: SAM\_Right; Type: QD000P40CD; Serial: S/N:1801
- Measurement SW: DASY52, Version 52.8 (8); SEMCAD X Version 14.6.10 (7373)

**Area Scan (71x131x1):** Interpolated grid: dx=1.500 mm, dy=1.500 mm

Maximum value of SAR (interpolated) = 0.0836 W/kg

**Zoom Scan (5x5x7)/Cube 0:** Measurement grid: dx=8mm, dy=8mm, dz=5mm

Reference Value = 9.873 V/m; Power Drift = 0.10 dB

Peak SAR (extrapolated) = 0.0920 W/kg

**SAR(1 g) = 0.070 W/kg; SAR(10 g) = 0.054 W/kg**

Maximum value of SAR (measured) = 0.0842 W/kg

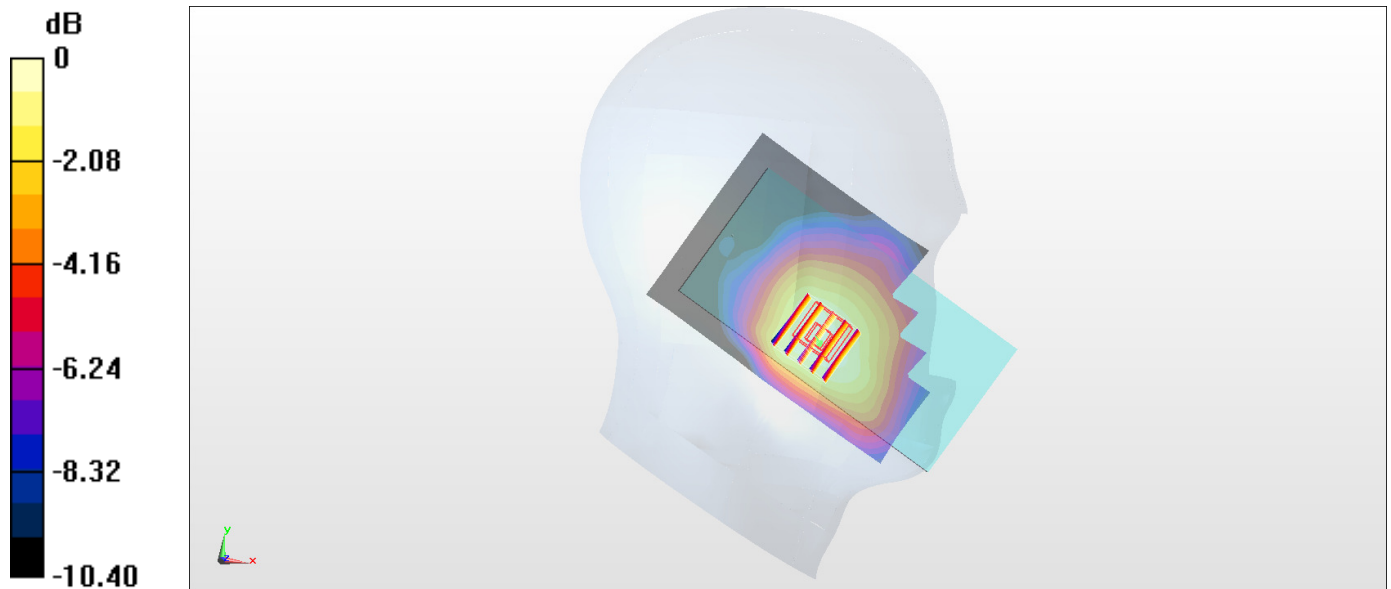

0 dB = 0.0842 W/kg = -10.75 dBW/kg

**#06\_LTE Band 2\_20M\_QPSK\_1\_99\_Right Cheek\_Ch18700**

Communication System: LTE; Frequency: 1860 MHz; Duty Cycle: 1:1

Medium: HSL\_1900\_170111 Medium parameters used:  $f = 1860$  MHz;  $\sigma = 1.361$  S/m;  $\epsilon_r = 41.336$ ;  $\rho = 1000$  kg/m<sup>3</sup>

Ambient Temperature : 23.8 °C; Liquid Temperature : 22.8 °C

DASY5 Configuration:

- Probe: ES3DV3 - SN3270; ConvF(5.08, 5.08, 5.08); Calibrated: 2016/8/26;
- Sensor-Surface: 3mm (Mechanical Surface Detection)
- Electronics: DAE4 Sn778; Calibrated: 2016/5/12
- Phantom: SAM\_Left; Type: QD000P40CD; Serial: TP:1644
- Measurement SW: DASY52, Version 52.8 (8); SEMCAD X Version 14.6.10 (7331)

**Area Scan (71x131x1):** Interpolated grid: dx=1.500 mm, dy=1.500 mm

Maximum value of SAR (interpolated) = 0.0363 W/kg

**Zoom Scan (5x5x7)/Cube 0:** Measurement grid: dx=8mm, dy=8mm, dz=5mm

Reference Value = 5.057 V/m; Power Drift = -0.04 dB

Peak SAR (extrapolated) = 0.0440 W/kg

**SAR(1 g) = 0.030 W/kg; SAR(10 g) = 0.020 W/kg**

Maximum value of SAR (measured) = 0.0351 W/kg

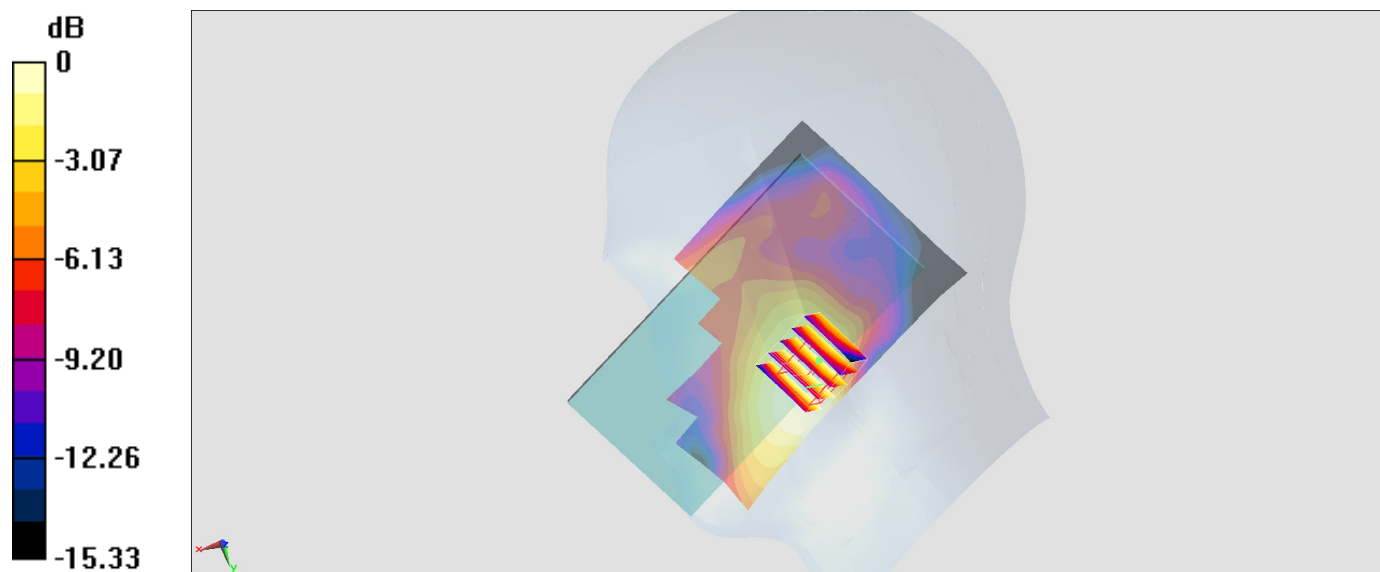

0 dB = 0.0351 W/kg = -14.55 dBW/kg

## #07\_LTE Band 4\_20M\_QPSK\_1\_0\_Left Cheek\_Ch20175

Communication System: LTE; Frequency: 1732.5 MHz; Duty Cycle: 1:1

Medium: HSL\_1750\_170110 Medium parameters used:  $f = 1732.5$  MHz;  $\sigma = 1.35$  S/m;  $\epsilon_r = 40.689$ ;  $\rho = 1000$  kg/m<sup>3</sup>

Ambient Temperature : 23 °C ; Liquid Temperature : 22 °C

DASY5 Configuration:

- Probe: ES3DV3 - SN3270; ConvF(5.21, 5.21, 5.21); Calibrated: 2016/8/26;
- Sensor-Surface: 3mm (Mechanical Surface Detection)
- Electronics: DAE4 Sn778; Calibrated: 2016/5/12
- Phantom: SAM\_Left; Type: QD000P40CD; Serial: TP:1644
- Measurement SW: DASY52, Version 52.8 (8); SEMCAD X Version 14.6.10 (7331)

**Area Scan (71x131x1):** Interpolated grid: dx=1.500 mm, dy=1.500 mm

Maximum value of SAR (interpolated) = 0.0475 W/kg

**Zoom Scan (5x5x7)/Cube 0:** Measurement grid: dx=8mm, dy=8mm, dz=5mm

Reference Value = 6.004 V/m; Power Drift = -0.09 dB

Peak SAR (extrapolated) = 0.0580 W/kg

**SAR(1 g) = 0.042 W/kg; SAR(10 g) = 0.029 W/kg**

Maximum value of SAR (measured) = 0.0476 W/kg

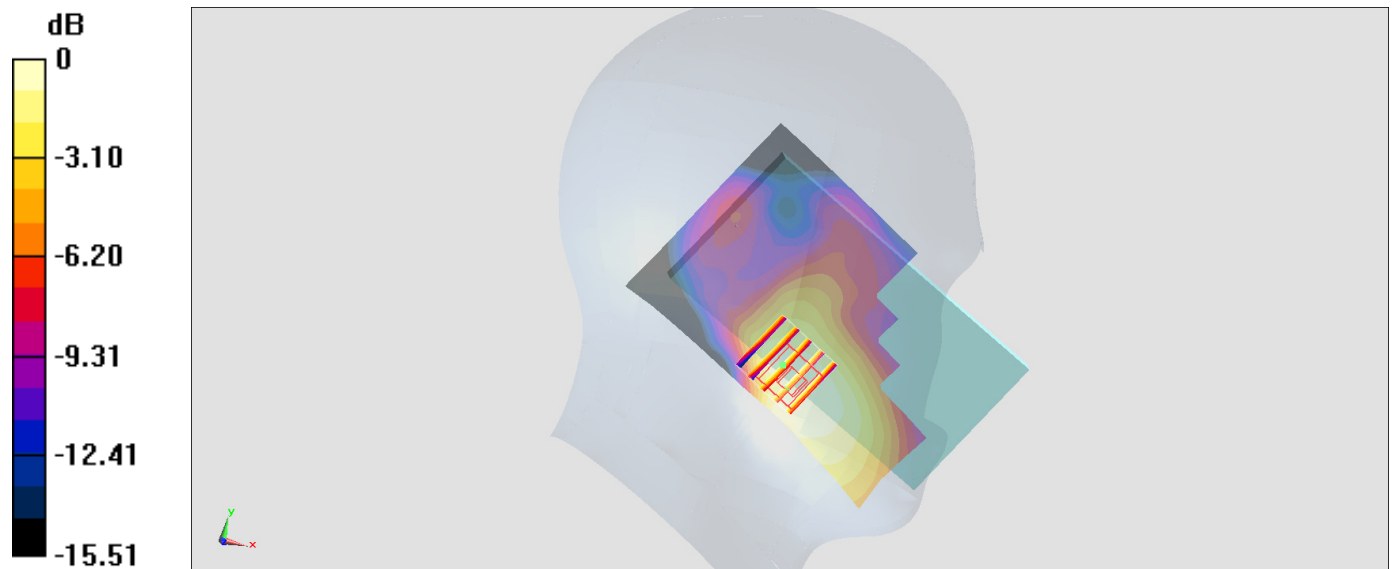

0 dB = 0.0476 W/kg = -13.22 dBW/kg



## #08\_LTE Band 5\_10M\_QPSK\_1\_0\_Left Cheek\_Ch20525

Communication System: LTE; Frequency: 836.5 MHz; Duty Cycle: 1:1

Medium: HSL\_850\_170112 Medium parameters used:  $f = 836.5$  MHz;  $\sigma = 0.882$  S/m;  $\epsilon_r = 41.167$ ;  $\rho = 1000$  kg/m<sup>3</sup>

Ambient Temperature : 23.3 °C; Liquid Temperature : 22.3 °C

DASY5 Configuration:

- Probe: ES3DV3 - SN3270; ConvF(6.03, 6.03, 6.03); Calibrated: 2016/8/26;
- Sensor-Surface: 3mm (Mechanical Surface Detection)
- Electronics: DAE4 Sn778; Calibrated: 2016/5/12
- Phantom: SAM\_Left; Type: QD000P40CD; Serial: TP:1644
- Measurement SW: DASY52, Version 52.8 (8); SEMCAD X Version 14.6.10 (7331)

**Area Scan (71x131x1):** Interpolated grid: dx=1.500 mm, dy=1.500 mm

Maximum value of SAR (interpolated) = 0.0662 W/kg

**Zoom Scan (5x5x7)/Cube 0:** Measurement grid: dx=8mm, dy=8mm, dz=5mm

Reference Value = 8.926 V/m; Power Drift = 0.06 dB

Peak SAR (extrapolated) = 0.0770 W/kg

**SAR(1 g) = 0.061 W/kg; SAR(10 g) = 0.048 W/kg**

Maximum value of SAR (measured) = 0.0669 W/kg

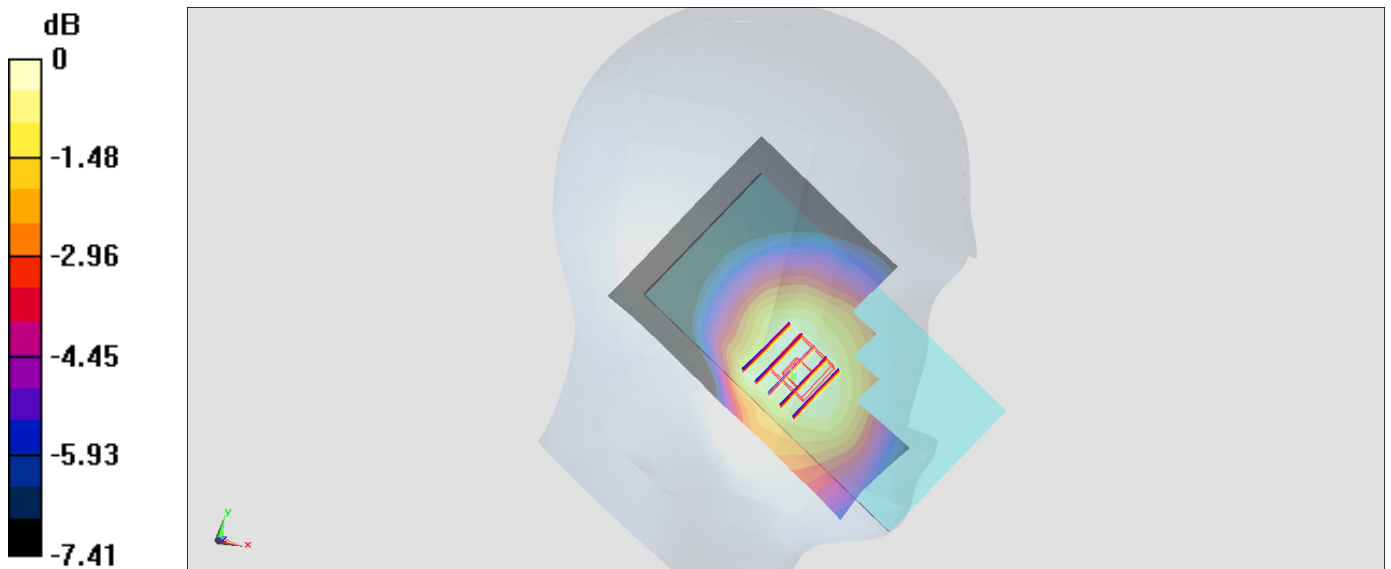

0 dB = 0.0669 W/kg = -11.75 dBW/kg

**#09\_LTE Band 7\_20M\_QPSK\_1\_0\_Right Cheek\_Ch21350**

Communication System: LTE; Frequency: 2560 MHz; Duty Cycle: 1:1

Medium: HSL\_2600\_170110 Medium parameters used:  $f = 2560$  MHz;  $\sigma = 1.945$  S/m;  $\epsilon_r = 39.15$ ;  $\rho = 1000$  kg/m<sup>3</sup>

Ambient Temperature : 23.1 °C; Liquid Temperature : 22.1 °C

DASY5 Configuration:

- Probe: ES3DV3 - SN3270; ConvF(4.37, 4.37, 4.37); Calibrated: 2016/8/26;
- Sensor-Surface: 3mm (Mechanical Surface Detection)
- Electronics: DAE4 Sn778; Calibrated: 2016/5/12
- Phantom: SAM\_Left; Type: QD000P40CD; Serial: TP:1644
- Measurement SW: DASY52, Version 52.8 (8); SEMCAD X Version 14.6.10 (7331)

**Area Scan (91x151x1):** Interpolated grid: dx=1.200 mm, dy=1.200 mm

Maximum value of SAR (interpolated) = 0.0898 W/kg

**Zoom Scan (7x7x7)/Cube 0:** Measurement grid: dx=5mm, dy=5mm, dz=5mm

Reference Value = 6.541 V/m; Power Drift = 0.06 dB

Peak SAR (extrapolated) = 0.119 W/kg

**SAR(1 g) = 0.070 W/kg; SAR(10 g) = 0.040 W/kg**

Maximum value of SAR (measured) = 0.0842 W/kg

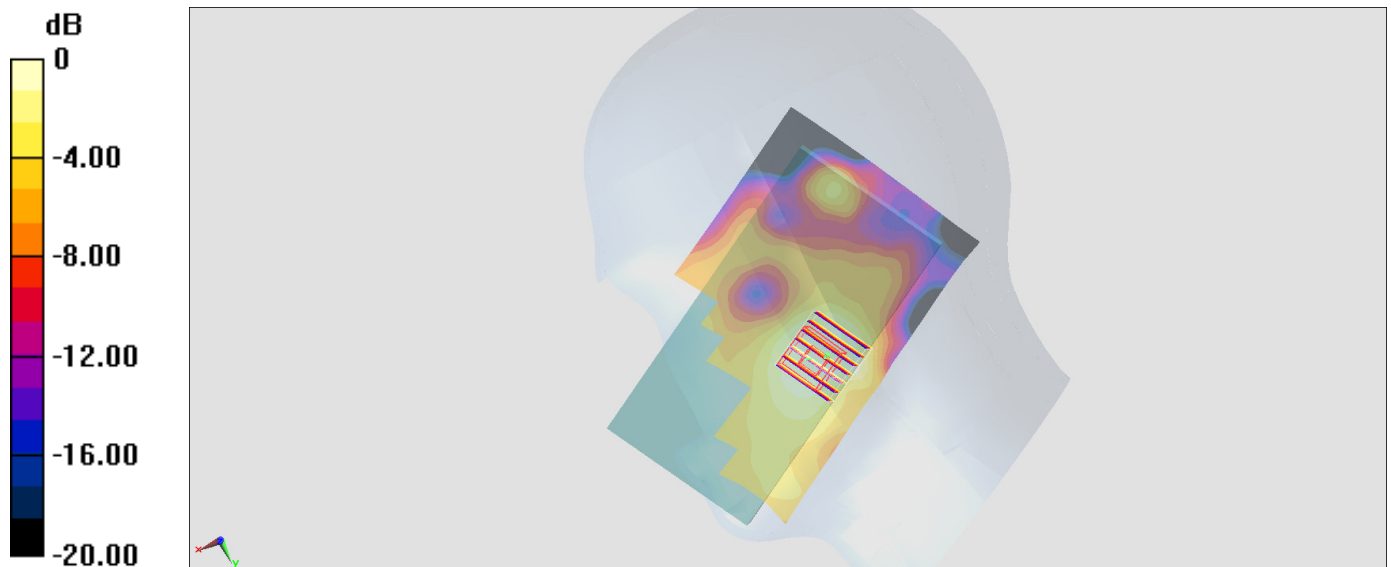

0 dB = 0.0842 W/kg = -10.75 dBW/kg

**#10\_LTE Band 12\_10M\_QPSK\_1\_49\_Left Cheek\_Ch23095**

Communication System: LTE ; Frequency: 707.5 MHz;Duty Cycle: 1:1

Medium: HSL\_750\_170111 Medium parameters used:  $f = 707.5$  MHz;  $\sigma = 0.852$  S/m;  $\epsilon_r = 43.546$ ;  $\rho = 1000$  kg/m<sup>3</sup>

Ambient Temperature : 23.6 °C ; Liquid Temperature : 22.6 °C

DASY5 Configuration:

- Probe: ES3DV3 - SN3270; ConvF(6.19, 6.19, 6.19); Calibrated: 2016/8/26;
- Sensor-Surface: 3mm (Mechanical Surface Detection)
- Electronics: DAE4 Sn778; Calibrated: 2016/5/12
- Phantom: SAM\_Left; Type: QD000P40CD; Serial: TP:1644
- Measurement SW: DASY52, Version 52.8 (8);SEMCAD X Version 14.6.10 (7331)

**Area Scan (71x131x1):** Interpolated grid: dx=1.500 mm, dy=1.500 mm

Maximum value of SAR (interpolated) = 0.0548 W/kg

**Zoom Scan (5x5x7)/Cube 0:** Measurement grid: dx=8mm, dy=8mm, dz=5mm

Reference Value = 8.220 V/m; Power Drift = 0.01 dB

Peak SAR (extrapolated) = 0.0620 W/kg

**SAR(1 g) = 0.052 W/kg; SAR(10 g) = 0.042 W/kg**

Maximum value of SAR (measured) = 0.0554 W/kg

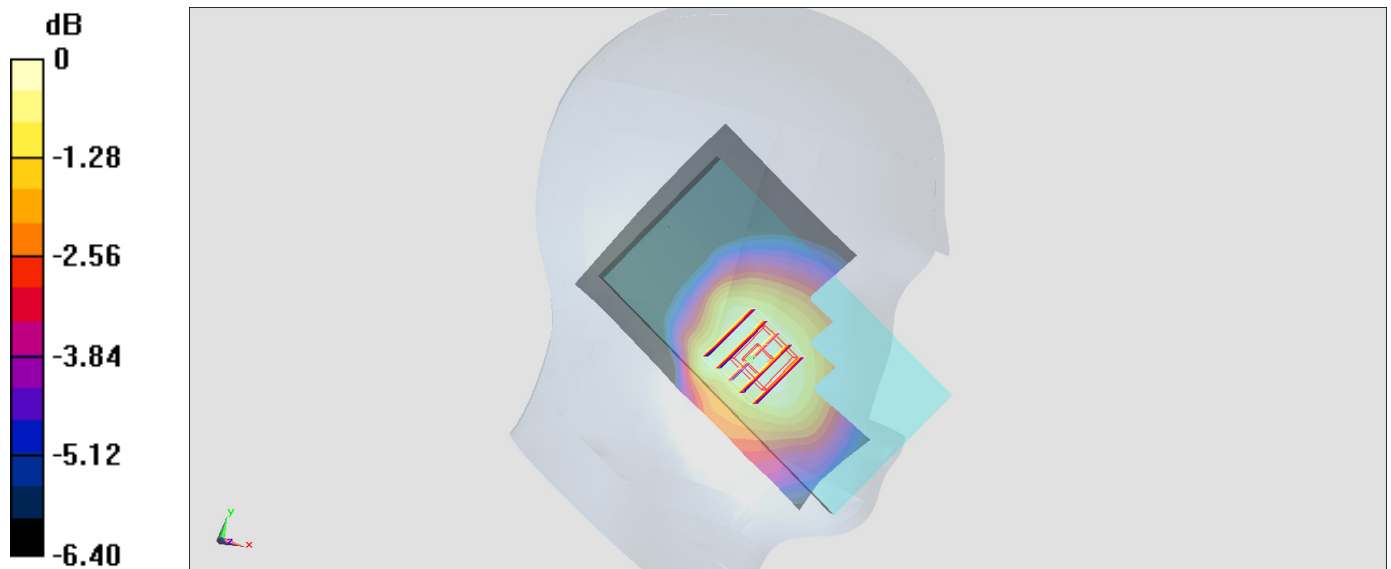

0 dB = 0.0554 W/kg = -12.56 dBW/kg

**#11\_LTE Band 41\_20M\_QPSK\_1\_99\_Right Cheek\_Ch40185**

Communication System: LTE; Frequency: 2549.5 MHz; Duty Cycle: 1:1.59

Medium: HSL\_2600\_170110 Medium parameters used:  $f = 2550$  MHz;  $\sigma = 1.933$  S/m;  $\epsilon_r = 39.196$ ;  $\rho = 1000$  kg/m<sup>3</sup>

Ambient Temperature : 23.1 °C; Liquid Temperature : 22.1 °C

DASY5 Configuration:

- Probe: ES3DV3 - SN3270; ConvF(4.51, 4.51, 4.51); Calibrated: 2016/8/26;
- Sensor-Surface: 3mm (Mechanical Surface Detection)
- Electronics: DAE4 Sn778; Calibrated: 2016/5/12
- Phantom: SAM\_Left; Type: QD000P40CD; Serial: TP:1644
- Measurement SW: DASY52, Version 52.8 (8); SEMCAD X Version 14.6.10 (7331)

**Area Scan (91x151x1):** Interpolated grid: dx=1.200 mm, dy=1.200 mm

Maximum value of SAR (interpolated) = 0.0522 W/kg

**Zoom Scan (7x7x7)/Cube 0:** Measurement grid: dx=5mm, dy=5mm, dz=5mm

Reference Value = 5.016 V/m; Power Drift = 0.13 dB

Peak SAR (extrapolated) = 0.0700 W/kg

**SAR(1 g) = 0.041 W/kg; SAR(10 g) = 0.025 W/kg**

Maximum value of SAR (measured) = 0.0492 W/kg

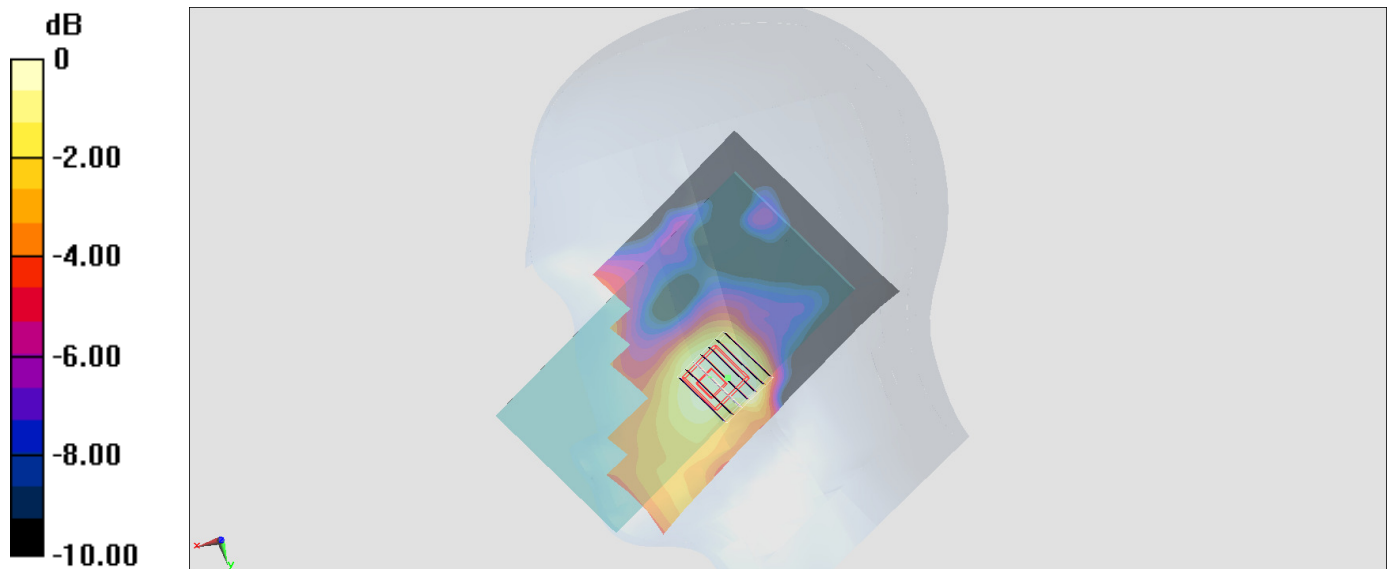

0 dB = 0.0492 W/kg = -13.08 dBW/kg

**#12\_WLAN2.4GHz\_802.11b 1Mbps\_Right Cheek\_Ant 2**

Communication System: 802.11b; Frequency: 2462 MHz; Duty Cycle: 1:1.013

Medium: HSL\_2450\_170112 Medium parameters used:  $f = 2462$  MHz;  $\sigma = 1.773$  S/m;  $\epsilon_r = 39.477$ ;  $\rho = 1000$  kg/m<sup>3</sup>

Ambient Temperature : 23.6 °C; Liquid Temperature : 22.6 °C

DASY5 Configuration:

- Probe: EX3DV4 - SN3925; ConvF(7.47, 7.47, 7.47); Calibrated: 2016/5/26;
- Sensor-Surface: 1.4mm (Mechanical Surface Detection)
- Electronics: DAE3 Sn495; Calibrated: 2016/5/27
- Phantom: SAM-Right; Type: SAM; Serial: 1795
- Measurement SW: DASY52, Version 52.8 (8); SEMCAD X Version 14.6.10 (7331)

**Area Scan (91x71x1):** Interpolated grid: dx=1.200 mm, dy=1.200 mm

Maximum value of SAR (interpolated) = 0.652 W/kg

**Zoom Scan (7x7x7)/Cube 0:** Measurement grid: dx=5mm, dy=5mm, dz=5mm

Reference Value = 19.35 V/m; Power Drift = 0.15 dB

Peak SAR (extrapolated) = 0.986 W/kg

**SAR(1 g) = 0.448 W/kg; SAR(10 g) = 0.195 W/kg**

Maximum value of SAR (measured) = 0.759 W/kg

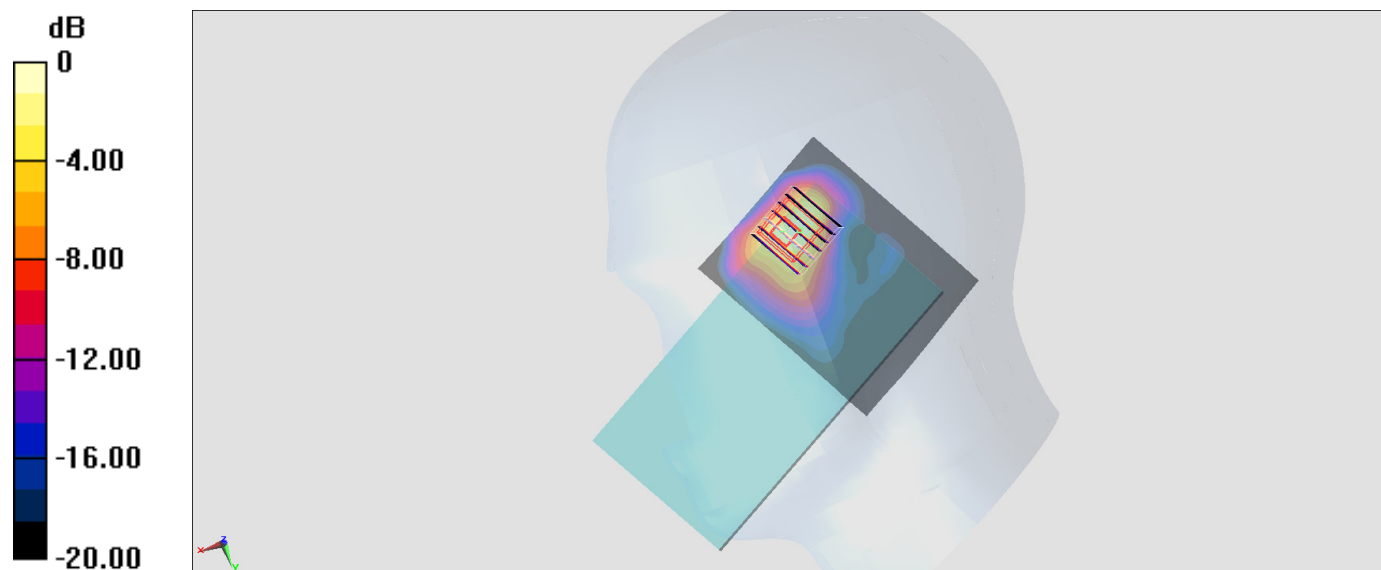

0 dB = 0.759 W/kg = -1.20 dBW/kg

**#13\_WLAN5GHz\_802.11ac-VHT80 MCS0\_Right Cheek\_Ch58;Ant 1**

Communication System: 802.11ac ; Frequency: 5290 MHz;Duty Cycle: 1:1.052

Medium: HSL\_5G\_170104 Medium parameters used:  $f = 5290$  MHz;  $\sigma = 4.592$  S/m;  $\epsilon_r = 34.239$ ;  $\rho = 1000$  kg/m<sup>3</sup>

Ambient Temperature : 23.2 °C ; Liquid Temperature : 22.2 °C

DASY5 Configuration:

- Probe: EX3DV4 - SN3925; ConvF(5.15, 5.15, 5.15); Calibrated: 2016/5/26;
- Sensor-Surface: 1.4mm (Mechanical Surface Detection)
- Electronics: DAE3 Sn495; Calibrated: 2016/5/27
- Phantom: SAM\_Right; Type: QD000P40CD; Serial: TP:1383
- Measurement SW: DASY52, Version 52.8 (8);SEMCAD X Version 14.6.10 (7331)

**Area Scan (101x71x1):** Interpolated grid: dx=1.000 mm, dy=1.000 mm

Maximum value of SAR (interpolated) = 1.31 W/kg

**Zoom Scan (8x8x7)/Cube 0:** Measurement grid: dx=4mm, dy=4mm, dz=1.4mm

Reference Value = 3.784 V/m; Power Drift = 0.11 dB

Peak SAR (extrapolated) = 3.07 W/kg

**SAR(1 g) = 0.370 W/kg; SAR(10 g) = 0.065 W/kg**

Maximum value of SAR (measured) = 1.21 W/kg



0 dB = 1.21 W/kg = 0.83 dBW/kg

**#14\_WLAN5GHz\_802.11n-HT40 MCS0\_Right Cheek\_Ch134;Ant 1**

Communication System: 802.11n ; Frequency: 5670 MHz;Duty Cycle: 1:1.032

Medium: HSL\_5G\_170104 Medium parameters used:  $f = 5670$  MHz;  $\sigma = 4.94$  S/m;  $\epsilon_r = 33.75$ ;  $\rho = 1000$  kg/m<sup>3</sup>

Ambient Temperature : 23.2 °C ; Liquid Temperature : 22.2 °C

DASY5 Configuration:

- Probe: EX3DV4 - SN3925; ConvF(4.47, 4.47, 4.47); Calibrated: 2016/5/26;
- Sensor-Surface: 1.4mm (Mechanical Surface Detection)
- Electronics: DAE3 Sn495; Calibrated: 2016/5/27
- Phantom: SAM\_Right; Type: QD000P40CD; Serial: TP:1383
- Measurement SW: DASY52, Version 52.8 (8);SEMCAD X Version 14.6.10 (7331)

**Area Scan (101x71x1):** Interpolated grid: dx=1.000 mm, dy=1.000 mm

Maximum value of SAR (interpolated) = 2.28 W/kg

**Zoom Scan (7x7x7)/Cube 0:** Measurement grid: dx=4mm, dy=4mm, dz=1.4mm

Reference Value = 6.363 V/m; Power Drift = 0.09 dB

Peak SAR (extrapolated) = 3.69 W/kg

**SAR(1 g) = 0.615 W/kg; SAR(10 g) = 0.100 W/kg**

Maximum value of SAR (measured) = 2.17 W/kg

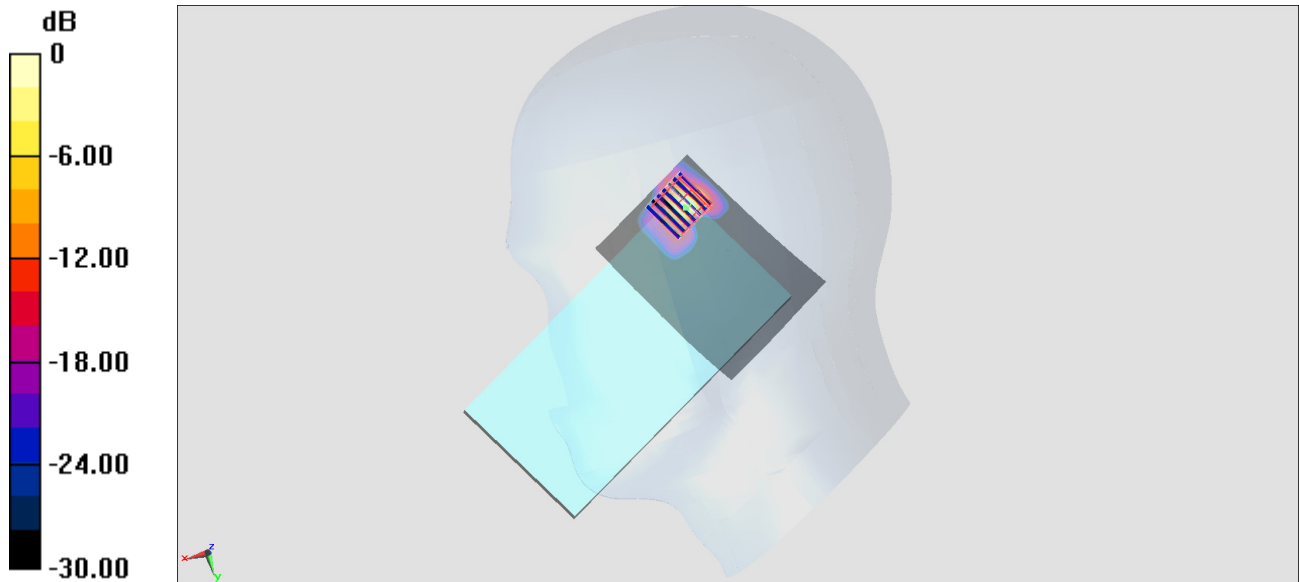

0 dB = 2.17 W/kg = 3.36 dBW/kg

**#15\_WLAN5GHz\_802.11ac-VHT80 MCS0\_Right Cheek\_Ch155;Ant 1**

Communication System: 802.11ac ; Frequency: 5775 MHz;Duty Cycle: 1:1.052

Medium: HSL\_5G\_161227 Medium parameters used:  $f = 5775$  MHz;  $\sigma = 5.252$  S/m;  $\epsilon_r = 36.836$ ;  $\rho = 1000$  kg/m<sup>3</sup>

Ambient Temperature : 23.5 °C ; Liquid Temperature : 22.5 °C

DASY5 Configuration:

- Probe: EX3DV4 - SN3955; ConvF(4.63, 4.63, 4.63); Calibrated: 2016/11/24;
- Sensor-Surface: 1.4mm (Mechanical Surface Detection)
- Electronics: DAE4 Sn1399; Calibrated: 2016/11/17
- Phantom: SAM\_Right; Type: QD000P40CD; Serial: TP:1383
- Measurement SW: DASY52, Version 52.8 (8);SEMCAD X Version 14.6.10 (7331)

**Area Scan (101x71x1):** Interpolated grid: dx=1.000 mm, dy=1.000 mm

Maximum value of SAR (interpolated) = 1.72 W/kg

**Zoom Scan (7x7x7)/Cube 0:** Measurement grid: dx=4mm, dy=4mm, dz=1.4mm

Reference Value = 4.802 V/m; Power Drift = -0.10 dB

Peak SAR (extrapolated) = 4.17 W/kg

**SAR(1 g) = 0.663 W/kg; SAR(10 g) = 0.103 W/kg**

Maximum value of SAR (measured) = 2.54 W/kg

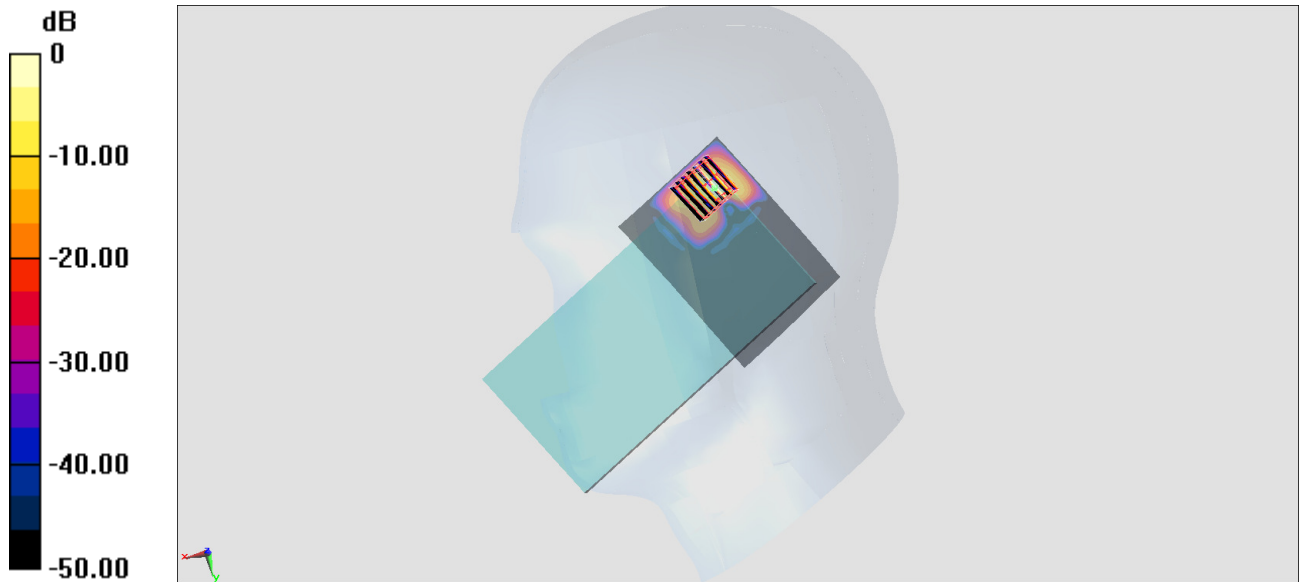



### #16\_Bluetooth\_1Mbps\_Right Cheek\_Ch39;Ant 1

Communication System: Bluetooth; Frequency: 2441 MHz; Duty Cycle: 1:1.305

Medium: HSL\_2450\_170113 Medium parameters used:  $f = 2441$  MHz;  $\sigma = 1.8$  mho/m;  $\epsilon_r = 40.1$ ;  $\rho = 1000$  kg/m<sup>3</sup>

Ambient Temperature : 23.1 °C ; Liquid Temperature : 22.1 °C

DASY4 Configuration:

- Probe: EX3DV4 - SN3931; ConvF(7.6, 7.6, 7.6); Calibrated: 2016/10/3
- Sensor-Surface: 1.4mm (Mechanical Surface Detection)
- Electronics: DAE3 Sn577; Calibrated: 2016/9/28
- Phantom: SAM\_Right; Type: QD000P40CD; Serial: TP:1383
- ;Postprocessing SW: SEMCAD, V1.8 Build 159

**Area Scan (81x81x1):** Measurement grid: dx=12mm, dy=12mm

Maximum value of SAR (interpolated) = 0.121 mW/g

**Zoom Scan (7x7x7)/Cube 0:** Measurement grid: dx=5mm, dy=5mm, dz=5mm

Reference Value = 7.70 V/m; Power Drift = 0.127 dB

Peak SAR (extrapolated) = 0.159 W/kg

**SAR(1 g) = 0.066 mW/g; SAR(10 g) = 0.028 mW/g**

Maximum value of SAR (measured) = 0.114 mW/g

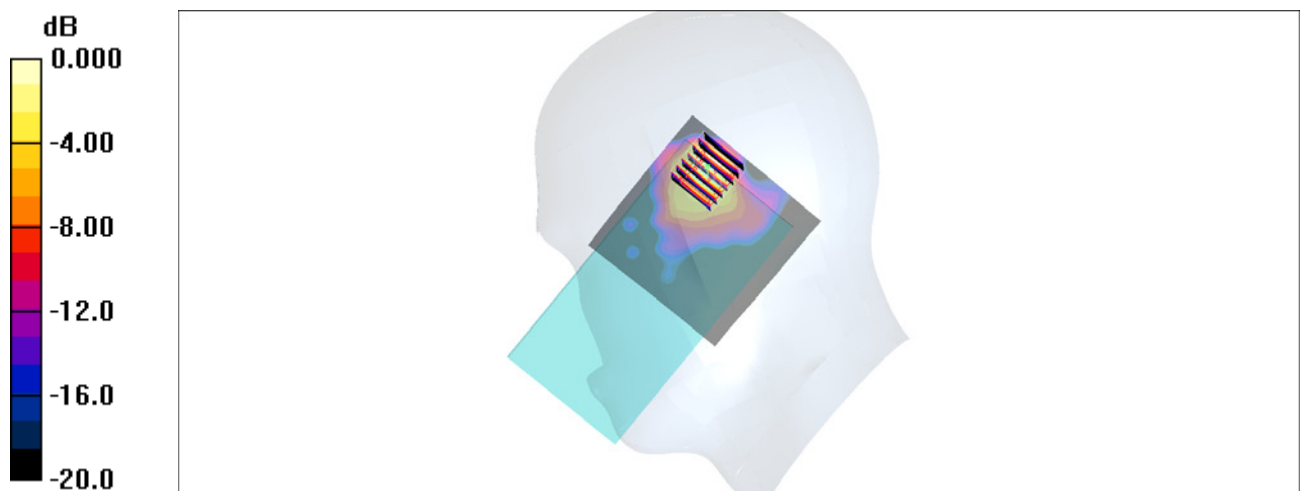

## #17\_GSM850\_GPRS (4 Tx slots)\_Back\_10mm\_Ch128

Communication System: GSM850 ; Frequency: 824.2 MHz; Duty Cycle: 1:2.08

Medium: MSL\_850\_170115 Medium parameters used :  $f = 824.2$  MHz;  $\sigma = 0.928$  S/m;  $\epsilon_r = 55.555$ ;  $\rho = 1000$  kg/m<sup>3</sup>

Ambient Temperature : 23.4 °C ; Liquid Temperature : 22.4 °C

DASY5 Configuration:

- Probe: ES3DV3 - SN3270; ConvF(6.01, 6.01, 6.01); Calibrated: 2016/8/26;
- Sensor-Surface: 3mm (Mechanical Surface Detection)
- Electronics: DAE4 Sn778; Calibrated: 2016/5/12
- Phantom: SAM\_Left; Type: QD000P40CD; Serial: TP:1644
- Measurement SW: DASY52, Version 52.8 (8); SEMCAD X Version 14.6.10 (7331)

**Area Scan (71x131x1):** Interpolated grid: dx=1.500 mm, dy=1.500 mm

Maximum value of SAR (interpolated) = 0.193 W/kg

**Zoom Scan (5x5x7)/Cube 0:** Measurement grid: dx=8mm, dy=8mm, dz=5mm

Reference Value = 11.99 V/m; Power Drift = 0.17 dB

Peak SAR (extrapolated) = 0.260 W/kg

**SAR(1 g) = 0.182 W/kg; SAR(10 g) = 0.126 W/kg**

Maximum value of SAR (measured) = 0.209 W/kg

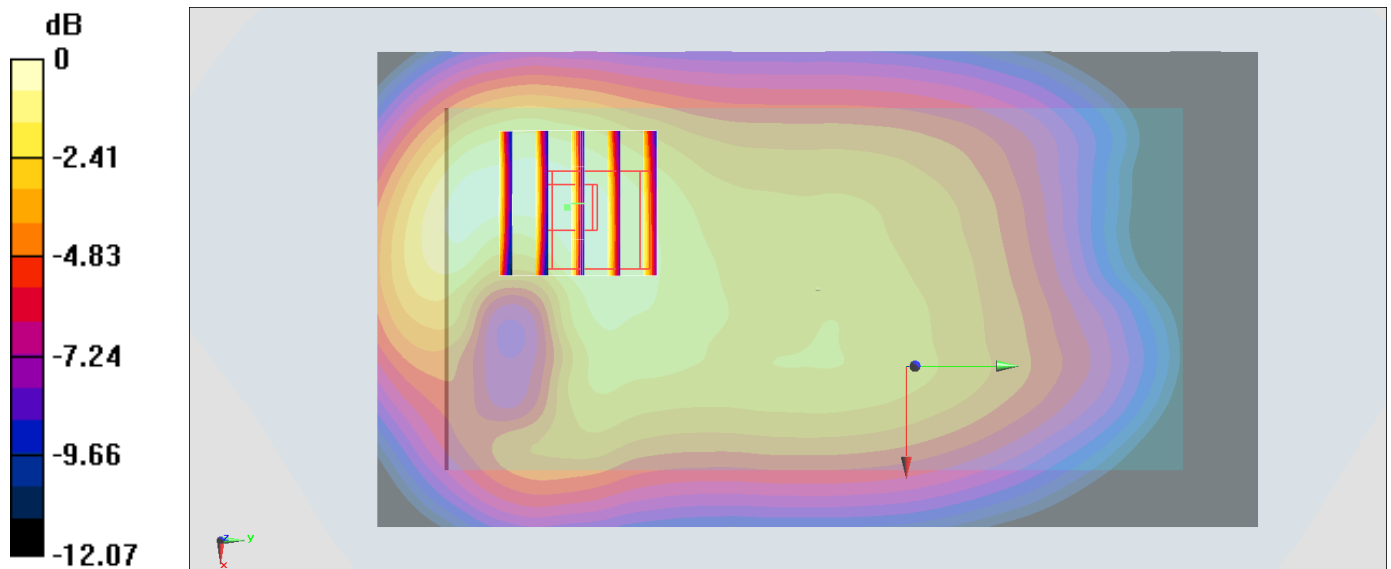

0 dB = 0.209 W/kg = -6.80 dBW/kg

## #18\_GSM1900\_GPRS (3 Tx slots)\_Bottom Side\_10mm\_Ch661

Communication System: PCS ; Frequency: 1880 MHz;Duty Cycle: 1:2.77

Medium: MSL\_1900\_170113 Medium parameters used:  $f = 1880$  MHz;  $\sigma = 1.529$  S/m;  $\epsilon_r = 55.025$ ;  $\rho = 1000$  kg/m<sup>3</sup>

Ambient Temperature : 23.6 °C ; Liquid Temperature : 22.6 °C

DASY5 Configuration:

- Probe: ES3DV3 - SN3270; ConvF(4.7, 4.7, 4.7); Calibrated: 2016/8/26;
- Sensor-Surface: 3mm (Mechanical Surface Detection)
- Electronics: DAE4 Sn778; Calibrated: 2016/5/12
- Phantom: SAM-Right; Type: SAM; Serial: 1795
- Measurement SW: DASY52, Version 52.8 (8);SEMCAD X Version 14.6.10 (7331)

**Area Scan (41x81x1):** Interpolated grid: dx=1.500 mm, dy=1.500 mm

Maximum value of SAR (interpolated) = 0.682 W/kg

**Zoom Scan (5x5x7)/Cube 0:** Measurement grid: dx=8mm, dy=8mm, dz=5mm

Reference Value = 21.72 V/m; Power Drift = 0.01 dB

Peak SAR (extrapolated) = 0.875 W/kg

**SAR(1 g) = 0.541 W/kg; SAR(10 g) = 0.308 W/kg**

Maximum value of SAR (measured) = 0.653 W/kg

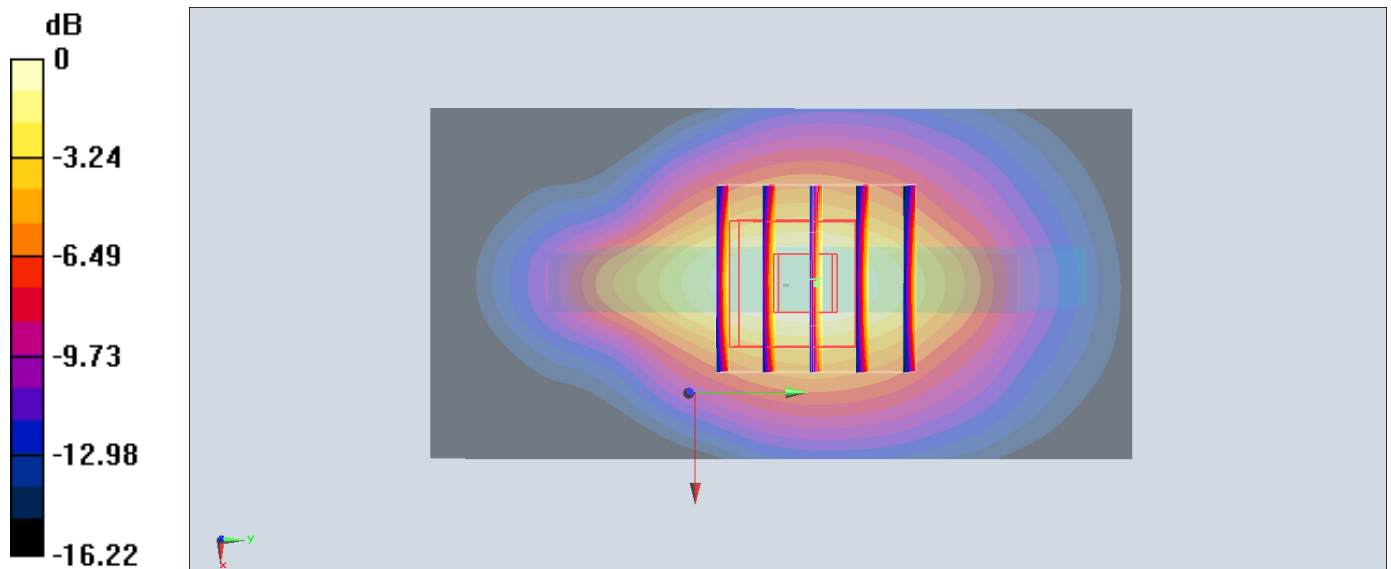

0 dB = 0.653 W/kg = -1.85 dBW/kg

## #19\_WCDMA II\_RMC 12.2Kbps\_Bottom Side\_10mm\_Ch9538

Communication System: WCDMA ; Frequency: 1907.6 MHz; Duty Cycle: 1:1

Medium: MSL\_1900\_170113 Medium parameters used:  $f = 1908$  MHz;  $\sigma = 1.561$  S/m;  $\epsilon_r = 54.927$ ;  $\rho = 1000$  kg/m<sup>3</sup>

Ambient Temperature : 23.6 °C ; Liquid Temperature : 22.6 °C

DASY5 Configuration:

- Probe: ES3DV3 - SN3270; ConvF(4.7, 4.7, 4.7); Calibrated: 2016/8/26;
- Sensor-Surface: 3mm (Mechanical Surface Detection)
- Electronics: DAE4 Sn778; Calibrated: 2016/5/12
- Phantom: SAM-Right; Type: SAM; Serial: 1795
- Measurement SW: DASY52, Version 52.8 (8); SEMCAD X Version 14.6.10 (7331)

**Area Scan (41x71x1):** Interpolated grid: dx=1.500 mm, dy=1.500 mm

Maximum value of SAR (interpolated) = 0.725 W/kg

**Zoom Scan (5x5x7)/Cube 0:** Measurement grid: dx=8mm, dy=8mm, dz=5mm

Reference Value = 21.68 V/m; Power Drift = -0.04 dB

Peak SAR (extrapolated) = 0.891 W/kg

**SAR(1 g) = 0.552 W/kg; SAR(10 g) = 0.314 W/kg**

Maximum value of SAR (measured) = 0.658 W/kg

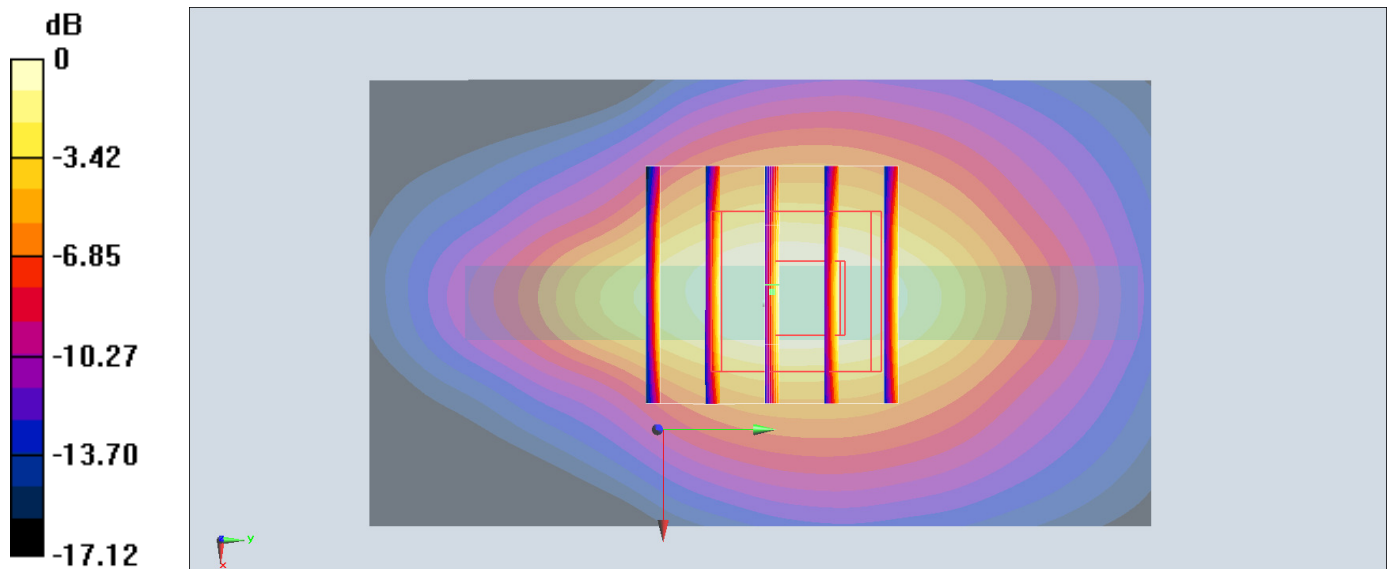

0 dB = 0.658 W/kg = -1.82 dBW/kg

## #20\_WCDMA IV\_RMC 12.2Kbps\_Bottom Side\_10mm\_Ch1312

Communication System: WCDMA ; Frequency: 1712.4 MHz;Duty Cycle: 1:1

Medium: MSL\_1750\_170114 Medium parameters used:  $f = 1712.4$  MHz;  $\sigma = 1.454$  S/m;  $\epsilon_r = 54.722$ ;

$\rho = 1000$  kg/m<sup>3</sup>

Ambient Temperature : 23.4 °C ; Liquid Temperature : 22.4 °C

DASY5 Configuration:

- Probe: ES3DV3 - SN3270; ConvF(4.95, 4.95, 4.95); Calibrated: 2016/8/26;
- Sensor-Surface: 3mm (Mechanical Surface Detection)
- Electronics: DAE4 Sn778; Calibrated: 2016/5/12
- Phantom: SAM-Right; Type: SAM; Serial: 1795
- Measurement SW: DASY52, Version 52.8 (8);SEMCAD X Version 14.6.10 (7331)

**Area Scan (51x81x1):** Interpolated grid: dx=1.500 mm, dy=1.500 mm

Maximum value of SAR (interpolated) = 1.58 W/kg

**Zoom Scan (5x5x7)/Cube 0:** Measurement grid: dx=8mm, dy=8mm, dz=5mm

Reference Value = 29.59 V/m; Power Drift = -0.18 dB

Peak SAR (extrapolated) = 1.71 W/kg

**SAR(1 g) = 1.08 W/kg; SAR(10 g) = 0.608 W/kg**

Maximum value of SAR (measured) = 1.31 W/kg

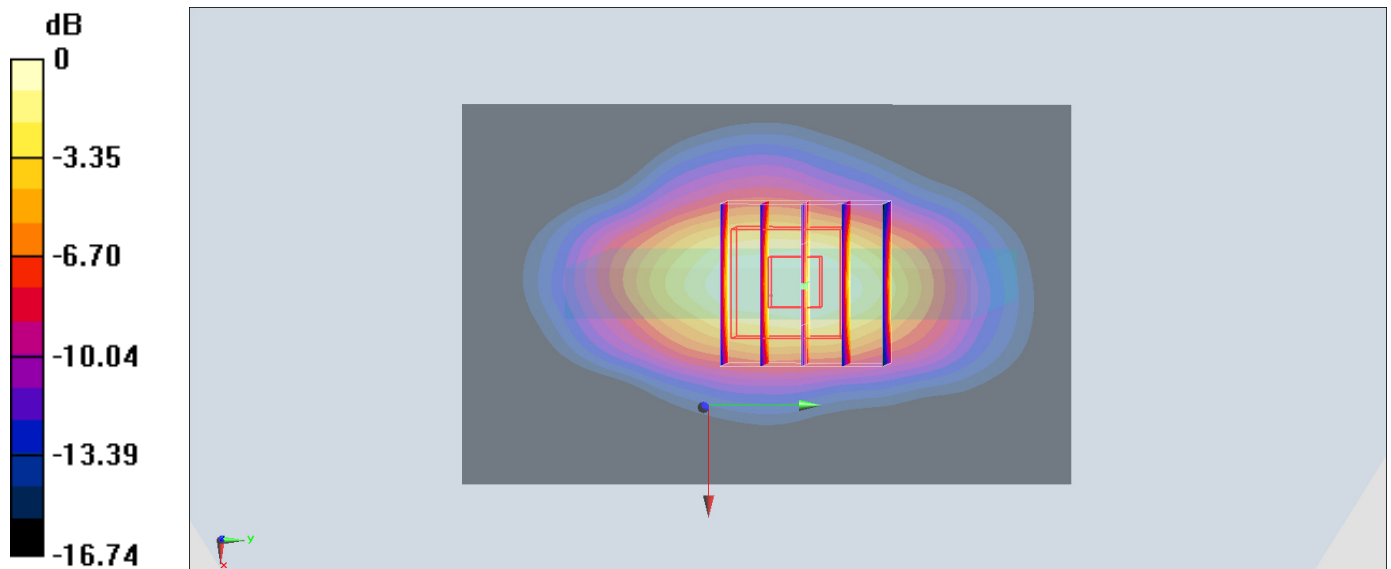

0 dB = 1.31 W/kg = 1.17 dBW/kg

## #21\_WCDMA V\_RMC 12.2Kbps\_Back\_10mm\_Ch4132

Communication System: WCDMA; Frequency: 826.4 MHz; Duty Cycle: 1:1

Medium: MSL\_850\_170115 Medium parameters used:  $f = 826.4$  MHz;  $\sigma = 0.93$  S/m;  $\epsilon_r = 55.535$ ;  $\rho = 1000$  kg/m<sup>3</sup>

Ambient Temperature : 23.4 °C; Liquid Temperature : 22.4 °C

DASY5 Configuration:

- Probe: ES3DV3 - SN3270; ConvF(6.01, 6.01, 6.01); Calibrated: 2016/8/26;
- Sensor-Surface: 3mm (Mechanical Surface Detection)
- Electronics: DAE4 Sn778; Calibrated: 2016/5/12
- Phantom: SAM\_Left; Type: QD000P40CD; Serial: TP:1644
- Measurement SW: DASY52, Version 52.8 (8); SEMCAD X Version 14.6.10 (7331)

**Area Scan (71x131x1):** Interpolated grid: dx=1.500 mm, dy=1.500 mm

Maximum value of SAR (interpolated) = 0.177 W/kg

**Zoom Scan (5x5x7)/Cube 0:** Measurement grid: dx=8mm, dy=8mm, dz=5mm

Reference Value = 14.13 V/m; Power Drift = -0.04 dB

Peak SAR (extrapolated) = 0.220 W/kg

**SAR(1 g) = 0.156 W/kg; SAR(10 g) = 0.109 W/kg**

Maximum value of SAR (measured) = 0.176 W/kg

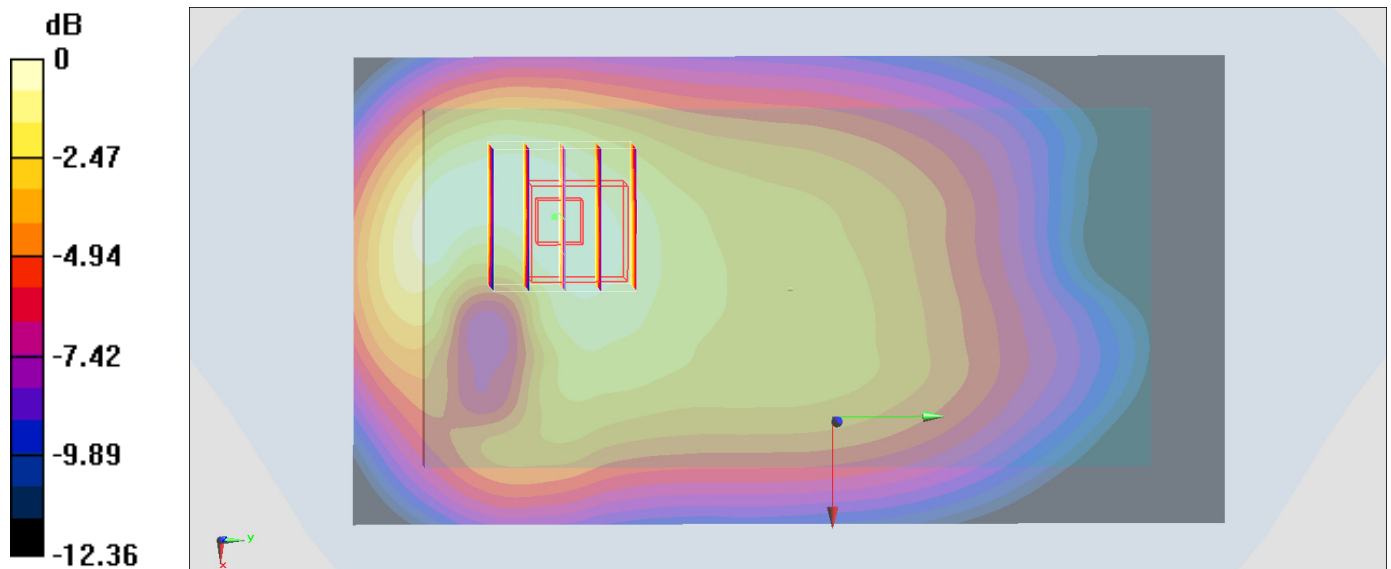

0 dB = 0.176 W/kg = -7.54 dBW/kg

## #22\_LTE Band 2\_20M\_QPSK\_1\_99\_Bottom Side\_10mm\_Ch18700

Communication System: LTE; Frequency: 1860 MHz; Duty Cycle: 1:1

Medium: MSL\_1900\_170113 Medium parameters used:  $f = 1860$  MHz;  $\sigma = 1.507$  S/m;  $\epsilon_r = 55.102$ ;  $\rho = 1000$  kg/m<sup>3</sup>

Ambient Temperature : 23.6 °C ; Liquid Temperature : 22.6 °C

DASY5 Configuration:

- Probe: ES3DV3 - SN3270; ConvF(4.7, 4.7, 4.7); Calibrated: 2016/8/26;
- Sensor-Surface: 3mm (Mechanical Surface Detection)
- Electronics: DAE4 Sn778; Calibrated: 2016/5/12
- Phantom: SAM-Right; Type: SAM; Serial: 1795
- Measurement SW: DASY52, Version 52.8 (8); SEMCAD X Version 14.6.10 (7331)

**Area Scan (41x71x1):** Interpolated grid: dx=1.500 mm, dy=1.500 mm

Maximum value of SAR (interpolated) = 0.680 W/kg

**Zoom Scan (5x5x7)/Cube 0:** Measurement grid: dx=8mm, dy=8mm, dz=5mm

Reference Value = 21.34 V/m; Power Drift = 0.03 dB

Peak SAR (extrapolated) = 0.829 W/kg

**SAR(1 g) = 0.522 W/kg; SAR(10 g) = 0.298 W/kg**

Maximum value of SAR (measured) = 0.625 W/kg

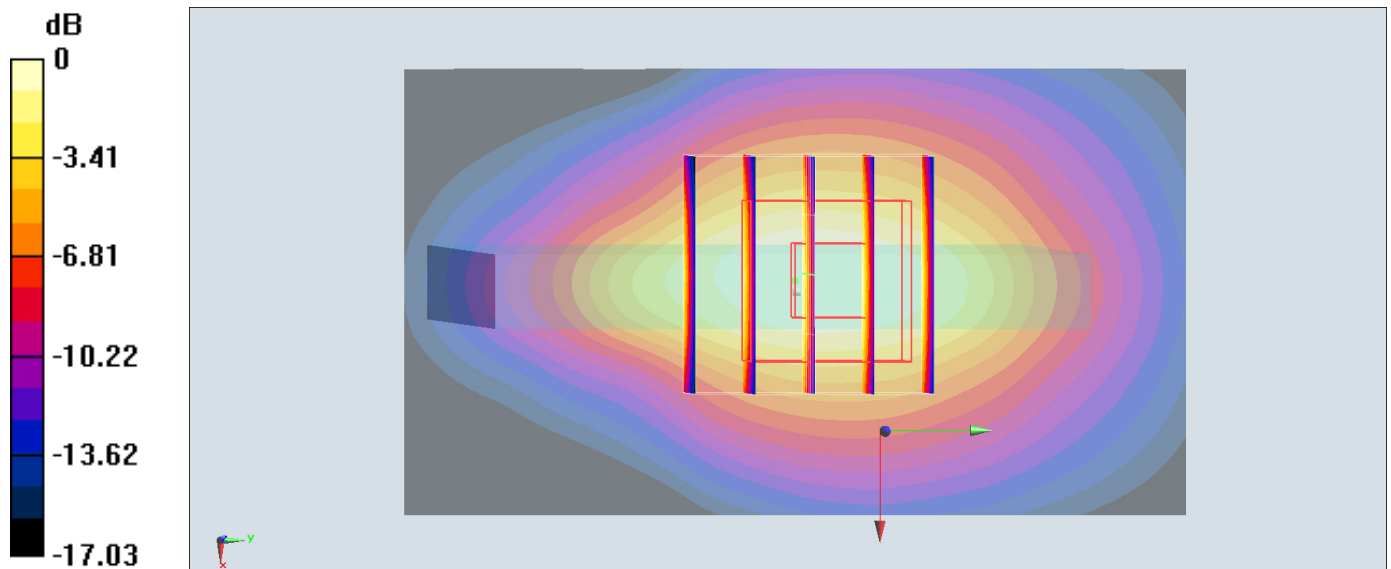

0 dB = 0.625 W/kg = -2.04 dBW/kg

**#23\_LTE Band 4\_20M\_QPSK\_1\_0\_Bottom Side\_10mm\_Ch20175**

Communication System: LTE ; Frequency: 1732.5 MHz;Duty Cycle: 1:1

Medium: MSL\_1750\_170114 Medium parameters used :  $f = 1732.5$  MHz;  $\sigma = 1.475$  S/m;  $\epsilon_r =$

$54.638$ ;  $\rho = 1000$  kg/m<sup>3</sup>

Ambient Temperature : 23.4 °C ; Liquid Temperature : 22.4 °C

DASY5 Configuration:

- Probe: ES3DV3 - SN3270; ConvF(4.95, 4.95, 4.95); Calibrated: 2016/8/26;

- Sensor-Surface: 3mm (Mechanical Surface Detection)

- Electronics: DAE4 Sn778; Calibrated: 2016/5/12

- Phantom: SAM-Right; Type: SAM; Serial: 1795

- Measurement SW: DASY52, Version 52.8 (8);SEMCAD X Version 14.6.10 (7331)

**Area Scan (41x81x1):** Interpolated grid: dx=1.500 mm, dy=1.500 mm

Maximum value of SAR (interpolated) = 1.19 W/kg

**Zoom Scan (5x5x7)/Cube 0:** Measurement grid: dx=8mm, dy=8mm, dz=5mm

Reference Value = 28.78 V/m; Power Drift = -0.13 dB

Peak SAR (extrapolated) = 1.46 W/kg

**SAR(1 g) = 0.919 W/kg; SAR(10 g) = 0.514 W/kg**

Maximum value of SAR (measured) = 1.09 W/kg

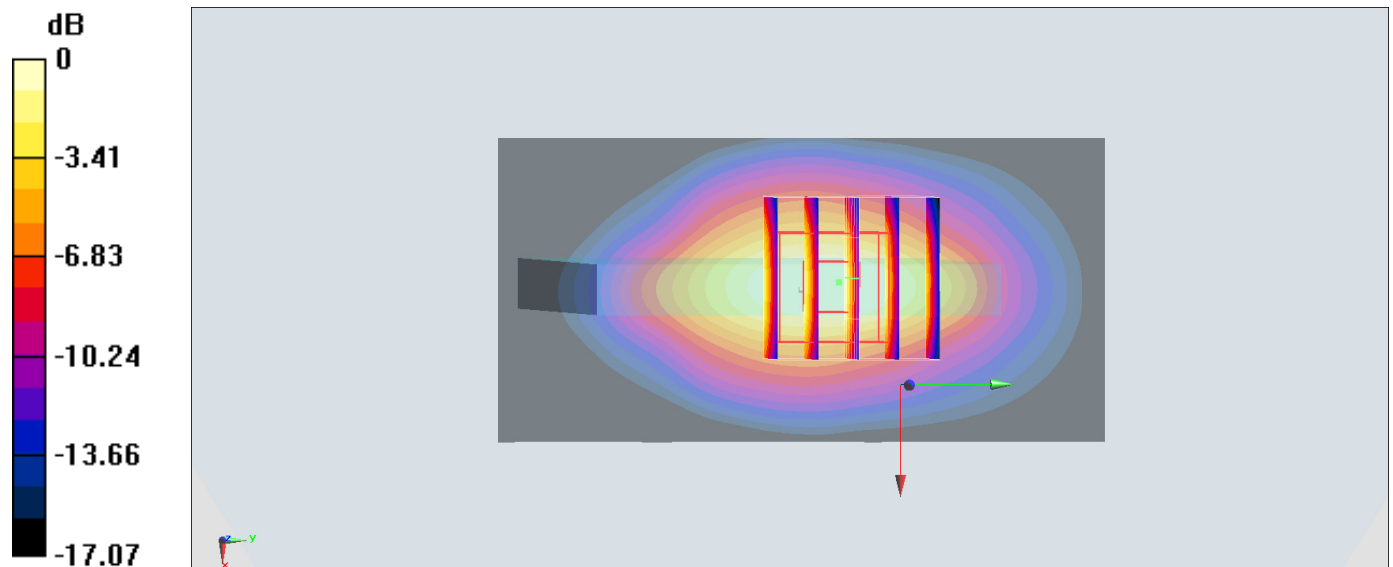

0 dB = 1.09 W/kg = 0.37 dBW/kg



## #24\_LTE Band 5\_10M\_QPSK\_1\_0\_Back\_10mm\_Ch20525

Communication System: LTE ; Frequency: 836.5 MHz; Duty Cycle: 1:1

Medium: MSL\_850\_170115 Medium parameters used :  $f = 836.5$  MHz;  $\sigma = 0.939$  S/m;  $\epsilon_r = 55.441$ ;  $\rho = 1000$  kg/m<sup>3</sup>

Ambient Temperature : 23.4 °C ; Liquid Temperature : 22.4 °C

DASY5 Configuration:

- Probe: ES3DV3 - SN3270; ConvF(6.01, 6.01, 6.01); Calibrated: 2016/8/26;
- Sensor-Surface: 3mm (Mechanical Surface Detection)
- Electronics: DAE4 Sn778; Calibrated: 2016/5/12
- Phantom: SAM\_Left; Type: QD000P40CD; Serial: TP:1644
- Measurement SW: DASY52, Version 52.8 (8); SEMCAD X Version 14.6.10 (7331)

**Area Scan (71x131x1):** Interpolated grid: dx=1.500 mm, dy=1.500 mm

Maximum value of SAR (interpolated) = 0.131 W/kg

**Zoom Scan (6x8x7)/Cube 0:** Measurement grid: dx=8mm, dy=8mm, dz=5mm

Reference Value = 9.544 V/m; Power Drift = 0.05 dB

Peak SAR (extrapolated) = 0.159 W/kg

**SAR(1 g) = 0.108 W/kg; SAR(10 g) = 0.074 W/kg**

Maximum value of SAR (measured) = 0.124 W/kg

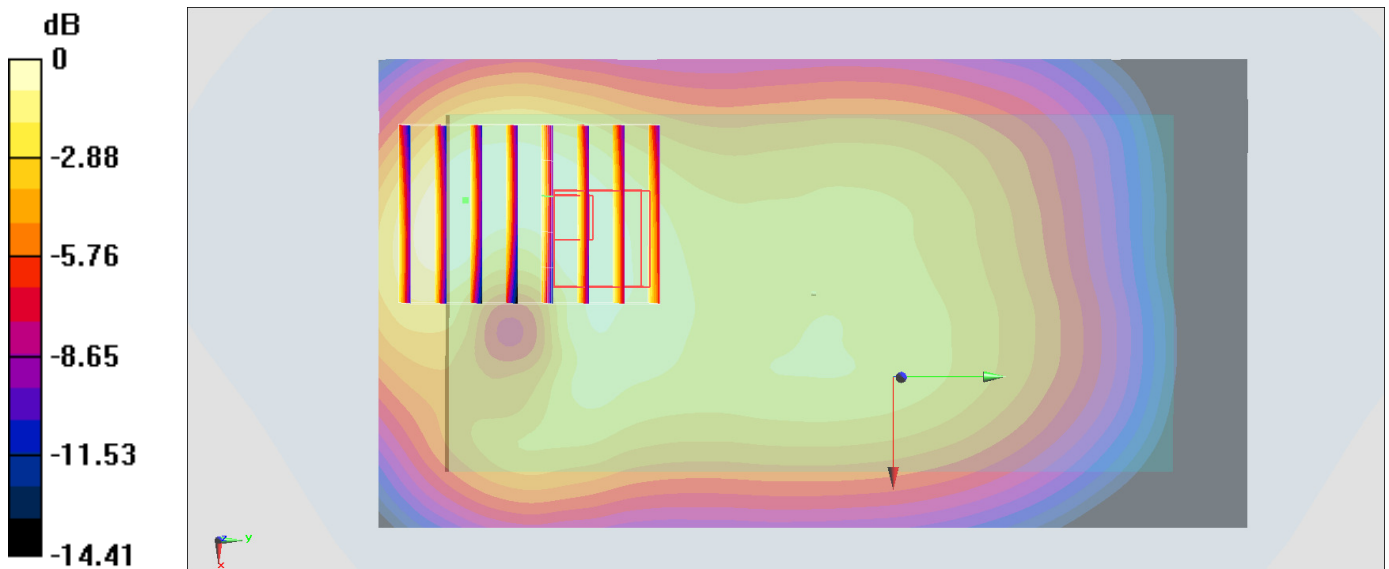

0 dB = 0.124 W/kg = -9.07 dBW/kg

## #25\_LTE Band 7\_20M\_QPSK\_1\_0\_Bottom Side\_10mm\_Ch21350

Communication System: LTE; Frequency: 2560 MHz; Duty Cycle: 1:1

Medium: MSL\_2600\_170110 Medium parameters used:  $f = 2560$  MHz;  $\sigma = 2.102$  S/m;  $\epsilon_r = 53.034$ ;  $\rho = 1000$  kg/m<sup>3</sup>

Ambient Temperature : 23.1 °C; Liquid Temperature : 22.1 °C

DASY5 Configuration:

- Probe: ES3DV3 - SN3270; ConvF(4.12, 4.12, 4.12); Calibrated: 2016/8/26;
- Sensor-Surface: 3mm (Mechanical Surface Detection)
- Electronics: DAE4 Sn778; Calibrated: 2016/5/12
- Phantom: SAM-Right; Type: SAM; Serial: 1795
- Measurement SW: DASY52, Version 52.8 (8); SEMCAD X Version 14.6.10 (7331)

**Area Scan (51x111x1):** Interpolated grid: dx=1.200 mm, dy=1.200 mm

Maximum value of SAR (interpolated) = 1.05 W/kg

**Zoom Scan (7x7x7)/Cube 0:** Measurement grid: dx=5mm, dy=5mm, dz=5mm

Reference Value = 22.45 V/m; Power Drift = -0.16 dB

Peak SAR (extrapolated) = 1.48 W/kg

**SAR(1 g) = 0.773 W/kg; SAR(10 g) = 0.400 W/kg**

Maximum value of SAR (measured) = 0.980 W/kg

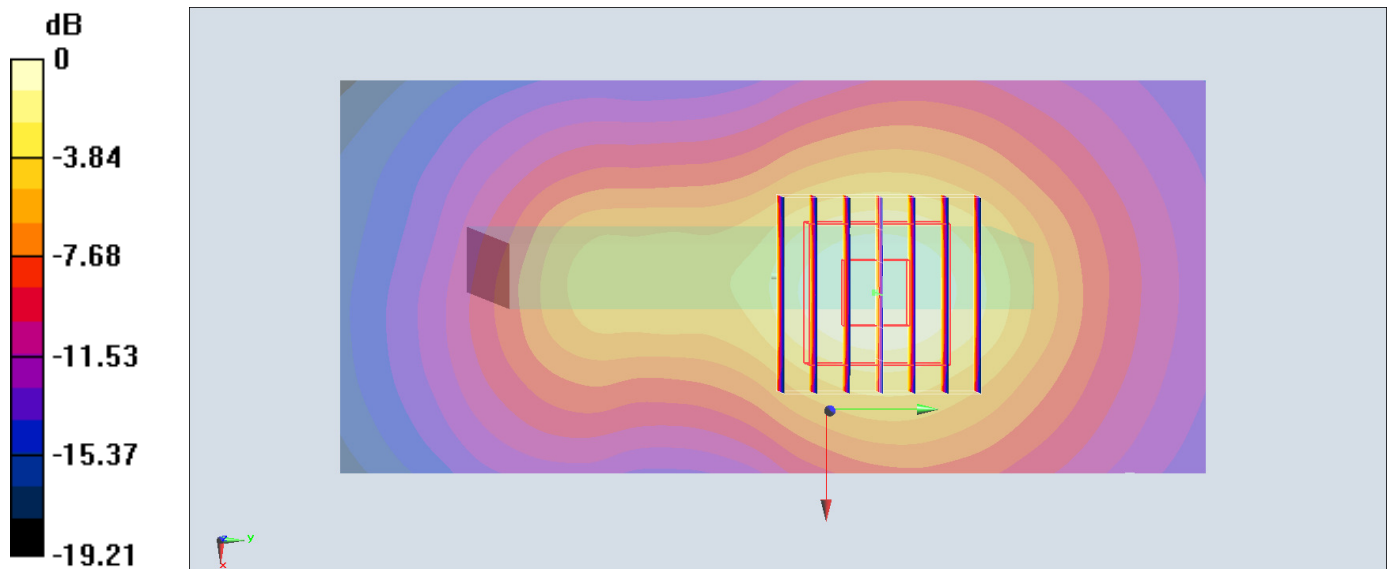

0 dB = 0.980 W/kg = -0.09 dBW/kg

## #26\_LTE Band 12\_10M\_QPSK\_1\_49\_Back\_10mm\_Ch23095

Communication System: LTE; Frequency: 707.5 MHz; Duty Cycle: 1:1

Medium: MSL\_750\_170115 Medium parameters used:  $f = 707.5$  MHz;  $\sigma = 0.916$  S/m;  $\epsilon_r = 56.506$ ;  $\rho = 1000$  kg/m<sup>3</sup>

Ambient Temperature : 23.4 °C ; Liquid Temperature : 22.4 °C

DASY5 Configuration:

- Probe: ES3DV3 - SN3270; ConvF(6.09, 6.09, 6.09); Calibrated: 2016/8/26;
- Sensor-Surface: 3mm (Mechanical Surface Detection)
- Electronics: DAE4 Sn778; Calibrated: 2016/5/12
- Phantom: SAM\_Left; Type: QD000P40CD; Serial: TP:1644
- Measurement SW: DASY52, Version 52.8 (8); SEMCAD X Version 14.6.10 (7331)

**Area Scan (71x131x1):** Interpolated grid: dx=1.500 mm, dy=1.500 mm

Maximum value of SAR (interpolated) = 0.137 W/kg

**Zoom Scan (5x5x7)/Cube 0:** Measurement grid: dx=8mm, dy=8mm, dz=5mm

Reference Value = 11.96 V/m; Power Drift = -0.01 dB

Peak SAR (extrapolated) = 0.172 W/kg

**SAR(1 g) = 0.124 W/kg; SAR(10 g) = 0.088 W/kg**

Maximum value of SAR (measured) = 0.139 W/kg

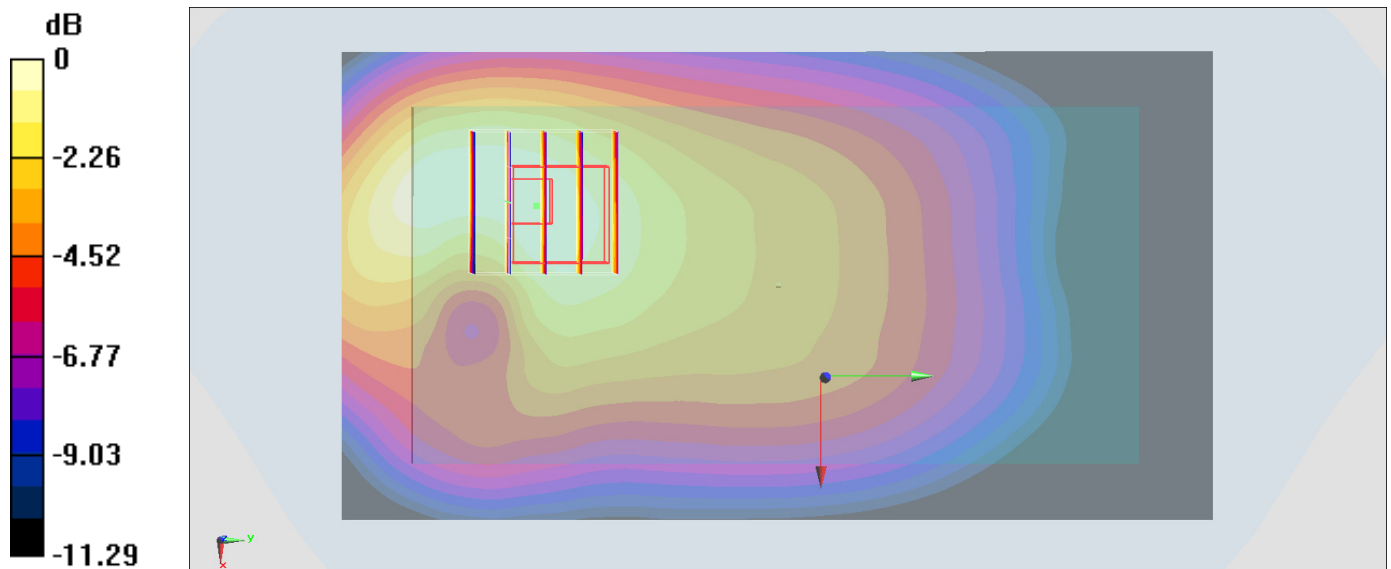

0 dB = 0.139 W/kg = -8.57 dBW/kg

## #27\_LTE Band 41\_20M\_QPSK\_1\_0\_Bottom Side\_10mm\_Ch40620

Communication System: LTE; Frequency: 2593 MHz; Duty Cycle: 1:1.59

Medium: MSL\_2600\_170112 Medium parameters used:  $f = 2593$  MHz;  $\sigma = 2.193$  S/m;  $\epsilon_r = 51.989$ ;  $\rho = 1000$  kg/m<sup>3</sup>

Ambient Temperature : 23.3 °C; Liquid Temperature : 22.3 °C

DASY5 Configuration:

- Probe: ES3DV3 - SN3270; ConvF(4.12, 4.12, 4.12); Calibrated: 2016/8/26;
- Sensor-Surface: 3mm (Mechanical Surface Detection)
- Electronics: DAE4 Sn778; Calibrated: 2016/5/12
- Phantom: SAM-Right; Type: SAM; Serial: 1795
- Measurement SW: DASY52, Version 52.8 (8); SEMCAD X Version 14.6.10 (7331)

**Area Scan (51x81x1):** Interpolated grid: dx=1.200 mm, dy=1.200 mm

Maximum value of SAR (interpolated) = 0.766 W/kg

**Zoom Scan (7x7x7)/Cube 0:** Measurement grid: dx=5mm, dy=5mm, dz=5mm

Reference Value = 18.73 V/m; Power Drift = 0.04 dB

Peak SAR (extrapolated) = 1.11 W/kg

**SAR(1 g) = 0.578 W/kg; SAR(10 g) = 0.294 W/kg**

Maximum value of SAR (measured) = 0.728 W/kg

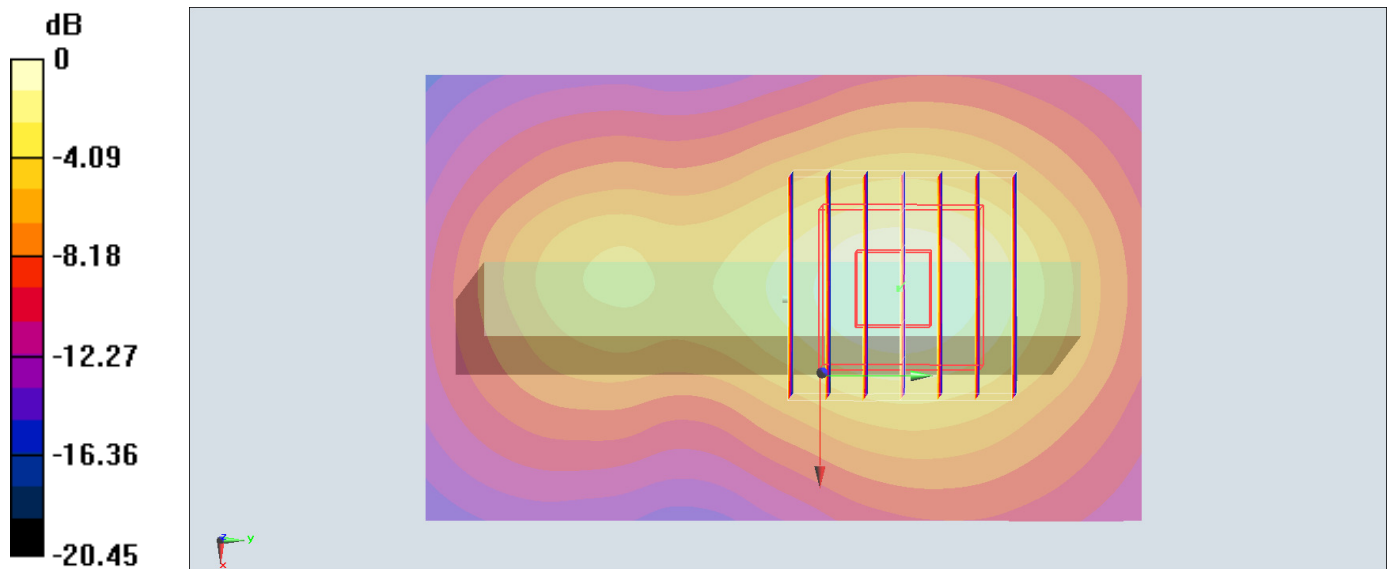

0 dB = 0.728 W/kg = -1.38 dBW/kg

**#28\_WLAN2.4GHz\_802.11b 1Mbps\_Back\_10mm\_Ch6;Ant 2**

Communication System: 802.11b ; Frequency: 2437 MHz;Duty Cycle: 1:1.013

Medium: MSL\_2450\_161228 Medium parameters used :  $f = 2437$  MHz;  $\sigma = 1.937$  S/m;  $\epsilon_r = 53.018$ ;  $\rho = 1000$  kg/m<sup>3</sup>

Ambient Temperature : 23.4 °C ; Liquid Temperature : 22.4 °C

DASY5 Configuration:

- Probe: EX3DV4 - SN3955; ConvF(7.65, 7.65, 7.65); Calibrated: 2016/11/24;
- Sensor-Surface: 1.4mm (Mechanical Surface Detection)
- Electronics: DAE3 Sn495; Calibrated: 2016/5/27
- Phantom: SAM\_Left; Type: QD 000 P40 CB; Serial: TP-1478
- Measurement SW: DASY52, Version 52.8 (8);SEMCAD X Version 14.6.10 (7331)

**Area Scan (91x51x1):** Interpolated grid: dx=1.200 mm, dy=1.200 mm

Maximum value of SAR (interpolated) = 0.144 W/kg

**Zoom Scan (7x7x7)/Cube 0:** Measurement grid: dx=5mm, dy=5mm, dz=5mm

Reference Value = 7.623 V/m; Power Drift = -0.13 dB

Peak SAR (extrapolated) = 0.158 W/kg

**SAR(1 g) = 0.088 W/kg; SAR(10 g) = 0.040 W/kg**

Maximum value of SAR (measured) = 0.132 W/kg

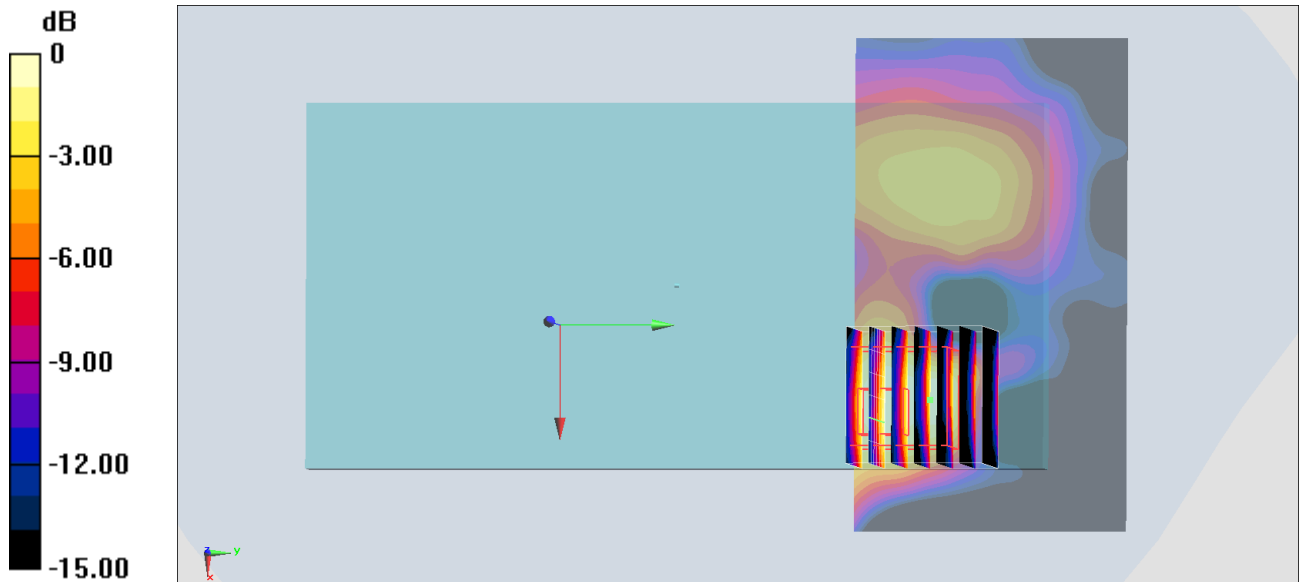

0 dB = 0.132 W/kg = -8.79 dBW/kg

## #29\_WLAN5GHz\_802.11ac-VHT80 MCS0\_Front\_10mm\_Ch42;Ant 1

Communication System: 802.11ac ; Frequency: 5210 MHz;Duty Cycle: 1:1.052

Medium: MSL\_5G\_170105 Medium parameters used:  $f = 5210$  MHz;  $\sigma = 5.375$  S/m;  $\epsilon_r = 47.069$ ;  $\rho = 1000$  kg/m<sup>3</sup>

Ambient Temperature : 23.6 °C ; Liquid Temperature : 22.6 °C

DASY5 Configuration:

- Probe: EX3DV4 - SN3931; ConvF(4.57, 4.57, 4.57); Calibrated: 2016/10/3;
- Sensor-Surface: 1.4mm (Mechanical Surface Detection)
- Electronics: DAE3 Sn577; Calibrated: 2016/9/28
- Phantom: SAM\_Right; Type: QD000P40CD; Serial: TP:1383
- Measurement SW: DASY52, Version 52.8 (8);SEMCAD X Version 14.6.10 (7331)

**Area Scan (101x101x1):** Interpolated grid: dx=1.000 mm, dy=1.000 mm

Maximum value of SAR (interpolated) = 0.120 W/kg

**Zoom Scan (8x8x7)/Cube 0:** Measurement grid: dx=4mm, dy=4mm, dz=1.4mm

Reference Value = 4.029 V/m; Power Drift = -0.01 dB

Peak SAR (extrapolated) = 0.190 W/kg

**SAR(1 g) = 0.051 W/kg; SAR(10 g) = 0.023 W/kg**

Maximum value of SAR (measured) = 0.106 W/kg

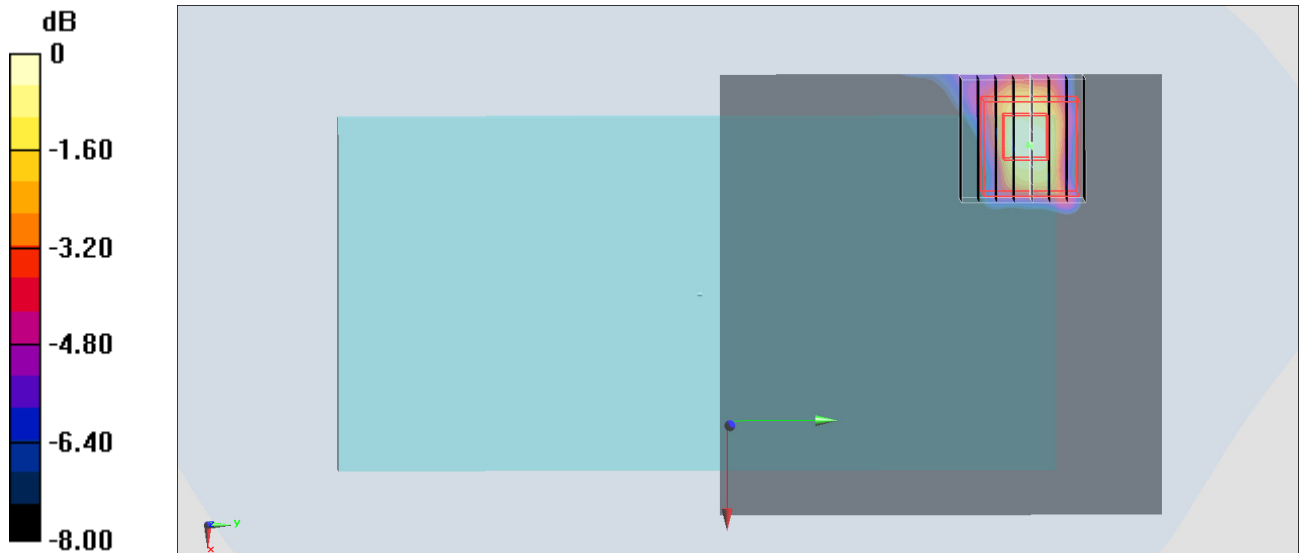

0 dB = 0.106 W/kg = -9.75 dBW/kg

**#30\_WLAN5GHz\_802.11ac-VHT80 MCS0\_Back\_10mm\_Ch155;Ant 2**

Communication System: 802.11ac ; Frequency: 5775 MHz;Duty Cycle: 1:1.053

Medium: MSL\_5G\_161229 Medium parameters used:  $f = 5775$  MHz;  $\sigma = 6.13$  S/m;  $\epsilon_r = 45.995$ ;  $\rho = 1000$  kg/m<sup>3</sup>

Ambient Temperature : 23.4 °C ; Liquid Temperature : 22.4 °C

DASY5 Configuration:

- Probe: EX3DV4 - SN3955; ConvF(4.12, 4.12, 4.12); Calibrated: 2016/11/24;
- Sensor-Surface: 1.4mm (Mechanical Surface Detection)
- Electronics: DAE3 Sn495; Calibrated: 2016/5/27
- Phantom: SAM\_Right; Type: QD000P40CD; Serial: TP:1383
- Measurement SW: DASY52, Version 52.8 (8);SEMCAD X Version 14.6.10 (7331)

**Area Scan (101x61x1):** Interpolated grid: dx=1.000 mm, dy=1.000 mm

Maximum value of SAR (interpolated) = 0.283 W/kg

**Zoom Scan (7x7x7)/Cube 0:** Measurement grid: dx=4mm, dy=4mm, dz=1.4mm

Reference Value = 7.473 V/m; Power Drift = 0.07 dB

Peak SAR (extrapolated) = 0.476 W/kg

**SAR(1 g) = 0.097 W/kg; SAR(10 g) = 0.024 W/kg**

Maximum value of SAR (measured) = 0.272 W/kg

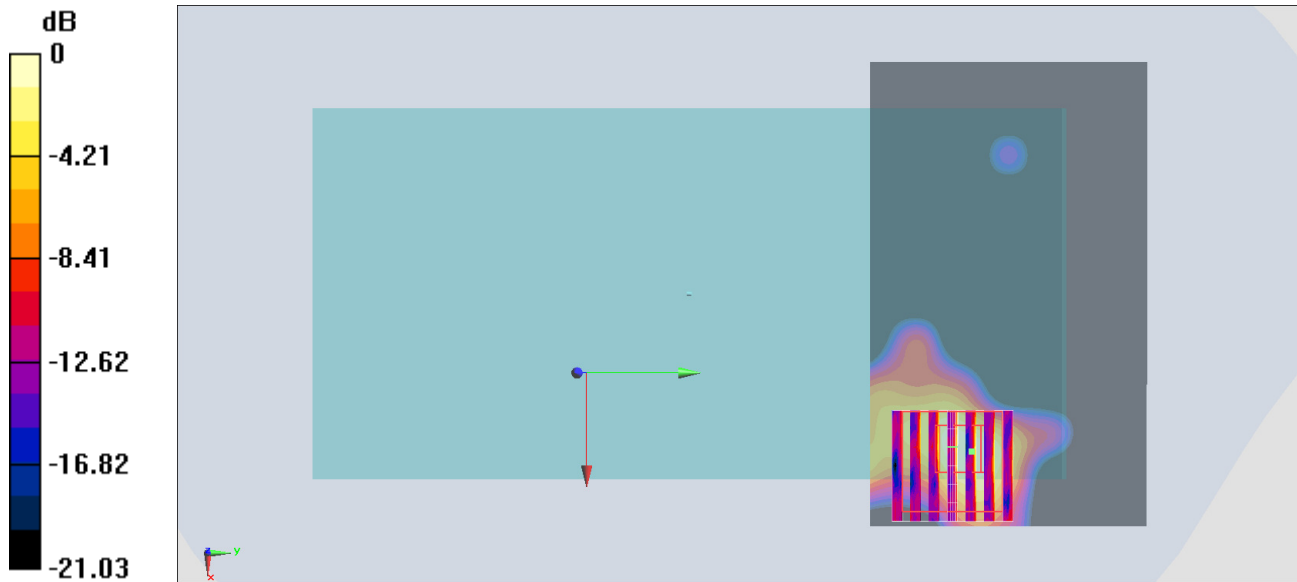

0 dB = 0.272 W/kg = -5.65 dBW/kg

**#31\_WLAN5GHz\_802.11ac-VHT80 MCS0\_Front\_0mm\_Ch58;Ant 1**

Communication System: 802.11ac ; Frequency: 5290 MHz;Duty Cycle: 1:1.052

Medium: MSL\_5G\_170105 Medium parameters used:  $f = 5290$  MHz;  $\sigma = 5.478$  S/m;  $\epsilon_r = 46.931$ ;  $\rho = 1000$  kg/m<sup>3</sup>

Ambient Temperature : 23.6 °C ; Liquid Temperature : 22.6 °C

DASY5 Configuration:

- Probe: EX3DV4 - SN3931; ConvF(4.57, 4.57, 4.57); Calibrated: 2016/10/3;
- Sensor-Surface: 1.4mm (Mechanical Surface Detection)
- Electronics: DAE3 Sn577; Calibrated: 2016/9/28
- Phantom: SAM\_Right; Type: QD000P40CD; Serial: TP:1383
- Measurement SW: DASY52, Version 52.8 (8);SEMCAD X Version 14.6.10 (7331)

**Area Scan (101x101x1):** Interpolated grid: dx=1.000 mm, dy=1.000 mm

Maximum value of SAR (interpolated) = 1.64 W/kg

**Zoom Scan (9x9x7)/Cube 0:** Measurement grid: dx=4mm, dy=4mm, dz=1.4mm

Reference Value = 16.22 V/m; Power Drift = 0.11 dB

Peak SAR (extrapolated) = 11.7 W/kg

**SAR(1 g) = 1.3 W/kg; SAR(10 g) = 0.192 W/kg**

Maximum value of SAR (measured) = 4.82 W/kg

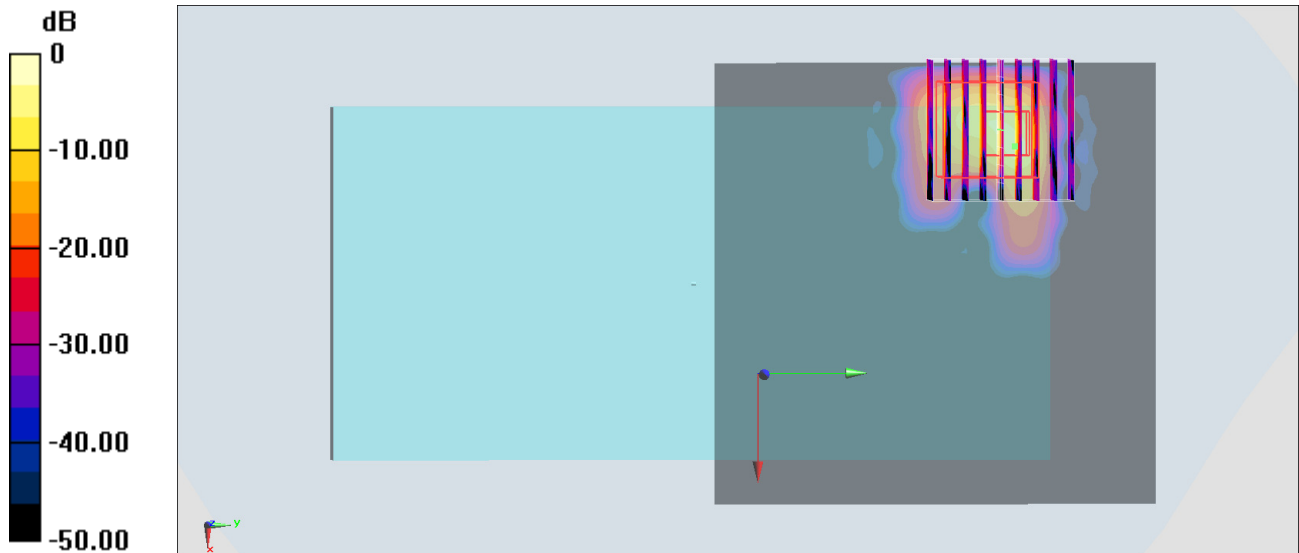

0 dB = 4.82 W/kg = 6.83 dBW/kg



**#32\_WLAN5GHz\_802.11n-HT40 MCS0\_Back\_0mm\_Ch110;Ant 2**

Communication System: 802.11n; Frequency: 5550 MHz; Duty Cycle: 1:1.032

Medium: MSL\_5G\_170105 Medium parameters used:  $f = 5550$  MHz;  $\sigma = 5.812$  S/m;  $\epsilon_r = 46.482$ ;  $\rho = 1000$  kg/m<sup>3</sup>

Ambient Temperature : 23.6 °C ; Liquid Temperature : 22.6 °C

DASY5 Configuration:

- Probe: EX3DV4 - SN3931; ConvF(3.71, 3.71, 3.71); Calibrated: 2016/10/3;
- Sensor-Surface: 1.4mm (Mechanical Surface Detection)
- Electronics: DAE3 Sn577; Calibrated: 2016/9/28
- Phantom: SAM\_Right; Type: QD000P40CD; Serial: TP:1383
- Measurement SW: DASY52, Version 52.8 (8); SEMCAD X Version 14.6.10 (7331)

**Area Scan (101x101x1):** Interpolated grid: dx=1.000 mm, dy=1.000 mm

Maximum value of SAR (interpolated) = 3.31 W/kg

**Zoom Scan (9x9x7)/Cube 0:** Measurement grid: dx=4mm, dy=4mm, dz=1.4mm

Reference Value = 11.28 V/m; Power Drift = -0.13 dB

Peak SAR (extrapolated) = 10.7 W/kg

**SAR(1 g) = 1.54 W/kg; SAR(10 g) = 0.333 W/kg**

Maximum value of SAR (measured) = 4.43 W/kg

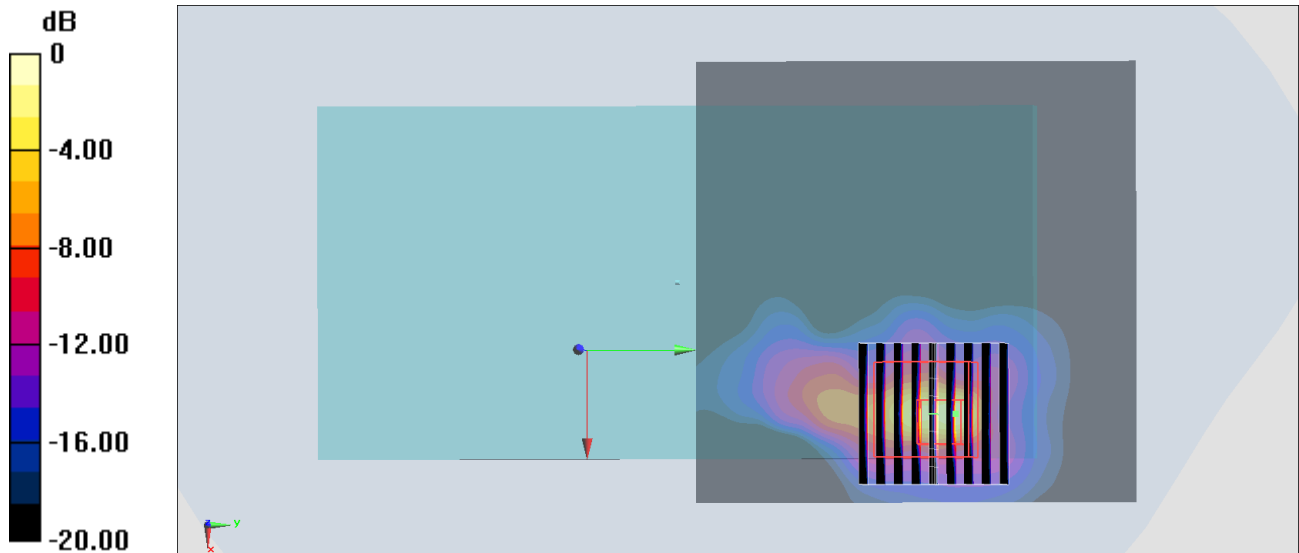

0 dB = 4.43 W/kg = 6.46 dBW/kg

### #33\_GSM850\_GPRS (4 Tx slots)\_Back\_10mm\_Ch128

Communication System: GSM850 ; Frequency: 824.2 MHz; Duty Cycle: 1:2.08

Medium: MSL\_850\_170115 Medium parameters used :  $f = 824.2$  MHz;  $\sigma = 0.928$  S/m;  $\epsilon_r = 55.555$ ;  $\rho = 1000$  kg/m<sup>3</sup>

Ambient Temperature : 23.4 °C ; Liquid Temperature : 22.4 °C

DASY5 Configuration:

- Probe: ES3DV3 - SN3270; ConvF(6.01, 6.01, 6.01); Calibrated: 2016/8/26;
- Sensor-Surface: 3mm (Mechanical Surface Detection)
- Electronics: DAE4 Sn778; Calibrated: 2016/5/12
- Phantom: SAM\_Left; Type: QD000P40CD; Serial: TP:1644
- Measurement SW: DASY52, Version 52.8 (8); SEMCAD X Version 14.6.10 (7331)

**Area Scan (71x131x1):** Interpolated grid: dx=1.500 mm, dy=1.500 mm

Maximum value of SAR (interpolated) = 0.193 W/kg

**Zoom Scan (5x5x7)/Cube 0:** Measurement grid: dx=8mm, dy=8mm, dz=5mm

Reference Value = 11.99 V/m; Power Drift = 0.17 dB

Peak SAR (extrapolated) = 0.260 W/kg

**SAR(1 g) = 0.182 W/kg; SAR(10 g) = 0.126 W/kg**

Maximum value of SAR (measured) = 0.209 W/kg

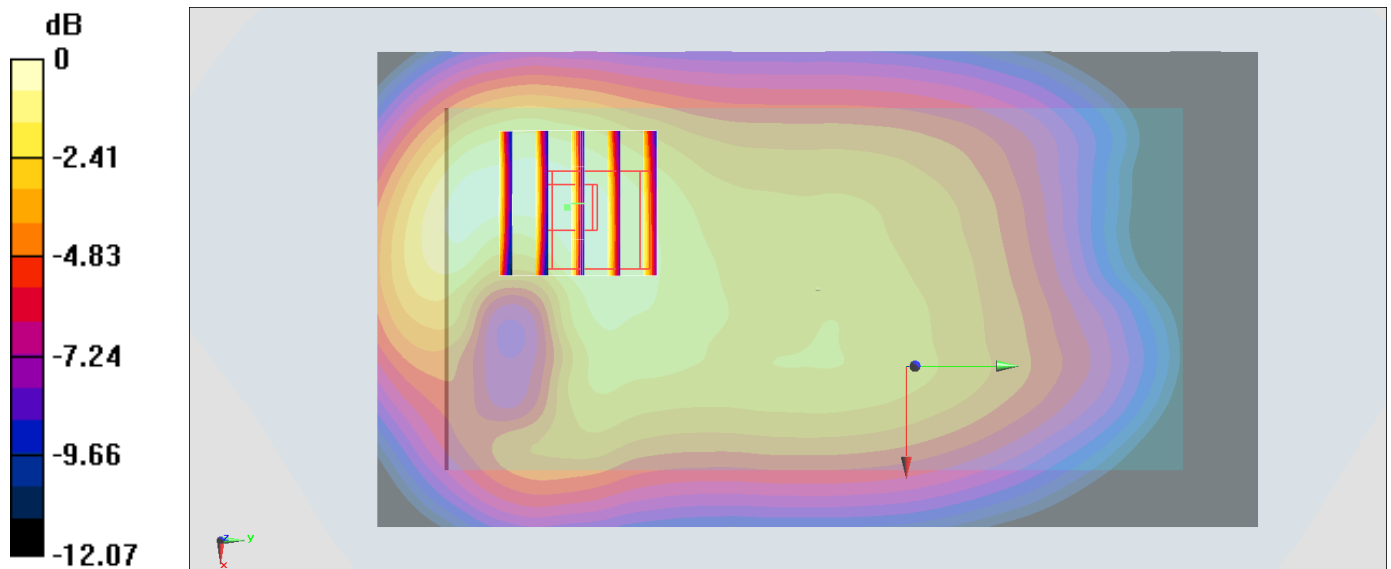

0 dB = 0.209 W/kg = -6.80 dBW/kg

### #34\_GSM1900\_GPRS (3 Tx slots)\_Back\_10mm\_Ch661

Communication System: PCS ; Frequency: 1880 MHz;Duty Cycle: 1:2.77

Medium: MSL\_1900\_170113 Medium parameters used:  $f = 1880 \text{ MHz}$ ;  $\sigma = 1.529 \text{ S/m}$ ;  $\epsilon_r = 55.025$ ;  $\rho = 1000 \text{ kg/m}^3$

Ambient Temperature :  $23.6 \text{ }^\circ\text{C}$ ; Liquid Temperature :  $22.6 \text{ }^\circ\text{C}$

DASY5 Configuration:

- Probe: ES3DV3 - SN3270; ConvF(4.7, 4.7, 4.7); Calibrated: 2016/8/26;
- Sensor-Surface: 3mm (Mechanical Surface Detection)
- Electronics: DAE4 Sn778; Calibrated: 2016/5/12
- Phantom: SAM-Right; Type: SAM; Serial: 1795
- Measurement SW: DASY52, Version 52.8 (8);SEMCAD X Version 14.6.10 (7331)

**Area Scan (71x131x1):** Interpolated grid:  $dx=1.500 \text{ mm}$ ,  $dy=1.500 \text{ mm}$

Maximum value of SAR (interpolated) =  $0.265 \text{ W/kg}$

**Zoom Scan (5x5x7)/Cube 0:** Measurement grid:  $dx=8\text{mm}$ ,  $dy=8\text{mm}$ ,  $dz=5\text{mm}$

Reference Value =  $10.30 \text{ V/m}$ ; Power Drift =  $-0.11 \text{ dB}$

Peak SAR (extrapolated) =  $0.375 \text{ W/kg}$

**SAR(1 g) =  $0.237 \text{ W/kg}$ ; SAR(10 g) =  $0.136 \text{ W/kg}$**

Maximum value of SAR (measured) =  $0.290 \text{ W/kg}$

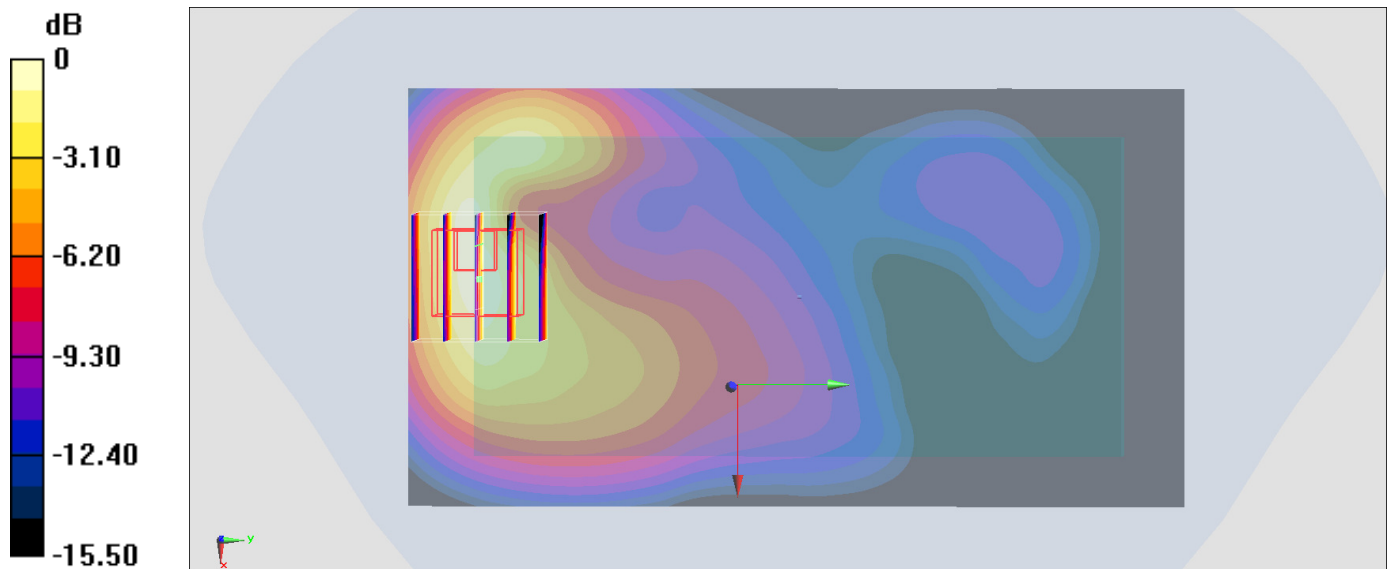

0 dB =  $0.290 \text{ W/kg}$  =  $-5.38 \text{ dBW/kg}$

### #35\_WCDMA II\_RMC 12.2Kbps\_Back\_10mm\_Ch9400

Communication System: WCDMA ; Frequency: 1880 MHz;Duty Cycle: 1:1

Medium: MSL\_1900\_170113 Medium parameters used:  $f = 1880$  MHz;  $\sigma = 1.529$  S/m;  $\epsilon_r = 55.025$ ;  $\rho = 1000$  kg/m<sup>3</sup>

Ambient Temperature : 23.6 °C ; Liquid Temperature : 22.6 °C

DASY5 Configuration:

- Probe: ES3DV3 - SN3270; ConvF(4.7, 4.7, 4.7); Calibrated: 2016/8/26;
- Sensor-Surface: 3mm (Mechanical Surface Detection)
- Electronics: DAE4 Sn778; Calibrated: 2016/5/12
- Phantom: SAM-Right; Type: SAM; Serial: 1795
- Measurement SW: DASY52, Version 52.8 (8);SEMCAD X Version 14.6.10 (7331)

**Area Scan (71x131x1):** Interpolated grid: dx=1.500 mm, dy=1.500 mm

Maximum value of SAR (interpolated) = 0.274 W/kg

**Zoom Scan (5x5x7)/Cube 0:** Measurement grid: dx=8mm, dy=8mm, dz=5mm

Reference Value = 11.35 V/m; Power Drift = -0.02 dB

Peak SAR (extrapolated) = 0.402 W/kg

**SAR(1 g) = 0.248 W/kg; SAR(10 g) = 0.142 W/kg**

Maximum value of SAR (measured) = 0.308 W/kg

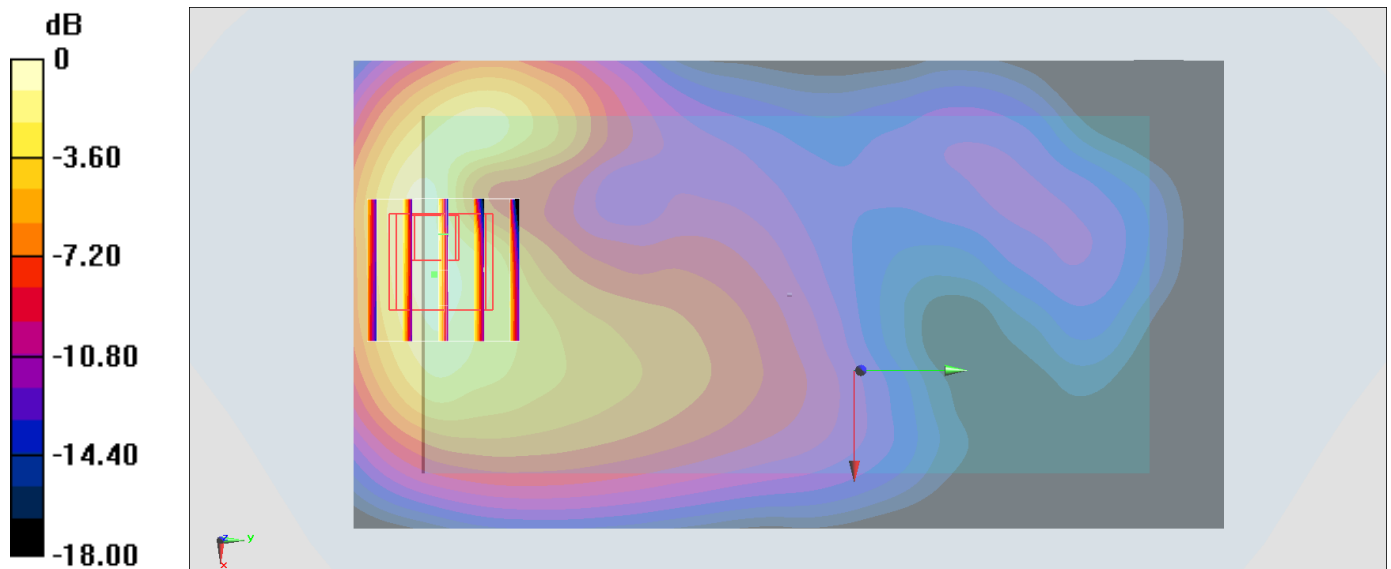

0 dB = 0.308 W/kg = -5.11 dBW/kg

### #36\_WCDMA IV\_RMC 12.2Kbps\_Back\_10mm\_Ch1312

Communication System: WCDMA ; Frequency: 1712.4 MHz; Duty Cycle: 1:1

Medium: MSL\_1750\_170114 Medium parameters used:  $f = 1712.4$  MHz;  $\sigma = 1.454$  S/m;  $\epsilon_r = 54.722$ ;

$\rho = 1000$  kg/m<sup>3</sup>

Ambient Temperature : 23.4 °C ; Liquid Temperature : 22.4 °C

DASY5 Configuration:

- Probe: ES3DV3 - SN3270; ConvF(4.95, 4.95, 4.95); Calibrated: 2016/8/26;
- Sensor-Surface: 3mm (Mechanical Surface Detection)
- Electronics: DAE4 Sn778; Calibrated: 2016/5/12
- Phantom: SAM-Right; Type: SAM; Serial: 1795
- Measurement SW: DASY52, Version 52.8 (8); SEMCAD X Version 14.6.10 (7331)

**Area Scan (71x131x1):** Interpolated grid: dx=1.500 mm, dy=1.500 mm

Maximum value of SAR (interpolated) = 0.669 W/kg

**Zoom Scan (5x5x7)/Cube 0:** Measurement grid: dx=8mm, dy=8mm, dz=5mm

Reference Value = 11.35 V/m; Power Drift = -0.04 dB

Peak SAR (extrapolated) = 0.928 W/kg

**SAR(1 g) = 0.583 W/kg; SAR(10 g) = 0.325 W/kg**

Maximum value of SAR (measured) = 0.717 W/kg

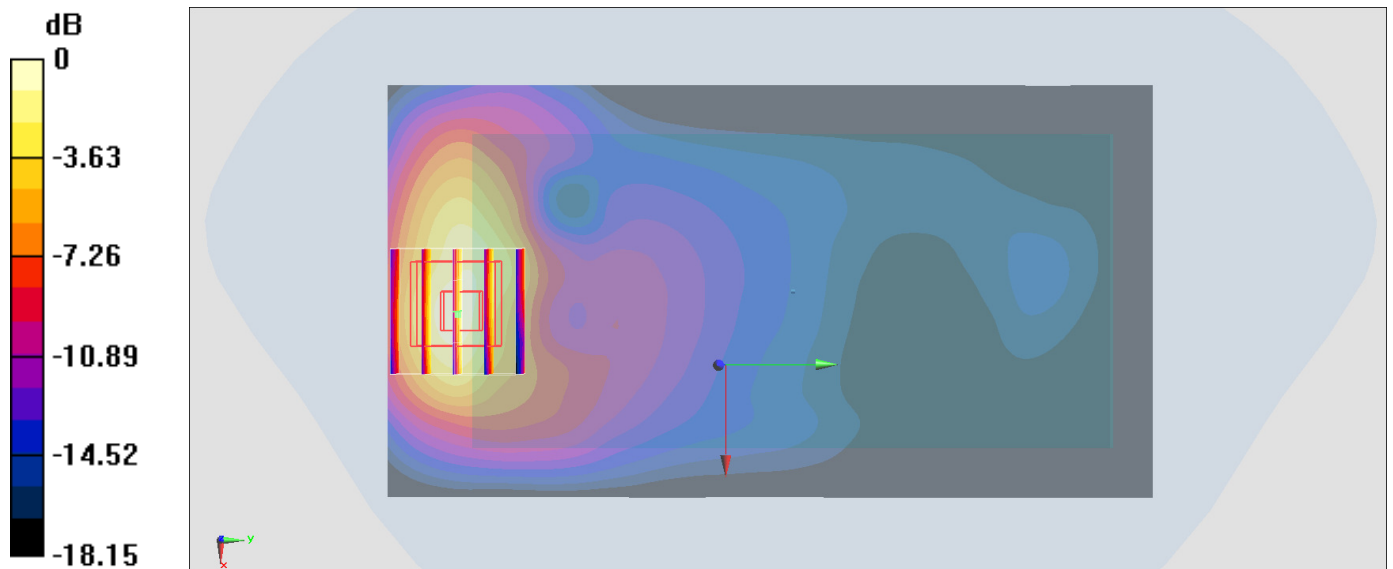

0 dB = 0.717 W/kg = -1.44 dBW/kg

### #37\_WCDMA V\_RMC 12.2Kbps\_Back\_10mm\_Ch4132

Communication System: WCDMA; Frequency: 826.4 MHz; Duty Cycle: 1:1

Medium: MSL\_850\_170115 Medium parameters used:  $f = 826.4$  MHz;  $\sigma = 0.93$  S/m;  $\epsilon_r = 55.535$ ;  $\rho = 1000$  kg/m<sup>3</sup>

Ambient Temperature : 23.4 °C; Liquid Temperature : 22.4 °C

DASY5 Configuration:

- Probe: ES3DV3 - SN3270; ConvF(6.01, 6.01, 6.01); Calibrated: 2016/8/26;
- Sensor-Surface: 3mm (Mechanical Surface Detection)
- Electronics: DAE4 Sn778; Calibrated: 2016/5/12
- Phantom: SAM\_Left; Type: QD000P40CD; Serial: TP:1644
- Measurement SW: DASY52, Version 52.8 (8); SEMCAD X Version 14.6.10 (7331)

**Area Scan (71x131x1):** Interpolated grid: dx=1.500 mm, dy=1.500 mm

Maximum value of SAR (interpolated) = 0.177 W/kg

**Zoom Scan (5x5x7)/Cube 0:** Measurement grid: dx=8mm, dy=8mm, dz=5mm

Reference Value = 14.13 V/m; Power Drift = -0.04 dB

Peak SAR (extrapolated) = 0.220 W/kg

**SAR(1 g) = 0.156 W/kg; SAR(10 g) = 0.109 W/kg**

Maximum value of SAR (measured) = 0.176 W/kg

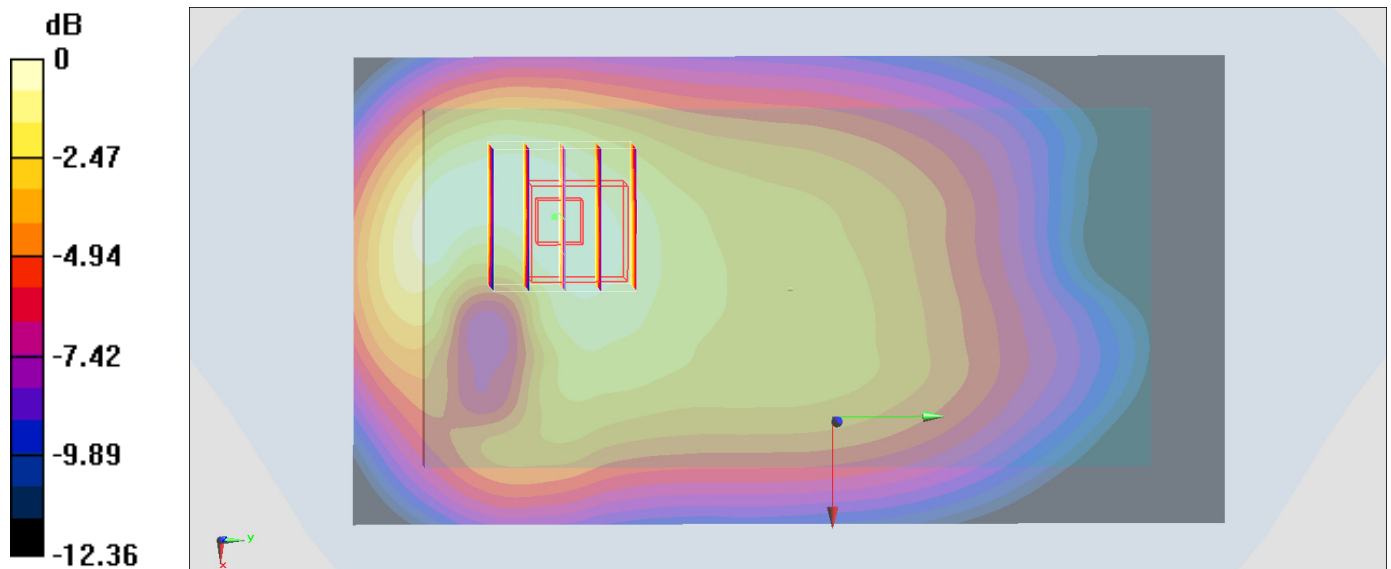

0 dB = 0.176 W/kg = -7.54 dBW/kg

### #38\_LTE Band 2\_20M\_QPSK\_1\_99\_Back\_10mm\_Ch18700

Communication System: LTE; Frequency: 1860 MHz; Duty Cycle: 1:1

Medium: MSL\_1900\_170113 Medium parameters used:  $f = 1860$  MHz;  $\sigma = 1.507$  S/m;  $\epsilon_r = 55.102$ ;  $\rho = 1000$  kg/m<sup>3</sup>

Ambient Temperature : 23.6 °C ; Liquid Temperature : 22.6 °C

DASY5 Configuration:

- Probe: ES3DV3 - SN3270; ConvF(4.7, 4.7, 4.7); Calibrated: 2016/8/26;
- Sensor-Surface: 3mm (Mechanical Surface Detection)
- Electronics: DAE4 Sn778; Calibrated: 2016/5/12
- Phantom: SAM-Right; Type: SAM; Serial: 1795
- Measurement SW: DASY52, Version 52.8 (8); SEMCAD X Version 14.6.10 (7331)

**Area Scan (71x131x1):** Interpolated grid: dx=1.500 mm, dy=1.500 mm

Maximum value of SAR (interpolated) = 0.271 W/kg

**Zoom Scan (5x5x7)/Cube 0:** Measurement grid: dx=8mm, dy=8mm, dz=5mm

Reference Value = 13.07 V/m; Power Drift = 0.02 dB

Peak SAR (extrapolated) = 0.404 W/kg

**SAR(1 g) = 0.251 W/kg; SAR(10 g) = 0.144 W/kg**

Maximum value of SAR (measured) = 0.309 W/kg

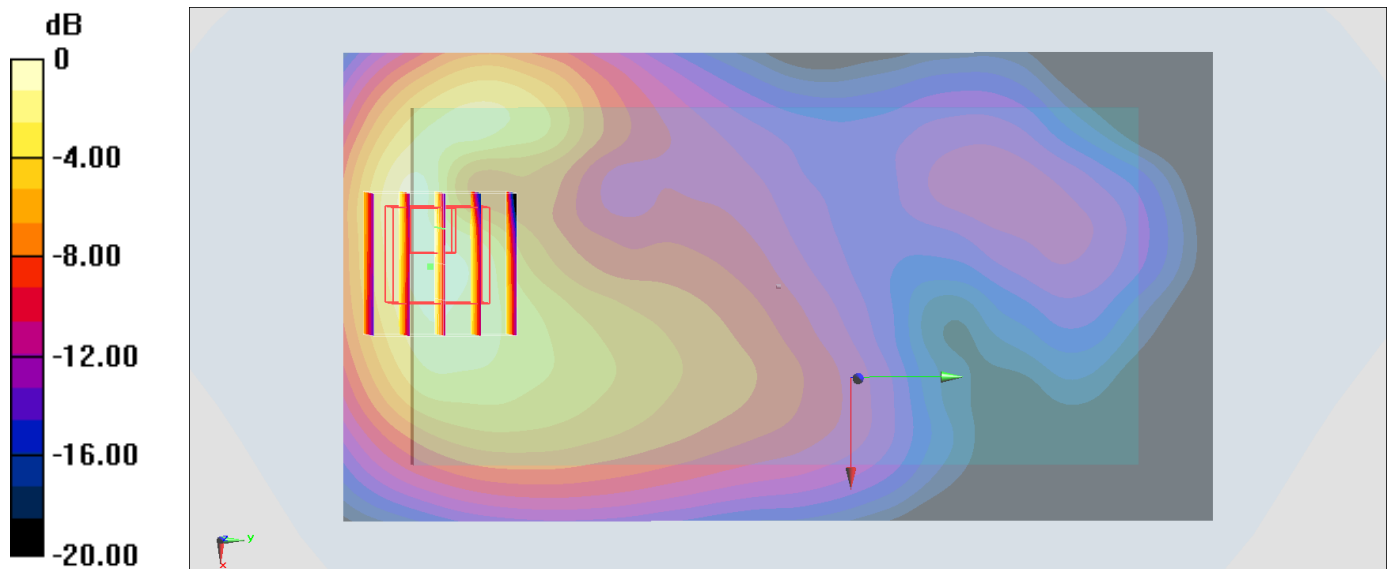

0 dB = 0.309 W/kg = -5.10 dBW/kg

### #39\_LTE Band 4\_20M\_QPSK\_1\_0\_Back\_10mm\_Ch20175

Communication System: LTE ; Frequency: 1732.5 MHz;Duty Cycle: 1:1

Medium: MSL\_1750\_170114 Medium parameters used:  $f = 1732.5$  MHz;  $\sigma = 1.475$  S/m;  $\epsilon_r = 54.638$ ;

$\rho = 1000$  kg/m<sup>3</sup>

Ambient Temperature : 23.4 °C ; Liquid Temperature : 22.4 °C

DASY5 Configuration:

- Probe: ES3DV3 - SN3270; ConvF(4.95, 4.95, 4.95); Calibrated: 2016/8/26;
- Sensor-Surface: 3mm (Mechanical Surface Detection)
- Electronics: DAE4 Sn778; Calibrated: 2016/5/12
- Phantom: SAM-Right; Type: SAM; Serial: 1795
- Measurement SW: DASY52, Version 52.8 (8);SEMCAD X Version 14.6.10 (7331)

**Area Scan (71x131x1):** Interpolated grid: dx=1.500 mm, dy=1.500 mm

Maximum value of SAR (interpolated) = 0.582 W/kg

**Zoom Scan (5x5x7)/Cube 0:** Measurement grid: dx=8mm, dy=8mm, dz=5mm

Reference Value = 16.70 V/m; Power Drift = -0.05 dB

Peak SAR (extrapolated) = 0.800 W/kg

**SAR(1 g) = 0.500 W/kg; SAR(10 g) = 0.274 W/kg**

Maximum value of SAR (measured) = 0.594 W/kg

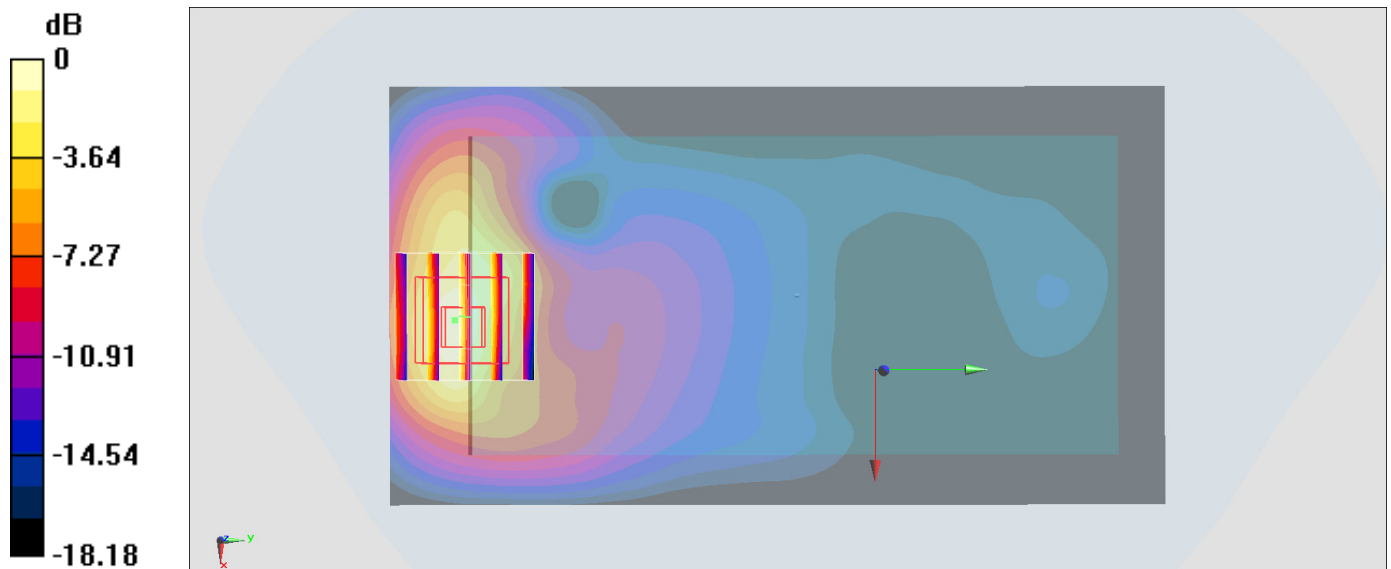

0 dB = 0.594 W/kg = -2.26 dBW/kg



## #40\_LTE Band 5\_10M\_QPSK\_1\_0\_Back\_10mm\_Ch20525

Communication System: LTE ; Frequency: 836.5 MHz; Duty Cycle: 1:1

Medium: MSL\_850\_170115 Medium parameters used :  $f = 836.5$  MHz;  $\sigma = 0.939$  S/m;  $\epsilon_r = 55.441$ ;  $\rho = 1000$  kg/m<sup>3</sup>

Ambient Temperature : 23.4 °C ; Liquid Temperature : 22.4 °C

DASY5 Configuration:

- Probe: ES3DV3 - SN3270; ConvF(6.01, 6.01, 6.01); Calibrated: 2016/8/26;
- Sensor-Surface: 3mm (Mechanical Surface Detection)
- Electronics: DAE4 Sn778; Calibrated: 2016/5/12
- Phantom: SAM\_Left; Type: QD000P40CD; Serial: TP:1644
- Measurement SW: DASY52, Version 52.8 (8); SEMCAD X Version 14.6.10 (7331)

**Area Scan (71x131x1):** Interpolated grid: dx=1.500 mm, dy=1.500 mm

Maximum value of SAR (interpolated) = 0.131 W/kg

**Zoom Scan (6x8x7)/Cube 0:** Measurement grid: dx=8mm, dy=8mm, dz=5mm

Reference Value = 9.544 V/m; Power Drift = 0.05 dB

Peak SAR (extrapolated) = 0.159 W/kg

**SAR(1 g) = 0.108 W/kg; SAR(10 g) = 0.074 W/kg**

Maximum value of SAR (measured) = 0.124 W/kg

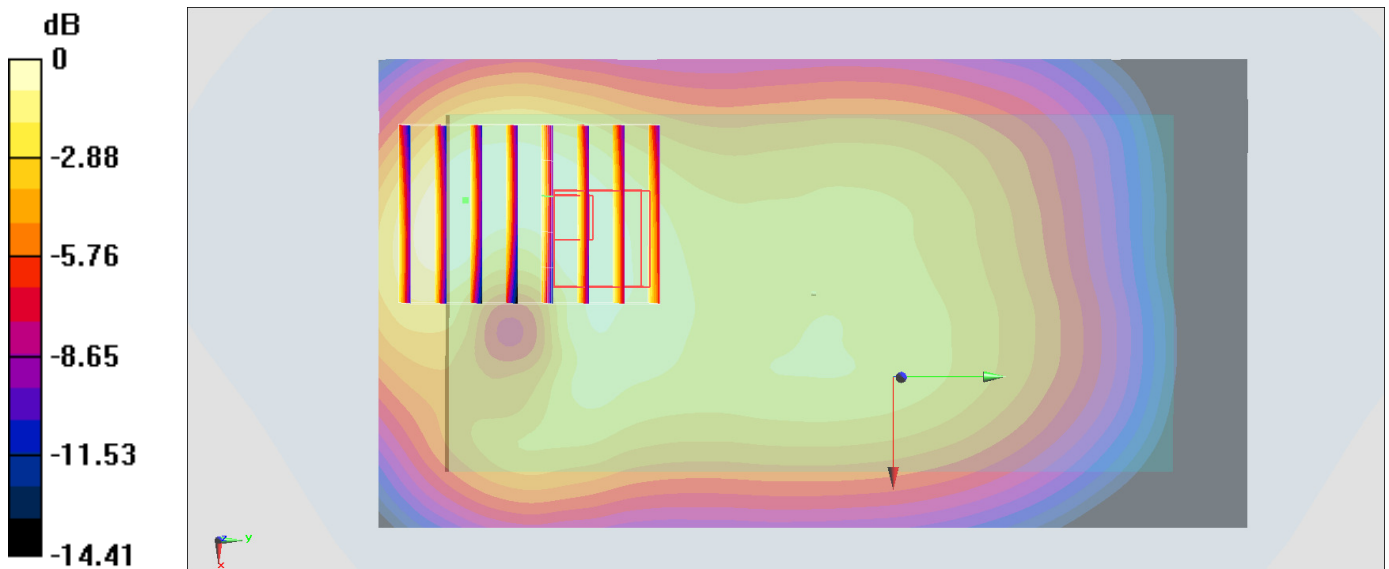

0 dB = 0.124 W/kg = -9.07 dBW/kg

## #41\_LTE Band 7\_20M\_QPSK\_1\_0\_Front\_10mm\_Ch21350

Communication System: LTE; Frequency: 2560 MHz; Duty Cycle: 1:1

Medium: MSL\_2600\_170110 Medium parameters used:  $f = 2560$  MHz;  $\sigma = 2.102$  S/m;  $\epsilon_r = 53.034$ ;  $\rho = 1000$  kg/m<sup>3</sup>

Ambient Temperature : 23.1 °C; Liquid Temperature : 22.1 °C

DASY5 Configuration:

- Probe: ES3DV3 - SN3270; ConvF(4.12, 4.12, 4.12); Calibrated: 2016/8/26;
- Sensor-Surface: 3mm (Mechanical Surface Detection)
- Electronics: DAE4 Sn778; Calibrated: 2016/5/12
- Phantom: SAM-Right; Type: SAM; Serial: 1795
- Measurement SW: DASY52, Version 52.8 (8); SEMCAD X Version 14.6.10 (7331)

**Area Scan (91x101x1):** Interpolated grid: dx=1.200 mm, dy=1.200 mm

Maximum value of SAR (interpolated) = 0.678 W/kg

**Zoom Scan (7x7x7)/Cube 0:** Measurement grid: dx=5mm, dy=5mm, dz=5mm

Reference Value = 16.21 V/m; Power Drift = -0.07 dB

Peak SAR (extrapolated) = 1.02 W/kg

**SAR(1 g) = 0.526 W/kg; SAR(10 g) = 0.285 W/kg**

Maximum value of SAR (measured) = 0.686 W/kg

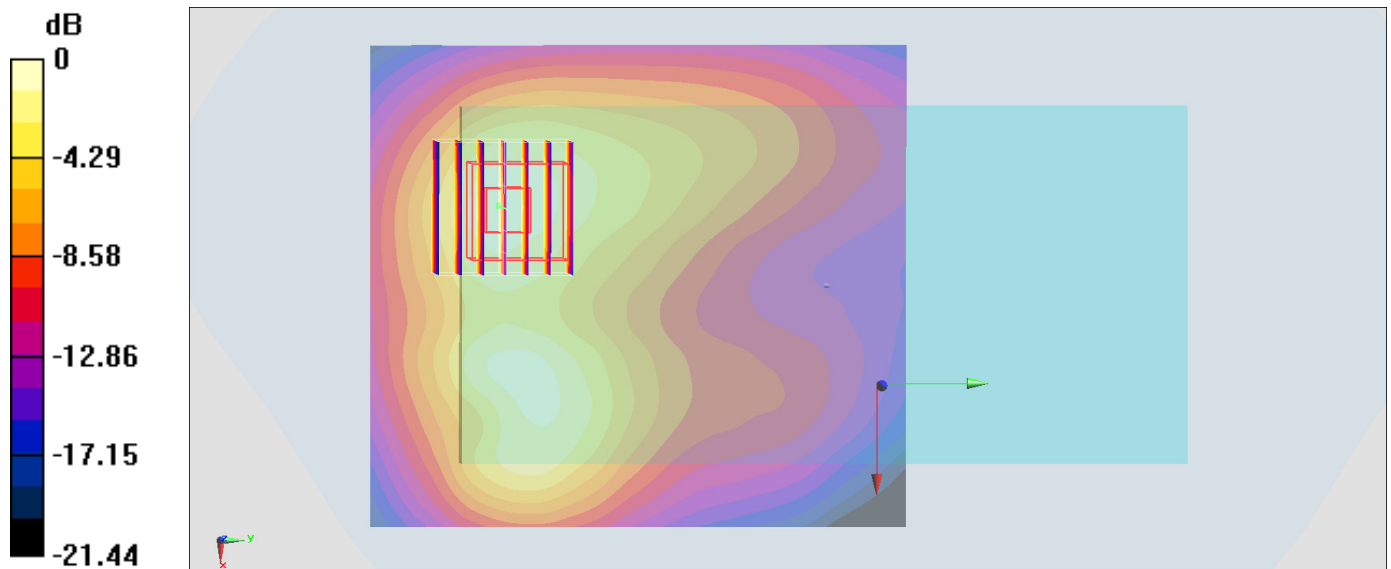

0 dB = 0.686 W/kg = -1.64 dBW/kg

## #42\_LTE Band 12\_10M\_QPSK\_1\_49\_Back\_10mm\_Ch23095

Communication System: LTE; Frequency: 707.5 MHz; Duty Cycle: 1:1

Medium: MSL\_750\_170115 Medium parameters used:  $f = 707.5$  MHz;  $\sigma = 0.916$  S/m;  $\epsilon_r = 56.506$ ;  $\rho = 1000$  kg/m<sup>3</sup>

Ambient Temperature : 23.4 °C ; Liquid Temperature : 22.4 °C

DASY5 Configuration:

- Probe: ES3DV3 - SN3270; ConvF(6.09, 6.09, 6.09); Calibrated: 2016/8/26;
- Sensor-Surface: 3mm (Mechanical Surface Detection)
- Electronics: DAE4 Sn778; Calibrated: 2016/5/12
- Phantom: SAM\_Left; Type: QD000P40CD; Serial: TP:1644
- Measurement SW: DASY52, Version 52.8 (8); SEMCAD X Version 14.6.10 (7331)

**Area Scan (71x131x1):** Interpolated grid: dx=1.500 mm, dy=1.500 mm

Maximum value of SAR (interpolated) = 0.137 W/kg

**Zoom Scan (5x5x7)/Cube 0:** Measurement grid: dx=8mm, dy=8mm, dz=5mm

Reference Value = 11.96 V/m; Power Drift = -0.01 dB

Peak SAR (extrapolated) = 0.172 W/kg

**SAR(1 g) = 0.124 W/kg; SAR(10 g) = 0.088 W/kg**

Maximum value of SAR (measured) = 0.139 W/kg

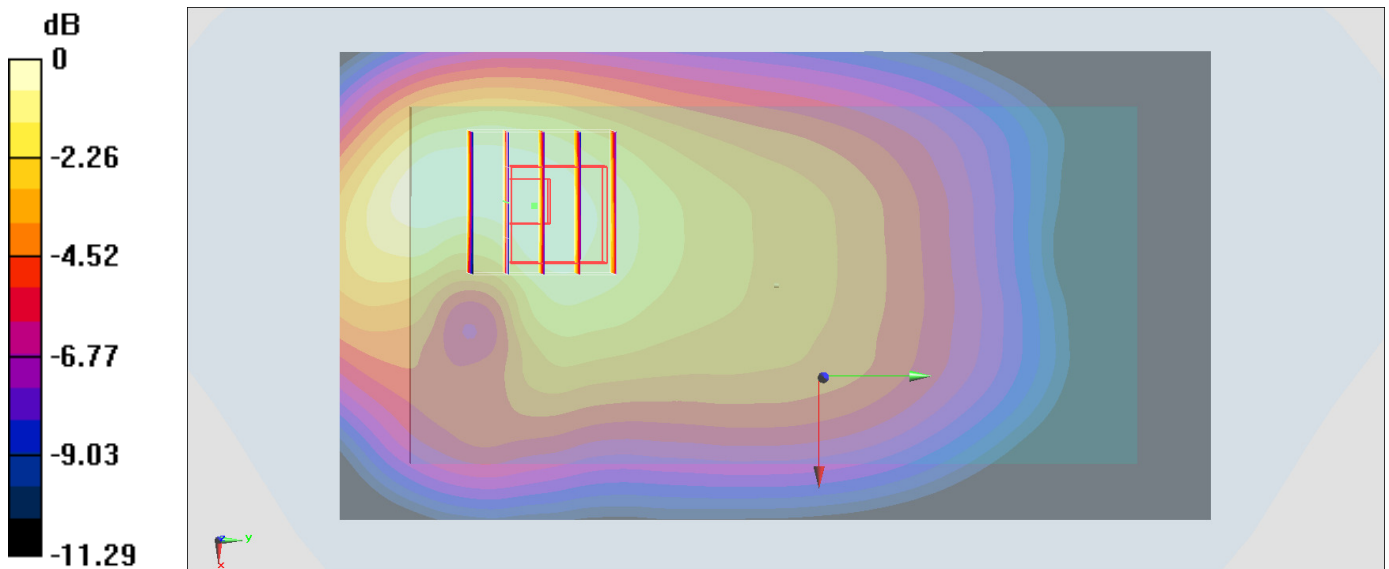

0 dB = 0.139 W/kg = -8.57 dBW/kg

### #43\_LTE Band 41\_20M\_QPSK\_1\_0\_Front\_10mm\_Ch40620

Communication System: LTE ; Frequency: 2593 MHz;Duty Cycle: 1:1.59

Medium: MSL\_2600\_170112 Medium parameters used:  $f = 2593$  MHz;  $\sigma = 2.193$  S/m;  $\epsilon_r = 51.989$ ;  $\rho = 1000$  kg/m<sup>3</sup>

Ambient Temperature : 23.3 °C ; Liquid Temperature : 22.3 °C

DASY5 Configuration:

- Probe: ES3DV3 - SN3270; ConvF(4.12, 4.12, 4.12); Calibrated: 2016/8/26;
- Sensor-Surface: 3mm (Mechanical Surface Detection)
- Electronics: DAE4 Sn778; Calibrated: 2016/5/12
- Phantom: SAM-Right; Type: SAM; Serial: 1795
- Measurement SW: DASY52, Version 52.8 (8);SEMCAD X Version 14.6.10 (7331)

**Area Scan (91x101x1):** Interpolated grid: dx=1.200 mm, dy=1.200 mm

Maximum value of SAR (interpolated) = 0.523 W/kg

**Zoom Scan (7x7x7)/Cube 0:** Measurement grid: dx=5mm, dy=5mm, dz=5mm

Reference Value = 9.826 V/m; Power Drift = -0.03 dB

Peak SAR (extrapolated) = 0.768 W/kg

**SAR(1 g) = 0.403 W/kg; SAR(10 g) = 0.205 W/kg**

Maximum value of SAR (measured) = 0.517 W/kg

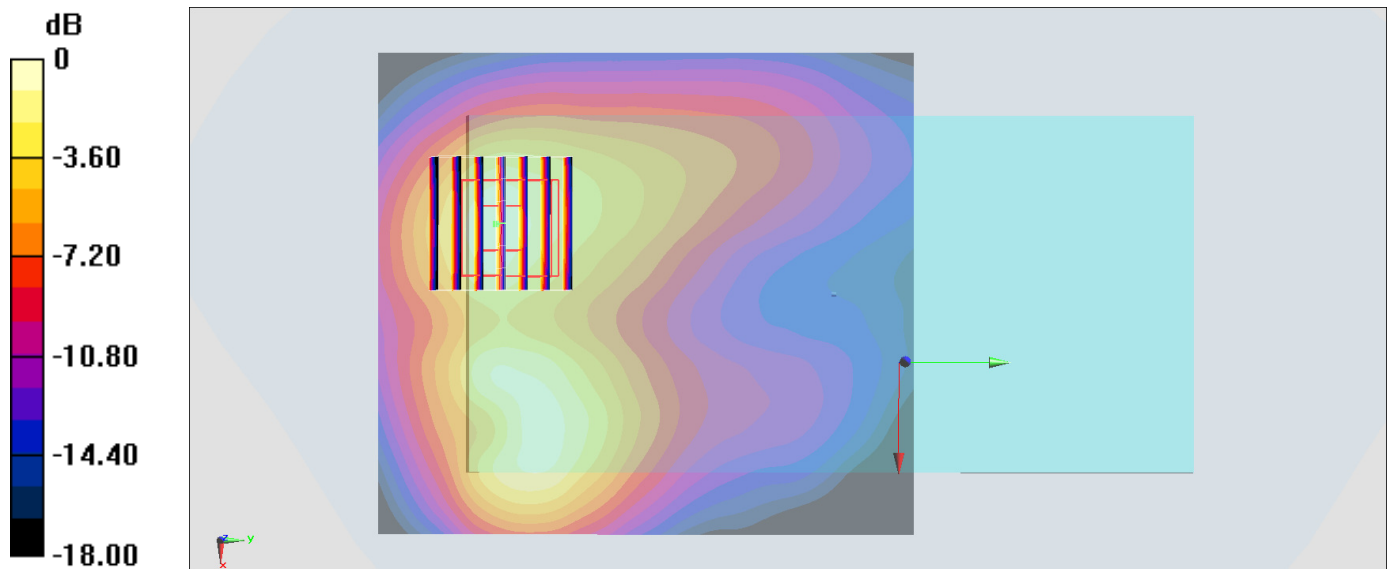

0 dB = 0.517 W/kg = -2.87 dBW/kg

**#44\_WLAN2.4GHz\_802.11b 1Mbps\_Back\_10mm\_Ch6;Ant 2**

Communication System: 802.11b ; Frequency: 2437 MHz;Duty Cycle: 1:1.013

Medium: MSL\_2450\_161228 Medium parameters used :  $f = 2437$  MHz;  $\sigma = 1.937$  S/m;  $\epsilon_r = 53.018$ ;  $\rho = 1000$  kg/m<sup>3</sup>

Ambient Temperature : 23.4 °C ; Liquid Temperature : 22.4 °C

DASY5 Configuration:

- Probe: EX3DV4 - SN3955; ConvF(7.65, 7.65, 7.65); Calibrated: 2016/11/24;
- Sensor-Surface: 1.4mm (Mechanical Surface Detection)
- Electronics: DAE3 Sn495; Calibrated: 2016/5/27
- Phantom: SAM\_Left; Type: QD 000 P40 CB; Serial: TP-1478
- Measurement SW: DASY52, Version 52.8 (8);SEMCAD X Version 14.6.10 (7331)

**Area Scan (91x51x1):** Interpolated grid: dx=1.200 mm, dy=1.200 mm

Maximum value of SAR (interpolated) = 0.144 W/kg

**Zoom Scan (7x7x7)/Cube 0:** Measurement grid: dx=5mm, dy=5mm, dz=5mm

Reference Value = 7.623 V/m; Power Drift = -0.13 dB

Peak SAR (extrapolated) = 0.158 W/kg

**SAR(1 g) = 0.088 W/kg; SAR(10 g) = 0.040 W/kg**

Maximum value of SAR (measured) = 0.132 W/kg

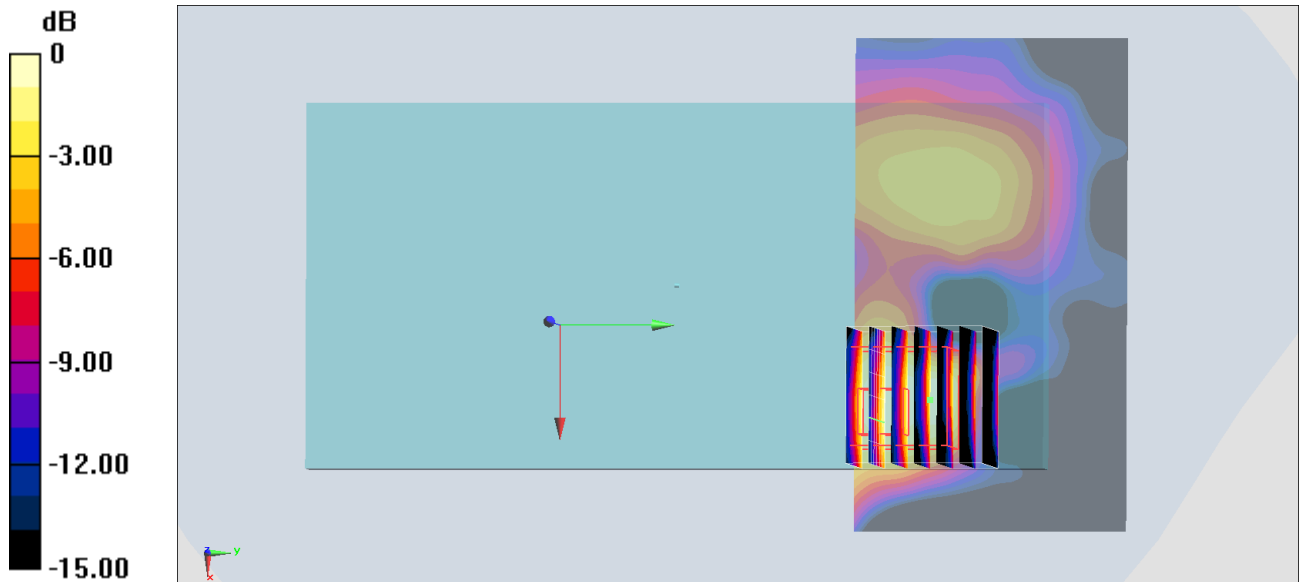

0 dB = 0.132 W/kg = -8.79 dBW/kg

## #45\_WLAN5GHz\_802.11ac-VHT80 MCS0\_Back\_10mm\_Ch58;Ant 2

Communication System: 802.11ac; Frequency: 5290 MHz; Duty Cycle: 1:1.053

Medium: MSL\_5G\_170105 Medium parameters used:  $f = 5290$  MHz;  $\sigma = 5.478$  S/m;  $\epsilon_r = 46.931$ ;  $\rho = 1000$  kg/m<sup>3</sup>

Ambient Temperature : 23.6 °C ; Liquid Temperature : 22.6 °C

DASY5 Configuration:

- Probe: EX3DV4 - SN3931; ConvF(4.57, 4.57, 4.57); Calibrated: 2016/10/3;
- Sensor-Surface: 1.4mm (Mechanical Surface Detection)
- Electronics: DAE3 Sn577; Calibrated: 2016/9/28
- Phantom: SAM\_Right; Type: QD000P40CD; Serial: TP:1383
- Measurement SW: DASY52, Version 52.8 (8); SEMCAD X Version 14.6.10 (7331)

**Area Scan (111x101x1):** Interpolated grid: dx=1.000 mm, dy=1.000 mm

Maximum value of SAR (interpolated) = 0.0737 W/kg

**Zoom Scan (9x9x7)/Cube 0:** Measurement grid: dx=4mm, dy=4mm, dz=1.4mm

Reference Value = 2.976 V/m; Power Drift = 0.14 dB

Peak SAR (extrapolated) = 0.0950 W/kg

**SAR(1 g) = 0.028 W/kg; SAR(10 g) = 0.017 W/kg**

Maximum value of SAR (measured) = 0.0595 W/kg

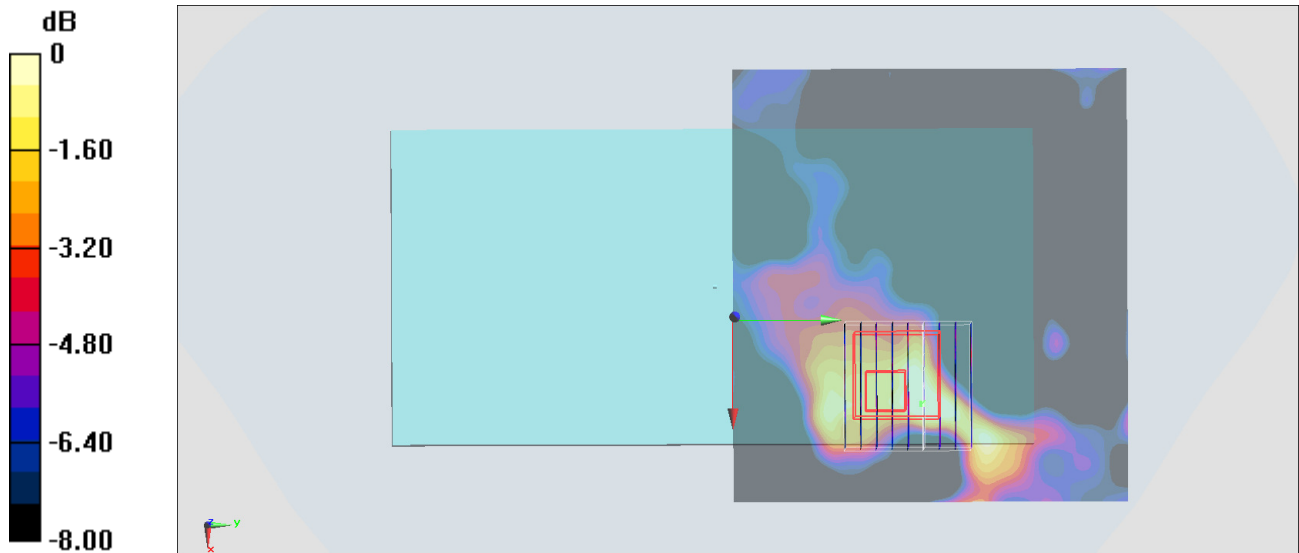

0 dB = 0.0595 W/kg = -12.25 dBW/kg

**#46\_WLAN5GHz\_802.11n-HT40 MCS0\_Back\_10mm\_Ch110;Ant 2**

Communication System: 802.11n ; Frequency: 5550 MHz;Duty Cycle: 1:1.032

Medium: MSL\_5G\_170105 Medium parameters used:  $f = 5550$  MHz;  $\sigma = 5.812$  S/m;  $\epsilon_r = 46.482$ ;  $\rho = 1000$  kg/m<sup>3</sup>

Ambient Temperature : 23.6 °C ; Liquid Temperature : 22.6 °C

DASY5 Configuration:

- Probe: EX3DV4 - SN3931; ConvF(3.71, 3.71, 3.71); Calibrated: 2016/10/3;
- Sensor-Surface: 1.4mm (Mechanical Surface Detection)
- Electronics: DAE3 Sn577; Calibrated: 2016/9/28
- Phantom: SAM\_Right; Type: QD000P40CD; Serial: TP:1383
- Measurement SW: DASY52, Version 52.8 (8);SEMCAD X Version 14.6.10 (7331)

**Area Scan (101x81x1):** Interpolated grid: dx=1.000 mm, dy=1.000 mm

Maximum value of SAR (interpolated) = 0.287 W/kg

**Zoom Scan (8x8x7)/Cube 0:** Measurement grid: dx=4mm, dy=4mm, dz=1.4mm

Reference Value = 4.337 V/m; Power Drift = 0.10 dB

Peak SAR (extrapolated) = 0.575 W/kg

**SAR(1 g) = 0.139 W/kg; SAR(10 g) = 0.053 W/kg**

Maximum value of SAR (measured) = 0.335 W/kg

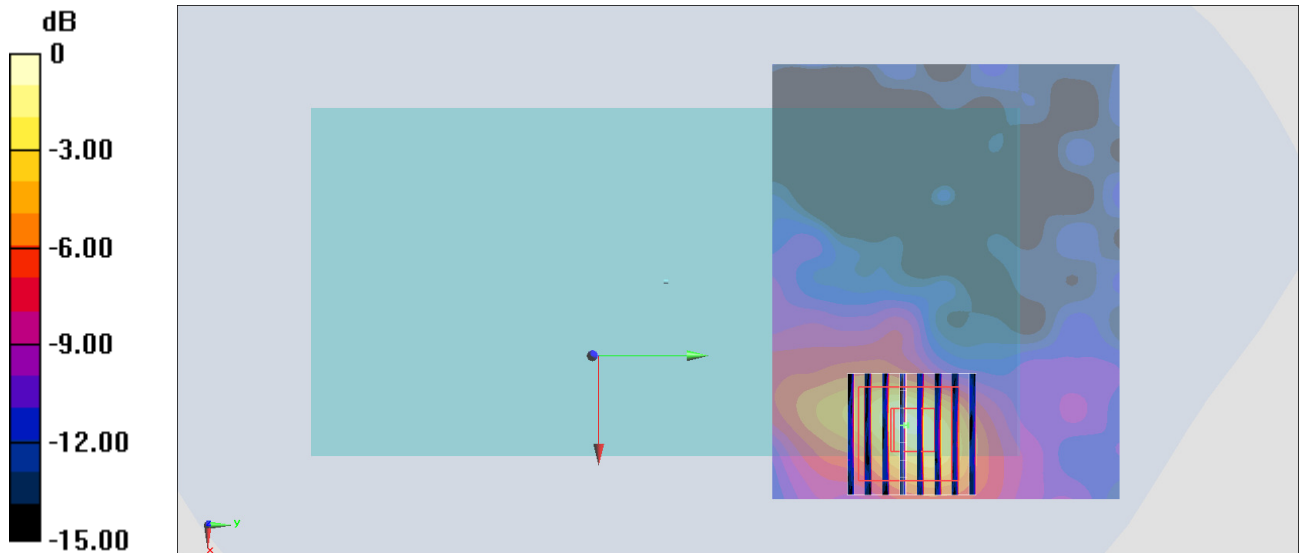

**#47\_WLAN5GHz\_802.11ac-VHT80 MCS0\_Back\_10mm\_Ch155;Ant 2**

Communication System: 802.11ac ; Frequency: 5775 MHz;Duty Cycle: 1:1.053

Medium: MSL\_5G\_161229 Medium parameters used:  $f = 5775$  MHz;  $\sigma = 6.13$  S/m;  $\epsilon_r = 45.995$ ;  $\rho = 1000$  kg/m<sup>3</sup>

Ambient Temperature : 23.4 °C ; Liquid Temperature : 22.4 °C

DASY5 Configuration:

- Probe: EX3DV4 - SN3955; ConvF(4.12, 4.12, 4.12); Calibrated: 2016/11/24;
- Sensor-Surface: 1.4mm (Mechanical Surface Detection)
- Electronics: DAE3 Sn495; Calibrated: 2016/5/27
- Phantom: SAM\_Right; Type: QD000P40CD; Serial: TP:1383
- Measurement SW: DASY52, Version 52.8 (8);SEMCAD X Version 14.6.10 (7331)

**Area Scan (101x61x1):** Interpolated grid: dx=1.000 mm, dy=1.000 mm

Maximum value of SAR (interpolated) = 0.283 W/kg

**Zoom Scan (7x7x7)/Cube 0:** Measurement grid: dx=4mm, dy=4mm, dz=1.4mm

Reference Value = 7.473 V/m; Power Drift = 0.07 dB

Peak SAR (extrapolated) = 0.476 W/kg

**SAR(1 g) = 0.097 W/kg; SAR(10 g) = 0.024 W/kg**

Maximum value of SAR (measured) = 0.272 W/kg

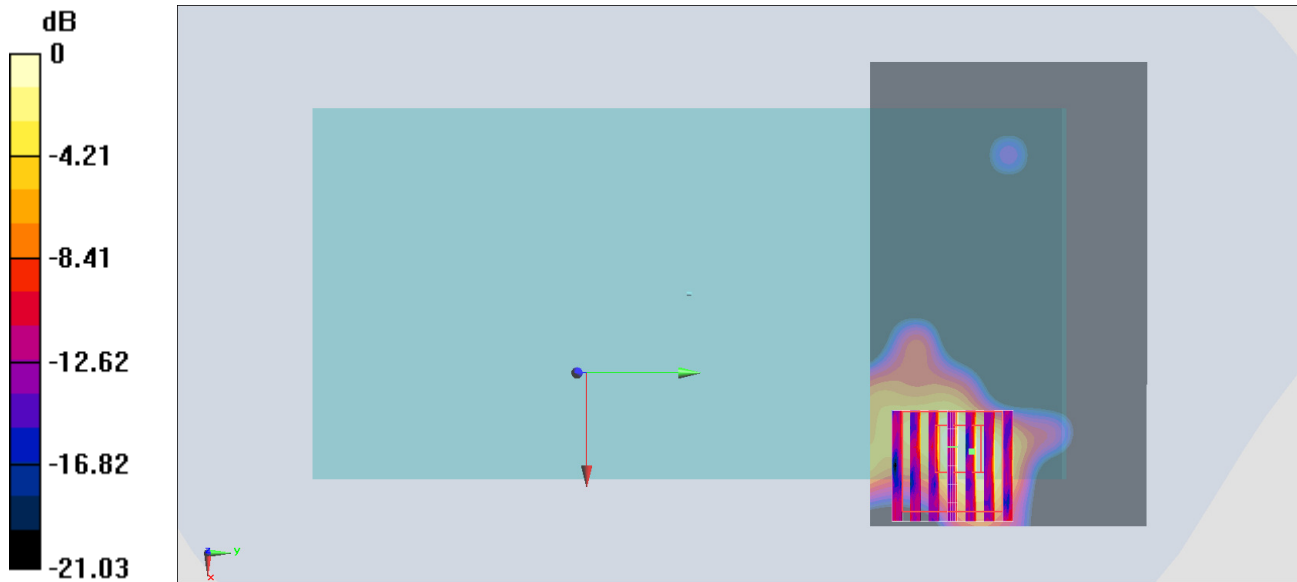

0 dB = 0.272 W/kg = -5.65 dBW/kg



**#48\_Bluetooth\_1Mbps\_Back\_10mm\_Ch39;Ant 1**

Communication System: Bluetooth ; Frequency: 2441 MHz;Duty Cycle: 1:1.305

Medium: MSL\_2450\_161228 Medium parameters used:  $f = 2441$  MHz;  $\sigma = 1.942$  S/m;  $\epsilon_r = 53.003$ ;  $\rho = 1000$  kg/m<sup>3</sup>

Ambient Temperature : 23.4 °C ; Liquid Temperature : 22.4 °C

DASY5 Configuration:

- Probe: EX3DV4 - SN3931; ConvF(7.73, 7.73, 7.73); Calibrated: 2016/10/3;
- Sensor-Surface: 1.4mm (Mechanical Surface Detection)
- Electronics: DAE3 Sn577; Calibrated: 2016/9/28
- Phantom: SAM\_Right; Type: QD000P40CD; Serial: TP:1383
- Measurement SW: DASY52, Version 52.8 (8);SEMCAD X Version 14.6.10 (7331)

**Area Scan (101x81x1):** Interpolated grid: dx=1.200 mm, dy=1.200 mm

Maximum value of SAR (interpolated) = 0.00497 W/kg

**Zoom Scan (7x7x7)/Cube 0:** Measurement grid: dx=5mm, dy=5mm, dz=5mm

Reference Value = 0 V/m; Power Drift = 0.01 dB

Peak SAR (extrapolated) = 0.00673 W/kg

**SAR(1 g) = 0.00126 W/kg; SAR(10 g) = 0.000395 W/kg**

Maximum value of SAR (measured) = 0.00384 W/kg

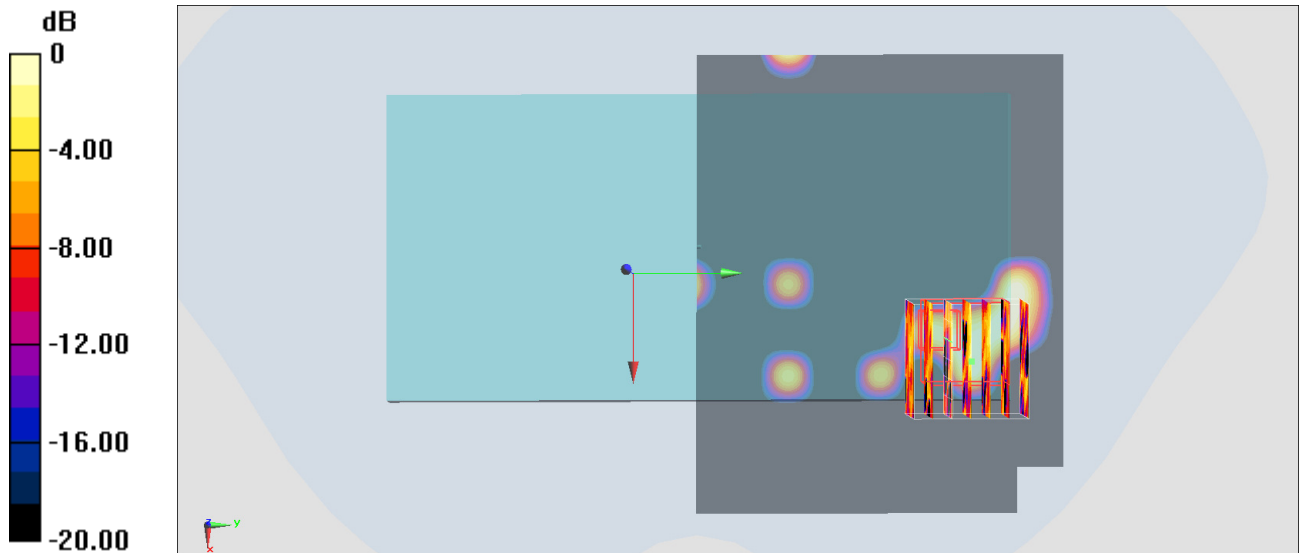

0 dB = 0.00384 W/kg = -24.16 dBW/kg