



# FCC RF Test Report

**APPLICANT** : HTC Corporation  
**EQUIPMENT** : Smartphone  
**MODEL NAME** : 2PZF100  
**FCC ID** : NM82PZF100  
**STANDARD** : FCC 47 CFR Part 2, 22(H), 24(E), 27(L)  
**CLASSIFICATION** : PCS Licensed Transmitter Held to Ear (PCE)

The product was received on Nov. 25, 2016 and testing was completed on Dec. 30, 2016. We, SPORTON INTERNATIONAL INC., would like to declare that the tested sample has been evaluated in accordance with the test procedures given in ANSI / TIA / EIA-603-D-2010 and has been in compliance with the applicable technical standards.

The test results in this report apply exclusively to the tested model / sample. Without written approval of SPORTON INTERNATIONAL INC., the test report shall not be reproduced except in full.

Reviewed by: Joseph Lin / Supervisor

Approved by: Jones Tsai / Manager



## **SPORTON INTERNATIONAL INC.**

No. 52, Hwa Ya 1<sup>st</sup> Rd., Hwa Ya Technology Park, Kwei-Shan District, Tao Yuan City, Taiwan, R.O.C.



# TABLE OF CONTENTS

**REVISION HISTORY.....3**

**SUMMARY OF TEST RESULT .....4**

**1 GENERAL DESCRIPTION .....5**

    1.1 Applicant.....5

    1.2 Manufacturer .....5

    1.3 Product Feature of Equipment Under Test .....5

    1.4 Product Specification of Equipment Under Test .....6

    1.5 Modification of EUT .....6

    1.6 Maximum ERP/EIRP Power, Frequency Tolerance, and Emission Designator .....7

    1.7 Testing Location .....7

    1.8 Applicable Standards .....8

**2 TEST CONFIGURATION OF EQUIPMENT UNDER TEST .....9**

    2.1 Test Mode.....9

    2.2 Connection Diagram of Test System .....10

    2.3 Support Unit used in test configuration .....10

    2.4 Measurement Results Explanation Example .....10

**3 CONDUCTED TEST RESULT.....11**

    3.1 Measuring Instruments.....11

    3.2 Test Setup .....11

    3.3 Test Result of Conducted Test.....11

    3.4 Conducted Output Power and ERP/EIRP .....12

    3.5 Peak-to-Average Ratio .....13

    3.6 99% Occupied Bandwidth and 26dB Bandwidth Measurement.....14

    3.7 Conducted Band Edge .....15

    3.8 Conducted Spurious Emission .....16

    3.9 Frequency Stability.....17

**4 RADIATED TEST ITEMS .....18**

    4.1 Measuring Instruments.....18

    4.2 Test Setup .....18

    4.3 Test Result of Radiated Test.....18

    4.4 Field Strength of Spurious Radiation Measurement .....19

**5 LIST OF MEASURING EQUIPMENT .....20**

**6 UNCERTAINTY OF EVALUATION.....21**

**APPENDIX A. TEST RESULTS OF CONDUCTED TEST**

**APPENDIX B. TEST RESULTS OF RADIATED TEST**



### REVISION HISTORY

REPORT NO.	VERSION	DESCRIPTION	ISSUED DATE
FG6N2506-02A	Rev. 01	Initial issue of report	Jan. 20, 2017



## SUMMARY OF TEST RESULT

Report Section	FCC Rule	Description	Limit	Result	Remark
3.4	§2.1046	Conducted Output Power	Reporting Only	PASS	-
	§22.913(a)(2)	Effective Radiated Power	< 7 Watts	PASS	-
	§24.232(c)	Equivalent Isotropic Radiated Power	< 2 Watts	PASS	-
	§27.50(d)(4)	Equivalent Isotropic Radiated Power	< 1 Watts	PASS	-
3.5	§24.232(d)	Peak-to-Average Ratio	< 13 dB	PASS	-
3.6	§2.1049 §22.917(b) §24.238(b) §27.53(g)	Occupied Bandwidth	Reporting Only	PASS	-
3.7	§2.1051 §22.917(a) §24.238(a) §27.53(h)	Band Edge Measurement	< 43+10log <sub>10</sub> (P[Watts])	PASS	-
3.8	§2.1051 §22.917(a) §24.238(a) §27.53(h)	Conducted Emission	< 43+10log <sub>10</sub> (P[Watts])	PASS	-
3.9	§2.1055 §22.355	Frequency Stability for Temperature & Voltage	< 2.5 ppm for Part 22	PASS	-
	§2.1055 §24.235 §27.54		Within Authorized Band		
4.4	§2.1053 §22.917(a) §24.238(a) §27.53(h)	Field Strength of Spurious Radiation	< 43+10log <sub>10</sub> (P[Watts])	PASS	Under limit 17.79 dB at 2544.000 MHz



# 1 General Description

## 1.1 Applicant

HTC Corporation

1F, 6-3 Baoqiang Rd., Xindian District, New Taipei City, Taiwan 231

## 1.2 Manufacturer

HTC Corporation

1F, 6-3 Baoqiang Rd., Xindian District, New Taipei City, Taiwan 231

## 1.3 Product Feature of Equipment Under Test

Product Feature	
Equipment	Smartphone
Model Name	2PZF100
FCC ID	NM82PZF100
Sample 1	EUT with battery 1 and memory 1
Sample 2	EUT with battery 2 and memory 2
EUT supports Radios application	GSM/EGPRS/WCDMA/HSPA/LTE/NFC WLAN 11a/b/g/n HT20/HT40 WLAN 11ac VHT20/VHT40/VHT80 Bluetooth BR/EDR/LE
EUT Stage	Production Unit

**Remark:**

1. The above EUT's information was declared by manufacturer. Please refer to the specifications or user's manual for more detailed description.
2. All test item are performed on sample 1.



### 1.4 Product Specification of Equipment Under Test

Standards-related Product Specification	
<b>Tx Frequency</b>	<b>GSM/GPRS/EDGE:</b> 850: 824.2 MHz ~ 848.8 MHz 1900: 1850.2 MHz ~ 1909.8MHz <b>WCDMA:</b> Band V: 826.4 MHz ~ 846.6 MHz Band II: 1852.4 MHz ~ 1907.6 MHz Band IV: 1712.4 MHz ~ 1752.6 MHz
<b>Rx Frequency</b>	<b>GSM/GPRS/EDGE:</b> 850: 869.2 MHz ~ 893.8 MHz 1900: 1930.2 MHz ~ 1989.8 MHz <b>WCDMA:</b> Band V: 871.4 MHz ~ 891.6 MHz Band II: 1932.4 MHz ~ 1987.6 MHz Band IV: 2112.4 MHz ~ 2152.6 MHz
<b>Maximum Output Power to Antenna</b>	<b>GSM/GPRS/EDGE:</b> 850: 32.68 dBm 1900: 30.16 dBm <b>WCDMA:</b> Band V: 23.95 dBm Band II: 24.11 dBm Band IV: 23.28 dBm
<b>Antenna Type</b>	Fixed Internal Antenna
<b>Antenna Gain</b>	Cellular Band: -3.50 dBi PCS Band: -0.10 dBi AWS Band: -3.00 dBi
<b>Type of Modulation</b>	GSM: GMSK GPRS: GMSK EDGE: GMSK / 8PSK WCDMA: BPSK (Uplink) HSDPA: QPSK (Uplink) HSUPA: QPSK (Uplink)

### 1.5 Modification of EUT

No modifications are made to the EUT during all test items.



### 1.6 Maximum ERP/EIRP Power, Frequency Tolerance, and Emission Designator

FCC Rule	System	Type of Modulation	Maximum ERP/EIRP (W)	Frequency Tolerance (ppm)	Emission Designator
Part 22	GSM850 GPRS class 8	GMSK	0.5047	0.0120 ppm	247KGXW
Part 22	GSM850 EDGE class 8	8PSK	0.1265	0.0179 ppm	239KG7W
Part 22	WCDMA Band V RMC 12.2Kbps	BPSK	0.0676	0.0215 ppm	4M14F9W
Part 24	GSM1900 GPRS class 8	GMSK	1.0139	0.0356 ppm	247KGXW
Part 24	GSM1900 EDGE class 8	8PSK	0.3855	0.0053 ppm	250KG7W
Part 24	WCDMA Band II RMC 12.2Kbps	BPSK	0.2518	0.0096 ppm	4M15F9W
Part 27	WCDMA Band IV RMC 12.2Kbps	BPSK	0.1067	0.0283 ppm	4M15F9W

### 1.7 Testing Location

Sporton Lab is accredited to ISO 17025 by Taiwan Accreditation Foundation (TAF code : 1190) and the FCC designation No. TW1022 under the FCC 2.948(e) by Mutual Recognition Agreement (MRA) in FCC Test.

<b>Test Site</b>	SPORTON INTERNATIONAL INC.
<b>Test Site Location</b>	No. 52, Hwa Ya 1 <sup>st</sup> Rd., Hwa Ya Technology Park, Kwei-Shan District, Tao Yuan City, Taiwan, R.O.C. TEL: +886-3-327-3456 FAX: +886-3-328-4978
<b>Test Site No.</b>	<b>Sporton Site No.</b> TH05-HY

<b>Test Site</b>	SPORTON INTERNATIONAL INC.
<b>Test Site Location</b>	No.58, Aly. 75, Ln. 564, Wenhua 3rd Rd., Kwei-Shan District, Tao Yuan City, Taiwan R.O.C. TEL: +886-3-327-0868 FAX: +886-3-327-0855
<b>Test Site No.</b>	<b>Sporton Site No. :</b> 03CH10-HY



## 1.8 Applicable Standards

According to the specifications of the manufacturer, the EUT must comply with the requirements of the following standards:

- ♦ 47 CFR Part 2, 22(H), 24(E), 27(L)
- ♦ ANSI / TIA / EIA-603-D-2010
- ♦ FCC KDB 971168 D01 Power Meas. License Digital Systems v02r02
- ♦ FCC KDB 412172 D01 Determining ERP and EIRP v01r01

**Remark:**

1. All test items were verified and recorded according to the standards and without any deviation during the test.
2. This EUT has also been tested and complied with the requirements of FCC Part 15, Subpart B, recorded in a separate test report.





## 2 Test Configuration of Equipment Under Test

### 2.1 Test Mode

Antenna port conducted and radiated test items were performed according to KDB 971168 D01 Power Meas. License Digital Systems v02r02 with maximum output power.

Radiated measurements were performed with rotating EUT in different three orthogonal test planes to find the maximum emission.

Radiated emissions were investigated as following frequency range:

1. 30 MHz to 9000 MHz for GSM850 and WCDMA Band V.
2. 30 MHz to 18000 MHz for WCDMA Band IV.
3. 30 MHz to 19100 MHz for GSM1900 and WCDMA Band II.

All modes and data rates and positions were investigated.

Test modes are chosen to be reported as the worst case configuration below:

Test Modes		
Band	Radiated TCs	Conducted TCs
GSM 850	<ul style="list-style-type: none"><li>■ GPRS class 8 Link</li><li>■ EDGE class 8 Link</li></ul>	<ul style="list-style-type: none"><li>■ GPRS class 8 Link</li><li>■ EDGE class 8 Link</li></ul>
GSM 1900	<ul style="list-style-type: none"><li>■ GPRS class 8 Link</li><li>■ EDGE class 8 Link</li></ul>	<ul style="list-style-type: none"><li>■ GPRS class 8 Link</li><li>■ EDGE class 8 Link</li></ul>
WCDMA Band V	<ul style="list-style-type: none"><li>■ RMC 12.2Kbps Link</li></ul>	<ul style="list-style-type: none"><li>■ RMC 12.2Kbps Link</li></ul>
WCDMA Band II	<ul style="list-style-type: none"><li>■ RMC 12.2Kbps Link</li></ul>	<ul style="list-style-type: none"><li>■ RMC 12.2Kbps Link</li></ul>
WCDMA Band IV	<ul style="list-style-type: none"><li>■ RMC 12.2Kbps Link</li></ul>	<ul style="list-style-type: none"><li>■ RMC 12.2Kbps Link</li></ul>

## 2.2 Connection Diagram of Test System

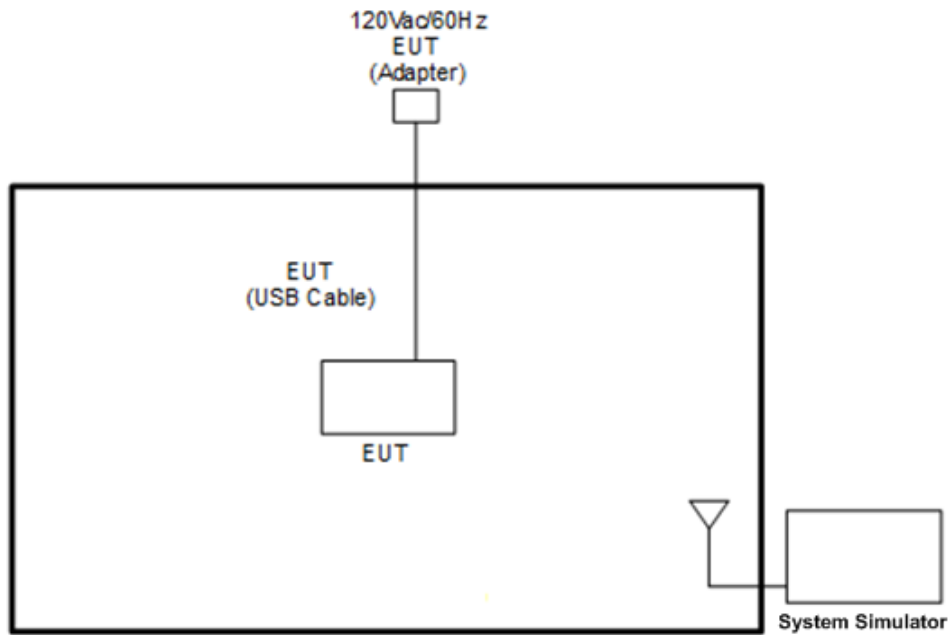

## 2.3 Support Unit used in test configuration

Item	Equipment	Trade Name	Model No.	FCC ID	Data Cable	Power Cord
1.	System Simulator	R&S	CMU 200	N/A	N/A	Unshielded, 1.8 m

## 2.4 Measurement Results Explanation Example

### For all conducted test items:

The offset level is set in the spectrum analyzer to compensate the RF cable loss and attenuator factor between RF conducted output port and spectrum analyzer. With the offset compensation, the spectrum analyzer reading level will be exactly the RF output level.

The spectrum analyzer offset is derived from RF cable loss and attenuator factor.

*Offset = RF cable loss + attenuator factor.*

The following shows an offset computation example with RF cable loss 4.2 dB and a 10dB attenuator.

Example :

$$\begin{aligned} \text{Offset(dB)} &= \text{RF cable loss(dB)} + \text{attenuator factor(dB)} \\ &= 4.2 + 10 = 14.2 \text{ (dB)} \end{aligned}$$

### 3 Conducted Test Result

#### 3.1 Measuring Instruments

See list of measuring instruments of this test report.

#### 3.2 Test Setup

##### 3.2.1 Conducted Output Power

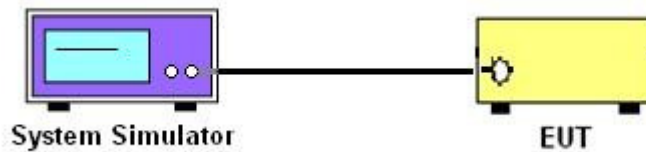

##### 3.2.2 Peak-to-Average Ratio, Occupied Bandwidth, Conducted Band-Edge and Conducted Spurious Emission

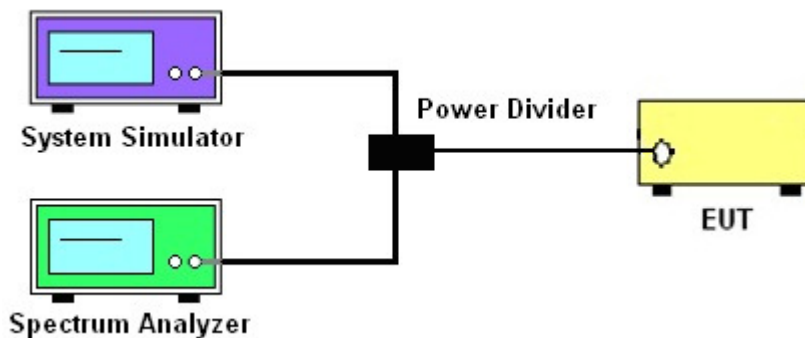

##### 3.2.3 Frequency Stability

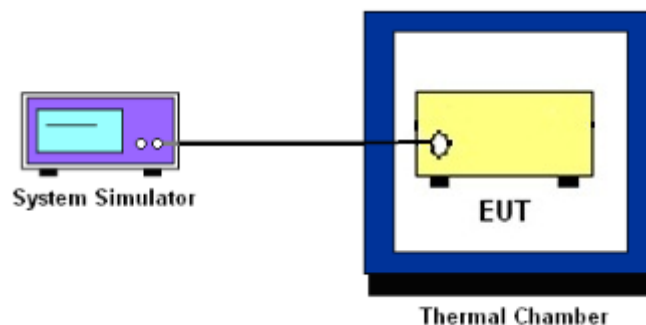

### 3.3 Test Result of Conducted Test

Please refer to Appendix A.



### 3.4 Conducted Output Power and ERP/EIRP

#### 3.4.1 Description of the Conducted Output Power and ERP/EIRP

A system simulator was used to establish communication with the EUT. Its parameters were set to enforce EUT transmitting at the maximum power. The measured power in the radio frequency on the transmitter output terminals shall be reported.

The ERP of mobile transmitters must not exceed 7 Watts for GSM850 and WCDMA Band V.

The EIRP of mobile transmitters must not exceed 2 Watts for GSM1900 and WCDMA Band II.

The EIRP of mobile transmitters must not exceed 1 Watts for WCDMA Band IV.

According to KDB 412172 D01 Power Approach,

$EIRP = P_T + G_T - L_C$ ,  $ERP = EIRP - 2.15$ , where

$P_T$  = transmitter output power in dBm

$G_T$  = gain of the transmitting antenna in dBi

$L_C$  = signal attenuation in the connecting cable between the transmitter and antenna in dB

#### 3.4.2 Test Procedures

1. The transmitter output port was connected to the system simulator.
2. Set EUT at maximum power through system simulator.
3. Select lowest, middle, and highest channels for each band and different modulation.
4. Measure the maximum burst average power for GSM and maximum average power for other modulation signal.



## **3.5 Peak-to-Average Ratio**

### **3.5.1 Description of the PAR Measurement**

The peak-to-average ratio (PAR) of the transmission may not exceed 13 dB.

### **3.5.2 Test Procedures**

1. The testing follows FCC KDB 971168 D01 v02r02 Section 5.7.1.
2. The EUT was connected to spectrum analyzer and system simulator via a power divider.
3. Set EUT to transmit at maximum output power.
4. When the duty cycle is less than 98%, then signal gating will be implemented on the spectrum analyzer by triggering from the system simulator.
5. Set the CCDF (Complementary Cumulative Distribution Function) option of the spectrum analyzer.  
Record the maximum PAPR level associated with a probability of 0.1%.



## 3.6 99% Occupied Bandwidth and 26dB Bandwidth Measurement

### 3.6.1 Description of 99% Occupied Bandwidth and 26dB Bandwidth Measurement

The occupied bandwidth is the width of a frequency band such that, below the lower and above the upper frequency limits, the mean powers emitted are each equal to a specified percentage 0.5% of the total mean transmitted power.

The 26 dB emission bandwidth is defined as the frequency range between two points, one above and one below the carrier frequency, at which the spectral density of the emission is attenuated 26 dB below the maximum in-band spectral density of the modulated signal. Spectral density (power per unit bandwidth) is to be measured with a detector of resolution bandwidth equal to approximately 1.0% of the emission bandwidth.

### 3.6.2 Test Procedures

1. The testing follows FCC KDB 971168 v02r02 Section 4.2.
2. The EUT was connected to spectrum analyzer and system simulator via a power divider.
3. The spectrum analyzer center frequency is set to the nominal EUT channel center frequency. The span range for the spectrum analyzer shall be between two and five times the anticipated OBW.
4. The nominal resolution bandwidth (RBW) shall be in the range of 1 to 5 % of the anticipated OBW, and the VBW shall be at least 3 times the RBW.
5. Set the detection mode to peak, and the trace mode to max hold.
6. Determine the reference value: Set the EUT to transmit a modulated signal. Allow the trace to stabilize. Set the spectrum analyzer marker to the highest level of the displayed trace.  
(this is the reference value)
7. Determine the “-26 dB down amplitude” as equal to (Reference Value – X).
8. Place two markers, one at the lowest and the other at the highest frequency of the envelope of the spectral display such that each marker is at or slightly below the “-X dB down amplitude” determined in step 6. If a marker is below this “-X dB down amplitude” value it shall be placed as close as possible to this value. The OBW is the positive frequency difference between the two markers.
9. Use the 99 % power bandwidth function of the spectrum analyzer and report the measured bandwidth.



### 3.7 Conducted Band Edge

#### 3.7.1 Description of Conducted Band Edge Measurement

The power of any emission outside of the authorized operating frequency ranges must be lower than the transmitter power (P) by a factor of at least  $43 + 10 \log (P)$  dB.

#### 3.7.2 Test Procedures

1. The testing follows FCC KDB 971168 D01 v02r02 Section 6.0.
2. The EUT was connected to the spectrum analyzer and system simulator via a power divider.
3. The RF output of EUT was connected to the spectrum analyzer by an RF cable and attenuator. The path loss was compensated to the results for each measurement.
4. The band edges of low and high channels for the highest RF powers were measured.
5. The RF fundamental frequency should be excluded against the limit line in the operating frequency band.
6. The limit line is derived from  $43 + 10\log(P)$  dB below the transmitter power P(Watts)  
=  $P(W) - [43 + 10\log(P)]$  (dB)  
=  $[30 + 10\log(P)]$  (dBm) -  $[43 + 10\log(P)]$  (dB)  
= -13dBm.



### 3.8 Conducted Spurious Emission

#### 3.8.1 Description of Conducted Spurious Emission Measurement

The power of any emission outside of the authorized operating frequency ranges must be lower than the transmitter power (P) by a factor of at least  $43 + 10 \log (P)$  dB.

It is measured by means of a calibrated spectrum analyzer and scanned from 30 MHz up to a frequency including its 10<sup>th</sup> harmonic.

#### 3.8.2 Test Procedures

1. The testing follows FCC KDB 971168 D01 v02r02 Section 6.0.
2. The EUT was connected to the spectrum analyzer and system simulator via a power divider.
3. The RF output of EUT was connected to the spectrum analyzer by an RF cable and attenuator. The path loss was compensated to the results for each measurement.
4. The middle channel for the highest RF power within the transmitting frequency was measured.
5. The conducted spurious emission for the whole frequency range was taken.
6. The RF fundamental frequency should be excluded against the limit line in the operating frequency band.
7. The limit line is derived from  $43 + 10\log(P)$  dB below the transmitter power P(Watts)  
=  $P(W) - [43 + 10\log(P)]$  (dB)  
=  $[30 + 10\log(P)]$  (dBm) -  $[43 + 10\log(P)]$  (dB)  
= -13dBm.





### 3.9 Frequency Stability

#### 3.9.1 Description of Frequency Stability Measurement

The frequency stability shall be measured by variation of ambient temperature and variation of primary supply voltage to ensure that the fundamental emission stays within the authorized frequency block. The frequency stability of the transmitter shall be maintained within  $\pm 0.00025\%$  ( $\pm 2.5\text{ppm}$ ) of the center frequency.

#### 3.9.2 Test Procedures for Temperature Variation

1. The testing follows FCC KDB 971168 D01 v02r02 Section 9.0.
2. The EUT was set up in the thermal chamber and connected with the system simulator.
3. With power OFF, the temperature was decreased to  $-30^{\circ}\text{C}$  and the EUT was stabilized before testing. Power was applied and the maximum change in frequency was recorded within one minute.
4. With power OFF, the temperature was raised in  $10^{\circ}\text{C}$  steps up to  $50^{\circ}\text{C}$ . The EUT was stabilized at each step for at least half an hour. Power was applied and the maximum frequency change was recorded within one minute.

#### 3.9.3 Test Procedures for Voltage Variation

1. The testing follows FCC KDB 971168 D01 v02r02 Section 9.0.
2. The EUT was placed in a temperature chamber at  $20\pm 5^{\circ}\text{C}$  and connected with the system simulator.
3. The power supply voltage to the EUT was varied from 85% to 115% of the nominal value measured at the input to the EUT.
4. The variation in frequency was measured for the worst case.

## 4 Radiated Test Items

### 4.1 Measuring Instruments

See list of measuring instruments of this test report.

### 4.2 Test Setup

#### 4.2.1 For radiated test from 30MHz to 1GHz

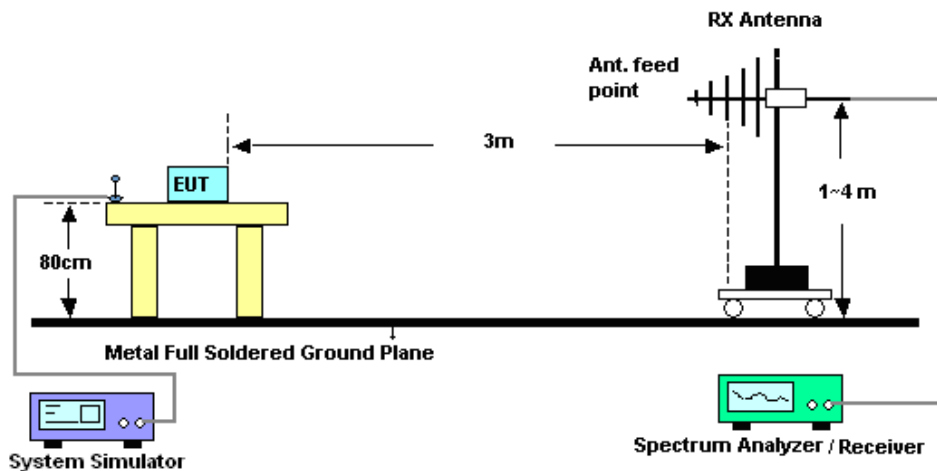

#### 4.2.2 For radiated test above 1GHz

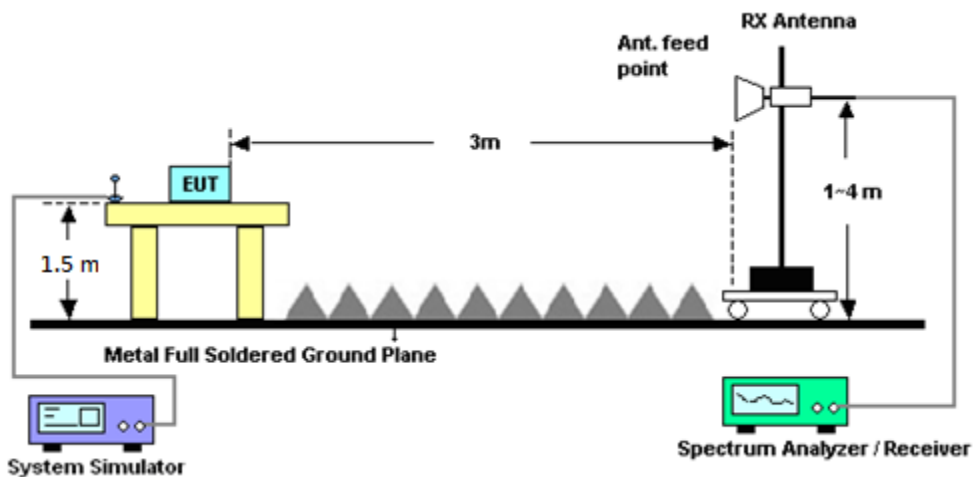

### 4.3 Test Result of Radiated Test

Please refer to Appendix B.



## 4.4 Field Strength of Spurious Radiation Measurement

### 4.4.1 Description of Field Strength of Spurious Radiated Measurement

The power of any emission outside of the authorized operating frequency ranges must be attenuated below the transmitter power (P) by a factor of at least  $43 + 10 \log (P)$  dB. The spectrum is scanned from 30 MHz up to a frequency including its 10th harmonic.

### 4.4.2 Test Procedures

1. The testing follows FCC KDB 971168 D01 v02r02 Section 5.8 and ANSI / TIA-603-D-2010 Section 2.2.12.
2. The EUT was placed on a rotatable wooden table 0.8 meters for frequency below 1GHz and 1.5 meter for frequency above 1GHz above the ground.
3. The EUT was set 3 meters from the receiving antenna, which was mounted on the antenna tower.
4. The table was rotated 360 degrees to determine the position of the highest spurious emission.
5. The height of the receiving antenna is varied between one meter and four meters to search for the maximum spurious emission for both horizontal and vertical polarizations.
6. Make the measurement with the spectrum analyzer's RBW = 1MHz, VBW = 3MHz, taking record of maximum spurious emission.
7. A horn antenna was substituted in place of the EUT and was driven by a signal generator.
8. Tune the output power of signal generator to the same emission level with EUT maximum spurious emission.
9. Taking the record of output power at antenna port.
10. Repeat step 7 to step 8 for another polarization.
11.  $EIRP \text{ (dBm)} = S.G. \text{ Power} - Tx \text{ Cable Loss} + Tx \text{ Antenna Gain}$
12.  $ERP \text{ (dBm)} = EIRP - 2.15$
13. The RF fundamental frequency should be excluded against the limit line in the operating frequency band.
14. The limit line is derived from  $43 + 10\log(P)$  dB below the transmitter power P(Watts)  
 $= P(W) - [43 + 10\log(P)] \text{ (dB)}$   
 $= [30 + 10\log(P)] \text{ (dBm)} - [43 + 10\log(P)] \text{ (dB)}$   
 $= -13\text{dBm}.$



## 5 List of Measuring Equipment

Instrument	Manufacturer	Model No.	Serial No.	Characteristics	Calibration Date	Test Date	Due Date	Remark
Spectrum Analyzer	Rohde & Schwarz	FSP30	101329	9kHz~30GHz	Jun. 27, 2016	Dec. 22, 2016	Jun. 26, 2017	Conducted (TH03-HY)
Temperature Chamber	ESPEC	SU-641	92013721	-30℃ ~70℃	Nov. 16, 2016	Dec. 22, 2016	Nov. 15, 2017	Conducted (TH03-HY)
Programmable Power Supply	GW Instek	PSS-2005	EL883644	Voltage:0~20V;Current:0~5A	Nov. 22, 2016	Dec. 22, 2016	Nov. 21, 2017	Conducted (TH03-HY)
Base Station (Measure)	Rohde & Schwarz	CMU200	117995	GSM / GPRS / WCDMA / CDMA	Aug. 03, 2016	Dec. 22, 2016	Aug. 04, 2017	Conducted (TH03-HY)
Amplifier	SONOMA	310N	187311	9kHz~1GHz	Oct. 26, 2016	Dec. 27, 2016 ~ Dec. 30, 2016	Oct. 25, 2017	Radiation (03CH10-HY)
Bilog Antenna	TESEQ	CBL 6111D&0080	35413&02	30MHz~1GHz	Jan. 13, 2016	Dec. 27, 2016 ~ Dec. 30, 2016	Jan. 12, 2017	Radiation (03CH10-HY)
Horn Antenna	SCHWARZBECK	BBHA 9120 D	9120D-1325	1GHz ~ 18GHz	Sep. 30, 2016	Dec. 27, 2016 ~ Dec. 30, 2016	Sep. 29, 2017	Radiation (03CH10-HY)
Preamplifier	Keysight	83017A	MY53270078	1GHz~26.5GHz	Oct. 26, 2016	Dec. 27, 2016 ~ Dec. 30, 2016	Oct. 25, 2017	Radiation (03CH10-HY)
Spectrum Analyzer	Keysight	N9010A	MY54200485	10Hz ~ 44GHz	Oct. 17, 2016	Dec. 27, 2016 ~ Dec. 30, 2016	Oct. 16, 2017	Radiation (03CH10-HY)
Antenna Mast	EMEC	AM-BS-4500-B	N/A	1~4m	N/A	Dec. 27, 2016 ~ Dec. 30, 2016	N/A	Radiation (03CH10-HY)
Turn Table	EMEC	TT 2200	N/A	0~360 Degree	N/A	Dec. 27, 2016 ~ Dec. 30, 2016	N/A	Radiation (03CH10-HY)
Preamplifier	MITEQ	JS44-180040 00-33-8P	1840917	18GHz ~ 40GHz	Jun. 14, 2016	Dec. 27, 2016 ~ Dec. 30, 2016	Jun. 13, 2017	Radiation (03CH10-HY)
Horn Antenna	SCHWARZBECK	BBHA 9120 D	9120D-1522	1G~18GHz	Mar. 31, 2016	Dec. 27, 2016 ~ Dec. 30, 2016	Mar. 30, 2017	Radiation (03CH10-HY)
Signal Generator	Rohde & Schwarz	SMC100A	102097	9K~1.1GHz	Jul. 27, 2016	Dec. 27, 2016 ~ Dec. 30, 2016	Jul. 26, 2017	Radiation (03CH10-HY)
SHF-EHF Horn Antenna	SCHWARZBECK	BBHA 9170	BBHA9170584	18GHz- 40GHz	Nov. 08, 2016	Dec. 27, 2016 ~ Dec. 30, 2016	Nov. 07, 2017	Radiation (03CH10-HY)



## 6 Uncertainty of Evaluation

### Uncertainty of Radiated Emission Measurement (30 MHz ~ 1000 MHz)

Measuring Uncertainty for a Level of Confidence of 95% ( $U = 2Uc(y)$ )	3.17
---	------

### Uncertainty of Radiated Emission Measurement (1 GHz ~ 18 GHz)

Measuring Uncertainty for a Level of Confidence of 95% ( $U = 2Uc(y)$ )	3.48
---	------

### Uncertainty of Radiated Emission Measurement (18 GHz ~ 40 GHz)

Measuring Uncertainty for a Level of Confidence of 95% ( $U = 2Uc(y)$ )	4.00
---	------



## Appendix A. Test Results of Conducted Test

### Conducted Output Power(Average power)

Conducted Power (*Unit: dBm)						
Band	GSM850			GSM1900		
Channel	128	189	251	512	661	810
Frequency	824.2	836.4	848.8	1850.2	1880	1909.8
GSM	32.51	32.59	32.65	30.07	29.78	29.89
GPRS class 8	32.56	32.62	32.68	30.16	29.88	29.98
GPRS class 10	31.32	31.35	31.33	28.79	28.98	29.06
GPRS class 11	29.87	29.90	29.96	28.33	28.49	28.53
GPRS class 12	28.65	28.70	28.71	27.06	27.26	26.92
EGPRS class 8	26.67	26.66	26.66	25.68	25.89	25.96
EGPRS class 10	26.00	25.99	25.99	25.05	25.29	25.33
EGPRS class 11	25.80	25.78	25.77	23.87	24.10	24.16
EGPRS class 12	23.69	23.68	23.65	22.67	22.88	22.97

Conducted Power (*Unit: dBm)						
Band	WCDMA Band V			WCDMA Band II		
Channel	4132	4182	4233	9262	9400	9538
Frequency	826.4	836.4	846.6	1852.4	1880	1907.6
RMC 12.2K	23.86	23.95	23.94	23.62	23.75	24.11
HSDPA Subtest-1	22.78	22.99	22.97	22.59	22.79	23.01
HSDPA Subtest-2	22.90	22.96	22.97	22.57	22.81	23.04
HSDPA Subtest-3	22.36	22.45	22.43	22.13	22.24	22.62
HSDPA Subtest-4	22.37	22.46	22.45	22.12	22.23	22.60
HSUPA Subtest-1	22.90	22.99	23.01	22.47	22.59	22.96
HSUPA Subtest-2	20.96	21.03	21.05	20.58	20.72	20.96
HSUPA Subtest-3	21.92	21.99	21.53	21.56	21.68	21.98
HSUPA Subtest-4	20.93	21.09	21.04	20.51	20.71	20.95
HSUPA Subtest-5	22.83	22.91	22.93	22.50	22.73	22.93



Conducted Power (*Unit: dBm)			
Band	WCDMA Band IV		
Channel	1312	1413	1513
Frequency	1712.4	1732.6	1752.6
RMC 12.2K	23.08	23.28	23.10
HSDPA Subtest-1	22.03	22.25	22.08
HSDPA Subtest-2	22.04	22.25	22.07
HSDPA Subtest-3	21.57	21.80	21.62
HSDPA Subtest-4	21.58	21.80	21.56
HSUPA Subtest-1	22.02	22.10	21.96
HSUPA Subtest-2	20.05	20.14	20.03
HSUPA Subtest-3	21.03	21.14	20.94
HSUPA Subtest-4	20.03	20.16	20.06
HSUPA Subtest-5	22.06	22.19	22.01



# A1. GSM

## Peak-to-Average Ratio

Mode	GSM850		Limit: 13dB
Mod.	GPRS class 8	EDGE class 8	Result
Lowest CH	0.20	3.24	PASS
Middle CH	0.20	3.20	
Highest CH	0.16	3.12	

Mode	GSM1900		Limit: 13dB
Mod.	GPRS class 8	EDGE class 8	Result
Lowest CH	0.16	3.24	PASS
Middle CH	0.20	3.36	
Highest CH	0.20	3.16	





GSM850 (GPRS class 8)	GSM850 (EDGE class 8)																
<p align="center"><b>Lowest Channel</b></p> <p>Ref: 35 dBm    *Att: 30 dB    AQT: 3.125 ms    Mean Pwr: +20 dB</p> <p>Center: 824.2 MHz    2 dB/    Mean Pwr: +20 dB</p> <p>Complementary Cumulative Distribution Function (100000 samples) Trace 1 Mean: 32.20 dBm Peak: 32.43 dBm Crest: 0.23 dB</p> <table border="1"> <tr><td>10 %</td><td>0.12 dB</td></tr> <tr><td>1 %</td><td>0.16 dB</td></tr> <tr><td>.1 %</td><td>0.20 dB</td></tr> <tr><td>.01 %</td><td>0.24 dB</td></tr> </table> <p>Date: 22.DEC.2016 10:57:28</p>	10 %	0.12 dB	1 %	0.16 dB	.1 %	0.20 dB	.01 %	0.24 dB	<p align="center"><b>Lowest Channel</b></p> <p>Ref: 35 dBm    *Att: 30 dB    AQT: 3.125 ms    Mean Pwr: +20 dB</p> <p>Center: 824.2 MHz    2 dB/    Mean Pwr: +20 dB</p> <p>Complementary Cumulative Distribution Function (100000 samples) Trace 1 Mean: 25.81 dBm Peak: 29.18 dBm Crest: 3.37 dB</p> <table border="1"> <tr><td>10 %</td><td>2.52 dB</td></tr> <tr><td>1 %</td><td>3.12 dB</td></tr> <tr><td>.1 %</td><td>3.24 dB</td></tr> <tr><td>.01 %</td><td>3.32 dB</td></tr> </table> <p>Date: 22.DEC.2016 11:20:14</p>	10 %	2.52 dB	1 %	3.12 dB	.1 %	3.24 dB	.01 %	3.32 dB
10 %	0.12 dB																
1 %	0.16 dB																
.1 %	0.20 dB																
.01 %	0.24 dB																
10 %	2.52 dB																
1 %	3.12 dB																
.1 %	3.24 dB																
.01 %	3.32 dB																
<p align="center"><b>Middle Channel</b></p> <p>Ref: 35 dBm    *Att: 30 dB    AQT: 3.125 ms    Mean Pwr: +20 dB</p> <p>Center: 836.4 MHz    2 dB/    Mean Pwr: +20 dB</p> <p>Complementary Cumulative Distribution Function (100000 samples) Trace 1 Mean: 32.08 dBm Peak: 32.29 dBm Crest: 0.20 dB</p> <table border="1"> <tr><td>10 %</td><td>0.12 dB</td></tr> <tr><td>1 %</td><td>0.16 dB</td></tr> <tr><td>.1 %</td><td>0.20 dB</td></tr> <tr><td>.01 %</td><td>0.24 dB</td></tr> </table> <p>Date: 22.DEC.2016 10:58:12</p>	10 %	0.12 dB	1 %	0.16 dB	.1 %	0.20 dB	.01 %	0.24 dB	<p align="center"><b>Middle Channel</b></p> <p>Ref: 35 dBm    *Att: 30 dB    AQT: 3.125 ms    Mean Pwr: +20 dB</p> <p>Center: 836.4 MHz    2 dB/    Mean Pwr: +20 dB</p> <p>Complementary Cumulative Distribution Function (100000 samples) Trace 1 Mean: 25.86 dBm Peak: 29.11 dBm Crest: 3.25 dB</p> <table border="1"> <tr><td>10 %</td><td>2.56 dB</td></tr> <tr><td>1 %</td><td>3.08 dB</td></tr> <tr><td>.1 %</td><td>3.20 dB</td></tr> <tr><td>.01 %</td><td>3.24 dB</td></tr> </table> <p>Date: 22.DEC.2016 11:22:12</p>	10 %	2.56 dB	1 %	3.08 dB	.1 %	3.20 dB	.01 %	3.24 dB
10 %	0.12 dB																
1 %	0.16 dB																
.1 %	0.20 dB																
.01 %	0.24 dB																
10 %	2.56 dB																
1 %	3.08 dB																
.1 %	3.20 dB																
.01 %	3.24 dB																
<p align="center"><b>Highest Channel</b></p> <p>Ref: 35 dBm    *Att: 30 dB    AQT: 3.125 ms    Mean Pwr: +20 dB</p> <p>Center: 848.8 MHz    2 dB/    Mean Pwr: +20 dB</p> <p>Complementary Cumulative Distribution Function (100000 samples) Trace 1 Mean: 31.99 dBm Peak: 32.15 dBm Crest: 0.16 dB</p> <table border="1"> <tr><td>10 %</td><td>0.12 dB</td></tr> <tr><td>1 %</td><td>0.16 dB</td></tr> <tr><td>.1 %</td><td>0.16 dB</td></tr> <tr><td>.01 %</td><td>0.16 dB</td></tr> </table> <p>Date: 22.DEC.2016 10:58:56</p>	10 %	0.12 dB	1 %	0.16 dB	.1 %	0.16 dB	.01 %	0.16 dB	<p align="center"><b>Highest Channel</b></p> <p>Ref: 35 dBm    *Att: 30 dB    AQT: 3.125 ms    Mean Pwr: +20 dB</p> <p>Center: 848.8 MHz    2 dB/    Mean Pwr: +20 dB</p> <p>Complementary Cumulative Distribution Function (100000 samples) Trace 1 Mean: 25.89 dBm Peak: 29.04 dBm Crest: 3.15 dB</p> <table border="1"> <tr><td>10 %</td><td>2.48 dB</td></tr> <tr><td>1 %</td><td>3.00 dB</td></tr> <tr><td>.1 %</td><td>3.12 dB</td></tr> <tr><td>.01 %</td><td>3.16 dB</td></tr> </table> <p>Date: 22.DEC.2016 11:22:58</p>	10 %	2.48 dB	1 %	3.00 dB	.1 %	3.12 dB	.01 %	3.16 dB
10 %	0.12 dB																
1 %	0.16 dB																
.1 %	0.16 dB																
.01 %	0.16 dB																
10 %	2.48 dB																
1 %	3.00 dB																
.1 %	3.12 dB																
.01 %	3.16 dB																

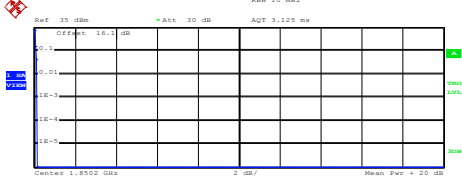
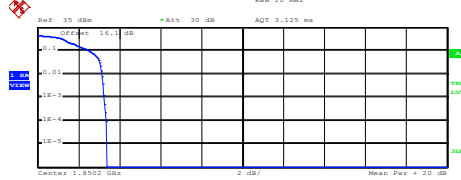
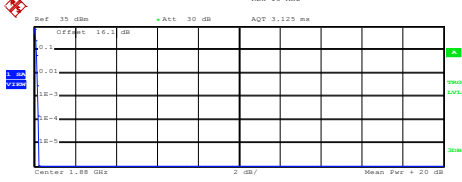
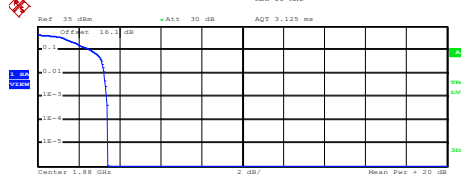
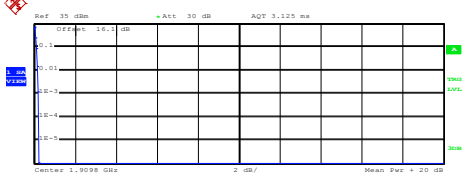
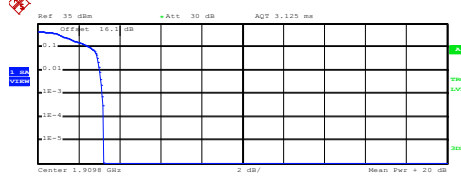

GSM1900 (GPRS class 8)	GSM1900 (EDGE class 8)																
<p style="text-align: center;"><b>Lowest Channel</b></p>  <p>Center 1.8502 GHz    2 dB/    Mean Pwr + 20 dB</p> <p>Complementary Cumulative Distribution Function (100000 samples) Trace 1 Mean 29.17 dBm Peak 29.32 dBm Crest 0.16 dB</p> <table border="1"> <tr><td>10 %</td><td>0.12 dB</td></tr> <tr><td>1 %</td><td>0.16 dB</td></tr> <tr><td>.1 %</td><td>0.16 dB</td></tr> <tr><td>.01 %</td><td>0.16 dB</td></tr> </table> <p>Date: 22.DEC.2016 11:35:44</p>	10 %	0.12 dB	1 %	0.16 dB	.1 %	0.16 dB	.01 %	0.16 dB	<p style="text-align: center;"><b>Lowest Channel</b></p>  <p>Center 1.8502 GHz    2 dB/    Mean Pwr + 20 dB</p> <p>Complementary Cumulative Distribution Function (100000 samples) Trace 1 Mean 24.11 dBm Peak 27.49 dBm Crest 3.38 dB</p> <table border="1"> <tr><td>10 %</td><td>2.56 dB</td></tr> <tr><td>1 %</td><td>3.16 dB</td></tr> <tr><td>.1 %</td><td>3.24 dB</td></tr> <tr><td>.01 %</td><td>3.36 dB</td></tr> </table> <p>Date: 22.DEC.2016 12:03:10</p>	10 %	2.56 dB	1 %	3.16 dB	.1 %	3.24 dB	.01 %	3.36 dB
10 %	0.12 dB																
1 %	0.16 dB																
.1 %	0.16 dB																
.01 %	0.16 dB																
10 %	2.56 dB																
1 %	3.16 dB																
.1 %	3.24 dB																
.01 %	3.36 dB																
<p style="text-align: center;"><b>Middle Channel</b></p>  <p>Center 1.85 GHz    2 dB/    Mean Pwr + 20 dB</p> <p>Complementary Cumulative Distribution Function (100000 samples) Trace 1 Mean 29.19 dBm Peak 29.39 dBm Crest 0.20 dB</p> <table border="1"> <tr><td>10 %</td><td>0.12 dB</td></tr> <tr><td>1 %</td><td>0.16 dB</td></tr> <tr><td>.1 %</td><td>0.20 dB</td></tr> <tr><td>.01 %</td><td>0.20 dB</td></tr> </table> <p>Date: 22.DEC.2016 11:36:40</p>	10 %	0.12 dB	1 %	0.16 dB	.1 %	0.20 dB	.01 %	0.20 dB	<p style="text-align: center;"><b>Middle Channel</b></p>  <p>Center 1.85 GHz    2 dB/    Mean Pwr + 20 dB</p> <p>Complementary Cumulative Distribution Function (100000 samples) Trace 1 Mean 24.00 dBm Peak 27.42 dBm Crest 3.42 dB</p> <table border="1"> <tr><td>10 %</td><td>2.60 dB</td></tr> <tr><td>1 %</td><td>3.24 dB</td></tr> <tr><td>.1 %</td><td>3.36 dB</td></tr> <tr><td>.01 %</td><td>3.44 dB</td></tr> </table> <p>Date: 22.DEC.2016 12:03:53</p>	10 %	2.60 dB	1 %	3.24 dB	.1 %	3.36 dB	.01 %	3.44 dB
10 %	0.12 dB																
1 %	0.16 dB																
.1 %	0.20 dB																
.01 %	0.20 dB																
10 %	2.60 dB																
1 %	3.24 dB																
.1 %	3.36 dB																
.01 %	3.44 dB																
<p style="text-align: center;"><b>Highest Channel</b></p>  <p>Center 1.9098 GHz    2 dB/    Mean Pwr + 20 dB</p> <p>Complementary Cumulative Distribution Function (100000 samples) Trace 1 Mean 29.09 dBm Peak 29.32 dBm Crest 0.24 dB</p> <table border="1"> <tr><td>10 %</td><td>0.12 dB</td></tr> <tr><td>1 %</td><td>0.16 dB</td></tr> <tr><td>.1 %</td><td>0.20 dB</td></tr> <tr><td>.01 %</td><td>0.24 dB</td></tr> </table> <p>Date: 22.DEC.2016 11:37:14</p>	10 %	0.12 dB	1 %	0.16 dB	.1 %	0.20 dB	.01 %	0.24 dB	<p style="text-align: center;"><b>Highest Channel</b></p>  <p>Center 1.9098 GHz    2 dB/    Mean Pwr + 20 dB</p> <p>Complementary Cumulative Distribution Function (100000 samples) Trace 1 Mean 23.92 dBm Peak 27.14 dBm Crest 3.22 dB</p> <table border="1"> <tr><td>10 %</td><td>2.56 dB</td></tr> <tr><td>1 %</td><td>3.04 dB</td></tr> <tr><td>.1 %</td><td>3.16 dB</td></tr> <tr><td>.01 %</td><td>3.24 dB</td></tr> </table> <p>Date: 22.DEC.2016 12:04:37</p>	10 %	2.56 dB	1 %	3.04 dB	.1 %	3.16 dB	.01 %	3.24 dB
10 %	0.12 dB																
1 %	0.16 dB																
.1 %	0.20 dB																
.01 %	0.24 dB																
10 %	2.56 dB																
1 %	3.04 dB																
.1 %	3.16 dB																
.01 %	3.24 dB																



**26dB Bandwidth**

Mode	GSM850	
Mod.	GPRS class 8	EDGE class 8
Lowest CH	0.302	0.300
Middle CH	0.299	0.289
Highest CH	0.310	0.294

Mode	GSM1900	
Mod.	GPRS class 8	EDGE class 8
Lowest CH	0.314	0.306
Middle CH	0.296	0.302
Highest CH	0.307	0.307

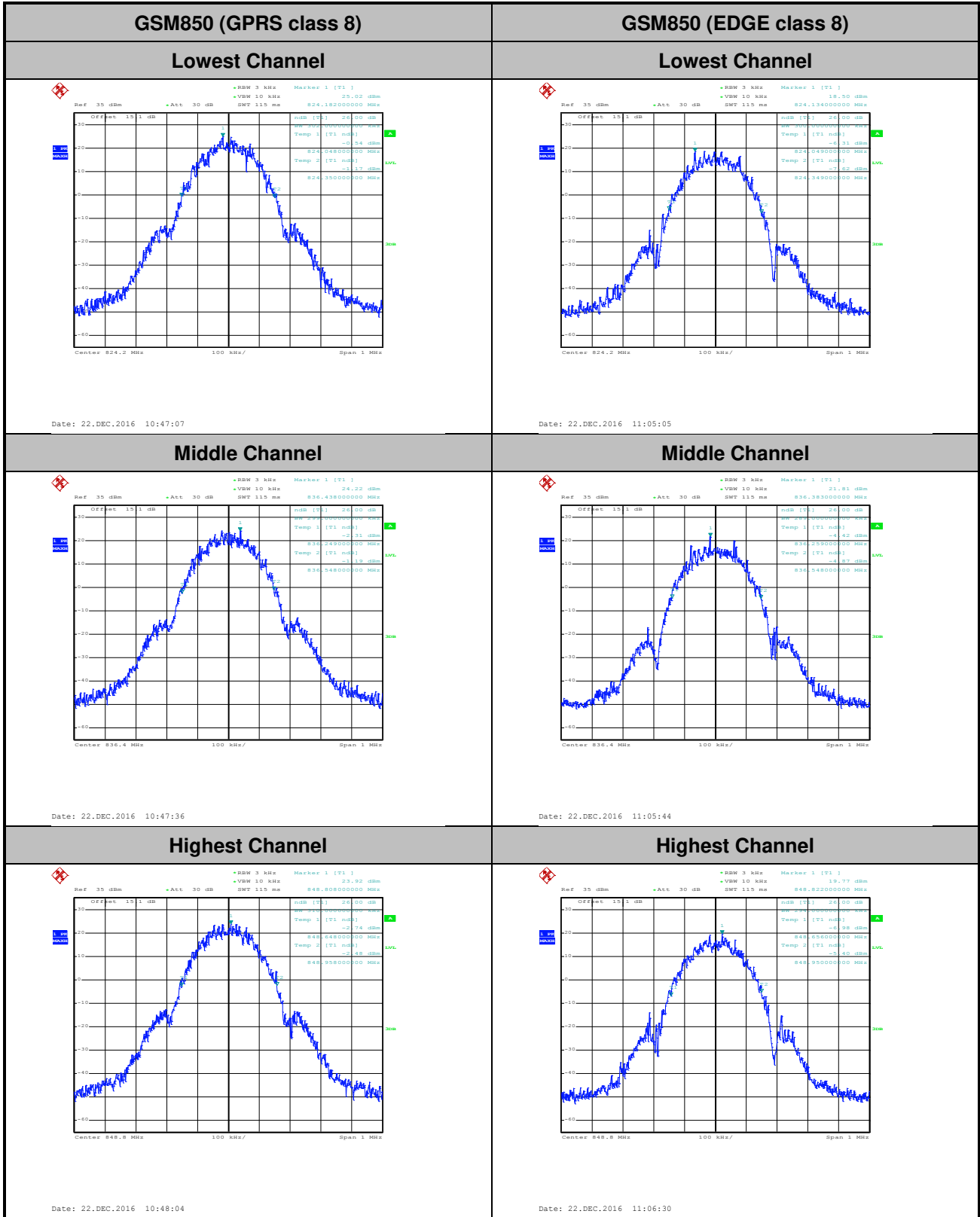

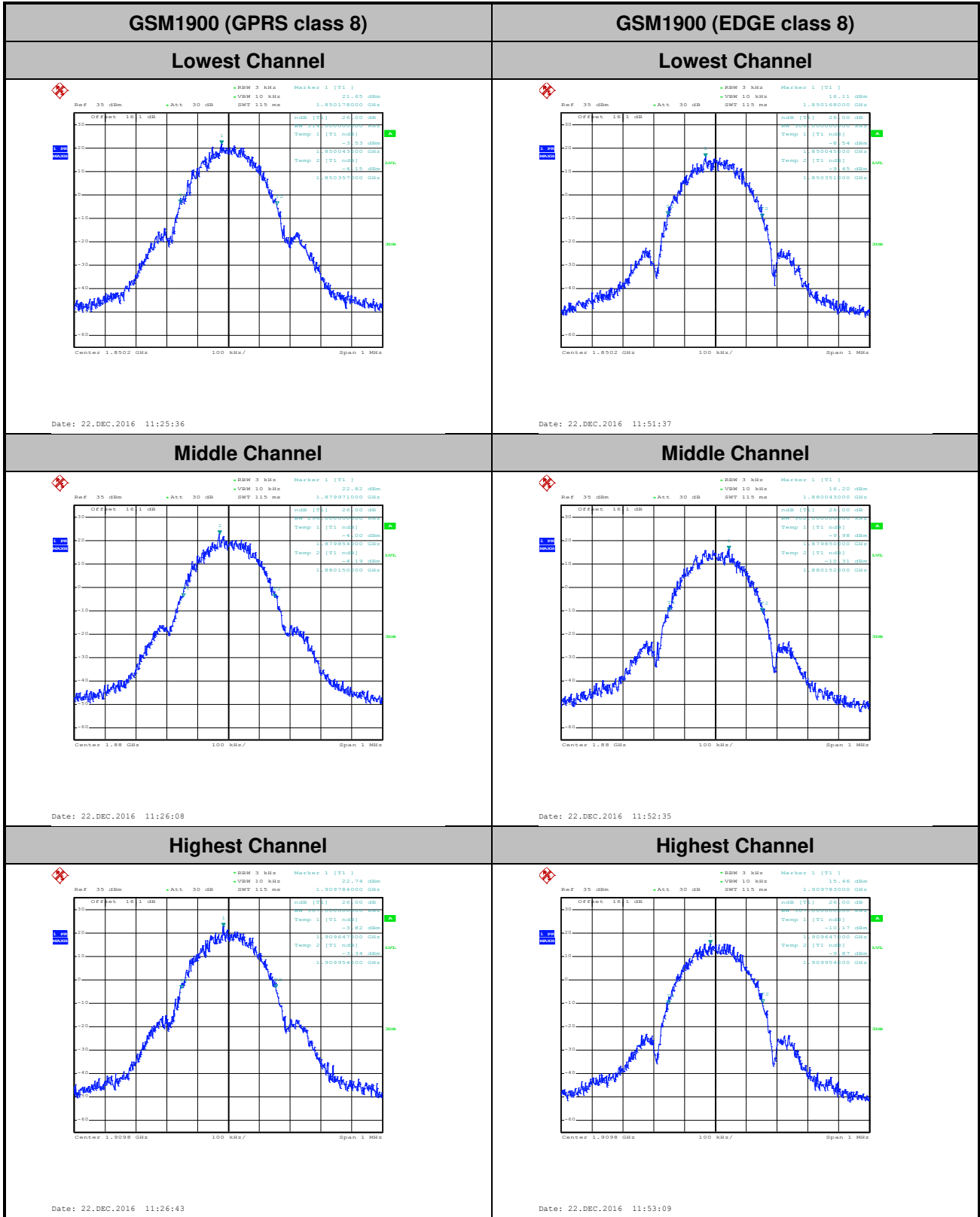



### Occupied Bandwidth

Mode	GSM850	
Mod.	GPRS class 8	EDGE class 8
Lowest CH	0.245	0.235
Middle CH	0.241	0.239
Highest CH	0.247	0.235

Mode	GSM1900	
Mod.	GPRS class 8	EDGE class 8
Lowest CH	0.246	0.250
Middle CH	0.244	0.246
Highest CH	0.247	0.244

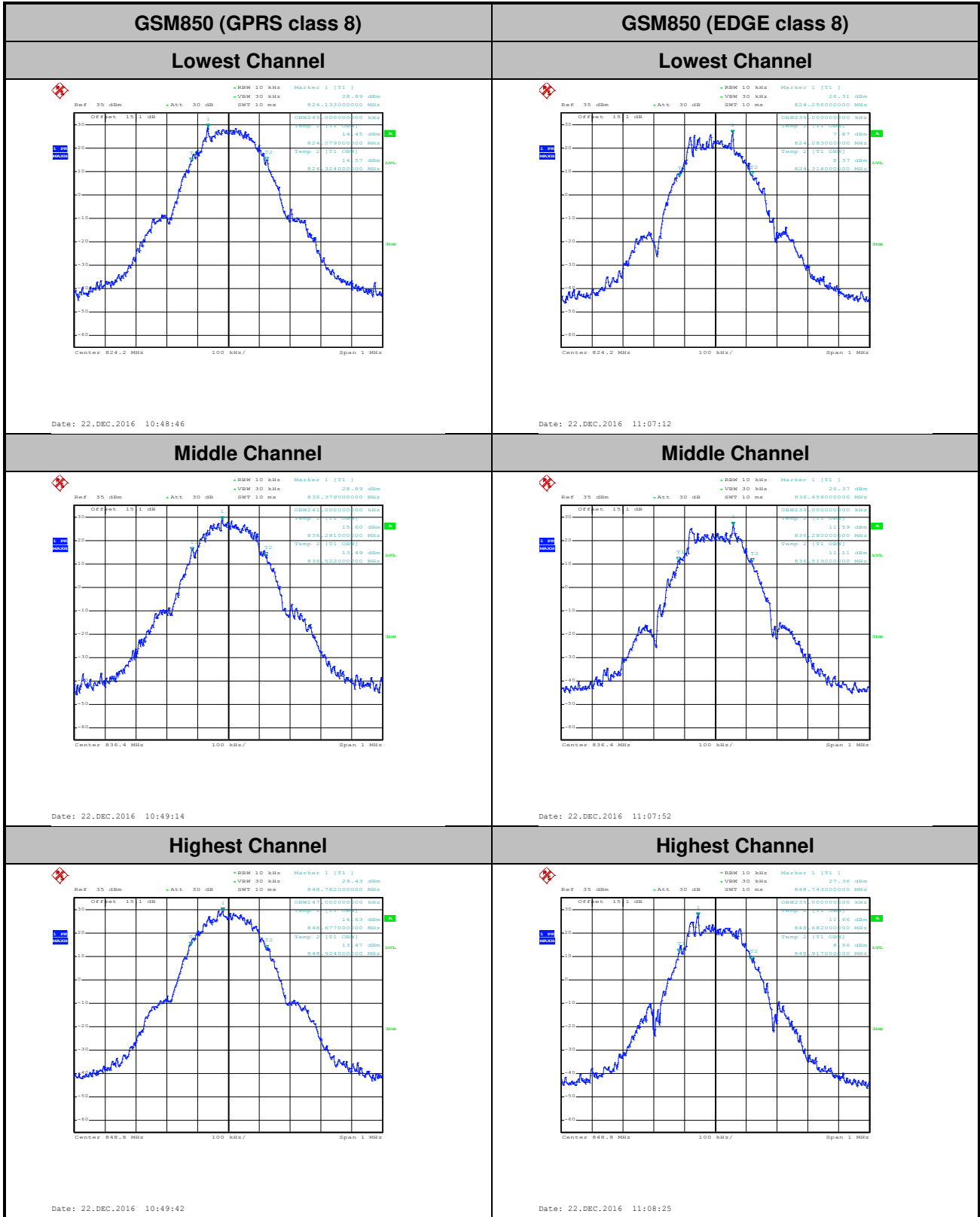

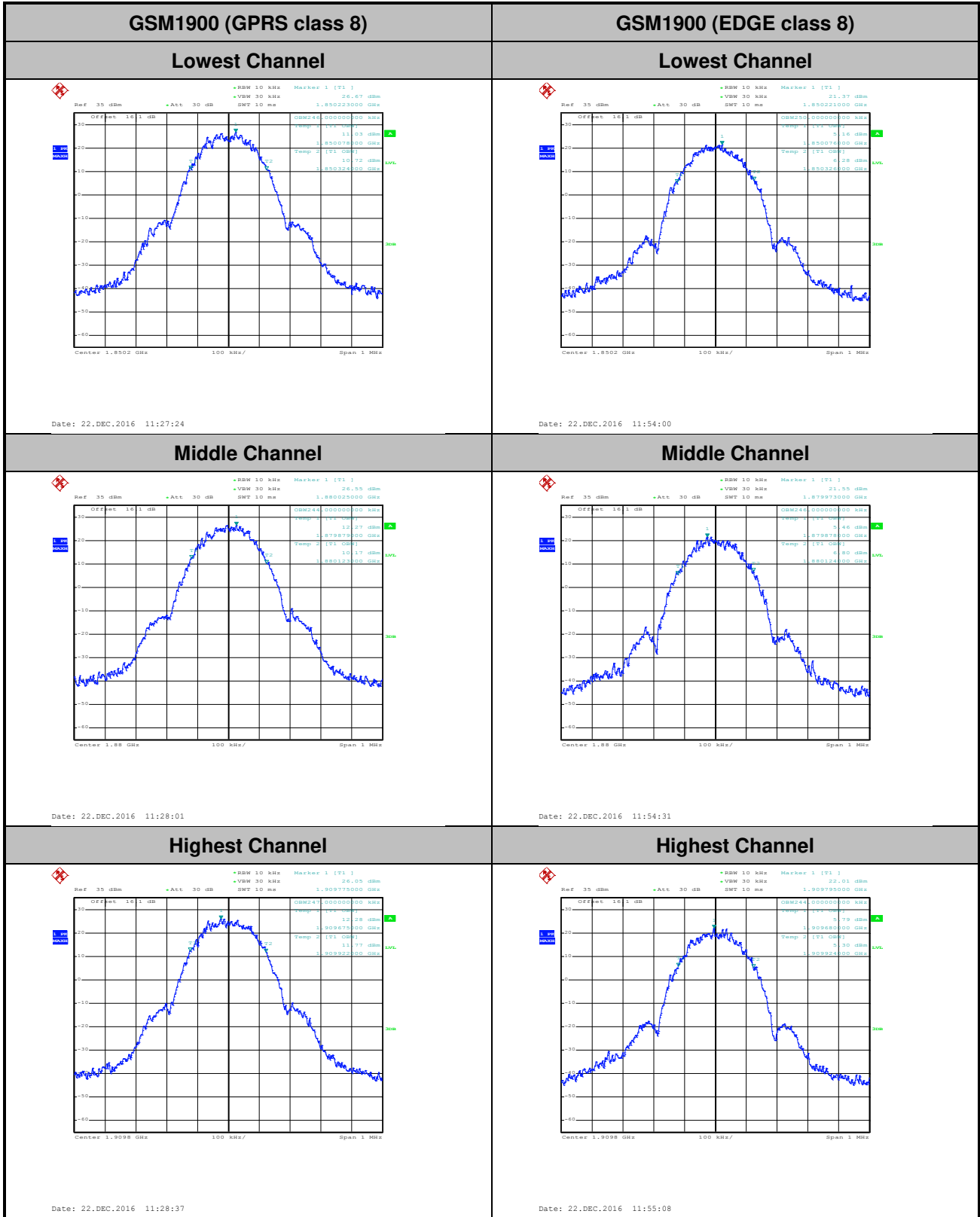





# Conducted Band Edge

## GSM850 (GPRS class 8)

### Lowest Band Edge

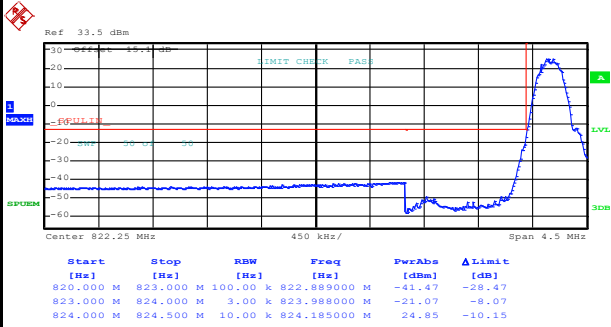

Date: 22.DEC.2016 10:51:12

### Highest Band Edge

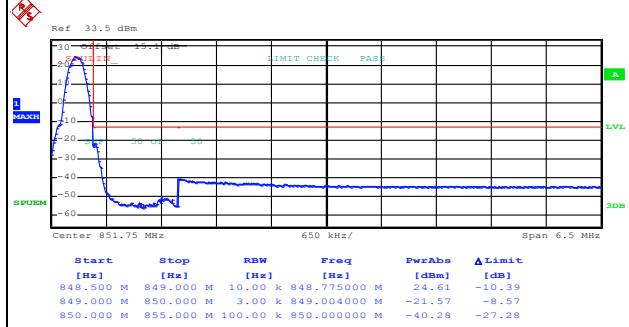

Date: 22.DEC.2016 10:52:40

## GSM850 (EDGE class 8)

### Lowest Band Edge

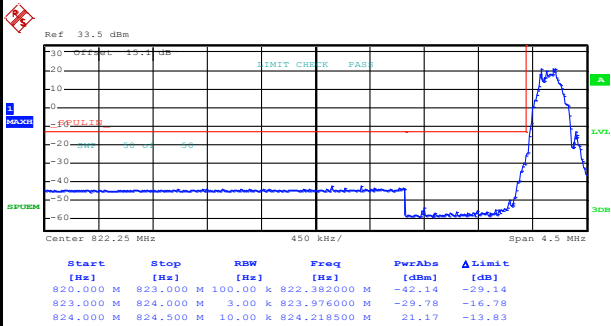

Date: 22.DEC.2016 11:10:00

### Highest Band Edge

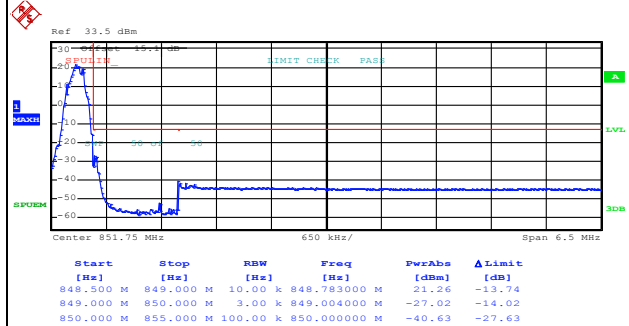

Date: 22.DEC.2016 11:12:17



GSM1900 (GPRS class 8)

Lowest Band Edge

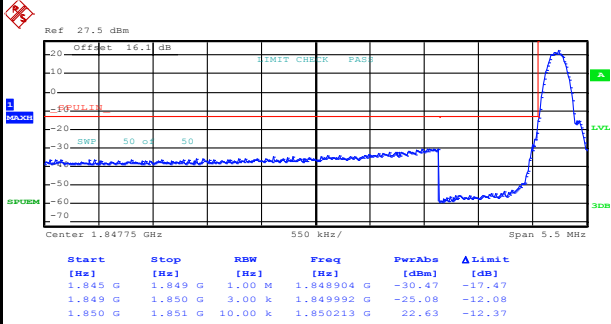

Date: 22.DEC.2016 11:30:14

Highest Band Edge

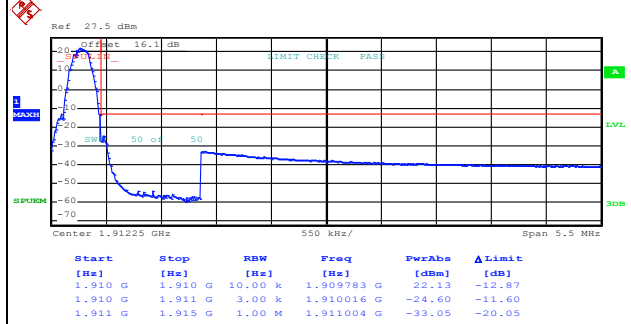

Date: 22.DEC.2016 11:31:45

GSM1900 (EDGE class 8)

Lowest Band Edge

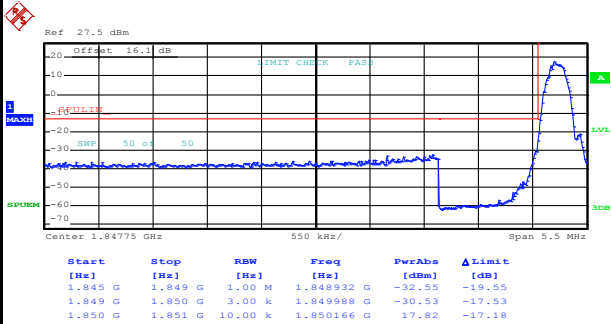

Date: 22.DEC.2016 11:56:57

Highest Band Edge

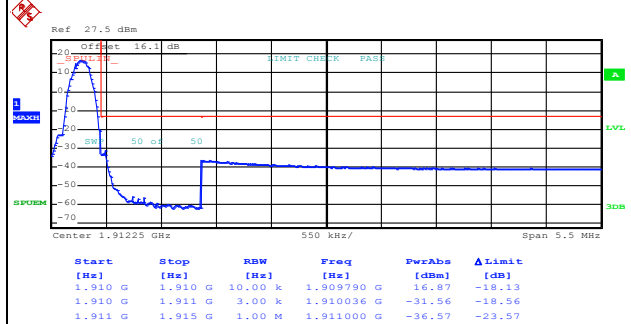

Date: 22.DEC.2016 11:58:31



# Conducted Spurious Emission

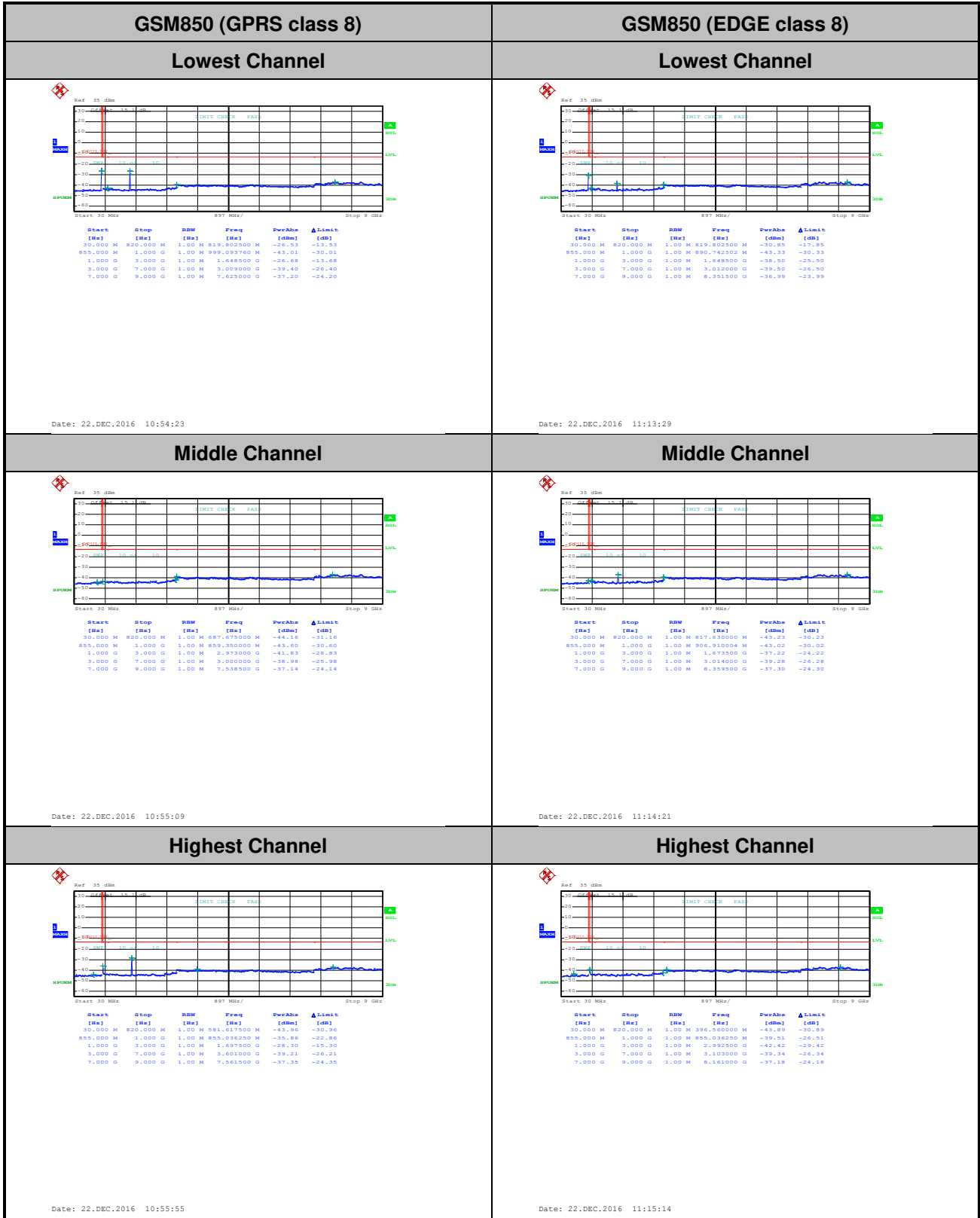

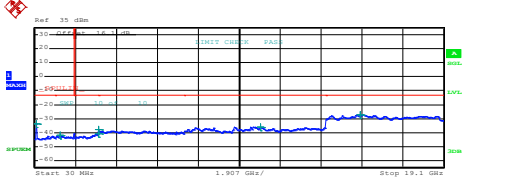
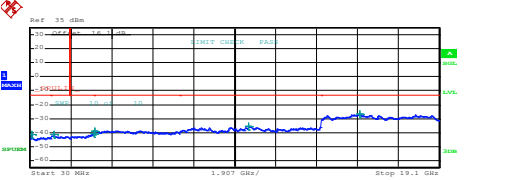
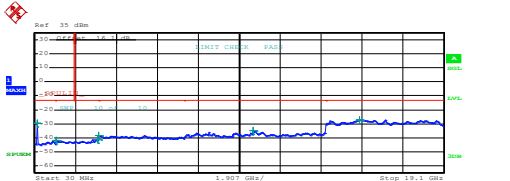
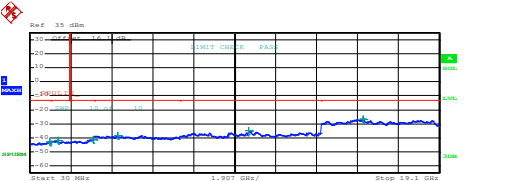
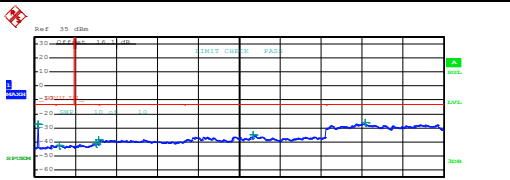
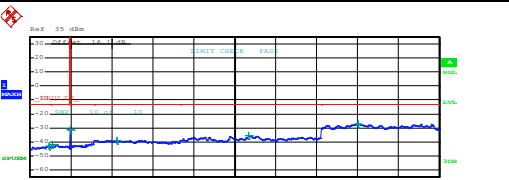

GSM1900 (GPRS class 8)	GSM1900 (EDGE class 8)																																																																																				
Lowest Channel	Lowest Channel																																																																																				
 <table border="1" data-bbox="239 571 686 672"> <thead> <tr> <th>Start [Hz]</th> <th>Stop [Hz]</th> <th>RBW [Hz]</th> <th>Freq [Hz]</th> <th>PwrAve [dBm]</th> <th>ΔLimit [dB]</th> </tr> </thead> <tbody> <tr><td>30.000 M</td><td>1.000 G</td><td>1.00 M</td><td>111.905000 M</td><td>-33.84</td><td>-29.44</td></tr> <tr><td>1.000 G</td><td>1.845 G</td><td>1.00 M</td><td>1.223500 G</td><td>-42.07</td><td>-29.07</td></tr> <tr><td>1.845 G</td><td>3.000 G</td><td>1.00 M</td><td>2.099460 G</td><td>-40.98</td><td>-27.98</td></tr> <tr><td>3.000 G</td><td>7.000 G</td><td>1.00 M</td><td>3.007000 G</td><td>-38.03</td><td>-25.03</td></tr> <tr><td>7.000 G</td><td>13.600 G</td><td>1.00 M</td><td>10.559000 G</td><td>-35.84</td><td>-22.84</td></tr> <tr><td>13.600 G</td><td>19.100 G</td><td>1.00 M</td><td>15.211500 G</td><td>-27.02</td><td>-14.02</td></tr> </tbody> </table> <p>Date: 22.DEC.2016 11:32:49</p>	Start [Hz]	Stop [Hz]	RBW [Hz]	Freq [Hz]	PwrAve [dBm]	ΔLimit [dB]	30.000 M	1.000 G	1.00 M	111.905000 M	-33.84	-29.44	1.000 G	1.845 G	1.00 M	1.223500 G	-42.07	-29.07	1.845 G	3.000 G	1.00 M	2.099460 G	-40.98	-27.98	3.000 G	7.000 G	1.00 M	3.007000 G	-38.03	-25.03	7.000 G	13.600 G	1.00 M	10.559000 G	-35.84	-22.84	13.600 G	19.100 G	1.00 M	15.211500 G	-27.02	-14.02	 <table border="1" data-bbox="893 571 1340 672"> <thead> <tr> <th>Start [Hz]</th> <th>Stop [Hz]</th> <th>RBW [Hz]</th> <th>Freq [Hz]</th> <th>PwrAve [dBm]</th> <th>ΔLimit [dB]</th> </tr> </thead> <tbody> <tr><td>30.000 M</td><td>1.000 G</td><td>1.00 M</td><td>112.207500 M</td><td>-41.27</td><td>-28.27</td></tr> <tr><td>1.000 G</td><td>1.845 G</td><td>1.00 M</td><td>1.139425 G</td><td>-41.61</td><td>-28.61</td></tr> <tr><td>1.845 G</td><td>3.000 G</td><td>1.00 M</td><td>2.994304 G</td><td>-40.94</td><td>-27.94</td></tr> <tr><td>3.000 G</td><td>7.000 G</td><td>1.00 M</td><td>3.027000 G</td><td>-38.73</td><td>-25.73</td></tr> <tr><td>7.000 G</td><td>13.600 G</td><td>1.00 M</td><td>10.229000 G</td><td>-35.53</td><td>-22.53</td></tr> <tr><td>13.600 G</td><td>19.100 G</td><td>1.00 M</td><td>15.432250 G</td><td>-26.70</td><td>-13.70</td></tr> </tbody> </table> <p>Date: 22.DEC.2016 11:59:36</p>	Start [Hz]	Stop [Hz]	RBW [Hz]	Freq [Hz]	PwrAve [dBm]	ΔLimit [dB]	30.000 M	1.000 G	1.00 M	112.207500 M	-41.27	-28.27	1.000 G	1.845 G	1.00 M	1.139425 G	-41.61	-28.61	1.845 G	3.000 G	1.00 M	2.994304 G	-40.94	-27.94	3.000 G	7.000 G	1.00 M	3.027000 G	-38.73	-25.73	7.000 G	13.600 G	1.00 M	10.229000 G	-35.53	-22.53	13.600 G	19.100 G	1.00 M	15.432250 G	-26.70	-13.70
Start [Hz]	Stop [Hz]	RBW [Hz]	Freq [Hz]	PwrAve [dBm]	ΔLimit [dB]																																																																																
30.000 M	1.000 G	1.00 M	111.905000 M	-33.84	-29.44																																																																																
1.000 G	1.845 G	1.00 M	1.223500 G	-42.07	-29.07																																																																																
1.845 G	3.000 G	1.00 M	2.099460 G	-40.98	-27.98																																																																																
3.000 G	7.000 G	1.00 M	3.007000 G	-38.03	-25.03																																																																																
7.000 G	13.600 G	1.00 M	10.559000 G	-35.84	-22.84																																																																																
13.600 G	19.100 G	1.00 M	15.211500 G	-27.02	-14.02																																																																																
Start [Hz]	Stop [Hz]	RBW [Hz]	Freq [Hz]	PwrAve [dBm]	ΔLimit [dB]																																																																																
30.000 M	1.000 G	1.00 M	112.207500 M	-41.27	-28.27																																																																																
1.000 G	1.845 G	1.00 M	1.139425 G	-41.61	-28.61																																																																																
1.845 G	3.000 G	1.00 M	2.994304 G	-40.94	-27.94																																																																																
3.000 G	7.000 G	1.00 M	3.027000 G	-38.73	-25.73																																																																																
7.000 G	13.600 G	1.00 M	10.229000 G	-35.53	-22.53																																																																																
13.600 G	19.100 G	1.00 M	15.432250 G	-26.70	-13.70																																																																																
Middle Channel	Middle Channel																																																																																				
 <table border="1" data-bbox="239 1086 686 1187"> <thead> <tr> <th>Start [Hz]</th> <th>Stop [Hz]</th> <th>RBW [Hz]</th> <th>Freq [Hz]</th> <th>PwrAve [dBm]</th> <th>ΔLimit [dB]</th> </tr> </thead> <tbody> <tr><td>30.000 M</td><td>1.000 G</td><td>1.00 M</td><td>141.792500 M</td><td>-29.70</td><td>-16.70</td></tr> <tr><td>1.000 G</td><td>3.845 G</td><td>1.00 M</td><td>1.033930 G</td><td>-42.04</td><td>-29.04</td></tr> <tr><td>1.915 G</td><td>3.000 G</td><td>1.00 M</td><td>2.960398 G</td><td>-41.05</td><td>-28.05</td></tr> <tr><td>3.000 G</td><td>7.000 G</td><td>1.00 M</td><td>3.000000 G</td><td>-38.33</td><td>-25.33</td></tr> <tr><td>7.000 G</td><td>13.600 G</td><td>1.00 M</td><td>10.210000 G</td><td>-35.08</td><td>-22.08</td></tr> <tr><td>13.600 G</td><td>19.100 G</td><td>1.00 M</td><td>15.168188 G</td><td>-27.26</td><td>-14.26</td></tr> </tbody> </table> <p>Date: 22.DEC.2016 11:33:46</p>	Start [Hz]	Stop [Hz]	RBW [Hz]	Freq [Hz]	PwrAve [dBm]	ΔLimit [dB]	30.000 M	1.000 G	1.00 M	141.792500 M	-29.70	-16.70	1.000 G	3.845 G	1.00 M	1.033930 G	-42.04	-29.04	1.915 G	3.000 G	1.00 M	2.960398 G	-41.05	-28.05	3.000 G	7.000 G	1.00 M	3.000000 G	-38.33	-25.33	7.000 G	13.600 G	1.00 M	10.210000 G	-35.08	-22.08	13.600 G	19.100 G	1.00 M	15.168188 G	-27.26	-14.26	 <table border="1" data-bbox="893 1086 1340 1187"> <thead> <tr> <th>Start [Hz]</th> <th>Stop [Hz]</th> <th>RBW [Hz]</th> <th>Freq [Hz]</th> <th>PwrAve [dBm]</th> <th>ΔLimit [dB]</th> </tr> </thead> <tbody> <tr><td>30.000 M</td><td>1.000 G</td><td>1.00 M</td><td>949.317500 M</td><td>-42.93</td><td>-29.93</td></tr> <tr><td>1.000 G</td><td>3.845 G</td><td>1.00 M</td><td>1.388214 G</td><td>-42.04</td><td>-29.04</td></tr> <tr><td>1.915 G</td><td>3.000 G</td><td>1.00 M</td><td>2.967179 G</td><td>-41.30</td><td>-28.30</td></tr> <tr><td>3.000 G</td><td>7.000 G</td><td>1.00 M</td><td>4.121000 G</td><td>-38.35</td><td>-25.35</td></tr> <tr><td>7.000 G</td><td>13.600 G</td><td>1.00 M</td><td>10.239500 G</td><td>-34.87</td><td>-21.87</td></tr> <tr><td>13.600 G</td><td>19.100 G</td><td>1.00 M</td><td>15.571750 G</td><td>-26.80</td><td>-13.80</td></tr> </tbody> </table> <p>Date: 22.DEC.2016 12:01:05</p>	Start [Hz]	Stop [Hz]	RBW [Hz]	Freq [Hz]	PwrAve [dBm]	ΔLimit [dB]	30.000 M	1.000 G	1.00 M	949.317500 M	-42.93	-29.93	1.000 G	3.845 G	1.00 M	1.388214 G	-42.04	-29.04	1.915 G	3.000 G	1.00 M	2.967179 G	-41.30	-28.30	3.000 G	7.000 G	1.00 M	4.121000 G	-38.35	-25.35	7.000 G	13.600 G	1.00 M	10.239500 G	-34.87	-21.87	13.600 G	19.100 G	1.00 M	15.571750 G	-26.80	-13.80
Start [Hz]	Stop [Hz]	RBW [Hz]	Freq [Hz]	PwrAve [dBm]	ΔLimit [dB]																																																																																
30.000 M	1.000 G	1.00 M	141.792500 M	-29.70	-16.70																																																																																
1.000 G	3.845 G	1.00 M	1.033930 G	-42.04	-29.04																																																																																
1.915 G	3.000 G	1.00 M	2.960398 G	-41.05	-28.05																																																																																
3.000 G	7.000 G	1.00 M	3.000000 G	-38.33	-25.33																																																																																
7.000 G	13.600 G	1.00 M	10.210000 G	-35.08	-22.08																																																																																
13.600 G	19.100 G	1.00 M	15.168188 G	-27.26	-14.26																																																																																
Start [Hz]	Stop [Hz]	RBW [Hz]	Freq [Hz]	PwrAve [dBm]	ΔLimit [dB]																																																																																
30.000 M	1.000 G	1.00 M	949.317500 M	-42.93	-29.93																																																																																
1.000 G	3.845 G	1.00 M	1.388214 G	-42.04	-29.04																																																																																
1.915 G	3.000 G	1.00 M	2.967179 G	-41.30	-28.30																																																																																
3.000 G	7.000 G	1.00 M	4.121000 G	-38.35	-25.35																																																																																
7.000 G	13.600 G	1.00 M	10.239500 G	-34.87	-21.87																																																																																
13.600 G	19.100 G	1.00 M	15.571750 G	-26.80	-13.80																																																																																
Highest Channel	Highest Channel																																																																																				
 <table border="1" data-bbox="239 1601 686 1702"> <thead> <tr> <th>Start [Hz]</th> <th>Stop [Hz]</th> <th>RBW [Hz]</th> <th>Freq [Hz]</th> <th>PwrAve [dBm]</th> <th>ΔLimit [dB]</th> </tr> </thead> <tbody> <tr><td>30.000 M</td><td>1.000 G</td><td>1.00 M</td><td>171.600000 M</td><td>-27.49</td><td>-14.49</td></tr> <tr><td>1.000 G</td><td>1.845 G</td><td>1.00 M</td><td>1.172803 G</td><td>-42.56</td><td>-29.56</td></tr> <tr><td>1.845 G</td><td>3.000 G</td><td>1.00 M</td><td>2.906961 G</td><td>-42.25</td><td>-28.25</td></tr> <tr><td>3.000 G</td><td>7.000 G</td><td>1.00 M</td><td>3.006000 G</td><td>-38.56</td><td>-25.56</td></tr> <tr><td>7.000 G</td><td>13.600 G</td><td>1.00 M</td><td>10.227400 G</td><td>-35.17</td><td>-22.17</td></tr> <tr><td>13.600 G</td><td>19.100 G</td><td>1.00 M</td><td>15.430325 G</td><td>-26.17</td><td>-13.17</td></tr> </tbody> </table> <p>Date: 22.DEC.2016 11:34:40</p>	Start [Hz]	Stop [Hz]	RBW [Hz]	Freq [Hz]	PwrAve [dBm]	ΔLimit [dB]	30.000 M	1.000 G	1.00 M	171.600000 M	-27.49	-14.49	1.000 G	1.845 G	1.00 M	1.172803 G	-42.56	-29.56	1.845 G	3.000 G	1.00 M	2.906961 G	-42.25	-28.25	3.000 G	7.000 G	1.00 M	3.006000 G	-38.56	-25.56	7.000 G	13.600 G	1.00 M	10.227400 G	-35.17	-22.17	13.600 G	19.100 G	1.00 M	15.430325 G	-26.17	-13.17	 <table border="1" data-bbox="893 1601 1340 1702"> <thead> <tr> <th>Start [Hz]</th> <th>Stop [Hz]</th> <th>RBW [Hz]</th> <th>Freq [Hz]</th> <th>PwrAve [dBm]</th> <th>ΔLimit [dB]</th> </tr> </thead> <tbody> <tr><td>30.000 M</td><td>1.000 G</td><td>1.00 M</td><td>907.305000 M</td><td>-43.05</td><td>-30.05</td></tr> <tr><td>1.000 G</td><td>1.845 G</td><td>1.00 M</td><td>1.071403 G</td><td>-41.90</td><td>-28.90</td></tr> <tr><td>1.845 G</td><td>3.000 G</td><td>1.00 M</td><td>1.935271 G</td><td>-39.29</td><td>-26.29</td></tr> <tr><td>3.000 G</td><td>7.000 G</td><td>1.00 M</td><td>4.090000 G</td><td>-38.70</td><td>-25.70</td></tr> <tr><td>7.000 G</td><td>13.600 G</td><td>1.00 M</td><td>10.217500 G</td><td>-35.75</td><td>-22.75</td></tr> <tr><td>13.600 G</td><td>19.100 G</td><td>1.00 M</td><td>15.342653 G</td><td>-27.00</td><td>-14.00</td></tr> </tbody> </table> <p>Date: 22.DEC.2016 12:02:08</p>	Start [Hz]	Stop [Hz]	RBW [Hz]	Freq [Hz]	PwrAve [dBm]	ΔLimit [dB]	30.000 M	1.000 G	1.00 M	907.305000 M	-43.05	-30.05	1.000 G	1.845 G	1.00 M	1.071403 G	-41.90	-28.90	1.845 G	3.000 G	1.00 M	1.935271 G	-39.29	-26.29	3.000 G	7.000 G	1.00 M	4.090000 G	-38.70	-25.70	7.000 G	13.600 G	1.00 M	10.217500 G	-35.75	-22.75	13.600 G	19.100 G	1.00 M	15.342653 G	-27.00	-14.00
Start [Hz]	Stop [Hz]	RBW [Hz]	Freq [Hz]	PwrAve [dBm]	ΔLimit [dB]																																																																																
30.000 M	1.000 G	1.00 M	171.600000 M	-27.49	-14.49																																																																																
1.000 G	1.845 G	1.00 M	1.172803 G	-42.56	-29.56																																																																																
1.845 G	3.000 G	1.00 M	2.906961 G	-42.25	-28.25																																																																																
3.000 G	7.000 G	1.00 M	3.006000 G	-38.56	-25.56																																																																																
7.000 G	13.600 G	1.00 M	10.227400 G	-35.17	-22.17																																																																																
13.600 G	19.100 G	1.00 M	15.430325 G	-26.17	-13.17																																																																																
Start [Hz]	Stop [Hz]	RBW [Hz]	Freq [Hz]	PwrAve [dBm]	ΔLimit [dB]																																																																																
30.000 M	1.000 G	1.00 M	907.305000 M	-43.05	-30.05																																																																																
1.000 G	1.845 G	1.00 M	1.071403 G	-41.90	-28.90																																																																																
1.845 G	3.000 G	1.00 M	1.935271 G	-39.29	-26.29																																																																																
3.000 G	7.000 G	1.00 M	4.090000 G	-38.70	-25.70																																																																																
7.000 G	13.600 G	1.00 M	10.217500 G	-35.75	-22.75																																																																																
13.600 G	19.100 G	1.00 M	15.342653 G	-27.00	-14.00																																																																																



**Frequency Stability**

Test Conditions	Middle Channel	GSM850 (GPRS class 8)	GSM850 (EDGE class 8)	Limit 2.5ppm
Temperature (°C)	Voltage (Volt)	Deviation (ppm)		Result
50	Normal Voltage	0.0036	0.0000	PASS
40	Normal Voltage	0.0024	0.0048	
30	Normal Voltage	0.0012	0.0024	
20(Ref.)	Normal Voltage	0.0000	0.0000	
10	Normal Voltage	0.0024	0.0060	
0	Normal Voltage	0.0048	0.0132	
-10	Normal Voltage	0.0120	0.0179	
-20	Normal Voltage	0.0096	0.0155	
-30	Normal Voltage	0.0120	0.0167	
20	Maximum Voltage	0.0060	0.0000	
20	Normal Voltage	0.0000	0.0000	
20	Battery End Point	0.0024	0.0024	

Test Conditions	Middle Channel	GSM1900 (GPRS class 8)	GSM1900 (EDGE class 8)	Limit Note 2.
Temperature (°C)	Voltage (Volt)	Deviation (ppm)		Result
50	Normal Voltage	0.0016	0.0005	PASS
40	Normal Voltage	0.0011	0.0000	
30	Normal Voltage	0.0021	0.0011	
20(Ref.)	Normal Voltage	0.0000	0.0000	
10	Normal Voltage	0.0197	0.0021	
0	Normal Voltage	0.0303	0.0032	
-10	Normal Voltage	0.0335	0.0027	
-20	Normal Voltage	0.0356	0.0048	
-30	Normal Voltage	0.0346	0.0053	
20	Maximum Voltage	0.0021	0.0011	
20	Normal Voltage	0.0000	0.0000	
20	Battery End Point	0.0032	0.0011	

**Note:**

1. Normal Voltage = 3.85V. ; Battery End Point (BEP) = 3.6 V. ; Maximum Voltage =4.4 V
2. The frequency fundamental emissions stay within the authorized frequency block.



## A2. WCDMA

### Peak-to-Average Ratio

Mode	WCDMA Band V	WCDMA Band II	WCDMA Band IV	Limit: 13dB
Mod.	RMC 12.2Kbps	RMC 12.2Kbps	RMC 12.2Kbps	Result
Lowest CH	3.16	3.16	3.16	<b>PASS</b>
Middle CH	3.16	3.16	3.16	
Highest CH	3.28	3.12	3.36	

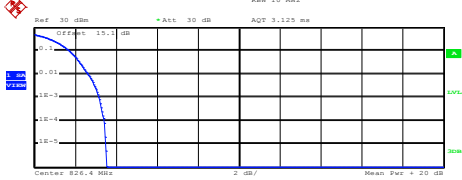
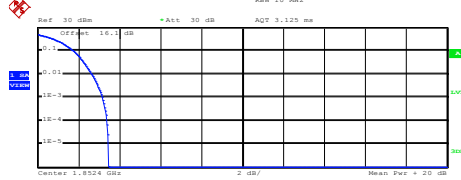
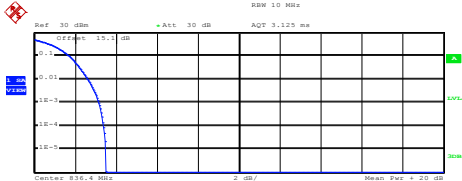
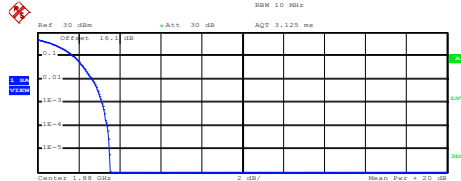
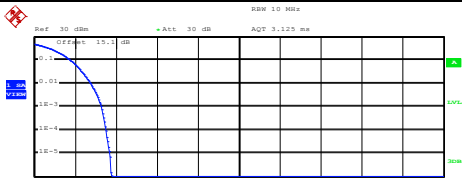
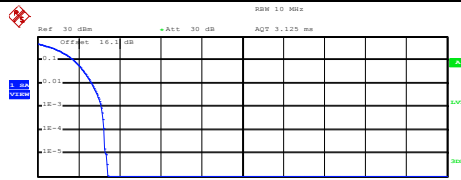

WCDMA Band V (RMC 12.2Kbps)	WCDMA Band II (RMC 12.2Kbps)																
<p align="center"><b>Lowest Channel</b></p>  <p>Center 826.4 MHz      2 dB/      Mean Pwr + 20 dB</p> <p>Complementary Cumulative Distribution Function (100000 samples) Trace 1 Mean 23.10 dBm Peak 26.65 dBm Crest 3.55 dB</p> <table border="0"> <tr><td>10 %</td><td>1.72 dB</td></tr> <tr><td>1 %</td><td>2.64 dB</td></tr> <tr><td>.1 %</td><td>3.16 dB</td></tr> <tr><td>.01 %</td><td>3.44 dB</td></tr> </table> <p>Date: 22.DEC.2016 12:23:00</p>	10 %	1.72 dB	1 %	2.64 dB	.1 %	3.16 dB	.01 %	3.44 dB	<p align="center"><b>Lowest Channel</b></p>  <p>Center 1.8524 GHz      2 dB/      Mean Pwr + 20 dB</p> <p>Complementary Cumulative Distribution Function (100000 samples) Trace 1 Mean 22.48 dBm Peak 25.95 dBm Crest 3.47 dB</p> <table border="0"> <tr><td>10 %</td><td>1.76 dB</td></tr> <tr><td>1 %</td><td>2.64 dB</td></tr> <tr><td>.1 %</td><td>3.16 dB</td></tr> <tr><td>.01 %</td><td>3.40 dB</td></tr> </table> <p>Date: 22.DEC.2016 12:42:19</p>	10 %	1.76 dB	1 %	2.64 dB	.1 %	3.16 dB	.01 %	3.40 dB
10 %	1.72 dB																
1 %	2.64 dB																
.1 %	3.16 dB																
.01 %	3.44 dB																
10 %	1.76 dB																
1 %	2.64 dB																
.1 %	3.16 dB																
.01 %	3.40 dB																
<p align="center"><b>Middle Channel</b></p>  <p>Center 830.4 MHz      2 dB/      Mean Pwr + 20 dB</p> <p>Complementary Cumulative Distribution Function (100000 samples) Trace 1 Mean 23.08 dBm Peak 26.58 dBm Crest 3.51 dB</p> <table border="0"> <tr><td>10 %</td><td>1.72 dB</td></tr> <tr><td>1 %</td><td>2.64 dB</td></tr> <tr><td>.1 %</td><td>3.16 dB</td></tr> <tr><td>.01 %</td><td>3.40 dB</td></tr> </table> <p>Date: 22.DEC.2016 12:23:16</p>	10 %	1.72 dB	1 %	2.64 dB	.1 %	3.16 dB	.01 %	3.40 dB	<p align="center"><b>Middle Channel</b></p>  <p>Center 1.88 GHz      2 dB/      Mean Pwr + 20 dB</p> <p>Complementary Cumulative Distribution Function (100000 samples) Trace 1 Mean 22.56 dBm Peak 26.09 dBm Crest 3.52 dB</p> <table border="0"> <tr><td>10 %</td><td>1.76 dB</td></tr> <tr><td>1 %</td><td>2.64 dB</td></tr> <tr><td>.1 %</td><td>3.16 dB</td></tr> <tr><td>.01 %</td><td>3.40 dB</td></tr> </table> <p>Date: 22.DEC.2016 12:42:39</p>	10 %	1.76 dB	1 %	2.64 dB	.1 %	3.16 dB	.01 %	3.40 dB
10 %	1.72 dB																
1 %	2.64 dB																
.1 %	3.16 dB																
.01 %	3.40 dB																
10 %	1.76 dB																
1 %	2.64 dB																
.1 %	3.16 dB																
.01 %	3.40 dB																
<p align="center"><b>Highest Channel</b></p>  <p>Center 846.6 MHz      2 dB/      Mean Pwr + 20 dB</p> <p>Complementary Cumulative Distribution Function (100000 samples) Trace 1 Mean 23.10 dBm Peak 26.86 dBm Crest 3.76 dB</p> <table border="0"> <tr><td>10 %</td><td>1.76 dB</td></tr> <tr><td>1 %</td><td>2.76 dB</td></tr> <tr><td>.1 %</td><td>3.28 dB</td></tr> <tr><td>.01 %</td><td>3.52 dB</td></tr> </table> <p>Date: 22.DEC.2016 12:23:29</p>	10 %	1.76 dB	1 %	2.76 dB	.1 %	3.28 dB	.01 %	3.52 dB	<p align="center"><b>Highest Channel</b></p>  <p>Center 1.9076 GHz      2 dB/      Mean Pwr + 20 dB</p> <p>Complementary Cumulative Distribution Function (100000 samples) Trace 1 Mean 22.53 dBm Peak 25.95 dBm Crest 3.42 dB</p> <table border="0"> <tr><td>10 %</td><td>1.76 dB</td></tr> <tr><td>1 %</td><td>2.64 dB</td></tr> <tr><td>.1 %</td><td>3.12 dB</td></tr> <tr><td>.01 %</td><td>3.24 dB</td></tr> </table> <p>Date: 22.DEC.2016 12:42:55</p>	10 %	1.76 dB	1 %	2.64 dB	.1 %	3.12 dB	.01 %	3.24 dB
10 %	1.76 dB																
1 %	2.76 dB																
.1 %	3.28 dB																
.01 %	3.52 dB																
10 %	1.76 dB																
1 %	2.64 dB																
.1 %	3.12 dB																
.01 %	3.24 dB																

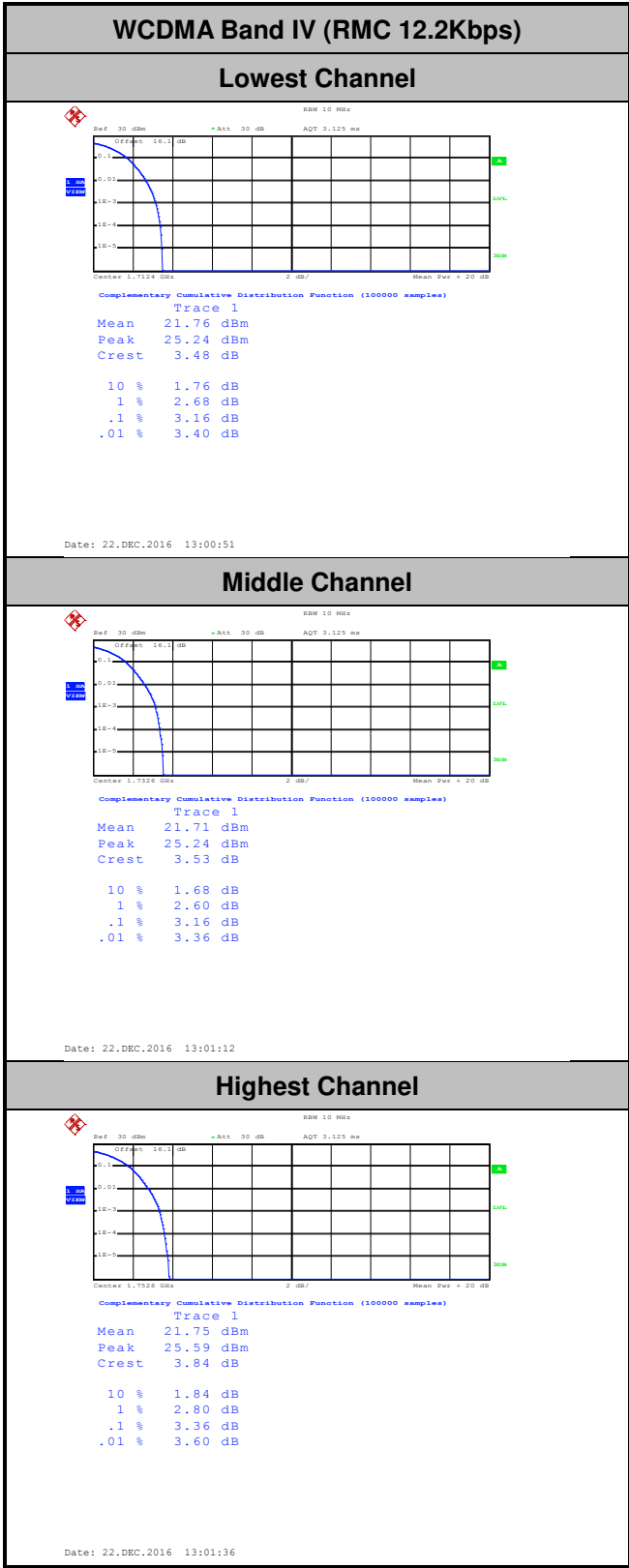





**26dB Bandwidth**

Mode	WCDMA Band V	WCDMA Band II	WCDMA Band IV
Mod.	RMC 12.2Kbps	RMC 12.2Kbps	RMC 12.2Kbps
Lowest CH	4.71	4.72	4.72
Middle CH	4.71	4.72	4.72
Highest CH	4.70	4.72	4.71



WCDMA Band V (RMC 12.2Kbps)

WCDMA Band II (RMC 12.2Kbps)

Lowest Channel

Lowest Channel

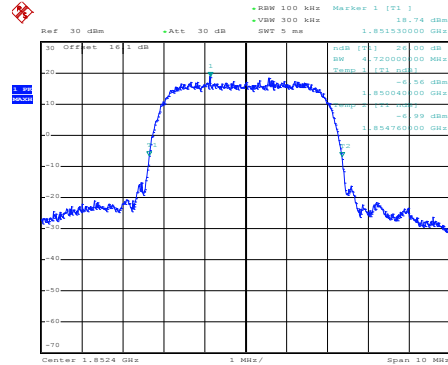
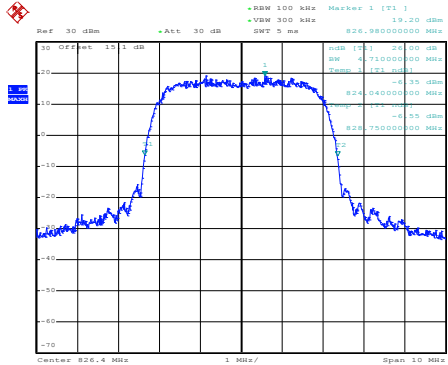

Date: 22.DEC.2016 12:09:03

Date: 22.DEC.2016 12:24:40

Middle Channel

Middle Channel

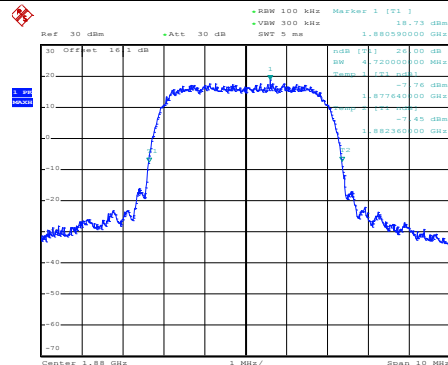
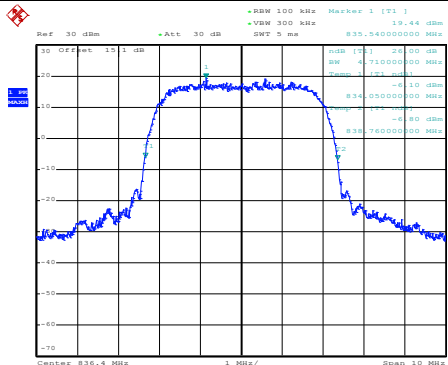

Date: 22.DEC.2016 12:09:40

Date: 22.DEC.2016 12:25:16

Highest Channel

Highest Channel

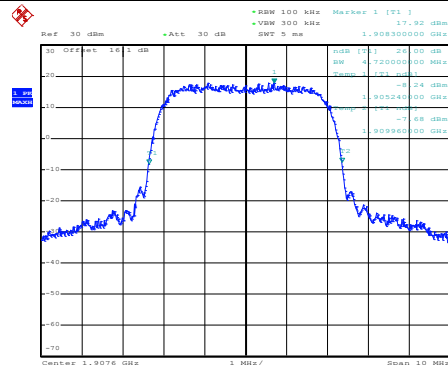
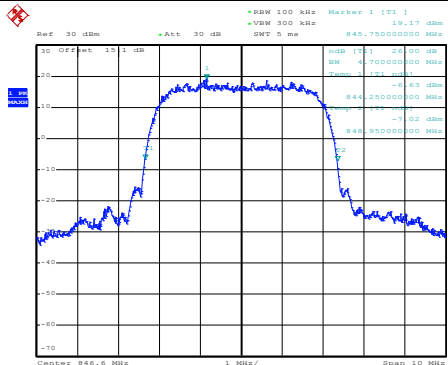

Date: 22.DEC.2016 12:11:08

Date: 22.DEC.2016 12:25:53



### WCDMA Band IV (RMC 12.2Kbps)

#### Lowest Channel

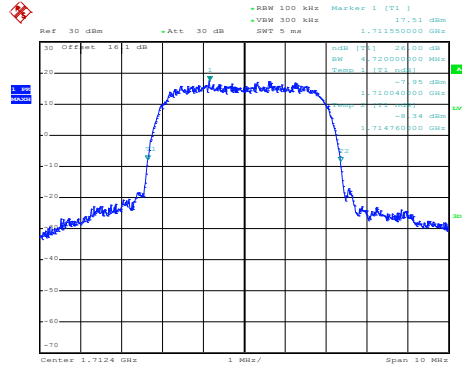

Date: 22.DEC.2016 12:44:39

#### Middle Channel

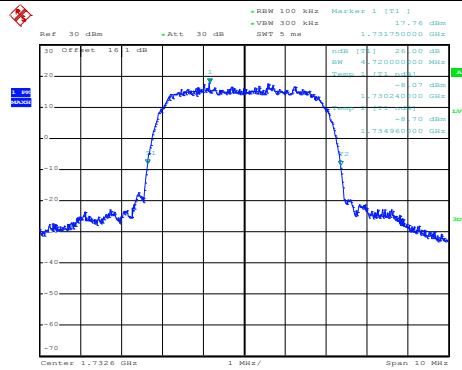

Date: 22.DEC.2016 12:45:13

#### Highest Channel

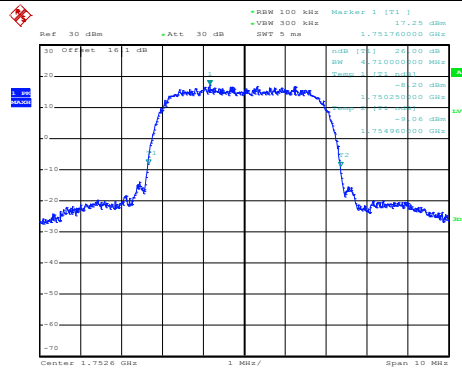

Date: 22.DEC.2016 12:45:47



**Occupied Bandwidth**

Mode	WCDMA Band V	WCDMA Band II	WCDMA Band IV
Mod.	RMC 12.2Kbps	RMC 12.2Kbps	RMC 12.2Kbps
Lowest CH	4.14	4.15	4.14
Middle CH	4.14	4.15	4.14
Highest CH	4.13	4.15	4.15

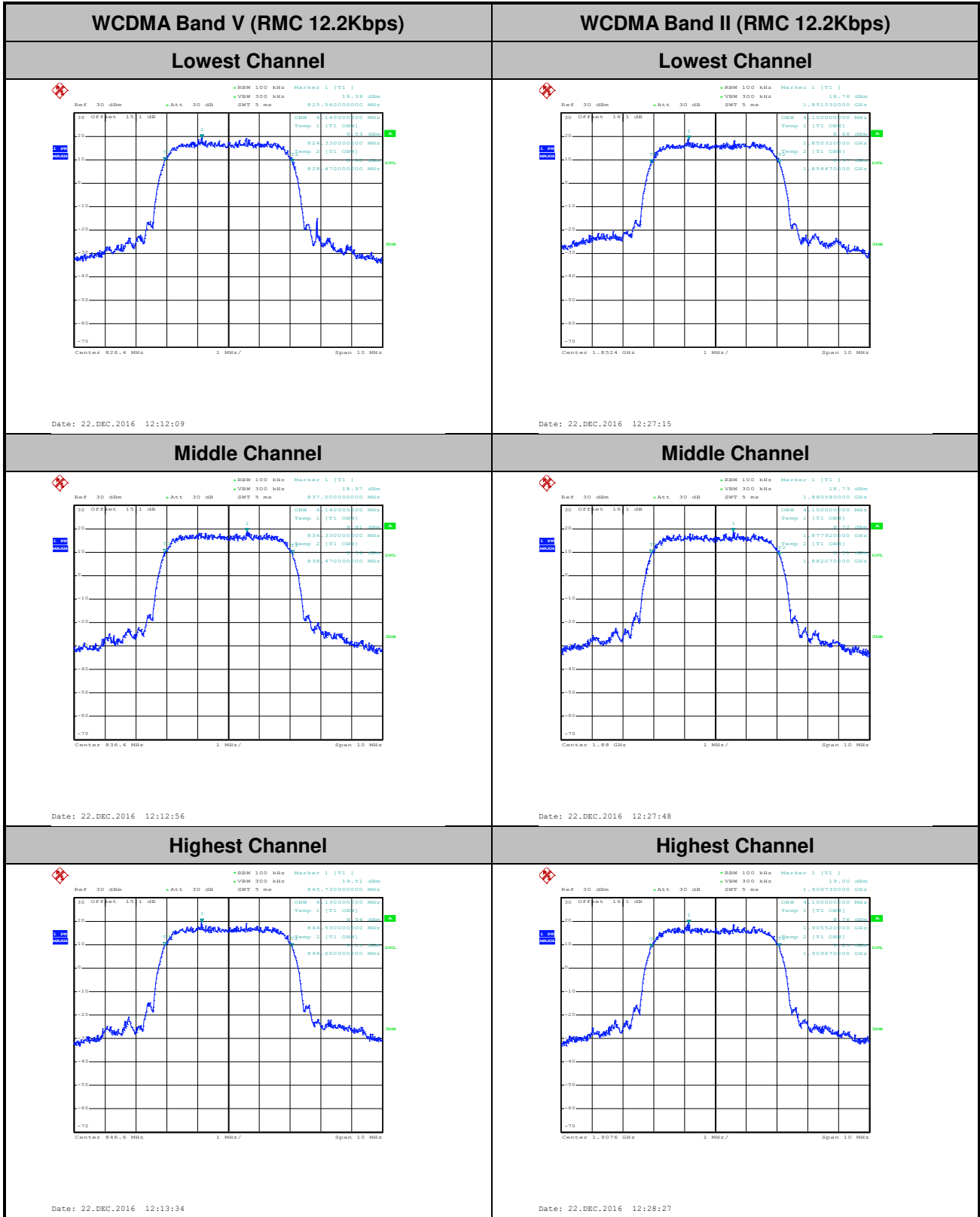

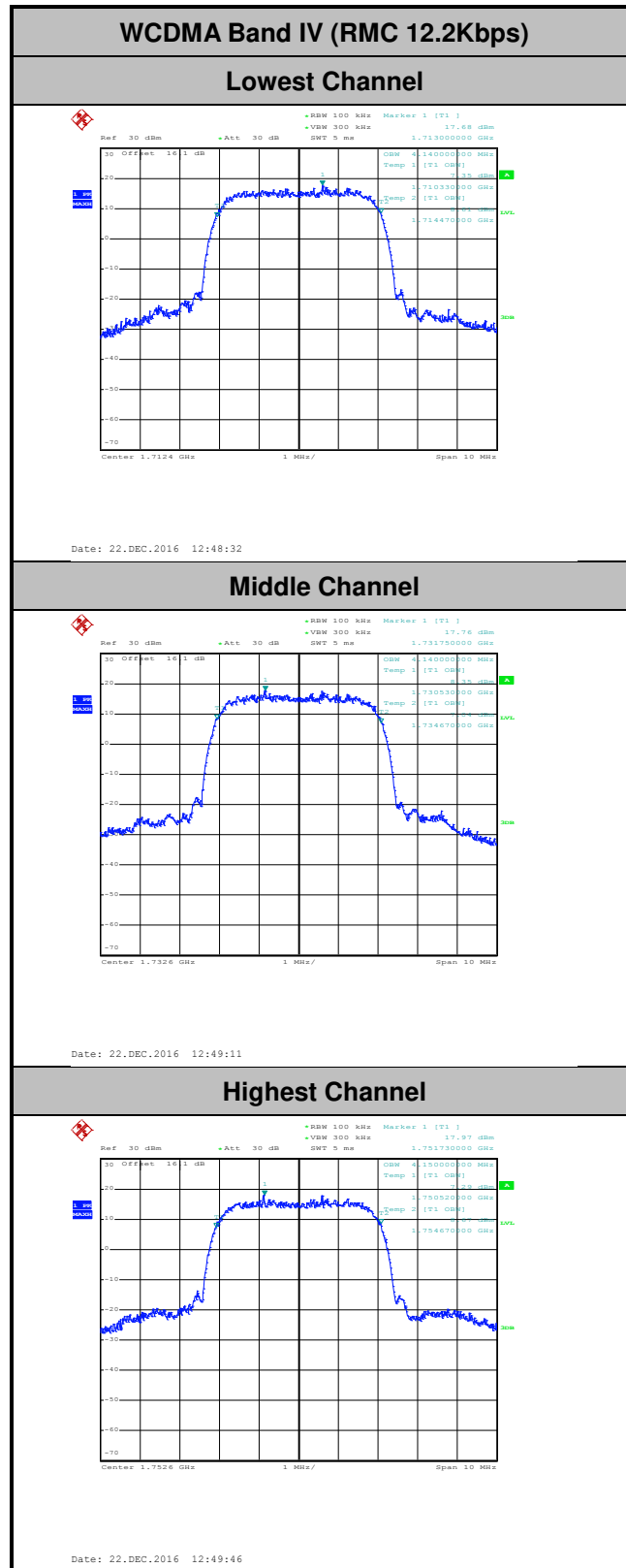



# Conducted Band Edge

## WCDMA Band V (RMC 12.2Kbps)

### Lowest Band Edge

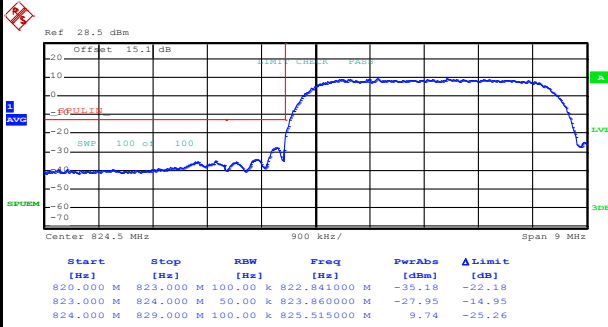

Date: 22.DEC.2016 12:16:20

### Highest Band Edge

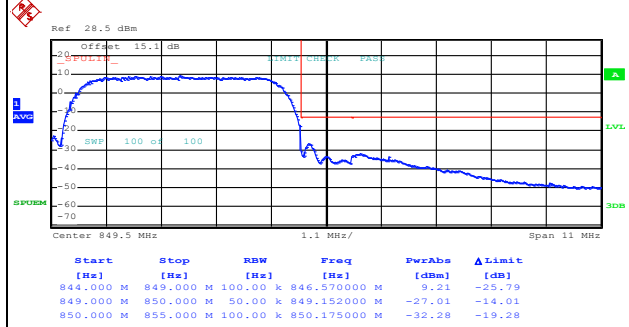

Date: 22.DEC.2016 12:19:10

## WCDMA Band II (RMC 12.2Kbps)

### Lowest Band Edge

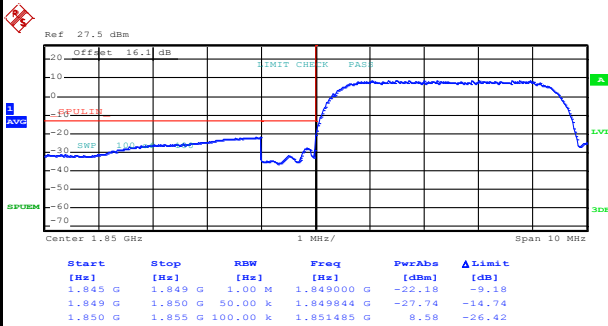

Date: 22.DEC.2016 12:31:21

### Highest Band Edge

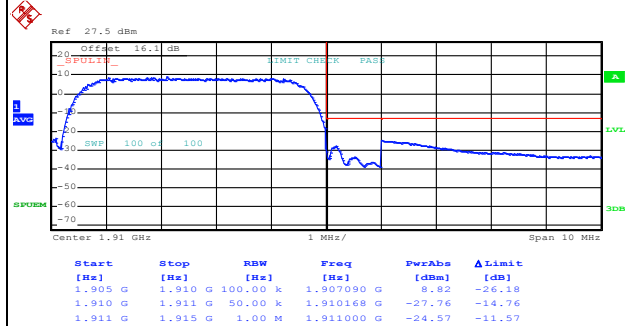

Date: 22.DEC.2016 12:34:19



WCDMA Band IV (RMC 12.2Kbps)

Lowest Band Edge

Highest Band Edge

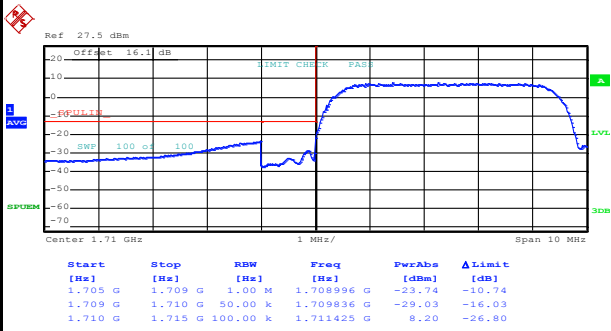

Date: 22.DEC.2016 12:52:38

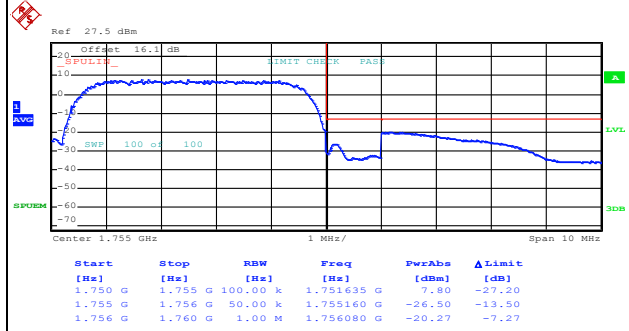

Date: 22.DEC.2016 12:55:57





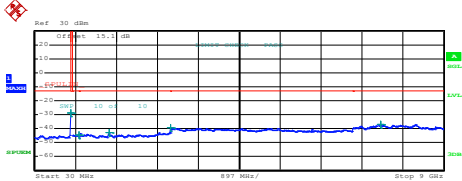
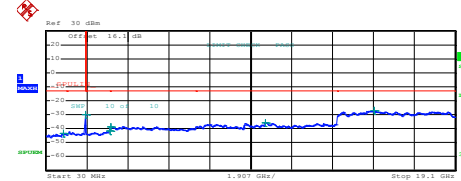
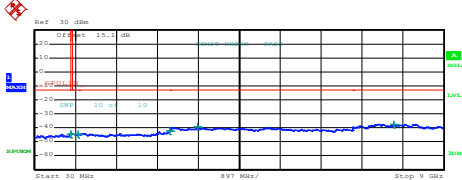
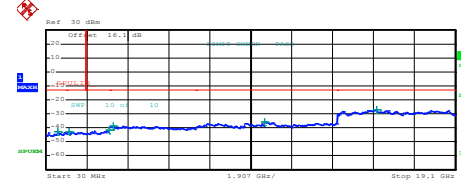
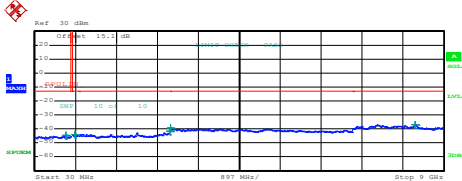
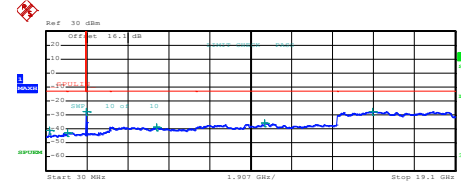

# Conducted Spurious Emission

WCDMA Band V (RMC 12.2Kbps)	WCDMA Band II (RMC 12.2Kbps)																																																																																										
Lowest Channel	Lowest Channel																																																																																										
 <table border="1" data-bbox="239 660 654 739"> <thead> <tr> <th>Start</th> <th>Stop</th> <th>RBW</th> <th>Freq</th> <th>PwrAve</th> <th>ΔLimit</th> </tr> <tr> <th>[Hz]</th> <th>[Hz]</th> <th>[Hz]</th> <th>[Hz]</th> <th>[dBm]</th> <th>[dB]</th> </tr> </thead> <tbody> <tr> <td>30.000 M</td> <td>820.000 M</td> <td>1.00 M</td> <td>819.407500 M</td> <td>-48.93</td> <td>-25.93</td> </tr> <tr> <td>835.000 M</td> <td>1.000 G</td> <td>1.00 M</td> <td>991.082500 M</td> <td>-44.32</td> <td>-31.32</td> </tr> <tr> <td>1.000 G</td> <td>3.000 G</td> <td>1.00 M</td> <td>1.16245000 G</td> <td>-42.87</td> <td>-29.87</td> </tr> <tr> <td>3.000 G</td> <td>7.000 G</td> <td>1.00 M</td> <td>3.00000000 G</td> <td>-39.10</td> <td>-26.10</td> </tr> <tr> <td>7.000 G</td> <td>9.000 G</td> <td>1.00 M</td> <td>7.62450000 G</td> <td>-36.82</td> <td>-23.82</td> </tr> </tbody> </table> <p>Date: 22.DEC.2016 12:20:21</p>	Start	Stop	RBW	Freq	PwrAve	ΔLimit	[Hz]	[Hz]	[Hz]	[Hz]	[dBm]	[dB]	30.000 M	820.000 M	1.00 M	819.407500 M	-48.93	-25.93	835.000 M	1.000 G	1.00 M	991.082500 M	-44.32	-31.32	1.000 G	3.000 G	1.00 M	1.16245000 G	-42.87	-29.87	3.000 G	7.000 G	1.00 M	3.00000000 G	-39.10	-26.10	7.000 G	9.000 G	1.00 M	7.62450000 G	-36.82	-23.82	 <table border="1" data-bbox="877 660 1292 739"> <thead> <tr> <th>Start</th> <th>Stop</th> <th>RBW</th> <th>Freq</th> <th>PwrAve</th> <th>ΔLimit</th> </tr> <tr> <th>[Hz]</th> <th>[Hz]</th> <th>[Hz]</th> <th>[Hz]</th> <th>[dBm]</th> <th>[dB]</th> </tr> </thead> <tbody> <tr> <td>30.000 M</td> <td>1.000 G</td> <td>1.00 M</td> <td>846.407500 M</td> <td>-43.47</td> <td>-30.47</td> </tr> <tr> <td>1.000 G</td> <td>3.000 G</td> <td>1.00 M</td> <td>1.844789 G</td> <td>-29.95</td> <td>-16.95</td> </tr> <tr> <td>3.000 G</td> <td>7.000 G</td> <td>1.00 M</td> <td>2.989421 G</td> <td>-41.66</td> <td>-28.66</td> </tr> <tr> <td>7.000 G</td> <td>13.600 G</td> <td>1.00 M</td> <td>10.238950 G</td> <td>-35.45</td> <td>-22.45</td> </tr> <tr> <td>13.600 G</td> <td>19.100 G</td> <td>1.00 M</td> <td>15.324250 G</td> <td>-27.30</td> <td>-14.30</td> </tr> </tbody> </table> <p>Date: 22.DEC.2016 12:35:16</p>	Start	Stop	RBW	Freq	PwrAve	ΔLimit	[Hz]	[Hz]	[Hz]	[Hz]	[dBm]	[dB]	30.000 M	1.000 G	1.00 M	846.407500 M	-43.47	-30.47	1.000 G	3.000 G	1.00 M	1.844789 G	-29.95	-16.95	3.000 G	7.000 G	1.00 M	2.989421 G	-41.66	-28.66	7.000 G	13.600 G	1.00 M	10.238950 G	-35.45	-22.45	13.600 G	19.100 G	1.00 M	15.324250 G	-27.30	-14.30						
Start	Stop	RBW	Freq	PwrAve	ΔLimit																																																																																						
[Hz]	[Hz]	[Hz]	[Hz]	[dBm]	[dB]																																																																																						
30.000 M	820.000 M	1.00 M	819.407500 M	-48.93	-25.93																																																																																						
835.000 M	1.000 G	1.00 M	991.082500 M	-44.32	-31.32																																																																																						
1.000 G	3.000 G	1.00 M	1.16245000 G	-42.87	-29.87																																																																																						
3.000 G	7.000 G	1.00 M	3.00000000 G	-39.10	-26.10																																																																																						
7.000 G	9.000 G	1.00 M	7.62450000 G	-36.82	-23.82																																																																																						
Start	Stop	RBW	Freq	PwrAve	ΔLimit																																																																																						
[Hz]	[Hz]	[Hz]	[Hz]	[dBm]	[dB]																																																																																						
30.000 M	1.000 G	1.00 M	846.407500 M	-43.47	-30.47																																																																																						
1.000 G	3.000 G	1.00 M	1.844789 G	-29.95	-16.95																																																																																						
3.000 G	7.000 G	1.00 M	2.989421 G	-41.66	-28.66																																																																																						
7.000 G	13.600 G	1.00 M	10.238950 G	-35.45	-22.45																																																																																						
13.600 G	19.100 G	1.00 M	15.324250 G	-27.30	-14.30																																																																																						
Middle Channel	Middle Channel																																																																																										
 <table border="1" data-bbox="239 1180 654 1258"> <thead> <tr> <th>Start</th> <th>Stop</th> <th>RBW</th> <th>Freq</th> <th>PwrAve</th> <th>ΔLimit</th> </tr> <tr> <th>[Hz]</th> <th>[Hz]</th> <th>[Hz]</th> <th>[Hz]</th> <th>[dBm]</th> <th>[dB]</th> </tr> </thead> <tbody> <tr> <td>30.000 M</td> <td>820.000 M</td> <td>1.00 M</td> <td>819.802500 M</td> <td>-44.52</td> <td>-31.52</td> </tr> <tr> <td>835.000 M</td> <td>1.000 G</td> <td>1.00 M</td> <td>991.602500 M</td> <td>-46.28</td> <td>-33.28</td> </tr> <tr> <td>1.000 G</td> <td>3.000 G</td> <td>1.00 M</td> <td>2.98650000 G</td> <td>-42.07</td> <td>-29.07</td> </tr> <tr> <td>3.000 G</td> <td>7.000 G</td> <td>1.00 M</td> <td>3.09900000 G</td> <td>-39.34</td> <td>-26.34</td> </tr> <tr> <td>7.000 G</td> <td>9.000 G</td> <td>1.00 M</td> <td>7.91400000 G</td> <td>-37.93</td> <td>-24.93</td> </tr> </tbody> </table> <p>Date: 22.DEC.2016 12:21:28</p>	Start	Stop	RBW	Freq	PwrAve	ΔLimit	[Hz]	[Hz]	[Hz]	[Hz]	[dBm]	[dB]	30.000 M	820.000 M	1.00 M	819.802500 M	-44.52	-31.52	835.000 M	1.000 G	1.00 M	991.602500 M	-46.28	-33.28	1.000 G	3.000 G	1.00 M	2.98650000 G	-42.07	-29.07	3.000 G	7.000 G	1.00 M	3.09900000 G	-39.34	-26.34	7.000 G	9.000 G	1.00 M	7.91400000 G	-37.93	-24.93	 <table border="1" data-bbox="877 1180 1292 1258"> <thead> <tr> <th>Start</th> <th>Stop</th> <th>RBW</th> <th>Freq</th> <th>PwrAve</th> <th>ΔLimit</th> </tr> <tr> <th>[Hz]</th> <th>[Hz]</th> <th>[Hz]</th> <th>[Hz]</th> <th>[dBm]</th> <th>[dB]</th> </tr> </thead> <tbody> <tr> <td>30.000 M</td> <td>1.000 G</td> <td>1.00 M</td> <td>563.500000 M</td> <td>-42.93</td> <td>-29.93</td> </tr> <tr> <td>1.000 G</td> <td>3.000 G</td> <td>1.00 M</td> <td>2.02890000 G</td> <td>-42.80</td> <td>-29.80</td> </tr> <tr> <td>3.000 G</td> <td>7.000 G</td> <td>1.00 M</td> <td>2.972604 G</td> <td>-41.30</td> <td>-28.30</td> </tr> <tr> <td>7.000 G</td> <td>13.600 G</td> <td>1.00 M</td> <td>3.142000 G</td> <td>-38.87</td> <td>-25.87</td> </tr> <tr> <td>13.600 G</td> <td>19.100 G</td> <td>1.00 M</td> <td>15.439063 G</td> <td>-26.75</td> <td>-13.75</td> </tr> </tbody> </table> <p>Date: 22.DEC.2016 12:40:50</p>	Start	Stop	RBW	Freq	PwrAve	ΔLimit	[Hz]	[Hz]	[Hz]	[Hz]	[dBm]	[dB]	30.000 M	1.000 G	1.00 M	563.500000 M	-42.93	-29.93	1.000 G	3.000 G	1.00 M	2.02890000 G	-42.80	-29.80	3.000 G	7.000 G	1.00 M	2.972604 G	-41.30	-28.30	7.000 G	13.600 G	1.00 M	3.142000 G	-38.87	-25.87	13.600 G	19.100 G	1.00 M	15.439063 G	-26.75	-13.75						
Start	Stop	RBW	Freq	PwrAve	ΔLimit																																																																																						
[Hz]	[Hz]	[Hz]	[Hz]	[dBm]	[dB]																																																																																						
30.000 M	820.000 M	1.00 M	819.802500 M	-44.52	-31.52																																																																																						
835.000 M	1.000 G	1.00 M	991.602500 M	-46.28	-33.28																																																																																						
1.000 G	3.000 G	1.00 M	2.98650000 G	-42.07	-29.07																																																																																						
3.000 G	7.000 G	1.00 M	3.09900000 G	-39.34	-26.34																																																																																						
7.000 G	9.000 G	1.00 M	7.91400000 G	-37.93	-24.93																																																																																						
Start	Stop	RBW	Freq	PwrAve	ΔLimit																																																																																						
[Hz]	[Hz]	[Hz]	[Hz]	[dBm]	[dB]																																																																																						
30.000 M	1.000 G	1.00 M	563.500000 M	-42.93	-29.93																																																																																						
1.000 G	3.000 G	1.00 M	2.02890000 G	-42.80	-29.80																																																																																						
3.000 G	7.000 G	1.00 M	2.972604 G	-41.30	-28.30																																																																																						
7.000 G	13.600 G	1.00 M	3.142000 G	-38.87	-25.87																																																																																						
13.600 G	19.100 G	1.00 M	15.439063 G	-26.75	-13.75																																																																																						
Highest Channel	Highest Channel																																																																																										
 <table border="1" data-bbox="239 1700 654 1778"> <thead> <tr> <th>Start</th> <th>Stop</th> <th>RBW</th> <th>Freq</th> <th>PwrAve</th> <th>ΔLimit</th> </tr> <tr> <th>[Hz]</th> <th>[Hz]</th> <th>[Hz]</th> <th>[Hz]</th> <th>[dBm]</th> <th>[dB]</th> </tr> </thead> <tbody> <tr> <td>30.000 M</td> <td>820.000 M</td> <td>1.00 M</td> <td>705.400000 M</td> <td>-46.60</td> <td>-33.60</td> </tr> <tr> <td>835.000 M</td> <td>1.000 G</td> <td>1.00 M</td> <td>902.958753 M</td> <td>-43.86</td> <td>-30.86</td> </tr> <tr> <td>1.000 G</td> <td>3.000 G</td> <td>1.00 M</td> <td>2.99450000 G</td> <td>-42.67</td> <td>-29.67</td> </tr> <tr> <td>3.000 G</td> <td>7.000 G</td> <td>1.00 M</td> <td>3.01100000 G</td> <td>-39.23</td> <td>-26.23</td> </tr> <tr> <td>7.000 G</td> <td>9.000 G</td> <td>1.00 M</td> <td>8.37050000 G</td> <td>-36.95</td> <td>-23.95</td> </tr> </tbody> </table> <p>Date: 22.DEC.2016 12:22:26</p>	Start	Stop	RBW	Freq	PwrAve	ΔLimit	[Hz]	[Hz]	[Hz]	[Hz]	[dBm]	[dB]	30.000 M	820.000 M	1.00 M	705.400000 M	-46.60	-33.60	835.000 M	1.000 G	1.00 M	902.958753 M	-43.86	-30.86	1.000 G	3.000 G	1.00 M	2.99450000 G	-42.67	-29.67	3.000 G	7.000 G	1.00 M	3.01100000 G	-39.23	-26.23	7.000 G	9.000 G	1.00 M	8.37050000 G	-36.95	-23.95	 <table border="1" data-bbox="877 1700 1292 1778"> <thead> <tr> <th>Start</th> <th>Stop</th> <th>RBW</th> <th>Freq</th> <th>PwrAve</th> <th>ΔLimit</th> </tr> <tr> <th>[Hz]</th> <th>[Hz]</th> <th>[Hz]</th> <th>[Hz]</th> <th>[dBm]</th> <th>[dB]</th> </tr> </thead> <tbody> <tr> <td>30.000 M</td> <td>1.000 G</td> <td>1.00 M</td> <td>168.407500 M</td> <td>-45.96</td> <td>-32.96</td> </tr> <tr> <td>1.000 G</td> <td>3.000 G</td> <td>1.00 M</td> <td>1.037380 G</td> <td>-42.97</td> <td>-29.97</td> </tr> <tr> <td>3.000 G</td> <td>7.000 G</td> <td>1.00 M</td> <td>2.932071 G</td> <td>-27.79</td> <td>-14.79</td> </tr> <tr> <td>7.000 G</td> <td>13.600 G</td> <td>1.00 M</td> <td>5.14100000 G</td> <td>-38.70</td> <td>-25.70</td> </tr> <tr> <td>13.600 G</td> <td>19.100 G</td> <td>1.00 M</td> <td>10.208425 G</td> <td>-35.78</td> <td>-22.78</td> </tr> <tr> <td>19.100 G</td> <td>19.100 G</td> <td>1.00 M</td> <td>15.249375 G</td> <td>-27.31</td> <td>-14.31</td> </tr> </tbody> </table> <p>Date: 22.DEC.2016 12:41:47</p>	Start	Stop	RBW	Freq	PwrAve	ΔLimit	[Hz]	[Hz]	[Hz]	[Hz]	[dBm]	[dB]	30.000 M	1.000 G	1.00 M	168.407500 M	-45.96	-32.96	1.000 G	3.000 G	1.00 M	1.037380 G	-42.97	-29.97	3.000 G	7.000 G	1.00 M	2.932071 G	-27.79	-14.79	7.000 G	13.600 G	1.00 M	5.14100000 G	-38.70	-25.70	13.600 G	19.100 G	1.00 M	10.208425 G	-35.78	-22.78	19.100 G	19.100 G	1.00 M	15.249375 G	-27.31	-14.31
Start	Stop	RBW	Freq	PwrAve	ΔLimit																																																																																						
[Hz]	[Hz]	[Hz]	[Hz]	[dBm]	[dB]																																																																																						
30.000 M	820.000 M	1.00 M	705.400000 M	-46.60	-33.60																																																																																						
835.000 M	1.000 G	1.00 M	902.958753 M	-43.86	-30.86																																																																																						
1.000 G	3.000 G	1.00 M	2.99450000 G	-42.67	-29.67																																																																																						
3.000 G	7.000 G	1.00 M	3.01100000 G	-39.23	-26.23																																																																																						
7.000 G	9.000 G	1.00 M	8.37050000 G	-36.95	-23.95																																																																																						
Start	Stop	RBW	Freq	PwrAve	ΔLimit																																																																																						
[Hz]	[Hz]	[Hz]	[Hz]	[dBm]	[dB]																																																																																						
30.000 M	1.000 G	1.00 M	168.407500 M	-45.96	-32.96																																																																																						
1.000 G	3.000 G	1.00 M	1.037380 G	-42.97	-29.97																																																																																						
3.000 G	7.000 G	1.00 M	2.932071 G	-27.79	-14.79																																																																																						
7.000 G	13.600 G	1.00 M	5.14100000 G	-38.70	-25.70																																																																																						
13.600 G	19.100 G	1.00 M	10.208425 G	-35.78	-22.78																																																																																						
19.100 G	19.100 G	1.00 M	15.249375 G	-27.31	-14.31																																																																																						



WCDMA Band IV (RMC 12.2Kbps)

Lowest Channel

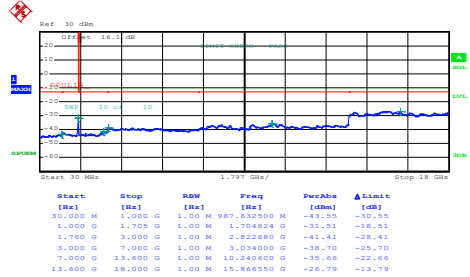

Date: 22.DEC.2016 12:56:55

Middle Channel

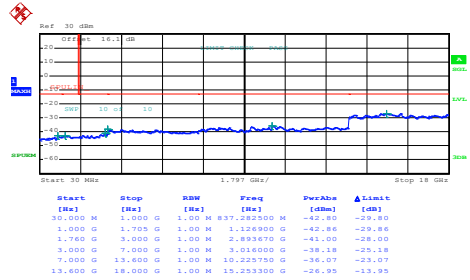

Date: 22.DEC.2016 12:57:45

Highest Channel

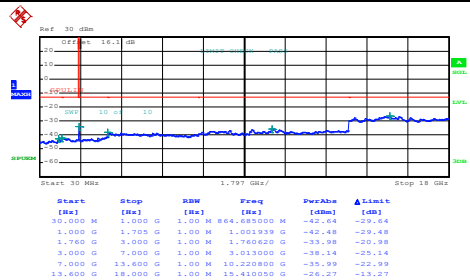

Date: 22.DEC.2016 13:00:31



**Frequency Stability**

Test Conditions	Middle Channel	WCDMA Band V (RMC 12.2Kbps)	Limit 2.5ppm
Temperature (°C)	Voltage (Volt)	Deviation (ppm)	Result
50	Normal Voltage	0.0024	PASS
40	Normal Voltage	0.0036	
30	Normal Voltage	0.0215	
20(Ref.)	Normal Voltage	0.0000	
10	Normal Voltage	0.0048	
0	Normal Voltage	0.0072	
-10	Normal Voltage	0.0036	
-20	Normal Voltage	0.0024	
-30	Normal Voltage	0.0191	
20	Maximum Voltage	0.0048	
20	Normal Voltage	0.0000	
20	Battery End Point	0.0012	

Test Conditions	Middle Channel	WCDMA Band II (RMC 12.2Kbps)	Limit Note 2.
Temperature (°C)	Voltage (Volt)	Deviation (ppm)	Result
50	Normal Voltage	0.0005	PASS
40	Normal Voltage	0.0011	
30	Normal Voltage	0.0005	
20(Ref.)	Normal Voltage	0.0000	
10	Normal Voltage	0.0011	
0	Normal Voltage	0.0064	
-10	Normal Voltage	0.0069	
-20	Normal Voltage	0.0085	
-30	Normal Voltage	0.0096	
20	Maximum Voltage	0.0011	
20	Normal Voltage	0.0000	
20	Battery End Point	0.0000	



Test Conditions	Middle Channel	WCDMA Band IV (RMC 12.2Kbps)	Limit Note 2.
Temperature (°C)	Voltage (Volt)	Deviation (ppm)	Result
50	Normal Voltage	0.0017	PASS
40	Normal Voltage	0.0006	
30	Normal Voltage	0.0006	
20(Ref.)	Normal Voltage	0.0000	
10	Normal Voltage	0.0012	
0	Normal Voltage	0.0231	
-10	Normal Voltage	0.0283	
-20	Normal Voltage	0.0277	
-30	Normal Voltage	0.0265	
20	Maximum Voltage	0.0012	
20	Normal Voltage	0.0000	
20	Battery End Point	0.0023	

**Note:**

1. Normal Voltage = 3.85V. ; Battery End Point (BEP) = 3.6 V. ; Maximum Voltage =4.4 V
2. The frequency fundamental emissions stay within the authorized frequency block.



## Appendix B. Test Results of ERP/EIRP and Radiated Test

### ERP/EIRP

Channel	Mode	Conducted		ERP	
		Power (dBm)	Power (Watts)	ERP(dBm)	ERP(W)
Lowest	GSM850	32.56	1.8030	26.91	0.4909
Middle	GPRS class 8	32.62	1.8281	26.97	0.4977
Highest	(GT - LC = -3.5 dB)	32.68	1.8535	27.03	0.5047
Lowest	GSM850	26.67	0.4645	21.02	0.1265
Middle	EDGE class 8	26.66	0.4634	21.01	0.1262
Highest	(GT - LC = -3.5 dB)	26.66	0.4634	21.01	0.1262
Lowest	WCDMA Band V	23.86	0.2432	18.21	0.0662
Middle	RMC 12.2Kbps	23.95	0.2483	18.30	0.0676
Highest	(GT - LC = -3.5 dB)	23.94	0.2477	18.29	0.0675
Limit	ERP < 7W	Result		PASS	

Channel	Mode	Conducted		EIRP	
		Power (dBm)	Power (Watts)	EIRP(dBm)	EIRP(W)
Lowest	GSM1900	30.16	1.0375	30.06	1.0139
Middle	GPRS class 8	29.88	0.9727	29.78	0.9506
Highest	(GT - LC = -0.1 dB)	29.98	0.9954	29.88	0.9727
Lowest	GSM1900	25.68	0.3698	25.58	0.3614
Middle	EDGE class 8	25.89	0.3882	25.79	0.3793
Highest	(GT - LC = -0.1 dB)	25.96	0.3945	25.86	0.3855
Lowest	WCDMA Band II	23.62	0.2301	23.52	0.2249
Middle	RMC 12.2Kbps	23.75	0.2371	23.65	0.2317
Highest	(GT - LC = -0.1 dB)	24.11	0.2576	24.01	0.2518
Limit	EIRP < 2W	Result		PASS	

Channel	Mode	Conducted		EIRP	
		Power (dBm)	Power (Watts)	EIRP(dBm)	EIRP(W)
Lowest	WCDMA Band IV	23.08	0.2032	20.08	0.1019
Middle	RMC 12.2Kbps	23.28	0.2128	20.28	0.1067
Highest	(GT - LC = -3 dB)	23.10	0.2042	20.10	0.1023
Limit	EIRP < 1W	Result		PASS	



**Radiated Spurious Emission**

GSM850 (GPRS class 8)									
Channel	Frequency ( MHz )	ERP ( dBm )	Limit ( dBm )	Over Limit ( dB )	SPA Reading (dBm)	S.G. Power ( dBm )	TX Cable loss ( dB )	TX Antenna Gain (dBi)	Polarization (H/V)
Lowest	1648	-47.65	-13	-34.65	-57.42	-49.41	0.98	4.89	H
	2472	-48.34	-13	-35.34	-62.04	-50.22	1.28	5.32	H
	3296	-54.12	-13	-41.12	-70.08	-57.53	1.54	7.10	H
									H
									H
									H
	1648	-46.20	-13	-33.20	-55.91	-47.96	0.98	4.89	V
	2472	-48.36	-13	-35.36	-62.1	-50.24	1.28	5.32	V
	3296	-53.64	-13	-40.64	-69.54	-57.05	1.54	7.10	V
									V
									V
									V
Middle	1672	-46.70	-13	-33.70	-56.6	-48.38	0.99	4.82	H
	2512	-45.75	-13	-32.75	-59.6	-47.72	1.29	5.41	H
	3344	-54.27	-13	-41.27	-70.3	-57.88	1.56	7.31	H
									H
									H
									H
	1672	-49.91	-13	-36.91	-59.75	-51.59	0.99	4.82	V
	2512	-46.90	-13	-33.90	-60.77	-48.87	1.29	5.41	V
	3344	-53.81	-13	-40.81	-69.85	-57.42	1.56	7.31	V
									V
									V
									V
Highest	1696	-47.91	-13	-34.91	-57.9	-49.51	1.00	4.75	H
	2544	-33.69	-13	-20.69	-47.66	-35.67	1.30	5.44	H
	3395	-53.99	-13	-40.99	-70.07	-57.81	1.57	7.54	H
									H
									H
									H
	1696	-45.38	-13	-32.38	-55.31	-46.98	1.00	4.75	V
	2544	-30.79	-13	-17.79	-44.75	-32.77	1.30	5.44	V
	3395	-53.28	-13	-40.28	-69.46	-57.1	1.57	7.54	V
									V
									V
									V

Remark: Spurious emissions within 30-1000MHz were found more than 20dB below limit line.



GSM850 (EDGE class 8)									
Channel	Frequency ( MHz )	ERP ( dBm )	Limit ( dBm )	Over Limit ( dB )	SPA Reading (dBm)	S.G. Power ( dBm )	TX Cable loss ( dB )	TX Antenna Gain (dBi)	Polarization (H/V)
Lowest	1648	-49.72	-13	-36.72	-59.49	-51.48	0.98	4.89	H
	2472	-39.14	-13	-26.14	-52.84	-41.02	1.28	5.32	H
	3296	-53.54	-13	-40.54	-69.5	-56.95	1.54	7.10	H
									H
									H
									H
	1648	-48.15	-13	-35.15	-57.86	-49.91	0.98	4.89	V
	2472	-37.61	-13	-24.61	-51.35	-39.49	1.28	5.32	V
	3296	-53.51	-13	-40.51	-69.41	-56.92	1.54	7.10	V
									V
Middle	1672	-55.42	-13	-42.42	-65.32	-57.1	0.99	4.82	H
	2512	-42.87	-13	-29.87	-56.72	-44.84	1.29	5.41	H
	3344	-53.61	-13	-40.61	-69.64	-57.22	1.56	7.31	H
									H
									H
									H
	1672	-53.14	-13	-40.14	-62.98	-54.82	0.99	4.82	V
	2512	-45.83	-13	-32.83	-59.7	-47.8	1.29	5.41	V
	3344	-54.32	-13	-41.32	-70.36	-57.93	1.56	7.31	V
									V
Highest	1696	-55.12	-13	-42.12	-65.11	-56.72	1.00	4.75	H
	2544	-43.43	-13	-30.43	-57.4	-45.41	1.30	5.44	H
	3395	-54.17	-13	-41.17	-70.25	-57.99	1.57	7.54	H
									H
									H
									H
	1696	-55.25	-13	-42.25	-65.18	-56.85	1.00	4.75	V
	2544	-46.55	-13	-33.55	-60.51	-48.53	1.30	5.44	V
	3395	-54.28	-13	-41.28	-70.46	-58.1	1.57	7.54	V
									V

Remark: Spurious emissions within 30-1000MHz were found more than 20dB below limit line.



GSM1900 (GPRS class 8)									
Channel	Frequency ( MHz )	EIRP ( dBm )	Limit ( dBm )	Over Limit ( dB )	SPA Reading (dBm)	S.G. Power ( dBm )	TX Cable loss ( dB )	TX Antenna Gain (dBi)	Polarization (H/V)
Lowest	3702	-58.98	-13	-45.98	-75.82	-65.55	1.67	8.24	H
	5550	-54.94	-13	-41.94	-77.6	-62.01	2.65	9.72	H
	7398	-51.07	-13	-38.07	-78.11	-60.2	2.46	11.60	H
									H
									H
									H
	3702	-59.39	-13	-46.39	-76.39	-65.96	1.67	8.24	V
	5550	-55.16	-13	-42.16	-77.65	-62.23	2.65	9.72	V
	7398	-50.96	-13	-37.96	-78.03	-60.09	2.46	11.60	V
									V
									V
									V
Middle	3762	-57.10	-13	-44.10	-74.1	-63.73	1.69	8.31	H
	5640	-51.49	-13	-38.49	-74.29	-58.54	2.71	9.76	H
	7520	-50.17	-13	-37.17	-77.46	-59.56	2.42	11.81	H
									H
									H
									H
	3762	-57.51	-13	-44.51	-74.64	-64.14	1.69	8.31	V
	5640	-54.20	-13	-41.20	-76.84	-61.25	2.71	9.76	V
	7520	-50.01	-13	-37.01	-77.41	-59.4	2.42	11.81	V
									V
									V
									V
Highest	3822	-57.04	-13	-44.04	-74.25	-63.72	1.71	8.39	H
	5730	-53.22	-13	-40.22	-76.16	-60.25	2.76	9.79	H
	7639	-50.31	-13	-37.31	-77.73	-59.81	2.38	11.88	H
									H
									H
									H
	3822	-58.35	-13	-45.35	-75.65	-65.03	1.71	8.39	V
	5730	-53.31	-13	-40.31	-76.11	-60.34	2.76	9.79	V
	7639	-50.14	-13	-37.14	-77.63	-59.64	2.38	11.88	V
									V
									V
									V

Remark: Spurious emissions within 30-1000MHz were found more than 20dB below limit line.





GSM1900 (EDGE class 8)									
Channel	Frequency ( MHz )	EIRP ( dBm )	Limit ( dBm )	Over Limit ( dB )	SPA Reading (dBm)	S.G. Power ( dBm )	TX Cable loss ( dB )	TX Antenna Gain (dBi)	Polarization (H/V)
Lowest	3702	-59.36	-13	-46.36	-76.2	-65.93	1.67	8.24	H
	5550	-55.29	-13	-42.29	-77.95	-62.36	2.65	9.72	H
	7398	-50.75	-13	-37.75	-77.79	-59.88	2.46	11.60	H
									H
									H
									H
	3702	-49.04	-13	-36.04	-76.04	-55.61	1.67	8.24	V
	5550	-55.35	-13	-42.35	-77.84	-62.42	2.65	9.72	V
	7398	-50.16	-13	-37.16	-77.23	-59.29	2.46	11.60	V
									V
									V
									V
Middle	3762	-59.25	-13	-46.25	-76.25	-65.88	1.69	8.31	H
	5640	-54.22	-13	-41.22	-77.02	-61.27	2.71	9.76	H
	7520	-50.25	-13	-37.25	-77.54	-59.64	2.42	11.81	H
									H
									H
									H
	3762	-58.84	-13	-45.84	-75.97	-65.47	1.69	8.31	V
	5640	-54.76	-13	-41.76	-77.4	-61.81	2.71	9.76	V
	7520	-49.68	-13	-36.68	-77.08	-59.07	2.42	11.81	V
									V
									V
									V
Highest	3822	-59.04	-13	-46.04	-76.25	-65.72	1.71	8.39	H
	5730	-55.17	-13	-42.17	-78.11	-62.2	2.76	9.79	H
	7638	-50.47	-13	-37.47	-77.87	-59.97	2.38	11.88	H
									H
									H
									H
	3822	-58.94	-13	-45.94	-76.24	-65.62	1.71	8.39	V
	5730	-54.98	-13	-41.98	-77.78	-62.01	2.76	9.79	V
	7638	-50.34	-13	-37.34	-77.82	-59.84	2.38	11.88	V
									V
									V
									V

Remark: Spurious emissions within 30-1000MHz were found more than 20dB below limit line.



WCDMA Band V(RMC 12.2Kbps)									
Channel	Frequency ( MHz )	ERP ( dBm )	Limit ( dBm )	Over Limit ( dB )	SPA Reading (dBm)	S.G. Power ( dBm )	TX Cable loss ( dB )	TX Antenna Gain (dBi)	Polarization (H/V)
Lowest	1652	-58.35	-13	-45.35	-68.15	-60.09	0.98	4.87	H
	2480	-42.00	-13	-29.00	-55.7	-43.91	1.28	5.34	H
	3312	-51.27	-13	-38.27	-67.26	-54.75	1.55	7.17	H
									H
									H
									H
	1652	-57.73	-13	-44.73	-67.47	-59.47	0.98	4.87	V
	2480	-42.12	-13	-29.12	-55.86	-44.03	1.28	5.34	V
	3312	-50.74	-13	-37.74	-66.69	-54.22	1.55	7.17	V
									V
Middle	1672	-55.47	-13	-42.47	-65.37	-57.15	0.99	4.82	H
	2504	-48.84	-13	-35.84	-62.63	-50.8	1.29	5.40	H
	3345	-53.48	-13	-40.48	-69.51	-57.09	1.56	7.32	H
									H
									H
									H
	1672	-55.13	-13	-42.13	-64.97	-56.81	0.99	4.82	V
	2504	-46.01	-13	-33.01	-59.84	-47.97	1.29	5.40	V
	3345	-52.69	-13	-39.69	-68.73	-56.3	1.56	7.32	V
									V
Highest	1688	-54.51	-13	-41.51	-64.45	-56.14	1.00	4.77	H
	2536	-42.82	-13	-29.82	-56.73	-44.8	1.30	5.43	H
	3384	-50.56	-13	-37.56	-66.63	-54.33	1.57	7.49	H
									H
									H
									H
	1688	-57.62	-13	-44.62	-67.5	-59.25	1.00	4.77	V
	2536	-41.81	-13	-28.81	-55.73	-43.79	1.30	5.43	V
	3392	-49.51	-13	-36.51	-65.72	-53.31	1.57	7.52	V
									V

Remark: Spurious emissions within 30-1000MHz were found more than 20dB below limit line.



WCDMA Band II(RMC 12.2Kbps)									
Channel	Frequency ( MHz )	EIRP ( dBm )	Limit ( dBm )	Over Limit ( dB )	SPA Reading (dBm)	S.G. Power ( dBm )	TX Cable loss ( dB )	TX Antenna Gain (dBi)	Polarization (H/V)
Lowest	3705	-59.36	-13	-46.36	-76.2	-65.94	1.67	8.25	H
	5557	-55.07	-13	-42.07	-77.72	-62.13	2.66	9.72	H
	7410	-50.58	-13	-37.58	-77.66	-59.74	2.46	11.62	H
									H
									H
									H
	3705	-59.03	-13	-46.03	-76.03	-65.61	1.67	8.25	V
	5557	-55.14	-13	-42.14	-77.62	-62.2	2.66	9.72	V
	7410	-50.40	-13	-37.40	-77.53	-59.56	2.46	11.62	V
									V
Middle	3760	-58.90	-13	-45.90	-75.9	-65.53	1.69	8.31	H
	5640	-54.46	-13	-41.46	-77.26	-61.51	2.71	9.76	H
	7520	-50.08	-13	-37.08	-77.37	-59.47	2.42	11.81	H
									H
									H
									H
	3760	-58.91	-13	-45.91	-76.04	-65.54	1.69	8.31	V
	5640	-54.83	-13	-41.83	-77.47	-61.88	2.71	9.76	V
	7520	-49.95	-13	-36.95	-77.35	-59.34	2.42	11.81	V
									V
Highest	3816	-59.46	-13	-46.46	-76.66	-66.14	1.70	8.38	H
	5724	-55.32	-13	-42.32	-78.26	-62.36	2.75	9.79	H
	7632	-50.48	-13	-37.48	-77.88	-59.97	2.39	11.88	H
									H
									H
									H
	3816	-59.24	-13	-46.24	-76.53	-65.92	1.70	8.38	V
	5724	-55.15	-13	-42.15	-77.95	-62.19	2.75	9.79	V
	7632	-50.40	-13	-37.40	-77.88	-59.89	2.39	11.88	V
									V

Remark: Spurious emissions within 30-1000MHz were found more than 20dB below limit line.



WCDMA Band IV(RMC 12.2Kbps)									
Channel	Frequency ( MHz )	EIRP ( dBm )	Limit ( dBm )	Over Limit ( dB )	SPA Reading (dBm)	S.G. Power ( dBm )	TX Cable loss ( dB )	TX Antenna Gain (dBi)	Polarization (H/V)
Lowest	3424	-59.41	-13	-46.41	-75.54	-65.5	1.58	7.67	H
	5137	-56.12	-13	-43.12	-77.6	-63.4	2.42	9.70	H
	6849	-51.61	-13	-38.61	-77.31	-59.59	2.64	10.62	H
									H
									H
									H
	3424	-59.36	-13	-46.36	-75.63	-65.45	1.58	7.67	V
	5137	-56.02	-13	-43.02	-77.62	-63.3	2.42	9.70	V
	6849	-51.88	-13	-38.88	-77.35	-59.86	2.64	10.62	V
									V
Middle	3468	-60.06	-13	-47.06	-76.23	-66.32	1.59	7.86	H
	5197	-56.30	-13	-43.30	-77.98	-63.55	2.45	9.70	H
	6930	-51.87	-13	-38.87	-77.85	-59.97	2.61	10.72	H
									H
									H
									H
	3468	-59.83	-13	-46.83	-76.2	-66.09	1.59	7.86	V
	5197	-56.09	-13	-43.09	-77.83	-63.34	2.45	9.70	V
	6930	-52.10	-13	-39.10	-77.81	-60.2	2.61	10.72	V
									V
Highest	3505	-59.26	-13	-46.26	-75.47	-65.66	1.61	8.01	H
	5257	-55.56	-13	-42.56	-77.39	-62.77	2.49	9.70	H
	7010	-51.39	-13	-38.39	-77.65	-59.62	2.59	10.82	H
									H
									H
									H
	3505	-59.17	-13	-46.17	-75.63	-65.57	1.61	8.01	V
	5257	-55.62	-13	-42.62	-77.48	-62.83	2.49	9.70	V
	7010	-51.37	-13	-38.37	-77.34	-59.6	2.59	10.82	V
									V

Remark: Spurious emissions within 30-1000MHz were found more than 20dB below limit line.