

## FCC Test Report

**Report No.:** RF161216C21

**FCC ID:** NM82PYV300

**Test Model:** 2PYV300

**Received Date:** Oct. 27, 2016

**Test Date:** Dec. 15, 2016 ~ Dec. 21, 2016

**Issued Date:** Jan. 03, 2017

**Applicant:** HTC Corporation

**Address:** 1F, 6-3 Baoqiang Road, Xindian District, New Taipei City 231, Taiwan

**Issued By:** Bureau Veritas Consumer Products Services (H.K.) Ltd., Taoyuan Branch

**Lab Address:** No. 47-2, 14th Ling, Chia Pau Vil., Lin Kou Dist., New Taipei City, Taiwan ( R.O.C )

**Test Location (1):** No. 19, Hwa Ya 2nd Rd, Wen Hwa Tsuen, Kwei Shan Hsiang, Taoyuan Hsien 333, Taiwan, R.O.C.

**Test Location (2):** No.215, Sec. 3, Beixin Rd., Xindian Dist., New Taipei City 231, Taiwan, R.O.C



This report is for your exclusive use. Any copying or replication of this report to or for any other person or entity, or use of our name or trademark, is permitted only with our prior written permission. This report sets forth our findings solely with respect to the test samples identified herein. The results set forth in this report are not indicative or representative of the quality or characteristics of the lot from which a test sample was taken or any similar or identical product unless specifically and expressly noted. Our report includes all of the tests requested by you and the results thereof based upon the information that you provided to us. You have 60 days from date of issuance of this report to notify us of any material error or omission caused by our negligence, provided, however, that such notice shall be in writing and shall specifically address the issue you wish to raise. A failure to raise such issue within the prescribed time shall constitute your unqualified acceptance of the completeness of this report, the tests conducted and the correctness of the report contents. Unless specific mention, the uncertainty of measurement has been explicitly taken into account to declare the compliance or non-compliance to the specification. The report must not be used by the client to claim product certification, approval, or endorsement by TAF or any government agencies.

## Table of Contents

<b>Release Control Record</b> .....	<b>3</b>
<b>1 Certificate of Conformity</b> .....	<b>4</b>
<b>2 Summary of Test Results</b> .....	<b>5</b>
2.1 Measurement Uncertainty .....	5
2.2 Modification Record .....	5
<b>3 General Information</b> .....	<b>6</b>
3.1 General Description of EUT .....	6
3.2 Description of Test Modes.....	6
3.2.1 Test Mode Applicability and Tested Channel Detail.....	7
3.3 Description of Support Units .....	8
3.3.1 Configuration of System under Test .....	8
3.4 General Description of Applied Standards.....	8
<b>4 Test Types and Results</b> .....	<b>9</b>
4.1 Radiated Emission and Bandedge Measurement .....	9
4.1.1 Limits of Radiated Emission and Bandedge Measurement .....	9
4.1.2 Test Instruments .....	10
4.1.3 Test Procedures.....	11
4.1.4 Deviation from Test Standard .....	11
4.1.5 Test Set Up .....	12
4.1.6 EUT Operating Conditions.....	12
4.1.7 Test Results .....	13
4.2 Conducted Emission Measurement.....	17
4.2.1 Limits of Conducted Emission Measurement .....	17
4.2.2 Test Instruments .....	17
4.2.3 Test Procedures.....	18
4.2.4 Deviation from Test Standard .....	18
4.2.5 Test Setup.....	18
4.2.6 EUT Operating Conditions.....	18
4.2.7 Test Results .....	19
4.3 20 dB Bandwidth .....	21
4.3.1 Limits of 20 dB Bandwidth Measurement.....	21
4.3.2 Test Setup.....	21
4.3.3 Test Instruments .....	21
4.3.4 Test Procedures.....	21
4.3.5 Deviation from Test Standard .....	21
4.3.6 EUT Operating Conditions.....	21
4.3.7 Test Results .....	22
4.4 Antenna Requirement.....	23
4.4.1 Standard Requirement .....	23
4.5 EUT Antenna.....	23
<b>5 Pictures of Test Arrangements</b> .....	<b>24</b>
<b>Appendix – Information on the Testing Laboratories</b> .....	<b>25</b>



A D T

### Release Control Record

Issue No.	Description	Date Issued
RF161216C21	Original Release	Jan. 03, 2017



## 2 Summary of Test Results

47 CFR FCC Part 15, Subpart C (SECTION 15.249)			
FCC Clause	Test Item	Result	Remarks
15.203	Antenna requirement	PASS	N/A
15.207	AC Power Conducted Emission	PASS	Meet the requirement of limit. Minimum passing margin is -9.43 dB at 0.17801 MHz.
15.215 (c)	20dB Bandwidth	PASS	Meet the requirement of limit.
15.209 15.249 15.249 (d)	Radiated Emission Test Band Edge Measurement Limit: 50dB less than the peak value of fundamental frequency or meet radiated emission limit in section 15.209	PASS	Meet the requirement of limit. Minimum passing margin is -1.34 dB at 2480 MHz.

### 2.1 Measurement Uncertainty

Where relevant, the following measurement uncertainty levels have been estimated for tests performed on the EUT as specified in CISPR 16-4-2:

Measurement	Frequency	Expanded Uncertainty (k=2) (±)
Conducted Emissions at mains ports	150 kHz ~ 30 MHz	2.44 dB
Radiated Emissions up to 1 GHz	30 MHz ~ 200 MHz	2.0153 dB
	200 MHz ~1000 MHz	2.0224 dB
Radiated Emissions above 1 GHz	1 GHz ~ 18 GHz	1.0121 dB
	18 GHz ~ 40 GHz	1.1508 dB

### 2.2 Modification Record

There were no modifications required for compliance.

### 3 General Information

#### 3.1 General Description of EUT

<b>Product</b>	Dongle
<b>Brand</b>	HTC
<b>Test Model</b>	2PYV300
<b>Status of EUT</b>	Identical Prototype
<b>Power Supply Rating</b>	5.0 Vdc (host equipment)
<b>Modulation Type</b>	GFSK
<b>Operating Frequency</b>	2402 ~ 2480 MHz
<b>Number of Channel</b>	40
<b>Antenna Type</b>	PCB antenna with -4.09 dBi gain
<b>Antenna Connector</b>	N/A
<b>Accessory Device</b>	Refer to Note as below
<b>Data Cable Supplied</b>	Refer to Note as below

Note:

1. The EUT's accessories list refers to Ext. Pho.
2. The above EUT information is declared by manufacturer and for more detailed features description, please refer to the manufacturer's specifications or user's manual.

#### 3.2 Description of Test Modes

40 channels are provided to this EUT:

Channel	Freq. (MHz)	Channel	Freq. (MHz)	Channel	Freq. (MHz)	Channel	Freq. (MHz)
0	2402	10	2422	20	2442	30	2462
1	2404	11	2424	21	2444	31	2464
2	2406	12	2426	22	2446	32	2466
3	2408	13	2428	23	2448	33	2468
4	2410	14	2430	24	2450	34	2470
5	2412	15	2432	25	2452	35	2472
6	2414	16	2434	26	2454	36	2474
7	2416	17	2436	27	2456	37	2476
8	2418	18	2438	28	2458	38	2478
9	2420	19	2440	29	2460	39	2480

### 3.2.1 Test Mode Applicability and Tested Channel Detail

EUT Configure Mode	Applicable To			Description
	RE $\geq$ 1G	RE<1G	PLC	
-	√	√	√	-

Where **RE $\geq$ 1G:** Radiated Emission above 1 GHz & Bandedge Measurement  
**PLC:** Power Line Conducted Emission

**RE<1G:** Radiated Emission below 1 GHz

**NOTE:** The EUT had been pre-tested on the positioned of each 3 axis. The worst case was found when positioned on **Z-plane**.

#### **Radiated Emission Test (Above 1 GHz):**

- Pre-Scan has been conducted to determine the worst-case mode from all possible combinations between available modulations, data rates and antenna ports (if EUT with antenna diversity architecture).
- Following channel(s) was (were) selected for the final test as listed below.

EUT Configure Mode	Available Channel	Tested Channel	Modulation Type
-	0 to 39	0, 19, 39	GFSK

#### **Radiated Emission Test (Below 1 GHz):**

- Pre-Scan has been conducted to determine the worst-case mode from all possible combinations between available modulations, data rates and antenna ports (if EUT with antenna diversity architecture).
- Following channel(s) was (were) selected for the final test as listed below.

EUT Configure Mode	Tested Channel	Modulation Technology	Modulation Type
-	0 to 39	39	GFSK

#### **Power Line Conducted Emission Test:**

- Pre-Scan has been conducted to determine the worst-case mode from all possible combinations between available modulations, data rates and antenna ports (if EUT with antenna diversity architecture).
- Following channel(s) was (were) selected for the final test as listed below.

EUT Configure Mode	Tested Channel	Modulation Technology	Modulation Type
-	0 to 39	39	GFSK

#### **Test Condition:**

Applicable To	Environmental Conditions	Input Power	Tested By
RE $\geq$ 1G	25 deg. C, 65 % RH	120 Vac, 60 Hz	Gavin Wu
RE<1G	25 deg. C, 65 % RH	120 Vac, 60 Hz	Gavin Wu
PLC	25 deg. C, 68 % RH	120 Vac, 60 Hz	Toby Tian

### 3.3 Description of Support Units

The EUT has been tested as an independent unit together with other necessary accessories or support units. The following support units or accessories were used to form a representative test configuration during the tests.

No.	Product	Brand	Model No.	Serial No.	FCC ID
A.	Notebook	DELL	N/A Inspiron 14R	8LRKKW1	N/A

No.	Signal Cable Description Of The Above Support Units
1.	N/A

Note:

1. All power cords of the above support units are non-shielded (1.8m).

#### 3.3.1 Configuration of System under Test

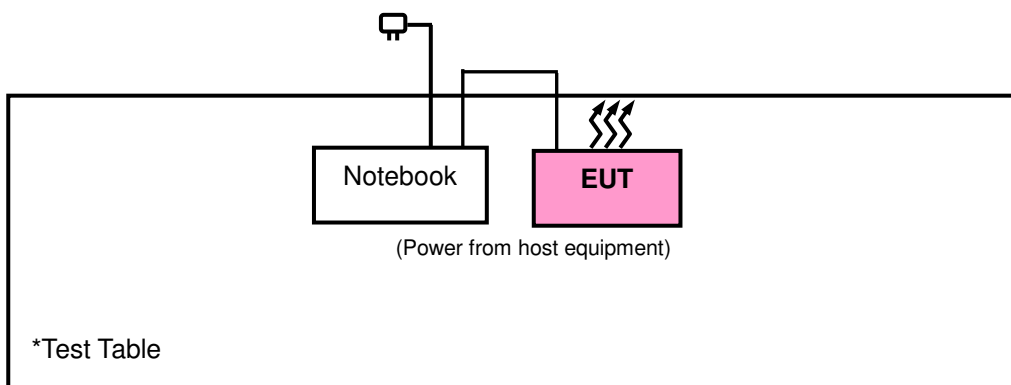

### 3.4 General Description of Applied Standards

The EUT is a RF Product. According to the specifications of the manufacturer, it must comply with the requirements of the following standards:

#### FCC Part 15, Subpart C (15.249)

ANSI C63.10-2013

All test items have been performed and recorded as per the above standards.

**NOTE:** The EUT has been verified to comply with the requirements of FCC Part 15, Subpart B, Class B (DoC). The test report has been issued separately.



## 4 Test Types and Results

### 4.1 Radiated Emission and Bandedge Measurement

#### 4.1.1 Limits of Radiated Emission and Bandedge Measurement

The field strength of emissions from intentional radiators operated within these frequency bands shall comply with the following

Fundamental Frequency	Field Strength of Fundamental (millivolts/meter)	Field Strength of Harmonics (microvolts/meter)
902 ~ 928 MHz	50	500
2400 ~ 2483.5 MHz	50	500
5725 ~ 5875 MHz	50	500
24 ~ 24.25 GHz	250	2500

Emissions radiated outside of the specified frequency bands, except for harmonics, shall be attenuated by at least 50 dB below the level of the fundamental or to the general radiated emission limits as below table, whichever is the lesser attenuation

Frequencies (MHz)	Field Strength (microvolts/meter)	Measurement Distance (meters)
0.009 ~ 0.490	2400/F(kHz)	300
0.490 ~ 1.705	24000/F(kHz)	30
1.705 ~ 30.0	30	30
30 ~ 88	100	3
88 ~ 216	150	3
216 ~ 960	200	3
Above 960	500	3

#### NOTE:

1. The lower limit shall apply at the transition frequencies.
2. Emission level (dBuV/m) = 20 log Emission level (uV/m).
3. For frequencies above 1000 MHz, the field strength limits are based on average detector, however, the peak field strength of any emission shall not exceed the maximum permitted average limits, specified above by more than 20dB under any condition of modulation.

#### 4.1.2 Test Instruments

Description & Manufacturer	Model No.	Serial No.	Date of Calibration	Due Date of Calibration
Test receiver Agilent	N9038a	My51210203	Jan. 21, 2016	Jan. 20, 2017
Spectrum analyzer Agilent	N9010a	My56070348	Sep. 02, 2016	Sep. 01, 2017
BILOG Antenna SCHWARZBECK	VULB9168	9168-472	Jan. 07, 2016	Jan. 06, 2017
HORN Antenna SCHWARZBECK	BBHA 9120 D	9120D-969	Jan. 04, 2016	Jan. 03, 2017
HORN Antenna SCHWARZBECK	BBHA 9170	9170-480	Jan. 08, 2016	Jan. 07, 2017
Fixed Attenuator Mini-Circuits	BW-N10W5+	NA	Jul. 08, 2016	Jul. 07, 2017
Loop Antenna	EM-6879	269	Aug. 11, 2016	Aug. 10, 2017
Preamplifier EMCI	EMC 012645	980115	Oct. 21, 2016	Oct. 20, 2017
Preamplifier EMCI	EMC 184045	980116	Oct. 21, 2016	Oct. 20, 2017
Preamplifier EMCI	EMC 330H	980112	Oct. 21, 2016	Oct. 20, 2017
RF signal cable HUBER+SUHNNER	SUCOFLEX 104	309219/4 2950114	Oct. 21, 2016	Oct. 20, 2017
RF signal cable HUBER+SUHNNER	SUCOFLEX 104	250130/4	Oct. 21, 2016	Oct. 20, 2017
RF Coaxial Cable Worken	8D-FB	Cable-Ch10-01	Oct. 21, 2016	Oct. 20, 2017
Software BV ADT	E3 6.120103	NA	NA	NA
Antenna Tower MF	MFA-440H	NA	NA	NA
Turn Table MF	MFT-201SS	NA	NA	NA
Antenna Tower & Turn Table Controller MF	MF-7802	NA	NA	NA
Fixed Attenuator Mini-Circuits	BW-N10W5+	NA	Jul. 08, 2016	Jul. 07, 2017

- Note: 1. The calibration interval of the above test instruments is 12 months and the calibrations are traceable to NML/ROC and NIST/USA.
2. The test was performed in HsinTien Chamber 1.
3. The horn antenna and preamplifier (model: 83017A) are used only for the measurement of emission frequency above 1GHz if tested.
4. The FCC Site Registration No. is 149147.
5. The IC Site Registration No. is IC7450I-1.

#### 4.1.3 Test Procedures

- a. The EUT was placed on the top of a rotating table 0.8 meters (for below 1 GHz) / 1.5 meters (for above 1 GHz) above the ground at 3 meter chamber room for test. The table was rotated 360 degrees to determine the position of the highest radiation.
- b. The EUT was set 3 meters away from the interference-receiving antenna, which was mounted on the top of a variable-height antenna tower.
- c. The height of antenna is varied from one meter to four meters above the ground to determine the maximum value of the field strength. Both horizontal and vertical polarizations of the antenna are set to make the measurement.
- d. For each suspected emission, the EUT was arranged to its worst case and then the antenna was tuned to heights from 1 meter to 4 meters and the rotatable table was turned from 0 degrees to 360 degrees to find the maximum reading.
- e. The test-receiver system was set to quasi-peak detect function and specified bandwidth with maximum hold mode when the test frequency is below 1 GHz.
- f. The test-receiver system was set to peak and average detect function and specified bandwidth with maximum hold mode when the test frequency is above 1 GHz. If the peak reading value also meets average limit, measurement with the average detector is unnecessary.

**Note:**

1. The resolution bandwidth and video bandwidth of test receiver/spectrum analyzer is 120 kHz for Quasi-peak detection (QP) at frequency below 1 GHz.
2. The resolution bandwidth of test receiver/spectrum analyzer is 1 MHz and the video bandwidth is 3 MHz for Peak detection (PK) at frequency above 1 GHz.
3. The resolution bandwidth of test receiver/spectrum analyzer is 1 MHz and the video bandwidth is 3 MHz for RMS Average (Duty cycle < 98 %) for Average detection (AV) at frequency above 1 GHz, then the measurement results was added to a correction factor ( $10 \log(1/\text{duty cycle})$ ).
4. The resolution bandwidth of test receiver/spectrum analyzer is 1MHz and the video bandwidth is 10 Hz (Duty cycle  $\geq 98 \%$ ) for Average detection (AV) at frequency above 1 GHz.
5. All modes of operation were investigated and the worst-case emissions are reported.

#### 4.1.4 Deviation from Test Standard

No deviation.

#### 4.1.5 Test Set Up

##### <Frequency Range below 1 GHz>

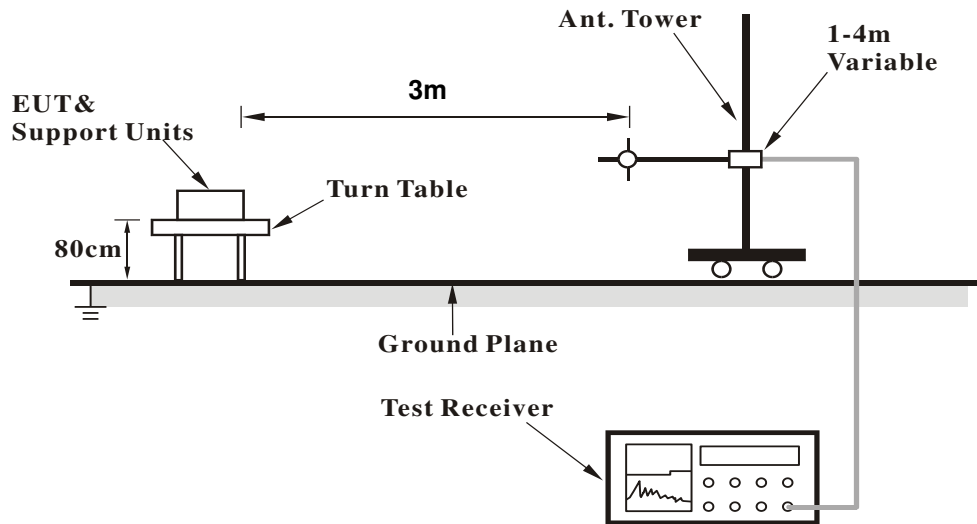

##### <Frequency Range above 1 GHz>

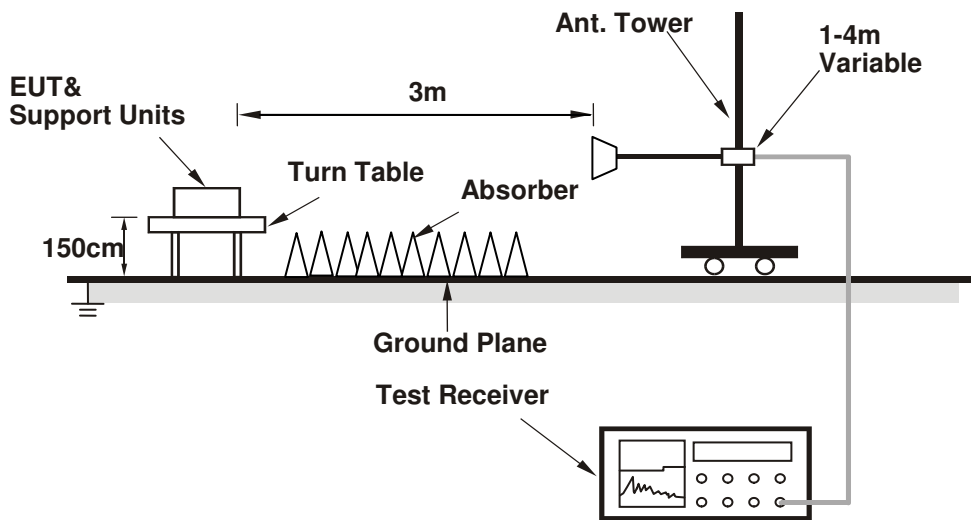

For the actual test configuration, please refer to the attached file (Test Setup Photo).

#### 4.1.6 EUT Operating Conditions

Set the EUT under transmission condition continuously at specific channel frequency.

#### 4.1.7 Test Results

#### Above 1 GHz WORST-CASE DATA:

EUT Test Condition		Measurement Detail	
Channel	Channel 0	Frequency Range	1 GHz ~ 25 GHz
Input Power	120 Vac, 60 Hz	Detector Function	Peak (PK) Average (AV)
Environmental Conditions	25 deg. C, 65 % RH	Tested By	Gavin Wu

Antennal Polarity & Test Distance: Horizontal at 3 m										
Frequency (MHz)	Emission Level (dBuV/m)	Read Level (dBuV)	Limit (dBuV/m)	Margin (dB)	Antenna Factor (dB/m)	Cable Loss (dB)	Preamp Factor (dB)	Antenna Height (cm)	Table Angle (Degree)	Remark
2389.74	60.61	67.12	74	-13.39	26.91	4.08	37.5	128	157	Peak
2389.92	44.34	50.87	54	-9.66	26.91	4.08	37.52	128	157	Average
2402	91.7	98.22	94	-2.3	26.91	4.09	37.52	128	157	Average
2402	93.58	100.1	114	-20.42	26.91	4.09	37.52	128	157	Peak
4804	38.27	53.61	54	-15.73	30.97	6.79	53.1	100	162	Average
4804	45.26	60.6	74	-28.74	30.97	6.79	53.1	100	162	Peak

Antennal Polarity & Test Distance: Vertical at 3 m										
Frequency (MHz)	Emission Level (dBuV/m)	Read Level (dBuV)	Limit (dBuV/m)	Margin (dB)	Antenna Factor (dB/m)	Cable Loss (dB)	Preamp Factor (dB)	Antenna Height (cm)	Table Angle (Degree)	Remark
2388.75	42.42	48.93	54	-11.58	26.91	4.08	37.5	104	217	Average
2389.83	59.07	65.6	74	-14.93	26.91	4.08	37.52	104	217	Peak
2402	91.64	98.16	94	-2.36	26.91	4.09	37.52	104	217	Average
2402	92.4	98.92	114	-21.6	26.91	4.09	37.52	104	217	Peak
4804	35.94	51.28	54	-18.06	30.97	6.79	53.1	100	192	Average
4804	44.29	59.63	74	-29.71	30.97	6.79	53.1	100	192	Peak

Remarks:

- Emission Level = Read Level + Antenna Factor + Cable Loss - Preamp Factor  
Margin value = Emission level – Limit value

EUT Test Condition		Measurement Detail	
Channel	Channel 19	Frequency Range	1 GHz ~ 25 GHz
Input Power	120 Vac, 60 Hz	Detector Function	Peak (PK) Average (AV)
Environmental Conditions	25 deg. C, 65 % RH	Tested By	Gavin Wu

Antennal Polarity & Test Distance: Horizontal at 3 m										
Frequency (MHz)	Emission Level (dBuV/m)	Read Level (dBuV)	Limit (dBuV/m)	Margin (dB)	Antenna Factor (dB/m)	Cable Loss (dB)	Preamp Factor (dB)	Antenna Height (cm)	Table Angle (Degree)	Remark
2377.86	38.09	44.66	54	-15.91	26.86	4.07	37.5	110	156	Average
2387.22	50.91	57.42	74	-23.09	26.91	4.08	37.5	110	156	Peak
2440	92.06	98.34	94	-1.94	27.06	4.12	37.46	110	156	Average
2440	92.83	99.11	114	-21.17	27.06	4.12	37.46	110	156	Peak
2485.2	38.73	44.75	54	-15.27	27.15	4.15	37.32	110	156	Average
2491.96	57.77	63.66	74	-16.23	27.2	4.16	37.25	110	156	Peak
4880	38.01	53.15	54	-15.99	31.06	6.85	53.05	100	128	Average
4880	44.5	59.64	74	-29.5	31.06	6.85	53.05	100	128	Peak

Antennal Polarity & Test Distance: Vertical at 3 m										
Frequency (MHz)	Emission Level (dBuV/m)	Read Level (dBuV)	Limit (dBuV/m)	Margin (dB)	Antenna Factor (dB/m)	Cable Loss (dB)	Preamp Factor (dB)	Antenna Height (cm)	Table Angle (Degree)	Remark
2389.74	42.89	49.4	54	-11.11	26.91	4.08	37.5	103	217	Average
2389.83	50.57	57.1	74	-23.43	26.91	4.08	37.52	103	217	Peak
2440	92.23	98.51	94	-1.77	27.06	4.12	37.46	103	217	Average
2440	93.13	99.41	114	-20.87	27.06	4.12	37.46	103	217	Peak
2484.96	38.23	44.25	54	-15.77	27.15	4.15	37.32	103	217	Average
2496.28	58.1	63.99	74	-15.9	27.2	4.16	37.25	103	217	Peak
4880	36.54	51.68	54	-17.46	31.06	6.85	53.05	100	351	Average
4880	44.26	59.4	74	-29.74	31.06	6.85	53.05	100	351	Peak

Remarks:

- Emission Level = Read Level + Antenna Factor + Cable Loss - Preamp Factor  
Margin value = Emission level – Limit value



A D T

EUT Test Condition		Measurement Detail	
Channel	Channel 39	Frequency Range	1 GHz ~ 25 GHz
Input Power	120 Vac, 60 Hz	Detector Function	Peak (PK) Average (AV)
Environmental Conditions	25 deg. C, 65 % RH	Tested By	Gavin Wu

**Antennal Polarity & Test Distance: Horizontal at 3 m**

Frequency (MHz)	Emission Level (dBuV/m)	Read Level (dBuV)	Limit (dBuV/m)	Margin (dB)	Antenna Factor (dB/m)	Cable Loss (dB)	Preamp Factor (dB)	Antenna Height (cm)	Table Angle (Degree)	Remark
2480	92.66	98.68	94	-1.34	27.15	4.15	37.32	141	163	Average
2480	93.42	99.44	114	-20.58	27.15	4.15	37.32	141	163	Peak
2483.56	52.49	58.51	54	-1.51	27.15	4.15	37.32	141	163	Average
2483.56	71.59	77.61	74	-2.41	27.15	4.15	37.32	141	163	Peak
4960	38.56	53.53	54	-15.44	31.16	6.91	53.04	103	122	Average
4960	44.35	59.32	74	-29.65	31.16	6.91	53.04	102	122	Peak

**Antennal Polarity & Test Distance: Vertical at 3 m**

Frequency (MHz)	Emission Level (dBuV/m)	Read Level (dBuV)	Limit (dBuV/m)	Margin (dB)	Antenna Factor (dB/m)	Cable Loss (dB)	Preamp Factor (dB)	Antenna Height (cm)	Table Angle (Degree)	Remark
2480	90.01	96.03	94	-3.99	27.15	4.15	37.32	100	218	Average
2480	90.87	96.89	114	-23.13	27.15	4.15	37.32	100	218	Peak
2483.52	49.79	55.81	54	-4.21	27.15	4.15	37.32	100	218	Average
2483.56	67.84	73.86	74	-6.16	27.15	4.15	37.32	100	218	Peak
4960	37.01	51.98	54	-16.99	31.16	6.91	53.04	102	184	Average
4960	44.47	59.44	74	-29.53	31.16	6.91	53.04	102	184	Peak

Remarks:

- Emission Level = Read Level + Antenna Factor + Cable Loss - Preamp Factor  
Margin value = Emission level – Limit value

**9 kHz ~ 30 MHz DATA:**

The amplitude of spurious emissions attenuated more than 20 dB below the permissible value is not required to be report.

**Below 1 GHz WORST-CASE DATA:**

EUT Test Condition		Measurement Detail	
Channel	Channel 0	Frequency Range	30 MHz ~ 1 GHz
Input Power	120 Vac, 60 Hz	Detector Function	Peak (PK) Quasi-peak (QP)
Environmental Conditions	25 deg. C, 65 % RH	Tested By	Gavin Wu

Antennal Polarity & Test Distance: Horizontal at 3 m										
Frequency (MHz)	Emission Level (dBuV/m)	Read Level (dBuV)	Limit (dBuV/m)	Margin (dB)	Antenna Factor (dB/m)	Cable Loss (dB)	Preamp Factor (dB)	Antenna Height (cm)	Table Angle (Degree)	Remark
101.78	22.38	44.01	43.5	-21.12	9.25	1.06	31.94	108	218	Peak
167.74	27.52	46.17	43.5	-15.98	11.96	1.15	31.76	104	137	Peak
305.48	31.31	48.48	46	-14.69	13.08	1.65	31.9	117	345	Peak
468.44	28.09	41.28	46	-17.91	16.7	2.02	31.91	128	173	Peak
620.73	26.15	36.17	46	-19.85	19.86	2.29	32.17	132	282	Peak
799.21	33.69	40.29	46	-12.31	22.22	2.61	31.43	108	271	Peak
Antennal Polarity & Test Distance: Vertical at 3 m										
Frequency (MHz)	Emission Level (dBuV/m)	Read Level (dBuV)	Limit (dBuV/m)	Margin (dB)	Antenna Factor (dB/m)	Cable Loss (dB)	Preamp Factor (dB)	Antenna Height (cm)	Table Angle (Degree)	Remark
101.78	23.8	45.43	43.5	-19.7	9.25	1.06	31.94	112	223	Peak
187.14	30.01	50.22	43.5	-13.49	10.26	1.25	31.72	133	60	Peak
394.72	23.45	38.42	46	-22.55	15.21	1.9	32.08	128	329	Peak
469.41	25.81	38.98	46	-20.19	16.71	2.02	31.9	108	212	Peak
551.86	28.91	40.2	46	-17.09	18.5	2.18	31.97	137	330	Peak
800.18	30.96	37.55	46	-15.04	22.23	2.61	31.43	134	103	Peak

Remarks:

- Emission Level = Read Level + Antenna Factor + Cable Loss - Preamp Factor  
Margin value = Emission level – Limit value



## 4.2 Conducted Emission Measurement

### 4.2.1 Limits of Conducted Emission Measurement

Frequency (MHz)	Conducted Limit (dBuV)	
	Quasi-peak	Average
0.15 - 0.5	66 - 56	56 - 46
0.50 - 5.0	56	46
5.0 - 30.0	60	50

Note:

1. The lower limit shall apply at the transition frequencies.
2. The limit decreases in line with the logarithm of the frequency in the range of 0.15 to 0.50 MHz.

### 4.2.2 Test Instruments

Description & Manufacturer	Model No.	Serial No.	Date Of Calibration	Due Date Of Calibration
Test Receiver ROHDE & SCHWARZ	ESCI	100424	Oct. 24, 2016	Oct. 23, 2017
RF signal cable (with 10dB PAD) Woken	5D-FB	Cable-cond1-01	Dec. 26, 2015	Dec. 25, 2016
LISN/AMN ROHDE & SCHWARZ (EUT)	ESH3-Z5	835239/001	Feb. 26, 2016	Feb. 25, 2017
LISN/AMN ROHDE & SCHWARZ (Peripheral)	ESH3-Z5	100311	Jul. 28, 2016	Jul. 27, 2017
Software ADT	BV ADT_Cond_ V7.3.7.3	NA	NA	NA

- Note:
1. The calibration interval of the above test instruments is 12 months and the calibrations are traceable to NML/ROC and NIST/USA.
  2. The test was performed in HwaYa Shielded Room 1.
  3. The VCCI Site Registration No. is C-2040.
  4. Test Date: Dec. 16, 2016

#### 4.2.3 Test Procedures

- a. The EUT was placed 0.4 meters from the conducting wall of the shielded room with EUT being connected to the power mains through a line impedance stabilization network (LISN). Other support units were connected to the power mains through another LISN. The two LISNs provide 50 ohm/ 50 uH of coupling impedance for the measuring instrument.
- b. Both lines of the power mains connected to the EUT were checked for maximum conducted interference.
- c. The frequency range from 150 kHz to 30 MHz was searched. Emission levels under (Limit – 20 dB) was not recorded.

**NOTE:** The resolution bandwidth and video bandwidth of test receiver is 9 kHz for quasi-peak detection (QP) and average detection (AV) at frequency 0.15 MHz - 30 MHz.

#### 4.2.4 Deviation from Test Standard

No deviation.

#### 4.2.5 Test Setup

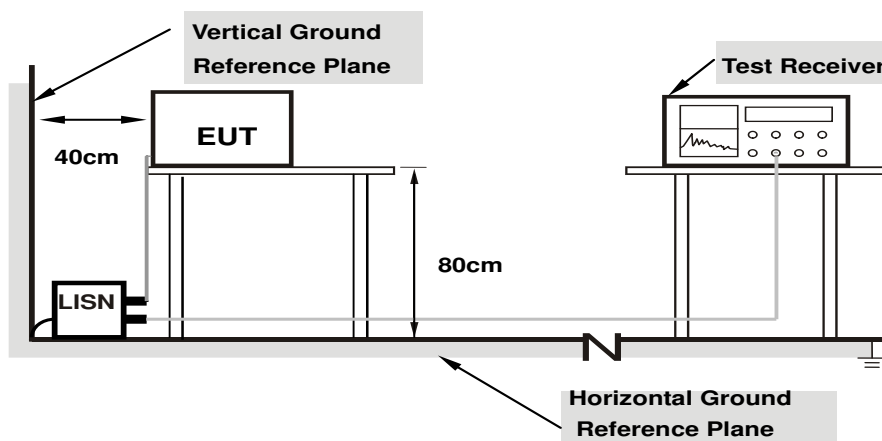

**Note: 1.Support units were connected to second LISN.**

For the actual test configuration, please refer to the attached file (Test Setup Photo).

#### 4.2.6 EUT Operating Conditions

Same as 4.1.6.

#### 4.2.7 Test Results

Frequency Range	150kHz ~ 30MHz	Detector Function & Resolution Bandwidth	Quasi-Peak (QP) / Average (AV), 9kHz
Input Power	120Vac, 60Hz	Environmental Conditions	25°C, 65%RH
Tested by	Toby Tian	Test Date	2016/12/16

Phase Of Power : Line (L)										
No	Frequency (MHz)	Correction Factor (dB)	Reading Value (dBuV)		Emission Level (dBuV)		Limit (dBuV)		Margin (dB)	
			Q.P.	AV.	Q.P.	AV.	Q.P.	AV.	Q.P.	AV.
1	0.15728	10.02	26.79	11.84	36.81	21.86	65.61	55.61	-28.80	-33.75
<b>2</b>	<b>0.17801</b>	<b>10.02</b>	<b>45.13</b>	<b>30.78</b>	<b>55.15</b>	<b>40.80</b>	<b>64.58</b>	<b>54.58</b>	<b>-9.43</b>	<b>-13.78</b>
3	0.24600	10.05	35.73	25.10	45.78	35.15	61.89	51.89	-16.11	-16.74
4	0.36600	10.10	25.55	15.76	35.65	25.86	58.59	48.59	-22.94	-22.73
5	0.41799	10.12	26.26	15.64	36.38	25.76	57.49	47.49	-21.11	-21.73
6	1.71800	10.25	21.17	12.67	31.42	22.92	56.00	46.00	-24.58	-23.08

Remarks:

1. Q.P. and AV. are abbreviations of quasi-peak and average individually.
2. The emission levels of other frequencies were very low against the limit.
3. Margin value = Emission level – Limit value
4. Correction factor = Insertion loss + Cable loss
5. Emission Level = Correction Factor + Reading Value

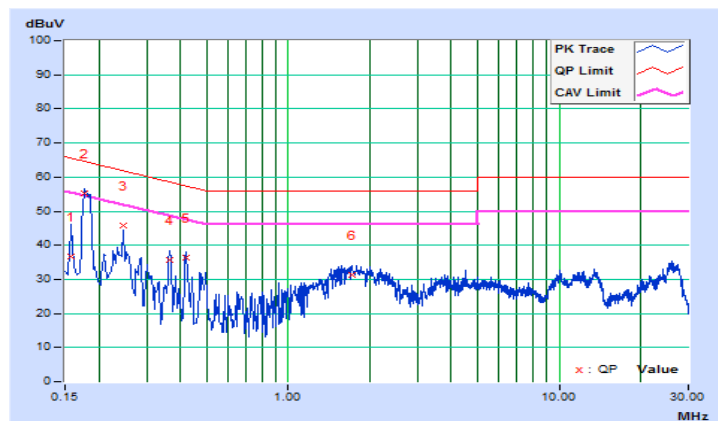

Frequency Range	150kHz ~ 30MHz	Detector Function & Resolution Bandwidth	Quasi-Peak (QP) / Average (AV), 9kHz
Input Power	120Vac, 60Hz	Environmental Conditions	25°C, 65%RH
Tested by	Toby Tian	Test Date	2016/12/16

Phase Of Power : Neutral (N)										
No	Frequency (MHz)	Correction Factor (dB)	Reading Value (dBuV)		Emission Level (dBuV)		Limit (dBuV)		Margin (dB)	
			Q.P.	AV.	Q.P.	AV.	Q.P.	AV.	Q.P.	AV.
1	0.18180	10.03	43.95	31.97	53.98	42.00	64.40	54.40	-10.42	-12.40
2	0.19400	10.04	38.51	16.18	48.55	26.22	63.86	53.86	-15.31	-27.64
3	0.24200	10.06	35.61	25.06	45.67	35.12	62.03	52.03	-16.36	-16.91
4	0.41000	10.13	20.60	5.90	30.73	16.03	57.65	47.65	-26.92	-31.62
5	1.69400	10.26	18.93	9.87	29.19	20.13	56.00	46.00	-26.81	-25.87
6	13.73400	11.03	19.63	12.75	30.66	23.78	60.00	50.00	-29.34	-26.22

**Remarks:**

1. Q.P. and AV. are abbreviations of quasi-peak and average individually.
2. The emission levels of other frequencies were very low against the limit.
3. Margin value = Emission level – Limit value
4. Correction factor = Insertion loss + Cable loss
5. Emission Level = Correction Factor + Reading Value

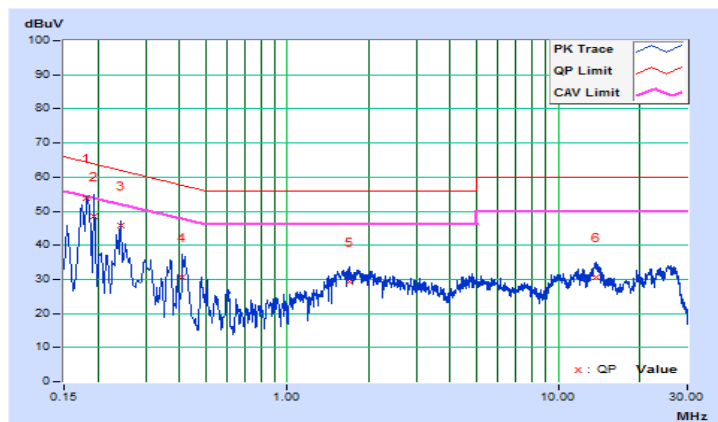

### 4.3 20 dB Bandwidth

#### 4.3.1 Limits of 20 dB Bandwidth Measurement

The 20 dB bandwidth shall be specified in operating frequency band.

#### 4.3.2 Test Setup

Refer to section 4.1.5.

#### 4.3.3 Test Instruments

Refer to section 4.1.2 to get information of above instrument.

#### 4.3.4 Test Procedures

The bandwidth of the fundamental frequency was measured by spectrum analyzer with 300 kHz RBW and 1 MHz VBW. The 20 dB bandwidth is defined as the total spectrum the power of which is higher than peak power minus 20 dB.

#### 4.3.5 Deviation from Test Standard

No deviation.

#### 4.3.6 EUT Operating Conditions

The software provided by client enabled the EUT to transmit and receive data at lowest, middle and highest channel frequencies individually.

4.3.7 Test Results

Channel	Frequency (MHz)	20 dB Bandwidth (MHz)
		GFSK
0	2402	2.47
19	2440	2.48
39	2480	2.57

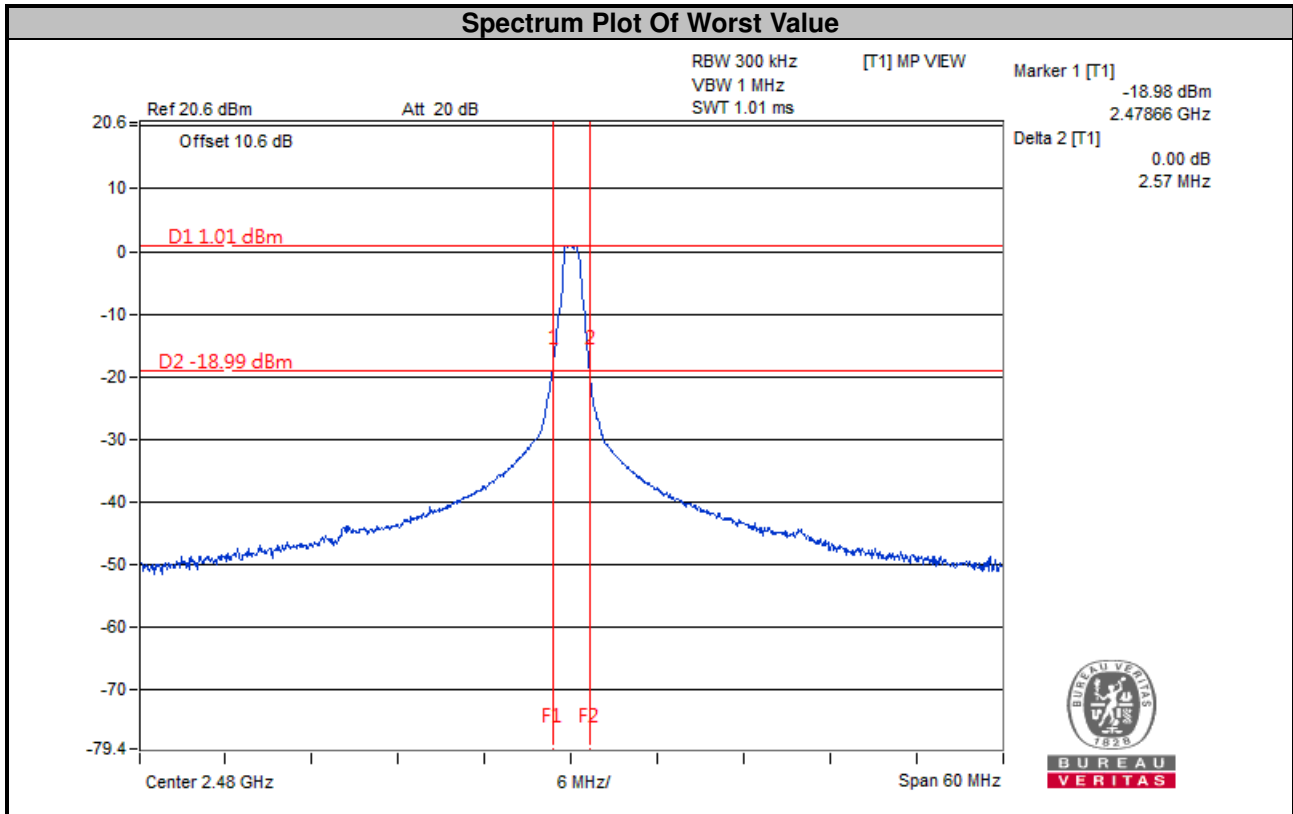

#### **4.4 Antenna Requirement**

##### **4.4.1 Standard Requirement**

15.203 requirement: For intentional device, according to 15.203: an intentional radiator shall be designed to ensure that no antenna other than that furnished by the responsible party shall be used with the device.

#### **4.5 EUT Antenna**

The EUT antenna is the permanent integral antenna. It comply with the standard requirement.



## 5 Pictures of Test Arrangements

Please refer to the attached file (Test Setup Photo).





## Appendix – Information on the Testing Laboratories

We, Bureau Veritas Consumer Products Services (H.K.) Ltd., Taoyuan Branch, were founded in 1988 to provide our best service in EMC, Radio, Telecom and Safety consultation. Our laboratories are accredited and approved according to ISO/IEC 17025.

If you have any comments, please feel free to contact us at the following:

**Linko EMC/RF Lab**

Tel: 886-2-26052180

Fax: 886-2-26051924

**Hsin Chu EMC/RF/Telecom Lab**

Tel: 886-3-6668565

Fax: 886-3-6668323

**Hwa Ya EMC/RF/Safety Lab**

Tel: 886-3-3183232

Fax: 886-3-3270892

**Email:** [service.adt@tw.bureauveritas.com](mailto:service.adt@tw.bureauveritas.com)

**Web Site:** [www.bureauveritas-adt.com](http://www.bureauveritas-adt.com)

The address and road map of all our labs can be found in our web site also.

--- END ---