

ELECTROMAGNETIC EMISSIONS COMPLIANCE REPORT
INTENTIONAL RADIATOR CERTIFICATION TO
FCC PART 22 SUBPART H, PART 24 SUBPART E and PART 27 SUBPART
H & SUBPART L REQUIREMENT

OF

Product Name: Smartphone

Brand Name: HTC

Model No.: 2PYR200, 2PYR210

Model Difference: device cover's color different

FCC ID: NM82PYR200

Report No.: E2/2016/C0004

Issue Date: Jan. 26, 2017

FCC Rule Part: 2 , 22H & 24E & 27H & L

Prepared for: HTC Corporation
No.23, Xinghua Rd., Taoyuan Dist., Taoyuan City 330,
Taiwan (R.O.C)

Prepared by: SGS Taiwan Ltd.
Electronics & Communication Laboratory
No.2, Keji 1st Rd., Guishan District, Taoyuan City,
Taiwan 333

***Note:** This report shall not be reproduced except in full, without the written approval of SGS Taiwan Ltd. This document may be altered or revised by SGS Taiwan Ltd. personnel only, and shall be noted in the revision section of the document.*

Unless otherwise stated the results shown in this test report refer only to the sample(s) tested and such sample(s) are retained for 90 days only.

除非另有說明，此報告結果僅對測試之樣品負責，同時此樣品僅保留90天。本報告未經本公司書面許可，不可部份複製。

This document is issued by the Company subject to its General Conditions of Service printed overleaf, available on request or accessible at www.sgs.com/terms_and_conditions.htm and, for electronic format documents, subject to Terms and Conditions for Electronic Documents at www.sgs.com/terms_e-document.htm. Attention is drawn to the limitation of liability, indemnification and jurisdiction issues defined therein. Any holder of this document is advised that information contained hereon reflects the Company's findings at the time of its intervention only and within the limits of Client's instructions, if any. The Company's sole responsibility is to its Client and this document does not exonerate parties to a transaction from exercising all their rights and obligations under the transaction documents. This document cannot be reproduced except in full, without prior written approval of the Company. Any unauthorized alteration, forgery or falsification of the content or appearance of this document is unlawful and offenders may be prosecuted to the fullest extent of the law.

SGS Taiwan Ltd.

No.134,WuKungRoad,NewTaipeiIndustrialPark,WukuDistrict,NewTaipeiCity,Taiwan24803/新北市五股區新北產業園區五工路 134 號

台灣檢驗科技股份有限公司

t (886-2) 2299-3279

f (886-2) 2298-0488

www.tw.sgs.com

Member of SGS Group

VERIFICATION OF COMPLIANCE

Applicant: HTC Corporation
No.23, Xinghua Rd., Taoyuan Dist., Taoyuan City 330, Taiwan
(R.O.C)

Product Name: Smartphone

Brand Name: HTC

Model No.: 2PYR200, 2PYR210

Model Difference: device cover's color different

FCC ID: NM82PYR200

File Number: E2/2016/C0004

Date of test: Dec. 01, 2016 ~ Jan. 10, 2017

Date of EUT Received: Dec. 01, 2016

We hereby certify that:

The above equipment was tested by SGS Taiwan Ltd. Electronics & Communication Laboratory. The test data, data evaluation, test procedures, and equipment configurations shown in this report were made in accordance with the procedures given in TIA/EIA-603-D-2010 and the energy emitted by the sample EUT tested as described in this report is in compliance with conducted and radiated emission limits.

The test results of this report relate only to the tested sample identified in this report.

Test By:

Aken Huang

Date: Jan. 10, 2017

Aken Huang / Engineer

Prepared By:

Karen Huang

Date: Jan. 10, 2017

Karen Huang / Clerk

Approved By:

Jim Chang

Date: Jan. 10, 2017

Jim Chang / Asst. Manager

Unless otherwise stated the results shown in this test report refer only to the sample(s) tested and such sample(s) are retained for 90 days only.

除非另有說明，此報告結果僅對測試之樣品負責，同時此樣品僅保留90天。本報告未經本公司書面許可，不可部份複製。

This document is issued by the Company subject to its General Conditions of Service printed overleaf, available on request or accessible at www.sgs.com/terms_and_conditions.htm and, for electronic format documents, subject to Terms and Conditions for Electronic Documents at www.sgs.com/terms_e-document.htm. Attention is drawn to the limitation of liability, indemnification and jurisdiction issues defined therein. Any holder of this document is advised that information contained hereon reflects the Company's findings at the time of its intervention only and within the limits of Client's instructions, if any. The Company's sole responsibility is to its Client and this document does not exonerate parties to a transaction from exercising all their rights and obligations under the transaction documents. This document cannot be reproduced except in full, without prior written approval of the Company. Any unauthorized alteration, forgery or falsification of the content or appearance of this document is unlawful and offenders may be prosecuted to the fullest extent of the law.

Revision History

Report Number	Revision	Description	Issue Date
E2/2016/C0004	Rev.00	Initial creation of document	Jan. 26, 2017

Unless otherwise stated the results shown in this test report refer only to the sample(s) tested and such sample(s) are retained for 90 days only.

除非另有說明，此報告結果僅對測試之樣品負責，同時此樣品僅保留90天。本報告未經本公司書面許可，不可部份複製。

This document is issued by the Company subject to its General Conditions of Service printed overleaf, available on request or accessible at www.sgs.com/terms_and_conditions.htm and, for electronic format documents, subject to Terms and Conditions for Electronic Documents at www.sgs.com/terms_e-document.htm. Attention is drawn to the limitation of liability, indemnification and jurisdiction issues defined therein. Any holder of this document is advised that information contained hereon reflects the Company's findings at the time of its intervention only and within the limits of Client's instructions, if any. The Company's sole responsibility is to its Client and this document does not exonerate parties to a transaction from exercising all their rights and obligations under the transaction documents. This document cannot be reproduced except in full, without prior written approval of the Company. Any unauthorized alteration, forgery or falsification of the content or appearance of this document is unlawful and offenders may be prosecuted to the fullest extent of the law.

SGS Taiwan Ltd.

No.134,WuKungRoad,NewTaipeiIndustrialPark,WukuDistrict,NewTaipeiCity,Taiwan24803/新北市五股區新北產業園區五工路 134 號

台灣檢驗科技股份有限公司

t (886-2) 2299-3279

f (886-2) 2298-0488

www.tw.sgs.com

Member of SGS Group

Contents

1. GENERAL PRODUCT INFORMATION	6
1.1. Product Description.....	6
1.2. Product Feature of Equipment Under Test.....	13
1.3. Test Methodology of Applied Standards.....	14
1.4. Test Facility	14
1.5. Special Accessories	14
1.6. Equipment Modifications.....	14
2. SYSTEM TEST CONFIGURATION	15
2.1. EUT Configuration	15
2.2. EUT Exercise	15
2.3. Test Procedure.....	15
2.4. Measurement Results Explanation Example	16
2.5. Final Amplifier Voltage and Current Information:	16
2.6. Configuration of Tested System	19
3. SUMMARY OF TEST RESULTS	20
4. DESCRIPTION OF TEST MODES.....	21
4.1. The Worst Test Modes and Channel Details.....	21
5. MEASUREMENT UNCERTAINTY	27
6. RF CONDUCTED OUTPUT POWER MEASUREMENT.....	28
6.1. Standard Applicable	28
6.2. Test Set-up.....	28
6.3. Measurement Procedure	28
6.4. Measurement Equipment Used	29
6.5. Measurement Result.....	29
7. EFFECTIVE RADIATED POWER AND EQUIVALENT ISOTROPIC RADIATED POWER MEASUREMENT.....	45
7.1. Standard Applicable	45
7.2. Test SET-UP	45
7.3. Measurement Procedure	47
7.4. Measurement Equipment Used	48
7.5. Measurement Result: (Peak) –using option of peak measurement.....	50

Unless otherwise stated the results shown in this test report refer only to the sample(s) tested and such sample(s) are retained for 90 days only.

除非另有說明，此報告結果僅對測試之樣品負責，同時此樣品僅保留90天。本報告未經本公司書面許可，不可部份複製。

This document is issued by the Company subject to its General Conditions of Service printed overleaf, available on request or accessible at www.sgs.com/terms_and_conditions.htm and, for electronic format documents, subject to Terms and Conditions for Electronic Documents at www.sgs.com/terms_e-document.htm. Attention is drawn to the limitation of liability, indemnification and jurisdiction issues defined therein. Any holder of this document is advised that information contained hereon reflects the Company's findings at the time of its intervention only and within the limits of Client's instructions, if any. The Company's sole responsibility is to its Client and this document does not exonerate parties to a transaction from exercising all their rights and obligations under the transaction documents. This document cannot be reproduced except in full, without prior written approval of the Company. Any unauthorized alteration, forgery or falsification of the content or appearance of this document is unlawful and offenders may be prosecuted to the fullest extent of the law.

8. OCCUPIED BANDWIDTH MEASUREMENT.....	75
8.1. Standard Applicable	75
8.2. Test Set-up.....	75
8.3. Measurement Procedure	75
8.4. Measurement Equipment Used	76
8.5. Measurement Result.....	77
9. OUT OF BAND EMISSION AT ANTENNA TERMINALS	111
9.1. Standard Applicable	111
9.2. Test SET-UP	113
9.3. Measurement Procedure	113
9.4. Measurement Equipment Used	114
9.5. Measurement Result:.....	114
10. FIELD STRENGTH OF SPURIOUS RADIATION MEASUREMENT	173
10.1. Standard Applicable	173
10.2. EUT Setup	175
10.3. Measurement Procedure:	176
10.4. Measurement Equipment Used:	177
10.5. Measurement Result:.....	179
11. FREQUENCY STABILITY MEASUREMENT.....	233
11.1. Standard Applicable:	233
11.2. Test Set-up:.....	233
11.3. Measurement Procedure:	234
11.4. Measurement Equipment Used:	235
11.5. Measurement Result:.....	236
12. PEAK TO AVERAGE RATIO	245
12.1. Standard Applicable	245
12.2. Test SET-UP	245
12.3. Measurement Procedure	245
12.4. Measurement Equipment Used	246
12.5. Measurement Result.....	247

Unless otherwise stated the results shown in this test report refer only to the sample(s) tested and such sample(s) are retained for 90 days only.

除非另有說明，此報告結果僅對測試之樣品負責，同時此樣品僅保留90天。本報告未經本公司書面許可，不可部份複製。

This document is issued by the Company subject to its General Conditions of Service printed overleaf, available on request or accessible at www.sgs.com/terms_and_conditions.htm and, for electronic format documents, subject to Terms and Conditions for Electronic Documents at www.sgs.com/terms_e-document.htm. Attention is drawn to the limitation of liability, indemnification and jurisdiction issues defined therein. Any holder of this document is advised that information contained hereon reflects the Company's findings at the time of its intervention only and within the limits of Client's instructions, if any. The Company's sole responsibility is to its Client and this document does not exonerate parties to a transaction from exercising all their rights and obligations under the transaction documents. This document cannot be reproduced except in full, without prior written approval of the Company. Any unauthorized alteration, forgery or falsification of the content or appearance of this document is unlawful and offenders may be prosecuted to the fullest extent of the law.

SGS Taiwan Ltd.

No.134,WuKungRoad,NewTaipeiIndustrialPark,WukuDistrict,NewTaipeiCity,Taiwan24803/新北市五股區新北產業園區五工路 134 號

台灣檢驗科技股份有限公司

t (886-2) 2299-3279

f (886-2) 2298-0488

www.tw.sgs.com

Member of SGS Group

1. GENERAL PRODUCT INFORMATION

1.1. Product Description

General:

Product Name:	Smartphone	
Brand Name:	HTC	
Model No.:	2PYR200, 2PYR210	
Model Difference:	device cover's color different	
Hardware Version:	EVT	
Software Version:	N/A	
Earphone:	Model No.: HS S270, Supplier: SIYOTO	
USB Cable:	1. Model No.: DC MSR600, Supplier: Luxshare 2. Model No.: DC MSR600, Supplier: Foxconn 3. Model No.: DC MSR600, Supplier: COXOC 4. Model No.: DC MSR600, Supplier: Foxlink	
Power Supply:	3.85Vdc from Rechargeable Li-ion Battery or 5Vdc from AC/DC Adapter	
	Battery:	1. Model No.: B2PST100, Supplier: ATL 2. Model No.: B2PST100, Supplier: BYD
	Adapter:	1. Model No.: TC U250, Supplier: Salcomp 2. Model No.: TC U250, Supplier: Deevan 3. Model No.: TC U250, Supplier: Phihong

Unless otherwise stated the results shown in this test report refer only to the sample(s) tested and such sample(s) are retained for 90 days only.

除非另有說明，此報告結果僅對測試之樣品負責，同時此樣品僅保留90天。本報告未經本公司書面許可，不可部份複製。

This document is issued by the Company subject to its General Conditions of Service printed overleaf, available on request or accessible at www.sgs.com/terms_and_conditions.htm and, for electronic format documents, subject to Terms and Conditions for Electronic Documents at www.sgs.com/terms_e-document.htm. Attention is drawn to the limitation of liability, indemnification and jurisdiction issues defined therein. Any holder of this document is advised that information contained hereon reflects the Company's findings at the time of its intervention only and within the limits of Client's instructions, if any. The Company's sole responsibility is to its Client and this document does not exonerate parties to a transaction from exercising all their rights and obligations under the transaction documents. This document cannot be reproduced except in full, without prior written approval of the Company. Any unauthorized alteration, forgery or falsification of the content or appearance of this document is unlawful and offenders may be prosecuted to the fullest extent of the law.

SGS Taiwan Ltd.

No.134,WuKungRoad,NewTaipeiIndustrialPark,WukuDistrict,NewTaipeiCity,Taiwan24803/新北市五股區新北產業園區五工路 134 號

台灣檢驗科技股份有限公司

t (886-2) 2299-3279

f (886-2) 2298-0488

www.tw.sgs.com

Member of SGS Group

GSM / WCDMA / LTE:

Cellular Phone Standards Frequency Range and Power	Operating Frequency		Rated Power
	GSM/GPRS 850	824.2 MHz– 848.8 MHz	33dBm
	EDGE 850	824.2 MHz– 848.8 MHz	27dBm
	GSM/GPRS 1900	1850.2MHz – 1909.8MHz	30dBm
	EDGE 1900	1850.2MHz – 1909.8MHz	26dBm
	WCDMA/HSUPA/HSDPA Band II	1852.4MHz – 1907.6MHz	24dBm
	WCDMA/HSUPA/HSDPA Band IV	1712.4MHz – 1752.6MHz	24dBm
	WCDMA/HSUPA/HSDPA Band V	826.4MHz - 846.6MHz	24dBm
	LTE-Band 2 (Bandwidth 1.4MHz)	1850.7MHz– 1909.3MHz	23dBm
	LTE-Band 2 (Bandwidth 3MHz)	1851.5MHz – 1908.5MHz	23dBm
	LTE-Band 2 (Bandwidth 5MHz)	1852.5MHz – 1907.5MHz	23dBm
	LTE-Band 2 (Bandwidth 10MHz)	1855.0MHz – 1905.0MHz	23dBm
	LTE-Band 2 (Bandwidth 15MHz)	1857.5MHz – 1902.5MHz	23dBm
	LTE-Band 2 (Bandwidth 20MHz)	1860.0MHz – 1900.0MHz	23dBm
	LTE-Band 4 (Bandwidth 1.4MHz)	1710.7MHz– 1754.3MHz	23dBm
	LTE-Band 4 (Bandwidth 3MHz)	1711.5MHz – 1753.5MHz	23dBm
	LTE-Band 4 (Bandwidth 5MHz)	1712.5MHz – 1752.5MHz	23dBm
	LTE-Band 4 (Bandwidth 10MHz)	1715MHz – 1750MHz	23dBm
	LTE-Band 4 (Bandwidth 15MHz)	1717.5MHz – 1747.5MHz	23dBm
	LTE-Band 4 (Bandwidth 20MHz)	1720MHz – 1745MHz	23dBm

Unless otherwise stated the results shown in this test report refer only to the sample(s) tested and such sample(s) are retained for 90 days only.

除非另有說明，此報告結果僅對測試之樣品負責，同時此樣品僅保留90天。本報告未經本公司書面許可，不可部份複製。

This document is issued by the Company subject to its General Conditions of Service printed overleaf, available on request or accessible at www.sgs.com/terms_and_conditions.htm and, for electronic format documents, subject to Terms and Conditions for Electronic Documents at www.sgs.com/terms_e-document.htm. Attention is drawn to the limitation of liability, indemnification and jurisdiction issues defined therein. Any holder of this document is advised that information contained hereon reflects the Company's findings at the time of its intervention only and within the limits of Client's instructions, if any. The Company's sole responsibility is to its Client and this document does not exonerate parties to a transaction from exercising all their rights and obligations under the transaction documents. This document cannot be reproduced except in full, without prior written approval of the Company. Any unauthorized alteration, forgery or falsification of the content or appearance of this document is unlawful and offenders may be prosecuted to the fullest extent of the law.

SGS Taiwan Ltd.

No.134,WuKungRoad,NewTaipeiIndustrialPark,WukuDistrict,NewTaipeiCity,Taiwan24803/新北市五股區新北產業園區五工路 134 號

台灣檢驗科技股份有限公司

t (886-2) 2299-3279

f (886-2) 2298-0488

www.tw.sgs.com

Member of SGS Group

Cellular Phone Standards Frequency Range and Power	Operating Frequency		Rated Power
	LTE-Band 5 (Bandwidth 1.4MHz)	824.7MHz – 848.3MHz	23dBm
	LTE-Band 5 (Bandwidth 3MHz)	825.5MHz – 847.5MHz	23dBm
	LTE-Band 5 (Bandwidth 5MHz)	826.5MHz – 846.5MHz	23dBm
	LTE-Band 5 (Bandwidth 10MHz)	829.0MHz – 844.0MHz	23dBm
	LTE-Band 12 (Bandwidth 1.4MHz)	699.7MHz– 715.3MHz	23dBm
	LTE-Band 12 (Bandwidth 3MHz)	700.5MHz – 714.5MHz	23dBm
	LTE-Band 12 (Bandwidth 5MHz)	701.5MHz – 713.5MHz	23dBm
	LTE-Band 12 (Bandwidth 10MHz)	704.0MHz – 711.0MHz	23dBm
IMEI:	353946080073189		

Unless otherwise stated the results shown in this test report refer only to the sample(s) tested and such sample(s) are retained for 90 days only.

除非另有說明，此報告結果僅對測試之樣品負責，同時此樣品僅保留90天。本報告未經本公司書面許可，不可部份複製。

This document is issued by the Company subject to its General Conditions of Service printed overleaf, available on request or accessible at www.sgs.com/terms_and_conditions.htm and, for electronic format documents, subject to Terms and Conditions for Electronic Documents at www.sgs.com/terms_e-document.htm. Attention is drawn to the limitation of liability, indemnification and jurisdiction issues defined therein. Any holder of this document is advised that information contained hereon reflects the Company's findings at the time of its intervention only and within the limits of Client's instructions, if any. The Company's sole responsibility is to its Client and this document does not exonerate parties to a transaction from exercising all their rights and obligations under the transaction documents. This document cannot be reproduced except in full, without prior written approval of the Company. Any unauthorized alteration, forgery or falsification of the content or appearance of this document is unlawful and offenders may be prosecuted to the fullest extent of the law.

SGS Taiwan Ltd.

No.134,WuKungRoad,NewTaipeiIndustrialPark,WukuDistrict,NewTaipeiCity,Taiwan24803/新北市五股區新北產業園區五工路 134 號

台灣檢驗科技股份有限公司

t (886-2) 2299-3279

f (886-2) 2298-0488

www.tw.sgs.com

Member of SGS Group

Type of Emission:

Frequency Band	Type of Emission:
GSM 850	248KGXW
GPRS 850	247KGXW
EDGE 850	251KG7W
GSM 1900	248KGXW
GPRS 1900	245KGXW
EDGE 1900	247KG7W
WCDMA Band II	4M25F9W
WCDMA Band IV	4M21F9W
WCDMA Band V	4M17F9W
HSDPA Band II	4M23F9W
HSDPA Band IV	4M13F9W
HSDPA Band V	4M21F9W
HSUPA Band II	4M18F9W
HSUPA Band IV	4M21F9W
HSUPA Band V	4M26F9W

LTE Band	BW (MHz)	Modulation	Type of Emission
LTE Band 2	1.4MHz	QPSK	1M10G7D
LTE Band 2	1.4MHz	16QAM	1M10D7W
LTE Band 2	3MHz	QPSK	2M70G7D
LTE Band 2	3MHz	16QAM	2M70D7W
LTE Band 2	5MHz	QPSK	4M51G7D
LTE Band 2	5MHz	16QAM	4M51D7W
LTE Band 2	10MHz	QPSK	9M01G7D
LTE Band 2	10MHz	16QAM	8M97D7W
LTE Band 2	15MHz	QPSK	13M5G7D
LTE Band 2	15MHz	16QAM	13M5D7W
LTE Band 2	20MHz	QPSK	18M0G7D
LTE Band 2	20MHz	16QAM	18M0D7W
LTE Band 4	1.4MHz	QPSK	1M10G7D
LTE Band 4	1.4MHz	16QAM	1M10D7W
LTE Band 4	3MHz	QPSK	2M70G7D
LTE Band 4	3MHz	16QAM	2M70D7W
LTE Band 4	5MHz	QPSK	4M51G7D
LTE Band 4	5MHz	16QAM	4M51D7W
LTE Band 4	10MHz	QPSK	9M01G7D
LTE Band 4	10MHz	16QAM	8M96D7W
LTE Band 4	15MHz	QPSK	13M5G7D
LTE Band 4	15MHz	16QAM	13M5D7W
LTE Band 4	20MHz	QPSK	17M9G7D
LTE Band 4	20MHz	16QAM	18M0D7W

Unless otherwise stated the results shown in this test report refer only to the sample(s) tested and such sample(s) are retained for 90 days only.

除非另有說明，此報告結果僅對測試之樣品負責，同時此樣品僅保留90天。本報告未經本公司書面許可，不可部份複製。

This document is issued by the Company subject to its General Conditions of Service printed overleaf, available on request or accessible at www.sgs.com/terms_and_conditions.htm and, for electronic format documents, subject to Terms and Conditions for Electronic Documents at www.sgs.com/terms_e-document.htm. Attention is drawn to the limitation of liability, indemnification and jurisdiction issues defined therein. Any holder of this document is advised that information contained hereon reflects the Company's findings at the time of its intervention only and within the limits of Client's instructions, if any. The Company's sole responsibility is to its Client and this document does not exonerate parties to a transaction from exercising all their rights and obligations under the transaction documents. This document cannot be reproduced except in full, without prior written approval of the Company. Any unauthorized alteration, forgery or falsification of the content or appearance of this document is unlawful and offenders may be prosecuted to the fullest extent of the law.

LTE Band	BW (MHz)	Modulation	Type of Emission
LTE Band 5	1.4MHz	QPSK	1M10G7D
LTE Band 5	1.4MHz	16QAM	1M10D7W
LTE Band 5	3MHz	QPSK	2M70G7D
LTE Band 5	3MHz	16QAM	2M70D7W
LTE Band 5	5MHz	QPSK	4M51G7D
LTE Band 5	5MHz	16QAM	4M51D7W
LTE Band 5	10MHz	QPSK	8M99G7D
LTE Band 5	10MHz	16QAM	8M97D7W
LTE Band 12	1.4MHz	QPSK	1M10G7D
LTE Band 12	1.4MHz	16QAM	1M10D7W
LTE Band 12	3MHz	QPSK	2M70G7D
LTE Band 12	3MHz	16QAM	2M71D7W
LTE Band 12	5MHz	QPSK	4M51G7D
LTE Band 12	5MHz	16QAM	4M52D7W
LTE Band 12	10MHz	QPSK	9M03G7D
LTE Band 12	10MHz	16QAM	8M99D7W

Unless otherwise stated the results shown in this test report refer only to the sample(s) tested and such sample(s) are retained for 90 days only.

除非另有說明，此報告結果僅對測試之樣品負責，同時此樣品僅保留90天。本報告未經本公司書面許可，不可部份複製。

This document is issued by the Company subject to its General Conditions of Service printed overleaf, available on request or accessible at www.sgs.com/terms_and_conditions.htm and, for electronic format documents, subject to Terms and Conditions for Electronic Documents at www.sgs.com/terms_e-document.htm. Attention is drawn to the limitation of liability, indemnification and jurisdiction issues defined therein. Any holder of this document is advised that information contained hereon reflects the Company's findings at the time of its intervention only and within the limits of Client's instructions, if any. The Company's sole responsibility is to its Client and this document does not exonerate parties to a transaction from exercising all their rights and obligations under the transaction documents. This document cannot be reproduced except in full, without prior written approval of the Company. Any unauthorized alteration, forgery or falsification of the content or appearance of this document is unlawful and offenders may be prosecuted to the fullest extent of the law.

SGS Taiwan Ltd.

No.134,WuKungRoad,NewTaipeiIndustrialPark,WukuDistrict,NewTaipeiCity,Taiwan24803/新北市五股區新北產業園區五工路 134 號

台灣檢驗科技股份有限公司

t (886-2) 2299-3279

f (886-2) 2298-0488

www.tw.sgs.com

Member of SGS Group

Max ERP/EIRP Power Measurement Result:

	dBm		W
GSM 850	31	ERP	1.259
GPRS 850	31.11	ERP	1.291
EDGE 850	25.66	ERP	0.368
GSM 1900	29.7	EIRP	0.933
GPRS 1900	30.21	EIRP	1.050
EDGE 1900	29.28	EIRP	0.847
WCDMA Band II	32.46	EIRP	1.762
WCDMA Band IV	29.2	EIRP	0.832
WCDMA Band V	22.62	ERP	0.183
HSDPA Band II	31.94	EIRP	1.563
HSDPA Band IV	28.14	EIRP	0.652
HSDPA Band V	22.76	ERP	0.189
HSUPA Band II	32.88	EIRP	1.941
HSUPA Band IV	29.16	EIRP	0.824
HSUPA Band V	23.73	ERP	0.236
LTE-Band 2 (Bandwidth 1.4MHz) QPSK	30.64	EIRP	1.159
LTE-Band 2 (Bandwidth 1.4MHz) 16QAM	30.54	EIRP	1.132
LTE-Band 2 (Bandwidth 3MHz) QPSK	30.82	EIRP	1.208
LTE-Band 2 (Bandwidth 3MHz) 16QAM	30.48	EIRP	1.117
LTE-Band 2 (Bandwidth 5MHz) QPSK	30.7	EIRP	1.175
LTE-Band 2 (Bandwidth 5MHz) 16QAM	30.58	EIRP	1.143
LTE-Band 2 (Bandwidth 10MHz) QPSK	31.19	EIRP	1.315
LTE-Band 2 (Bandwidth 10MHz) 16QAM	31.11	EIRP	1.291
LTE-Band 2 (Bandwidth 15MHz) QPSK	31.3	EIRP	1.349
LTE-Band 2 (Bandwidth 15MHz) 16QAM	31.51	EIRP	1.416
LTE-Band 2 (Bandwidth 20MHz) QPSK	31.42	EIRP	1.387
LTE-Band 2 (Bandwidth 20MHz) 16QAM	31.42	EIRP	1.387

Unless otherwise stated the results shown in this test report refer only to the sample(s) tested and such sample(s) are retained for 90 days only.

除非另有說明，此報告結果僅對測試之樣品負責，同時此樣品僅保留90天。本報告未經本公司書面許可，不可部份複製。

This document is issued by the Company subject to its General Conditions of Service printed overleaf, available on request or accessible at www.sgs.com/terms_and_conditions.htm and, for electronic format documents, subject to Terms and Conditions for Electronic Documents at www.sgs.com/terms_e-document.htm. Attention is drawn to the limitation of liability, indemnification and jurisdiction issues defined therein. Any holder of this document is advised that information contained hereon reflects the Company's findings at the time of its intervention only and within the limits of Client's instructions, if any. The Company's sole responsibility is to its Client and this document does not exonerate parties to a transaction from exercising all their rights and obligations under the transaction documents. This document cannot be reproduced except in full, without prior written approval of the Company. Any unauthorized alteration, forgery or falsification of the content or appearance of this document is unlawful and offenders may be prosecuted to the fullest extent of the law.

	dBm		W
LTE-Band 4 (Bandwidth 1.4MHz) QPSK	28.50	EIRP	0.708
LTE-Band 4 (Bandwidth 1.4MHz) 16QAM	28.37	EIRP	0.687
LTE-Band 4 (Bandwidth 3MHz) QPSK	29.89	EIRP	0.975
LTE-Band 4 (Bandwidth 3MHz) 16QAM	29.63	EIRP	0.918
LTE-Band 4 (Bandwidth 5MHz) QPSK	29.54	EIRP	0.899
LTE-Band 4 (Bandwidth 5MHz) 16QAM	29.35	EIRP	0.861
LTE-Band 4 (Bandwidth 10MHz) QPSK	29.86	EIRP	0.968
LTE-Band 4 (Bandwidth 10MHz) 16QAM	29.95	EIRP	0.989
LTE-Band 4 (Bandwidth 15MHz) QPSK	29.34	EIRP	0.859
LTE-Band 4 (Bandwidth 15MHz) 16QAM	29.09	EIRP	0.811
LTE-Band 4 (Bandwidth 20MHz) QPSK	29.84	EIRP	0.964
LTE-Band 4 (Bandwidth 20MHz) 16QAM	29.91	EIRP	0.979
LTE-Band 5 (Bandwidth 1.4MHz) QPSK	26.92	ERP	0.492
LTE-Band 5 (Bandwidth 1.4MHz) 16QAM	26.28	ERP	0.425
LTE-Band 5 (Bandwidth 3MHz) QPSK	23.90	ERP	0.245
LTE-Band 5 (Bandwidth 3MHz) 16QAM	23.59	ERP	0.229
LTE-Band 5 (Bandwidth 5MHz) QPSK	24.22	ERP	0.264
LTE-Band 5 (Bandwidth 5MHz) 16QAM	23.97	ERP	0.249
LTE-Band 5 (Bandwidth 10MHz) QPSK	23.86	ERP	0.243
LTE-Band 5 (Bandwidth 10MHz) 16QAM	23.67	ERP	0.233

	dBm		W
LTE-Band 12 (Bandwidth 1.4MHz) QPSK	22.74	ERP	0.188
LTE-Band 12 (Bandwidth 1.4MHz) 16QAM	22.38	ERP	0.173
LTE-Band 12 (Bandwidth 3MHz) QPSK	22.49	ERP	0.177
LTE-Band 12 (Bandwidth 3MHz) 16QAM	22.19	ERP	0.166
LTE-Band 12 (Bandwidth 5MHz) QPSK	22.14	ERP	0.164
LTE-Band 12 (Bandwidth 5MHz) 16QAM	21.82	ERP	0.152
LTE-Band 12 (Bandwidth 10MHz) QPSK	22.13	ERP	0.163
LTE-Band 12 (Bandwidth 10MHz) 16QAM	21.93	ERP	0.156

Unless otherwise stated the results shown in this test report refer only to the sample(s) tested and such sample(s) are retained for 90 days only.

除非另有說明，此報告結果僅對測試之樣品負責，同時此樣品僅保留90天。本報告未經本公司書面許可，不可部份複製。

This document is issued by the Company subject to its General Conditions of Service printed overleaf, available on request or accessible at www.sgs.com/terms_and_conditions.htm and, for electronic format documents, subject to Terms and Conditions for Electronic Documents at www.sgs.com/terms_e-document.htm. Attention is drawn to the limitation of liability, indemnification and jurisdiction issues defined therein. Any holder of this document is advised that information contained hereon reflects the Company's findings at the time of its intervention only and within the limits of Client's instructions, if any. The Company's sole responsibility is to its Client and this document does not exonerate parties to a transaction from exercising all their rights and obligations under the transaction documents. This document cannot be reproduced except in full, without prior written approval of the Company. Any unauthorized alteration, forgery or falsification of the content or appearance of this document is unlawful and offenders may be prosecuted to the fullest extent of the law.

1.2. Product Feature of Equipment Under Test

The equipment under Test (Hereafter Called: EUT) is supporting below features.

Product Feature	
GSM Operating Band(s)	GSM 850/1900MHz
GPRS / EGPRS Multi Slot Class	GPRS Class 10
WCDMA Operating Band(s)	FDD Band II / IV / V
WCDMA Rel. Version	Rel.8
LTE Operating Band(s)	FCC Band 5: Part 22. / FCC Band 2: Part 24. FCC Band 4 / 12: Part 27.
LTE Rel. Version	Rel.10
Bluetooth Version	V4.1 dual mode
Wi-Fi- Specification	802.11 b/g/n

Note: The above EUT information was declared by manufacturer. Please refer to the specifications or user's manual for more detailed description.

Unless otherwise stated the results shown in this test report refer only to the sample(s) tested and such sample(s) are retained for 90 days only.

除非另有說明，此報告結果僅對測試之樣品負責，同時此樣品僅保留90天。本報告未經本公司書面許可，不可部份複製。

This document is issued by the Company subject to its General Conditions of Service printed overleaf, available on request or accessible at www.sgs.com/terms_and_conditions.htm and, for electronic format documents, subject to Terms and Conditions for Electronic Documents at www.sgs.com/terms_e-document.htm. Attention is drawn to the limitation of liability, indemnification and jurisdiction issues defined therein. Any holder of this document is advised that information contained hereon reflects the Company's findings at the time of its intervention only and within the limits of Client's instructions, if any. The Company's sole responsibility is to its Client and this document does not exonerate parties to a transaction from exercising all their rights and obligations under the transaction documents. This document cannot be reproduced except in full, without prior written approval of the Company. Any unauthorized alteration, forgery or falsification of the content or appearance of this document is unlawful and offenders may be prosecuted to the fullest extent of the law.

SGS Taiwan Ltd.

No.134,WuKungRoad,NewTaipeiIndustrialPark,WukuDistrict,NewTaipeiCity,Taiwan24803/新北市五股區新北產業園區五工路 134 號

台灣檢驗科技股份有限公司

t (886-2) 2299-3279

f (886-2) 2298-0488

www.tw.sgs.com

Member of SGS Group

1.3. Test Methodology of Applied Standards

FCC 47 CFR Part 2, 22, 24, 27.

ANSI / TIA / EIA 603-D-2010

KDB971168 D01 Power Meas license Digital System

KDB941225 of the Output power Procedure of (SAR Measurement Procedures for 3G Devices, WCDMA / HSPA) was used for EUT and Base station setting.

TS 151 010-1 is used to set, and measure the output power.

Note:

All test items have been performed and record as per the above standards.

1.4. Test Facility

SGS Taiwan Ltd. Electronics & Communication Laboratory No.2, Keji 1st Rd.,
Guishan District, Taoyuan City, Taiwan 333(TAF code 0513)

FCC Registration Numbers are: 735305

1.5. Special Accessories

No special accessories were used during testing.

1.6. Equipment Modifications

There were no modifications incorporated into the EUT.

Unless otherwise stated the results shown in this test report refer only to the sample(s) tested and such sample(s) are retained for 90 days only.

除非另有說明，此報告結果僅對測試之樣品負責，同時此樣品僅保留90天。本報告未經本公司書面許可，不可部份複製。

This document is issued by the Company subject to its General Conditions of Service printed overleaf, available on request or accessible at www.sgs.com/terms_and_conditions.htm and, for electronic format documents, subject to Terms and Conditions for Electronic Documents at www.sgs.com/terms_e-document.htm. Attention is drawn to the limitation of liability, indemnification and jurisdiction issues defined therein. Any holder of this document is advised that information contained hereon reflects the Company's findings at the time of its intervention only and within the limits of Client's instructions, if any. The Company's sole responsibility is to its Client and this document does not exonerate parties to a transaction from exercising all their rights and obligations under the transaction documents. This document cannot be reproduced except in full, without prior written approval of the Company. Any unauthorized alteration, forgery or falsification of the content or appearance of this document is unlawful and offenders may be prosecuted to the fullest extent of the law.

SGS Taiwan Ltd.

No.134,WuKungRoad,NewTaipeiIndustrialPark,WukuDistrict,NewTaipeiCity,Taiwan24803/新北市五股區新北產業園區五工路 134 號

台灣檢驗科技股份有限公司

t (886-2) 2299-3279

f (886-2) 2298-0488

www.tw.sgs.com

Member of SGS Group

2. SYSTEM TEST CONFIGURATION

2.1. EUT Configuration

The EUT configuration for testing is installed on RF field strength measurement to meet the Commissions requirement and operating in a manner which intends to maximize its emission characteristics in a continuous normal application.

2.2. EUT Exercise

The EUT (Transmitter) was operated in the continuous transmission mode employed with the simulator of the Base Station that fixates at test default channels to fix the Tx frequency which was for the purpose of the measurements.

2.3. Test Procedure

2.3.1 Conducted Measurement at Antenna Port

According to measurement procured TIA/EIA 603C, the EUT is placed on a turn table which is 0.8 m above ground plane. A low loss of RF cable was used to connect the antenna port of EUT to measurement equipment.

2.3.2 Radiated Emissions (ERP/EIRP)

According to measurement procured TIA/EIA 603C, The EUT is a placed on as turn table which is 0.8 m above ground plane. The turn table shall rotate 360 degrees to determine the position of maximum emission level. EUT is set 3m away from the receiving antenna which varied from 1m to 4m to find out the highest emission. And also, each emission was to be maximized by changing the polarization of receiving antenna both Horizontal and Vertical. In order to find out the max. emission, the relative positions of this hand-held transmitter (EUT) was rotated through three orthogonal axes and measurement procedures for electric field radiated emissions above 1 GHz the EUT measurement is to be made "while keeping the antenna in the 'cone of radiation' from that area and pointed at the area both in azimuth and elevation, with polarization oriented for maximum response." is still within the 3dB illumination BW of the measurement antenna according to the requirements in Section 8 and 13.

Unless otherwise stated the results shown in this test report refer only to the sample(s) tested and such sample(s) are retained for 90 days only.

除非另有說明，此報告結果僅對測試之樣品負責，同時此樣品僅保留90天。本報告未經本公司書面許可，不可部份複製。

This document is issued by the Company subject to its General Conditions of Service printed overleaf, available on request or accessible at www.sgs.com/terms_and_conditions.htm and, for electronic format documents, subject to Terms and Conditions for Electronic Documents at www.sgs.com/terms_e-document.htm. Attention is drawn to the limitation of liability, indemnification and jurisdiction issues defined therein. Any holder of this document is advised that information contained hereon reflects the Company's findings at the time of its intervention only and within the limits of Client's instructions, if any. The Company's sole responsibility is to its Client and this document does not exonerate parties to a transaction from exercising all their rights and obligations under the transaction documents. This document cannot be reproduced except in full, without prior written approval of the Company. Any unauthorized alteration, forgery or falsification of the content or appearance of this document is unlawful and offenders may be prosecuted to the fullest extent of the law.

SGS Taiwan Ltd.

台灣檢驗科技股份有限公司

No.134,WuKungRoad,NewTaipeiIndustrialPark,WukuDistrict,NewTaipeiCity,Taiwan24803/新北市五股區新北產業園區五工路 134 號

t (886-2) 2299-3279

f (886-2) 2298-0488

www.tw.sgs.com

Member of SGS Group

2.4. Measurement Results Explanation Example

For all conducted test items:

The offset level is set in the spectrum analyzer to compensate the RF cable loss and attenuation factor between EUT conducted port and spectrum analyzer. With the offset compensation, the spectrum analyzer reading level is exactly EUT RF output level.

Note:

The spectrum analyzer offset is derived from RF cable loss and attenuator factor.

Following shows an offset computation example with cable loss 1 dB for low band and 1 for high band with 10 dB attenuator and 3.2 splitter.

Low Band: Offset = RF cable loss (dB)+ attenuation factor(dB) =13.6(dB)

High Band: Offset = RF cable loss (dB)+ attenuation factor(dB) =13.8(dB)

2.5. Final Amplifier Voltage and Current Information:

Test mode	DC voltage (V)	DC current (mA)
GSM 850	3.85	880
GSM 1900	3.85	820
GPRS 850	3.85	540
GPRS 1900	3.85	530
EDGE 850	3.85	510
EDGE 1900	3.85	520
WCDMA B2	3.85	840
WCDMA B4	3.85	830
WCDMA B5	3.85	820
HSUPA B2	3.85	800
HSUPA B4	3.85	820
HSUPA B5	3.85	880
HSDPA B2	3.85	840
HSDPA B4	3.85	800
HSDPA B5	3.85	830

Unless otherwise stated the results shown in this test report refer only to the sample(s) tested and such sample(s) are retained for 90 days only.

除非另有說明，此報告結果僅對測試之樣品負責，同時此樣品僅保留90天。本報告未經本公司書面許可，不可部份複製。

This document is issued by the Company subject to its General Conditions of Service printed overleaf, available on request or accessible at www.sgs.com/terms_and_conditions.htm and, for electronic format documents, subject to Terms and Conditions for Electronic Documents at www.sgs.com/terms_e-document.htm. Attention is drawn to the limitation of liability, indemnification and jurisdiction issues defined therein. Any holder of this document is advised that information contained hereon reflects the Company's findings at the time of its intervention only and within the limits of Client's instructions, if any. The Company's sole responsibility is to its Client and this document does not exonerate parties to a transaction from exercising all their rights and obligations under the transaction documents. This document cannot be reproduced except in full, without prior written approval of the Company. Any unauthorized alteration, forgery or falsification of the content or appearance of this document is unlawful and offenders may be prosecuted to the fullest extent of the law.

LTE Band 2

Test mode	DC voltage (V)	DC current (mA)
LTE Band 2_1.4M QPSK	3.85	660
LTE Band 2_1.4M 16QAM	3.85	650
LTE Band 2_3M QPSK	3.85	670
LTE Band 2_3M 16QAM	3.85	650
LTE Band 2_5M QPSK	3.85	690
LTE Band 2_5M 16QAM	3.85	660
LTE Band 2_10M QPSK	3.85	720
LTE Band 2_10M 16QAM	3.85	680
LTE Band 2_15M QPSK	3.85	760
LTE Band 2_15M 16QAM	3.85	710
LTE Band 2_20M QPSK	3.85	780
LTE Band 2_20M 16QAM	3.85	720

LTE Band 4

Test mode	DC voltage (V)	DC current (mA)
LTE Band 4_1.4M QPSK	3.85	720
LTE Band 4_1.4M 16QAM	3.85	680
LTE Band 4_3M QPSK	3.85	750
LTE Band 4_3M 16QAM	3.85	700
LTE Band 4_5M QPSK	3.85	770
LTE Band 4_5M 16QAM	3.85	730
LTE Band 4_10M QPSK	3.85	780
LTE Band 4_10M 16QAM	3.85	720
LTE Band 4_15M QPSK	3.85	810
LTE Band 4_15M 16QAM	3.85	740
LTE Band 4_20M QPSK	3.85	800
LTE Band 4_20M 16QAM	3.85	750

LTE Band 5

Test mode	DC voltage (V)	DC current (mA)
LTE Band 5_1.4M QPSK	3.85	710
LTE Band 5_1.4M 16QAM	3.85	670
LTE Band 5_3M QPSK	3.85	720
LTE Band 5_3M 16QAM	3.85	680
LTE Band 5_5M QPSK	3.85	710
LTE Band 5_5M 16QAM	3.85	670
LTE Band 5_10M QPSK	3.85	740
LTE Band 5_10M 16QAM	3.85	690

Unless otherwise stated the results shown in this test report refer only to the sample(s) tested and such sample(s) are retained for 90 days only.

除非另有說明，此報告結果僅對測試之樣品負責，同時此樣品僅保留90天。本報告未經本公司書面許可，不可部份複製。

This document is issued by the Company subject to its General Conditions of Service printed overleaf, available on request or accessible at www.sgs.com/terms_and_conditions.htm and, for electronic format documents, subject to Terms and Conditions for Electronic Documents at www.sgs.com/terms_e-document.htm. Attention is drawn to the limitation of liability, indemnification and jurisdiction issues defined therein. Any holder of this document is advised that information contained hereon reflects the Company's findings at the time of its intervention only and within the limits of Client's instructions, if any. The Company's sole responsibility is to its Client and this document does not exonerate parties to a transaction from exercising all their rights and obligations under the transaction documents. This document cannot be reproduced except in full, without prior written approval of the Company. Any unauthorized alteration, forgery or falsification of the content or appearance of this document is unlawful and offenders may be prosecuted to the fullest extent of the law.

LTE Band 12

Test mode	DC voltage (V)	DC current (mA)
LTE Band 5_1.4M QPSK	3.85	700
LTE Band 5_1.4M 16QAM	3.85	680
LTE Band 5_3M QPSK	3.85	710
LTE Band 5_3M 16QAM	3.85	680
LTE Band 5_5M QPSK	3.85	710
LTE Band 5_5M 16QAM	3.85	670
LTE Band 5_10M QPSK	3.85	720
LTE Band 5_10M 16QAM	3.85	690

Unless otherwise stated the results shown in this test report refer only to the sample(s) tested and such sample(s) are retained for 90 days only.

除非另有說明，此報告結果僅對測試之樣品負責，同時此樣品僅保留90天。本報告未經本公司書面許可，不可部份複製。

This document is issued by the Company subject to its General Conditions of Service printed overleaf, available on request or accessible at www.sgs.com/terms_and_conditions.htm and, for electronic format documents, subject to Terms and Conditions for Electronic Documents at www.sgs.com/terms_e-document.htm. Attention is drawn to the limitation of liability, indemnification and jurisdiction issues defined therein. Any holder of this document is advised that information contained hereon reflects the Company's findings at the time of its intervention only and within the limits of Client's instructions, if any. The Company's sole responsibility is to its Client and this document does not exonerate parties to a transaction from exercising all their rights and obligations under the transaction documents. This document cannot be reproduced except in full, without prior written approval of the Company. Any unauthorized alteration, forgery or falsification of the content or appearance of this document is unlawful and offenders may be prosecuted to the fullest extent of the law.

SGS Taiwan Ltd.

No.134,WuKungRoad,NewTaipeiIndustrialPark,WukuDistrict,NewTaipeiCity,Taiwan24803/新北市五股區新北產業園區五工路 134 號

台灣檢驗科技股份有限公司

t (886-2) 2299-3279

f (886-2) 2298-0488

www.tw.sgs.com

Member of SGS Group

2.6. Configuration of Tested System

Fig. 2-1 Configuration of Tested System (Fixed Channel-Conducted)

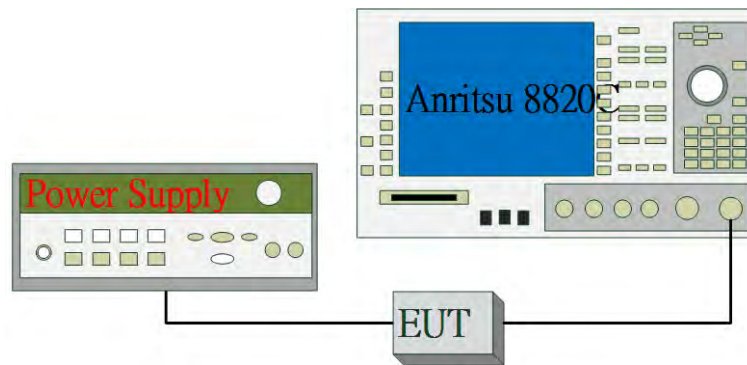

Fig. 2-2 Configuration of Tested System (Fixed Channel-Radiated)

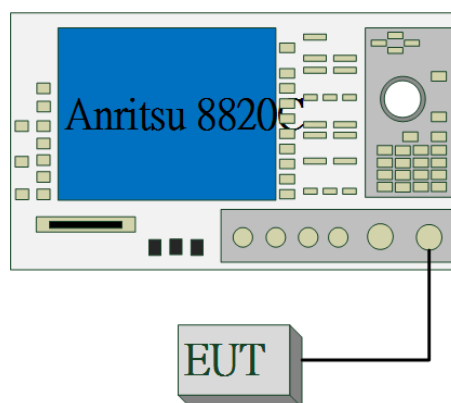

Table 2-1 Equipment Used in

Item	Equipment	Mfr/Brand	Model/ Type No.	Series No.	Data Cable	Power Cord
1.	DC power supply	Agilent	E3640A	MY53140006	N/A	N/A
2.	Universal Radio Communication Tester	Anritsu	MT8820C	6200307563	shielded	Un-shielded

Unless otherwise stated the results shown in this test report refer only to the sample(s) tested and such sample(s) are retained for 90 days only.

除非另有說明，此報告結果僅對測試之樣品負責，同時此樣品僅保留90天。本報告未經本公司書面許可，不可部份複製。

This document is issued by the Company subject to its General Conditions of Service printed overleaf, available on request or accessible at www.sgs.com/terms_and_conditions.htm and, for electronic format documents, subject to Terms and Conditions for Electronic Documents at www.sgs.com/terms_e-document.htm. Attention is drawn to the limitation of liability, indemnification and jurisdiction issues defined therein. Any holder of this document is advised that information contained hereon reflects the Company's findings at the time of its intervention only and within the limits of Client's instructions, if any. The Company's sole responsibility is to its Client and this document does not exonerate parties to a transaction from exercising all their rights and obligations under the transaction documents. This document cannot be reproduced except in full, without prior written approval of the Company. Any unauthorized alteration, forgery or falsification of the content or appearance of this document is unlawful and offenders may be prosecuted to the fullest extent of the law.

SGS Taiwan Ltd.

No.134,WuKungRoad,NewTaipeiIndustrialPark,WukuDistrict,NewTaipeiCity,Taiwan24803/新北市五股區新北產業園區五工路 134 號

台灣檢驗科技股份有限公司

t (886-2) 2299-3279

f (886-2) 2298-0488

www.tw.sgs.com

Member of SGS Group

3. SUMMARY OF TEST RESULTS

FCC Rules	Description Of Test	Result
§2.1046(a)	RF Power Output	Compliant
§2.1046(a) §22.913(a)(2) §24.232(c) §27.50(c)(10) §27.50(d)(4) §27.50(h)(2) §90.635	ERP/ EIRP measurement	Compliant
§2.1049(h)	99% & 26dB Occupied Bandwidth	Compliant
§2.1051 §22.917(a) §24.238(a) §27.53(g) §27.50(c)(5) §27.53(h) §27.53(m)(4)(6) §90.691	Out of Band Emissions at Antenna Terminals and Band Edge / Emission mask requirements	Compliant
§2.1053 §22.917(a) §24.238(a) §27.53(c)(2),(4) §27.50(c)(5) §27.53(g) §27.53(h) §27.53(m)(4) §90.691(a)(1)(2)	Field Strength of Spurious Radiation	Compliant
§24.232(d) §27.53(d) (5) §27.50(i) (B)	Peak to Average Ratio	Compliant
§2.1055(a)(1) §22.355 §24.235 §27.54 §90.213	Frequency Stability	Compliant

Unless otherwise stated the results shown in this test report refer only to the sample(s) tested and such sample(s) are retained for 90 days only.

除非另有說明，此報告結果僅對測試之樣品負責，同時此樣品僅保留90天。本報告未經本公司書面許可，不可部份複製。

This document is issued by the Company subject to its General Conditions of Service printed overleaf, available on request or accessible at www.sgs.com/terms_and_conditions.htm and, for electronic format documents, subject to Terms and Conditions for Electronic Documents at www.sgs.com/terms_e-document.htm. Attention is drawn to the limitation of liability, indemnification and jurisdiction issues defined therein. Any holder of this document is advised that information contained hereon reflects the Company's findings at the time of its intervention only and within the limits of Client's instructions, if any. The Company's sole responsibility is to its Client and this document does not exonerate parties to a transaction from exercising all their rights and obligations under the transaction documents. This document cannot be reproduced except in full, without prior written approval of the Company. Any unauthorized alteration, forgery or falsification of the content or appearance of this document is unlawful and offenders may be prosecuted to the fullest extent of the law.

4. DESCRIPTION OF TEST MODES

4.1. The Worst Test Modes and Channel Details

1. The EUT has been tested under operating condition.
2. Pre-Scan has been conducted to determine the worst-case mode from all possible combinations between available modulations, data rates, X(E1)Y(E2)Z(H) axis and antenna ports. The worst case was found as listed below. Following channel(s) was (were) selected for the final test as listed below:

BAND	ERP/EIRP	RADIATED EMISSION and Wireless charging Cover
GSM/GPRS/EDGE 850	H-plan	H-plan
GSM/GPRS/EDGE 1900	E1-plan	E1-plan
WCDMA/HSPA Band II	E1-plan	E1-plan
WCDMA/HSPA Band IV	E1-plan	E1-plan
WCDMA/HSPA Band V	E1-plan	E1-plan
LTE Band 2	E1-plan	E1-plan
LTE Band 4	E1-plan	E1-plan
LTE Band 5	H-plan	H-plan
LTE Band 12	H-plan	H-plan

Unless otherwise stated the results shown in this test report refer only to the sample(s) tested and such sample(s) are retained for 90 days only.

除非另有說明，此報告結果僅對測試之樣品負責，同時此樣品僅保留90天。本報告未經本公司書面許可，不可部份複製。

This document is issued by the Company subject to its General Conditions of Service printed overleaf, available on request or accessible at www.sgs.com/terms_and_conditions.htm and, for electronic format documents, subject to Terms and Conditions for Electronic Documents at www.sgs.com/terms_e-document.htm. Attention is drawn to the limitation of liability, indemnification and jurisdiction issues defined therein. Any holder of this document is advised that information contained hereon reflects the Company's findings at the time of its intervention only and within the limits of Client's instructions, if any. The Company's sole responsibility is to its Client and this document does not exonerate parties to a transaction from exercising all their rights and obligations under the transaction documents. This document cannot be reproduced except in full, without prior written approval of the Company. Any unauthorized alteration, forgery or falsification of the content or appearance of this document is unlawful and offenders may be prosecuted to the fullest extent of the law.

SGS Taiwan Ltd.

No.134,WuKungRoad,NewTaipeiIndustrialPark,WukuDistrict,NewTaipeiCity,Taiwan24803/新北市五股區新北產業園區五工路 134 號

台灣檢驗科技股份有限公司

t (886-2) 2299-3279

f (886-2) 2298-0488

www.tw.sgs.com

Member of SGS Group

GSM/GPRS/EDGE MODE

TEST ITEM	AVAILABLE CHANNEL	TESTED CHANNEL	MODE
ERP	128 to 251	128, 190, 251	GSM/GPRS/EDGE 850
EIRP	512 to 810	512, 661, 810	GSM/GPRS/EDGE 1900
FREQUENCY STABILITY	128 to 251 512 to 810	190 661	GPRS 850 GPRS 1900
OCCUPIED BANDWIDTH	128 to 251 512 to 810	190 661	GSM/GPRS/EDGE 850 GSM/GPRS/EDGE 1900
PEAK TO AVERAGE RATIO	128 to 251 512 to 810	128, 190, 251 512, 661, 810	GSM/GPRS/EDGE 1900
BAND EDGE	128 to 251 512 to 810	128, 251 512, 810	GSM/GPRS/EDGE 850 GSM/GPRS/EDGE 1900
CONDCUDED EMISSION	128 to 251 512 to 810	128, 190, 251 512, 661, 810	GSM/GPRS/EDGE 850 GSM/GPRS/EDGE 1900
RADIATED EMISSION	128 to 251 512 to 810	128, 190, 251 512, 661, 810	GSM 850 GPRS 1900

WCDMA/HSPA MODE

TEST ITEM	AVAILABLE CHANNEL	TESTED CHANNEL	MODE
ERP	4132 to 4233	4132, 4183, 4233	WCDMA/HSPA Band V
EIRP	9262 to 9538 1312 to 1513	9262, 9400, 9583 1312, 1413, 1513	WCDMA/HSPA Band II WCDMA/HSPA Band IV
FREQUENCY STABILITY	4132 to 4233 1312 to 1513 9262 to 9538	4183 1413 9400	WCDMA Band II WCDMA Band IV WCDMA Band V
OCCUPIED BANDWIDTH	4132 to 4233 1312 to 1513 9262 to 9538	4183 1413 9400	WCDMA/HSPA Band II WCDMA/HSPA Band IV WCDMA/HSPA Band V
PEAK TO AVERAGE RATIO	4132 to 4233 1312 to 1513 9262 to 9538	4132, 4183, 4233 1312, 1413, 1513 9262, 9400, 9583	WCDMA/HSPA Band II WCDMA/HSPA Band IV
BAND EDGE	4132 to 4233 1312 to 1513 9262 to 9538	4132, 4183, 4233 1312, 1413, 1513 9262, 9400, 9583	WCDMA Band II WCDMA Band IV WCDMA Band V
CONDCUDED EMISSION	4132 to 4233 1312 to 1513 9262 to 9538	4132, 4183, 4233 1312, 1413, 1513 9262, 9400, 9583	WCDMA Band II WCDMA Band IV WCDMA Band V
RADIATED EMISSION	4132 to 4233 1312 to 1513 9262 to 9538	4132, 4183, 4233 1312, 1413, 1513 9262, 9400, 9583	HSDPA Band II HSUPA Band IV WCDMA Band V

Unless otherwise stated the results shown in this test report refer only to the sample(s) tested and such sample(s) are retained for 90 days only.

除非另有說明，此報告結果僅對測試之樣品負責，同時此樣品僅保留90天。本報告未經本公司書面許可，不可部份複製。

This document is issued by the Company subject to its General Conditions of Service printed overleaf, available on request or accessible at www.sgs.com/terms_and_conditions.htm and, for electronic format documents, subject to Terms and Conditions for Electronic Documents at www.sgs.com/terms_e-document.htm. Attention is drawn to the limitation of liability, indemnification and jurisdiction issues defined therein. Any holder of this document is advised that information contained hereon reflects the Company's findings at the time of its intervention only and within the limits of Client's instructions, if any. The Company's sole responsibility is to its Client and this document does not exonerate parties to a transaction from exercising all their rights and obligations under the transaction documents. This document cannot be reproduced except in full, without prior written approval of the Company. Any unauthorized alteration, forgery or falsification of the content or appearance of this document is unlawful and offenders may be prosecuted to the fullest extent of the law.

LTE Band 2 MODE

TEST ITEM	AVAILABLE CHANNEL	TESTED CHANNEL	CHANNEL BANDWIDTH	MODULATION	MODE
EIRP	18607 to 19193	18607, 18900, 19193	1.4MHz	QPSK, 16QAM	1 RB/ 0,5 RB Offest
	18615 to 19185	18615, 18900, 19185	3MHz	QPSK, 16QAM	1 RB/ 0,14 RB Offest
	18625 to 19175	18625, 18900, 19175	5MHz	QPSK, 16QAM	1 RB/ 0,24 RB Offest
	18650 to 19150	18650, 18900, 19150	10MHz	QPSK, 16QAM	1 RB/ 0,49 RB Offest
	18675 to 19125	18675, 18900, 19125	15MHz	QPSK, 16QAM	1 RB/ 0,74 RB Offest
	18700 to 19100	18700, 18900, 19100	20MHz	QPSK, 16QAM	1 RB/ 0,99 RB Offest
FREQUENCY STABILITY	18650 to 19150	18900	10MHz	QPSK,	Full RB
OCCUPIED BANDWIDTH	18607 to 19193	18607, 18900, 19193	1.4MHz	QPSK, 16QAM	Full RB
	18615 to 19185	18615, 18900, 19185	3MHz	QPSK, 16QAM	Full RB
	18625 to 19175	18625, 18900, 19175	5MHz	QPSK, 16QAM	Full RB
	18650 to 19150	18650, 18900, 19150	10MHz	QPSK, 16QAM	Full RB
	18675 to 19125	18675, 18900, 19125	15MHz	QPSK, 16QAM	Full RB
	18700 to 19100	18700, 18900, 19100	20MHz	QPSK, 16QAM	Full RB
PEAK TO AVERAGE RATIO	18607 to 19193	18607, 18900, 19193	1.4MHz	16QAM	Full RB
	18615 to 19185	18615, 18900, 19185	3MHz	16QAM	Full RB
	18625 to 19175	18625, 18900, 19175	5MHz	16QAM	Full RB
	18650 to 19150	18650, 18900, 19150	10MHz	16QAM	Full RB
	18675 to 19125	18675, 18900, 19125	15MHz	16QAM	Full RB
	18700 to 19100	18700, 18900, 19100	20MHz	16QAM	Full RB
BAND EDGE	18607 to 19193	18607, 19193	1.4MHz	QPSK,	1 RB/ 0,5 RB Offes Full RB
	18615 to 19185	18615, 19185	3MHz	QPSK,	1 RB/ 0,14 RB Offest Full RB
	18625 to 19175	18625, 19175	5MHz	QPSK,	1 RB/ 0,24 RB Offest Full RB
	18650 to 19150	18650, 19150	10MHz	QPSK,	1 RB/ 0,49 RB Offest Full RB
	18675 to 19125	18675, 19125	15MHz	QPSK,	1 RB/ 0,74 RB Offest Full RB
	18700 to 19100	18700, 19100	20MHz	QPSK,	1 RB/ 0,99 RB Offest Full RB
CONDCUDED EMISSION	18607 to 19193	18607, 18900, 19193	1.4MHz	QPSK,	1 RB, 0 RB Offest
	18615 to 19185	18615, 18900, 19185	3MHz	QPSK,	1 RB, 0 RB Offest
	18625 to 19175	18625, 18900, 19175	5MHz	QPSK,	1 RB, 0 RB Offest
	18650 to 19150	18650, 18900, 19150	10MHz	QPSK,	1 RB, 0 RB Offest
	18675 to 19125	18675, 18900, 19125	15MHz	QPSK,	1 RB, 0 RB Offest
	18700 to 19100	18700, 18900, 19100	20MHz	QPSK,	1 RB, 0 RB Offest
RADIATED EMISSION	18625 to 19175	18625, 18900, 19175	5MHz	QPSK	1 RB, 0 RB Offest

Unless otherwise stated the results shown in this test report refer only to the sample(s) tested and such sample(s) are retained for 90 days only.

除非另有說明，此報告結果僅對測試之樣品負責，同時此樣品僅保留90天。本報告未經本公司書面許可，不可部份複製。

This document is issued by the Company subject to its General Conditions of Service printed overleaf, available on request or accessible at www.sgs.com/terms_and_conditions.htm and, for electronic format documents, subject to Terms and Conditions for Electronic Documents at www.sgs.com/terms_e-document.htm. Attention is drawn to the limitation of liability, indemnification and jurisdiction issues defined therein. Any holder of this document is advised that information contained hereon reflects the Company's findings at the time of its intervention only and within the limits of Client's instructions, if any. The Company's sole responsibility is to its Client and this document does not exonerate parties to a transaction from exercising all their rights and obligations under the transaction documents. This document cannot be reproduced except in full, without prior written approval of the Company. Any unauthorized alteration, forgery or falsification of the content or appearance of this document is unlawful and offenders may be prosecuted to the fullest extent of the law.

SGS Taiwan Ltd.

No.134,WuKungRoad,NewTaipeiIndustrialPark,WukuDistrict,NewTaipeiCity,Taiwan24803/新北市五股區新北產業園區五工路 134 號

台灣檢驗科技股份有限公司

t (886-2) 2299-3279

f (886-2) 2298-0488

www.tw.sgs.com

Member of SGS Group

LTE Band 4 MODE

TEST ITEM	AVAILABLE CHANNEL	TESTED CHANNEL	CHANNEL BANDWIDTH	MODULATION	MODE
EIRP	19957 to 19393	19957, 20175, 19393	1.4MHz	QPSK, 16QAM	1 RB/ 0,5 RB Offest
	19965 to 22385	19965, 20175, 22385	3MHz	QPSK, 16QAM	1 RB/ 0,14 RB Offest
	19975 to 20375	19975, 20175, 20375	5MHz	QPSK, 16QAM	1 RB/ 0,24 RB Offest
	20000 to 20350	20000, 20175, 20350	10MHz	QPSK, 16QAM	1 RB/ 0,49 RB Offest
	20025 to 20325	20025, 20175, 20325	15MHz	QPSK, 16QAM	1 RB/ 0,74 RB Offest
	20050 to 20300	20050, 20175, 20300	20MHz	QPSK, 16QAM	1 RB/ 0,99 RB Offest
FREQUENCY STABILITY	20000 to 20350	20175	10MHz	QPSK,	Full RB
OCCUPIED BANDWIDTH	19957 to 19393	19957, 20175, 19393	1.4MHz	QPSK, 16QAM	Full RB
	19965 to 22385	19965, 20175, 22385	3MHz	QPSK, 16QAM	Full RB
	19975 to 20375	19975, 20175, 20375	5MHz	QPSK, 16QAM	Full RB
	20000 to 20350	20000, 20175, 20350	10MHz	QPSK, 16QAM	Full RB
	20025 to 20325	20025, 20175, 20325	15MHz	QPSK, 16QAM	Full RB
	20050 to 20300	20050, 20175, 20300	20MHz	QPSK, 16QAM	Full RB
PEAK TO AVERAGE RATIO	19957 to 19393	19957, 20175, 19393	1.4MHz	16QAM	Full RB
	19965 to 22385	19965, 20175, 22385	3MHz	16QAM	Full RB
	19975 to 20375	19975, 20175, 20375	5MHz	16QAM	Full RB
	20000 to 20350	20000, 20175, 20350	10MHz	16QAM	Full RB
	20025 to 20325	20025, 20175, 20325	15MHz	16QAM	Full RB
	20050 to 20300	20050, 20175, 20300	20MHz	16QAM	Full RB
BAND EDGE	19957 to 19393	19957, 19393	1.4MHz	QPSK,	1 RB/ 0,5 RB Offes Full RB
	19965 to 22385	19965, 22385	3MHz	QPSK,	1 RB/ 0,14 RB Offest Full RB
	19975 to 20375	19975, 20375	5MHz	QPSK,	1 RB/ 0,24 RB Offest Full RB
	20000 to 20350	20000, 20350	10MHz	QPSK,	1 RB/ 0,49 RB Offest Full RB
	20025 to 20325	20025, 20325	15MHz	QPSK,	1 RB/ 0,74 RB Offest Full RB
	20050 to 20300	20050, 20300	20MHz	QPSK,	1 RB/ 0,99 RB Offest Full RB
CONDCUDED EMISSION	19957 to 19393	19957, 20175, 19393	1.4MHz	QPSK,	1 RB, 0 RB Offest
	19965 to 22385	19965, 20175, 22385	3MHz	QPSK,	1 RB, 0 RB Offest
	19975 to 20375	19975, 20175, 20375	5MHz	QPSK,	1 RB, 0 RB Offest
	20000 to 20350	20000, 20175, 20350	10MHz	QPSK,	1 RB, 0 RB Offest
	20025 to 20325	20025, 20175, 20325	15MHz	QPSK,	1 RB, 0 RB Offest
	20050 to 20300	20050, 20175, 20300	20MHz	QPSK,	1 RB, 0 RB Offest
RADIATED EMISSION	19965 to 22385	19965, 20175, 22385	3MHz	16QAM,	1 RB, 0 RB Offest

Unless otherwise stated the results shown in this test report refer only to the sample(s) tested and such sample(s) are retained for 90 days only.

除非另有說明，此報告結果僅對測試之樣品負責，同時此樣品僅保留90天。本報告未經本公司書面許可，不可部份複製。

This document is issued by the Company subject to its General Conditions of Service printed overleaf, available on request or accessible at www.sgs.com/terms_and_conditions.htm and, for electronic format documents, subject to Terms and Conditions for Electronic Documents at www.sgs.com/terms_e-document.htm. Attention is drawn to the limitation of liability, indemnification and jurisdiction issues defined therein. Any holder of this document is advised that information contained hereon reflects the Company's findings at the time of its intervention only and within the limits of Client's instructions, if any. The Company's sole responsibility is to its Client and this document does not exonerate parties to a transaction from exercising all their rights and obligations under the transaction documents. This document cannot be reproduced except in full, without prior written approval of the Company. Any unauthorized alteration, forgery or falsification of the content or appearance of this document is unlawful and offenders may be prosecuted to the fullest extent of the law.

SGS Taiwan Ltd.

No.134,WuKungRoad,NewTaipeiIndustrialPark,WukuDistrict,NewTaipeiCity,Taiwan24803/新北市五股區新北產業園區五工路 134 號

台灣檢驗科技股份有限公司

t (886-2) 2299-3279

f (886-2) 2298-0488

www.tw.sgs.com

Member of SGS Group

LTE Band 5 MODE

TEST ITEM	AVAILABLE CHANNEL	TESTED CHANNEL	CHANNEL BANDWIDTH	MODULATION	MODE
ERP	20470 to 20643	20470, 20525, 20643	1.4MHz	QPSK, 16QAM	1 RB/ 0,5 RB Offest
	20415 to 20635	20415, 20525, 20635	3MHz	QPSK, 16QAM	1 RB/ 0,14 RB Offest
	20425 to 20625	20425, 20525, 20625	5MHz	QPSK, 16QAM	1 RB/ 0,24 RB Offest
	20450 to 20600	20450, 20525, 20600	10MHz	QPSK, 16QAM	1 RB/ 0,49 RB Offest
FREQUENCY STABILITY	20450 to 20600	20525	10MHz	QPSK,	Full RB
OCCUPIED BANDWIDTH	20470 to 20643	20470, 20525, 20643	1.4MHz	QPSK, 16QAM	Full RB
	20415 to 20635	20415, 20525, 20635	3MHz	QPSK, 16QAM	Full RB
	20425 to 20625	20425, 20525, 20625	5MHz	QPSK, 16QAM	Full RB
	20450 to 20600	20450, 20525, 20600	10MHz	QPSK, 16QAM	Full RB
PEAK TO AVERAGE RATIO	N/A	N/A	N/A	N/A	N/A
BAND EDGE	20470 to 20643	20470, 20643	1.4MHz	QPSK,	1 RB/ 0,5 RB Offes Full RB
	20415 to 20635	20415, 20635	3MHz	QPSK,	1 RB/ 0,14 RB Offest Full RB
	20425 to 20625	20425, 20625	5MHz	QPSK,	1 RB/ 0,24 RB Offest Full RB
	20450 to 20600	20450, 20600	10MHz	QPSK,	1 RB/ 0,49 RB Offest Full RB
CONDCUDED EMISSION	20470 to 20643	20470, 20525, 20643	1.4MHz	QPSK,	1 RB, 0 RB Offest
	20415 to 20635	20415, 20525, 20635	3MHz	QPSK,	1 RB, 0 RB Offest
	20425 to 20625	20425, 20525, 20625	5MHz	QPSK,	1 RB, 0 RB Offest
	20450 to 20600	20450, 20525, 20600	10MHz	QPSK,	1 RB, 0 RB Offest
RADIATED EMISSION	20425 to 20625	20425, 20525, 20625	5MHz	QPSK	1 RB/ 0 RB Offest

Unless otherwise stated the results shown in this test report refer only to the sample(s) tested and such sample(s) are retained for 90 days only.

除非另有說明，此報告結果僅對測試之樣品負責，同時此樣品僅保留90天。本報告未經本公司書面許可，不可部份複製。

This document is issued by the Company subject to its General Conditions of Service printed overleaf, available on request or accessible at www.sgs.com/terms_and_conditions.htm and, for electronic format documents, subject to Terms and Conditions for Electronic Documents at www.sgs.com/terms_e-document.htm. Attention is drawn to the limitation of liability, indemnification and jurisdiction issues defined therein. Any holder of this document is advised that information contained hereon reflects the Company's findings at the time of its intervention only and within the limits of Client's instructions, if any. The Company's sole responsibility is to its Client and this document does not exonerate parties to a transaction from exercising all their rights and obligations under the transaction documents. This document cannot be reproduced except in full, without prior written approval of the Company. Any unauthorized alteration, forgery or falsification of the content or appearance of this document is unlawful and offenders may be prosecuted to the fullest extent of the law.

SGS Taiwan Ltd.

No.134,WuKungRoad,NewTaipeiIndustrialPark,WukuDistrict,NewTaipeiCity,Taiwan24803/新北市五股區新北產業園區五工路 134 號

台灣檢驗科技股份有限公司

t (886-2) 2299-3279

f (886-2) 2298-0488

www.tw.sgs.com

Member of SGS Group

LTE Band 12 MODE

TEST ITEM	AVAILABLE CHANNEL	TESTED CHANNEL	CHANNEL BANDWIDTH	MODULATION	MODE
ERP	23017 to 23173	23017, 23095, 23173	1.4MHz	QPSK, 16QAM	1 RB/ 0,5 RB Offest
	23025 to 23165	23025, 23095, 23165	3MHz	QPSK, 16QAM	1 RB/ 0,14 RB Offest
	23035 to 23155	23035, 23095, 23155	5MHz	QPSK, 16QAM	1 RB/ 0,24 RB Offest
	23060 to 23130	23060, 23095, 23130	10MHz	QPSK, 16QAM	1 RB/ 0,49 RB Offest
FREQUENCY STABILITY	23060 to 23130	23095	10MHz	QPSK,	Full RB
OCCUPIED BANDWIDTH	23017 to 23173	23017, 23095, 23173	1.4MHz	QPSK, 16QAM	Full RB
	23025 to 23165	23025, 23095, 23165	3MHz	QPSK, 16QAM	Full RB
	23035 to 23155	23035, 23095, 23155	5MHz	QPSK, 16QAM	Full RB
	23060 to 23130	23060, 23095, 23130	10MHz	QPSK, 16QAM	Full RB
PEAK TO AVERAGE RATIO	N/A	N/A	N/A	N/A	N/A
BAND EDGE	23017 to 23173	23017, 23095, 23173	1.4MHz	QPSK,	1 RB/ 0,5 RB Offest Full RB
	23025 to 23165	23025, 23095, 23165	3MHz	QPSK,	1 RB/ 0,14 RB Offest Full RB
	23035 to 23155	23035, 23095, 23155	5MHz	QPSK,	1 RB/ 0,24 RB Offest Full RB
	23060 to 23130	23060, 23095, 23130	10MHz	QPSK,	1 RB/ 0,49 RB Offest Full RB
CONDCUDED EMISSION	23017 to 23173	23017, 23095, 23173	1.4MHz	QPSK,	1 RB, 0 RB Offest
	23025 to 23165	23025, 23095, 23165	3MHz	QPSK,	1 RB, 0 RB Offest
	23035 to 23155	23035, 23095, 23155	5MHz	QPSK,	1 RB, 0 RB Offest
	23060 to 23130	23060, 23095, 23130	10MHz	QPSK,	1 RB, 0 RB Offest
RADIATED EMISSION	23035 to 23155	23035, 23095, 23155	5MHz	16QAM	1 RB, 24 RB Offest

Unless otherwise stated the results shown in this test report refer only to the sample(s) tested and such sample(s) are retained for 90 days only.

除非另有說明，此報告結果僅對測試之樣品負責，同時此樣品僅保留90天。本報告未經本公司書面許可，不可部份複製。

This document is issued by the Company subject to its General Conditions of Service printed overleaf, available on request or accessible at www.sgs.com/terms_and_conditions.htm and, for electronic format documents, subject to Terms and Conditions for Electronic Documents at www.sgs.com/terms_e-document.htm. Attention is drawn to the limitation of liability, indemnification and jurisdiction issues defined therein. Any holder of this document is advised that information contained hereon reflects the Company's findings at the time of its intervention only and within the limits of Client's instructions, if any. The Company's sole responsibility is to its Client and this document does not exonerate parties to a transaction from exercising all their rights and obligations under the transaction documents. This document cannot be reproduced except in full, without prior written approval of the Company. Any unauthorized alteration, forgery or falsification of the content or appearance of this document is unlawful and offenders may be prosecuted to the fullest extent of the law.

SGS Taiwan Ltd.

No.134,WuKungRoad,NewTaipeiIndustrialPark,WukuDistrict,NewTaipeiCity,Taiwan24803/新北市五股區新北產業園區五工路 134 號

台灣檢驗科技股份有限公司

t (886-2) 2299-3279

f (886-2) 2298-0488

www.tw.sgs.com

Member of SGS Group

5. MEASUREMENT UNCERTAINTY

Test Items	Uncertainty
RF Power Output	+/- 1.10 dB
ERP/ EIRP measurement	Vertical Polarization = +/- 4.74dB Horizontal Polarization = +/- 4.62dB
99% Occupied Bandwidth	+/- 5.19 Hz
Out of Band Emissions at Antenna Terminals and Band Edge	+/- 0.70 dB
Peak to Average Ratio	+/- 0.70 dB
Frequency Stability vs. Temperature	+/- 5.19 Hz
Frequency Stability vs. Voltage	+/- 5.19 Hz
Temperature	+/- 0.65 °C
Humidity	+/- 4.6 %
DC / AC Power Source	DC= +/- 0.13%, AC= +/- 0.2%

Radiated Spurious Emission:

Measurement uncertainty (Polarization : Vertical)	9kHz – 30MHz: +/- 2.87 dB
	30MHz - 180MHz: +/- 3.37dB
	180MHz -417MHz: +/- 3.19dB
	0.417GHz-1GHz: +/- 3.19dB
	1GHz - 18GHz: +/- 4.04dB
	18GHz - 40GHz: +/- 4.04dB

Measurement uncertainty (Polarization : Horizontal)	9kHz – 30MHz: +/- 2.87 dB
	30MHz - 167MHz: +/- 4.22dB
	167MHz -500MHz: +/- 3.44dB
	0.5GHz-1GHz: +/- 3.39dB
	1GHz - 18GHz: +/- 4.08dB
	18GHz - 40GHz: +/- 4.08dB

This uncertainty represents an expanded uncertainty expressed at approximately the 95% confidence level using a coverage factor of k=2.

Unless otherwise stated the results shown in this test report refer only to the sample(s) tested and such sample(s) are retained for 90 days only.

除非另有說明，此報告結果僅對測試之樣品負責，同時此樣品僅保留90天。本報告未經本公司書面許可，不可部份複製。

This document is issued by the Company subject to its General Conditions of Service printed overleaf, available on request or accessible at www.sgs.com/terms_and_conditions.htm and, for electronic format documents, subject to Terms and Conditions for Electronic Documents at www.sgs.com/terms_e-document.htm. Attention is drawn to the limitation of liability, indemnification and jurisdiction issues defined therein. Any holder of this document is advised that information contained hereon reflects the Company's findings at the time of its intervention only and within the limits of Client's instructions, if any. The Company's sole responsibility is to its Client and this document does not exonerate parties to a transaction from exercising all their rights and obligations under the transaction documents. This document cannot be reproduced except in full, without prior written approval of the Company. Any unauthorized alteration, forgery or falsification of the content or appearance of this document is unlawful and offenders may be prosecuted to the fullest extent of the law.

SGS Taiwan Ltd.

No.134,WuKungRoad,NewTaipeiIndustrialPark,WukuDistrict,NewTaipeiCity,Taiwan24803/新北市五股區新北產業園區五工路 134 號

台灣檢驗科技股份有限公司

t (886-2) 2299-3279

f (886-2) 2298-0488

www.tw.sgs.com

Member of SGS Group

6. RF CONDUCTED OUTPUT POWER MEASUREMENT

6.1. Standard Applicable

A base station simulator was used to establish communication with the EUT. Its parameters were set to transmit the maximum power on the EUT. The measured power in the radio frequency on the transmitter output terminals.

6.2. Test Set-up

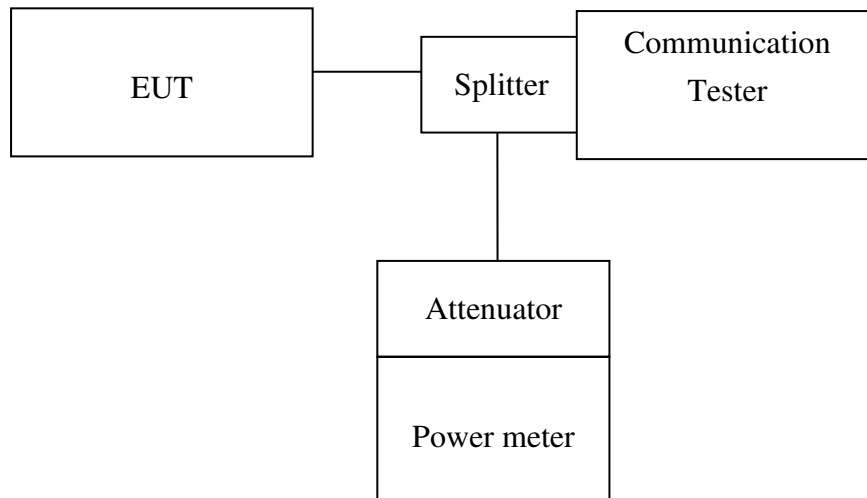

Note: Measurement setup for testing on Antenna connector

6.3. Measurement Procedure

The transmitter output was connected to a calibrated attenuator, the other end of which was connected to a power meter. Transmitter output was read off the power meter in dBm. The power output at the transmitter antenna port was determined by adding the value of the attenuator to the power meter reading. TS 151 010-1 is reference to conduct the test measurement of output power.

The Procedure of KDB941225 (SAR Measurement Procedures for 3G devices, (WCDMA/HSPA) was used for EUT and Base station setting. RMC 12.2kps is used for this testing, and KDB 971168 D01 Power Meas License Digital System as the supplemental test methodology to adjust the proper setting obtaining the measurement results

Unless otherwise stated the results shown in this test report refer only to the sample(s) tested and such sample(s) are retained for 90 days only.

除非另有說明，此報告結果僅對測試之樣品負責，同時此樣品僅保留90天。本報告未經本公司書面許可，不可部份複製。

This document is issued by the Company subject to its General Conditions of Service printed overleaf, available on request or accessible at www.sgs.com/terms_and_conditions.htm and, for electronic format documents, subject to Terms and Conditions for Electronic Documents at www.sgs.com/terms_e-document.htm. Attention is drawn to the limitation of liability, indemnification and jurisdiction issues defined therein. Any holder of this document is advised that information contained hereon reflects the Company's findings at the time of its intervention only and within the limits of Client's instructions, if any. The Company's sole responsibility is to its Client and this document does not exonerate parties to a transaction from exercising all their rights and obligations under the transaction documents. This document cannot be reproduced except in full, without prior written approval of the Company. Any unauthorized alteration, forgery or falsification of the content or appearance of this document is unlawful and offenders may be prosecuted to the fullest extent of the law.

SGS Taiwan Ltd.

No.134,WuKungRoad,NewTaipeiIndustrialPark,WukuDistrict,NewTaipeiCity,Taiwan24803/新北市五股區新北產業園區五工路 134 號

台灣檢驗科技股份有限公司

t (886-2) 2299-3279

f (886-2) 2298-0488

www.tw.sgs.com

Member of SGS Group

6.4. Measurement Equipment Used

Conducted Emission (measured at antenna port) Test Site					
EQUIPMENT TYPE	MFR	MODEL NUMBER	SERIAL NUMBER	LAST CAL.	CAL DUE.
Spectrum Analyzer	KEYSIGHT	N9010A	MY54510568	04/14/2016	04/13/2017
Communication Tester	Anritsu	MT8820C	6201107337	05/25/2016	05/24/2017
Coaxial Cable 30cm	WOKEN	00100A1F1A 195C	RF01	12/12/2016	12/11/2017
Temperature Chamber	TERCHY	MHK-120LK	1020582	06/16/2016	06/15/2017
DC Block	PASTERNAK	PE8210	RF29	12/12/2016	12/11/2017
Splitter	RF-LAMBAD	RFLT2W1G1 8G	RF35	12/12/2016	12/11/2017
Attenuator	WOKEN	218FS-10	RF23	12/12/2016	12/11/2017
DC Power Supply	Agilent	E3640A	MY53140006	05/04/2016	05/03/2017
Communication Tester	Anritsu	MT8820C	6201107337	05/25/2016	05/24/2017

6.5. Measurement Result

RF Conducted Output Power

GSM/GPRS/EDGE (GMSK; 8-PSK) Resu

EUT Mode	Frequency (MHz)	CH	Averager Burst Power (dBm)
GSM 850	824.2	128	32.27
	836.6	190	32.38
	848.8	251	32.42
GSM 1900	1850.2	512	29.43
	1880	661	29.72
	1909.8	810	29.65

Unless otherwise stated the results shown in this test report refer only to the sample(s) tested and such sample(s) are retained for 90 days only.

除非另有說明，此報告結果僅對測試之樣品負責，同時此樣品僅保留90天。本報告未經本公司書面許可，不可部份複製。

This document is issued by the Company subject to its General Conditions of Service printed overleaf, available on request or accessible at www.sgs.com/terms_and_conditions.htm and, for electronic format documents, subject to Terms and Conditions for Electronic Documents at www.sgs.com/terms_e-document.htm. Attention is drawn to the limitation of liability, indemnification and jurisdiction issues defined therein. Any holder of this document is advised that information contained hereon reflects the Company's findings at the time of its intervention only and within the limits of Client's instructions, if any. The Company's sole responsibility is to its Client and this document does not exonerate parties to a transaction from exercising all their rights and obligations under the transaction documents. This document cannot be reproduced except in full, without prior written approval of the Company. Any unauthorized alteration, forgery or falsification of the content or appearance of this document is unlawful and offenders may be prosecuted to the fullest extent of the law.

SGS Taiwan Ltd.

No.134,WuKungRoad,NewTaipeiIndustrialPark,WukuDistrict,NewTaipeiCity,Taiwan24803/新北市五股區新北產業園區五工路 134 號

台灣檢驗科技股份有限公司

t (886-2) 2299-3279

f (886-2) 2298-0488

www.tw.sgs.com

Member of SGS Group

EUT Mode	Frequency (MHz)	CH	Average Burst Power (1DN 1UP) Class 8 (dBm)	Average Burst Power (1DN 2UP) Class 10 (dBm)
GPRS 850	824.2	128	32.27	30.79
	836.6	190	32.38	30.87
	848.8	251	32.42	30.89
GPRS 1900	1850.2	512	29.43	28.54
	1880	661	29.72	28.74
	1909.8	810	29.65	28.55
EDGE 850	824.2	128	26.39	25.71
	836.6	190	26.41	25.85
	848.8	251	26.44	25.86
EDGE 1900	1850.2	512	25.52	25.03
	1880	661	25.7	25.12
	1909.8	810	25.6	25.09

Unless otherwise stated the results shown in this test report refer only to the sample(s) tested and such sample(s) are retained for 90 days only.

除非另有說明，此報告結果僅對測試之樣品負責，同時此樣品僅保留90天。本報告未經本公司書面許可，不可部份複製。

This document is issued by the Company subject to its General Conditions of Service printed overleaf, available on request or accessible at www.sgs.com/terms_and_conditions.htm and, for electronic format documents, subject to Terms and Conditions for Electronic Documents at www.sgs.com/terms_e-document.htm. Attention is drawn to the limitation of liability, indemnification and jurisdiction issues defined therein. Any holder of this document is advised that information contained hereon reflects the Company's findings at the time of its intervention only and within the limits of Client's instructions, if any. The Company's sole responsibility is to its Client and this document does not exonerate parties to a transaction from exercising all their rights and obligations under the transaction documents. This document cannot be reproduced except in full, without prior written approval of the Company. Any unauthorized alteration, forgery or falsification of the content or appearance of this document is unlawful and offenders may be prosecuted to the fullest extent of the law.

SGS Taiwan Ltd.

No.134,WuKungRoad,NewTaipeiIndustrialPark,WukuDistrict,NewTaipeiCity,Taiwan24803/新北市五股區新北產業園區五工路 134 號

台灣檢驗科技股份有限公司

t (886-2) 2299-3279

f (886-2) 2298-0488

www.tw.sgs.com

Member of SGS Group

WCDMA MODE:

The following tests were completed according to the test requirements outlined in section 5.2 of the 3GPP TS34.121-1 V8.4.0 specification. The EUT supports power Class 3, which has a nominal maximum output power of 24 dBm (+1.7/-3.7). RMC 12.2kps is used for this testing.

Results:

WCDMA MODE:

EUT Mode	Frequency (MHz)	CH	Avg. Power (dBm)
WCDMA Band II	1852.4	9262	23.87
	1880	9400	23.79
	1907.6	9538	23.83
WCDMA Band IV	1712.4	1312	23.86
	1732.6	1413	23.88
	1752.6	1513	23.84
WCDMA Band V	826.4	4132	23.37
	836.6	4183	23.44
	846.6	4233	23.31
HSDPA Band II	1852.4	9262	23.69
	1880	9400	23.54
	1907.6	9538	23.49
HSDPA Band IV	1712.4	1312	23.34
	1732.6	1413	23.5
	1752.6	1513	23.39
HSDPA Band V	826.4	4132	23.26
	836.6	4183	23.29
	846.6	4233	23.21
HSUPA Band II	1852.4	9262	22.61
	1880	9400	22.56
	1907.6	9538	23.36
HSUPA Band IV	1712.4	1312	22.4
	1732.6	1413	22.57
	1752.6	1513	23.06
HSUPA Band V	826.4	4132	22.05
	836.6	4183	22.27
	846.6	4233	22.04

Unless otherwise stated the results shown in this test report refer only to the sample(s) tested and such sample(s) are retained for 90 days only.

除非另有說明，此報告結果僅對測試之樣品負責，同時此樣品僅保留90天。本報告未經本公司書面許可，不可部份複製。

This document is issued by the Company subject to its General Conditions of Service printed overleaf, available on request or accessible at www.sgs.com/terms_and_conditions.htm and, for electronic format documents, subject to Terms and Conditions for Electronic Documents at www.sgs.com/terms_e-document.htm. Attention is drawn to the limitation of liability, indemnification and jurisdiction issues defined therein. Any holder of this document is advised that information contained hereon reflects the Company's findings at the time of its intervention only and within the limits of Client's instructions, if any. The Company's sole responsibility is to its Client and this document does not exonerate parties to a transaction from exercising all their rights and obligations under the transaction documents. This document cannot be reproduced except in full, without prior written approval of the Company. Any unauthorized alteration, forgery or falsification of the content or appearance of this document is unlawful and offenders may be prosecuted to the fullest extent of the law.

LTE Result:

LTE Band 2

LTE Band 2_Uplink frequency band : 1850 to 1910 MHz								
BW (MHz)	RB Size	RB Offset	Conducted power (dBm)					
			QPSK			16QAM		
			CH (Low) 18607	CH (Mid) 18900	CH (High) 19193	CH (Low) 18607	CH (Mid) 18900	CH (High) 19193
1.4	1	0	22.71	22.61	22.78	21.69	21.85	21.28
	1	5	22.63	22.61	22.5	21.18	21.01	21.1
	3	2	22.7	22.72	22.59	21.78	21.48	21.61
	6	0	21.76	21.71	21.58	20.59	20.33	20.43

LTE Band 2_Uplink frequency band : 1850 to 1910 MHz								
BW (MHz)	RB Size	RB Offset	Conducted power (dBm)					
			QPSK			16QAM		
			CH (Low) 18615	CH (Mid) 18900	CH (High) 19185	CH (Low) 18615	CH (Mid) 18900	CH (High) 19185
3	1	0	22.89	22.96	22.94	21.94	21.85	21.69
	1	14	22.87	22.88	22.87	21.72	21.69	21.53
	8	4	21.95	21.91	21.94	20.79	20.49	20.58
	15	0	21.93	21.91	21.83	20.66	20.26	20.72

LTE Band 2_Uplink frequency band : 1850 to 1910 MHz								
BW (MHz)	RB Size	RB Offset	Conducted power (dBm)					
			QPSK			16QAM		
			CH (Low) 18625	CH (Mid) 18900	CH (High) 19175	CH (Low) 18625	CH (Mid) 18900	CH (High) 19175
5	1	0	22.91	22.92	22.9	21.58	21.61	21.98
	1	24	22.81	22.87	22.97	21.64	21.87	21.64
	12	6	21.97	21.94	21.81	20.98	20.9	20.92
	25	0	21.9	21.99	21.83	20.97	20.83	20.77

Unless otherwise stated the results shown in this test report refer only to the sample(s) tested and such sample(s) are retained for 90 days only.

除非另有說明，此報告結果僅對測試之樣品負責，同時此樣品僅保留90天。本報告未經本公司書面許可，不可部份複製。

This document is issued by the Company subject to its General Conditions of Service printed overleaf, available on request or accessible at www.sgs.com/terms_and_conditions.htm and, for electronic format documents, subject to Terms and Conditions for Electronic Documents at www.sgs.com/terms_e-document.htm. Attention is drawn to the limitation of liability, indemnification and jurisdiction issues defined therein. Any holder of this document is advised that information contained hereon reflects the Company's findings at the time of its intervention only and within the limits of Client's instructions, if any. The Company's sole responsibility is to its Client and this document does not exonerate parties to a transaction from exercising all their rights and obligations under the transaction documents. This document cannot be reproduced except in full, without prior written approval of the Company. Any unauthorized alteration, forgery or falsification of the content or appearance of this document is unlawful and offenders may be prosecuted to the fullest extent of the law.

LTE Band 2_Uplink frequency band : 1850 to 1910 MHz								
BW (MHz)	RB Size	RB Offset	Conducted power (dBm)					
			QPSK			16QAM		
			CH (Low)	CH (Mid)	CH (High)	CH (Low)	CH (Mid)	CH (High)
			18650	18900	19150	18650	18900	19150
10	1	0	22.96	22.81	22.92	21.85	21.99	21.84
	1	49	22.93	22.79	22.9	21.87	21.88	21.92
	25	12	21.95	21.98	21.99	20.95	20.91	20.94
	50	0	21.99	21.83	21.98	20.85	20.83	20.96

LTE Band 2_Uplink frequency band : 1850 to 1910 MHz								
BW (MHz)	RB Size	RB Offset	Conducted power (dBm)					
			QPSK			16QAM		
			CH (Low)	CH (Mid)	CH (High)	CH (Low)	CH (Mid)	CH (High)
			18675	18900	19125	18675	18900	19125
15	1	0	22.9	22.91	22.81	21.58	21.97	21.98
	1	74	22.82	22.94	22.9	21.51	21.75	21.79
	36	19	21.91	21.85	21.91	20.97	20.98	20.91
	75	0	22	21.92	21.86	20.97	20.86	20.96

LTE Band 2_Uplink frequency band : 1850 to 1910 MHz								
BW (MHz)	RB Size	RB Offset	Conducted power (dBm)					
			(dBm)					
			QPSK			16QAM		
			CH (Low)	CH (Mid)	CH (High)	CH (Low)	CH (Mid)	CH (High)
18700	18900	19100	18700	18900	19100			
20	1	0	22.97	22.93	22.91	21.88	21.89	21.85
	1	99	22.89	22.8	22.87	21.76	21.74	21.81
	50	25	21.88	21.96	21.97	20.91	20.98	20.97
	100	0	21.94	21.99	21.96	20.97	20.96	20.91

Unless otherwise stated the results shown in this test report refer only to the sample(s) tested and such sample(s) are retained for 90 days only.

除非另有說明，此報告結果僅對測試之樣品負責，同時此樣品僅保留90天。本報告未經本公司書面許可，不可部份複製。

This document is issued by the Company subject to its General Conditions of Service printed overleaf, available on request or accessible at www.sgs.com/terms_and_conditions.htm and, for electronic format documents, subject to Terms and Conditions for Electronic Documents at www.sgs.com/terms_e-document.htm. Attention is drawn to the limitation of liability, indemnification and jurisdiction issues defined therein. Any holder of this document is advised that information contained hereon reflects the Company's findings at the time of its intervention only and within the limits of Client's instructions, if any. The Company's sole responsibility is to its Client and this document does not exonerate parties to a transaction from exercising all their rights and obligations under the transaction documents. This document cannot be reproduced except in full, without prior written approval of the Company. Any unauthorized alteration, forgery or falsification of the content or appearance of this document is unlawful and offenders may be prosecuted to the fullest extent of the law.

LTE Band 4

LTE Band 4_Uplink frequency band : 1710 to 1755 MHz								
BW (MHz)	RB Size	RB Offset	Conducted power (dBm)					
			QPSK			16QAM		
			CH (Low) 19957	CH (Mid) 20175	CH (High) 20393	CH (Low) 19957	CH (Mid) 20175	CH (High) 20393
1.4	1	0	22.75	22.73	22.8	21.67	21.95	21.34
	1	5	22.6	22.67	22.84	21.54	21.96	21.87
	3	2	22.89	22.89	22.96	21.48	21.49	21.46
	6	0	21.89	21.89	21.86	20.49	20.1	20.54

LTE Band 4_Uplink frequency band : 1710 to 1755 MHz								
BW (MHz)	RB Size	RB Offset	Conducted power (dBm)					
			QPSK			16QAM		
			CH (Low) 19965	CH (Mid) 20175	CH (High) 20385	CH (Low) 19965	CH (Mid) 20175	CH (High) 20385
3	1	0	22.96	22.67	22.91	21.9	21.86	21.37
	1	14	22.62	22.61	22.81	21.75	21.53	21.68
	8	4	21.77	21.73	21.87	20.88	20.43	20.83
	15	0	21.78	21.76	21.84	20.75	20.86	20.51

LTE Band 4_Uplink frequency band : 1710 to 1755 MHz								
BW (MHz)	RB Size	RB Offset	Conducted power (dBm)					
			QPSK			16QAM		
			CH (Low) 19975	CH (Mid) 20175	CH (High) 20375	CH (Low) 19975	CH (Mid) 20175	CH (High) 20375
5	1	0	22.83	22.89	22.68	21.73	21.92	21.51
	1	24	22.81	22.67	22.97	21.49	21.87	21.97
	12	6	21.71	21.77	21.6	20.69	20.71	20.94
	25	0	21.75	21.79	21.73	20.78	20.81	20.79

Unless otherwise stated the results shown in this test report refer only to the sample(s) tested and such sample(s) are retained for 90 days only.

除非另有說明，此報告結果僅對測試之樣品負責，同時此樣品僅保留90天。本報告未經本公司書面許可，不可部份複製。

This document is issued by the Company subject to its General Conditions of Service printed overleaf, available on request or accessible at www.sgs.com/terms_and_conditions.htm and, for electronic format documents, subject to Terms and Conditions for Electronic Documents at www.sgs.com/terms_e-document.htm. Attention is drawn to the limitation of liability, indemnification and jurisdiction issues defined therein. Any holder of this document is advised that information contained hereon reflects the Company's findings at the time of its intervention only and within the limits of Client's instructions, if any. The Company's sole responsibility is to its Client and this document does not exonerate parties to a transaction from exercising all their rights and obligations under the transaction documents. This document cannot be reproduced except in full, without prior written approval of the Company. Any unauthorized alteration, forgery or falsification of the content or appearance of this document is unlawful and offenders may be prosecuted to the fullest extent of the law.

LTE Band 4_Uplink frequency band : 1710 to 1755 MHz								
BW (MHz)	RB Size	RB Offset	Conducted power (dBm)					
			QPSK			16QAM		
			CH (Low) 20000	CH (Mid) 20175	CH (High) 20350	CH (Low) 20000	CH (Mid) 20175	CH (High) 20350
10	1	0	22.71	22.64	22.64	21.68	21.64	21.8
	1	49	22.61	22.69	22.82	21.37	21.92	21.87
	25	12	21.81	21.83	21.92	20.69	20.78	20.86
	50	0	21.73	21.83	21.88	20.75	20.87	20.85

LTE Band 4_Uplink frequency band : 1710 to 1755 MHz								
BW (MHz)	RB Size	RB Offset	Conducted power (dBm)					
			QPSK			16QAM		
			CH (Low) 20025	CH (Mid) 20175	CH (High) 20325	CH (Low) 20025	CH (Mid) 20175	CH (High) 20325
15	1	0	22.85	22.81	22.83	21.73	21.92	21.62
	1	74	22.76	22.85	22.85	21.74	21.64	21.83
	36	19	21.86	21.79	21.87	20.84	20.73	20.86
	75	0	21.79	21.79	21.84	20.9	20.85	20.89

LTE Band 4_Uplink frequency band : 1710 to 1755 MHz								
BW (MHz)	RB Size	RB Offset	Conducted power (dBm)					
			QPSK			16QAM		
			CH (Low) 20050	CH (Mid) 20175	CH (High) 20300	CH (Low) 20050	CH (Mid) 20175	CH (High) 20300
20	1	0	22.94	22.83	22.98	21.96	21.94	21.92
	1	99	22.54	22.57	22.85	21.62	21.44	21.93
	50	25	21.83	21.86	21.92	20.92	20.89	20.99
	100	0	21.89	21.82	21.88	20.81	20.84	20.83

Unless otherwise stated the results shown in this test report refer only to the sample(s) tested and such sample(s) are retained for 90 days only.

除非另有說明，此報告結果僅對測試之樣品負責，同時此樣品僅保留90天。本報告未經本公司書面許可，不可部份複製。

This document is issued by the Company subject to its General Conditions of Service printed overleaf, available on request or accessible at www.sgs.com/terms_and_conditions.htm and, for electronic format documents, subject to Terms and Conditions for Electronic Documents at www.sgs.com/terms_e-document.htm. Attention is drawn to the limitation of liability, indemnification and jurisdiction issues defined therein. Any holder of this document is advised that information contained hereon reflects the Company's findings at the time of its intervention only and within the limits of Client's instructions, if any. The Company's sole responsibility is to its Client and this document does not exonerate parties to a transaction from exercising all their rights and obligations under the transaction documents. This document cannot be reproduced except in full, without prior written approval of the Company. Any unauthorized alteration, forgery or falsification of the content or appearance of this document is unlawful and offenders may be prosecuted to the fullest extent of the law.

LTE Band 5

LTE Band 5_Uplink frequency band : 824 to 849 MHz								
BW (MHz)	RB Size	RB Offset	Conducted power (dBm)					
			QPSK			16QAM		
			CH (Low) 20407	CH (Mid) 20525	CH (High) 20643	CH (Low) 20407	CH (Mid) 20525	CH (High) 20643
1.4	1	0	22.74	22.49	22.57	21.88	21.81	21.79
	1	5	22.8	22.55	22.58	21.79	21.92	21.82
	3	2	22.67	22.74	22.73	21.73	21.9	21.89
	6	0	21.69	21.54	21.62	20.41	20.37	20.64

LTE Band 5_Uplink frequency band : 824 to 849 MHz								
BW (MHz)	RB Size	RB Offset	Conducted power (dBm)					
			QPSK			16QAM		
			CH (Low) 20415	CH (Mid) 20525	CH (High) 20635	CH (Low) 20415	CH (Mid) 20525	CH (High) 20635
3	1	0	22.81	22.63	22.75	21.59	21.74	21.86
	1	14	22.91	22.73	22.44	21.48	21.36	21.55
	8	4	21.73	21.54	21.71	20.95	20.24	20.89
	15	0	21.74	21.6	21.64	20.55	20.5	20.95

LTE Band 5_Uplink frequency band : 824 to 849 MHz								
BW (MHz)	RB Size	RB Offset	Conducted power (dBm)					
			QPSK			16QAM		
			CH (Low) 20425	CH (Mid) 20525	CH (High) 20625	CH (Low) 20425	CH (Mid) 20525	CH (High) 20625
5	1	0	22.58	22.91	22.7	21.71	21.89	21.73
	1	24	22.58	22.85	22.38	21.83	21.68	21.41
	12	6	21.72	21.64	21.64	20.64	20.47	20.64
	25	0	21.67	21.52	21.55	20.71	20.55	20.57

Unless otherwise stated the results shown in this test report refer only to the sample(s) tested and such sample(s) are retained for 90 days only.

除非另有說明，此報告結果僅對測試之樣品負責，同時此樣品僅保留90天。本報告未經本公司書面許可，不可部份複製。

This document is issued by the Company subject to its General Conditions of Service printed overleaf, available on request or accessible at www.sgs.com/terms_and_conditions.htm and, for electronic format documents, subject to Terms and Conditions for Electronic Documents at www.sgs.com/terms_e-document.htm. Attention is drawn to the limitation of liability, indemnification and jurisdiction issues defined therein. Any holder of this document is advised that information contained hereon reflects the Company's findings at the time of its intervention only and within the limits of Client's instructions, if any. The Company's sole responsibility is to its Client and this document does not exonerate parties to a transaction from exercising all their rights and obligations under the transaction documents. This document cannot be reproduced except in full, without prior written approval of the Company. Any unauthorized alteration, forgery or falsification of the content or appearance of this document is unlawful and offenders may be prosecuted to the fullest extent of the law.

LTE Band 5_Uplink frequency band : 824 to 849 MHz								
BW (MHz)	RB Size	RB Offset	Conducted power (dBm)					
			QPSK			16QAM		
			CH (Low) 20450	CH (Mid) 20525	CH (High) 20600	CH (Low) 20450	CH (Mid) 20525	CH (High) 20600
10	1	0	22.75	22.78	22.89	21.41	21.94	21.72
	1	49	22.91	22.65	22.56	20.51	21.58	21.99
	25	12	21.6	21.68	21.85	20.74	20.83	20.68
	50	0	21.67	21.85	21.88	20.6	20.58	20.68

Unless otherwise stated the results shown in this test report refer only to the sample(s) tested and such sample(s) are retained for 90 days only.

除非另有說明，此報告結果僅對測試之樣品負責，同時此樣品僅保留90天。本報告未經本公司書面許可，不可部份複製。

This document is issued by the Company subject to its General Conditions of Service printed overleaf, available on request or accessible at www.sgs.com/terms_and_conditions.htm and, for electronic format documents, subject to Terms and Conditions for Electronic Documents at www.sgs.com/terms_e-document.htm. Attention is drawn to the limitation of liability, indemnification and jurisdiction issues defined therein. Any holder of this document is advised that information contained hereon reflects the Company's findings at the time of its intervention only and within the limits of Client's instructions, if any. The Company's sole responsibility is to its Client and this document does not exonerate parties to a transaction from exercising all their rights and obligations under the transaction documents. This document cannot be reproduced except in full, without prior written approval of the Company. Any unauthorized alteration, forgery or falsification of the content or appearance of this document is unlawful and offenders may be prosecuted to the fullest extent of the law.

SGS Taiwan Ltd.

No.134,WuKungRoad,NewTaipeiIndustrialPark,WukuDistrict,NewTaipeiCity,Taiwan24803/新北市五股區新北產業園區五工路 134 號

台灣檢驗科技股份有限公司

t (886-2) 2299-3279

f (886-2) 2298-0488

www.tw.sgs.com

Member of SGS Group

LTE Band 12

LTE Band 12_Uplink frequency band : 699 to 716 MHz								
BW (MHz)	RB Size	RB Offset	Conducted power (dBm)					
			QPSK			16QAM		
			CH (Low) 23017	CH (Mid) 23095	CH (High) 23173	CH (Low) 23017	CH (Mid) 23095	CH (High) 23173
1.4	1	0	22.53	22.59	22.56	21.65	21.82	21.63
	1	5	22.58	22.49	22.44	21.44	21.86	21.71
	3	2	22.53	22.63	22.65	21.99	21.67	21.7
	6	0	21.51	21.7	21.66	20.62	20.48	20.6

LTE Band 12_Uplink frequency band : 699 to 716 MHz								
BW (MHz)	RB Size	RB Offset	Conducted power (dBm)					
			QPSK			16QAM		
			CH (Low) 23025	CH (Mid) 23095	CH (High) 23165	CH (Low) 23025	CH (Mid) 23095	CH (High) 23165
3	1	0	22.5	22.48	22.66	21.89	21.36	21.66
	1	14	22.79	22.5	22.73	21.84	21.53	21.95
	8	4	21.59	21.66	21.57	20.31	20.68	20.72
	15	0	21.49	21.53	21.57	20.4	20.78	20.79

LTE Band 12_Uplink frequency band : 699 to 716 MHz								
BW (MHz)	RB Size	RB Offset	Conducted power (dBm)					
			QPSK			16QAM		
			CH (Low) 23035	CH (Mid) 23095	CH (High) 23155	CH (Low) 23035	CH (Mid) 23095	CH (High) 23155
5	1	0	22.49	22.55	22.45	21.87	21.94	21.77
	1	24	22.76	22.45	22.74	21.68	21.53	21.46
	12	6	21.57	21.49	21.57	20.5	20.41	20.55
	25	0	21.48	21.39	21.56	20.29	20.37	20.62

Unless otherwise stated the results shown in this test report refer only to the sample(s) tested and such sample(s) are retained for 90 days only.

除非另有說明，此報告結果僅對測試之樣品負責，同時此樣品僅保留90天。本報告未經本公司書面許可，不可部份複製。

This document is issued by the Company subject to its General Conditions of Service printed overleaf, available on request or accessible at www.sgs.com/terms_and_conditions.htm and, for electronic format documents, subject to Terms and Conditions for Electronic Documents at www.sgs.com/terms_e-document.htm. Attention is drawn to the limitation of liability, indemnification and jurisdiction issues defined therein. Any holder of this document is advised that information contained hereon reflects the Company's findings at the time of its intervention only and within the limits of Client's instructions, if any. The Company's sole responsibility is to its Client and this document does not exonerate parties to a transaction from exercising all their rights and obligations under the transaction documents. This document cannot be reproduced except in full, without prior written approval of the Company. Any unauthorized alteration, forgery or falsification of the content or appearance of this document is unlawful and offenders may be prosecuted to the fullest extent of the law.

LTE Band 12_Uplink frequency band : 699 to 716 MHz								
BW (MHz)	RB Size	RB Offset	Conducted power (dBm)					
			QPSK			16QAM		
			CH (Low) 23060	CH (Mid) 23095	CH (High) 23130	CH (Low) 23060	CH (Mid) 23095	CH (High) 23130
10	1	0	22.46	22.9	22.89	21.74	21.94	21.6
	1	49	22.65	22.79	22.86	21.57	21.76	21.54
	25	12	21.72	21.79	21.94	20.85	20.52	20.6
	50	0	21.69	21.77	21.89	20.56	20.53	20.74

Unless otherwise stated the results shown in this test report refer only to the sample(s) tested and such sample(s) are retained for 90 days only.

除非另有說明，此報告結果僅對測試之樣品負責，同時此樣品僅保留90天。本報告未經本公司書面許可，不可部份複製。

This document is issued by the Company subject to its General Conditions of Service printed overleaf, available on request or accessible at www.sgs.com/terms_and_conditions.htm and, for electronic format documents, subject to Terms and Conditions for Electronic Documents at www.sgs.com/terms_e-document.htm. Attention is drawn to the limitation of liability, indemnification and jurisdiction issues defined therein. Any holder of this document is advised that information contained hereon reflects the Company's findings at the time of its intervention only and within the limits of Client's instructions, if any. The Company's sole responsibility is to its Client and this document does not exonerate parties to a transaction from exercising all their rights and obligations under the transaction documents. This document cannot be reproduced except in full, without prior written approval of the Company. Any unauthorized alteration, forgery or falsification of the content or appearance of this document is unlawful and offenders may be prosecuted to the fullest extent of the law.

SGS Taiwan Ltd.

No.134,WuKungRoad,NewTaipeiIndustrialPark,WukuDistrict,NewTaipeiCity,Taiwan24803/新北市五股區新北產業園區五工路 134 號

台灣檢驗科技股份有限公司

t (886-2) 2299-3279

f (886-2) 2298-0488

www.tw.sgs.com

Member of SGS Group

HSDPA Release 6 MODE:

The following 4 Sub-Tests were completed according to the test requirements outlined in section 5.2A of the 3GPP TS34.121-1 V8.4.0 specification. All TX RMS power requirements for Power Class 3 were met according to table 5.2AA.5 and 5.2B.5 All UE channels and power ratio's are set according to table C10.1.4 & C11.1.3 in the 3GPP TS34.121-1 V8.4.0. RMC 12.2kps is used for this testing.

HSDPA SUB-TEST Setting

Table C.10.1.4: β values for transmitter characteristics tests with HS-DPCCH(FOR HSDPA)

Sub-test	β_c	β_d	β_d (SF)	β_c/β_d	β_{HS} (Note 1, Note 2)	CM (dB) (Note 3)	MPR (dB) (Note 3)	RMC (Kbps)
1	2/15	15/15	64	2/15	4/15	0.0	0.0	12.2
2	12/15 (Note 4)	15/15 (Note 4)	64	12/15 (Note 4)	24/15	1.0	0.0	12.2
3	15/15	8/15	64	15/8	30/15	1.5	0.5	12.2
4	15/15	4/15	64	15/4	30/15	1.5	0.5	12.2

Note: The recommended HSDPA MPRs are implemented as per following sub-tests.

Unless otherwise stated the results shown in this test report refer only to the sample(s) tested and such sample(s) are retained for 90 days only.

除非另有說明，此報告結果僅對測試之樣品負責，同時此樣品僅保留90天。本報告未經本公司書面許可，不可部份複製。

This document is issued by the Company subject to its General Conditions of Service printed overleaf, available on request or accessible at www.sgs.com/terms_and_conditions.htm and, for electronic format documents, subject to Terms and Conditions for Electronic Documents at www.sgs.com/terms_e-document.htm. Attention is drawn to the limitation of liability, indemnification and jurisdiction issues defined therein. Any holder of this document is advised that information contained hereon reflects the Company's findings at the time of its intervention only and within the limits of Client's instructions, if any. The Company's sole responsibility is to its Client and this document does not exonerate parties to a transaction from exercising all their rights and obligations under the transaction documents. This document cannot be reproduced except in full, without prior written approval of the Company. Any unauthorized alteration, forgery or falsification of the content or appearance of this document is unlawful and offenders may be prosecuted to the fullest extent of the law.

Results:

Mode	Sub-test	Avg. Power (dBm) Channel			Power Class 3 Limitation (dBm)	Comments
		9262	9400	9538		
HSDPA (B2)	1	23.69	23.54	23.49	20.3dBm – 25.7dBm	Pass
	2	23.74	23.51	23.46	20.3dBm – 25.7dBm	Pass
	3	22.71	22.57	22.69	19.8dBm – 25.7dBm	Pass
	4	22.69	22.55	22.58	19.8dBm – 25.7dBm	Pass

Mode	Sub-test	Avg. Power (dBm) Channel			Power Class 3 Limitation (dBm)	Comments
		1312	1413	1513		
HSDPA (B4)	1	23.34	23.5	23.39	20.3dBm – 25.7dBm	Pass
	2	23.33	23.48	23.36	20.3dBm – 25.7dBm	Pass
	3	22.35	22.41	22.33	19.8dBm – 25.7dBm	Pass
	4	22.37	22.45	22.34	19.8dBm – 25.7dBm	Pass

Mode	Sub-test	Avg. Power (dBm) Channel			Power Class 3 Limitation (dBm)	Comments
		4132	4183	4233		
HSDPA (B5)	1	23.26	23.29	23.21	20.3dBm – 25.7dBm	Pass
	2	23.26	23.29	23.17	20.3dBm – 25.7dBm	Pass
	3	22.21	22.28	22.29	19.8dBm – 25.7dBm	Pass
	4	22.2	22.26	22.27	19.8dBm – 25.7dBm	Pass

Unless otherwise stated the results shown in this test report refer only to the sample(s) tested and such sample(s) are retained for 90 days only.

除非另有說明，此報告結果僅對測試之樣品負責，同時此樣品僅保留90天。本報告未經本公司書面許可，不可部份複製。

This document is issued by the Company subject to its General Conditions of Service printed overleaf, available on request or accessible at www.sgs.com/terms_and_conditions.htm and, for electronic format documents, subject to Terms and Conditions for Electronic Documents at www.sgs.com/terms_e-document.htm. Attention is drawn to the limitation of liability, indemnification and jurisdiction issues defined therein. Any holder of this document is advised that information contained hereon reflects the Company's findings at the time of its intervention only and within the limits of Client's instructions, if any. The Company's sole responsibility is to its Client and this document does not exonerate parties to a transaction from exercising all their rights and obligations under the transaction documents. This document cannot be reproduced except in full, without prior written approval of the Company. Any unauthorized alteration, forgery or falsification of the content or appearance of this document is unlawful and offenders may be prosecuted to the fullest extent of the law.

HSPA (HSDPA & HSUPA) Release 6 MODE

The following 5 Sub-Tests were completed according to the test requirements outlined in section 5.2A of the 3GPP TS34.121-1 V8.4.0 specification. All TX RMS power requirements for Power Class 3 were met according to table 5.2AA.5 and 5.2B.5 All UE channels and power ratio's are set according to table C11.1.3 in the 3GPP TS34.121-1 V8.4.0. RMC 12.2kps is used for this testing

HSPA SUB-TEST Setting

Table C.11.1.3: β values for transmitter characteristics tests with HS-DPCCH and E-DCH(FOR HSUPA)

Sub-test	β_c	β_d	β_d (SF)	β_c/β_d	β_{HS}	β_{ec}	β_{ed}	β_{ed} (SF)	β_{ed} (Code s)	CM (dB)	MPR (dB)	AG Index	E-TFCI	RMC (Kbps)
1	11/15 (Note 3)	15/15 (Note 3)	64	11/15 (Note 3)	22/15	209/225	1309/225	4	1	1.0	0.0	20	75	12.2
2	6/15	15/15	64	6/15	12/15	12/15	94/75	4	1	3.0	2.0	12	67	12.2
3	15/15	9/15	64	15/9	30/15	30/15	$\beta_{ed1}: 47/15$ $\beta_{ed2}: 47/15$	4 4	2	2.0	1.0	15	92	12.2
4	2/15	15/15	64	2/15	4/15	2/15	56/75	4	1	3.0	2.0	17	71	12.2
5	15/15 (Note 4)	15/15 (Note 4)	64	15/15 (Note 4)	30/15	24/15	134/15	4	1	1.0	0.0	21	81	12.2

Note: The recommended HSUPA MPRs are implemented as per following sub-tests.

Results:

Mode	Sub-test	Avg. Power (dBm) Channel			Power Class 3 Limitation (dBm)	Comments
		9262	9400	9538		
HSUPA(B2)	1	22.61	22.56	23.36	18.8dBm – 25.7dBm	Pass
	2	21.44	21.39	21.32	16.8dBm – 25.7dBm	Pass
	3	21.53	21.61	21.54	17.8dBm – 25.7dBm	Pass
	4	21.43	22.11	21.43	16.8dBm – 25.7dBm	Pass
	5	23.5	23.4	23.5	18.8dBm – 25.7dBm	Pass

Unless otherwise stated the results shown in this test report refer only to the sample(s) tested and such sample(s) are retained for 90 days only.

除非另有說明，此報告結果僅對測試之樣品負責，同時此樣品僅保留90天。本報告未經本公司書面許可，不可部份複製。

This document is issued by the Company subject to its General Conditions of Service printed overleaf, available on request or accessible at www.sgs.com/terms_and_conditions.htm and, for electronic format documents, subject to Terms and Conditions for Electronic Documents at www.sgs.com/terms_e-document.htm. Attention is drawn to the limitation of liability, indemnification and jurisdiction issues defined therein. Any holder of this document is advised that information contained hereon reflects the Company's findings at the time of its intervention only and within the limits of Client's instructions, if any. The Company's sole responsibility is to its Client and this document does not exonerate parties to a transaction from exercising all their rights and obligations under the transaction documents. This document cannot be reproduced except in full, without prior written approval of the Company. Any unauthorized alteration, forgery or falsification of the content or appearance of this document is unlawful and offenders may be prosecuted to the fullest extent of the law.

Mode	Sub-test	Avg. Power (dBm) Channel			Power Class 3 Limitation (dBm)	Comments
		1312	1413	1513		
HSDPA (B4)	1	22.4	22.57	23.06	20.3dBm – 25.7dBm	Pass
	2	21.19	21.43	21.3	20.3dBm – 25.7dBm	Pass
	3	21.38	21.53	21.49	19.8dBm – 25.7dBm	Pass
	4	21.88	21.41	21.98	19.8dBm – 25.7dBm	Pass
	5	23.2	23.5	23.2	19.8dBm – 25.7dBm	Pass

Mode	Sub-test	Avg. Power (dBm) Channel			Power Class 3 Limitation (dBm)	Comments
		4132	4183	4233		
HSUPA(B5)	1	22.05	22.27	22.04	18.8dBm – 25.7dBm	Pass
	2	21.29	21.28	21.05	16.8dBm – 25.7dBm	Pass
	3	21.4	21.32	21.35	17.8dBm – 25.7dBm	Pass
	4	22.02	22	21.86	16.8dBm – 25.7dBm	Pass
	5	23.3	23.3	23	18.8dBm – 25.7dBm	Pass

Unless otherwise stated the results shown in this test report refer only to the sample(s) tested and such sample(s) are retained for 90 days only.

除非另有說明，此報告結果僅對測試之樣品負責，同時此樣品僅保留90天。本報告未經本公司書面許可，不可部份複製。

This document is issued by the Company subject to its General Conditions of Service printed overleaf, available on request or accessible at www.sgs.com/terms_and_conditions.htm and, for electronic format documents, subject to Terms and Conditions for Electronic Documents at www.sgs.com/terms_e-document.htm. Attention is drawn to the limitation of liability, indemnification and jurisdiction issues defined therein. Any holder of this document is advised that information contained hereon reflects the Company's findings at the time of its intervention only and within the limits of Client's instructions, if any. The Company's sole responsibility is to its Client and this document does not exonerate parties to a transaction from exercising all their rights and obligations under the transaction documents. This document cannot be reproduced except in full, without prior written approval of the Company. Any unauthorized alteration, forgery or falsification of the content or appearance of this document is unlawful and offenders may be prosecuted to the fullest extent of the law.

SGS Taiwan Ltd.

No.134,WuKungRoad,NewTaipeiIndustrialPark,WukuDistrict,NewTaipeiCity,Taiwan24803/新北市五股區新北產業園區五工路 134 號

台灣檢驗科技股份有限公司

t (886-2) 2299-3279

f (886-2) 2298-0488

www.tw.sgs.com

Member of SGS Group

Minimum Communications Power Measurement

PCS 1900 band

PCL	0	1	2	3	4	5	6	7	8
Output power (dBm)	29.7	27.7	25.6	23.5	22.4	20.4	18.3	16.3	14.1

PCL	9	10	11	12	13	14	15
Output power (dBm)	12	9.9	7.8	5.6	3.7	1.9	-0.2

Note: The EUT output power was controlled by simulator. Set Communication Tester [MT8820C](#) PCL as above, and get the mobile phone output power reading.

WCDMA/HSDPA/HSUPA band II, IV, V

The EUT output power was controlled by simulator. Set Communication Tester [MT8820C](#) function key "UE Power Control" and enter max rated power 24dBm. The EUT is going to be set to max output power to 24dBm. Then record the read (see page 15 for measurement data). The min. power was measures by a function key "minimum power" then record the read. It is -52.3dBm. The power variation can be 0.1dB step by setting.

Unless otherwise stated the results shown in this test report refer only to the sample(s) tested and such sample(s) are retained for 90 days only.

除非另有說明，此報告結果僅對測試之樣品負責，同時此樣品僅保留90天。本報告未經本公司書面許可，不可部份複製。

This document is issued by the Company subject to its General Conditions of Service printed overleaf, available on request or accessible at www.sgs.com/terms_and_conditions.htm and, for electronic format documents, subject to Terms and Conditions for Electronic Documents at www.sgs.com/terms_e-document.htm. Attention is drawn to the limitation of liability, indemnification and jurisdiction issues defined therein. Any holder of this document is advised that information contained hereon reflects the Company's findings at the time of its intervention only and within the limits of Client's instructions, if any. The Company's sole responsibility is to its Client and this document does not exonerate parties to a transaction from exercising all their rights and obligations under the transaction documents. This document cannot be reproduced except in full, without prior written approval of the Company. Any unauthorized alteration, forgery or falsification of the content or appearance of this document is unlawful and offenders may be prosecuted to the fullest extent of the law.

7. EFFECTIVE RADIATED POWER AND EQUIVALENT ISOTROPIC RADIATED POWER MEASUREMENT

7.1. Standard Applicable

According to FCC §2.1046

FCC 22.913(a) Mobile station is limited to 7W ERP.

FCC 24.232(b) Mobile and portable stations are limited to 2 W EIRP.

FCC 27.50(c)(10) Portable stations (hand-held devices) are limited to 3W ERP.

FCC 27.50(d)(4) Fixed, mobile, and portable (hand-held) stations are limited to 1W EIRP.

FCC 27, 50(h)(2) Mobile and other user stations. Mobile stations are limited to 2 W EIRP

7.2. Test SET-UP

(A) Radiated Power Test Set-Up, Frequency Below 1000MHz

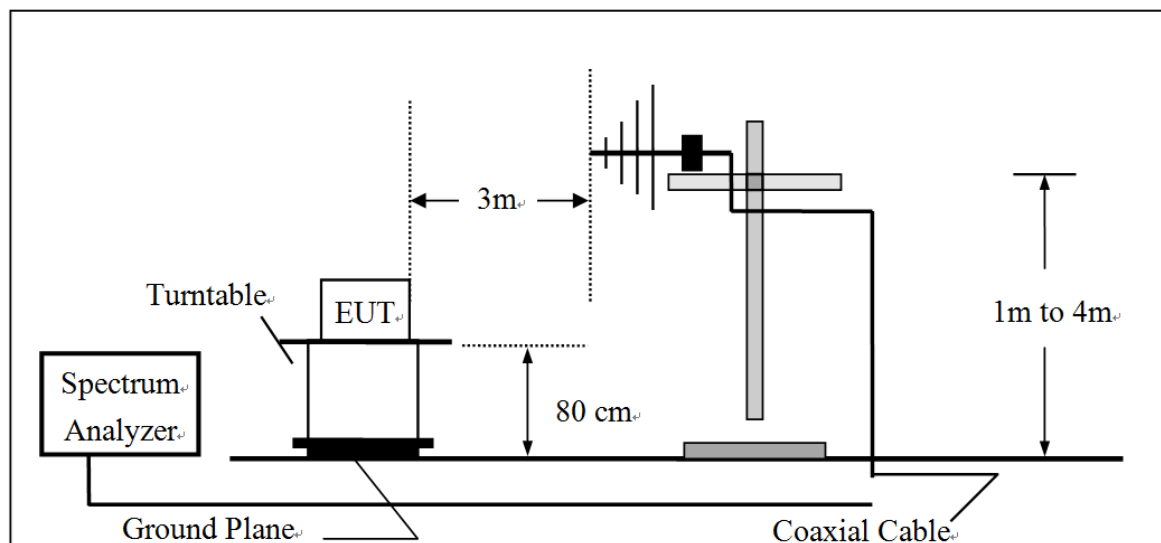

Unless otherwise stated the results shown in this test report refer only to the sample(s) tested and such sample(s) are retained for 90 days only.

除非另有說明，此報告結果僅對測試之樣品負責，同時此樣品僅保留90天。本報告未經本公司書面許可，不可部份複製。

This document is issued by the Company subject to its General Conditions of Service printed overleaf, available on request or accessible at www.sgs.com/terms_and_conditions.htm and, for electronic format documents, subject to Terms and Conditions for Electronic Documents at www.sgs.com/terms_e-document.htm. Attention is drawn to the limitation of liability, indemnification and jurisdiction issues defined therein. Any holder of this document is advised that information contained hereon reflects the Company's findings at the time of its intervention only and within the limits of Client's instructions, if any. The Company's sole responsibility is to its Client and this document does not exonerate parties to a transaction from exercising all their rights and obligations under the transaction documents. This document cannot be reproduced except in full, without prior written approval of the Company. Any unauthorized alteration, forgery or falsification of the content or appearance of this document is unlawful and offenders may be prosecuted to the fullest extent of the law.

(B) Radiated Power Test Set-UP Frequency Over 1 GHz

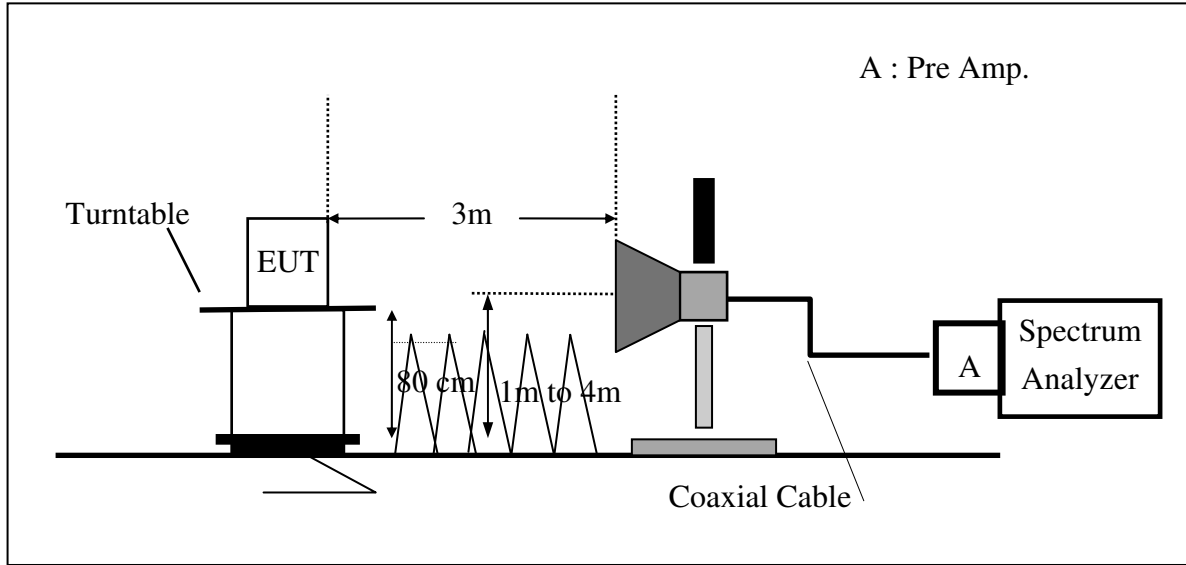

(C) Substituted Method Test Set-UP

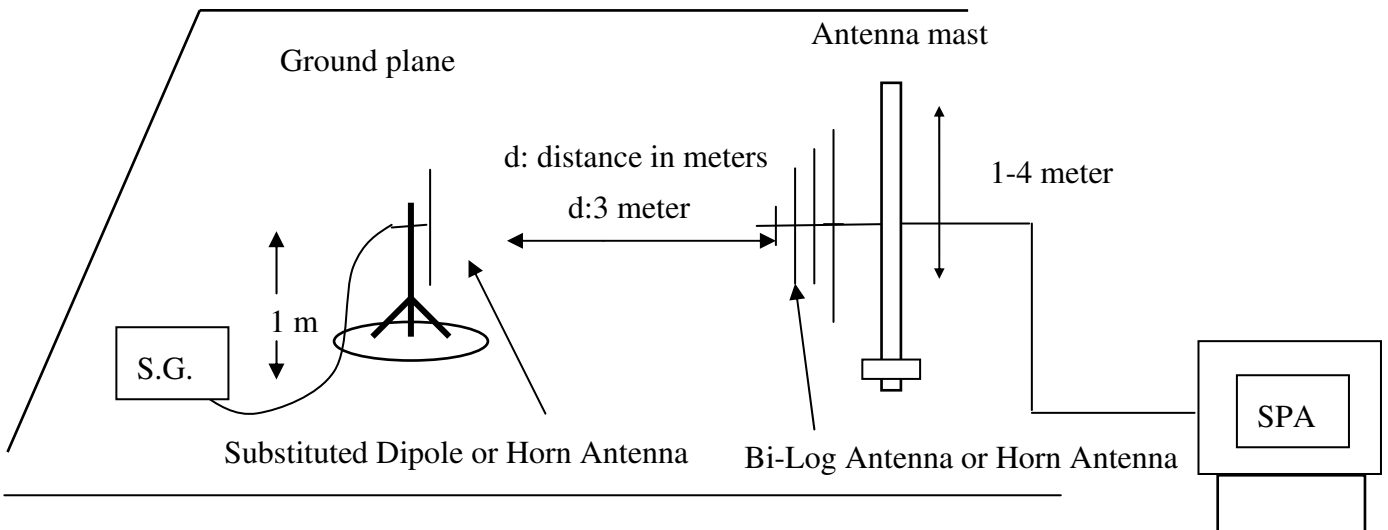

Unless otherwise stated the results shown in this test report refer only to the sample(s) tested and such sample(s) are retained for 90 days only.

除非另有說明，此報告結果僅對測試之樣品負責，同時此樣品僅保留90天。本報告未經本公司書面許可，不可部份複製。

This document is issued by the Company subject to its General Conditions of Service printed overleaf, available on request or accessible at www.sgs.com/terms_and_conditions.htm and, for electronic format documents, subject to Terms and Conditions for Electronic Documents at www.sgs.com/terms_e-document.htm. Attention is drawn to the limitation of liability, indemnification and jurisdiction issues defined therein. Any holder of this document is advised that information contained hereon reflects the Company's findings at the time of its intervention only and within the limits of Client's instructions, if any. The Company's sole responsibility is to its Client and this document does not exonerate parties to a transaction from exercising all their rights and obligations under the transaction documents. This document cannot be reproduced except in full, without prior written approval of the Company. Any unauthorized alteration, forgery or falsification of the content or appearance of this document is unlawful and offenders may be prosecuted to the fullest extent of the law.

7.3. Measurement Procedure

1. The testing follows the Measurement Procedure of FCC KDB 971168 D01
2. The EUT was placed on a non-conductive turntable using a non-conductive support. The radiated emission at the fundamental frequency was measured at 3 m with a test antenna and EMI spectrum analyzer.
3. During the measurement, the EUT was communication with the station. The highest emission was recorded with the rotation of the turntable and the lowering of the test antenna from 4m to 1m. The reading was recorded and the field strength (E in dBuV/m) was calculated
4. The testing follows the Measurement Procedure of FCC KDB 971168 D01
5. The substitution horn antenna is substituted for EUT at the same position and signals generator export the CW signal to the substitution antenna via a tx cable. Rotated the Turn Table and moved receiving antenna to find the maximum radiation power. Adjust output power level of S.G to get a Value of spectrum reading equal to "Read Value" of step b. Record the power level of S.G.
6. $ERP = S.G. \text{ output (dBm)} + \text{Antenna Gain (dBd)} - \text{Cable Loss (dB)}$
7. $ERP = S.G. \text{ output (dBm)} + \text{Antenna Gain (dBd)} - \text{Cable Loss (dB)}$
8. Spectrum setting:
 - (1) Detector = Peak, marker the highest value of the detector by maximum hold, set RBW wide enough to capture the entire signal of emission, and $VBW \geq 3 \times RBW$.
 - (2) KDB 971168 D01 is adopted, and the procedure as lists under item 4, Measurement of the Average Power over the Fundamental Signal Bandwidth, is followed to set correspondingly for the acquisition of proper measurement data.Set frequency = nominal signal center frequency;
Set span = 2 X occupied BW;
Set RBW $\approx 1 \sim 5\%$ of the span, not to exceed 1 MHz
Set VBW = 3 x RBW;
Select average power (RMS) detector
Set sweep time and number of measurement points to achieve a minimum of 1 millisecond/pt integration time (ex. Point = 601points, then sweep time = $601 \times 10^{-3} = 6s$.)

Activate trace averaging routine over a minimum of 10 sweeps;

Activate marker/span pair and set span = signal or channel bandwidth;

Activate the band/interval power marker function;

Record the band power level;

Record adjusted value as the average signal power level. Then activate the occupied bandwidth measurement function.

The proper adjustment due to limitation of spectrum capability is given compensated to spectrum with conversion factor of $10 \times \log(TBW/RBW)$, where TBW is the transmission of UE exceeding the maximum BW UE can extends, and RBW is the resolution BW in UE.

Unless otherwise stated the results shown in this test report refer only to the sample(s) tested and such sample(s) are retained for 90 days only.

除非另有說明，此報告結果僅對測試之樣品負責，同時此樣品僅保留90天。本報告未經本公司書面許可，不可部份複製。

This document is issued by the Company subject to its General Conditions of Service printed overleaf, available on request or accessible at www.sgs.com/terms_and_conditions.htm and, for electronic format documents, subject to Terms and Conditions for Electronic Documents at www.sgs.com/terms_e-document.htm. Attention is drawn to the limitation of liability, indemnification and jurisdiction issues defined therein. Any holder of this document is advised that information contained hereon reflects the Company's findings at the time of its intervention only and within the limits of Client's instructions, if any. The Company's sole responsibility is to its Client and this document does not exonerate parties to a transaction from exercising all their rights and obligations under the transaction documents. This document cannot be reproduced except in full, without prior written approval of the Company. Any unauthorized alteration, forgery or falsification of the content or appearance of this document is unlawful and offenders may be prosecuted to the fullest extent of the law.

7.4. Measurement Equipment Used

ERP, EIRP MEASUREMENT EQUIPMENT List 966 Chamber					
EQUIPMENT TYPE	MFR	MODEL NUMBER	SERIAL NUMBER	LAST CAL.	CAL DUE.
EMI Test Receiver	R&S	ESU 40	100363	04/12/2016	04/11/2017
Broadband Antenna	TESEQ	CBL 6112D	35240	11/03/2016	11/02/2017
Broadband Antenna	TESEQ	CBL 6112D	35243	11/09/2016	11/08/2017
Horn Antenna	ETS-Lindgren	3117	00143272	12/16/2015	12/15/2016
Horn Antenna	ETS-Lindgren	3117	143279	11/14/2016	11/13/2017
Horn Antenna	Schwarzbeck	BBHA9170	184	12/11/2016	12/10/2017
Horn Antenna	Schwarzbeck	BBHA9170	185	07/24/2016	07/23/2017
Pre Amplifier	EMC Instruments	EMC330	980096	12/12/2016	12/11/2017
Pre Amplifier	EMC Instruments	EMC0011830	980199	12/12/2016	12/11/2017
Pre Amplifier	R&S	SCU-18	10204	12/12/2016	12/11/2017
Pre Amplifier	R&S	SCU-26	100780	12/12/2016	12/11/2017
Pre Amplifier	EMC Instruments	EMC184045B	980135	12/12/2016	12/11/2017
Coaxial Cable	Huber+Suhner	RG 214/U	966Rx 9K-30M	12/12/2016	12/11/2017
Coaxial Cable	Huber+Suhner	RG 214/U SUCOFLEX 104	966Rx 30M-3G	12/12/2016	12/11/2017
Coaxial Cable	Huber+Suhner	SUCOFLEX 104	966Rx 1G-18G	12/12/2016	12/11/2017
Coaxial Cable	Huber+Suhner	mini 141-12 SUCOFLEX 104	966Rx 18G-40G	12/12/2016	12/11/2017

Unless otherwise stated the results shown in this test report refer only to the sample(s) tested and such sample(s) are retained for 90 days only.

除非另有說明，此報告結果僅對測試之樣品負責，同時此樣品僅保留90天。本報告未經本公司書面許可，不可部份複製。

This document is issued by the Company subject to its General Conditions of Service printed overleaf, available on request or accessible at www.sgs.com/terms_and_conditions.htm and, for electronic format documents, subject to Terms and Conditions for Electronic Documents at www.sgs.com/terms_e-document.htm. Attention is drawn to the limitation of liability, indemnification and jurisdiction issues defined therein. Any holder of this document is advised that information contained hereon reflects the Company's findings at the time of its intervention only and within the limits of Client's instructions, if any. The Company's sole responsibility is to its Client and this document does not exonerate parties to a transaction from exercising all their rights and obligations under the transaction documents. This document cannot be reproduced except in full, without prior written approval of the Company. Any unauthorized alteration, forgery or falsification of the content or appearance of this document is unlawful and offenders may be prosecuted to the fullest extent of the law.

EQUIPMENT TYPE	MFR	MODEL NUMBER	SERIAL NUMBER	LAST CAL.	CAL DUE.
Coaxial Cable	Huber+Suhner	SUCOFLEX 104	966Tx 30M-18G	12/12/2016	12/11/2017
Coaxial Cable	Huber+Suhner	SUCOFLEX 102	966Tx 18G-40G	12/12/2016	12/11/2017
Attenuator	WOKEN	218FS-10	RF27	12/12/2016	12/11/2017
Communication Tester	Anritsu	MT8820C	6201107337	05/25/2016	05/24/2017
Site NSA	SGS	966 Chamber C	SAC-C	03/04/2016	03/03/2017
Site VSWR	SGS	966 Chamber C	SAC-C	03/04/2016	03/03/2017
DC Power Supply	HOLA	DP-3003	D7070035	05/04/2016	05/03/2017
Controller	MF	MF-7802	N/A	N.C.R.	N.C.R.
Antenna Master	MF	N/A	N/A	N.C.R.	N.C.R.
Turn Table	MF	N/A	N/A	N.C.R.	N.C.R.
Test Software	World-Pallas	Dr. E	V 3.0 Lite	N.C.R.	N.C.R.

Remark: Please note that the duration to conduct the test took place in the mean time when the calibration for several equipments is due, and therefore extra tables of equipment calibration is constructed to indicate the calibration work is still maintained.

EQUIPMENT TYPE	MFR	MODEL NUMBER	SERIAL NUMBER	LAST CAL.	CAL DUE.
Horn Antenna	ETS-Lindgren	3117	00143272	12/15/2016	12/16/2017

Unless otherwise stated the results shown in this test report refer only to the sample(s) tested and such sample(s) are retained for 90 days only.

除非另有說明，此報告結果僅對測試之樣品負責，同時此樣品僅保留90天。本報告未經本公司書面許可，不可部份複製。

This document is issued by the Company subject to its General Conditions of Service printed overleaf, available on request or accessible at www.sgs.com/terms_and_conditions.htm and, for electronic format documents, subject to Terms and Conditions for Electronic Documents at www.sgs.com/terms_e-document.htm. Attention is drawn to the limitation of liability, indemnification and jurisdiction issues defined therein. Any holder of this document is advised that information contained hereon reflects the Company's findings at the time of its intervention only and within the limits of Client's instructions, if any. The Company's sole responsibility is to its Client and this document does not exonerate parties to a transaction from exercising all their rights and obligations under the transaction documents. This document cannot be reproduced except in full, without prior written approval of the Company. Any unauthorized alteration, forgery or falsification of the content or appearance of this document is unlawful and offenders may be prosecuted to the fullest extent of the law.

SGS Taiwan Ltd.

No.134,WuKungRoad,NewTaipeiIndustrialPark,WukuDistrict,NewTaipeiCity,Taiwan24803/新北市五股區新北產業園區五工路 134 號

台灣檢驗科技股份有限公司

t (886-2) 2299-3279

f (886-2) 2298-0488

www.tw.sgs.com

Member of SGS Group

7.5. Measurement Result: (Peak) –using option of peak measurement

EUT			Measurement					
Operation Band	Fundamental Frequency	CH	Antenna Pol.	S.G. Output	Antenna Gain	Cable Loss	ERP	Limit
	MHz		V/H	dBm	dBd	dB	dBm	dBm
GSM 850	824.2	128	V	27.48	5.49	-3.63	29.34	38.45
			H	27.02	5.49	-3.63	28.88	38.45
	836.6	190	V	26.62	5.47	-3.29	28.8	38.45
			H	28.16	5.47	-3.29	30.34	38.45
	848.8	251	V	26.93	5.45	-3.09	29.29	38.45
			H	28.64	5.45	-3.09	31	38.45

EUT			Measurement					
Operation Band	Fundamental Frequency	CH	Antenna Pol.	S.G. Output	Antenna Gain	Cable Loss	ERP	Limit
	MHz		V/H	dBm	dBd	dB	dBm	dBm
GPRS 850	824.2	128	V	26.72	5.49	-3.38	28.83	38.45
			H	27.61	5.49	-3.38	29.72	38.45
	836.6	190	V	26.8	5.47	-3.3	28.97	38.45
			H	28.23	5.47	-3.3	30.4	38.45
	848.8	251	V	27	5.45	-3.11	29.34	38.45
			H	28.77	5.45	-3.11	31.11	38.45

EUT			Measurement					
Operation Band	Fundamental Frequency	CH	Antenna Pol.	S.G. Output	Antenna Gain	Cable Loss	ERP	Limit
	MHz		V/H	dBm	dBd	dB	dBm	dBm
EDGE 850	824.2	128	V	20.45	5.49	-3.36	22.58	38.45
			H	21.3	5.49	-3.36	23.43	38.45
	836.6	190	V	20.64	5.47	-3.29	22.82	38.45
			H	22.05	5.47	-3.29	24.23	38.45
	848.8	251	V	21.08	5.45	-3.11	23.42	38.45
			H	23.32	5.45	-3.11	25.66	38.45

Remark : (1) The RBW,VBW of SPA for frequency RBW=300 KHz, VBW=1MHz

Unless otherwise stated the results shown in this test report refer only to the sample(s) tested and such sample(s) are retained for 90 days only.

除非另有說明，此報告結果僅對測試之樣品負責，同時此樣品僅保留90天。本報告未經本公司書面許可，不可部份複製。

This document is issued by the Company subject to its General Conditions of Service printed overleaf, available on request or accessible at www.sgs.com/terms_and_conditions.htm and, for electronic format documents, subject to Terms and Conditions for Electronic Documents at www.sgs.com/terms_e-document.htm. Attention is drawn to the limitation of liability, indemnification and jurisdiction issues defined therein. Any holder of this document is advised that information contained hereon reflects the Company's findings at the time of its intervention only and within the limits of Client's instructions, if any. The Company's sole responsibility is to its Client and this document does not exonerate parties to a transaction from exercising all their rights and obligations under the transaction documents. This document cannot be reproduced except in full, without prior written approval of the Company. Any unauthorized alteration, forgery or falsification of the content or appearance of this document is unlawful and offenders may be prosecuted to the fullest extent of the law.

EUT			Measurement					
Operation Band	Fundamental Frequency	CH	Antenna Pol.	S.G. Output	Antenna Gain	Cable Loss	EIRP	Limit
	MHz		V/H	dBm	dBi	dB	dBm	dBm
GSM 1900	1850.2	512	V	21.8	9.59	-5.05	26.34	33.01
			H	23.52	9.59	-5.05	28.06	33.01
	1880.0	661	V	24.2	9.69	-5.15	28.74	33.01
			H	23.42	9.69	-5.15	27.96	33.01
	1909.8	810	V	25.04	9.79	-5.13	29.7	33.01
			H	23.44	9.79	-5.13	28.1	33.01

EUT			Measurement					
Operation Band	Fundamental Frequency	CH	Antenna Pol.	S.G. Output	Antenna Gain	Cable Loss	EIRP	Limit
	MHz		V/H	dBm	dBi	dB	dBm	dBm
GPRS 1900	1850.2	512	V	24.78	9.59	-5.05	29.32	33.01
			H	18.49	9.59	-5.05	23.03	33.01
	1880.0	661	V	25.28	9.69	-5.16	29.81	33.01
			H	18.88	9.69	-5.16	23.41	33.01
	1909.8	810	V	25.55	9.79	-5.13	30.21	33.01
			H	23.3	9.79	-5.13	27.96	33.01

EUT			Measurement					
Operation Band	Fundamental Frequency	CH	Antenna Pol.	S.G. Output	Antenna Gain	Cable Loss	EIRP	Limit
	MHz		V/H	dBm	dBi	dB	dBm	dBm
EDGE 1900	1850.2	512	V	23.86	9.59	-5.45	28	33.01
			H	22.2	9.59	-5.45	26.34	33.01
	1880.0	661	V	24.63	9.69	-5.15	29.17	33.01
			H	22.93	9.69	-5.15	27.47	33.01
	1909.8	810	V	24.62	9.79	-5.13	29.28	33.01
			H	22.52	9.79	-5.13	27.18	33.01

Remark: 1) (1) The RBW,VBW of SPA for frequency RBW=300K, VBW=1MHz

Unless otherwise stated the results shown in this test report refer only to the sample(s) tested and such sample(s) are retained for 90 days only.

除非另有說明，此報告結果僅對測試之樣品負責，同時此樣品僅保留90天。本報告未經本公司書面許可，不可部份複製。

This document is issued by the Company subject to its General Conditions of Service printed overleaf, available on request or accessible at www.sgs.com/terms_and_conditions.htm and, for electronic format documents, subject to Terms and Conditions for Electronic Documents at www.sgs.com/terms_e-document.htm. Attention is drawn to the limitation of liability, indemnification and jurisdiction issues defined therein. Any holder of this document is advised that information contained hereon reflects the Company's findings at the time of its intervention only and within the limits of Client's instructions, if any. The Company's sole responsibility is to its Client and this document does not exonerate parties to a transaction from exercising all their rights and obligations under the transaction documents. This document cannot be reproduced except in full, without prior written approval of the Company. Any unauthorized alteration, forgery or falsification of the content or appearance of this document is unlawful and offenders may be prosecuted to the fullest extent of the law.

EUT			Measurement					
Operation Band	Fundamental Frequency	CH	Antenna Pol.	S.G. Output	Antenna Gain	Cable Loss	EIRP	Limit
WCDMA B2	1852.4	9262	V	27.28	9.6	-5.05	31.83	33.01
			H	24.72	9.6	-5.05	29.27	33.01
	1880.0	9400	V	27.64	9.69	-5.15	32.18	33.01
			H	25.9	9.69	-5.15	30.44	33.01
	1907.6	9538	V	27.79	9.79	-5.12	32.46	33.01
			H	26.11	9.79	-5.12	30.78	33.01

EUT			Measurement					
Operation Band	Fundamental Frequency	CH	Antenna Pol.	S.G. Output	Antenna Gain	Cable Loss	EIRP	Limit
HSDPA B2	1852.4	9262	V	27.39	9.6	-5.05	31.94	33.01
			H	25.34	9.6	-5.05	29.89	33.01
	1880.0	9400	V	27.29	9.69	-5.15	31.83	33.01
			H	25.97	9.69	-5.15	30.51	33.01
	1907.6	9538	V	26.81	9.78	-5.12	31.47	33.01
			H	26.12	9.78	-5.12	30.78	33.01

EUT			Measurement					
Operation Band	Fundamental Frequency	CH	Antenna Pol.	S.G. Output	Antenna Gain	Cable Loss	EIRP	Limit
HSUPA B2	1852.4	9262	V	28.06	9.6	-5.05	32.61	33.01
			H	26.49	9.6	-5.05	31.04	33.01
	1880.0	9400	V	28.24	9.69	-5.15	32.78	33.01
			H	26.87	9.69	-5.15	31.41	33.01
	1907.6	9538	V	28.2	9.78	-5.1	32.88	33.01
			H	27.06	9.78	-5.1	31.74	33.01

Remark :

- (1) The RBW,VBW of SPA for frequency RBW= 5MHz , VBW= 8MHz

Unless otherwise stated the results shown in this test report refer only to the sample(s) tested and such sample(s) are retained for 90 days only.

除非另有說明，此報告結果僅對測試之樣品負責，同時此樣品僅保留90天。本報告未經本公司書面許可，不可部份複製。

This document is issued by the Company subject to its General Conditions of Service printed overleaf, available on request or accessible at www.sgs.com/terms_and_conditions.htm and, for electronic format documents, subject to Terms and Conditions for Electronic Documents at www.sgs.com/terms_e-document.htm. Attention is drawn to the limitation of liability, indemnification and jurisdiction issues defined therein. Any holder of this document is advised that information contained hereon reflects the Company's findings at the time of its intervention only and within the limits of Client's instructions, if any. The Company's sole responsibility is to its Client and this document does not exonerate parties to a transaction from exercising all their rights and obligations under the transaction documents. This document cannot be reproduced except in full, without prior written approval of the Company. Any unauthorized alteration, forgery or falsification of the content or appearance of this document is unlawful and offenders may be prosecuted to the fullest extent of the law.

EUT			Measurement					
Operation Band	Fundamental Frequency	CH	Antenna Pol.	S.G. Output	Antenna Gain	Cable Loss	EIRP	Limit
	MHz		V/H	dBm	dBi	dB	dBm	dBm
WCDMA B4	1712.4	1312	V	21.11	9.12	-4.82	25.41	33.01
			H	21.19	9.12	-4.82	25.49	33.01
	1732.6	1413	V	21.4	9.19	-4.85	25.74	33.01
			H	24.86	9.19	-4.85	29.2	33.01
	1752.6	1513	V	22.43	9.26	-4.91	26.78	33.01
			H	22.19	9.26	-4.91	26.54	33.01

EUT			Measurement					
Operation Band	Fundamental Frequency	CH	Antenna Pol.	S.G. Output	Antenna Gain	Cable Loss	EIRP	Limit
	MHz		V/H	dBm	dBi	dB	dBm	dBm
HSDPA B4	1712.4	1312	V	20.92	9.12	-4.82	25.22	33.01
			H	21.49	9.12	-4.82	25.79	33.01
	1732.6	1413	V	22.23	9.19	-4.85	26.57	33.01
			H	22.71	9.19	-4.85	27.05	33.01
	1752.6	1513	V	23.79	9.26	-4.91	28.14	33.01
			H	23.48	9.26	-4.91	27.83	33.01

EUT			Measurement					
Operation Band	Fundamental Frequency	CH	Antenna Pol.	S.G. Output	Antenna Gain	Cable Loss	EIRP	Limit
	MHz		V/H	dBm	dBi	dB	dBm	dBm
HSUPA B4	1712.4	1312	V	21.84	9.12	-4.82	26.14	33.01
			H	22.04	9.12	-4.82	26.34	33.01
	1732.6	1413	V	23.82	9.19	-4.85	28.16	33.01
			H	23.67	9.19	-4.85	28.01	33.01
	1752.6	1513	V	24.81	9.26	-4.91	29.16	33.01
			H	24.04	9.26	-4.91	28.39	33.01

Remark :

- (1) The RBW,VBW of SPA for frequency RBW= 5MHz , VBW= 8MHz

Unless otherwise stated the results shown in this test report refer only to the sample(s) tested and such sample(s) are retained for 90 days only.

除非另有說明，此報告結果僅對測試之樣品負責，同時此樣品僅保留90天。本報告未經本公司書面許可，不可部份複製。

This document is issued by the Company subject to its General Conditions of Service printed overleaf, available on request or accessible at www.sgs.com/terms_and_conditions.htm and, for electronic format documents, subject to Terms and Conditions for Electronic Documents at www.sgs.com/terms_e-document.htm. Attention is drawn to the limitation of liability, indemnification and jurisdiction issues defined therein. Any holder of this document is advised that information contained hereon reflects the Company's findings at the time of its intervention only and within the limits of Client's instructions, if any. The Company's sole responsibility is to its Client and this document does not exonerate parties to a transaction from exercising all their rights and obligations under the transaction documents. This document cannot be reproduced except in full, without prior written approval of the Company. Any unauthorized alteration, forgery or falsification of the content or appearance of this document is unlawful and offenders may be prosecuted to the fullest extent of the law.

EUT			Measurement					
Operation Band	Fundamental Frequency	CH	Antenna Pol.	S.G. Output	Antenna Gain	Cable Loss	ERP	Limit
	MHz		V/H	dBm	dBd	dB	dBm	dBm
WCDMA B5	826.4	4132	V	17.34	5.48	-3.21	19.61	38.45
			H	20.07	5.48	-3.21	22.34	38.45
	836.6	4183	V	16.96	5.47	-3.35	19.08	38.45
			H	20.08	5.47	-3.35	22.2	38.45
	846.6	4233	V	17.26	5.45	-3.31	19.4	38.45
			H	20.48	5.45	-3.31	22.62	38.45

EUT			Measurement					
Operation Band	Fundamental Frequency	CH	Antenna Pol.	S.G. Output	Antenna Gain	Cable Loss	ERP	Limit
	MHz		V/H	dBm	dBd	dB	dBm	dBm
HSDPA B5	826.4	4132	V	18.3	5.48	-3.21	20.57	38.45
			H	20.49	5.48	-3.21	22.76	38.45
	836.6	4183	V	18.26	5.47	-3.31	20.42	38.45
			H	20.57	5.47	-3.31	22.73	38.45
	846.6	4233	V	17.5	5.45	-3.29	19.66	38.45
			H	20.32	5.45	-3.29	22.48	38.45

EUT			Measurement					
Operation Band	Fundamental Frequency	CH	Antenna Pol.	S.G. Output	Antenna Gain	Cable Loss	ERP	Limit
	MHz		V/H	dBm	dBd	dB	dBm	dBm
HSUPA B5	826.4	4132	V	18.3	5.48	-3.22	20.56	38.45
			H	21.15	5.48	-3.22	23.41	38.45
	836.6	4183	V	18.66	5.47	-3.33	20.8	38.45
			H	21.59	5.47	-3.33	23.73	38.45
	846.6	4233	V	18.59	5.45	-3.315	20.73	38.45
			H	21.11	5.45	-3.315	23.25	38.45

Remark :

- (1) The RBW,VBW of SPA for frequency RBW= 5MHz , VBW= 8MHz

Unless otherwise stated the results shown in this test report refer only to the sample(s) tested and such sample(s) are retained for 90 days only.

除非另有說明，此報告結果僅對測試之樣品負責，同時此樣品僅保留90天。本報告未經本公司書面許可，不可部份複製。

This document is issued by the Company subject to its General Conditions of Service printed overleaf, available on request or accessible at www.sgs.com/terms_and_conditions.htm and, for electronic format documents, subject to Terms and Conditions for Electronic Documents at www.sgs.com/terms_e-document.htm. Attention is drawn to the limitation of liability, indemnification and jurisdiction issues defined therein. Any holder of this document is advised that information contained hereon reflects the Company's findings at the time of its intervention only and within the limits of Client's instructions, if any. The Company's sole responsibility is to its Client and this document does not exonerate parties to a transaction from exercising all their rights and obligations under the transaction documents. This document cannot be reproduced except in full, without prior written approval of the Company. Any unauthorized alteration, forgery or falsification of the content or appearance of this document is unlawful and offenders may be prosecuted to the fullest extent of the law.

SGS Taiwan Ltd.

No.134,WuKungRoad,NewTaipeiIndustrialPark,WukuDistrict,NewTaipeiCity,Taiwan24803/新北市五股區新北產業園區五工路 134 號

台灣檢驗科技股份有限公司

t (886-2) 2299-3279

f (886-2) 2298-0488

www.tw.sgs.com

Member of SGS Group

EUT			Measurement					
Operation Band	Fundamental Frequency	CH	Antenna Pol.	S.G. Output	Antenna Gain	Cable Loss	EIRP	Limit
	MHz		V/H	dBm	dBi	dB	dBm	dBm
BAND 2 BW: 1.4M QPSK RB: 1,0	1850.7	18607	V	26.1	9.59	-5.05	30.64	33.01
			H	24.58	9.59	-5.05	29.12	33.01
	1880.0	18900	V	25.84	9.69	-5.15	30.38	33.01
			H	25.22	9.69	-5.15	29.76	33.01
	1909.3	19193	V	25.46	9.79	-5.13	30.12	33.01
			H	25.54	9.79	-5.13	30.2	33.01
BAND 2 BW: 1.4M QPSK RB: 1,5	1850.7	18607	V	25.89	9.59	-5.05	30.43	33.01
			H	24.64	9.59	-5.05	29.18	33.01
	1880.0	18900	V	26.04	9.69	-5.16	30.57	33.01
			H	25.47	9.69	-5.16	30	33.01
	1909.3	19193	V	25.17	9.79	-5.13	29.83	33.01
			H	25.3	9.79	-5.13	29.96	33.01
BAND 2 BW: 1.4M 16QAM RB: 1,0	1850.7	18607	V	25.9	9.59	-5.05	30.44	33.01
			H	24.64	9.59	-5.05	29.18	33.01
	1880.0	18900	V	25.72	9.69	-5.15	30.26	33.01
			H	25.32	9.69	-5.15	29.86	33.01
	1909.3	19193	V	25.35	9.79	-5.13	30.01	33.01
			H	25.41	9.79	-5.13	30.07	33.01
BAND 2 BW: 1.4M 16QAM RB: 1,5	1850.7	18607	V	25.99	9.6	-5.05	30.54	33.01
			H	24.42	9.6	-5.05	28.97	33.01
	1880.0	18900	V	25.66	9.69	-5.15	30.2	33.01
			H	25.13	9.69	-5.15	29.67	33.01
	1909.3	19193	V	25.16	9.79	-5.13	29.82	33.01
			H	25.29	9.79	-5.13	29.95	33.01

Remark :

- (1) The RBW,VBW of SPA for frequency RBW= 8MHz , VBW= 8MHz

Unless otherwise stated the results shown in this test report refer only to the sample(s) tested and such sample(s) are retained for 90 days only.

除非另有說明，此報告結果僅對測試之樣品負責，同時此樣品僅保留90天。本報告未經本公司書面許可，不可部份複製。

This document is issued by the Company subject to its General Conditions of Service printed overleaf, available on request or accessible at www.sgs.com/terms_and_conditions.htm and, for electronic format documents, subject to Terms and Conditions for Electronic Documents at www.sgs.com/terms_e-document.htm. Attention is drawn to the limitation of liability, indemnification and jurisdiction issues defined therein. Any holder of this document is advised that information contained hereon reflects the Company's findings at the time of its intervention only and within the limits of Client's instructions, if any. The Company's sole responsibility is to its Client and this document does not exonerate parties to a transaction from exercising all their rights and obligations under the transaction documents. This document cannot be reproduced except in full, without prior written approval of the Company. Any unauthorized alteration, forgery or falsification of the content or appearance of this document is unlawful and offenders may be prosecuted to the fullest extent of the law.

SGS Taiwan Ltd.

No.134,WuKungRoad,NewTaipeiIndustrialPark,WukuDistrict,NewTaipeiCity,Taiwan24803/新北市五股區新北產業園區五工路 134 號

台灣檢驗科技股份有限公司

t (886-2) 2299-3279

f (886-2) 2298-0488

www.tw.sgs.com

Member of SGS Group

EUT			Measurement					
Operation Band	Fundamental Frequency	CH	Antenna Pol.	S.G. Output	Antenna Gain	Cable Loss	EIRP	Limit
	MHz		V/H	dBm	dBi	dB	dBm	dBm
BAND 2 BW: 3M QPSK RB: 1,0	1851.5	18615	V	24.52	9.59	-5.05	29.06	33.01
			H	24.14	9.59	-5.05	28.68	33.01
	1880.0	18900	V	26.28	9.69	-5.15	30.82	33.01
			H	25.01	9.69	-5.15	29.55	33.01
	1908.5	19185	V	25.32	9.78	-5.12	29.98	33.01
			H	25.63	9.78	-5.12	30.29	33.01
BAND 2 BW: 3M QPSK RB: 1,14	1851.5	18615	V	24.96	9.6	-5.05	29.51	33.01
			H	24.28	9.6	-5.05	28.83	33.01
	1880.0	18900	V	25.85	9.7	-5.16	30.39	33.01
			H	25	9.7	-5.16	29.54	33.01
	1908.5	19185	V	25.15	9.79	-5.13	29.81	33.01
			H	25.29	9.79	-5.13	29.95	33.01
BAND 2 BW: 3M 16QAM RB: 1,0	1851.5	18615	V	24.74	9.59	-5.05	29.28	33.01
			H	24.22	9.59	-5.05	28.76	33.01
	1880.0	18900	V	25.74	9.69	-5.15	30.28	33.01
			H	24.95	9.69	-5.15	29.49	33.01
	1908.5	19185	V	25.61	9.78	-5.12	30.27	33.01
			H	25.62	9.78	-5.12	30.28	33.01
BAND 2 BW: 3M 16QAM RB: 1,14	1851.5	18615	V	24.98	9.6	-5.05	29.53	33.01
			H	24.13	9.6	-5.05	28.68	33.01
	1880.0	18900	V	25.94	9.7	-5.16	30.48	33.01
			H	25.01	9.7	-5.16	29.55	33.01
	1908.5	19185	V	25.3	9.79	-5.13	29.96	33.01
			H	25.38	9.79	-5.13	30.04	33.01

Remark :

- (1) The RBW,VBW of SPA for frequency RBW= 8MHz , VBW= 8MHz

Unless otherwise stated the results shown in this test report refer only to the sample(s) tested and such sample(s) are retained for 90 days only.

除非另有說明，此報告結果僅對測試之樣品負責，同時此樣品僅保留90天。本報告未經本公司書面許可，不可部份複製。

This document is issued by the Company subject to its General Conditions of Service printed overleaf, available on request or accessible at www.sgs.com/terms_and_conditions.htm and, for electronic format documents, subject to Terms and Conditions for Electronic Documents at www.sgs.com/terms_e-document.htm. Attention is drawn to the limitation of liability, indemnification and jurisdiction issues defined therein. Any holder of this document is advised that information contained hereon reflects the Company's findings at the time of its intervention only and within the limits of Client's instructions, if any. The Company's sole responsibility is to its Client and this document does not exonerate parties to a transaction from exercising all their rights and obligations under the transaction documents. This document cannot be reproduced except in full, without prior written approval of the Company. Any unauthorized alteration, forgery or falsification of the content or appearance of this document is unlawful and offenders may be prosecuted to the fullest extent of the law.

SGS Taiwan Ltd.

No.134,WuKungRoad,NewTaipeiIndustrialPark,WukuDistrict,NewTaipeiCity,Taiwan24803/新北市五股區新北產業園區五工路 134 號

台灣檢驗科技股份有限公司

t (886-2) 2299-3279

f (886-2) 2298-0488

www.tw.sgs.com

Member of SGS Group

EUT			Measurement					
Operation Band	Fundamental Frequency	CH	Antenna Pol.	S.G. Output	Antenna Gain	Cable Loss	EIRP	Limit
	MHz		V/H	dBm	dBi	dB	dBm	dBm
BAND 2 BW: 5M QPSK RB: 1,0	1852.5	18625	V	25.61	9.59	-5.05	30.15	33.01
			H	24.08	9.59	-5.05	28.62	33.01
	1880.0	18900	V	25.77	9.68	-5.15	30.3	33.01
			H	25.03	9.68	-5.15	29.56	33.01
	1907.5	19175	V	25.75	9.78	-5.12	30.41	33.01
			H	25.78	9.78	-5.12	30.44	33.01
BAND 2 BW: 5M QPSK RB: 1,24	1852.5	18625	V	26.14	9.61	-5.05	30.7	33.01
			H	24.42	9.61	-5.05	28.98	33.01
	1880.0	18900	V	25.4	9.7	-5.17	29.93	33.01
			H	25.16	9.7	-5.17	29.69	33.01
	1907.5	19175	V	25.3	9.79	-5.13	29.96	33.01
			H	25.14	9.79	-5.13	29.8	33.01
BAND 2 BW: 5M 16QAM RB: 1,0	1852.5	18625	V	25.68	9.59	-5.05	30.22	33.01
			H	23.72	9.59	-5.05	28.26	33.01
	1880.0	18900	V	25.64	9.69	-5.15	30.18	33.01
			H	24.79	9.69	-5.15	29.33	33.01
	1907.5	19175	V	25.68	9.78	-5.12	30.34	33.01
			H	25.92	9.78	-5.12	30.58	33.01
BAND 2 BW: 5M 16QAM RB: 1,24	1852.5	18625	V	25.93	9.61	-5.05	30.49	33.01
			H	24.2	9.61	-5.05	28.76	33.01
	1880.0	18900	V	25.43	9.7	-5.17	29.96	33.01
			H	24.87	9.7	-5.17	29.4	33.01
	1907.5	19175	V	25.39	9.79	-5.13	30.05	33.01
			H	24.77	9.79	-5.13	29.43	33.01

Remark :

- (1) The RBW,VBW of SPA for frequency RBW= 8MHz , VBW= 8MHz

Unless otherwise stated the results shown in this test report refer only to the sample(s) tested and such sample(s) are retained for 90 days only.

除非另有說明，此報告結果僅對測試之樣品負責，同時此樣品僅保留90天。本報告未經本公司書面許可，不可部份複製。

This document is issued by the Company subject to its General Conditions of Service printed overleaf, available on request or accessible at www.sgs.com/terms_and_conditions.htm and, for electronic format documents, subject to Terms and Conditions for Electronic Documents at www.sgs.com/terms_e-document.htm. Attention is drawn to the limitation of liability, indemnification and jurisdiction issues defined therein. Any holder of this document is advised that information contained hereon reflects the Company's findings at the time of its intervention only and within the limits of Client's instructions, if any. The Company's sole responsibility is to its Client and this document does not exonerate parties to a transaction from exercising all their rights and obligations under the transaction documents. This document cannot be reproduced except in full, without prior written approval of the Company. Any unauthorized alteration, forgery or falsification of the content or appearance of this document is unlawful and offenders may be prosecuted to the fullest extent of the law.

SGS Taiwan Ltd.

No.134,WuKungRoad,NewTaipeiIndustrialPark,WukuDistrict,NewTaipeiCity,Taiwan24803/新北市五股區新北產業園區五工路 134 號

台灣檢驗科技股份有限公司

t (886-2) 2299-3279

f (886-2) 2298-0488

www.tw.sgs.com

Member of SGS Group

EUT			Measurement					
Operation Band	Fundamental Frequency	CH	Antenna Pol.	S.G. Output	Antenna Gain	Cable Loss	EIRP	Limit
	MHz		V/H	dBm	dBi	dB	dBm	dBm
BAND 2 BW: 10M QPSK RB: 1,0	1855.0	18650	V	25.23	9.59	-5.05	29.77	33.01
			H	23.99	9.59	-5.05	28.53	33.01
	1880.0	18900	V	26.64	9.68	-5.13	31.19	33.01
			H	25.24	9.68	-5.13	29.79	33.01
	1905.0	19150	V	26.25	9.76	-5.11	30.9	33.01
			H	26.34	9.76	-5.11	30.99	33.01
BAND 2 BW: 10M QPSK RB: 1,49	1855.0	18650	V	26.46	9.62	-5.06	31.02	33.01
			H	24.77	9.62	-5.06	29.33	33.01
	1880.0	18900	V	26.55	9.71	-5.18	31.08	33.01
			H	25.44	9.71	-5.18	29.97	33.01
	1905.0	19150	V	25.38	9.79	-5.13	30.04	33.01
			H	25.38	9.79	-5.13	30.04	33.01
BAND 2 BW: 10M 16QAM RB: 1,0	1855.0	18650	V	25.38	9.59	-5.05	29.92	33.01
			H	23.9	9.59	-5.05	28.44	33.01
	1880.0	18900	V	26.51	9.68	-5.13	31.06	33.01
			H	25.19	9.68	-5.13	29.74	33.01
	1905.0	19150	V	26.24	9.76	-5.1	30.9	33.01
			H	26.36	9.76	-5.1	31.02	33.01
BAND 2 BW: 10M 16QAM RB: 1,49	1855.0	18650	V	26.55	9.62	-5.06	31.11	33.01
			H	24.46	9.62	-5.06	29.02	33.01
	1880.0	18900	V	26.28	9.71	-5.18	30.81	33.01
			H	25.2	9.71	-5.18	29.73	33.01
	1905.0	19150	V	25.2	9.79	-5.13	29.86	33.01
			H	25.05	9.79	-5.13	29.71	33.01

Remark :

- (1) The RBW,VBW of SPA for frequency RBW= 8MHz , VBW= 8MHz

Unless otherwise stated the results shown in this test report refer only to the sample(s) tested and such sample(s) are retained for 90 days only.

除非另有說明，此報告結果僅對測試之樣品負責，同時此樣品僅保留90天。本報告未經本公司書面許可，不可部份複製。

This document is issued by the Company subject to its General Conditions of Service printed overleaf, available on request or accessible at www.sgs.com/terms_and_conditions.htm and, for electronic format documents, subject to Terms and Conditions for Electronic Documents at www.sgs.com/terms_e-document.htm. Attention is drawn to the limitation of liability, indemnification and jurisdiction issues defined therein. Any holder of this document is advised that information contained hereon reflects the Company's findings at the time of its intervention only and within the limits of Client's instructions, if any. The Company's sole responsibility is to its Client and this document does not exonerate parties to a transaction from exercising all their rights and obligations under the transaction documents. This document cannot be reproduced except in full, without prior written approval of the Company. Any unauthorized alteration, forgery or falsification of the content or appearance of this document is unlawful and offenders may be prosecuted to the fullest extent of the law.

SGS Taiwan Ltd.

No.134,WuKungRoad,NewTaipeiIndustrialPark,WukuDistrict,NewTaipeiCity,Taiwan24803/新北市五股區新北產業園區五工路 134 號

台灣檢驗科技股份有限公司

t (886-2) 2299-3279

f (886-2) 2298-0488

www.tw.sgs.com

Member of SGS Group

EUT			Measurement					
Operation Band	Fundamental Frequency	CH	Antenna Pol.	S.G. Output	Antenna Gain	Cable Loss	EIRP	Limit
	MHz		V/H	dBm	dBi	dB	dBm	dBm
BAND 2 BW: 15M QPSK RB: 1,0	1857.5	18675	V	25.86	9.59	-5.05	30.4	33.01
			H	24.23	9.59	-5.05	28.77	33.01
	1880.0	18900	V	26.57	9.67	-5.12	31.12	33.01
			H	25.39	9.67	-5.12	29.94	33.01
	1902.5	19125	V	26.68	9.75	-5.13	31.3	33.01
			H	26.08	9.75	-5.13	30.7	33.01
BAND 2 BW: 15M QPSK RB: 1,74	1857.5	18675	V	26.72	9.64	-5.07	31.29	33.01
			H	25.24	9.64	-5.07	29.81	33.01
	1880.0	18900	V	26.13	9.72	-5.17	30.68	33.01
			H	25.52	9.72	-5.17	30.07	33.01
	1902.5	19125	V	25.67	9.79	-5.13	30.33	33.01
			H	25.43	9.79	-5.13	30.09	33.01
BAND 2 BW: 15M 16QAM RB: 1,0	1857.5	18675	V	25.78	9.59	-5.05	30.32	33.01
			H	24.25	9.59	-5.05	28.79	33.01
	1880.0	18900	V	26.64	9.67	-5.12	31.19	33.01
			H	25.33	9.67	-5.12	29.88	33.01
	1902.5	19125	V	26.24	9.75	-5.13	30.86	33.01
			H	25.83	9.75	-5.13	30.45	33.01
BAND 2 BW: 15M 16QAM RB: 1,74	1857.5	18675	V	26.94	9.64	-5.07	31.51	33.01
			H	24.85	9.64	-5.07	29.42	33.01
	1880.0	18900	V	25.78	9.71	-5.17	30.32	33.01
			H	25.17	9.71	-5.17	29.71	33.01
	1902.5	19125	V	25.54	9.79	-5.13	30.2	33.01
			H	25.47	9.79	-5.13	30.13	33.01

Remark :

- (1) The RBW,VBW of SPA for frequency RBW= 8MHz , VBW= 8MHz

Unless otherwise stated the results shown in this test report refer only to the sample(s) tested and such sample(s) are retained for 90 days only.

除非另有說明，此報告結果僅對測試之樣品負責，同時此樣品僅保留90天。本報告未經本公司書面許可，不可部份複製。

This document is issued by the Company subject to its General Conditions of Service printed overleaf, available on request or accessible at www.sgs.com/terms_and_conditions.htm and, for electronic format documents, subject to Terms and Conditions for Electronic Documents at www.sgs.com/terms_e-document.htm. Attention is drawn to the limitation of liability, indemnification and jurisdiction issues defined therein. Any holder of this document is advised that information contained hereon reflects the Company's findings at the time of its intervention only and within the limits of Client's instructions, if any. The Company's sole responsibility is to its Client and this document does not exonerate parties to a transaction from exercising all their rights and obligations under the transaction documents. This document cannot be reproduced except in full, without prior written approval of the Company. Any unauthorized alteration, forgery or falsification of the content or appearance of this document is unlawful and offenders may be prosecuted to the fullest extent of the law.

SGS Taiwan Ltd.

No.134,WuKungRoad,NewTaipeiIndustrialPark,WukuDistrict,NewTaipeiCity,Taiwan24803/新北市五股區新北產業園區五工路 134 號

台灣檢驗科技股份有限公司

t (886-2) 2299-3279

f (886-2) 2298-0488

www.tw.sgs.com

Member of SGS Group

EUT			Measurement					
Operation Band	Fundamental Frequency	CH	Antenna Pol.	S.G. Output	Antenna Gain	Cable Loss	EIRP	Limit
	MHz		V/H	dBm	dBi	dB	dBm	dBm
BAND 2 BW: 20M QPSK RB: 1,0	1860.0	18700	V	25.58	9.59	-5.05	30.12	33.01
			H	24.15	9.59	-5.05	28.69	33.01
	1880.0	18900	V	26.86	9.66	-5.1	31.42	33.01
			H	25.35	9.66	-5.1	29.91	33.01
	1900.0	19100	V	26.28	9.73	-5.15	30.86	33.01
			H	25.7	9.73	-5.15	30.28	33.01
BAND 2 BW: 20M QPSK RB: 1,99	1860.0	18700	V	26.53	9.66	-5.09	31.1	33.01
			H	25.19	9.66	-5.09	29.76	33.01
	1880.0	18900	V	26.02	9.72	-5.16	30.58	33.01
			H	25.46	9.72	-5.16	30.02	33.01
	1900.0	19100	V	25.59	9.79	-5.13	30.25	33.01
			H	25.39	9.79	-5.13	30.05	33.01
BAND 2 BW: 20M 16QAM RB: 1,0	1860.0	18700	V	25.41	9.6	-5.05	29.96	33.01
			H	23.88	9.6	-5.05	28.43	33.01
	1880.0	18900	V	26.86	9.66	-5.1	31.42	33.01
			H	25.24	9.66	-5.1	29.8	33.01
	1900.0	19100	V	26.09	9.73	-5.15	30.67	33.01
			H	25.28	9.73	-5.15	29.86	33.01
BAND 2 BW: 20M 16QAM RB: 1,99	1860.0	18700	V	26.56	9.65	-5.09	31.12	33.01
			H	24.88	9.65	-5.09	29.44	33.01
	1880.0	18900	V	25.89	9.73	-5.15	30.47	33.01
			H	25.24	9.73	-5.15	29.82	33.01
	1900.0	19100	V	25.64	9.79	-5.13	30.3	33.01
			H	25.41	9.79	-5.13	30.07	33.01

Remark :

- (1) The RBW,VBW of SPA for frequency RBW= 8MHz , VBW= 8MHz

Unless otherwise stated the results shown in this test report refer only to the sample(s) tested and such sample(s) are retained for 90 days only.

除非另有說明，此報告結果僅對測試之樣品負責，同時此樣品僅保留90天。本報告未經本公司書面許可，不可部份複製。

This document is issued by the Company subject to its General Conditions of Service printed overleaf, available on request or accessible at www.sgs.com/terms_and_conditions.htm and, for electronic format documents, subject to Terms and Conditions for Electronic Documents at www.sgs.com/terms_e-document.htm. Attention is drawn to the limitation of liability, indemnification and jurisdiction issues defined therein. Any holder of this document is advised that information contained hereon reflects the Company's findings at the time of its intervention only and within the limits of Client's instructions, if any. The Company's sole responsibility is to its Client and this document does not exonerate parties to a transaction from exercising all their rights and obligations under the transaction documents. This document cannot be reproduced except in full, without prior written approval of the Company. Any unauthorized alteration, forgery or falsification of the content or appearance of this document is unlawful and offenders may be prosecuted to the fullest extent of the law.

SGS Taiwan Ltd.

No.134,WuKungRoad,NewTaipeiIndustrialPark,WukuDistrict,NewTaipeiCity,Taiwan24803/新北市五股區新北產業園區五工路 134 號

台灣檢驗科技股份有限公司

t (886-2) 2299-3279

f (886-2) 2298-0488

www.tw.sgs.com

Member of SGS Group

EUT			Measurement					
Operation Band	Fundamental Frequency	CH	Antenna Pol.	S.G. Output	Antenna Gain	Cable Loss	EIRP	Limit
	MHz		V/H	dBm	dBi	dB	dBm	dBm
BAND 4 BW: 1.4M/ QPSK RB: 1,0	1710.7	19957	V	19.39	9.11	-4.82	23.68	30.00
			H	18.56	9.11	-4.82	22.85	30.00
	1732.5	20175	V	22.65	9.19	-4.85	26.99	30.00
			H	18.57	9.19	-4.85	22.91	30.00
	1754.3	20393	V	24.04	9.26	-4.91	28.39	30.00
			H	22.86	9.26	-4.91	27.21	30.00
BAND 4 BW: 1.4M QPSK RB: 1,5	1710.7	19957	V	19.71	9.11	-4.82	24	30.00
			H	18.63	9.11	-4.82	22.92	30.00
	1732.5	20175	V	22.64	9.19	-4.86	26.97	30.00
			H	18.49	9.19	-4.86	22.82	30.00
	1754.3	20393	V	24.14	9.27	-4.91	28.5	30.00
			H	22.93	9.27	-4.91	27.29	30.00
BAND 4 BW: 1.4M 16QAM RB: 1,0	1710.7	19957	V	19.5	9.11	-4.82	23.79	30.00
			H	18.65	9.11	-4.82	22.94	30.00
	1732.5	20175	V	22.7	9.19	-4.85	27.04	30.00
			H	18.59	9.19	-4.85	22.93	30.00
	1754.3	20393	V	23.76	9.26	-4.9	28.12	30.00
			H	22.71	9.26	-4.9	27.07	30.00
BAND 4 BW: 1.4M 16QAM RB: 1,5	1710.7	19957	V	19.58	9.12	-4.82	23.88	30.00
			H	18.79	9.12	-4.82	23.09	30.00
	1732.5	20175	V	22.75	9.19	-4.86	27.08	30.00
			H	18.37	9.19	-4.86	22.7	30.00
	1754.3	20393	V	24.01	9.27	-4.91	28.37	30.00
			H	22.87	9.27	-4.91	27.23	30.00

Remark :

- (1) The RBW,VBW of SPA for frequency RBW= 8MHz , VBW= 8MHz

Unless otherwise stated the results shown in this test report refer only to the sample(s) tested and such sample(s) are retained for 90 days only.

除非另有說明，此報告結果僅對測試之樣品負責，同時此樣品僅保留90天。本報告未經本公司書面許可，不可部份複製。

This document is issued by the Company subject to its General Conditions of Service printed overleaf, available on request or accessible at www.sgs.com/terms_and_conditions.htm and, for electronic format documents, subject to Terms and Conditions for Electronic Documents at www.sgs.com/terms_e-document.htm. Attention is drawn to the limitation of liability, indemnification and jurisdiction issues defined therein. Any holder of this document is advised that information contained hereon reflects the Company's findings at the time of its intervention only and within the limits of Client's instructions, if any. The Company's sole responsibility is to its Client and this document does not exonerate parties to a transaction from exercising all their rights and obligations under the transaction documents. This document cannot be reproduced except in full, without prior written approval of the Company. Any unauthorized alteration, forgery or falsification of the content or appearance of this document is unlawful and offenders may be prosecuted to the fullest extent of the law.

SGS Taiwan Ltd.

No.134,WuKungRoad,NewTaipeiIndustrialPark,WukuDistrict,NewTaipeiCity,Taiwan24803/新北市五股區新北產業園區五工路 134 號

台灣檢驗科技股份有限公司

t (886-2) 2299-3279

f (886-2) 2298-0488

www.tw.sgs.com

Member of SGS Group

EUT			Measurement					
Operation Band	Fundamental Frequency	CH	Antenna Pol.	S.G. Output	Antenna Gain	Cable Loss	EIRP	Limit
	MHz		V/H	dBm	dBi	dB	dBm	dBm
BAND 4 BW: 3M QPSK RB: 1,0	1711.5	19965	V	21.86	9.11	-4.82	26.15	30.00
			H	22.04	9.11	-4.82	26.33	30.00
	1732.5	20175	V	24.24	9.19	-4.85	28.58	30.00
			H	22.91	9.19	-4.85	27.25	30.00
	1753.5	20385	V	25.31	9.25	-4.91	29.65	30.00
			H	23.24	9.25	-4.91	27.58	30.00
BAND 4 BW: 3M QPSK RB: 1,14	1711.5	19965	V	22.56	9.13	-4.82	26.87	30.00
			H	22.49	9.13	-4.82	26.8	30.00
	1732.5	20175	V	24.16	9.19	-4.86	28.49	30.00
			H	22.7	9.19	-4.86	27.03	30.00
	1753.5	20385	V	25.53	9.27	-4.91	29.89	30.00
			H	23.44	9.27	-4.91	27.8	30.00
BAND 4 BW: 3M 16QAM RB: 1,0	1711.5	19965	V	21.89	9.12	-4.82	26.19	30.00
			H	21.91	9.12	-4.82	26.21	30.00
	1732.5	20175	V	24.27	9.19	-4.85	28.61	30.00
			H	22.84	9.19	-4.85	27.18	30.00
	1753.5	20385	V	25.05	9.26	-4.91	29.4	30.00
			H	23.19	9.26	-4.91	27.54	30.00
BAND 4 BW: 3M 16QAM RB: 1,14	1711.5	19965	V	22.47	9.12	-4.82	26.77	30.00
			H	22.41	9.12	-4.82	26.71	30.00
	1732.5	20175	V	24.11	9.2	-4.86	28.45	30.00
			H	22.63	9.2	-4.86	26.97	30.00
	1753.5	20385	V	25.27	9.27	-4.91	29.63	30.00
			H	23.3	9.27	-4.91	27.66	30.00

Remark :

- (1) The RBW,VBW of SPA for frequency RBW= 8MHz , VBW= 8MHz

Unless otherwise stated the results shown in this test report refer only to the sample(s) tested and such sample(s) are retained for 90 days only.

除非另有說明，此報告結果僅對測試之樣品負責，同時此樣品僅保留90天。本報告未經本公司書面許可，不可部份複製。

This document is issued by the Company subject to its General Conditions of Service printed overleaf, available on request or accessible at www.sgs.com/terms_and_conditions.htm and, for electronic format documents, subject to Terms and Conditions for Electronic Documents at www.sgs.com/terms_e-document.htm. Attention is drawn to the limitation of liability, indemnification and jurisdiction issues defined therein. Any holder of this document is advised that information contained hereon reflects the Company's findings at the time of its intervention only and within the limits of Client's instructions, if any. The Company's sole responsibility is to its Client and this document does not exonerate parties to a transaction from exercising all their rights and obligations under the transaction documents. This document cannot be reproduced except in full, without prior written approval of the Company. Any unauthorized alteration, forgery or falsification of the content or appearance of this document is unlawful and offenders may be prosecuted to the fullest extent of the law.

SGS Taiwan Ltd.

No.134,WuKungRoad,NewTaipeiIndustrialPark,WukuDistrict,NewTaipeiCity,Taiwan24803/新北市五股區新北產業園區五工路 134 號

台灣檢驗科技股份有限公司

t (886-2) 2299-3279

f (886-2) 2298-0488

www.tw.sgs.com

Member of SGS Group

EUT			Measurement					
Operation Band	Fundamental Frequency	CH	Antenna Pol.	S.G. Output	Antenna Gain	Cable Loss	EIRP	Limit
	MHz		V/H	dBm	dBi	dB	dBm	dBm
BAND 4 BW: 5M QPSK RB: 1,0	1712.5	19975	V	22.25	9.12	-4.82	26.55	30.00
			H	23.37	9.12	-4.82	27.67	30.00
	1732.5	20175	V	24.6	9.18	-4.85	28.93	30.00
			H	23.06	9.18	-4.85	27.39	30.00
	1752.5	20375	V	24.99	9.25	-4.91	29.33	30.00
			H	22.81	9.25	-4.91	27.15	30.00
BAND 4 BW: 5M QPSK RB: 1,24	1712.5	19975	V	24.04	9.13	-4.83	28.34	30.00
			H	22.99	9.13	-4.83	27.29	30.00
	1732.5	20175	V	24.28	9.2	-4.86	28.62	30.00
			H	22.37	9.2	-4.86	26.71	30.00
	1752.5	20375	V	25.18	9.27	-4.91	29.54	30.00
			H	23.27	9.27	-4.91	27.63	30.00
BAND 4 BW: 5M 16QAM RB: 1,0	1712.5	19975	V	23.2	9.11	-4.81	27.5	30.00
			H	22.14	9.11	-4.81	26.44	30.00
	1732.5	20175	V	24.24	9.18	-4.85	28.57	30.00
			H	22.56	9.18	-4.85	26.89	30.00
	1752.5	20375	V	24.16	9.25	-4.91	28.5	30.00
			H	22.84	9.25	-4.91	27.18	30.00
BAND 4 BW: 5M 16QAM RB: 1,24	1712.5	19975	V	23.73	9.13	-4.83	28.03	30.00
			H	22.85	9.13	-4.83	27.15	30.00
	1732.5	20175	V	24.04	9.2	-4.86	28.38	30.00
			H	22.24	9.2	-4.86	26.58	30.00
	1752.5	20375	V	25	9.26	-4.91	29.35	30.00
			H	22.99	9.26	-4.91	27.34	30.00

Remark :

- (1) The RBW,VBW of SPA for frequency RBW= 8MHz , VBW= 8MHz

Unless otherwise stated the results shown in this test report refer only to the sample(s) tested and such sample(s) are retained for 90 days only.

除非另有說明，此報告結果僅對測試之樣品負責，同時此樣品僅保留90天。本報告未經本公司書面許可，不可部份複製。

This document is issued by the Company subject to its General Conditions of Service printed overleaf, available on request or accessible at www.sgs.com/terms_and_conditions.htm and, for electronic format documents, subject to Terms and Conditions for Electronic Documents at www.sgs.com/terms_e-document.htm. Attention is drawn to the limitation of liability, indemnification and jurisdiction issues defined therein. Any holder of this document is advised that information contained hereon reflects the Company's findings at the time of its intervention only and within the limits of Client's instructions, if any. The Company's sole responsibility is to its Client and this document does not exonerate parties to a transaction from exercising all their rights and obligations under the transaction documents. This document cannot be reproduced except in full, without prior written approval of the Company. Any unauthorized alteration, forgery or falsification of the content or appearance of this document is unlawful and offenders may be prosecuted to the fullest extent of the law.

EUT			Measurement					
Operation Band	Fundamental Frequency	CH	Antenna Pol.	S.G. Output	Antenna Gain	Cable Loss	EIRP	Limit
	MHz		V/H	dBm	dBi	dB	dBm	dBm
BAND 4 BW: 10M QPSK RB: 1,0	1715.0	20000	V	23.53	9.12	-4.82	27.83	30.00
			H	22.2	9.12	-4.82	26.5	30.00
	1732.5	20175	V	24.71	9.18	-4.84	29.05	30.00
			H	22.6	9.18	-4.84	26.94	30.00
	1750.0	20350	V	24.32	9.24	-4.9	28.66	30.00
			H	22.47	9.24	-4.9	26.81	30.00
BAND 4 BW: 10M QPSK RB: 1,49	1715.0	20000	V	24.24	9.15	-4.83	28.56	30.00
			H	22.69	9.15	-4.83	27.01	30.00
	1732.5	20175	V	23.97	9.2	-4.87	28.3	30.00
			H	23.17	9.2	-4.87	27.5	30.00
	1750.0	20350	V	25.5	9.27	-4.91	29.86	30.00
			H	23.32	9.27	-4.91	27.68	30.00
BAND 4 BW: 10M 16QAM RB: 1,0	1715.0	20000	V	23.55	9.12	-4.82	27.85	30.00
			H	22.04	9.12	-4.82	26.34	30.00
	1732.5	20175	V	24.78	9.18	-4.84	29.12	30.00
			H	22.99	9.18	-4.84	27.33	30.00
	1750.0	20350	V	24.3	9.24	-4.9	28.64	30.00
			H	22.25	9.24	-4.9	26.59	30.00
BAND 4 BW: 10M 16QAM RB: 1,49	1715.0	20000	V	24.16	9.15	-4.83	28.48	30.00
			H	22.57	9.15	-4.83	26.89	30.00
	1732.5	20175	V	23.71	9.2	-4.87	28.04	30.00
			H	21.95	9.2	-4.87	26.28	30.00
	1750.0	20350	V	25.59	9.27	-4.91	29.95	30.00
			H	23.61	9.27	-4.91	27.97	30.00

Remark :

- (1) The RBW,VBW of SPA for frequency RBW= 8MHz , VBW= 8MHz

Unless otherwise stated the results shown in this test report refer only to the sample(s) tested and such sample(s) are retained for 90 days only.

除非另有說明，此報告結果僅對測試之樣品負責，同時此樣品僅保留90天。本報告未經本公司書面許可，不可部份複製。

This document is issued by the Company subject to its General Conditions of Service printed overleaf, available on request or accessible at www.sgs.com/terms_and_conditions.htm and, for electronic format documents, subject to Terms and Conditions for Electronic Documents at www.sgs.com/terms_e-document.htm. Attention is drawn to the limitation of liability, indemnification and jurisdiction issues defined therein. Any holder of this document is advised that information contained hereon reflects the Company's findings at the time of its intervention only and within the limits of Client's instructions, if any. The Company's sole responsibility is to its Client and this document does not exonerate parties to a transaction from exercising all their rights and obligations under the transaction documents. This document cannot be reproduced except in full, without prior written approval of the Company. Any unauthorized alteration, forgery or falsification of the content or appearance of this document is unlawful and offenders may be prosecuted to the fullest extent of the law.

SGS Taiwan Ltd.

No.134,WuKungRoad,NewTaipeiIndustrialPark,WukuDistrict,NewTaipeiCity,Taiwan24803/新北市五股區新北產業園區五工路 134 號

台灣檢驗科技股份有限公司

t (886-2) 2299-3279

f (886-2) 2298-0488

www.tw.sgs.com

Member of SGS Group

EUT			Measurement					
Operation Band	Fundamental Frequency	CH	Antenna Pol.	S.G. Output	Antenna Gain	Cable Loss	EIRP	Limit
	MHz		V/H	dBm	dBi	dB	dBm	dBm
BAND 4 BW: 15M QPSK RB: 1,0	1717.5	20025	V	23.43	9.12	-4.82	27.73	30.00
			H	22.61	9.12	-4.82	26.91	30.00
	1732.5	20175	V	24.77	9.17	-4.84	29.1	30.00
			H	23.3	9.17	-4.84	27.63	30.00
	1747.5	20325	V	24.08	9.22	-4.88	28.42	30.00
			H	22.12	9.22	-4.88	26.46	30.00
BAND 4 BW: 15M QPSK RB: 1,74	1717.5	20025	V	24.52	9.16	-4.84	28.84	30.00
			H	23.13	9.16	-4.84	27.45	30.00
	1732.5	20175	V	23.88	9.21	-4.88	28.21	30.00
			H	22.03	9.21	-4.88	26.36	30.00
	1747.5	20325	V	24.98	9.27	-4.91	29.34	30.00
			H	23.27	9.27	-4.91	27.63	30.00
BAND 4 BW: 15M 16QAM RB: 1,0	1717.5	20025	V	23.56	9.12	-4.82	27.86	30.00
			H	22.54	9.12	-4.82	26.84	30.00
	1732.5	20175	V	24.62	9.17	-4.84	28.95	30.00
			H	22.9	9.17	-4.84	27.23	30.00
	1747.5	20325	V	23.46	9.21	-4.88	27.79	30.00
			H	22.16	9.21	-4.88	26.49	30.00
BAND 4 BW: 15M 16QAM RB: 1,74	1717.5	20025	V	24.15	9.16	-4.84	28.47	30.00
			H	23.09	9.16	-4.84	27.41	30.00
	1732.5	20175	V	23.79	9.21	-4.88	28.12	30.00
			H	21.88	9.21	-4.88	26.21	30.00
	1747.5	20325	V	24.74	9.26	-4.91	29.09	30.00
			H	23.16	9.26	-4.91	27.51	30.00

Remark :

- (1) The RBW,VBW of SPA for frequency RBW= 8MHz , VBW= 8MHz

Unless otherwise stated the results shown in this test report refer only to the sample(s) tested and such sample(s) are retained for 90 days only.

除非另有說明，此報告結果僅對測試之樣品負責，同時此樣品僅保留90天。本報告未經本公司書面許可，不可部份複製。

This document is issued by the Company subject to its General Conditions of Service printed overleaf, available on request or accessible at www.sgs.com/terms_and_conditions.htm and, for electronic format documents, subject to Terms and Conditions for Electronic Documents at www.sgs.com/terms_e-document.htm. Attention is drawn to the limitation of liability, indemnification and jurisdiction issues defined therein. Any holder of this document is advised that information contained hereon reflects the Company's findings at the time of its intervention only and within the limits of Client's instructions, if any. The Company's sole responsibility is to its Client and this document does not exonerate parties to a transaction from exercising all their rights and obligations under the transaction documents. This document cannot be reproduced except in full, without prior written approval of the Company. Any unauthorized alteration, forgery or falsification of the content or appearance of this document is unlawful and offenders may be prosecuted to the fullest extent of the law.

SGS Taiwan Ltd.

No.134,WuKungRoad,NewTaipeiIndustrialPark,WukuDistrict,NewTaipeiCity,Taiwan24803/新北市五股區新北產業園區五工路 134 號

台灣檢驗科技股份有限公司

t (886-2) 2299-3279

f (886-2) 2298-0488

www.tw.sgs.com

Member of SGS Group

EUT			Measurement					
Operation Band	Fundamental Frequency	CH	Antenna Pol.	S.G. Output	Antenna Gain	Cable Loss	EIRP	Limit
	MHz		V/H	dBm	dBi	dB	dBm	dBm
BAND 4 BW: 20M QPSK RB: 1,0	1720.0	20050	V	21.24	9.12	-4.82	25.54	30.00
			H	22.3	9.12	-4.82	26.6	30.00
	1732.5	20175	V	24.33	9.16	-4.84	28.65	30.00
			H	23.34	9.16	-4.84	27.66	30.00
	1745.0	20300	V	23.87	9.2	-4.87	28.2	30.00
			H	22.42	9.2	-4.87	26.75	30.00
BAND 4 BW: 20M QPSK RB: 1,99	1720.0	20050	V	20.33	9.18	-4.85	24.66	30.00
			H	23.17	9.18	-4.85	27.5	30.00
	1732.5	20175	V	23.9	9.22	-4.88	28.24	30.00
			H	22.2	9.22	-4.88	26.54	30.00
	1745.0	20300	V	25.49	9.26	-4.91	29.84	30.00
			H	23.25	9.26	-4.91	27.6	30.00
BAND 4 BW: 20M 16QAM RB: 1,0	1720.0	20050	V	21	9.12	-4.82	25.3	30.00
			H	22.06	9.12	-4.82	26.36	30.00
	1732.5	20175	V	24.2	9.16	-4.84	28.52	30.00
			H	22.63	9.16	-4.84	26.95	30.00
	1745.0	20300	V	23.81	9.2	-4.87	28.14	30.00
			H	22.29	9.2	-4.87	26.62	30.00
BAND 4 BW: 20M 16QAM RB: 1,99	1720.0	20050	V	19.82	9.17	-4.85	24.14	30.00
			H	22.68	9.17	-4.85	27	30.00
	1732.5	20175	V	23.99	9.22	-4.88	28.33	30.00
			H	21.94	9.22	-4.88	26.28	30.00
	1745.0	20300	V	25.56	9.26	-4.91	29.91	30.00
			H	23.21	9.26	-4.91	27.56	30.00

Remark :

- (1) The RBW,VBW of SPA for frequency RBW= 8MHz , VBW= 8MHz

Unless otherwise stated the results shown in this test report refer only to the sample(s) tested and such sample(s) are retained for 90 days only.

除非另有說明，此報告結果僅對測試之樣品負責，同時此樣品僅保留90天。本報告未經本公司書面許可，不可部份複製。

This document is issued by the Company subject to its General Conditions of Service printed overleaf, available on request or accessible at www.sgs.com/terms_and_conditions.htm and, for electronic format documents, subject to Terms and Conditions for Electronic Documents at www.sgs.com/terms_e-document.htm. Attention is drawn to the limitation of liability, indemnification and jurisdiction issues defined therein. Any holder of this document is advised that information contained hereon reflects the Company's findings at the time of its intervention only and within the limits of Client's instructions, if any. The Company's sole responsibility is to its Client and this document does not exonerate parties to a transaction from exercising all their rights and obligations under the transaction documents. This document cannot be reproduced except in full, without prior written approval of the Company. Any unauthorized alteration, forgery or falsification of the content or appearance of this document is unlawful and offenders may be prosecuted to the fullest extent of the law.

SGS Taiwan Ltd.

No.134,WuKungRoad,NewTaipeiIndustrialPark,WukuDistrict,NewTaipeiCity,Taiwan24803/新北市五股區新北產業園區五工路 134 號

台灣檢驗科技股份有限公司

t (886-2) 2299-3279

f (886-2) 2298-0488

www.tw.sgs.com

Member of SGS Group

EUT			Measurement					
Operation Band	Fundamental Frequency	CH	Antenna Pol.	S.G. Output	Antenna Gain	Cable Loss	ERP	Limit
	MHz		V/H	dBm	dBd	dB	dBm	dBm
BAND 5 BW: 1.4M QPSK RB: 1,0	824.7	20407	V	22.14	5.49	-3.32	24.31	38.45
			H	18.08	5.49	-3.32	20.25	38.45
	836.5	20525	V	24.8	5.47	-3.35	26.92	38.45
			H	18.23	5.47	-3.35	20.35	38.45
	848.3	20643	V	22.8	5.45	-3.08	25.17	38.45
			H	18.21	5.45	-3.08	20.58	38.45
BAND 5 BW: 1.4M QPSK RB: 1,5	824.7	20407	V	21.81	5.49	-3.27	24.03	38.45
			H	17.91	5.49	-3.27	20.13	38.45
	836.5	20525	V	24.59	5.47	-3.25	26.81	38.45
			H	17.84	5.47	-3.25	20.06	38.45
	848.3	20643	V	22.9	5.45	-3.1	25.25	38.45
			H	18.32	5.45	-3.1	20.67	38.45
BAND 5 BW: 1.4M 16QAM RB: 1,0	824.7	20407	V	21.65	5.49	-3.38	23.76	38.45
			H	17.69	5.49	-3.38	19.8	38.45
	836.5	20525	V	24.15	5.47	-3.35	26.27	38.45
			H	17.66	5.47	-3.35	19.78	38.45
	848.3	20643	V	22.71	5.45	-3.08	25.08	38.45
			H	17.78	5.45	-3.08	20.15	38.45
BAND 5 BW: 1.4M 16QAM RB: 1,5	824.7	20407	V	21.57	5.48	-3.23	23.82	38.45
			H	17.41	5.48	-3.23	19.66	38.45
	836.5	20525	V	24.13	5.47	-3.32	26.28	38.45
			H	17.8	5.47	-3.32	19.95	38.45
	848.3	20643	V	22.5	5.45	-3.16	24.79	38.45
			H	17.58	5.45	-3.16	19.87	38.45

Remark :

- (1) The RBW,VBW of SPA for frequency RBW= 8MHz , VBW= 8MHz

Unless otherwise stated the results shown in this test report refer only to the sample(s) tested and such sample(s) are retained for 90 days only.

除非另有說明，此報告結果僅對測試之樣品負責，同時此樣品僅保留90天。本報告未經本公司書面許可，不可部份複製。

This document is issued by the Company subject to its General Conditions of Service printed overleaf, available on request or accessible at www.sgs.com/terms_and_conditions.htm and, for electronic format documents, subject to Terms and Conditions for Electronic Documents at www.sgs.com/terms_e-document.htm. Attention is drawn to the limitation of liability, indemnification and jurisdiction issues defined therein. Any holder of this document is advised that information contained hereon reflects the Company's findings at the time of its intervention only and within the limits of Client's instructions, if any. The Company's sole responsibility is to its Client and this document does not exonerate parties to a transaction from exercising all their rights and obligations under the transaction documents. This document cannot be reproduced except in full, without prior written approval of the Company. Any unauthorized alteration, forgery or falsification of the content or appearance of this document is unlawful and offenders may be prosecuted to the fullest extent of the law.

SGS Taiwan Ltd.

No.134,WuKungRoad,NewTaipeiIndustrialPark,WukuDistrict,NewTaipeiCity,Taiwan24803/新北市五股區新北產業園區五工路 134 號

台灣檢驗科技股份有限公司

t (886-2) 2299-3279

f (886-2) 2298-0488

www.tw.sgs.com

Member of SGS Group

EUT			Measurement					
Operation Band	Fundamental Frequency	CH	Antenna Pol.	S.G. Output	Antenna Gain	Cable Loss	ERP	Limit
	MHz		V/H	dBm	dBd	dB	dBm	dBm
BAND 5 BW: 3M QPSK RB: 1,0	825.5	20415	V	20.71	5.49	-3.34	22.86	38.45
			H	18.4	5.49	-3.34	20.55	38.45
	836.5	20525	V	19.78	5.47	-3.36	21.89	38.45
			H	19.05	5.47	-3.36	21.16	38.45
	847.5	20635	V	21.62	5.45	-3.24	23.83	38.45
			H	19.17	5.45	-3.24	21.38	38.45
BAND 5 BW: 3M QPSK RB: 1,14	825.5	20415	V	20.23	5.48	-3.21	22.5	38.45
			H	18.22	5.48	-3.21	20.49	38.45
	836.5	20525	V	19.18	5.47	-3.25	21.4	38.45
			H	19.06	5.47	-3.25	21.28	38.45
	847.5	20635	V	21.53	5.45	-3.08	23.9	38.45
			H	19.44	5.45	-3.08	21.81	38.45
BAND 5 BW: 3M 16QAM RB: 1,0	825.5	20415	V	20.59	5.49	-3.31	22.77	38.45
			H	18.22	5.49	-3.31	20.4	38.45
	836.5	20525	V	19.83	5.47	-3.36	21.94	38.45
			H	18.97	5.47	-3.36	21.08	38.45
	847.5	20635	V	21.38	5.45	-3.24	23.59	38.45
			H	19.05	5.45	-3.24	21.26	38.45
BAND 5 BW: 3M 16QAM RB: 1,14	825.5	20415	V	20.12	5.48	-3.21	22.39	38.45
			H	18.17	5.48	-3.21	20.44	38.45
	836.5	20525	V	18.94	5.47	-3.25	21.16	38.45
			H	18.83	5.47	-3.25	21.05	38.45
	847.5	20635	V	21.2	5.45	-3.08	23.57	38.45
			H	19.1	5.45	-3.08	21.47	38.45

Remark :

- (1) The RBW,VBW of SPA for frequency RBW= 8MHz , VBW= 8MHz

Unless otherwise stated the results shown in this test report refer only to the sample(s) tested and such sample(s) are retained for 90 days only.

除非另有說明，此報告結果僅對測試之樣品負責，同時此樣品僅保留90天。本報告未經本公司書面許可，不可部份複製。

This document is issued by the Company subject to its General Conditions of Service printed overleaf, available on request or accessible at www.sgs.com/terms_and_conditions.htm and, for electronic format documents, subject to Terms and Conditions for Electronic Documents at www.sgs.com/terms_e-document.htm. Attention is drawn to the limitation of liability, indemnification and jurisdiction issues defined therein. Any holder of this document is advised that information contained hereon reflects the Company's findings at the time of its intervention only and within the limits of Client's instructions, if any. The Company's sole responsibility is to its Client and this document does not exonerate parties to a transaction from exercising all their rights and obligations under the transaction documents. This document cannot be reproduced except in full, without prior written approval of the Company. Any unauthorized alteration, forgery or falsification of the content or appearance of this document is unlawful and offenders may be prosecuted to the fullest extent of the law.

SGS Taiwan Ltd.

No.134,WuKungRoad,NewTaipeiIndustrialPark,WukuDistrict,NewTaipeiCity,Taiwan24803/新北市五股區新北產業園區五工路 134 號

台灣檢驗科技股份有限公司

t (886-2) 2299-3279

f (886-2) 2298-0488

www.tw.sgs.com

Member of SGS Group

EUT			Measurement					
Operation Band	Fundamental Frequency	CH	Antenna Pol.	S.G. Output	Antenna Gain	Cable Loss	ERP	Limit
	MHz		V/H	dBm	dBd	dB	dBm	dBm
BAND 5 BW: 5M QPSK RB: 1,0	826.5	20425	V	22.07	5.49	-3.34	24.22	38.45
			H	18.4	5.49	-3.34	20.55	38.45
	836.5	20525	V	19.94	5.47	-3.37	22.04	38.45
			H	18.93	5.47	-3.37	21.03	38.45
	846.5	20625	V	19.74	5.46	-3.47	21.73	38.45
			H	18.91	5.46	-3.47	20.9	38.45
BAND 5 BW: 5M QPSK RB: 1,24	826.5	20425	V	21.8	5.48	-3.16	24.12	38.45
			H	18.02	5.48	-3.16	20.34	38.45
	836.5	20525	V	19.39	5.47	-3.13	21.73	38.45
			H	18.51	5.47	-3.13	20.85	38.45
	846.5	20625	V	19.41	5.45	-3.08	21.78	38.45
			H	19	5.45	-3.08	21.37	38.45
BAND 5 BW: 5M 16QAM RB: 1,0	826.5	20425	V	21.97	5.49	-3.49	23.97	38.45
			H	18.22	5.49	-3.49	20.22	38.45
	836.5	20525	V	19.6	5.47	-3.37	21.7	38.45
			H	19.45	5.47	-3.37	21.55	38.45
	846.5	20625	V	19.36	5.46	-3.46	21.36	38.45
			H	18.69	5.46	-3.46	20.69	38.45
BAND 5 BW: 5M 16QAM RB: 1,24	826.5	20425	V	21.55	5.48	-3.17	23.86	38.45
			H	17.82	5.48	-3.17	20.13	38.45
	836.5	20525	V	19.25	5.47	-3.13	21.59	38.45
			H	18.32	5.47	-3.13	20.66	38.45
	846.5	20625	V	19.17	5.45	-3.08	21.54	38.45
			H	19.08	5.45	-3.08	21.45	38.45

Remark :

- (1) The RBW,VBW of SPA for frequency RBW= 8MHz , VBW= 8MHz

Unless otherwise stated the results shown in this test report refer only to the sample(s) tested and such sample(s) are retained for 90 days only.

除非另有說明，此報告結果僅對測試之樣品負責，同時此樣品僅保留90天。本報告未經本公司書面許可，不可部份複製。

This document is issued by the Company subject to its General Conditions of Service printed overleaf, available on request or accessible at www.sgs.com/terms_and_conditions.htm and, for electronic format documents, subject to Terms and Conditions for Electronic Documents at www.sgs.com/terms_e-document.htm. Attention is drawn to the limitation of liability, indemnification and jurisdiction issues defined therein. Any holder of this document is advised that information contained hereon reflects the Company's findings at the time of its intervention only and within the limits of Client's instructions, if any. The Company's sole responsibility is to its Client and this document does not exonerate parties to a transaction from exercising all their rights and obligations under the transaction documents. This document cannot be reproduced except in full, without prior written approval of the Company. Any unauthorized alteration, forgery or falsification of the content or appearance of this document is unlawful and offenders may be prosecuted to the fullest extent of the law.

SGS Taiwan Ltd.

No.134,WuKungRoad,NewTaipeiIndustrialPark,WukuDistrict,NewTaipeiCity,Taiwan24803/新北市五股區新北產業園區五工路 134 號

台灣檢驗科技股份有限公司

t (886-2) 2299-3279

f (886-2) 2298-0488

www.tw.sgs.com

Member of SGS Group

EUT			Measurement					
Operation Band	Fundamental Frequency	CH	Antenna Pol.	S.G. Output	Antenna Gain	Cable Loss	ERP	Limit
	MHz		V/H	dBm	dBd	dB	dBm	dBm
BAND 5 BW: 10M QPSK RB: 1,0	829.0	20450	V	20.66	5.49	-3.38	22.77	38.45
			H	18.65	5.49	-3.38	20.76	38.45
	836.5	20525	V	20.58	5.47	-3.5	22.55	38.45
			H	19.17	5.47	-3.5	21.14	38.45
	844.0	20600	V	21.52	5.46	-3.12	23.86	38.45
			H	18.53	5.46	-3.12	20.87	38.45
BAND 5 BW: 10M QPSK RB: 1,49	829.0	20450	V	20.29	5.47	-3.48	22.28	38.45
			H	19.16	5.47	-3.48	21.15	38.45
	836.5	20525	V	19.72	5.46	-3.44	21.74	38.45
			H	18.9	5.46	-3.44	20.92	38.45
	844.0	20600	V	21.02	5.45	-3.1	23.37	38.45
			H	19.17	5.45	-3.1	21.52	38.45
BAND 5 BW: 10M 16QAM RB: 1,0	829.0	20450	V	20.45	5.49	-3.28	22.66	38.45
			H	18.22	5.49	-3.28	20.43	38.45
	836.5	20525	V	20.51	5.48	-3.48	22.51	38.45
			H	19.15	5.48	-3.48	21.15	38.45
	844.0	20600	V	21.4	5.46	-3.19	23.67	38.45
			H	18.42	5.46	-3.19	20.69	38.45
BAND 5 BW: 10M 16QAM RB: 1,49	829.0	20450	V	20.33	5.47	-3.44	22.36	38.45
			H	18.79	5.47	-3.44	20.82	38.45
	836.5	20525	V	19.37	5.46	-3.46	21.37	38.45
			H	18.49	5.46	-3.46	20.49	38.45
	844.0	20600	V	20.79	5.45	-3.14	23.1	38.45
			H	18.93	5.45	-3.14	21.24	38.45

Remark :

- (1) The RBW,VBW of SPA for frequency RBW= 8MHz , VBW= 8MHz

Unless otherwise stated the results shown in this test report refer only to the sample(s) tested and such sample(s) are retained for 90 days only.

除非另有說明，此報告結果僅對測試之樣品負責，同時此樣品僅保留90天。本報告未經本公司書面許可，不可部份複製。

This document is issued by the Company subject to its General Conditions of Service printed overleaf, available on request or accessible at www.sgs.com/terms_and_conditions.htm and, for electronic format documents, subject to Terms and Conditions for Electronic Documents at www.sgs.com/terms_e-document.htm. Attention is drawn to the limitation of liability, indemnification and jurisdiction issues defined therein. Any holder of this document is advised that information contained hereon reflects the Company's findings at the time of its intervention only and within the limits of Client's instructions, if any. The Company's sole responsibility is to its Client and this document does not exonerate parties to a transaction from exercising all their rights and obligations under the transaction documents. This document cannot be reproduced except in full, without prior written approval of the Company. Any unauthorized alteration, forgery or falsification of the content or appearance of this document is unlawful and offenders may be prosecuted to the fullest extent of the law.

SGS Taiwan Ltd.

No.134,WuKungRoad,NewTaipeiIndustrialPark,WukuDistrict,NewTaipeiCity,Taiwan24803/新北市五股區新北產業園區五工路 134 號

台灣檢驗科技股份有限公司

t (886-2) 2299-3279

f (886-2) 2298-0488

www.tw.sgs.com

Member of SGS Group

EUT			Measurement					
Operation Band	Fundamental Frequency	CH	Antenna Pol.	S.G. Output	Antenna Gain	Cable Loss	ERP	Limit
	MHz		V/H	dBm	dBd	dB	dBm	dBm
BAND 12 BW: 1.4M QPSK RB: 1,0	699.7	23017	V	19.83	5.46	-3.06	22.23	34.77
			H	16.68	5.46	-3.06	19.08	34.77
	707.5	23095	V	15.04	5.46	-3.19	17.31	34.77
			H	13.26	5.46	-3.19	15.53	34.77
	715.3	23173	V	16	5.46	-2.92	18.54	34.77
			H	5.76	5.46	-2.95	8.27	34.77
BAND 12 BW: 1.4M QPSK RB: 1,5	699.7	23017	V	20.28	5.46	-3	22.74	34.77
			H	16.59	5.46	-3	19.05	34.77
	707.5	23095	V	14.66	5.46	-3.23	16.89	34.77
			H	12.73	5.46	-3.23	14.96	34.77
	715.3	23173	V	15.41	5.46	-3.11	17.76	34.77
			H	12.81	5.46	-3.11	15.16	34.77
BAND 12 BW: 1.4M 16QAM RB: 1,0	699.7	23017	V	19.93	5.46	-3.05	22.34	34.77
			H	16.19	5.46	-3.05	18.6	34.77
	707.5	23095	V	15.81	5.46	-3.2	18.07	34.77
			H	13.3	5.46	-3.2	15.56	34.77
	715.3	23173	V	16.82	5.46	-2.92	19.36	34.77
			H	13.68	5.46	-2.92	16.22	34.77
BAND 12 BW: 1.4M 16QAM RB: 1,5	699.7	23017	V	19.92	5.46	-3	22.38	34.77
			H	16.37	5.46	-3	18.83	34.77
	707.5	23095	V	15.39	5.46	-3.23	17.62	34.77
			H	12.8	5.46	-3.23	15.03	34.77
	715.3	23173	V	16.14	5.46	-3.11	18.49	34.77
			H	13.43	5.46	-3.11	15.78	34.77

Remark :

- (1) The RBW,VBW of SPA for frequency RBW= 8MHz , VBW= 8MHz

Unless otherwise stated the results shown in this test report refer only to the sample(s) tested and such sample(s) are retained for 90 days only.

除非另有說明，此報告結果僅對測試之樣品負責，同時此樣品僅保留90天。本報告未經本公司書面許可，不可部份複製。

This document is issued by the Company subject to its General Conditions of Service printed overleaf, available on request or accessible at www.sgs.com/terms_and_conditions.htm and, for electronic format documents, subject to Terms and Conditions for Electronic Documents at www.sgs.com/terms_e-document.htm. Attention is drawn to the limitation of liability, indemnification and jurisdiction issues defined therein. Any holder of this document is advised that information contained hereon reflects the Company's findings at the time of its intervention only and within the limits of Client's instructions, if any. The Company's sole responsibility is to its Client and this document does not exonerate parties to a transaction from exercising all their rights and obligations under the transaction documents. This document cannot be reproduced except in full, without prior written approval of the Company. Any unauthorized alteration, forgery or falsification of the content or appearance of this document is unlawful and offenders may be prosecuted to the fullest extent of the law.

SGS Taiwan Ltd.

No.134,WuKungRoad,NewTaipeiIndustrialPark,WukuDistrict,NewTaipeiCity,Taiwan24803/新北市五股區新北產業園區五工路 134 號

台灣檢驗科技股份有限公司

t (886-2) 2299-3279

f (886-2) 2298-0488

www.tw.sgs.com

Member of SGS Group

EUT			Measurement					
Operation Band	Fundamental Frequency	CH	Antenna Pol.	S.G. Output	Antenna Gain	Cable Loss	ERP	Limit
	MHz		V/H	dBm	dBd	dB	dBm	dBm
BAND 12 BW: 3M QPSK RB: 1,0	700.5	23025	V	19.1	5.45	-3.16	21.39	34.77
			H	15.11	5.45	-3.16	17.4	34.77
	707.5	23095	V	18.7	5.46	-3.12	21.04	34.77
			H	14.81	5.46	-3.12	17.15	34.77
	714.5	23165	V	19.14	5.46	-2.91	21.69	34.77
			H	15.4	5.46	-2.91	17.95	34.77
BAND 12 BW: 3M QPSK RB: 1,14	700.5	23025	V	20.05	5.46	-3.02	22.49	34.77
			H	15.78	5.46	-3.02	18.22	34.77
	707.5	23095	V	17.73	5.46	-3.18	20.01	34.77
			H	13.71	5.46	-3.18	15.99	34.77
	714.5	23165	V	17.49	5.46	-3.08	19.87	34.77
			H	13.77	5.46	-3.08	16.15	34.77
BAND 12 BW: 3M 16QAM RB: 1,0	700.5	23025	V	19.02	5.46	-3.11	21.37	34.77
			H	14.79	5.46	-3.11	17.14	34.77
	707.5	23095	V	18.8	5.46	-3.09	21.17	34.77
			H	14.61	5.46	-3.09	16.98	34.77
	714.5	23165	V	19.03	5.46	-2.97	21.52	34.77
			H	15.53	5.46	-2.97	18.02	34.77
BAND 12 BW: 3M 16QAM RB: 1,14	700.5	23025	V	19.75	5.46	-3.02	22.19	34.77
			H	15.64	5.46	-3.02	18.08	34.77
	707.5	23095	V	17.48	5.46	-3.19	19.75	34.77
			H	13.65	5.46	-3.19	15.92	34.77
	714.5	23165	V	17.5	5.46	-3.07	19.89	34.77
			H	13.99	5.46	-3.07	16.38	34.77

Remark :

- (1) The RBW,VBW of SPA for frequency RBW= 8MHz , VBW= 8MHz

Unless otherwise stated the results shown in this test report refer only to the sample(s) tested and such sample(s) are retained for 90 days only.

除非另有說明，此報告結果僅對測試之樣品負責，同時此樣品僅保留90天。本報告未經本公司書面許可，不可部份複製。

This document is issued by the Company subject to its General Conditions of Service printed overleaf, available on request or accessible at www.sgs.com/terms_and_conditions.htm and, for electronic format documents, subject to Terms and Conditions for Electronic Documents at www.sgs.com/terms_e-document.htm. Attention is drawn to the limitation of liability, indemnification and jurisdiction issues defined therein. Any holder of this document is advised that information contained hereon reflects the Company's findings at the time of its intervention only and within the limits of Client's instructions, if any. The Company's sole responsibility is to its Client and this document does not exonerate parties to a transaction from exercising all their rights and obligations under the transaction documents. This document cannot be reproduced except in full, without prior written approval of the Company. Any unauthorized alteration, forgery or falsification of the content or appearance of this document is unlawful and offenders may be prosecuted to the fullest extent of the law.

SGS Taiwan Ltd.

No.134,WuKungRoad,NewTaipeiIndustrialPark,WukuDistrict,NewTaipeiCity,Taiwan24803/新北市五股區新北產業園區五工路 134 號

台灣檢驗科技股份有限公司

t (886-2) 2299-3279

f (886-2) 2298-0488

www.tw.sgs.com

Member of SGS Group

EUT			Measurement					
Operation Band	Fundamental Frequency	CH	Antenna Pol.	S.G. Output	Antenna Gain	Cable Loss	ERP	Limit
	MHz		V/H	dBm	dBd	dB	dBm	dBm
BAND 12 BW: 5M QPSK RB: 1,0	701.5	23035	V	19.12	5.45	-3.15	21.42	34.77
			H	15.1	5.45	-3.15	17.4	34.77
	707.5	23095	V	19.3	5.46	-3	21.76	34.77
			H	15.27	5.46	-3	17.73	34.77
	713.5	23155	V	18.67	5.46	-3.08	21.05	34.77
			H	14.93	5.46	-3.08	17.31	34.77
BAND 12 BW: 5M QPSK RB: 1,24	701.5	23035	V	19.71	5.46	-3.03	22.14	34.77
			H	15.85	5.46	-3.03	18.28	34.77
	707.5	23095	V	17.62	5.46	-3.11	19.97	34.77
			H	13.75	5.46	-3.11	16.1	34.77
	713.5	23155	V	17.33	5.46	-3.14	19.65	34.77
			H	13.91	5.46	-3.14	16.23	34.77
BAND 12 BW: 5M 16QAM RB: 1,0	701.5	23035	V	19.02	5.46	-3.11	21.37	34.77
			H	15.04	5.46	-3.11	17.39	34.77
	707.5	23095	V	19.2	5.46	-3	21.66	34.77
			H	15.2	5.46	-3	17.66	34.77
	713.5	23155	V	18.29	5.46	-3.08	20.67	34.77
			H	14.89	5.46	-3.08	17.27	34.77
BAND 12 BW: 5M 16QAM RB: 1,24	701.5	23035	V	19.37	5.47	-3.02	21.82	34.77
			H	15.23	5.47	-3.02	17.68	34.77
	707.5	23095	V	17.62	5.46	-3.11	19.97	34.77
			H	13.78	5.46	-3.11	16.13	34.77
	713.5	23155	V	17.45	5.46	-3.08	19.83	34.77
			H	13.91	5.46	-3.08	16.29	34.77

Remark :

- (1) The RBW,VBW of SPA for frequency RBW= 8MHz , VBW= 8MHz

Unless otherwise stated the results shown in this test report refer only to the sample(s) tested and such sample(s) are retained for 90 days only.

除非另有說明，此報告結果僅對測試之樣品負責，同時此樣品僅保留90天。本報告未經本公司書面許可，不可部份複製。

This document is issued by the Company subject to its General Conditions of Service printed overleaf, available on request or accessible at www.sgs.com/terms_and_conditions.htm and, for electronic format documents, subject to Terms and Conditions for Electronic Documents at www.sgs.com/terms_e-document.htm. Attention is drawn to the limitation of liability, indemnification and jurisdiction issues defined therein. Any holder of this document is advised that information contained hereon reflects the Company's findings at the time of its intervention only and within the limits of Client's instructions, if any. The Company's sole responsibility is to its Client and this document does not exonerate parties to a transaction from exercising all their rights and obligations under the transaction documents. This document cannot be reproduced except in full, without prior written approval of the Company. Any unauthorized alteration, forgery or falsification of the content or appearance of this document is unlawful and offenders may be prosecuted to the fullest extent of the law.

SGS Taiwan Ltd.

No.134,WuKungRoad,NewTaipeiIndustrialPark,WukuDistrict,NewTaipeiCity,Taiwan24803/新北市五股區新北產業園區五工路 134 號

台灣檢驗科技股份有限公司

t (886-2) 2299-3279

f (886-2) 2298-0488

www.tw.sgs.com

Member of SGS Group

EUT			Measurement					
Operation Band	Fundamental Frequency	CH	Antenna Pol.	S.G. Output	Antenna Gain	Cable Loss	ERP	Limit
	MHz		V/H	dBm	dBd	dB	dBm	dBm
BAND 12 BW: 10M QPSK RB: 1,0	704.0	23060	V	18.82	5.46	-3.06	21.22	34.77
			H	14.38	5.46	-3.06	16.78	34.77
	707.5	23095	V	19.7	5.46	-3.03	22.13	34.77
			H	15.39	5.46	-3.03	17.82	34.77
	711.0	23130	V	18.26	5.46	-3.14	20.58	34.77
			H	14.85	5.46	-3.14	17.17	34.77
BAND 12 BW: 10M QPSK RB: 1,49	704.0	23060	V	17.49	5.46	-3.19	19.76	34.77
			H	13.51	5.46	-3.19	15.78	34.77
	707.5	23095	V	18.24	5.46	-3.06	20.64	34.77
			H	14.54	5.46	-3.06	16.94	34.77
	711.0	23130	V	17.28	5.46	-3.04	19.7	34.77
			H	13.99	5.46	-3.04	16.41	34.77
BAND 12 BW: 10M 16QAM RB: 1,0	704.0	23060	V	18.69	5.45	-3.15	20.99	34.77
			H	14.42	5.45	-3.15	16.72	34.77
	707.5	23095	V	19.5	5.46	-3.03	21.93	34.77
			H	15.04	5.46	-3.03	17.47	34.77
	711.0	23130	V	18.36	5.46	-3.14	20.68	34.77
			H	14.51	5.46	-3.14	16.83	34.77
BAND 12 BW: 10M 16QAM RB: 1,49	704.0	23060	V	17.39	5.46	-3.22	19.63	34.77
			H	13.34	5.46	-3.22	15.58	34.77
	707.5	23095	V	18.13	5.46	-3.07	20.52	34.77
			H	14.35	5.46	-3.07	16.74	34.77
	711.0	23130	V	17.3	5.46	-3.05	19.71	34.77
			H	14.01	5.46	-3.05	16.42	34.77

Remark :

- (1) The RBW,VBW of SPA for frequency RBW= 8MHz , VBW= 8MHz

Unless otherwise stated the results shown in this test report refer only to the sample(s) tested and such sample(s) are retained for 90 days only.

除非另有說明，此報告結果僅對測試之樣品負責，同時此樣品僅保留90天。本報告未經本公司書面許可，不可部份複製。

This document is issued by the Company subject to its General Conditions of Service printed overleaf, available on request or accessible at www.sgs.com/terms_and_conditions.htm and, for electronic format documents, subject to Terms and Conditions for Electronic Documents at www.sgs.com/terms_e-document.htm. Attention is drawn to the limitation of liability, indemnification and jurisdiction issues defined therein. Any holder of this document is advised that information contained hereon reflects the Company's findings at the time of its intervention only and within the limits of Client's instructions, if any. The Company's sole responsibility is to its Client and this document does not exonerate parties to a transaction from exercising all their rights and obligations under the transaction documents. This document cannot be reproduced except in full, without prior written approval of the Company. Any unauthorized alteration, forgery or falsification of the content or appearance of this document is unlawful and offenders may be prosecuted to the fullest extent of the law.

SGS Taiwan Ltd.

No.134,WuKungRoad,NewTaipeiIndustrialPark,WukuDistrict,NewTaipeiCity,Taiwan24803/新北市五股區新北產業園區五工路 134 號

台灣檢驗科技股份有限公司

t (886-2) 2299-3279

f (886-2) 2298-0488

www.tw.sgs.com

Member of SGS Group

8. OCCUPIED BANDWIDTH MEASUREMENT

8.1. Standard Applicable

The occupied bandwidth is the frequency bandwidth such that, below its lower and above its upper frequency limits, the mean powers radiated are each equal to 0.5 percent of the total mean power.

8.2. Test Set-up

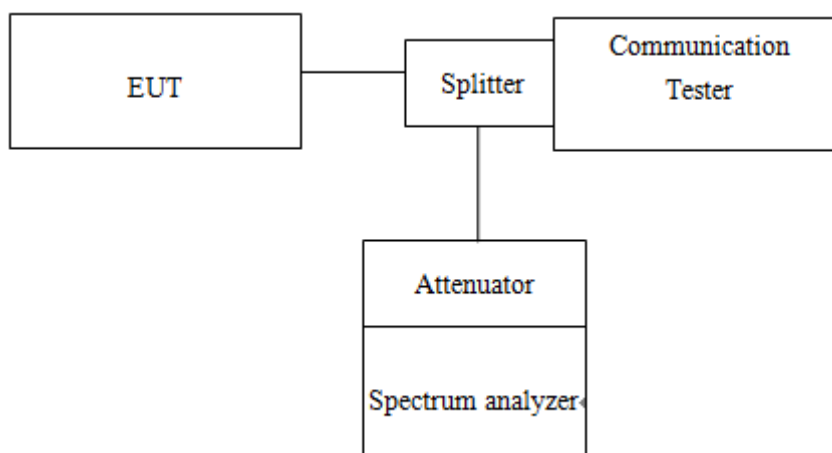

8.3. Measurement Procedure

99% & 26dB Bandwidth with detector peak

The EUT's output RF connector was connected with a short cable to the spectrum analyzer, RBW was set to about 1% of emission BW, VBW= 3 times RBW, -26dBc display line was placed on the screen (or 26dB bandwidth), the occupied bandwidth is the delta frequency between the two points where the display line intersects the signal trace. Then set RBW to 99% bandwidth, RBW= 1%, VBW= 3 RBW, with span > 2 * Signal BW, set % Power = 99%.

99% Bandwidth with detector sample

The EUT's output RF connector was connected with a short cable to the spectrum analyzer, RBW was set to about 1% ~ 5% of emission BW, VBW= 3 times RBW, -20dBc display line was placed on the screen (or 20dB bandwidth). Set RBW to 99% bandwidth, RBW= 1% ~ 5%, VBW= 3 RBW, with span > 2 * Signal BW, set % Power = 99%.

NOTE: For the plot of bandwidth measurement, the marker of the 99% bandwidth is diamond-shape while the marker of the 20dB BW is arrow-mark

Unless otherwise stated the results shown in this test report refer only to the sample(s) tested and such sample(s) are retained for 90 days only.

除非另有說明，此報告結果僅對測試之樣品負責，同時此樣品僅保留90天。本報告未經本公司書面許可，不可部份複製。

This document is issued by the Company subject to its General Conditions of Service printed overleaf, available on request or accessible at www.sgs.com/terms_and_conditions.htm and, for electronic format documents, subject to Terms and Conditions for Electronic Documents at www.sgs.com/terms_e-document.htm. Attention is drawn to the limitation of liability, indemnification and jurisdiction issues defined therein. Any holder of this document is advised that information contained hereon reflects the Company's findings at the time of its intervention only and within the limits of Client's instructions, if any. The Company's sole responsibility is to its Client and this document does not exonerate parties to a transaction from exercising all their rights and obligations under the transaction documents. This document cannot be reproduced except in full, without prior written approval of the Company. Any unauthorized alteration, forgery or falsification of the content or appearance of this document is unlawful and offenders may be prosecuted to the fullest extent of the law.

8.4. Measurement Equipment Used

Conducted Emission (measured at antenna port) Test Site					
EQUIPMENT TYPE	MFR	MODEL NUMBER	SERIAL NUMBER	LAST CAL.	CAL DUE.
Spectrum Analyzer	KEYSIGHT	N9010A	MY54510568	04/14/2016	04/13/2017
Communication Tester	Anritsu	MT8820C	6201107337	05/25/2016	05/24/2017
Coaxial Cable 30cm	WOKEN	00100A1F1 A195C	RF01	12/12/2016	12/11/2017
Temperature Chamber	TERCHY	MHK-120LK	1020582	06/16/2016	06/15/2017
DC Block	PASTERNAK	PE8210	RF29	12/12/2016	12/11/2017
Splitter	RF-LAMBAD	RFLT2W1G 18G	RF35	12/12/2016	12/11/2017
Attenuator	WOKEN	218FS-10	RF23	12/12/2016	12/11/2017
DC Power Supply	Agilent	E3640A	MY53140006	05/04/2016	05/03/2017
Communication Tester	Anritsu	MT8820C	6201107337	05/25/2016	05/24/2017

Unless otherwise stated the results shown in this test report refer only to the sample(s) tested and such sample(s) are retained for 90 days only.

除非另有說明，此報告結果僅對測試之樣品負責，同時此樣品僅保留90天。本報告未經本公司書面許可，不可部份複製。

This document is issued by the Company subject to its General Conditions of Service printed overleaf, available on request or accessible at www.sgs.com/terms_and_conditions.htm and, for electronic format documents, subject to Terms and Conditions for Electronic Documents at www.sgs.com/terms_e-document.htm. Attention is drawn to the limitation of liability, indemnification and jurisdiction issues defined therein. Any holder of this document is advised that information contained hereon reflects the Company's findings at the time of its intervention only and within the limits of Client's instructions, if any. The Company's sole responsibility is to its Client and this document does not exonerate parties to a transaction from exercising all their rights and obligations under the transaction documents. This document cannot be reproduced except in full, without prior written approval of the Company. Any unauthorized alteration, forgery or falsification of the content or appearance of this document is unlawful and offenders may be prosecuted to the fullest extent of the law.

SGS Taiwan Ltd.

No.134,WuKungRoad,NewTaipeiIndustrialPark,WukuDistrict,NewTaipeiCity,Taiwan24803/新北市五股區新北產業園區五工路 134 號

台灣檢驗科技股份有限公司

t (886-2) 2299-3279

f (886-2) 2298-0488

www.tw.sgs.com

Member of SGS Group

8.5. Measurement Result

99% Bandwidth (*Detector Peak*)

Frequency (MHz)	CH	99% Bandwidth (KHz)	99% Bandwidth (KHz)	99% Bandwidth (KHz)
		GSM 850	GPRS 850	EDGE 850
824.2	128	241.41	240.65	250.9
836.6	190	246.57	246.74	248.74
848.8	251	248.29	240.84	244.64

Frequency (MHz)	CH	99% Bandwidth (KHz)	99% Bandwidth (KHz)	99% Bandwidth (KHz)
		GSM 1900	GPRS 1900	EDGE 1900
1850.2	512	248.11	242.52	244.65
1880	661	245.44	244.87	246.51
1909.8	810	246.07	244.05	245.13

Frequency (MHz)	CH	99% Bandwidth (KHz)	99% Bandwidth (KHz)	99% Bandwidth (KHz)
		WCDMA II	HSDPA II	HSUPA II
1852.4	9262	4.2518	4.2380	4.1764
1880	9400	4.1380	4.0882	4.1035
1907.6	9538	4.1338	4.0934	4.1110

Frequency (MHz)	CH	99% Bandwidth (KHz)	99% Bandwidth (KHz)	99% Bandwidth (KHz)
		WCDMA IV	HSDPA IV	HSUPA IV
1712.4	1312	4.1636	4.1287	4.2001
1732.6	1413	4.1778	4.1289	4.1922
1752.6	1513	4.2109	4.0921	4.2132

Frequency (MHz)	CH	99% Bandwidth (KHz)	99% Bandwidth (KHz)	99% Bandwidth (KHz)
		WCDMA V	HSDPA V	HSUPA V
826.4	4132	4.1080	4.1815	4.1338
836.6	4183	4.1735	4.2080	4.1158
846.6	4233	4.1435	4.1963	4.2578

Unless otherwise stated the results shown in this test report refer only to the sample(s) tested and such sample(s) are retained for 90 days only.

除非另有說明，此報告結果僅對測試之樣品負責，同時此樣品僅保留90天。本報告未經本公司書面許可，不可部份複製。

This document is issued by the Company subject to its General Conditions of Service printed overleaf, available on request or accessible at www.sgs.com/terms_and_conditions.htm and, for electronic format documents, subject to Terms and Conditions for Electronic Documents at www.sgs.com/terms_e-document.htm. Attention is drawn to the limitation of liability, indemnification and jurisdiction issues defined therein. Any holder of this document is advised that information contained hereon reflects the Company's findings at the time of its intervention only and within the limits of Client's instructions, if any. The Company's sole responsibility is to its Client and this document does not exonerate parties to a transaction from exercising all their rights and obligations under the transaction documents. This document cannot be reproduced except in full, without prior written approval of the Company. Any unauthorized alteration, forgery or falsification of the content or appearance of this document is unlawful and offenders may be prosecuted to the fullest extent of the law.

26dB Bandwidth

Frequency (MHz)	CH	26dB Bandwidth (KHz)	26dB Bandwidth (KHz)	26dB Bandwidth (KHz)
		GSM 850	GPRS 850	EDGE 850
824.20	128	305.1	323.8	323.8
836.60	190	317.5	323.1	313.2
848.80	251	316.0	318.9	313.2

Frequency (MHz)	CH	26dB Bandwidth (KHz)	26dB Bandwidth (KHz)	26dB Bandwidth (KHz)
		GSM 1900	GPRS 1900	EDGE 1900
1850.20	512	322.0	317.1	312.7
1880.00	661	317.2	316.5	318.1
1909.80	810	316.3	324.8	316.9

Frequency (MHz)	CH	26dB Bandwidth (MHz)	26dB Bandwidth (MHz)	26dB Bandwidth (MHz)
		WCDMA II	HSDPA II	HSUPA II
1850.20	9262	4.722	4.714	4.726
1880.00	9400	4.734	4.741	4.738
1909.80	9538	4.728	4.723	4.719

Unless otherwise stated the results shown in this test report refer only to the sample(s) tested and such sample(s) are retained for 90 days only.

除非另有說明，此報告結果僅對測試之樣品負責，同時此樣品僅保留90天。本報告未經本公司書面許可，不可部份複製。

This document is issued by the Company subject to its General Conditions of Service printed overleaf, available on request or accessible at www.sgs.com/terms_and_conditions.htm and, for electronic format documents, subject to Terms and Conditions for Electronic Documents at www.sgs.com/terms_e-document.htm. Attention is drawn to the limitation of liability, indemnification and jurisdiction issues defined therein. Any holder of this document is advised that information contained hereon reflects the Company's findings at the time of its intervention only and within the limits of Client's instructions, if any. The Company's sole responsibility is to its Client and this document does not exonerate parties to a transaction from exercising all their rights and obligations under the transaction documents. This document cannot be reproduced except in full, without prior written approval of the Company. Any unauthorized alteration, forgery or falsification of the content or appearance of this document is unlawful and offenders may be prosecuted to the fullest extent of the law.

Frequency (MHz)	CH	26dB Bandwidth (MHz)	26dB Bandwidth (MHz)	26dB Bandwidth (MHz)
		WCDMA IV	HSDPA IV	HSUPA IV
1712.4	1312	4.755	4.746	4.733
1732.6	1413	4.718	4.714	4.720
1752.6	1513	4.731	4.727	4.733

Frequency (MHz)	CH	26dB Bandwidth (MHz)	26dB Bandwidth (MHz)	26dB Bandwidth (MHz)
		WCDMA V	HSDPA V	HSUPA V
826.40	4132	4.702	4.705	4.707
836.60	4183	4.711	4.711	4.711
846.60	4233	4.706	4.723	4.711

Unless otherwise stated the results shown in this test report refer only to the sample(s) tested and such sample(s) are retained for 90 days only.

除非另有說明，此報告結果僅對測試之樣品負責，同時此樣品僅保留90天。本報告未經本公司書面許可，不可部份複製。

This document is issued by the Company subject to its General Conditions of Service printed overleaf, available on request or accessible at www.sgs.com/terms_and_conditions.htm and, for electronic format documents, subject to Terms and Conditions for Electronic Documents at www.sgs.com/terms_e-document.htm. Attention is drawn to the limitation of liability, indemnification and jurisdiction issues defined therein. Any holder of this document is advised that information contained hereon reflects the Company's findings at the time of its intervention only and within the limits of Client's instructions, if any. The Company's sole responsibility is to its Client and this document does not exonerate parties to a transaction from exercising all their rights and obligations under the transaction documents. This document cannot be reproduced except in full, without prior written approval of the Company. Any unauthorized alteration, forgery or falsification of the content or appearance of this document is unlawful and offenders may be prosecuted to the fullest extent of the law.

SGS Taiwan Ltd.

No.134,WuKungRoad,NewTaipeiIndustrialPark,WukuDistrict,NewTaipeiCity,Taiwan24803/新北市五股區新北產業園區五工路 134 號

台灣檢驗科技股份有限公司

t (886-2) 2299-3279

f (886-2) 2298-0488

www.tw.sgs.com

Member of SGS Group

LTE BAND 2 Channel bandwidth: 1.4MHz					
Freq. (MHz)	CH	99% BW (MHz)	99% BW (MHz)	26 dB BW (MHz)	26 dB BW (MHz)
		QPSK	16QAM	QPSK	16QAM
1850.7	18607	1.0931	1.0997	1.317	1.300
1880.0	18900	1.0953	1.0953	1.281	1.293
1909.3	19193	1.0999	1.0999	1.304	1.307

LTE BAND 2 Channel bandwidth: 3MHz					
Freq. (MHz)	CH	99% BW (MHz)	99% BW (MHz)	26 dB BW (MHz)	26 dB BW (MHz)
		QPSK	16QAM	QPSK	16QAM
1851.5	18615	2.6984	2.6984	2.976	2.987
1880.0	18900	2.7002	2.6997	2.959	2.994
1908.5	19185	2.6967	2.6973	2.984	2.997

LTE BAND 2 Channel bandwidth: 5MHz					
Freq. (MHz)	CH	99% BW (MHz)	99% BW (MHz)	26 dB BW (MHz)	26 dB BW (MHz)
		QPSK	16QAM	QPSK	16QAM
1852.5	18625	4.5083	4.5029	5.041	5.026
1880.0	18900	4.5072	4.5037	5.067	5.041
1907.5	19175	4.5013	4.5069	5.067	5.017

LTE BAND 2 Channel bandwidth: 10MHz					
Freq. (MHz)	CH	99% BW (MHz)	99% BW (MHz)	26 dB BW (MHz)	26 dB BW (MHz)
		QPSK	16QAM	QPSK	16QAM
1855.0	18650	9.0087	8.9542	9.966	9.873
1880.0	18900	8.9977	8.9472	9.868	9.851
1905.0	19150	9.0140	8.9724	9.917	9.758

LTE BAND 2 Channel bandwidth: 15MHz					
Freq. (MHz)	CH	99% BW (MHz)	99% BW (MHz)	26 dB BW (MHz)	26 dB BW (MHz)
		QPSK	16QAM	QPSK	16QAM
1857.5	18675	13.491	13.499	14.70	14.68
1880.0	18900	13.463	13.466	14.71	14.66
1902.5	19125	13.503	13.498	14.87	14.70

LTE BAND 2 Channel bandwidth: 20MHz					
Freq. (MHz)	CH	99% BW (MHz)	99% BW (MHz)	26 dB BW (MHz)	26 dB BW (MHz)
		QPSK	16QAM	QPSK	16QAM
1860.0	18700	17.966	17.974	19.59	19.55
1880.0	18900	17.922	17.943	19.53	19.41
1900.0	19100	17.979	17.994	19.65	19.54

Unless otherwise stated the results shown in this test report refer only to the sample(s) tested and such sample(s) are retained for 90 days only.

除非另有說明，此報告結果僅對測試之樣品負責，同時此樣品僅保留90天。本報告未經本公司書面許可，不可部份複製。

This document is issued by the Company subject to its General Conditions of Service printed overleaf, available on request or accessible at www.sgs.com/terms_and_conditions.htm and, for electronic format documents, subject to Terms and Conditions for Electronic Documents at www.sgs.com/terms_e-document.htm. Attention is drawn to the limitation of liability, indemnification and jurisdiction issues defined therein. Any holder of this document is advised that information contained hereon reflects the Company's findings at the time of its intervention only and within the limits of Client's instructions, if any. The Company's sole responsibility is to its Client and this document does not exonerate parties to a transaction from exercising all their rights and obligations under the transaction documents. This document cannot be reproduced except in full, without prior written approval of the Company. Any unauthorized alteration, forgery or falsification of the content or appearance of this document is unlawful and offenders may be prosecuted to the fullest extent of the law.

SGS Taiwan Ltd.

No.134,WuKungRoad,NewTaipeiIndustrialPark,WukuDistrict,NewTaipeiCity,Taiwan24803/新北市五股區新北產業園區五工路 134 號

台灣檢驗科技股份有限公司

t (886-2) 2299-3279

f (886-2) 2298-0488

www.tw.sgs.com

Member of SGS Group

LTE BAND 4 Channel bandwidth: 1.4MHz					
Freq. (MHz)	CH	99% BW (MHz)	99% BW (MHz)	26 dB BW (MHz)	26 dB BW (MHz)
		QPSK	16QAM	QPSK	16QAM
1710.7	19957	1.0973	1.0986	1.293	1.296
1732.5	20175	1.0972	1.0984	1.283	1.299
1754.3	20393	1.0966	1.0948	1.286	1.298

LTE BAND 4 Channel bandwidth: 3MHz					
Freq. (MHz)	CH	99% BW (MHz)	99% BW (MHz)	26 dB BW (MHz)	26 dB BW (MHz)
		QPSK	16QAM	QPSK	16QAM
1711.5	19965	2.6958	2.6983	2.971	2.987
1732.5	20175	2.6992	2.7040	2.960	3.000
1753.5	20385	2.6998	2.7003	2.981	2.996

LTE BAND 4 Channel bandwidth: 5MHz					
Freq. (MHz)	CH	99% BW (MHz)	99% BW (MHz)	26 dB BW (MHz)	26 dB BW (MHz)
		QPSK	16QAM	QPSK	16QAM
1712.5	19957	4.5074	4.5087	5.065	5.035
1732.5	20175	4.5063	4.5062	5.045	5.011
1752.5	20375	4.5146	4.5020	5.071	5.010

LTE BAND 4 Channel bandwidth: 10MHz					
Freq. (MHz)	CH	99% BW (MHz)	99% BW (MHz)	26 dB BW (MHz)	26 dB BW (MHz)
		QPSK	16QAM	QPSK	16QAM
1715.0	20000	8.9875	8.9573	9.888	9.808
1732.5	20175	9.0102	8.9615	9.873	9.839
1750.0	20350	8.9700	8.9607	9.918	9.834

LTE BAND 4 Channel bandwidth: 15MHz					
Freq. (MHz)	CH	99% BW (MHz)	99% BW (MHz)	26 dB BW (MHz)	26 dB BW (MHz)
		QPSK	16QAM	QPSK	16QAM
1717.5	20025	13.494	13.475	14.63	14.67
1732.5	20175	13.515	13.493	14.84	14.74
1747.5	20325	13.464	13.468	14.79	14.76

LTE BAND 4 Channel bandwidth: 20MHz					
Freq. (MHz)	CH	99% BW (MHz)	99% BW (MHz)	26 dB BW (MHz)	26 dB BW (MHz)
		QPSK	16QAM	QPSK	16QAM
1720.0	20050	17.929	17.967	19.50	19.51
1732.5	20175	17.920	17.947	19.55	19.45
1745.0	20300	17.878	17.893	19.42	19.51

Unless otherwise stated the results shown in this test report refer only to the sample(s) tested and such sample(s) are retained for 90 days only.

除非另有說明，此報告結果僅對測試之樣品負責，同時此樣品僅保留90天。本報告未經本公司書面許可，不可部份複製。

This document is issued by the Company subject to its General Conditions of Service printed overleaf, available on request or accessible at www.sgs.com/terms_and_conditions.htm and, for electronic format documents, subject to Terms and Conditions for Electronic Documents at www.sgs.com/terms_e-document.htm. Attention is drawn to the limitation of liability, indemnification and jurisdiction issues defined therein. Any holder of this document is advised that information contained hereon reflects the Company's findings at the time of its intervention only and within the limits of Client's instructions, if any. The Company's sole responsibility is to its Client and this document does not exonerate parties to a transaction from exercising all their rights and obligations under the transaction documents. This document cannot be reproduced except in full, without prior written approval of the Company. Any unauthorized alteration, forgery or falsification of the content or appearance of this document is unlawful and offenders may be prosecuted to the fullest extent of the law.

LTE BAND 5 Channel bandwidth: 1.4MHz					
Freq. (MHz)	CH	99% BW (MHz)	99% BW (MHz)	26 dB BW (MHz)	26 dB BW (MHz)
		QPSK	16QAM	QPSK	16QAM
824.7	20407	1.0967	1.0982	1.300	1.292
836.5	20525	1.0972	1.0981	1.297	1.288
848.3	20643	1.0968	1.0988	1.278	1.303

LTE BAND 5 Channel bandwidth: 3MHz					
Freq. (MHz)	CH	99% BW (MHz)	99% BW (MHz)	26 dB BW (MHz)	26 dB BW (MHz)
		QPSK	16QAM	QPSK	16QAM
825.5	20415	2.7003	2.7016	2.984	3.004
836.5	20525	2.6971	2.6990	2.988	2.988
847.5	20635	2.6971	2.7000	2.972	2.987

LTE BAND 5 Channel bandwidth: 5MHz					
Freq. (MHz)	CH	99% BW (MHz)	99% BW (MHz)	26 dB BW (MHz)	26 dB BW (MHz)
		QPSK	16QAM	QPSK	16QAM
826.5	20425	4.5033	4.5122	5.026	5.021
836.5	20525	4.5119	4.5064	5.033	5.015
846.5	20625	4.4982	4.4973	5.045	4.998

LTE BAND 5 Channel bandwidth: 10MHz					
Freq. (MHz)	CH	99% BW (MHz)	99% BW (MHz)	26 dB BW (MHz)	26 dB BW (MHz)
		QPSK	16QAM	QPSK	16QAM
829.0	20450	8.9692	8.9701	9.856	9.824
836.5	20525	8.9771	8.9529	9.922	9.801
844.0	20600	8.9890	8.9629	9.882	9.829

LTE BAND 12 Channel bandwidth: 1.4MHz					
Freq. (MHz)	CH	99% BW (MHz)	99% BW (MHz)	26 dB BW (MHz)	26 dB BW (MHz)
		QPSK	16QAM	QPSK	16QAM
699.7	23017	1.0948	1.0971	1.295	1.295
707.5	23095	1.0975	1.0981	1.278	1.308
715.3	23173	1.0971	1.0979	1.275	1.297

LTE BAND 12 Channel bandwidth: 3MHz					
Freq. (MHz)	CH	99% BW (MHz)	99% BW (MHz)	26 dB BW (MHz)	26 dB BW (MHz)
		QPSK	16QAM	QPSK	16QAM
700.5	23025	2.7037	2.7066	2.984	3.507
707.5	23095	2.6940	2.6951	2.977	2.987
714.5	23165	2.6983	2.7007	2.990	3.005

LTE BAND 12 Channel bandwidth: 5MHz					
Freq. (MHz)	CH	99% BW (MHz)	99% BW (MHz)	26 dB BW (MHz)	26 dB BW (MHz)
		QPSK	16QAM	QPSK	16QAM
701.5	23035	4.5068	4.5170	5.056	5.192
707.5	23095	4.4986	4.5033	5.036	5.022
713.5	23155	4.5126	4.5131	5.076	5.059

LTE BAND 12 Channel bandwidth: 10MHz					
Freq. (MHz)	CH	99% BW (MHz)	99% BW (MHz)	26 dB BW (MHz)	26 dB BW (MHz)
		QPSK	16QAM	QPSK	16QAM
704.0	23060	9.0313	8.9903	9.929	9.821
707.5	23095	8.9435	8.9391	9.850	9.728
711.0	23130	9.0026	8.9724	9.901	9.880

Unless otherwise stated the results shown in this test report refer only to the sample(s) tested and such sample(s) are retained for 90 days only.

除非另有說明，此報告結果僅對測試之樣品負責，同時此樣品僅保留90天。本報告未經本公司書面許可，不可部份複製。

This document is issued by the Company subject to its General Conditions of Service printed overleaf, available on request or accessible at www.sgs.com/terms_and_conditions.htm and, for electronic format documents, subject to Terms and Conditions for Electronic Documents at www.sgs.com/terms_e-document.htm. Attention is drawn to the limitation of liability, indemnification and jurisdiction issues defined therein. Any holder of this document is advised that information contained hereon reflects the Company's findings at the time of its intervention only and within the limits of Client's instructions, if any. The Company's sole responsibility is to its Client and this document does not exonerate parties to a transaction from exercising all their rights and obligations under the transaction documents. This document cannot be reproduced except in full, without prior written approval of the Company. Any unauthorized alteration, forgery or falsification of the content or appearance of this document is unlawful and offenders may be prosecuted to the fullest extent of the law.

SGS Taiwan Ltd.

No.134,WuKungRoad,NewTaipeiIndustrialPark,WukuDistrict,NewTaipeiCity,Taiwan24803/新北市五股區新北產業園區五工路 134 號

台灣檢驗科技股份有限公司

t (886-2) 2299-3279

f (886-2) 2298-0488

www.tw.sgs.com

Member of SGS Group

99% & 26dB Bandwidth Test Data (Detector Peak)

GSM_850MHz_LowCH128-824.2

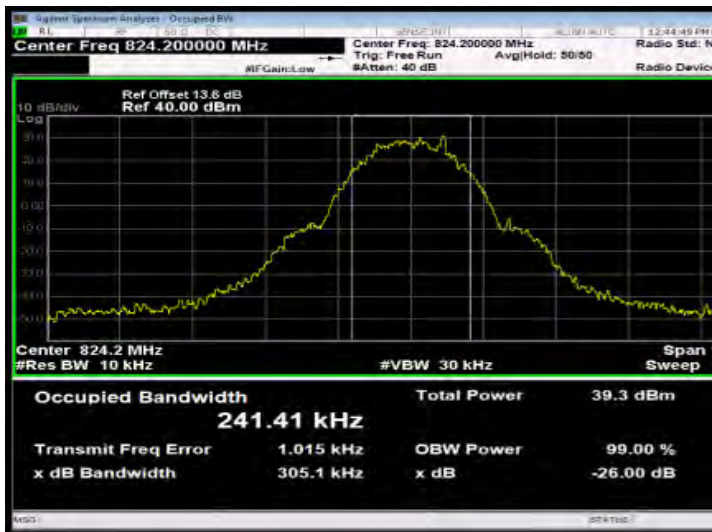

GSM_850MHz_HighCH251-848.8



GSM_850MHz_MidCH190-836.6

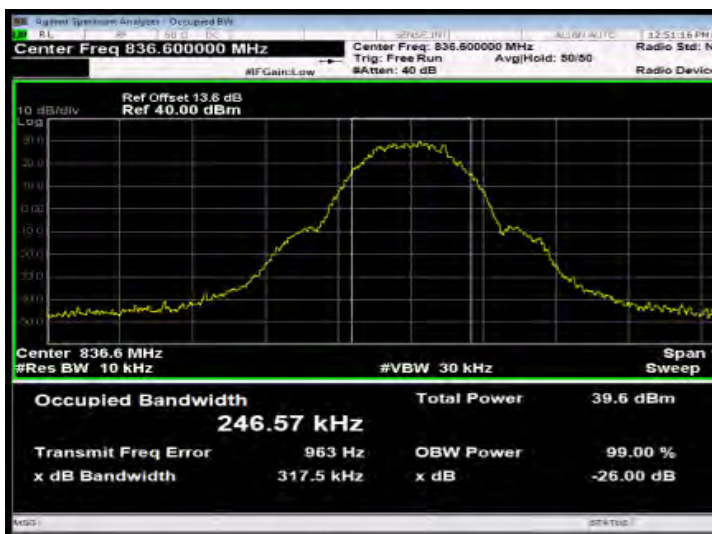

GPRS_850MHz_LowCH128-824.2

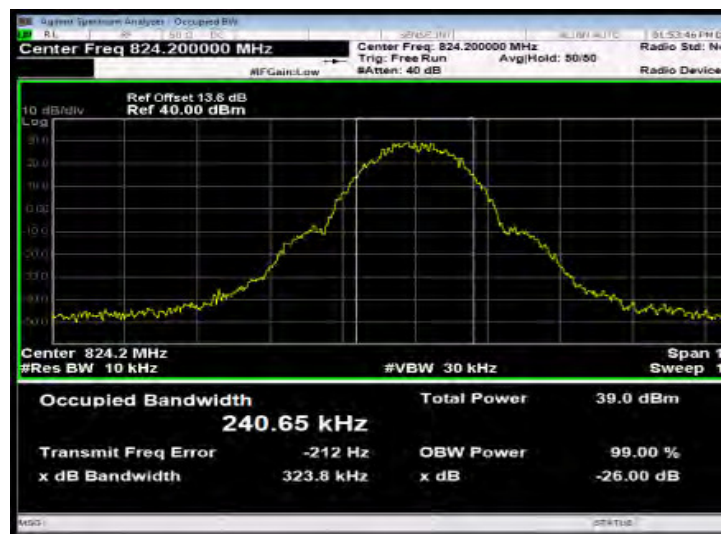

Unless otherwise stated the results shown in this test report refer only to the sample(s) tested and such sample(s) are retained for 90 days only.

除非另有說明，此報告結果僅對測試之樣品負責，同時此樣品僅保留90天。本報告未經本公司書面許可，不可部份複製。

This document is issued by the Company subject to its General Conditions of Service printed overleaf, available on request or accessible at www.sgs.com/terms_and_conditions.htm and, for electronic format documents, subject to Terms and Conditions for Electronic Documents at www.sgs.com/terms_e-document.htm. Attention is drawn to the limitation of liability, indemnification and jurisdiction issues defined therein. Any holder of this document is advised that information contained hereon reflects the Company's findings at the time of its intervention only and within the limits of Client's instructions, if any. The Company's sole responsibility is to its Client and this document does not exonerate parties to a transaction from exercising all their rights and obligations under the transaction documents. This document cannot be reproduced except in full, without prior written approval of the Company. Any unauthorized alteration, forgery or falsification of the content or appearance of this document is unlawful and offenders may be prosecuted to the fullest extent of the law.

SGS Taiwan Ltd.

No.134,WuKungRoad,NewTaipeiIndustrialPark,WukuDistrict,NewTaipeiCity,Taiwan24803/新北市五股區新北產業園區五工路 134 號

台灣檢驗科技股份有限公司

t (886-2) 2299-3279

f (886-2) 2298-0488

www.tw.sgs.com

Member of SGS Group

GPRS_850MHz_MidCH190-836.6

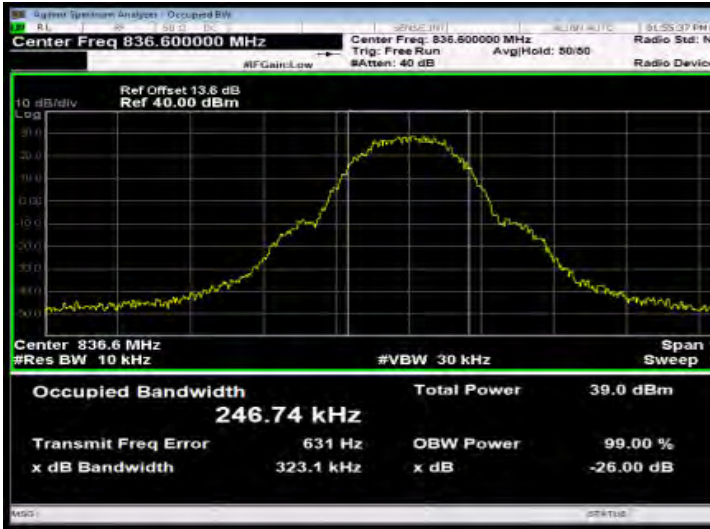

EDGE_850MHz_MidCH190-836.6

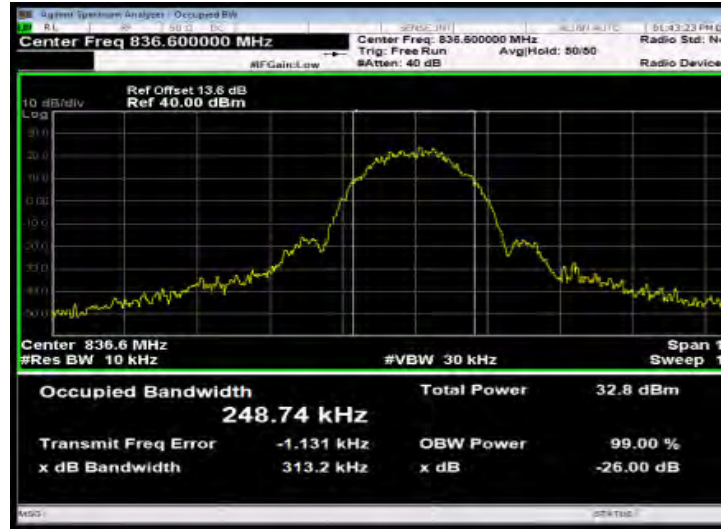

GPRS_850MHz_HighCH251-848.8



EDGE_850MHz_HighCH251-848.8



EDGE_850MHz_LowCH128-824.2

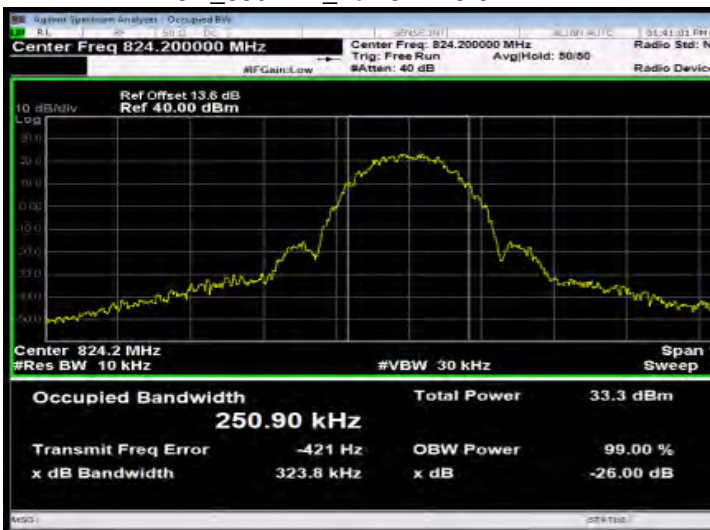

GSM_1900MHz_LowCH512-1850.2

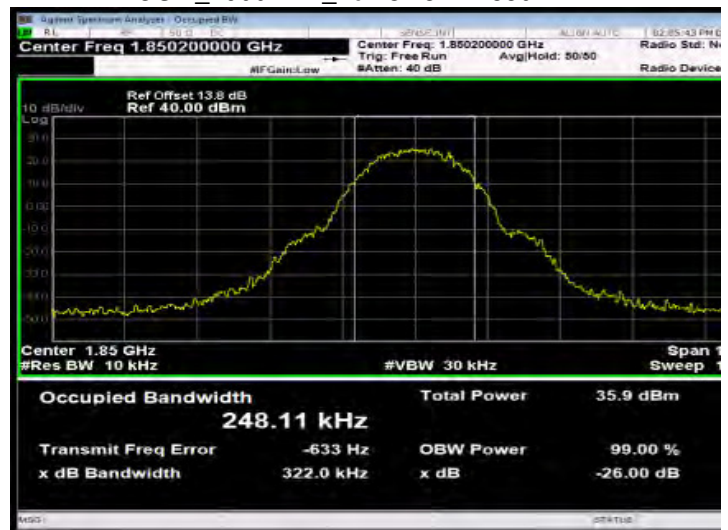

Unless otherwise stated the results shown in this test report refer only to the sample(s) tested and such sample(s) are retained for 90 days only.

除非另有說明，此報告結果僅對測試之樣品負責，同時此樣品僅保留90天。本報告未經本公司書面許可，不可部份複製。

This document is issued by the Company subject to its General Conditions of Service printed overleaf, available on request or accessible at www.sgs.com/terms_and_conditions.htm and, for electronic format documents, subject to Terms and Conditions for Electronic Documents at www.sgs.com/terms_e-document.htm. Attention is drawn to the limitation of liability, indemnification and jurisdiction issues defined therein. Any holder of this document is advised that information contained hereon reflects the Company's findings at the time of its intervention only and within the limits of Client's instructions, if any. The Company's sole responsibility is to its Client and this document does not exonerate parties to a transaction from exercising all their rights and obligations under the transaction documents. This document cannot be reproduced except in full, without prior written approval of the Company. Any unauthorized alteration, forgery or falsification of the content or appearance of this document is unlawful and offenders may be prosecuted to the fullest extent of the law.

SGS Taiwan Ltd.

No. 134, WuKungRoad, New Taipei Industrial Park, WuKu District, New Taipei City, Taiwan 24803/新北市五股區新北產業園區五工路 134 號

台灣檢驗科技股份有限公司

t (886-2) 2299-3279

f (886-2) 2298-0488

www.tw.sgs.com

Member of SGS Group

GSM_1900MHz_MidCH661-1880

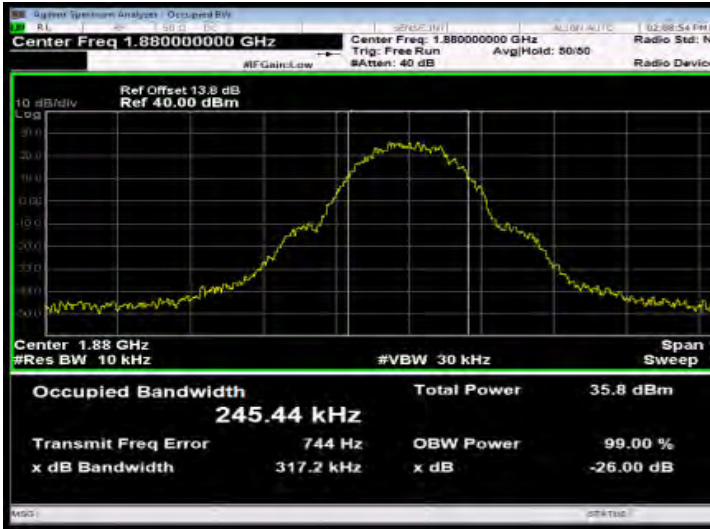

GPRS_1900MHz_MidCH661-1880

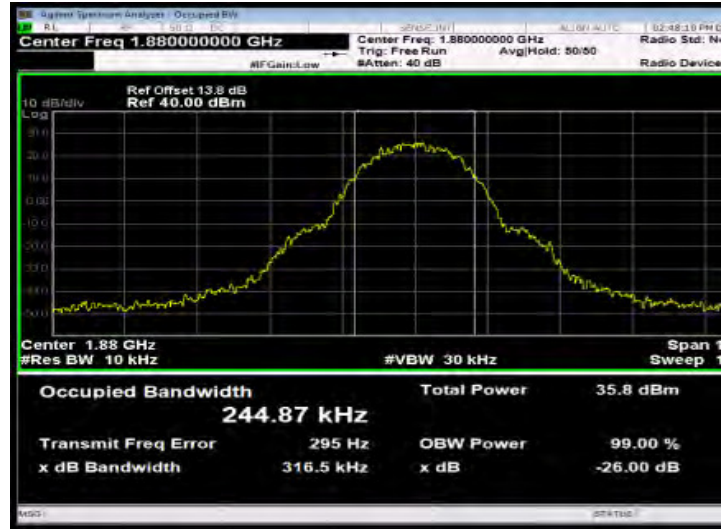

GSM_1900MHz_HighCH810-1909.8



GPRS_1900MHz_HighCH810-1909.8



GPRS_1900MHz_LowCH512-1850.2



EDGE_1900MHz_LowCH512-1850.2

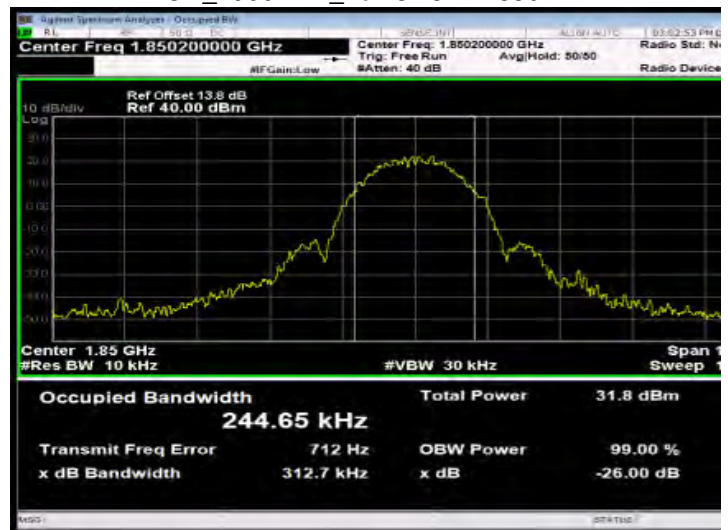

Unless otherwise stated the results shown in this test report refer only to the sample(s) tested and such sample(s) are retained for 90 days only.

除非另有說明，此報告結果僅對測試之樣品負責，同時此樣品僅保留90天。本報告未經本公司書面許可，不可部份複製。

This document is issued by the Company subject to its General Conditions of Service printed overleaf, available on request or accessible at www.sgs.com/terms_and_conditions.htm and, for electronic format documents, subject to Terms and Conditions for Electronic Documents at www.sgs.com/terms_e-document.htm. Attention is drawn to the limitation of liability, indemnification and jurisdiction issues defined therein. Any holder of this document is advised that information contained hereon reflects the Company's findings at the time of its intervention only and within the limits of Client's instructions, if any. The Company's sole responsibility is to its Client and this document does not exonerate parties to a transaction from exercising all their rights and obligations under the transaction documents. This document cannot be reproduced except in full, without prior written approval of the Company. Any unauthorized alteration, forgery or falsification of the content or appearance of this document is unlawful and offenders may be prosecuted to the fullest extent of the law.

SGS Taiwan Ltd.

No. 134, WuKungRoad, New Taipei Industrial Park, WuKu District, New Taipei City, Taiwan 24803/新北市五股區新北產業園區五工路 134 號

台灣檢驗科技股份有限公司

t (886-2) 2299-3279

f (886-2) 2298-0488

www.tw.sgs.com

Member of SGS Group

EDGE_1900MHz_MidCH661-1880

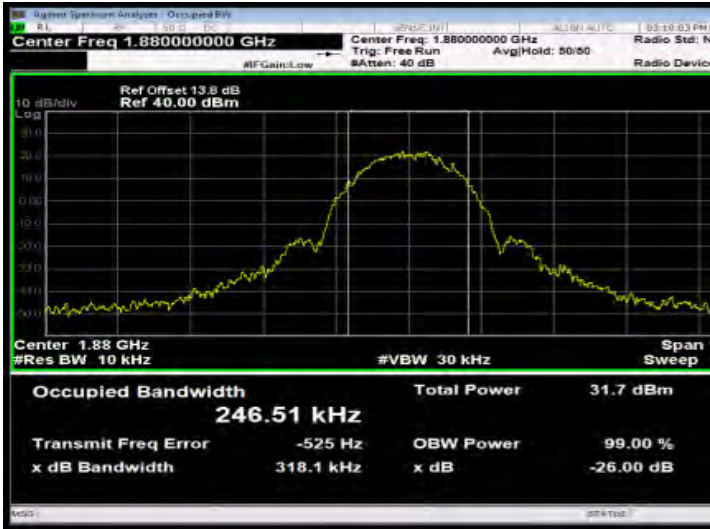

WCDMA_B2_MidCH9400-1880

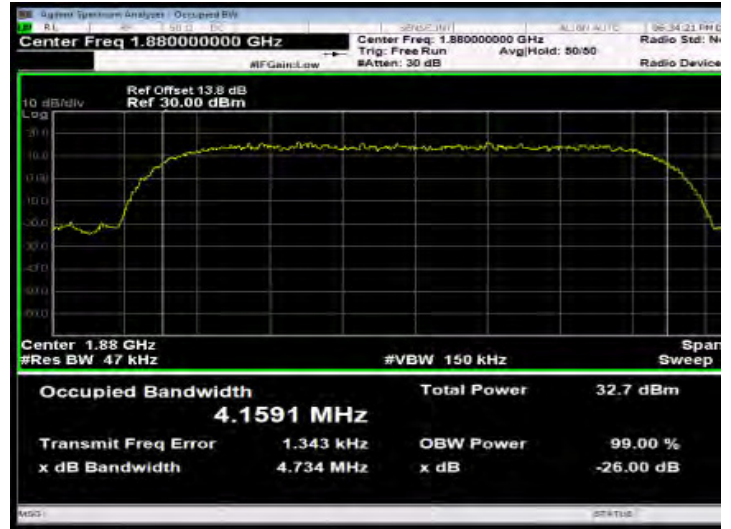

EDGE_1900MHz_HighCH810-1909.8



WCDMA_B2_HighCH9538-1907.6

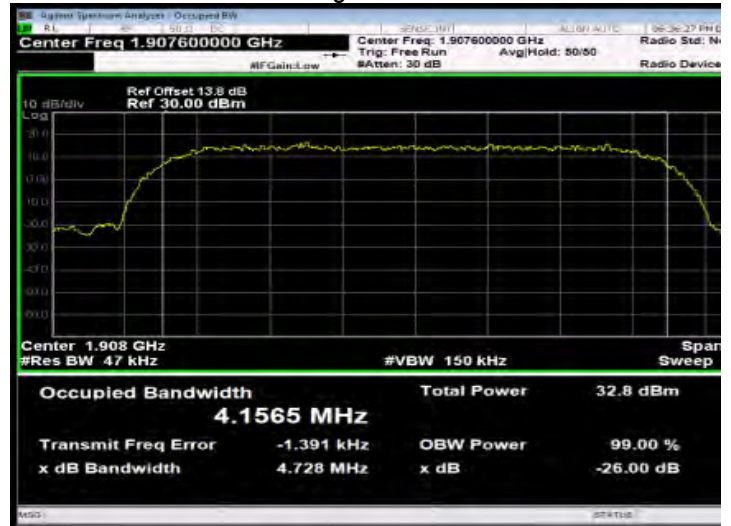

WCDMA_B2_LowCH9262-1852.4



HSDPA_B2_LowCH9262-1852.4

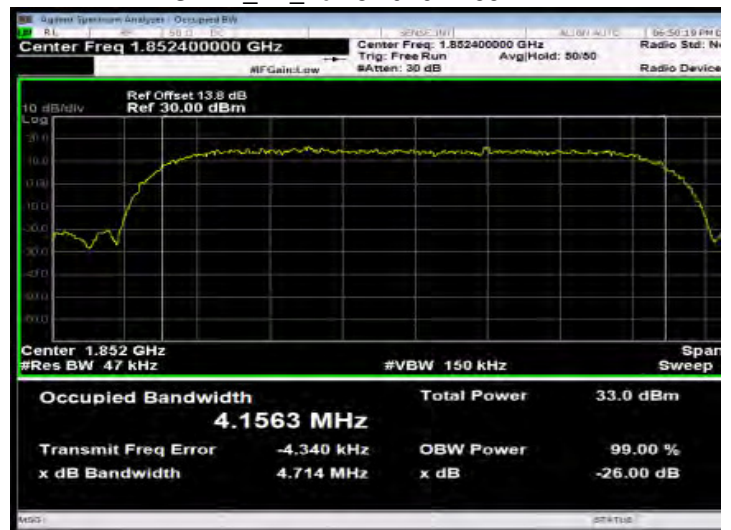

Unless otherwise stated the results shown in this test report refer only to the sample(s) tested and such sample(s) are retained for 90 days only.

除非另有說明，此報告結果僅對測試之樣品負責，同時此樣品僅保留90天。本報告未經本公司書面許可，不可部份複製。

This document is issued by the Company subject to its General Conditions of Service printed overleaf, available on request or accessible at www.sgs.com/terms_and_conditions.htm and, for electronic format documents, subject to Terms and Conditions for Electronic Documents at www.sgs.com/terms_e-document.htm. Attention is drawn to the limitation of liability, indemnification and jurisdiction issues defined therein. Any holder of this document is advised that information contained hereon reflects the Company's findings at the time of its intervention only and within the limits of Client's instructions, if any. The Company's sole responsibility is to its Client and this document does not exonerate parties to a transaction from exercising all their rights and obligations under the transaction documents. This document cannot be reproduced except in full, without prior written approval of the Company. Any unauthorized alteration, forgery or falsification of the content or appearance of this document is unlawful and offenders may be prosecuted to the fullest extent of the law.

SGS Taiwan Ltd.

No. 134, WuKungRoad, New Taipei Industrial Park, WuKu District, New Taipei City, Taiwan 24803/新北市五股區新北產業園區五工路 134 號

台灣檢驗科技股份有限公司

t (886-2) 2299-3279

f (886-2) 2298-0488

www.tw.sgs.com

Member of SGS Group

HSDPA_B2_MidCH9400-1880

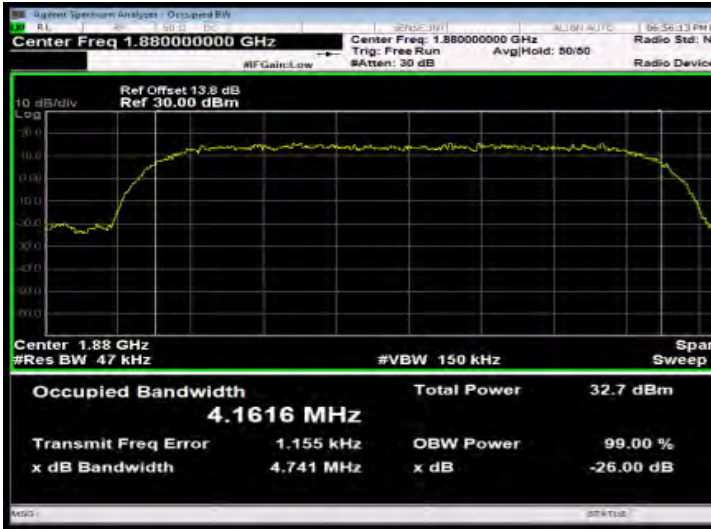

HSUPA_B2_MidCH9400-1880

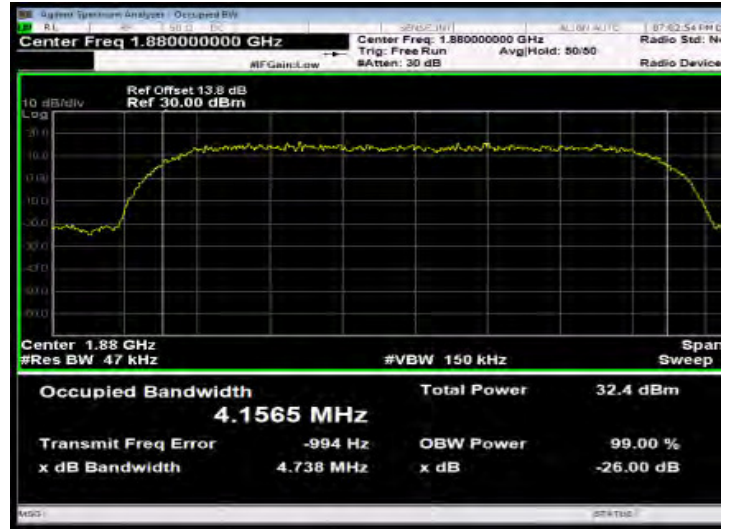

HSDPA_B2_HighCH9538-1907.6

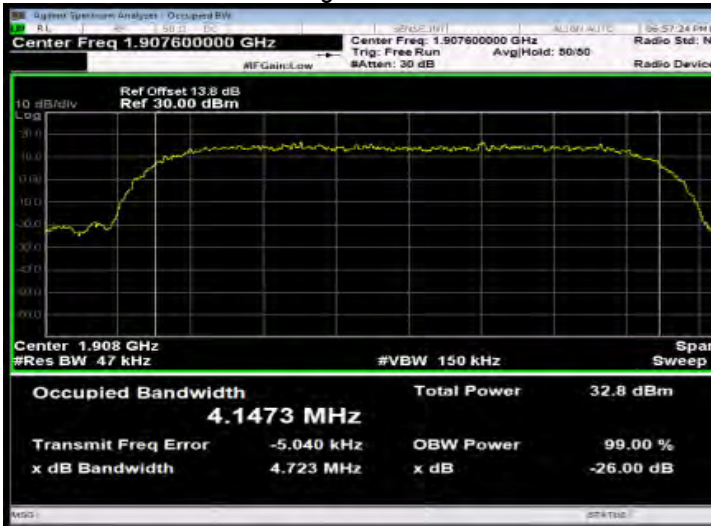

HSUPA_B2_HighCH9538-1907.6

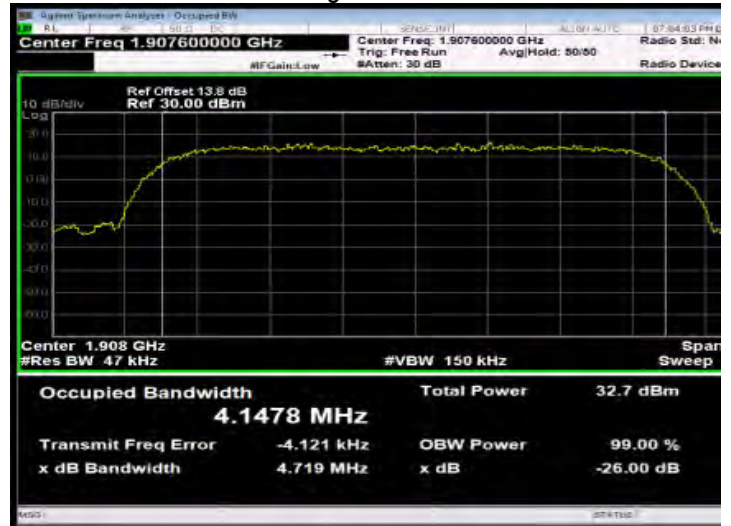

HSUPA_B2_LowCH9262-1852.4

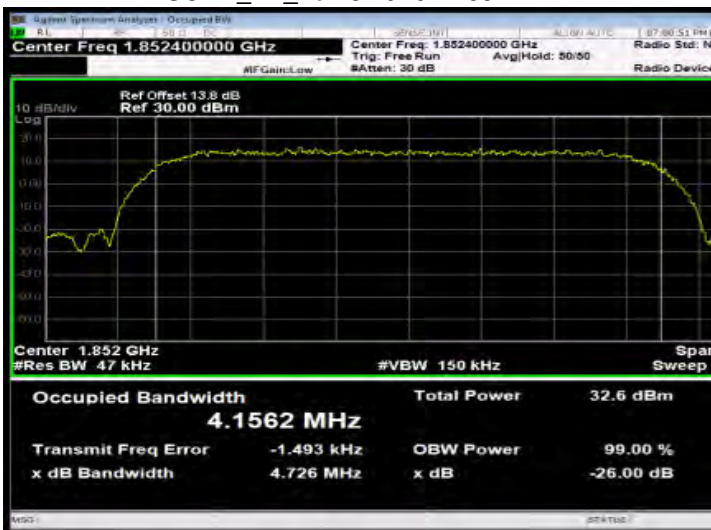

WCDMA_B4_LowCH1312-1712.4

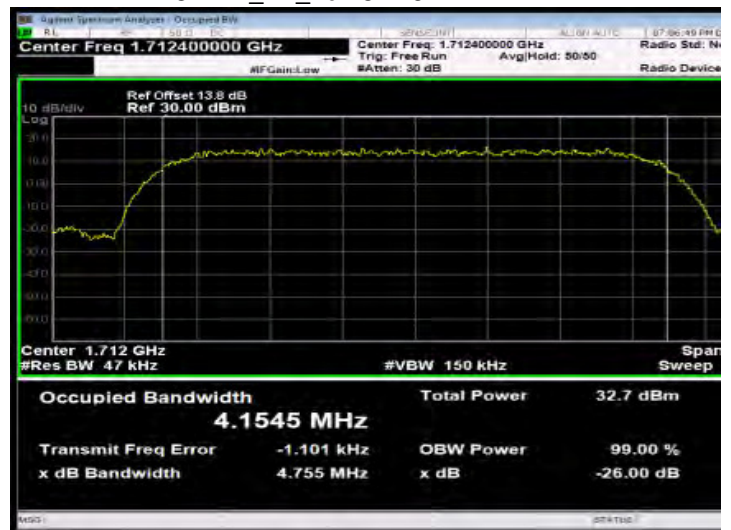

Unless otherwise stated the results shown in this test report refer only to the sample(s) tested and such sample(s) are retained for 90 days only.

除非另有說明，此報告結果僅對測試之樣品負責，同時此樣品僅保留90天。本報告未經本公司書面許可，不可部份複製。

This document is issued by the Company subject to its General Conditions of Service printed overleaf, available on request or accessible at www.sgs.com/terms_and_conditions.htm and, for electronic format documents, subject to Terms and Conditions for Electronic Documents at www.sgs.com/terms_e-document.htm. Attention is drawn to the limitation of liability, indemnification and jurisdiction issues defined therein. Any holder of this document is advised that information contained hereon reflects the Company's findings at the time of its intervention only and within the limits of Client's instructions, if any. The Company's sole responsibility is to its Client and this document does not exonerate parties to a transaction from exercising all their rights and obligations under the transaction documents. This document cannot be reproduced except in full, without prior written approval of the Company. Any unauthorized alteration, forgery or falsification of the content or appearance of this document is unlawful and offenders may be prosecuted to the fullest extent of the law.

SGS Taiwan Ltd.

No. 134, WuKungRoad, New Taipei Industrial Park, WuKu District, New Taipei City, Taiwan 24803 / 新北市五股區新北產業園區五工路 134 號

台灣檢驗科技股份有限公司

t (886-2) 2299-3279

f (886-2) 2298-0488

www.tw.sgs.com

Member of SGS Group

WCDMA_B4_MidCH1413-1732.6

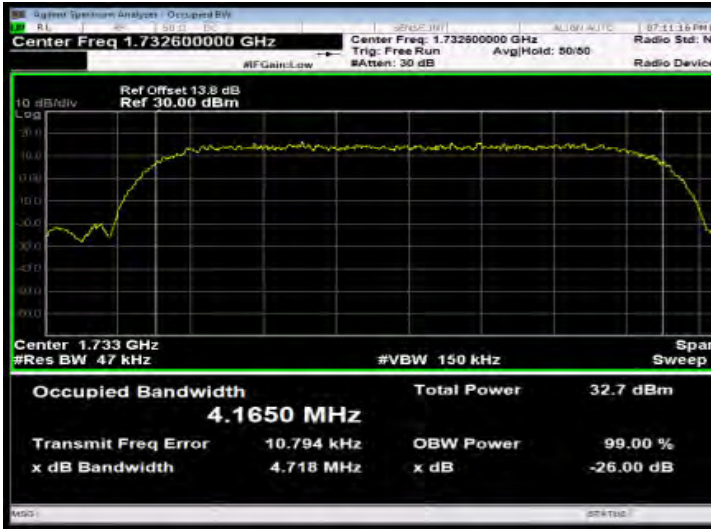

HSDPA_B4_MidCH1413-1732.6

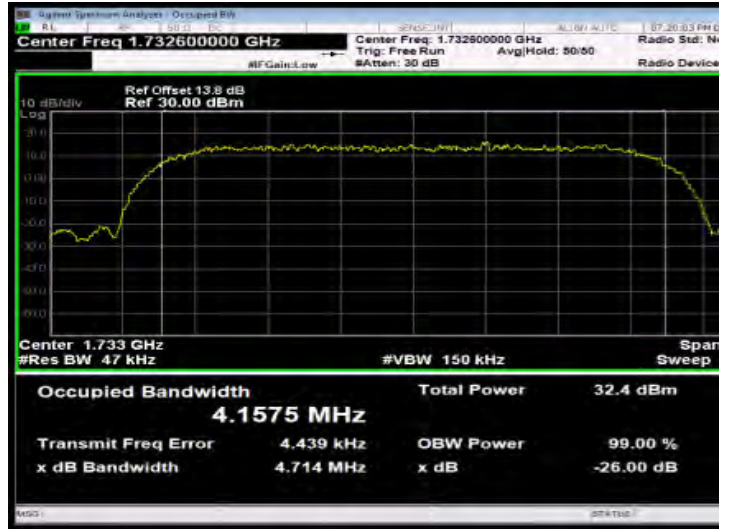

WCDMA_B4_HighCH1513-1752.6

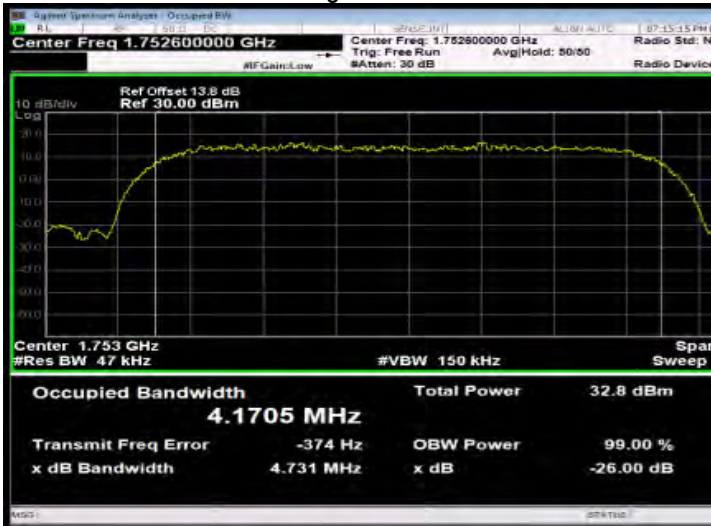

HSDPA_B4_HighCH1513-1752.6

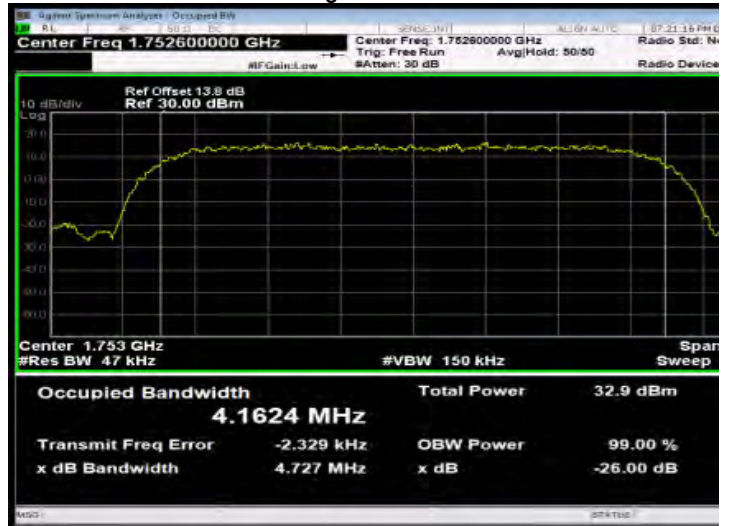

HSDPA_B4_LowCH1312-1712.4



HSUPA_B4_LowCH1312-1712.4

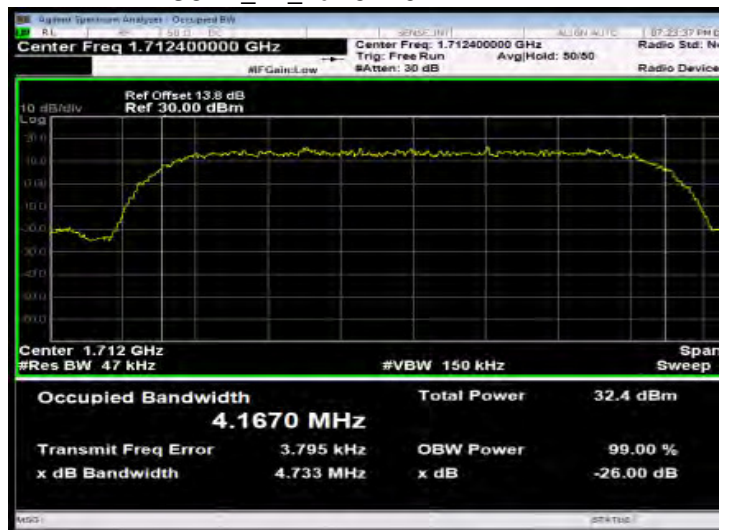

Unless otherwise stated the results shown in this test report refer only to the sample(s) tested and such sample(s) are retained for 90 days only.

除非另有說明，此報告結果僅對測試之樣品負責，同時此樣品僅保留90天。本報告未經本公司書面許可，不可部份複製。

This document is issued by the Company subject to its General Conditions of Service printed overleaf, available on request or accessible at www.sgs.com/terms_and_conditions.htm and, for electronic format documents, subject to Terms and Conditions for Electronic Documents at www.sgs.com/terms_e-document.htm. Attention is drawn to the limitation of liability, indemnification and jurisdiction issues defined therein. Any holder of this document is advised that information contained herein reflects the Company's findings at the time of its intervention only and within the limits of Client's instructions, if any. The Company's sole responsibility is to its Client and this document does not exonerate parties to a transaction from exercising all their rights and obligations under the transaction documents. This document cannot be reproduced except in full, without prior written approval of the Company. Any unauthorized alteration, forgery or falsification of the content or appearance of this document is unlawful and offenders may be prosecuted to the fullest extent of the law.

SGS Taiwan Ltd.

No. 134, WuKungRoad, New Taipei Industrial Park, WuKu District, New Taipei City, Taiwan 24803 / 新北市五股區新北產業園區五工路 134 號

台灣檢驗科技股份有限公司

t (886-2) 2299-3279

f (886-2) 2298-0488

www.tw.sgs.com

Member of SGS Group

HSUPA_B4_MidCH1413-1732.6

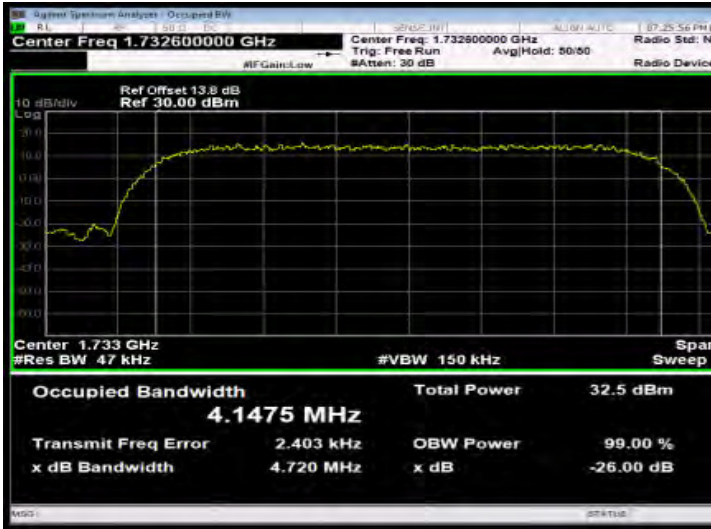

WCDMA_B5_MidCH4183-836.6

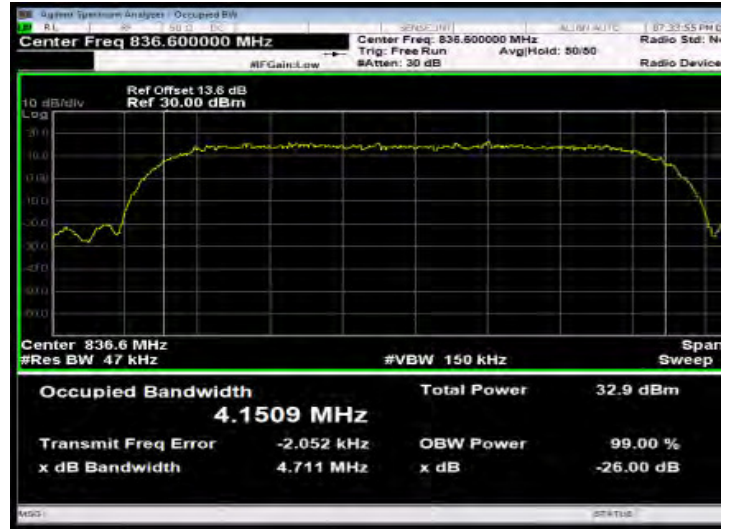

HSUPA_B4_HighCH1513-1752.6

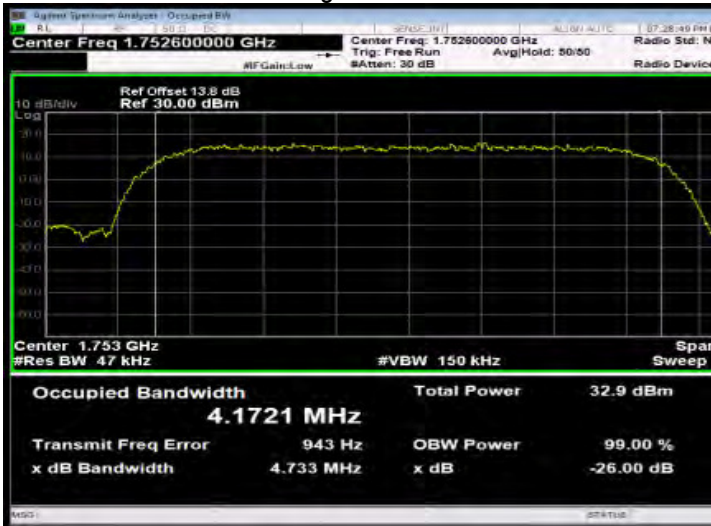

WCDMA_B5_HighCH4233-846.6

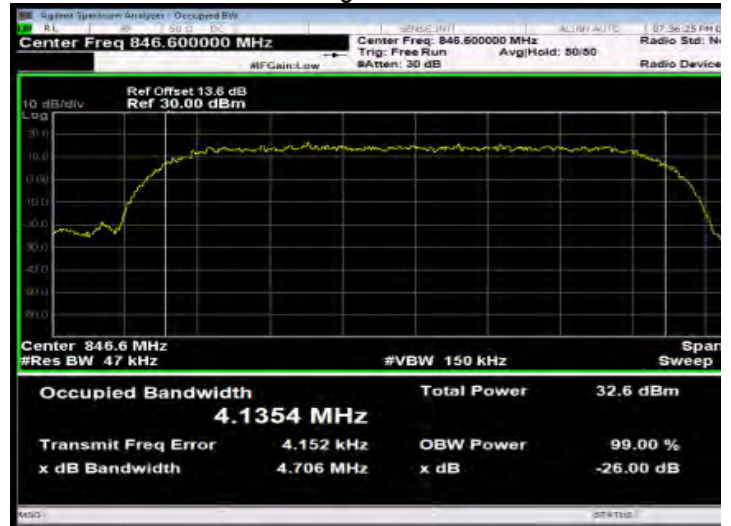

WCDMA_B5_LowCH4132-826.4

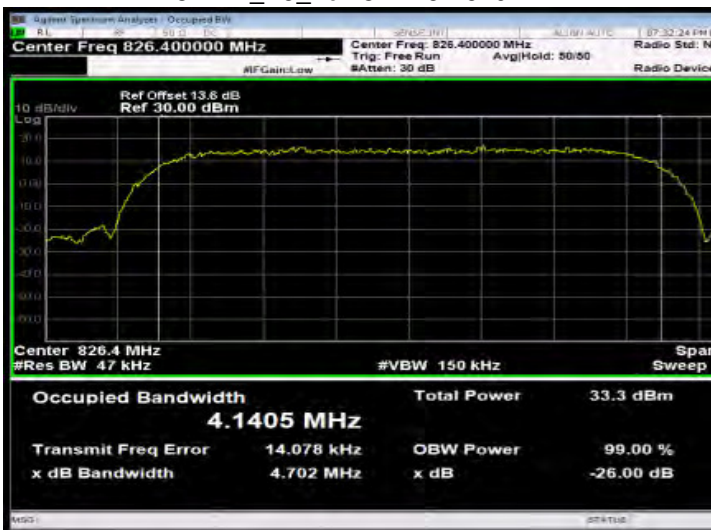

HSDPA_B5_LowCH4132-826.4

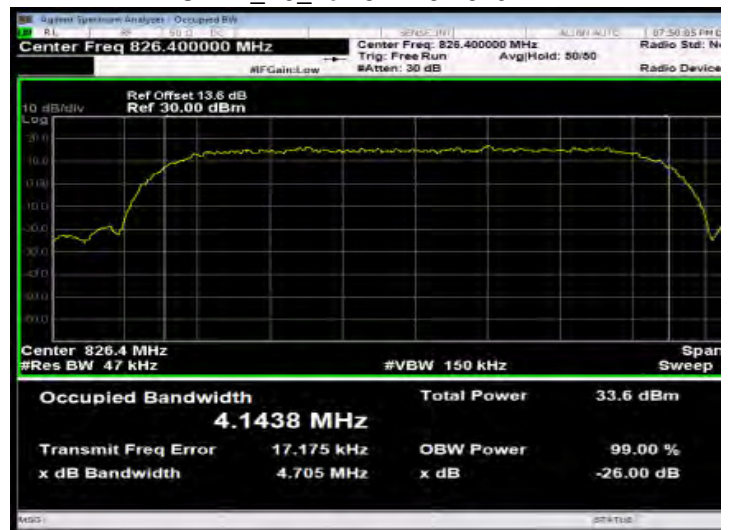

Unless otherwise stated the results shown in this test report refer only to the sample(s) tested and such sample(s) are retained for 90 days only.

除非另有說明，此報告結果僅對測試之樣品負責，同時此樣品僅保留90天。本報告未經本公司書面許可，不可部份複製。

This document is issued by the Company subject to its General Conditions of Service printed overleaf, available on request or accessible at www.sgs.com/terms_and_conditions.htm and, for electronic format documents, subject to Terms and Conditions for Electronic Documents at www.sgs.com/terms_e-document.htm. Attention is drawn to the limitation of liability, indemnification and jurisdiction issues defined therein. Any holder of this document is advised that information contained hereon reflects the Company's findings at the time of its intervention only and within the limits of Client's instructions, if any. The Company's sole responsibility is to its Client and this document does not exonerate parties to a transaction from exercising all their rights and obligations under the transaction documents. This document cannot be reproduced except in full, without prior written approval of the Company. Any unauthorized alteration, forgery or falsification of the content or appearance of this document is unlawful and offenders may be prosecuted to the fullest extent of the law.

SGS Taiwan Ltd.

No. 134, WuKungRoad, New Taipei Industrial Park, WuKu District, New Taipei City, Taiwan 24803 / 新北市五股區新北產業園區五工路 134 號

台灣檢驗科技股份有限公司

t (886-2) 2299-3279

f (886-2) 2298-0488

www.tw.sgs.com

Member of SGS Group

HSDPA_B5_MidCH4183-836.6

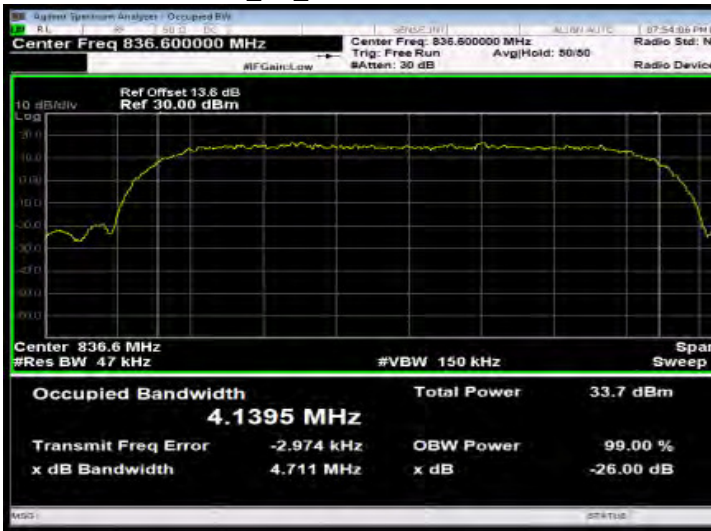

HSUPA_B5_MidCH4183-836.6

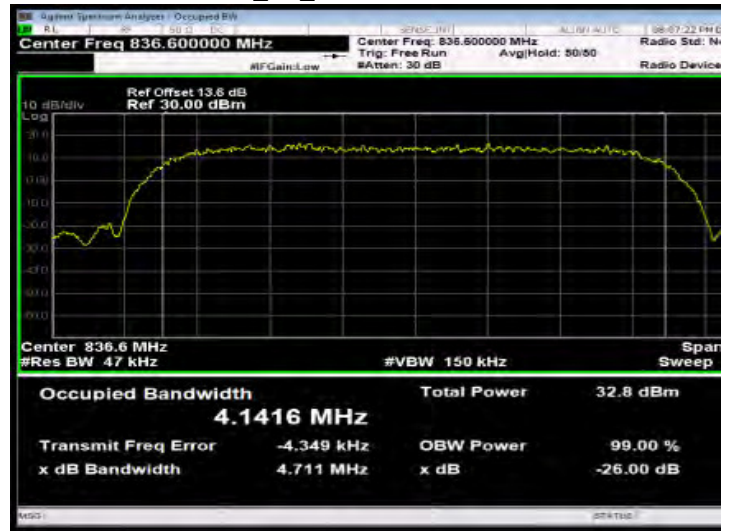

HSDPA_B5_HighCH4233-846.6

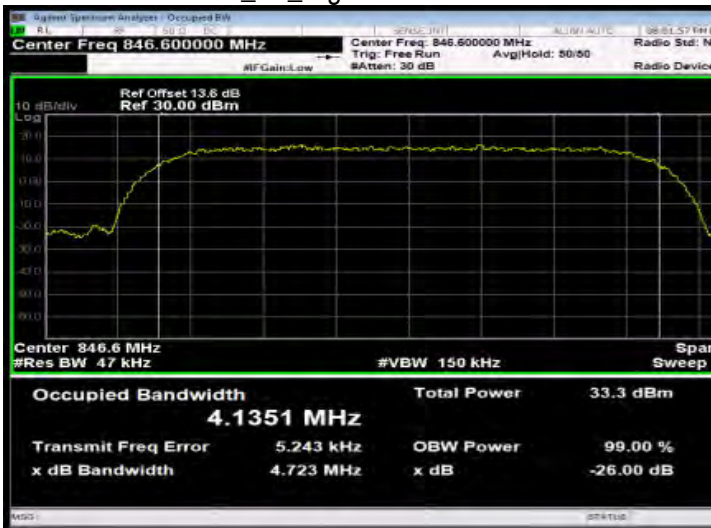

HSUPA_B5_HighCH4233-846.6

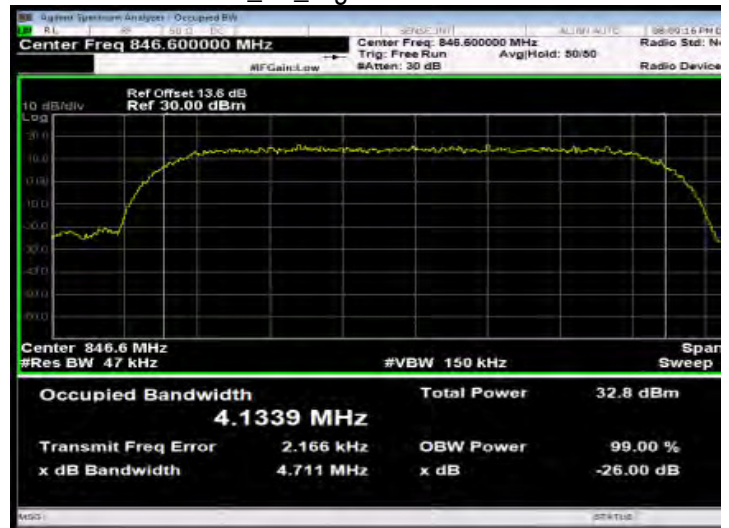

HSUPA_B5_LowCH4132-826.4

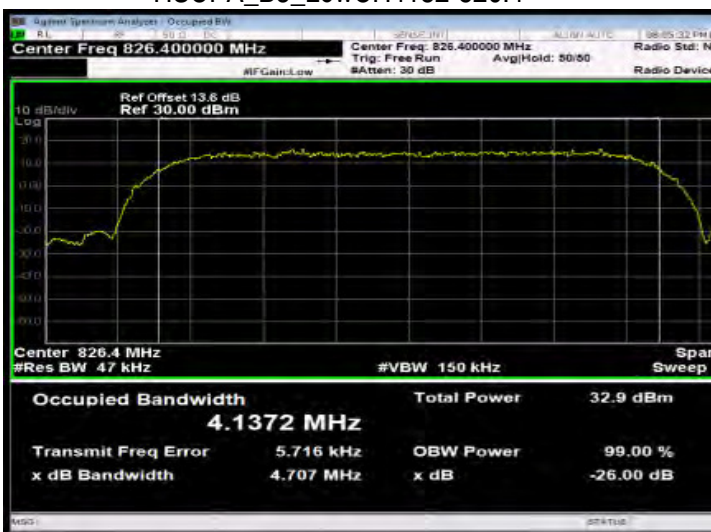

Unless otherwise stated the results shown in this test report refer only to the sample(s) tested and such sample(s) are retained for 90 days only.

除非另有說明，此報告結果僅對測試之樣品負責，同時此樣品僅保留90天。本報告未經本公司書面許可，不可部份複製。

This document is issued by the Company subject to its General Conditions of Service printed overleaf, available on request or accessible at www.sgs.com/terms_and_conditions.htm and, for electronic format documents, subject to Terms and Conditions for Electronic Documents at www.sgs.com/terms_e-document.htm. Attention is drawn to the limitation of liability, indemnification and jurisdiction issues defined therein. Any holder of this document is advised that information contained hereon reflects the Company's findings at the time of its intervention only and within the limits of Client's instructions, if any. The Company's sole responsibility is to its Client and this document does not exonerate parties to a transaction from exercising all their rights and obligations under the transaction documents. This document cannot be reproduced except in full, without prior written approval of the Company. Any unauthorized alteration, forgery or falsification of the content or appearance of this document is unlawful and offenders may be prosecuted to the fullest extent of the law.

SGS Taiwan Ltd.

No. 134, WuKungRoad, New Taipei Industrial Park, WuKu District, New Taipei City, Taiwan 24803 / 新北市五股區新北產業園區五工路 134 號

台灣檢驗科技股份有限公司

t (886-2) 2299-3279

f (886-2) 2298-0488

www.tw.sgs.com

Member of SGS Group

Band2_1.4MHz_QPSK_6_0_LowCH18607-1850.7

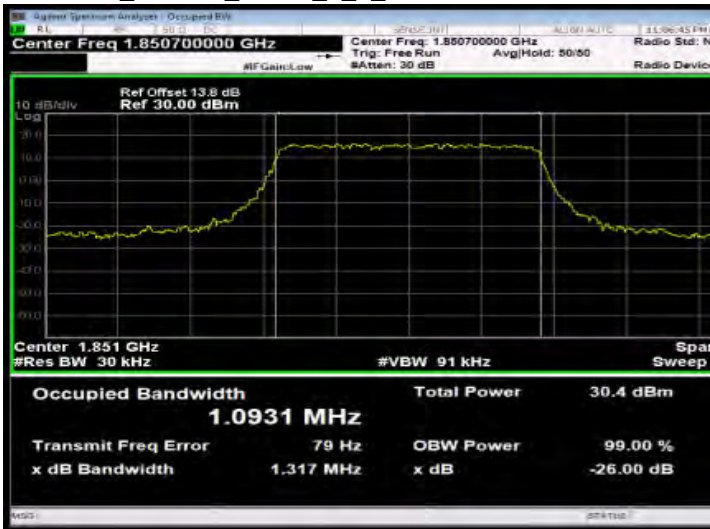

Band2_1.4MHz_16QAM_6_0_LowCH18607-1850.7

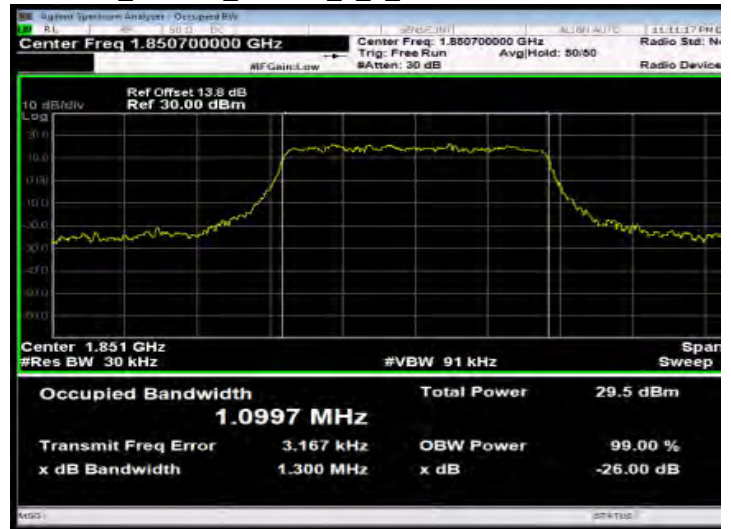

Band2_1.4MHz_QPSK_6_0_MidCH18900-1880



Band2_1.4MHz_16QAM_6_0_MidCH18900-1880



Band2_1.4MHz_QPSK_6_0_HighCH19193-1909.3

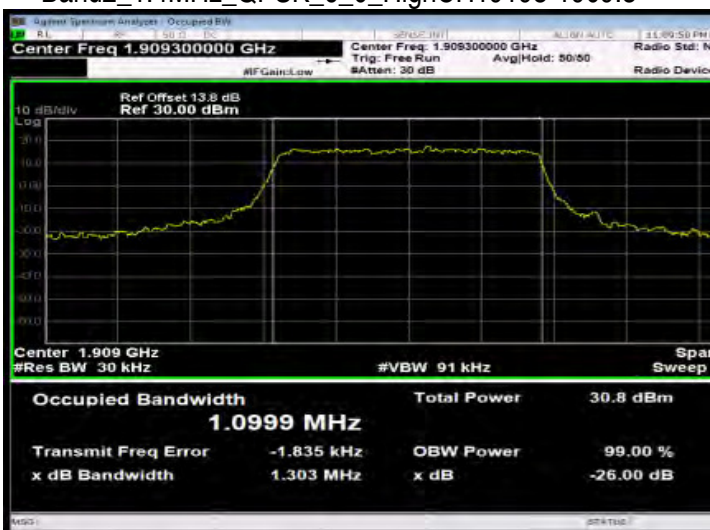

Band2_1.4MHz_16QAM_6_0_HighCH19193-1909.3

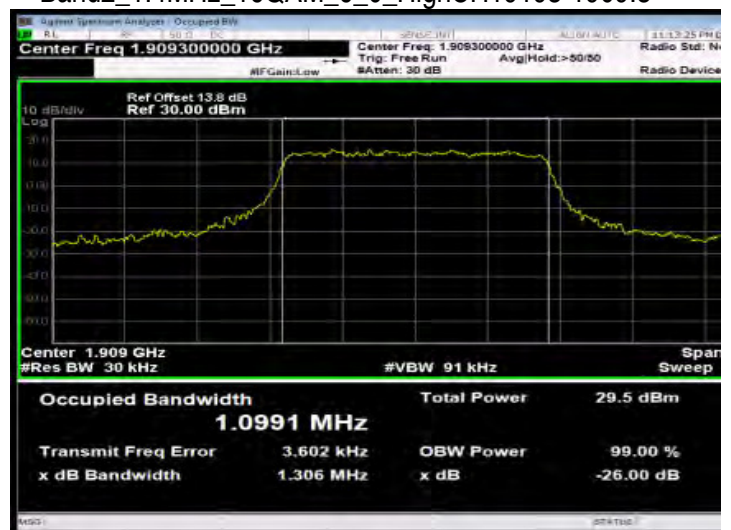

Unless otherwise stated the results shown in this test report refer only to the sample(s) tested and such sample(s) are retained for 90 days only.

除非另有說明，此報告結果僅對測試之樣品負責，同時此樣品僅保留90天。本報告未經本公司書面許可，不可部份複製。

This document is issued by the Company subject to its General Conditions of Service printed overleaf, available on request or accessible at www.sgs.com/terms_and_conditions.htm and, for electronic format documents, subject to Terms and Conditions for Electronic Documents at www.sgs.com/terms_e-document.htm. Attention is drawn to the limitation of liability, indemnification and jurisdiction issues defined therein. Any holder of this document is advised that information contained hereon reflects the Company's findings at the time of its intervention only and within the limits of Client's instructions, if any. The Company's sole responsibility is to its Client and this document does not exonerate parties to a transaction from exercising all their rights and obligations under the transaction documents. This document cannot be reproduced except in full, without prior written approval of the Company. Any unauthorized alteration, forgery or falsification of the content or appearance of this document is unlawful and offenders may be prosecuted to the fullest extent of the law.

SGS Taiwan Ltd.

No. 134, WuKungRoad, New Taipei Industrial Park, WuKu District, New Taipei City, Taiwan 24803/新北市五股區新北產業園區五工路 134 號

台灣檢驗科技股份有限公司

t (886-2) 2299-3279

f (886-2) 2298-0488

www.tw.sgs.com

Member of SGS Group

Band2_3MHz_QPSK_15_0_LowCH18615-1851.5

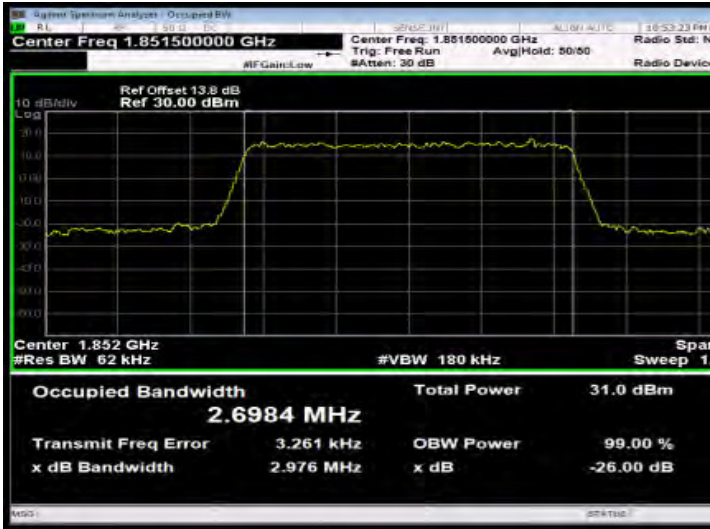

Band2_3MHz_16QAM_15_0_LowCH18615-1851.5

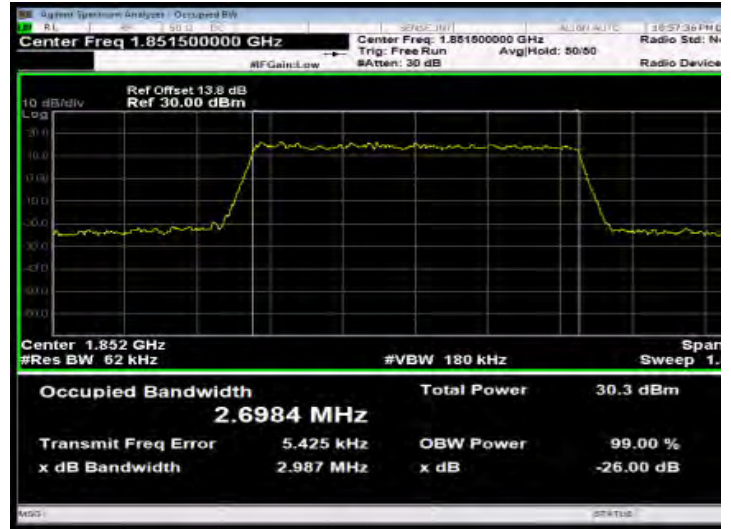

Band2_3MHz_QPSK_15_0_MidCH18900-1880

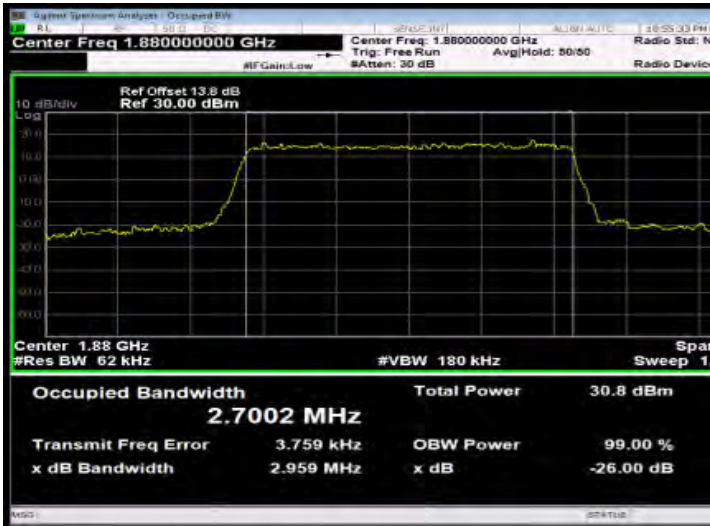

Band2_3MHz_16QAM_15_0_MidCH18900-1880

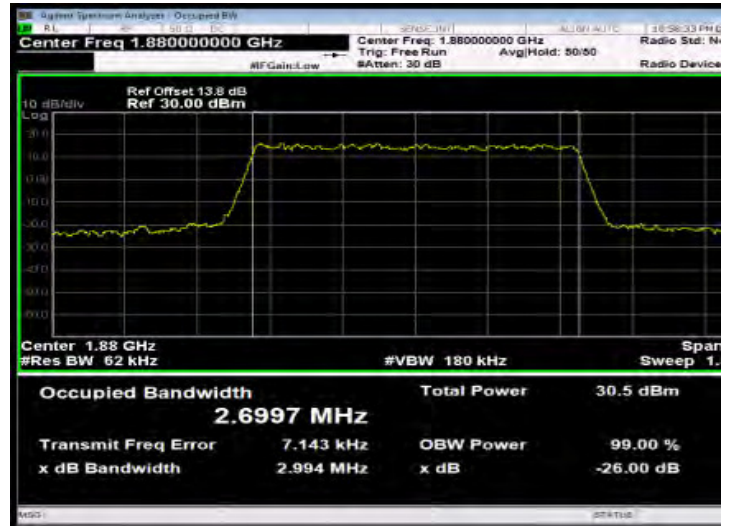

Band2_3MHz_QPSK_15_0_HighCH19185-1908.5

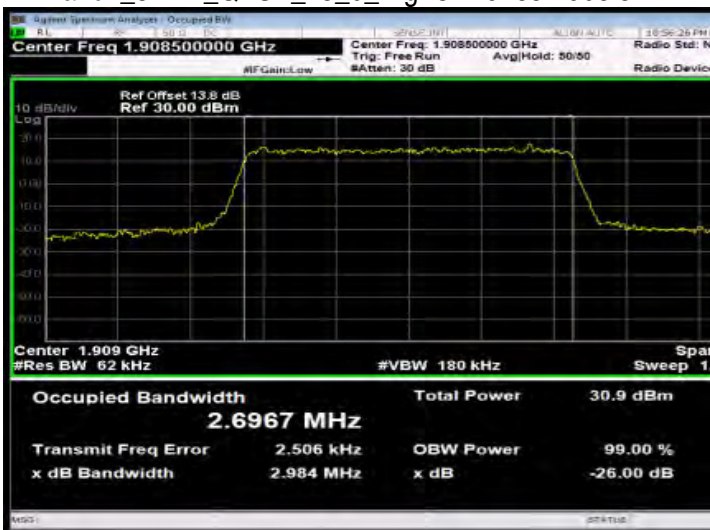

Band2_3MHz_16QAM_15_0_HighCH19185-1908.5

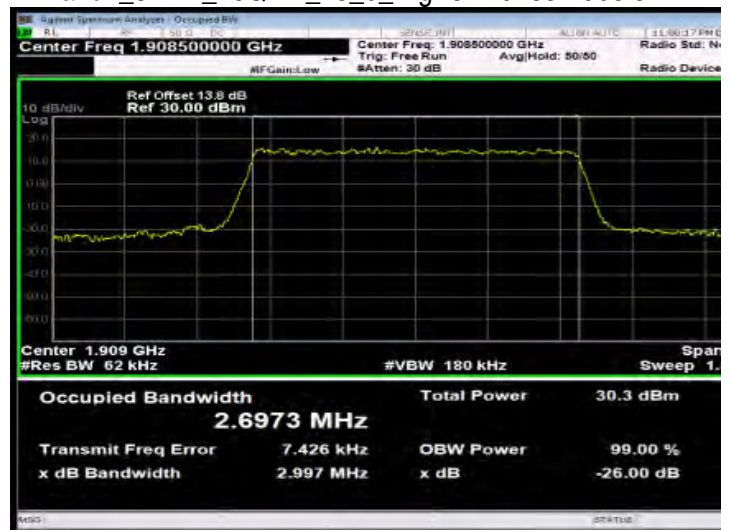

Unless otherwise stated the results shown in this test report refer only to the sample(s) tested and such sample(s) are retained for 90 days only.

除非另有說明，此報告結果僅對測試之樣品負責，同時此樣品僅保留90天。本報告未經本公司書面許可，不可部份複製。

This document is issued by the Company subject to its General Conditions of Service printed overleaf, available on request or accessible at www.sgs.com/terms_and_conditions.htm and, for electronic format documents, subject to Terms and Conditions for Electronic Documents at www.sgs.com/terms_e-document.htm. Attention is drawn to the limitation of liability, indemnification and jurisdiction issues defined therein. Any holder of this document is advised that information contained hereon reflects the Company's findings at the time of its intervention only and within the limits of Client's instructions, if any. The Company's sole responsibility is to its Client and this document does not exonerate parties to a transaction from exercising all their rights and obligations under the transaction documents. This document cannot be reproduced except in full, without prior written approval of the Company. Any unauthorized alteration, forgery or falsification of the content or appearance of this document is unlawful and offenders may be prosecuted to the fullest extent of the law.

SGS Taiwan Ltd.

No. 134, WuKungRoad, New Taipei Industrial Park, WuKu District, New Taipei City, Taiwan 24803/新北市五股區新北產業園區五工路 134 號

台灣檢驗科技股份有限公司

t (886-2) 2299-3279

f (886-2) 2298-0488

www.tw.sgs.com

Member of SGS Group

Band2_5MHz_QPSK_25_0_LowCH18625-1852.5

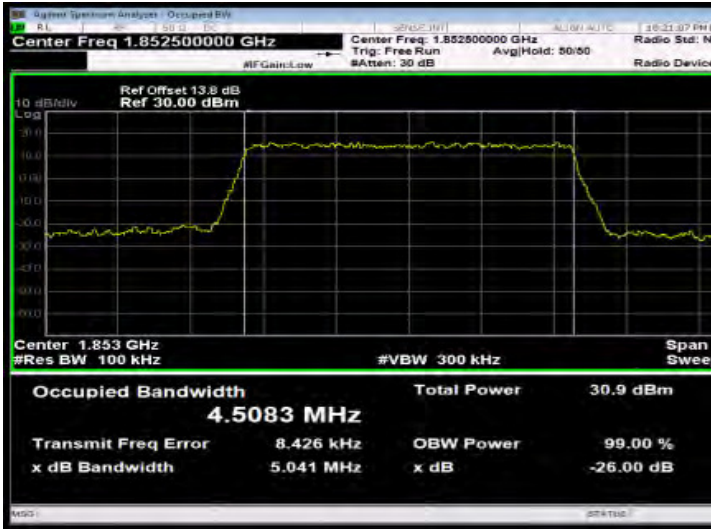

Band2_5MHz_16QAM_25_0_LowCH18625-1852.5

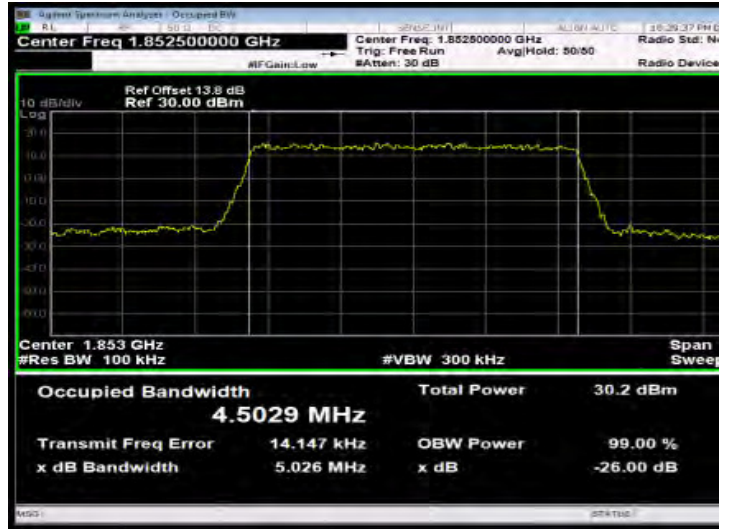

Band2_5MHz_QPSK_25_0_MidCH18900-1880

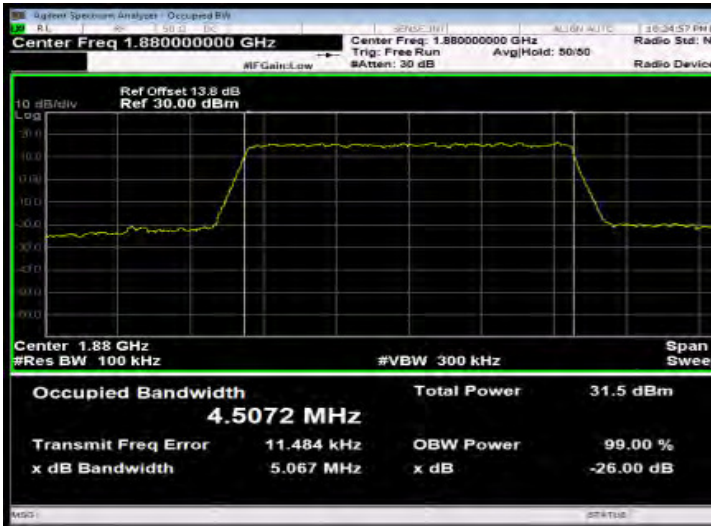

Band2_5MHz_16QAM_25_0_MidCH18900-1880

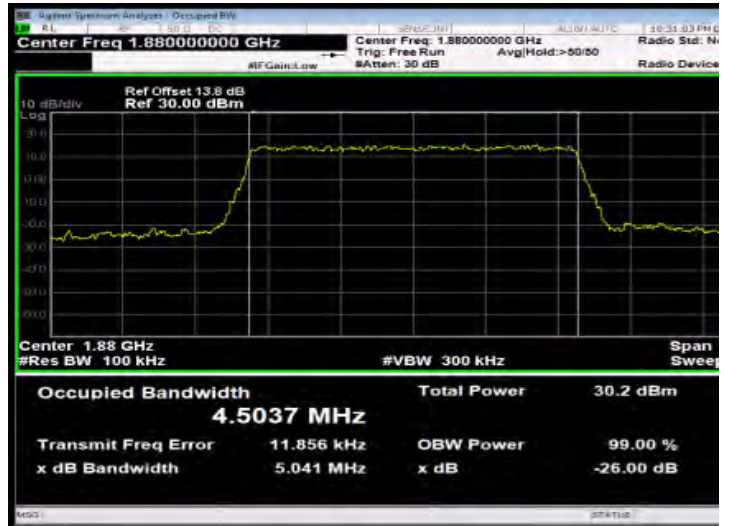

Band2_5MHz_QPSK_25_0_HighCH19175-1907.5

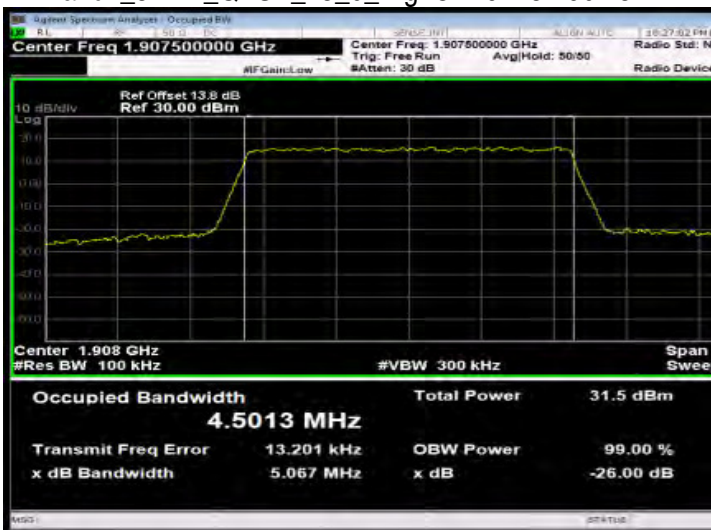

Band2_5MHz_16QAM_25_0_HighCH19175-1907.5



Unless otherwise stated the results shown in this test report refer only to the sample(s) tested and such sample(s) are retained for 90 days only.

除非另有說明，此報告結果僅對測試之樣品負責，同時此樣品僅保留90天。本報告未經本公司書面許可，不可部份複製。

This document is issued by the Company subject to its General Conditions of Service printed overleaf, available on request or accessible at www.sgs.com/terms_and_conditions.htm and, for electronic format documents, subject to Terms and Conditions for Electronic Documents at www.sgs.com/terms_e-document.htm. Attention is drawn to the limitation of liability, indemnification and jurisdiction issues defined therein. Any holder of this document is advised that information contained hereon reflects the Company's findings at the time of its intervention only and within the limits of Client's instructions, if any. The Company's sole responsibility is to its Client and this document does not exonerate parties to a transaction from exercising all their rights and obligations under the transaction documents. This document cannot be reproduced except in full, without prior written approval of the Company. Any unauthorized alteration, forgery or falsification of the content or appearance of this document is unlawful and offenders may be prosecuted to the fullest extent of the law.

SGS Taiwan Ltd.

No. 134, WuKungRoad, New Taipei Industrial Park, WuKu District, New Taipei City, Taiwan 24803/新北市五股區新北產業園區五工路 134 號

台灣檢驗科技股份有限公司

t (886-2) 2299-3279

f (886-2) 2298-0488

www.tw.sgs.com

Member of SGS Group

Band2_10MHz_QPSK_50_0_LowCH18650-1855

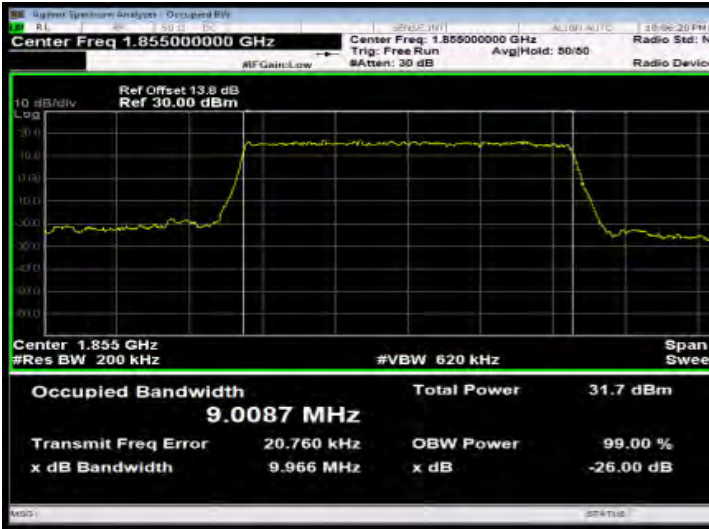

Band2_10MHz_16QAM_50_0_LowCH18650-1855

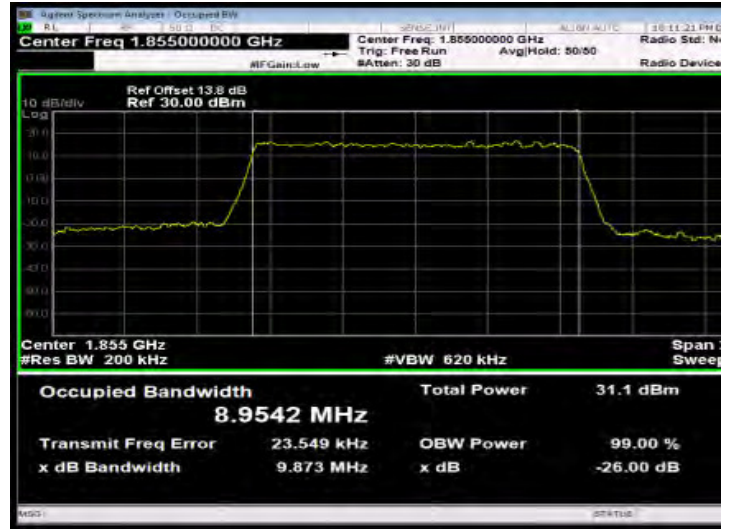

Band2_10MHz_QPSK_50_0_MidCH18900-1880

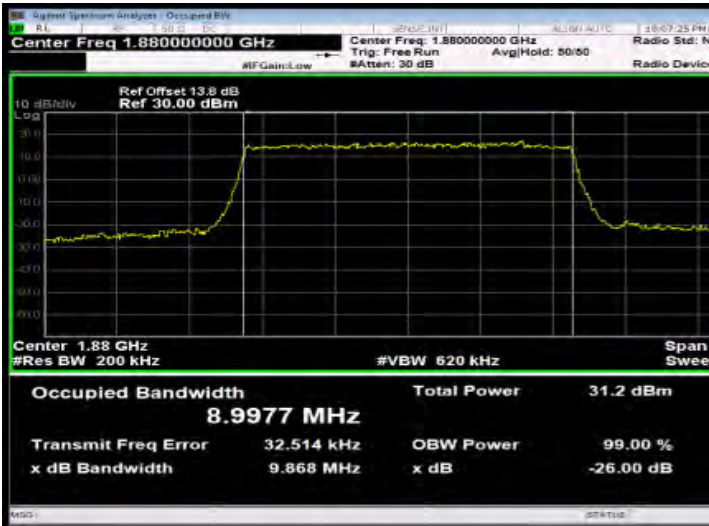

Band2_10MHz_16QAM_50_0_MidCH18900-1880

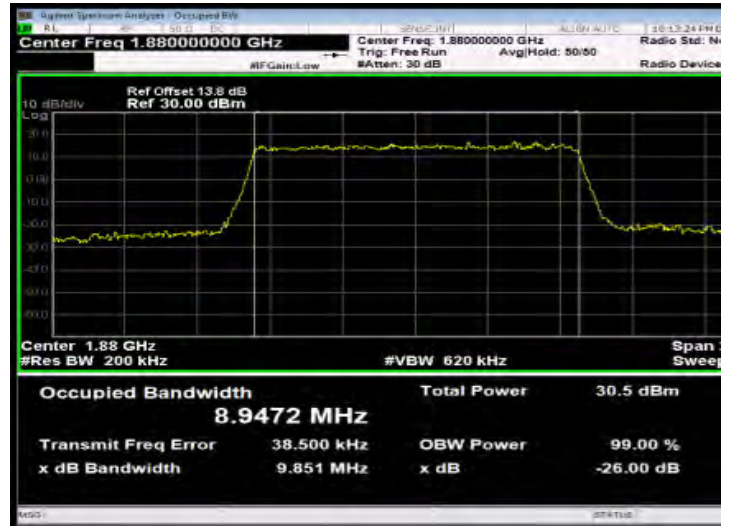

Band2_10MHz_QPSK_50_0_HighCH19150-1905

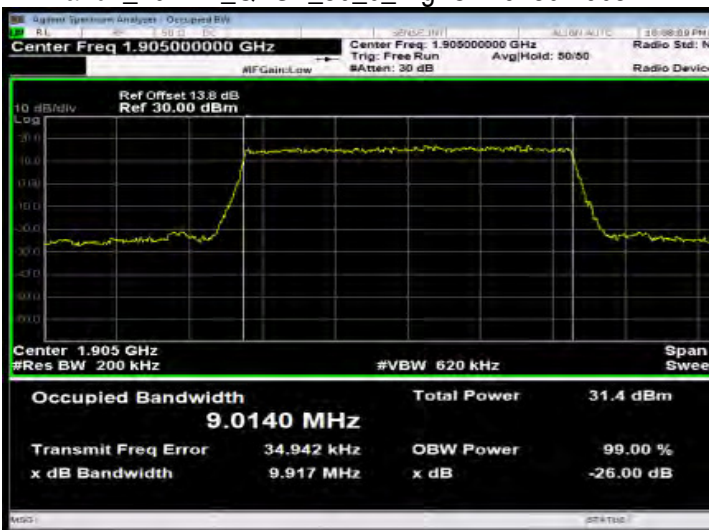

Band2_10MHz_16QAM_50_0_HighCH19150-1905

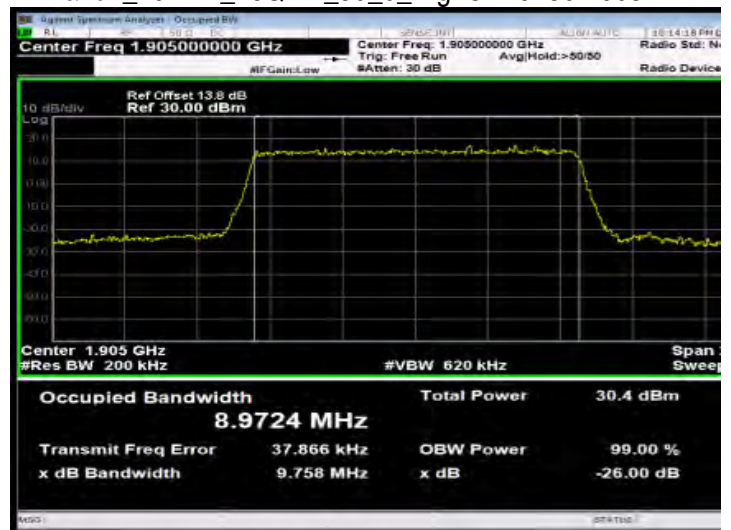

Unless otherwise stated the results shown in this test report refer only to the sample(s) tested and such sample(s) are retained for 90 days only.

除非另有說明，此報告結果僅對測試之樣品負責，同時此樣品僅保留90天。本報告未經本公司書面許可，不可部份複製。

This document is issued by the Company subject to its General Conditions of Service printed overleaf, available on request or accessible at www.sgs.com/terms_and_conditions.htm and, for electronic format documents, subject to Terms and Conditions for Electronic Documents at www.sgs.com/terms_e-document.htm. Attention is drawn to the limitation of liability, indemnification and jurisdiction issues defined therein. Any holder of this document is advised that information contained hereon reflects the Company's findings at the time of its intervention only and within the limits of Client's instructions, if any. The Company's sole responsibility is to its Client and this document does not exonerate parties to a transaction from exercising all their rights and obligations under the transaction documents. This document cannot be reproduced except in full, without prior written approval of the Company. Any unauthorized alteration, forgery or falsification of the content or appearance of this document is unlawful and offenders may be prosecuted to the fullest extent of the law.

SGS Taiwan Ltd.

No. 134, WuKungRoad, New Taipei Industrial Park, WuKu District, New Taipei City, Taiwan 24803/新北市五股區新北產業園區五工路 134 號

台灣檢驗科技股份有限公司

t (886-2) 2299-3279

f (886-2) 2298-0488

www.tw.sgs.com

Member of SGS Group

Band2_15MHz_QPSK_75_0_LowCH18675-1857.5

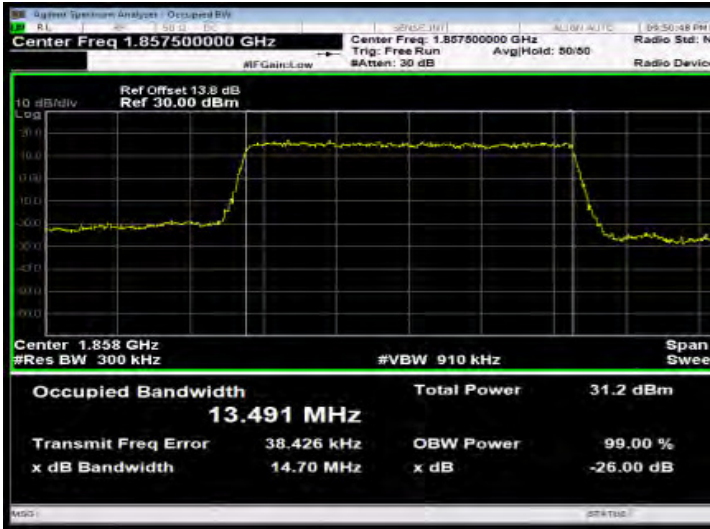

Band2_15MHz_16QAM_75_0_LowCH18675-1857.5

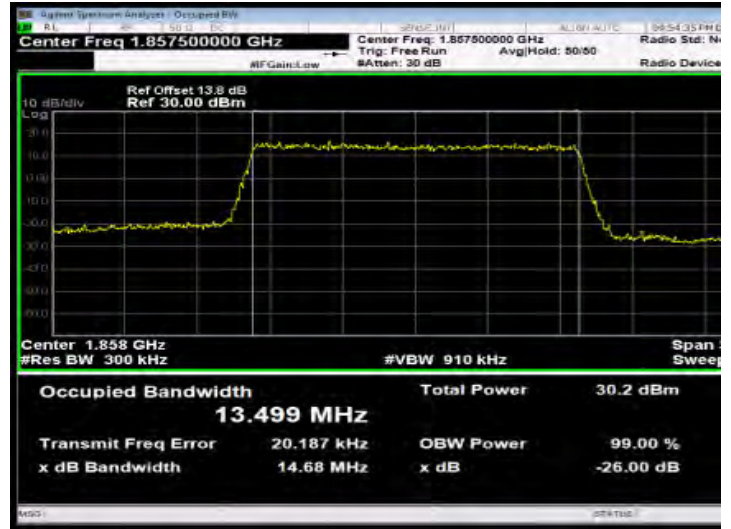

Band2_15MHz_QPSK_75_0_MidCH18900-1880

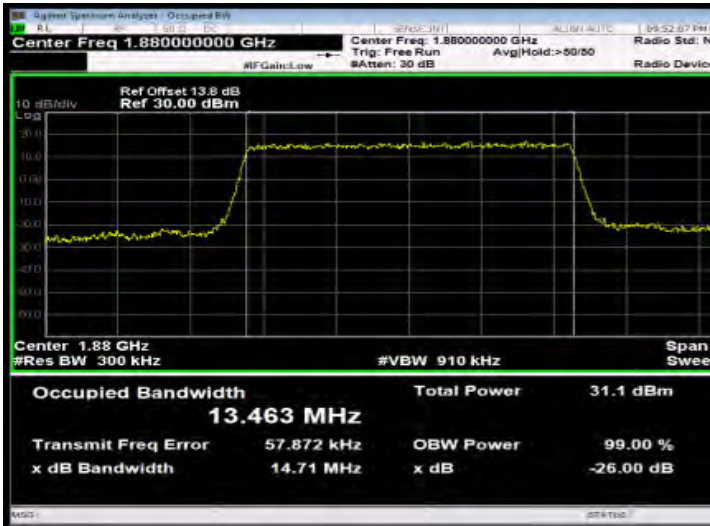

Band2_15MHz_16QAM_75_0_MidCH18900-1880

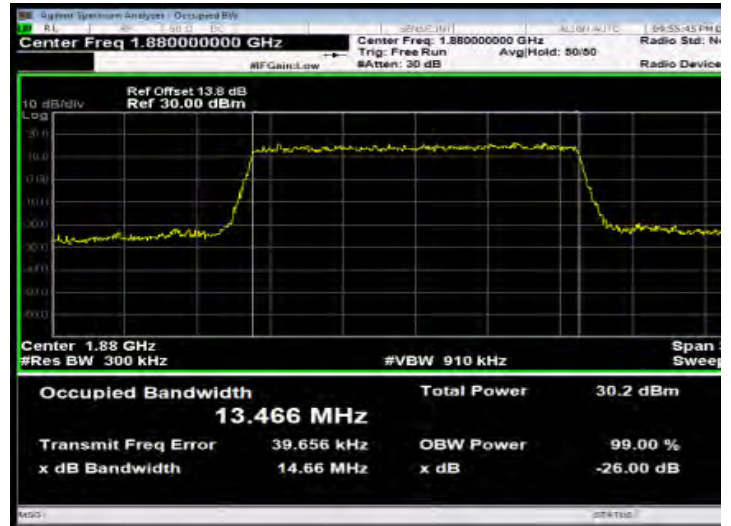

Band2_15MHz_QPSK_75_0_HighCH19125-1902.5



Band2_15MHz_16QAM_75_0_HighCH19125-1902.5

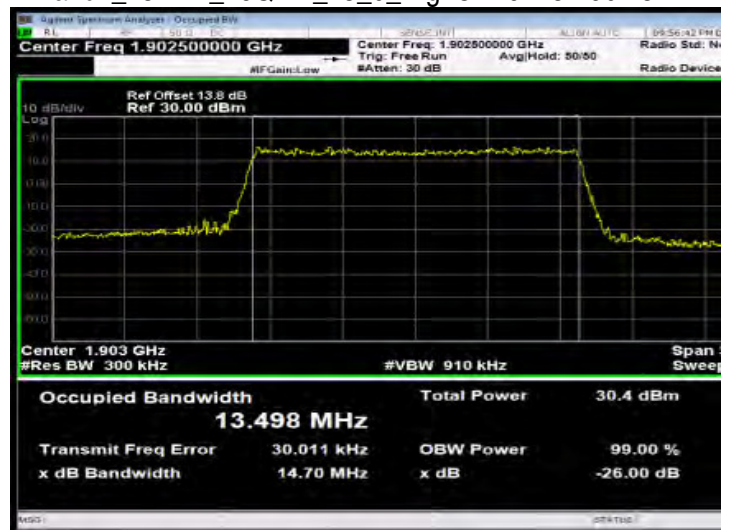

Unless otherwise stated the results shown in this test report refer only to the sample(s) tested and such sample(s) are retained for 90 days only.

除非另有說明，此報告結果僅對測試之樣品負責，同時此樣品僅保留90天。本報告未經本公司書面許可，不可部份複製。

This document is issued by the Company subject to its General Conditions of Service printed overleaf, available on request or accessible at www.sgs.com/terms_and_conditions.htm and, for electronic format documents, subject to Terms and Conditions for Electronic Documents at www.sgs.com/terms_e-document.htm. Attention is drawn to the limitation of liability, indemnification and jurisdiction issues defined therein. Any holder of this document is advised that information contained hereon reflects the Company's findings at the time of its intervention only and within the limits of Client's instructions, if any. The Company's sole responsibility is to its Client and this document does not exonerate parties to a transaction from exercising all their rights and obligations under the transaction documents. This document cannot be reproduced except in full, without prior written approval of the Company. Any unauthorized alteration, forgery or falsification of the content or appearance of this document is unlawful and offenders may be prosecuted to the fullest extent of the law.

SGS Taiwan Ltd.

No. 134, WuKungRoad, New Taipei Industrial Park, WuKu District, New Taipei City, Taiwan 24803/新北市五股區新北產業園區五工路 134 號

台灣檢驗科技股份有限公司

t (886-2) 2299-3279

f (886-2) 2298-0488

www.tw.sgs.com

Member of SGS Group

Band2_20MHz_QPSK_100_0_LowCH18700-1860

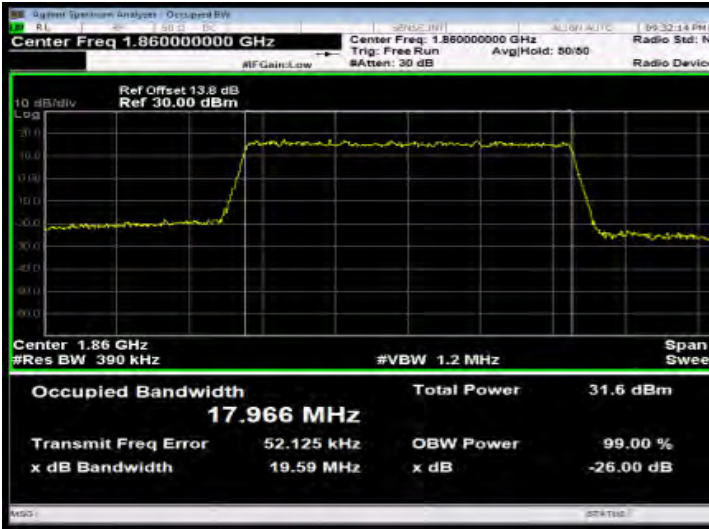

Band2_20MHz_16QAM_100_0_LowCH18700-1860

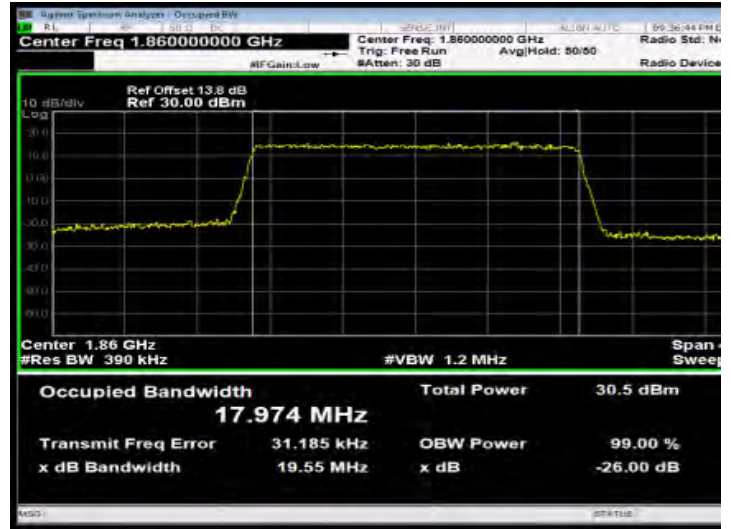

Band2_20MHz_QPSK_100_0_MidCH18900-1880

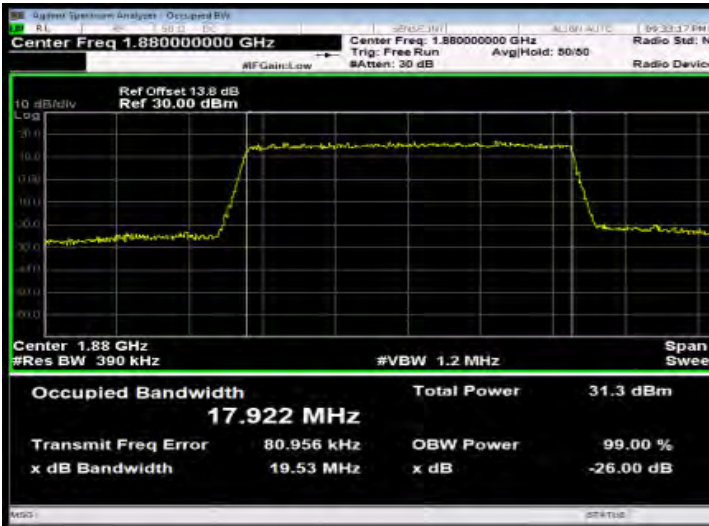

Band2_20MHz_16QAM_100_0_MidCH18900-1880

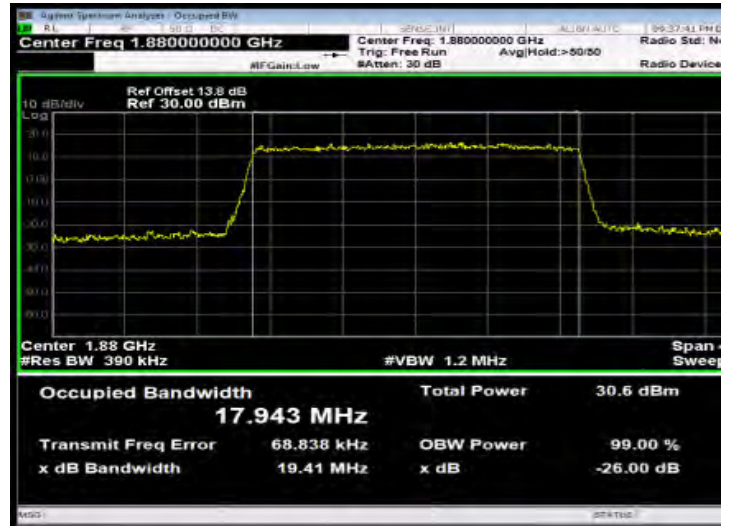

Band2_20MHz_QPSK_100_0_HighCH19100-1900

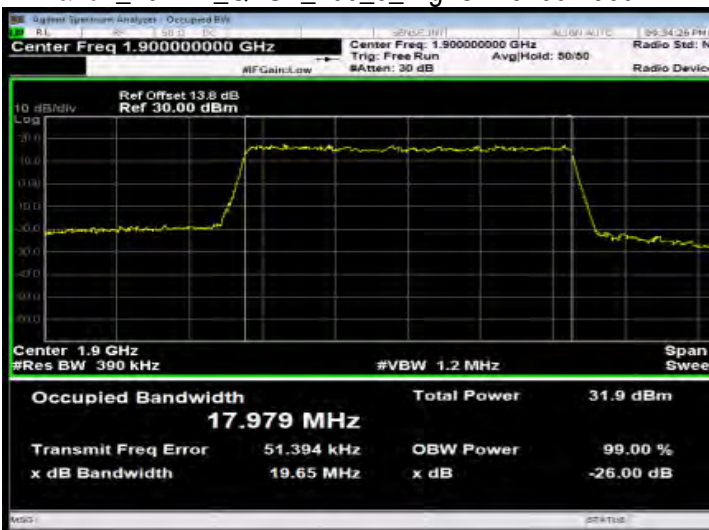

Band2_20MHz_16QAM_100_0_HighCH19100-1900

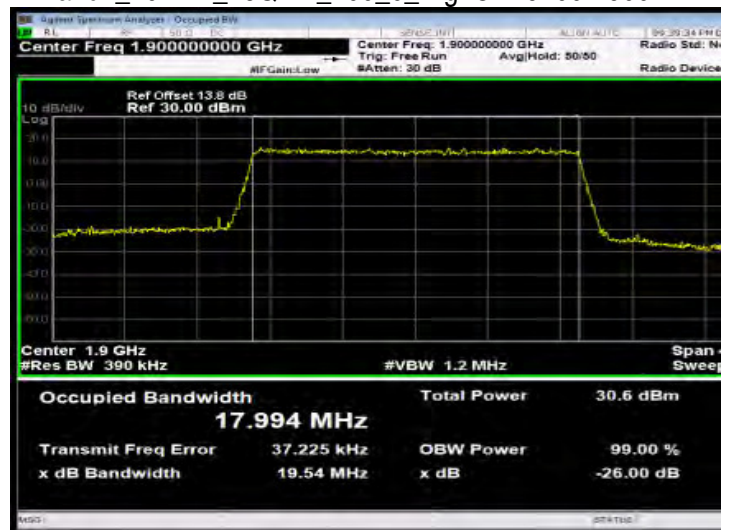

Unless otherwise stated the results shown in this test report refer only to the sample(s) tested and such sample(s) are retained for 90 days only.

除非另有說明，此報告結果僅對測試之樣品負責，同時此樣品僅保留90天。本報告未經本公司書面許可，不可部份複製。

This document is issued by the Company subject to its General Conditions of Service printed overleaf, available on request or accessible at www.sgs.com/terms_and_conditions.htm and, for electronic format documents, subject to Terms and Conditions for Electronic Documents at www.sgs.com/terms_e-document.htm. Attention is drawn to the limitation of liability, indemnification and jurisdiction issues defined therein. Any holder of this document is advised that information contained hereon reflects the Company's findings at the time of its intervention only and within the limits of Client's instructions, if any. The Company's sole responsibility is to its Client and this document does not exonerate parties to a transaction from exercising all their rights and obligations under the transaction documents. This document cannot be reproduced except in full, without prior written approval of the Company. Any unauthorized alteration, forgery or falsification of the content or appearance of this document is unlawful and offenders may be prosecuted to the fullest extent of the law.

SGS Taiwan Ltd.

No. 134, WuKungRoad, New Taipei Industrial Park, WuKu District, New Taipei City, Taiwan 24803 / 新北市五股區新北產業園區五工路 134 號

台灣檢驗科技股份有限公司

t (886-2) 2299-3279

f (886-2) 2298-0488

www.tw.sgs.com

Member of SGS Group

Band4_1.4MHz_QPSK_6_0_LowCH19957-1710.7

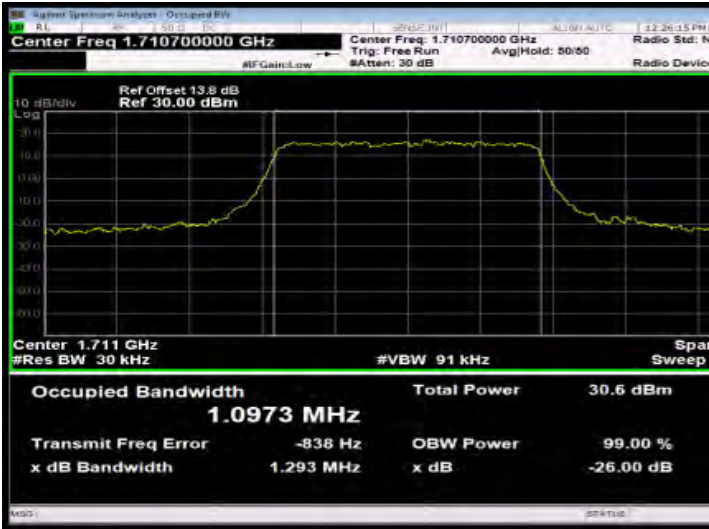

Band4_1.4MHz_16QAM_6_0_LowCH19957-1710.7

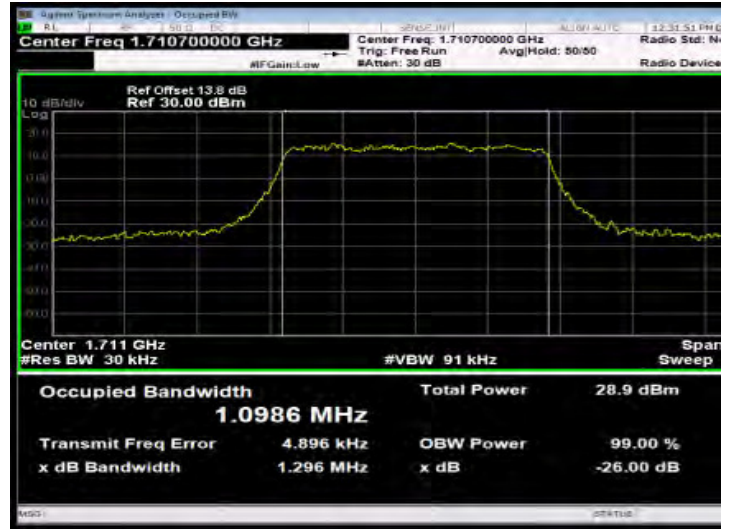

Band4_1.4MHz_QPSK_6_0_MidCH20175-1732.5

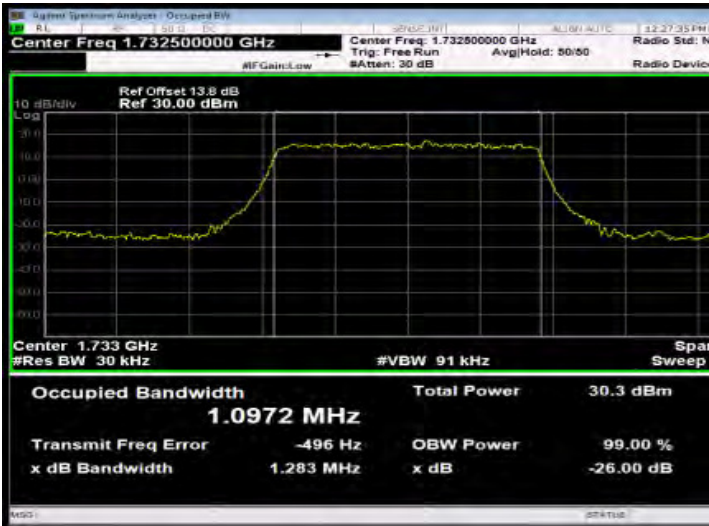

Band4_1.4MHz_16QAM_6_0_MidCH20175-1732.5

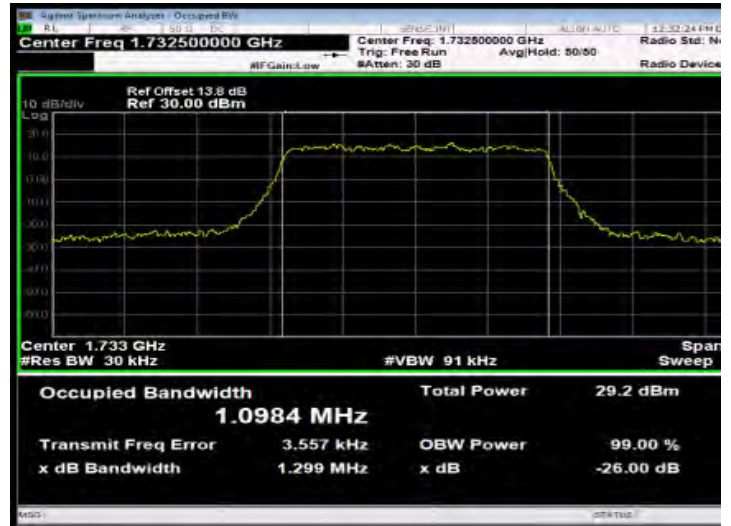

Band4_1.4MHz_QPSK_6_0_HighCH20393-1754.3



Band4_1.4MHz_16QAM_6_0_HighCH20393-1754.3

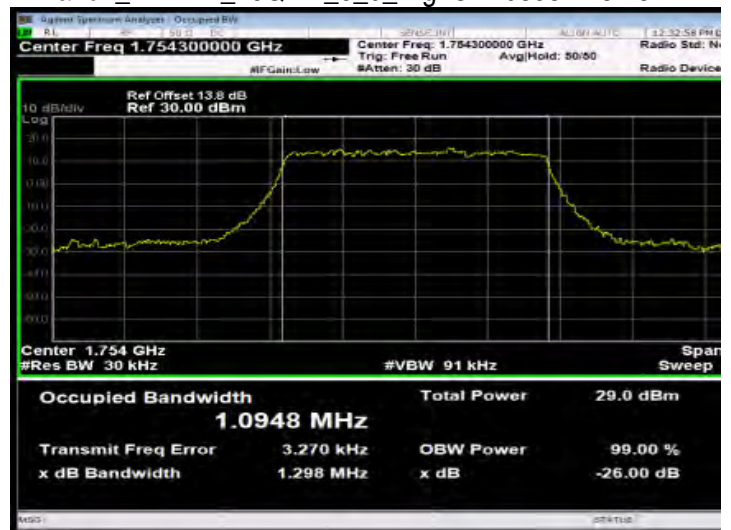

Unless otherwise stated the results shown in this test report refer only to the sample(s) tested and such sample(s) are retained for 90 days only.

除非另有說明，此報告結果僅對測試之樣品負責，同時此樣品僅保留90天。本報告未經本公司書面許可，不可部份複製。

This document is issued by the Company subject to its General Conditions of Service printed overleaf, available on request or accessible at www.sgs.com/terms_and_conditions.htm and, for electronic format documents, subject to Terms and Conditions for Electronic Documents at www.sgs.com/terms_e-document.htm. Attention is drawn to the limitation of liability, indemnification and jurisdiction issues defined therein. Any holder of this document is advised that information contained hereon reflects the Company's findings at the time of its intervention only and within the limits of Client's instructions, if any. The Company's sole responsibility is to its Client and this document does not exonerate parties to a transaction from exercising all their rights and obligations under the transaction documents. This document cannot be reproduced except in full, without prior written approval of the Company. Any unauthorized alteration, forgery or falsification of the content or appearance of this document is unlawful and offenders may be prosecuted to the fullest extent of the law.

SGS Taiwan Ltd.

No. 134, WuKungRoad, New Taipei Industrial Park, WuKu District, New Taipei City, Taiwan 24803 / 新北市五股區新北產業園區五工路 134 號

台灣檢驗科技股份有限公司

t (886-2) 2299-3279

f (886-2) 2298-0488

www.tw.sgs.com

Member of SGS Group

Band4_3MHz_QPSK_15_0_LowCH19965-1711.5

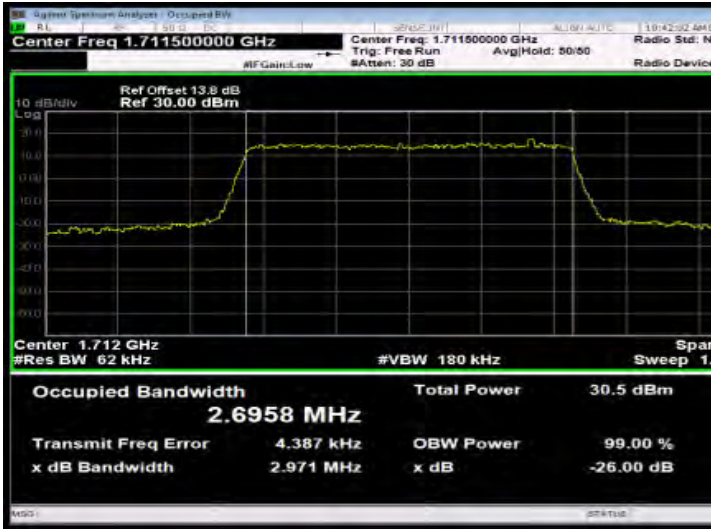

Band4_3MHz_16QAM_15_0_LowCH19965-1711.5

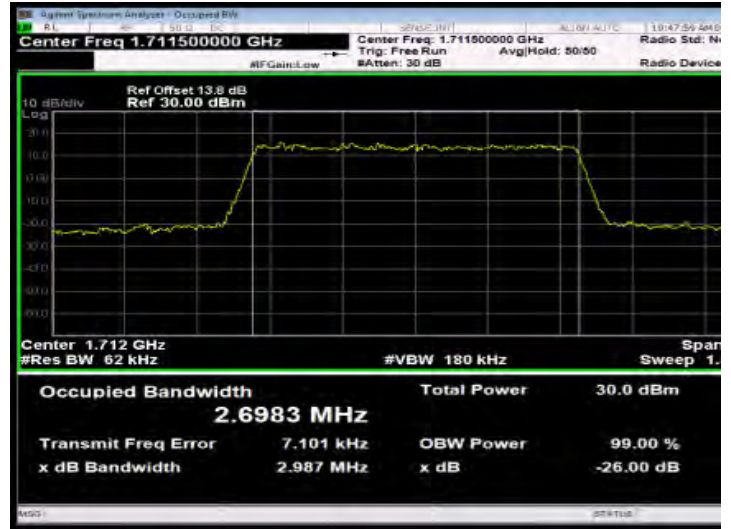

Band4_3MHz_QPSK_15_0_MidCH20175-1732.5

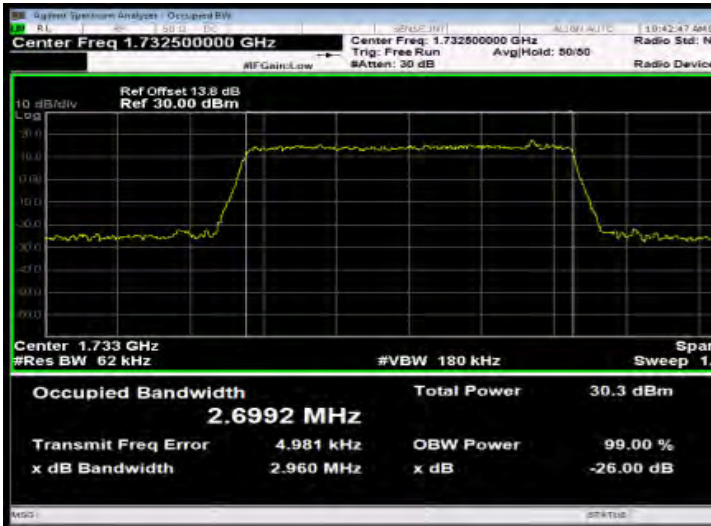

Band4_3MHz_16QAM_15_0_MidCH20175-1732.5

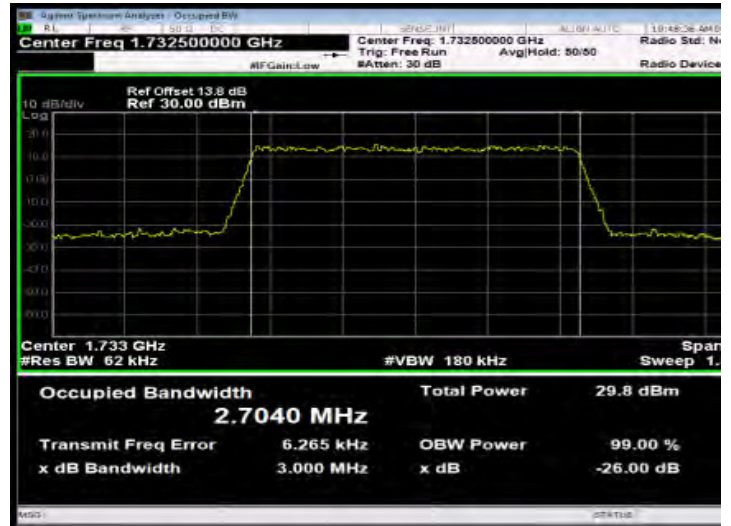

Band4_3MHz_QPSK_15_0_HighCH20385-1753.5

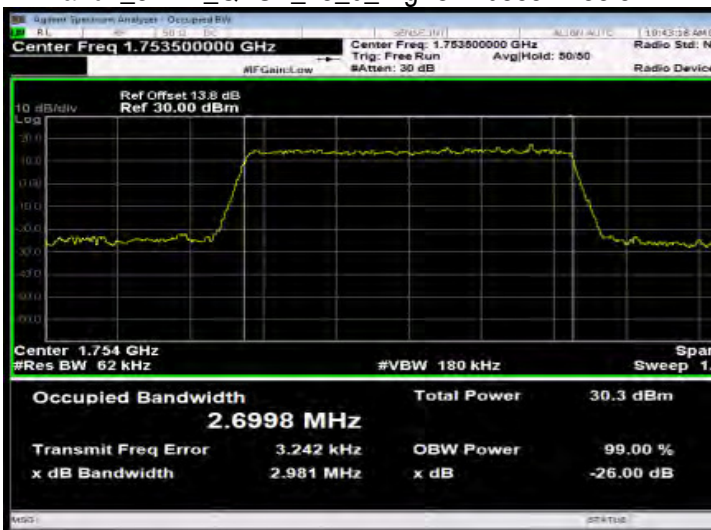

Band4_3MHz_16QAM_15_0_HighCH20385-1753.5

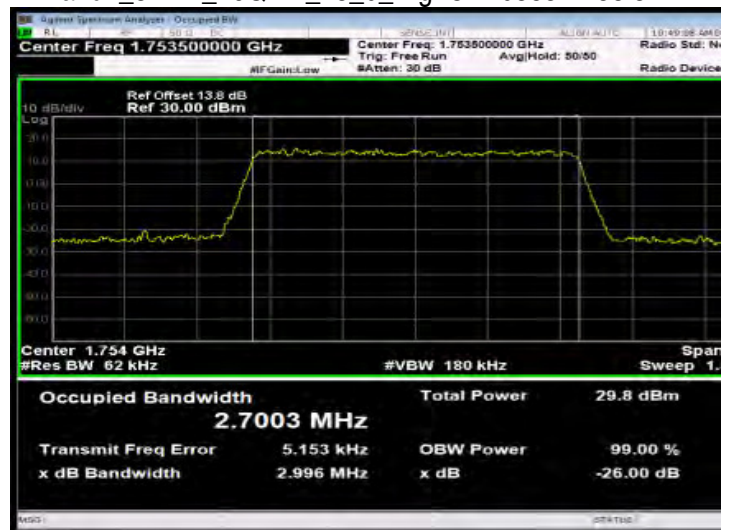

Unless otherwise stated the results shown in this test report refer only to the sample(s) tested and such sample(s) are retained for 90 days only.

除非另有說明，此報告結果僅對測試之樣品負責，同時此樣品僅保留90天。本報告未經本公司書面許可，不可部份複製。

This document is issued by the Company subject to its General Conditions of Service printed overleaf, available on request or accessible at www.sgs.com/terms_and_conditions.htm and, for electronic format documents, subject to Terms and Conditions for Electronic Documents at www.sgs.com/terms_e-document.htm. Attention is drawn to the limitation of liability, indemnification and jurisdiction issues defined therein. Any holder of this document is advised that information contained hereon reflects the Company's findings at the time of its intervention only and within the limits of Client's instructions, if any. The Company's sole responsibility is to its Client and this document does not exonerate parties to a transaction from exercising all their rights and obligations under the transaction documents. This document cannot be reproduced except in full, without prior written approval of the Company. Any unauthorized alteration, forgery or falsification of the content or appearance of this document is unlawful and offenders may be prosecuted to the fullest extent of the law.

SGS Taiwan Ltd.

No. 134, WuKungRoad, New Taipei Industrial Park, WuKu District, New Taipei City, Taiwan 24803 / 新北市五股區新北產業園區五工路 134 號

台灣檢驗科技股份有限公司

t (886-2) 2299-3279

f (886-2) 2298-0488

www.tw.sgs.com

Member of SGS Group

Band4_5MHz_QPSK_25_0_LowCH19975-1712.5

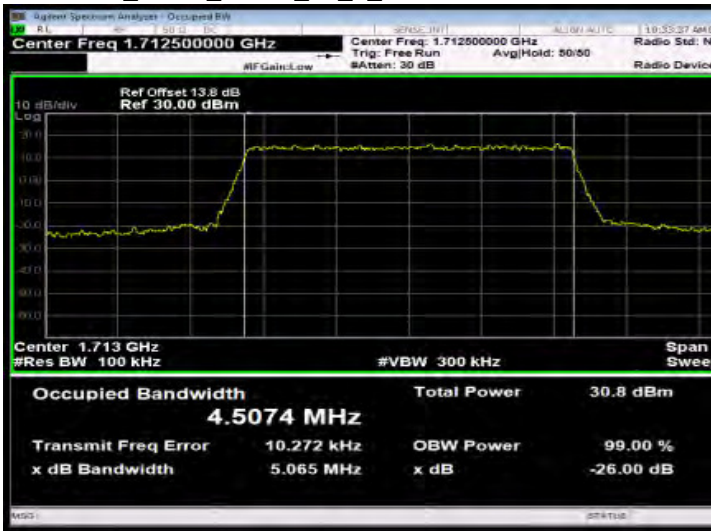

Band4_5MHz_16QAM_25_0_LowCH19975-1712.5

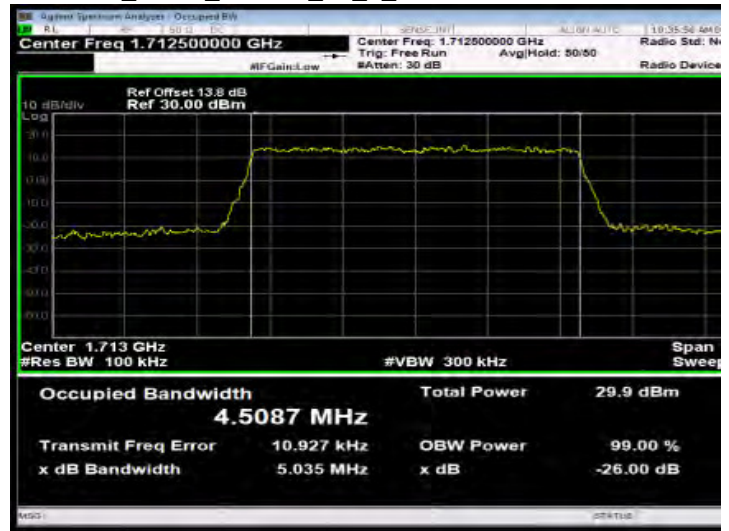

Band4_5MHz_QPSK_25_0_MidCH20175-1732.5



Band4_5MHz_16QAM_25_0_MidCH20175-1732.5

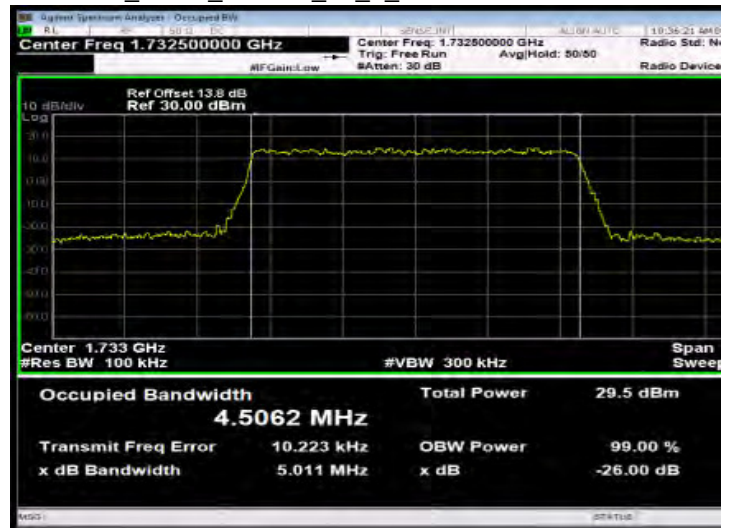

Band4_5MHz_QPSK_25_0_HighCH20375-1752.5

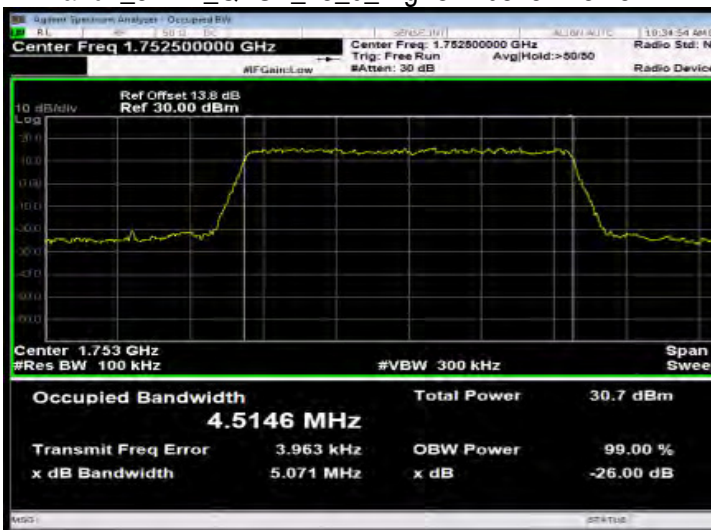

Band4_5MHz_16QAM_25_0_HighCH20375-1752.5

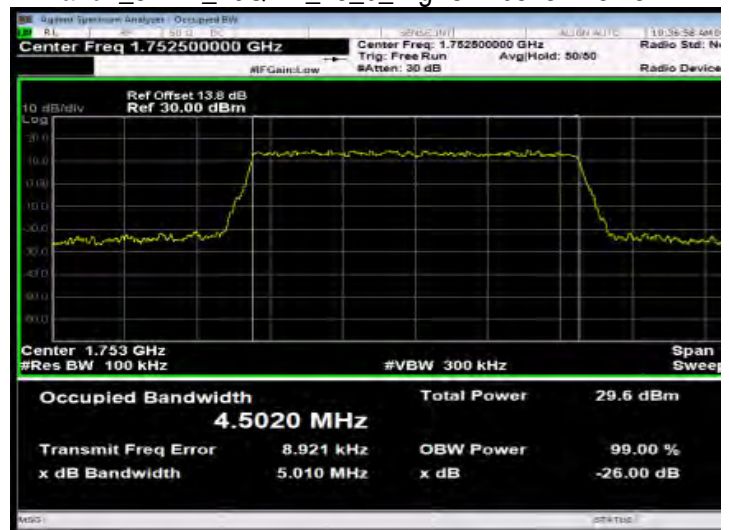

Unless otherwise stated the results shown in this test report refer only to the sample(s) tested and such sample(s) are retained for 90 days only.

除非另有說明，此報告結果僅對測試之樣品負責，同時此樣品僅保留90天。本報告未經本公司書面許可，不可部份複製。

This document is issued by the Company subject to its General Conditions of Service printed overleaf, available on request or accessible at www.sgs.com/terms_and_conditions.htm and, for electronic format documents, subject to Terms and Conditions for Electronic Documents at www.sgs.com/terms_e-document.htm. Attention is drawn to the limitation of liability, indemnification and jurisdiction issues defined therein. Any holder of this document is advised that information contained hereon reflects the Company's findings at the time of its intervention only and within the limits of Client's instructions, if any. The Company's sole responsibility is to its Client and this document does not exonerate parties to a transaction from exercising all their rights and obligations under the transaction documents. This document cannot be reproduced except in full, without prior written approval of the Company. Any unauthorized alteration, forgery or falsification of the content or appearance of this document is unlawful and offenders may be prosecuted to the fullest extent of the law.

SGS Taiwan Ltd.

No. 134, WuKungRoad, New Taipei Industrial Park, WuKu District, New Taipei City, Taiwan 24803/新北市五股區新北產業園區五工路 134 號

台灣檢驗科技股份有限公司

t (886-2) 2299-3279

f (886-2) 2298-0488

www.tw.sgs.com

Member of SGS Group

Band4_10MHz_QPSK_50_0_LowCH20000-1715

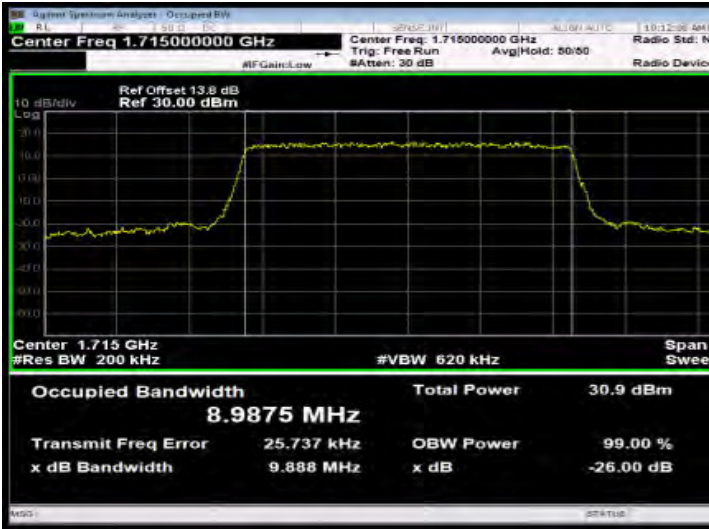

Band4_10MHz_16QAM_50_0_LowCH20000-1715

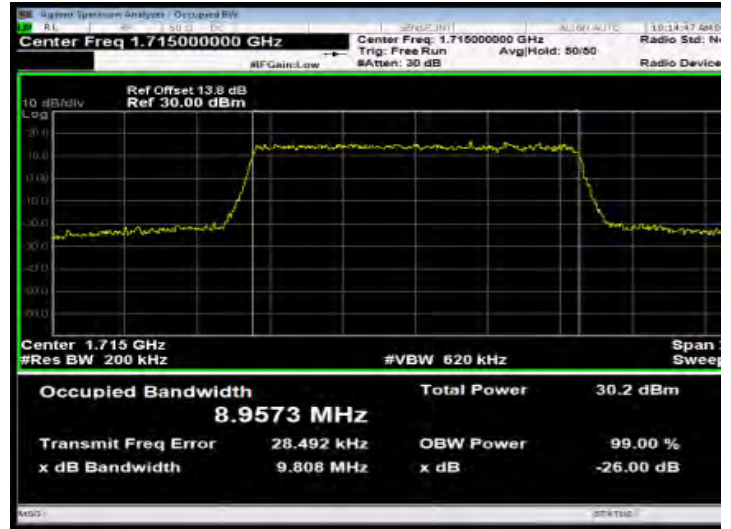

Band4_10MHz_QPSK_50_0_MidCH20175-1732.5

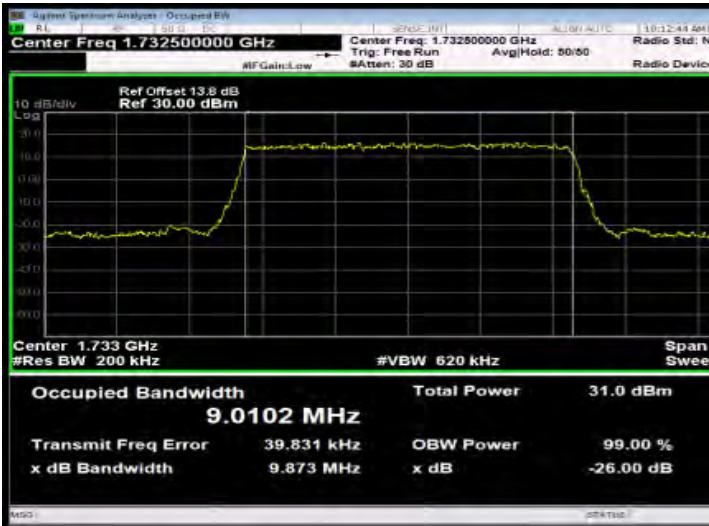

Band4_10MHz_16QAM_50_0_MidCH20175-1732.5

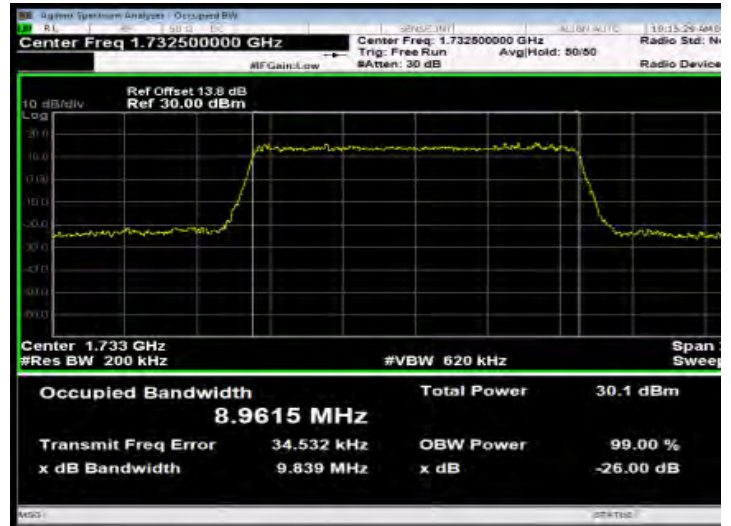

Band4_10MHz_QPSK_50_0_HighCH20350-1750

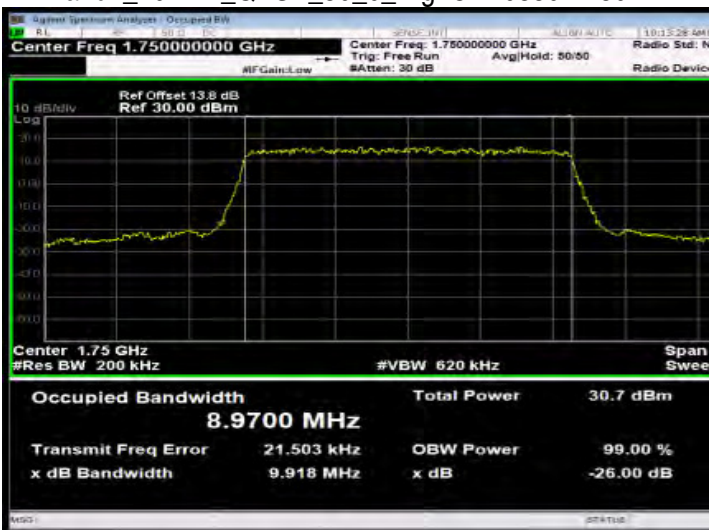

Band4_10MHz_16QAM_50_0_HighCH20350-1750

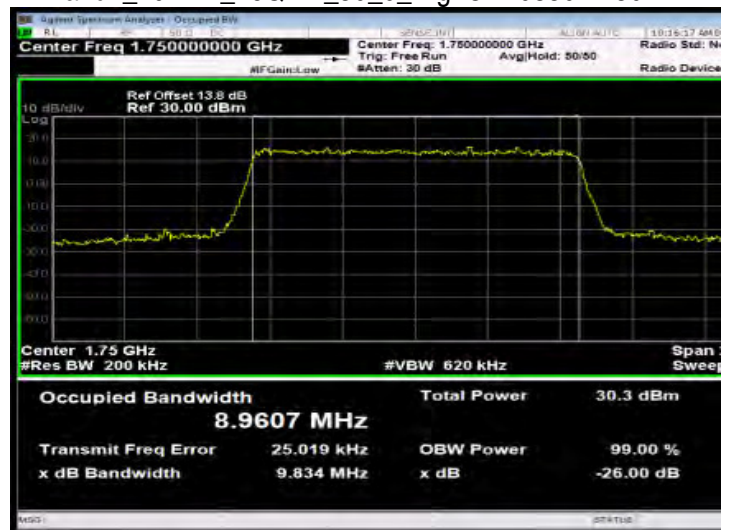

Unless otherwise stated the results shown in this test report refer only to the sample(s) tested and such sample(s) are retained for 90 days only.

除非另有說明，此報告結果僅對測試之樣品負責，同時此樣品僅保留90天。本報告未經本公司書面許可，不可部份複製。

This document is issued by the Company subject to its General Conditions of Service printed overleaf, available on request or accessible at www.sgs.com/terms_and_conditions.htm and, for electronic format documents, subject to Terms and Conditions for Electronic Documents at www.sgs.com/terms_e-document.htm. Attention is drawn to the limitation of liability, indemnification and jurisdiction issues defined therein. Any holder of this document is advised that information contained hereon reflects the Company's findings at the time of its intervention only and within the limits of Client's instructions, if any. The Company's sole responsibility is to its Client and this document does not exonerate parties to a transaction from exercising all their rights and obligations under the transaction documents. This document cannot be reproduced except in full, without prior written approval of the Company. Any unauthorized alteration, forgery or falsification of the content or appearance of this document is unlawful and offenders may be prosecuted to the fullest extent of the law.

SGS Taiwan Ltd.

No. 134, WuKungRoad, New Taipei Industrial Park, WuKu District, New Taipei City, Taiwan 24803/新北市五股區新北產業園區五工路 134 號

台灣檢驗科技股份有限公司

t (886-2) 2299-3279

f (886-2) 2298-0488

www.tw.sgs.com

Member of SGS Group

Band4_15MHz_QPSK_75_0_LowCH20025-1717.5

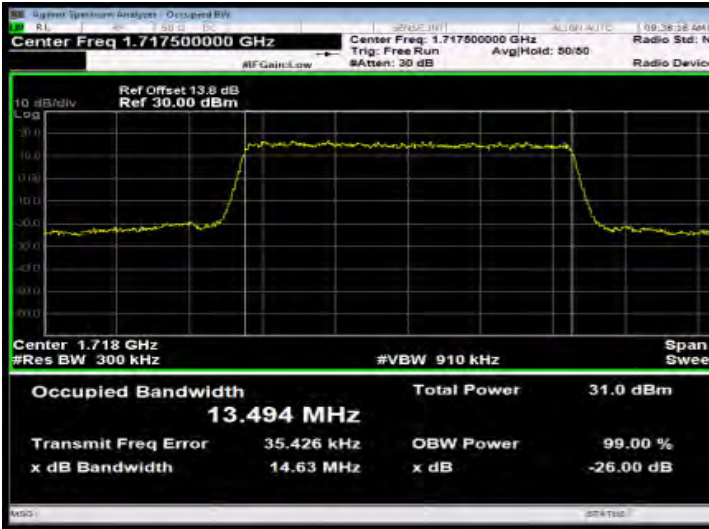

Band4_15MHz_16QAM_75_0_LowCH20025-1717.5

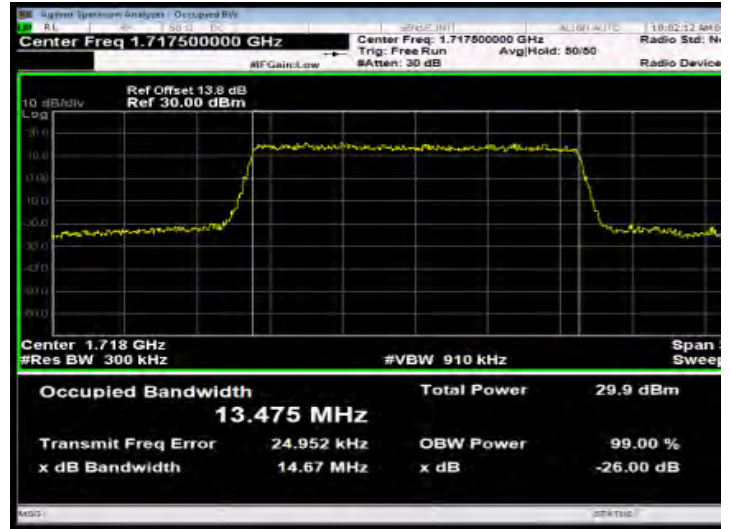

Band4_15MHz_QPSK_75_0_MidCH20175-1732.5

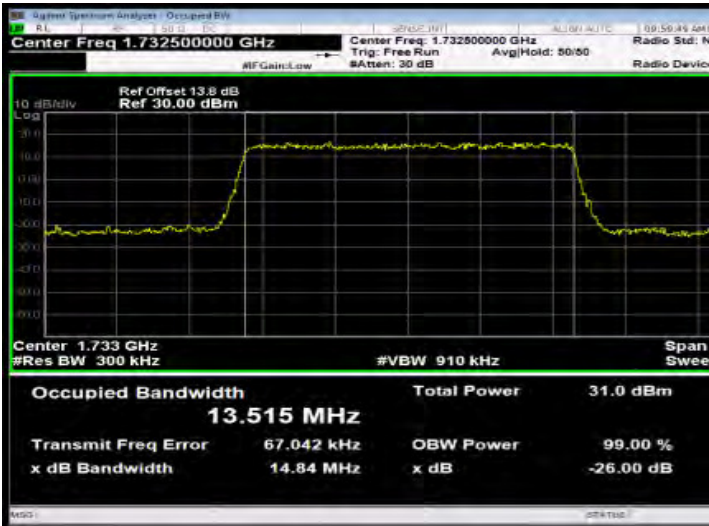

Band4_15MHz_16QAM_75_0_MidCH20175-1732.5

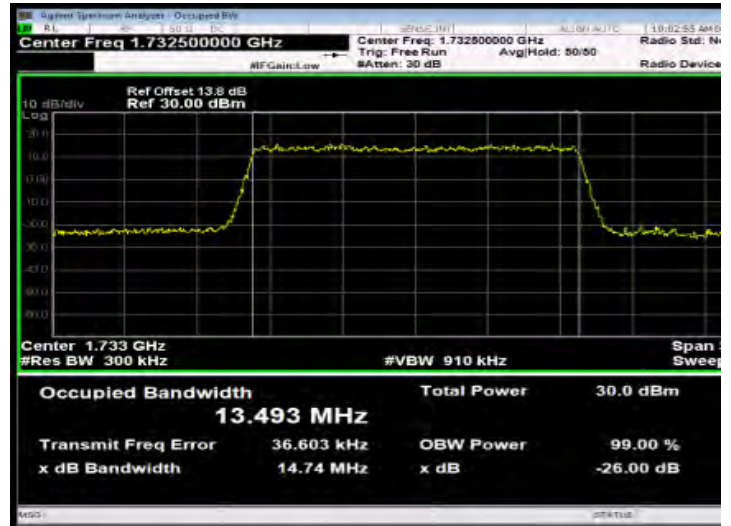

Band4_15MHz_QPSK_75_0_HighCH20325-1747.5

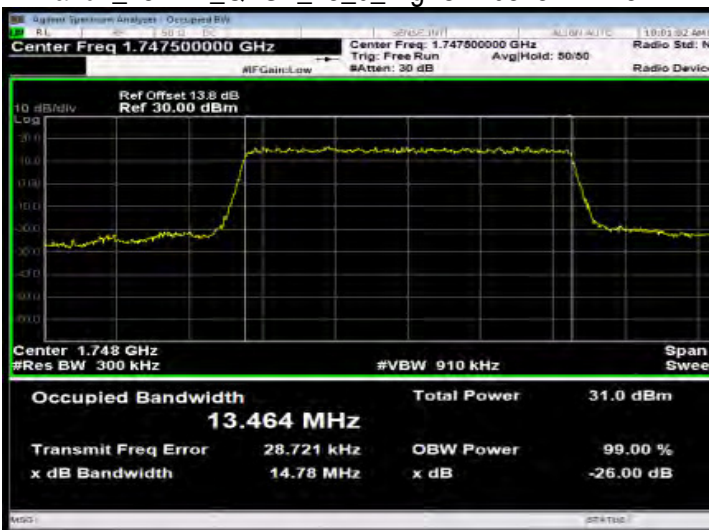

Band4_15MHz_16QAM_75_0_HighCH20325-1747.5

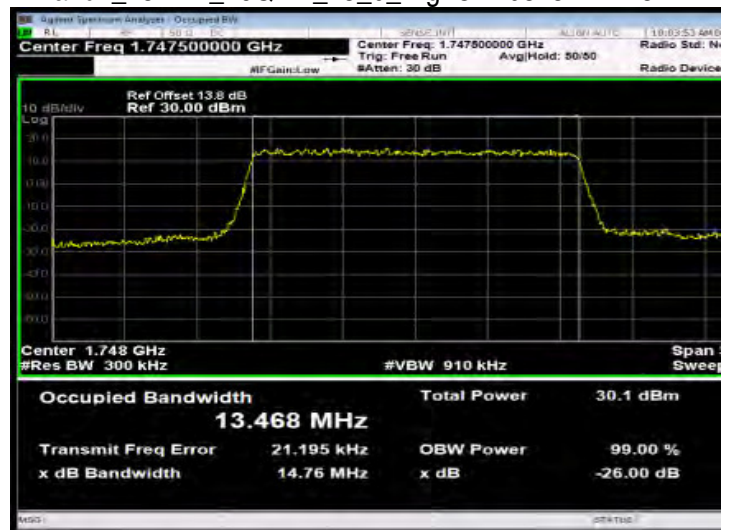

Unless otherwise stated the results shown in this test report refer only to the sample(s) tested and such sample(s) are retained for 90 days only.

除非另有說明，此報告結果僅對測試之樣品負責，同時此樣品僅保留90天。本報告未經本公司書面許可，不可部份複製。

This document is issued by the Company subject to its General Conditions of Service printed overleaf, available on request or accessible at www.sgs.com/terms_and_conditions.htm and, for electronic format documents, subject to Terms and Conditions for Electronic Documents at www.sgs.com/terms_e-document.htm. Attention is drawn to the limitation of liability, indemnification and jurisdiction issues defined therein. Any holder of this document is advised that information contained hereon reflects the Company's findings at the time of its intervention only and within the limits of Client's instructions, if any. The Company's sole responsibility is to its Client and this document does not exonerate parties to a transaction from exercising all their rights and obligations under the transaction documents. This document cannot be reproduced except in full, without prior written approval of the Company. Any unauthorized alteration, forgery or falsification of the content or appearance of this document is unlawful and offenders may be prosecuted to the fullest extent of the law.

SGS Taiwan Ltd.

No. 134, WuKungRoad, New Taipei Industrial Park, WuKu District, New Taipei City, Taiwan 24803/新北市五股區新北產業園區五工路 134 號

台灣檢驗科技股份有限公司

t (886-2) 2299-3279

f (886-2) 2298-0488

www.tw.sgs.com

Member of SGS Group

Band4_20MHz_QPSK_100_0_LowCH20050-1720

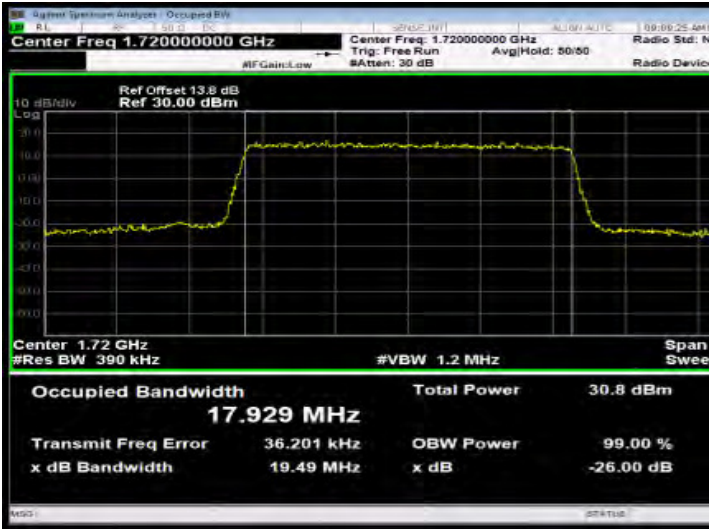

Band4_20MHz_16QAM_100_0_LowCH20050-1720

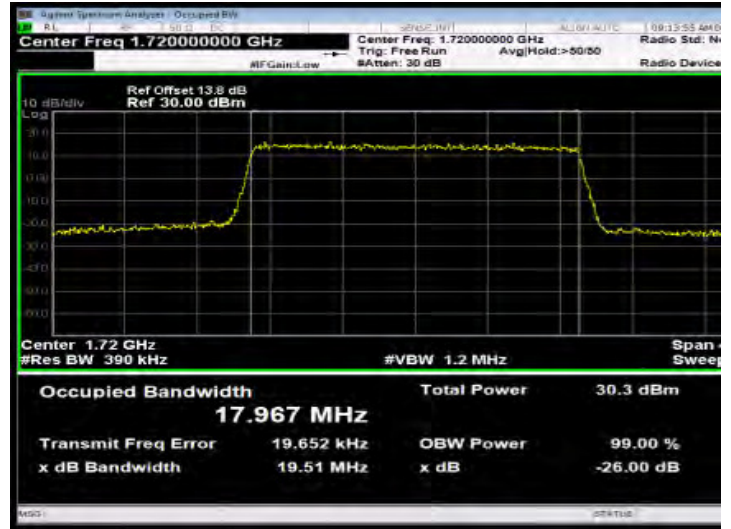

Band4_20MHz_QPSK_100_0_MidCH20175-1732.5

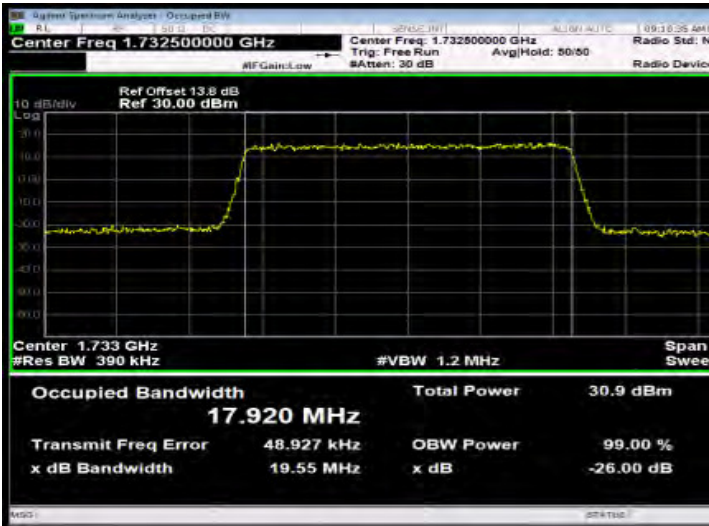

Band4_20MHz_16QAM_100_0_MidCH20175-1732.5

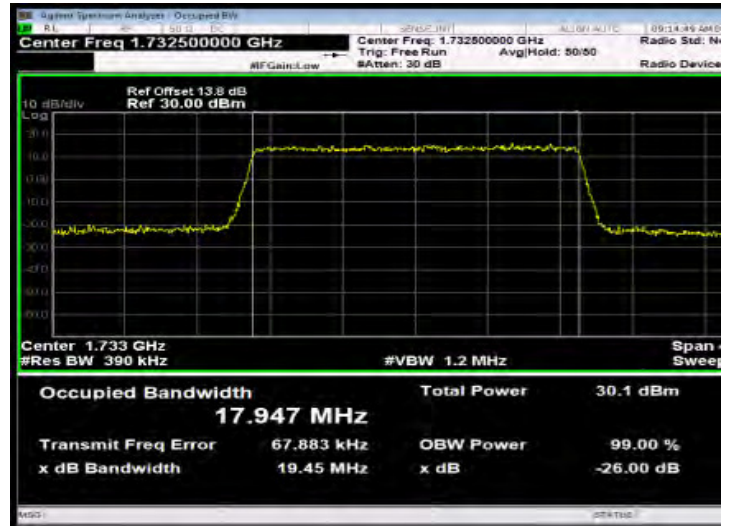

Band4_20MHz_QPSK_100_0_HighCH20300-1745

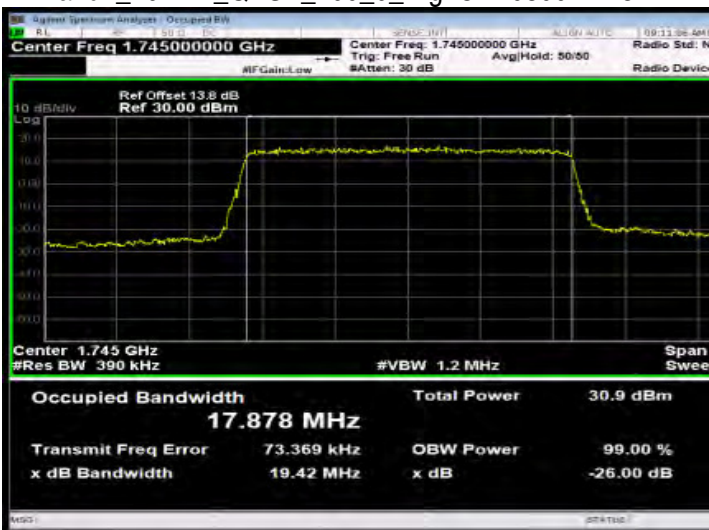

Band4_20MHz_16QAM_100_0_HighCH20300-1745

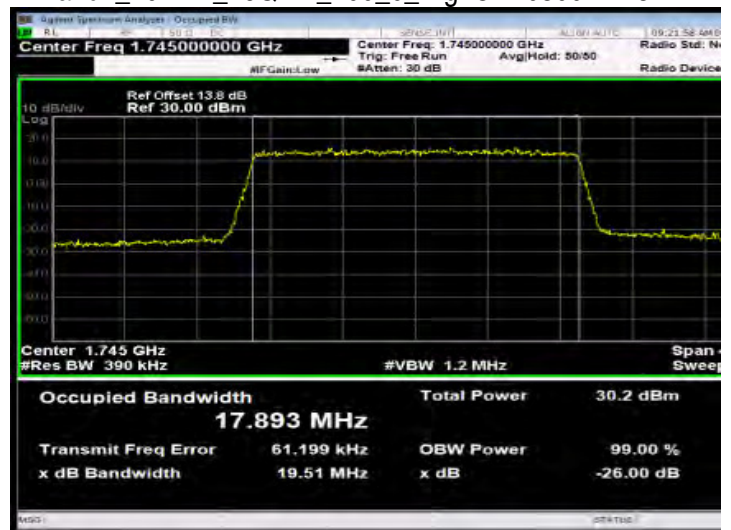

Unless otherwise stated the results shown in this test report refer only to the sample(s) tested and such sample(s) are retained for 90 days only.

除非另有說明，此報告結果僅對測試之樣品負責，同時此樣品僅保留90天。本報告未經本公司書面許可，不可部份複製。

This document is issued by the Company subject to its General Conditions of Service printed overleaf, available on request or accessible at www.sgs.com/terms_and_conditions.htm and, for electronic format documents, subject to Terms and Conditions for Electronic Documents at www.sgs.com/terms_e-document.htm. Attention is drawn to the limitation of liability, indemnification and jurisdiction issues defined therein. Any holder of this document is advised that information contained hereon reflects the Company's findings at the time of its intervention only and within the limits of Client's instructions, if any. The Company's sole responsibility is to its Client and this document does not exonerate parties to a transaction from exercising all their rights and obligations under the transaction documents. This document cannot be reproduced except in full, without prior written approval of the Company. Any unauthorized alteration, forgery or falsification of the content or appearance of this document is unlawful and offenders may be prosecuted to the fullest extent of the law.

SGS Taiwan Ltd.

No. 134, WuKungRoad, New Taipei Industrial Park, WuKu District, New Taipei City, Taiwan 24803 / 新北市五股區新北產業園區五工路 134 號

台灣檢驗科技股份有限公司

t (886-2) 2299-3279

f (886-2) 2298-0488

www.tw.sgs.com

Member of SGS Group

Band5_1.4MHz_QPSK_6_0_LowCH20407-824.7

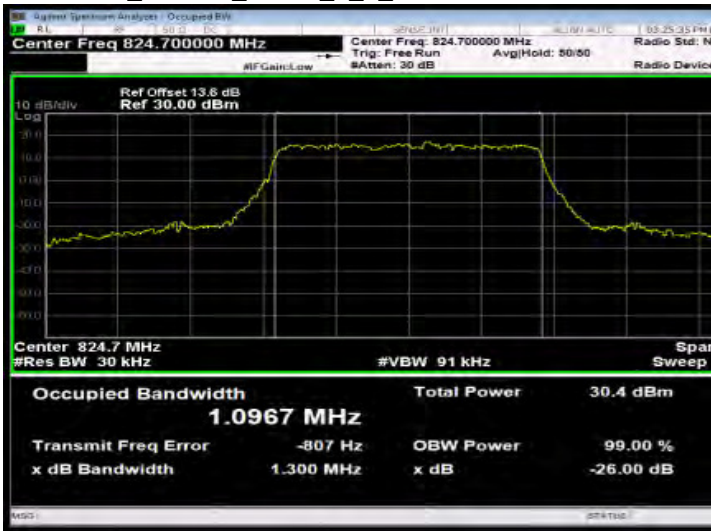

Band5_1.4MHz_16QAM_6_0_LowCH20407-824.7

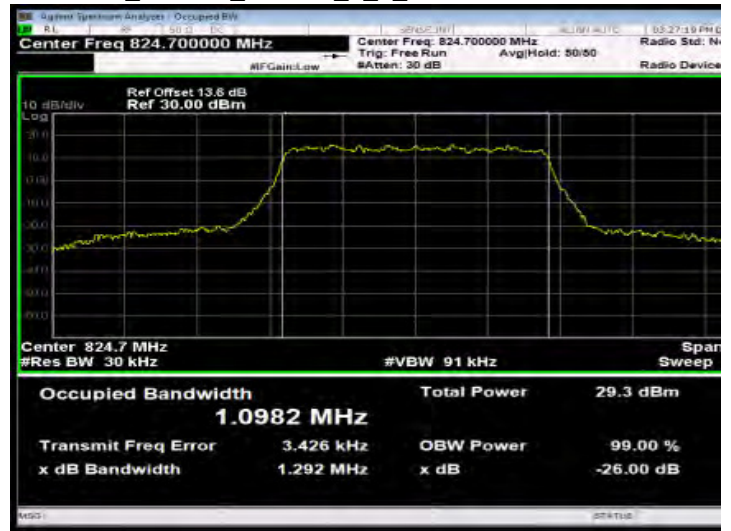

Band5_1.4MHz_QPSK_6_0_MidCH20525-836.5



Band5_1.4MHz_16QAM_6_0_MidCH20525-836.5

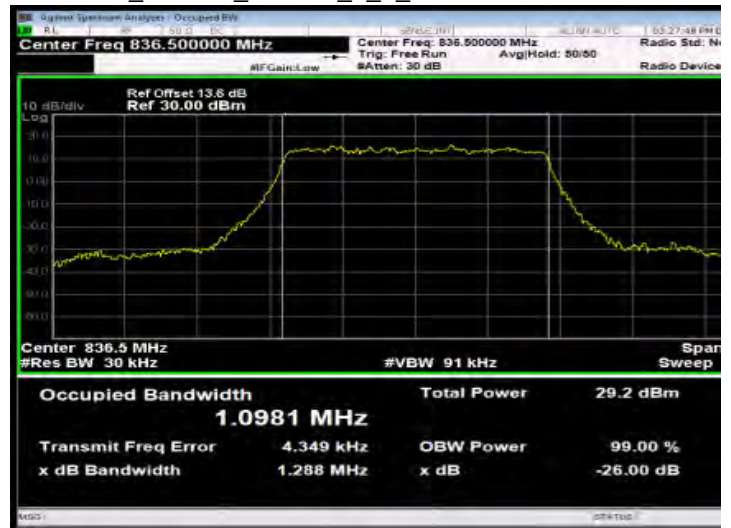

Band5_1.4MHz_QPSK_6_0_HighCH20643-848.3

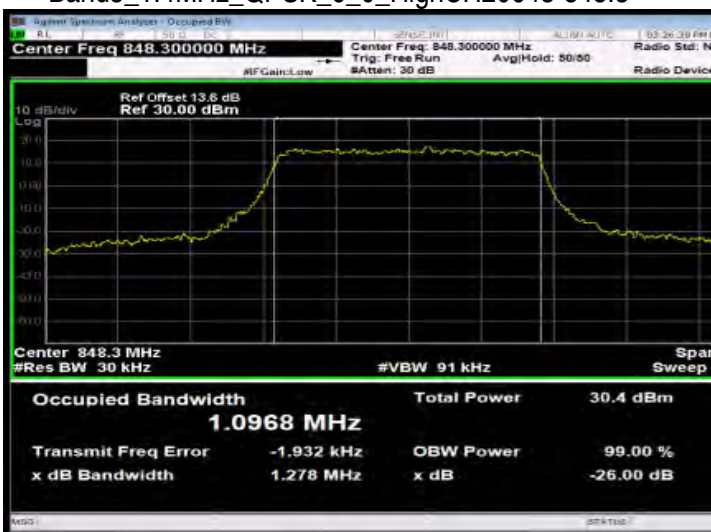

Band5_1.4MHz_16QAM_6_0_HighCH20643-848.3

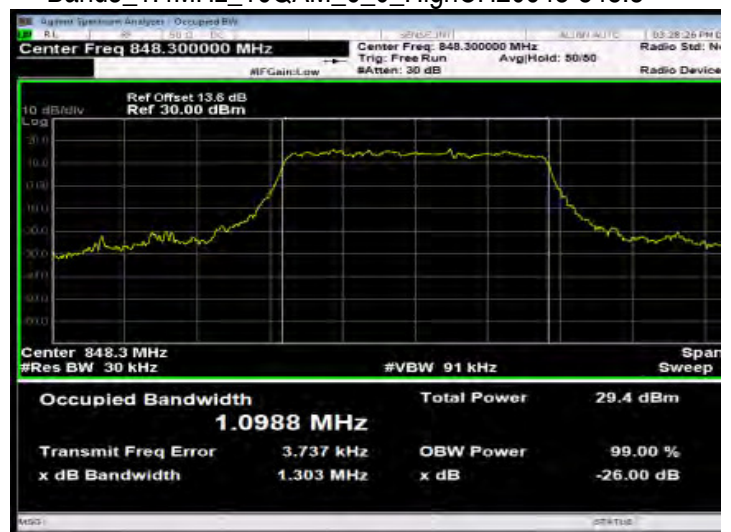

Unless otherwise stated the results shown in this test report refer only to the sample(s) tested and such sample(s) are retained for 90 days only.

除非另有說明，此報告結果僅對測試之樣品負責，同時此樣品僅保留90天。本報告未經本公司書面許可，不可部份複製。

This document is issued by the Company subject to its General Conditions of Service printed overleaf, available on request or accessible at www.sgs.com/terms_and_conditions.htm and, for electronic format documents, subject to Terms and Conditions for Electronic Documents at www.sgs.com/terms_e-document.htm. Attention is drawn to the limitation of liability, indemnification and jurisdiction issues defined therein. Any holder of this document is advised that information contained hereon reflects the Company's findings at the time of its intervention only and within the limits of Client's instructions, if any. The Company's sole responsibility is to its Client and this document does not exonerate parties to a transaction from exercising all their rights and obligations under the transaction documents. This document cannot be reproduced except in full, without prior written approval of the Company. Any unauthorized alteration, forgery or falsification of the content or appearance of this document is unlawful and offenders may be prosecuted to the fullest extent of the law.

SGS Taiwan Ltd.

No. 134, WuKungRoad, New Taipei Industrial Park, WuKu District, New Taipei City, Taiwan 24803/新北市五股區新北產業園區五工路 134 號

台灣檢驗科技股份有限公司

t (886-2) 2299-3279

f (886-2) 2298-0488

www.tw.sgs.com

Member of SGS Group

Band5_3MHz_QPSK_15_0_LowCH20415-825.5

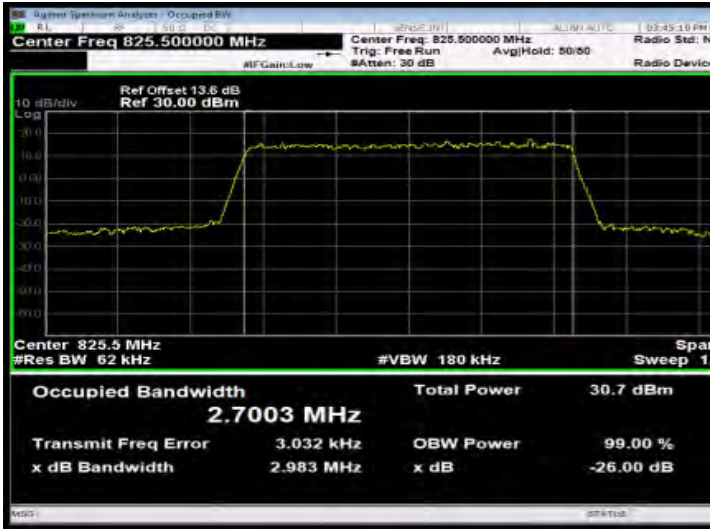

Band5_3MHz_16QAM_15_0_LowCH20415-825.5

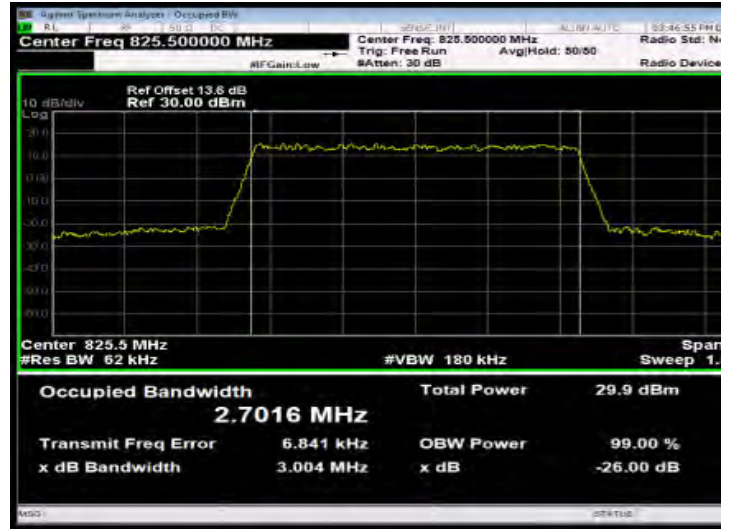

Band5_3MHz_QPSK_15_0_MidCH20525-836.5

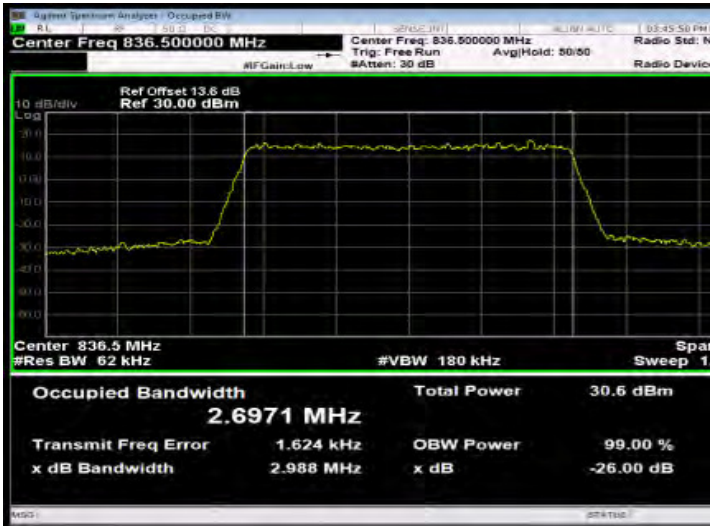

Band5_3MHz_16QAM_15_0_MidCH20525-836.5

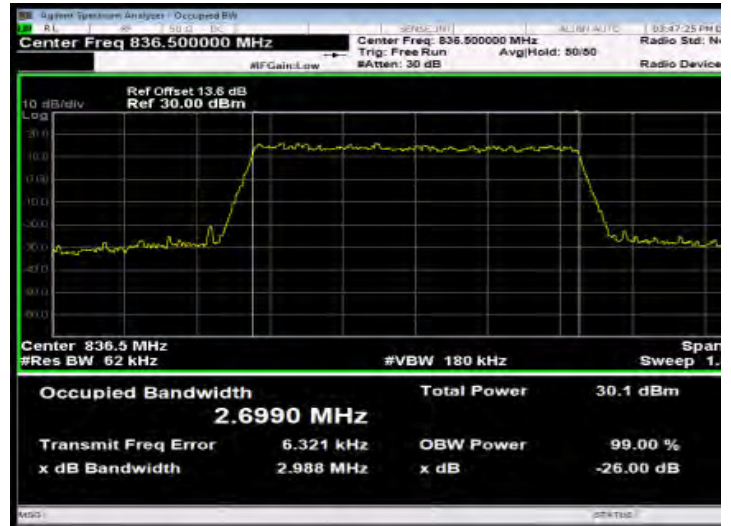

Band5_3MHz_QPSK_15_0_HighCH20635-847.5

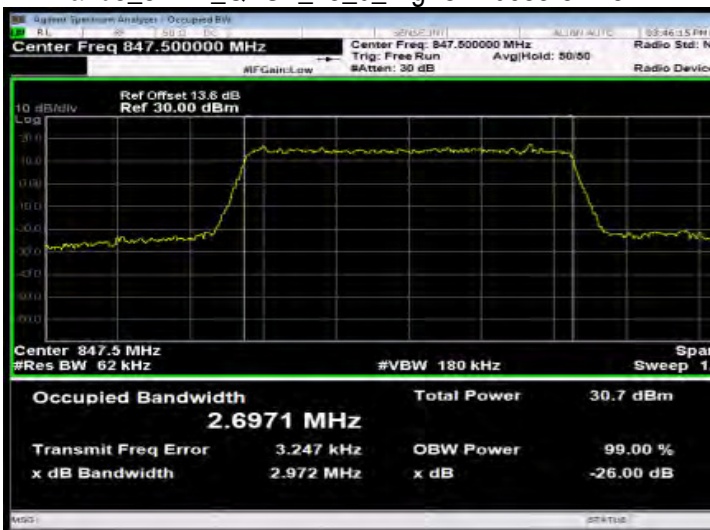

Band5_3MHz_16QAM_15_0_HighCH20635-847.5

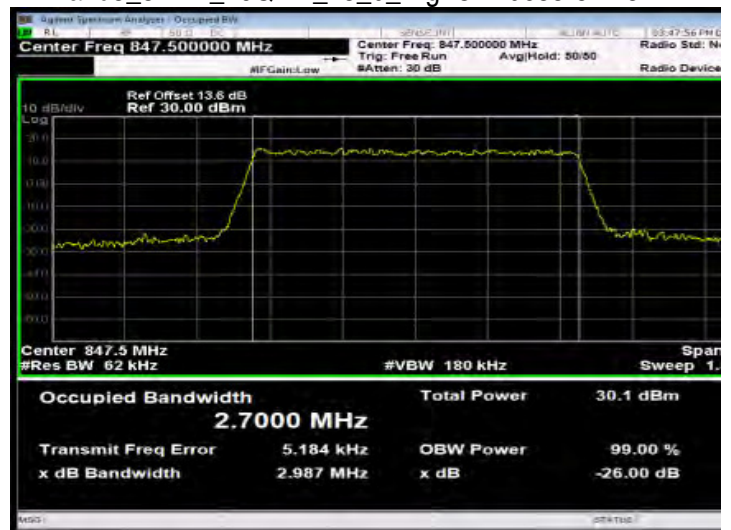

Unless otherwise stated the results shown in this test report refer only to the sample(s) tested and such sample(s) are retained for 90 days only.

除非另有說明，此報告結果僅對測試之樣品負責，同時此樣品僅保留90天。本報告未經本公司書面許可，不可部份複製。

This document is issued by the Company subject to its General Conditions of Service printed overleaf, available on request or accessible at www.sgs.com/terms_and_conditions.htm and, for electronic format documents, subject to Terms and Conditions for Electronic Documents at www.sgs.com/terms_e-document.htm. Attention is drawn to the limitation of liability, indemnification and jurisdiction issues defined therein. Any holder of this document is advised that information contained hereon reflects the Company's findings at the time of its intervention only and within the limits of Client's instructions, if any. The Company's sole responsibility is to its Client and this document does not exonerate parties to a transaction from exercising all their rights and obligations under the transaction documents. This document cannot be reproduced except in full, without prior written approval of the Company. Any unauthorized alteration, forgery or falsification of the content or appearance of this document is unlawful and offenders may be prosecuted to the fullest extent of the law.

SGS Taiwan Ltd.

No. 134, WuKungRoad, New Taipei Industrial Park, WuKu District, New Taipei City, Taiwan 24803/新北市五股區新北產業園區五工路 134 號

台灣檢驗科技股份有限公司

t (886-2) 2299-3279

f (886-2) 2298-0488

www.tw.sgs.com

Member of SGS Group

Band5_5MHz_QPSK_25_0_LowCH20425-826.5

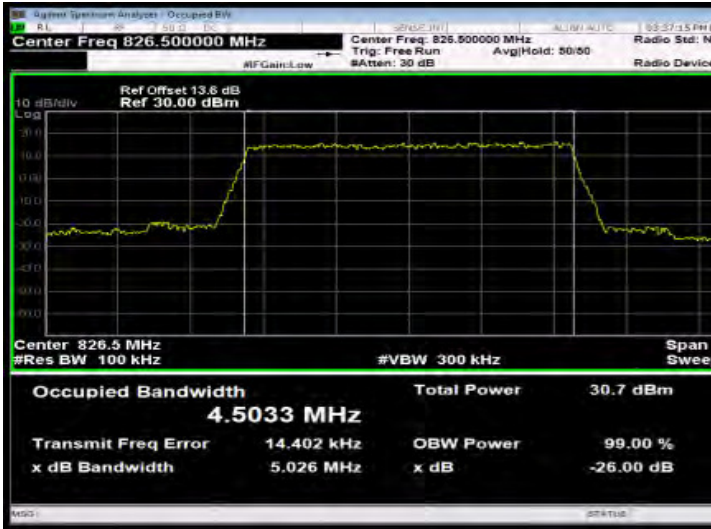

Band5_5MHz_16QAM_25_0_LowCH20425-826.5

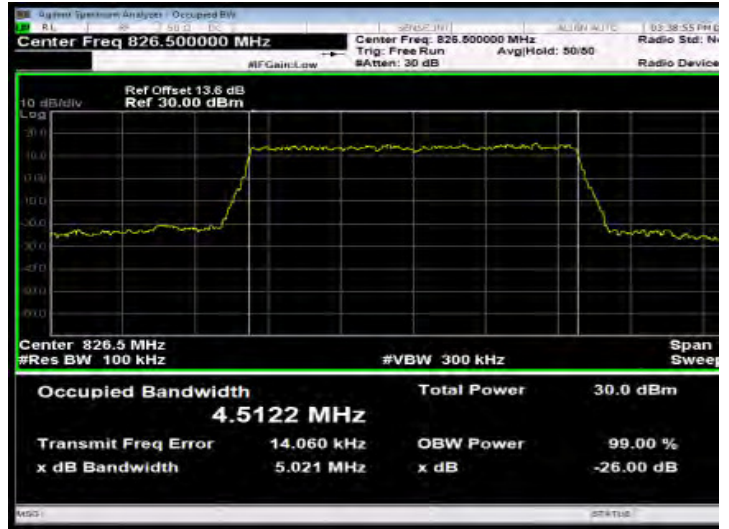

Band5_5MHz_QPSK_25_0_MidCH20525-836.5

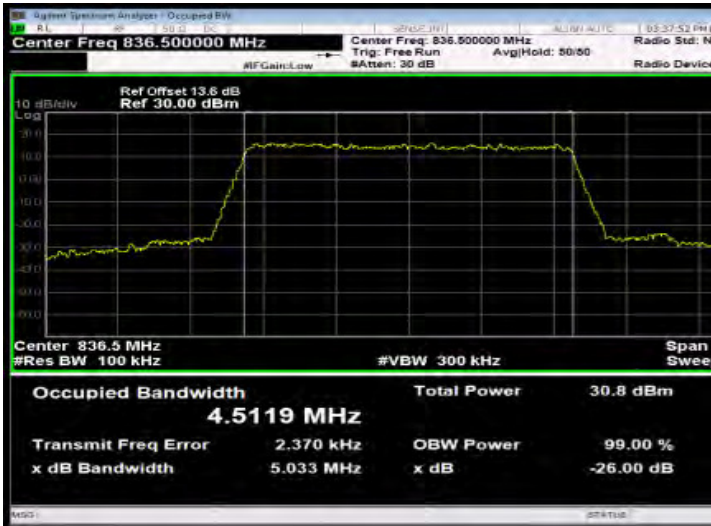

Band5_5MHz_16QAM_25_0_MidCH20525-836.5

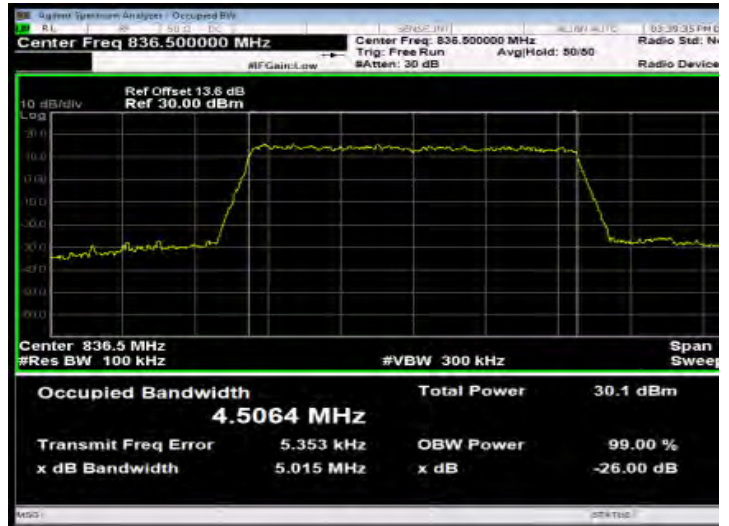

Band5_5MHz_QPSK_25_0_HighCH20625-846.5

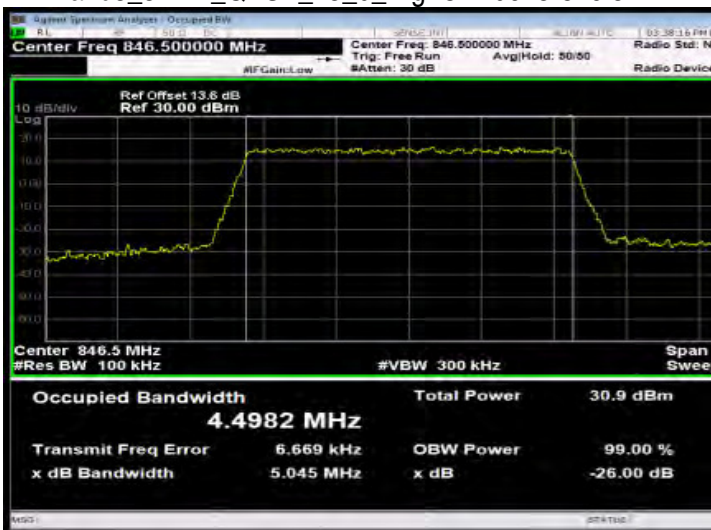

Band5_5MHz_16QAM_25_0_HighCH20625-846.5

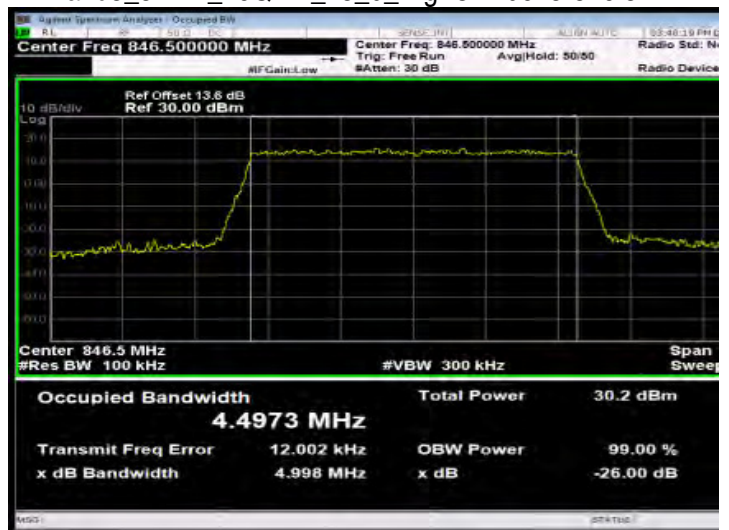

Unless otherwise stated the results shown in this test report refer only to the sample(s) tested and such sample(s) are retained for 90 days only.

除非另有說明，此報告結果僅對測試之樣品負責，同時此樣品僅保留90天。本報告未經本公司書面許可，不可部份複製。

This document is issued by the Company subject to its General Conditions of Service printed overleaf, available on request or accessible at www.sgs.com/terms_and_conditions.htm and, for electronic format documents, subject to Terms and Conditions for Electronic Documents at www.sgs.com/terms_e-document.htm. Attention is drawn to the limitation of liability, indemnification and jurisdiction issues defined therein. Any holder of this document is advised that information contained hereon reflects the Company's findings at the time of its intervention only and within the limits of Client's instructions, if any. The Company's sole responsibility is to its Client and this document does not exonerate parties to a transaction from exercising all their rights and obligations under the transaction documents. This document cannot be reproduced except in full, without prior written approval of the Company. Any unauthorized alteration, forgery or falsification of the content or appearance of this document is unlawful and offenders may be prosecuted to the fullest extent of the law.

SGS Taiwan Ltd.

No. 134, WuKungRoad, New Taipei Industrial Park, WuKu District, New Taipei City, Taiwan 24803/新北市五股區新北產業園區五工路 134 號

台灣檢驗科技股份有限公司

t (886-2) 2299-3279

f (886-2) 2298-0488

www.tw.sgs.com

Member of SGS Group

Band5_10MHz_QPSK_50_0_LowCH20450-829

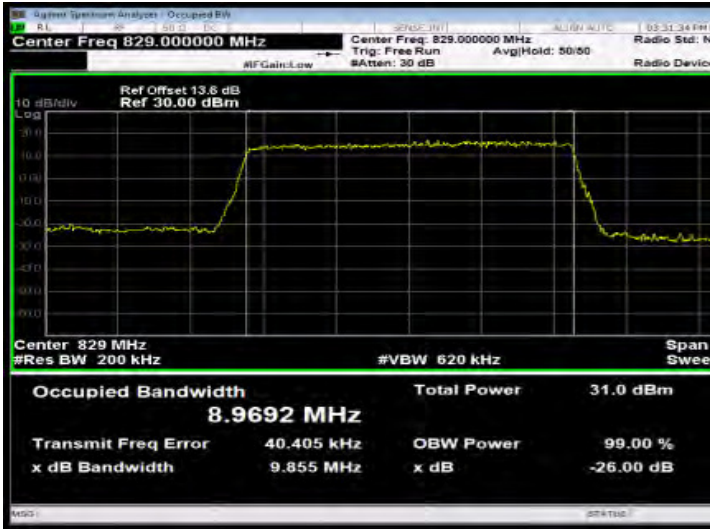

Band5_10MHz_16QAM_50_0_LowCH20450-829

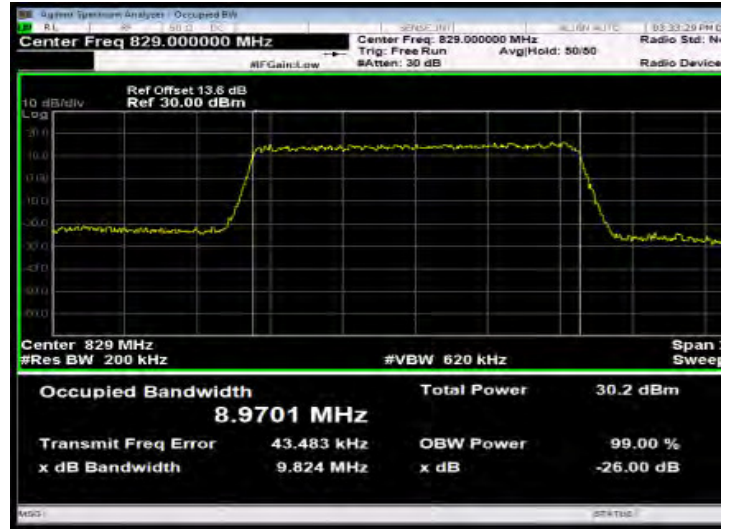

Band5_10MHz_QPSK_50_0_MidCH20525-836.5

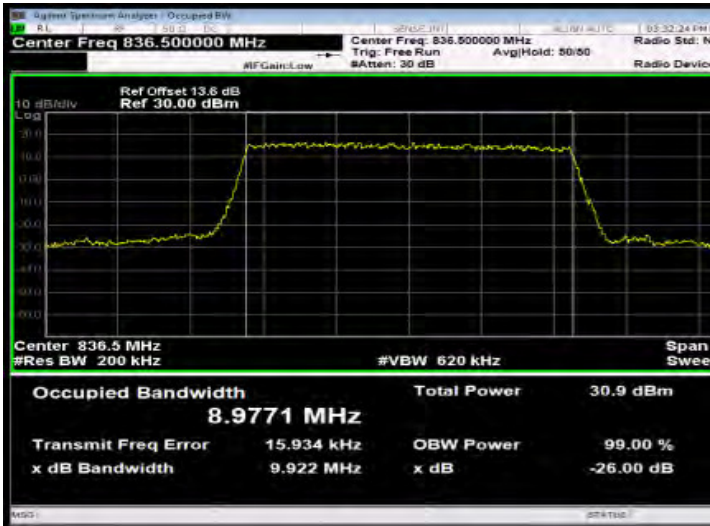

Band5_10MHz_16QAM_50_0_MidCH20525-836.5

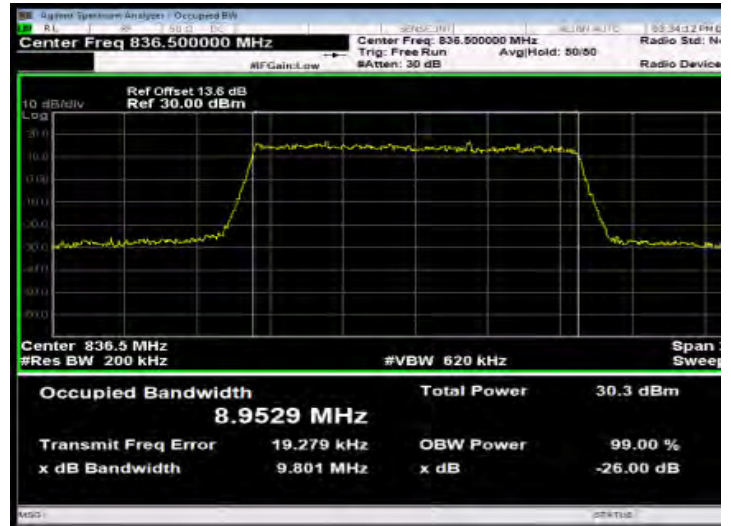

Band5_10MHz_QPSK_50_0_HighCH20600-844



Band5_10MHz_16QAM_50_0_HighCH20600-844

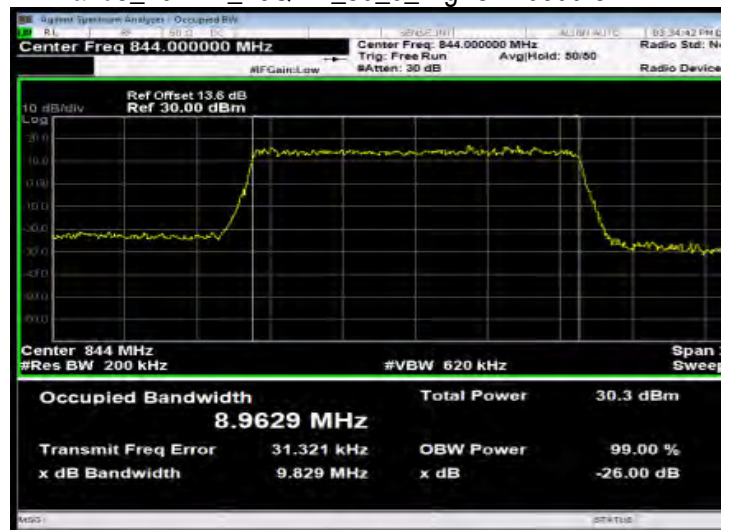

Unless otherwise stated the results shown in this test report refer only to the sample(s) tested and such sample(s) are retained for 90 days only.

除非另有說明，此報告結果僅對測試之樣品負責，同時此樣品僅保留90天。本報告未經本公司書面許可，不可部份複製。

This document is issued by the Company subject to its General Conditions of Service printed overleaf, available on request or accessible at www.sgs.com/terms_and_conditions.htm and, for electronic format documents, subject to Terms and Conditions for Electronic Documents at www.sgs.com/terms_e-document.htm. Attention is drawn to the limitation of liability, indemnification and jurisdiction issues defined therein. Any holder of this document is advised that information contained hereon reflects the Company's findings at the time of its intervention only and within the limits of Client's instructions, if any. The Company's sole responsibility is to its Client and this document does not exonerate parties to a transaction from exercising all their rights and obligations under the transaction documents. This document cannot be reproduced except in full, without prior written approval of the Company. Any unauthorized alteration, forgery or falsification of the content or appearance of this document is unlawful and offenders may be prosecuted to the fullest extent of the law.

SGS Taiwan Ltd.

No. 134, WuKungRoad, New Taipei Industrial Park, WuKu District, New Taipei City, Taiwan 24803 / 新北市五股區新北產業園區五工路 134 號

台灣檢驗科技股份有限公司

t (886-2) 2299-3279

f (886-2) 2298-0488

www.tw.sgs.com

Member of SGS Group

Band12_1.4MHz_QPSK_6_0_LowCH23017-699.7

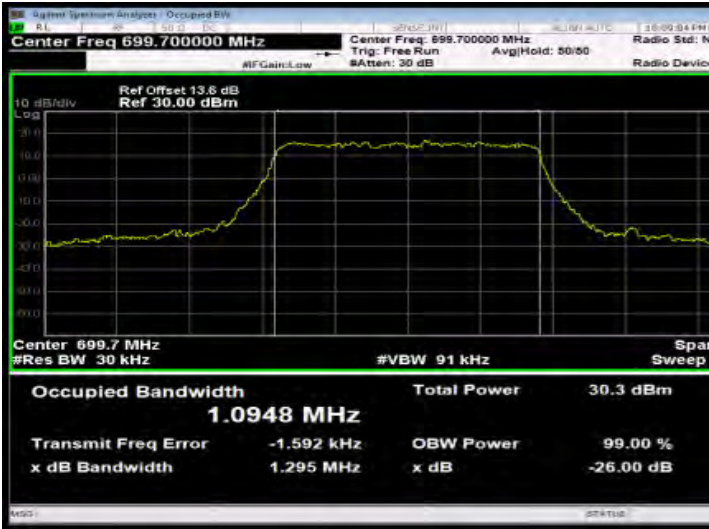

Band12_1.4MHz_16QAM_6_0_LowCH23017-699.7

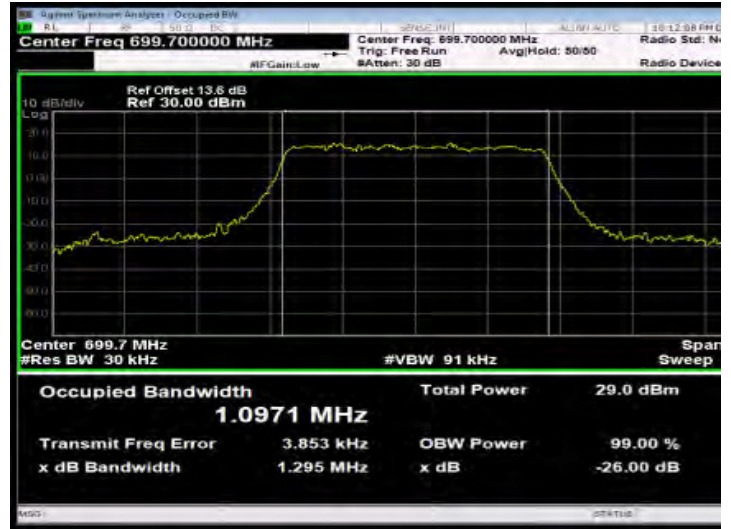

Band12_1.4MHz_QPSK_6_0_MidCH23095-707.5

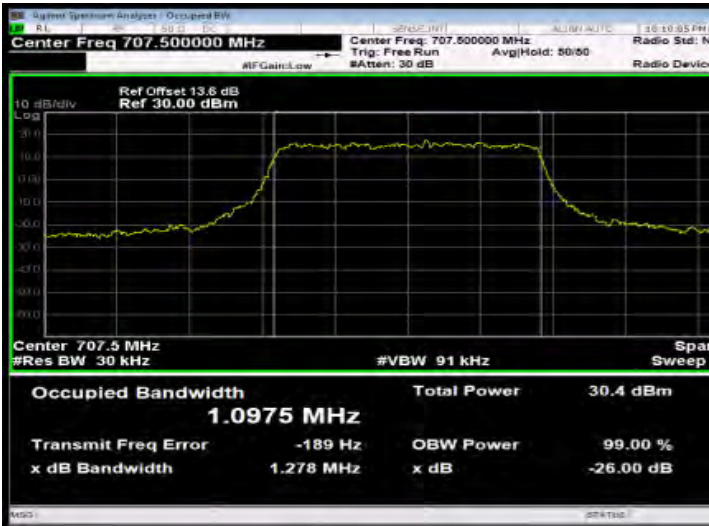

Band12_1.4MHz_16QAM_6_0_MidCH23095-707.5

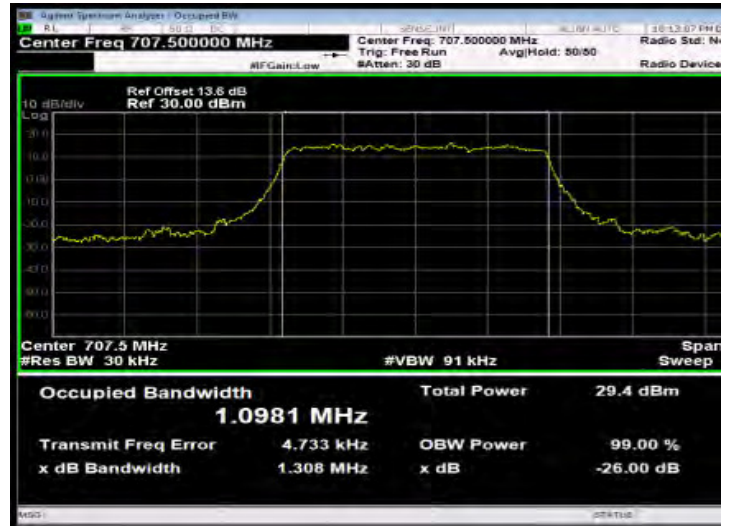

Band12_1.4MHz_QPSK_6_0_HighCH23173-715.3



Band12_1.4MHz_16QAM_6_0_HighCH23173-715.3

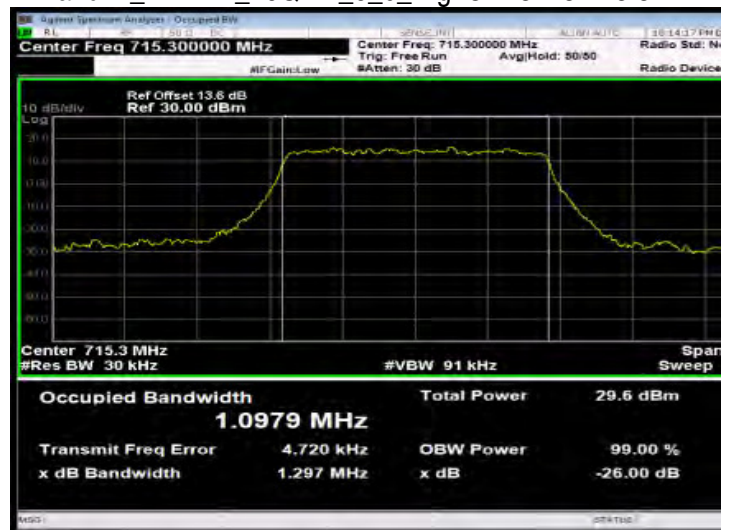

Unless otherwise stated the results shown in this test report refer only to the sample(s) tested and such sample(s) are retained for 90 days only.

除非另有說明，此報告結果僅對測試之樣品負責，同時此樣品僅保留90天。本報告未經本公司書面許可，不可部份複製。

This document is issued by the Company subject to its General Conditions of Service printed overleaf, available on request or accessible at www.sgs.com/terms_and_conditions.htm and, for electronic format documents, subject to Terms and Conditions for Electronic Documents at www.sgs.com/terms_e-document.htm. Attention is drawn to the limitation of liability, indemnification and jurisdiction issues defined therein. Any holder of this document is advised that information contained hereon reflects the Company's findings at the time of its intervention only and within the limits of Client's instructions, if any. The Company's sole responsibility is to its Client and this document does not exonerate parties to a transaction from exercising all their rights and obligations under the transaction documents. This document cannot be reproduced except in full, without prior written approval of the Company. Any unauthorized alteration, forgery or falsification of the content or appearance of this document is unlawful and offenders may be prosecuted to the fullest extent of the law.

SGS Taiwan Ltd.

No. 134, WuKungRoad, New Taipei Industrial Park, WuKu District, New Taipei City, Taiwan 24803/新北市五股區新北產業園區五工路 134 號

台灣檢驗科技股份有限公司

t (886-2) 2299-3279

f (886-2) 2298-0488

www.tw.sgs.com

Member of SGS Group

Band12_3MHz_QPSK_15_0_LowCH23025-700.5

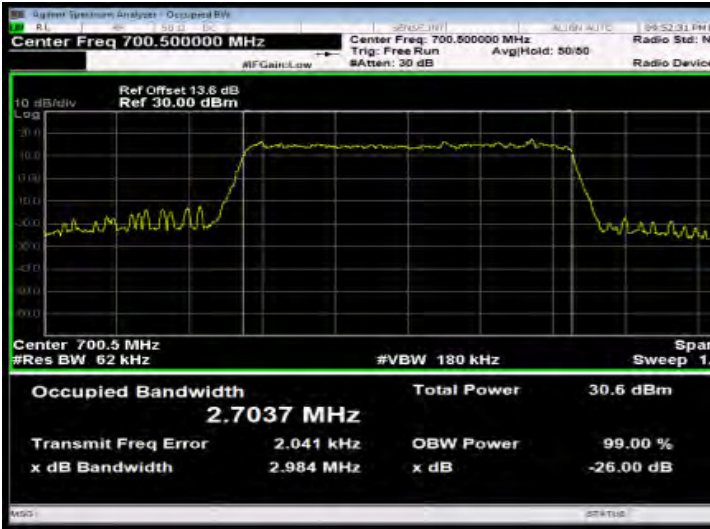

Band12_3MHz_16QAM_15_0_LowCH23025-700.5

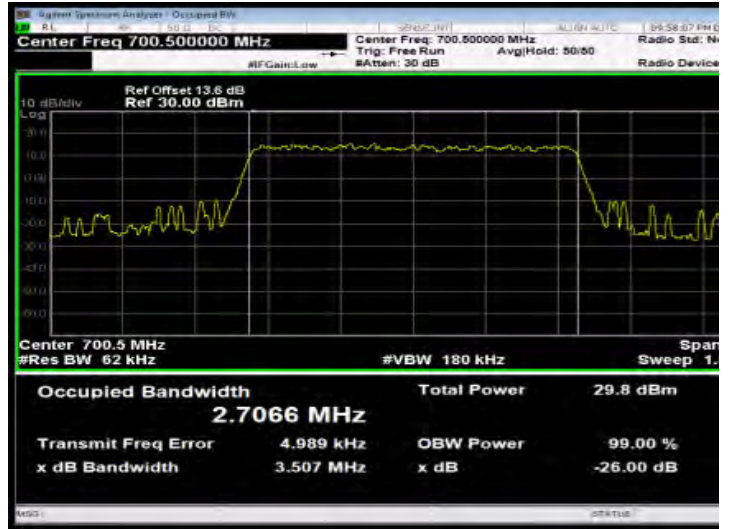

Band12_3MHz_QPSK_15_0_MidCH23095-707.5

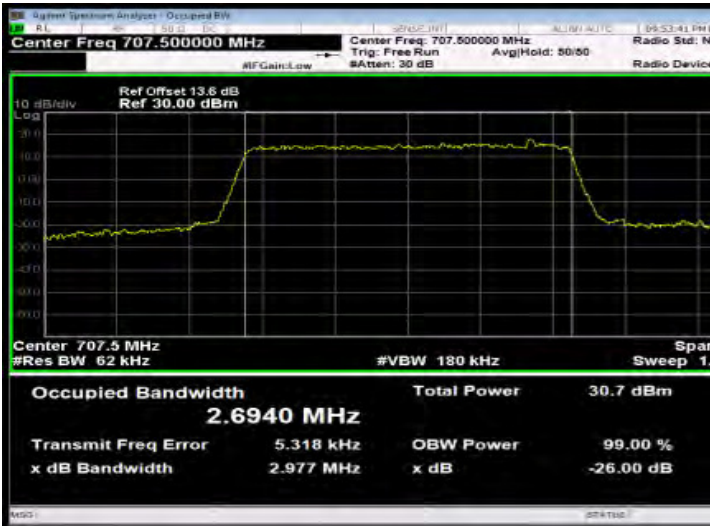

Band12_3MHz_16QAM_15_0_MidCH23095-707.5

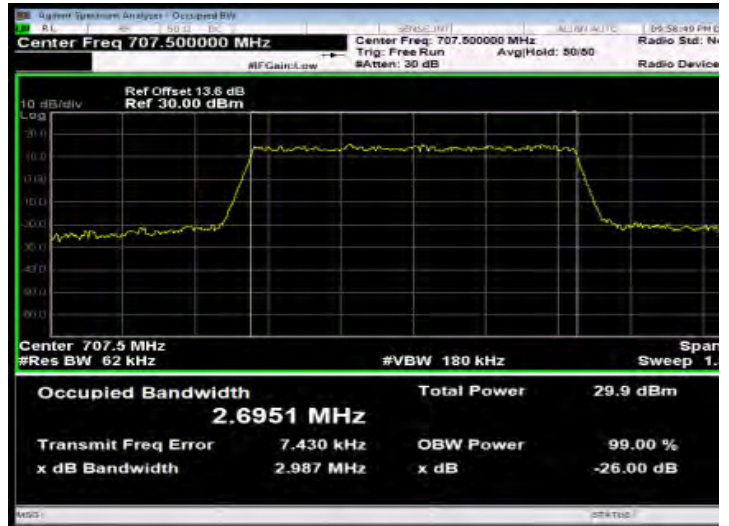

Band12_3MHz_QPSK_15_0_HighCH23165-714.5

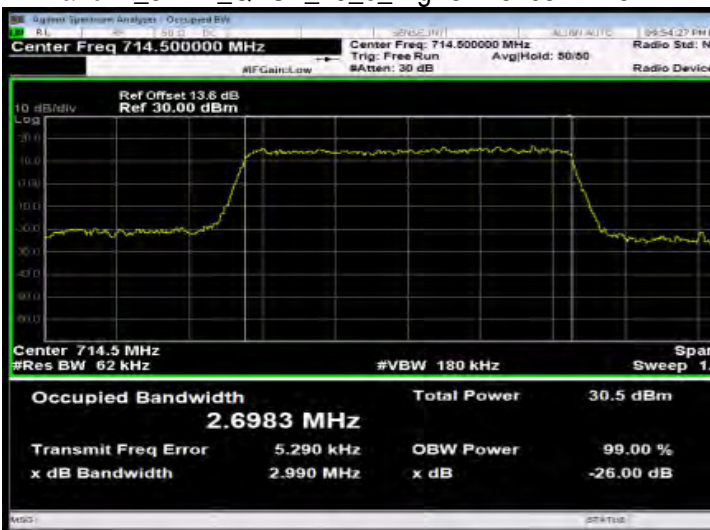

Band12_3MHz_16QAM_15_0_HighCH23165-714.5

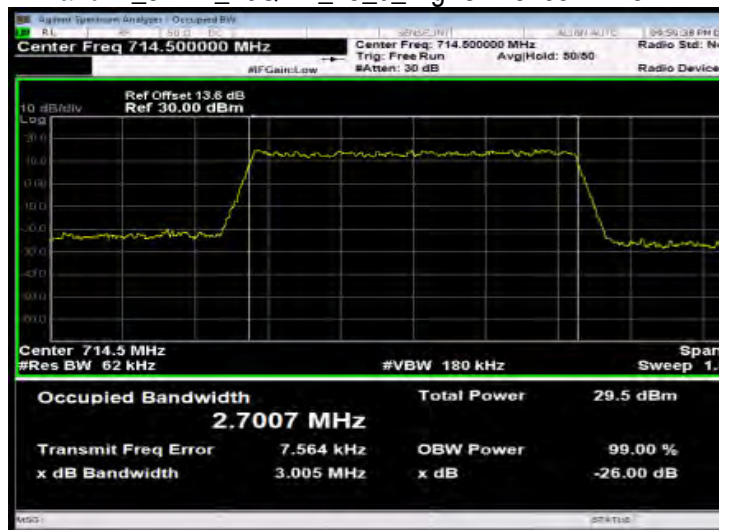

Unless otherwise stated the results shown in this test report refer only to the sample(s) tested and such sample(s) are retained for 90 days only.

除非另有說明，此報告結果僅對測試之樣品負責，同時此樣品僅保留90天。本報告未經本公司書面許可，不可部份複製。

This document is issued by the Company subject to its General Conditions of Service printed overleaf, available on request or accessible at www.sgs.com/terms_and_conditions.htm and, for electronic format documents, subject to Terms and Conditions for Electronic Documents at www.sgs.com/terms_e-document.htm. Attention is drawn to the limitation of liability, indemnification and jurisdiction issues defined therein. Any holder of this document is advised that information contained hereon reflects the Company's findings at the time of its intervention only and within the limits of Client's instructions, if any. The Company's sole responsibility is to its Client and this document does not exonerate parties to a transaction from exercising all their rights and obligations under the transaction documents. This document cannot be reproduced except in full, without prior written approval of the Company. Any unauthorized alteration, forgery or falsification of the content or appearance of this document is unlawful and offenders may be prosecuted to the fullest extent of the law.

SGS Taiwan Ltd.

No. 134, WuKungRoad, New Taipei Industrial Park, WuKu District, New Taipei City, Taiwan 24803/新北市五股區新北產業園區五工路 134 號

台灣檢驗科技股份有限公司

t (886-2) 2299-3279

f (886-2) 2298-0488

www.tw.sgs.com

Member of SGS Group

Band12_5MHz_QPSK_25_0_LowCH23035-701.5

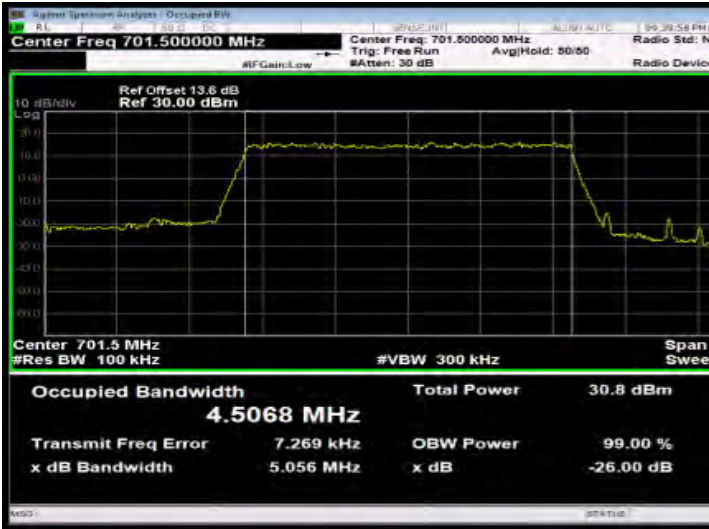

Band12_5MHz_16QAM_25_0_LowCH23035-701.5

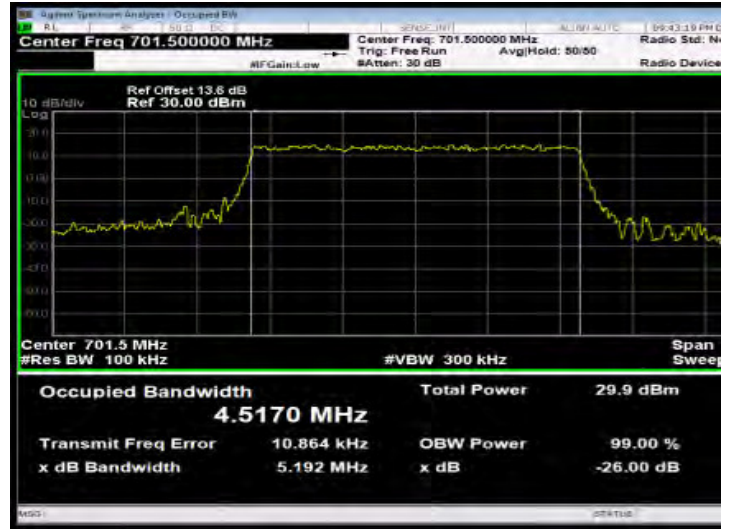

Band12_5MHz_QPSK_25_0_MidCH23095-707.5

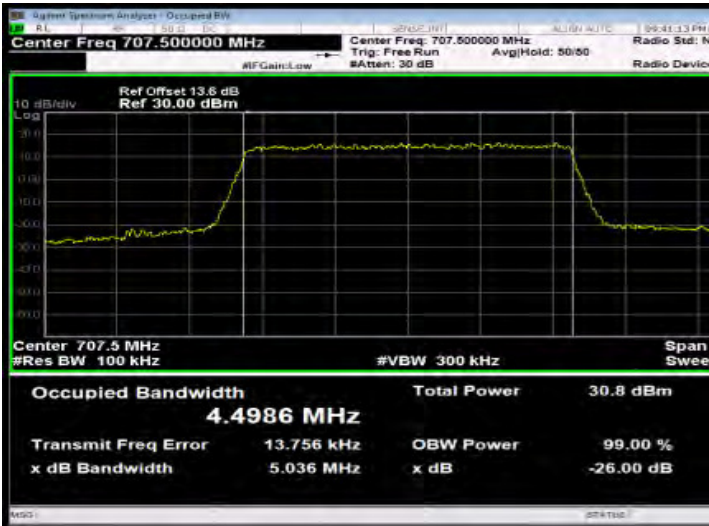

Band12_5MHz_16QAM_25_0_MidCH23095-707.5

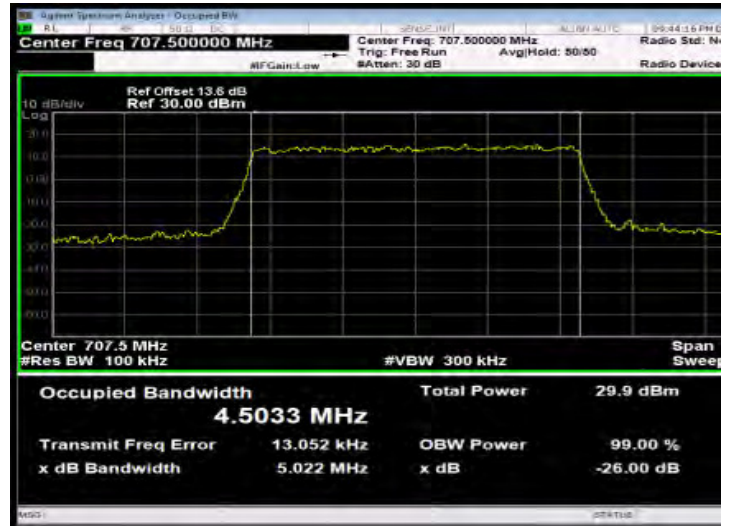

Band12_5MHz_QPSK_25_0_HighCH23155-713.5

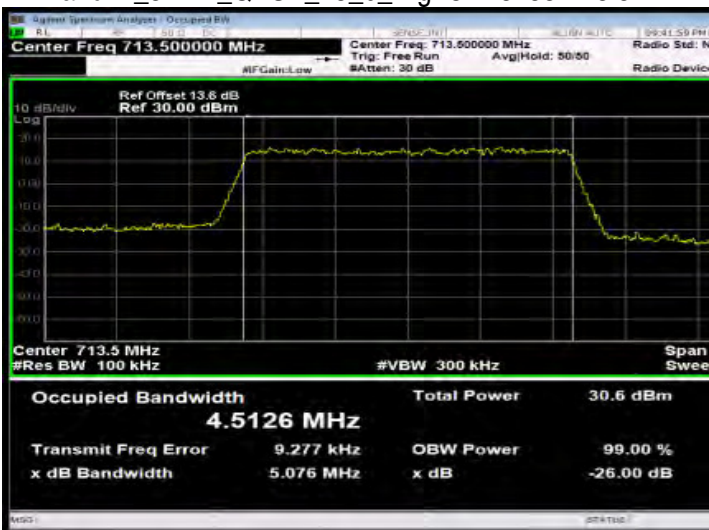

Band12_5MHz_16QAM_25_0_HighCH23155-713.5

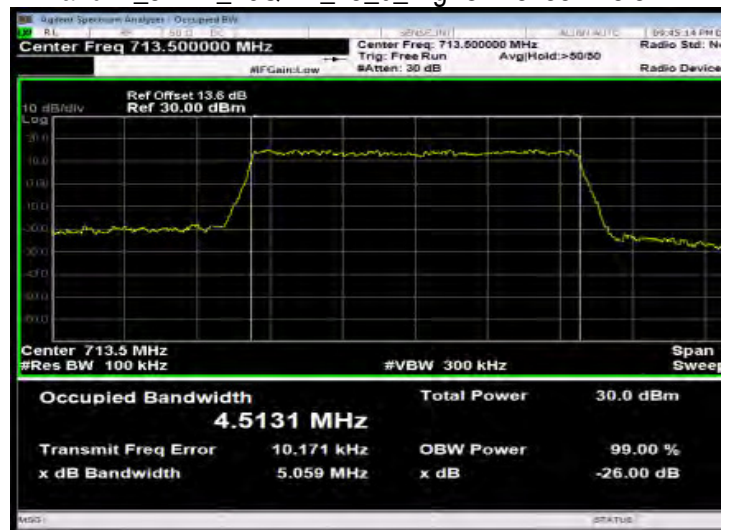

Unless otherwise stated the results shown in this test report refer only to the sample(s) tested and such sample(s) are retained for 90 days only.

除非另有說明，此報告結果僅對測試之樣品負責，同時此樣品僅保留90天。本報告未經本公司書面許可，不可部份複製。

This document is issued by the Company subject to its General Conditions of Service printed overleaf, available on request or accessible at www.sgs.com/terms_and_conditions.htm and, for electronic format documents, subject to Terms and Conditions for Electronic Documents at www.sgs.com/terms_e-document.htm. Attention is drawn to the limitation of liability, indemnification and jurisdiction issues defined therein. Any holder of this document is advised that information contained hereon reflects the Company's findings at the time of its intervention only and within the limits of Client's instructions, if any. The Company's sole responsibility is to its Client and this document does not exonerate parties to a transaction from exercising all their rights and obligations under the transaction documents. This document cannot be reproduced except in full, without prior written approval of the Company. Any unauthorized alteration, forgery or falsification of the content or appearance of this document is unlawful and offenders may be prosecuted to the fullest extent of the law.

SGS Taiwan Ltd.

No. 134, WuKungRoad, New Taipei Industrial Park, WuKu District, New Taipei City, Taiwan 24803 / 新北市五股區新北產業園區五工路 134 號

台灣檢驗科技股份有限公司

t (886-2) 2299-3279

f (886-2) 2298-0488

www.tw.sgs.com

Member of SGS Group

Band12_10MHz_QPSK_50_0_LowCH23060-704

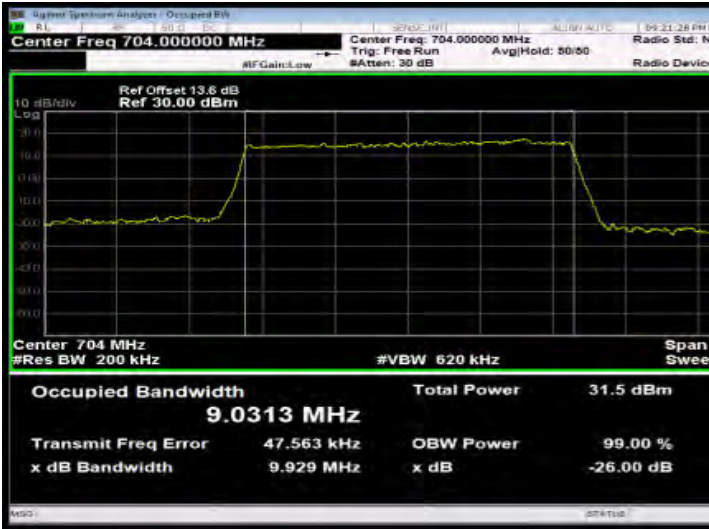

Band12_10MHz_16QAM_50_0_LowCH23060-704

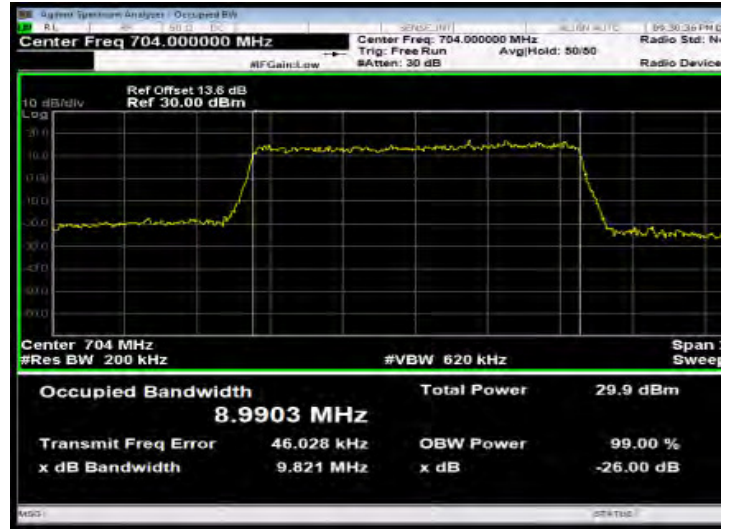

Band12_10MHz_QPSK_50_0_MidCH23095-707.5

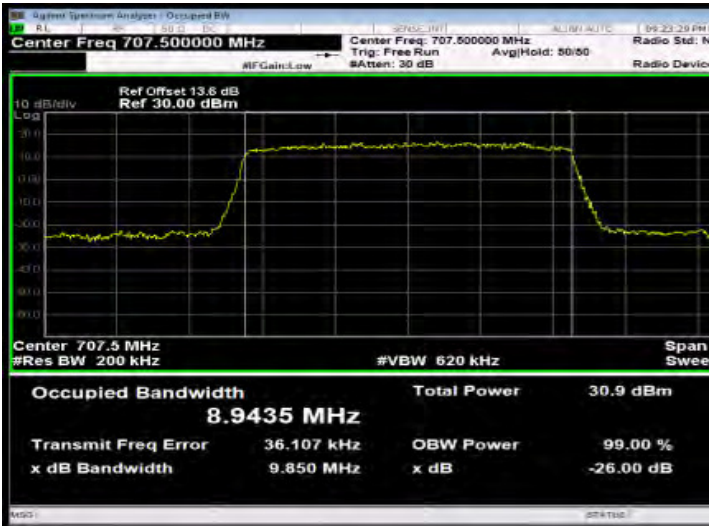

Band12_10MHz_16QAM_50_0_MidCH23095-707.5

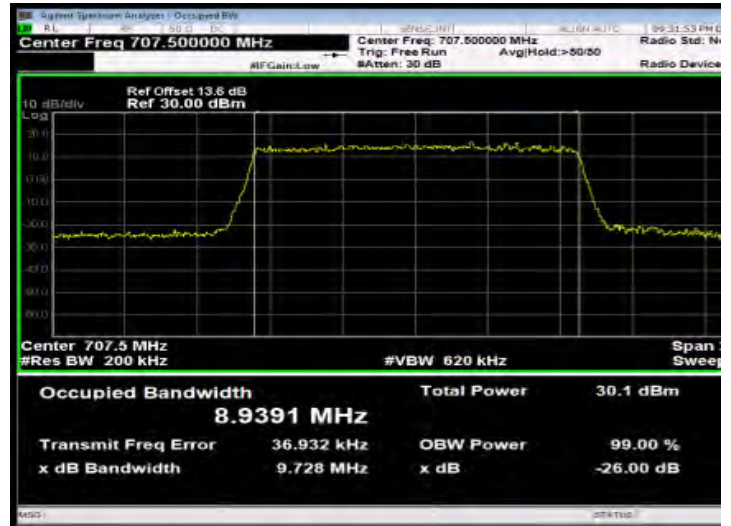

Band12_10MHz_QPSK_50_0_HighCH23130-711

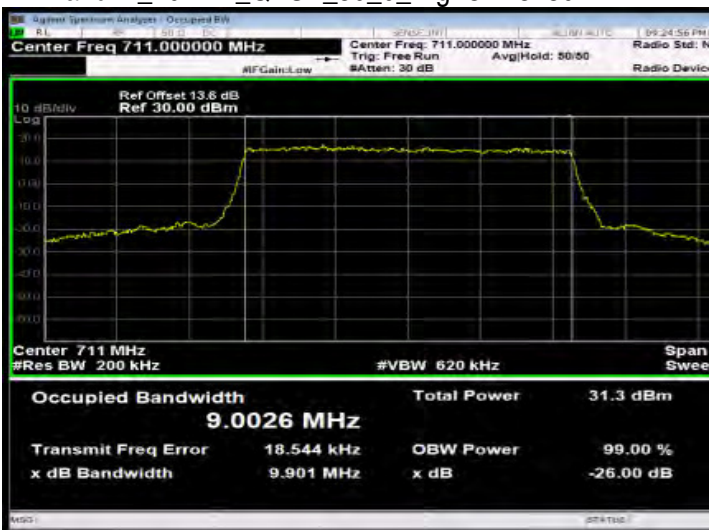

Band12_10MHz_16QAM_50_0_HighCH23130-711

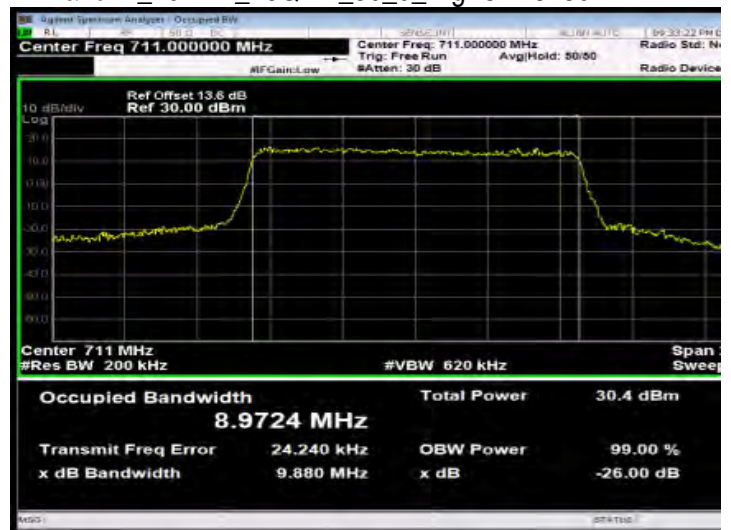

Unless otherwise stated the results shown in this test report refer only to the sample(s) tested and such sample(s) are retained for 90 days only.

除非另有說明，此報告結果僅對測試之樣品負責，同時此樣品僅保留90天。本報告未經本公司書面許可，不可部份複製。

This document is issued by the Company subject to its General Conditions of Service printed overleaf, available on request or accessible at www.sgs.com/terms_and_conditions.htm and, for electronic format documents, subject to Terms and Conditions for Electronic Documents at www.sgs.com/terms_e-document.htm. Attention is drawn to the limitation of liability, indemnification and jurisdiction issues defined therein. Any holder of this document is advised that information contained hereon reflects the Company's findings at the time of its intervention only and within the limits of Client's instructions, if any. The Company's sole responsibility is to its Client and this document does not exonerate parties to a transaction from exercising all their rights and obligations under the transaction documents. This document cannot be reproduced except in full, without prior written approval of the Company. Any unauthorized alteration, forgery or falsification of the content or appearance of this document is unlawful and offenders may be prosecuted to the fullest extent of the law.

SGS Taiwan Ltd.

No. 134, WuKungRoad, New Taipei Industrial Park, WuKu District, New Taipei City, Taiwan 24803 / 新北市五股區新北產業園區五工路 134 號

台灣檢驗科技股份有限公司

t (886-2) 2299-3279

f (886-2) 2298-0488

www.tw.sgs.com

Member of SGS Group

9. OUT OF BAND EMISSION AT ANTENNA TERMINALS

9.1. Standard Applicable

FCC §22.917(a), §24.238(a), §27.53(g)(h), the magnitude of each spurious and harmonic emission that can be detected when the equipment is operated under the conditions specified in the instruction manual and/ or alignment procedure, shall not be less than $43 + 10 \log$ (mean output power in watts) dBc below the mean power output outside a license's frequency block (-13dBm).

§27.53 (m) (4) shall not be less than $55 + 10 \log$ (mean output power in watt) dBc below the mean power output outside a license's frequency block (-25dBm).

FCC §27.53(c) (2) (4)

(c) For operations in the 746–758 MHz band and the 776–788 MHz band, the power of any emission outside the licensee's frequency band(s) of operation shall be attenuated below the transmitter power (P) within the licensed band(s) of operation, measured in watts, in accordance with the following:

(2) On any frequency outside the 776– 788 MHz band, the power of any emission shall be attenuated outside the band below the transmitter power (P) by at least $43 + 10 \log$ (P) dB (-13dBm)

(4) On all frequencies between 763-775 MHz and 793-805 MHz, by a factor not less than $65 + 10 \log$ (P) dB in a 6.25 kHz band segment, for mobile and portable stations;

FCC §27.53(c) (5) & FCC §27.53(g)

Compliance with this provision is based on the use of measurement instrumentation employing a resolution bandwidth of 100 kilohertz or greater. However, in the 100 kilohertz bands immediately outside and adjacent to a licensee's frequency block, a resolution bandwidth of at least 30 kHz may be employed.

FCC §27.53(h)

Compliance with this provision is based on the use of measurement instrumentation employing a resolution bandwidth of 1 megahertz or greater. However, in the 1 megahertz bands immediately outside and adjacent to the licensee's frequency block, a resolution bandwidth of at least one percent of the emission bandwidth of the fundamental emission of the transmitter may be employed. The emission bandwidth is defined as the width of the signal between two points, one below the carrier center frequency and one above the carrier center frequency, outside of which all emissions are attenuated at least 26 dB below the transmitter power.

Unless otherwise stated the results shown in this test report refer only to the sample(s) tested and such sample(s) are retained for 90 days only.

除非另有說明，此報告結果僅對測試之樣品負責，同時此樣品僅保留90天。本報告未經本公司書面許可，不可部份複製。

This document is issued by the Company subject to its General Conditions of Service printed overleaf, available on request or accessible at www.sgs.com/terms_and_conditions.htm and, for electronic format documents, subject to Terms and Conditions for Electronic Documents at www.sgs.com/terms_e-document.htm. Attention is drawn to the limitation of liability, indemnification and jurisdiction issues defined therein. Any holder of this document is advised that information contained hereon reflects the Company's findings at the time of its intervention only and within the limits of Client's instructions, if any. The Company's sole responsibility is to its Client and this document does not exonerate parties to a transaction from exercising all their rights and obligations under the transaction documents. This document cannot be reproduced except in full, without prior written approval of the Company. Any unauthorized alteration, forgery or falsification of the content or appearance of this document is unlawful and offenders may be prosecuted to the fullest extent of the law.

SGS Taiwan Ltd.

No.134,WuKungRoad,NewTaipeiIndustrialPark,WukuDistrict,NewTaipeiCity,Taiwan24803/新北市五股區新北產業園區五工路 134 號

台灣檢驗科技股份有限公司

t (886-2) 2299-3279

f (886-2) 2298-0488

www.tw.sgs.com

Member of SGS Group

FCC §27.53(m) (4) (6)

For mobile digital stations, the attenuation factor shall be not less than $40 + 10 \log (P)$ dB on all frequencies between the channel edge and 5 megahertz from the channel edge, $43 + 10 \log (P)$ dB on all frequencies between 5 megahertz and X megahertz from the channel edge, and $55 + 10 \log (P)$ dB on all frequencies more than X megahertz from the channel edge, where X is the greater of 6 megahertz or the actual emission bandwidth as defined in § 27.53(m)(6). In addition, the attenuation factor shall not be less than $43 + 10 \log (P)$ dB on all frequencies between 2490.5 MHz and 2496 MHz and $55 + 10 \log (P)$ dB at or below 2490.5 MHz.

Measurement procedure. Compliance with these rules is based on the use of measurement instrumentation employing a resolution bandwidth of 1 megahertz or greater. However, in the 1 MHz bands immediately outside and adjacent to the frequency block a resolution bandwidth of at least one percent of the emission bandwidth of the fundamental emission of the transmitter may be employed; for mobile digital stations, in the 1 megahertz bands immediately outside and adjacent to the frequency block a resolution bandwidth of at least two percent may be employed, except when the 1 megahertz band is 2495-2496 MHz, in which case a resolution bandwidth of at least one percent may be employed. A narrower resolution bandwidth is permitted in all cases to improve measurement accuracy provided the measured power is integrated over the full required measurement bandwidth (i.e. 1 megahertz or 1 percent of emission bandwidth, as specified; or 1 megahertz or 2 percent for mobile digital stations, except in the band 2495-2496 MHz). The emission bandwidth is defined as the width of the signal between two points, one below the carrier center frequency and one above the carrier center frequency, outside of which all emissions are attenuated at least 26 dB below the transmitter power. With respect to television operations, measurements must be made of the separate visual and aural operating powers at sufficiently frequent intervals to ensure compliance with the rules.

Unless otherwise stated the results shown in this test report refer only to the sample(s) tested and such sample(s) are retained for 90 days only.

除非另有說明，此報告結果僅對測試之樣品負責，同時此樣品僅保留90天。本報告未經本公司書面許可，不可部份複製。

This document is issued by the Company subject to its General Conditions of Service printed overleaf, available on request or accessible at www.sgs.com/terms_and_conditions.htm and, for electronic format documents, subject to Terms and Conditions for Electronic Documents at www.sgs.com/terms_e-document.htm. Attention is drawn to the limitation of liability, indemnification and jurisdiction issues defined therein. Any holder of this document is advised that information contained hereon reflects the Company's findings at the time of its intervention only and within the limits of Client's instructions, if any. The Company's sole responsibility is to its Client and this document does not exonerate parties to a transaction from exercising all their rights and obligations under the transaction documents. This document cannot be reproduced except in full, without prior written approval of the Company. Any unauthorized alteration, forgery or falsification of the content or appearance of this document is unlawful and offenders may be prosecuted to the fullest extent of the law.

SGS Taiwan Ltd.

No.134,WuKungRoad,NewTaipeiIndustrialPark,WukuDistrict,NewTaipeiCity,Taiwan24803/新北市五股區新北產業園區五工路 134 號

台灣檢驗科技股份有限公司

t (886-2) 2299-3279

f (886-2) 2298-0488

www.tw.sgs.com

Member of SGS Group

9.2. Test SET-UP

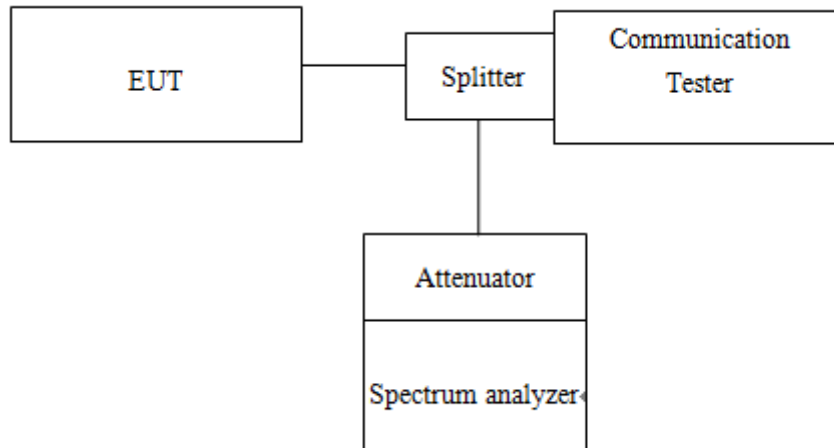

9.3. Measurement Procedure

Conducted Emission

The RF output of the transceiver was connected to a spectrum analyzer through appropriate attenuation. The resolution bandwidth of the spectrum analyzer was set at 1MHz, sufficient scans were taken to show the out of band Emissions if any up to 10th harmonic.

1. To connect Antenna Port of EUT to Spectrum.
2. Set RBW = 1MHz & VBW = 1MHz on Spectrum.
3. Allow trace to fully stabilize
4. Repeat above procedures until all default test channel measured were complete.

Band Edge

1. To connect Antenna Port of EUT to Spectrum.
2. The band edge of low and high channels for the highest RF powers was measured. Setting RBW \geq 1% EBW.
3. Allow trace to fully stabilize
4. Repeat above procedures until all default test channel measured were complete.

Unless otherwise stated the results shown in this test report refer only to the sample(s) tested and such sample(s) are retained for 90 days only.

除非另有說明，此報告結果僅對測試之樣品負責，同時此樣品僅保留90天。本報告未經本公司書面許可，不可部份複製。

This document is issued by the Company subject to its General Conditions of Service printed overleaf, available on request or accessible at www.sgs.com/terms_and_conditions.htm and, for electronic format documents, subject to Terms and Conditions for Electronic Documents at www.sgs.com/terms_e-document.htm. Attention is drawn to the limitation of liability, indemnification and jurisdiction issues defined therein. Any holder of this document is advised that information contained hereon reflects the Company's findings at the time of its intervention only and within the limits of Client's instructions, if any. The Company's sole responsibility is to its Client and this document does not exonerate parties to a transaction from exercising all their rights and obligations under the transaction documents. This document cannot be reproduced except in full, without prior written approval of the Company. Any unauthorized alteration, forgery or falsification of the content or appearance of this document is unlawful and offenders may be prosecuted to the fullest extent of the law.

9.4. Measurement Equipment Used

Conducted Emission (measured at antenna port) Test Site					
EQUIPMENT TYPE	MFR	MODEL NUMBER	SERIAL NUMBER	LAST CAL.	CAL DUE.
Spectrum Analyzer	KEYSIGHT	N9010A	MY54510568	04/14/2016	04/13/2017
Communication Tester	Anritsu	MT8820C	6201107337	05/25/2016	05/24/2017
Coaxial Cable 30cm	WOKEN	00100A1F1A195C	RF01	12/12/2016	12/11/2017
Temperature Chamber	TERCHY	MHK-120LK	1020582	06/16/2016	06/15/2017
DC Block	PASTERNAK	PE8210	RF29	12/12/2016	12/11/2017
Splitter	RF-LAMBAD	RFLT2W1G18G	RF35	12/12/2016	12/11/2017
Attenuator	WOKEN	218FS-10	RF23	12/12/2016	12/11/2017
DC Power Supply	Agilent	E3640A	MY53140006	05/04/2016	05/03/2017
Communication Tester	Anritsu	MT8820C	6201107337	05/25/2016	05/24/2017

9.5. Measurement Result:

Refer to next pages.

NOTE: The occurrence of the spike on the conducted emission is the signal of the fundamental emission.

Unless otherwise stated the results shown in this test report refer only to the sample(s) tested and such sample(s) are retained for 90 days only.

除非另有說明，此報告結果僅對測試之樣品負責，同時此樣品僅保留90天。本報告未經本公司書面許可，不可部份複製。

This document is issued by the Company subject to its General Conditions of Service printed overleaf, available on request or accessible at www.sgs.com/terms_and_conditions.htm and, for electronic format documents, subject to Terms and Conditions for Electronic Documents at www.sgs.com/terms_e-document.htm. Attention is drawn to the limitation of liability, indemnification and jurisdiction issues defined therein. Any holder of this document is advised that information contained hereon reflects the Company's findings at the time of its intervention only and within the limits of Client's instructions, if any. The Company's sole responsibility is to its Client and this document does not exonerate parties to a transaction from exercising all their rights and obligations under the transaction documents. This document cannot be reproduced except in full, without prior written approval of the Company. Any unauthorized alteration, forgery or falsification of the content or appearance of this document is unlawful and offenders may be prosecuted to the fullest extent of the law.

SGS Taiwan Ltd.

No.134,WuKungRoad,NewTaipeiIndustrialPark,WukuDistrict,NewTaipeiCity,Taiwan24803/新北市五股區新北產業園區五工路 134 號

台灣檢驗科技股份有限公司

t (886-2) 2299-3279

f (886-2) 2298-0488

www.tw.sgs.com

Member of SGS Group

30MHz~3GHz_GSM_850MHz_LowCH128-824.2

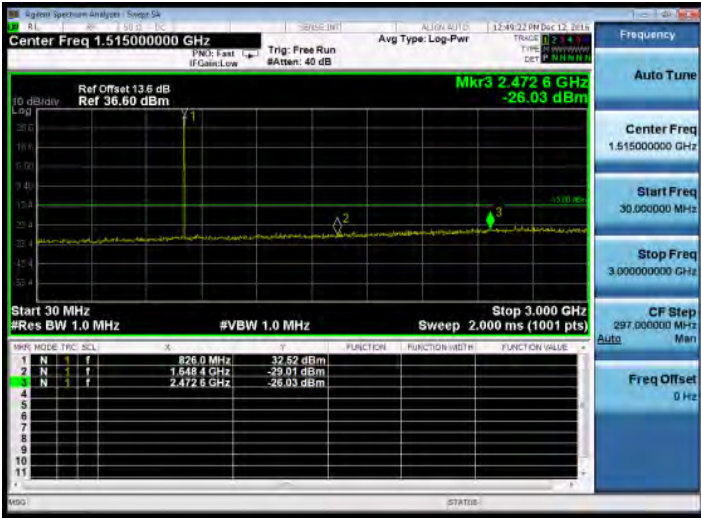

30MHz~3GHz_GSM_850MHz_MidCH190-836.6

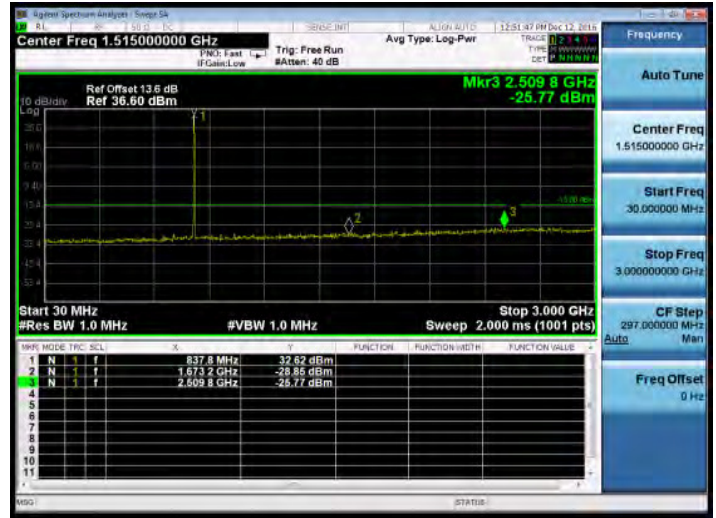

3GHz~10GHz_GSM_850MHz_LowCH128-824.2

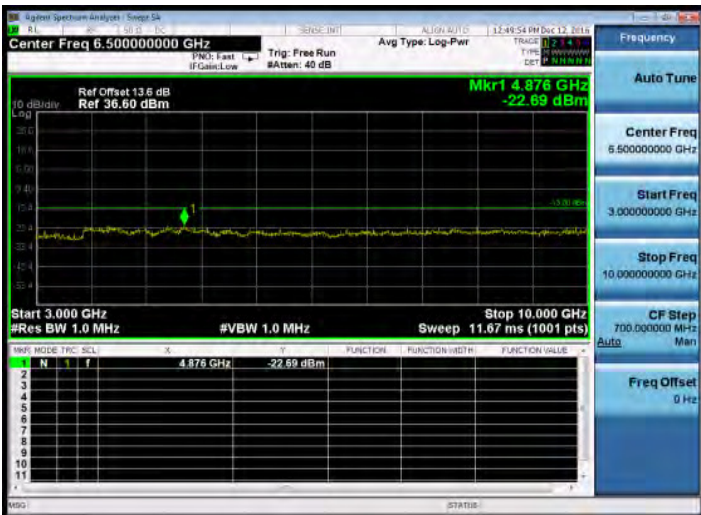

3GHz~10GHz_GSM_850MHz_MidCH190-836.6

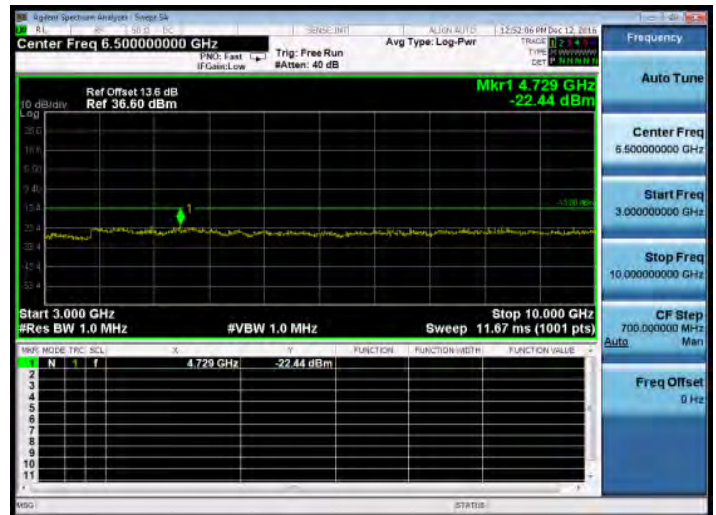

Unless otherwise stated the results shown in this test report refer only to the sample(s) tested and such sample(s) are retained for 90 days only.

除非另有說明，此報告結果僅對測試之樣品負責，同時此樣品僅保留90天。本報告未經本公司書面許可，不可部份複製。

This document is issued by the Company subject to its General Conditions of Service printed overleaf, available on request or accessible at www.sgs.com/terms_and_conditions.htm and, for electronic format documents, subject to Terms and Conditions for Electronic Documents at www.sgs.com/terms_e-document.htm. Attention is drawn to the limitation of liability, indemnification and jurisdiction issues defined therein. Any holder of this document is advised that information contained hereon reflects the Company's findings at the time of its intervention only and within the limits of Client's instructions, if any. The Company's sole responsibility is to its Client and this document does not exonerate parties to a transaction from exercising all their rights and obligations under the transaction documents. This document cannot be reproduced except in full, without prior written approval of the Company. Any unauthorized alteration, forgery or falsification of the content or appearance of this document is unlawful and offenders may be prosecuted to the fullest extent of the law.

30MHz~3GHz_GSM_850MHz_HighCH251-848.8

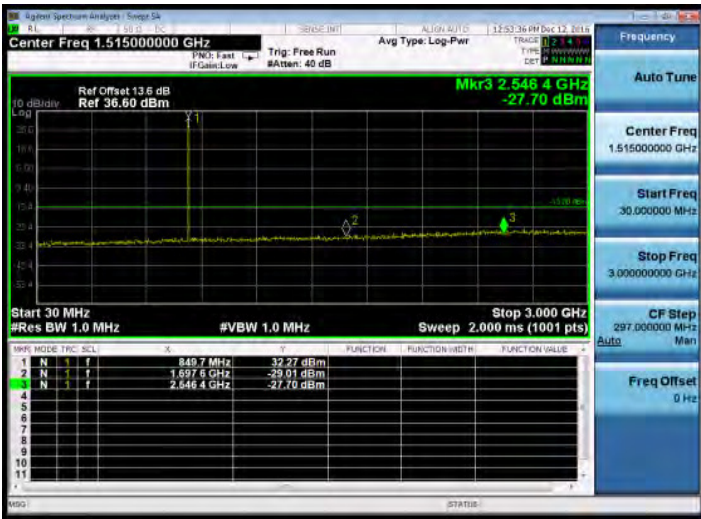

3GHz~10GHz_GPRS_850MHz_LowCH128-824.2

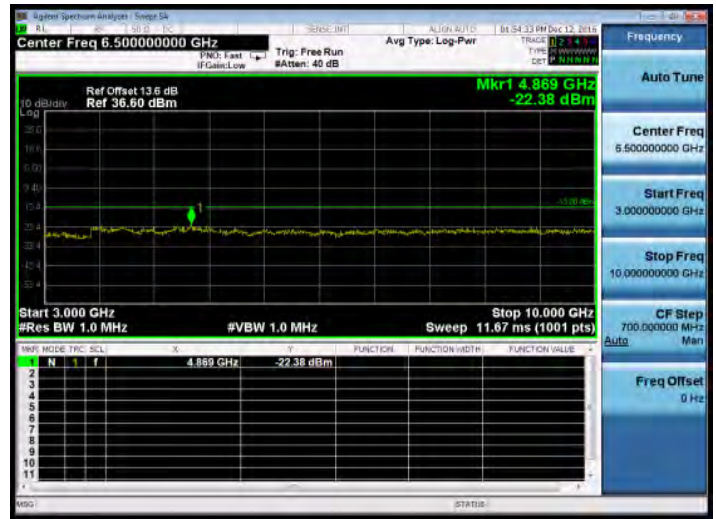

3GHz~10GHz_GSM_850MHz_HighCH251-848.8

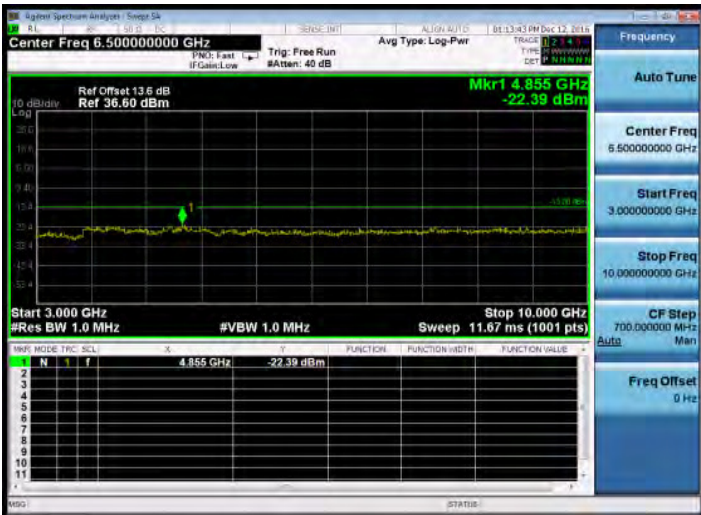

30MHz~3GHz_GPRS_850MHz_MidCH190-836.6



30MHz~3GHz_GPRS_850MHz_LowCH128-824.2

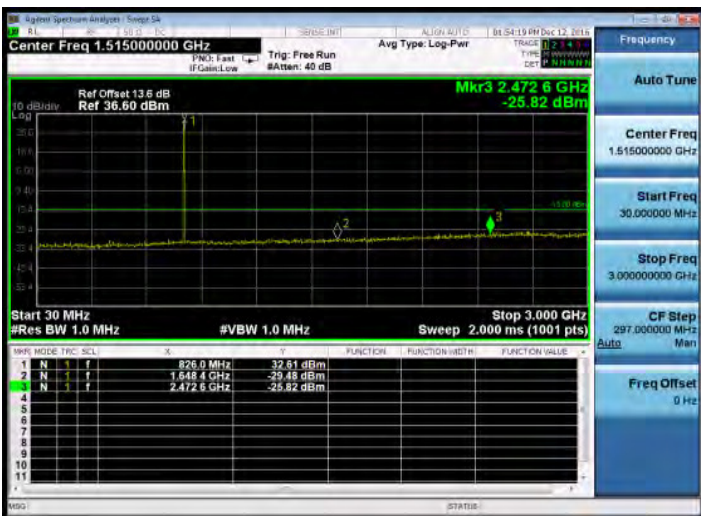

3GHz~10GHz_GPRS_850MHz_MidCH190-836.6

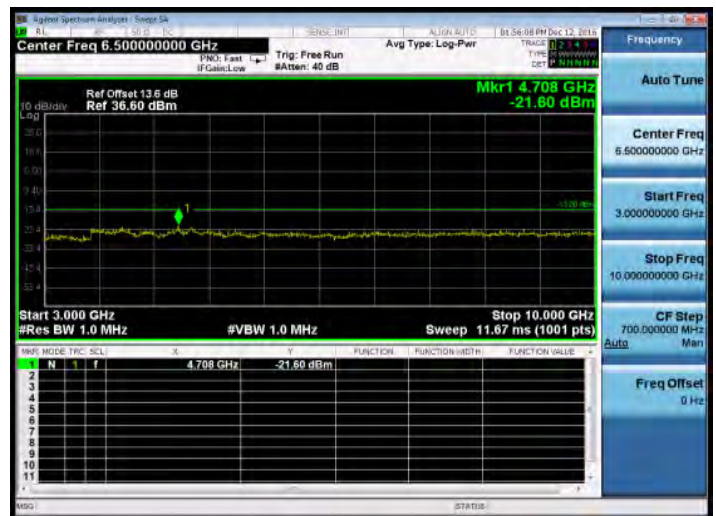

Unless otherwise stated the results shown in this test report refer only to the sample(s) tested and such sample(s) are retained for 90 days only.

除非另有說明，此報告結果僅對測試之樣品負責，同時此樣品僅保留90天。本報告未經本公司書面許可，不可部份複製。

This document is issued by the Company subject to its General Conditions of Service printed overleaf, available on request or accessible at www.sgs.com/terms_and_conditions.htm and, for electronic format documents, subject to Terms and Conditions for Electronic Documents at www.sgs.com/terms_e-document.htm. Attention is drawn to the limitation of liability, indemnification and jurisdiction issues defined therein. Any holder of this document is advised that information contained hereon reflects the Company's findings at the time of its intervention only and within the limits of Client's instructions, if any. The Company's sole responsibility is to its Client and this document does not exonerate parties to a transaction from exercising all their rights and obligations under the transaction documents. This document cannot be reproduced except in full, without prior written approval of the Company. Any unauthorized alteration, forgery or falsification of the content or appearance of this document is unlawful and offenders may be prosecuted to the fullest extent of the law.

30MHz~3GHz_GPRS_850MHz_HighCH251-848.8

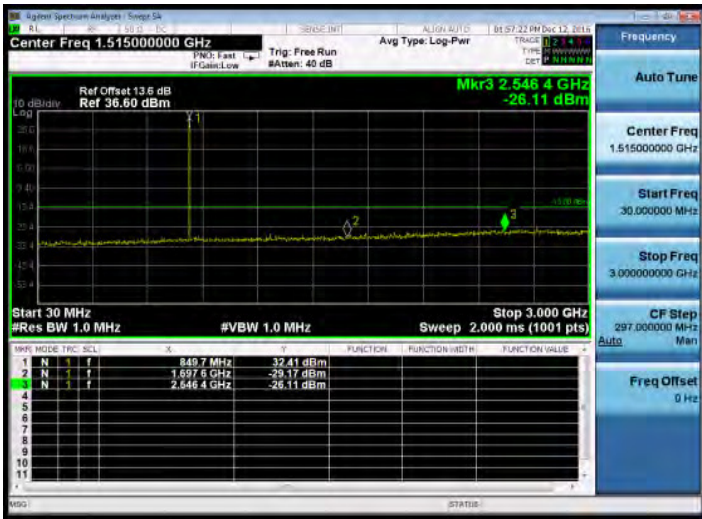

3GHz~10GHz_EDGE_850MHz_LowCH128-824.2

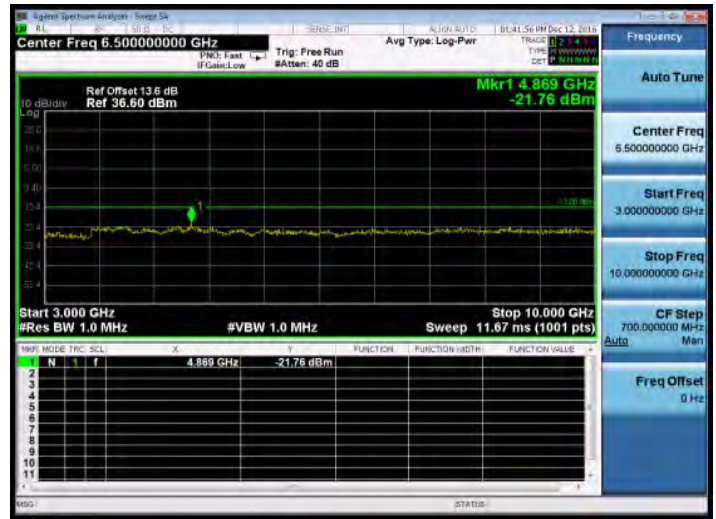

3GHz~10GHz_GPRS_850MHz_HighCH251-848.8

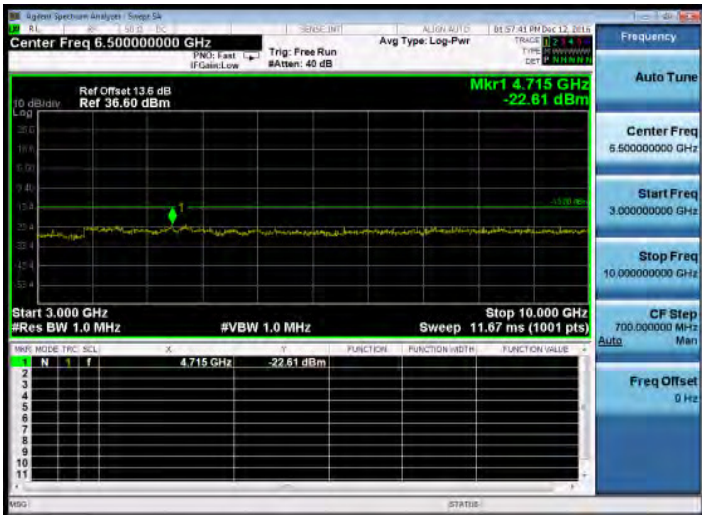

30MHz~3GHz_EDGE_850MHz_MidCH190-836.6

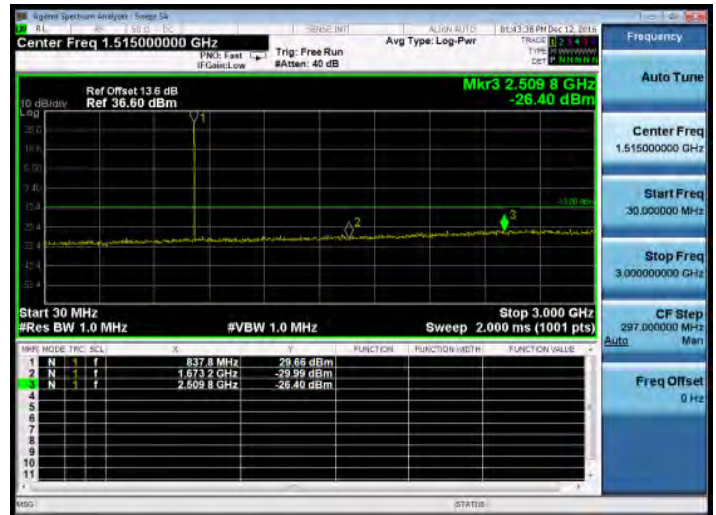

30MHz~3GHz_EDGE_850MHz_LowCH128-824.2



3GHz~10GHz_EDGE_850MHz_MidCH190-836.6

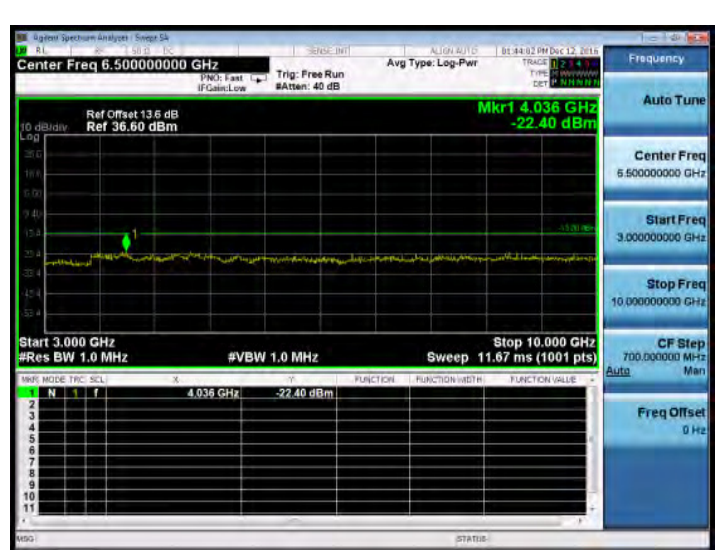

Unless otherwise stated the results shown in this test report refer only to the sample(s) tested and such sample(s) are retained for 90 days only.
除非另有說明，此報告結果僅對測試之樣品負責，同時此樣品僅保留90天。本報告未經本公司書面許可，不可部份複製。

This document is issued by the Company subject to its General Conditions of Service printed overleaf, available on request or accessible at www.sgs.com/terms_and_conditions.htm and, for electronic format documents, subject to Terms and Conditions for Electronic Documents at www.sgs.com/terms_e-document.htm. Attention is drawn to the limitation of liability, indemnification and jurisdiction issues defined therein. Any holder of this document is advised that information contained hereon reflects the Company's findings at the time of its intervention only and within the limits of Client's instructions, if any. The Company's sole responsibility is to its Client and this document does not exonerate parties to a transaction from exercising all their rights and obligations under the transaction documents. This document cannot be reproduced except in full, without prior written approval of the Company. Any unauthorized alteration, forgery or falsification of the content or appearance of this document is unlawful and offenders may be prosecuted to the fullest extent of the law.

30MHz~3GHz_EDGE_850MHz_HighCH251-848.8

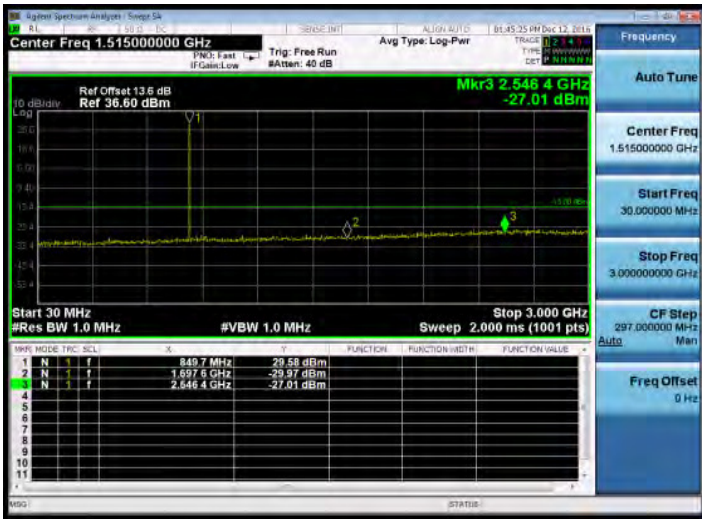

3GHz~10GHz_GSM_1900MHz_LowCH512-1850.2

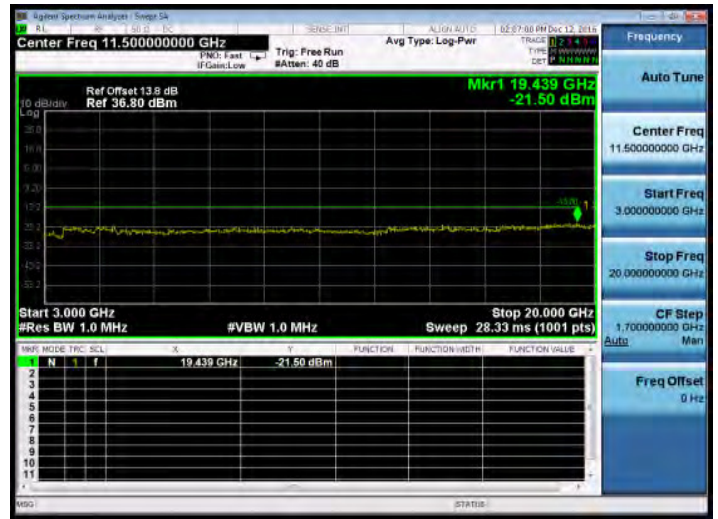

3GHz~10GHz_EDGE_850MHz_HighCH251-848.8

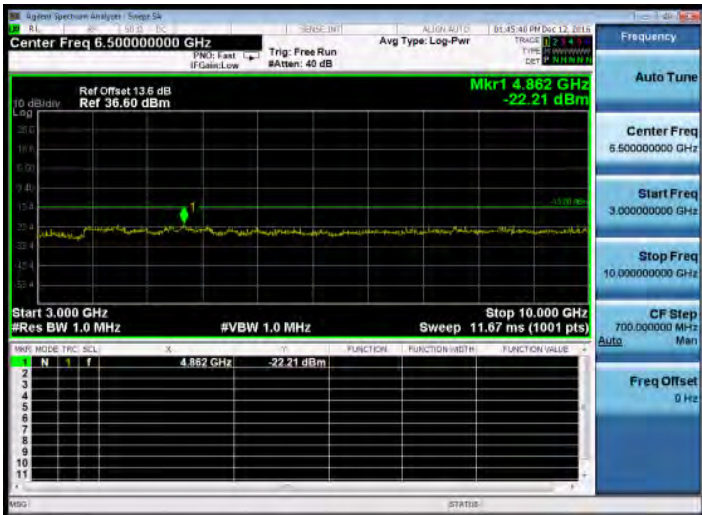

30MHz~3GHz_GSM_1900MHz_MidCH661-1880

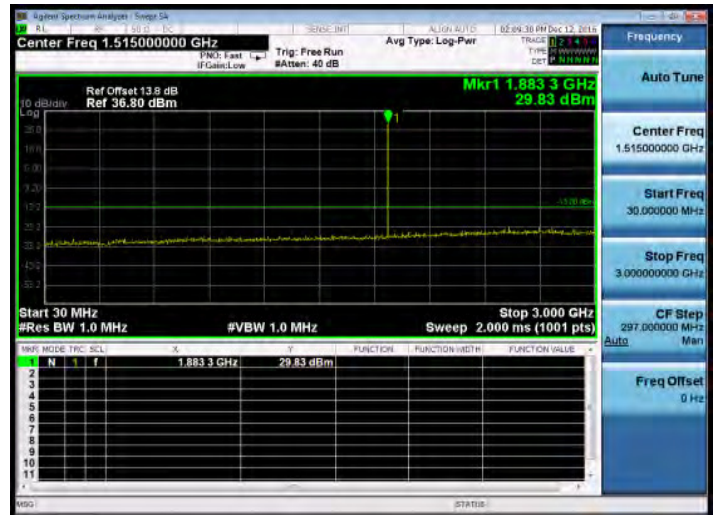

30MHz~3GHz_GSM_1900MHz_LowCH512-1850.2

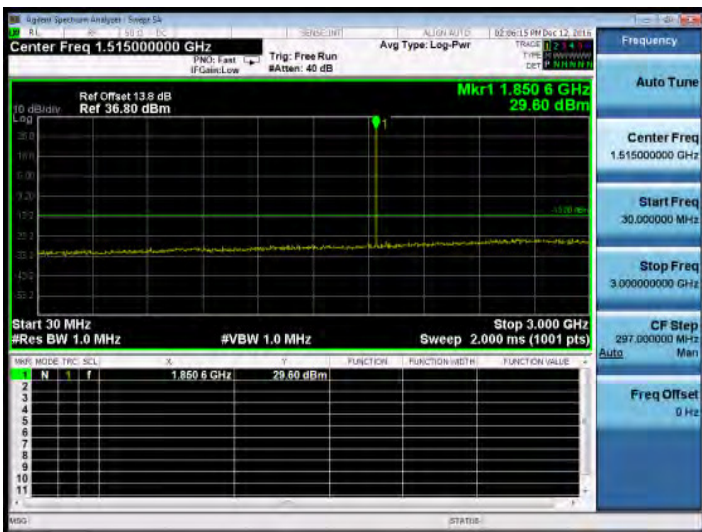

3GHz~10GHz_GSM_1900MHz_MidCH661-1880

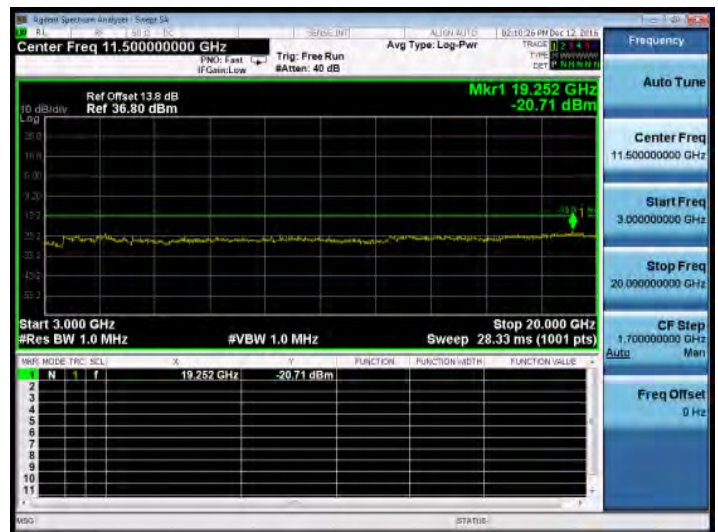

Unless otherwise stated the results shown in this test report refer only to the sample(s) tested and such sample(s) are retained for 90 days only.

除非另有說明，此報告結果僅對測試之樣品負責，同時此樣品僅保留90天。本報告未經本公司書面許可，不可部份複製。

This document is issued by the Company subject to its General Conditions of Service printed overleaf, available on request or accessible at www.sgs.com/terms_and_conditions.htm and, for electronic format documents, subject to Terms and Conditions for Electronic Documents at www.sgs.com/terms_e-document.htm. Attention is drawn to the limitation of liability, indemnification and jurisdiction issues defined therein. Any holder of this document is advised that information contained hereon reflects the Company's findings at the time of its intervention only and within the limits of Client's instructions, if any. The Company's sole responsibility is to its Client and this document does not exonerate parties to a transaction from exercising all their rights and obligations under the transaction documents. This document cannot be reproduced except in full, without prior written approval of the Company. Any unauthorized alteration, forgery or falsification of the content or appearance of this document is unlawful and offenders may be prosecuted to the fullest extent of the law.

SGS Taiwan Ltd.

No. 134, WuKungRoad, New Taipei Industrial Park, WuKu District, New Taipei City, Taiwan 24803/新北市五股區新北產業園區五工路 134 號

台灣檢驗科技股份有限公司

t (886-2) 2299-3279

f (886-2) 2298-0488

www.tw.sgs.com

Member of SGS Group

30MHz~3GHz_GSM_1900MHz_HighCH810-1909.8

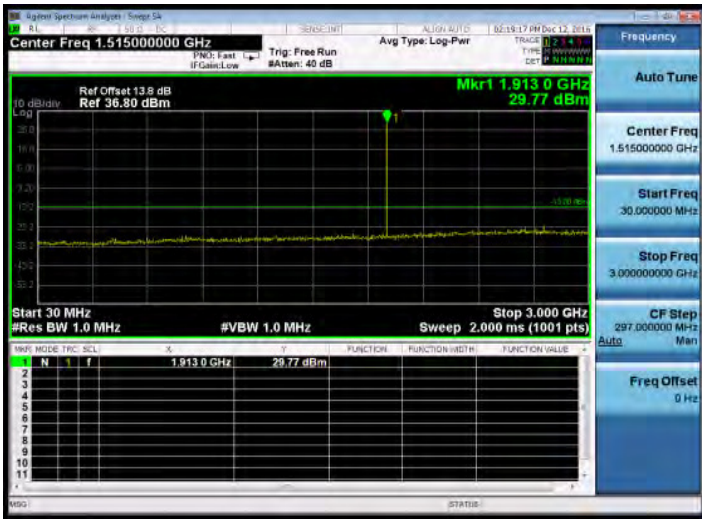

3GHz~10GHz_GPRS_1900MHz_LowCH512-1850.2

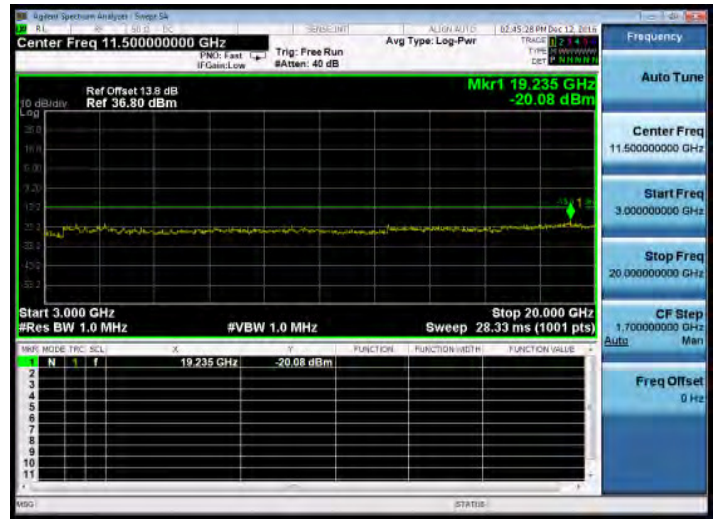

3GHz~10GHz_GSM_1900MHz_HighCH810-1909.8

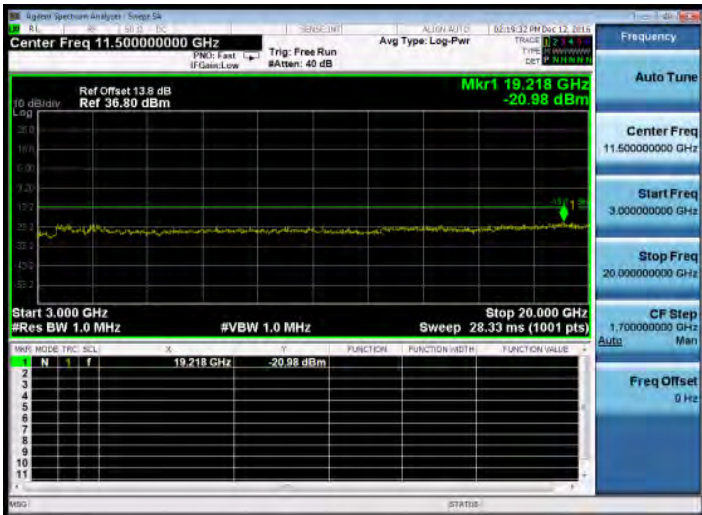

30MHz~3GHz_GPRS_1900MHz_MidCH661-1880

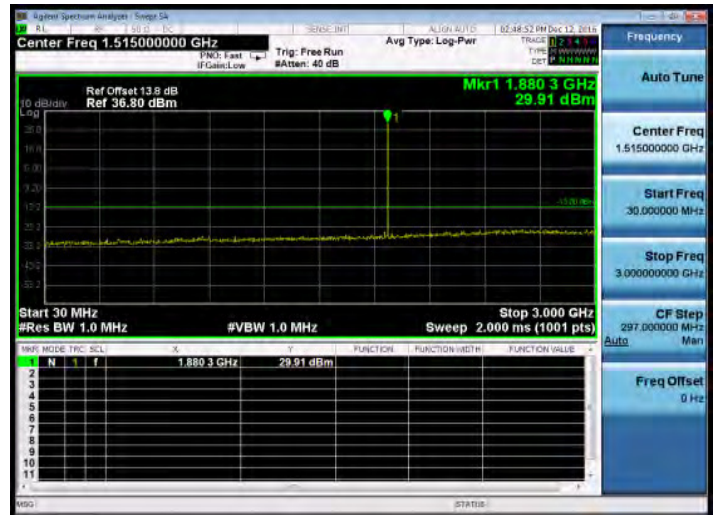

30MHz~3GHz_GPRS_1900MHz_LowCH512-1850.2

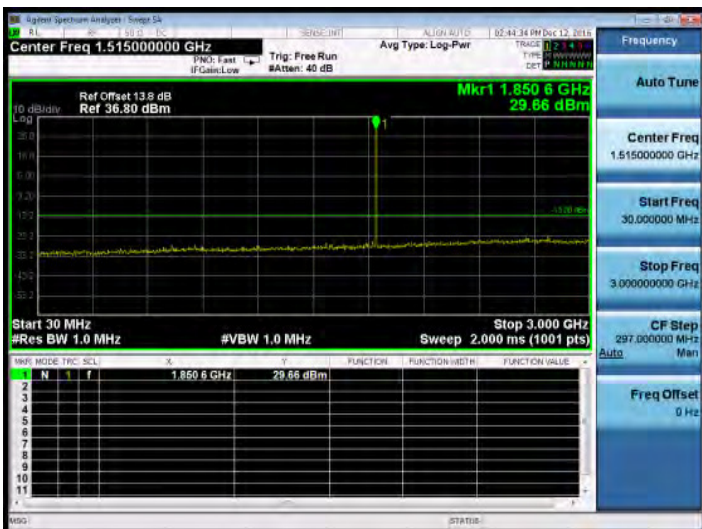

3GHz~10GHz_GPRS_1900MHz_MidCH661-1880

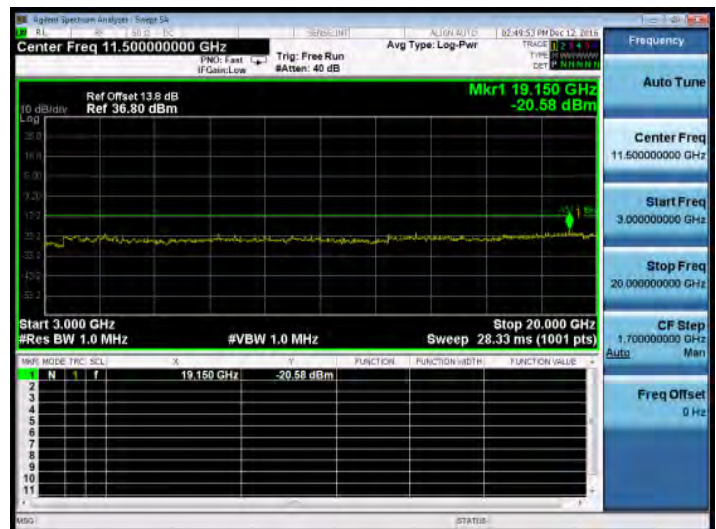

Unless otherwise stated the results shown in this test report refer only to the sample(s) tested and such sample(s) are retained for 90 days only.
除非另有說明，此報告結果僅對測試之樣品負責，同時此樣品僅保留90天。本報告未經本公司書面許可，不可部份複製。

This document is issued by the Company subject to its General Conditions of Service printed overleaf, available on request or accessible at www.sgs.com/terms_and_conditions.htm and, for electronic format documents, subject to Terms and Conditions for Electronic Documents at www.sgs.com/terms_e-document.htm. Attention is drawn to the limitation of liability, indemnification and jurisdiction issues defined therein. Any holder of this document is advised that information contained hereon reflects the Company's findings at the time of its intervention only and within the limits of Client's instructions, if any. The Company's sole responsibility is to its Client and this document does not exonerate parties to a transaction from exercising all their rights and obligations under the transaction documents. This document cannot be reproduced except in full, without prior written approval of the Company. Any unauthorized alteration, forgery or falsification of the content or appearance of this document is unlawful and offenders may be prosecuted to the fullest extent of the law.

30MHz~3GHz_GPRS_1900MHz_HighCH810-1909.8

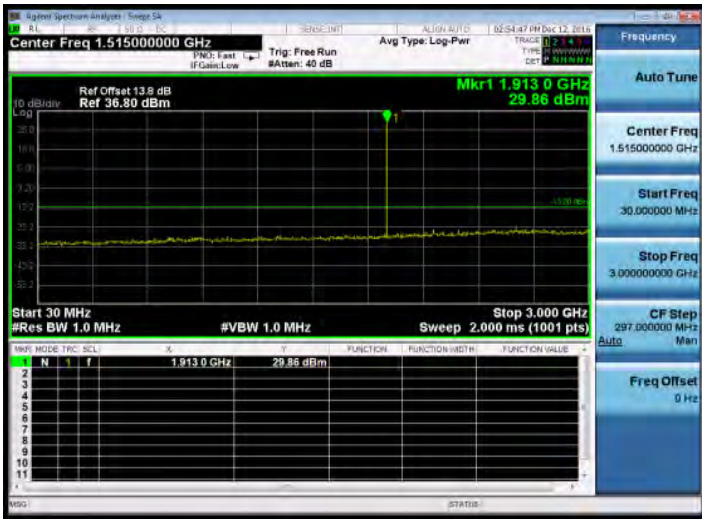

3GHz~10GHz_EDGE_1900MHz_LowCH512-1850.2

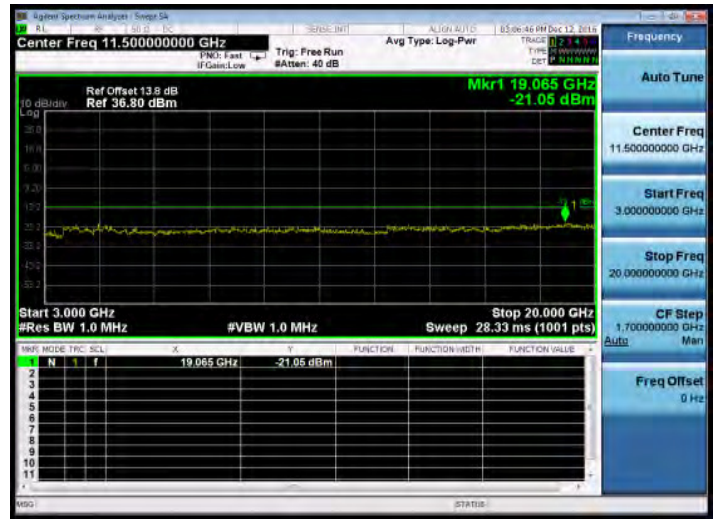

3GHz~10GHz_GPRS_1900MHz_HighCH810-1909.8

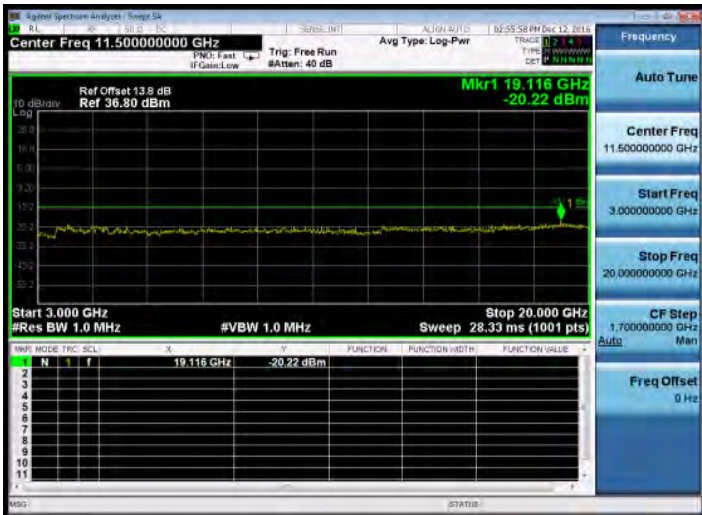

30MHz~3GHz_EDGE_1900MHz_MidCH661-1880

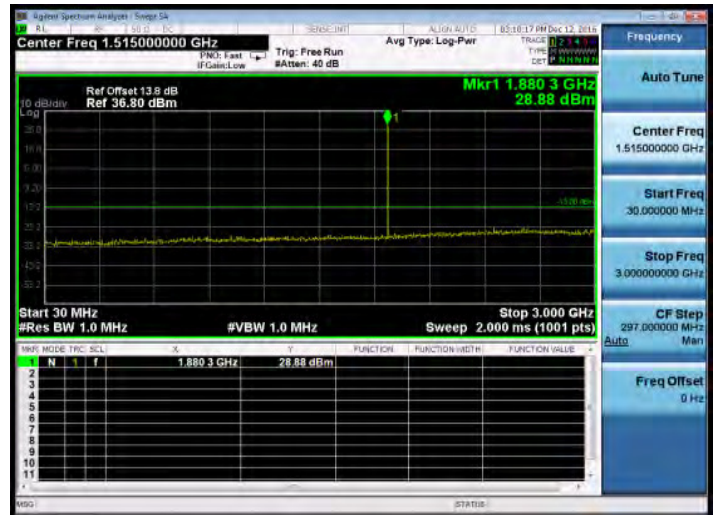

30MHz~3GHz_EDGE_1900MHz_LowCH512-1850.2

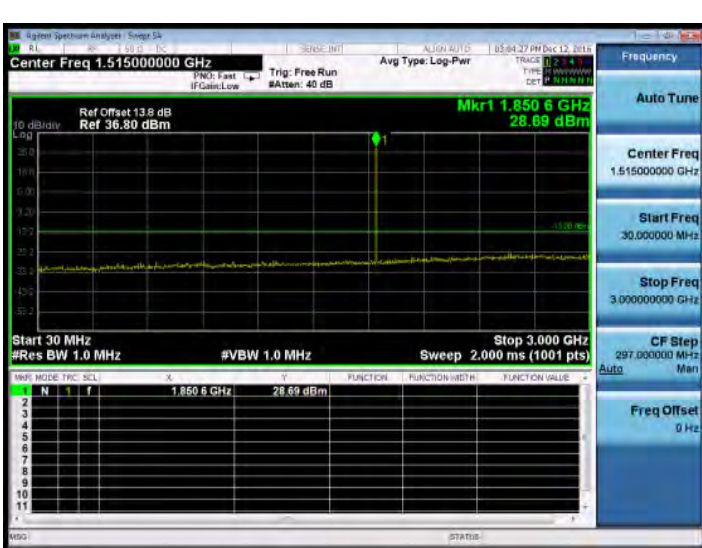

3GHz~10GHz_EDGE_1900MHz_MidCH661-1880

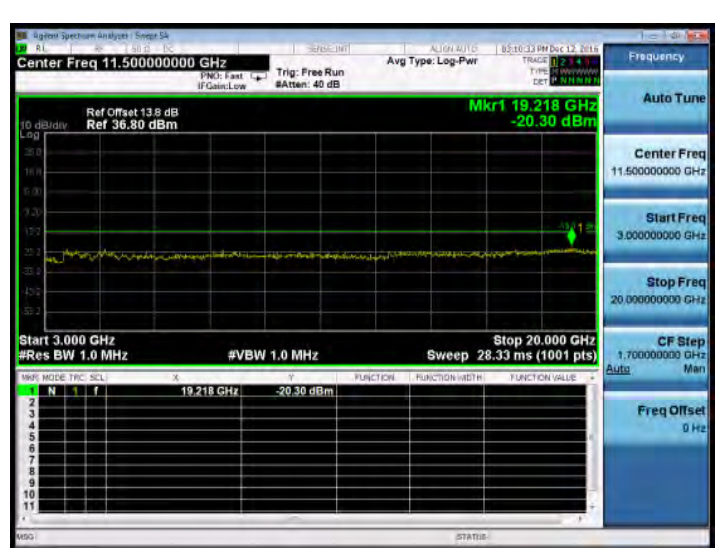

Unless otherwise stated the results shown in this test report refer only to the sample(s) tested and such sample(s) are retained for 90 days only.

除非另有說明，此報告結果僅對測試之樣品負責，同時此樣品僅保留90天。本報告未經本公司書面許可，不可部份複製。

This document is issued by the Company subject to its General Conditions of Service printed overleaf, available on request or accessible at www.sgs.com/terms_and_conditions.htm and, for electronic format documents, subject to Terms and Conditions for Electronic Documents at www.sgs.com/terms_e-document.htm. Attention is drawn to the limitation of liability, indemnification and jurisdiction issues defined therein. Any holder of this document is advised that information contained herein reflects the Company's findings at the time of its intervention only and within the limits of Client's instructions, if any. The Company's sole responsibility is to its Client and this document does not exonerate parties to a transaction from exercising all their rights and obligations under the transaction documents. This document cannot be reproduced except in full, without prior written approval of the Company. Any unauthorized alteration, forgery or falsification of the content or appearance of this document is unlawful and offenders may be prosecuted to the fullest extent of the law.

SGS Taiwan Ltd.

No. 134, WuKungRoad, New Taipei Industrial Park, WuKu District, New Taipei City, Taiwan 24803/新北市五股區新北產業園區五工路 134 號

台灣檢驗科技股份有限公司

t (886-2) 2299-3279

f (886-2) 2298-0488

www.tw.sgs.com

Member of SGS Group

30MHz~3GHz_EDGE_1900MHz_HighCH810-1909.8

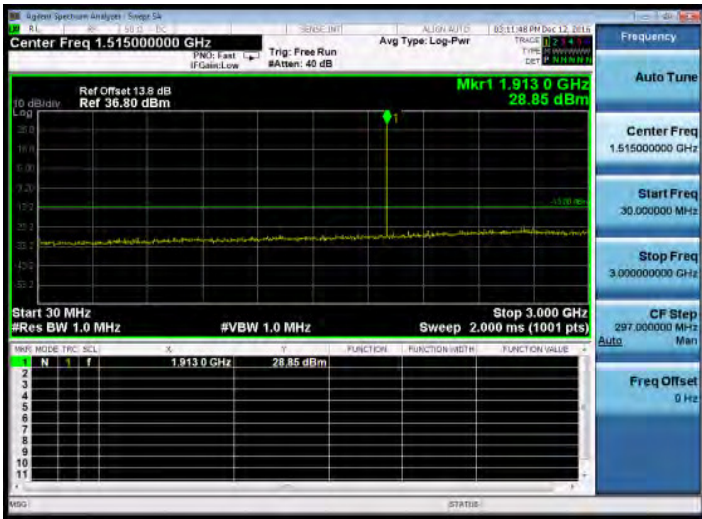

3GHz~10GHz_EDGE_1900MHz_HighCH810-1909.8

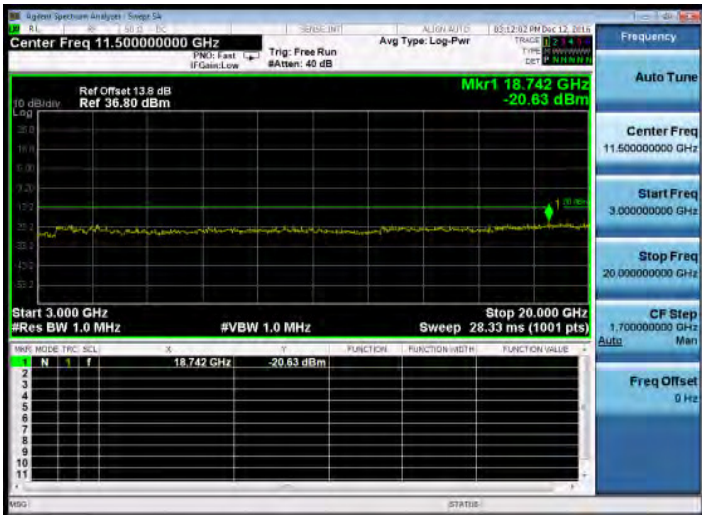

Unless otherwise stated the results shown in this test report refer only to the sample(s) tested and such sample(s) are retained for 90 days only.

除非另有說明，此報告結果僅對測試之樣品負責，同時此樣品僅保留90天。本報告未經本公司書面許可，不可部份複製。

This document is issued by the Company subject to its General Conditions of Service printed overleaf, available on request or accessible at www.sgs.com/terms_and_conditions.htm and, for electronic format documents, subject to Terms and Conditions for Electronic Documents at www.sgs.com/terms_e-document.htm. Attention is drawn to the limitation of liability, indemnification and jurisdiction issues defined therein. Any holder of this document is advised that information contained hereon reflects the Company's findings at the time of its intervention only and within the limits of Client's instructions, if any. The Company's sole responsibility is to its Client and this document does not exonerate parties to a transaction from exercising all their rights and obligations under the transaction documents. This document cannot be reproduced except in full, without prior written approval of the Company. Any unauthorized alteration, forgery or falsification of the content or appearance of this document is unlawful and offenders may be prosecuted to the fullest extent of the law.

30MHz~3GHz_WCDMA_B2_LowCH9262-1852.4

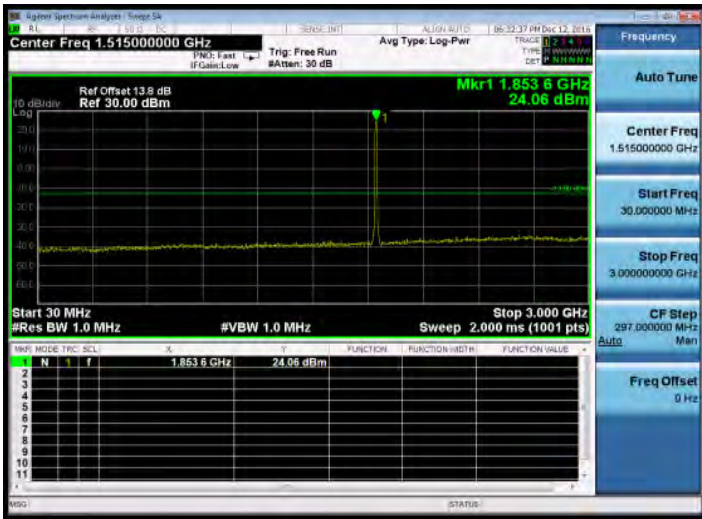

3GHz~10GHz_WCDMA_B2_MidCH9400-1880

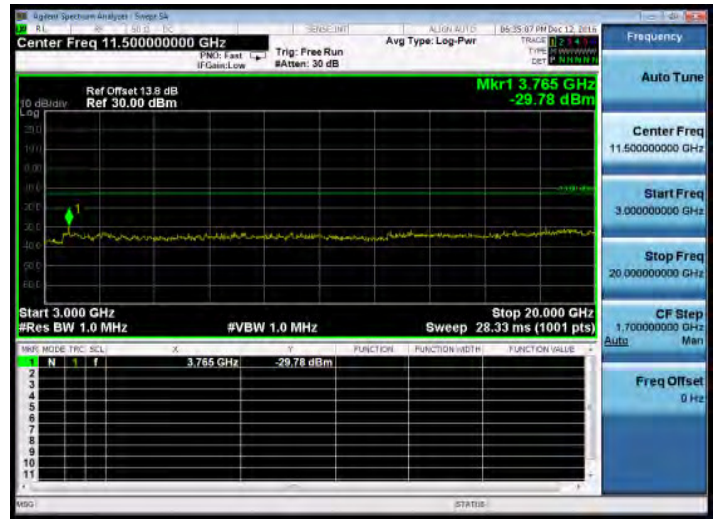

3GHz~10GHz_WCDMA_B2_LowCH9262-1852.4

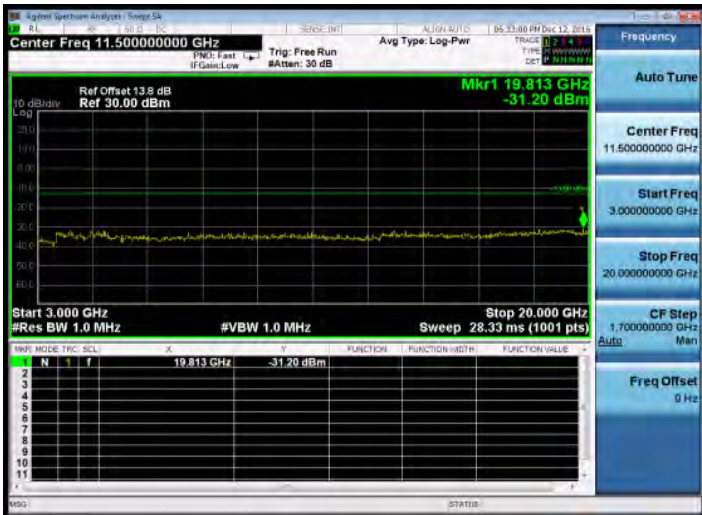

30MHz~3GHz_WCDMA_B2_HighCH9538-1907.6

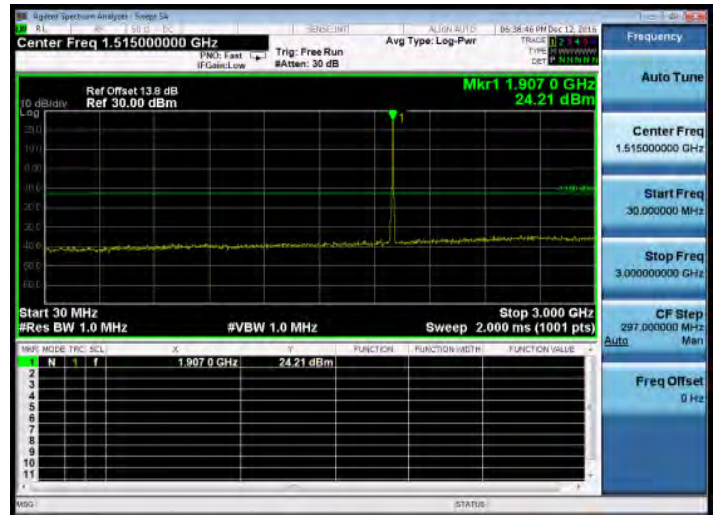

30MHz~3GHz_WCDMA_B2_MidCH9400-1880

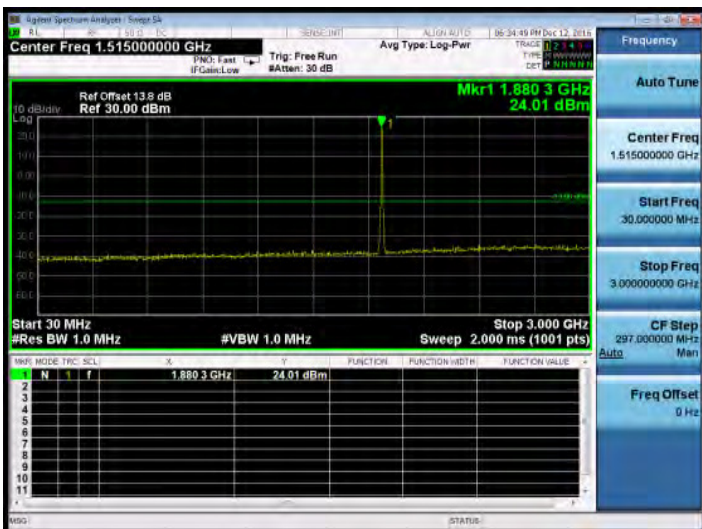

3GHz~10GHz_WCDMA_B2_HighCH9538-1907.6

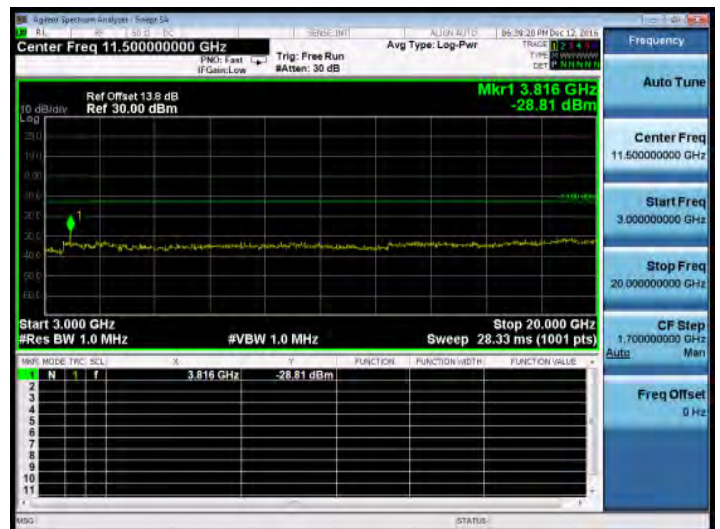

Unless otherwise stated the results shown in this test report refer only to the sample(s) tested and such sample(s) are retained for 90 days only.
除非另有說明，此報告結果僅對測試之樣品負責，同時此樣品僅保留90天。本報告未經本公司書面許可，不可部份複製。

This document is issued by the Company subject to its General Conditions of Service printed overleaf, available on request or accessible at www.sgs.com/terms_and_conditions.htm and, for electronic format documents, subject to Terms and Conditions for Electronic Documents at www.sgs.com/terms_e-document.htm. Attention is drawn to the limitation of liability, indemnification and jurisdiction issues defined therein. Any holder of this document is advised that information contained herein reflects the Company's findings at the time of its intervention only and within the limits of Client's instructions, if any. The Company's sole responsibility is to its Client and this document does not exonerate parties to a transaction from exercising all their rights and obligations under the transaction documents. This document cannot be reproduced except in full, without prior written approval of the Company. Any unauthorized alteration, forgery or falsification of the content or appearance of this document is unlawful and offenders may be prosecuted to the fullest extent of the law.

30MHz~3GHz_HSDPA_B2_LowCH9262-1852.4

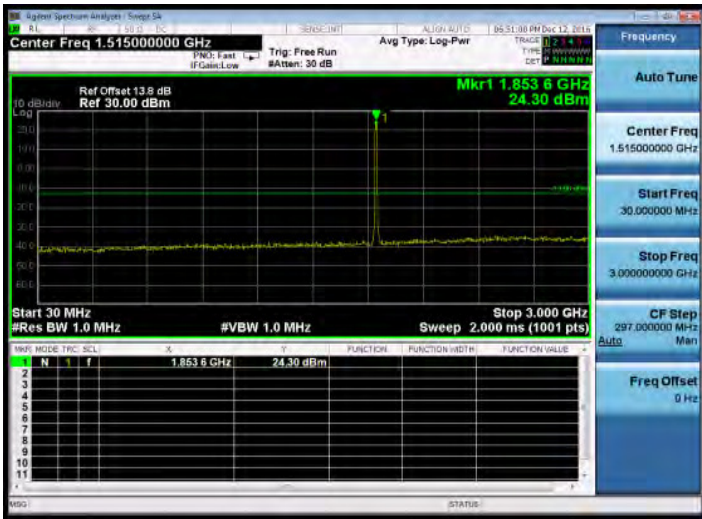

3GHz~10GHz_HSDPA_B2_MidCH9400-1880

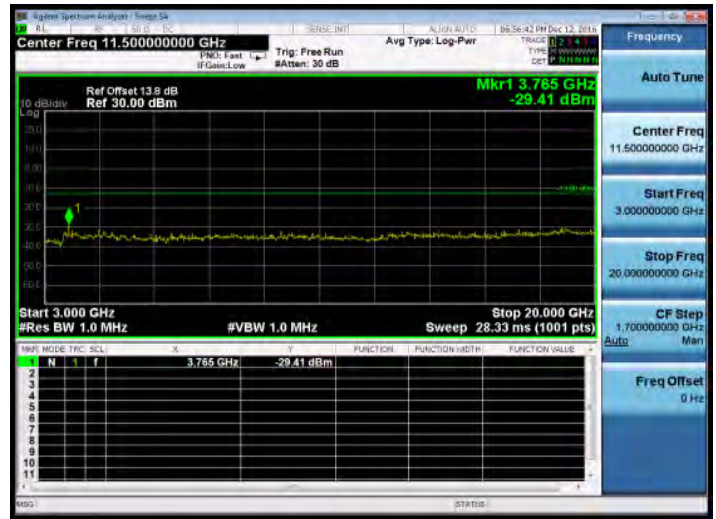

3GHz~10GHz_HSDPA_B2_LowCH9262-1852.4

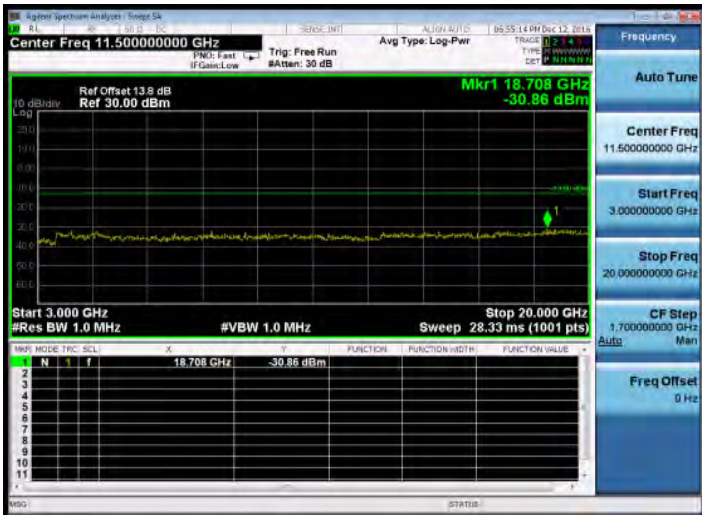

30MHz~3GHz_HSDPA_B2_HighCH9538-1907.6

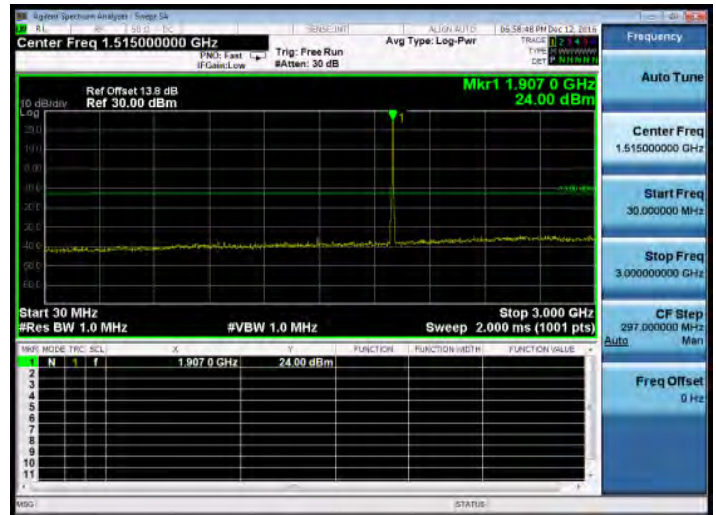

30MHz~3GHz_HSDPA_B2_MidCH9400-1880

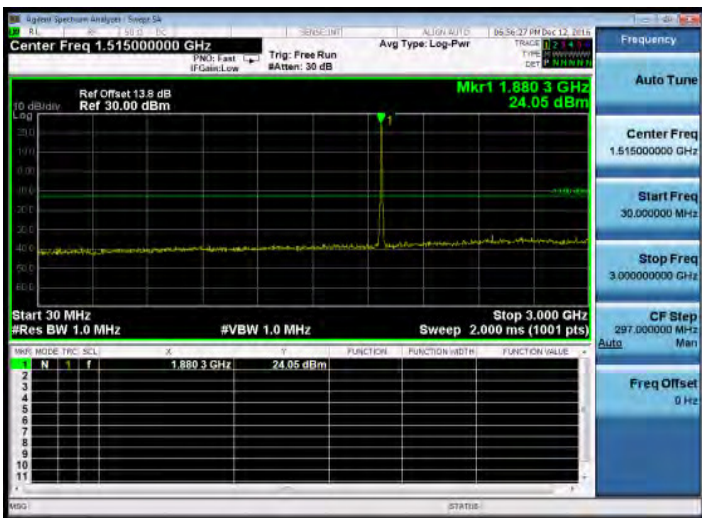

3GHz~10GHz_HSDPA_B2_HighCH9538-1907.6

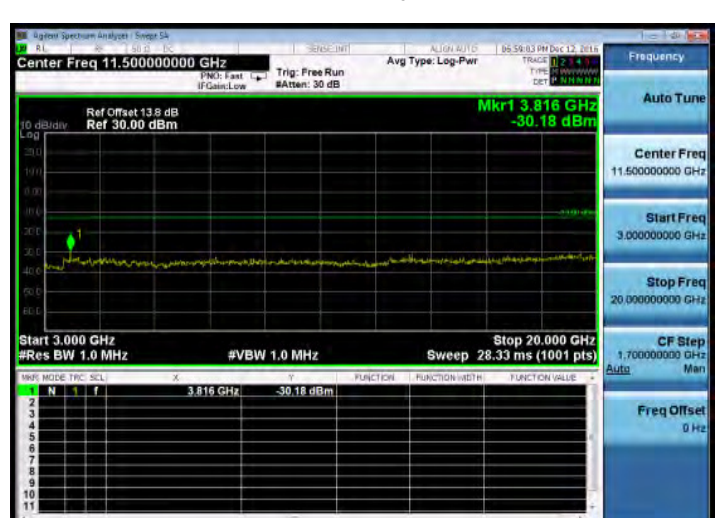

Unless otherwise stated the results shown in this test report refer only to the sample(s) tested and such sample(s) are retained for 90 days only.

除非另有說明，此報告結果僅對測試之樣品負責，同時此樣品僅保留90天。本報告未經本公司書面許可，不可部份複製。

This document is issued by the Company subject to its General Conditions of Service printed overleaf, available on request or accessible at www.sgs.com/terms_and_conditions.htm and, for electronic format documents, subject to Terms and Conditions for Electronic Documents at www.sgs.com/terms_e-document.htm. Attention is drawn to the limitation of liability, indemnification and jurisdiction issues defined therein. Any holder of this document is advised that information contained herein reflects the Company's findings at the time of its intervention only and within the limits of Client's instructions, if any. The Company's sole responsibility is to its Client and this document does not exonerate parties to a transaction from exercising all their rights and obligations under the transaction documents. This document cannot be reproduced except in full, without prior written approval of the Company. Any unauthorized alteration, forgery or falsification of the content or appearance of this document is unlawful and offenders may be prosecuted to the fullest extent of the law.

SGS Taiwan Ltd.

No. 134, WuKungRoad, New Taipei Industrial Park, WuKu District, New Taipei City, Taiwan 24803 / 新北市五股區新北產業園區五工路 134 號

台灣檢驗科技股份有限公司

t (886-2) 2299-3279

f (886-2) 2298-0488

www.tw.sgs.com

Member of SGS Group

30MHz~3GHz_HSUPA_B2_LowCH9262-1852.4

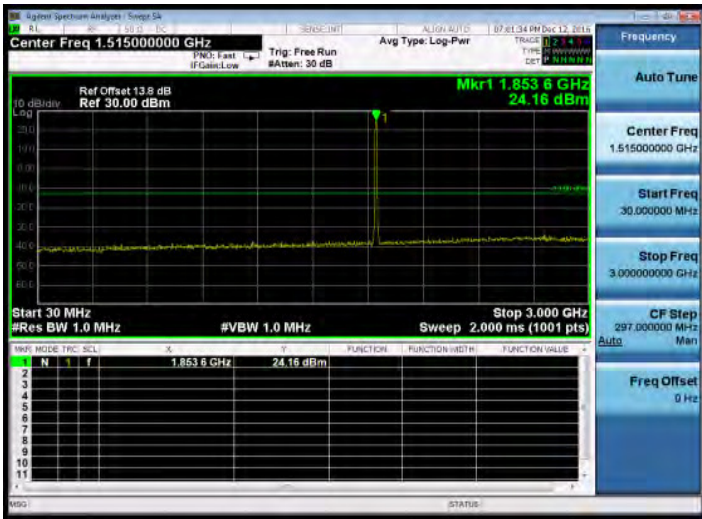

3GHz~10GHz_HSUPA_B2_MidCH9400-1880

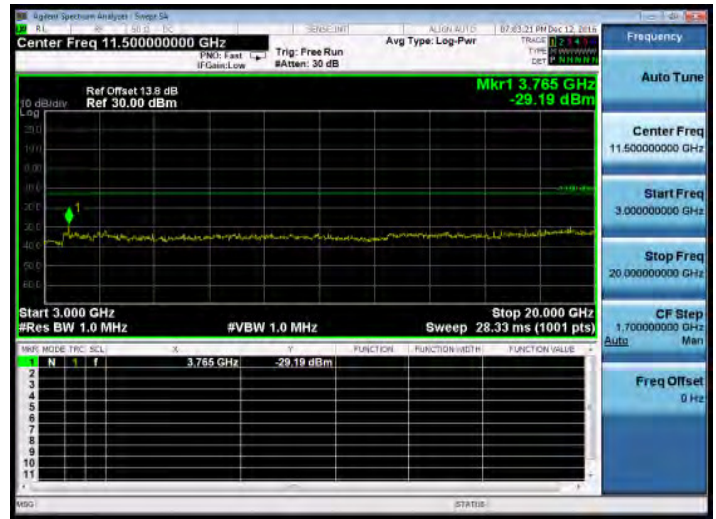

3GHz~10GHz_HSUPA_B2_LowCH9262-1852.4

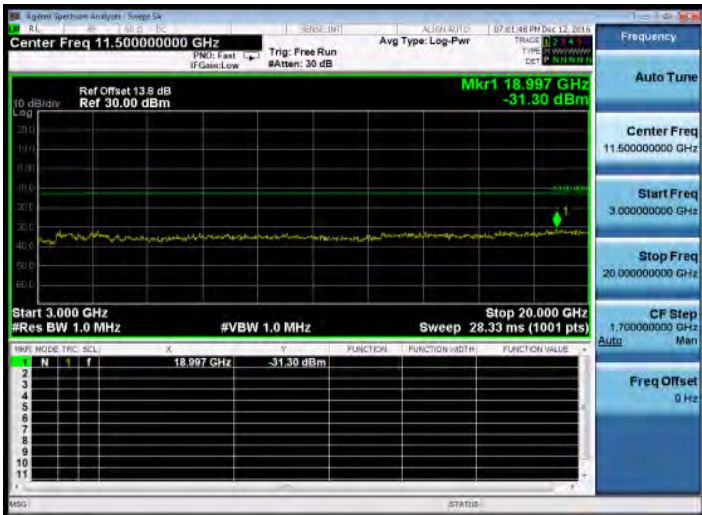

30MHz~3GHz_HSUPA_B2_HighCH9538-1907.6

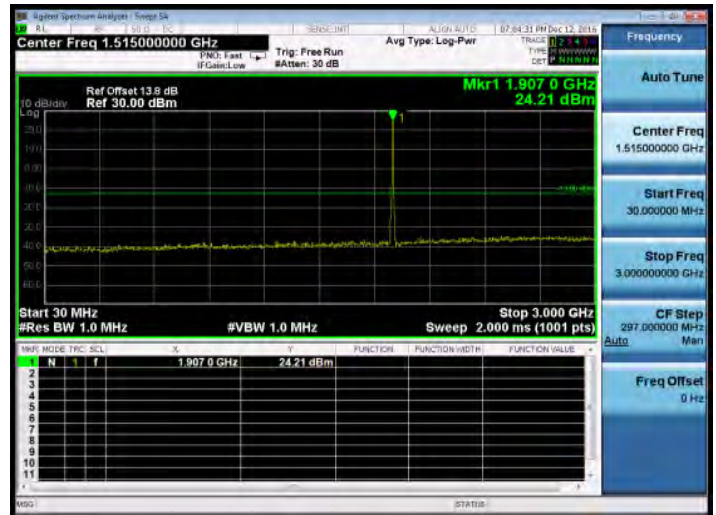

30MHz~3GHz_HSUPA_B2_MidCH9400-1880

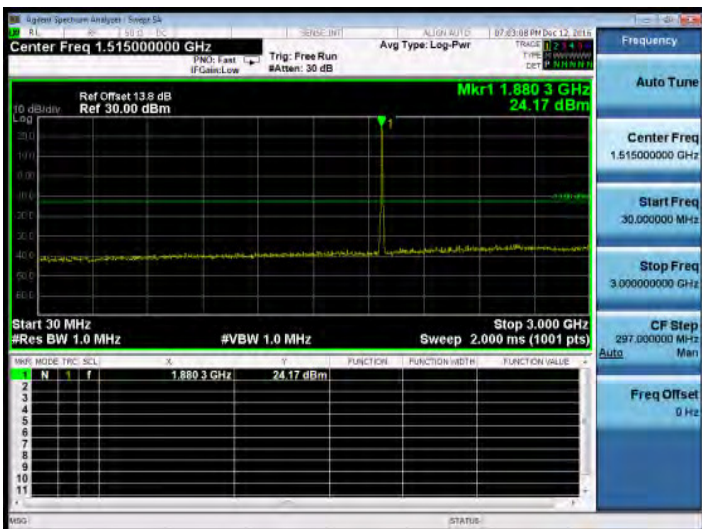

3GHz~10GHz_HSUPA_B2_HighCH9538-1907.6

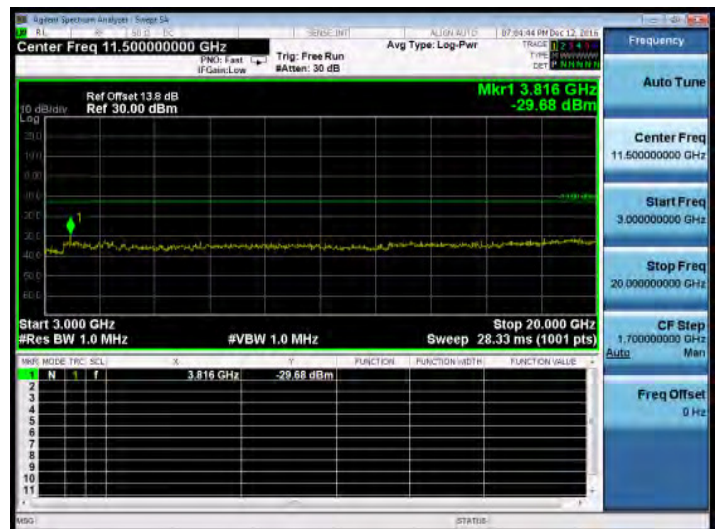

Unless otherwise stated the results shown in this test report refer only to the sample(s) tested and such sample(s) are retained for 90 days only.
除非另有說明，此報告結果僅對測試之樣品負責，同時此樣品僅保留90天。本報告未經本公司書面許可，不可部份複製。

This document is issued by the Company subject to its General Conditions of Service printed overleaf, available on request or accessible at www.sgs.com/terms_and_conditions.htm and, for electronic format documents, subject to Terms and Conditions for Electronic Documents at www.sgs.com/terms_e-document.htm. Attention is drawn to the limitation of liability, indemnification and jurisdiction issues defined therein. Any holder of this document is advised that information contained herein reflects the Company's findings at the time of its intervention only and within the limits of Client's instructions, if any. The Company's sole responsibility is to its Client and this document does not exonerate parties to a transaction from exercising all their rights and obligations under the transaction documents. This document cannot be reproduced except in full, without prior written approval of the Company. Any unauthorized alteration, forgery or falsification of the content or appearance of this document is unlawful and offenders may be prosecuted to the fullest extent of the law.

30MHz~3GHz_WCDMA_B4_LowCH1312-1712.4

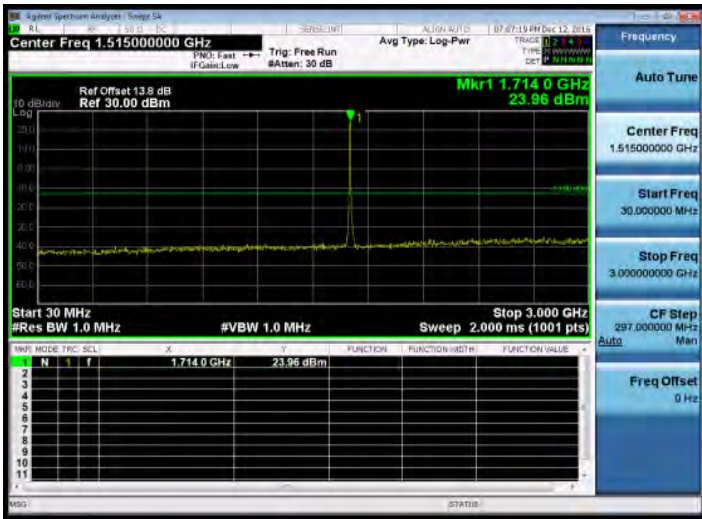

3GHz~10GHz_WCDMA_B4_MidCH1413-1732.6

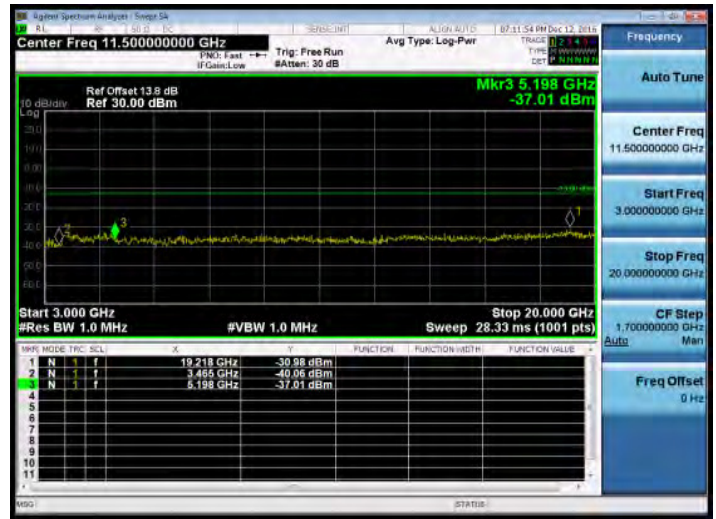

3GHz~10GHz_WCDMA_B4_LowCH1312-1712.4

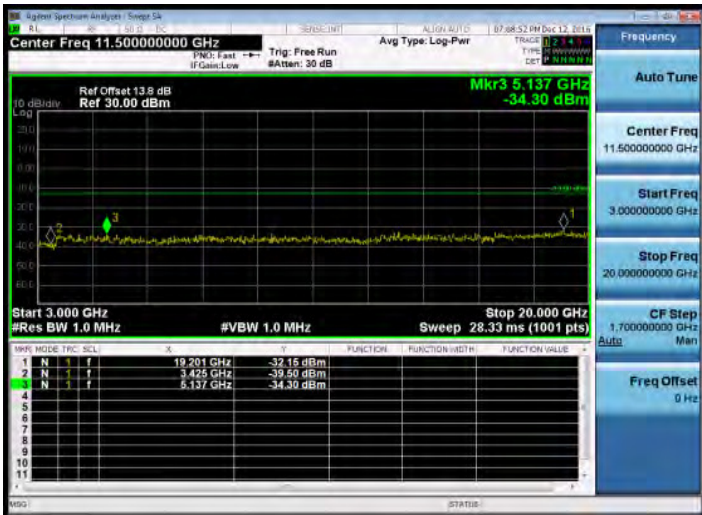

30MHz~3GHz_WCDMA_B4_HighCH1513-1752.6

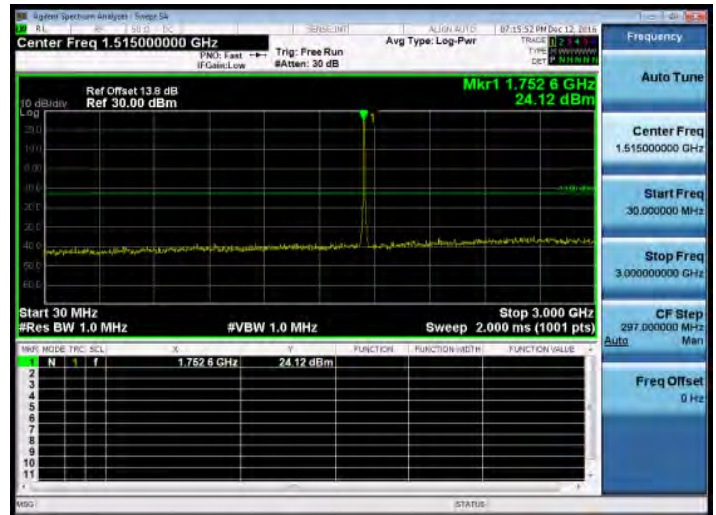

30MHz~3GHz_WCDMA_B4_MidCH1413-1732.6

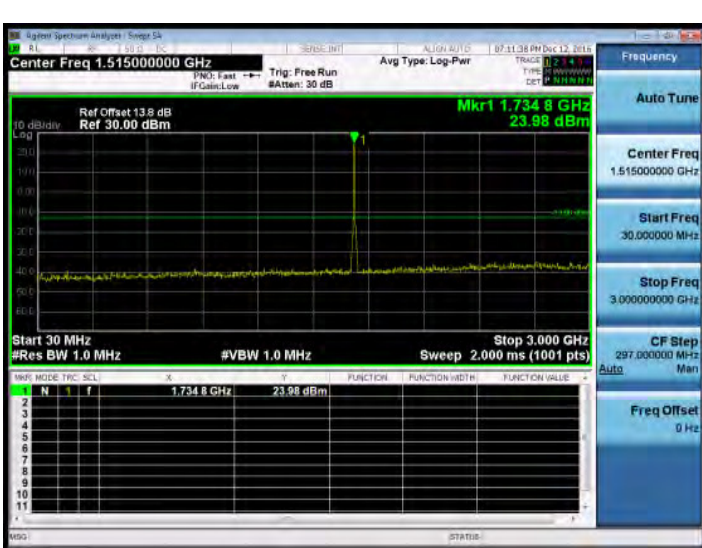

3GHz~10GHz_WCDMA_B4_HighCH1513-1752.6



Unless otherwise stated the results shown in this test report refer only to the sample(s) tested and such sample(s) are retained for 90 days only.
除非另有說明，此報告結果僅對測試之樣品負責，同時此樣品僅保留90天。本報告未經本公司書面許可，不可部份複製。

This document is issued by the Company subject to its General Conditions of Service printed overleaf, available on request or accessible at www.sgs.com/terms_and_conditions.htm and, for electronic format documents, subject to Terms and Conditions for Electronic Documents at www.sgs.com/terms_e-document.htm. Attention is drawn to the limitation of liability, indemnification and jurisdiction issues defined therein. Any holder of this document is advised that information contained hereon reflects the Company's findings at the time of its intervention only and within the limits of Client's instructions, if any. The Company's sole responsibility is to its Client and this document does not exonerate parties to a transaction from exercising all their rights and obligations under the transaction documents. This document cannot be reproduced except in full, without prior written approval of the Company. Any unauthorized alteration, forgery or falsification of the content or appearance of this document is unlawful and offenders may be prosecuted to the fullest extent of the law.

30MHz~3GHz_HSDPA_B4_LowCH1312-1712.4

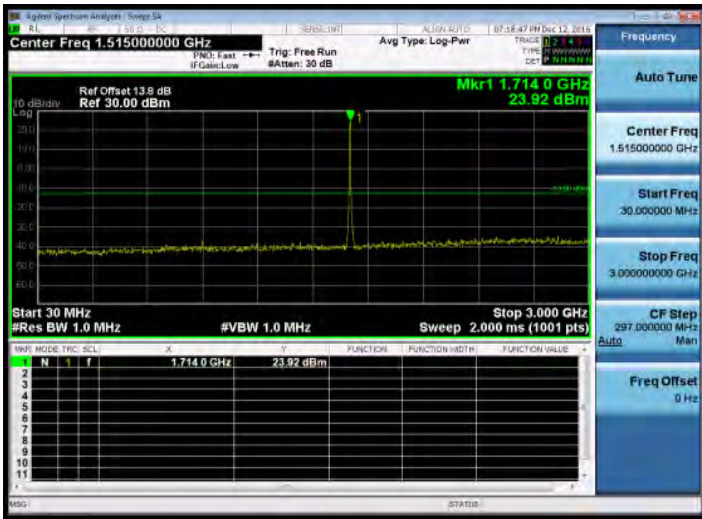

3GHz~10GHz_HSDPA_B4_MidCH1413-1732.6

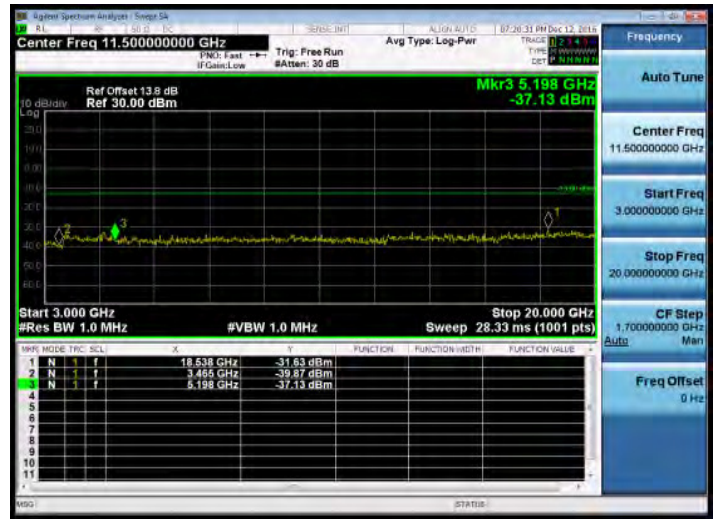

3GHz~10GHz_HSDPA_B4_LowCH1312-1712.4

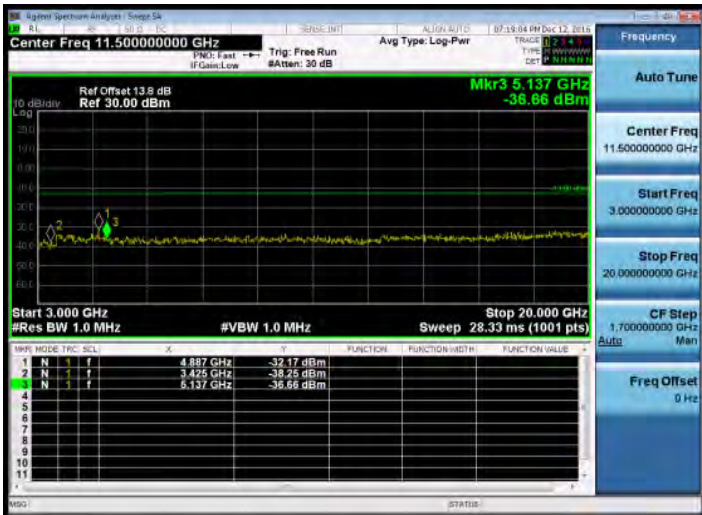

30MHz~3GHz_HSDPA_B4_HighCH1513-1752.6

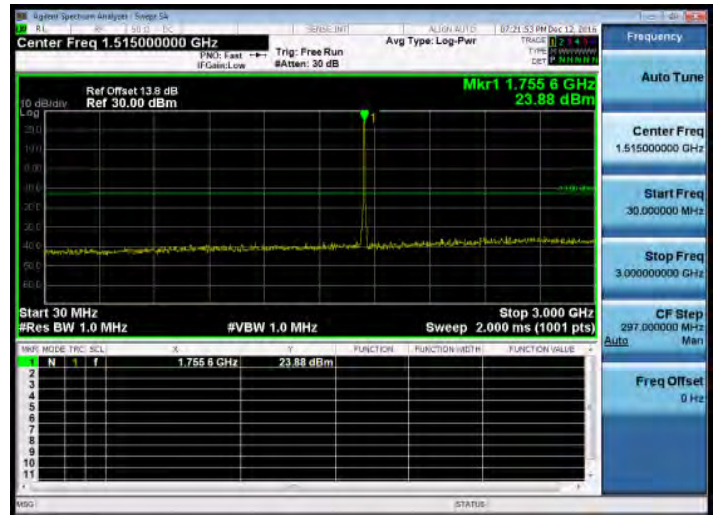

30MHz~3GHz_HSDPA_B4_MidCH1413-1732.6

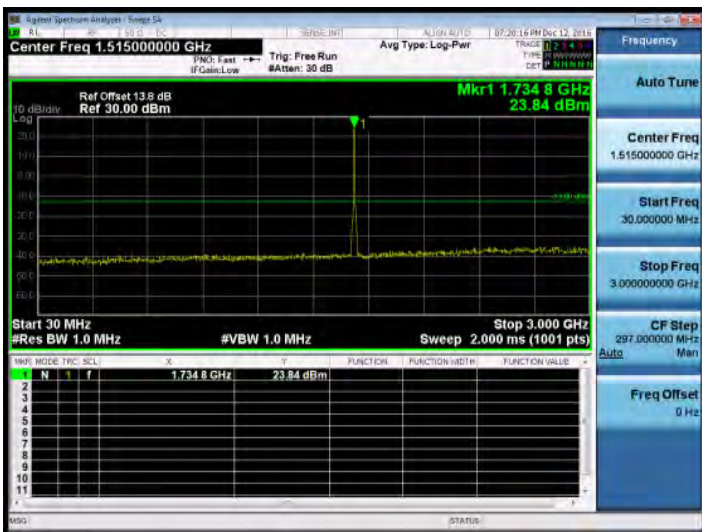

3GHz~10GHz_HSDPA_B4_HighCH1513-1752.6

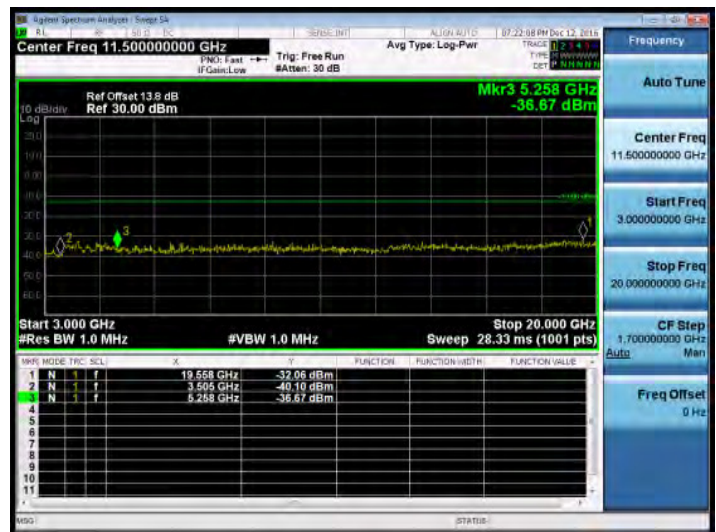

Unless otherwise stated the results shown in this test report refer only to the sample(s) tested and such sample(s) are retained for 90 days only.
除非另有說明，此報告結果僅對測試之樣品負責，同時此樣品僅保留90天。本報告未經本公司書面許可，不可部份複製。

This document is issued by the Company subject to its General Conditions of Service printed overleaf, available on request or accessible at www.sgs.com/terms_and_conditions.htm and, for electronic format documents, subject to Terms and Conditions for Electronic Documents at www.sgs.com/terms_e-document.htm. Attention is drawn to the limitation of liability, indemnification and jurisdiction issues defined therein. Any holder of this document is advised that information contained hereon reflects the Company's findings at the time of its intervention only and within the limits of Client's instructions, if any. The Company's sole responsibility is to its Client and this document does not exonerate parties to a transaction from exercising all their rights and obligations under the transaction documents. This document cannot be reproduced except in full, without prior written approval of the Company. Any unauthorized alteration, forgery or falsification of the content or appearance of this document is unlawful and offenders may be prosecuted to the fullest extent of the law.

30MHz~3GHz_HSUPA_B4_LowCH1312-1712.4

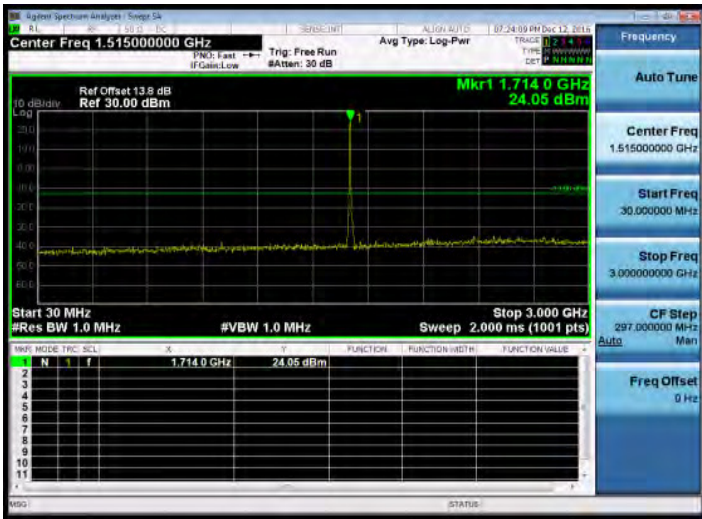

3GHz~10GHz_HSUPA_B4_MidCH1413-1732.6

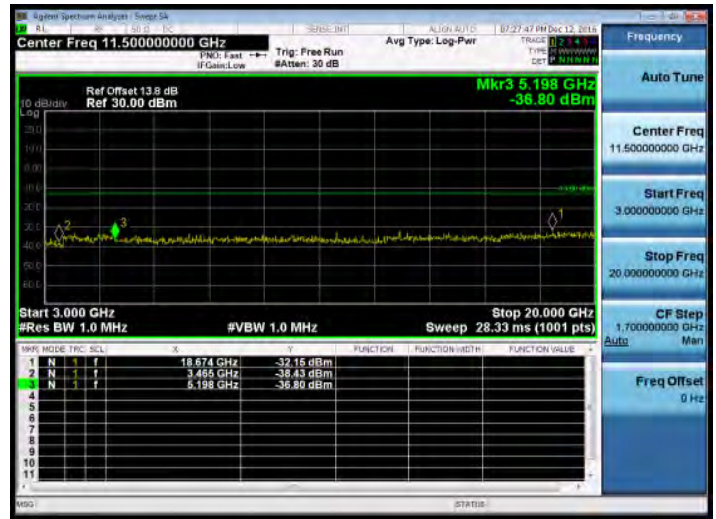

3GHz~10GHz_HSUPA_B4_LowCH1312-1712.4

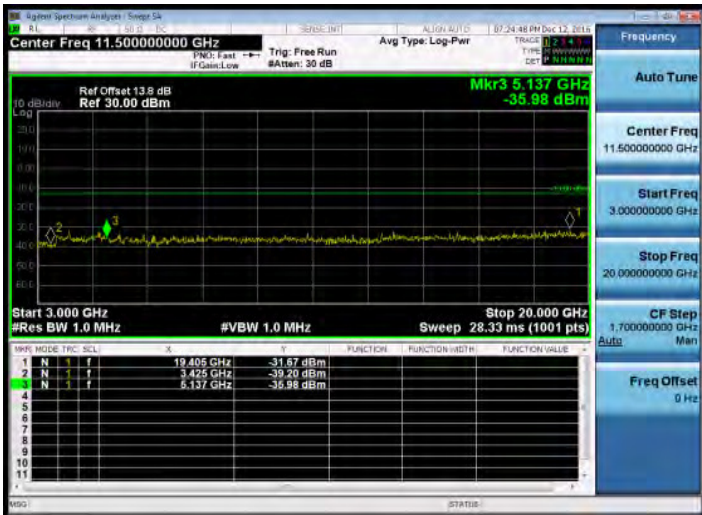

30MHz~3GHz_HSUPA_B4_HighCH1513-1752.6

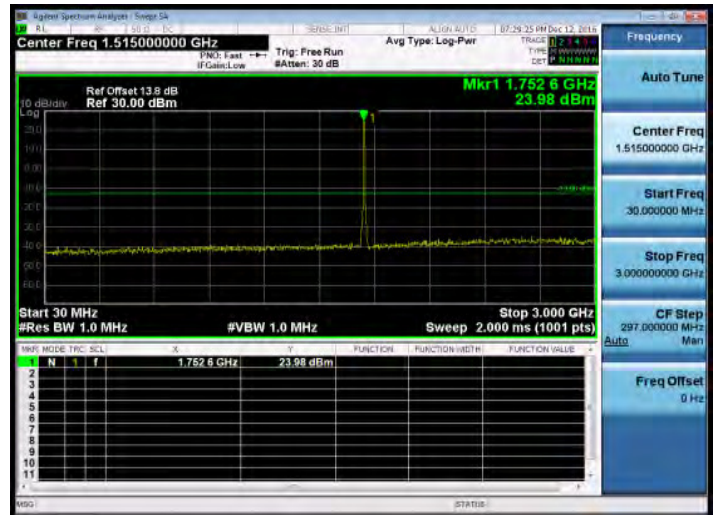

30MHz~3GHz_HSUPA_B4_MidCH1413-1732.6

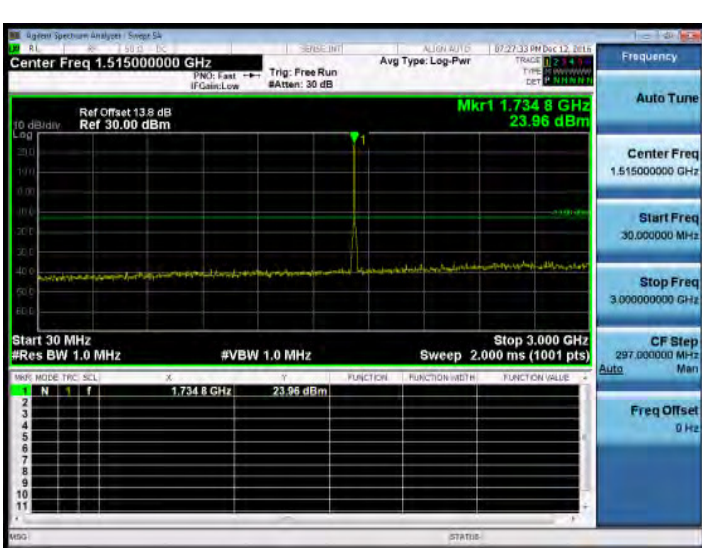

3GHz~10GHz_HSUPA_B4_HighCH1513-1752.6



Unless otherwise stated the results shown in this test report refer only to the sample(s) tested and such sample(s) are retained for 90 days only.
除非另有說明，此報告結果僅對測試之樣品負責，同時此樣品僅保留90天。本報告未經本公司書面許可，不可部份複製。

This document is issued by the Company subject to its General Conditions of Service printed overleaf, available on request or accessible at www.sgs.com/terms_and_conditions.htm and, for electronic format documents, subject to Terms and Conditions for Electronic Documents at www.sgs.com/terms_e-document.htm. Attention is drawn to the limitation of liability, indemnification and jurisdiction issues defined therein. Any holder of this document is advised that information contained hereon reflects the Company's findings at the time of its intervention only and within the limits of Client's instructions, if any. The Company's sole responsibility is to its Client and this document does not exonerate parties to a transaction from exercising all their rights and obligations under the transaction documents. This document cannot be reproduced except in full, without prior written approval of the Company. Any unauthorized alteration, forgery or falsification of the content or appearance of this document is unlawful and offenders may be prosecuted to the fullest extent of the law.

30MHz~3GHz_WCDMA_B5_LowCH4132-826.4

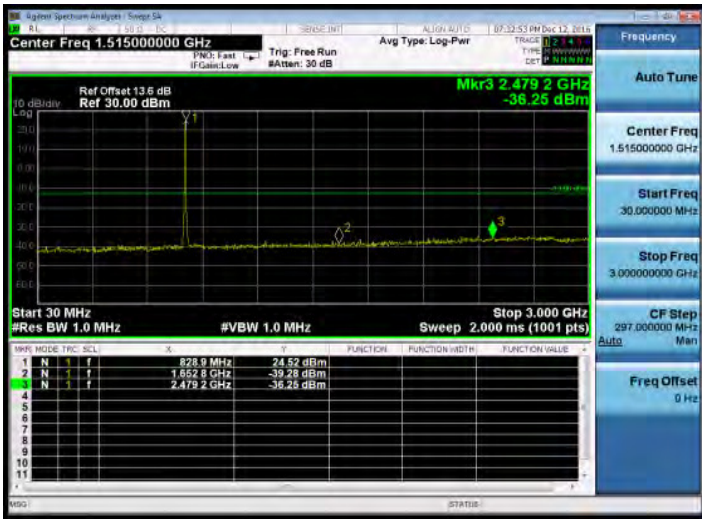

3GHz~10GHz_WCDMA_B5_MidCH4183-836.6

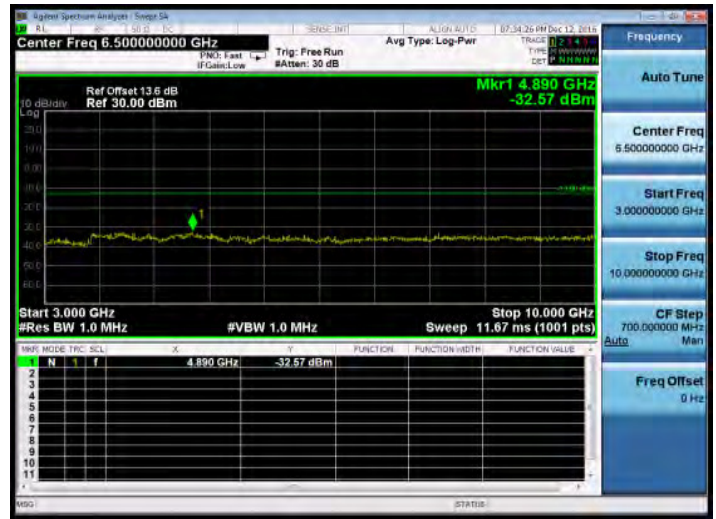

3GHz~10GHz_WCDMA_B5_LowCH4132-826.4

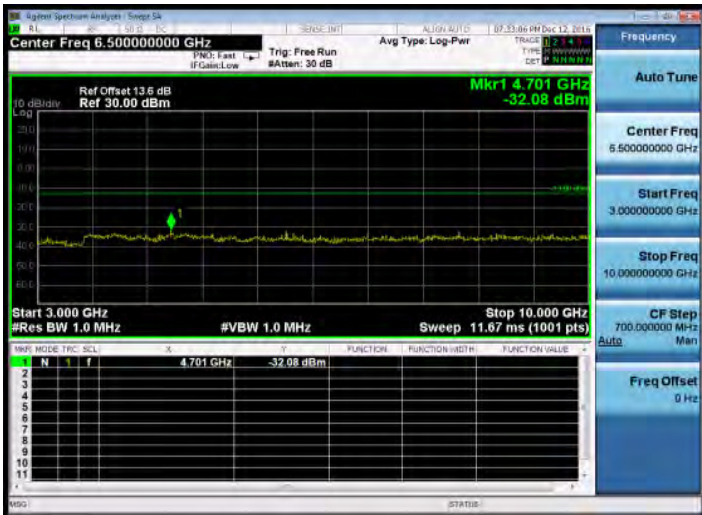

30MHz~3GHz_WCDMA_B5_HighCH4233-846.6

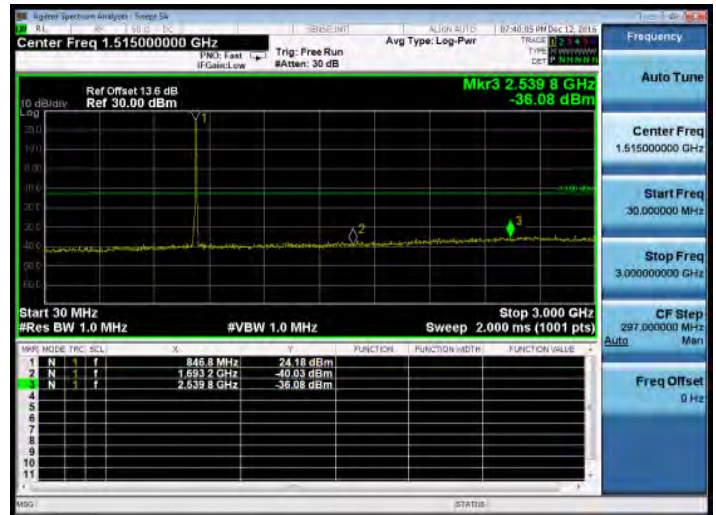

30MHz~3GHz_WCDMA_B5_MidCH4183-836.6

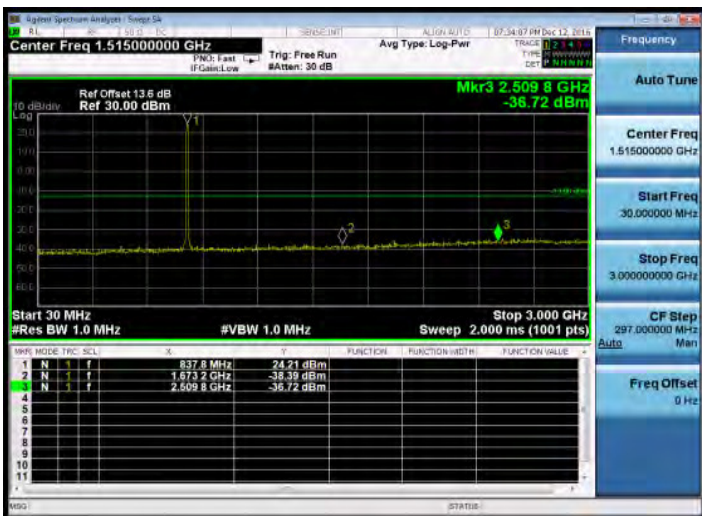

3GHz~10GHz_WCDMA_B5_HighCH4233-846.6

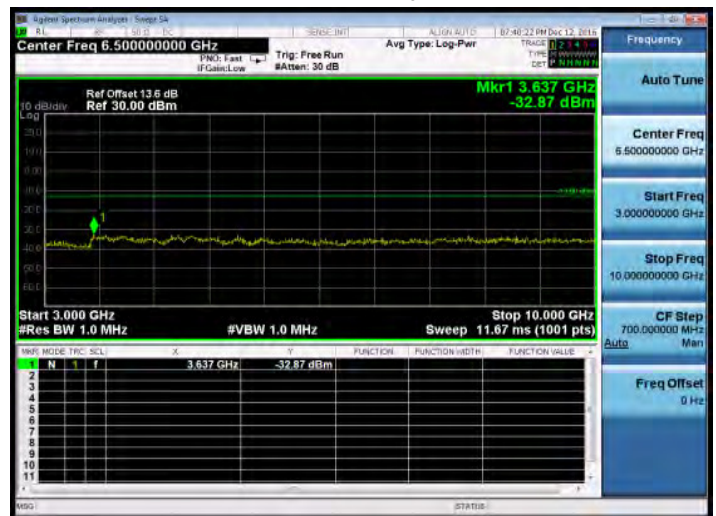

Unless otherwise stated the results shown in this test report refer only to the sample(s) tested and such sample(s) are retained for 90 days only.

除非另有說明，此報告結果僅對測試之樣品負責，同時此樣品僅保留90天。本報告未經本公司書面許可，不可部份複製。

This document is issued by the Company subject to its General Conditions of Service printed overleaf, available on request or accessible at www.sgs.com/terms_and_conditions.htm and, for electronic format documents, subject to Terms and Conditions for Electronic Documents at www.sgs.com/terms_e-document.htm. Attention is drawn to the limitation of liability, indemnification and jurisdiction issues defined therein. Any holder of this document is advised that information contained hereon reflects the Company's findings at the time of its intervention only and within the limits of Client's instructions, if any. The Company's sole responsibility is to its Client and this document does not exonerate parties to a transaction from exercising all their rights and obligations under the transaction documents. This document cannot be reproduced except in full, without prior written approval of the Company. Any unauthorized alteration, forgery or falsification of the content or appearance of this document is unlawful and offenders may be prosecuted to the fullest extent of the law.

30MHz~3GHz_HSDPA_B5_LowCH4132-826.4

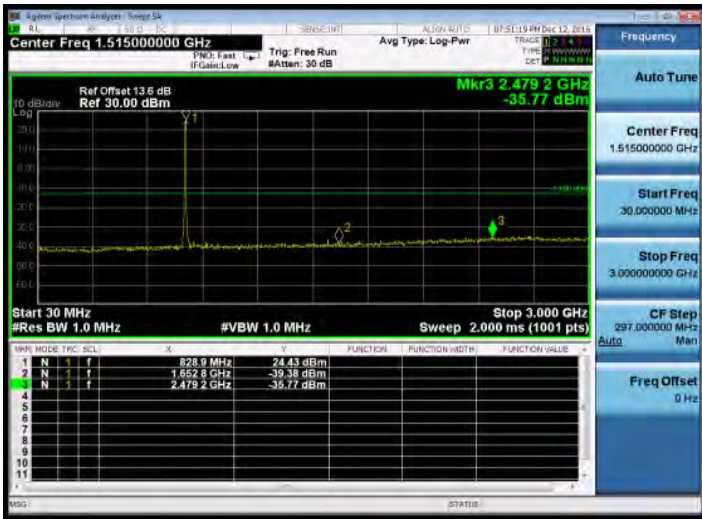

3GHz~10GHz_HSDPA_B5_MidCH4183-836.6

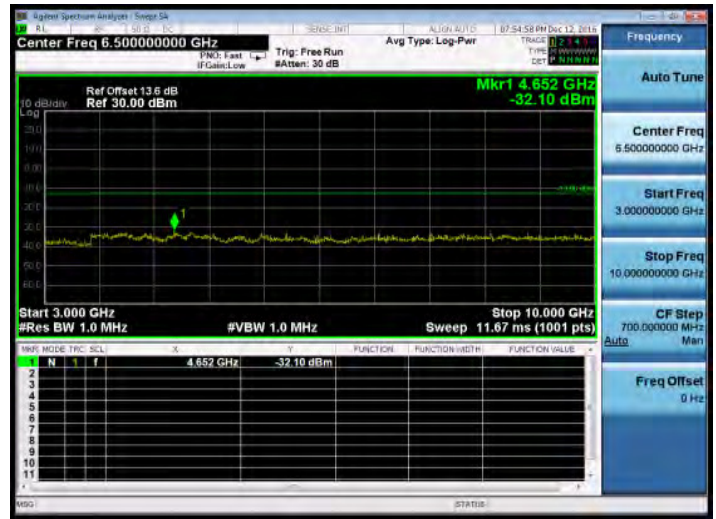

3GHz~10GHz_HSDPA_B5_LowCH4132-826.4

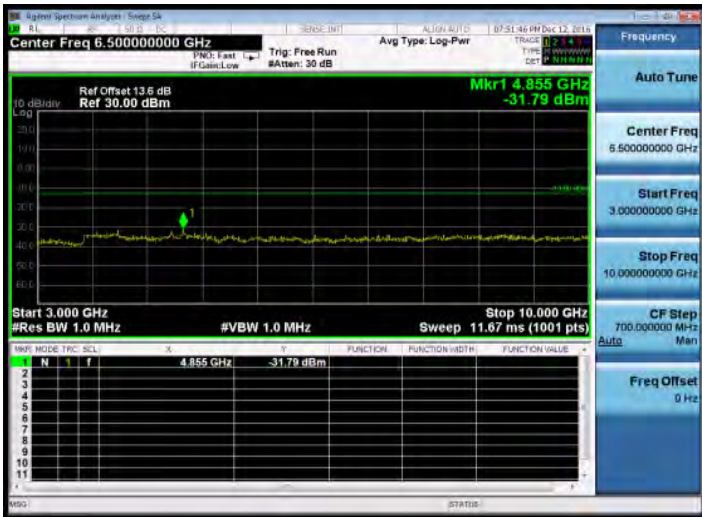

30MHz~3GHz_HSDPA_B5_HighCH4233-846.6

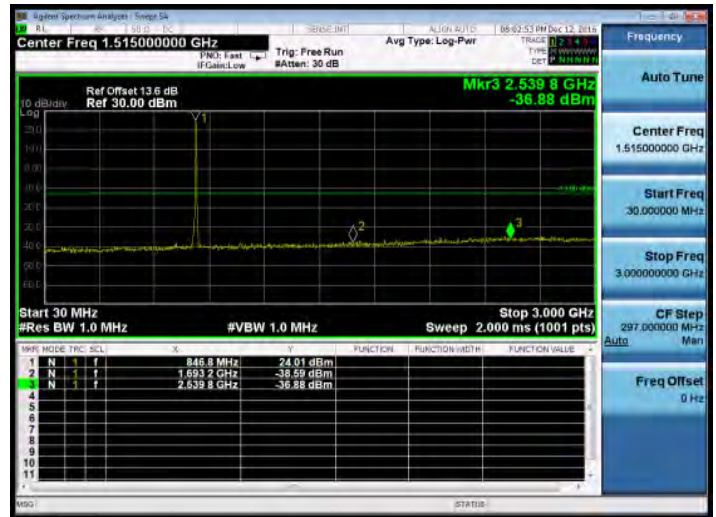

30MHz~3GHz_HSDPA_B5_MidCH4183-836.6

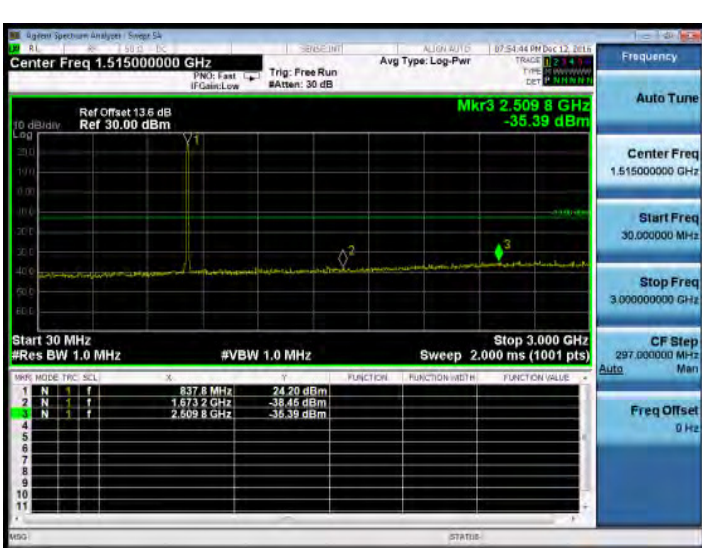

3GHz~10GHz_HSDPA_B5_HighCH4233-846.6

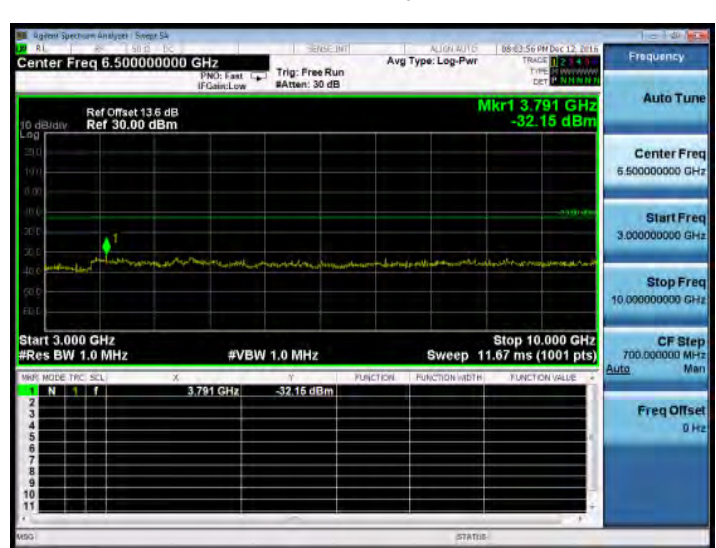

Unless otherwise stated the results shown in this test report refer only to the sample(s) tested and such sample(s) are retained for 90 days only.
除非另有說明，此報告結果僅對測試之樣品負責，同時此樣品僅保留90天。本報告未經本公司書面許可，不可部份複製。

This document is issued by the Company subject to its General Conditions of Service printed overleaf, available on request or accessible at www.sgs.com/terms_and_conditions.htm and, for electronic format documents, subject to Terms and Conditions for Electronic Documents at www.sgs.com/terms_e-document.htm. Attention is drawn to the limitation of liability, indemnification and jurisdiction issues defined therein. Any holder of this document is advised that information contained herein reflects the Company's findings at the time of its intervention only and within the limits of Client's instructions, if any. The Company's sole responsibility is to its Client and this document does not exonerate parties to a transaction from exercising all their rights and obligations under the transaction documents. This document cannot be reproduced except in full, without prior written approval of the Company. Any unauthorized alteration, forgery or falsification of the content or appearance of this document is unlawful and offenders may be prosecuted to the fullest extent of the law.

30MHz~3GHz_HSUPA_B5_LowCH4132-826.4

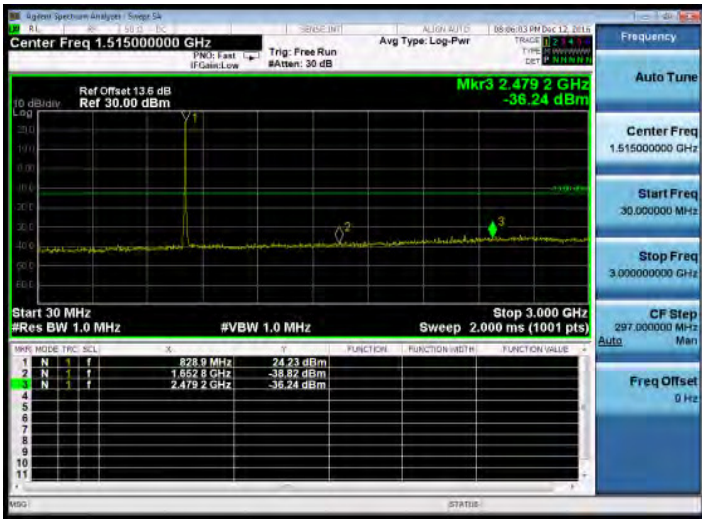

3GHz~10GHz_HSUPA_B5_MidCH4183-836.6

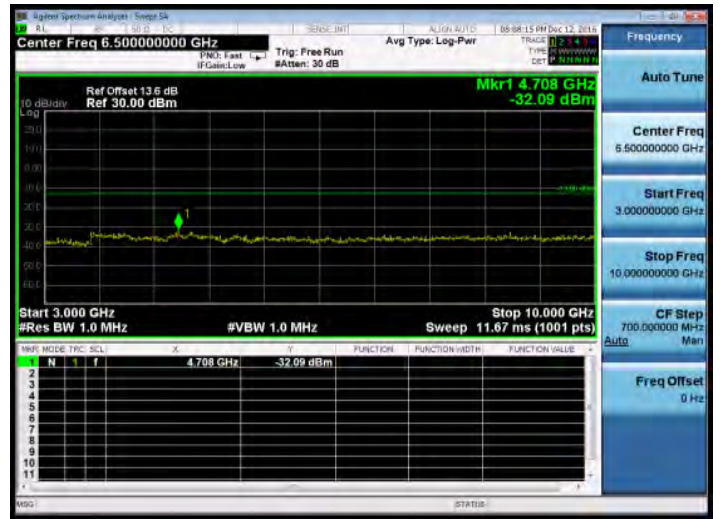

3GHz~10GHz_HSUPA_B5_LowCH4132-826.4

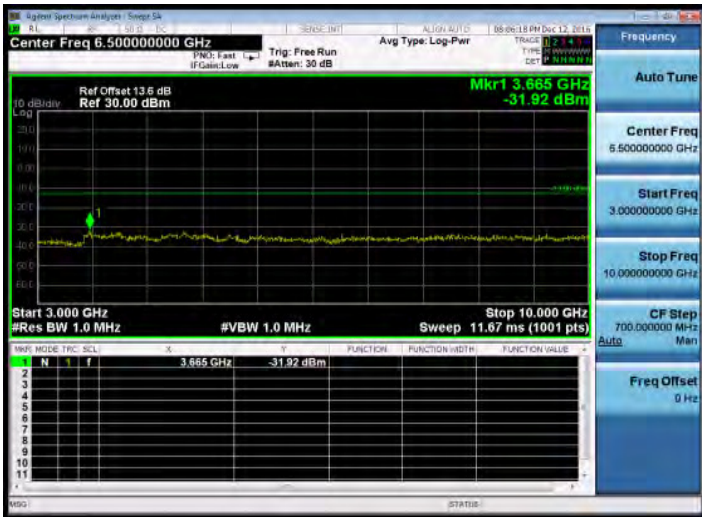

30MHz~3GHz_HSUPA_B5_HighCH4233-846.6

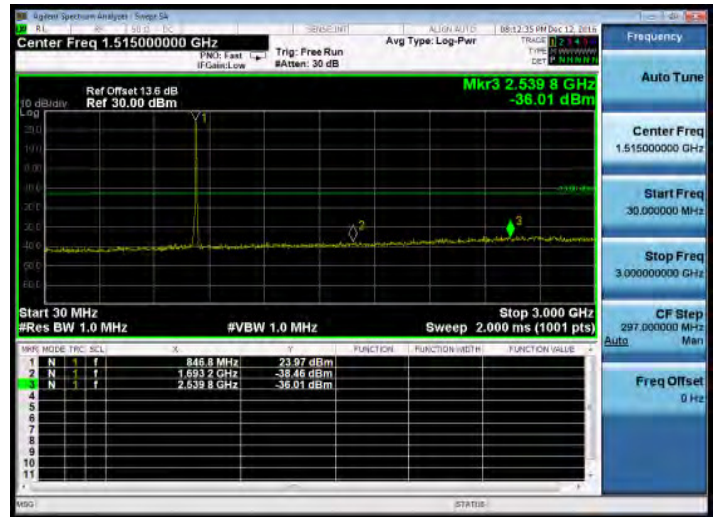

30MHz~3GHz_HSUPA_B5_MidCH4183-836.6

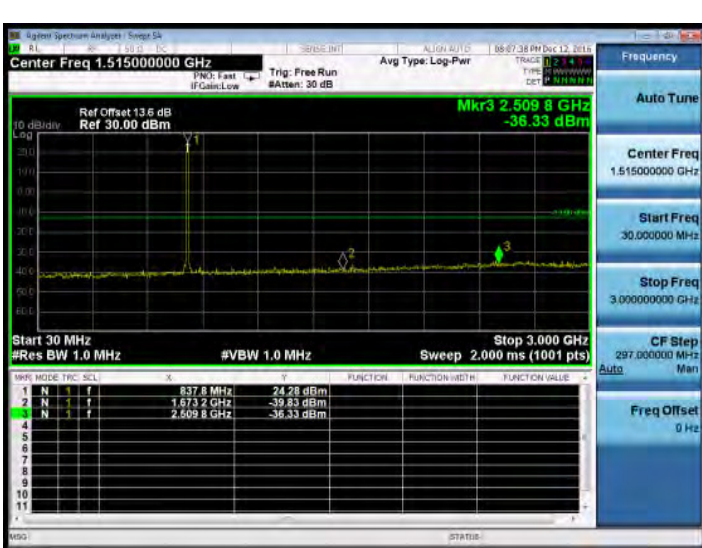

3GHz~10GHz_HSUPA_B5_HighCH4233-846.6

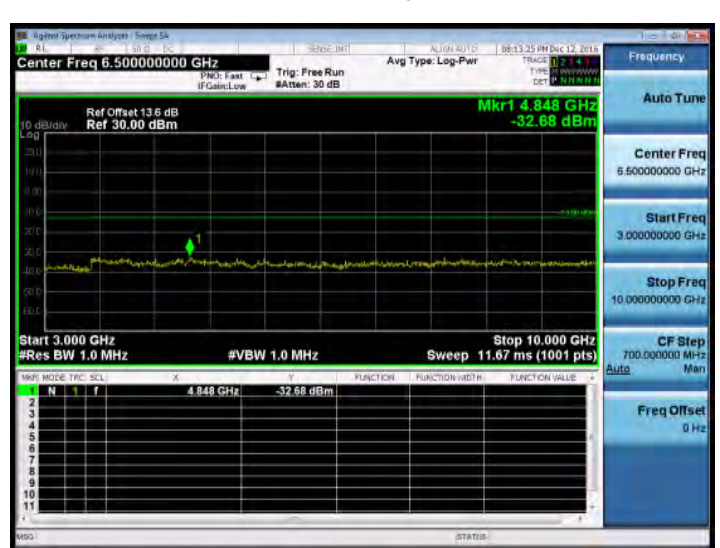

Unless otherwise stated the results shown in this test report refer only to the sample(s) tested and such sample(s) are retained for 90 days only.

除非另有說明，此報告結果僅對測試之樣品負責，同時此樣品僅保留90天。本報告未經本公司書面許可，不可部份複製。

This document is issued by the Company subject to its General Conditions of Service printed overleaf, available on request or accessible at www.sgs.com/terms_and_conditions.htm and, for electronic format documents, subject to Terms and Conditions for Electronic Documents at www.sgs.com/terms_e-document.htm. Attention is drawn to the limitation of liability, indemnification and jurisdiction issues defined therein. Any holder of this document is advised that information contained herein reflects the Company's findings at the time of its intervention only and within the limits of Client's instructions, if any. The Company's sole responsibility is to its Client and this document does not exonerate parties to a transaction from exercising all their rights and obligations under the transaction documents. This document cannot be reproduced except in full, without prior written approval of the Company. Any unauthorized alteration, forgery or falsification of the content or appearance of this document is unlawful and offenders may be prosecuted to the fullest extent of the law.

SGS Taiwan Ltd.

No. 134, WuKungRoad, New Taipei Industrial Park, WuKu District, New Taipei City, Taiwan 24803/新北市五股區新北產業園區五工路 134 號

台灣檢驗科技股份有限公司

t (886-2) 2299-3279

f (886-2) 2298-0488

www.tw.sgs.com

Member of SGS Group

30MHz-3GHz_Band2_1.4MHz_QPSK_1_0_LowCH18607-1850.7

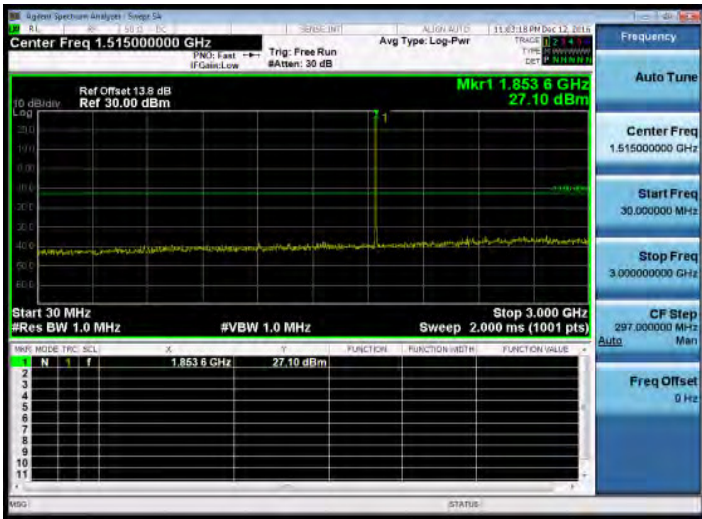

3GHz-10GHz_Band2_1_4MHz_QPSK_1_0_MidCH18900-1880

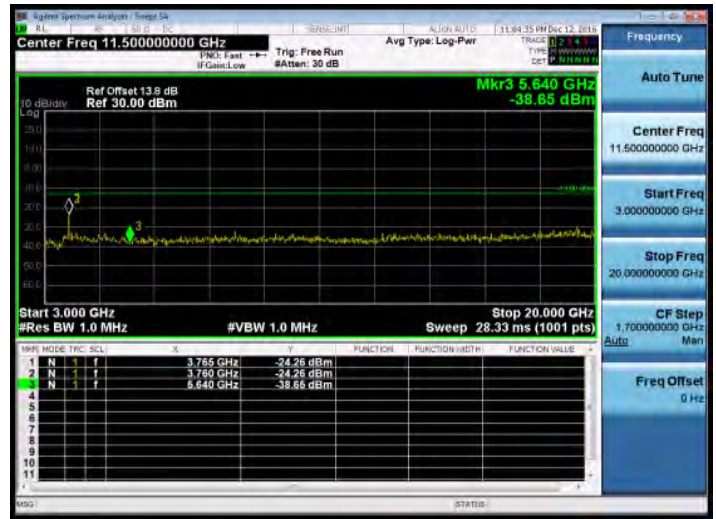

3GHz-10GHz_Band2_1_4MHz_QPSK_1_0_LowCH18607-1850.7

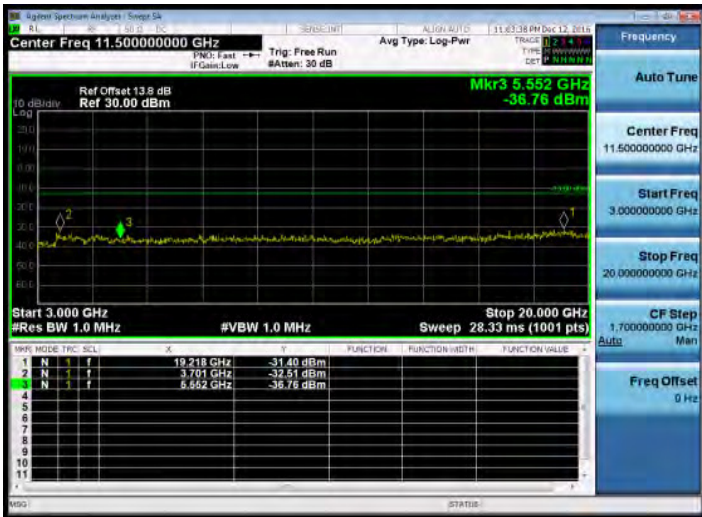

30MHz-3GHz_Band2_1.4MHz_QPSK_1_0_HighCH19193-1909.3

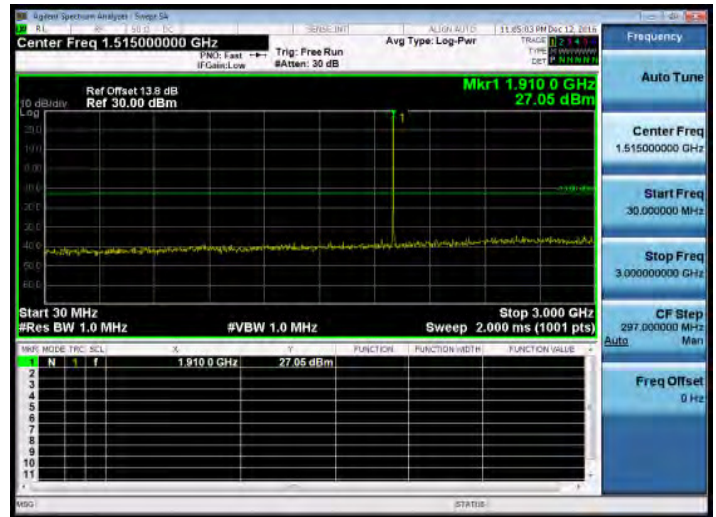

30MHz-3GHz_Band2_1.4MHz_QPSK_1_0_MidCH18900-1880

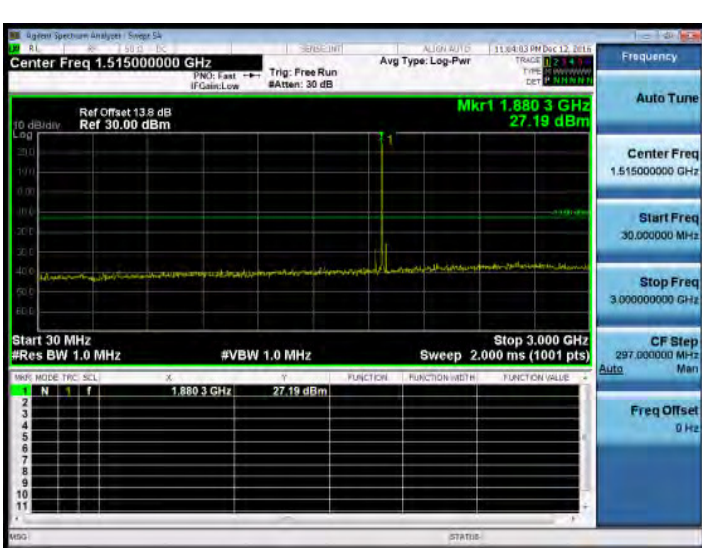

3GHz-10GHz_Band2_1_4MHz_QPSK_1_0_HighCH19193-1909.3

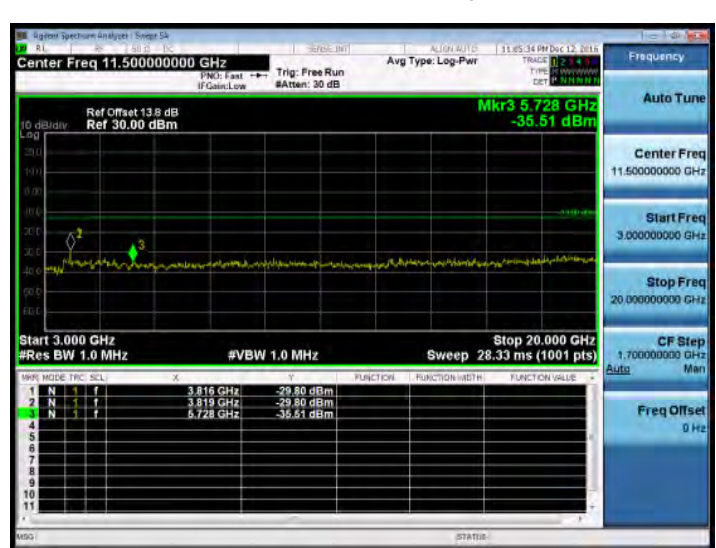

Unless otherwise stated the results shown in this test report refer only to the sample(s) tested and such sample(s) are retained for 90 days only.

除非另有說明，此報告結果僅對測試之樣品負責，同時此樣品僅保留90天。本報告未經本公司書面許可，不可部份複製。

This document is issued by the Company subject to its General Conditions of Service printed overleaf, available on request or accessible at www.sgs.com/terms_and_conditions.htm and, for electronic format documents, subject to Terms and Conditions for Electronic Documents at www.sgs.com/terms_e-document.htm. Attention is drawn to the limitation of liability, indemnification and jurisdiction issues defined therein. Any holder of this document is advised that information contained herein reflects the Company's findings at the time of its intervention only and within the limits of Client's instructions, if any. The Company's sole responsibility is to its Client and this document does not exonerate parties to a transaction from exercising all their rights and obligations under the transaction documents. This document cannot be reproduced except in full, without prior written approval of the Company. Any unauthorized alteration, forgery or falsification of the content or appearance of this document is unlawful and offenders may be prosecuted to the fullest extent of the law.

SGS Taiwan Ltd.

No. 134, WuKungRoad, New Taipei Industrial Park, WuKu District, New Taipei City, Taiwan 24803 / 新北市五股區新北產業園區五工路 134 號

台灣檢驗科技股份有限公司

t (886-2) 2299-3279

f (886-2) 2298-0488

www.tw.sgs.com

Member of SGS Group