

## FCC Test Report

**Report No.:** RF160829C09-3

**FCC ID:** NM82PYB200

**Test Model:** 2PYB200

**Received Date:** Aug. 29, 2016

**Test Date:** Sep. 05, 2016 ~ Sep. 13, 2016

**Issued Date:** Sep. 30, 2016

**Applicant:** HTC Corporation

**Address:** 23 Xinghua Road ,Taoyuan District, Taoyuan City 330, Taiwan

**Issued By:** Bureau Veritas Consumer Products Services (H.K.) Ltd., Taoyuan Branch

**Lab Address:** No. 47-2, 14th Ling, Chia Pau Vil., Lin Kou Dist., New Taipei City, Taiwan  
( R.O.C )

**Test Location (1):** No. 19, Hwa Ya 2nd Rd, Wen Hwa Tsuen, Kwei Shan Hsiang, Taoyuan  
Hsien 333, Taiwan, R.O.C.

**Test Location (2):** No.215, Sec. 3, Beixin Rd., Xindian Dist., New Taipei City 231, Taiwan,  
R.O.C



This report is for your exclusive use. Any copying or replication of this report to or for any other person or entity, or use of our name or trademark, is permitted only with our prior written permission. This report sets forth our findings solely with respect to the test samples identified herein. The results set forth in this report are not indicative or representative of the quality or characteristics of the lot from which a test sample was taken or any similar or identical product unless specifically and expressly noted. Our report includes all of the tests requested by you and the results thereof based upon the information that you provided to us. You have 60 days from date of issuance of this report to notify us of any material error or omission caused by our negligence, provided, however, that such notice shall be in writing and shall specifically address the issue you wish to raise. A failure to raise such issue within the prescribed time shall constitute your unqualified acceptance of the completeness of this report, the tests conducted and the correctness of the report contents. Unless specific mention, the uncertainty of measurement has been explicitly taken into account to declare the compliance or non-compliance to the specification. The report must not be used by the client to claim product certification, approval, or endorsement by TAF or any government agencies.

## Table of Contents

<b>Release Control Record .....</b>	<b>4</b>
<b>1 Certificate of Conformity .....</b>	<b>5</b>
<b>2 Summary of Test Results.....</b>	<b>6</b>
2.1 Measurement Uncertainty.....	6
2.2 Modification Record .....	6
<b>3 General Information .....</b>	<b>7</b>
3.1 General Description of EUT .....	7
3.2 Description of Test Modes.....	9
3.2.1 Test Mode Applicability and Tested Channel Detail.....	11
3.3 Duty Cycle of Test Signal .....	13
3.4 Description of Support Units .....	14
3.4.1 Configuration of System under Test .....	14
3.5 General Description of Applied Standards.....	14
<b>4 Test Types and Results .....</b>	<b>15</b>
4.1 Radiated Emission and Bandedge Measurement .....	15
4.1.1 Limits of Radiated Emission and Bandedge Measurement .....	15
4.1.2 Limits of Unwanted Emission Out of the Restricted Bands .....	16
4.1.3 Test Instruments .....	17
4.1.4 Test Procedures.....	18
4.1.5 Deviation from Test Standard .....	18
4.1.6 Test Set Up .....	19
4.1.7 EUT Operating Conditions.....	19
4.1.8 Test Results .....	20
4.2 Conducted Emission Measurement.....	80
4.2.1 Limits of Conducted Emission Measurement .....	80
4.2.2 Test Instruments .....	80
4.2.3 Test Procedures.....	81
4.2.4 Deviation from Test Standard .....	81
4.2.5 Test Setup.....	81
4.2.6 EUT Operating Conditions.....	81
4.2.7 Test Results .....	82
4.3 Transmit Power Measurement.....	86
4.3.1 Limits of Transmit Power Measurement .....	86
4.3.2 Test Setup.....	86
4.3.3 Test Instruments .....	87
4.3.4 Test Procedure .....	87
4.3.5 Deviation from Test Standard .....	87
4.3.6 EUT Operating Conditions.....	87
4.3.7 Test Result .....	88
4.4 Peak Power Spectral Density Measurement .....	93
4.4.1 Limits of Peak Power Spectral Density Measurement .....	93
4.4.2 Test Setup.....	93
4.4.3 Test Instruments .....	93
4.4.4 Test Procedures.....	93
4.4.5 Deviation from Test Standard .....	94
4.4.6 EUT Operating Conditions.....	94
4.4.7 Test Results .....	95
4.5 Frequency Stability .....	100
4.5.1 Limit of Frequency Stability Measurement .....	100
4.5.2 Test Setup.....	100
4.5.3 Test Instruments .....	100
4.5.4 Test Procedure .....	100
4.5.5 Deviation from Test Standard .....	100

4.5.6 EUT Operating Condition .....	100
4.5.7 Test Results .....	101
4.6 6 dB Bandwidth Measurement.....	102
4.6.1 Limits of 6 dB Bandwidth Measurement.....	102
4.6.2 Test Setup.....	102
4.6.3 Test Instruments .....	102
4.6.4 Test Procedure .....	102
4.6.5 Deviation from Test Standard .....	102
4.6.6 EUT Operating Condition .....	102
4.6.7 Test Results .....	103
<b>5 Pictures of Test Arrangements.....</b>	<b>105</b>
<b>Annex A- Radiated Out of Band Emisison (OOBE) Measurement (For U-NII-3 band) .....</b>	<b>106</b>
<b>Appendix – Information on the Testing Laboratories .....</b>	<b>110</b>

### Release Control Record

Issue No.	Description	Date Issued
RF160829C09-3	Original Release	Sep. 30, 2016

## 1 Certificate of Conformity

**Product:** Smartphone

**Brand:** HTC

**Test Model:** 2PYB200

**Sample Status:** Production Unit

**Applicant:** HTC Corporation

**Test Date:** Sep. 05, 2016 ~ Sep. 13, 2016

**Standards:** 47 CFR FCC Part 15, Subpart E (Section 15.407)  
ANSI C63.10:2013

The above equipment has been tested by **Bureau Veritas Consumer Products Services (H.K.) Ltd., Taoyuan Branch**, and found compliance with the requirement of the above standards. The test record, data evaluation & Equipment Under Test (EUT) configurations represented herein are true and accurate accounts of the measurements of the sample's EMC characteristics under the conditions specified in this report.

**Prepared by :**  , **Date:** Sep. 30, 2016  
Ivonne Wu / Supervisor

**Approved by :**  , **Date:** Sep. 30, 2016  
Stanley Wu / Assistant Manager

## 2 Summary of Test Results

47 CFR FCC Part 15, Subpart E (Section 15.407)			
FCC Clause	Test Item	Result	Remarks
15.407(b)(6)	AC Power Conducted Emissions	Pass	Meet the requirement of limit. Minimum passing margin is -17.70 dB at 0.60747 MHz.
15.407(b) (1/2/3/4(i/ii)/6)	Radiated Emissions & Band Edge Measurement	Pass	Meet the requirement of limit. Minimum passing margin is -1.19 dB at 5352.31 MHz.
15.407(a)(1/2/3)	Max Average Transmit Power	Pass	Meet the requirement of limit.
15.407(a)(1/2/3)	Peak Power Spectral Density	Pass	Meet the requirement of limit.
15.407(e)	6 dB Bandwidth	Pass	Meet the requirement of limit. (U-NII-3 Band only)
15.407(g)	Frequency Stability	Pass	Meet the requirement of limit.
15.203	Antenna Requirement	Pass	No antenna connector is used.

\*For U-NII-3 band compliance with rule part 15.407(b)(4)(i), the OOB test plots were recorded in Annex A.

### 2.1 Measurement Uncertainty

Where relevant, the following measurement uncertainty levels have been estimated for tests performed on the EUT as specified in CISPR 16-4-2:

Measurement	Frequency	Expanded Uncertainty (k=2) (±)
Conducted Emissions at mains ports	150 kHz ~ 30 MHz	2.44 dB
Radiated Emissions up to 1 GHz	30 MHz ~ 200 MHz	2.0153 dB
	200 MHz ~ 1000 MHz	2.0224 dB
Radiated Emissions above 1 GHz	1 GHz ~ 18 GHz	1.0121 dB
	18 GHz ~ 40 GHz	1.1508 dB

### 2.2 Modification Record

There were no modifications required for compliance.

### 3 General Information

#### 3.1 General Description of EUT

<b>Product</b>	Smartphone
<b>Brand</b>	HTC
<b>Test Model</b>	2PYB200
<b>Status of EUT</b>	Production Unit
<b>Power Supply Rating</b>	5.0 Vdc or 9 Vdc or 12 Vdc (Adapter) 5.0 Vdc (Host equipment) 3.85 Vdc (Li-ion battery)
<b>Modulation Type</b>	256QAM, 64QAM, 16QAM, QPSK, BPSK
<b>Modulation Technology</b>	OFDM
<b>Transfer Rate</b>	802.11a: 54.0/ 48.0/ 36.0/ 24.0/ 18.0/ 12.0/ 9.0/ 6.0 Mbps 802.11n: up to MCS7 802.11ac: up to V9
<b>Operating Frequency</b>	5180 ~ 5240 MHz, 5260 ~ 5320 MHz, 5500 ~ 5700 MHz, 5745 ~ 5825 MHz
<b>Number of Channel</b>	5180 ~ 5240 MHz: 4 for 802.11a, 802.11n (HT20) 2 for 802.11n (HT40) 1 for 802.11ac (VHT80) 5260 ~ 5320 MHz: 4 for 802.11a, 802.11n (HT20) 2 for 802.11n (HT40) 1 for 802.11ac (VHT80) 5500 ~ 5700 MHz: 11 for 802.11a, 802.11n (HT20) 5 for 802.11n (HT40) 2 for 802.11ac (VHT80) 5745 ~ 5825 MHz: 5 for 802.11a, 802.11n (HT20) 2 for 802.11n (HT40) 1 for 802.11ac (VHT80)
<b>Output Power</b>	40.36 mW for 5180 ~ 5240 MHz 43.15 mW for 5260 ~ 5320 MHz 43.25 mW for 5500 ~ 5700 MHz 43.55 mW for 5745 ~ 5825 MHz
<b>Antenna Type</b>	PCB antenna with -1.2 dBi gain (5180 ~ 5240 MHz) PCB antenna with -2.3 dBi gain (5260 ~ 5320 MHz) PCB antenna with -1 dBi gain (5500 ~ 5700 MHz) PCB antenna with -1.1 dBi gain (5745 ~ 5825 MHz)
<b>Antenna Connector</b>	N/A
<b>Accessory Device</b>	Refer to Note as below
<b>Data Cable Supplied</b>	Refer to Note as below

**Note:**

1. There're 2 configurations for the EUT listed as below.

Main Sample: EUT + Battery 1 + LCM 1

2<sup>nd</sup> Sample: EUT + Battery 2 + LCM 2

✧ Only the worst test data was presented in the report.

2. The EUT provides one completed transmitter and receiver.

<b>Modulation Mode</b>	<b>Tx Function</b>
802.11a	1TX
802.11n (HT20)	1TX
802.11n (HT40)	1TX
802.11ac (VHT80)	1TX

3. The EUT's accessories list refers to Ext. Pho.

4. The above EUT information is declared by manufacturer and for more detailed features description, please refer to the manufacturer's specifications or user's manual.



### 3.2 Description of Test Modes

#### FOR 5180 ~ 5240 MHz

4 channels are provided for 802.11a, 802.11n (HT20):

Channel	Frequency (MHz)	Channel	Frequency (MHz)
36	5180	44	5220
40	5200	48	5240

2 channels are provided for 802.11n (HT40):

Channel	Frequency (MHz)	Channel	Frequency (MHz)
38	5190	46	5230

1 channel is provided for 802.11ac (VHT80):

Channel	Frequency (MHz)
42	5210

#### FOR 5260 ~ 5320 MHz

4 channels are provided for 802.11a, 802.11n (HT20):

Channel	Frequency (MHz)	Channel	Frequency (MHz)
52	5260	60	5300
56	5280	64	5320

2 channels are provided for 802.11n (HT40):

Channel	Frequency (MHz)	Channel	Frequency (MHz)
54	5270	62	5310

1 channel is provided for 802.11ac (VHT80):

Channel	Frequency (MHz)
58	5290

### FOR 5500 ~ 5700 MHz

11 channels are provided for 802.11a, 802.11n (HT20):

Channel	Frequency (MHz)	Channel	Frequency (MHz)
100	5500	124	5620
104	5520	128	5640
108	5540	132	5660
112	5560	136	5680
116	5580	140	5700
120	5600		

5 channels are provided for 802.11n (HT40):

Channel	Frequency (MHz)	Channel	Frequency (MHz)
102	5510	126	5630
110	5550	134	5670
118	5590		

2 channels are provided for 802.11ac (VHT80):

Channel	Frequency (MHz)	Channel	Frequency (MHz)
106	5530	122	5610

### FOR 5745 ~ 5825 MHz:

5 channels are provided for 802.11a, 802.11n (HT20):

Channel	Frequency (MHz)	Channel	Frequency (MHz)
149	5745	161	5805
153	5765	165	5825
157	5785		

2 channels are provided for 802.11n (HT40):

Channel	Frequency (MHz)	Channel	Frequency (MHz)
151	5755	159	5795

1 channel is provided for 802.11ac (VHT80):

Channel	Frequency (MHz)
155	5775

### 3.2.1 Test Mode Applicability and Tested Channel Detail

EUT Configure Mode	Applicable To				Description
	RE $\geq$ 1G	RE $<$ 1G	PLC	APCM	
A	√	√	√	√	Main Sample
B	√	√	√	-	2 <sup>nd</sup> Sample

Where **RE $\geq$ 1G**: Radiated Emission above 1 GHz      **RE $<$ 1G**: Radiated Emission below 1 GHz  
**PLC**: Power Line Conducted Emission      **APCM**: Antenna Port Conducted Measurement

**NOTE:**

- The EUT had been pre-tested on the positioned of each 3 axis. The worst case was found when positioned on **Y-plane**.
- "-" means no effect.

#### **Radiated Emission Test (Above 1 GHz):**

- Pre-Scan has been conducted to determine the worst-case mode from all possible combinations between available modulations, data rates and antenna ports (if EUT with antenna diversity architecture).
- Following channel(s) was (were) selected for the final test as listed below.

EUT Configure Mode	Frequency Band (MHz)	Mode	Available Channel	Tested Channel	Modulation Technology	Modulation Type	Data Rate (Mbps)
A	5180-5240	802.11a	36 to 48	36, 44, 48	OFDM	BPSK	6.0
		802.11n (HT20)	36 to 48	36, 44, 48	OFDM	BPSK	MCS0
		802.11n (HT40)	38 to 46	38, 46	OFDM	BPSK	MCS0
		802.11ac (VHT80)	42	42	OFDM	BPSK	V0
	5260-5320	802.11a	52 to 64	52, 60, 64	OFDM	BPSK	6.0
		802.11n (HT20)	52 to 64	52, 60, 64	OFDM	BPSK	MCS0
		802.11n (HT40)	54 to 62	54, 62	OFDM	BPSK	MCS0
		802.11ac (VHT80)	58	58	OFDM	BPSK	V0
	5500-5700	802.11a	100 to 140	100, 116, 140	OFDM	BPSK	6.0
		802.11n (HT20)	100 to 140	100, 116, 140	OFDM	BPSK	MCS0
		802.11n (HT40)	102 to 134	102, 110, 134	OFDM	BPSK	MCS0
		802.11ac (VHT80)	106 to 122	106, 122	OFDM	BPSK	V0
5745-5825	802.11a	149 to 165	149, 157, 165	OFDM	BPSK	6.0	
	802.11n (HT20)	149 to 165	149, 157, 165	OFDM	BPSK	MCS0	
	802.11n (HT40)	151 to 159	151, 159	OFDM	BPSK	MCS0	
	802.11ac (VHT80)	155	155	OFDM	BPSK	V0	
B	5180-5240	802.11n (HT40)	38 to 46	38	OFDM	BPSK	MCS0
	5260-5320	802.11ac (VHT80)	58	58	OFDM	BPSK	V0
	5500-5700	802.11n (HT40)	102 to 134	102	OFDM	BPSK	MCS0
	5745-5825	802.11ac (VHT80)	155	155	OFDM	BPSK	V0

#### **Radiated Emission Test (Below 1 GHz):**

- Pre-Scan has been conducted to determine the worst-case mode from all possible combinations between available modulations, data rates and antenna ports (if EUT with antenna diversity architecture).
- Following channel(s) was (were) selected for the final test as listed below.

EUT Configure Mode	Frequency Band (MHz)	Mode	Available Channel	Tested Channel	Modulation Technology	Modulation Type	Data Rate (Mbps)
A, B	5180-5240	802.11n (HT40)	38 to 46	38	OFDM	BPSK	MCS0
	5260-5320	802.11ac (VHT80)	58	58	OFDM	BPSK	V0
	5500-5700	802.11n (HT40)	102 to 134	102	OFDM	BPSK	MCS0
	5745-5825	802.11ac (VHT80)	155	155	OFDM	BPSK	V0

**Power Line Conducted Emission Test:**

Pre-Scan has been conducted to determine the worst-case mode from all possible combinations between available modulations, data rates and antenna ports (if EUT with antenna diversity architecture).

Following channel(s) was (were) selected for the final test as listed below.

EUT Configure Mode	Frequency Band (MHz)	Mode	Available Channel	Tested Channel	Modulation Technology	Modulation Type	Data Rate (Mbps)
A, B	5260-5320	802.11ac	58	58	OFDM	BPSK	V0

**Antenna Port Conducted Measurement:**

This item includes all test value of each mode, but only includes spectrum plot of worst value of each mode.

Pre-Scan has been conducted to determine the worst-case mode from all possible combinations between available modulations, data rates and antenna ports (if EUT with antenna diversity architecture).

Following channel(s) was (were) selected for the final test as listed below.

EUT Configure Mode	Frequency Band (MHz)	Mode	Available Channel	Tested Channel	Modulation Technology	Modulation Type	Data Rate (Mbps)
A	5180-5240	802.11a	36 to 48	36, 44, 48	OFDM	BPSK	6.0
		802.11n (HT20)	36 to 48	36, 44, 48	OFDM	BPSK	MCS0
		802.11n (HT40)	38 to 46	38, 46	OFDM	BPSK	MCS0
		802.11ac (VHT80)	42	42	OFDM	BPSK	V0
	5260-5320	802.11a	52 to 64	52, 60, 64	OFDM	BPSK	6.0
		802.11n (HT20)	52 to 64	52, 60, 64	OFDM	BPSK	MCS0
		802.11n (HT40)	54 to 62	54, 62	OFDM	BPSK	MCS0
		802.11ac (VHT80)	58	58	OFDM	BPSK	V0
	5500-5700	802.11a	100 to 140	100, 116, 140	OFDM	BPSK	6.0
		802.11n (HT20)	100 to 140	100, 116, 140	OFDM	BPSK	MCS0
		802.11n (HT40)	102 to 134	102, 110, 134	OFDM	BPSK	MCS0
		802.11ac (VHT80)	106 to 122	106, 122	OFDM	BPSK	V0
	5745-5825	802.11a	149 to 165	149, 157, 165	OFDM	BPSK	6.0
		802.11n (HT20)	149 to 165	149, 157, 165	OFDM	BPSK	MCS0
		802.11n (HT40)	151 to 159	151, 159	OFDM	BPSK	MCS0
		802.11ac (VHT80)	155	155	OFDM	BPSK	V0

**Test Condition:**

Applicable To	Environmental Conditions	Input Power	Tested by
RE≥1G	25 deg. C, 65 % RH	120 Vac, 60 Hz	Karl Lee
RE<1G	25 deg. C, 65 % RH	120 Vac, 60 Hz	Karl Lee
PLC	25 deg. C, 65 % RH	120 Vac, 60 Hz	Toby Tian
APCM	25 deg. C, 65 % RH	3.85 Vdc	Taylor Liu

### 3.3 Duty Cycle of Test Signal

#### MODULATION TYPE: BPSK

Duty cycle of test signal is < 98 %, duty factor is required.

**802.11a:** Duty cycle =  $2.067/2.171 = 0.952$ , Duty factor =  $10 * \log(1/0.952) = 0.21$

**802.11n (HT20):** Duty cycle =  $1.907/2.019 = 0.945$ , Duty factor =  $10 * \log(1/0.945) = 0.25$

**802.11n (HT40):** Duty cycle =  $945.51/1049.68 = 0.901$ , Duty factor =  $10 * \log(1/0.901) = 0.45$

**802.11ac (VHT80):** Duty cycle =  $945.51/1049.68 = 0.901$ , Duty factor =  $10 * \log(1/0.901) = 0.45$

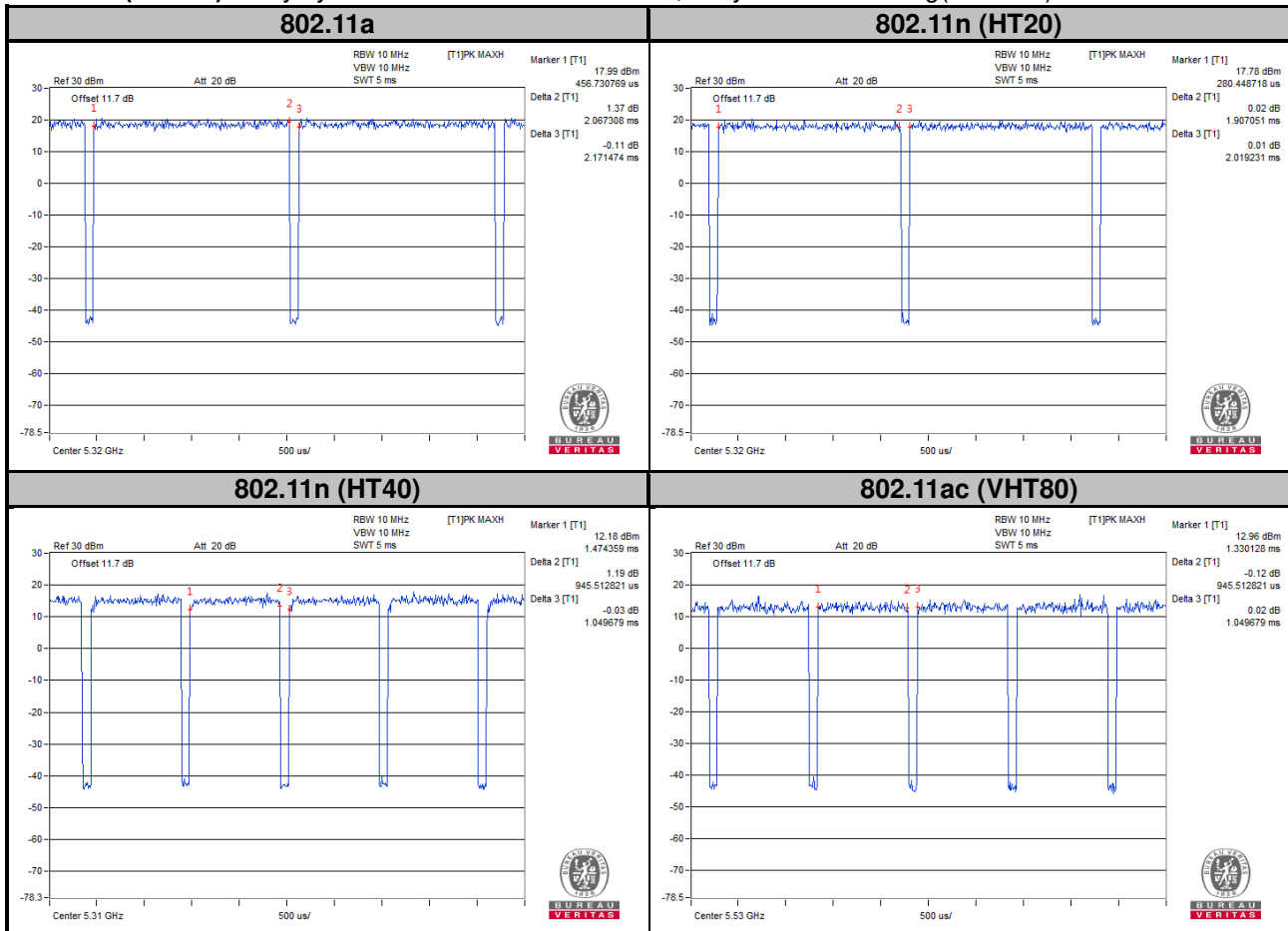

### 3.4 Description of Support Units

The EUT has been tested as an independent unit together with other necessary accessories or support units.

#### 3.4.1 Configuration of System under Test

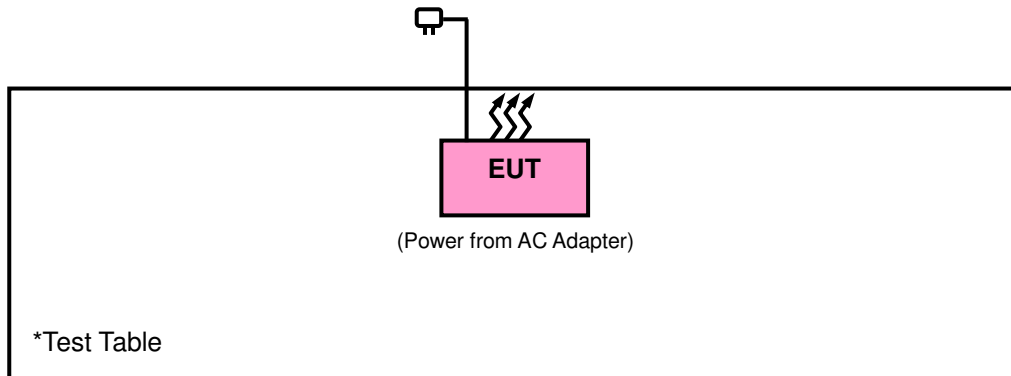

### 3.5 General Description of Applied Standards

The EUT is a RF Product. According to the specifications of the manufacturer, it must comply with the requirements of the following standards:

**FCC Part 15, Subpart E (15.407)**

**789033 D02 General UNII Test Procedures New Rules v01r03**

**644545 D01 Guidance for IEEE 802 11ac v01r02**

ANSI C63.10-2013

All test items have been performed and recorded as per the above standards.

**NOTE:** The EUT has been verified to comply with the requirements of FCC Part 15, Subpart B, Class B (DoC).  
The test report has been issued separately.

## 4 Test Types and Results

### 4.1 Radiated Emission and Bandedge Measurement

#### 4.1.1 Limits of Radiated Emission and Bandedge Measurement

Radiated emissions which fall in the restricted bands must comply with the radiated emission limits specified as below table. Other emissions shall be at least 20 dB below the highest level of the desired power:

Frequencies (MHz)	Field Strength (microvolts/meter)	Measurement Distance (meters)
0.009 ~ 0.490	2400/F (kHz)	300
0.490 ~ 1.705	24000/F (kHz)	30
1.705 ~ 30.0	30	30
30 ~ 88	100	3
88 ~ 216	150	3
216 ~ 960	200	3
Above 960	500	3

**NOTE:**

1. The lower limit shall apply at the transition frequencies.
2. Emission level (dBuV/m) = 20 log Emission level (uV/m).
3. For frequencies above 1000 MHz, the field strength limits are based on average detector, however, the peak field strength of any emission shall not exceed the maximum permitted average limits, specified above by more than 20 dB under any condition of modulation.

4.1.2 Limits of Unwanted Emission Out of the Restricted Bands

Applicable To		Limit	
789033 D02 General UNII Test Procedures New Rules v01r03		Field Strength at 3 m	
		PK: 74 (dBμV/m)	AV: 54 (dBμV/m)
Frequency Band	Applicable To	EIRP Limit	Equivalent Field Strength at 3 m
5150~5250 MHz	15.407(b)(1)	PK: -27 (dBm/MHz)	PK: 68.2 (dBμV/m)
5250~5350 MHz	15.407(b)(2)		
5470~5725 MHz	15.407(b)(3)		
5725~5850 MHz	15.407(b)(4)(i)	PK:-27 (dBm/MHz) <sup>*1</sup> PK:10 (dBm/MHz) <sup>*2</sup> PK:15.6 (dBm/MHz) <sup>*3</sup> PK:27 (dBm/MHz) <sup>*4</sup>	PK: 68.2 (dBμV/m) <sup>*1</sup> PK:105.2 (dBμV/m) <sup>*2</sup> PK: 110.8 (dBμV/m) <sup>*3</sup> PK:122.2 (dBμV/m) <sup>*4</sup>
	15.407(b)(4)(ii)	Emission limits in section 15.247(d)	

<sup>\*1</sup> beyond 75 MHz or more above of the band edge.

<sup>\*2</sup> below the band edge increasing linearly to 10 dBm/MHz at 25 MHz above.

<sup>\*3</sup> below the band edge increasing linearly to a level of 15.6 dBm/MHz at 5 MHz above.

<sup>\*4</sup> from 5 MHz above or below the band edge increasing linearly to a level of 27 dBm/MHz at the band edge.

**NOTE:**

The following formula is used to convert the equipment isotropic radiated power (eirp) to field strength:

$$E = \frac{1000000\sqrt{30P}}{3} \mu\text{V/m, where } P \text{ is the eirp (Watts).}$$



## 4.1.3 Test Instruments

Description & Manufacturer	Model No.	Serial No.	Date of Calibration	Due Date of Calibration
Test Receiver Agilent Technologies	N9038A	MY52260177	Jun. 21, 2016	Jun. 20, 2017
Spectrum Analyzer ROHDE & SCHWARZ	FSU43	101261	Dec. 17, 2015	Dec. 16, 2016
BILOG Antenna SCHWARZBECK	VULB9168	9168-472	Jan. 07, 2016	Jan. 06, 2017
HORN Antenna ETS-Lindgren	3117	00143293	Jan. 04, 2016	Jan. 03, 2017
HORN Antenna SCHWARZBECK	BBHA 9170	9170-480	Jan. 04, 2016	Jan. 03, 2017
Bluetooth Tester	CBT	100980	Apr. 27, 2015	Apr. 26, 2017
Loop Antenna	EM-6879	269	Aug. 11, 2016	Aug. 10, 2017
Preamplifier Agilent	310N	187226	Jun. 24, 2016	Jun. 23, 2017
Preamplifier Agilent	83017A	MY39501357	Jun. 24, 2016	Jun. 23, 2017
Power Meter Anritsu	ML2495A	1012010	Aug. 11, 2016	Aug. 10, 2017
Power Sensor Anritsu	MA2411B	1315050	Aug. 11, 2016	Aug. 10, 2017
RF signal cable ETS-LINDGREN	5D-FB	Cable-CH1-01(R FC-SMS-100-SM S-120+RFC-SMS -100-SMS-400)	Jun. 24, 2016	Jun. 23, 2017
RF signal cable ETS-LINDGREN	8D-FB	Cable-CH1-02(R FC-SMS-100-SM S-24)	Jun. 24, 2016	Jun. 23, 2017
Software BV ADT	E3 8.130425b	NA	NA	NA
Antenna Tower MF	NA	NA	NA	NA
Turn Table MF	NA	NA	NA	NA
Antenna Tower & Turn Table Controller MF	MF-7802	NA	NA	NA
Temperature & Humidity Chamber	GTH-120-40-CP-A R	MAA1306-019	Sep. 02, 2016	Sep. 01, 2017
DC Power Supply Topward	33010D	807748	Oct. 27, 2014	Oct. 26, 2016
Digital Multimeter Fluke	87-III	70360742	Jul. 01, 2016	Jun. 30, 2017

- Note: 1. The calibration interval of the above test instruments is 12 / 24 months and the calibrations are traceable to NML/ROC and NIST/USA.
2. The test was performed in HsinTien Chamber 1.
3. The horn antenna and preamplifier (model: 83017A) are used only for the measurement of emission frequency above 1 GHz if tested.
4. The FCC Site Registration No. is 149147.
5. The IC Site Registration No. is IC7450I-1.

#### 4.1.4 Test Procedures

- a. The EUT was placed on the top of a rotating table 0.8 meters (for below 1 GHz) / 1.5 meters (for above 1 GHz) above the ground at 3 meter chamber room for test. The table was rotated 360 degrees to determine the position of the highest radiation.
- b. The EUT was set 3 meters away from the interference-receiving antenna, which was mounted on the top of a variable-height antenna tower.
- c. The height of antenna is varied from one meter to four meters above the ground to determine the maximum value of the field strength. Both horizontal and vertical polarizations of the antenna are set to make the measurement.
- d. For each suspected emission, the EUT was arranged to its worst case and then the antenna was tuned to heights from 1 meter to 4 meters and the rotatable table was turned from 0 degrees to 360 degrees to find the maximum reading.
- e. The test-receiver system was set to quasi-peak detect function and specified bandwidth with maximum hold mode when the test frequency is below 1 GHz.
- f. The test-receiver system was set to peak and average detected function and specified bandwidth with maximum hold mode when the test frequency is above 1 GHz. If the peak reading value also meets average limit, measurement with the average detector is unnecessary.

**Note:**

1. The resolution bandwidth and video bandwidth of test receiver/spectrum analyzer is 120 kHz & 360 KHz for Quasi-peak detection (QP) at frequency below 1 GHz.
2. The resolution bandwidth of test receiver/spectrum analyzer is 1 MHz and the video bandwidth is 3 MHz for Peak detection (PK) at frequency above 1 GHz.
3. The resolution bandwidth of test receiver/spectrum analyzer is 1 MHz and the video bandwidth is 1/T for RMS Average (Duty cycle < 98 %) for Peak detection at frequency above 1 GHz.
4. The resolution bandwidth of test receiver/spectrum analyzer is 1 MHz and the video bandwidth is 10 Hz (Duty cycle  $\geq$  98 %) for Average detection (AV) at frequency above 1 GHz.
5. All modes of operation were investigated and the worst-case emissions are reported.

#### 4.1.5 Deviation from Test Standard

No deviation.

#### 4.1.6 Test Set Up

##### <Frequency Range below 1 GHz>

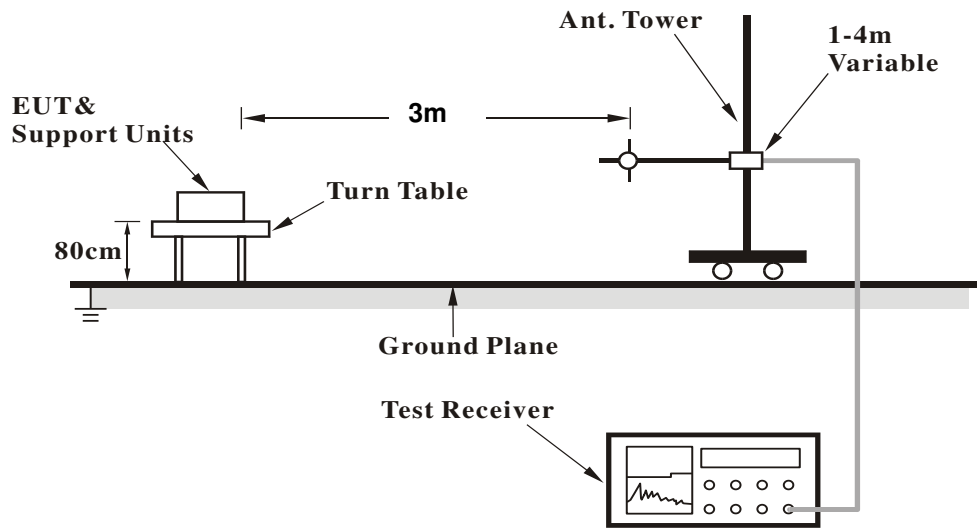

##### <Frequency Range above 1 GHz>

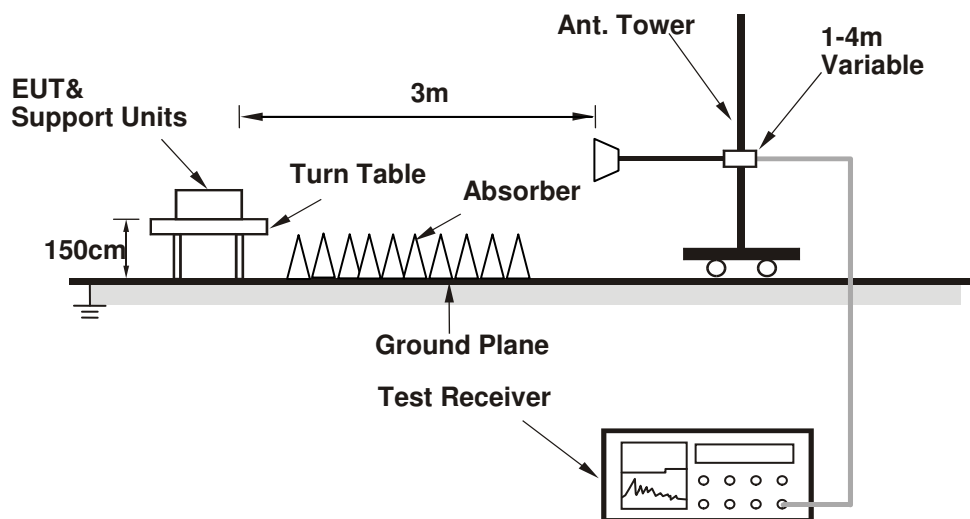

For the actual test configuration, please refer to the attached file (Test Setup Photo).

#### 4.1.7 EUT Operating Conditions

- Placed the EUT on a testing table.
- Use the software to control the EUT under transmission condition continuously at specific channel frequency.

4.1.8 Test Results  
 Above 1 GHz Data :  
 Mode A  
 802.11a

EUT Test Condition		Measurement Detail	
Channel	Channel 36	Frequency Range	1 GHz ~ 40 GHz
Input Power	120 Vac, 60 Hz	Detector Function	Peak (PK) Average (AV)
Environmental Conditions	25 deg. C, 65 % RH	Tested By	Karl Lee

Antenna Polarity & Test Distance: Horizontal at 3 m										
Frequency (MHz)	Emission Level (dBuV/m)	Read Level (dBuV)	Limit (dBuV/m)	Margin (dB)	Antenna Factor (dB/m)	Cable Loss (dB)	Preamp Factor (dB)	Antenna Height (cm)	Table Angle (Degree)	Remark
5146.4	57.81	49.56	74	-16.19	34.12	8.13	34	207	296	Peak
5149.85	48.23	39.98	54	-5.77	34.12	8.13	34	207	296	Average
5180	98.31	90			34.15	8.16	34	207	296	Average
5180	105.45	97.14			34.15	8.16	34	207	296	Peak
*10360	47.3	33	54	-6.7	37.12	12.3	35.12	115	145	Average
*10360	56.48	42.18	74	-17.52	37.12	12.3	35.12	115	145	Peak

Antenna Polarity & Test Distance: Vertical at 3 m										
Frequency (MHz)	Emission Level (dBuV/m)	Read Level (dBuV)	Limit (dBuV/m)	Margin (dB)	Antenna Factor (dB/m)	Cable Loss (dB)	Preamp Factor (dB)	Antenna Height (cm)	Table Angle (Degree)	Remark
5147.3	54.04	45.79	74	-19.96	34.12	8.13	34	218	26	Peak
5149.4	45.63	37.38	54	-8.37	34.12	8.13	34	218	26	Average
5180	91.71	83.4			34.15	8.16	34	218	26	Average
5180	98.78	90.47			34.15	8.16	34	218	26	Peak
*10360	47.05	32.75	54	-6.95	37.12	12.3	35.12	157	114	Average
*10360	57.21	42.91	74	-16.79	37.12	12.3	35.12	157	114	Peak

Remarks:

- Emission Level = Read Level + Antenna Factor + Cable Loss - Preamp Factor  
 Margin value = Emission level – Limit value
- 5180 MHz: Fundamental Frequency
- \*: Out of Restricted Band

EUT Test Condition		Measurement Detail	
Channel	Channel 44	Frequency Range	1 GHz ~ 40 GHz
Input Power	120 Vac, 60 Hz	Detector Function	Peak (PK) Average (AV)
Environmental Conditions	25 deg. C, 65 % RH	Tested By	Karl Lee

Antenna Polarity & Test Distance: Horizontal at 3 m										
Frequency (MHz)	Emission Level (dBuV/m)	Read Level (dBuV)	Limit (dBuV/m)	Margin (dB)	Antenna Factor (dB/m)	Cable Loss (dB)	Preamp Factor (dB)	Antenna Height (cm)	Table Angle (Degree)	Remark
5135.9	54.25	46	74	-19.75	34.11	8.13	33.99	207	296	Peak
5148.35	43.76	35.51	54	-10.24	34.12	8.13	34	207	296	Average
5220	98.15	89.76			34.17	8.22	34	207	296	Average
5220	105.38	96.99			34.17	8.22	34	207	296	Peak
5429.2	53.91	45.12	74	-20.09	34.35	8.48	34.04	207	296	Peak
5435.91	43.43	34.64	54	-10.57	34.35	8.48	34.04	207	296	Average
Antenna Polarity & Test Distance: Vertical at 3 m										
Frequency (MHz)	Emission Level (dBuV/m)	Read Level (dBuV)	Limit (dBuV/m)	Margin (dB)	Antenna Factor (dB/m)	Cable Loss (dB)	Preamp Factor (dB)	Antenna Height (cm)	Table Angle (Degree)	Remark
5053.4	53.29	45.23	74	-20.71	34.04	8	33.98	218	26	Peak
5149.25	43.1	34.85	54	-10.9	34.12	8.13	34	218	26	Average
5220	91.65	83.26			34.17	8.22	34	218	26	Average
5220	98.48	90.09			34.17	8.22	34	218	26	Peak
5433.16	43.17	34.38	54	-10.83	34.35	8.48	34.04	218	26	Average
5454.83	53.86	45.04	74	-20.14	34.36	8.51	34.05	218	26	Peak

Remarks:

- Emission Level = Read Level + Antenna Factor + Cable Loss - Preamp Factor  
Margin value = Emission level – Limit value
- 5220 MHz: Fundamental Frequency

EUT Test Condition		Measurement Detail	
Channel	Channel 48	Frequency Range	1 GHz ~ 40 GHz
Input Power	120 Vac, 60 Hz	Detector Function	Peak (PK) Average (AV)
Environmental Conditions	25 deg. C, 65 % RH	Tested By	Karl Lee

Antenna Polarity & Test Distance: Horizontal at 3 m										
Frequency (MHz)	Emission Level (dBuV/m)	Read Level (dBuV)	Limit (dBuV/m)	Margin (dB)	Antenna Factor (dB/m)	Cable Loss (dB)	Preamp Factor (dB)	Antenna Height (cm)	Table Angle (Degree)	Remark
5240	98.32	89.88			34.19	8.26	34.01	207	296	Average
5240	105.43	96.99			34.19	8.26	34.01	207	296	Peak
5451.53	54.19	45.37	74	-19.81	34.36	8.51	34.05	207	296	Peak
5459.12	43.55	34.73	54	-10.45	34.36	8.51	34.05	207	296	Average
*10480	47.39	32.88	54	-6.61	37.19	12.53	35.21	148	104	Average
*10480	57.15	42.64	74	-16.85	37.19	12.53	35.21	148	104	Peak

Antenna Polarity & Test Distance: Vertical at 3 m										
Frequency (MHz)	Emission Level (dBuV/m)	Read Level (dBuV)	Limit (dBuV/m)	Margin (dB)	Antenna Factor (dB/m)	Cable Loss (dB)	Preamp Factor (dB)	Antenna Height (cm)	Table Angle (Degree)	Remark
5240	91.34	82.9			34.19	8.26	34.01	218	26	Average
5240	98.45	90.01			34.19	8.26	34.01	218	26	Peak
5416.33	54.78	46.05	74	-19.22	34.33	8.44	34.04	218	26	Peak
5445.7	43.26	34.43	54	-10.74	34.36	8.51	34.04	218	26	Average
*10480	47.25	32.74	54	-6.75	37.19	12.53	35.21	119	137	Average
*10480	56.87	42.36	74	-17.13	37.19	12.53	35.21	119	137	Peak

Remarks:

- Emission Level = Read Level + Antenna Factor + Cable Loss - Preamp Factor  
Margin value = Emission level – Limit value
- 5240 MHz: Fundamental Frequency
- \*: Out of Restricted Band

EUT Test Condition		Measurement Detail	
Channel	Channel 52	Frequency Range	1 GHz ~ 40 GHz
Input Power	120 Vac, 60 Hz	Detector Function	Peak (PK) Average (AV)
Environmental Conditions	25 deg. C, 65 % RH	Tested By	Karl Lee

Antenna Polarity & Test Distance: Horizontal at 3 m										
Frequency (MHz)	Emission Level (dBuV/m)	Read Level (dBuV)	Limit (dBuV/m)	Margin (dB)	Antenna Factor (dB/m)	Cable Loss (dB)	Preamp Factor (dB)	Antenna Height (cm)	Table Angle (Degree)	Remark
5078	54.09	45.97	74	-19.91	34.07	8.03	33.98	209	299	Peak
5149.4	43.34	35.09	54	-10.66	34.12	8.13	34	209	299	Average
5260	99.27	90.81			34.21	8.26	34.01	209	299	Average
5260	106.37	97.91			34.21	8.26	34.01	209	299	Peak
*10520	47.75	33.16	54	-6.25	37.21	12.61	35.23	131	174	Average
*10520	57.78	43.19	74	-16.22	37.21	12.61	35.23	131	174	Peak

Antenna Polarity & Test Distance: Vertical at 3 m										
Frequency (MHz)	Emission Level (dBuV/m)	Read Level (dBuV)	Limit (dBuV/m)	Margin (dB)	Antenna Factor (dB/m)	Cable Loss (dB)	Preamp Factor (dB)	Antenna Height (cm)	Table Angle (Degree)	Remark
5109.35	54	45.8	74	-20	34.09	8.1	33.99	218	4	Peak
5128.1	42.92	34.7	54	-11.08	34.11	8.1	33.99	218	4	Average
5260	92.97	84.51			34.21	8.26	34.01	218	4	Average
5260	99.35	90.89			34.21	8.26	34.01	218	4	Peak
*10520	47.46	32.87	54	-6.54	37.21	12.61	35.23	189	240	Average
*10520	57.84	43.25	74	-16.16	37.21	12.61	35.23	189	240	Peak

Remarks:

- Emission Level = Read Level + Antenna Factor + Cable Loss - Preamp Factor  
Margin value = Emission level – Limit value
- 5260 MHz: Fundamental Frequency
- \*: Out of Restricted Band

EUT Test Condition		Measurement Detail	
Channel	Channel 60	Frequency Range	1 GHz ~ 40 GHz
Input Power	120 Vac, 60 Hz	Detector Function	Peak (PK) Average (AV)
Environmental Conditions	25 deg. C, 65 % RH	Tested By	Karl Lee

Antenna Polarity & Test Distance: Horizontal at 3 m										
Frequency (MHz)	Emission Level (dBuV/m)	Read Level (dBuV)	Limit (dBuV/m)	Margin (dB)	Antenna Factor (dB/m)	Cable Loss (dB)	Preamp Factor (dB)	Antenna Height (cm)	Table Angle (Degree)	Remark
5044.85	53.73	45.67	74	-20.27	34.04	8	33.98	209	299	Peak
5145.8	43.26	35.01	54	-10.74	34.12	8.13	34	209	299	Average
5300	99.51	90.97			34.24	8.32	34.02	209	299	Average
5300	106.21	97.67			34.24	8.32	34.02	209	299	Peak
5350.22	45.29	36.66	54	-8.71	34.28	8.38	34.03	209	299	Average
5355.06	55.5	46.87	74	-18.5	34.28	8.38	34.03	209	299	Peak
Antenna Polarity & Test Distance: Vertical at 3 m										
Frequency (MHz)	Emission Level (dBuV/m)	Read Level (dBuV)	Limit (dBuV/m)	Margin (dB)	Antenna Factor (dB/m)	Cable Loss (dB)	Preamp Factor (dB)	Antenna Height (cm)	Table Angle (Degree)	Remark
5034.8	53.52	45.46	74	-20.48	34.03	8	33.97	218	4	Peak
5070.65	42.97	34.87	54	-11.03	34.05	8.03	33.98	218	4	Average
5300	92.44	83.9			34.24	8.32	34.02	218	4	Average
5300	99	90.46			34.24	8.32	34.02	218	4	Peak
5353.74	43.45	34.82	54	-10.55	34.28	8.38	34.03	218	4	Average
5424.25	54.18	45.41	74	-19.82	34.33	8.48	34.04	218	4	Peak

Remarks:

- Emission Level = Read Level + Antenna Factor + Cable Loss - Preamp Factor  
Margin value = Emission level – Limit value
- 5300 MHz: Fundamental Frequency



EUT Test Condition		Measurement Detail	
Channel	Channel 64	Frequency Range	1 GHz ~ 40 GHz
Input Power	120 Vac, 60 Hz	Detector Function	Peak (PK) Average (AV)
Environmental Conditions	25 deg. C, 65 % RH	Tested By	Karl Lee

Antenna Polarity & Test Distance: Horizontal at 3 m										
Frequency (MHz)	Emission Level (dBuV/m)	Read Level (dBuV)	Limit (dBuV/m)	Margin (dB)	Antenna Factor (dB/m)	Cable Loss (dB)	Preamp Factor (dB)	Antenna Height (cm)	Table Angle (Degree)	Remark
5320	99.34	90.76			34.25	8.35	34.02	209	299	Average
5320	106.06	97.48			34.25	8.35	34.02	209	299	Peak
5350	49.64	41.01	54	-4.36	34.28	8.38	34.03	209	299	Average
5350.55	59.85	51.22	74	-14.15	34.28	8.38	34.03	209	299	Peak
10640	47.72	32.99	54	-6.28	37.31	12.71	35.29	141	128	Average
10640	56.94	42.21	74	-17.06	37.31	12.71	35.29	141	128	Peak
Antenna Polarity & Test Distance: Vertical at 3 m										
Frequency (MHz)	Emission Level (dBuV/m)	Read Level (dBuV)	Limit (dBuV/m)	Margin (dB)	Antenna Factor (dB/m)	Cable Loss (dB)	Preamp Factor (dB)	Antenna Height (cm)	Table Angle (Degree)	Remark
5320	92.18	83.6			34.25	8.35	34.02	218	4	Average
5320	99.32	90.74			34.25	8.35	34.02	218	4	Peak
5350	45.82	37.19	54	-8.18	34.28	8.38	34.03	218	4	Average
5350.33	54.66	46.03	74	-19.34	34.28	8.38	34.03	218	4	Peak
10640	47.83	33.1	54	-6.17	37.31	12.71	35.29	185	246	Average
10640	56.92	42.19	74	-17.08	37.31	12.71	35.29	185	246	Peak

Remarks:

- Emission Level = Read Level + Antenna Factor + Cable Loss - Preamp Factor  
Margin value = Emission level – Limit value
- 5320 MHz: Fundamental Frequency

EUT Test Condition		Measurement Detail	
Channel	Channel 100	Frequency Range	1 GHz ~ 40 GHz
Input Power	120 Vac, 60 Hz	Detector Function	Peak (PK) Average (AV)
Environmental Conditions	25 deg. C, 65 % RH	Tested By	Karl Lee

Antenna Polarity & Test Distance: Horizontal at 3 m										
Frequency (MHz)	Emission Level (dBuV/m)	Read Level (dBuV)	Limit (dBuV/m)	Margin (dB)	Antenna Factor (dB/m)	Cable Loss (dB)	Preamp Factor (dB)	Antenna Height (cm)	Table Angle (Degree)	Remark
5458	44.31	35.49	54	-9.69	34.36	8.51	34.05	116	357	Average
5460	54.41	45.59	74	-19.59	34.36	8.51	34.05	116	357	Peak
*5470.32	55.34	46.51	74	-18.66	34.37	8.51	34.05	116	357	Peak
*5470.8	45.81	36.95	54	-8.19	34.37	8.54	34.05	116	357	Average
5500	94.28	85.36			34.4	8.57	34.05	116	357	Average
5500	101.14	92.22			34.4	8.57	34.05	116	357	Peak
11000	49.31	34.23	54	-4.69	37.6	12.96	35.48	163	249	Average
11000	58.29	43.21	74	-15.71	37.6	12.96	35.48	163	249	Peak

Antenna Polarity & Test Distance: Vertical at 3 m										
Frequency (MHz)	Emission Level (dBuV/m)	Read Level (dBuV)	Limit (dBuV/m)	Margin (dB)	Antenna Factor (dB/m)	Cable Loss (dB)	Preamp Factor (dB)	Antenna Height (cm)	Table Angle (Degree)	Remark
5419.92	53.84	45.07	74	-20.16	34.33	8.48	34.04	106	28	Peak
5459.76	43.61	34.79	54	-10.39	34.36	8.51	34.05	106	28	Average
*5470.16	53.18	44.35	74	-20.82	34.37	8.51	34.05	106	28	Peak
*5470.8	43.6	34.74	54	-10.4	34.37	8.54	34.05	106	28	Average
5500	88.56	79.64			34.4	8.57	34.05	106	28	Average
5500	95.36	86.44			34.4	8.57	34.05	106	28	Peak
11000	49.61	34.53	54	-4.39	37.6	12.96	35.48	175	114	Average
11000	58.74	43.66	74	-15.26	37.6	12.96	35.48	175	114	Peak

Remarks:

- Emission Level = Read Level + Antenna Factor + Cable Loss - Preamp Factor  
Margin value = Emission level – Limit value
- 5500 MHz: Fundamental Frequency
- \*: Out of Restricted Band

EUT Test Condition		Measurement Detail	
Channel	Channel 116	Frequency Range	1 GHz ~ 40 GHz
Input Power	120 Vac, 60 Hz	Detector Function	Peak (PK) Average (AV)
Environmental Conditions	25 deg. C, 65 % RH	Tested By	Karl Lee

Antenna Polarity & Test Distance: Horizontal at 3 m										
Frequency (MHz)	Emission Level (dBuV/m)	Read Level (dBuV)	Limit (dBuV/m)	Margin (dB)	Antenna Factor (dB/m)	Cable Loss (dB)	Preamp Factor (dB)	Antenna Height (cm)	Table Angle (Degree)	Remark
5371.92	54.2	45.53	74	-19.8	34.29	8.41	34.03	114	357	Peak
5455.76	43.16	34.34	54	-10.84	34.36	8.51	34.05	114	357	Average
*5469.52	52.26	43.43	74	-21.74	34.37	8.51	34.05	114	357	Peak
*5470.8	43.14	34.28	54	-10.86	34.37	8.54	34.05	114	357	Average
5580	93.84	84.85			34.47	8.6	34.08	114	357	Average
5580	102.15	93.16			34.47	8.6	34.08	114	357	Peak
*5723.96	53.76	44.6	74	-20.24	34.62	8.65	34.11	114	357	Peak
*5724.84	43.72	34.56	54	-10.28	34.62	8.65	34.11	114	357	Average

Antenna Polarity & Test Distance: Vertical at 3 m										
Frequency (MHz)	Emission Level (dBuV/m)	Read Level (dBuV)	Limit (dBuV/m)	Margin (dB)	Antenna Factor (dB/m)	Cable Loss (dB)	Preamp Factor (dB)	Antenna Height (cm)	Table Angle (Degree)	Remark
5350.16	53.6	44.97	74	-20.4	34.28	8.38	34.03	156	326	Peak
5371.76	43.13	34.46	54	-10.87	34.29	8.41	34.03	156	326	Average
*5468.56	42.92	34.09	54	-11.08	34.37	8.51	34.05	156	326	Average
*5469.2	52.68	43.85	74	-21.32	34.37	8.51	34.05	156	326	Peak
5580	88.03	79.04			34.47	8.6	34.08	156	326	Average
5580	95.8	86.81			34.47	8.6	34.08	156	326	Peak
*5724.28	43.46	34.3	54	-10.54	34.62	8.65	34.11	156	326	Average
*5725.96	53.97	44.81	74	-20.03	34.62	8.65	34.11	156	326	Peak

Remarks:

- Emission Level = Read Level + Antenna Factor + Cable Loss - Preamp Factor  
Margin value = Emission level – Limit value
- 5580 MHz: Fundamental Frequency
- \*: Out of Restricted Band

EUT Test Condition		Measurement Detail	
Channel	Channel 140	Frequency Range	1 GHz ~ 40 GHz
Input Power	120 Vac, 60 Hz	Detector Function	Peak (PK) Average (AV)
Environmental Conditions	25 deg. C, 65 % RH	Tested By	Karl Lee

Antenna Polarity & Test Distance: Horizontal at 3 m										
Frequency (MHz)	Emission Level (dBuV/m)	Read Level (dBuV)	Limit (dBuV/m)	Margin (dB)	Antenna Factor (dB/m)	Cable Loss (dB)	Preamp Factor (dB)	Antenna Height (cm)	Table Angle (Degree)	Remark
5700	94.51	85.38			34.59	8.64	34.1	103	47	Average
5700	102.39	93.26			34.59	8.64	34.1	103	47	Peak
*5725.24	45.62	36.46	54	-8.38	34.62	8.65	34.11	103	47	Average
*5725.24	55.65	46.49	74	-18.35	34.62	8.65	34.11	103	47	Peak
11400	48.35	33.25	54	-5.65	37.84	12.67	35.41	169	274	Average
11400	57.33	42.23	74	-16.67	37.84	12.67	35.41	169	274	Peak
Antenna Polarity & Test Distance: Vertical at 3 m										
Frequency (MHz)	Emission Level (dBuV/m)	Read Level (dBuV)	Limit (dBuV/m)	Margin (dB)	Antenna Factor (dB/m)	Cable Loss (dB)	Preamp Factor (dB)	Antenna Height (cm)	Table Angle (Degree)	Remark
5700	88.35	79.22			34.59	8.64	34.1	120	326	Average
5700	96.17	87.04			34.59	8.64	34.1	120	326	Peak
*5724.28	44.32	35.16	54	-9.68	34.62	8.65	34.11	120	326	Average
*5724.76	53.32	44.16	74	-20.68	34.62	8.65	34.11	120	326	Peak
11400	49.16	34.06	54	-4.84	37.84	12.67	35.41	128	76	Average
11400	57.04	41.94	74	-16.96	37.84	12.67	35.41	128	76	Peak

Remarks:

- Emission Level = Read Level + Antenna Factor + Cable Loss - Preamp Factor  
Margin value = Emission level – Limit value
- 5700 MHz: Fundamental Frequency
- \*: Out of Restricted Band

EUT Test Condition		Measurement Detail	
Channel	Channel 149	Frequency Range	1 GHz ~ 40 GHz
Input Power	120 Vac, 60 Hz	Detector Function	Peak (PK) Average (AV)
Environmental Conditions	25 deg. C, 65 % RH	Tested By	Karl Lee

<Spurious Emission>

Antenna Polarity & Test Distance: Horizontal at 3 m										
Frequency (MHz)	Emission Level (dBuV/m)	Read Level (dBuV)	Limit (dBuV/m)	Margin (dB)	Antenna Factor (dB/m)	Cable Loss (dB)	Preamp Factor (dB)	Antenna Height (cm)	Table Angle (Degree)	Remark
5745	93.33	84.14			34.64	8.66	34.11	110	353	Average
5745	101.61	92.42			34.64	8.66	34.11	110	353	Peak
11490	47.86	32.74	54	-6.14	37.89	12.62	35.39	108	144	Average
11490	57.13	42.01	74	-16.87	37.89	12.62	35.39	108	144	Peak
Antenna Polarity & Test Distance: Vertical at 3 m										
Frequency (MHz)	Emission Level (dBuV/m)	Read Level (dBuV)	Limit (dBuV/m)	Margin (dB)	Antenna Factor (dB/m)	Cable Loss (dB)	Preamp Factor (dB)	Antenna Height (cm)	Table Angle (Degree)	Remark
5745	89.39	80.2			34.64	8.66	34.11	104	252	Average
5745	96.65	87.46			34.64	8.66	34.11	104	252	Peak
11490	47.77	32.65	54	-6.23	37.89	12.62	35.39	176	119	Average
11490	56.88	41.76	74	-17.12	37.89	12.62	35.39	176	119	Peak

<Radiated Out of Band Emission (OOBE)>

**Antenna Polarity & Test Distance: Horizontal at 3 m**

Frequency (MHz)	Emission Level (dBuV/m)	Read Level (dBuV)	Limit (dBuV/m)	Margin (dB)	Antenna Factor (dB/m)	Cable Loss (dB)	Preamp Factor (dB)	Antenna Height (cm)	Table Angle (Degree)	Remark
*5642.8	43.33	34.26	54	-10.67	34.54	8.62	34.09	110	353	Average
*5642.8	54.39	45.32	74	-19.61	34.54	8.62	34.09	110	353	Peak
5655.93	53.69	44.6	77.7	-24.01	34.56	8.63	34.1	110	353	Peak
5921.58	54.46	45.06	76.14	-21.68	34.83	8.73	34.16	110	353	Peak
*5957.28	44.29	34.84	54	-9.71	34.87	8.74	34.16	110	353	Average
*5957.28	55.03	45.58	74	-18.97	34.87	8.74	34.16	110	353	Peak

**Antenna Polarity & Test Distance: Vertical at 3 m**

Frequency (MHz)	Emission Level (dBuV/m)	Read Level (dBuV)	Limit (dBuV/m)	Margin (dB)	Antenna Factor (dB/m)	Cable Loss (dB)	Preamp Factor (dB)	Antenna Height (cm)	Table Angle (Degree)	Remark
*5600.28	43.34	34.32	54	-10.66	34.5	8.6	34.08	104	252	Average
*5600.28	54.94	45.92	74	-19.06	34.5	8.6	34.08	104	252	Peak
5653.3	52.5	43.4	76.06	-23.56	34.56	8.63	34.09	104	252	Peak
5918.95	53.21	43.83	77.78	-24.57	34.81	8.73	34.16	104	252	Peak
*6001.38	43.91	34.42	54	-10.09	34.9	8.76	34.17	104	252	Average
*6001.38	54.91	45.42	74	-19.09	34.9	8.76	34.17	104	252	Peak

Remarks:

- Emission Level = Read Level + Antenna Factor + Cable Loss - Preamp Factor  
Margin value = Emission level – Limit value
- 5745 MHz: Fundamental Frequency
- \*: Out of Restricted Band

EUT Test Condition		Measurement Detail	
Channel	Channel 157	Frequency Range	1 GHz ~ 40 GHz
Input Power	120 Vac, 60 Hz	Detector Function	Peak (PK) Average (AV)
Environmental Conditions	25 deg. C, 65 % RH	Tested By	Karl Lee

<Spurious Emission>

Antenna Polarity & Test Distance: Horizontal at 3 m										
Frequency (MHz)	Emission Level (dBuV/m)	Read Level (dBuV)	Limit (dBuV/m)	Margin (dB)	Antenna Factor (dB/m)	Cable Loss (dB)	Preamp Factor (dB)	Antenna Height (cm)	Table Angle (Degree)	Remark
5785	93.83	84.6			34.68	8.68	34.13	100	353	Average
5785	101.23	92			34.68	8.68	34.13	100	353	Peak
11570	47.74	32.43	54	-6.26	38	12.68	35.37	168	341	Average
11570	56.68	41.37	74	-17.32	38	12.68	35.37	168	341	Peak
Antenna Polarity & Test Distance: Vertical at 3 m										
Frequency (MHz)	Emission Level (dBuV/m)	Read Level (dBuV)	Limit (dBuV/m)	Margin (dB)	Antenna Factor (dB/m)	Cable Loss (dB)	Preamp Factor (dB)	Antenna Height (cm)	Table Angle (Degree)	Remark
5785	88.36	79.13			34.68	8.68	34.13	104	252	Average
5785	96.69	87.46			34.68	8.68	34.13	104	252	Peak
11570	47.9	32.59	54	-6.1	38	12.68	35.37	138	11	Average
11570	57.64	42.33	74	-16.36	38	12.68	35.37	138	11	Peak

<Radiated Out of Band Emission (OOBE)>

**Antenna Polarity & Test Distance: Horizontal at 3 m**

Frequency (MHz)	Emission Level (dBuV/m)	Read Level (dBuV)	Limit (dBuV/m)	Margin (dB)	Antenna Factor (dB/m)	Cable Loss (dB)	Preamp Factor (dB)	Antenna Height (cm)	Table Angle (Degree)	Remark
*5599.75	44.63	35.61	54	-9.37	34.5	8.6	34.08	100	353	Average
*5599.75	53.75	44.73	74	-20.25	34.5	8.6	34.08	100	353	Peak
5654.35	51.84	42.75	76.71	-24.87	34.56	8.63	34.1	100	353	Peak
5918.43	53.68	44.3	78.1	-24.42	34.81	8.73	34.16	100	353	Peak
*5984.05	45.07	35.61	54	-8.93	34.88	8.75	34.17	100	353	Average
*5984.05	54.63	45.17	74	-19.37	34.88	8.75	34.17	100	353	Peak

**Antenna Polarity & Test Distance: Vertical at 3 m**

Frequency (MHz)	Emission Level (dBuV/m)	Read Level (dBuV)	Limit (dBuV/m)	Margin (dB)	Antenna Factor (dB/m)	Cable Loss (dB)	Preamp Factor (dB)	Antenna Height (cm)	Table Angle (Degree)	Remark
*5640.18	44.71	35.64	54	-9.29	34.54	8.62	34.09	104	252	Average
*5640.18	53.72	44.65	74	-20.28	34.54	8.62	34.09	104	252	Peak
5656.98	54.14	45.05	78.35	-24.21	34.56	8.63	34.1	104	252	Peak
5916.33	52.86	43.48	79.41	-26.55	34.81	8.73	34.16	104	252	Peak
*6012.4	45.23	35.73	54	-8.77	34.92	8.76	34.18	104	252	Average
*6012.4	55.41	45.91	74	-18.59	34.92	8.76	34.18	104	252	Peak

Remarks:

- Emission Level = Read Level + Antenna Factor + Cable Loss - Preamp Factor  
Margin value = Emission level – Limit value
- 5785 MHz: Fundamental Frequency
- \*: Out of Restricted Band



EUT Test Condition		Measurement Detail	
Channel	Channel 165	Frequency Range	1 GHz ~ 40 GHz
Input Power	120 Vac, 60 Hz	Detector Function	Peak (PK) Average (AV)
Environmental Conditions	25 deg. C, 65 % RH	Tested By	Karl Lee

<Spurious Emission>

Antenna Polarity & Test Distance: Horizontal at 3 m										
Frequency (MHz)	Emission Level (dBuV/m)	Read Level (dBuV)	Limit (dBuV/m)	Margin (dB)	Antenna Factor (dB/m)	Cable Loss (dB)	Preamp Factor (dB)	Antenna Height (cm)	Table Angle (Degree)	Remark
5825	93.77	84.48			34.73	8.69	34.13	121	353	Average
5825	101.43	92.14			34.73	8.69	34.13	121	353	Peak
11650	48.29	32.76	54	-5.71	38.09	12.8	35.36	128	113	Average
11650	57.86	42.33	74	-16.14	38.09	12.8	35.36	128	113	Peak
Antenna Polarity & Test Distance: Vertical at 3 m										
Frequency (MHz)	Emission Level (dBuV/m)	Read Level (dBuV)	Limit (dBuV/m)	Margin (dB)	Antenna Factor (dB/m)	Cable Loss (dB)	Preamp Factor (dB)	Antenna Height (cm)	Table Angle (Degree)	Remark
5825	88.99	79.7			34.73	8.69	34.13	102	252	Average
5825	96.79	87.5			34.73	8.69	34.13	102	252	Peak
11650	48.25	32.72	54	-5.75	38.09	12.8	35.36	103	116	Average
11650	56.79	41.26	74	-17.21	38.09	12.8	35.36	103	116	Peak

<Radiated Out of Band Emission (OOBE)>

**Antenna Polarity & Test Distance: Horizontal at 3 m**

Frequency (MHz)	Emission Level (dBuV/m)	Read Level (dBuV)	Limit (dBuV/m)	Margin (dB)	Antenna Factor (dB/m)	Cable Loss (dB)	Preamp Factor (dB)	Antenna Height (cm)	Table Angle (Degree)	Remark
*5510.5	44.44	35.53	54	-9.56	34.4	8.57	34.06	121	353	Average
*5510.5	54.63	45.72	74	-19.37	34.4	8.57	34.06	121	353	Peak
5654.88	52.34	43.25	77.04	-24.7	34.56	8.63	34.1	121	353	Peak
5918.95	53.61	44.23	77.78	-24.17	34.81	8.73	34.16	121	353	Peak
*5944.15	45.05	35.62	54	-8.95	34.85	8.74	34.16	121	353	Average
*5944.15	54.6	45.17	74	-19.4	34.85	8.74	34.16	121	353	Peak

**Antenna Polarity & Test Distance: Vertical at 3 m**

Frequency (MHz)	Emission Level (dBuV/m)	Read Level (dBuV)	Limit (dBuV/m)	Margin (dB)	Antenna Factor (dB/m)	Cable Loss (dB)	Preamp Factor (dB)	Antenna Height (cm)	Table Angle (Degree)	Remark
*5608.15	44.63	35.6	54	-9.37	34.5	8.61	34.08	102	252	Average
*5608.15	53.61	44.58	74	-20.39	34.5	8.61	34.08	102	252	Peak
5655.93	53.83	44.74	77.7	-23.87	34.56	8.63	34.1	102	252	Peak
5920.53	52.97	43.59	76.79	-23.82	34.81	8.73	34.16	102	252	Peak
*5975.65	45.12	35.66	54	-8.88	34.88	8.75	34.17	102	252	Average
*5975.65	55.07	45.61	74	-18.93	34.88	8.75	34.17	102	252	Peak

Remarks:

- Emission Level = Read Level + Antenna Factor + Cable Loss - Preamp Factor  
Margin value = Emission level – Limit value
- 5825 MHz: Fundamental Frequency
- \*: Out of Restricted Band

802.11n (HT20)

EUT Test Condition		Measurement Detail	
Channel	Channel 36	Frequency Range	1 GHz ~ 40 GHz
Input Power	120 Vac, 60 Hz	Detector Function	Peak (PK) Average (AV)
Environmental Conditions	25 deg. C, 65 % RH	Tested By	Karl Lee

**Antenna Polarity & Test Distance: Horizontal at 3 m**

Frequency (MHz)	Emission Level (dBuV/m)	Read Level (dBuV)	Limit (dBuV/m)	Margin (dB)	Antenna Factor (dB/m)	Cable Loss (dB)	Preamp Factor (dB)	Antenna Height (cm)	Table Angle (Degree)	Remark
5145.65	57.96	49.71	74	-16.04	34.12	8.13	34	207	296	Peak
5149.25	48.39	40.14	54	-5.61	34.12	8.13	34	207	296	Average
5180	98.43	90.12			34.15	8.16	34	207	296	Average
5180	105.69	97.38			34.15	8.16	34	207	296	Peak
*10360	47.32	33.02	54	-6.68	37.12	12.3	35.12	136	174	Average
*10360	56.48	42.18	74	-17.52	37.12	12.3	35.12	136	174	Peak

**Antenna Polarity & Test Distance: Vertical at 3 m**

Frequency (MHz)	Emission Level (dBuV/m)	Read Level (dBuV)	Limit (dBuV/m)	Margin (dB)	Antenna Factor (dB/m)	Cable Loss (dB)	Preamp Factor (dB)	Antenna Height (cm)	Table Angle (Degree)	Remark
5148.2	54.13	45.88	74	-19.87	34.12	8.13	34	218	26	Peak
5149.55	45.33	37.08	54	-8.67	34.12	8.13	34	218	26	Average
5180	91.78	83.47			34.15	8.16	34	218	26	Average
5180	98.36	90.05			34.15	8.16	34	218	26	Peak
*10360	46.96	32.66	54	-7.04	37.12	12.3	35.12	157	120	Average
*10360	57.21	42.91	74	-16.79	37.12	12.3	35.12	157	120	Peak

Remarks:

- Emission Level = Read Level + Antenna Factor + Cable Loss - Preamp Factor  
Margin value = Emission level – Limit value
- 5180 MHz: Fundamental Frequency
- \*: Out of Restricted Band

EUT Test Condition		Measurement Detail	
Channel	Channel 44	Frequency Range	1 GHz ~ 40 GHz
Input Power	120 Vac, 60 Hz	Detector Function	Peak (PK) Average (AV)
Environmental Conditions	25 deg. C, 65 % RH	Tested By	Karl Lee

Antenna Polarity & Test Distance: Horizontal at 3 m										
Frequency (MHz)	Emission Level (dBuV/m)	Read Level (dBuV)	Limit (dBuV/m)	Margin (dB)	Antenna Factor (dB/m)	Cable Loss (dB)	Preamp Factor (dB)	Antenna Height (cm)	Table Angle (Degree)	Remark
5109.8	54.15	45.95	74	-19.85	34.09	8.1	33.99	207	296	Peak
5148.8	43.72	35.47	54	-10.28	34.12	8.13	34	207	296	Average
5220	98.45	90.06			34.17	8.22	34	207	296	Average
5220	105.86	97.47			34.17	8.22	34	207	296	Peak
5419.41	54.86	46.09	74	-19.14	34.33	8.48	34.04	207	296	Peak
5445.15	43.38	34.56	54	-10.62	34.35	8.51	34.04	207	296	Average
Antenna Polarity & Test Distance: Vertical at 3 m										
Frequency (MHz)	Emission Level (dBuV/m)	Read Level (dBuV)	Limit (dBuV/m)	Margin (dB)	Antenna Factor (dB/m)	Cable Loss (dB)	Preamp Factor (dB)	Antenna Height (cm)	Table Angle (Degree)	Remark
5139.65	53.83	45.57	74	-20.17	34.12	8.13	33.99	218	26	Peak
5141.6	43.1	34.84	54	-10.9	34.12	8.13	33.99	218	26	Average
5220	91.25	82.86			34.17	8.22	34	218	26	Average
5220	98.64	90.25			34.17	8.22	34	218	26	Peak
5383.55	54.12	45.44	74	-19.88	34.31	8.41	34.04	218	26	Peak
5446.25	43.42	34.59	54	-10.58	34.36	8.51	34.04	218	26	Average

Remarks:

- Emission Level = Read Level + Antenna Factor + Cable Loss - Preamp Factor  
Margin value = Emission level – Limit value
- 5220 MHz: Fundamental Frequency

EUT Test Condition		Measurement Detail	
Channel	Channel 48	Frequency Range	1 GHz ~ 40 GHz
Input Power	120 Vac, 60 Hz	Detector Function	Peak (PK) Average (AV)
Environmental Conditions	25 deg. C, 65 % RH	Tested By	Karl Lee

Antenna Polarity & Test Distance: Horizontal at 3 m										
Frequency (MHz)	Emission Level (dBuV/m)	Read Level (dBuV)	Limit (dBuV/m)	Margin (dB)	Antenna Factor (dB/m)	Cable Loss (dB)	Preamp Factor (dB)	Antenna Height (cm)	Table Angle (Degree)	Remark
5240	98.54	90.1			34.19	8.26	34.01	207	296	Average
5240	105.78	97.34			34.19	8.26	34.01	207	296	Peak
5459.23	43.55	34.73	54	-10.45	34.36	8.51	34.05	207	296	Average
5459.34	53.89	45.07	74	-20.11	34.36	8.51	34.05	207	296	Peak
*10480	47.66	33.15	54	-6.34	37.19	12.53	35.21	103	104	Average
*10480	57.15	42.64	74	-16.85	37.19	12.53	35.21	103	104	Peak

Antenna Polarity & Test Distance: Vertical at 3 m										
Frequency (MHz)	Emission Level (dBuV/m)	Read Level (dBuV)	Limit (dBuV/m)	Margin (dB)	Antenna Factor (dB/m)	Cable Loss (dB)	Preamp Factor (dB)	Antenna Height (cm)	Table Angle (Degree)	Remark
5240	91.21	82.77			34.19	8.26	34.01	218	26	Average
5240	98.95	90.51			34.19	8.26	34.01	218	26	Peak
5426.01	53.93	45.16	74	-20.07	34.33	8.48	34.04	218	26	Peak
5440.2	43.18	34.39	54	-10.82	34.35	8.48	34.04	218	26	Average
*10480	47.28	32.77	54	-6.72	37.19	12.53	35.21	105	156	Average
*10480	56.87	42.36	74	-17.13	37.19	12.53	35.21	105	156	Peak

Remarks:

- Emission Level = Read Level + Antenna Factor + Cable Loss - Preamp Factor  
Margin value = Emission level – Limit value
- 5240 MHz: Fundamental Frequency
- \*: Out of Restricted Band

EUT Test Condition		Measurement Detail	
Channel	Channel 52	Frequency Range	1 GHz ~ 40 GHz
Input Power	120 Vac, 60 Hz	Detector Function	Peak (PK) Average (AV)
Environmental Conditions	25 deg. C, 65 % RH	Tested By	Karl Lee

Antenna Polarity & Test Distance: Horizontal at 3 m										
Frequency (MHz)	Emission Level (dBuV/m)	Read Level (dBuV)	Limit (dBuV/m)	Margin (dB)	Antenna Factor (dB/m)	Cable Loss (dB)	Preamp Factor (dB)	Antenna Height (cm)	Table Angle (Degree)	Remark
5141.9	43.37	35.11	54	-10.63	34.12	8.13	33.99	209	299	Average
5148.35	54.23	45.98	74	-19.77	34.12	8.13	34	209	299	Peak
5260	99.94	91.48			34.21	8.26	34.01	209	299	Average
5260	106.95	98.49			34.21	8.26	34.01	209	299	Peak
*10520	47.55	32.96	54	-6.45	37.21	12.61	35.23	153	191	Average
*10520	56.19	41.6	74	-17.81	37.21	12.61	35.23	153	191	Peak
Antenna Polarity & Test Distance: Vertical at 3 m										
Frequency (MHz)	Emission Level (dBuV/m)	Read Level (dBuV)	Limit (dBuV/m)	Margin (dB)	Antenna Factor (dB/m)	Cable Loss (dB)	Preamp Factor (dB)	Antenna Height (cm)	Table Angle (Degree)	Remark
5064.8	53.61	45.51	74	-20.39	34.05	8.03	33.98	218	4	Peak
5120.45	42.94	34.74	54	-11.06	34.09	8.1	33.99	218	4	Average
5260	92.47	84.01			34.21	8.26	34.01	218	4	Average
5260	99.86	91.4			34.21	8.26	34.01	218	4	Peak
*10520	47.37	32.78	54	-6.63	37.21	12.61	35.23	156	255	Average
*10520	56.51	41.92	74	-17.49	37.21	12.61	35.23	156	255	Peak

Remarks:

- Emission Level = Read Level + Antenna Factor + Cable Loss - Preamp Factor  
Margin value = Emission level – Limit value
- 5260 MHz: Fundamental Frequency
- \*: Out of Restricted Band

EUT Test Condition		Measurement Detail	
Channel	Channel 60	Frequency Range	1 GHz ~ 40 GHz
Input Power	120 Vac, 60 Hz	Detector Function	Peak (PK) Average (AV)
Environmental Conditions	25 deg. C, 65 % RH	Tested By	Karl Lee

Antenna Polarity & Test Distance: Horizontal at 3 m										
Frequency (MHz)	Emission Level (dBuV/m)	Read Level (dBuV)	Limit (dBuV/m)	Margin (dB)	Antenna Factor (dB/m)	Cable Loss (dB)	Preamp Factor (dB)	Antenna Height (cm)	Table Angle (Degree)	Remark
5016.5	53.9	45.89	74	-20.1	34.01	7.97	33.97	209	299	Peak
5125.25	43.27	35.05	54	-10.73	34.11	8.1	33.99	209	299	Average
5300	99.4	90.86			34.24	8.32	34.02	209	299	Average
5300	106.28	97.74			34.24	8.32	34.02	209	299	Peak
5350.99	45.49	36.86	54	-8.51	34.28	8.38	34.03	209	299	Average
5367.27	55.64	46.97	74	-18.36	34.29	8.41	34.03	209	299	Peak
Antenna Polarity & Test Distance: Vertical at 3 m										
Frequency (MHz)	Emission Level (dBuV/m)	Read Level (dBuV)	Limit (dBuV/m)	Margin (dB)	Antenna Factor (dB/m)	Cable Loss (dB)	Preamp Factor (dB)	Antenna Height (cm)	Table Angle (Degree)	Remark
5111	42.98	34.78	54	-11.02	34.09	8.1	33.99	218	4	Average
5144.15	53.68	45.43	74	-20.32	34.12	8.13	34	218	4	Peak
5300	92.86	84.32			34.24	8.32	34.02	218	4	Average
5300	99.57	91.03			34.24	8.32	34.02	218	4	Peak
5351.98	43.52	34.89	54	-10.48	34.28	8.38	34.03	218	4	Average
5445.92	53.78	44.95	74	-20.22	34.36	8.51	34.04	218	4	Peak

Remarks:

- Emission Level = Read Level + Antenna Factor + Cable Loss - Preamp Factor  
Margin value = Emission level – Limit value
- 5300 MHz: Fundamental Frequency

EUT Test Condition		Measurement Detail	
Channel	Channel 64	Frequency Range	1 GHz ~ 40 GHz
Input Power	120 Vac, 60 Hz	Detector Function	Peak (PK) Average (AV)
Environmental Conditions	25 deg. C, 65 % RH	Tested By	Karl Lee

Antenna Polarity & Test Distance: Horizontal at 3 m										
Frequency (MHz)	Emission Level (dBuV/m)	Read Level (dBuV)	Limit (dBuV/m)	Margin (dB)	Antenna Factor (dB/m)	Cable Loss (dB)	Preamp Factor (dB)	Antenna Height (cm)	Table Angle (Degree)	Remark
5320	99.26	90.68			34.25	8.35	34.02	209	299	Average
5320	106.74	98.16			34.25	8.35	34.02	209	299	Peak
5350.33	49.84	41.21	54	-4.16	34.28	8.38	34.03	209	299	Average
5356.6	59.39	50.76	74	-14.61	34.28	8.38	34.03	209	299	Peak
10640	47.4	32.67	54	-6.6	37.31	12.71	35.29	141	146	Average
10640	56.29	41.56	74	-17.71	37.31	12.71	35.29	141	146	Peak

Antenna Polarity & Test Distance: Vertical at 3 m										
Frequency (MHz)	Emission Level (dBuV/m)	Read Level (dBuV)	Limit (dBuV/m)	Margin (dB)	Antenna Factor (dB/m)	Cable Loss (dB)	Preamp Factor (dB)	Antenna Height (cm)	Table Angle (Degree)	Remark
5320	92.1	83.52			34.25	8.35	34.02	218	4	Average
5320	99.61	91.03			34.25	8.35	34.02	218	4	Peak
5350.44	56.3	47.67	74	-17.7	34.28	8.38	34.03	218	4	Peak
5350.66	45.75	37.12	54	-8.25	34.28	8.38	34.03	218	4	Average
10640	47.49	32.76	54	-6.51	37.31	12.71	35.29	147	224	Average
10640	56.77	42.04	74	-17.23	37.31	12.71	35.29	147	224	Peak

Remarks:

- Emission Level = Read Level + Antenna Factor + Cable Loss - Preamp Factor  
Margin value = Emission level – Limit value
- 5320 MHz: Fundamental Frequency



EUT Test Condition		Measurement Detail	
Channel	Channel 100	Frequency Range	1 GHz ~ 40 GHz
Input Power	120 Vac, 60 Hz	Detector Function	Peak (PK) Average (AV)
Environmental Conditions	25 deg. C, 65 % RH	Tested By	Karl Lee

Antenna Polarity & Test Distance: Horizontal at 3 m										
Frequency (MHz)	Emission Level (dBuV/m)	Read Level (dBuV)	Limit (dBuV/m)	Margin (dB)	Antenna Factor (dB/m)	Cable Loss (dB)	Preamp Factor (dB)	Antenna Height (cm)	Table Angle (Degree)	Remark
5455.12	55.48	46.66	74	-18.52	34.36	8.51	34.05	116	357	Peak
5459.44	44.29	35.47	54	-9.71	34.36	8.51	34.05	116	357	Average
*5468.72	55.13	46.3	74	-18.87	34.37	8.51	34.05	116	357	Peak
*5470.8	45.22	36.36	54	-8.78	34.37	8.54	34.05	116	357	Average
5500	94.4	85.48			34.4	8.57	34.05	116	357	Average
5500	101.74	92.82			34.4	8.57	34.05	116	357	Peak
11000	49.18	34.1	54	-4.82	37.6	12.96	35.48	136	48	Average
11000	57.26	42.18	74	-16.74	37.6	12.96	35.48	136	48	Peak

Antenna Polarity & Test Distance: Vertical at 3 m										
Frequency (MHz)	Emission Level (dBuV/m)	Read Level (dBuV)	Limit (dBuV/m)	Margin (dB)	Antenna Factor (dB/m)	Cable Loss (dB)	Preamp Factor (dB)	Antenna Height (cm)	Table Angle (Degree)	Remark
5377.68	53.28	44.6	74	-20.72	34.31	8.41	34.04	106	28	Peak
5447.92	43.51	34.68	54	-10.49	34.36	8.51	34.04	106	28	Average
*5470.64	43.64	34.81	54	-10.36	34.37	8.51	34.05	106	28	Average
*5470.96	52.93	44.07	74	-21.07	34.37	8.54	34.05	106	28	Peak
5500	88.57	79.65			34.4	8.57	34.05	106	28	Average
5500	96.58	87.66			34.4	8.57	34.05	106	28	Peak
11000	49.16	34.08	54	-4.84	37.6	12.96	35.48	158	109	Average
11000	57.15	42.07	74	-16.85	37.6	12.96	35.48	158	109	Peak

Remarks:

- Emission Level = Read Level + Antenna Factor + Cable Loss - Preamp Factor  
Margin value = Emission level – Limit value
- 5500 MHz: Fundamental Frequency
- \*: Out of Restricted Band

EUT Test Condition		Measurement Detail	
Channel	Channel 116	Frequency Range	1 GHz ~ 40 GHz
Input Power	120 Vac, 60 Hz	Detector Function	Peak (PK) Average (AV)
Environmental Conditions	25 deg. C, 65 % RH	Tested By	Karl Lee

Antenna Polarity & Test Distance: Horizontal at 3 m										
Frequency (MHz)	Emission Level (dBuV/m)	Read Level (dBuV)	Limit (dBuV/m)	Margin (dB)	Antenna Factor (dB/m)	Cable Loss (dB)	Preamp Factor (dB)	Antenna Height (cm)	Table Angle (Degree)	Remark
5437.2	53.92	45.13	74	-20.08	34.35	8.48	34.04	114	357	Peak
5443.44	43.19	34.4	54	-10.81	34.35	8.48	34.04	114	357	Average
*5470.16	43.22	34.39	54	-10.78	34.37	8.51	34.05	114	357	Average
*5470.8	54.34	45.48	74	-19.66	34.37	8.54	34.05	114	357	Peak
5580	93.98	84.99			34.47	8.6	34.08	114	357	Average
5580	101.67	92.68			34.47	8.6	34.08	114	357	Peak
*5724.04	54.18	45.02	74	-19.82	34.62	8.65	34.11	114	357	Peak
*5725.8	43.66	34.5	54	-10.34	34.62	8.65	34.11	114	357	Average

Antenna Polarity & Test Distance: Vertical at 3 m										
Frequency (MHz)	Emission Level (dBuV/m)	Read Level (dBuV)	Limit (dBuV/m)	Margin (dB)	Antenna Factor (dB/m)	Cable Loss (dB)	Preamp Factor (dB)	Antenna Height (cm)	Table Angle (Degree)	Remark
5436.24	54.2	45.41	74	-19.8	34.35	8.48	34.04	156	326	Peak
5450	43.11	34.29	54	-10.89	34.36	8.51	34.05	156	326	Average
*5469.52	42.87	34.04	54	-11.13	34.37	8.51	34.05	156	326	Average
*5470.16	52.84	44.01	74	-21.16	34.37	8.51	34.05	156	326	Peak
5580	88.23	79.24			34.47	8.6	34.08	156	326	Average
5580	96.51	87.52			34.47	8.6	34.08	156	326	Peak
*5724.04	43.46	34.3	54	-10.54	34.62	8.65	34.11	156	326	Average
*5724.92	53.38	44.22	74	-20.62	34.62	8.65	34.11	156	326	Peak

Remarks:

- Emission Level = Read Level + Antenna Factor + Cable Loss - Preamp Factor  
Margin value = Emission level – Limit value
- 5580 MHz: Fundamental Frequency
- \*: Out of Restricted Band

EUT Test Condition		Measurement Detail	
Channel	Channel 140	Frequency Range	1 GHz ~ 40 GHz
Input Power	120 Vac, 60 Hz	Detector Function	Peak (PK) Average (AV)
Environmental Conditions	25 deg. C, 65 % RH	Tested By	Karl Lee

Antenna Polarity & Test Distance: Horizontal at 3 m										
Frequency (MHz)	Emission Level (dBuV/m)	Read Level (dBuV)	Limit (dBuV/m)	Margin (dB)	Antenna Factor (dB/m)	Cable Loss (dB)	Preamp Factor (dB)	Antenna Height (cm)	Table Angle (Degree)	Remark
5700	94.62	85.49			34.59	8.64	34.1	103	47	Average
5700	102.79	93.66			34.59	8.64	34.1	103	47	Peak
*5724.36	46.36	37.2	54	-7.64	34.62	8.65	34.11	103	47	Average
*5724.68	60.6	51.44	74	-13.4	34.62	8.65	34.11	103	47	Peak
11400	48.39	33.29	54	-5.61	37.84	12.67	35.41	108	39	Average
11400	56.44	41.34	74	-17.56	37.84	12.67	35.41	108	39	Peak
Antenna Polarity & Test Distance: Vertical at 3 m										
Frequency (MHz)	Emission Level (dBuV/m)	Read Level (dBuV)	Limit (dBuV/m)	Margin (dB)	Antenna Factor (dB/m)	Cable Loss (dB)	Preamp Factor (dB)	Antenna Height (cm)	Table Angle (Degree)	Remark
5700	89.4	80.27			34.59	8.64	34.1	120	326	Average
5700	96.91	87.78			34.59	8.64	34.1	120	326	Peak
*5724.28	44.58	35.42	54	-9.42	34.62	8.65	34.11	120	326	Average
*5725.24	56.06	46.9	74	-17.94	34.62	8.65	34.11	120	326	Peak
11400	48.03	32.93	54	-5.97	37.84	12.67	35.41	164	117	Average
11400	56.32	41.22	74	-17.68	37.84	12.67	35.41	164	117	Peak

Remarks:

- Emission Level = Read Level + Antenna Factor + Cable Loss - Preamp Factor  
Margin value = Emission level – Limit value
- 5700 MHz: Fundamental Frequency
- \*: Out of Restricted Band

EUT Test Condition		Measurement Detail	
Channel	Channel 149	Frequency Range	1 GHz ~ 40 GHz
Input Power	120 Vac, 60 Hz	Detector Function	Peak (PK) Average (AV)
Environmental Conditions	25 deg. C, 65 % RH	Tested By	Karl Lee

<Spurious Emission>

Antenna Polarity & Test Distance: Horizontal at 3 m										
Frequency (MHz)	Emission Level (dBuV/m)	Read Level (dBuV)	Limit (dBuV/m)	Margin (dB)	Antenna Factor (dB/m)	Cable Loss (dB)	Preamp Factor (dB)	Antenna Height (cm)	Table Angle (Degree)	Remark
5745	93.09	83.9			34.64	8.66	34.11	110	353	Average
5745	100.91	91.72			34.64	8.66	34.11	110	353	Peak
11490	48	32.88	54	-6	37.89	12.62	35.39	100	146	Average
11490	57.47	42.35	74	-16.53	37.89	12.62	35.39	100	146	Peak
Antenna Polarity & Test Distance: Vertical at 3 m										
Frequency (MHz)	Emission Level (dBuV/m)	Read Level (dBuV)	Limit (dBuV/m)	Margin (dB)	Antenna Factor (dB/m)	Cable Loss (dB)	Preamp Factor (dB)	Antenna Height (cm)	Table Angle (Degree)	Remark
5745	89.44	80.25			34.64	8.66	34.11	104	252	Average
5745	97.07	87.88			34.64	8.66	34.11	104	252	Peak
11490	47.67	32.55	54	-6.33	37.89	12.62	35.39	142	247	Average
11490	57.59	42.47	74	-16.41	37.89	12.62	35.39	142	247	Peak

<Radiated Out of Band Emission (OOBE)>

**Antenna Polarity & Test Distance: Horizontal at 3 m**

Frequency (MHz)	Emission Level (dBuV/m)	Read Level (dBuV)	Limit (dBuV/m)	Margin (dB)	Antenna Factor (dB/m)	Cable Loss (dB)	Preamp Factor (dB)	Antenna Height (cm)	Table Angle (Degree)	Remark
*5620.23	43.48	34.43	54	-10.52	34.52	8.61	34.08	110	353	Average
*5620.75	54.21	45.16	74	-19.79	34.52	8.61	34.08	110	353	Peak
5656.98	54.28	45.19	78.35	-24.07	34.56	8.63	34.1	110	353	Peak
5918.43	53.82	44.44	78.1	-24.28	34.81	8.73	34.16	110	353	Peak
*5935.75	43.81	34.41	54	-10.19	34.83	8.73	34.16	110	353	Average
*5935.75	55.23	45.83	74	-18.77	34.83	8.73	34.16	110	353	Peak

**Antenna Polarity & Test Distance: Vertical at 3 m**

Frequency (MHz)	Emission Level (dBuV/m)	Read Level (dBuV)	Limit (dBuV/m)	Margin (dB)	Antenna Factor (dB/m)	Cable Loss (dB)	Preamp Factor (dB)	Antenna Height (cm)	Table Angle (Degree)	Remark
*5586.63	42.92	33.91	54	-11.08	34.49	8.6	34.08	104	252	Average
*5586.63	55.32	46.31	74	-18.68	34.49	8.6	34.08	104	252	Peak
5652.78	53.21	44.11	75.73	-22.52	34.56	8.63	34.09	104	252	Peak
5918.43	54.88	45.5	78.1	-23.22	34.81	8.73	34.16	104	252	Peak
*6003.48	43.91	34.42	54	-10.09	34.9	8.76	34.17	104	252	Average
*6003.48	54.42	44.93	74	-19.58	34.9	8.76	34.17	104	252	Peak

Remarks:

- Emission Level = Read Level + Antenna Factor + Cable Loss - Preamp Factor  
Margin value = Emission level – Limit value
- 5745 MHz: Fundamental Frequency
- \*: Out of Restricted Band

EUT Test Condition		Measurement Detail	
Channel	Channel 157	Frequency Range	1 GHz ~ 40 GHz
Input Power	120 Vac, 60 Hz	Detector Function	Peak (PK) Average (AV)
Environmental Conditions	25 deg. C, 65 % RH	Tested By	Karl Lee

**<Spurious Emission>**

Antenna Polarity & Test Distance: Horizontal at 3 m										
Frequency (MHz)	Emission Level (dBuV/m)	Read Level (dBuV)	Limit (dBuV/m)	Margin (dB)	Antenna Factor (dB/m)	Cable Loss (dB)	Preamp Factor (dB)	Antenna Height (cm)	Table Angle (Degree)	Remark
5785	94.75	85.52			34.68	8.68	34.13	100	353	Average
5785	102.9	93.67			34.68	8.68	34.13	100	353	Peak
11570	47.85	32.54	54	-6.15	38	12.68	35.37	120	206	Average
11570	57.21	41.9	74	-16.79	38	12.68	35.37	120	206	Peak
Antenna Polarity & Test Distance: Vertical at 3 m										
Frequency (MHz)	Emission Level (dBuV/m)	Read Level (dBuV)	Limit (dBuV/m)	Margin (dB)	Antenna Factor (dB/m)	Cable Loss (dB)	Preamp Factor (dB)	Antenna Height (cm)	Table Angle (Degree)	Remark
5785	89.6	80.37			34.68	8.68	34.13	104	252	Average
5785	97.38	88.15			34.68	8.68	34.13	104	252	Peak
11570	47.96	32.65	54	-6.04	38	12.68	35.37	101	114	Average
11570	57.52	42.21	74	-16.48	38	12.68	35.37	101	114	Peak

<Radiated Out of Band Emission (OOBE)>

**Antenna Polarity & Test Distance: Horizontal at 3 m**

Frequency (MHz)	Emission Level (dBuV/m)	Read Level (dBuV)	Limit (dBuV/m)	Margin (dB)	Antenna Factor (dB/m)	Cable Loss (dB)	Preamp Factor (dB)	Antenna Height (cm)	Table Angle (Degree)	Remark
*5605	44.67	35.64	54	-9.33	34.5	8.61	34.08	100	353	Average
*5605	53.79	44.76	74	-20.21	34.5	8.61	34.08	100	353	Peak
5658.03	55.18	46.09	79.01	-23.83	34.56	8.63	34.1	100	353	Peak
5921.05	52.77	43.39	76.46	-23.69	34.81	8.73	34.16	100	353	Peak
*6003.48	45.26	35.77	54	-8.74	34.9	8.76	34.17	100	353	Average
*6003.48	54.5	45.01	74	-19.5	34.9	8.76	34.17	100	353	Peak

**Antenna Polarity & Test Distance: Vertical at 3 m**

Frequency (MHz)	Emission Level (dBuV/m)	Read Level (dBuV)	Limit (dBuV/m)	Margin (dB)	Antenna Factor (dB/m)	Cable Loss (dB)	Preamp Factor (dB)	Antenna Height (cm)	Table Angle (Degree)	Remark
*5535.7	44.56	35.62	54	-9.44	34.43	8.58	34.07	104	252	Average
*5535.7	53.31	44.37	74	-20.69	34.43	8.58	34.07	104	252	Peak
5652.25	50.49	41.4	75.4	-24.91	34.56	8.62	34.09	104	252	Peak
5921.05	52.75	43.37	76.46	-23.71	34.81	8.73	34.16	104	252	Peak
*5977.23	45.17	35.71	54	-8.83	34.88	8.75	34.17	104	252	Average
*5977.23	54.79	45.33	74	-19.21	34.88	8.75	34.17	104	252	Peak

Remarks:

- Emission Level = Read Level + Antenna Factor + Cable Loss - Preamp Factor  
Margin value = Emission level – Limit value
- 5785 MHz: Fundamental Frequency
- \*: Out of Restricted Band

EUT Test Condition		Measurement Detail	
Channel	Channel 165	Frequency Range	1 GHz ~ 40 GHz
Input Power	120 Vac, 60 Hz	Detector Function	Peak (PK) Average (AV)
Environmental Conditions	25 deg. C, 65 % RH	Tested By	Karl Lee

<Spurious Emission>

Antenna Polarity & Test Distance: Horizontal at 3 m										
Frequency (MHz)	Emission Level (dBuV/m)	Read Level (dBuV)	Limit (dBuV/m)	Margin (dB)	Antenna Factor (dB/m)	Cable Loss (dB)	Preamp Factor (dB)	Antenna Height (cm)	Table Angle (Degree)	Remark
5825	94.87	85.58			34.73	8.69	34.13	121	353	Average
5825	102.74	93.45			34.73	8.69	34.13	121	353	Peak
11650	48.3	32.77	54	-5.7	38.09	12.8	35.36	138	328	Average
11650	56.37	40.84	74	-17.63	38.09	12.8	35.36	138	328	Peak
Antenna Polarity & Test Distance: Vertical at 3 m										
Frequency (MHz)	Emission Level (dBuV/m)	Read Level (dBuV)	Limit (dBuV/m)	Margin (dB)	Antenna Factor (dB/m)	Cable Loss (dB)	Preamp Factor (dB)	Antenna Height (cm)	Table Angle (Degree)	Remark
5825	89.87	80.58			34.73	8.69	34.13	102	252	Average
5825	97.8	88.51			34.73	8.69	34.13	102	252	Peak
11650	47.93	32.4	54	-6.07	38.09	12.8	35.36	156	122	Average
11650	56.89	41.36	74	-17.11	38.09	12.8	35.36	156	122	Peak



<Radiated Out of Band Emission (OOBE)>

**Antenna Polarity & Test Distance: Horizontal at 3 m**

Frequency (MHz)	Emission Level (dBuV/m)	Read Level (dBuV)	Limit (dBuV/m)	Margin (dB)	Antenna Factor (dB/m)	Cable Loss (dB)	Preamp Factor (dB)	Antenna Height (cm)	Table Angle (Degree)	Remark
*5628.63	44.69	35.64	54	-9.31	34.52	8.62	34.09	121	353	Average
*5628.63	54.52	45.47	74	-19.48	34.52	8.62	34.09	121	353	Peak
5651.2	54.22	45.13	74.75	-20.53	34.56	8.62	34.09	121	353	Peak
5913.7	54.46	45.08	81.05	-26.59	34.81	8.73	34.16	121	353	Peak
*5975.13	45.11	35.65	54	-8.89	34.88	8.75	34.17	121	353	Average
*5975.13	54.32	44.86	74	-19.68	34.88	8.75	34.17	121	353	Peak

**Antenna Polarity & Test Distance: Vertical at 3 m**

Frequency (MHz)	Emission Level (dBuV/m)	Read Level (dBuV)	Limit (dBuV/m)	Margin (dB)	Antenna Factor (dB/m)	Cable Loss (dB)	Preamp Factor (dB)	Antenna Height (cm)	Table Angle (Degree)	Remark
*5609.73	44.51	35.48	54	-9.49	34.5	8.61	34.08	102	252	Average
*5609.73	54.67	45.64	74	-19.33	34.5	8.61	34.08	102	252	Peak
5655.4	53.92	44.83	77.37	-23.45	34.56	8.63	34.1	102	252	Peak
5920	53.11	43.73	77.12	-24.01	34.81	8.73	34.16	102	252	Peak
*6021.85	45.04	35.53	54	-8.96	34.92	8.77	34.18	102	252	Average
*6021.85	54.14	44.63	74	-19.86	34.92	8.77	34.18	102	252	Peak

Remarks:

- Emission Level = Read Level + Antenna Factor + Cable Loss - Preamp Factor  
Margin value = Emission level – Limit value
- 5825 MHz: Fundamental Frequency
- \*: Out of Restricted Band

802.11n (HT40)

EUT Test Condition		Measurement Detail	
Channel	Channel 38	Frequency Range	1 GHz ~ 40 GHz
Input Power	120 Vac, 60 Hz	Detector Function	Peak (PK) Average (AV)
Environmental Conditions	25 deg. C, 65 % RH	Tested By	Karl Lee

**Antenna Polarity & Test Distance: Horizontal at 3 m**

Frequency (MHz)	Emission Level (dBuV/m)	Read Level (dBuV)	Limit (dBuV/m)	Margin (dB)	Antenna Factor (dB/m)	Cable Loss (dB)	Preamp Factor (dB)	Antenna Height (cm)	Table Angle (Degree)	Remark
5147.3	64.86	56.61	74	-9.14	34.12	8.13	34	207	296	Peak
5149.7	52.8	44.55	54	-1.2	34.12	8.13	34	207	296	Average
5190	95.54	87.2			34.15	8.19	34	207	296	Average
5190	102.11	93.77			34.15	8.19	34	207	296	Peak
5438.44	43.26	34.47	54	-10.74	34.35	8.48	34.04	200	296	Average
5440.53	53.81	45.02	74	-20.19	34.35	8.48	34.04	200	296	Peak

**Antenna Polarity & Test Distance: Vertical at 3 m**

Frequency (MHz)	Emission Level (dBuV/m)	Read Level (dBuV)	Limit (dBuV/m)	Margin (dB)	Antenna Factor (dB/m)	Cable Loss (dB)	Preamp Factor (dB)	Antenna Height (cm)	Table Angle (Degree)	Remark
5148.2	57.77	49.52	74	-16.23	34.12	8.13	34	218	26	Peak
5148.65	48.61	40.36	54	-5.39	34.12	8.13	34	218	26	Average
5190	88.49	80.15			34.15	8.19	34	218	26	Average
5190	95.49	87.15			34.15	8.19	34	218	26	Peak
5446.47	53.91	45.08	74	-20.09	34.36	8.51	34.04	218	26	Peak
5446.8	43.18	34.35	54	-10.82	34.36	8.51	34.04	218	26	Average

Remarks:

- Emission Level = Read Level + Antenna Factor + Cable Loss - Preamp Factor  
Margin value = Emission level – Limit value
- 5190 MHz: Fundamental Frequency

EUT Test Condition		Measurement Detail	
Channel	Channel 46	Frequency Range	1 GHz ~ 40 GHz
Input Power	120 Vac, 60 Hz	Detector Function	Peak (PK) Average (AV)
Environmental Conditions	25 deg. C, 65 % RH	Tested By	Karl Lee

Antenna Polarity & Test Distance: Horizontal at 3 m										
Frequency (MHz)	Emission Level (dBuV/m)	Read Level (dBuV)	Limit (dBuV/m)	Margin (dB)	Antenna Factor (dB/m)	Cable Loss (dB)	Preamp Factor (dB)	Antenna Height (cm)	Table Angle (Degree)	Remark
5142.5	54.79	46.53	74	-19.21	34.12	8.13	33.99	207	296	Peak
5149.7	44.81	36.56	54	-9.19	34.12	8.13	34	207	296	Average
5230	95.66	87.26			34.19	8.22	34.01	207	296	Average
5230	102.08	93.68			34.19	8.22	34.01	207	296	Peak
5437.45	43.23	34.44	54	-10.77	34.35	8.48	34.04	207	296	Average
5452.52	53.85	45.03	74	-20.15	34.36	8.51	34.05	207	296	Peak
Antenna Polarity & Test Distance: Vertical at 3 m										
Frequency (MHz)	Emission Level (dBuV/m)	Read Level (dBuV)	Limit (dBuV/m)	Margin (dB)	Antenna Factor (dB/m)	Cable Loss (dB)	Preamp Factor (dB)	Antenna Height (cm)	Table Angle (Degree)	Remark
5021	54.42	46.39	74	-19.58	34.03	7.97	33.97	218	26	Peak
5144.9	43.31	35.06	54	-10.69	34.12	8.13	34	218	26	Average
5230	88.11	79.71			34.19	8.22	34.01	218	26	Average
5230	95.74	87.34			34.19	8.22	34.01	218	26	Peak
5420.29	43.14	34.37	54	-10.86	34.33	8.48	34.04	218	26	Average
5438.77	55.43	46.64	74	-18.57	34.35	8.48	34.04	218	26	Peak

Remarks:

- Emission Level = Read Level + Antenna Factor + Cable Loss - Preamp Factor  
Margin value = Emission level – Limit value
- 5230 MHz: Fundamental Frequency

EUT Test Condition		Measurement Detail	
Channel	Channel 54	Frequency Range	1 GHz ~ 40 GHz
Input Power	120 Vac, 60 Hz	Detector Function	Peak (PK) Average (AV)
Environmental Conditions	25 deg. C, 65 % RH	Tested By	Karl Lee

Antenna Polarity & Test Distance: Horizontal at 3 m										
Frequency (MHz)	Emission Level (dBuV/m)	Read Level (dBuV)	Limit (dBuV/m)	Margin (dB)	Antenna Factor (dB/m)	Cable Loss (dB)	Preamp Factor (dB)	Antenna Height (cm)	Table Angle (Degree)	Remark
5073.95	53.58	45.46	74	-20.42	34.07	8.03	33.98	209	299	Peak
5129.9	43.39	35.17	54	-10.61	34.11	8.1	33.99	209	299	Average
5270	96.07	87.58			34.21	8.29	34.01	209	299	Average
5270	103.34	94.85			34.21	8.29	34.01	209	299	Peak
5350.11	44.92	36.29	54	-9.08	34.28	8.38	34.03	209	299	Average
5350.44	55.92	47.29	74	-18.08	34.28	8.38	34.03	209	299	Peak
Antenna Polarity & Test Distance: Vertical at 3 m										
Frequency (MHz)	Emission Level (dBuV/m)	Read Level (dBuV)	Limit (dBuV/m)	Margin (dB)	Antenna Factor (dB/m)	Cable Loss (dB)	Preamp Factor (dB)	Antenna Height (cm)	Table Angle (Degree)	Remark
5098.25	54.02	45.86	74	-19.98	34.08	8.07	33.99	218	4	Peak
5103.65	43.05	34.89	54	-10.95	34.08	8.07	33.99	218	4	Average
5270	89.9	81.41			34.21	8.29	34.01	218	4	Average
5270	96.31	87.82			34.21	8.29	34.01	218	4	Peak
5350.88	53.56	44.93	74	-20.44	34.28	8.38	34.03	218	4	Peak
5352.53	43.38	34.75	54	-10.62	34.28	8.38	34.03	218	4	Average

Remarks:

- Emission Level = Read Level + Antenna Factor + Cable Loss - Preamp Factor  
Margin value = Emission level – Limit value
- 5270 MHz: Fundamental Frequency

EUT Test Condition		Measurement Detail	
Channel	Channel 62	Frequency Range	1 GHz ~ 40 GHz
Input Power	120 Vac, 60 Hz	Detector Function	Peak (PK) Average (AV)
Environmental Conditions	25 deg. C, 65 % RH	Tested By	Karl Lee

Antenna Polarity & Test Distance: Horizontal at 3 m										
Frequency (MHz)	Emission Level (dBuV/m)	Read Level (dBuV)	Limit (dBuV/m)	Margin (dB)	Antenna Factor (dB/m)	Cable Loss (dB)	Preamp Factor (dB)	Antenna Height (cm)	Table Angle (Degree)	Remark
5063.75	42.28	34.18	54	-11.72	34.05	8.03	33.98	100	117	Average
5149.25	52.93	44.68	74	-21.07	34.12	8.13	34	100	117	Peak
5310	87.85	79.3			34.25	8.32	34.02	100	117	Average
5310	95.5	86.95			34.25	8.32	34.02	100	117	Peak
5350.22	50.58	41.95	54	-3.42	34.28	8.38	34.03	100	117	Average
5350.88	58.02	49.39	74	-15.98	34.28	8.38	34.03	100	117	Peak
Antenna Polarity & Test Distance: Vertical at 3 m										
Frequency (MHz)	Emission Level (dBuV/m)	Read Level (dBuV)	Limit (dBuV/m)	Margin (dB)	Antenna Factor (dB/m)	Cable Loss (dB)	Preamp Factor (dB)	Antenna Height (cm)	Table Angle (Degree)	Remark
5141.15	42.44	34.18	54	-11.56	34.12	8.13	33.99	270	352	Average
5148.65	53.12	44.87	74	-20.88	34.12	8.13	34	270	352	Peak
5310	82.12	73.57			34.25	8.32	34.02	270	352	Average
5310	89.83	81.28			34.25	8.32	34.02	270	352	Peak
5350.88	45.08	36.45	54	-8.92	34.28	8.38	34.03	270	352	Average
5350.88	55.97	47.34	74	-18.03	34.28	8.38	34.03	270	352	Peak

Remarks:

- Emission Level = Read Level + Antenna Factor + Cable Loss - Preamp Factor  
Margin value = Emission level – Limit value
- 5310 MHz: Fundamental Frequency

EUT Test Condition		Measurement Detail	
Channel	Channel 102	Frequency Range	1 GHz ~ 40 GHz
Input Power	120 Vac, 60 Hz	Detector Function	Peak (PK) Average (AV)
Environmental Conditions	25 deg. C, 65 % RH	Tested By	Karl Lee

Antenna Polarity & Test Distance: Horizontal at 3 m										
Frequency (MHz)	Emissino Level (dBuV/m)	Read Level (dBuV)	Limit (dBuV/m)	Margin (dB)	Antenna Factor (dB/m)	Cable Loss (dB)	Preamp Factor (dB)	Antenna Height (cm)	Table Angle (Degree)	Remark
5458.48	57.58	48.76	74	-16.42	34.36	8.51	34.05	116	357	Peak
5460	47.4	38.58	54	-6.6	34.36	8.51	34.05	116	357	Average
*5468.72	60.44	51.61	74	-13.56	34.37	8.51	34.05	116	357	Peak
*5470.64	50.09	41.26	54	-3.91	34.37	8.51	34.05	116	357	Average
5510	91.56	82.65			34.4	8.57	34.06	116	357	Average
5510	99.59	90.68			34.4	8.57	34.06	116	357	Peak
*5724.28	43.53	34.37	54	-10.47	34.62	8.65	34.11	116	357	Average
*5725.56	52.67	43.51	74	-21.33	34.62	8.65	34.11	116	357	Peak

Antenna Polarity & Test Distance: Vertical at 3 m										
Frequency (MHz)	Emissino Level (dBuV/m)	Read Level (dBuV)	Limit (dBuV/m)	Margin (dB)	Antenna Factor (dB/m)	Cable Loss (dB)	Preamp Factor (dB)	Antenna Height (cm)	Table Angle (Degree)	Remark
5458.96	44.84	36.02	54	-9.16	34.36	8.51	34.05	106	28	Average
5459.76	54	45.18	74	-20	34.36	8.51	34.05	106	28	Peak
*5469.36	57.23	48.4	74	-16.77	34.37	8.51	34.05	106	28	Peak
*5470.32	46.27	37.44	54	-7.73	34.37	8.51	34.05	106	28	Average
5510	85.79	76.88			34.4	8.57	34.06	106	28	Average
5510	92.44	83.53			34.4	8.57	34.06	106	28	Peak
*5725.56	55.53	46.37	74	-18.47	34.62	8.65	34.11	106	28	Peak
*5726.04	43.67	34.51	54	-10.33	34.62	8.65	34.11	106	28	Average

Remarks:

- Emission Level = Read Level + Antenna Factor + Cable Loss - Preamp Factor  
Margin value = Emission level – Limit value
- 5510 MHz: Fundamental Frequency
- \*: Out of Restricted Band

EUT Test Condition		Measurement Detail	
Channel	Channel 110	Frequency Range	1 GHz ~ 40 GHz
Input Power	120 Vac, 60 Hz	Detector Function	Peak (PK) Average (AV)
Environmental Conditions	25 deg. C, 65 % RH	Tested By	Karl Lee

Antenna Polarity & Test Distance: Horizontal at 3 m										
Frequency (MHz)	Emissino Level (dBuV/m)	Read Level (dBuV)	Limit (dBuV/m)	Margin (dB)	Antenna Factor (dB/m)	Cable Loss (dB)	Preamp Factor (dB)	Antenna Height (cm)	Table Angle (Degree)	Remark
5446	44.42	35.59	54	-9.58	34.36	8.51	34.04	114	357	Average
5455.28	54.11	45.29	74	-19.89	34.36	8.51	34.05	114	357	Peak
*5470	44.18	35.35	54	-9.82	34.37	8.51	34.05	114	357	Average
*5470	52.16	43.33	74	-21.84	34.37	8.51	34.05	114	357	Peak
5550	91.04	82.07			34.45	8.59	34.07	114	357	Average
5550	99.23	90.26			34.45	8.59	34.07	114	357	Peak
*5725	44.25	35.09	54	-9.75	34.62	8.65	34.11	114	357	Average
*5725	53.02	43.86	74	-20.98	34.62	8.65	34.11	114	357	Peak

Antenna Polarity & Test Distance: Vertical at 3 m										
Frequency (MHz)	Emissino Level (dBuV/m)	Read Level (dBuV)	Limit (dBuV/m)	Margin (dB)	Antenna Factor (dB/m)	Cable Loss (dB)	Preamp Factor (dB)	Antenna Height (cm)	Table Angle (Degree)	Remark
5367.44	54.78	46.11	74	-19.22	34.29	8.41	34.03	156	326	Peak
5457.2	44.31	35.49	54	-9.69	34.36	8.51	34.05	156	326	Average
*5470	44	35.17	54	-10	34.37	8.51	34.05	156	326	Average
*5470	52.37	43.54	74	-21.63	34.37	8.51	34.05	156	326	Peak
5550	85.32	76.35			34.45	8.59	34.07	156	326	Average
5550	93.05	84.08			34.45	8.59	34.07	156	326	Peak
*5725	44.55	35.39	54	-9.45	34.62	8.65	34.11	156	326	Average
*5725	52.23	43.07	74	-21.77	34.62	8.65	34.11	156	326	Peak

Remarks:

- Emission Level = Read Level + Antenna Factor + Cable Loss - Preamp Factor  
Margin value = Emission level – Limit value
- 5550 MHz: Fundamental Frequency
- \*: Out of Restricted Band

EUT Test Condition		Measurement Detail	
Channel	Channel 134	Frequency Range	1 GHz ~ 40 GHz
Input Power	120 Vac, 60 Hz	Detector Function	Peak (PK) Average (AV)
Environmental Conditions	25 deg. C, 65 % RH	Tested By	Karl Lee

Antenna Polarity & Test Distance: Horizontal at 3 m										
Frequency (MHz)	Emissino Level (dBuV/m)	Read Level (dBuV)	Limit (dBuV/m)	Margin (dB)	Antenna Factor (dB/m)	Cable Loss (dB)	Preamp Factor (dB)	Antenna Height (cm)	Table Angle (Degree)	Remark
5441.84	43.2	34.41	54	-10.8	34.35	8.48	34.04	103	47	Average
5459.6	53.52	44.7	74	-20.48	34.36	8.51	34.05	103	47	Peak
*5469.84	53.12	44.29	74	-20.88	34.37	8.51	34.05	103	47	Peak
*5470.16	43.14	34.31	54	-10.86	34.37	8.51	34.05	103	47	Average
5670	93.03	83.93			34.57	8.63	34.1	103	47	Average
5670	100.96	91.86			34.57	8.63	34.1	103	47	Peak
*5724.12	47.01	37.85	54	-6.99	34.62	8.65	34.11	103	47	Average
*5724.28	57.96	48.8	74	-16.04	34.62	8.65	34.11	103	47	Peak

Antenna Polarity & Test Distance: Vertical at 3 m										
Frequency (MHz)	Emissino Level (dBuV/m)	Read Level (dBuV)	Limit (dBuV/m)	Margin (dB)	Antenna Factor (dB/m)	Cable Loss (dB)	Preamp Factor (dB)	Antenna Height (cm)	Table Angle (Degree)	Remark
5402.48	53.45	44.73	74	-20.55	34.32	8.44	34.04	141	325	Peak
5442.64	43.11	34.32	54	-10.89	34.35	8.48	34.04	141	325	Average
*5468.72	52	43.17	74	-22	34.37	8.51	34.05	141	325	Peak
*5470.8	43.12	34.26	54	-10.88	34.37	8.54	34.05	141	325	Average
5670	87.07	77.97			34.57	8.63	34.1	141	325	Average
5670	94.26	85.16			34.57	8.63	34.1	141	325	Peak
*5723.96	44.52	35.36	54	-9.48	34.62	8.65	34.11	141	325	Average
*5724.52	54.41	45.25	74	-19.59	34.62	8.65	34.11	141	325	Peak

Remarks:

- Emission Level = Read Level + Antenna Factor + Cable Loss - Preamp Factor  
Margin value = Emission level – Limit value
- 5670 MHz: Fundamental Frequency
- \*: Out of Restricted Band



EUT Test Condition		Measurement Detail	
Channel	Channel 151	Frequency Range	1 GHz ~ 40 GHz
Input Power	120 Vac, 60 Hz	Detector Function	Peak (PK) Average (AV)
Environmental Conditions	25 deg. C, 65 % RH	Tested By	Karl Lee

<Spurious Emission>

Antenna Polarity & Test Distance: Horizontal at 3 m										
Frequency (MHz)	Emission Level (dBuV/m)	Read Level (dBuV)	Limit (dBuV/m)	Margin (dB)	Antenna Factor (dB/m)	Cable Loss (dB)	Preamp Factor (dB)	Antenna Height (cm)	Table Angle (Degree)	Remark
5755	90.08	80.87			34.66	8.66	34.11	110	353	Average
5755	98.71	89.5			34.66	8.66	34.11	110	353	Peak
11510	48.11	33	54	-5.89	37.9	12.6	35.39	159	77	Average
11510	56.69	41.58	74	-17.31	37.9	12.6	35.39	159	77	Peak
Antenna Polarity & Test Distance: Vertical at 3 m										
Frequency (MHz)	Emission Level (dBuV/m)	Read Level (dBuV)	Limit (dBuV/m)	Margin (dB)	Antenna Factor (dB/m)	Cable Loss (dB)	Preamp Factor (dB)	Antenna Height (cm)	Table Angle (Degree)	Remark
5755	86.92	77.71			34.66	8.66	34.11	104	252	Average
5755	95.04	85.83			34.66	8.66	34.11	104	252	Peak
11510	48.25	33.14	54	-5.75	37.9	12.6	35.39	130	359	Average
11510	56.65	41.54	74	-17.35	37.9	12.6	35.39	130	359	Peak

<Radiated Out of Band Emission (OOBE)>

**Antenna Polarity & Test Distance: Horizontal at 3 m**

Frequency (MHz)	Emission Level (dBuV/m)	Read Level (dBuV)	Limit (dBuV/m)	Margin (dB)	Antenna Factor (dB/m)	Cable Loss (dB)	Preamp Factor (dB)	Antenna Height (cm)	Table Angle (Degree)	Remark
*5541.48	43.02	34.08	54	-10.98	34.43	8.58	34.07	110	353	Average
*5541.48	54.74	45.8	74	-19.26	34.43	8.58	34.07	110	353	Peak
5661.7	54.72	45.63	81.3	-26.58	34.56	8.63	34.1	110	353	Peak
5915.28	54.82	45.44	80.07	-25.25	34.81	8.73	34.16	110	353	Peak
*5941	43.81	34.38	54	-10.19	34.85	8.74	34.16	110	353	Average
*5941	56.02	46.59	74	-17.98	34.85	8.74	34.16	110	353	Peak

**Antenna Polarity & Test Distance: Vertical at 3 m**

Frequency (MHz)	Emission Level (dBuV/m)	Read Level (dBuV)	Limit (dBuV/m)	Margin (dB)	Antenna Factor (dB/m)	Cable Loss (dB)	Preamp Factor (dB)	Antenna Height (cm)	Table Angle (Degree)	Remark
*5617.08	43.39	34.34	54	-10.61	34.52	8.61	34.08	104	252	Average
*5617.08	54.47	45.42	74	-19.53	34.52	8.61	34.08	104	252	Peak
5663.8	53.09	44	82.61	-29.52	34.56	8.63	34.1	104	252	Peak
5908.98	54.03	44.66	84	-29.97	34.81	8.72	34.16	104	252	Peak
*5996.65	44.07	34.58	54	-9.93	34.9	8.76	34.17	104	252	Average
*5996.65	54.77	45.28	74	-19.23	34.9	8.76	34.17	104	252	Peak

Remarks:

- Emission Level = Read Level + Antenna Factor + Cable Loss - Preamp Factor  
Margin value = Emission level – Limit value
- 5755 MHz: Fundamental Frequency
- \*: Out of Restricted Band

EUT Test Condition		Measurement Detail	
Channel	Channel 159	Frequency Range	1 GHz ~ 40 GHz
Input Power	120 Vac, 60 Hz	Detector Function	Peak (PK) Average (AV)
Environmental Conditions	25 deg. C, 65 % RH	Tested By	Karl Lee

<Spurious Emission>

Antenna Polarity & Test Distance: Horizontal at 3 m										
Frequency (MHz)	Emission Level (dBuV/m)	Read Level (dBuV)	Limit (dBuV/m)	Margin (dB)	Antenna Factor (dB/m)	Cable Loss (dB)	Preamp Factor (dB)	Antenna Height (cm)	Table Angle (Degree)	Remark
5795	92.87	83.63			34.69	8.68	34.13	121	353	Average
5795	99.73	90.49			34.69	8.68	34.13	121	353	Peak
11590	48.4	33.03	54	-5.6	38.02	12.72	35.37	159	115	Average
11590	57.08	41.71	74	-16.92	38.02	12.72	35.37	159	115	Peak
Antenna Polarity & Test Distance: Vertical at 3 m										
Frequency (MHz)	Emission Level (dBuV/m)	Read Level (dBuV)	Limit (dBuV/m)	Margin (dB)	Antenna Factor (dB/m)	Cable Loss (dB)	Preamp Factor (dB)	Antenna Height (cm)	Table Angle (Degree)	Remark
5795	87.14	77.9			34.69	8.68	34.13	102	252	Average
5795	94.37	85.13			34.69	8.68	34.13	102	252	Peak
11590	48.32	32.95	54	-5.68	38.02	12.72	35.37	135	55	Average
11590	57.33	41.96	74	-16.67	38.02	12.72	35.37	135	55	Peak

<Radiated Out of Band Emission (OOBE)>

**Antenna Polarity & Test Distance: Horizontal at 3 m**

Frequency (MHz)	Emission Level (dBuV/m)	Read Level (dBuV)	Limit (dBuV/m)	Margin (dB)	Antenna Factor (dB/m)	Cable Loss (dB)	Preamp Factor (dB)	Antenna Height (cm)	Table Angle (Degree)	Remark
*5514.18	44.88	35.95	54	-9.12	34.42	8.57	34.06	121	353	Average
*5514.18	54.01	45.08	74	-19.99	34.42	8.57	34.06	121	353	Peak
5654.35	51	41.91	76.71	-25.71	34.56	8.63	34.1	121	353	Peak
5921.58	53.05	43.65	76.14	-23.09	34.83	8.73	34.16	121	353	Peak
*5948.35	45.49	36.06	54	-8.51	34.85	8.74	34.16	121	353	Average
*5948.35	53.9	44.47	74	-20.1	34.85	8.74	34.16	121	353	Peak

**Antenna Polarity & Test Distance: Vertical at 3 m**

Frequency (MHz)	Emission Level (dBuV/m)	Read Level (dBuV)	Limit (dBuV/m)	Margin (dB)	Antenna Factor (dB/m)	Cable Loss (dB)	Preamp Factor (dB)	Antenna Height (cm)	Table Angle (Degree)	Remark
*5596.08	45.43	36.42	54	-8.57	34.49	8.6	34.08	102	252	Average
*5596.08	54.49	45.48	74	-19.51	34.49	8.6	34.08	102	252	Peak
5653.3	52.45	43.35	76.06	-23.61	34.56	8.63	34.09	102	252	Peak
5923.15	53.2	43.8	75.15	-21.95	34.83	8.73	34.16	102	252	Peak
*5991.93	46.11	36.62	54	-7.89	34.9	8.76	34.17	102	252	Average
*5991.93	54.29	44.8	74	-19.71	34.9	8.76	34.17	102	252	Peak

Remarks:

- Emission Level = Read Level + Antenna Factor + Cable Loss - Preamp Factor  
Margin value = Emission level – Limit value
- 5795 MHz: Fundamental Frequency
- \*: Out of Restricted Band

802.11ac (VHT80)

EUT Test Condition		Measurement Detail	
Channel	Channel 42	Frequency Range	1 GHz ~ 40 GHz
Input Power	120 Vac, 60 Hz	Detector Function	Peak (PK) Average (AV)
Environmental Conditions	25 deg. C, 65 % RH	Tested By	Karl Lee

**Antenna Polarity & Test Distance: Horizontal at 3 m**

Frequency (MHz)	Emission Level (dBuV/m)	Read Level (dBuV)	Limit (dBuV/m)	Margin (dB)	Antenna Factor (dB/m)	Cable Loss (dB)	Preamp Factor (dB)	Antenna Height (cm)	Table Angle (Degree)	Remark
5147.3	50.71	42.46	54	-3.29	34.12	8.13	34	211	299	Average
5148.8	58.12	49.87	74	-15.88	34.12	8.13	34	211	299	Peak
5210	85.84	77.48			34.17	8.19	34	211	299	Average
5210	93.1	84.74			34.17	8.19	34	211	299	Peak
5362.87	44.72	36.08	54	-9.28	34.29	8.38	34.03	211	299	Average
5368.48	54.1	45.43	74	-19.9	34.29	8.41	34.03	211	299	Peak

**Antenna Polarity & Test Distance: Vertical at 3 m**

Frequency (MHz)	Emission Level (dBuV/m)	Read Level (dBuV)	Limit (dBuV/m)	Margin (dB)	Antenna Factor (dB/m)	Cable Loss (dB)	Preamp Factor (dB)	Antenna Height (cm)	Table Angle (Degree)	Remark
5115.95	54.47	46.27	74	-19.53	34.09	8.1	33.99	290	0	Peak
5148.95	45.16	36.91	54	-8.84	34.12	8.13	34	290	0	Average
5210	79.92	71.56			34.17	8.19	34	290	0	Average
5210	87.01	78.65			34.17	8.19	34	290	0	Peak
5393.12	44.32	35.61	54	-9.68	34.31	8.44	34.04	290	0	Average
5450.43	54.41	45.59	74	-19.59	34.36	8.51	34.05	290	0	Peak

Remarks:

- Emission Level = Read Level + Antenna Factor + Cable Loss - Preamp Factor  
Margin value = Emission level – Limit value
- 5210 MHz: Fundamental Frequency

EUT Test Condition		Measurement Detail	
Channel	Channel 58	Frequency Range	1 GHz ~ 40 GHz
Input Power	120 Vac, 60 Hz	Detector Function	Peak (PK) Average (AV)
Environmental Conditions	25 deg. C, 65 % RH	Tested By	Karl Lee

Antenna Polarity & Test Distance: Horizontal at 3 m										
Frequency (MHz)	Emission Level (dBuV/m)	Read Level (dBuV)	Limit (dBuV/m)	Margin (dB)	Antenna Factor (dB/m)	Cable Loss (dB)	Preamp Factor (dB)	Antenna Height (cm)	Table Angle (Degree)	Remark
5064.95	53.86	45.76	74	-20.14	34.05	8.03	33.98	211	299	Peak
5098.85	43.83	35.67	54	-10.17	34.08	8.07	33.99	211	299	Average
5290	86.35	77.82			34.23	8.32	34.02	211	299	Average
5290	94.48	85.95			34.23	8.32	34.02	211	299	Peak
5351.21	64.7	56.07	74	-9.3	34.28	8.38	34.03	211	299	Peak
5352.31	52.81	44.18	54	-1.19	34.28	8.38	34.03	211	299	Average
Antenna Polarity & Test Distance: Vertical at 3 m										
Frequency (MHz)	Emission Level (dBuV/m)	Read Level (dBuV)	Limit (dBuV/m)	Margin (dB)	Antenna Factor (dB/m)	Cable Loss (dB)	Preamp Factor (dB)	Antenna Height (cm)	Table Angle (Degree)	Remark
5034.8	53.23	45.17	74	-20.77	34.03	8	33.97	284	6	Peak
5053.1	43.94	35.88	54	-10.06	34.04	8	33.98	284	6	Average
5290	79.61	71.08			34.23	8.32	34.02	284	6	Average
5290	88.27	79.74			34.23	8.32	34.02	284	6	Peak
5350.55	48.45	39.82	54	-5.55	34.28	8.38	34.03	284	6	Average
5352.09	58	49.37	74	-16	34.28	8.38	34.03	284	6	Peak

Remarks:

- Emission Level = Read Level + Antenna Factor + Cable Loss - Preamp Factor  
Margin value = Emission level – Limit value
- 5290 MHz: Fundamental Frequency

EUT Test Condition		Measurement Detail	
Channel	Channel 106	Frequency Range	1 GHz ~ 40 GHz
Input Power	120 Vac, 60 Hz	Detector Function	Peak (PK) Average (AV)
Environmental Conditions	25 deg. C, 65 % RH	Tested By	Karl Lee

Antenna Polarity & Test Distance: Horizontal at 3 m										
Frequency (MHz)	Emission Level (dBuV/m)	Read Level (dBuV)	Limit (dBuV/m)	Margin (dB)	Antenna Factor (dB/m)	Cable Loss (dB)	Preamp Factor (dB)	Antenna Height (cm)	Table Angle (Degree)	Remark
5453.68	57.76	48.94	74	-16.24	34.36	8.51	34.05	116	357	Peak
5458.48	48.82	40	54	-5.18	34.36	8.51	34.05	116	357	Average
*5470	48.57	39.74	54	-5.43	34.37	8.51	34.05	116	357	Average
*5470	56.88	48.05	74	-17.12	34.37	8.51	34.05	116	357	Peak
5530	87.87	78.94			34.42	8.58	34.07	116	357	Average
5530	95.1	86.17			34.42	8.58	34.07	116	357	Peak
*5725	45.09	35.93	54	-8.91	34.62	8.65	34.11	116	357	Average
*5725	51.69	42.53	74	-22.31	34.62	8.65	34.11	116	357	Peak

Antenna Polarity & Test Distance: Vertical at 3 m										
Frequency (MHz)	Emission Level (dBuV/m)	Read Level (dBuV)	Limit (dBuV/m)	Margin (dB)	Antenna Factor (dB/m)	Cable Loss (dB)	Preamp Factor (dB)	Antenna Height (cm)	Table Angle (Degree)	Remark
5442.64	54.84	46.05	74	-19.16	34.35	8.48	34.04	105	28	Peak
5452.4	45.69	36.87	54	-8.31	34.36	8.51	34.05	105	28	Average
*5470	45	36.17	54	-9	34.37	8.51	34.05	105	28	Average
*5470	52.29	43.46	74	-21.71	34.37	8.51	34.05	105	28	Peak
5530	81.85	72.92			34.42	8.58	34.07	105	28	Average
5530	88.55	79.62			34.42	8.58	34.07	105	28	Peak
*5725	44.71	35.55	54	-9.29	34.62	8.65	34.11	105	28	Average
*5725	52.7	43.54	74	-21.3	34.62	8.65	34.11	105	28	Peak

Remarks:

- Emission Level = Read Level + Antenna Factor + Cable Loss - Preamp Factor  
Margin value = Emission level – Limit value
- 5530 MHz: Fundamental Frequency
- \*: Out of Restricted Band

EUT Test Condition		Measurement Detail	
Channel	Channel 122	Frequency Range	1 GHz ~ 40 GHz
Input Power	120 Vac, 60 Hz	Detector Function	Peak (PK) Average (AV)
Environmental Conditions	25 deg. C, 65 % RH	Tested By	Karl Lee

Antenna Polarity & Test Distance: Horizontal at 3 m										
Frequency (MHz)	Emission Level (dBuV/m)	Read Level (dBuV)	Limit (dBuV/m)	Margin (dB)	Antenna Factor (dB/m)	Cable Loss (dB)	Preamp Factor (dB)	Antenna Height (cm)	Table Angle (Degree)	Remark
5459.12	54.75	45.93	74	-19.25	34.36	8.51	34.05	100	49	Peak
5459.92	45.19	36.37	54	-8.81	34.36	8.51	34.05	100	49	Average
*5470	44.85	36.02	54	-9.15	34.37	8.51	34.05	100	49	Average
*5470	52.63	43.8	74	-21.37	34.37	8.51	34.05	100	49	Peak
5610	89.07	80.04			34.5	8.61	34.08	100	49	Average
5610	97.11	88.08			34.5	8.61	34.08	100	49	Peak
*5725	45.37	36.21	54	-8.63	34.62	8.65	34.11	100	49	Average
*5725	52.61	43.45	74	-21.39	34.62	8.65	34.11	100	49	Peak

Antenna Polarity & Test Distance: Vertical at 3 m										
Frequency (MHz)	Emission Level (dBuV/m)	Read Level (dBuV)	Limit (dBuV/m)	Margin (dB)	Antenna Factor (dB/m)	Cable Loss (dB)	Preamp Factor (dB)	Antenna Height (cm)	Table Angle (Degree)	Remark
5435.92	54.04	45.25	74	-19.96	34.35	8.48	34.04	174	326	Peak
5457.84	44.62	35.8	54	-9.38	34.36	8.51	34.05	174	326	Average
*5470	44.1	35.27	54	-9.9	34.37	8.51	34.05	174	326	Average
*5470	51.45	42.62	74	-22.55	34.37	8.51	34.05	174	326	Peak
5610	83.94	74.91			34.5	8.61	34.08	174	326	Average
5610	91.11	82.08			34.5	8.61	34.08	174	326	Peak
*5725	45.16	36	54	-8.84	34.62	8.65	34.11	174	326	Average
*5725	54.03	44.87	74	-19.97	34.62	8.65	34.11	174	326	Peak

Remarks:

- Emission Level = Read Level + Antenna Factor + Cable Loss - Preamp Factor  
Margin value = Emission level – Limit value
- 5610 MHz: Fundamental Frequency
- \*: Out of Restricted Band



EUT Test Condition		Measurement Detail	
Channel	Channel 155	Frequency Range	1 GHz ~ 40 GHz
Input Power	120 Vac, 60 Hz	Detector Function	Peak (PK) Average (AV)
Environmental Conditions	25 deg. C, 65 % RH	Tested By	Karl Lee

<Spurious Emission>

Antenna Polarity & Test Distance: Horizontal at 3 m										
Frequency (MHz)	Emission Level (dBuV/m)	Read Level (dBuV)	Limit (dBuV/m)	Margin (dB)	Antenna Factor (dB/m)	Cable Loss (dB)	Preamp Factor (dB)	Antenna Height (cm)	Table Angle (Degree)	Remark
5755	90.08	80.87			34.66	8.66	34.11	110	353	Average
5755	98.71	89.5			34.66	8.66	34.11	110	353	Peak
11510	48.11	33	54	-5.89	37.9	12.6	35.39	159	77	Average
11510	56.69	41.58	74	-17.31	37.9	12.6	35.39	159	77	Peak
Antenna Polarity & Test Distance: Vertical at 3 m										
Frequency (MHz)	Emission Level (dBuV/m)	Read Level (dBuV)	Limit (dBuV/m)	Margin (dB)	Antenna Factor (dB/m)	Cable Loss (dB)	Preamp Factor (dB)	Antenna Height (cm)	Table Angle (Degree)	Remark
5755	86.92	77.71			34.66	8.66	34.11	104	252	Average
5755	95.04	85.83			34.66	8.66	34.11	104	252	Peak
11510	48.25	33.14	54	-5.75	37.9	12.6	35.39	130	359	Average
11510	56.65	41.54	74	-17.35	37.9	12.6	35.39	130	359	Peak

<Radiated Out of Band Emission (OOBE)>

**Antenna Polarity & Test Distance: Horizontal at 3 m**

Frequency (MHz)	Emission Level (dBuV/m)	Read Level (dBuV)	Limit (dBuV/m)	Margin (dB)	Antenna Factor (dB/m)	Cable Loss (dB)	Preamp Factor (dB)	Antenna Height (cm)	Table Angle (Degree)	Remark
*5541.48	43.02	34.08	54	-10.98	34.43	8.58	34.07	110	353	Average
*5541.48	54.74	45.8	74	-19.26	34.43	8.58	34.07	110	353	Peak
5661.7	54.72	45.63	81.3	-26.58	34.56	8.63	34.1	110	353	Peak
5915.28	54.82	45.44	80.07	-25.25	34.81	8.73	34.16	110	353	Peak
*5941	43.81	34.38	54	-10.19	34.85	8.74	34.16	110	353	Average
*5941	56.02	46.59	74	-17.98	34.85	8.74	34.16	110	353	Peak

**Antenna Polarity & Test Distance: Vertical at 3 m**

Frequency (MHz)	Emission Level (dBuV/m)	Read Level (dBuV)	Limit (dBuV/m)	Margin (dB)	Antenna Factor (dB/m)	Cable Loss (dB)	Preamp Factor (dB)	Antenna Height (cm)	Table Angle (Degree)	Remark
*5617.08	43.39	34.34	54	-10.61	34.52	8.61	34.08	104	252	Average
*5617.08	54.47	45.42	74	-19.53	34.52	8.61	34.08	104	252	Peak
5663.8	53.09	44	82.61	-29.52	34.56	8.63	34.1	104	252	Peak
5908.98	54.03	44.66	84	-29.97	34.81	8.72	34.16	104	252	Peak
*5996.65	44.07	34.58	54	-9.93	34.9	8.76	34.17	104	252	Average
*5996.65	54.77	45.28	74	-19.23	34.9	8.76	34.17	104	252	Peak

Remarks:

- Emission Level = Read Level + Antenna Factor + Cable Loss - Preamp Factor  
Margin value = Emission level – Limit value
- 5775 MHz: Fundamental Frequency
- \*: Out of Restricted Band

**Mode B**  
**802.11n (HT40)**

EUT Test Condition		Measurement Detail	
Channel	Channel 38	Frequency Range	1 GHz ~ 40 GHz
Input Power	120 Vac, 60 Hz	Detector Function	Peak (PK) Average (AV)
Environmental Conditions	25 deg. C, 65 % RH	Tested By	Karl Lee

Antenna Polarity & Test Distance: Horizontal at 3 m										
Frequency (MHz)	Emission Level (dBuV/m)	Read Level (dBuV)	Limit (dBuV/m)	Margin (dB)	Antenna Factor (dB/m)	Cable Loss (dB)	Preamp Factor (dB)	Antenna Height (cm)	Table Angle (Degree)	Remark
5148.95	61.58	53.33	74	-12.42	34.12	8.13	34	116	357	Peak
5149.7	50.16	41.91	54	-3.84	34.12	8.13	34	116	357	Average
5190	88.41	80.07			34.15	8.19	34	116	357	Average
5190	96.12	87.78			34.15	8.19	34	116	357	Peak
5378.49	53.07	44.39	74	-20.93	34.31	8.41	34.04	116	357	Peak
5446.03	42.7	33.87	54	-11.3	34.36	8.51	34.04	116	357	Average

Antenna Polarity & Test Distance: Vertical at 3 m										
Frequency (MHz)	Emission Level (dBuV/m)	Read Level (dBuV)	Limit (dBuV/m)	Margin (dB)	Antenna Factor (dB/m)	Cable Loss (dB)	Preamp Factor (dB)	Antenna Height (cm)	Table Angle (Degree)	Remark
5146.85	62.89	54.64	74	-11.11	34.12	8.13	34	219	0	Peak
5149.4	51.74	43.49	54	-2.26	34.12	8.13	34	219	0	Average
5190	93.53	85.19			34.15	8.19	34	219	0	Average
5190	101.14	92.8			34.15	8.19	34	219	0	Peak
5374.86	42.97	34.31	54	-11.03	34.29	8.41	34.04	219	0	Average
5439.98	54.36	45.57	74	-19.64	34.35	8.48	34.04	219	0	Peak

Remarks:

- Emission Level = Read Level + Antenna Factor + Cable Loss - Preamp Factor  
Margin value = Emission level – Limit value
- 5190 MHz: Fundamental Frequency

802.11ac (VHT80)

EUT Test Condition		Measurement Detail	
Channel	Channel 58	Frequency Range	1 GHz ~ 40 GHz
Input Power	120 Vac, 60 Hz	Detector Function	Peak (PK) Average (AV)
Environmental Conditions	25 deg. C, 65 % RH	Tested By	Karl Lee

**Antenna Polarity & Test Distance: Horizontal at 3 m**

Frequency (MHz)	Emission Level (dBuV/m)	Read Level (dBuV)	Limit (dBuV/m)	Margin (dB)	Antenna Factor (dB/m)	Cable Loss (dB)	Preamp Factor (dB)	Antenna Height (cm)	Table Angle (Degree)	Remark
5105.6	42.65	34.48	54	-11.35	34.09	8.07	33.99	121	358	Average
5107.85	53.6	45.4	74	-20.4	34.09	8.1	33.99	121	358	Peak
5290	85.85	77.32			34.23	8.32	34.02	121	358	Average
5290	94.17	85.64			34.23	8.32	34.02	121	358	Peak
5356.49	49.21	40.58	54	-4.79	34.28	8.38	34.03	121	358	Average
5357.37	59.28	50.65	74	-14.72	34.28	8.38	34.03	121	358	Peak

**Antenna Polarity & Test Distance: Vertical at 3 m**

Frequency (MHz)	Emission Level (dBuV/m)	Read Level (dBuV)	Limit (dBuV/m)	Margin (dB)	Antenna Factor (dB/m)	Cable Loss (dB)	Preamp Factor (dB)	Antenna Height (cm)	Table Angle (Degree)	Remark
5149.25	55.32	47.07	74	-18.68	34.12	8.13	34	185	4	Peak
5150	44.97	36.72	54	-9.03	34.12	8.13	34	185	4	Average
5290	91.79	83.26			34.23	8.32	34.02	185	4	Average
5290	99.33	90.8			34.23	8.32	34.02	185	4	Peak
5350.55	69.19	60.56	74	-4.81	34.28	8.38	34.03	185	4	Peak
5350.88	52.14	43.51	54	-1.86	34.28	8.38	34.03	185	4	Average

Remarks:

- Emission Level = Read Level + Antenna Factor + Cable Loss - Preamp Factor  
Margin value = Emission level – Limit value
- 5290 MHz: Fundamental Frequency

802.11n (HT40)

EUT Test Condition		Measurement Detail	
Channel	Channel 102	Frequency Range	1 GHz ~ 40 GHz
Input Power	120 Vac, 60 Hz	Detector Function	Peak (PK) Average (AV)
Environmental Conditions	25 deg. C, 65 % RH	Tested By	Karl Lee

**Antenna Polarity & Test Distance: Horizontal at 3 m**

Frequency (MHz)	Emission Level (dBuV/m)	Read Level (dBuV)	Limit (dBuV/m)	Margin (dB)	Antenna Factor (dB/m)	Cable Loss (dB)	Preamp Factor (dB)	Antenna Height (cm)	Table Angle (Degree)	Remark
5457.84	54.36	45.54	74	-19.64	34.36	8.51	34.05	194	300	Peak
5459.12	45.98	37.16	54	-8.02	34.36	8.51	34.05	194	300	Average
*5470	47.94	39.11	54	-6.06	34.37	8.51	34.05	194	300	Average
*5470	57.7	48.87	74	-16.3	34.37	8.51	34.05	194	300	Peak
5510	89.83	80.92			34.4	8.57	34.06	194	300	Average
5510	96.74	87.83			34.4	8.57	34.06	194	300	Peak
*5725	44.29	35.13	54	-9.71	34.62	8.65	34.11	194	300	Average
*5725	50.56	41.4	74	-23.44	34.62	8.65	34.11	194	300	Peak

**Antenna Polarity & Test Distance: Vertical at 3 m**

Frequency (MHz)	Emission Level (dBuV/m)	Read Level (dBuV)	Limit (dBuV/m)	Margin (dB)	Antenna Factor (dB/m)	Cable Loss (dB)	Preamp Factor (dB)	Antenna Height (cm)	Table Angle (Degree)	Remark
5459.28	57.43	48.61	74	-16.57	34.36	8.51	34.05	177	0	Peak
5459.92	48.37	39.55	54	-5.63	34.36	8.51	34.05	177	0	Average
*5470	50.03	41.2	54	-3.97	34.37	8.51	34.05	177	0	Average
*5470	59.53	50.7	74	-14.47	34.37	8.51	34.05	177	0	Peak
5510	93.63	84.72			34.4	8.57	34.06	177	0	Average
5510	101.07	92.16			34.4	8.57	34.06	177	0	Peak
*5725	44.46	35.3	54	-9.54	34.62	8.65	34.11	177	0	Average
*5725	51.98	42.82	74	-22.02	34.62	8.65	34.11	177	0	Peak

Remarks:

- Emission Level = Read Level + Antenna Factor + Cable Loss - Preamp Factor  
Margin value = Emission level – Limit value
- 5510 MHz: Fundamental Frequency
- \*: Out of Restricted Band

**802.11ac (VHT80)**

EUT Test Condition		Measurement Detail	
Channel	Channel 155	Frequency Range	1 GHz ~ 40 GHz
Input Power	120 Vac, 60 Hz	Detector Function	Peak (PK) Average (AV)
Environmental Conditions	25 deg. C, 65 % RH	Tested By	Karl Lee

**<Spurious Emission>**

Antenna Polarity & Test Distance: Horizontal at 3 m										
Frequency (MHz)	Emission Level (dBuV/m)	Read Level (dBuV)	Limit (dBuV/m)	Margin (dB)	Antenna Factor (dB/m)	Cable Loss (dB)	Preamp Factor (dB)	Antenna Height (cm)	Table Angle (Degree)	Remark
5775	87.59	78.36			34.68	8.67	34.12	265	295	Average
5775	95.49	86.26			34.68	8.67	34.12	265	295	Peak
11550	47.97	32.7	54	-6.03	37.97	12.68	35.38	169	274	Average
11550	56.94	41.67	74	-17.06	37.97	12.68	35.38	169	274	Peak
Antenna Polarity & Test Distance: Vertical at 3 m										
Frequency (MHz)	Emission Level (dBuV/m)	Read Level (dBuV)	Limit (dBuV/m)	Margin (dB)	Antenna Factor (dB/m)	Cable Loss (dB)	Preamp Factor (dB)	Antenna Height (cm)	Table Angle (Degree)	Remark
5775	92.84	83.61			34.68	8.67	34.12	126	343	Average
5775	100.54	91.31			34.68	8.67	34.12	126	343	Peak
11550	48.04	32.77	54	-5.96	37.97	12.68	35.38	138	126	Average
11550	56.42	41.15	74	-17.58	37.97	12.68	35.38	138	126	Peak

<Radiated Out of Band Emission (OOBE)>

**Antenna Polarity & Test Distance: Horizontal at 3 m**

Frequency (MHz)	Emission Level (dBuV/m)	Read Level (dBuV)	Limit (dBuV/m)	Margin (dB)	Antenna Factor (dB/m)	Cable Loss (dB)	Preamp Factor (dB)	Antenna Height (cm)	Table Angle (Degree)	Remark
*5512.08	43	34.09	54	-11	34.4	8.57	34.06	265	295	Average
*5512.08	53.97	45.06	74	-20.03	34.4	8.57	34.06	265	295	Peak
5663.28	57.46	48.37	82.28	-24.82	34.56	8.63	34.1	265	295	Peak
5911.08	54.19	44.82	82.69	-28.5	34.81	8.72	34.16	265	295	Peak
*5929.45	44.25	34.85	54	-9.75	34.83	8.73	34.16	265	295	Average
*5929.45	54.48	45.08	74	-19.52	34.83	8.73	34.16	265	295	Peak

**Antenna Polarity & Test Distance: Vertical at 3 m**

Frequency (MHz)	Emission Level (dBuV/m)	Read Level (dBuV)	Limit (dBuV/m)	Margin (dB)	Antenna Factor (dB/m)	Cable Loss (dB)	Preamp Factor (dB)	Antenna Height (cm)	Table Angle (Degree)	Remark
*5568.25	44.08	35.09	54	-9.92	34.47	8.59	34.07	126	343	Average
*5568.25	55.02	46.03	74	-18.98	34.47	8.59	34.07	126	343	Peak
5657.5	55.59	46.5	78.68	-23.09	34.56	8.63	34.1	126	343	Peak
5918.43	54.21	44.83	78.1	-23.89	34.81	8.73	34.16	126	343	Peak
*6003.48	43.88	34.39	54	-10.12	34.9	8.76	34.17	126	343	Average
*6003.48	54.28	44.79	74	-19.72	34.9	8.76	34.17	126	343	Peak

Remarks:

- Emission Level = Read Level + Antenna Factor + Cable Loss - Preamp Factor  
Margin value = Emission level – Limit value
- 5775 MHz: Fundamental Frequency
- \*: Out of Restricted Band

**9 kHz ~ 30 MHz DATA:**

The amplitude of spurious emissions attenuated more than 20 dB below the permissible value is not required to be report.

**30 MHz ~ 1 GHz WORST-CASE DATA:**

**Mode A**

**802.11n (HT40)**

EUT Test Condition		Measurement Detail	
Channel	Channel 38	Frequency Range	30 MHz ~ 1 GHz
Input Power	120 Vac, 60 Hz	Detector Function	Peak (PK) Quasi-peak (QP)
Environmental Conditions	25 deg. C, 65 % RH	Tested By	Karl Lee

Antenna Polarity & Test Distance: Horizontal at 3 m										
Frequency (MHz)	Emission Level (dBuV/m)	Read Level (dBuV)	Limit (dBuV/m)	Margin (dB)	Antenna Factor (dB/m)	Cable Loss (dB)	Preamp Factor (dB)	Antenna Height (cm)	Table Angle (Degree)	Remark
81.57	21.31	43.89	40	-18.69	8.47	1.11	32.16	124	151	Peak
169.86	32.27	52.99	43.5	-11.23	10	1.52	32.24	101	144	Peak
218.19	28.95	47.89	46	-17.05	11.63	1.65	32.22	147	185	Peak
472.2	19.52	30.27	46	-26.48	18.81	2.56	32.12	125	115	Peak
625.5	23.01	30.15	46	-22.99	22.1	2.93	32.17	111	121	Peak
799.1	26.24	30.38	46	-19.76	24.6	3.32	32.06	131	165	Peak

Antenna Polarity & Test Distance: Vertical at 3 m										
Frequency (MHz)	Emission Level (dBuV/m)	Read Level (dBuV)	Limit (dBuV/m)	Margin (dB)	Antenna Factor (dB/m)	Cable Loss (dB)	Preamp Factor (dB)	Antenna Height (cm)	Table Angle (Degree)	Remark
33.78	33.6	50	40	-6.4	15.1	0.74	32.24	196	172	Peak
68.34	18.46	41.87	40	-21.54	7.91	0.9	32.22	131	142	Peak
153.66	24	44.36	43.5	-19.5	10.39	1.52	32.27	102	154	Peak
474.3	19.38	30.04	46	-26.62	18.9	2.56	32.12	102	114	Peak
692	24.8	30.66	46	-21.2	23.19	3.05	32.1	131	162	Peak
857.2	26.08	30.39	46	-19.92	24	3.44	31.75	102	115	Peak

Remarks:

- Emission Level = Read Level + Antenna Factor + Cable Loss - Preamp Factor  
Margin value = Emission level – Limit value



**802.11ac (VHT80)**

EUT Test Condition		Measurement Detail	
Channel	Channel 58	Frequency Range	30 MHz ~ 1 GHz
Input Power	120 Vac, 60 Hz	Detector Function	Peak (PK) Quasi-peak (QP)
Environmental Conditions	25 deg. C, 65 % RH	Tested By	Karl Lee

**Antenna Polarity & Test Distance: Horizontal at 3 m**

Frequency (MHz)	Emission Level (dBuV/m)	Read Level (dBuV)	Limit (dBuV/m)	Margin (dB)	Antenna Factor (dB/m)	Cable Loss (dB)	Preamp Factor (dB)	Antenna Height (cm)	Table Angle (Degree)	Remark
33.51	23.3	39.58	40	-16.7	15.22	0.74	32.24	164	332	Peak
169.86	32.37	53.09	43.5	-11.13	10	1.52	32.24	154	269	Peak
250.05	25.84	43.09	46	-20.16	13	1.85	32.1	187	352	Peak
407.1	17.63	29.48	46	-28.37	17.95	2.41	32.21	201	165	Peak
649.3	23.34	30.4	46	-22.66	22.1	2.99	32.15	143	222	Peak
925.8	29.45	31.01	46	-16.55	26.2	3.53	31.29	198	64	Peak

**Antenna Polarity & Test Distance: Vertical at 3 m**

Frequency (MHz)	Emission Level (dBuV/m)	Read Level (dBuV)	Limit (dBuV/m)	Margin (dB)	Antenna Factor (dB/m)	Cable Loss (dB)	Preamp Factor (dB)	Antenna Height (cm)	Table Angle (Degree)	Remark
33.24	34.45	50.49	40	-5.55	15.47	0.74	32.25	187	234	Peak
157.17	24.18	44.31	43.5	-19.32	10.62	1.52	32.27	143	201	Peak
254.64	25.71	42.75	46	-20.29	13.12	1.94	32.1	185	258	Peak
414.8	18.43	30.37	46	-27.57	17.85	2.41	32.2	143	257	Peak
671.7	24.14	29.81	46	-21.86	23.4	3.05	32.12	124	94	Peak
928.6	28.72	30.17	46	-17.28	26.2	3.62	31.27	236	198	Peak

Remarks:

- Emission Level = Read Level + Antenna Factor + Cable Loss - Preamp Factor  
Margin value = Emission level – Limit value

### 802.11n (HT40)

EUT Test Condition		Measurement Detail	
Channel	Channel 102	Frequency Range	30 MHz ~ 1 GHz
Input Power	120 Vac, 60 Hz	Detector Function	Peak (PK) Quasi-peak (QP)
Environmental Conditions	25 deg. C, 65 % RH	Tested By	Karl Lee

#### Antenna Polarity & Test Distance: Horizontal at 3 m

Frequency (MHz)	Emission Level (dBuV/m)	Read Level (dBuV)	Limit (dBuV/m)	Margin (dB)	Antenna Factor (dB/m)	Cable Loss (dB)	Preamp Factor (dB)	Antenna Height (cm)	Table Angle (Degree)	Remark
33.51	23.27	39.55	40	-16.73	15.22	0.74	32.24	200	32	Peak
169.86	32.6	53.32	43.5	-10.9	10	1.52	32.24	199	328	Peak
257.07	25.58	42.53	46	-20.42	13.21	1.94	32.1	143	333	Peak
414.8	18.32	30.26	46	-27.68	17.85	2.41	32.2	179	233	Peak
677.3	25.1	30.81	46	-20.9	23.36	3.05	32.12	135	219	Peak
932.8	28.91	30.33	46	-17.09	26.2	3.62	31.24	129	296	Peak

#### Antenna Polarity & Test Distance: Vertical at 3 m

Frequency (MHz)	Emission Level (dBuV/m)	Read Level (dBuV)	Limit (dBuV/m)	Margin (dB)	Antenna Factor (dB/m)	Cable Loss (dB)	Preamp Factor (dB)	Antenna Height (cm)	Table Angle (Degree)	Remark
33.78	34.21	50.61	40	-5.79	15.1	0.74	32.24	154	301	Peak
152.58	23.62	44.09	43.5	-19.88	10.28	1.52	32.27	169	354	Peak
254.91	25.66	42.66	46	-20.34	13.16	1.94	32.1	132	198	Peak
451.2	18.6	30.25	46	-27.4	18	2.49	32.14	156	93	Peak
692.7	24.69	30.49	46	-21.31	23.19	3.11	32.1	178	205	Peak
938.4	29.08	30.46	46	-16.92	26.2	3.62	31.2	206	91	Peak

Remarks:

- Emission Level = Read Level + Antenna Factor + Cable Loss - Preamp Factor  
Margin value = Emission level – Limit value

**802.11ac (VHT80)**

EUT Test Condition		Measurement Detail	
Channel	Channel 155	Frequency Range	30 MHz ~ 1 GHz
Input Power	120 Vac, 60 Hz	Detector Function	Peak (PK) Quasi-peak (QP)
Environmental Conditions	25 deg. C, 65 % RH	Tested By	Karl Lee

**Antenna Polarity & Test Distance: Horizontal at 3 m**

Frequency (MHz)	Emission Level (dBuV/m)	Read Level (dBuV)	Limit (dBuV/m)	Margin (dB)	Antenna Factor (dB/m)	Cable Loss (dB)	Preamp Factor (dB)	Antenna Height (cm)	Table Angle (Degree)	Remark
37.29	18.81	37.41	40	-21.19	12.89	0.74	32.23	111	299	Peak
169.86	31.89	52.61	43.5	-11.61	10	1.52	32.24	102	334	Peak
261.93	25.12	41.92	46	-20.88	13.37	1.94	32.11	132	195	Peak
364.4	16.18	29.69	46	-29.82	16.34	2.26	32.11	203	157	Peak
531.7	21.75	30.64	46	-24.25	20.57	2.7	32.16	152	183	Peak
916.7	28.36	30.23	46	-17.64	25.96	3.53	31.36	231	254	Peak

**Antenna Polarity & Test Distance: Vertical at 3 m**

Frequency (MHz)	Emission Level (dBuV/m)	Read Level (dBuV)	Limit (dBuV/m)	Margin (dB)	Antenna Factor (dB/m)	Cable Loss (dB)	Preamp Factor (dB)	Antenna Height (cm)	Table Angle (Degree)	Remark
34.05	33.11	49.75	40	-6.89	14.86	0.74	32.24	136	196	Peak
157.17	23.94	44.07	43.5	-19.56	10.62	1.52	32.27	178	279	Peak
264.36	24.36	41.12	46	-21.64	13.41	1.94	32.11	132	186	Peak
419.7	16.67	28.68	46	-29.33	17.77	2.41	32.19	184	135	Peak
699.7	23.89	29.77	46	-22.11	23.1	3.11	32.09	181	132	Peak
935.6	27.59	28.98	46	-18.41	26.2	3.62	31.21	121	255	Peak

Remarks:

- Emission Level = Read Level + Antenna Factor + Cable Loss - Preamp Factor  
Margin value = Emission level – Limit value

**Mode B**  
**802.11n (HT40)**

EUT Test Condition		Measurement Detail	
Channel	Channel 38	Frequency Range	30 MHz ~ 1 GHz
Input Power	120 Vac, 60 Hz	Detector Function	Peak (PK) Quasi-peak (QP)
Environmental Conditions	25 deg. C, 65 % RH	Tested By	Karl Lee

Antenna Polarity & Test Distance: Horizontal at 3 m										
Frequency (MHz)	Emission Level (dBuV/m)	Read Level (dBuV)	Limit (dBuV/m)	Margin (dB)	Antenna Factor (dB/m)	Cable Loss (dB)	Preamp Factor (dB)	Antenna Height (cm)	Table Angle (Degree)	Remark
156.09	26.98	47.22	43.5	-16.52	10.51	1.52	32.27	159	10	Peak
164.19	28.54	48.84	43.5	-14.96	10.44	1.52	32.26	185	226	Peak
250.86	23.56	40.68	46	-22.44	13.04	1.94	32.1	134	118	Peak
468.7	18.62	29.56	46	-27.38	18.63	2.56	32.13	170	186	Peak
619.9	22.34	29.63	46	-23.66	21.96	2.93	32.18	122	336	Peak
701.1	24.07	29.95	46	-21.93	23.1	3.11	32.09	161	113	Peak

Antenna Polarity & Test Distance: Vertical at 3 m										
Frequency (MHz)	Emission Level (dBuV/m)	Read Level (dBuV)	Limit (dBuV/m)	Margin (dB)	Antenna Factor (dB/m)	Cable Loss (dB)	Preamp Factor (dB)	Antenna Height (cm)	Table Angle (Degree)	Remark
164.46	27.76	48.06	43.5	-15.74	10.44	1.52	32.26	155	211	Peak
189.03	22.28	42.52	43.5	-21.22	10.4	1.61	32.25	122	107	Peak
257.88	20.29	37.2	46	-25.71	13.25	1.94	32.1	133	194	Peak
510	19.99	29.72	46	-26.01	19.76	2.63	32.12	199	247	Peak
603.8	23.46	31.54	46	-22.54	21.24	2.87	32.19	106	350	Peak
694.1	24.42	30.26	46	-21.58	23.14	3.11	32.09	164	159	Peak

Remarks:

- Emission Level = Read Level + Antenna Factor + Cable Loss - Preamp Factor  
Margin value = Emission level – Limit value

802.11ac (VHT80)

EUT Test Condition		Measurement Detail	
Channel	Channel 58	Frequency Range	30 MHz ~ 1 GHz
Input Power	120 Vac, 60 Hz	Detector Function	Peak (PK) Quasi-peak (QP)
Environmental Conditions	25 deg. C, 65 % RH	Tested By	Karl Lee

**Antenna Polarity & Test Distance: Horizontal at 3 m**

Frequency (MHz)	Emission Level (dBuV/m)	Read Level (dBuV)	Limit (dBuV/m)	Margin (dB)	Antenna Factor (dB/m)	Cable Loss (dB)	Preamp Factor (dB)	Antenna Height (cm)	Table Angle (Degree)	Remark
149.07	27.24	47.95	43.5	-16.26	10.04	1.52	32.27	127	240	Peak
164.19	28.81	49.11	43.5	-14.69	10.44	1.52	32.26	128	288	Peak
249.51	23.72	40.97	46	-22.28	13	1.85	32.1	149	200	Peak
543.6	20.9	29.94	46	-25.1	20.39	2.76	32.19	150	120	Peak
591.2	21.2	29.79	46	-24.8	20.73	2.87	32.19	194	243	Peak
680.1	24.21	29.96	46	-21.79	23.31	3.05	32.11	168	1	Peak

**Antenna Polarity & Test Distance: Vertical at 3 m**

Frequency (MHz)	Emission Level (dBuV/m)	Read Level (dBuV)	Limit (dBuV/m)	Margin (dB)	Antenna Factor (dB/m)	Cable Loss (dB)	Preamp Factor (dB)	Antenna Height (cm)	Table Angle (Degree)	Remark
156.36	25.98	46.16	43.5	-17.52	10.57	1.52	32.27	198	225	Peak
164.73	28.6	48.9	43.5	-14.9	10.44	1.52	32.26	170	173	Peak
238.98	18.83	36.58	46	-27.17	12.54	1.85	32.14	188	245	Peak
534.5	21.23	30.18	46	-24.77	20.52	2.7	32.17	127	177	Peak
637.4	31.4	38.53	46	-14.6	22.1	2.93	32.16	140	340	Peak
702.5	24.62	30.46	46	-21.38	23.14	3.11	32.09	163	119	Peak

Remarks:

- Emission Level = Read Level + Antenna Factor + Cable Loss - Preamp Factor  
Margin value = Emission level – Limit value

802.11n (HT40)

EUT Test Condition		Measurement Detail	
Channel	Channel 102	Frequency Range	30 MHz ~ 1 GHz
Input Power	120 Vac, 60 Hz	Detector Function	Peak (PK) Quasi-peak (QP)
Environmental Conditions	25 deg. C, 65 % RH	Tested By	Karl Lee

**Antenna Polarity & Test Distance: Horizontal at 3 m**

Frequency (MHz)	Emission Level (dBuV/m)	Read Level (dBuV)	Limit (dBuV/m)	Margin (dB)	Antenna Factor (dB/m)	Cable Loss (dB)	Preamp Factor (dB)	Antenna Height (cm)	Table Angle (Degree)	Remark
148.8	27.01	47.72	43.5	-16.49	10.04	1.52	32.27	127	70	Peak
164.73	28.82	49.12	43.5	-14.68	10.44	1.52	32.26	187	199	Peak
253.83	24.45	41.49	46	-21.55	13.12	1.94	32.1	179	360	Peak
529.6	20.83	29.68	46	-25.17	20.61	2.7	32.16	108	111	Peak
668.2	23.54	29.44	46	-22.46	23.18	3.05	32.13	170	235	Peak
775.3	24.54	29.87	46	-21.46	23.5	3.27	32.1	129	298	Peak

**Antenna Polarity & Test Distance: Vertical at 3 m**

Frequency (MHz)	Emission Level (dBuV/m)	Read Level (dBuV)	Limit (dBuV/m)	Margin (dB)	Antenna Factor (dB/m)	Cable Loss (dB)	Preamp Factor (dB)	Antenna Height (cm)	Table Angle (Degree)	Remark
78.6	18.33	41.08	40	-21.67	8.35	1.11	32.21	178	60	Peak
164.73	28.6	48.9	43.5	-14.9	10.44	1.52	32.26	136	325	Peak
251.4	20.32	37.44	46	-25.68	13.04	1.94	32.1	130	101	Peak
544.3	21.39	30.43	46	-24.61	20.39	2.76	32.19	130	213	Peak
717.2	24.29	29.98	46	-21.71	23.31	3.11	32.11	171	218	Peak
762	24.55	30.1	46	-21.45	23.35	3.22	32.12	123	321	Peak

Remarks:

- Emission Level = Read Level + Antenna Factor + Cable Loss - Preamp Factor  
Margin value = Emission level – Limit value

802.11ac (VHT80)

EUT Test Condition		Measurement Detail	
Channel	Channel 155	Frequency Range	30 MHz ~ 1 GHz
Input Power	120 Vac, 60 Hz	Detector Function	Peak (PK) Quasi-peak (QP)
Environmental Conditions	25 deg. C, 65 % RH	Tested By	Karl Lee

**Antenna Polarity & Test Distance: Horizontal at 3 m**

Frequency (MHz)	Emission Level (dBuV/m)	Read Level (dBuV)	Limit (dBuV/m)	Margin (dB)	Antenna Factor (dB/m)	Cable Loss (dB)	Preamp Factor (dB)	Antenna Height (cm)	Table Angle (Degree)	Remark
89.4	14.96	36.73	43.5	-28.54	8.88	1.11	31.76	149	144	Peak
160.68	28.42	48.44	43.5	-15.08	10.73	1.52	32.27	124	160	Peak
168.24	27.2	47.77	43.5	-16.3	10.15	1.52	32.24	195	155	Peak
500.9	20.48	30.76	46	-25.52	19.19	2.63	32.1	191	320	Peak
529.6	20.76	29.61	46	-25.24	20.61	2.7	32.16	120	217	Peak
801.9	25.94	30.07	46	-20.06	24.6	3.32	32.05	180	119	Peak

**Antenna Polarity & Test Distance: Vertical at 3 m**

Frequency (MHz)	Emission Level (dBuV/m)	Read Level (dBuV)	Limit (dBuV/m)	Margin (dB)	Antenna Factor (dB/m)	Cable Loss (dB)	Preamp Factor (dB)	Antenna Height (cm)	Table Angle (Degree)	Remark
78.87	18.67	41.41	40	-21.33	8.36	1.11	32.21	108	168	Peak
164.46	28.34	48.64	43.5	-15.16	10.44	1.52	32.26	135	55	Peak
241.95	18.86	36.49	46	-27.14	12.65	1.85	32.13	165	355	Peak
484.8	20.39	30.93	46	-25.61	18.94	2.63	32.11	138	225	Peak
611.5	22.01	29.79	46	-23.99	21.53	2.87	32.18	122	285	Peak
776	24.78	30.11	46	-21.22	23.5	3.27	32.1	102	47	Peak

Remarks:

- Emission Level = Read Level + Antenna Factor + Cable Loss - Preamp Factor  
Margin value = Emission level – Limit value

## 4.2 Conducted Emission Measurement

### 4.2.1 Limits of Conducted Emission Measurement

Frequency (MHz)	Conducted Limit (dBuV)	
	Quasi-peak	Average
0.15 - 0.5	66 - 56	56 - 46
0.50 - 5.0	56	46
5.0 - 30.0	60	50

Note: 1. The lower limit shall apply at the transition frequencies.

2. The limit decreases in line with the logarithm of the frequency in the range of 0.15 to 0.50 MHz.

### 4.2.2 Test Instruments

Description & Manufacturer	Model No.	Serial No.	Date Of Calibration	Due Date Of Calibration
Test Receiver ROHDE & SCHWARZ	ESCI	100613	Nov. 16, 2015	Nov. 15, 2016
RF signal cable (with 10dB PAD) Woken	5D-FB	Cable-cond1-01	Dec. 26, 2015	Dec. 25, 2016
LISN ROHDE & SCHWARZ (EUT)	ESH3-Z5	835239/001	Feb. 26, 2016	Feb. 25, 2017
LISN ROHDE & SCHWARZ (Peripheral)	ESH3-Z5	100311	Jul. 28, 2016	Jul. 27, 2017
Software ADT	BV ADT_Cond_ V7.3.7.3	NA	NA	NA

- Note:**
1. The calibration interval of the above test instruments is 12 months and the calibrations are traceable to NML/ROC and NIST/USA.
  2. The test was performed in HwaYa Shielded Room 1.
  3. The VCCI Site Registration No. is C-2040.



#### 4.2.3 Test Procedures

- a. The EUT was placed 0.4 meters from the conducting wall of the shielded room with EUT being connected to the power mains through a line impedance stabilization network (LISN). Other support units were connected to the power mains through another LISN. The two LISNs provide 50 ohm/ 50uH of coupling impedance for the measuring instrument.
- b. Both lines of the power mains connected to the EUT were checked for maximum conducted interference.
- c. The frequency range from 150 kHz to 30 MHz was searched. Emission levels under (Limit -20 dB) was not recorded.

**NOTE:** All modes of operation were investigated and the worst-case emissions are reported.

#### 4.2.4 Deviation from Test Standard

No deviation.

#### 4.2.5 Test Setup

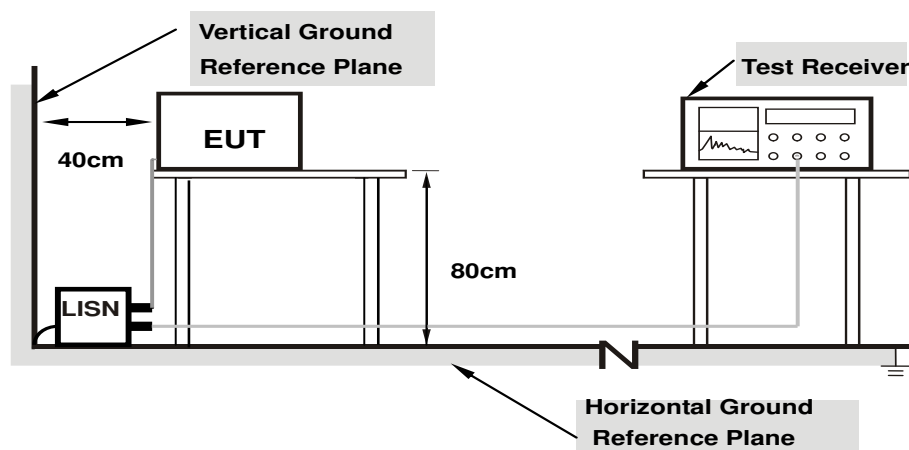

- Note: 1.Support units were connected to second LISN.**  
**2.Both of LISNs (AMN) are 80 cm from EUT and at least 80 from other units and other metal planes**

For the actual test configuration, please refer to the attached file (Test Setup Photo).

#### 4.2.6 EUT Operating Conditions

- a. Placed the EUT on a testing table.
- b. Use the software to control the EUT under transmission condition continuously at specific channel frequency.

#### 4.2.7 Test Results

##### Mode A

Frequency Range	150kHz ~ 30MHz	Detector Function & Resolution Bandwidth	Quasi-Peak (QP) / Average (AV), 9kHz
Input Power	120Vac, 60Hz	Environmental Conditions	25°C, 65%RH
Tested by	Toby Tian	Test Date	2016/9/6

Phase Of Power : Line (L)										
No	Frequency (MHz)	Correction Factor (dB)	Reading Value (dBuV)		Emission Level (dBuV)		Limit (dBuV)		Margin (dB)	
			Q.P.	AV.	Q.P.	AV.	Q.P.	AV.	Q.P.	AV.
1	0.15000	10.01	31.22	17.13	41.23	27.14	66.00	56.00	-24.77	-28.86
2	0.20243	10.03	27.79	17.06	37.82	27.09	63.51	53.51	-25.69	-26.42
3	0.24775	10.05	18.83	6.21	28.88	16.26	61.83	51.83	-32.95	-35.57
4	0.59627	10.15	23.39	12.27	33.54	22.42	56.00	46.00	-22.46	-23.58
5	3.07863	10.35	14.11	7.71	24.46	18.06	56.00	46.00	-31.54	-27.94
6	17.60815	11.19	23.93	15.72	35.12	26.91	60.00	50.00	-24.88	-23.09

##### Remarks:

1. Q.P. and AV. are abbreviations of quasi-peak and average individually.
2. The emission levels of other frequencies were very low against the limit.
3. Margin value = Emission level – Limit value
4. Correction factor = Insertion loss + Cable loss
5. Emission Level = Correction Factor + Reading Value

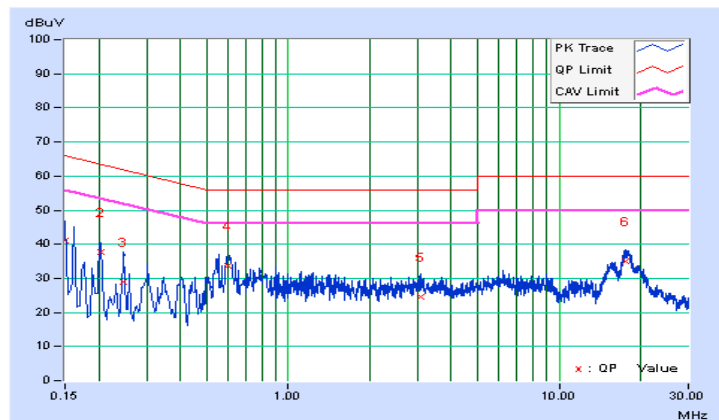

Frequency Range	150kHz ~ 30MHz	Detector Function & Resolution Bandwidth	Quasi-Peak (QP) / Average (AV), 9kHz
Input Power	120Vac, 60Hz	Environmental Conditions	25°C, 65%RH
Tested by	Toby Tian	Test Date	2016/9/6

Phase Of Power : Neutral (N)										
No	Frequency (MHz)	Correction Factor (dB)	Reading Value (dBuV)		Emission Level (dBuV)		Limit (dBuV)		Margin (dB)	
			Q.P.	AV.	Q.P.	AV.	Q.P.	AV.	Q.P.	AV.
1	0.15782	10.03	23.55	10.90	33.58	20.93	65.58	55.58	-32.00	-34.65
2	0.32595	10.10	17.49	7.14	27.59	17.24	59.55	49.55	-31.96	-32.31
3	0.60737	10.16	26.12	12.21	36.28	22.37	56.00	46.00	-19.72	-23.63
4	0.74432	10.18	17.12	5.41	27.30	15.59	56.00	46.00	-28.70	-30.41
5	0.99847	10.21	16.25	3.98	26.46	14.19	56.00	46.00	-29.54	-31.81
6	17.43220	11.29	17.70	11.43	28.99	22.72	60.00	50.00	-31.01	-27.28

Remarks:

1. Q.P. and AV. are abbreviations of quasi-peak and average individually.
2. The emission levels of other frequencies were very low against the limit.
3. Margin value = Emission level – Limit value
4. Correction factor = Insertion loss + Cable loss
5. Emission Level = Correction Factor + Reading Value

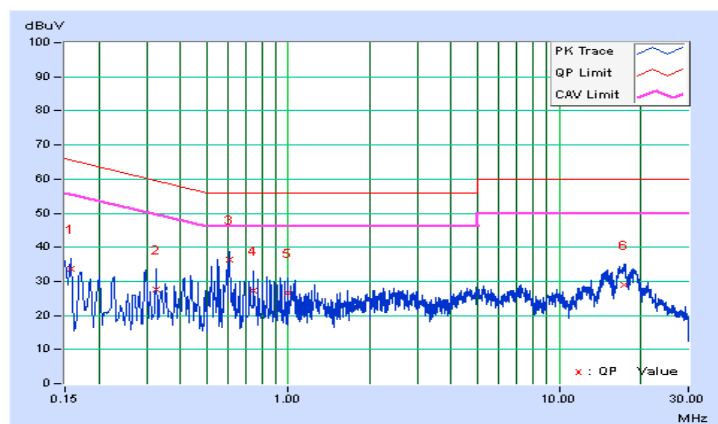

**Mode B**

Frequency Range	150kHz ~ 30MHz	Detector Function & Resolution Bandwidth	Quasi-Peak (QP) / Average (AV), 9kHz
Input Power	120Vac, 60Hz	Environmental Conditions	25°C, 65%RH
Tested by	Toby Tian	Test Date	2016/9/10

Phase Of Power : Line (L)										
No	Frequency (MHz)	Correction Factor (dB)	Reading Value (dBuV)		Emission Level (dBuV)		Limit (dBuV)		Margin (dB)	
			Q.P.	AV.	Q.P.	AV.	Q.P.	AV.	Q.P.	AV.
1	0.15000	10.01	26.29	18.47	36.30	28.48	66.00	56.00	-29.70	-27.52
2	0.30534	10.08	22.52	10.43	32.60	20.51	60.10	50.10	-27.50	-29.59
3	0.55664	10.14	25.55	14.47	35.69	24.61	56.00	46.00	-20.31	-21.39
4	0.91858	10.19	21.49	7.00	31.68	17.19	56.00	46.00	-24.32	-28.81
5	1.36992	10.23	17.85	6.49	28.08	16.72	56.00	46.00	-27.92	-29.28
6	16.23965	11.10	23.65	17.15	34.75	28.25	60.00	50.00	-25.25	-21.75

Remarks:

1. Q.P. and AV. are abbreviations of quasi-peak and average individually.
2. The emission levels of other frequencies were very low against the limit.
3. Margin value = Emission level – Limit value
4. Correction factor = Insertion loss + Cable loss
5. Emission Level = Correction Factor + Reading Value

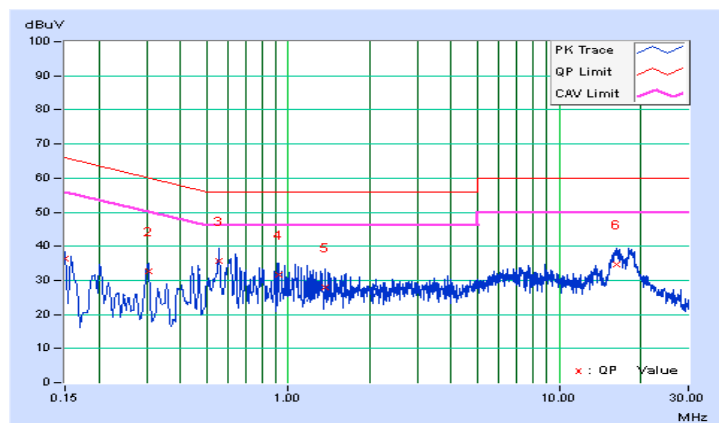

Frequency Range	150kHz ~ 30MHz	Detector Function & Resolution Bandwidth	Quasi-Peak (QP) / Average (AV), 9kHz
Input Power	120Vac, 60Hz	Environmental Conditions	25°C, 65%RH
Tested by	Toby Tian	Test Date	2016/9/10

Phase Of Power : Neutral (N)										
No	Frequency (MHz)	Correction Factor (dB)	Reading Value (dBuV)		Emission Level (dBuV)		Limit (dBuV)		Margin (dB)	
			Q.P.	AV.	Q.P.	AV.	Q.P.	AV.	Q.P.	AV.
1	0.29858	10.08	26.11	12.51	36.19	22.59	60.28	50.28	-24.09	-27.69
2	0.49017	10.14	25.82	12.38	35.96	22.52	56.16	46.16	-20.20	-23.64
<b>3</b>	<b>0.60747</b>	<b>10.16</b>	<b>28.14</b>	<b>12.47</b>	<b>38.30</b>	<b>22.63</b>	<b>56.00</b>	<b>46.00</b>	<b>-17.70</b>	<b>-23.37</b>
4	0.88899	10.20	23.34	6.04	33.54	16.24	56.00	46.00	-22.46	-29.76
5	1.11186	10.22	19.20	5.07	29.42	15.29	56.00	46.00	-26.58	-30.71
6	16.62283	11.23	23.82	17.59	35.05	28.82	60.00	50.00	-24.95	-21.18

Remarks:

1. Q.P. and AV. are abbreviations of quasi-peak and average individually.
2. The emission levels of other frequencies were very low against the limit.
3. Margin value = Emission level – Limit value
4. Correction factor = Insertion loss + Cable loss
5. Emission Level = Correction Factor + Reading Value

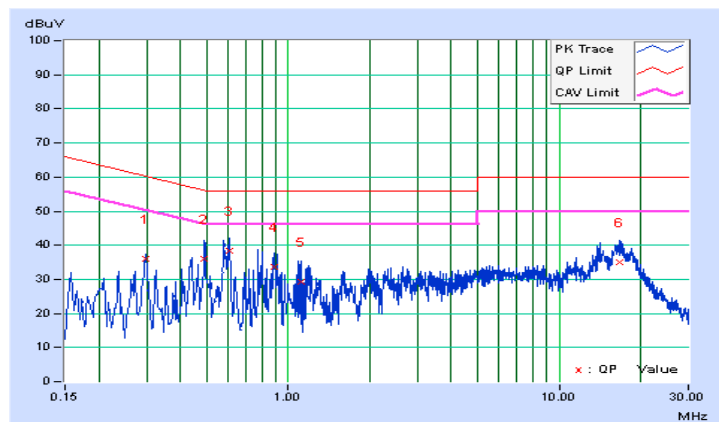

### 4.3 Transmit Power Measurement

#### 4.3.1 Limits of Transmit Power Measurement

Operation Band	EUT Category	Limit
U-NII-1	Outdoor Access Point	1 Watt (30 dBm) (Max. e.i.r.p $\leq$ 125 mW (21 dBm) at any elevation angle above 30 degrees as measured from the horizon)
	Fixed point-to-point Access Point	1 Watt (30 dBm)
	Indoor Access Point	1 Watt (30 dBm)
	√ Mobile and Portable client device	250 mW (24 dBm)
U-NII-2A	√	250 mW (24 dBm) or 11 dBm+10 log B*
U-NII-2C	√	250 mW (24 dBm) or 11 dBm+10 log B*
U-NII-3	√	1 Watt (30 dBm)

\*B is the 26 dB emission bandwidth in megahertz

#### 4.3.2 Test Setup

##### <Power Output Measurement>

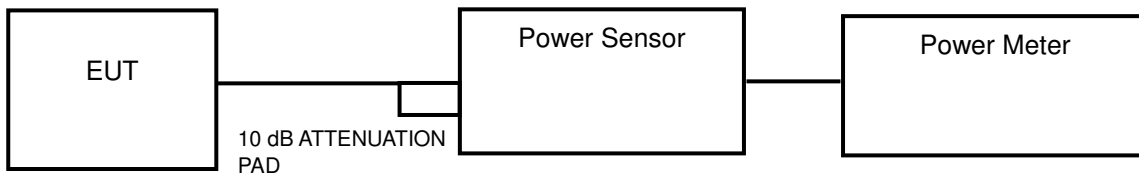

or



##### <26 dB Bandwidth>

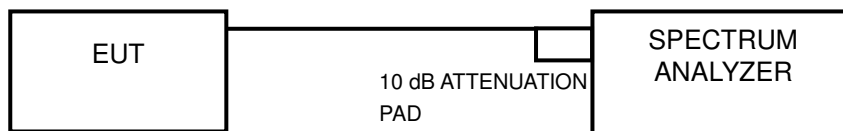

#### 4.3.3 Test Instruments

Refer to section 4.1.2 to get information of above instrument.

#### 4.3.4 Test Procedure

##### **Average Power Measurement**

<802.11a, 802.11n (HT20), 802.11n (HT40)>

Method PM is used to perform output power measurement, trigger and gating function of wide band power meter is enabled to measure max output power of TX on burst. Duty factor is not added to measured value.

<802.11ac (VHT80)>

Method SA-1 is used to perform output power measurement, trigger and gating function of spectrum analyzer is enabled to measure max output power of TX on burst. Duty factor is not added to measured value.

##### **26 dB Bandwidth**

- 1) Set RBW = approximately 1 % of the emission bandwidth.
- 2) Set the VBW > RBW.
- 3) Detector = Peak.
- 4) Trace mode = max hold.
- 5) Measure the maximum width of the emission that is 26 dB down from the peak of the emission. Compare this with the RBW setting of the analyzer. Readjust RBW and repeat measurement as needed until the RBW/EBW ratio is approximately 1 %.

#### 4.3.5 Deviation from Test Standard

No deviation.

#### 4.3.6 EUT Operating Conditions

The software provided by client to enable the EUT under transmission condition continuously at lowest, middle and highest channel frequencies individually.

#### 4.3.7 Test Result

##### Power Output:

##### 802.11a

Channel	Frequency (MHz)	Maximum Conducted Power (mW)	Maximum Conducted Power (dBm)	Power Limit (dBm)	Pass / Fail
36	5180	40.09	16.03	24	Pass
44	5220	40.36	16.06	24	Pass
48	5240	39.90	16.01	24	Pass
52	5260	40.18	16.04	23.78	Pass
60	5300	42.46	16.28	24	Pass
64	5320	42.27	16.26	24	Pass
100	5500	42.17	16.25	24	Pass
116	5580	40.55	16.08	23.78	Pass
140	5700	40.46	16.07	24	Pass
149	5745	39.90	16.01	30	Pass
157	5785	40.55	16.08	30	Pass
165	5825	39.99	16.02	30	Pass

##### Note:

##### For U-NII-2A, U-NII-2C Band:

1.  $11 \text{ dBm} + 10\log(18.95) = 23.78 \text{ dBm} < 24 \text{ dBm}$ .
2.  $11 \text{ dBm} + 10\log(21.84) = 24.39 \text{ dBm} > 24 \text{ dBm}$ .
3.  $11 \text{ dBm} + 10\log(21.86) = 24.40 \text{ dBm} > 24 \text{ dBm}$ .
4.  $11 \text{ dBm} + 10\log(21.79) = 24.38 \text{ dBm} > 24 \text{ dBm}$ .
5.  $11 \text{ dBm} + 10\log(18.98) = 23.78 \text{ dBm} < 24 \text{ dBm}$ .
6.  $11 \text{ dBm} + 10\log(21.82) = 24.39 \text{ dBm} > 24 \text{ dBm}$ .



### 802.11n (HT20)

Channel	Frequency (MHz)	Maximum Conducted Power (mW)	Maximum Conducted Power (dBm)	Power Limit (dBm)	Pass / Fail
36	5180	39.90	16.01	24	Pass
44	5220	40.18	16.04	24	Pass
48	5240	40.09	16.03	24	Pass
52	5260	40.64	16.09	23.87	Pass
60	5300	42.46	16.28	24	Pass
64	5320	41.98	16.23	24	Pass
100	5500	40.83	16.11	24	Pass
116	5580	42.56	16.29	23.86	Pass
140	5700	41.88	16.22	24	Pass
149	5745	41.21	16.15	30	Pass
157	5785	42.36	16.27	30	Pass
165	5825	41.78	16.21	30	Pass

**Note:**

**For U-NII-2A, U-NII-2C Band:**

1.  $11 \text{ dBm} + 10\log(19.35) = 23.87 \text{ dBm} < 24 \text{ dBm}$ .
2.  $11 \text{ dBm} + 10\log(22.08) = 24.44 \text{ dBm} > 24 \text{ dBm}$ .
3.  $11 \text{ dBm} + 10\log(22.21) = 24.47 \text{ dBm} > 24 \text{ dBm}$ .
4.  $11 \text{ dBm} + 10\log(22.08) = 24.44 \text{ dBm} > 24 \text{ dBm}$ .
5.  $11 \text{ dBm} + 10\log(19.32) = 23.86 \text{ dBm} < 24 \text{ dBm}$ .
6.  $11 \text{ dBm} + 10\log(22.18) = 24.46 \text{ dBm} > 24 \text{ dBm}$ .

### 802.11n (HT40)

Channel	Frequency (MHz)	Maximum Conducted Power (mW)	Maximum Conducted Power (dBm)	Power Limit (dBm)	Pass / Fail
38	5190	39.99	16.02	24	Pass
46	5230	40.27	16.05	24	Pass
54	5270	42.76	16.31	24	Pass
62	5310	43.15	16.35	24	Pass
102	5510	42.27	16.26	24	Pass
110	5550	43.25	16.36	24	Pass
134	5670	40.09	16.03	24	Pass
151	5755	39.99	16.02	30	Pass
159	5795	40.46	16.07	30	Pass

**Note:**

**For U-NII-2A, U-NII-2C Band:**

- $11 \text{ dBm} + 10\log(41.62) = 27.19 \text{ dBm} > 24 \text{ dBm}$ .
- $11 \text{ dBm} + 10\log(41.71) = 27.20 \text{ dBm} > 24 \text{ dBm}$ .
- $11 \text{ dBm} + 10\log(41.47) = 27.18 \text{ dBm} > 24 \text{ dBm}$ .
- $11 \text{ dBm} + 10\log(41.62) = 27.19 \text{ dBm} > 24 \text{ dBm}$ .
- $11 \text{ dBm} + 10\log(41.78) = 27.21 \text{ dBm} > 24 \text{ dBm}$ .

### 802.11ac (VHT80)

Channel	Frequency (MHz)	Maximum Conducted Power (mW)	Maximum Conducted Power (dBm)	Power Limit (dBm)	Pass / Fail
42	5210	40.18	16.04	24	Pass
58	5290	41.88	16.22	24	Pass
106	5530	41.78	16.21	24	Pass
122	5610	41.59	16.19	24	Pass
155	5775	43.55	16.39	30	Pass

**Note:**

**For U-NII-2A, U-NII-2C Band:**

- $11 \text{ dBm} + 10\log(82.82) = 30.18 \text{ dBm} > 24 \text{ dBm}$ .
- $11 \text{ dBm} + 10\log(82.77) = 30.18 \text{ dBm} > 24 \text{ dBm}$ .
- $11 \text{ dBm} + 10\log(82.39) = 30.16 \text{ dBm} > 24 \text{ dBm}$ .

**26 dB Bandwidth:**
**802.11a**

Channel	Frequency (MHz)	26 dBc Bandwidth (MHz)
36	5180	21.95
44	5220	21.94
48	5240	18.97
52	5260	18.95
60	5300	21.84
64	5320	21.86
100	5500	21.79
116	5580	18.98
140	5700	21.82

**802.11n (HT20)**

Channel	Frequency (MHz)	26 dBc Bandwidth (MHz)
36	5180	22.09
44	5220	22.11
48	5240	19.42
52	5260	19.35
60	5300	22.08
64	5320	22.21
100	5500	22.08
116	5580	19.32
140	5700	22.18

**802.11n (HT40)**

Channel	Frequency (MHz)	26 dBc Bandwidth (MHz)
38	5190	41.56
46	5230	41.63
54	5270	41.62
62	5310	41.71
102	5510	41.47
110	5550	41.62
134	5670	41.78

802.11ac (VHT80)

Channel	Frequency (MHz)	26 dBc Bandwidth (MHz)
42	5210	82.53
58	5290	82.82
106	5530	82.77
122	5610	82.39

Spectrum Plot of Worst Value

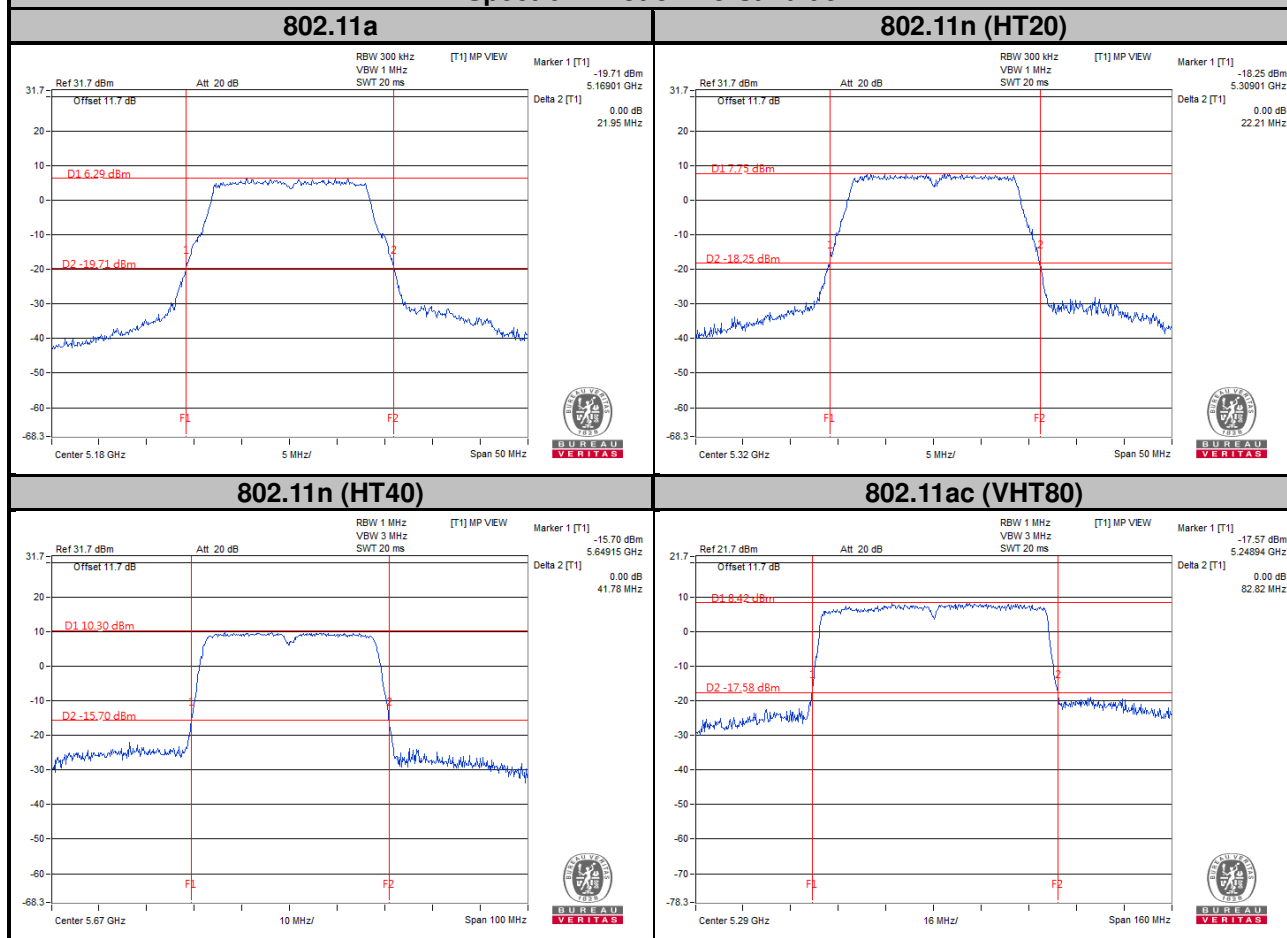

#### 4.4 Peak Power Spectral Density Measurement

##### 4.4.1 Limits of Peak Power Spectral Density Measurement

Operation Band	EUT Category		Limit
U-NII-1		Outdoor Access Point	17 dBm/MHz
		Fixed point-to-point Access Point	
		Indoor Access Point	
	√	Mobile and Portable client device	11 dBm/MHz
U-NII-2A		√	11 dBm/MHz
U-NII-2C		√	11 dBm/MHz
U-NII-3		√	30 dBm/500 kHz

##### 4.4.2 Test Setup

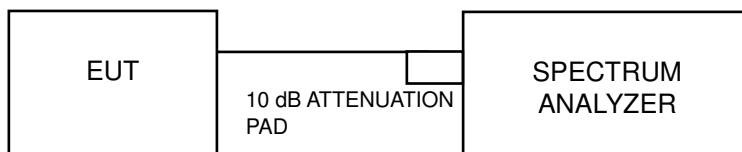

##### 4.4.3 Test Instruments

Refer to section 4.1.3 to get information of above instrument.

##### 4.4.4 Test Procedures

###### **For U-NII-1, U-NII-2A, U-NII-2C band:**

Using method SA-2

1. Set span to encompass the entire emission bandwidth (EBW) of the signal.
2. Set RBW = 1 MHz, Set VBW ≥ 3 RBW, Detector = RMS
3. Sweep time = auto, trigger set to “free run”.
4. Trace average at least 100 traces in power averaging mode.
5. Record the max value and add 10 log (1/duty cycle)

###### **※For U-NII-3:**

1. Set span to encompass the entire emission bandwidth (EBW) of the signal.
2. Set RBW = 500 kHz, Set VBW ≥ 3 RBW, Detector = RMS
3. Use the peak marker function to determine the maximum power level in any 500 kHz band segment within the fundamental EBW.
4. Sweep time = auto, trigger set to “free run”.
5. Trace average at least 100 traces in power averaging mode.
6. Record the max value and add 10 log (1/duty cycle)

#### 4.4.5 Deviation from Test Standard

No deviation.

#### 4.4.6 EUT Operating Conditions

The software provided by client to enable the EUT under transmission condition continuously at lowest, middle and highest channel frequencies individually.

#### 4.4.7 Test Results

##### 802.11a

Channel	Frequency (MHz)	PSD w/o Duty Factor (dBm)	Duty Factor	PSD with Duty Factor (dBm)	Maximum Limit (dBm)	Pass / Fail
36	5180	2.83	0.21	3.04	11	Pass
44	5220	2.92	0.21	3.13	11	Pass
48	5240	3.23	0.21	3.44	11	Pass
52	5260	3.46	0.21	3.67	11	Pass
60	5300	4.37	0.21	4.58	11	Pass
64	5320	4.66	0.21	4.87	11	Pass
100	5500	4.86	0.21	5.07	11	Pass
116	5580	4.21	0.21	4.42	11	Pass
140	5700	3.47	0.21	3.68	11	Pass

**Note:** Refer to section 3.3 for duty cycle spectrum plot.

##### 802.11n (HT20)

Channel	Frequency (MHz)	PSD w/o Duty Factor (dBm)	Duty Factor	PSD with Duty Factor (dBm)	Maximum Limit (dBm)	Pass / Fail
36	5180	2.32	0.25	2.57	11	Pass
44	5220	2.50	0.25	2.75	11	Pass
48	5240	2.59	0.25	2.84	11	Pass
52	5260	3.13	0.25	3.38	11	Pass
60	5300	3.98	0.25	4.23	11	Pass
64	5320	4.32	0.25	4.57	11	Pass
100	5500	4.45	0.25	4.70	11	Pass
116	5580	4.48	0.25	4.73	11	Pass
140	5700	3.64	0.25	3.89	11	Pass

**Note:** Refer to section 3.3 for duty cycle spectrum plot.

### 802.11n (HT40)

Channel	Frequency (MHz)	PSD w/o Duty Factor (dBm)	Duty Factor	PSD with Duty Factor (dBm)	Maximum Limit (dBm)	Pass / Fail
38	5190	-0.03	0.45	0.42	11	Pass
46	5230	0.28	0.45	0.73	11	Pass
54	5270	1.24	0.45	1.69	11	Pass
62	5310	1.69	0.45	2.14	11	Pass
102	5510	2.10	0.45	2.55	11	Pass
110	5550	2.03	0.45	2.48	11	Pass
134	5670	0.82	0.45	1.27	11	Pass

**Note:** Refer to section 3.3 for duty cycle spectrum plot.

### 802.11ac (VHT80)

Channel	Frequency (MHz)	PSD w/o Duty Factor (dBm)	Duty Factor	PSD with Duty Factor (dBm)	Maximum Limit (dBm)	Pass / Fail
42	5210	-2.79	0.45	-2.34	11	Pass
58	5290	-2.25	0.45	-1.80	11	Pass
106	5530	-2.59	0.45	-2.14	11	Pass
122	5610	-2.73	0.45	-2.28	11	Pass

**Note:** Refer to section 3.3 for duty cycle spectrum plot.



### Spectrum Plot of Worst Value

#### 802.11a

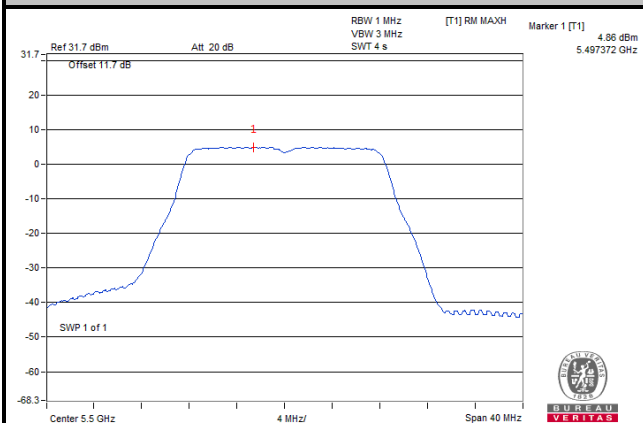

#### 802.11n (HT20)

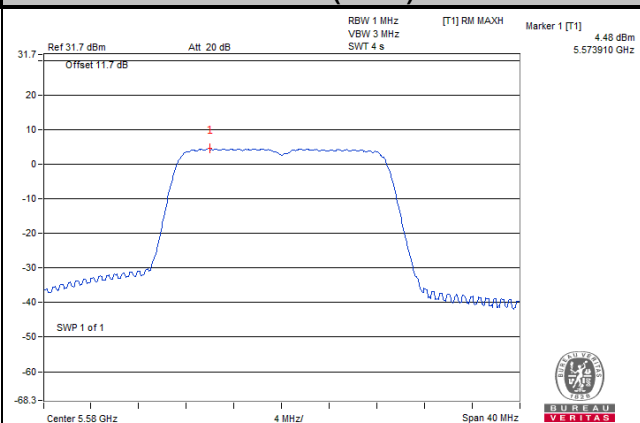

#### 802.11n (HT40)

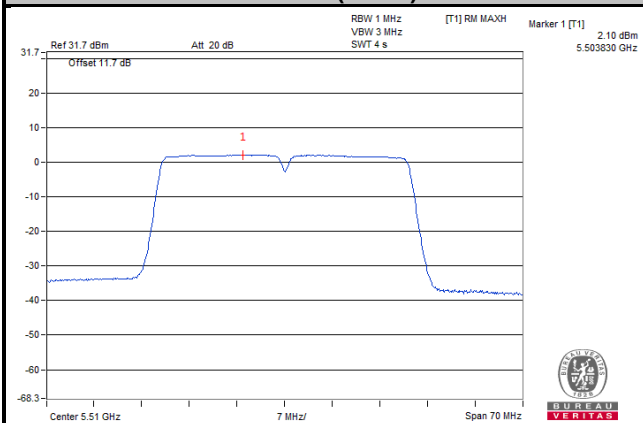

#### 802.11ac (VHT80)

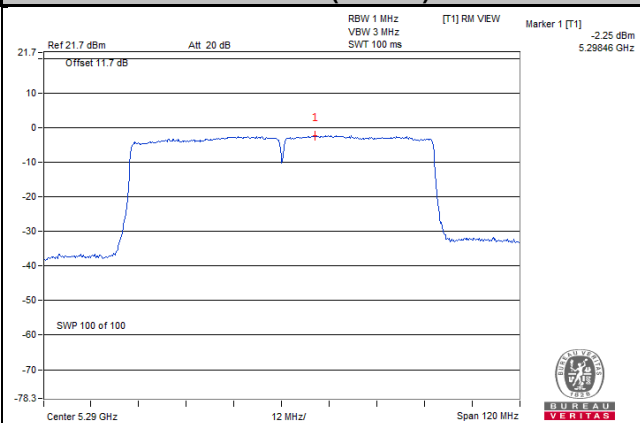

## For U-NII-3 Band

### 802.11a

Channel	Frequency (MHz)	PSD w/o Duty Factor (dBm)	Duty Factor	PSD with Duty Factor (dBm)	Limit (dBm/500 kHz)	Pass / Fail
149	5745	-0.26	0.21	-0.05	30	Pass
157	5785	0.19	0.21	0.40	30	Pass
165	5825	-0.41	0.21	-0.20	30	Pass

**Note:** Refer to section 3.3 for duty cycle spectrum plot.

### 802.11n (HT20)

Channel	Frequency (MHz)	PSD w/o Duty Factor (dBm)	Duty Factor	PSD with Duty Factor (dBm)	Limit (dBm/500 kHz)	Pass / Fail
149	5745	-0.15	0.25	0.10	30	Pass
157	5785	0.14	0.25	0.39	30	Pass
165	5825	0.14	0.25	0.39	30	Pass

**Note:** Refer to section 3.3 for duty cycle spectrum plot.

### 802.11n (HT40)

Channel	Frequency (MHz)	PSD w/o Duty Factor (dBm)	Duty Factor	PSD with Duty Factor (dBm)	Limit (dBm/500 kHz)	Pass / Fail
151	5755	-3.40	0.45	-2.95	30	Pass
159	5795	-2.86	0.45	-2.41	30	Pass

**Note:** Refer to section 3.3 for duty cycle spectrum plot.

### 802.11ac (VHT80)

Channel	Frequency (MHz)	PSD w/o Duty Factor (dBm)	Duty Factor	PSD with Duty Factor (dBm)	Limit (dBm/500 kHz)	Pass / Fail
155	5775	-4.84	0.45	-4.39	30	Pass

**Note:** Refer to section 3.3 for duty cycle spectrum plot.

### Spectrum Plot of Worst Value

#### 802.11a

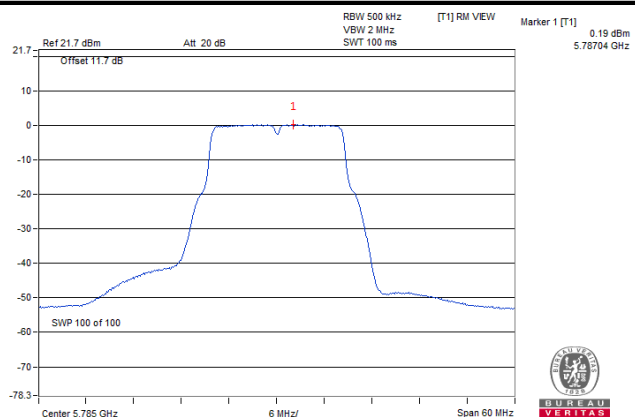

#### 802.11n (HT20)

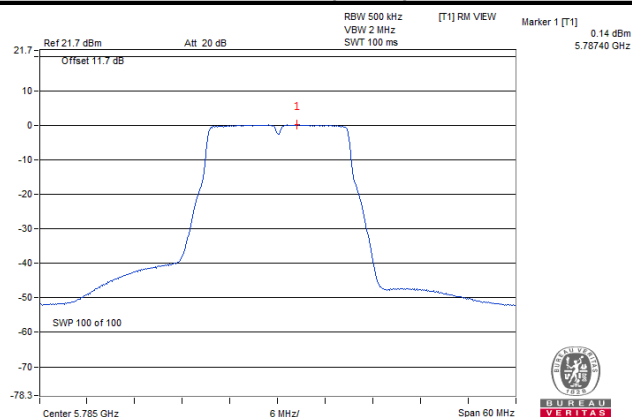

#### 802.11n (HT40)

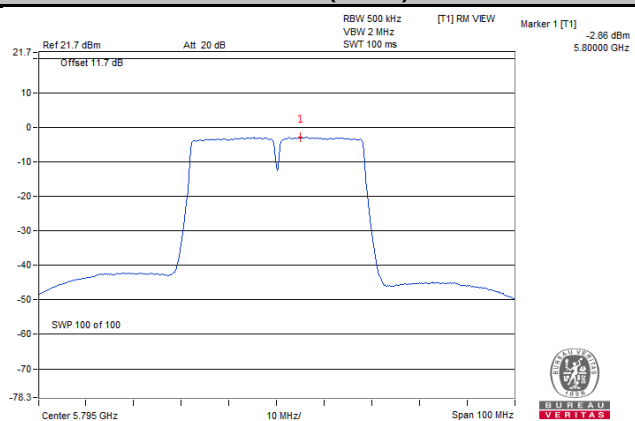

#### 802.11ac (VHT80)

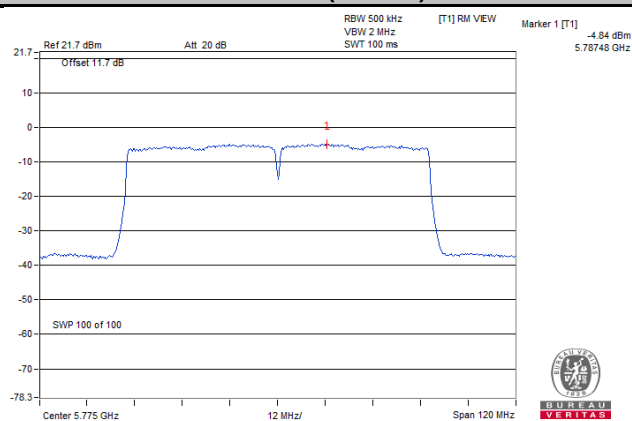

## 4.5 Frequency Stability

### 4.5.1 Limit of Frequency Stability Measurement

The frequency of the carrier signal shall be maintained within band of operation.

### 4.5.2 Test Setup

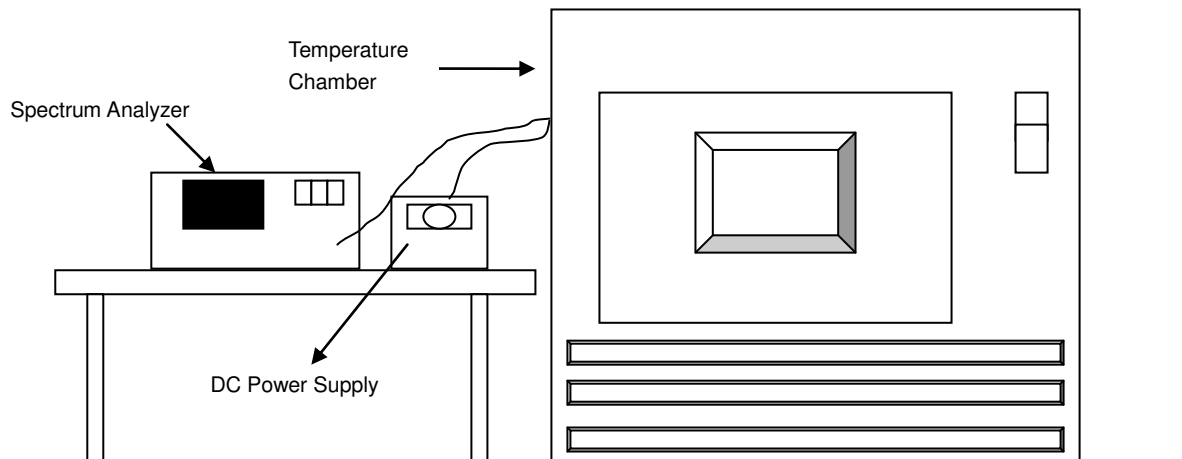

### 4.5.3 Test Instruments

Refer to section 4.1.3 to get information of above instrument.

### 4.5.4 Test Procedure

- To ensure emission at the band edge is maintained within the authorized band, those values shall be measured by radiation emissions at upper and lower frequency points, and finally compensated by frequency deviation as procedures below.
- The EUT was operated at the maximum output power, and connected to the spectrum analyzer, which is set to maximum hold function and peak detector. The peak value of the power envelope was measured and noted. The upper and lower frequency points were respectively measured relatively 10 dB lower than the measured peak value.
- The frequency deviation was calculated by adding the upper frequency point and the lower frequency point divided by two. Those detailed values of frequency deviation are provided in table below.

### 4.5.5 Deviation from Test Standard

No deviation.

### 4.5.6 EUT Operating Condition

Set the EUT transmit at un-modulation mode to test frequency stability.

4.5.7 Test Results

Frequency Stability Versus Temp.									
Operating Frequency: 5320 MHz									
Temp. (°C)	Power Supply (Vdc)	0 Minute		2 Minute		5 Minute		10 Minute	
		Measured Frequency (MHz)	Frequency Drift (ppm)	Measured Frequency (MHz)	Frequency Drift (ppm)	Measured Frequency (MHz)	Frequency Drift (ppm)	Measured Frequency (MHz)	Frequency Drift (ppm)
55	3.85	5320.048127	9.046	5320.048681	9.151	5320.048651	9.145	5320.048264	9.072
50	3.85	5320.049086	9.227	5320.049032	9.217	5320.048906	9.193	5320.048923	9.196
40	3.85	5320.049250	9.258	5320.048813	9.175	5320.048892	9.190	5320.048661	9.147
30	3.85	5320.050195	9.435	5320.050185	9.433	5320.050199	9.436	5320.050079	9.413
20	3.85	5320.050849	9.558	5320.050774	9.544	5320.051440	9.669	5320.050849	9.558
10	3.85	5320.052981	9.959	5320.052252	9.822	5320.052764	9.918	5320.052614	9.890
0	3.85	5320.050876	9.563	5320.050931	9.573	5320.050909	9.569	5320.051140	9.613
-10	3.85	5320.049606	9.324	5320.049617	9.327	5320.049763	9.354	5320.049317	9.270
-20	3.85	5320.049392	9.284	5320.049331	9.273	5320.049239	9.255	5320.048812	9.175
-30	3.85	5320.048196	9.059	5320.048455	9.108	5320.048107	9.043	5320.047880	9.000

Frequency Stability Versus Temp.									
Operating Frequency: 5320 MHz									
Temp. (°C)	Power Supply (Vdc)	0 Minute		2 Minute		5 Minute		10 Minute	
		Measured Frequency (MHz)	Frequency Drift (ppm)	Measured Frequency (MHz)	Frequency Drift (ppm)	Measured Frequency (MHz)	Frequency Drift (ppm)	Measured Frequency (MHz)	Frequency Drift (ppm)
20	3.6	5320.044746	8.411	5320.045020	8.462	5320.044442	8.354	5320.044705	8.403
	3.85	5320.050849	9.558	5320.050774	9.544	5320.051440	9.669	5320.050849	9.558
	4.35	5320.046351	8.713	5320.046200	8.684	5320.046245	8.693	5320.046357	8.714

## 4.6 6 dB Bandwidth Measurement

### 4.6.1 Limits of 6 dB Bandwidth Measurement

The minimum of 6 dB Bandwidth Measurement is 0.5 MHz.

### 4.6.2 Test Setup

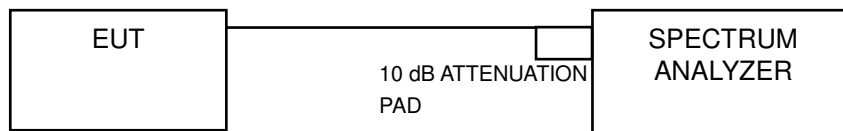

### 4.6.3 Test Instruments

Refer to section 4.1.3 to get information of above instrument.

### 4.6.4 Test Procedure

#### MEASUREMENT PROCEDURE REF

- Set resolution bandwidth (RBW) = 100 kHz
- Set the video bandwidth (VBW)  $\geq 3 \times$  RBW, Detector = Peak.
- Trace mode = max hold.
- Sweep = auto couple.
- Measure the maximum width of the emission that is constrained by the frequencies associated with the two amplitude points (upper and lower) that are attenuated by 6 dB relative to the maximum level measured in the fundamental emission

### 4.6.5 Deviation from Test Standard

No deviation.

### 4.6.6 EUT Operating Condition

The software provided by client to enable the EUT under transmission condition continuously at lowest, middle and highest channel frequencies individually.

#### 4.6.7 Test Results

##### 802.11a

Channel	Frequency (MHz)	6 dB Bandwidth (MHz)	Minimum Limit (MHz)	Pass / Fail
149	5745	16.41	0.5	Pass
157	5785	16.40	0.5	Pass
165	5825	16.40	0.5	Pass

##### 802.11n (HT20)

Channel	Frequency (MHz)	6 dB Bandwidth (MHz)	Minimum Limit (MHz)	Pass / Fail
149	5745	17.62	0.5	Pass
157	5785	17.64	0.5	Pass
165	5825	17.61	0.5	Pass

##### 802.11n (HT40)

Channel	Frequency (MHz)	6 dB Bandwidth (MHz)	Minimum Limit (MHz)	Pass / Fail
151	5755	36.47	0.5	Pass
159	5795	36.40	0.5	Pass

##### 802.11ac (VHT80)

Channel	Frequency (MHz)	6 dB Bandwidth (MHz)	Minimum Limit (MHz)	Pass / Fail
155	5775	75.74	0.5	Pass

### Spectrum Plot of Worst Value

#### 802.11a

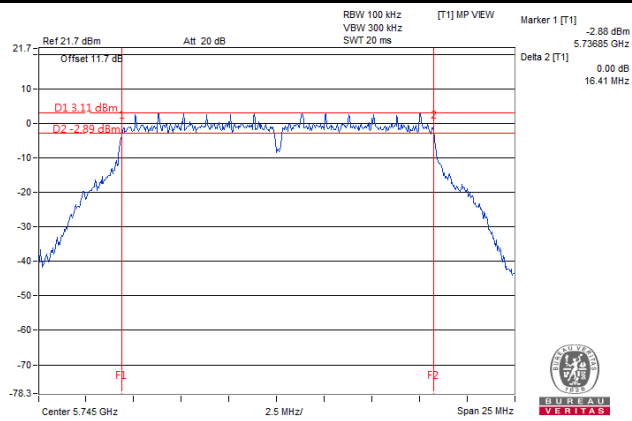

#### 802.11n (HT20)

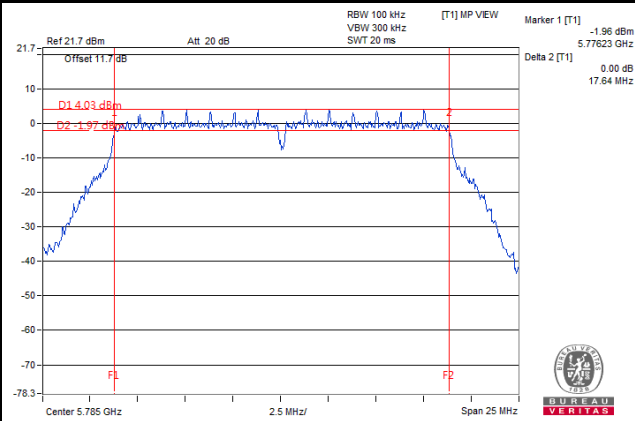

#### 802.11n (HT40)

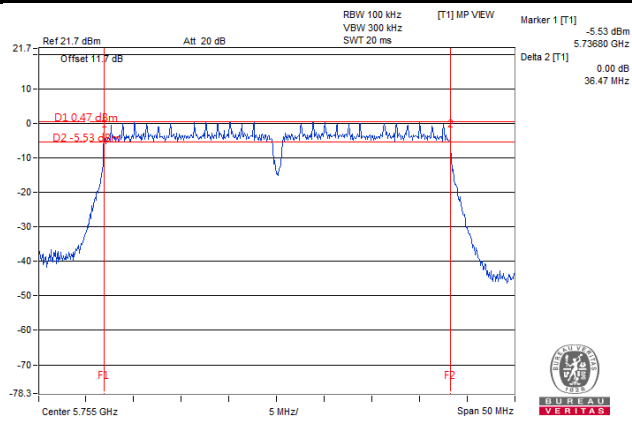

#### 802.11ac (VHT80)

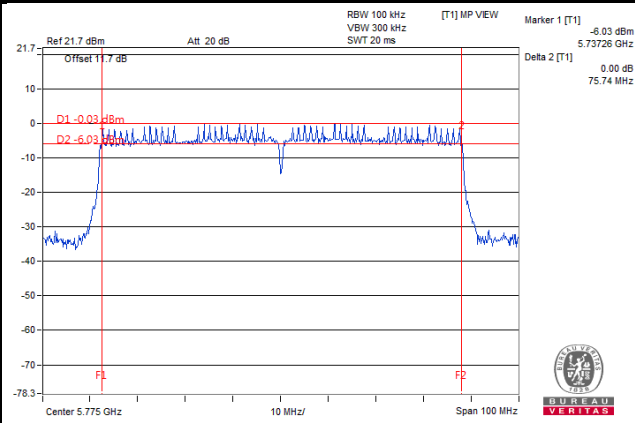



## 5 Pictures of Test Arrangements

Please refer to the attached file (Test Setup Photo).

# Annex A- Radiated Out of Band Emisison (OOBE) Measurement (For U-NII-3 band)

Mode A  
802.11a

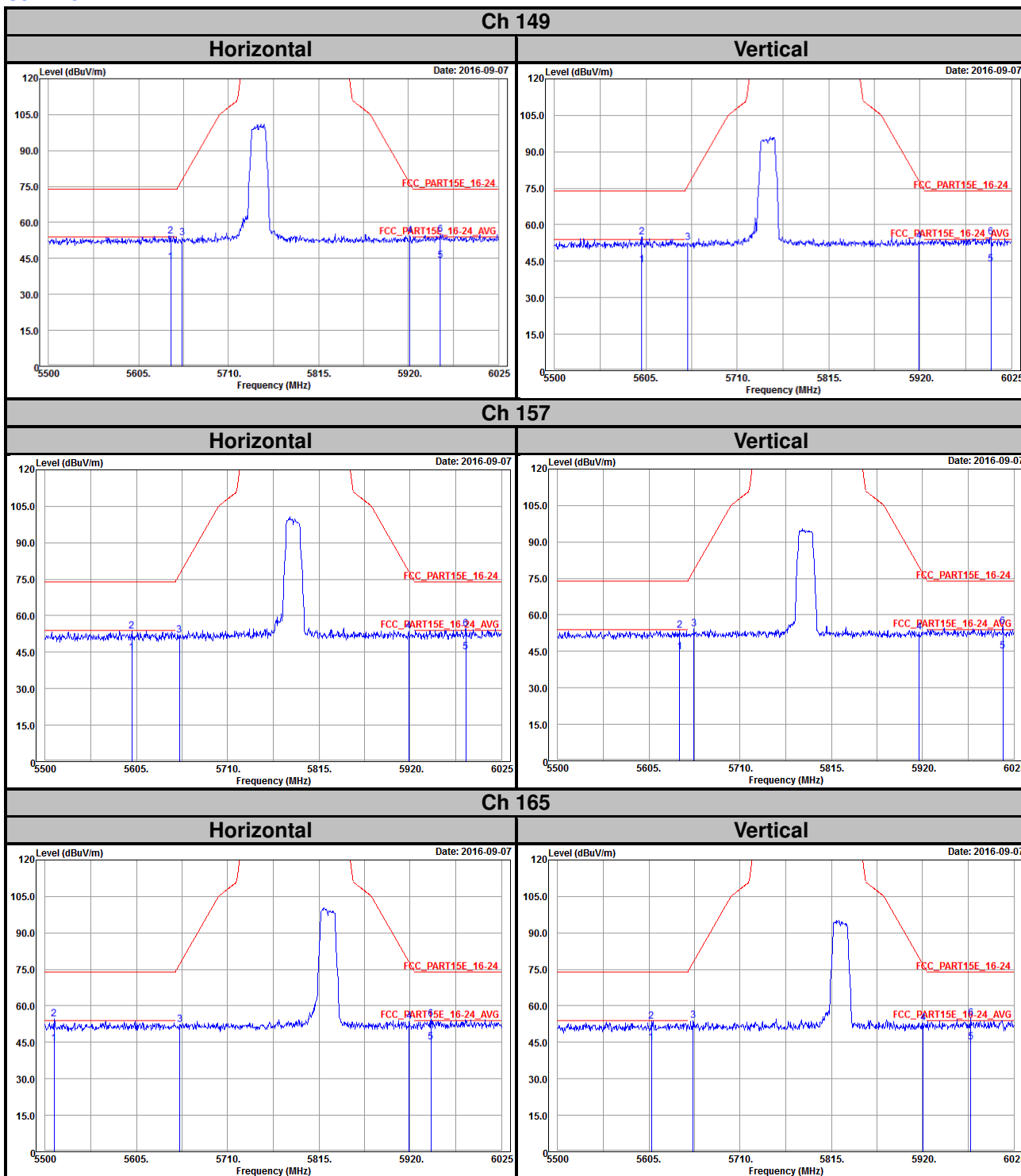

802.11n (HT20)

Ch 149

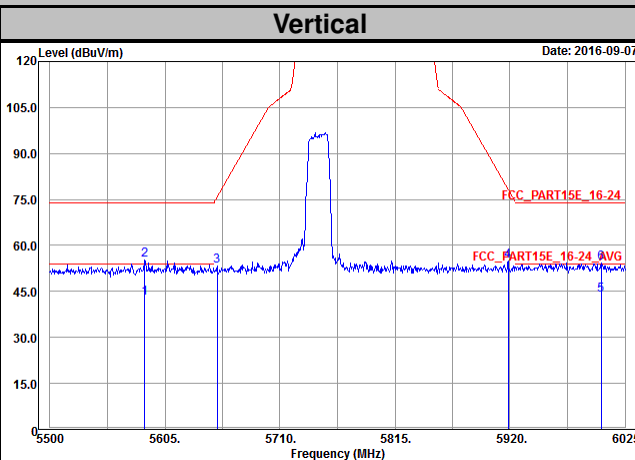
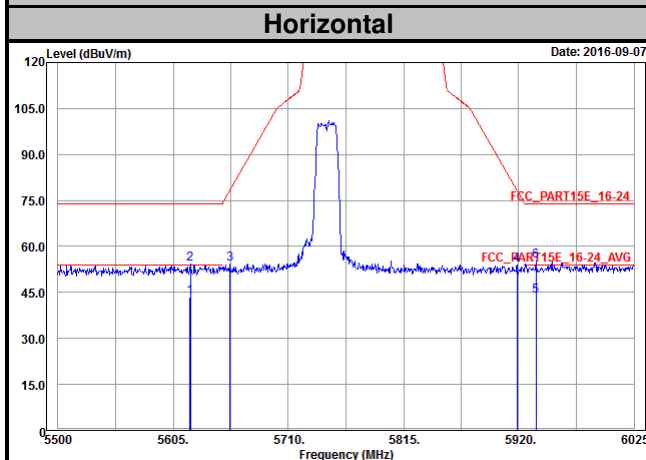

Ch 157

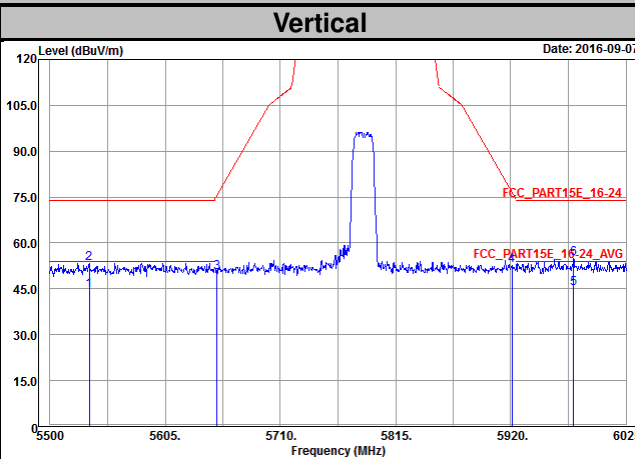
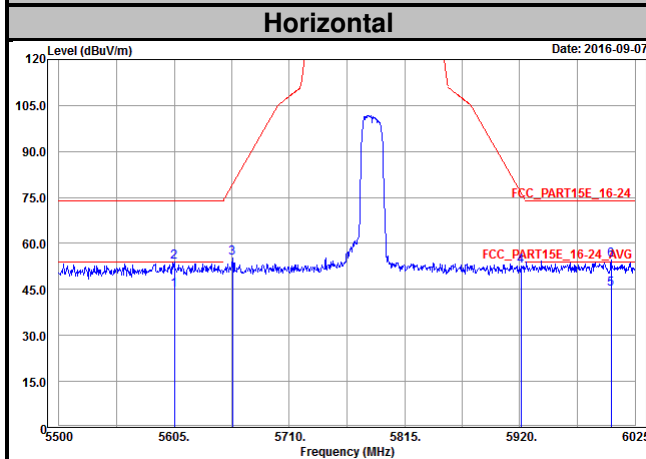

Ch 165

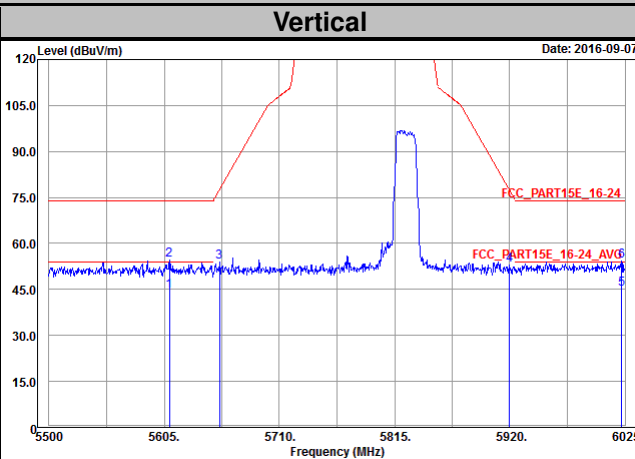
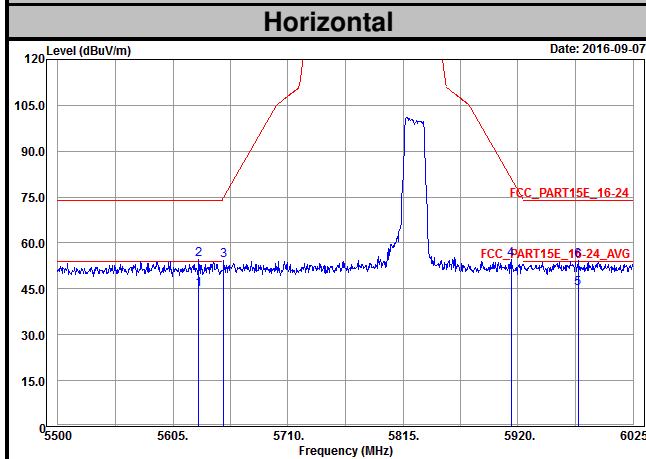

### 802.11n (HT40)

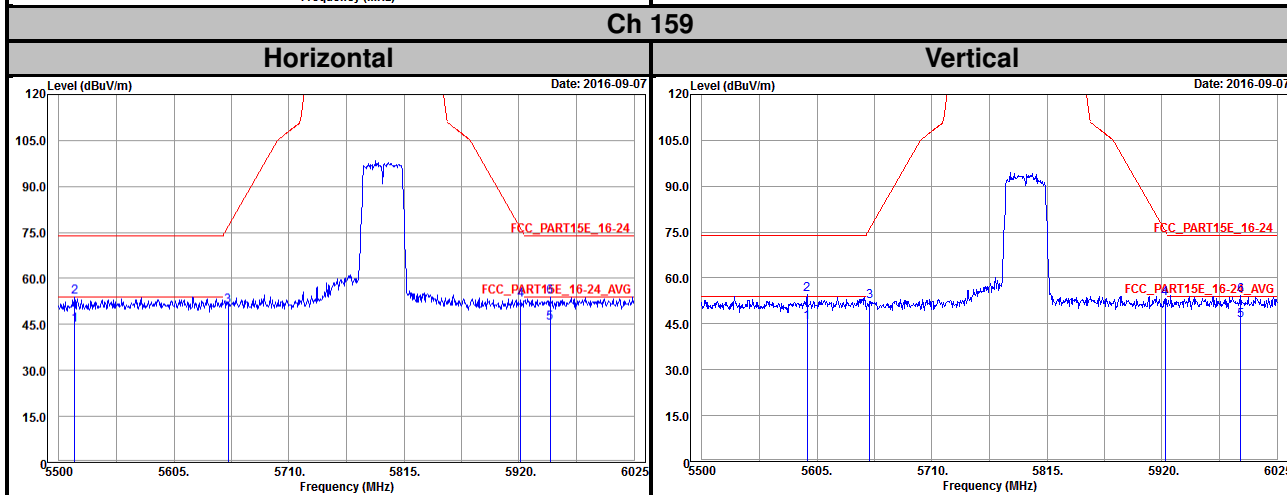
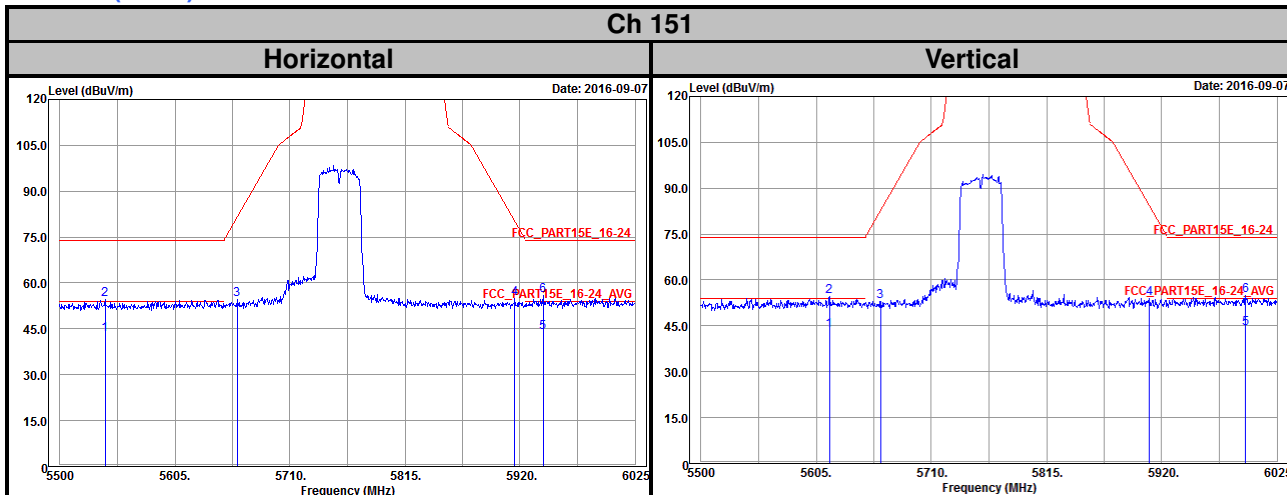

### 802.11ac (VHT80)

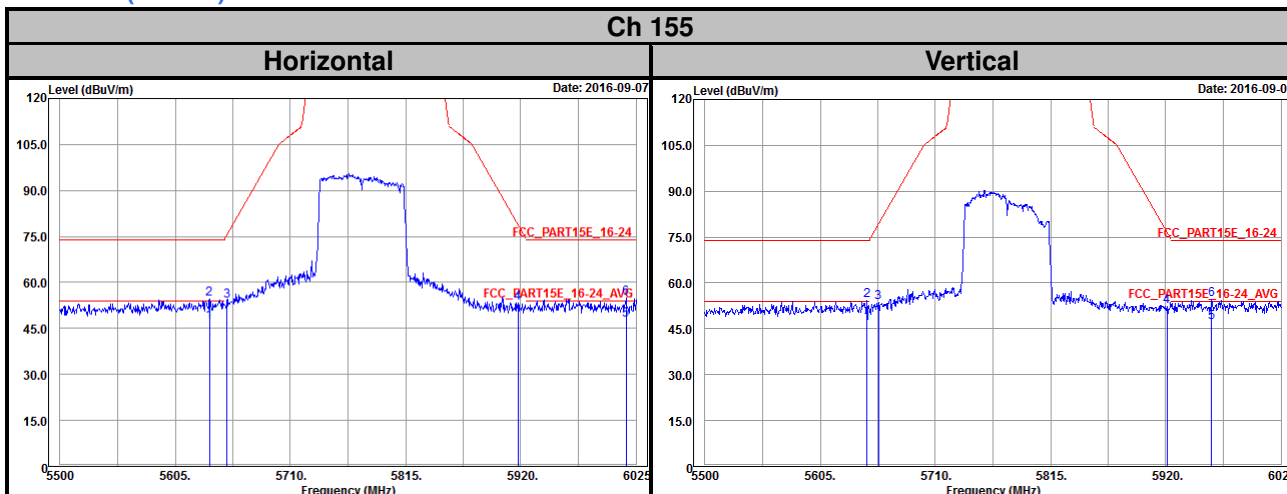

**Mode B**  
**802.11ac (VHT80)**

**Ch 155**

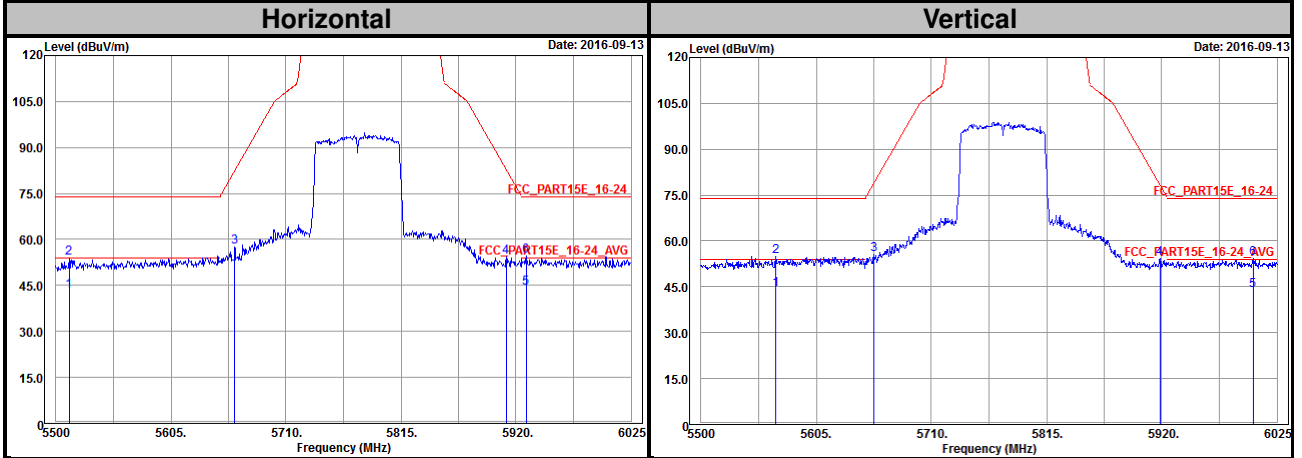

## Appendix – Information on the Testing Laboratories

We, Bureau Veritas Consumer Products Services (H.K.) Ltd., Taoyuan Branch, were founded in 1988 to provide our best service in EMC, Radio, Telecom and Safety consultation. Our laboratories are accredited and approved according to ISO/IEC 17025.

If you have any comments, please feel free to contact us at the following:

**Linko EMC/RF Lab**

Tel: 886-2-26052180

Fax: 886-2-26051924

**Hsin Chu EMC/RF/Telecom Lab**

Tel: 886-3-6668565

Fax: 886-3-6668323

**Hwa Ya EMC/RF/Safety**

Tel: 886-3-3183232

Fax: 886-3-3270892

**Email:** [service.adt@tw.bureauveritas.com](mailto:service.adt@tw.bureauveritas.com)

**Web Site:** [www.bureauveritas-adt.com](http://www.bureauveritas-adt.com)

The address and road map of all our labs can be found in our web site also.

--- END ---