

FCC SAR Test Report

APPLICANT : HTC Corporation
EQUIPMENT : Smartphone
MODEL NAME : 2PWD100
FCC ID : NM82PWD100
STANDARD : FCC 47 CFR Part 2 (2.1093)
ANSI/IEEE C95.1-1992
IEEE 1528-2013

We, SPORTON INTERNATIONAL INC., would like to declare that the tested sample has been evaluated in accordance with the procedures and had been in compliance with the applicable technical standards.

The test results in this report apply exclusively to the tested model / sample. Without written approval of SPORTON INTERNATIONAL INC., the test report shall not be reproduced except in full.

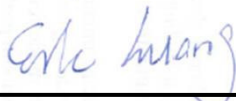

Reviewed by: Eric Huang / Deputy Manager



Approved by: Jones Tsai / Manager



SPORTON INTERNATIONAL INC.

No.52, Hwa Ya 1st Rd., Hwa Ya Technology Park, Kwei-Shan District, Taoyuan City, Taiwan (R.O.C.)



Table of Contents

1. Statement of Compliance 4
2. Administration Data 5
3. Guidance Applied..... 5
4. Equipment Under Test (EUT) Information..... 6
4.1 General Information 6
4.2 General LTE SAR Test and Reporting Considerations 8
5. RF Exposure Limits.....10
5.1 Uncontrolled Environment.....10
5.2 Controlled Environment.....10
6. Specific Absorption Rate (SAR).....11
6.1 Introduction 11
6.2 SAR Definition..... 11
7. System Description and Setup12
7.1 E-Field Probe13
7.2 Data Acquisition Electronics (DAE)13
7.3 Phantom.....14
7.4 Device Holder.....15
8. Measurement Procedures16
8.1 Spatial Peak SAR Evaluation16
8.2 Power Reference Measurement.....17
8.3 Area Scan17
8.4 Zoom Scan.....18
8.5 Volume Scan Procedures.....18
8.6 Power Drift Monitoring.....18
9. Test Equipment List.....19
10. System Verification20
10.1 Tissue Simulating Liquids.....20
10.2 Tissue Verification20
10.3 System Performance Check Results.....22
11. RF Exposure Positions24
11.1 Ear and handset reference point24
11.2 Definition of the cheek position.....25
11.3 Definition of the tilt position.....26
11.4 Body Worn Accessory27
11.5 Wireless Router.....27
12. Conducted RF Output Power (Unit: dBm).....28
13. Bluetooth Exclusions Applied53
14. Antenna Location54
15. SAR Test Results55
15.1 Head SAR57
15.2 Hotspot SAR63
15.3 Body Worn Accessory SAR.....69
16. Simultaneous Transmission Analysis72
16.1 Head Exposure Conditions73
16.2 Hotspot Exposure Conditions.....75
16.3 Body-Worn Accessory Exposure Conditions78
17. Uncertainty Assessment79
18. References.....82
Appendix A. Plots of System Performance Check
Appendix B. Plots of High SAR Measurement
Appendix C. DASy Calibration Certificate
Appendix D. Test Setup Photos



1. Statement of Compliance

The maximum results of Specific Absorption Rate (SAR) found during testing for **HTC Corporation, Smartphone, 2PWD100**, are as follows.

Equipment Class	Frequency Band	Highest SAR Summary			Highest Simultaneous Transmission 1g SAR (W/kg)
		Head (Separation 0mm)	Body-worn (Separation 10mm)	Hotspot (Separation 10mm)	
Licensed	GSM850	0.22	0.38	0.38	1.23
	GSM1900	0.32	0.10	0.10	
	WCDMA II	0.55	0.15	0.15	
	WCDMA IV	0.59	0.19	0.19	
	WCDMA V	0.09	0.14	0.14	
	LTE Band 2	0.51	0.16	0.16	
	LTE Band 4	0.57	0.20	0.20	
	LTE Band 5	0.07	0.17	0.17	
	LTE Band 7	0.88	0.22	0.22	
	LTE Band 12 / 17	0.07	0.20	0.20	
	LTE Band 38	0.70	0.16	0.16	
DTS	2.4GHz WLAN	0.76	0.07	0.07	1.06
NII	5GHz WLAN	0.68	0.22	0.16	1.23
Date of Testing:		2016/8/20 ~ 2016/9/14			

Remark :
 1. LTE band 17 SAR test was covered by Band 12; according to April 2015 TCB workshop, SAR test for overlapping LTE bands can be reduced if:
 a. The maximum output power, including tolerance, for the smaller band is ≤ the larger band to qualify for the SAR test exclusion.
 b. The channel bandwidth and other operating parameters for the smaller band are fully supported by the larger band.

This device is in compliance with Specific Absorption Rate (SAR) for general population/uncontrolled exposure limits (1.6 W/kg) specified in FCC 47 CFR part 2 (2.1093) and ANSI/IEEE C95.1-1992, and had been tested in accordance with the measurement methods and procedures specified in IEEE 1528-2013 and FCC KDB publications



2. Administration Data

Testing Laboratory	
Test Site	SPORTON INTERNATIONAL INC.
Test Site Location	No.52, Hwa Ya 1st Rd., Hwa Ya Technology Park, Kwei-Shan District, Taoyuan City, Taiwan (R.O.C.) TEL: +886-3-327-3456 FAX: +886-3-328-4978

Applicant	
Company Name	HTC Corporation
Address	No.23, Xinghua Rd., Taoyuan District, Taoyuan City, Taiwan 330

Manufacturer	
Company Name	HTC Corporation
Address	No.23, Xinghua Rd., Taoyuan District, Taoyuan City, Taiwan 330

3. Guidance Applied

The Specific Absorption Rate (SAR) testing specification, method, and procedure for this device is in accordance with the following standards:

- FCC 47 CFR Part 2 (2.1093)
- ANSI/IEEE C95.1-1992
- IEEE 1528-2013
- FCC KDB 865664 D01 SAR Measurement 100 MHz to 6 GHz v01r04
- FCC KDB 865664 D02 SAR Reporting v01r02
- FCC KDB 447498 D01 General RF Exposure Guidance v06
- FCC KDB 648474 D04 SAR Evaluation Considerations for Wireless Handsets v01r03
- FCC KDB 248227 D01 802.11 Wi-Fi SAR v02r02
- FCC KDB 941225 D01 3G SAR Procedures v03r01
- FCC KDB 941225 D05 SAR for LTE Devices v02r05
- FCC KDB 941225 D05A Rel.10 LTE SAR Test Guidance v01r02
- FCC KDB 941225 D06 Hotspot Mode SAR v02r01



4. Equipment Under Test (EUT) Information

4.1 General Information

Product Feature & Specification	
Equipment Name	Smartphone
Model Name	2PWD100
FCC ID	NM82PWD100
Wireless Technology and Frequency Range	GSM850: 824.2 MHz ~ 848.8 MHz GSM1900: 1850.2 MHz ~ 1909.8 MHz WCDMA Band II: 1852.4 MHz ~ 1907.6 MHz WCDMA Band IV: 1712.4 MHz ~ 1752.6 MHz WCDMA Band V: 826.4 MHz ~ 846.6 MHz LTE Band 2: 1850 MHz ~ 1910 MHz LTE Band 4: 1710 MHz ~ 1755 MHz LTE Band 5: 824 MHz ~ 849 MHz LTE Band 7: 2500 MHz ~ 2570 MHz LTE Band 12: 699 MHz ~ 716 MHz LTE Band 17: 704 MHz ~ 716 MHz LTE Band 38: 2572.5 MHz ~ 2617.5 MHz WLAN 2.4GHz Band: 2412 MHz ~ 2462 MHz WLAN 5.2GHz Band: 5180 MHz ~ 5240 MHz WLAN 5.3GHz Band: 5260 MHz ~ 5320 MHz WLAN 5.5GHz Band: 5500 MHz ~ 5700 MHz WLAN 5.8GHz Band: 5745 MHz ~ 5825 MHz Bluetooth: 2402 MHz ~ 2480 MHz NFC : 13.56 MHz
Mode	<ul style="list-style-type: none"> · GSM/GPRS/EGPRS · RMC/AMR 12.2Kbps · HSDPA · HSUPA · DC-HSDPA · HSPA+ (16QAM uplink) · LTE: QPSK, 16QAM · 802.11a/b/g/n HT20/HT40 · Bluetooth BR/EDR/LE · NFC:ASK
GSM / (E)GPRS Transfer mode	Class B – EUT cannot support Packet Switched and Circuit Switched Network simultaneously but can automatically switch between Packet and Circuit Switched Network.
EUT Stage	Production Unit
Remark: 1. This device WLAN 2.4GHz / 5.2GHz (U-NII-1) / 5.8GHz (U-NII-3) supports Hotspot operation. 2. RF Exposure was Selected Sample 1 as the main testing and Sample 2 will select worst case found in Sample 1 performs, Sample list information please refer to the following table.	

Sample List			
Sample 1	EUT with battery 1 and LCD Panel 1_black	IMEI	351515080011200
Sample 2	EUT with battery 2 and LCD Panel 2_white	IMEI	351515080012257



Accessories		
Battery 1	Brand Name	HTC
	Manufacturer	ATL
	Model Name	B2PWD100
Battery 2	Brand Name	HTC
	Manufacturer	Sunwoda
	Model Name	B2PWD100
Earphone 1	Brand Name	HTC
	Manufacturer	Merry
	Model Name	MAX 301
Earphone 2	Brand Name	HTC
	Manufacturer	Cotron
	Model Name	MAX 301
LCD Panel 1 (black)	Brand Name	HTC
	Manufacturer	Truly
	Model Name	TDO-HD0496K71344
LCD Panel 1 (white)	Brand Name	HTC
	Manufacturer	Truly
	Model Name	TDO-HD0496K71348
LCD Panel 2 (black)	Brand Name	HTC
	Manufacturer	Tianma
	Model Name	TM049JVSP02-00
LCD Panel 2 (white)	Brand Name	HTC
	Manufacturer	Tianma
	Model Name	TM049JVSP03-00



4.2 General LTE SAR Test and Reporting Considerations

Summarized necessary items addressed in KDB 941225 D05 v02r05																																							
FCC ID	NM82PWD100																																						
Equipment Name	SMARTPHONE																																						
Operating Frequency Range of each LTE transmission band	LTE Band 02: 1850 MHz ~ 1910 MHz LTE Band 04: 1710 MHz ~ 1755 MHz LTE Band 05: 824 MHz ~ 849 MHz LTE Band 07: 2500 MHz ~ 2570 MHz LTE Band 12: 699 MHz ~ 716 MHz LTE Band 17: 704 MHz ~ 716 MHz LTE Band 38: 2572.5 MHz ~ 2617.5 MHz																																						
Channel Bandwidth	LTE Band 02: 1.4MHz, 3MHz, 5MHz, 10MHz, 15MHz, 20MHz LTE Band 04: 1.4MHz, 3MHz, 5MHz, 10MHz, 15MHz, 20MHz LTE Band 05: 1.4MHz, 3MHz, 5MHz, 10MHz LTE Band 07: 5MHz, 10MHz, 15MHz, 20MHz LTE Band 12: 1.4MHz, 3MHz, 5MHz, 10MHz LTE Band 17: 5MHz, 10MHz LTE Band 38: 5MHz, 10MHz, 15MHz, 20MHz																																						
uplink modulations used	QPSK, and 16QAM																																						
LTE Voice / Data requirements	Voice and data																																						
LTE MPR permanently built-in by design	<p style="text-align: center;">Table 6.2.3-1: Maximum Power Reduction (MPR) for Power Class 3</p> <table border="1"> <thead> <tr> <th rowspan="2">Modulation</th> <th colspan="6">Channel bandwidth / Transmission bandwidth (RB)</th> <th rowspan="2">MPR (dB)</th> </tr> <tr> <th>1.4 MHz</th> <th>3.0 MHz</th> <th>5 MHz</th> <th>10 MHz</th> <th>15 MHz</th> <th>20 MHz</th> </tr> </thead> <tbody> <tr> <td>QPSK</td> <td>> 5</td> <td>> 4</td> <td>> 8</td> <td>> 12</td> <td>> 16</td> <td>> 18</td> <td>≤ 1</td> </tr> <tr> <td>16 QAM</td> <td>≤ 5</td> <td>≤ 4</td> <td>≤ 8</td> <td>≤ 12</td> <td>≤ 16</td> <td>≤ 18</td> <td>≤ 1</td> </tr> <tr> <td>16 QAM</td> <td>> 5</td> <td>> 4</td> <td>> 8</td> <td>> 12</td> <td>> 16</td> <td>> 18</td> <td>≤ 2</td> </tr> </tbody> </table>	Modulation	Channel bandwidth / Transmission bandwidth (RB)						MPR (dB)	1.4 MHz	3.0 MHz	5 MHz	10 MHz	15 MHz	20 MHz	QPSK	> 5	> 4	> 8	> 12	> 16	> 18	≤ 1	16 QAM	≤ 5	≤ 4	≤ 8	≤ 12	≤ 16	≤ 18	≤ 1	16 QAM	> 5	> 4	> 8	> 12	> 16	> 18	≤ 2
Modulation	Channel bandwidth / Transmission bandwidth (RB)						MPR (dB)																																
	1.4 MHz	3.0 MHz	5 MHz	10 MHz	15 MHz	20 MHz																																	
QPSK	> 5	> 4	> 8	> 12	> 16	> 18	≤ 1																																
16 QAM	≤ 5	≤ 4	≤ 8	≤ 12	≤ 16	≤ 18	≤ 1																																
16 QAM	> 5	> 4	> 8	> 12	> 16	> 18	≤ 2																																
LTE A-MPR	In the base station simulator configuration, Network Setting value is set to NS_01 to disable A-MPR during SAR testing and the LTE SAR tests was transmitting on all TTI frames (Maximum TT)																																						
Spectrum plots for RB configuration	A properly configured base station simulator was used for the SAR and power measurement; therefore, spectrum plots for each RB allocation and offset configuration are not included in the SAR report.																																						
LTE Carrier Aggregation Combinations	Intra-Band possible combinations as below page and the detail power verification please referred to page 50.																																						
LTE Carrier Aggregation Additional Information	This device does not support full CA features on 3GPP Release 10. It supports a maximum of 2 carriers in the downlink only. All uplink communications are identical to the Release 8 Specifications. Uplink communications are done on the PCC. Due to carrier capability, only the combinations listed above are supported. The following LTE Release features are not supported: Relay, HetNet, Enhanced MIMO, eICI, WiFi Offloading, MDH, eMBMA, Cross-Carrier Scheduling, Enhanced SC-FDMA.																																						



Transmission (H, M, L) channel numbers and frequencies in each LTE band												
LTE Band 2												
	Bandwidth 1.4 MHz		Bandwidth 3 MHz		Bandwidth 5 MHz		Bandwidth 10 MHz		Bandwidth 15 MHz		Bandwidth 20 MHz	
	Ch. #	Freq. (MHz)	Ch. #	Freq. (MHz)	Ch. #	Freq. (MHz)	Ch. #	Freq. (MHz)	Ch. #	Freq. (MHz)	Ch. #	Freq. (MHz)
L	18607	1850.7	18615	1851.5	18625	1852.5	18650	1855	18675	1857.5	18700	1860
M	18900	1880	18900	1880	18900	1880	18900	1880	18900	1880	18900	1880
H	19193	1909.3	19185	1908.5	19175	1907.5	19150	1905	19125	1902.5	19100	1900
LTE Band 4												
	Bandwidth 1.4 MHz		Bandwidth 3 MHz		Bandwidth 5 MHz		Bandwidth 10 MHz		Bandwidth 15 MHz		Bandwidth 20 MHz	
	Ch. #	Freq. (MHz)	Ch. #	Freq. (MHz)	Ch. #	Freq. (MHz)	Ch. #	Freq. (MHz)	Ch. #	Freq. (MHz)	Ch. #	Freq. (MHz)
L	19957	1710.7	19965	1711.5	19975	1712.5	20000	1715	20025	1717.5	20050	1720
M	20175	1732.5	20175	1732.5	20175	1732.5	20175	1732.5	20175	1732.5	20175	1732.5
H	20393	1754.3	20385	1753.5	20375	1752.5	20350	1750	20325	1747.5	20300	1745
LTE Band 5												
	Bandwidth 1.4 MHz		Bandwidth 3 MHz		Bandwidth 5 MHz		Bandwidth 10 MHz					
	Ch. #	Freq. (MHz)	Ch. #	Freq. (MHz)	Ch. #	Freq. (MHz)	Ch. #	Freq. (MHz)	Ch. #	Freq. (MHz)	Ch. #	Freq. (MHz)
L	20407	824.7	20415	825.5	20425	826.5	20450	829				
M	20525	836.5	20525	836.5	20525	836.5	20525	836.5				
H	20643	848.3	20635	847.5	20625	846.5	20600	844				
LTE Band 7												
	Bandwidth 5 MHz		Bandwidth 10 MHz		Bandwidth 15 MHz		Bandwidth 20 MHz					
	Ch. #	Freq. (MHz)	Ch. #	Freq. (MHz)	Ch. #	Freq. (MHz)	Ch. #	Freq. (MHz)	Ch. #	Freq. (MHz)	Ch. #	Freq. (MHz)
L	20775	2502.5	20800	2505	20825	2507.5	20850	2510				
M	21100	2535	21100	2535	21100	2535	21100	2535				
H	21425	2567.5	21400	2565	21375	2562.5	21350	2560				
LTE Band 12												
	Bandwidth 1.4 MHz		Bandwidth 3 MHz		Bandwidth 5 MHz		Bandwidth 10 MHz					
	Ch. #	Freq. (MHz)	Ch. #	Freq. (MHz)	Ch. #	Freq. (MHz)	Ch. #	Freq. (MHz)	Ch. #	Freq. (MHz)	Ch. #	Freq. (MHz)
L	23017	699.7	23025	700.5	23035	701.5	23060	704				
M	23095	707.5	23095	707.5	23095	707.5	23095	707.5				
H	23173	715.3	23165	714.5	23155	713.5	23130	711				
LTE Band 17												
	Bandwidth 5 MHz				Bandwidth 10 MHz							
	Channel #		Freq.(MHz)		Channel #		Freq. (MHz)					
L	23755		706.5		23780		709					
M	23790		710		23790		710					
H	23825		713.5		23800		711					
LTE Band 38												
	Bandwidth 5 MHz		Bandwidth 10 MHz		Bandwidth 15 MHz		Bandwidth 20 MHz					
	Ch. #	Freq. (MHz)	Ch. #	Freq. (MHz)	Ch. #	Freq. (MHz)	Ch. #	Freq. (MHz)	Ch. #	Freq. (MHz)	Ch. #	Freq. (MHz)
L	37775	2572.5	37800	2575	37825	2577.5	37850	2580				
M	38000	2595	38000	2595	38000	2595	38000	2595				
H	38225	2617.5	38200	2615	38175	2612.5	38150	2610				



5. RF Exposure Limits

5.1 Uncontrolled Environment

Uncontrolled Environments are defined as locations where there is the exposure of individuals who have no knowledge or control of their exposure. The general population/uncontrolled exposure limits are applicable to situations in which the general public may be exposed or in which persons who are exposed as a consequence of their employment may not be made fully aware of the potential for exposure or cannot exercise control over their exposure. Members of the general public would come under this category when exposure is not employment-related; for example, in the case of a wireless transmitter that exposes persons in its vicinity.

5.2 Controlled Environment

Controlled Environments are defined as locations where there is exposure that may be incurred by persons who are aware of the potential for exposure, (i.e. as a result of employment or occupation). In general, occupational/controlled exposure limits are applicable to situations in which persons are exposed as a consequence of their employment, who have been made fully aware of the potential for exposure and can exercise control over their exposure. The exposure category is also applicable when the exposure is of a transient nature due to incidental passage through a location where the exposure levels may be higher than the general population/uncontrolled limits, but the exposed person is fully aware of the potential for exposure and can exercise control over his or her exposure by leaving the area or by some other appropriate means.

Limits for Occupational/Controlled Exposure (W/kg)

Table with 3 columns: Whole-Body, Partial-Body, Hands, Wrists, Feet and Ankles. Values: 0.4, 8.0, 20.0

Limits for General Population/Uncontrolled Exposure (W/kg)

Table with 3 columns: Whole-Body, Partial-Body, Hands, Wrists, Feet and Ankles. Values: 0.08, 1.6, 4.0

- 1. Whole-Body SAR is averaged over the entire body, partial-body SAR is averaged over any 1gram of tissue defined as a tissue volume in the shape of a cube. SAR for hands, wrists, feet and ankles is averaged over any 10 grams of tissue defined as a tissue volume in the shape of a cube.

6. Specific Absorption Rate (SAR)

6.1 Introduction

SAR is related to the rate at which energy is absorbed per unit mass in an object exposed to a radio field. The SAR distribution in a biological body is complicated and is usually carried out by experimental techniques or numerical modeling. The standard recommends limits for two tiers of groups, occupational/controlled and general population/uncontrolled, based on a person's awareness and ability to exercise control over his or her exposure. In general, occupational/controlled exposure limits are higher than the limits for general population/uncontrolled.

6.2 SAR Definition

The SAR definition is the time derivative (rate) of the incremental energy (dW) absorbed by (dissipated in) an incremental mass (dm) contained in a volume element (dv) of a given density (ρ). The equation description is as below:

$$SAR = \frac{d}{dt} \left(\frac{dW}{dm} \right) = \frac{d}{dt} \left(\frac{dW}{\rho dv} \right)$$

SAR is expressed in units of Watts per kilogram (W/kg)

$$SAR = \frac{\sigma |E|^2}{\rho}$$

Where: σ is the conductivity of the tissue, ρ is the mass density of the tissue and E is the RMS electrical field strength.

7. System Description and Setup

The DASY system used for performing compliance tests consists of the following items:

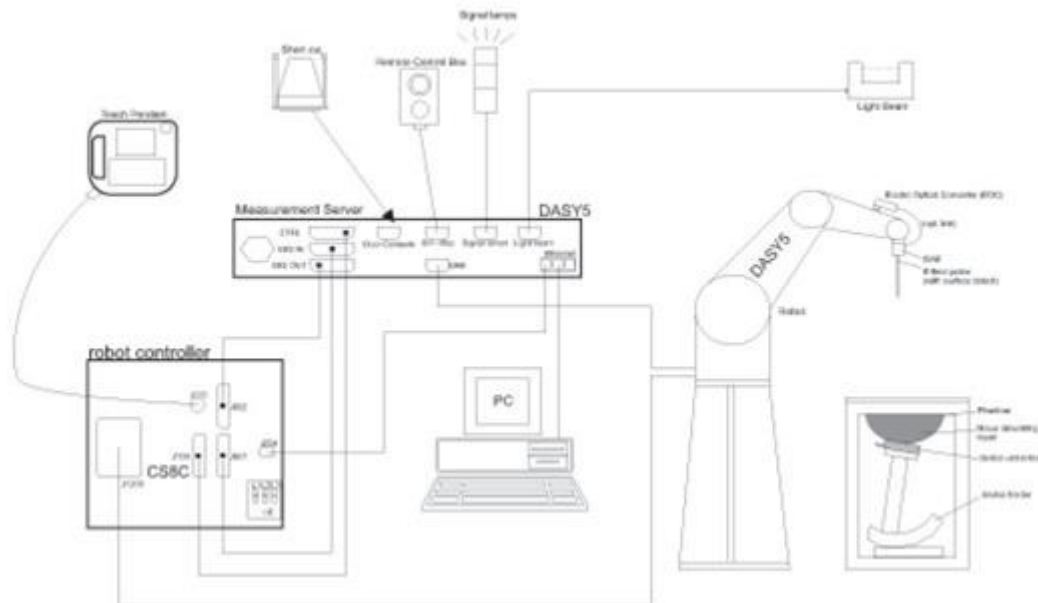

- A standard high precision 6-axis robot with controller, teach pendant and software. An arm extension for accommodating the data acquisition electronics (DAE).
- An isotropic Field probe optimized and calibrated for the targeted measurement.
- A data acquisition electronics (DAE) which performs the signal amplification, signal multiplexing, AD-conversion, offset measurements, mechanical surface detection, collision detection, etc. The unit is battery powered with standard or rechargeable batteries. The signal is optically transmitted to the EOC.
- The Electro-optical converter (EOC) performs the conversion from optical to electrical signals for the digital communication to the DAE. To use optical surface detection, a special version of the EOC is required. The EOC signal is transmitted to the measurement server.
- The function of the measurement server is to perform the time critical tasks such as signal filtering, control of the robot operation and fast movement interrupts.
- The Light Beam used is for probe alignment. This improves the (absolute) accuracy of the probe positioning.
- A computer running WinXP or Win7 and the DASY5 software.
- Remote control and teach pendant as well as additional circuitry for robot safety such as warning lamps, etc.
- The phantom, the device holder and other accessories according to the targeted measurement.

7.1 E-Field Probe

The SAR measurement is conducted with the dosimetric probe (manufactured by SPEAG).The probe is specially designed and calibrated for use in liquid with high permittivity. The dosimetric probe has special calibration in liquid at different frequency. This probe has a built in optical surface detection system to prevent from collision with phantom.

<ES3DV3 Probe>

Construction	Symmetric design with triangular core Interleaved sensors Built-in shielding against static charges PEEK enclosure material (resistant to organic solvents, e.g., DGBE)	
Frequency	10 MHz – 4 GHz; Linearity: ±0.2 dB (30 MHz – 4 GHz)	
Directivity	±0.2 dB in TSL (rotation around probe axis) ±0.3 dB in TSL (rotation normal to probe axis)	
Dynamic Range	5 µW/g – >100 mW/g; Linearity: ±0.2 dB	
Dimensions	Overall length: 337 mm (tip: 20 mm) Tip diameter: 3.9 mm (body: 12 mm) Distance from probe tip to dipole centers: 3.0 mm	

<EX3DV4 Probe>

Construction	Symmetric design with triangular core Built-in shielding against static charges PEEK enclosure material (resistant to organic solvents, e.g., DGBE)	
Frequency	10 MHz – >6 GHz Linearity: ±0.2 dB (30 MHz – 6 GHz)	
Directivity	±0.3 dB in TSL (rotation around probe axis) ±0.5 dB in TSL (rotation normal to probe axis)	
Dynamic Range	10 µW/g – >100 mW/g Linearity: ±0.2 dB (noise: typically <1 µW/g)	
Dimensions	Overall length: 337 mm (tip: 20 mm) Tip diameter: 2.5 mm (body: 12 mm) Typical distance from probe tip to dipole centers: 1 mm	

7.2 Data Acquisition Electronics (DAE)

The data acquisition electronics (DAE) consists of a highly sensitive electrometer-grade preamplifier with auto-zeroing, a channel and gain-switching multiplexer, a fast 16 bit AD-converter and a command decoder and control logic unit. Transmission to the measurement server is accomplished through an optical downlink for data and status information as well as an optical uplink for commands and the clock.

The input impedance of the DAE is 200 MOhm; the inputs are symmetrical and floating. Common mode rejection is above 80 dB.



Fig 5.1 Photo of DAE

7.3 Phantom

<SAM Twin Phantom>

Shell Thickness	2 ± 0.2 mm; Center ear point: 6 ± 0.2 mm	
Filling Volume	Approx. 25 liters	
Dimensions	Length: 1000 mm; Width: 500 mm; Height: adjustable feet	
Measurement Areas	Left Hand, Right Hand, Flat Phantom	

The bottom plate contains three pair of bolts for locking the device holder. The device holder positions are adjusted to the standard measurement positions in the three sections. A white cover is provided to tap the phantom during off-periods to prevent water evaporation and changes in the liquid parameters. On the phantom top, three reference markers are provided to identify the phantom position with respect to the robot.

<ELI Phantom>

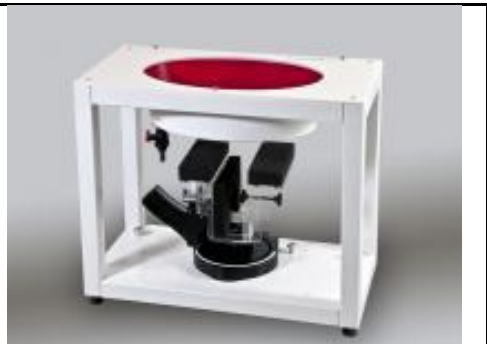
Shell Thickness	2 ± 0.2 mm (sagging: <1%)	
Filling Volume	Approx. 30 liters	
Dimensions	Major ellipse axis: 600 mm Minor axis: 400 mm	

The ELI phantom is intended for compliance testing of handheld and body-mounted wireless devices in the frequency range of 30 MHz to 6 GHz. ELI4 is fully compatible with standard and all known tissue simulating liquids.

7.4 Device Holder

<Mounting Device for Hand-Held Transmitter>

In combination with the Twin SAM V5.0/V5.0c or ELI phantoms, the Mounting Device for Hand-Held Transmitters enables rotation of the mounted transmitter device to specified spherical coordinates. At the heads, the rotation axis is at the ear opening. Transmitter devices can be easily and accurately positioned according to IEC 62209-1, IEEE 1528, FCC, or other specifications. The device holder can be locked for positioning at different phantom sections (left head, right head, flat). And upgrade kit to Mounting Device to enable easy mounting of wider devices like big smart-phones, e-books, small tablets, etc. It holds devices with width up to 140 mm.



Mounting Device for Hand-Held Transmitters



Mounting Device Adaptor for Wide-Phones

<Mounting Device for Laptops and other Body-Worn Transmitters>

The extension is lightweight and made of POM, acrylic glass and foam. It fits easily on the upper part of the mounting device in place of the phone positioned. The extension is fully compatible with the SAM Twin and ELI phantoms.



Mounting Device for Laptops

8. Measurement Procedures

The measurement procedures are as follows:

<Conducted power measurement>

- (a) For WWAN power measurement, use base station simulator to configure EUT WWAN transmission in conducted connection with RF cable, at maximum power in each supported wireless interface and frequency band.
- (b) Read the WWAN RF power level from the base station simulator.
- (c) For WLAN/BT power measurement, use engineering software to configure EUT WLAN/BT continuously transmission, at maximum RF power in each supported wireless interface and frequency band
- (d) Connect EUT RF port through RF cable to the power meter, and measure WLAN/BT output power

<SAR measurement>

- (a) Use base station simulator to configure EUT WWAN transmission in radiated connection, and engineering software to configure EUT WLAN/BT continuously transmission, at maximum RF power, in the highest power channel.
- (b) Place the EUT in the positions as Appendix D demonstrates.
- (c) Set scan area, grid size and other setting on the DASY software.
- (d) Measure SAR results for the highest power channel on each testing position.
- (e) Find out the largest SAR result on these testing positions of each band
- (f) Measure SAR results for other channels in worst SAR testing position if the reported SAR of highest power channel is larger than 0.8 W/kg

According to the test standard, the recommended procedure for assessing the peak spatial-average SAR value consists of the following steps:

- (a) Power reference measurement
- (b) Area scan
- (c) Zoom scan
- (d) Power drift measurement

8.1 Spatial Peak SAR Evaluation

The procedure for spatial peak SAR evaluation has been implemented according to the test standard. It can be conducted for 1g and 10g, as well as for user-specific masses. The DASY software includes all numerical procedures necessary to evaluate the spatial peak SAR value.

The base for the evaluation is a "cube" measurement. The measured volume must include the 1g and 10g cubes with the highest averaged SAR values. For that purpose, the center of the measured volume is aligned to the interpolated peak SAR value of a previously performed area scan.

The entire evaluation of the spatial peak values is performed within the post-processing engine (SEMCAD). The system always gives the maximum values for the 1g and 10g cubes. The algorithm to find the cube with highest averaged SAR is divided into the following stages:

- (a) Extraction of the measured data (grid and values) from the Zoom Scan
- (b) Calculation of the SAR value at every measurement point based on all stored data (A/D values and measurement parameters)
- (c) Generation of a high-resolution mesh within the measured volume
- (d) Interpolation of all measured values from the measurement grid to the high-resolution grid
- (e) Extrapolation of the entire 3-D field distribution to the phantom surface over the distance from sensor to surface
- (f) Calculation of the averaged SAR within masses of 1g and 10g

8.2 Power Reference Measurement

The Power Reference Measurement and Power Drift Measurements are for monitoring the power drift of the device under test in the batch process. The minimum distance of probe sensors to surface determines the closest measurement point to phantom surface. This distance cannot be smaller than the distance of sensor calibration points to probe tip as defined in the probe properties.

8.3 Area Scan

The area scan is used as a fast scan in two dimensions to find the area of high field values, before doing a fine measurement around the hot spot. The sophisticated interpolation routines implemented in DASY software can find the maximum found in the scanned area, within a range of the global maximum. The range (in dB0) is specified in the standards for compliance testing. For example, a 2 dB range is required in IEEE standard 1528 and IEC 62209 standards, whereby 3 dB is a requirement when compliance is assessed in accordance with the ARIB standard (Japan), if only one zoom scan follows the area scan, then only the absolute maximum will be taken as reference. For cases where multiple maximums are detected, the number of zoom scans has to be increased accordingly.

Area scan parameters extracted from FCC KDB 865664 D01v01r04 SAR measurement 100 MHz to 6 GHz.

	≤ 3 GHz	> 3 GHz
Maximum distance from closest measurement point (geometric center of probe sensors) to phantom surface	5 ± 1 mm	$\frac{1}{2} \cdot \delta \cdot \ln(2) \pm 0.5$ mm
Maximum probe angle from probe axis to phantom surface normal at the measurement location	30° ± 1°	20° ± 1°
Maximum area scan spatial resolution: $\Delta x_{Area}, \Delta y_{Area}$	≤ 2 GHz: ≤ 15 mm 2 – 3 GHz: ≤ 12 mm	3 – 4 GHz: ≤ 12 mm 4 – 6 GHz: ≤ 10 mm
	When the x or y dimension of the test device, in the measurement plane orientation, is smaller than the above, the measurement resolution must be ≤ the corresponding x or y dimension of the test device with at least one measurement point on the test device.	

8.4 Zoom Scan

Zoom scans are used assess the peak spatial SAR values within a cubic averaging volume containing 1 gram and 10 gram of simulated tissue. The zoom scan measures points (refer to table below) within a cube shoes base faces are centered on the maxima found in a preceding area scan job within the same procedure. When the measurement is done, the zoom scan evaluates the averaged SAR for 1 gram and 10 gram and displays these values next to the job's label.

Zoom scan parameters extracted from FCC KDB 865664 D01v01r04 SAR measurement 100 MHz to 6 GHz.

		≤ 3 GHz	> 3 GHz	
Maximum zoom scan spatial resolution: $\Delta x_{Zoom}, \Delta y_{Zoom}$		≤ 2 GHz: ≤ 8 mm 2 – 3 GHz: ≤ 5 mm*	3 – 4 GHz: ≤ 5 mm* 4 – 6 GHz: ≤ 4 mm*	
Maximum zoom scan spatial resolution, normal to phantom surface	uniform grid: $\Delta z_{Zoom}(n)$	≤ 5 mm	3 – 4 GHz: ≤ 4 mm 4 – 5 GHz: ≤ 3 mm 5 – 6 GHz: ≤ 2 mm	
	graded grid	$\Delta z_{Zoom}(1)$: between 1 st two points closest to phantom surface	≤ 4 mm	3 – 4 GHz: ≤ 3 mm 4 – 5 GHz: ≤ 2.5 mm 5 – 6 GHz: ≤ 2 mm
		$\Delta z_{Zoom}(n>1)$: between subsequent points	$\leq 1.5 \cdot \Delta z_{Zoom}(n-1)$	
Minimum zoom scan volume	x, y, z	≥ 30 mm	3 – 4 GHz: ≥ 28 mm 4 – 5 GHz: ≥ 25 mm 5 – 6 GHz: ≥ 22 mm	
Note: δ is the penetration depth of a plane-wave at normal incidence to the tissue medium; see draft standard IEEE P1528-2011 for details. * When zoom scan is required and the <i>reported</i> SAR from the <i>area scan based 1-g SAR estimation</i> procedures of KDB 447498 is ≤ 1.4 W/kg, ≤ 8 mm, ≤ 7 mm and ≤ 5 mm zoom scan resolution may be applied, respectively, for 2 GHz to 3 GHz, 3 GHz to 4 GHz and 4 GHz to 6 GHz.				

8.5 Volume Scan Procedures

The volume scan is used for assess overlapping SAR distributions for antennas transmitting in different frequency bands. It is equivalent to an oversized zoom scan used in standalone measurements. The measurement volume will be used to enclose all the simultaneous transmitting antennas. For antennas transmitting simultaneously in different frequency bands, the volume scan is measured separately in each frequency band. In order to sum correctly to compute the 1g aggregate SAR, the EUT remain in the same test position for all measurements and all volume scan use the same spatial resolution and grid spacing. When all volume scan were completed, the software, SEMCAD postprocessor can combine and subsequently superpose these measurement data to calculating the multiband SAR.

8.6 Power Drift Monitoring

All SAR testing is under the EUT install full charged battery and transmit maximum output power. In DASy measurement software, the power reference measurement and power drift measurement procedures are used for monitoring the power drift of EUT during SAR test. Both these procedures measure the field at a specified reference position before and after the SAR testing. The software will calculate the field difference in dB. If the power drifts more than 5%, the SAR will be retested.



9. Test Equipment List

Manufacturer	Name of Equipment	Type/Model	Serial Number	Calibration	
				Last Cal.	Due Date
SPEAG	750MHz System Validation Kit	D750V3	1012	May. 18, 2016	May. 17, 2017
SPEAG	835MHz System Validation Kit	D835V2	499	Mar. 21, 2016	Mar. 20, 2017
SPEAG	1750MHz System Validation Kit	D1750V2	1068	Nov. 23, 2015	Nov. 22, 2016
SPEAG	1900MHz System Validation Kit	D1900V2	5d041	Oct. 22, 2015	Oct. 21, 2016
SPEAG	2450MHz System Validation Kit	D2450V2	926	Jul. 25, 2016	Jul. 24, 2017
SPEAG	2600MHz System Validation Kit	D2600V2	1058	Jun. 22, 2016	Jun. 21, 2017
SPEAG	5GHz System Validation Kit	D5GHzV2	1006	Oct. 06, 2015	Oct. 05, 2016
SPEAG	5GHz System Validation Kit	D5GHzV2	1128	Jul. 27, 2016	Jul. 26, 2017
SPEAG	Data Acquisition Electronics	DAE3	495	May. 27, 2016	May. 26, 2017
SPEAG	Data Acquisition Electronics	DAE4	778	May. 12, 2016	May. 11, 2017
SPEAG	Data Acquisition Electronics	DAE3	577	Sep. 24, 2015	Sep. 23, 2016
SPEAG	Data Acquisition Electronics	DAE4	1399	Nov. 23, 2015	Nov. 22, 2016
SPEAG	Dosimetric E-Field Probe	EX3DV4	3925	May. 26, 2016	May. 25, 2017
SPEAG	Dosimetric E-Field Probe	ES3DV3	3270	Aug. 26, 2016	Aug. 25, 2017
SPEAG	Dosimetric E-Field Probe	EX3DV4	3931	Oct. 01, 2015	Sep. 30, 2016
SPEAG	Dosimetric E-Field Probe	EX3DV4	3955	Nov. 24, 2015	Nov. 23, 2016
WonDer	Thermometer	WD-5015	TM642	Oct. 16, 2015	Oct. 15, 2016
WonDer	Thermometer	WD-5015	TM281	Oct. 16, 2015	Oct. 15, 2016
Wisewind	Thermometer	HTC-1	TM560	Oct. 16, 2015	Oct. 15, 2016
Wisewind	Thermometer	HTC-1	TM225	Oct. 16, 2015	Oct. 15, 2016
Anritsu	Radio Communication Analyzer	MT8820C	6201381760	May. 10, 2016	May. 09, 2017
Agilent	Wireless Communication Test Set	E5515C	MY50266977	May. 17, 2016	May. 16, 2017
SPEAG	Device Holder	N/A	N/A	N/A	N/A
R&S	Signal Generator	MG3710A	6201502524	Dec. 18, 2015	Dec. 17, 2016
Agilent	ENA Network Analyzer	E5071C	MY46316648	Jan. 12, 2016	Jan. 11, 2017
SPEAG	Dielectric Probe Kit	DAK-3.5	1126	Jul. 19, 2016	Jul. 18, 2017
Anritsu	Power Meter	ML2495A	1419002	May. 10, 2016	May. 09, 2017
Anritsu	Power Sensor	MA2411B	1339124	May. 10, 2016	May. 09, 2017
Anritsu	Spectrum Analyzer	MS2830A	6201396378	Jun. 21, 2016	Jun. 20, 2017
Mini-Circuits	Power Amplifier	ZVE-8G+	D120604	Mar. 16, 2016	Mar. 15, 2017
Mini-Circuits	Power Amplifier	ZHL-42W+	QA1344002	Mar. 16, 2016	Mar. 15, 2017
ATM	Dual Directional Coupler	C122H-10	P610410z-02	Note 1	
Woken	Attenuator 1	WK0602-XX	N/A	Note 1	
PE	Attenuator 2	PE7005-10	N/A	Note 1	
PE	Attenuator 3	PE7005-3	N/A	Note 1	

General Note:

1. Prior to system verification and validation, the path loss from the signal generator to the system check source and the power meter, which includes the amplifier, cable, attenuator and directional coupler, was measured by the network analyzer. The reading of the power meter was offset by the path loss difference between the path to the power meter and the path to the system check source to monitor the actual power level fed to the system check source.

10. System Verification

10.1 Tissue Simulating Liquids

For the measurement of the field distribution inside the SAM phantom with DASY, the phantom must be filled with around 25 liters of homogeneous body tissue simulating liquid. For head SAR testing, the liquid height from the ear reference point (ERP) of the phantom to the liquid top surface is larger than 15 cm, which is shown in Fig. 10.1. For body SAR testing, the liquid height from the center of the flat phantom to the liquid top surface is larger than 15 cm, which is shown in Fig. 10.2.

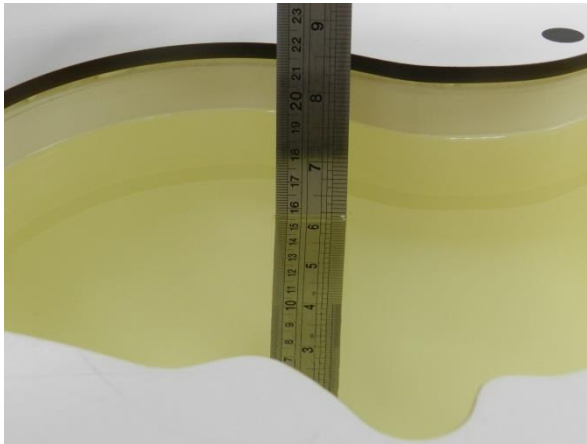

Fig 10.1 Photo of Liquid Height for Head SAR

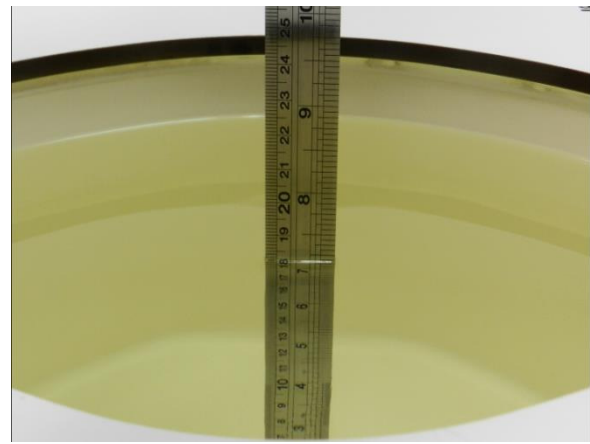

Fig 10.2 Photo of Liquid Height for Body SAR

10.2 Tissue Verification

The following tissue formulations are provided for reference only as some of the parameters have not been thoroughly verified. The composition of ingredients may be modified accordingly to achieve the desired target tissue parameters required for routine SAR evaluation.

Frequency (MHz)	Water (%)	Sugar (%)	Cellulose (%)	Salt (%)	Preventol (%)	DGBE (%)	Conductivity (σ)	Permittivity (ϵ_r)
For Head								
750	41.1	57.0	0.2	1.4	0.2	0	0.89	41.9
835	40.3	57.9	0.2	1.4	0.2	0	0.90	41.5
900	40.3	57.9	0.2	1.4	0.2	0	0.97	41.5
1800, 1900, 2000	55.2	0	0	0.3	0	44.5	1.40	40.0
2450	55.0	0	0	0	0	45.0	1.80	39.2
2600	54.8	0	0	0.1	0	45.1	1.96	39.0
For Body								
750	51.7	47.2	0	0.9	0.1	0	0.96	55.5
835	50.8	48.2	0	0.9	0.1	0	0.97	55.2
900	50.8	48.2	0	0.9	0.1	0	1.05	55.0
1800, 1900, 2000	70.2	0	0	0.4	0	29.4	1.52	53.3
2450	68.6	0	0	0	0	31.4	1.95	52.7
2600	68.1	0	0	0.1	0	31.8	2.16	52.5

Simulating Liquid for 5GHz, Manufactured by SPEAG

Ingredients	(% by weight)
Water	64~78%
Mineral oil	11~18%
Emulsifiers	9~15%
Additives and Salt	2~3%



<Tissue Dielectric Parameter Check Results>

Frequency (MHz)	Tissue Type	Liquid Temp. (°C)	Conductivity (σ)	Permittivity (ϵ_r)	Conductivity Target (σ)	Permittivity Target (ϵ_r)	Delta (σ) (%)	Delta (ϵ_r) (%)	Limit (%)	Date
750	HSL	22.4	0.900	42.423	0.89	41.90	1.12	1.25	±5	2016/8/31
750	MSL	22.2	0.961	56.354	0.96	55.50	0.10	1.54	±5	2016/9/5
835	HSL	22.4	0.898	43.054	0.90	41.50	-0.22	3.74	±5	2016/8/30
835	HSL	22.2	0.891	41.127	0.90	41.50	-1.00	-0.90	±5	2016/9/1
835	MSL	22.9	0.992	56.767	0.97	55.20	2.27	2.84	±5	2016/9/5
1750	HSL	22.6	1.374	40.350	1.37	40.10	0.29	0.62	±5	2016/9/2
1750	MSL	22.8	1.459	55.690	1.49	53.40	-2.08	4.29	±5	2016/9/4
1900	HSL	22.6	1.432	38.309	1.40	40.00	2.29	-4.23	±5	2016/9/1
1900	MSL	22.6	1.575	55.365	1.52	53.30	3.62	3.87	±5	2016/9/3
2450	HSL	22.3	1.748	38.342	1.80	39.20	-2.89	-2.19	±5	2016/8/20
2450	HSL	22.5	1.770	40.225	1.80	39.20	-1.67	2.61	±5	2016/9/14
2450	MSL	22.7	1.954	52.459	1.95	52.70	0.21	-0.46	±5	2016/8/23
2450	MSL	22.5	1.952	51.922	1.95	52.70	0.10	-1.48	±5	2016/9/6
2600	HSL	22.2	1.940	39.136	1.96	39.00	-1.02	0.35	±5	2016/8/26
2600	HSL	22.4	1.950	37.900	1.96	39.00	-0.51	-2.82	±5	2016/9/2
2600	HSL	22.9	1.924	37.251	1.96	39.00	-1.84	-4.48	±5	2016/9/6
2600	HSL	22.9	1.924	37.251	1.96	39.00	-1.84	-4.48	±5	2016/9/6
2600	MSL	22.2	2.103	51.672	2.16	52.50	-2.64	-1.58	±5	2016/8/25
2600	MSL	22.6	2.176	53.028	2.16	52.50	0.74	1.01	±5	2016/9/4
2600	MSL	22.5	2.150	51.411	2.16	52.50	-0.46	-2.07	±5	2016/9/6
5200	HSL	22.5	4.450	35.600	4.66	36.00	-4.51	-1.11	±5	2016/9/14
5250	HSL	22.5	4.508	35.614	4.71	35.95	-4.29	-0.93	±5	2016/9/12
5250	MSL	22.5	5.492	46.888	5.36	48.95	2.46	-4.21	±5	2016/8/27
5250	MSL	22.4	5.400	46.700	5.36	48.95	0.75	-4.60	±5	2016/9/5
5250	MSL	22.5	5.477	46.848	5.36	48.95	2.18	-4.29	±5	2016/9/12
5600	HSL	22.7	4.979	35.931	5.07	35.50	-1.79	1.21	±5	2016/8/24
5600	HSL	22.4	4.830	35.800	5.07	35.50	-4.73	0.85	±5	2016/9/5
5600	HSL	22.5	4.840	35.000	5.07	35.50	-4.54	-1.41	±5	2016/9/14
5600	MSL	22.5	5.946	46.272	5.77	48.50	3.05	-4.59	±5	2016/8/27
5600	MSL	22.4	5.850	46.200	5.77	48.50	1.39	-4.74	±5	2016/9/5
5750	HSL	22.7	5.140	35.708	5.22	35.35	-1.53	1.01	±5	2016/8/24
5750	MSL	22.5	6.145	46.009	5.94	48.28	3.45	-4.70	±5	2016/8/27
5750	MSL	22.4	6.040	46.000	5.94	48.28	1.68	-4.72	±5	2016/9/5
5800	HSL	22.5	5.040	34.800	5.27	35.30	-4.36	-1.42	±5	2016/9/14



10.3 System Performance Check Results

Comparing to the original SAR value provided by SPEAG, the verification data should be within its specification of 10 %. Below table shows the target SAR and measured SAR after normalized to 1W input power. The table below indicates the system performance check can meet the variation criterion and the plots can be referred to Appendix A of this report.

Date	Frequency (MHz)	Tissue Type	Input Power (mW)	Dipole S/N	Probe S/N	DAE S/N	Measured 1g SAR (W/kg)	Targeted 1g SAR (W/kg)	Normalized 1g SAR (W/kg)	Deviation (%)
2016/8/31	750	HSL	250	D750V3-1012	EX3DV4 - SN3925	DAE3 Sn495	2.08	8.21	8.32	1.34
2016/9/5	750	MSL	250	D750V3-1012	EX3DV4 - SN3925	DAE3 Sn495	2.29	8.72	9.16	5.05
2016/8/30	835	HSL	250	D835V2-499	EX3DV4 - SN3925	DAE3 Sn495	2.43	9.14	9.72	6.35
2016/9/1	835	HSL	250	D835V2-499	EX3DV4 - SN3925	DAE3 Sn495	2.31	9.14	9.24	1.09
2016/9/5	835	MSL	250	D835V2-499	EX3DV4 - SN3925	DAE3 Sn495	2.54	9.52	10.16	6.72
2016/9/2	1750	HSL	250	D1750V2-1068	EX3DV4 - SN3925	DAE3 Sn495	9.32	36.80	37.28	1.30
2016/9/4	1750	MSL	250	D1750V2-1068	EX3DV4 - SN3925	DAE3 Sn495	8.82	35.70	35.28	-1.18
2016/9/1	1900	HSL	250	D1900V2-5d041	EX3DV4 - SN3925	DAE3 Sn495	9.98	39.80	39.92	0.30
2016/9/3	1900	MSL	250	D1900V2-5d041	EX3DV4 - SN3925	DAE3 Sn495	10.20	40.00	40.80	2.00
2016/8/20	2450	HSL	250	D2450V2-926	EX3DV4 - SN3955	DAE4 Sn778	12.80	52.80	51.20	-3.03
2016/9/14	2450	HSL	250	D2450V2-926	EX3DV4 - SN3925	DAE3 Sn495	12.50	52.80	50.00	-5.30
2016/8/23	2450	MSL	250	D2450V2-926	EX3DV4 - SN3931	DAE3 Sn577	13.00	51.20	52.00	1.56
2016/9/6	2450	MSL	250	D2450V2-926	ES3DV3 - SN3270	DAE4 Sn1399	12.50	51.20	50.00	-2.34
2016/8/26	2600	HSL	250	D2600V2-1058	EX3DV4 - SN3925	DAE3 Sn495	13.30	55.70	53.20	-4.49
2016/9/2	2600	HSL	250	D2600V2-1058	EX3DV4 - SN3955	DAE4 Sn778	13.90	55.70	55.60	-0.18
2016/9/6	2600	HSL	250	D2600V2-1058	EX3DV4 - SN3925	DAE3 Sn495	13.20	55.70	52.80	-5.21
2016/9/6	2600	HSL	250	D2600V2-1058	ES3DV3 - SN3270	DAE4 Sn1399	13.90	55.70	55.60	-0.18
2016/8/25	2600	MSL	250	D2600V2-1058	EX3DV4 - SN3925	DAE3 Sn495	13.80	53.20	55.20	3.76
2016/9/4	2600	MSL	250	D2600V2-1058	EX3DV4 - SN3955	DAE4 Sn778	13.50	53.20	54.00	1.50
2016/9/6	2600	MSL	250	D2600V2-1058	ES3DV3 - SN3270	DAE4 Sn1399	13.40	53.20	53.60	0.75
2016/9/14	5200	HSL	100	D5GHzV2-1006	EX3DV4 - SN3925	DAE3 Sn495	7.69	78.00	76.9	-1.41
2016/9/12	5250	HSL	100	D5GHzV2-1128	EX3DV4 - SN3931	DAE3 Sn577	8.02	77.90	80.20	2.95
2016/8/27	5250	MSL	100	D5GHzV2-1128	EX3DV4 - SN3931	DAE3 Sn577	7.08	74.50	70.80	-4.97
2016/9/5	5250	MSL	100	D5GHzV2-1128	EX3DV4 - SN3931	DAE3 Sn577	7.62	74.50	76.20	2.28
2016/9/12	5250	MSL	100	D5GHzV2-1128	EX3DV4 - SN3931	DAE3 Sn577	7.84	74.50	78.4	5.23
2016/8/24	5600	HSL	100	D5GHzV2-1128	EX3DV4 - SN3931	DAE3 Sn577	7.67	81.20	76.70	-5.54
2016/9/5	5600	HSL	100	D5GHzV2-1128	EX3DV4 - SN3931	DAE3 Sn577	8.14	81.20	81.40	0.25
2016/9/14	5600	HSL	100	D5GHzV2-1006	EX3DV4 - SN3925	DAE3 Sn495	8.14	84.80	81.4	-4.01
2016/8/27	5600	MSL	100	D5GHzV2-1128	EX3DV4 - SN3931	DAE3 Sn577	8.31	78.00	83.10	6.54
2016/9/5	5600	MSL	100	D5GHzV2-1128	EX3DV4 - SN3931	DAE3 Sn577	7.75	78.00	77.50	-0.64
2016/8/24	5750	HSL	100	D5GHzV2-1128	EX3DV4 - SN3931	DAE3 Sn577	7.97	78.30	79.70	1.79
2016/8/27	5750	MSL	100	D5GHzV2-1128	EX3DV4 - SN3931	DAE3 Sn577	7.39	76.10	73.90	-2.89
2016/9/5	5750	MSL	100	D5GHzV2-1128	EX3DV4 - SN3931	DAE3 Sn577	7.69	76.10	76.90	1.05
2016/9/14	5800	HSL	100	D5GHzV2-1006	EX3DV4 - SN3925	DAE3 Sn495	8.31	82.00	83.1	1.34

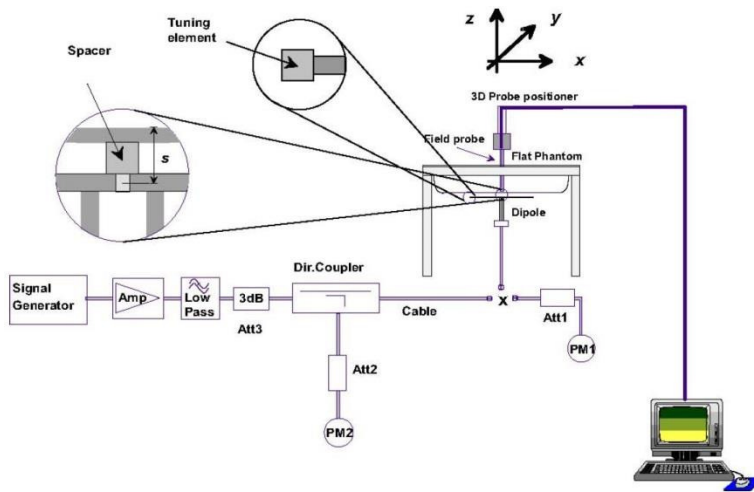

Fig 8.3.1 System Performance Check Setup



Fig 8.3.2 Setup Photo

11. RF Exposure Positions

11.1 Ear and handset reference point

Figure 9.1.1 shows the front, back, and side views of the SAM phantom. The center-of-mouth reference point is labeled “M,” the left ear reference point (ERP) is marked “LE,” and the right ERP is marked “RE.” Each ERP is 15 mm along the B-M (back-mouth) line behind the entrance-to-ear-canal (EEC) point, as shown in Figure 9.1.2 The Reference Plane is defined as passing through the two ear reference points and point M. The line N-F (neck-front), also called the reference pivoting line, is normal to the Reference Plane and perpendicular to both a line passing through RE and LE and the B-M line (see Figure 9.1.3). Both N-F and B-M lines should be marked on the exterior of the phantom shell to facilitate handset positioning. Posterior to the N-F line the ear shape is a flat surface with 6 mm thickness at each ERP, and forward of the N-F line the ear is truncated, as illustrated in Figure 9.1.2. The ear truncation is introduced to preclude the ear lobe from interfering with handset tilt, which could lead to unstable positioning at the cheek.

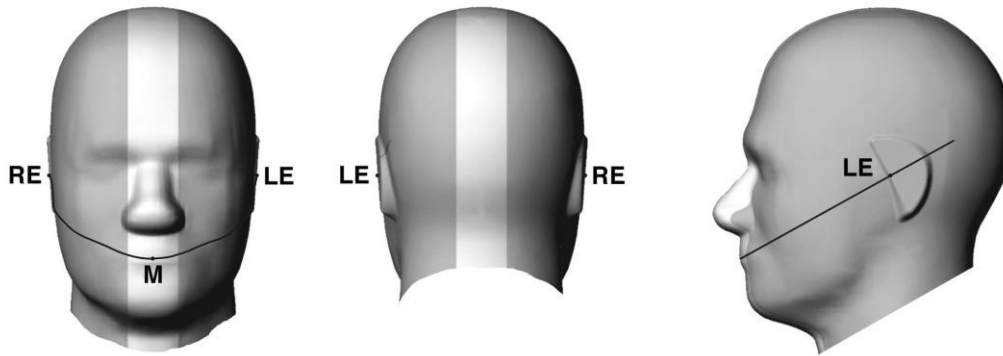

Fig 9.1.1 Front, back, and side views of SAM twin phantom

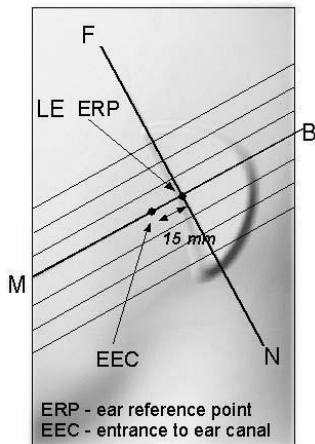

Fig 9.1.2 Close-up side view of phantom showing the ear region.

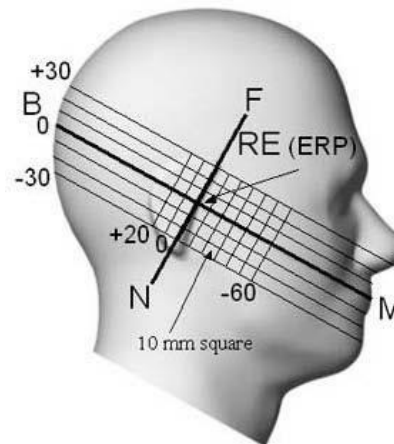

Fig 9.1.3 Side view of the phantom showing relevant markings and seven cross-sectional plane locations

11.2 Definition of the cheek position

1. Ready the handset for talk operation, if necessary. For example, for handsets with a cover piece (flip cover), open the cover. If the handset can transmit with the cover closed, both configurations must be tested.
2. Define two imaginary lines on the handset—the vertical centerline and the horizontal line. The vertical centerline passes through two points on the front side of the handset—the midpoint of the width w_t of the handset at the level of the acoustic output (point A in Figure 9.2.1 and Figure 9.2.2), and the midpoint of the width w_b of the bottom of the handset (point B). The horizontal line is perpendicular to the vertical centerline and passes through the center of the acoustic output (see Figure 9.2.1). The two lines intersect at point A. Note that for many handsets, point A coincides with the center of the acoustic output; however, the acoustic output may be located elsewhere on the horizontal line. Also note that the vertical centerline is not necessarily parallel to the front face of the handset (see Figure 9.2.2), especially for clamshell handsets, handsets with flip covers, and other irregularly-shaped handsets.
3. Position the handset close to the surface of the phantom such that point A is on the (virtual) extension of the line passing through points RE and LE on the phantom (see Figure 9.2.3), such that the plane defined by the vertical centerline and the horizontal line of the handset is approximately parallel to the sagittal plane of the phantom.
4. Translate the handset towards the phantom along the line passing through RE and LE until handset point A touches the pinna at the ERP.
5. While maintaining the handset in this plane, rotate it around the LE-RE line until the vertical centerline is in the plane normal to the plane containing B-M and N-F lines, i.e., the Reference Plane.
6. Rotate the handset around the vertical centerline until the handset (horizontal line) is parallel to the N-F line.
7. While maintaining the vertical centerline in the Reference Plane, keeping point A on the line passing through RE and LE, and maintaining the handset contact with the pinna, rotate the handset about the N-F line until any point on the handset is in contact with a phantom point below the pinna on the cheek. See Figure 9.2.3. The actual rotation angles should be documented in the test report.

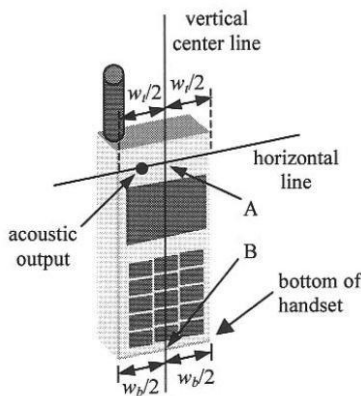

Fig 9.2.1 Handset vertical and horizontal reference lines—“fixed case”

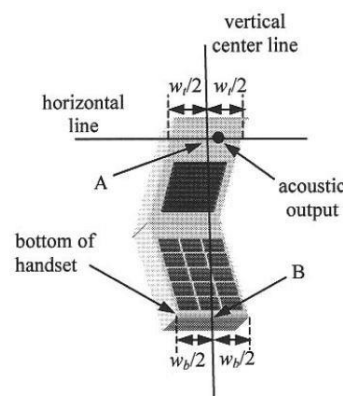

Fig 9.2.2 Handset vertical and horizontal reference lines—“clam-shell case”

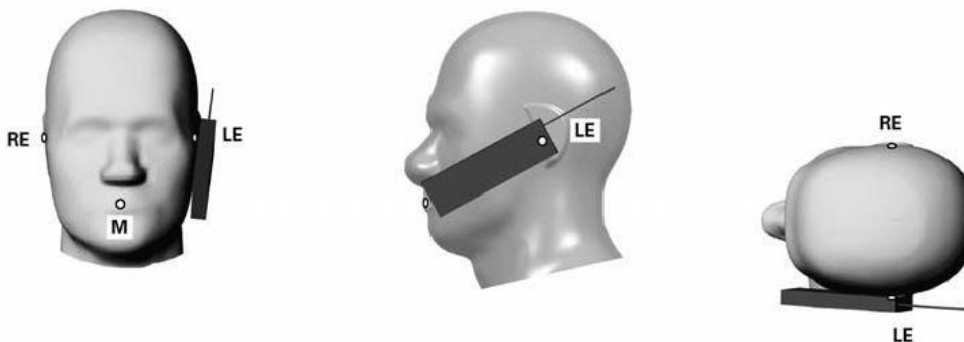

Fig 9.2.3 cheek or touch position. The reference points for the right ear (RE), left ear (LE), and mouth (M), which establish the Reference Plane for handset positioning, are indicated.

11.3 Definition of the tilt position

1. Ready the handset for talk operation, if necessary. For example, for handsets with a cover piece (flip cover), open the cover. If the handset can transmit with the cover closed, both configurations must be tested.
2. While maintaining the orientation of the handset, move the handset away from the pinna along the line passing through RE and LE far enough to allow a rotation of the handset away from the cheek by 15°.
3. Rotate the handset around the horizontal line by 15°.
4. While maintaining the orientation of the handset, move the handset towards the phantom on the line passing through RE and LE until any part of the handset touches the ear. The tilt position is obtained when the contact point is on the pinna. See Figure 9.3.1. If contact occurs at any location other than the pinna, e.g., the antenna at the back of the phantom head, the angle of the handset should be reduced. In this case, the tilt position is obtained if any point on the handset is in contact with the pinna and a second point

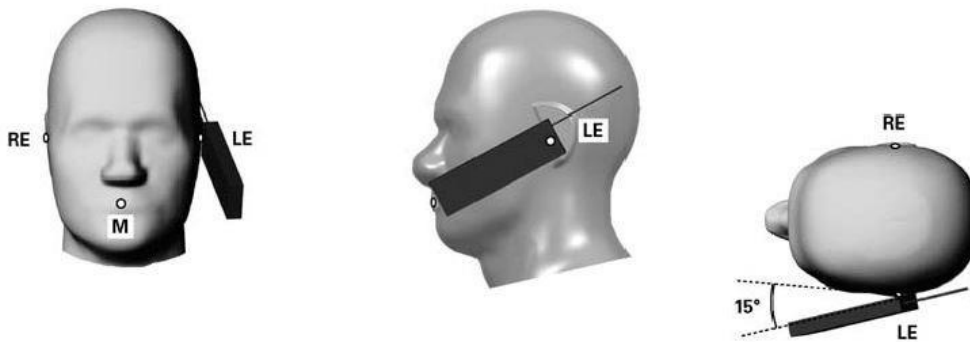

Fig 9.3.1 Tilt position. The reference points for the right ear (RE), left ear (LE), and mouth (M), which define the Reference Plane for handset positioning, are indicated.

11.4 Body Worn Accessory

Body-worn operating configurations are tested with the belt-clips and holsters attached to the device and positioned against a flat phantom in a normal use configuration (see Figure 9.4). Per KDB648474 D04v01r03, body-worn accessory exposure is typically related to voice mode operations when handsets are carried in body-worn accessories. The body-worn accessory procedures in FCC KDB 447498 D01v06 should be used to test for body-worn accessory SAR compliance, without a headset connected to it. This enables the test results for such configuration to be compatible with that required for hotspot mode when the body-worn accessory test separation distance is greater than or equal to that required for hotspot mode, when applicable. When the reported SAR for body-worn accessory, measured without a headset connected to the handset is < 1.2 W/kg, the highest reported SAR configuration for that wireless mode and frequency band should be repeated for that body-worn accessory with a headset attached to the handset.

Accessories for body-worn operation configurations are divided into two categories: those that do not contain metallic components and those that do contain metallic components. When multiple accessories that do not contain metallic components are supplied with the device, the device is tested with only the accessory that dictates the closest spacing to the body. Then multiple accessories that contain metallic components are test with the device with each accessory. If multiple accessories share an identical metallic component (i.e. the same metallic belt-clip used with different holsters with no other metallic components) only the accessory that dictates the closest spacing to the body is tested.

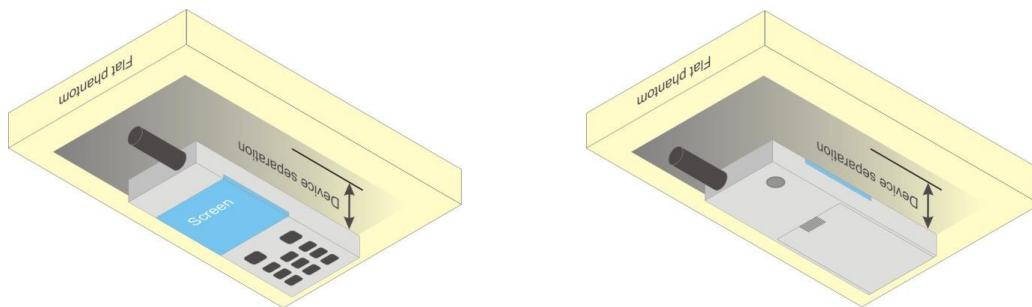

Fig 9.4 Body Worn Position

11.5 Wireless Router

Some battery-operated handsets have the capability to transmit and receive user through simultaneous transmission of WIFI simultaneously with a separate licensed transmitter. The FCC has provided guidance in FCC KDB Publication 941225 D06 v02r01 where SAR test considerations for handsets (L x W ≥ 9 cm x 5 cm) are based on a composite test separation distance of 10mm from the front, back and edges of the device containing transmitting antennas within 2.5cm of their edges, determined from general mixed use conditions for this type of devices. Since the hotspot SAR results may overlap with the body-worn accessory SAR requirements, the more conservative configurations can be considered, thus excluding some body-worn accessory SAR tests.

When the user enables the personal wireless router functions for the handset, actual operations include simultaneous transmission of both the WIFI transmitter and another licensed transmitter. Both transmitters often do not transmit at the same transmitting frequency and thus cannot be evaluated for SAR under actual use conditions due to the limitations of the SAR assessment probes. Therefore, SAR must be evaluated for each frequency transmission and mode separately and spatially summed with the WIFI transmitter according to FCC KDB Publication 447498 D01v06 publication procedures. The “Portable Hotspot” feature on the handset was NOT activated during SAR assessments, to ensure the SAR measurements were evaluated for a single transmission frequency RF signal at a time.

12. Conducted RF Output Power (Unit: dBm)

<GSM Conducted Power>

General Note:

1. Per KDB 447498 D01v06, the maximum output power channel is used for SAR testing and for further SAR test reduction.
2. Per KDB 941225 D01v03r01, for SAR test reduction for GSM / GPRS / EDGE modes is determined by the source-based time-averaged output power including tune-up tolerance. The mode with highest specified time-averaged output power should be tested for SAR compliance in the applicable exposure conditions. For modes with the same specified maximum output power and tolerance, the higher number time-slot configuration should be tested. Therefore, the GPRS (4Tx slots) for GSM850/GSM1900 is considered as the primary mode.
3. Other configurations of GSM / GPRS / EDGE are considered as secondary modes. The 3G SAR test reduction procedure is applied, when the maximum output power and tune-up tolerance specified for production units in a secondary mode is $\leq \frac{1}{4}$ dB higher than the primary mode, SAR measurement is not required for the secondary mode

GSM850 TX Channel	Burst Average Power (dBm)			Tune-up Limit (dBm)	Frame-Average Power (dBm)			Tune-up Limit (dBm)
	128	189	251		128	189	251	
Frequency (MHz)	824.2	836.4	848.8		824.2	836.4	848.8	
GSM 1 Tx slot	32.12	32.11	32.30	33.50	23.12	23.11	23.30	24.50
GPRS 1 Tx slot	32.11	32.11	32.29	33.50	23.11	23.11	23.29	24.50
GPRS 2 Tx slots	31.38	31.36	31.57	32.50	25.38	25.36	25.57	26.50
GPRS 3 Tx slots	29.68	29.62	29.80	30.50	25.42	25.36	25.54	26.24
GPRS 4 Tx slots	28.62	28.57	28.75	29.50	25.62	25.57	25.75	26.50
EDGE 1 Tx slot	25.96	25.95	26.02	27.00	16.96	16.95	17.02	18.00
EDGE 2 Tx slots	25.33	25.33	25.38	26.50	19.33	19.33	19.38	20.50
EDGE 3 Tx slots	24.60	24.61	24.66	25.50	20.34	20.35	20.40	21.24
EDGE 4 Tx slots	24.39	24.32	24.46	25.50	21.39	21.32	21.46	22.50

GSM1900 TX Channel	Burst Average Power (dBm)			Tune-up Limit (dBm)	Frame-Average Power (dBm)			Tune-up Limit (dBm)
	512	661	810		512	661	810	
Frequency (MHz)	1850.2	1880	1909.8		1850.2	1880	1909.8	
GSM 1 Tx slot	29.29	29.37	29.14	30.50	20.29	20.37	20.14	21.50
GPRS 1 Tx slot	29.28	29.36	29.13	30.50	20.28	20.36	20.13	21.50
GPRS 2 Tx slots	28.54	28.63	28.40	29.50	22.54	22.63	22.40	23.50
GPRS 3 Tx slots	26.76	26.86	26.62	27.50	22.50	22.60	22.36	23.24
GPRS 4 Tx slots	25.69	25.80	25.55	26.50	22.69	22.80	22.55	23.50
EDGE 1 Tx slot	25.14	25.08	25.10	26.00	16.14	16.08	16.10	17.00
EDGE 2 Tx slots	24.50	24.44	24.50	25.50	18.50	18.44	18.50	19.50
EDGE 3 Tx slots	23.72	23.64	23.73	24.50	19.46	19.38	19.47	20.24
EDGE 4 Tx slots	22.30	22.22	22.22	23.50	19.30	19.22	19.22	20.50

<WCDMA Conducted Power>

1. The following tests were conducted according to the test requirements outlines in 3GPP TS 34.121 specification.
2. The procedures in KDB 941225 D01v03r01 are applied for 3GPP Rel. 6 HSPA to configure the device in the required sub-test mode(s) to determine SAR test exclusion.
3. For HSPA+ devices supporting 16 QAM in the uplink, power measurements procedure is according to the configurations in Table C.11.1.4 of 3GPP TS 34.121-1.
4. For DC-HSDPA, the device was configured according to the H-Set 12, Fixed Reference Channel (FRC) configuration in Table C.8.1.12 of 3GPP TS 34.121-1, with the primary and the secondary serving HS-DSCH Cell enabled during the power measurement.

A summary of these settings are illustrated below:

HSDPA Setup Configuration:

- a. The EUT was connected to Base Station Agilent E5515C referred to the Setup Configuration.
- b. The RF path losses were compensated into the measurements.
- c. A call was established between EUT and Base Station with following setting:
 - i. Set Gain Factors (β_c and β_d) and parameters were set according to each
 - ii. Specific sub-test in the following table, C10.1.4, quoted from the TS 34.121
 - iii. Set RMC 12.2Kbps + HSDPA mode.
 - iv. Set Cell Power = -86 dBm
 - v. Set HS-DSCH Configuration Type to FRC (H-set 1, QPSK)
 - vi. Select HSDPA Uplink Parameters
 - vii. Set Delta ACK, Delta NACK and Delta CQI = 8
 - viii. Set Ack-Nack Repetition Factor to 3
 - ix. Set CQI Feedback Cycle (k) to 4 ms
 - x. Set CQI Repetition Factor to 2
 - xi. Power Ctrl Mode = All Up bits
- d. The transmitted maximum output power was recorded.

Table C.10.1.4: β values for transmitter characteristics tests with HS-DPCCH

Sub-test	β_c	β_d	β_d (SF)	β_c/β_d	β_{HS} (Note 1, Note 2)	CM (dB) (Note 3)	MPR (dB) (Note 3)
1	2/15	15/15	64	2/15	4/15	0.0	0.0
2	12/15 (Note 4)	15/15 (Note 4)	64	12/15 (Note 4)	24/15	1.0	0.0
3	15/15	8/15	64	15/8	30/15	1.5	0.5
4	15/15	4/15	64	15/4	30/15	1.5	0.5

Note 1: $\Delta_{ACK}, \Delta_{NACK}$ and $\Delta_{CQI} = 30/15$ with $\beta_{HS} = 30/15 * \beta_c$.

Note 2: For the HS-DPCCH power mask requirement test in clause 5.2C, 5.7A, and the Error Vector Magnitude (EVM) with HS-DPCCH test in clause 5.13.1A, and HSDPA EVM with phase discontinuity in clause 5.13.1AA, Δ_{ACK} and $\Delta_{NACK} = 30/15$ with $\beta_{HS} = 30/15 * \beta_c$, and $\Delta_{CQI} = 24/15$ with $\beta_{HS} = 24/15 * \beta_c$.

Note 3: CM = 1 for $\beta_c/\beta_d = 12/15, \beta_{HS}/\beta_c = 24/15$. For all other combinations of DPDCH, DPCCH and HS-DPCCH the MPR is based on the relative CM difference. This is applicable for only UEs that support HSDPA in release 6 and later releases.

Note 4: For subtest 2 the β_c/β_d ratio of 12/15 for the TFC during the measurement period (TF1, TF0) is achieved by setting the signalled gain factors for the reference TFC (TF1, TF1) to $\beta_c = 11/15$ and $\beta_d = 15/15$.

Setup Configuration

HSUPA Setup Configuration:

- a. The EUT was connected to Base Station Agilent E5515C referred to the Setup Configuration.
- b. The RF path losses were compensated into the measurements.
- c. A call was established between EUT and Base Station with following setting * :
 - i. Call Configs = 5.2B, 5.9B, 5.10B, and 5.13.2B with QPSK
 - ii. Set the Gain Factors (β_c and β_d) and parameters (AG Index) were set according to each specific sub-test in the following table, C11.1.3, quoted from the TS 34.121
 - iii. Set Cell Power = -86 dBm
 - iv. Set Channel Type = 12.2k + HSPA
 - v. Set UE Target Power
 - vi. Power Ctrl Mode= Alternating bits
 - vii. Set and observe the E-TFCl
 - viii. Confirm that E-TFCl is equal to the target E-TFCl of 75 for sub-test 1, and other subtest's E-TFCl
- d. The transmitted maximum output power was recorded.

Table C.11.1.3: β values for transmitter characteristics tests with HS-DPCCH and E-DCH

Sub-test	β_c	β_d	β_d (SF)	β_c/β_d	β_{HS} (Note 1)	β_{ec}	β_{ed} (Note 5) (Note 6)	β_{ed} (SF)	β_{ed} (Codes)	CM (dB) (Note 2)	MPR (dB) (Note 2)	AG Index (Note 6)	E-TFCl
1	11/15 (Note 3)	15/15 (Note 3)	64	11/15 (Note 3)	22/15	209/25	1309/225	4	1	1.0	0.0	20	75
2	6/15	15/15	64	6/15	12/15	12/15	94/75	4	1	3.0	2.0	12	67
3	15/15	9/15	64	15/9	30/15	30/15	$\beta_{ed1}: 47/15$ $\beta_{ed2}: 47/15$	4 4	2	2.0	1.0	15	92
4	2/15	15/15	64	2/15	4/15	2/15	56/75	4	1	3.0	2.0	17	71
5	15/15 (Note 4)	15/15 (Note 4)	64	15/15 (Note 4)	30/15	24/15	134/15	4	1	1.0	0.0	21	81

Note 1: $\Delta_{ACK}, \Delta_{NACK}$ and $\Delta_{CQI} = 30/15$ with $\beta_{hs} = 30/15 * \beta_c$.

Note 2: CM = 1 for $\beta_c/\beta_d = 12/15$, $\beta_{hs}/\beta_c = 24/15$. For all other combinations of DPDCH, DPCCH, HS- DPCCH, E-DPDCH and E-DPCCH the MPR is based on the relative CM difference.

Note 3: For subtest 1 the β_c/β_d ratio of 11/15 for the TFC during the measurement period (TF1, TF0) is achieved by setting the signalled gain factors for the reference TFC (TF1, TF1) to $\beta_c = 10/15$ and $\beta_d = 15/15$.

Note 4: For subtest 5 the β_c/β_d ratio of 15/15 for the TFC during the measurement period (TF1, TF0) is achieved by setting the signalled gain factors for the reference TFC (TF1, TF1) to $\beta_c = 14/15$ and $\beta_d = 15/15$.

Note 5: In case of testing by UE using E-DPDCH Physical Layer category 1, Sub-test 3 is omitted according to TS25.306 Table 5.1g.

Note 6: β_{ed} can not be set directly, it is set by Absolute Grant Value.

Setup Configuration

DC-HSDPA 3GPP release 8 Setup Configuration:

- a. The EUT was connected to Base Station Agilent E5515C referred to the Setup Configuration below
- b. The RF path losses were compensated into the measurements.
- c. A call was established between EUT and Base Station with following setting:
 - i. Set RMC 12.2Kbps + HSDPA mode.
 - ii. Set Cell Power = -25 dBm
 - iii. Set HS-DSCH Configuration Type to FRC (H-set 12, QPSK)
 - iv. Select HSDPA Uplink Parameters
 - v. Set Gain Factors (β_c and β_d) and parameters were set according to each Specific sub-test in the following table, C10.1.4, quoted from the TS 34.121
 - a). Subtest 1: $\beta_c/\beta_d=2/15$
 - b). Subtest 2: $\beta_c/\beta_d=12/15$
 - c). Subtest 3: $\beta_c/\beta_d=15/8$
 - d). Subtest 4: $\beta_c/\beta_d=15/4$
 - vi. Set Delta ACK, Delta NACK and Delta CQI = 8
 - vii. Set Ack-Nack Repetition Factor to 3
 - viii. Set CQI Feedback Cycle (k) to 4 ms
 - ix. Set CQI Repetition Factor to 2
 - x. Power Ctrl Mode = All Up bits
- d. The transmitted maximum output power was recorded.

The following tests were conducted according to the test requirements outlines in 3GPP TS 34.121 specification. A summary of these settings are illustrated below:

C.8.1.12 Fixed Reference Channel Definition H-Set 12

Table C.8.1.12: Fixed Reference Channel H-Set 12

Parameter	Unit	Value
Nominal Avg. Inf. Bit Rate	kbps	60
Inter-TTI Distance	TTI's	1
Number of HARQ Processes	Processes	6
Information Bit Payload (N_{INF})	Bits	120
Number Code Blocks	Blocks	1
Binary Channel Bits Per TTI	Bits	960
Total Available SML's in UE	SML's	19200
Number of SML's per HARQ Proc.	SML's	3200
Coding Rate		0.15
Number of Physical Channel Codes	Codes	1
Modulation		QPSK
Note 1: The RMC is intended to be used for DC-HSDPA mode and both cells shall transmit with identical parameters as listed in the table. Note 2: Maximum number of transmission is limited to 1, i.e., retransmission is not allowed. The redundancy and constellation version 0 shall be used.		

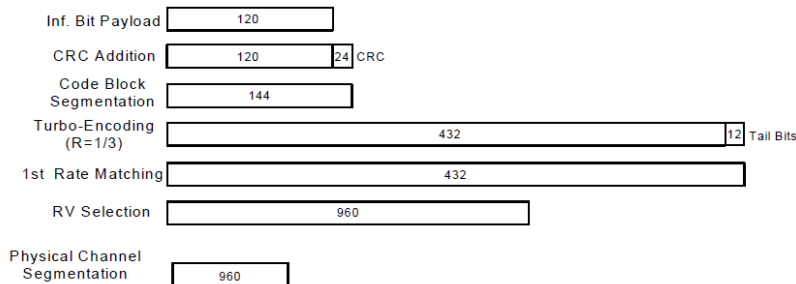

Figure C.8.19: Coding rate for Fixed reference Channel H-Set 12 (QPSK)

Setup Configuration

HSPA+ 3GPP release 7 (uplink category 7) 16QAM, Setup Configuration:

- a. The EUT was connected to Base Station Agilent E5515C referred to the Setup Configuration.
- b. The RF path losses were compensated into the measurements.
- c. A call was established between EUT and Base Station with following setting * :
 - i. Call Configs = 5.2E:HSPA+:UL with 16QAM
 - ii. Set the Gain Factors (β_c and β_d) and parameters (AG Index) were set according to each specific sub-test in the following table, C11.1.4, quoted from the TS 34.121-1 s5.2E
 - iii. Set Channel Parm
 - iv. Set Cell Power = -86 dBm
 - v. Set Channel Type = HSPA
 - vi. Set UE Target Power =21 dBm
 - vii. Power Ctrl Mode= All Up Bits
 - viii. Set Manual Uplink DPCH Bc/Bd = Manual
 - ix. Set Manual Uplink DPCH Bc and Bd=15,15(for 34.121-1 v8.10.0 table C11.1.4 sub-test 1)
 - x. Set HSPA Conn DL Channel Levels
 - xi. Set HS-SCCH Configs
 - xii. Set RB Test Mode Setup
 - xiii. Set Common HSUPA Parameters
 - xiv. Set Serving Grant
 - xv. Confirm that E-TFCI is equal to the target E-TFCI of 105 for sub-test 1, and other subtest's E-TFCI
- d. The transmitted maximum output power was recorded.

Table C.11.1.4: β values for transmitter characteristics tests with HS-DPCCH and E-DCH with 16QAM

Sub-test	β_c (Note3)	β_d	β_{HS} (Note1)	β_{ec}	β_{ed} (2xSF2) (Note 4)	β_{ed} (2xSF4) (Note 4)	CM (dB) (Note 2)	MPR (dB) (Note 2)	AG Index (Note 4)	E-TFCI (Note 5)	E-TFCI (boost)
1	1	0	30/15	30/15	β_{ed1} : 30/15 β_{ed2} : 30/15	β_{ed3} : 24/15 β_{ed4} : 24/15	3.5	2.5	14	105	105

Note 1: $\Delta_{ACK}, \Delta_{NACK}$ and $\Delta_{CQI} = 30/15$ with $\beta_{HS} = 30/15 * \beta_c$.

Note 2: CM = 3.5 and the MPR is based on the relative CM difference, MPR = MAX(CM-1,0).

Note 3: DPDCH is not configured, therefore the β_c is set to 1 and $\beta_d = 0$ by default.

Note 4: β_{ed} can not be set directly; it is set by Absolute Grant Value.

Note 5: All the sub-tests require the UE to transmit 2SF2+2SF4 16QAM EDCH and they apply for UE using E-DPDCH category 7. E-DCH TTI is set to 2ms TTI and E-DCH table index = 2. To support these E-DCH configurations DPDCH is not allocated. The UE is signaled to use the extrapolation algorithm.

Setup Configuration



<WCDMA Conducted Power>

General Note:

1. Per KDB 941225 D01v03r01, for SAR testing is measured using a 12.2 kbps RMC with TPC bits configured to all "1's".
2. Per KDB 941225 D01v03r01, RMC 12.2kbps setting is used to evaluate SAR. If the maximum output power and tune-up tolerance specified for production units in HSDPA / HSUPA / DC-HSDPA is $\leq \frac{1}{4}$ dB higher than RMC 12.2Kbps or when the highest reported SAR of the RMC12.2Kbps is scaled by the ratio of specified maximum output power and tune-up tolerance of HSDPA / HSUPA / DC-HSDPA to RMC12.2Kbps and the adjusted SAR is ≤ 1.2 W/kg, SAR measurement is not required for HSDPA / HSUPA / DC-HSDPA.

Band		WCDMA II			Tune-up Limit (dBm)	WCDMA IV			Tune-up Limit (dBm)	WCDMA V			Tune-up Limit (dBm)
TX Channel		9262	9400	9538		1312	1413	1513		4132	4182	4233	
Rx Channel		9662	9800	9938	1537	1638	1738	4357	4407	4458			
Frequency (MHz)		1852.4	1880	1907.6	1712.4	1732.6	1752.6	826.4	836.4	846.6			
3GPP Rel 99	AMR 12.2Kbps	22.52	22.71	22.80	24.00	23.25	23.31	23.01	24.00	23.42	23.27	23.26	24.00
3GPP Rel 99	RMC 12.2Kbps	22.53	22.71	22.81	24.00	23.34	23.32	23.09	24.00	23.43	23.33	23.35	24.00
3GPP Rel 6	HSDPA Subtest-1	21.57	21.81	21.89	23.00	22.34	22.27	22.09	23.00	22.36	22.26	22.23	23.00
3GPP Rel 6	HSDPA Subtest-2	21.55	21.80	21.87	23.00	22.34	22.33	22.08	23.00	22.34	22.25	22.23	23.00
3GPP Rel 6	HSDPA Subtest-3	21.10	21.31	21.29	22.50	21.88	21.88	21.57	22.50	21.87	21.79	21.73	22.50
3GPP Rel 6	HSDPA Subtest-4	21.09	21.30	21.27	22.50	21.86	21.83	21.56	22.50	21.85	21.78	21.72	22.50
3GPP Rel 8	DC-HSDPA Subtest-1	21.55	21.83	21.87	23.00	22.36	22.28	22.12	23.00	22.38	22.24	22.25	23.00
3GPP Rel 8	DC-HSDPA Subtest-2	21.54	21.81	21.89	23.00	22.34	22.35	22.10	23.00	22.35	22.26	22.22	23.00
3GPP Rel 8	DC-HSDPA Subtest-3	21.12	21.32	21.30	22.50	21.90	21.85	21.60	22.50	21.86	21.81	21.75	22.50
3GPP Rel 8	DC-HSDPA Subtest-4	21.08	21.30	21.28	22.50	21.87	21.84	21.57	22.50	21.86	21.82	21.73	22.50
3GPP Rel 6	HSUPA Subtest-1	19.58	19.77	19.75	21.50	20.39	20.30	20.10	21.50	20.31	20.28	20.24	21.50
3GPP Rel 6	HSUPA Subtest-2	19.54	19.74	19.72	20.50	20.37	20.29	20.08	20.50	20.33	20.26	20.23	20.50
3GPP Rel 6	HSUPA Subtest-3	20.57	20.82	20.83	21.50	21.40	21.31	21.07	21.50	21.36	21.36	21.23	21.50
3GPP Rel 6	HSUPA Subtest-4	19.13	19.32	19.35	20.50	19.92	19.85	19.63	20.50	19.87	19.85	19.81	20.50
3GPP Rel 6	HSUPA Subtest-5	20.59	20.84	20.80	21.50	21.41	21.32	21.10	21.50	21.31	21.18	21.14	21.50
3GPP Rel 7	HSPA+ (16QAM) Subtest-1	20.01	20.27	20.32	21.00	20.92	20.78	20.58	21.00	20.82	20.78	20.69	21.00



<LTE Conducted Power>

General Note:

2. Anritsu MT8820C base station simulator was used to setup the connection with EUT; the frequency band, channel bandwidth, RB allocation configuration, modulation type are set in the base station simulator to configure EUT transmitting at maximum power and at different configurations which are requested to be reported to FCC, for conducted power measurement and SAR testing.
3. Per KDB 941225 D05v02r05, when a properly configured base station simulator is used for the SAR and power measurements, spectrum plots for each RB allocation and offset configuration is not required.
4. Per KDB 941225 D05v02r05, start with the largest channel bandwidth and measure SAR for QPSK with 1 RB allocation, using the RB offset and required test channel combination with the highest maximum output power for RB offsets at the upper edge, middle and lower edge of each required test channel.
5. Per KDB 941225 D05v02r05, 50% RB allocation for QPSK SAR testing follows 1RB QPSK allocation procedure.
6. Per KDB 941225 D05v02r05, For QPSK with 100% RB allocation, SAR is not required when the highest maximum output power for 100 % RB allocation is less than the highest maximum output power in 50% and 1 RB allocations and the highest reported SAR for 1 RB and 50% RB allocation are ≤ 0.8 W/kg. Otherwise, SAR is measured for the highest output power channel; and if the reported SAR is > 1.45 W/kg, the remaining required test channels must also be tested.
7. Per KDB 941225 D05v02r05, 16QAM output power for each RB allocation configuration is $>$ not $\frac{1}{2}$ dB higher than the same configuration in QPSK and the reported SAR for the QPSK configuration is ≤ 1.45 W/kg; Per KDB 941225 D05v02r05, 16QAM SAR testing is not required.
8. Per KDB 941225 D05v02r05, Smaller bandwidth output power for each RB allocation configuration is $>$ not $\frac{1}{2}$ dB higher than the same configuration in the largest supported bandwidth, and the reported SAR for the largest supported bandwidth is ≤ 1.45 W/kg; Per KDB 941225 D05v02r05, smaller bandwidth SAR testing is not required.
9. For LTE B4 / B5 / B12 / B38 the maximum bandwidth does not support three non-overlapping channels, per KDB 941225 D05v02r05, when a device supports overlapping channel assignment in a channel bandwidth configuration, the middle channel of the group of overlapping channels should be selected for testing.
10. LTE band 17 SAR test was covered by Band 12; according to April 2015 TCB workshop, SAR test for overlapping LTE bands can be reduced if
 - c. the maximum output power, including tolerance, for the smaller band is \leq the larger band to qualify for the SAR test exclusion
 - d. the channel bandwidth and other operating parameters for the smaller band are fully supported by the larger band



<LTE Band 2>

BW [MHz]	Modulation	RB Size	RB Offset	Power Low Ch. / Freq.	Power Middle Ch. / Freq.	Power High Ch. / Freq.	Tune-up limit (dBm)	MPR (dB)
Channel				18700	18900	19100		
Frequency (MHz)				1860	1880	1900		
20	QPSK	1	0	23.26	23.28	23.23	24	0
20	QPSK	1	49	23.03	23.01	23.02		
20	QPSK	1	99	23.11	23.12	23.17		
20	QPSK	50	0	22.30	22.33	22.26	23	1
20	QPSK	50	24	22.17	22.16	22.19		
20	QPSK	50	50	22.14	22.09	22.14		
20	QPSK	100	0	22.21	22.23	22.17		
20	16QAM	1	0	22.39	22.44	22.36	23	1
20	16QAM	1	49	22.23	22.24	22.20		
20	16QAM	1	99	22.28	22.27	22.18		
20	16QAM	50	0	21.25	21.24	21.29	22	2
20	16QAM	50	24	21.13	21.13	21.16		
20	16QAM	50	50	21.10	21.07	21.09		
20	16QAM	100	0	21.17	21.15	21.19		
Channel				18675	18900	19125		
Frequency (MHz)				1857.5	1880	1902.5		
15	QPSK	1	0	23.20	23.21	23.16	24	0
15	QPSK	1	37	23.08	23.05	23.04		
15	QPSK	1	74	23.09	23.09	23.07		
15	QPSK	36	0	22.24	22.20	22.22	23	1
15	QPSK	36	20	22.18	22.14	22.15		
15	QPSK	36	39	22.15	22.11	22.10		
15	QPSK	75	0	22.20	22.16	22.16		
15	16QAM	1	0	22.31	22.39	22.30	23	1
15	16QAM	1	37	22.24	22.25	22.19		
15	16QAM	1	74	22.26	22.24	22.12		
15	16QAM	36	0	21.17	21.19	21.20	22	2
15	16QAM	36	20	21.14	21.13	21.13		
15	16QAM	36	39	21.11	21.09	21.07		
15	16QAM	75	0	21.16	21.14	21.13		
Channel				18650	18900	19150		
Frequency (MHz)				1855	1880	1905		
10	QPSK	1	0	23.10	23.12	23.09	24	0
10	QPSK	1	25	23.05	23.03	23.03		
10	QPSK	1	49	23.06	23.04	22.98		
10	QPSK	25	0	22.18	22.15	22.16	23	1
10	QPSK	25	12	22.16	22.13	22.13		
10	QPSK	25	25	22.13	22.09	22.06		
10	QPSK	50	0	22.17	22.13	22.14		
10	16QAM	1	0	22.23	22.31	22.24	23	1
10	16QAM	1	25	22.21	22.24	22.17		
10	16QAM	1	49	22.23	22.22	22.09		
10	16QAM	25	0	21.12	21.13	21.13	22	2
10	16QAM	25	12	21.10	21.10	21.09		
10	16QAM	25	25	21.07	21.06	21.01		
10	16QAM	50	0	21.11	21.11	21.08		



Channel				18625	18900	19175	Tune-up limit (dBm)	MPR (dB)
Frequency (MHz)				1852.5	1880	1907.5		
5	QPSK	1	0	23.03	23.09	23.02	24	0
5	QPSK	1	12	23.07	23.04	23.08		
5	QPSK	1	24	23.02	23.00	22.89		
5	QPSK	12	0	22.08	22.07	22.09	23	1
5	QPSK	12	7	22.12	22.11	22.12		
5	QPSK	12	13	22.09	22.08	22.07		
5	QPSK	25	0	22.10	22.09	22.09	23	1
5	16QAM	1	0	22.15	22.22	22.14		
5	16QAM	1	12	22.21	22.24	22.15		
5	16QAM	1	24	22.16	22.18	22.03	22	2
5	16QAM	12	0	21.02	21.05	21.03		
5	16QAM	12	7	21.06	21.09	21.05		
5	16QAM	12	13	21.03	21.06	21.01	22	2
5	16QAM	25	0	21.04	21.05	21.01		
Channel				18615	18900	19185	Tune-up limit (dBm)	MPR (dB)
Frequency (MHz)				1851.5	1880	1908.5		
3	QPSK	1	0	23.08	23.10	23.09	24	0
3	QPSK	1	8	23.07	23.06	23.09		
3	QPSK	1	14	23.08	23.05	23.09		
3	QPSK	8	0	22.16	22.16	22.17	23	1
3	QPSK	8	4	22.15	22.14	22.14		
3	QPSK	8	7	22.15	22.13	22.13		
3	QPSK	15	0	22.17	22.17	22.19	23	1
3	16QAM	1	0	22.21	22.28	22.16		
3	16QAM	1	8	22.21	22.25	22.12		
3	16QAM	1	14	22.21	22.23	22.07	22	2
3	16QAM	8	0	21.14	21.18	21.13		
3	16QAM	8	4	21.13	21.16	21.10		
3	16QAM	8	7	21.12	21.14	21.08	22	2
3	16QAM	15	0	21.12	21.15	21.11		
Channel				18607	18900	19193	Tune-up limit (dBm)	MPR (dB)
Frequency (MHz)				1850.7	1880	1909.3		
1.4	QPSK	1	0	22.86	22.87	22.88	24	0
1.4	QPSK	1	3	22.84	22.85	22.84		
1.4	QPSK	1	5	22.89	22.89	22.90		
1.4	QPSK	3	0	23.02	23.02	23.04		
1.4	QPSK	3	1	23.03	23.03	23.06		
1.4	QPSK	3	3	23.03	23.07	23.03		
1.4	QPSK	6	0	22.09	22.10	22.11	23	1
1.4	16QAM	1	0	22.09	22.16	22.01	23	1
1.4	16QAM	1	3	22.08	22.15	21.98		
1.4	16QAM	1	5	22.09	22.14	21.97		
1.4	16QAM	3	0	21.97	22.02	21.92		
1.4	16QAM	3	1	21.99	22.04	21.94		
1.4	16QAM	3	3	21.96	22.00	21.90		
1.4	16QAM	6	0	21.10	21.16	21.08	22	2



<LTE Band 4>

BW [MHz]	Modulation	RB Size	RB Offset	Power Low Ch. / Freq.	Power Middle Ch. / Freq.	Power High Ch. / Freq.	Tune-up limit (dBm)	MPR (dB)
Channel				20050	20175	20300		
Frequency (MHz)				1720	1732.5	1745		
20	QPSK	1	0	22.75	22.80	22.76	23.5	0
20	QPSK	1	49	22.54	22.57	22.58		
20	QPSK	1	99	22.61	22.64	22.63		
20	QPSK	50	0	21.68	21.85	21.82	22.5	1
20	QPSK	50	24	21.65	21.67	21.69		
20	QPSK	50	50	21.61	21.60	21.64		
20	QPSK	100	0	21.63	21.74	21.69	22.5	1
20	16QAM	1	0	21.95	21.99	21.97		
20	16QAM	1	49	21.75	21.78	21.80		
20	16QAM	1	99	21.81	21.84	21.80	21.5	2
20	16QAM	50	0	20.65	20.79	20.83		
20	16QAM	50	24	20.63	20.65	20.67		
20	16QAM	50	50	20.59	20.58	20.62	21.5	2
20	16QAM	100	0	20.61	20.66	20.72		
20	16QAM	100	0	20.61	20.66	20.72		
Channel				20025	20175	20325		
Frequency (MHz)				1717.5	1732.5	1747.5		
15	QPSK	1	0	22.69	22.73	22.71	23.5	0
15	QPSK	1	37	22.57	22.58	22.60		
15	QPSK	1	74	22.59	22.61	22.59		
15	QPSK	36	0	21.67	21.73	21.73	22.5	1
15	QPSK	36	20	21.65	21.66	21.66		
15	QPSK	36	39	21.63	21.61	21.62		
15	QPSK	75	0	21.64	21.67	21.68	22.5	1
15	16QAM	1	0	21.85	21.93	21.89		
15	16QAM	1	37	21.76	21.77	21.80		
15	16QAM	1	74	21.78	21.81	21.76	21.5	2
15	16QAM	36	0	20.63	20.70	20.72		
15	16QAM	36	20	20.62	20.63	20.64		
15	16QAM	36	39	20.60	20.58	20.61	21.5	2
15	16QAM	36	39	20.60	20.58	20.61		
15	16QAM	75	0	20.62	20.64	20.66		
Channel				20000	20175	20350		
Frequency (MHz)				1715	1732.5	1750		
10	QPSK	1	0	22.62	22.65	22.63	23.5	0
10	QPSK	1	25	22.57	22.58	22.58		
10	QPSK	1	49	22.56	22.58	22.56		
10	QPSK	25	0	21.60	21.68	21.67	22.5	1
10	QPSK	25	12	21.63	21.63	21.64		
10	QPSK	25	25	21.62	21.56	21.59		
10	QPSK	50	0	21.64	21.65	21.65	22.5	1
10	16QAM	1	0	21.78	21.86	21.83		
10	16QAM	1	25	21.78	21.79	21.80		
10	16QAM	1	49	21.76	21.79	21.74	21.5	2
10	16QAM	25	0	20.58	20.64	20.65		
10	16QAM	25	12	20.60	20.59	20.61		
10	16QAM	25	25	20.59	20.54	20.56	21.5	2
10	16QAM	25	25	20.59	20.54	20.56		
10	16QAM	50	0	20.61	20.62	20.64		



Channel				19975	20175	20375	Tune-up limit (dBm)	MPR (dB)
Frequency (MHz)				1712.5	1732.5	1752.5		
5	QPSK	1	0	22.56	22.58	22.58	23.5	0
5	QPSK	1	12	22.61	22.62	22.61		
5	QPSK	1	24	22.54	22.55	22.53		
5	QPSK	12	0	21.54	21.57	21.58	22.5	1
5	QPSK	12	7	21.62	21.62	21.61		
5	QPSK	12	13	21.62	21.59	21.59		
5	QPSK	25	0	21.60	21.59	21.59		
5	16QAM	1	0	21.70	21.80	21.78	22.5	1
5	16QAM	1	12	21.77	21.76	21.77		
5	16QAM	1	24	21.71	21.73	21.69		
5	16QAM	12	0	20.51	20.55	20.55	21.5	2
5	16QAM	12	7	20.59	20.59	20.59		
5	16QAM	12	13	20.60	20.58	20.56		
5	16QAM	25	0	20.56	20.56	20.56		
Channel				19965	20175	20385	Tune-up limit (dBm)	MPR (dB)
Frequency (MHz)				1711.5	1732.5	1753.5		
3	QPSK	1	0	22.61	22.63	22.61	23.5	0
3	QPSK	1	8	22.61	22.59	22.61		
3	QPSK	1	14	22.61	22.59	22.59		
3	QPSK	8	0	21.66	21.65	21.66	22.5	1
3	QPSK	8	4	21.65	21.64	21.65		
3	QPSK	8	7	21.65	21.62	21.63		
3	QPSK	15	0	21.68	21.67	21.67		
3	16QAM	1	0	21.74	21.81	21.79	22.5	1
3	16QAM	1	8	21.75	21.77	21.78		
3	16QAM	1	14	21.78	21.77	21.75		
3	16QAM	8	0	20.67	20.67	20.69	21.5	2
3	16QAM	8	4	20.67	20.65	20.66		
3	16QAM	8	7	20.66	20.65	20.64		
3	16QAM	15	0	20.65	20.66	20.65		
Channel				19957	20175	20393	Tune-up limit (dBm)	MPR (dB)
Frequency (MHz)				1710.7	1732.5	1754.3		
1.4	QPSK	1	0	22.39	22.42	22.41	23.5	0
1.4	QPSK	1	3	22.37	22.39	22.37		
1.4	QPSK	1	5	22.42	22.44	22.42		
1.4	QPSK	3	0	22.55	22.58	22.56		
1.4	QPSK	3	1	22.55	22.59	22.56		
1.4	QPSK	3	3	22.55	22.57	22.56		
1.4	QPSK	6	0	21.58	21.59	21.58	22.5	1
1.4	16QAM	1	0	21.62	21.68	21.66	22.5	1
1.4	16QAM	1	3	21.63	21.67	21.64		
1.4	16QAM	1	5	21.64	21.69	21.64		
1.4	16QAM	3	0	21.50	21.55	21.52		
1.4	16QAM	3	1	21.53	21.58	21.54		
1.4	16QAM	3	3	21.50	21.54	21.50		
1.4	16QAM	6	0	20.63	20.66	20.63		
							21.5	2



<LTE Band 5>

BW [MHz]	Modulation	RB Size	RB Offset	Power Low Ch. / Freq.	Power Middle Ch. / Freq.	Power High Ch. / Freq.	Tune-up limit (dBm)	MPR (dB)
Channel				20450	20525	20600		
Frequency (MHz)				829	836.5	844		
10	QPSK	1	0	23.13	23.14	23.09	24	0
10	QPSK	1	25	23.08	23.03	23.01		
10	QPSK	1	49	23.08	23.04	23.06		
10	QPSK	25	0	22.14	22.22	22.11	23	1
10	QPSK	25	12	22.13	22.15	22.10		
10	QPSK	25	25	22.11	22.13	22.07		
10	QPSK	50	0	22.14	22.21	22.11		
10	16QAM	1	0	22.32	22.29	22.33	23	1
10	16QAM	1	25	22.27	22.25	22.25		
10	16QAM	1	49	22.27	22.28	22.14		
10	16QAM	25	0	21.10	21.17	21.09	22	2
10	16QAM	25	12	21.12	21.12	21.08		
10	16QAM	25	25	21.07	21.10	21.03		
10	16QAM	50	0	21.10	21.16	21.09		
Channel				20425	20525	20625	Tune-up limit (dBm)	MPR (dB)
Frequency (MHz)				826.5	836.5	846.5		
5	QPSK	1	0	23.09	23.03	22.99	24	0
5	QPSK	1	12	23.13	23.06	23.06		
5	QPSK	1	24	23.06	23.00	22.98		
5	QPSK	12	0	22.11	22.12	22.05	23	1
5	QPSK	12	7	22.15	22.13	22.10		
5	QPSK	12	13	22.14	22.11	22.05		
5	16QAM	25	0	22.14	22.12	22.07	23	1
5	16QAM	1	0	22.26	22.24	22.23		
5	16QAM	1	12	22.33	22.26	22.22		
5	16QAM	1	24	22.26	22.24	22.07	22	2
5	16QAM	12	0	21.10	21.10	21.04		
5	16QAM	12	7	21.14	21.11	21.05		
5	16QAM	12	13	21.13	21.10	20.99		
5	16QAM	25	0	21.10	21.09	21.00		



Channel				20415	20525	20635	Tune-up limit (dBm)	MPR (dB)
Frequency (MHz)				825.5	836.5	847.5		
3	QPSK	1	0	23.15	23.09	23.06	24	0
3	QPSK	1	8	23.07	23.01	22.99		
3	QPSK	1	14	23.12	23.07	23.07		
3	QPSK	8	0	22.20	22.18	22.15	23	1
3	QPSK	8	4	22.19	22.18	22.13		
3	QPSK	8	7	22.18	22.16	22.12		
3	QPSK	15	0	22.22	22.20	22.16		
3	16QAM	1	0	22.31	22.26	22.22	23	1
3	16QAM	1	8	22.26	22.22	22.12		
3	16QAM	1	14	22.31	22.29	22.13		
3	16QAM	8	0	21.23	21.20	21.14	22	2
3	16QAM	8	4	21.23	21.20	21.11		
3	16QAM	8	7	21.21	21.18	21.08		
3	16QAM	15	0	21.19	21.17	21.11		
Channel				20407	20525	20643	Tune-up limit (dBm)	MPR (dB)
Frequency (MHz)				824.7	836.5	848.3		
1.4	QPSK	1	0	22.94	22.86	22.86	24	0
1.4	QPSK	1	3	22.90	22.82	22.81		
1.4	QPSK	1	5	22.96	22.88	22.87		
1.4	QPSK	3	0	23.09	23.02	23.00		
1.4	QPSK	3	1	23.10	23.03	23.02		
1.4	QPSK	3	3	23.11	23.04	23.02		
1.4	QPSK	6	0	22.14	22.10	22.07	23	1
1.4	16QAM	1	0	22.20	22.15	22.05	23	1
1.4	16QAM	1	3	22.17	22.12	22.00		
1.4	16QAM	1	5	22.20	22.16	22.02		
1.4	16QAM	3	0	22.09	22.04	21.97		
1.4	16QAM	3	1	22.12	22.07	21.98		
1.4	16QAM	3	3	22.09	22.04	21.94		
1.4	16QAM	6	0	21.19	21.14	21.07	22	2



<LTE Band 7>

BW [MHz]	Modulation	RB Size	RB Offset	Power Low Ch. / Freq.	Power Middle Ch. / Freq.	Power High Ch. / Freq.	Tune-up limit (dBm)	MPR (dB)
Channel				20850	21100	21350		
Frequency (MHz)				2510	2535	2560		
20	QPSK	1	0	22.33	22.36	22.35	23	0
20	QPSK	1	49	22.19	22.22	22.25		
20	QPSK	1	99	22.42	22.40	22.36		
20	QPSK	50	0	21.50	21.47	21.49	22	1
20	QPSK	50	24	21.34	21.35	21.39		
20	QPSK	50	50	21.38	21.36	21.38		
20	QPSK	100	0	21.43	21.42	21.36	22	1
20	16QAM	1	0	21.49	21.53	21.54		
20	16QAM	1	49	21.41	21.42	21.41		
20	16QAM	1	99	21.58	21.59	21.62	21	2
20	16QAM	50	0	20.33	20.45	20.47		
20	16QAM	50	24	20.31	20.35	20.37		
20	16QAM	50	50	20.34	20.35	20.35		
20	16QAM	100	0	20.32	20.39	20.39		
Channel				20825	21100	21375		
Frequency (MHz)				2507.5	2535	2562.5	Tune-up limit (dBm)	MPR (dB)
15	QPSK	1	0	22.34	22.34	22.36	23	0
15	QPSK	1	37	22.27	22.28	22.30		
15	QPSK	1	74	22.41	22.32	22.16		
15	QPSK	36	0	21.39	21.40	21.45	22	1
15	QPSK	36	20	21.39	21.36	21.40		
15	QPSK	36	39	21.41	21.38	21.42		
15	QPSK	75	0	21.41	21.39	21.43	22	1
15	16QAM	1	0	21.46	21.51	21.51		
15	16QAM	1	37	21.44	21.44	21.45		
15	16QAM	1	74	21.56	21.54	21.57	21	2
15	16QAM	36	0	20.33	20.39	20.43		
15	16QAM	36	20	20.33	20.36	20.39		
15	16QAM	36	39	20.36	20.36	20.40		
15	16QAM	75	0	20.35	20.38	20.41		
Channel				20800	21100	21400		
Frequency (MHz)				2505	2535	2565	Tune-up limit (dBm)	MPR (dB)
10	QPSK	1	0	22.25	22.25	22.27	23	0
10	QPSK	1	25	22.26	22.28	22.31		
10	QPSK	1	49	22.36	22.27	22.06		
10	QPSK	25	0	21.36	21.37	21.40	22	1
10	QPSK	25	12	21.39	21.35	21.40		
10	QPSK	25	25	21.41	21.36	21.38		
10	QPSK	50	0	21.40	21.39	21.43	22	1
10	16QAM	1	0	21.39	21.41	21.41		
10	16QAM	1	25	21.44	21.46	21.44		
10	16QAM	1	49	21.52	21.52	21.53	21	2
10	16QAM	25	0	20.30	20.37	20.39		
10	16QAM	25	12	20.33	20.35	20.38		
10	16QAM	25	25	20.35	20.35	20.36		
10	16QAM	50	0	20.34	20.38	20.40		



Channel				20775	21100	21425	Tune-up limit (dBm)	MPR (dB)
Frequency (MHz)				2502.5	2535	2567.5		
5	QPSK	1	0	22.25	22.25	22.25	23	0
5	QPSK	1	12	22.31	22.31	22.29		
5	QPSK	1	24	22.24	22.24	21.99		
5	QPSK	12	0	21.35	21.32	21.40	22	1
5	QPSK	12	7	21.38	21.35	21.44		
5	QPSK	12	13	21.39	21.35	21.42		
5	QPSK	25	0	21.37	21.34	21.41		
5	16QAM	1	0	21.40	21.42	21.41	22	1
5	16QAM	1	12	21.47	21.49	21.51		
5	16QAM	1	24	21.44	21.45	21.46		
5	16QAM	12	0	20.27	20.32	20.37	21	2
5	16QAM	12	7	20.32	20.35	20.41		
5	16QAM	12	13	20.32	20.36	20.39		
5	16QAM	25	0	20.31	20.33	20.36		
5	16QAM	25	0	20.31	20.33	20.36		



<LTE Band 12>

BW [MHz]	Modulation	RB Size	RB Offset	Power Low Ch. / Freq.	Power Middle Ch. / Freq.	Power High Ch. / Freq.	Tune-up limit (dBm)	MPR (dB)
Channel				23060	23095	23130		
Frequency (MHz)				704	707.5	711		
10	QPSK	1	0	22.16	22.15	22.15	23.5	0
10	QPSK	1	25	22.15	22.15	22.16		
10	QPSK	1	49	22.20	22.25	22.22		
10	QPSK	25	0	21.26	21.32	21.22	22.5	1
10	QPSK	25	12	21.23	21.24	21.22		
10	QPSK	25	25	21.17	21.23	21.17		
10	QPSK	50	0	21.24	21.32	21.17		
10	16QAM	1	0	21.46	21.35	21.33	22.5	1
10	16QAM	1	25	21.37	21.38	21.45		
10	16QAM	1	49	21.49	21.52	21.45		
10	16QAM	25	0	20.13	20.24	20.18	21.5	2
10	16QAM	25	12	20.16	20.19	20.18		
10	16QAM	25	25	20.09	20.21	20.17		
10	16QAM	50	0	20.12	20.25	20.18		
Channel				23035	23095	23155	Tune-up limit (dBm)	MPR (dB)
Frequency (MHz)				701.5	707.5	713.5		
5	QPSK	1	0	22.18	22.12	22.11	23.5	0
5	QPSK	1	12	22.19	22.23	22.18		
5	QPSK	1	24	22.16	22.11	22.15		
5	QPSK	12	0	21.17	21.22	21.12	22.5	1
5	QPSK	12	7	21.24	21.22	21.19		
5	QPSK	12	13	21.25	21.21	21.19		
5	QPSK	25	0	21.20	21.22	21.14	22.5	1
5	16QAM	1	0	21.42	21.31	21.39		
5	16QAM	1	12	21.41	21.45	21.43		
5	16QAM	1	24	21.37	21.42	21.37	21.5	2
5	16QAM	12	0	20.13	20.16	20.08		
5	16QAM	12	7	20.21	20.16	20.17		
5	16QAM	12	13	20.20	20.17	20.14		
5	16QAM	25	0	20.15	20.15	20.09		
Channel				23025	23095	23165	Tune-up limit (dBm)	MPR (dB)
Frequency (MHz)				700.5	707.5	714.5		
3	QPSK	1	0	22.16	22.23	22.14	23.5	0
3	QPSK	1	8	22.22	22.14	22.15		
3	QPSK	1	14	22.20	22.19	22.18		
3	QPSK	8	0	21.30	21.24	21.23	22.5	1
3	QPSK	8	4	21.30	21.23	21.23		
3	QPSK	8	7	21.30	21.24	21.23		
3	QPSK	15	0	21.30	21.25	21.24	22.5	1
3	16QAM	1	0	21.34	21.48	21.40		
3	16QAM	1	8	21.46	21.36	21.38		
3	16QAM	1	14	21.44	21.43	21.41	21.5	2
3	16QAM	8	0	20.30	20.22	20.24		
3	16QAM	8	4	20.30	20.22	20.24		
3	16QAM	8	7	20.29	20.23	20.23		
3	16QAM	15	0	20.27	20.19	20.20		



Channel				23017	23095	23173	Tune-up limit (dBm)	MPR (dB)
Frequency (MHz)				699.7	707.5	715.3		
1.4	QPSK	1	0	22.01	21.95	21.93	23.5	0
1.4	QPSK	1	3	22.01	21.95	21.94		
1.4	QPSK	1	5	22.06	22.00	21.99		
1.4	QPSK	3	0	22.19	22.20	22.10		
1.4	QPSK	3	1	22.19	22.12	22.12		
1.4	QPSK	3	3	22.19	22.12	22.12		
1.4	QPSK	6	0	21.23	21.18	21.17	22.5	1
1.4	16QAM	1	0	21.28	21.37	21.28	22.5	1
1.4	16QAM	1	3	21.36	21.26	21.26		
1.4	16QAM	1	5	21.35	21.27	21.27		
1.4	16QAM	3	0	21.23	21.15	21.14		
1.4	16QAM	3	1	21.26	21.18	21.18		
1.4	16QAM	3	3	21.22	21.14	21.14		
1.4	16QAM	6	0	20.28	20.20	20.20	21.5	2



<LTE Band 17>

BW [MHz]	Modulation	RB Size	RB Offset	Power Low Ch. / Freq.	Power Middle Ch. / Freq.	Power High Ch. / Freq.	Tune-up limit (dBm)	MPR (dB)
Channel				23780	23790	23800		
Frequency (MHz)				709	710	711		
10	QPSK	1	0	22.28	22.28	22.28	23.5	0
10	QPSK	1	25	22.31	22.29	22.28		
10	QPSK	1	49	22.34	22.35	22.34		
10	QPSK	25	0	21.42	21.45	21.38	22.5	1
10	QPSK	25	12	21.37	21.35	21.33		
10	QPSK	25	25	21.41	21.36	21.31		
10	QPSK	50	0	21.42	21.43	21.36	22.5	1
10	16QAM	1	0	21.49	21.47	21.49		
10	16QAM	1	25	21.58	21.59	21.58		
10	16QAM	1	49	21.61	21.62	21.59	21.5	2
10	16QAM	25	0	20.39	20.35	20.32		
10	16QAM	25	12	20.33	20.31	20.30		
10	16QAM	25	25	20.37	20.33	20.27	21.5	2
10	16QAM	50	0	20.41	20.36	20.31		
Channel				23755	23790	23825	Tune-up limit (dBm)	MPR (dB)
Frequency (MHz)				706.5	710	713.5		
5	QPSK	1	0	22.25	22.25	22.23	23.5	0
5	QPSK	1	12	22.33	22.34	22.30		
5	QPSK	1	24	22.32	22.26	22.25		
5	QPSK	12	0	21.38	21.32	21.24	22.5	1
5	QPSK	12	7	21.37	21.36	21.33		
5	QPSK	12	13	21.33	21.37	21.30		
5	QPSK	25	0	21.36	21.35	21.27	22.5	1
5	16QAM	1	0	21.45	21.49	21.51		
5	16QAM	1	12	21.56	21.61	21.55		
5	16QAM	1	24	21.57	21.54	21.51	21.5	2
5	16QAM	12	0	20.30	20.28	20.22		
5	16QAM	12	7	20.31	20.33	20.30		
5	16QAM	12	13	20.28	20.34	20.25	21.5	2
5	16QAM	25	0	20.28	20.29	20.22		

<TDD LTE SAR Measurement>

TDD LTE configuration setup for SAR measurement

SAR was tested with a fixed periodic duty factor according to the highest transmission duty factor implemented for the device and supported by 3GPP.

- a. 3GPP TS 36.211 section 4.2 for Type 2 Frame Structure and Table 4.2-2 for uplink-downlink configurations
- b. "special subframe S" contains both uplink and downlink transmissions, it has been taken into consideration to determine the transmission duty factor according to the worst case uplink and downlink cyclic prefix requirements for UpPTS
- c. Establishing connections with base station simulators ensure a consistent means for testing SAR and recommended for evaluating SAR. The Anritsu MT8820C (firmware: #22.52#004) was used for LTE output power measurements and SAR testing.

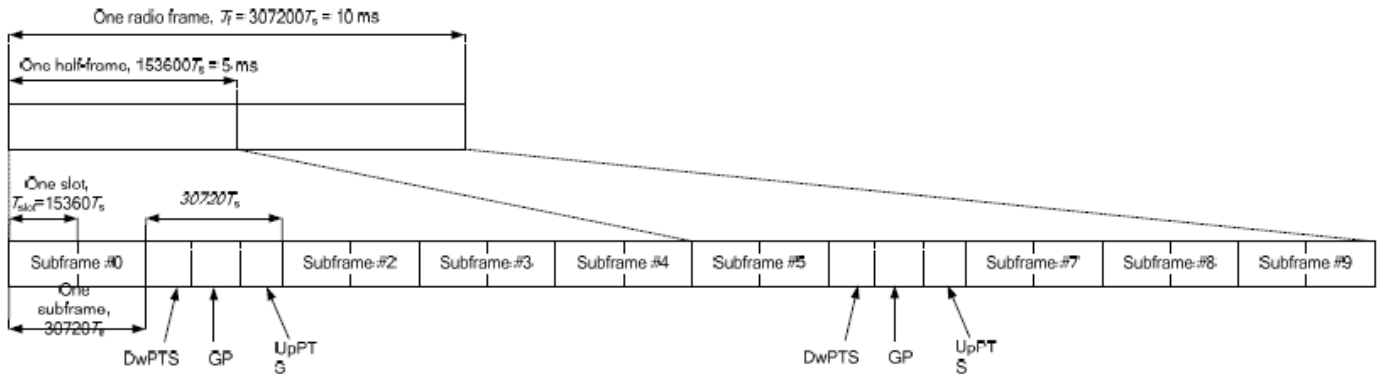

Figure 4.2-1: Frame structure type 2 (for 5 ms switch-point periodicity).

Table 4.2-2: Uplink-downlink configurations.

Uplink-downlink configuration	Downlink-to-Uplink Switch-point periodicity	Subframe number									
		0	1	2	3	4	5	6	7	8	9
0	5 ms	D	S	U	U	U	D	S	U	U	U
1	5 ms	D	S	U	U	D	D	S	U	U	D
2	5 ms	D	S	U	D	D	D	S	U	D	D
3	10 ms	D	S	U	U	U	D	D	D	D	D
4	10 ms	D	S	U	U	D	D	D	D	D	D
5	10 ms	D	S	U	D	D	D	D	D	D	D
6	5 ms	D	S	U	U	U	D	S	U	U	D

Table 4.2-1: Configuration of special subframe (lengths of DwPTS/GP/UpPTS).

Special subframe configuration	Normal cyclic prefix in downlink				Extended cyclic prefix in downlink			
	DwPTS	UpPTS		DwPTS	UpPTS			
		Normal cyclic prefix in uplink	Extended cyclic prefix in uplink		Normal cyclic prefix in uplink	Extended cyclic prefix in uplink		
0	6592 · Ts	2192 · Ts	2560 · Ts	7680 · Ts	2192 · Ts	2560 · Ts		
1	19760 · Ts			20480 · Ts				
2	21952 · Ts			23040 · Ts				
3	24144 · Ts			25600 · Ts				
4	26336 · Ts			7680 · Ts	4384 · Ts	5120 · Ts		
5	6592 · Ts	4384 · Ts	5120 · Ts	20480 · Ts				
6	19760 · Ts			23040 · Ts				
7	21952 · Ts			12800 · Ts				
8	24144 · Ts			-	-	-		
9	13168 · Ts			-	-	-	-	

Special subframe (30720·T_s): Normal cyclic prefix in downlink (UpPTS)			
	Special subframe configuration	Normal cyclic prefix in uplink	Extended cyclic prefix in uplink
Uplink duty factor in one special subframe	0~4	7.13%	8.33%
	5~9	14.3%	16.7%

Special subframe(30720·T_s): Extended cyclic prefix in downlink (UpPTS)			
	Special subframe configuration	Normal cyclic prefix in uplink	Extended cyclic prefix in uplink
Uplink duty factor in one special subframe	0~3	7.13%	8.33%
	4~7	14.3%	16.7%

The highest duty factor is resulted from:

- i. Uplink-downlink configuration: 0. In a half-frame consisted of 5 subframes, uplink operation is in 3 uplink subframes and 1 special subframe.
- ii. special subframe configuration: 5-9 for normal cyclic prefix in downlink, 4-7 for extended cyclic prefix in downlink
- iii. for special subframe with extended cyclic prefix in uplink, the total uplink duty factor in one half-frame is: $(3+0.167)/5 = 63.3\%$
- iv. for special subframe with normal cyclic prefix in uplink, the total uplink duty factor in one half-frame is: $(3+0.143)/5 = 62.9\%$
- v. For TDD LTE SAR measurement, the duty cycle 1:1.59 (62.9 %) was used perform testing and considering the theoretical duty cycle of 63.3% for extended cyclic prefix in the uplink, and the theoretical duty cycle of 62.9% for normal cyclic prefix in uplink, a scaling factor of extended cyclic prefix $63.3\%/62.9\% = 1.006$ is applied to scale-up the measured SAR result. The scaled TDD LTE SAR = measured SAR (W/kg)* Tune-up Scaling Factor* scaling factor for extended cyclic prefix.



<LTE Band 38>

BW [MHz]	Modulation	RB Size	RB Offset	Power Low Ch. / Freq.	Power Middle Ch. / Freq.	Power High Ch. / Freq.	Tune-up limit (dBm)	MPR (dB)
Channel				37850	38000	38150		
Frequency (MHz)				2580	2595	2610		
20	QPSK	1	0	23.25	23.19	23.14	24	0
20	QPSK	1	49	23.13	23.03	23.05		
20	QPSK	1	99	23.33	23.23	23.21		
20	QPSK	50	0	22.31	22.23	22.25	23	1
20	QPSK	50	24	22.23	22.13	22.15		
20	QPSK	50	50	22.23	22.14	22.15		
20	QPSK	100	0	22.26	22.19	22.17		
20	16QAM	1	0	22.36	22.25	22.25	23	1
20	16QAM	1	49	22.23	22.13	22.14		
20	16QAM	1	99	22.42	22.31	22.30		
20	16QAM	50	0	21.40	21.29	21.31	22	2
20	16QAM	50	24	21.31	21.20	21.21		
20	16QAM	50	50	21.29	21.21	21.20		
20	16QAM	100	0	21.32	21.22	21.23		
Channel				37825	38000	38175		
Frequency (MHz)				2577.5	2595	2612.5		
15	QPSK	1	0	23.15	23.15	23.14	24	0
15	QPSK	1	37	23.07	23.09	23.08		
15	QPSK	1	74	23.19	23.20	23.19		
15	QPSK	36	0	22.14	22.18	22.20	23	1
15	QPSK	36	20	22.13	22.15	22.15		
15	QPSK	36	39	22.16	22.16	22.13		
15	QPSK	75	0	22.17	22.16	22.17		
15	16QAM	1	0	22.28	22.25	22.24	23	1
15	16QAM	1	37	22.22	22.20	22.20		
15	16QAM	1	74	22.34	22.31	22.30		
15	16QAM	36	0	21.17	21.17	21.20	22	2
15	16QAM	36	20	21.16	21.14	21.15		
15	16QAM	36	39	21.18	21.14	21.15		
15	16QAM	75	0	21.24	21.22	21.23		
Channel				37800	38000	38200		
Frequency (MHz)				2575	2595	2615		
10	QPSK	1	0	23.08	23.06	23.06	24	0
10	QPSK	1	25	23.08	23.10	23.07		
10	QPSK	1	49	23.19	23.18	23.16		
10	QPSK	25	0	22.13	22.12	22.13	23	1
10	QPSK	25	12	22.14	22.14	22.13		
10	QPSK	25	25	22.15	22.14	22.13		
10	QPSK	50	0	22.17	22.16	22.13		
10	16QAM	1	0	22.20	22.15	22.15	23	1
10	16QAM	1	25	22.19	22.19	22.16		
10	16QAM	1	49	22.29	22.26	22.23		
10	16QAM	25	0	21.21	21.18	21.20	22	2
10	16QAM	25	12	21.20	21.19	21.19		
10	16QAM	25	25	21.22	21.19	21.21		
10	16QAM	50	0	21.24	21.21	21.21		



Channel				37775	38000	38225	Tune-up limit (dBm)	MPR (dB)
Frequency (MHz)				2572.5	2595	2617.5		
5	QPSK	1	0	23.08	23.04	23.02	24	0
5	QPSK	1	12	23.12	23.10	23.08		
5	QPSK	1	24	23.05	23.04	23.01		
5	QPSK	12	0	22.14	22.10	22.11	23	1
5	QPSK	12	7	22.18	22.14	22.14		
5	QPSK	12	13	22.14	22.14	22.14		
5	QPSK	25	0	22.13	22.10	22.10		
5	16QAM	1	0	22.18	22.13	22.12	23	1
5	16QAM	1	12	22.23	22.20	22.19		
5	16QAM	1	24	22.18	22.16	22.15		
5	16QAM	12	0	21.15	21.11	21.10	22	2
5	16QAM	12	7	21.19	21.15	21.15		
5	16QAM	12	13	21.16	21.14	21.14		
5	16QAM	25	0	21.20	21.14	21.16		

<LTE Carrier Aggregation>

General Note:

1. This device supports Carrier Aggregation on downlink only for inter and intra band, Uplink CA is not supported. For the device supports bands and bandwidths and configurations are provided as follow table was according to 3GPP.
2. All permutations exist. No restrictions on Pcell & Scell combinations.
3. Only supported intra-band contiguous CA, intra-band non-contiguous CA is not supported.

E-UTRA CA Configuration	Component carriers in order of increasing carrier frequency		Maximum aggregates bandwidth [MHz]	Bandwidth combination set
	Channel bandwidths for carrier [MHz]	Channel bandwidths for carrier [MHz]		
CA_7C	15	15	40	0
	20	20		
CA_7C	10	20	40	1
	15	15,20		
	20	10,15,20		
CA_7C	15	10,15	40	2
	20	15,20		

<LTE Carrier Aggregation Conducted Power>

General Note:

1. According to KDB941225 D05A v01r02 LTE CA conducted power requirement will base on below procedure for conducted power verification.
2. Selected highest measured power when downlink carrier aggregation is inactive for conducted power comparison with downlink carrier aggregation is active, to confirm that when downlink carrier aggregation is active uplink maximum output power remains within the specified tune-up tolerance limits and not more than ¼ dB higher than the maximum output power measured when downlink carrier aggregation inactive.
3. For Intra-band, contiguous CA, the downlink channels selected to perform the uplink power measurement must satisfy 3GPP channel spacing (5.4.1A of 3GPP TS 36.521 or equivalent) and channel bandwidth (5.4.2A) requirements.

$$\text{Nominal channel spacing} = \left\lceil \frac{BW_{\text{Channel}(1)} + BW_{\text{Channel}(2)} - 0.1 |BW_{\text{Channel}(1)} - BW_{\text{Channel}(2)}|}{0.6} \right\rceil 0.3 \text{ [MHz]}$$

Configure		PCC								SCC				Power		
		LTE Band	BW (MHz)	UL Freq. (MHz)	UL Channel	Modulation	UL# RB	UL RB Offset	DL Freq. (MHz)	DL Channel	LTE Band	BW (MHz)	DL Freq. (MHz)	DL Channel	With CA Tx.Power(dBm)	W/O CA Tx.Power(dBm)
Intra-Band	Contiguous	Band 7	20	2510	20850	QPSK	1	99	2630	2850	Band 7	20	2649.8	3048	22.4	22.42



<WLAN Conducted Power>

General Note:

1. Per KDB 248227 D01v02r02, SAR test reduction is determined according to 802.11 transmission mode configurations and certain exposure conditions with multiple test positions. In the 2.4 GHz band, separate SAR procedures are applied to DSSS and OFDM configurations to simplify DSSS test requirements. For OFDM, in both 2.4 and 5 GHz bands, an initial test configuration must be determined for each standalone and aggregated frequency band, according to the transmission mode configuration with the highest maximum output power specified for production units to perform SAR measurements. If the same highest maximum output power applies to different combinations of channel bandwidths, modulations and data rates, additional procedures are applied to determine which test configurations require SAR measurement. When applicable, an initial test position may be applied to reduce the number of SAR measurements required for next to the ear, UMPC mini-tablet or hotspot mode configurations with multiple test positions.
2. For 2.4 GHz 802.11b DSSS, either the initial test position procedure for multiple exposure test positions or the DSSS procedure for fixed exposure position is applied; these are mutually exclusive. For 2.4 GHz and 5 GHz OFDM configurations, the initial test configuration is applied to measure SAR using either the initial test position procedure for multiple exposure test position configurations or the initial test configuration procedures for fixed exposure test conditions. Based on the reported SAR of the measured configurations and maximum output power of the transmission mode configurations that are not included in the initial test configuration, the subsequent test configuration and initial test position procedures are applied to determine if SAR measurements are required for the remaining OFDM transmission configurations. In general, the number of test channels that require SAR measurement is minimized based on maximum output power measured for the test sample(s).
3. For OFDM transmission configurations in the 2.4 GHz and 5 GHz bands, When the same maximum power is specified for multiple transmission modes in a frequency band, the largest channel bandwidth, lowest order modulation, lowest data rate and lowest order 802.11a/g/n/ac mode is used for SAR measurement, on the highest measured output power channel for each frequency band.
4. DSSS and OFDM configurations are considered separately according to the required SAR procedures. SAR is measured in the initial test position using the 802.11 transmission mode configuration required by the DSSS procedure or initial test configuration and subsequent test configuration(s) according to the OFDM procedures.18 The initial test position procedure is described in the following:
 - a. When the reported SAR of the initial test position is ≤ 0.4 W/kg, further SAR measurement is not required for the other test positions in that exposure configuration and 802.11 transmission mode combinations within the frequency band or aggregated band.
 - b. When the reported SAR of the test position is > 0.4 W/kg, SAR is repeated for the 802.11 transmission mode configuration tested in the initial test position to measure the subsequent next closet/smallest test separation distance and maximum coupling test position on the highest maximum output power channel, until the report SAR is ≤ 0.8 W/kg or all required test position are tested.
 - c. For all positions/configurations, when the reported SAR is > 0.8 W/kg, SAR is measured for these test positions/configurations on the subsequent next highest measured output power channel(s) until the reported SAR is ≤ 1.2 W/kg or all required channels are tested.

<2.4GHz WLAN>

	Mode	Channel	Frequency (MHz)	Data Rate	Average power (dBm)	Tune-Up Limit	Duty Cycle %
2.4GHz WLAN	802.11b	CH 1	2412	1Mbps	17.94	19.50	100.00
		CH 6	2437		17.95	19.50	
		CH 11	2462		17.99	19.50	
	802.11g	CH 1	2412	6Mbps	16.87	18.50	96.98
		CH 6	2437		17.18	18.50	
		CH 11	2462		17.17	18.50	
	802.11n-HT20	CH 1	2412	MCS0	16.88	18.50	97.17
		CH 6	2437		17.36	18.50	
		CH 11	2462		17.35	18.50	
	802.11n-HT40	CH 3	2422	MCS0	15.29	18.50	95.31
		CH 6	2437		16.81	18.50	
		CH 9	2452		16.54	18.50	



<5GHz WLAN>

	Mode	Channel	Frequency (MHz)	Data Rate	Average power (dBm)	Tune-Up Limit	Duty Cycle %
5.2GHz WLAN	802.11a	CH 36	5180	6Mbps	16.66	18.50	97.22
		CH 40	5200		16.70	18.50	
		CH 44	5220		16.80	18.50	
		CH 48	5240		16.83	18.50	
	802.11n-HT20	CH 36	5180	MCS0	17.24	18.50	97.02
		CH 40	5200		17.22	18.50	
		CH 44	5220		17.19	18.50	
		CH 48	5240		17.26	18.50	
	802.11n-HT40	CH 38	5190	MCS0	13.80	14.00	93.86
		CH 46	5230		16.21	18.00	

	Mode	Channel	Frequency (MHz)	Data Rate	Average power (dBm)	Tune-Up Limit	Duty Cycle %
5.3GHz WLAN	802.11a	CH 52	5260	6Mbps	16.07	18.00	97.22
		CH 56	5280		16.24	18.00	
		CH 60	5300		16.50	18.00	
		CH 64	5320		16.49	18.00	
	802.11n-HT20	CH 52	5260	MCS0	16.87	18.50	97.02
		CH 56	5280		16.90	18.50	
		CH 60	5300		16.94	18.50	
		CH 64	5320		16.97	18.50	
	802.11n-HT40	CH 54	5270	MCS0	15.71	18.00	93.86
		CH 62	5310		12.09	12.50	

	Mode	Channel	Frequency (MHz)	Data Rate	Average power (dBm)	Tune-Up Limit	Duty Cycle %
5.5GHz WLAN	802.11a	CH 100	5500	6Mbps	16.18	18.00	97.22
		CH 116	5580		16.53	18.00	
		CH 124	5620		16.46	18.00	
		CH 132	5660		15.99	18.00	
		CH 140	5700		15.23	15.50	
	802.11n-HT20	CH 100	5500	MCS0	16.23	16.50	97.02
		CH 116	5580		16.63	18.50	
		CH 124	5620		16.62	18.50	
		CH 132	5660		16.64	18.50	
		CH 140	5700		14.69	15.00	
	802.11n-HT40	CH 102	5510	MCS0	13.46	13.50	93.86
		CH 110	5550		16.80	18.00	
		CH 126	5630		16.51	18.00	
		CH 134	5670		16.37	18.00	

	Mode	Channel	Frequency (MHz)	Data Rate	Average power (dBm)	Tune-Up Limit	Duty Cycle %
5.8GHz WLAN	802.11a	CH 149	5745	MCS0	15.38	18.00	97.22
		CH 157	5785		15.48	18.00	
		CH 165	5825		15.77	18.00	
	802.11n-HT20	CH 149	5745	MCS0	16.43	18.00	97.02
		CH 157	5785		16.78	18.00	
		CH 165	5825		16.37	18.00	
	802.11n-HT40	CH 151	5755	MCS0	16.06	18.00	93.86
		CH 159	5795		16.37	18.00	

13. Bluetooth Exclusions Applied

Mode Band	Average power(dBm)	
	Bluetooth-BR/EDR	Bluetooth-LE
2.4GHz Bluetooth	9	9

Note:

- Per KDB 447498 D01v06, the 1-g and 10-g SAR test exclusion thresholds for 100 MHz to 6 GHz at *test separation distances* ≤ 50 mm are determined by:

$$[(\text{max. power of channel, including tune-up tolerance, mW}) / (\text{min. test separation distance, mm})] \cdot [\sqrt{f(\text{GHz})}] \leq 3.0$$
 for 1-g SAR and ≤ 7.5 for 10-g extremity SAR
 - f(GHz) is the RF channel transmit frequency in GHz
 - Power and distance are rounded to the nearest mW and mm before calculation
 - The result is rounded to one decimal place for comparison

Bluetooth Max Power (dBm)	Separation Distance (mm)	Frequency (GHz)	exclusion thresholds
9	10	2.48	1.26

Note:

Per KDB 447498 D01v06, when the minimum test separation distance is 10 mm. The test exclusion threshold is 1.26 which is ≤ 3, SAR testing is not required.

14. Antenna Location

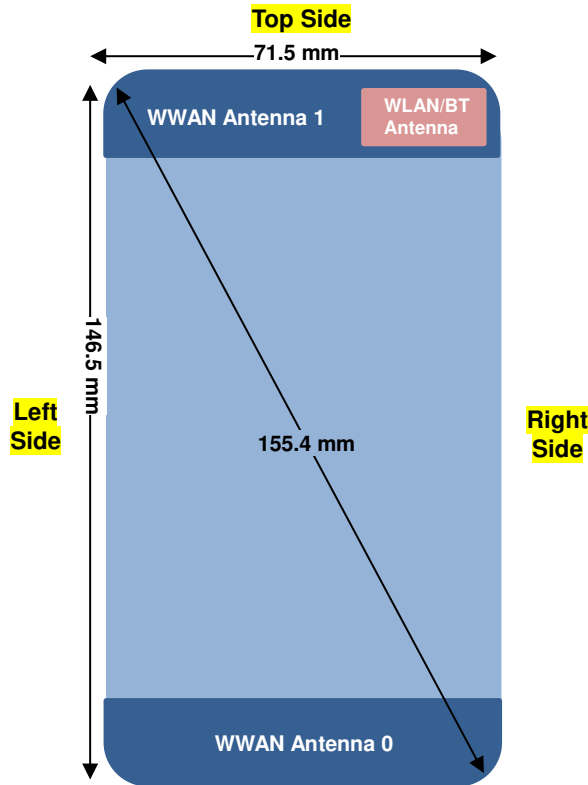

Bottom Side

Front View

Antenna	Support Band
WWAN Ant 0	GSM 850 / 1900 WCDMA B2 / B4 / B5 LTE B2 / B4 / B5 / B7 / B12 / B17 / B38
WWAN Ant 1	GSM 850 / 1900 WCDMA B2 / B4 / B5 LTE B2 / B4 / B5 / B7 / B12 / B17 / B38

Distance of the Antenna to the EUT surface/edge						
Antennas	Back	Front	Top Side	Bottom Side	Right Side	Left Side
WWAN Antenna 0	≤ 25mm	≤ 25mm	>25mm	≤ 25mm	≤ 25mm	≤ 25mm
WWAN Antenna 1	≤ 25mm	≤ 25mm	≤ 25mm	>25mm	≤ 25mm	≤ 25mm
BT&WLAN	≤ 25mm	≤ 25mm	≤ 25mm	>25mm	≤ 25mm	>25mm

Positions for SAR tests; Hotspot mode						
Antennas	Back	Front	Top Side	Bottom Side	Right Side	Left Side
WWAN Antenna 0	Yes	Yes	No	Yes	Yes	Yes
WWAN Antenna 1	Yes	Yes	Yes	No	Yes	Yes
BT&WLAN	Yes	Yes	Yes	No	Yes	No

General Note:

- Referring to KDB 941225 D06 v02r01, when the overall device length and width are ≥ 9cm*5cm, the test distance is 10 mm. SAR must be measured for all sides and surfaces with a transmitting antenna located within 25mm from that surface or edge



15. SAR Test Results

General Note:

1. Per KDB 447498 D01v06, the reported SAR is the measured SAR value adjusted for maximum tune-up tolerance.
 - a. Tune-up scaling Factor = tune-up limit power (mW) / EUT RF power (mW), where tune-up limit is the maximum rated power among all production units.
 - b. For SAR testing of WLAN signal with non-100% duty cycle, the measured SAR is scaled-up by the duty cycle scaling factor which is equal to "1/(duty cycle)"
 - c. For WWAN: Reported SAR(W/kg)= Measured SAR(W/kg)*Tune-up Scaling Factor
 - d. For WLAN: Reported SAR(W/kg)= Measured SAR(W/kg)* Duty Cycle scaling factor * Tune-up scaling factor
 - e. For TDD LTE SAR measurement, the duty cycle 1:1.59 (62.9 %) was used perform testing and considering the theoretical duty cycle of 63.3% for extended cyclic prefix in the uplink, and the theoretical duty cycle of 62.9% for normal cyclic prefix in uplink, a scaling factor of extended cyclic prefix 63.3%/62.9% = 1.006 is applied to scale-up the measured SAR result. The Reported TDD LTE SAR = measured SAR (W/kg) * Tune-up Scaling Factor* scaling factor for extended cyclic prefix.
2. Per KDB 447498 D01v06, for each exposure position, testing of other required channels within the operating mode of a frequency band is not required when the *reported* 1-g or 10-g SAR for the mid-band or highest output power channel is:
 - ≤ 0.8 W/kg or 2.0 W/kg, for 1-g or 10-g respectively, when the transmission band is ≤ 100 MHz
 - ≤ 0.6 W/kg or 1.5 W/kg, for 1-g or 10-g respectively, when the transmission band is between 100 MHz and 200 MHz
 - ≤ 0.4 W/kg or 1.0 W/kg, for 1-g or 10-g respectively, when the transmission band is ≥ 200 MHz
3. Per KDB 865664 D01v01r04, for each frequency band, repeated SAR measurement is required only when the measured SAR is ≥ 0.8 W/kg.
4. Per KDB 648474 D04v01r03, when the reported SAR for a body-worn accessory measured without a headset connected to the handset is ≤ 1.2 W/kg, SAR testing with a headset connected to the handset is not required.

GSM Note:

1. Per KDB 941225 D01v03r01, for SAR test reduction for GSM / GPRS / EDGE modes is determined by the source-based time-averaged output power including tune-up tolerance. The mode with highest specified time-averaged output power should be tested for SAR compliance in the applicable exposure conditions. For modes with the same specified maximum output power and tolerance, the higher number time-slot configuration should be tested. Therefore, the GPRS (4Tx slots) for GSM850/GSM1900 is considered as the primary mode.
2. Other configurations of GSM / GPRS / EDGE are considered as secondary modes. The 3G SAR test reduction procedure is applied, when the maximum output power and tune-up tolerance specified for production units in a secondary mode is $\leq \frac{1}{4}$ dB higher than the primary mode, SAR measurement is not required for the secondary mode.

UMTS Note:

1. Per KDB 941225 D01v03r01, for SAR testing is measured using a 12.2 kbps RMC with TPC bits configured to all "1's".
2. Per KDB 941225 D01v03r01, RMC 12.2kbps setting is used to evaluate SAR. If the maximum output power and tune-up tolerance specified for production units in HSDPA / HSUPA / DC-HSDPA is $\leq \frac{1}{4}$ dB higher than RMC 12.2Kbps or when the highest reported SAR of the RMC12.2Kbps is scaled by the ratio of specified maximum output power and tune-up tolerance of HSDPA / HSUPA / DC-HSDPA to RMC12.2Kbps and the adjusted SAR is ≤ 1.2 W/kg, SAR measurement is not required for HSDPA / HSUPA / DC-HSDPA.

**LTE Note:**

1. Per KDB 941225 D05v02r05, start with the largest channel bandwidth and measure SAR for QPSK with 1 RB allocation, using the RB offset and required test channel combination with the highest maximum output power for RB offsets at the upper edge, middle and lower edge of each required test channel.
2. Per KDB 941225 D05v02r05, 50% RB allocation for QPSK SAR testing follows 1RB QPSK allocation procedure.
3. Per KDB 941225 D05v02r05, For QPSK with 100% RB allocation, SAR is not required when the highest maximum output power for 100 % RB allocation is less than the highest maximum output power in 50% and 1 RB allocations and the highest reported SAR for 1 RB and 50% RB allocation are ≤ 0.8 W/kg. Otherwise, SAR is measured for the highest output power channel; and if the reported SAR is > 1.45 W/kg, the remaining required test channels must also be tested.
4. Per KDB 941225 D05v02r05, 16QAM output power for each RB allocation configuration is $> \text{not } \frac{1}{2}$ dB higher than the same configuration in QPSK and the reported SAR for the QPSK configuration is ≤ 1.45 W/kg; Per KDB 941225 D05v02r05, 16QAM SAR testing is not required.
5. Per KDB 941225 D05v02r05, Smaller bandwidth output power for each RB allocation configuration is $> \text{not } \frac{1}{2}$ dB higher than the same configuration in the largest supported bandwidth, and the reported SAR for the largest supported bandwidth is ≤ 1.45 W/kg; Per KDB 941225 D05v02r05, smaller bandwidth SAR testing is not required.
6. For LTE B4 / B5 / B12 / B38 the maximum bandwidth does not support three non-overlapping channels, per KDB 941225 D05v02r05, when a device supports overlapping channel assignment in a channel bandwidth configuration, the middle channel of the group of overlapping channels should be selected for testing.
7. LTE band 17 SAR test was covered by Band 12; according to TCB workshop, SAR test for overlapping LTE bands can be reduced if
 - a. The maximum output power, including tolerance, for the smaller band is \leq the larger band to qualify for the SAR test exclusion.
 - b. The channel bandwidth and other operating parameters for the smaller band are fully supported by the larger band.

WLAN Note:

1. Per KDB 248227 D01v02r02, for 2.4GHz 802.11g/n SAR testing is not required when the highest reported SAR for DSSS is adjusted by the ratio of OFDM to DSSS specified maximum output power and the adjusted SAR is ≤ 1.2 W/kg.
2. Per KDB 248227 D01v02r02, U-NII-2A SAR testing is not required when the U-NII-1 band highest reported SAR for a test configuration is ≤ 1.2 W/kg, SAR is not required for U-NII-2A band.
3. When the reported SAR of the test position is > 0.4 W/kg, SAR is repeated for the 802.11 transmission mode configuration tested in the initial test position to measure the subsequent next closet/smallest test separation distance and maximum coupling test position on the highest maximum output power channel, until the report SAR is ≤ 0.8 W/kg or all required test position are tested.
4. For all positions / configurations, when the reported SAR is > 0.8 W/kg, SAR is measured for these test positions / configurations on the subsequent next highest measured output power channel(s) until the reported SAR is ≤ 1.2 W/kg or all required channels are tested.
5. During SAR testing the WLAN transmission was verified using a spectrum analyzer.



15.1 Head SAR

<GSM SAR>

Plot No.	Band	Mode	Test Position	Gap (mm)	Ant	Sample	Ch.	Freq. (MHz)	Average Power (dBm)	Tune-Up Limit (dBm)	Tune-up Scaling Factor	Power Drift (dB)	Measured 1g SAR (W/kg)	Reported 1g SAR (W/kg)
01	GSM850	GPRS (4 Tx slots)	Right Cheek	0mm	ANT1	Sample 1	251	848.8	28.75	29.50	1.189	-0.02	0.188	0.223
	GSM850	GPRS (4 Tx slots)	Right Tilted	0mm	ANT1	Sample 1	251	848.8	28.75	29.50	1.189	0.05	0.080	0.095
	GSM850	GPRS (4 Tx slots)	Left Cheek	0mm	ANT1	Sample 1	251	848.8	28.75	29.50	1.189	-0.08	0.080	0.095
	GSM850	GPRS (4 Tx slots)	Left Tilted	0mm	ANT1	Sample 1	251	848.8	28.75	29.50	1.189	0.02	0.044	0.052
	GSM850	GPRS (4 Tx slots)	Right Cheek	0mm	ANT1	Sample 2	251	848.8	28.75	29.50	1.189	-0.07	0.185	0.220
	GSM850	GPRS (4 Tx slots)	Right Cheek	0mm	ANT0	Sample 1	251	848.8	28.75	29.50	1.189	-0.13	0.078	0.093
	GSM850	GPRS (4 Tx slots)	Right Tilted	0mm	ANT0	Sample 1	251	848.8	28.75	29.50	1.189	-0.05	0.052	0.062
	GSM850	GPRS (4 Tx slots)	Left Cheek	0mm	ANT0	Sample 1	251	848.8	28.75	29.50	1.189	0.02	0.106	0.126
	GSM850	GPRS (4 Tx slots)	Left Tilted	0mm	ANT0	Sample 1	251	848.8	28.75	29.50	1.189	0.08	0.047	0.056
	GSM850	GPRS (4 Tx slots)	Left Cheek	0mm	ANT0	Sample 2	251	848.8	28.75	29.50	1.189	0.05	0.066	0.078
02	GSM1900	GPRS (4 Tx slots)	Right Cheek	0mm	ANT1	Sample 1	661	1880	25.80	26.50	1.175	0	0.272	0.320
	GSM1900	GPRS (4 Tx slots)	Right Tilted	0mm	ANT1	Sample 1	661	1880	25.80	26.50	1.175	-0.05	0.175	0.206
	GSM1900	GPRS (4 Tx slots)	Left Cheek	0mm	ANT1	Sample 1	661	1880	25.80	26.50	1.175	-0.1	0.100	0.117
	GSM1900	GPRS (4 Tx slots)	Left Tilted	0mm	ANT1	Sample 1	661	1880	25.80	26.50	1.175	0.02	0.103	0.121
	GSM1900	GPRS (4 Tx slots)	Right Cheek	0mm	ANT1	Sample 2	661	1880	25.80	26.50	1.175	-0.11	0.215	0.253
	GSM1900	GPRS (4 Tx slots)	Right Cheek	0mm	ANT0	Sample 1	661	1880	25.80	26.50	1.175	-0.13	0.054	0.063
	GSM1900	GPRS (4 Tx slots)	Right Tilted	0mm	ANT0	Sample 1	661	1880	25.80	26.50	1.175	0.12	0.041	0.048
	GSM1900	GPRS (4 Tx slots)	Left Cheek	0mm	ANT0	Sample 1	661	1880	25.80	26.50	1.175	0.1	0.080	0.094
	GSM1900	GPRS (4 Tx slots)	Left Tilted	0mm	ANT0	Sample 1	661	1880	25.80	26.50	1.175	-0.12	0.039	0.046
	GSM1900	GPRS (4 Tx slots)	Left Cheek	0mm	ANT0	Sample 2	661	1880	25.80	26.50	1.175	0.03	0.106	0.125



<WCDMA SAR>

Plot No.	Band	Mode	Test Position	Gap (mm)	Ant	Sample	Ch.	Freq. (MHz)	Average Power (dBm)	Tune-Up Limit (dBm)	Tune-up Scaling Factor	Power Drift (dB)	Measured 1g SAR (W/kg)	Reported 1g SAR (W/kg)
	WCDMA II	RMC 12.2Kbps	Right Cheek	0mm	ANT1	Sample 1	9538	1907.6	22.81	24.00	1.315	-0.04	0.347	0.456
	WCDMA II	RMC 12.2Kbps	Right Tilted	0mm	ANT1	Sample 1	9538	1907.6	22.81	24.00	1.315	0	0.263	0.346
	WCDMA II	RMC 12.2Kbps	Left Cheek	0mm	ANT1	Sample 1	9538	1907.6	22.81	24.00	1.315	-0.11	0.229	0.301
	WCDMA II	RMC 12.2Kbps	Left Tilted	0mm	ANT1	Sample 1	9538	1907.6	22.81	24.00	1.315	-0.03	0.148	0.195
03	WCDMA II	RMC 12.2Kbps	Right Cheek	0mm	ANT1	Sample 2	9538	1907.6	22.81	24.00	1.315	0.02	0.420	0.552
	WCDMA II	RMC 12.2Kbps	Right Cheek	0mm	ANT0	Sample 1	9538	1907.6	22.81	24.00	1.315	0.01	0.043	0.057
	WCDMA II	RMC 12.2Kbps	Right Tilted	0mm	ANT0	Sample 1	9538	1907.6	22.81	24.00	1.315	0.19	0.026	0.034
	WCDMA II	RMC 12.2Kbps	Left Cheek	0mm	ANT0	Sample 1	9538	1907.6	22.81	24.00	1.315	0.09	0.089	0.117
	WCDMA II	RMC 12.2Kbps	Left Tilted	0mm	ANT0	Sample 1	9538	1907.6	22.81	24.00	1.315	0.12	0.039	0.051
	WCDMA II	RMC 12.2Kbps	Left Cheek	0mm	ANT0	Sample 2	9538	1907.6	22.81	24.00	1.315	0.15	0.106	0.139
	WCDMA IV	RMC 12.2Kbps	Right Cheek	0mm	ANT1	Sample 1	1312	1712.4	23.34	24.00	1.164	0.05	0.504	0.587
	WCDMA IV	RMC 12.2Kbps	Right Tilted	0mm	ANT1	Sample 1	1312	1712.4	23.34	24.00	1.164	0.03	0.404	0.470
	WCDMA IV	RMC 12.2Kbps	Left Cheek	0mm	ANT1	Sample 1	1312	1712.4	23.34	24.00	1.164	-0.03	0.216	0.251
	WCDMA IV	RMC 12.2Kbps	Left Tilted	0mm	ANT1	Sample 1	1312	1712.4	23.34	24.00	1.164	-0.03	0.229	0.267
04	WCDMA IV	RMC 12.2Kbps	Right Cheek	0mm	ANT1	Sample 2	1312	1712.4	23.34	24.00	1.164	0.09	0.506	0.589
	WCDMA IV	RMC 12.2Kbps	Right Cheek	0mm	ANT0	Sample 1	1312	1712.4	23.34	24.00	1.164	0.1	0.056	0.065
	WCDMA IV	RMC 12.2Kbps	Right Tilted	0mm	ANT0	Sample 1	1312	1712.4	23.34	24.00	1.164	-0.01	0.032	0.037
	WCDMA IV	RMC 12.2Kbps	Left Cheek	0mm	ANT0	Sample 1	1312	1712.4	23.34	24.00	1.164	-0.06	0.099	0.115
	WCDMA IV	RMC 12.2Kbps	Left Tilted	0mm	ANT0	Sample 1	1312	1712.4	23.34	24.00	1.164	0.08	0.035	0.041
	WCDMA IV	RMC 12.2Kbps	Left Cheek	0mm	ANT0	Sample 2	1312	1712.4	23.34	24.00	1.164	0.16	0.095	0.111
05	WCDMA V	RMC 12.2Kbps	Right Cheek	0mm	ANT1	Sample 1	4132	826.4	23.43	24.00	1.140	0.15	0.078	0.089
	WCDMA V	RMC 12.2Kbps	Right Tilted	0mm	ANT1	Sample 1	4132	826.4	23.43	24.00	1.140	-0.01	0.036	0.041
	WCDMA V	RMC 12.2Kbps	Left Cheek	0mm	ANT1	Sample 1	4132	826.4	23.43	24.00	1.140	0.16	0.015	0.017
	WCDMA V	RMC 12.2Kbps	Left Tilted	0mm	ANT1	Sample 1	4132	826.4	23.43	24.00	1.140	0.14	0.006	0.007
	WCDMA V	RMC 12.2Kbps	Right Cheek	0mm	ANT1	Sample 2	4132	826.4	23.43	24.00	1.140	0.12	0.065	0.074
	WCDMA V	RMC 12.2Kbps	Right Cheek	0mm	ANT0	Sample 1	4132	826.4	23.43	24.00	1.140	-0.18	0.023	0.026
	WCDMA V	RMC 12.2Kbps	Right Tilted	0mm	ANT0	Sample 1	4132	826.4	23.43	24.00	1.140	0.12	0.017	0.019
	WCDMA V	RMC 12.2Kbps	Left Cheek	0mm	ANT0	Sample 1	4132	826.4	23.43	24.00	1.140	-0.1	0.033	0.038
	WCDMA V	RMC 12.2Kbps	Left Tilted	0mm	ANT0	Sample 1	4132	826.4	23.43	24.00	1.140	0.06	0.014	0.016
	WCDMA V	RMC 12.2Kbps	Left Cheek	0mm	ANT0	Sample 2	4132	826.4	23.43	24.00	1.140	-0.18	0.019	0.022



<FDD LTE SAR>

Plot No.	Band	BW (MHz)	Modulation	RB Size	RB offset	Test Position	Gap (mm)	Ant	Sample	Ch.	Freq. (MHz)	Average Power (dBm)	Tune-Up Limit (dBm)	Tune-up Scaling Factor	Power Drift (dB)	Measured 1g SAR (W/kg)	Reported 1g SAR (W/kg)
	LTE Band 2	20M	QPSK	1	0	Right Cheek	0mm	ANT1	Sample 1	18900	1880	23.28	24.00	1.180	-0.09	0.432	0.510
	LTE Band 2	20M	QPSK	50	0	Right Cheek	0mm	ANT1	Sample 1	18900	1880	22.33	23.00	1.167	0.05	0.330	0.385
	LTE Band 2	20M	QPSK	1	0	Right Tilted	0mm	ANT1	Sample 1	18900	1880	23.28	24.00	1.180	-0.01	0.275	0.325
	LTE Band 2	20M	QPSK	50	0	Right Tilted	0mm	ANT1	Sample 1	18900	1880	22.33	23.00	1.167	0.02	0.214	0.250
	LTE Band 2	20M	QPSK	1	0	Left Cheek	0mm	ANT1	Sample 1	18900	1880	23.28	24.00	1.180	-0.11	0.210	0.248
	LTE Band 2	20M	QPSK	50	0	Left Cheek	0mm	ANT1	Sample 1	18900	1880	22.33	23.00	1.167	-0.02	0.168	0.196
	LTE Band 2	20M	QPSK	1	0	Left Tilted	0mm	ANT1	Sample 1	18900	1880	23.28	24.00	1.180	-0.05	0.159	0.188
	LTE Band 2	20M	QPSK	50	0	Left Tilted	0mm	ANT1	Sample 1	18900	1880	22.33	23.00	1.167	0.01	0.122	0.142
06	LTE Band 2	20M	QPSK	1	0	Right Cheek	0mm	ANT1	Sample 2	18900	1880	23.28	24.00	1.180	-0.04	0.433	0.511
	LTE Band 2	20M	QPSK	1	0	Right Cheek	0mm	ANT0	Sample 1	18900	1880	23.28	24.00	1.180	0.04	0.052	0.061
	LTE Band 2	20M	QPSK	50	0	Right Cheek	0mm	ANT0	Sample 1	18900	1880	22.33	23.00	1.167	-0.05	0.042	0.049
	LTE Band 2	20M	QPSK	1	0	Right Tilted	0mm	ANT0	Sample 1	18900	1880	23.28	24.00	1.180	0.1	0.031	0.037
	LTE Band 2	20M	QPSK	50	0	Right Tilted	0mm	ANT0	Sample 1	18900	1880	22.33	23.00	1.167	-0.04	0.026	0.030
	LTE Band 2	20M	QPSK	1	0	Left Cheek	0mm	ANT0	Sample 1	18900	1880	23.28	24.00	1.180	0.07	0.103	0.122
	LTE Band 2	20M	QPSK	50	0	Left Cheek	0mm	ANT0	Sample 1	18900	1880	22.33	23.00	1.167	0	0.077	0.090
	LTE Band 2	20M	QPSK	1	0	Left Tilted	0mm	ANT0	Sample 1	18900	1880	23.28	24.00	1.180	0.04	0.040	0.047
	LTE Band 2	20M	QPSK	50	0	Left Tilted	0mm	ANT0	Sample 1	18900	1880	22.33	23.00	1.167	-0.16	0.033	0.039
	LTE Band 2	20M	QPSK	1	0	Left Cheek	0mm	ANT0	Sample 2	18900	1880	23.28	24.00	1.180	0.05	0.125	0.148
	LTE Band 4	20M	QPSK	1	0	Right Cheek	0mm	ANT1	Sample 1	20175	1732.5	22.80	23.50	1.175	0.04	0.455	0.535
	LTE Band 4	20M	QPSK	50	0	Right Cheek	0mm	ANT1	Sample 1	20175	1732.5	21.85	22.50	1.161	0	0.345	0.401
	LTE Band 4	20M	QPSK	1	0	Right Tilted	0mm	ANT1	Sample 1	20175	1732.5	22.80	23.50	1.175	-0.04	0.368	0.432
	LTE Band 4	20M	QPSK	50	0	Right Tilted	0mm	ANT1	Sample 1	20175	1732.5	21.85	22.50	1.161	0.02	0.278	0.323
	LTE Band 4	20M	QPSK	1	0	Left Cheek	0mm	ANT1	Sample 1	20175	1732.5	22.80	23.50	1.175	0.02	0.213	0.250
	LTE Band 4	20M	QPSK	50	0	Left Cheek	0mm	ANT1	Sample 1	20175	1732.5	21.85	22.50	1.161	0.04	0.132	0.153
	LTE Band 4	20M	QPSK	1	0	Left Tilted	0mm	ANT1	Sample 1	20175	1732.5	22.80	23.50	1.175	-0.04	0.228	0.268
	LTE Band 4	20M	QPSK	50	0	Left Tilted	0mm	ANT1	Sample 1	20175	1732.5	21.85	22.50	1.161	-0.02	0.168	0.195
07	LTE Band 4	20M	QPSK	1	0	Right Cheek	0mm	ANT1	Sample 2	20175	1732.5	22.80	23.50	1.175	-0.02	0.484	0.569
	LTE Band 4	20M	QPSK	1	0	Right Cheek	0mm	ANT0	Sample 1	20175	1732.5	22.80	23.50	1.175	-0.11	0.050	0.059
	LTE Band 4	20M	QPSK	50	0	Right Cheek	0mm	ANT0	Sample 1	20175	1732.5	21.85	22.50	1.161	0.1	0.041	0.048
	LTE Band 4	20M	QPSK	1	0	Right Tilted	0mm	ANT0	Sample 1	20175	1732.5	22.80	23.50	1.175	0.01	0.026	0.031
	LTE Band 4	20M	QPSK	50	0	Right Tilted	0mm	ANT0	Sample 1	20175	1732.5	21.85	22.50	1.161	0.01	0.022	0.026
	LTE Band 4	20M	QPSK	1	0	Left Cheek	0mm	ANT0	Sample 1	20175	1732.5	22.80	23.50	1.175	0.08	0.090	0.106
	LTE Band 4	20M	QPSK	50	0	Left Cheek	0mm	ANT0	Sample 1	20175	1732.5	21.85	22.50	1.161	0.1	0.074	0.086
	LTE Band 4	20M	QPSK	1	0	Left Tilted	0mm	ANT0	Sample 1	20175	1732.5	22.80	23.50	1.175	-0.04	0.032	0.038
	LTE Band 4	20M	QPSK	50	0	Left Tilted	0mm	ANT0	Sample 1	20175	1732.5	21.85	22.50	1.161	0.09	0.026	0.030
	LTE Band 4	20M	QPSK	1	0	Left Cheek	0mm	ANT0	Sample 2	20175	1732.5	22.80	23.50	1.175	0.15	0.091	0.107



Plot No.	Band	BW (MHz)	Modulation	RB Size	RB offset	Test Position	Gap (mm)	Ant	Sample	Ch.	Freq. (MHz)	Average Power (dBm)	Tune-Up Limit (dBm)	Tune-up Scaling Factor	Power Drift (dB)	Measured 1g SAR (W/kg)	Reported 1g SAR (W/kg)
	LTE Band 5	10M	QPSK	1	0	Right Cheek	0mm	ANT1	Sample 1	20525	836.5	23.14	24.00	1.219	-0.07	0.038	0.046
	LTE Band 5	10M	QPSK	25	0	Right Cheek	0mm	ANT1	Sample 1	20525	836.5	22.22	23.00	1.197	-0.14	0.032	0.038
	LTE Band 5	10M	QPSK	1	0	Right Tilted	0mm	ANT1	Sample 1	20525	836.5	23.14	24.00	1.219	0.08	0.018	0.022
	LTE Band 5	10M	QPSK	25	0	Right Tilted	0mm	ANT1	Sample 1	20525	836.5	22.22	23.00	1.197	-0.04	0.015	0.018
	LTE Band 5	10M	QPSK	1	0	Left Cheek	0mm	ANT1	Sample 1	20525	836.5	23.14	24.00	1.219	0.11	0.017	0.021
	LTE Band 5	10M	QPSK	25	0	Left Cheek	0mm	ANT1	Sample 1	20525	836.5	22.22	23.00	1.197	-0.15	0.012	0.014
	LTE Band 5	10M	QPSK	1	0	Left Tilted	0mm	ANT1	Sample 1	20525	836.5	23.14	24.00	1.219	0	0.001	0.001
	LTE Band 5	10M	QPSK	25	0	Left Tilted	0mm	ANT1	Sample 1	20525	836.5	22.22	23.00	1.197	0	0.001	0.001
	LTE Band 5	10M	QPSK	1	0	Right Cheek	0mm	ANT1	Sample 2	20525	836.5	23.14	24.00	1.219	-0.1	0.037	0.045
	LTE Band 5	10M	QPSK	1	0	Right Cheek	0mm	ANT0	Sample 1	20525	836.5	23.14	24.00	1.219	-0.19	0.028	0.034
	LTE Band 5	10M	QPSK	25	0	Right Cheek	0mm	ANT0	Sample 1	20525	836.5	22.22	23.00	1.197	-0.16	0.023	0.028
	LTE Band 5	10M	QPSK	1	0	Right Tilted	0mm	ANT0	Sample 1	20525	836.5	23.14	24.00	1.219	-0.1	0.017	0.021
	LTE Band 5	10M	QPSK	25	0	Right Tilted	0mm	ANT0	Sample 1	20525	836.5	22.22	23.00	1.197	0.13	0.015	0.018
	LTE Band 5	10M	QPSK	1	0	Left Cheek	0mm	ANT0	Sample 1	20525	836.5	23.14	24.00	1.219	-0.18	0.043	0.052
	LTE Band 5	10M	QPSK	25	0	Left Cheek	0mm	ANT0	Sample 1	20525	836.5	22.22	23.00	1.197	-0.17	0.036	0.043
	LTE Band 5	10M	QPSK	1	0	Left Tilted	0mm	ANT0	Sample 1	20525	836.5	23.14	24.00	1.219	0.11	0.018	0.022
	LTE Band 5	10M	QPSK	25	0	Left Tilted	0mm	ANT0	Sample 1	20525	836.5	22.22	23.00	1.197	-0.18	0.016	0.019
08	LTE Band 5	10M	QPSK	1	0	Left Cheek	0mm	ANT0	Sample 2	20525	836.5	23.14	24.00	1.219	-0.01	0.055	0.067
	LTE Band 7	20M	QPSK	1	99	Right Cheek	0mm	ANT1	Sample 1	20850	2510	22.42	23.00	1.143	-0.129	0.738	0.843
	LTE Band 7	20M	QPSK	1	99	Right Cheek	0mm	ANT1	Sample 1	21100	2535	22.40	23.00	1.148	0.141	0.718	0.824
09	LTE Band 7	20M	QPSK	1	99	Right Cheek	0mm	ANT1	Sample 1	21350	2560	22.36	23.00	1.159	-0.064	0.762	0.883
	LTE Band 7	20M	QPSK	50	0	Right Cheek	0mm	ANT1	Sample 1	20850	2510	21.50	22.00	1.122	0.078	0.676	0.758
	LTE Band 7	20M	QPSK	100	0	Right Cheek	0mm	ANT1	Sample 1	20850	2510	21.43	22.00	1.140	-0.015	0.649	0.740
	LTE Band 7	20M	QPSK	1	99	Right Tilted	0mm	ANT1	Sample 1	20850	2510	22.42	23.00	1.143	0.07	0.303	0.346
	LTE Band 7	20M	QPSK	50	0	Right Tilted	0mm	ANT1	Sample 1	20850	2510	21.50	22.00	1.122	0.053	0.314	0.352
	LTE Band 7	20M	QPSK	1	99	Left Cheek	0mm	ANT1	Sample 1	20850	2510	22.42	23.00	1.143	-0.183	0.248	0.283
	LTE Band 7	20M	QPSK	50	0	Left Cheek	0mm	ANT1	Sample 1	20850	2510	21.50	22.00	1.122	0.133	0.245	0.275
	LTE Band 7	20M	QPSK	1	99	Left Tilted	0mm	ANT1	Sample 1	20850	2510	22.42	23.00	1.143	-0.055	0.123	0.141
	LTE Band 7	20M	QPSK	50	0	Left Tilted	0mm	ANT1	Sample 1	20850	2510	21.50	22.00	1.122	0.114	0.129	0.145
	LTE Band 7	20M	QPSK	1	99	Right Cheek	0mm	ANT1	Sample 2	21350	2560	22.36	23.00	1.159	-0.07	0.594	0.688
	LTE Band 7	20M	QPSK	1	99	Right Cheek	0mm	ANT0	Sample 1	20850	2510	22.42	23.00	1.143	0	0.049	0.056
	LTE Band 7	20M	QPSK	50	0	Right Cheek	0mm	ANT0	Sample 1	20850	2510	21.50	22.00	1.122	0.06	0.037	0.042
	LTE Band 7	20M	QPSK	1	99	Right Tilted	0mm	ANT0	Sample 1	20850	2510	22.42	23.00	1.143	0.18	0.032	0.037
	LTE Band 7	20M	QPSK	50	0	Right Tilted	0mm	ANT0	Sample 1	20850	2510	21.50	22.00	1.122	0.05	0.020	0.022
	LTE Band 7	20M	QPSK	1	99	Left Cheek	0mm	ANT0	Sample 1	20850	2510	22.42	23.00	1.143	0.03	0.131	0.150
	LTE Band 7	20M	QPSK	50	0	Left Cheek	0mm	ANT0	Sample 1	20850	2510	21.50	22.00	1.122	-0.12	0.109	0.122
	LTE Band 7	20M	QPSK	1	99	Left Tilted	0mm	ANT0	Sample 1	20850	2510	22.42	23.00	1.143	0.04	0.036	0.041
	LTE Band 7	20M	QPSK	50	0	Left Tilted	0mm	ANT0	Sample 1	20850	2510	21.50	22.00	1.122	-0.05	0.027	0.030
	LTE Band 7	20M	QPSK	1	99	Left Cheek	0mm	ANT0	Sample 2	20850	2510	22.42	23.00	1.143	0.05	0.111	0.127



Plot No.	Band	BW (MHz)	Modulation	RB Size	RB offset	Test Position	Gap (mm)	Ant	Sample	Ch.	Freq. (MHz)	Average Power (dBm)	Tune-Up Limit (dBm)	Tune-up Scaling Factor	Power Drift (dB)	Measured 1g SAR (W/kg)	Reported 1g SAR (W/kg)
	LTE Band 12	10M	QPSK	1	49	Right Cheek	0mm	ANT1	Sample 1	23095	707.5	22.25	23.50	1.334	0.07	0.015	0.020
	LTE Band 12	10M	QPSK	25	0	Right Cheek	0mm	ANT1	Sample 1	23095	707.5	21.32	22.50	1.312	-0.13	0.012	0.016
	LTE Band 12	10M	QPSK	1	49	Right Tilted	0mm	ANT1	Sample 1	23095	707.5	22.25	23.50	1.334	-0.15	0.008	0.010
	LTE Band 12	10M	QPSK	25	0	Right Tilted	0mm	ANT1	Sample 1	23095	707.5	21.32	22.50	1.312	0.12	0.006	0.008
	LTE Band 12	10M	QPSK	1	49	Left Cheek	0mm	ANT1	Sample 1	23095	707.5	22.25	23.50	1.334	0	0.001	0.001
	LTE Band 12	10M	QPSK	25	0	Left Cheek	0mm	ANT1	Sample 1	23095	707.5	21.32	22.50	1.312	0	0.001	0.001
	LTE Band 12	10M	QPSK	1	49	Left Tilted	0mm	ANT1	Sample 1	23095	707.5	22.25	23.50	1.334	-0.14	0.004	0.005
	LTE Band 12	10M	QPSK	25	0	Left Tilted	0mm	ANT1	Sample 1	23095	707.5	21.32	22.50	1.312	-0.1	0.001	0.001
	LTE Band 12	10M	QPSK	1	49	Right Cheek	0mm	ANT1	Sample 2	23095	707.5	22.25	23.50	1.334	-0.04	0.008	0.011
	LTE Band 12	10M	QPSK	1	49	Right Cheek	0mm	ANT0	Sample 1	23095	707.5	22.25	23.50	1.334	0.01	0.026	0.035
	LTE Band 12	10M	QPSK	25	0	Right Cheek	0mm	ANT0	Sample 1	23095	707.5	21.32	22.50	1.312	-0.01	0.018	0.024
	LTE Band 12	10M	QPSK	1	49	Right Tilted	0mm	ANT0	Sample 1	23095	707.5	22.25	23.50	1.334	0.14	0.016	0.021
	LTE Band 12	10M	QPSK	25	0	Right Tilted	0mm	ANT0	Sample 1	23095	707.5	21.32	22.50	1.312	0.04	0.011	0.014
	LTE Band 12	10M	QPSK	1	49	Left Cheek	0mm	ANT0	Sample 1	23095	707.5	22.25	23.50	1.334	0.04	0.027	0.036
	LTE Band 12	10M	QPSK	25	0	Left Cheek	0mm	ANT0	Sample 1	23095	707.5	21.32	22.50	1.312	-0.01	0.019	0.025
	LTE Band 12	10M	QPSK	1	49	Left Tilted	0mm	ANT0	Sample 1	23095	707.5	22.25	23.50	1.334	-0.04	0.012	0.016
	LTE Band 12	10M	QPSK	25	0	Left Tilted	0mm	ANT0	Sample 1	23095	707.5	21.32	22.50	1.312	-0.14	0.008	0.010
10	LTE Band 12	10M	QPSK	1	49	Left Cheek	0mm	ANT0	Sample 2	23095	707.5	22.25	23.50	1.334	0.02	0.055	0.073

<TDD LTE SAR>

Plot No.	Band	BW (MHz)	Modulation	RB Size	RB offset	Test Position	Gap (mm)	Ant	Sample	Ch.	Freq. (MHz)	Average Power (dBm)	Tune-Up Limit (dBm)	Tune-up Scaling Factor	Duty Cycle %	Duty Cycle Scaling Factor	Power Drift (dB)	Measured 1g SAR (W/kg)	Reported 1g SAR (W/kg)
	LTE Band 38	20M	QPSK	1	99	Right Cheek	0mm	ANT1	Sample 1	37850	2580	23.33	24.00	1.167	62.9	1.006	-0.06	0.477	0.560
	LTE Band 38	20M	QPSK	50	0	Right Cheek	0mm	ANT1	Sample 1	37850	2580	22.31	23.00	1.172	62.9	1.006	0.05	0.503	0.593
	LTE Band 38	20M	QPSK	1	99	Right Tilted	0mm	ANT1	Sample 1	37850	2580	23.33	24.00	1.167	62.9	1.006	0	0.254	0.298
	LTE Band 38	20M	QPSK	50	0	Right Tilted	0mm	ANT1	Sample 1	37850	2580	22.31	23.00	1.172	62.9	1.006	-0.02	0.270	0.318
	LTE Band 38	20M	QPSK	1	99	Left Cheek	0mm	ANT1	Sample 1	37850	2580	23.33	24.00	1.167	62.9	1.006	0.08	0.188	0.221
	LTE Band 38	20M	QPSK	50	0	Left Cheek	0mm	ANT1	Sample 1	37850	2580	22.31	23.00	1.172	62.9	1.006	0.04	0.198	0.233
	LTE Band 38	20M	QPSK	1	99	Left Tilted	0mm	ANT1	Sample 1	37850	2580	23.33	24.00	1.167	62.9	1.006	-0.14	0.109	0.128
	LTE Band 38	20M	QPSK	50	0	Left Tilted	0mm	ANT1	Sample 1	37850	2580	22.31	23.00	1.172	62.9	1.006	0.02	0.116	0.137
11	LTE Band 38	20M	QPSK	50	0	Right Cheek	0mm	ANT1	Sample 2	37850	2580	22.31	23.00	1.172	62.9	1.006	-0.02	0.592	0.698
	LTE Band 38	20M	QPSK	1	99	Right Cheek	0mm	ANT0	Sample 1	37850	2580	23.33	24.00	1.167	62.9	1.006	0.08	0.035	0.041
	LTE Band 38	20M	QPSK	50	0	Right Cheek	0mm	ANT0	Sample 1	37850	2580	22.31	23.00	1.172	62.9	1.006	0.16	0.032	0.038
	LTE Band 38	20M	QPSK	1	99	Right Tilted	0mm	ANT0	Sample 1	37850	2580	23.33	24.00	1.167	62.9	1.006	0.12	0.023	0.027
	LTE Band 38	20M	QPSK	50	0	Right Tilted	0mm	ANT0	Sample 1	37850	2580	22.31	23.00	1.172	62.9	1.006	-0.16	0.009	0.011
	LTE Band 38	20M	QPSK	1	99	Left Cheek	0mm	ANT0	Sample 1	37850	2580	23.33	24.00	1.167	62.9	1.006	0.1	0.074	0.087
	LTE Band 38	20M	QPSK	50	0	Left Cheek	0mm	ANT0	Sample 1	37850	2580	22.31	23.00	1.172	62.9	1.006	0.13	0.060	0.071
	LTE Band 38	20M	QPSK	1	99	Left Tilted	0mm	ANT0	Sample 1	37850	2580	23.33	24.00	1.167	62.9	1.006	-0.14	0.012	0.014
	LTE Band 38	20M	QPSK	50	0	Left Tilted	0mm	ANT0	Sample 1	37850	2580	22.31	23.00	1.172	62.9	1.006	-0.1	0.012	0.014
	LTE Band 38	20M	QPSK	1	99	Left Cheek	0mm	ANT0	Sample 2	37850	2580	23.33	24.00	1.167	62.9	1.006	0.15	0.073	0.086



<WLAN SAR>

Plot No.	Band	Mode	Test Position	Gap (mm)	Sample	Ch.	Freq. (MHz)	Average Power (dBm)	Tune-Up Limit (dBm)	Tune-up Scaling Factor	Duty Cycle %	Duty Cycle Scaling Factor	Power Drift (dB)	Measured 1g SAR (W/kg)	Reported 1g SAR (W/kg)
	WLAN2.4GHz	802.11b 1Mbps	Right Cheek	0mm	Sample 1	11	2462	17.99	19.50	1.416	100	1.000	0.06	0.111	0.157
	WLAN2.4GHz	802.11b 1Mbps	Right Tilted	0mm	Sample 1	11	2462	17.99	19.50	1.416	100	1.000	0.06	0.073	0.103
12	WLAN2.4GHz	802.11b 1Mbps	Left Cheek	0mm	Sample 1	11	2462	17.99	19.50	1.416	100	1.000	0.04	0.536	0.759
	WLAN2.4GHz	802.11b 1Mbps	Left Cheek	0mm	Sample 2	11	2462	17.99	19.50	1.416	100	1.000	0.073	0.244	0.345
	WLAN2.4GHz	802.11b 1Mbps	Left Tilted	0mm	Sample 1	11	2462	17.99	19.50	1.416	100	1.000	0.03	0.310	0.439
	WLAN5GHz	802.11a 6Mbps	Right Cheek	0mm	Sample 1	48	5240	16.83	18.50	1.469	97.22	1.029	-0.05	0.144	0.218
	WLAN5GHz	802.11a 6Mbps	Right Tilted	0mm	Sample 1	48	5240	16.83	18.50	1.469	97.22	1.029	-0.1	0.089	0.135
13	WLAN5GHz	802.11a 6Mbps	Left Cheek	0mm	Sample 1	48	5240	16.83	18.50	1.469	97.22	1.029	0.14	0.245	0.370
	WLAN5GHz	802.11a 6Mbps	Left Cheek	0mm	Sample 2	48	5240	16.83	18.50	1.469	97.22	1.029	0.064	0.234	0.354
	WLAN5GHz	802.11a 6Mbps	Left Tilted	0mm	Sample 1	48	5240	16.83	18.50	1.469	97.22	1.029	0.03	0.103	0.156
	WLAN5GHz	802.11n-HT20 MCS0	Right Cheek	0mm	Sample 1	132	5660	16.64	18.50	1.535	97.02	1.031	-0.182	0.201	0.318
	WLAN5GHz	802.11n-HT20 MCS0	Right Tilted	0mm	Sample 1	132	5660	16.64	18.50	1.535	97.02	1.031	0.057	0.197	0.312
	WLAN5GHz	802.11n-HT20 MCS0	Left Cheek	0mm	Sample 1	132	5660	16.64	18.50	1.535	97.02	1.031	-0.181	0.303	0.479
14	WLAN5GHz	802.11n-HT20 MCS0	Left Tilted	0mm	Sample 1	132	5660	16.64	18.50	1.535	97.02	1.031	0.18	0.315	0.498
	WLAN5GHz	802.11n-HT20 MCS0	Left Tilted	0mm	Sample 2	132	5660	16.64	18.50	1.535	97.02	1.031	0.1	0.313	0.495
	WLAN5GHz	802.11n-HT40 MCS0	Right Cheek	0mm	Sample 1	159	5795	16.37	18.00	1.455	93.86	1.065	-0.07	0.226	0.350
	WLAN5GHz	802.11n-HT40 MCS0	Right Tilted	0mm	Sample 1	159	5795	16.37	18.00	1.455	93.86	1.065	0.19	0.233	0.361
	WLAN5GHz	802.11n-HT40 MCS0	Left Cheek	0mm	Sample 1	159	5795	16.37	18.00	1.455	93.86	1.065	0.15	0.406	0.629
15	WLAN5GHz	802.11n-HT40 MCS0	Left Tilted	0mm	Sample 1	159	5795	16.37	18.00	1.455	93.86	1.065	0.19	0.440	0.682
	WLAN5GHz	802.11n-HT40 MCS0	Left Tilted	0mm	Sample 2	159	5795	16.37	18.00	1.455	93.86	1.065	0.117	0.336	0.521



15.2 Hotspot SAR

<GSM SAR>

Plot No.	Band	Mode	Test Position	Gap (mm)	Antenna	Sample	Ch.	Freq. (MHz)	Average Power (dBm)	Tune-Up Limit (dBm)	Tune-up Scaling Factor	Power Drift (dB)	Measured 1g SAR (W/kg)	Reported 1g SAR (W/kg)
	GSM850	GPRS (4 Tx slots)	Front	10mm	Ant 1	Sample 1	251	848.8	28.75	29.50	1.189	0.06	0.055	0.065
	GSM850	GPRS (4 Tx slots)	Back	10mm	Ant 1	Sample 1	251	848.8	28.75	29.50	1.189	-0.09	0.076	0.090
	GSM850	GPRS (4 Tx slots)	Left Side	10mm	Ant 1	Sample 1	251	848.8	28.75	29.50	1.189	-0.1	0.067	0.080
	GSM850	GPRS (4 Tx slots)	Right Side	10mm	Ant 1	Sample 1	251	848.8	28.75	29.50	1.189	-0.04	0.037	0.044
	GSM850	GPRS (4 Tx slots)	Top Side	10mm	Ant 1	Sample 1	251	848.8	28.75	29.50	1.189	-0.13	0.005	0.006
	GSM850	GPRS (4 Tx slots)	Back	10mm	Ant 1	Sample 2	251	848.8	28.75	29.50	1.189	-0.16	0.065	0.077
	GSM850	GPRS (4 Tx slots)	Front	10mm	Ant 0	Sample 1	251	848.8	28.75	29.50	1.189	-0.13	0.137	0.163
	GSM850	GPRS (4 Tx slots)	Back	10mm	Ant 0	Sample 1	251	848.8	28.75	29.50	1.189	-0.14	0.287	0.341
	GSM850	GPRS (4 Tx slots)	Left Side	10mm	Ant 0	Sample 1	251	848.8	28.75	29.50	1.189	-0.11	0.161	0.191
	GSM850	GPRS (4 Tx slots)	Right Side	10mm	Ant 0	Sample 1	251	848.8	28.75	29.50	1.189	-0.07	0.057	0.068
	GSM850	GPRS (4 Tx slots)	Bottom Side	10mm	Ant 0	Sample 1	251	848.8	28.75	29.50	1.189	0.14	0.083	0.099
16	GSM850	GPRS (4 Tx slots)	Back	10mm	Ant 0	Sample 2	251	848.8	28.75	29.50	1.189	0	0.321	0.382
	GSM1900	GPRS (4 Tx slots)	Front	10mm	Ant 1	Sample 1	661	1880	25.80	26.50	1.175	-0.13	0.035	0.041
	GSM1900	GPRS (4 Tx slots)	Back	10mm	Ant 1	Sample 1	661	1880	25.80	26.50	1.175	-0.12	0.084	0.099
	GSM1900	GPRS (4 Tx slots)	Left Side	10mm	Ant 1	Sample 1	661	1880	25.80	26.50	1.175	-0.07	0.059	0.069
	GSM1900	GPRS (4 Tx slots)	Right Side	10mm	Ant 1	Sample 1	661	1880	25.80	26.50	1.175	0.14	0.006	0.007
	GSM1900	GPRS (4 Tx slots)	Top Side	10mm	Ant 1	Sample 1	661	1880	25.80	26.50	1.175	0.13	0.048	0.056
	GSM1900	GPRS (4 Tx slots)	Back	10mm	Ant 1	Sample 2	661	1880	25.80	26.50	1.175	-0.09	0.081	0.095
	GSM1900	GPRS (4 Tx slots)	Front	10mm	Ant 0	Sample 1	661	1880	25.80	26.50	1.175	0.07	0.053	0.062
17	GSM1900	GPRS (4 Tx slots)	Back	10mm	Ant 0	Sample 1	661	1880	25.80	26.50	1.175	0.13	0.085	0.100
	GSM1900	GPRS (4 Tx slots)	Left Side	10mm	Ant 0	Sample 1	661	1880	25.80	26.50	1.175	0.05	0.043	0.051
	GSM1900	GPRS (4 Tx slots)	Right Side	10mm	Ant 0	Sample 1	661	1880	25.80	26.50	1.175	-0.14	0.013	0.015
	GSM1900	GPRS (4 Tx slots)	Bottom Side	10mm	Ant 0	Sample 1	661	1880	25.80	26.50	1.175	0	0.065	0.076
	GSM1900	GPRS (4 Tx slots)	Back	10mm	Ant 0	Sample 2	661	1880	25.80	26.50	1.175	-0.06	0.075	0.088



<WCDMA SAR>

Plot No.	Band	Mode	Test Position	Gap (mm)	Antenna	Sample	Ch.	Freq. (MHz)	Average Power (dBm)	Tune-Up Limit (dBm)	Tune-up Scaling Factor	Power Drift (dB)	Measured 1g SAR (W/kg)	Reported 1g SAR (W/kg)
	WCDMA II	RMC 12.2Kbps	Front	10mm	Ant 1	Sample 1	9538	1907.6	22.81	24.00	1.315	-0.14	0.049	0.064
	WCDMA II	RMC 12.2Kbps	Back	10mm	Ant 1	Sample 1	9538	1907.6	22.81	24.00	1.315	-0.12	0.105	0.138
	WCDMA II	RMC 12.2Kbps	Left Side	10mm	Ant 1	Sample 1	9538	1907.6	22.81	24.00	1.315	0.01	0.081	0.107
	WCDMA II	RMC 12.2Kbps	Right Side	10mm	Ant 1	Sample 1	9538	1907.6	22.81	24.00	1.315	-0.11	0.008	0.010
	WCDMA II	RMC 12.2Kbps	Top Side	10mm	Ant 1	Sample 1	9538	1907.6	22.81	24.00	1.315	0.02	0.067	0.088
	WCDMA II	RMC 12.2Kbps	Back	10mm	Ant 1	Sample 2	9538	1907.6	22.81	24.00	1.315	-0.12	0.104	0.137
	WCDMA II	RMC 12.2Kbps	Front	10mm	Ant 0	Sample 1	9538	1907.6	22.81	24.00	1.315	-0.14	0.067	0.088
18	WCDMA II	RMC 12.2Kbps	Back	10mm	Ant 0	Sample 1	9538	1907.6	22.81	24.00	1.315	-0.05	0.110	0.145
	WCDMA II	RMC 12.2Kbps	Left Side	10mm	Ant 0	Sample 1	9538	1907.6	22.81	24.00	1.315	0.1	0.050	0.066
	WCDMA II	RMC 12.2Kbps	Right Side	10mm	Ant 0	Sample 1	9538	1907.6	22.81	24.00	1.315	-0.15	0.015	0.020
	WCDMA II	RMC 12.2Kbps	Bottom Side	10mm	Ant 0	Sample 1	9538	1907.6	22.81	24.00	1.315	0.11	0.096	0.126
	WCDMA II	RMC 12.2Kbps	Back	10mm	Ant 0	Sample 2	9538	1907.6	22.81	24.00	1.315	-0.17	0.083	0.109
	WCDMA IV	RMC 12.2Kbps	Front	10mm	Ant 1	Sample 1	1312	1712.4	23.34	24.00	1.164	-0.01	0.099	0.115
19	WCDMA IV	RMC 12.2Kbps	Back	10mm	Ant 1	Sample 1	1312	1712.4	23.34	24.00	1.164	-0.12	0.160	0.186
	WCDMA IV	RMC 12.2Kbps	Left Side	10mm	Ant 1	Sample 1	1312	1712.4	23.34	24.00	1.164	0.07	0.065	0.076
	WCDMA IV	RMC 12.2Kbps	Right Side	10mm	Ant 1	Sample 1	1312	1712.4	23.34	24.00	1.164	-0.15	0.008	0.009
	WCDMA IV	RMC 12.2Kbps	Top Side	10mm	Ant 1	Sample 1	1312	1712.4	23.34	24.00	1.164	0.13	0.100	0.116
	WCDMA IV	RMC 12.2Kbps	Back	10mm	Ant 1	Sample 2	1312	1712.4	23.34	24.00	1.164	0	0.160	0.186
	WCDMA IV	RMC 12.2Kbps	Front	10mm	Ant 0	Sample 1	1312	1712.4	23.34	24.00	1.164	0.02	0.072	0.084
	WCDMA IV	RMC 12.2Kbps	Back	10mm	Ant 0	Sample 1	1312	1712.4	23.34	24.00	1.164	-0.13	0.095	0.111
	WCDMA IV	RMC 12.2Kbps	Left Side	10mm	Ant 0	Sample 1	1312	1712.4	23.34	24.00	1.164	-0.01	0.045	0.052
	WCDMA IV	RMC 12.2Kbps	Right Side	10mm	Ant 0	Sample 1	1312	1712.4	23.34	24.00	1.164	0.1	0.015	0.017
	WCDMA IV	RMC 12.2Kbps	Bottom Side	10mm	Ant 0	Sample 1	1312	1712.4	23.34	24.00	1.164	0.19	0.081	0.094
	WCDMA IV	RMC 12.2Kbps	Back	10mm	Ant 0	Sample 2	1312	1712.4	23.34	24.00	1.164	-0.12	0.092	0.107
	WCDMA V	RMC 12.2Kbps	Front	10mm	Ant 1	Sample 1	4132	826.4	23.43	24.00	1.140	-0.12	0.008	0.009
	WCDMA V	RMC 12.2Kbps	Back	10mm	Ant 1	Sample 1	4132	826.4	23.43	24.00	1.140	0.05	0.017	0.019
	WCDMA V	RMC 12.2Kbps	Left Side	10mm	Ant 1	Sample 1	4132	826.4	23.43	24.00	1.140	-0.01	0.015	0.017
	WCDMA V	RMC 12.2Kbps	Right Side	10mm	Ant 1	Sample 1	4132	826.4	23.43	24.00	1.140	0.04	0.007	0.008
	WCDMA V	RMC 12.2Kbps	Top Side	10mm	Ant 1	Sample 1	4132	826.4	23.43	24.00	1.140	0	0.001	0.001
	WCDMA V	RMC 12.2Kbps	Back	10mm	Ant 1	Sample 2	4132	826.4	23.43	24.00	1.140	-0.19	0.017	0.019
	WCDMA V	RMC 12.2Kbps	Front	10mm	Ant 0	Sample 1	4132	826.4	23.43	24.00	1.140	0.12	0.053	0.060
	WCDMA V	RMC 12.2Kbps	Back	10mm	Ant 0	Sample 1	4132	826.4	23.43	24.00	1.140	-0.12	0.106	0.121
	WCDMA V	RMC 12.2Kbps	Left Side	10mm	Ant 0	Sample 1	4132	826.4	23.43	24.00	1.140	0.04	0.062	0.071
	WCDMA V	RMC 12.2Kbps	Right Side	10mm	Ant 0	Sample 1	4132	826.4	23.43	24.00	1.140	-0.01	0.022	0.025
	WCDMA V	RMC 12.2Kbps	Bottom Side	10mm	Ant 0	Sample 1	4132	826.4	23.43	24.00	1.140	0.07	0.028	0.032
20	WCDMA V	RMC 12.2Kbps	Back	10mm	Ant 0	Sample 2	4132	826.4	23.43	24.00	1.140	-0.1	0.121	0.138



<FDD LTE SAR>

Plot No.	Band	BW (MHz)	Modulation	RB Size	RB offset	Test Position	Gap (mm)	Antenna	Sample	Ch.	Freq. (MHz)	Average Power (dBm)	Tune-Up Limit (dBm)	Tune-up Scaling Factor	Power Drift (dB)	Measured 1g SAR (W/kg)	Reported 1g SAR (W/kg)
	LTE Band 2	20M	QPSK	1	0	Front	10mm	Ant 1	Sample 1	18900	1880	23.28	24.00	1.180	0.01	0.057	0.067
	LTE Band 2	20M	QPSK	50	0	Front	10mm	Ant 1	Sample 1	18900	1880	22.33	23.00	1.167	0.02	0.042	0.049
	LTE Band 2	20M	QPSK	1	0	Back	10mm	Ant 1	Sample 1	18900	1880	23.28	24.00	1.180	-0.19	0.134	0.158
	LTE Band 2	20M	QPSK	50	0	Back	10mm	Ant 1	Sample 1	18900	1880	22.33	23.00	1.167	-0.04	0.103	0.120
	LTE Band 2	20M	QPSK	1	0	Left Side	10mm	Ant 1	Sample 1	18900	1880	23.28	24.00	1.180	-0.02	0.088	0.104
	LTE Band 2	20M	QPSK	50	0	Left Side	10mm	Ant 1	Sample 1	18900	1880	22.33	23.00	1.167	-0.01	0.065	0.076
	LTE Band 2	20M	QPSK	1	0	Right Side	10mm	Ant 1	Sample 1	18900	1880	23.28	24.00	1.180	0.16	0.009	0.010
	LTE Band 2	20M	QPSK	50	0	Right Side	10mm	Ant 1	Sample 1	18900	1880	22.33	23.00	1.167	-0.02	0.006	0.007
	LTE Band 2	20M	QPSK	1	0	Top Side	10mm	Ant 1	Sample 1	18900	1880	23.28	24.00	1.180	0.03	0.075	0.089
	LTE Band 2	20M	QPSK	50	0	Top Side	10mm	Ant 1	Sample 1	18900	1880	22.33	23.00	1.167	0.07	0.056	0.065
21	LTE Band 2	20M	QPSK	1	0	Back	10mm	Ant 1	Sample 2	18900	1880	23.28	24.00	1.180	-0.16	0.139	0.164
	LTE Band 2	20M	QPSK	1	0	Front	10mm	Ant 0	Sample 1	18900	1880	23.28	24.00	1.180	0.03	0.067	0.079
	LTE Band 2	20M	QPSK	50	0	Front	10mm	Ant 0	Sample 1	18900	1880	22.33	23.00	1.167	0.01	0.055	0.064
	LTE Band 2	20M	QPSK	1	0	Back	10mm	Ant 0	Sample 1	18900	1880	23.28	24.00	1.180	0.01	0.119	0.140
	LTE Band 2	20M	QPSK	50	0	Back	10mm	Ant 0	Sample 1	18900	1880	22.33	23.00	1.167	-0.01	0.099	0.116
	LTE Band 2	20M	QPSK	1	0	Left Side	10mm	Ant 0	Sample 1	18900	1880	23.28	24.00	1.180	0.01	0.046	0.054
	LTE Band 2	20M	QPSK	50	0	Left Side	10mm	Ant 0	Sample 1	18900	1880	22.33	23.00	1.167	0.04	0.038	0.044
	LTE Band 2	20M	QPSK	1	0	Right Side	10mm	Ant 0	Sample 1	18900	1880	23.28	24.00	1.180	0.14	0.019	0.022
	LTE Band 2	20M	QPSK	50	0	Right Side	10mm	Ant 0	Sample 1	18900	1880	22.33	23.00	1.167	-0.02	0.015	0.018
	LTE Band 2	20M	QPSK	1	0	Bottom Side	10mm	Ant 0	Sample 1	18900	1880	23.28	24.00	1.180	0.14	0.094	0.111
	LTE Band 2	20M	QPSK	50	0	Bottom Side	10mm	Ant 0	Sample 1	18900	1880	22.33	23.00	1.167	0.13	0.077	0.090
	LTE Band 2	20M	QPSK	1	0	Back	10mm	Ant 0	Sample 2	18900	1880	23.28	24.00	1.180	0.11	0.101	0.119
	LTE Band 4	20M	QPSK	1	0	Front	10mm	Ant 1	Sample 1	20175	1732.5	22.80	23.50	1.175	-0.18	0.085	0.100
	LTE Band 4	20M	QPSK	50	0	Front	10mm	Ant 1	Sample 1	20175	1732.5	21.85	22.50	1.161	0.19	0.062	0.072
	LTE Band 4	20M	QPSK	1	0	Back	10mm	Ant 1	Sample 1	20175	1732.5	22.80	23.50	1.175	-0.1	0.171	0.201
	LTE Band 4	20M	QPSK	50	0	Back	10mm	Ant 1	Sample 1	20175	1732.5	21.85	22.50	1.161	0.02	0.128	0.149
	LTE Band 4	20M	QPSK	1	0	Left Side	10mm	Ant 1	Sample 1	20175	1732.5	22.80	23.50	1.175	0.07	0.067	0.079
	LTE Band 4	20M	QPSK	50	0	Left Side	10mm	Ant 1	Sample 1	20175	1732.5	21.85	22.50	1.161	0.07	0.049	0.057
	LTE Band 4	20M	QPSK	1	0	Right Side	10mm	Ant 1	Sample 1	20175	1732.5	22.80	23.50	1.175	-0.15	0.008	0.009
	LTE Band 4	20M	QPSK	50	0	Right Side	10mm	Ant 1	Sample 1	20175	1732.5	21.85	22.50	1.161	-0.15	0.006	0.006
	LTE Band 4	20M	QPSK	1	0	Top Side	10mm	Ant 1	Sample 1	20175	1732.5	22.80	23.50	1.175	0.13	0.102	0.120
	LTE Band 4	20M	QPSK	50	0	Top Side	10mm	Ant 1	Sample 1	20175	1732.5	21.85	22.50	1.161	0.16	0.076	0.088
22	LTE Band 4	20M	QPSK	1	0	Back	10mm	Ant 1	Sample 2	20175	1732.5	22.80	23.50	1.175	-0.1	0.173	0.203
	LTE Band 4	20M	QPSK	1	0	Front	10mm	Ant 0	Sample 1	20175	1732.5	22.80	23.50	1.175	0.01	0.068	0.080
	LTE Band 4	20M	QPSK	50	0	Front	10mm	Ant 0	Sample 1	20175	1732.5	21.85	22.50	1.161	0.03	0.058	0.067
	LTE Band 4	20M	QPSK	1	0	Back	10mm	Ant 0	Sample 1	20175	1732.5	22.80	23.50	1.175	-0.01	0.092	0.108
	LTE Band 4	20M	QPSK	50	0	Back	10mm	Ant 0	Sample 1	20175	1732.5	21.85	22.50	1.161	0.15	0.077	0.089
	LTE Band 4	20M	QPSK	1	0	Left Side	10mm	Ant 0	Sample 1	20175	1732.5	22.80	23.50	1.175	-0.1	0.037	0.043
	LTE Band 4	20M	QPSK	50	0	Left Side	10mm	Ant 0	Sample 1	20175	1732.5	21.85	22.50	1.161	0.17	0.032	0.037
	LTE Band 4	20M	QPSK	1	0	Right Side	10mm	Ant 0	Sample 1	20175	1732.5	22.80	23.50	1.175	0.19	0.012	0.014
	LTE Band 4	20M	QPSK	50	0	Right Side	10mm	Ant 0	Sample 1	20175	1732.5	21.85	22.50	1.161	0.14	0.010	0.011
	LTE Band 4	20M	QPSK	1	0	Bottom Side	10mm	Ant 0	Sample 1	20175	1732.5	22.80	23.50	1.175	0.15	0.074	0.087
	LTE Band 4	20M	QPSK	50	0	Bottom Side	10mm	Ant 0	Sample 1	20175	1732.5	21.85	22.50	1.161	0.03	0.063	0.073
	LTE Band 4	20M	QPSK	1	0	Back	10mm	Ant 0	Sample 2	20175	1732.5	22.80	23.50	1.175	-0.01	0.102	0.120



Plot No.	Band	BW (MHz)	Modulation	RB Size	RB offset	Test Position	Gap (mm)	Antenna	Sample	Ch.	Freq. (MHz)	Average Power (dBm)	Tune-Up Limit (dBm)	Tune-up Scaling Factor	Power Drift (dB)	Measured 1g SAR (W/kg)	Reported 1g SAR (W/kg)
	LTE Band 5	10M	QPSK	1	0	Front	10mm	Ant 1	Sample 1	20525	836.5	23.14	24.00	1.219	0.03	0.008	0.009
	LTE Band 5	10M	QPSK	25	0	Front	10mm	Ant 1	Sample 1	20525	836.5	22.22	23.00	1.197	-0.01	0.005	0.006
	LTE Band 5	10M	QPSK	1	0	Back	10mm	Ant 1	Sample 1	20525	836.5	23.14	24.00	1.219	0.12	0.016	0.020
	LTE Band 5	10M	QPSK	25	0	Back	10mm	Ant 1	Sample 1	20525	836.5	22.22	23.00	1.197	-0.05	0.013	0.016
	LTE Band 5	10M	QPSK	1	0	Left Side	10mm	Ant 1	Sample 1	20525	836.5	23.14	24.00	1.219	-0.01	0.014	0.017
	LTE Band 5	10M	QPSK	25	0	Left Side	10mm	Ant 1	Sample 1	20525	836.5	22.22	23.00	1.197	0.01	0.012	0.014
	LTE Band 5	10M	QPSK	1	0	Right Side	10mm	Ant 1	Sample 1	20525	836.5	23.14	24.00	1.219	-0.16	0.006	0.007
	LTE Band 5	10M	QPSK	25	0	Right Side	10mm	Ant 1	Sample 1	20525	836.5	22.22	23.00	1.197	-0.04	0.004	0.005
	LTE Band 5	10M	QPSK	1	0	Top Side	10mm	Ant 1	Sample 1	20525	836.5	23.14	24.00	1.219	0.09	0.001	0.001
	LTE Band 5	10M	QPSK	25	0	Top Side	10mm	Ant 1	Sample 1	20525	836.5	22.22	23.00	1.197	-0.15	0.001	0.001
	LTE Band 5	10M	QPSK	1	0	Back	10mm	Ant 1	Sample 2	20525	836.5	23.14	24.00	1.219	-0.11	0.015	0.018
	LTE Band 5	10M	QPSK	1	0	Front	10mm	Ant 0	Sample 1	20525	836.5	23.14	24.00	1.219	-0.11	0.058	0.071
	LTE Band 5	10M	QPSK	25	0	Front	10mm	Ant 0	Sample 1	20525	836.5	22.22	23.00	1.197	-0.02	0.049	0.059
	LTE Band 5	10M	QPSK	1	0	Back	10mm	Ant 0	Sample 1	20525	836.5	23.14	24.00	1.219	-0.05	0.116	0.141
	LTE Band 5	10M	QPSK	25	0	Back	10mm	Ant 0	Sample 1	20525	836.5	22.22	23.00	1.197	-0.1	0.098	0.117
	LTE Band 5	10M	QPSK	1	0	Left Side	10mm	Ant 0	Sample 1	20525	836.5	23.14	24.00	1.219	0	0.064	0.078
	LTE Band 5	10M	QPSK	25	0	Left Side	10mm	Ant 0	Sample 1	20525	836.5	22.22	23.00	1.197	-0.01	0.054	0.065
	LTE Band 5	10M	QPSK	1	0	Right Side	10mm	Ant 0	Sample 1	20525	836.5	23.14	24.00	1.219	0.03	0.020	0.024
	LTE Band 5	10M	QPSK	25	0	Right Side	10mm	Ant 0	Sample 1	20525	836.5	22.22	23.00	1.197	0.02	0.020	0.024
	LTE Band 5	10M	QPSK	1	0	Bottom Side	10mm	Ant 0	Sample 1	20525	836.5	23.14	24.00	1.219	-0.13	0.032	0.039
	LTE Band 5	10M	QPSK	25	0	Bottom Side	10mm	Ant 0	Sample 1	20525	836.5	22.22	23.00	1.197	-0.1	0.027	0.032
23	LTE Band 5	10M	QPSK	1	0	Back	10mm	Ant 0	Sample 2	20525	836.5	23.14	24.00	1.219	-0.11	0.140	0.171
	LTE Band 7	20M	QPSK	1	99	Front	10mm	Ant 1	Sample 1	20850	2510	22.42	23.00	1.143	-0.12	0.097	0.111
	LTE Band 7	20M	QPSK	50	0	Front	10mm	Ant 1	Sample 1	20850	2510	21.50	22.00	1.122	-0.09	0.115	0.129
	LTE Band 7	20M	QPSK	1	99	Back	10mm	Ant 1	Sample 1	20850	2510	22.42	23.00	1.143	-0.1	0.152	0.174
	LTE Band 7	20M	QPSK	50	0	Back	10mm	Ant 1	Sample 1	20850	2510	21.50	22.00	1.122	-0.02	0.178	0.200
	LTE Band 7	20M	QPSK	1	99	Left Side	10mm	Ant 1	Sample 1	20850	2510	22.42	23.00	1.143	-0.15	0.171	0.195
	LTE Band 7	20M	QPSK	50	0	Left Side	10mm	Ant 1	Sample 1	20850	2510	21.50	22.00	1.122	-0.12	0.177	0.199
	LTE Band 7	20M	QPSK	1	99	Right Side	10mm	Ant 1	Sample 1	20850	2510	22.42	23.00	1.143	0.12	0.010	0.011
	LTE Band 7	20M	QPSK	50	0	Right Side	10mm	Ant 1	Sample 1	20850	2510	21.50	22.00	1.122	-0.15	0.009	0.010
	LTE Band 7	20M	QPSK	1	99	Top Side	10mm	Ant 1	Sample 1	20850	2510	22.42	23.00	1.143	-0.13	0.058	0.066
	LTE Band 7	20M	QPSK	50	0	Top Side	10mm	Ant 1	Sample 1	20850	2510	21.50	22.00	1.122	0.11	0.058	0.065
	LTE Band 7	20M	QPSK	50	0	Back	10mm	Ant 1	Sample 2	20850	2510	21.50	22.00	1.122	0.16	0.141	0.158
	LTE Band 7	20M	QPSK	1	99	Front	10mm	Ant 0	Sample 1	20850	2510	22.42	23.00	1.143	-0.02	0.114	0.130
	LTE Band 7	20M	QPSK	50	0	Front	10mm	Ant 0	Sample 1	20850	2510	21.50	22.00	1.122	0.02	0.099	0.111
24	LTE Band 7	20M	QPSK	1	99	Back	10mm	Ant 0	Sample 1	20850	2510	22.42	23.00	1.143	-0.15	0.189	0.216
	LTE Band 7	20M	QPSK	50	0	Back	10mm	Ant 0	Sample 1	20850	2510	21.50	22.00	1.122	-0.13	0.161	0.181
	LTE Band 7	20M	QPSK	1	99	Left Side	10mm	Ant 0	Sample 1	20850	2510	22.42	23.00	1.143	-0.09	0.123	0.141
	LTE Band 7	20M	QPSK	50	0	Left Side	10mm	Ant 0	Sample 1	20850	2510	21.50	22.00	1.122	-0.04	0.102	0.114
	LTE Band 7	20M	QPSK	1	99	Right Side	10mm	Ant 0	Sample 1	20850	2510	22.42	23.00	1.143	-0.12	0.013	0.015
	LTE Band 7	20M	QPSK	50	0	Right Side	10mm	Ant 0	Sample 1	20850	2510	21.50	22.00	1.122	0.19	0.011	0.012
	LTE Band 7	20M	QPSK	1	99	Bottom Side	10mm	Ant 0	Sample 1	20850	2510	22.42	23.00	1.143	0.14	0.063	0.072
	LTE Band 7	20M	QPSK	50	0	Bottom Side	10mm	Ant 0	Sample 1	20850	2510	21.50	22.00	1.122	0.18	0.053	0.059
	LTE Band 7	20M	QPSK	1	99	Back	10mm	Ant 0	Sample 2	20850	2510	22.42	23.00	1.143	-0.15	0.185	0.211



Plot No.	Band	BW (MHz)	Modulation	RB Size	RB offset	Test Position	Gap (mm)	Antenna	Sample	Ch.	Freq. (MHz)	Average Power (dBm)	Tune-Up Limit (dBm)	Tune-up Scaling Factor	Power Drift (dB)	Measured 1g SAR (W/kg)	Reported 1g SAR (W/kg)
	LTE Band 12	10M	QPSK	1	49	Front	10mm	Ant 1	Sample 1	23095	707.5	22.25	23.50	1.334	0.05	0.001	0.002
	LTE Band 12	10M	QPSK	25	0	Front	10mm	Ant 1	Sample 1	23095	707.5	21.32	22.50	1.312	0.18	0.002	0.002
	LTE Band 12	10M	QPSK	1	49	Back	10mm	Ant 1	Sample 1	23095	707.5	22.25	23.50	1.334	-0.1	0.005	0.006
	LTE Band 12	10M	QPSK	25	0	Back	10mm	Ant 1	Sample 1	23095	707.5	21.32	22.50	1.312	-0.11	0.003	0.004
	LTE Band 12	10M	QPSK	1	49	Left Side	10mm	Ant 1	Sample 1	23095	707.5	22.25	23.50	1.334	-0.12	0.004	0.005
	LTE Band 12	10M	QPSK	25	0	Left Side	10mm	Ant 1	Sample 1	23095	707.5	21.32	22.50	1.312	-0.03	0.003	0.004
	LTE Band 12	10M	QPSK	1	49	Right Side	10mm	Ant 1	Sample 1	23095	707.5	22.25	23.50	1.334	-0.11	0.002	0.002
	LTE Band 12	10M	QPSK	25	0	Right Side	10mm	Ant 1	Sample 1	23095	707.5	21.32	22.50	1.312	-0.17	0.001	0.002
	LTE Band 12	10M	QPSK	1	49	Top Side	10mm	Ant 1	Sample 1	23095	707.5	22.25	23.50	1.334	0.13	0.001	0.001
	LTE Band 12	10M	QPSK	25	0	Top Side	10mm	Ant 1	Sample 1	23095	707.5	21.32	22.50	1.312	-0.1	0.001	0.001
	LTE Band 12	10M	QPSK	1	49	Back	10mm	Ant 1	Sample 2	23095	707.5	22.25	23.50	1.334	0.1	0.004	0.005
	LTE Band 12	10M	QPSK	1	49	Front	10mm	Ant 0	Sample 1	23095	707.5	22.25	23.50	1.334	-0.02	0.067	0.089
	LTE Band 12	10M	QPSK	25	0	Front	10mm	Ant 0	Sample 1	23095	707.5	21.32	22.50	1.312	0.03	0.049	0.064
	LTE Band 12	10M	QPSK	1	49	Back	10mm	Ant 0	Sample 1	23095	707.5	22.25	23.50	1.334	0.02	0.142	0.189
	LTE Band 12	10M	QPSK	25	0	Back	10mm	Ant 0	Sample 1	23095	707.5	21.32	22.50	1.312	0	0.105	0.138
	LTE Band 12	10M	QPSK	1	49	Left Side	10mm	Ant 0	Sample 1	23095	707.5	22.25	23.50	1.334	-0.05	0.076	0.101
	LTE Band 12	10M	QPSK	25	0	Left Side	10mm	Ant 0	Sample 1	23095	707.5	21.32	22.50	1.312	0	0.054	0.071
	LTE Band 12	10M	QPSK	1	49	Right Side	10mm	Ant 0	Sample 1	23095	707.5	22.25	23.50	1.334	0.09	0.068	0.091
	LTE Band 12	10M	QPSK	25	0	Right Side	10mm	Ant 0	Sample 1	23095	707.5	21.32	22.50	1.312	-0.05	0.048	0.063
	LTE Band 12	10M	QPSK	1	49	Bottom Side	10mm	Ant 0	Sample 1	23095	707.5	22.25	23.50	1.334	0.09	0.028	0.037
	LTE Band 12	10M	QPSK	25	0	Bottom Side	10mm	Ant 0	Sample 1	23095	707.5	21.32	22.50	1.312	0.02	0.022	0.029
25	LTE Band 12	10M	QPSK	1	49	Back	10mm	Ant 0	Sample 2	23095	707.5	22.25	23.50	1.334	0	0.152	0.203

<TDD LTE SAR>

Plot No.	Band	BW (MHz)	Modulation	RB Size	RB offset	Test Position	Gap (mm)	Antenna	Sample	Ch.	Freq. (MHz)	Average Power (dBm)	Tune-Up Limit (dBm)	Tune-up Scaling Factor	Duty Cycle %	Duty Cycle Scaling Factor	Power Drift (dB)	Measured 1g SAR (W/kg)	Reported 1g SAR (W/kg)
	LTE Band 38	20M	QPSK	1	99	Front	10mm	Ant 1	Sample 1	37850	2580	23.33	24.00	1.167	62.9	1.006	-0.18	0.076	0.089
	LTE Band 38	20M	QPSK	50	0	Front	10mm	Ant 1	Sample 1	37850	2580	22.31	23.00	1.172	62.9	1.006	0.14	0.084	0.099
	LTE Band 38	20M	QPSK	1	99	Back	10mm	Ant 1	Sample 1	37850	2580	23.33	24.00	1.167	62.9	1.006	-0.09	0.119	0.140
26	LTE Band 38	20M	QPSK	50	0	Back	10mm	Ant 1	Sample 1	37850	2580	22.31	23.00	1.172	62.9	1.006	-0.06	0.135	0.159
	LTE Band 38	20M	QPSK	1	99	Left Side	10mm	Ant 1	Sample 1	37850	2580	23.33	24.00	1.167	62.9	1.006	-0.11	0.122	0.143
	LTE Band 38	20M	QPSK	50	0	Left Side	10mm	Ant 1	Sample 1	37850	2580	22.31	23.00	1.172	62.9	1.006	0.05	0.130	0.153
	LTE Band 38	20M	QPSK	1	99	Right Side	10mm	Ant 1	Sample 1	37850	2580	23.33	24.00	1.167	62.9	1.006	0.18	0.009	0.011
	LTE Band 38	20M	QPSK	50	0	Right Side	10mm	Ant 1	Sample 1	37850	2580	22.31	23.00	1.172	62.9	1.006	0.07	0.017	0.020
	LTE Band 38	20M	QPSK	1	99	Top Side	10mm	Ant 1	Sample 1	37850	2580	23.33	24.00	1.167	62.9	1.006	0	0.051	0.060
	LTE Band 38	20M	QPSK	50	0	Top Side	10mm	Ant 1	Sample 1	37850	2580	22.31	23.00	1.172	62.9	1.006	0.05	0.057	0.067
	LTE Band 38	20M	QPSK	50	0	Back	10mm	Ant 1	Sample 2	37850	2580	22.31	23.00	1.172	62.9	1.006	-0.1	0.129	0.152
	LTE Band 38	20M	QPSK	1	99	Front	10mm	Ant 0	Sample 1	37850	2580	23.33	24.00	1.167	62.9	1.006	-0.04	0.074	0.087
	LTE Band 38	20M	QPSK	50	0	Front	10mm	Ant 0	Sample 1	37850	2580	22.31	23.00	1.172	62.9	1.006	0.16	0.063	0.074
	LTE Band 38	20M	QPSK	1	99	Back	10mm	Ant 0	Sample 1	37850	2580	23.33	24.00	1.167	62.9	1.006	-0.03	0.102	0.120
	LTE Band 38	20M	QPSK	50	0	Back	10mm	Ant 0	Sample 1	37850	2580	22.31	23.00	1.172	62.9	1.006	0.06	0.085	0.100
	LTE Band 38	20M	QPSK	1	99	Left Side	10mm	Ant 0	Sample 1	37850	2580	23.33	24.00	1.167	62.9	1.006	-0.07	0.093	0.109
	LTE Band 38	20M	QPSK	50	0	Left Side	10mm	Ant 0	Sample 1	37850	2580	22.31	23.00	1.172	62.9	1.006	0.06	0.075	0.088
	LTE Band 38	20M	QPSK	1	99	Right Side	10mm	Ant 0	Sample 1	37850	2580	23.33	24.00	1.167	62.9	1.006	-0.07	0.009	0.010
	LTE Band 38	20M	QPSK	50	0	Right Side	10mm	Ant 0	Sample 1	37850	2580	22.31	23.00	1.172	62.9	1.006	-0.16	0.009	0.010
	LTE Band 38	20M	QPSK	1	99	Bottom Side	10mm	Ant 0	Sample 1	37850	2580	23.33	24.00	1.167	62.9	1.006	0.05	0.046	0.054
	LTE Band 38	20M	QPSK	50	0	Bottom Side	10mm	Ant 0	Sample 1	37850	2580	22.31	23.00	1.172	62.9	1.006	0.19	0.042	0.050
	LTE Band 38	20M	QPSK	1	99	Back	10mm	Ant 0	Sample 2	37850	2580	23.33	24.00	1.167	62.9	1.006	-0.06	0.098	0.115



<WLAN SAR>

Plot No.	Band	Mode	Test Position	Gap (mm)	Sample	Ch.	Freq. (MHz)	Average Power (dBm)	Tune-Up Limit (dBm)	Tune-up Scaling Factor	Duty Cycle %	Duty Cycle Scaling Factor	Power Drift (dB)	Measured 1g SAR (W/kg)	Reported 1g SAR (W/kg)
27	WLAN2.4GHz	802.11b 1Mbps	Front	10mm	Sample 1	11	2462	17.99	19.50	1.416	100	1.000	0.01	0.046	0.065
	WLAN2.4GHz	802.11b 1Mbps	Back	10mm	Sample 1	11	2462	17.99	19.50	1.416	100	1.000	0.02	0.033	0.047
	WLAN2.4GHz	802.11b 1Mbps	Right Side	10mm	Sample 1	11	2462	17.99	19.50	1.416	100	1.000	0.1	0.032	0.045
	WLAN2.4GHz	802.11b 1Mbps	Top Side	10mm	Sample 1	11	2462	17.99	19.50	1.416	100	1.000	-0.01	0.017	0.024
	WLAN2.4GHz	802.11b 1Mbps	Front	10mm	Sample 2	11	2462	17.99	19.50	1.416	100	1.000	0.14	0.041	0.058
	WLAN5GHz	802.11a 6Mbps	Front	10mm	Sample 1	48	5240	16.83	18.50	1.469	97.22	1.029	-0.06	0.019	0.029
	WLAN5GHz	802.11a 6Mbps	Back	10mm	Sample 1	48	5240	16.83	18.50	1.469	97.22	1.029	0.08	0.016	0.024
	WLAN5GHz	802.11a 6Mbps	Right Side	10mm	Sample 1	48	5240	16.83	18.50	1.469	97.22	1.029	-0.12	0.028	0.042
	WLAN5GHz	802.11a 6Mbps	Top Side	10mm	Sample 1	48	5240	16.83	18.50	1.469	97.22	1.029	0.19	0.008	0.013
28	WLAN5GHz	802.11a 6Mbps	Right Side	10mm	Sample 2	48	5240	16.83	18.50	1.469	97.22	1.029	0.102	0.045	0.068
	WLAN5GHz	802.11n-HT40 MCS0	Front	10mm	Sample 1	159	5795	16.37	18.00	1.455	93.86	1.065	-0.03	0.076	0.118
	WLAN5GHz	802.11n-HT40 MCS0	Back	10mm	Sample 1	159	5795	16.37	18.00	1.455	93.86	1.065	-0.06	0.023	0.036
	WLAN5GHz	802.11n-HT40 MCS0	Right Side	10mm	Sample 1	159	5795	16.37	18.00	1.455	93.86	1.065	0.11	0.016	0.025
	WLAN5GHz	802.11n-HT40 MCS0	Top Side	10mm	Sample 1	159	5795	16.37	18.00	1.455	93.86	1.065	0.17	0.028	0.043
29	WLAN5GHz	802.11n-HT40 MCS0	Front	10mm	Sample 2	159	5795	16.37	18.00	1.455	93.86	1.065	0.169	0.102	0.158



15.3 Body Worn Accessory SAR

<GSM SAR>

Plot No.	Band	Mode	Test Position	Gap (mm)	Antenna	Sample	Ch.	Freq. (MHz)	Average Power (dBm)	Tune-Up Limit (dBm)	Tune-up Scaling Factor	Power Drift (dB)	Measured 1g SAR (W/kg)	Reported 1g SAR (W/kg)
	GSM850	GPRS (4 Tx slots)	Front	10mm	Ant 1	Sample 1	251	848.8	28.75	29.50	1.189	0.06	0.055	0.065
	GSM850	GPRS (4 Tx slots)	Back	10mm	Ant 1	Sample 1	251	848.8	28.75	29.50	1.189	-0.09	0.076	0.090
	GSM850	GPRS (4 Tx slots)	Back	10mm	Ant 1	Sample 2	251	848.8	28.75	29.50	1.189	-0.16	0.065	0.077
	GSM850	GPRS (4 Tx slots)	Front	10mm	Ant 0	Sample 1	251	848.8	28.75	29.50	1.189	-0.13	0.137	0.163
	GSM850	GPRS (4 Tx slots)	Back	10mm	Ant 0	Sample 1	251	848.8	28.75	29.50	1.189	-0.14	0.287	0.341
30	GSM850	GPRS (4 Tx slots)	Back	10mm	Ant 0	Sample 2	251	848.8	28.75	29.50	1.189	0	0.321	0.382
	GSM1900	GPRS (4 Tx slots)	Front	10mm	Ant 1	Sample 1	661	1880	25.80	26.50	1.175	-0.13	0.035	0.041
	GSM1900	GPRS (4 Tx slots)	Back	10mm	Ant 1	Sample 1	661	1880	25.80	26.50	1.175	-0.12	0.084	0.099
	GSM1900	GPRS (4 Tx slots)	Back	10mm	Ant 1	Sample 2	661	1880	25.80	26.50	1.175	-0.09	0.081	0.095
	GSM1900	GPRS (4 Tx slots)	Front	10mm	Ant 0	Sample 1	661	1880	25.80	26.50	1.175	0.07	0.053	0.062
31	GSM1900	GPRS (4 Tx slots)	Back	10mm	Ant 0	Sample 1	661	1880	25.80	26.50	1.175	0.13	0.085	0.100
	GSM1900	GPRS (4 Tx slots)	Back	10mm	Ant 0	Sample 2	661	1880	25.80	26.50	1.175	-0.06	0.075	0.088

<WCDMA SAR>

Plot No.	Band	Mode	Test Position	Gap (mm)	Antenna	Sample	Ch.	Freq. (MHz)	Average Power (dBm)	Tune-Up Limit (dBm)	Tune-up Scaling Factor	Power Drift (dB)	Measured 1g SAR (W/kg)	Reported 1g SAR (W/kg)
	WCDMA II	RMC 12.2Kbps	Front	10mm	Ant 1	Sample 1	9538	1907.6	22.81	24.00	1.315	-0.14	0.049	0.064
	WCDMA II	RMC 12.2Kbps	Back	10mm	Ant 1	Sample 1	9538	1907.6	22.81	24.00	1.315	-0.12	0.105	0.138
	WCDMA II	RMC 12.2Kbps	Back	10mm	Ant 1	Sample 2	9538	1907.6	22.81	24.00	1.315	-0.12	0.104	0.137
	WCDMA II	RMC 12.2Kbps	Front	10mm	Ant 0	Sample 1	9538	1907.6	22.81	24.00	1.315	-0.14	0.067	0.088
32	WCDMA II	RMC 12.2Kbps	Back	10mm	Ant 0	Sample 1	9538	1907.6	22.81	24.00	1.315	-0.05	0.110	0.145
	WCDMA II	RMC 12.2Kbps	Back	10mm	Ant 0	Sample 2	9538	1907.6	22.81	24.00	1.315	-0.17	0.083	0.109
	WCDMA IV	RMC 12.2Kbps	Front	10mm	Ant 1	Sample 1	1312	1712.4	23.34	24.00	1.164	-0.01	0.099	0.115
33	WCDMA IV	RMC 12.2Kbps	Back	10mm	Ant 1	Sample 1	1312	1712.4	23.34	24.00	1.164	-0.12	0.160	0.186
	WCDMA IV	RMC 12.2Kbps	Back	10mm	Ant 1	Sample 2	1312	1712.4	23.34	24.00	1.164	0	0.160	0.186
	WCDMA IV	RMC 12.2Kbps	Front	10mm	Ant 0	Sample 1	1312	1712.4	23.34	24.00	1.164	0.02	0.072	0.084
	WCDMA IV	RMC 12.2Kbps	Back	10mm	Ant 0	Sample 1	1312	1712.4	23.34	24.00	1.164	-0.13	0.095	0.111
	WCDMA IV	RMC 12.2Kbps	Back	10mm	Ant 0	Sample 2	1312	1712.4	23.34	24.00	1.164	-0.12	0.092	0.107
	WCDMA V	RMC 12.2Kbps	Front	10mm	Ant 1	Sample 1	4132	826.4	23.43	24.00	1.140	-0.12	0.008	0.009
	WCDMA V	RMC 12.2Kbps	Back	10mm	Ant 1	Sample 1	4132	826.4	23.43	24.00	1.140	0.05	0.017	0.019
	WCDMA V	RMC 12.2Kbps	Back	10mm	Ant 1	Sample 2	4132	826.4	23.43	24.00	1.140	-0.19	0.017	0.019
	WCDMA V	RMC 12.2Kbps	Front	10mm	Ant 0	Sample 1	4132	826.4	23.43	24.00	1.140	0.12	0.053	0.060
	WCDMA V	RMC 12.2Kbps	Back	10mm	Ant 0	Sample 1	4132	826.4	23.43	24.00	1.140	-0.12	0.106	0.121
34	WCDMA V	RMC 12.2Kbps	Back	10mm	Ant 0	Sample 2	4132	826.4	23.43	24.00	1.140	-0.1	0.121	0.138



<FDD LTE SAR>

Plot No.	Band	BW (MHz)	Modulation	RB Size	RB offset	Test Position	Gap (mm)	Antenna	Sample	Ch.	Freq. (MHz)	Average Power (dBm)	Tune-Up Limit (dBm)	Tune-up Scaling Factor	Power Drift (dB)	Measured 1g SAR (W/kg)	Reported 1g SAR (W/kg)
	LTE Band 2	20M	QPSK	1	0	Front	10mm	Ant 1	Sample 1	18900	1880	23.28	24.00	1.180	0.01	0.057	0.067
	LTE Band 2	20M	QPSK	50	0	Front	10mm	Ant 1	Sample 1	18900	1880	22.33	23.00	1.167	0.02	0.042	0.049
	LTE Band 2	20M	QPSK	1	0	Back	10mm	Ant 1	Sample 1	18900	1880	23.28	24.00	1.180	-0.19	0.134	0.158
	LTE Band 2	20M	QPSK	50	0	Back	10mm	Ant 1	Sample 1	18900	1880	22.33	23.00	1.167	-0.04	0.103	0.120
35	LTE Band 2	20M	QPSK	1	0	Back	10mm	Ant 1	Sample 2	18900	1880	23.28	24.00	1.180	-0.16	0.139	0.164
	LTE Band 2	20M	QPSK	1	0	Front	10mm	Ant 0	Sample 1	18900	1880	23.28	24.00	1.180	0.03	0.067	0.079
	LTE Band 2	20M	QPSK	50	0	Front	10mm	Ant 0	Sample 1	18900	1880	22.33	23.00	1.167	0.01	0.055	0.064
	LTE Band 2	20M	QPSK	1	0	Back	10mm	Ant 0	Sample 1	18900	1880	23.28	24.00	1.180	0.01	0.119	0.140
	LTE Band 2	20M	QPSK	50	0	Back	10mm	Ant 0	Sample 1	18900	1880	22.33	23.00	1.167	-0.01	0.099	0.116
	LTE Band 2	20M	QPSK	1	0	Back	10mm	Ant 0	Sample 2	18900	1880	23.28	24.00	1.180	0.11	0.101	0.119
	LTE Band 4	20M	QPSK	1	0	Front	10mm	Ant 1	Sample 1	20175	1732.5	22.80	23.50	1.175	-0.18	0.085	0.100
	LTE Band 4	20M	QPSK	50	0	Front	10mm	Ant 1	Sample 1	20175	1732.5	21.85	22.50	1.161	0.19	0.062	0.072
	LTE Band 4	20M	QPSK	1	0	Back	10mm	Ant 1	Sample 1	20175	1732.5	22.80	23.50	1.175	-0.1	0.171	0.201
	LTE Band 4	20M	QPSK	50	0	Back	10mm	Ant 1	Sample 1	20175	1732.5	21.85	22.50	1.161	0.02	0.128	0.149
36	LTE Band 4	20M	QPSK	1	0	Back	10mm	Ant 1	Sample 2	20175	1732.5	22.80	23.50	1.175	-0.1	0.173	0.203
	LTE Band 4	20M	QPSK	1	0	Front	10mm	Ant 0	Sample 1	20175	1732.5	22.80	23.50	1.175	0.01	0.068	0.080
	LTE Band 4	20M	QPSK	50	0	Front	10mm	Ant 0	Sample 1	20175	1732.5	21.85	22.50	1.161	0.03	0.058	0.067
	LTE Band 4	20M	QPSK	1	0	Back	10mm	Ant 0	Sample 1	20175	1732.5	22.80	23.50	1.175	-0.01	0.092	0.108
	LTE Band 4	20M	QPSK	50	0	Back	10mm	Ant 0	Sample 1	20175	1732.5	21.85	22.50	1.161	0.15	0.077	0.089
	LTE Band 4	20M	QPSK	1	0	Back	10mm	Ant 0	Sample 2	20175	1732.5	22.80	23.50	1.175	-0.01	0.102	0.120
	LTE Band 5	10M	QPSK	1	0	Front	10mm	Ant 1	Sample 1	20525	836.5	23.14	24.00	1.219	0.03	0.008	0.009
	LTE Band 5	10M	QPSK	25	0	Front	10mm	Ant 1	Sample 1	20525	836.5	22.22	23.00	1.197	-0.01	0.005	0.006
	LTE Band 5	10M	QPSK	1	0	Back	10mm	Ant 1	Sample 1	20525	836.5	23.14	24.00	1.219	0.12	0.016	0.020
	LTE Band 5	10M	QPSK	25	0	Back	10mm	Ant 1	Sample 1	20525	836.5	22.22	23.00	1.197	-0.05	0.013	0.016
	LTE Band 5	10M	QPSK	1	0	Back	10mm	Ant 1	Sample 2	20525	836.5	23.14	24.00	1.219	-0.11	0.015	0.018
	LTE Band 5	10M	QPSK	1	0	Front	10mm	Ant 0	Sample 1	20525	836.5	23.14	24.00	1.219	-0.11	0.058	0.071
	LTE Band 5	10M	QPSK	25	0	Front	10mm	Ant 0	Sample 1	20525	836.5	22.22	23.00	1.197	-0.02	0.049	0.059
	LTE Band 5	10M	QPSK	1	0	Back	10mm	Ant 0	Sample 1	20525	836.5	23.14	24.00	1.219	-0.05	0.116	0.141
	LTE Band 5	10M	QPSK	25	0	Back	10mm	Ant 0	Sample 1	20525	836.5	22.22	23.00	1.197	-0.1	0.098	0.117
37	LTE Band 5	10M	QPSK	1	0	Back	10mm	Ant 0	Sample 2	20525	836.5	23.14	24.00	1.219	-0.11	0.140	0.171
	LTE Band 7	20M	QPSK	1	99	Front	10mm	Ant 1	Sample 1	20850	2510	22.42	23.00	1.143	-0.12	0.097	0.111
	LTE Band 7	20M	QPSK	50	0	Front	10mm	Ant 1	Sample 1	20850	2510	21.50	22.00	1.122	-0.09	0.115	0.129
	LTE Band 7	20M	QPSK	1	99	Back	10mm	Ant 1	Sample 1	20850	2510	22.42	23.00	1.143	-0.1	0.152	0.174
	LTE Band 7	20M	QPSK	50	0	Back	10mm	Ant 1	Sample 1	20850	2510	21.50	22.00	1.122	-0.02	0.178	0.200
	LTE Band 7	20M	QPSK	50	0	Back	10mm	Ant 1	Sample 2	20850	2510	21.50	22.00	1.122	0.16	0.141	0.158
	LTE Band 7	20M	QPSK	1	99	Front	10mm	Ant 0	Sample 1	20850	2510	22.42	23.00	1.143	-0.02	0.114	0.130
	LTE Band 7	20M	QPSK	50	0	Front	10mm	Ant 0	Sample 1	20850	2510	21.50	22.00	1.122	0.02	0.099	0.111
	LTE Band 7	20M	QPSK	1	99	Back	10mm	Ant 0	Sample 1	20850	2510	22.42	23.00	1.143	-0.15	0.189	0.216
38	LTE Band 7	20M	QPSK	50	0	Back	10mm	Ant 0	Sample 1	20850	2510	21.50	22.00	1.122	-0.13	0.161	0.181
	LTE Band 7	20M	QPSK	1	99	Back	10mm	Ant 0	Sample 2	20850	2510	22.42	23.00	1.143	-0.15	0.185	0.211
	LTE Band 12	10M	QPSK	1	49	Front	10mm	Ant 1	Sample 1	23095	707.5	22.25	23.50	1.334	0.05	0.001	0.002
	LTE Band 12	10M	QPSK	25	0	Front	10mm	Ant 1	Sample 1	23095	707.5	21.32	22.50	1.312	0.18	0.002	0.002
	LTE Band 12	10M	QPSK	1	49	Back	10mm	Ant 1	Sample 1	23095	707.5	22.25	23.50	1.334	-0.1	0.005	0.006
	LTE Band 12	10M	QPSK	25	0	Back	10mm	Ant 1	Sample 1	23095	707.5	21.32	22.50	1.312	-0.11	0.003	0.004
	LTE Band 12	10M	QPSK	1	49	Back	10mm	Ant 1	Sample 2	23095	707.5	22.25	23.50	1.334	0.1	0.004	0.005
	LTE Band 12	10M	QPSK	1	49	Front	10mm	Ant 0	Sample 1	23095	707.5	22.25	23.50	1.334	-0.02	0.067	0.089
	LTE Band 12	10M	QPSK	25	0	Front	10mm	Ant 0	Sample 1	23095	707.5	21.32	22.50	1.312	0.03	0.049	0.064
	LTE Band 12	10M	QPSK	1	49	Back	10mm	Ant 0	Sample 1	23095	707.5	22.25	23.50	1.334	0.02	0.142	0.189
	LTE Band 12	10M	QPSK	25	0	Back	10mm	Ant 0	Sample 1	23095	707.5	21.32	22.50	1.312	0	0.105	0.138
39	LTE Band 12	10M	QPSK	1	49	Back	10mm	Ant 0	Sample 2	23095	707.5	22.25	23.50	1.334	0	0.152	0.203



<TDD LTE SAR>

Plot No.	Band	BW (MHz)	Modulation	RB Size	RB offset	Test Position	Gap (mm)	Antenna	Sample	Ch.	Freq. (MHz)	Average Power (dBm)	Tune-Up Limit (dBm)	Tune-up Scaling Factor	Duty Cycle %	Duty Cycle Scaling Factor	Power Drift (dB)	Measured 1g SAR (W/kg)	Reported 1g SAR (W/kg)
	LTE Band 38	20M	QPSK	1	99	Front	10mm	Ant 1	Sample 1	37850	2580	23.33	24.00	1.167	62.9	1.006	-0.18	0.076	0.089
	LTE Band 38	20M	QPSK	50	0	Front	10mm	Ant 1	Sample 1	37850	2580	22.31	23.00	1.172	62.9	1.006	0.14	0.084	0.099
	LTE Band 38	20M	QPSK	1	99	Back	10mm	Ant 1	Sample 1	37850	2580	23.33	24.00	1.167	62.9	1.006	-0.09	0.119	0.140
40	LTE Band 38	20M	QPSK	50	0	Back	10mm	Ant 1	Sample 1	37850	2580	22.31	23.00	1.172	62.9	1.006	-0.06	0.135	0.159
	LTE Band 38	20M	QPSK	50	0	Back	10mm	Ant 1	Sample 2	37850	2580	22.31	23.00	1.172	62.9	1.006	-0.1	0.129	0.152
	LTE Band 38	20M	QPSK	1	99	Front	10mm	Ant 0	Sample 1	37850	2580	23.33	24.00	1.167	62.9	1.006	-0.04	0.074	0.087
	LTE Band 38	20M	QPSK	50	0	Front	10mm	Ant 0	Sample 1	37850	2580	22.31	23.00	1.172	62.9	1.006	0.16	0.063	0.074
	LTE Band 38	20M	QPSK	1	99	Back	10mm	Ant 0	Sample 1	37850	2580	23.33	24.00	1.167	62.9	1.006	-0.03	0.102	0.120
	LTE Band 38	20M	QPSK	50	0	Back	10mm	Ant 0	Sample 1	37850	2580	22.31	23.00	1.172	62.9	1.006	0.06	0.085	0.100
	LTE Band 38	20M	QPSK	1	99	Back	10mm	Ant 0	Sample 2	37850	2580	23.33	24.00	1.167	62.9	1.006	-0.06	0.098	0.115

<WLAN SAR>

Plot No.	Band	Mode	Test Position	Gap (mm)	Sample	Ch.	Freq. (MHz)	Average Power (dBm)	Tune-Up Limit (dBm)	Tune-up Scaling Factor	Duty Cycle %	Duty Cycle Scaling Factor	Power Drift (dB)	Measured 1g SAR (W/kg)	Reported 1g SAR (W/kg)
41	WLAN2.4GHz	802.11b 1Mbps	Front	10mm	Sample 1	11	2462	17.99	19.50	1.416	100	1.000	0.01	0.046	0.065
	WLAN2.4GHz	802.11b 1Mbps	Back	10mm	Sample 1	11	2462	17.99	19.50	1.416	100	1.000	0.02	0.033	0.047
	WLAN2.4GHz	802.11b 1Mbps	Front	10mm	Sample 2	11	2462	17.99	19.50	1.416	100	1.000	0.14	0.041	0.058
	WLAN5GHz	802.11a 6Mbps	Front	10mm	Sample 1	48	5240	16.83	18.50	1.469	97.22	1.029	-0.06	0.019	0.029
	WLAN5GHz	802.11a 6Mbps	Back	10mm	Sample 1	48	5240	16.83	18.50	1.469	97.22	1.029	0.08	0.016	0.024
42	WLAN5GHz	802.11a 6Mbps	Front	10mm	Sample 2	48	5240	16.83	18.50	1.469	97.22	1.029	-0.07	0.051	0.077
	WLAN5GHz	802.11n-HT20 MCS0	Front	10mm	Sample 1	132	5660	16.64	18.50	1.535	97.02	1.031	0.11	0.062	0.098
	WLAN5GHz	802.11n-HT20 MCS0	Back	10mm	Sample 1	132	5660	16.64	18.50	1.535	97.02	1.031	-0.124	0.036	0.057
43	WLAN5GHz	802.11n-HT20 MCS0	Front	10mm	Sample 2	132	5660	16.64	18.50	1.535	97.02	1.031	-0.119	0.140	0.222
	WLAN5GHz	802.11n-HT40 MCS0	Front	10mm	Sample 1	159	5795	16.37	18.00	1.455	93.86	1.065	-0.03	0.076	0.118
	WLAN5GHz	802.11n-HT40 MCS0	Back	10mm	Sample 1	159	5795	16.37	18.00	1.455	93.86	1.065	-0.06	0.023	0.036
44	WLAN5GHz	802.11n-HT40 MCS0	Front	10mm	Sample 2	159	5795	16.37	18.00	1.455	93.86	1.065	0.169	0.102	0.158

16. Simultaneous Transmission Analysis

NO.	Simultaneous Transmission Configurations	Portable Handset		
		Head	Body-worn	Hotspot
1.	WWAN (Voice) + WLAN2.4GHz	Yes	Yes	
2.	WWAN (Data)+ WLAN2.4GHz	Yes	Yes	Yes
3.	WWAN (Voice) + Bluetooth		Yes	
4.	WWAN (Data) + Bluetooth		Yes	
5.	WWAN (Voice) + WLAN5GHz	Yes	Yes	
6.	WWAN (Data) + WLAN5GHz	Yes	Yes	Yes

General Note:

1. This device WLAN 2.4GHz / 5.2GHz (U-NII-1) / 5.8GHz (U-NII-3) supports Hotspot operation.
2. WLAN and Bluetooth share the same antenna, and cannot transmit simultaneously.
3. The worst case WLAN reported SAR for each configuration was used for SAR summation. Therefore, the following summations represent the absolute worst cases for simultaneous transmission with WLAN
4. EUT will choose either WLAN 2.4GHz or WLAN 5GHz according to the network signal condition; therefore, 2.4GHz WLAN and 5GHz WLAN will not operate simultaneously at any moment.
5. The Scaled SAR summation is calculated based on the same configuration and test position.
6. Per KDB 447498 D01v06, simultaneous transmission SAR is compliant if,
 - i) Scalar SAR summation < 1.6W/kg.
 - ii) $SPLSR = (SAR1 + SAR2)^{1.5} / (\text{min. separation distance, mm})$, and the peak separation distance is determined from the square root of $[(x1-x2)^2 + (y1-y2)^2 + (z1-z2)^2]$, where (x1, y1, z1) and (x2, y2, z2) are the coordinates of the extrapolated peak SAR locations in the zoom scan.
 - iii) If $SPLSR \leq 0.04$, simultaneously transmission SAR measurement is not necessary.
 - iv) Simultaneously transmission SAR measurement, and the reported multi-band SAR < 1.6W/kg.
7. For simultaneous transmission analysis, Bluetooth SAR is estimated per KDB 447498 D01v06 based on the formula below.
 - i) $(\text{max. power of channel, including tune-up tolerance, mW}) / (\text{min. test separation distance, mm}) \cdot [\sqrt{f(\text{GHz})}] \cdot x$ W/kg for test separation distances ≤ 50 mm; where $x = 7.5$ for 1-g SAR, and $x = 18.75$ for 10-g SAR.
 - ii) When the minimum separation distance is < 5mm, the distance is used 5mm to determine SAR test exclusion.
 - iii) 0.4 W/kg for 1-g SAR and 1.0 W/kg for 10-g SAR, when the test separation distances is > 50 mm.

Bluetooth Max Power	Exposure Position	Body worn
	Test separation	10 mm
9 dBm	Estimated SAR (W/kg)	0.168 W/kg



16.1 Head Exposure Conditions

WWAN Band		Exposure Position	1	2	3	1+2 Summed 1g SAR (W/kg)	1+3 Summed 1g SAR (W/kg)
			WWAN 1g SAR (W/kg)	2.4GHz WLAN 1g SAR (W/kg)	5GHz WLAN 1g SAR (W/kg)		
GSM	GSM850 ANT1	Right Cheek	0.223	0.157	0.350	0.380	0.573
		Right Tilted	0.095	0.103	0.361	0.198	0.456
		Left Cheek	0.095	0.759	0.629	0.854	0.724
		Left Tilted	0.052	0.439	0.682	0.491	0.734
	GSM850 ANT0	Right Cheek	0.093	0.157	0.350	0.250	0.443
		Right Tilted	0.062	0.103	0.361	0.165	0.423
		Left Cheek	0.126	0.759	0.629	0.885	0.755
		Left Tilted	0.056	0.439	0.682	0.495	0.738
	GSM1900 ANT1	Right Cheek	0.320	0.157	0.350	0.477	0.670
		Right Tilted	0.206	0.103	0.361	0.309	0.567
		Left Cheek	0.117	0.759	0.629	0.876	0.746
		Left Tilted	0.121	0.439	0.682	0.560	0.803
	GSM1900 ANT0	Right Cheek	0.063	0.157	0.350	0.220	0.413
		Right Tilted	0.048	0.103	0.361	0.151	0.409
		Left Cheek	0.125	0.759	0.629	0.884	0.754
		Left Tilted	0.046	0.439	0.682	0.485	0.728
WCDMA	WCDMA II ANT1	Right Cheek	0.552	0.157	0.350	0.709	0.902
		Right Tilted	0.346	0.103	0.361	0.449	0.707
		Left Cheek	0.301	0.759	0.629	1.060	0.930
		Left Tilted	0.195	0.439	0.682	0.634	0.877
	WCDMA II ANT0	Right Cheek	0.057	0.157	0.350	0.214	0.407
		Right Tilted	0.034	0.103	0.361	0.137	0.395
		Left Cheek	0.139	0.759	0.629	0.898	0.768
		Left Tilted	0.051	0.439	0.682	0.490	0.733
	WCDMA IV ANT1	Right Cheek	0.589	0.157	0.350	0.746	0.939
		Right Tilted	0.470	0.103	0.361	0.573	0.831
		Left Cheek	0.251	0.759	0.629	1.010	0.880
		Left Tilted	0.267	0.439	0.682	0.706	0.949
	WCDMA IV ANT0	Right Cheek	0.065	0.157	0.350	0.222	0.415
		Right Tilted	0.037	0.103	0.361	0.140	0.398
		Left Cheek	0.115	0.759	0.629	0.874	0.744
		Left Tilted	0.041	0.439	0.682	0.480	0.723
	WCDMA V ANT1	Right Cheek	0.089	0.157	0.350	0.246	0.439
		Right Tilted	0.041	0.103	0.361	0.144	0.402
		Left Cheek	0.017	0.759	0.629	0.776	0.646
		Left Tilted	0.007	0.439	0.682	0.446	0.689
	WCDMA V ANT0	Right Cheek	0.026	0.157	0.350	0.183	0.376
		Right Tilted	0.019	0.103	0.361	0.122	0.380
		Left Cheek	0.038	0.759	0.629	0.797	0.667
		Left Tilted	0.016	0.439	0.682	0.455	0.698



WWAN Band	Exposure Position	1	2	3	1+2 Summed 1g SAR (W/kg)	1+3 Summed 1g SAR (W/kg)	
		WWAN	2.4GHz WLAN	5GHz WLAN			
		1g SAR (W/kg)	1g SAR (W/kg)	1g SAR (W/kg)			
LTE	LTE Band 2 ANT1	Right Cheek	0.511	0.157	0.350	0.668	0.861
		Right Tilted	0.325	0.103	0.361	0.428	0.686
		Left Cheek	0.248	0.759	0.629	1.007	0.877
		Left Tilted	0.188	0.439	0.682	0.627	0.870
	LTE Band 2 ANT0	Right Cheek	0.061	0.157	0.350	0.218	0.411
		Right Tilted	0.037	0.103	0.361	0.140	0.398
		Left Cheek	0.148	0.759	0.629	0.907	0.777
		Left Tilted	0.047	0.439	0.682	0.486	0.729
	LTE Band 4 ANT1	Right Cheek	0.569	0.157	0.350	0.726	0.919
		Right Tilted	0.432	0.103	0.361	0.535	0.793
		Left Cheek	0.250	0.759	0.629	1.009	0.879
		Left Tilted	0.268	0.439	0.682	0.707	0.950
	LTE Band 4 ANT0	Right Cheek	0.059	0.157	0.350	0.216	0.409
		Right Tilted	0.031	0.103	0.361	0.134	0.392
		Left Cheek	0.107	0.759	0.629	0.866	0.736
		Left Tilted	0.038	0.439	0.682	0.477	0.720
	LTE Band 5 ANT1	Right Cheek	0.046	0.157	0.350	0.203	0.396
		Right Tilted	0.022	0.103	0.361	0.125	0.383
		Left Cheek	0.021	0.759	0.629	0.780	0.650
		Left Tilted	0.001	0.439	0.682	0.440	0.683
	LTE Band 5 ANT0	Right Cheek	0.034	0.157	0.350	0.191	0.384
		Right Tilted	0.021	0.103	0.361	0.124	0.382
		Left Cheek	0.067	0.759	0.629	0.826	0.696
		Left Tilted	0.022	0.439	0.682	0.461	0.704
	LTE Band 7 ANT1	Right Cheek	0.883	0.157	0.350	1.040	1.233
		Right Tilted	0.352	0.103	0.361	0.455	0.713
		Left Cheek	0.283	0.759	0.629	1.042	0.912
		Left Tilted	0.145	0.439	0.682	0.584	0.827
	LTE Band 7 ANT0	Right Cheek	0.056	0.157	0.350	0.213	0.406
		Right Tilted	0.037	0.103	0.361	0.140	0.398
		Left Cheek	0.150	0.759	0.629	0.909	0.779
		Left Tilted	0.041	0.439	0.682	0.480	0.723
	LTE Band 12 ANT1	Right Cheek	0.020	0.157	0.350	0.177	0.370
		Right Tilted	0.010	0.103	0.361	0.113	0.371
		Left Cheek	0.001	0.759	0.629	0.760	0.630
		Left Tilted	0.005	0.439	0.682	0.444	0.687
	LTE Band 12 ANT0	Right Cheek	0.035	0.157	0.350	0.192	0.385
		Right Tilted	0.021	0.103	0.361	0.124	0.382
		Left Cheek	0.073	0.759	0.629	0.832	0.702
		Left Tilted	0.016	0.439	0.682	0.455	0.698
LTE Band 38 ANT1	Right Cheek	0.698	0.157	0.350	0.855	1.048	
	Right Tilted	0.318	0.103	0.361	0.421	0.679	
	Left Cheek	0.233	0.759	0.629	0.992	0.862	
	Left Tilted	0.137	0.439	0.682	0.576	0.819	
LTE Band 38 ANT0	Right Cheek	0.041	0.157	0.350	0.198	0.391	
	Right Tilted	0.027	0.103	0.361	0.130	0.388	
	Left Cheek	0.087	0.759	0.629	0.846	0.716	
	Left Tilted	0.014	0.439	0.682	0.453	0.696	



16.2 Hotspot Exposure Conditions

WWAN Band		Exposure Position	1	2	3	1+2 Summed 1g SAR (W/kg)	1+3 Summed 1g SAR (W/kg)
			WWAN 1g SAR (W/kg)	2.4GHz WLAN 1g SAR (W/kg)	5GHz WLAN 1g SAR (W/kg)		
GSM	GSM850 ANT1	Front	0.065	0.065	0.158	0.130	0.223
		Back	0.090	0.047	0.036	0.137	0.126
		Left side	0.080			0.080	0.080
		Right side	0.044	0.045	0.068	0.089	0.112
		Top side	0.006	0.024	0.043	0.030	0.049
		Bottom side				0.000	0.000
	GSM850 ANT0	Front	0.163	0.065	0.158	0.228	0.321
		Back	0.382	0.047	0.036	0.429	0.418
		Left side	0.191			0.191	0.191
		Right side	0.068	0.045	0.068	0.113	0.136
		Top side		0.024	0.043	0.024	0.043
		Bottom side	0.099			0.099	0.099
	GSM1900 ANT1	Front	0.041	0.065	0.158	0.106	0.199
		Back	0.099	0.047	0.036	0.146	0.135
		Left side	0.069			0.069	0.069
		Right side	0.007	0.045	0.068	0.052	0.075
		Top side	0.056	0.024	0.043	0.080	0.099
		Bottom side				0.000	0.000
	GSM1900 ANT0	Front	0.062	0.065	0.158	0.127	0.220
		Back	0.100	0.047	0.036	0.147	0.136
Left side		0.051			0.051	0.051	
Right side		0.015	0.045	0.068	0.060	0.083	
Top side			0.024	0.043	0.024	0.043	
Bottom side		0.076			0.076	0.076	
WCDMA	WCDMA II ANT1	Front	0.064	0.065	0.158	0.129	0.222
		Back	0.138	0.047	0.036	0.185	0.174
		Left side	0.107			0.107	0.107
		Right side	0.010	0.045	0.068	0.055	0.078
		Top side	0.088	0.024	0.043	0.112	0.131
		Bottom side				0.000	0.000
	WCDMA II ANT0	Front	0.088	0.065	0.158	0.153	0.246
		Back	0.145	0.047	0.036	0.192	0.181
		Left side	0.066			0.066	0.066
		Right side	0.020	0.045	0.068	0.065	0.088
		Top side		0.024	0.043	0.024	0.043
		Bottom side	0.126			0.126	0.126
	WCDMA IV ANT1	Front	0.115	0.065	0.158	0.180	0.273
		Back	0.186	0.047	0.036	0.233	0.222
		Left side	0.076			0.076	0.076
		Right side	0.009	0.045	0.068	0.054	0.077
		Top side	0.116	0.024	0.043	0.140	0.159
		Bottom side				0.000	0.000
	WCDMA IV ANT0	Front	0.084	0.065	0.158	0.149	0.242
		Back	0.111	0.047	0.036	0.158	0.147
		Left side	0.052			0.052	0.052
		Right side	0.017	0.045	0.068	0.062	0.085
		Top side		0.024	0.043	0.024	0.043
		Bottom side	0.094			0.094	0.094
WCDMA V ANT1	Front	0.009	0.065	0.158	0.074	0.167	
	Back	0.019	0.047	0.036	0.066	0.055	
	Left side	0.017			0.017	0.017	
	Right side	0.008	0.045	0.068	0.053	0.076	
	Top side	0.001	0.024	0.043	0.025	0.044	
	Bottom side				0.000	0.000	
WCDMA V ANT0	Front	0.060	0.065	0.158	0.125	0.218	
	Back	0.138	0.047	0.036	0.185	0.174	
	Left side	0.071			0.071	0.071	
	Right side	0.025	0.045	0.068	0.070	0.093	
	Top side		0.024	0.043	0.024	0.043	
	Bottom side	0.032			0.032	0.032	



WWAN Band	Exposure Position	1	2	3	1+2 Summed 1g SAR (W/kg)	1+3 Summed 1g SAR (W/kg)	
		WWAN 1g SAR (W/kg)	2.4GHz WLAN 1g SAR (W/kg)	5GHz WLAN 1g SAR (W/kg)			
LTE	LTE Band 2 ANT1	Front	0.067	0.065	0.158	0.132	0.225
		Back	0.164	0.047	0.036	0.211	0.200
		Left side	0.104			0.104	0.104
		Right side	0.010	0.045	0.068	0.055	0.078
		Top side	0.089	0.024	0.043	0.113	0.132
		Bottom side				0.000	0.000
	LTE Band 2 ANT0	Front	0.079	0.065	0.158	0.144	0.237
		Back	0.140	0.047	0.036	0.187	0.176
		Left side	0.054			0.054	0.054
		Right side	0.022	0.045	0.068	0.067	0.090
		Top side		0.024	0.043	0.024	0.043
		Bottom side	0.111			0.111	0.111
	LTE Band 4 ANT1	Front	0.100	0.065	0.158	0.165	0.258
		Back	0.203	0.047	0.036	0.250	0.239
		Left side	0.079			0.079	0.079
		Right side	0.009	0.045	0.068	0.054	0.077
		Top side	0.120	0.024	0.043	0.144	0.163
		Bottom side				0.000	0.000
	LTE Band 4 ANT0	Front	0.080	0.065	0.158	0.145	0.238
		Back	0.120	0.047	0.036	0.167	0.156
		Left side	0.043			0.043	0.043
		Right side	0.014	0.045	0.068	0.059	0.082
		Top side		0.024	0.043	0.024	0.043
		Bottom side	0.087			0.087	0.087
	LTE Band 5 ANT1	Front	0.009	0.065	0.158	0.074	0.167
		Back	0.020	0.047	0.036	0.067	0.056
		Left side	0.017			0.017	0.017
		Right side	0.007	0.045	0.068	0.052	0.075
		Top side	0.001	0.024	0.043	0.025	0.044
		Bottom side				0.000	0.000
	LTE Band 5 ANT0	Front	0.071	0.065	0.158	0.136	0.229
		Back	0.171	0.047	0.036	0.218	0.207
		Left side	0.078			0.078	0.078
		Right side	0.024	0.045	0.068	0.069	0.092
		Top side		0.024	0.043	0.024	0.043
		Bottom side	0.039			0.039	0.039
	LTE Band 7 ANT1	Front	0.129	0.065	0.158	0.194	0.287
		Back	0.200	0.047	0.036	0.247	0.236
		Left side	0.199			0.199	0.199
		Right side	0.011	0.045	0.068	0.056	0.079
		Top side	0.066	0.024	0.043	0.090	0.109
		Bottom side				0.000	0.000
	LTE Band 7 ANT0	Front	0.130	0.065	0.158	0.195	0.288
		Back	0.216	0.047	0.036	0.263	0.252
		Left side	0.141			0.141	0.141
		Right side	0.015	0.045	0.068	0.060	0.083
		Top side		0.024	0.043	0.024	0.043
		Bottom side	0.072			0.072	0.072
LTE Band 12 ANT1	Front	0.002	0.065	0.158	0.067	0.160	
	Back	0.006	0.047	0.036	0.053	0.042	
	Left side	0.005			0.005	0.005	
	Right side	0.002	0.045	0.068	0.047	0.070	
	Top side	0.001	0.024	0.043	0.025	0.044	
	Bottom side				0.000	0.000	
LTE Band 12 ANT0	Front	0.089	0.065	0.158	0.154	0.247	
	Back	0.203	0.047	0.036	0.250	0.239	
	Left side	0.101			0.101	0.101	
	Right side	0.091	0.045	0.068	0.136	0.159	
	Top side		0.024	0.043	0.024	0.043	
	Bottom side	0.037			0.037	0.037	



WWAN Band		Exposure Position	1	2	3	1+2 Summed 1g SAR (W/kg)	1+3 Summed 1g SAR (W/kg)
			WWAN 1g SAR (W/kg)	2.4GHz WLAN 1g SAR (W/kg)	5GHz WLAN 1g SAR (W/kg)		
LTE	LTE Band 38 ANT1	Front	0.099	0.065	0.158	0.164	0.257
		Back	0.159	0.047	0.036	0.206	0.195
		Left side	0.153			0.153	0.153
		Right side	0.020	0.045	0.068	0.065	0.088
		Top side	0.067	0.024	0.043	0.091	0.110
		Bottom side				0.000	0.000
	LTE Band 38 ANT0	Front	0.087	0.065	0.158	0.152	0.245
		Back	0.120	0.047	0.036	0.167	0.156
		Left side	0.109			0.109	0.109
		Right side	0.010	0.045	0.068	0.055	0.078
		Top side		0.024	0.043	0.024	0.043
		Bottom side	0.054			0.054	0.054



16.3 Body-Worn Accessory Exposure Conditions

WWAN Band		Exposure Position	1	2	3	4	1+2 Summed 1g SAR (W/kg)	1+3 Summed 1g SAR (W/kg)	1+4 Summed 1g SAR (W/kg)
			WWAN	2.4GHz WLAN	5GHz WLAN	Bluetooth			
			1g SAR (W/kg)	1g SAR (W/kg)	1g SAR (W/kg)	Estimated 1g SAR (W/kg)			
GSM	GSM850 ANT1	Front	0.065	0.065	0.222	0.168	0.130	0.287	0.233
		Back	0.090	0.047	0.057	0.168	0.137	0.147	0.258
	GSM850 ANT0	Front	0.163	0.065	0.222	0.168	0.228	0.385	0.331
		Back	0.382	0.047	0.057	0.168	0.429	0.439	0.550
	GSM1900 ANT1	Front	0.041	0.065	0.222	0.168	0.106	0.263	0.209
		Back	0.099	0.047	0.057	0.168	0.146	0.156	0.267
	GSM1900 ANT0	Front	0.062	0.065	0.222	0.168	0.127	0.284	0.230
		Back	0.100	0.047	0.057	0.168	0.147	0.157	0.268
WCDMA	WCDMA II ANT1	Front	0.064	0.065	0.222	0.168	0.129	0.286	0.232
		Back	0.138	0.047	0.057	0.168	0.185	0.195	0.306
	WCDMA II ANT0	Front	0.088	0.065	0.222	0.168	0.153	0.310	0.256
		Back	0.145	0.047	0.057	0.168	0.192	0.202	0.313
	WCDMA IV ANT1	Front	0.115	0.065	0.222	0.168	0.180	0.337	0.283
		Back	0.186	0.047	0.057	0.168	0.233	0.243	0.354
	WCDMA IV ANT0	Front	0.084	0.065	0.222	0.168	0.149	0.306	0.252
		Back	0.111	0.047	0.057	0.168	0.158	0.168	0.279
	WCDMA V ANT1	Front	0.009	0.065	0.222	0.168	0.074	0.231	0.177
		Back	0.019	0.047	0.057	0.168	0.066	0.076	0.187
	WCDMA V ANT0	Front	0.060	0.065	0.222	0.168	0.125	0.282	0.228
		Back	0.138	0.047	0.057	0.168	0.185	0.195	0.306
LTE	LTE Band 2 ANT1	Front	0.067	0.065	0.222	0.168	0.132	0.289	0.235
		Back	0.164	0.047	0.057	0.168	0.211	0.221	0.332
	LTE Band 2 ANT0	Front	0.079	0.065	0.222	0.168	0.144	0.301	0.247
		Back	0.140	0.047	0.057	0.168	0.187	0.197	0.308
	LTE Band 4 ANT1	Front	0.100	0.065	0.222	0.168	0.165	0.322	0.268
		Back	0.203	0.047	0.057	0.168	0.250	0.260	0.371
	LTE Band 4 ANT0	Front	0.080	0.065	0.222	0.168	0.145	0.302	0.248
		Back	0.120	0.047	0.057	0.168	0.167	0.177	0.288
	LTE Band 5 ANT1	Front	0.009	0.065	0.222	0.168	0.074	0.231	0.177
		Back	0.020	0.047	0.057	0.168	0.067	0.077	0.188
	LTE Band 5 ANT0	Front	0.071	0.065	0.222	0.168	0.136	0.293	0.239
		Back	0.171	0.047	0.057	0.168	0.218	0.228	0.339
	LTE Band 7 ANT1	Front	0.129	0.065	0.222	0.168	0.194	0.351	0.297
		Back	0.200	0.047	0.057	0.168	0.247	0.257	0.368
	LTE Band 7 ANT0	Front	0.130	0.065	0.222	0.168	0.195	0.352	0.298
		Back	0.216	0.047	0.057	0.168	0.263	0.273	0.384
	LTE Band 12 ANT1	Front	0.002	0.065	0.222	0.168	0.067	0.224	0.170
		Back	0.006	0.047	0.057	0.168	0.053	0.063	0.174
	LTE Band 12 ANT0	Front	0.089	0.065	0.222	0.168	0.154	0.311	0.257
		Back	0.203	0.047	0.057	0.168	0.250	0.260	0.371
LTE Band 38 ANT1	Front	0.099	0.065	0.222	0.168	0.164	0.321	0.267	
	Back	0.159	0.047	0.057	0.168	0.206	0.216	0.327	
LTE Band 38 ANT0	Front	0.087	0.065	0.222	0.168	0.152	0.309	0.255	
	Back	0.120	0.047	0.057	0.168	0.167	0.177	0.288	

Test Engineer : Iran Wang, Kurt Liu, Steven Chang, Nick Yu and Poa Pan

17. Uncertainty Assessment

The component of uncertainty may generally be categorized according to the methods used to evaluate them. The evaluation of uncertainty by the statistical analysis of a series of observations is termed a Type A evaluation of uncertainty. The evaluation of uncertainty by means other than the statistical analysis of a series of observation is termed a Type B evaluation of uncertainty. Each component of uncertainty, however evaluated, is represented by an estimated standard deviation, termed standard uncertainty, which is determined by the positive square root of the estimated variance.

A Type A evaluation of standard uncertainty may be based on any valid statistical method for treating data. This includes calculating the standard deviation of the mean of a series of independent observations; using the method of least squares to fit a curve to the data in order to estimate the parameter of the curve and their standard deviations; or carrying out an analysis of variance in order to identify and quantify random effects in certain kinds of measurement.

A type B evaluation of standard uncertainty is typically based on scientific judgment using all of the relevant information available. These may include previous measurement data, experience, and knowledge of the behavior and properties of relevant materials and instruments, manufacture’s specification, data provided in calibration reports and uncertainties assigned to reference data taken from handbooks. Broadly speaking, the uncertainty is either obtained from an outdoor source or obtained from an assumed distribution, such as the normal distribution, rectangular or triangular distributions indicated in table below.

Uncertainty Distributions	Normal	Rectangular	Triangular	U-Shape
Multi-plying Factor ^(a)	1/k ^(b)	1/√3	1/√6	1/√2

(a) standard uncertainty is determined as the product of the multiplying factor and the estimated range of variations in the measured quantity

(b) κ is the coverage factor

Table 17.1. Standard Uncertainty for Assumed Distribution

The combined standard uncertainty of the measurement result represents the estimated standard deviation of the result. It is obtained by combining the individual standard uncertainties of both Type A and Type B evaluation using the usual “root-sum-squares” (RSS) methods of combining standard deviations by taking the positive square root of the estimated variances.

Expanded uncertainty is a measure of uncertainty that defines an interval about the measurement result within which the measured value is confidently believed to lie. It is obtained by multiplying the combined standard uncertainty by a coverage factor. Typically, the coverage factor ranges from 2 to 3. Using a coverage factor allows the true value of a measured quantity to be specified with a defined probability within the specified uncertainty range. For purpose of this document, a coverage factor two is used, which corresponds to confidence interval of about 95 %. The DASY uncertainty Budget is shown in the following tables.



Error Description	Uncertainty Value (±%)	Probability	Divisor	(Ci) 1g	(Ci) 10g	Standard Uncertainty (1g) (±%)	Standard Uncertainty (10g) (±%)
Measurement System							
Probe Calibration	6.0	N	1	1	1	6.0	6.0
Axial Isotropy	4.7	R	1.732	0.7	0.7	1.9	1.9
Hemispherical Isotropy	9.6	R	1.732	0.7	0.7	3.9	3.9
Boundary Effects	1.0	R	1.732	1	1	0.6	0.6
Linearity	4.7	R	1.732	1	1	2.7	2.7
System Detection Limits	1.0	R	1.732	1	1	0.6	0.6
Modulation Response	3.2	R	1.732	1	1	1.8	1.8
Readout Electronics	0.3	N	1	1	1	0.3	0.3
Response Time	0.0	R	1.732	1	1	0.0	0.0
Integration Time	2.6	R	1.732	1	1	1.5	1.5
RF Ambient Noise	3.0	R	1.732	1	1	1.7	1.7
RF Ambient Reflections	3.0	R	1.732	1	1	1.7	1.7
Probe Positioner	0.4	R	1.732	1	1	0.2	0.2
Probe Positioning	2.9	R	1.732	1	1	1.7	1.7
Max. SAR Eval.	2.0	R	1.732	1	1	1.2	1.2
Test Sample Related							
Device Positioning	3.0	N	1	1	1	3.0	3.0
Device Holder	3.6	N	1	1	1	3.6	3.6
Power Drift	5.0	R	1.732	1	1	2.9	2.9
Power Scaling	0.0	R	1.732	1	1	0.0	0.0
Phantom and Setup							
Phantom Uncertainty	6.1	R	1.732	1	1	3.5	3.5
SAR correction	0.0	R	1.732	1	0.84	0.0	0.0
Liquid Conductivity Repeatability	0.2	N	1	0.78	0.71	0.1	0.1
Liquid Conductivity (target)	5.0	R	1.732	0.78	0.71	2.3	2.0
Liquid Conductivity (mea.)	2.5	R	1.732	0.78	0.71	1.1	1.0
Temp. unc. - Conductivity	3.4	R	1.732	0.78	0.71	1.5	1.4
Liquid Permittivity Repeatability	0.15	N	1	0.23	0.26	0.0	0.0
Liquid Permittivity (target)	5.0	R	1.732	0.23	0.26	0.7	0.8
Liquid Permittivity (mea.)	2.5	R	1.732	0.23	0.26	0.3	0.4
Temp. unc. - Permittivity	0.83	R	1.732	0.23	0.26	0.1	0.1
Combined Std. Uncertainty						11.4%	11.4%
Coverage Factor for 95 %						K=2	K=2
Expanded STD Uncertainty						22.9%	22.7%

Table 17.2. Uncertainty Budget for frequency range 300 MHz to 3 GHz



Error Description	Uncertainty Value (±%)	Probability	Divisor	(Ci) 1g	(Ci) 10g	Standard Uncertainty (1g) (±%)	Standard Uncertainty (10g) (±%)
Measurement System							
Probe Calibration	7.0	N	1	1	1	7.0	7.0
Axial Isotropy	4.7	R	1.732	0.7	0.7	1.9	1.9
Hemispherical Isotropy	9.6	R	1.732	0.7	0.7	3.9	3.9
Boundary Effects	2.0	R	1.732	1	1	1.2	1.2
Linearity	4.7	R	1.732	1	1	2.7	2.7
System Detection Limits	1.0	R	1.732	1	1	0.6	0.6
Modulation Response	3.2	R	1.732	1	1	1.8	1.8
Readout Electronics	0.3	N	1	1	1	0.3	0.3
Response Time	0.0	R	1.732	1	1	0.0	0.0
Integration Time	2.6	R	1.732	1	1	1.5	1.5
RF Ambient Noise	3.0	R	1.732	1	1	1.7	1.7
RF Ambient Reflections	3.0	R	1.732	1	1	1.7	1.7
Probe Positioner	0.4	R	1.732	1	1	0.2	0.2
Probe Positioning	6.7	R	1.732	1	1	3.9	3.9
Max. SAR Eval.	4.0	R	1.732	1	1	2.3	2.3
Test Sample Related							
Device Positioning	3.0	N	1	1	1	3.0	3.0
Device Holder	3.6	N	1	1	1	3.6	3.6
Power Drift	5.0	R	1.732	1	1	2.9	2.9
Power Scaling	0.0	R	1.732	1	1	0.0	0.0
Phantom and Setup							
Phantom Uncertainty	6.6	R	1.732	1	1	3.8	3.8
SAR correction	0.0	R	1.732	1	0.84	0.0	0.0
Liquid Conductivity Repeatability	0.2	N	1	0.78	0.71	0.1	0.1
Liquid Conductivity (target)	5.0	R	1.732	0.78	0.71	2.3	2.0
Liquid Conductivity (mea.)	2.5	R	1.732	0.78	0.71	1.1	1.0
Temp. unc. - Conductivity	3.4	R	1.732	0.78	0.71	1.5	1.4
Liquid Permittivity Repeatability	0.15	N	1	0.23	0.26	0.0	0.0
Liquid Permittivity (target)	5.0	R	1.732	0.23	0.26	0.7	0.8
Liquid Permittivity (mea.)	2.5	R	1.732	0.23	0.26	0.3	0.4
Temp. unc. - Permittivity	0.83	R	1.732	0.23	0.26	0.1	0.1
Combined Std. Uncertainty						12.8%	12.7%
Coverage Factor for 95 %						K=2	K=2
Expanded STD Uncertainty						25.5%	25.4%

Table 17.3. Uncertainty Budget for frequency range 3 GHz to 6 GHz



18. References

- [1] FCC 47 CFR Part 2 "Frequency Allocations and Radio Treaty Matters; General Rules and Regulations"
- [2] ANSI/IEEE Std. C95.1-1992, "IEEE Standard for Safety Levels with Respect to Human Exposure to Radio Frequency Electromagnetic Fields, 3 kHz to 300 GHz", September 1992
- [3] IEEE Std. 1528-2013, "IEEE Recommended Practice for Determining the Peak Spatial-Average Specific Absorption Rate (SAR) in the Human Head from Wireless Communications Devices: Measurement Techniques", Sep 2013
- [4] SPEAG DASY System Handbook
- [5] FCC KDB 248227 D01 v02r02, "SAR Guidance for IEEE 802.11 (WiFi) Transmitters", Oct 2015.
- [6] FCC KDB 447498 D01 v06, "Mobile and Portable Device RF Exposure Procedures and Equipment Authorization Policies", Oct 2015
- [7] FCC KDB 648474 D04 v01r03, "SAR Evaluation Considerations for Wireless Handsets", Oct 2015.
- [8] FCC KDB 941225 D01 v03r01, "3G SAR MEAUREMENT PROCEDURES", Oct 2015
- [9] FCC KDB 941225 D05 v02r05, "SAR Evaluation Considerations for LTE Devices", Dec 2015
- [10] FCC KDB 941225 D05A v01r02, "Rel. 10 LTE SAR Test Guidance and KDB Inquiries", Oct 2015
- [11] FCC KDB 941225 D06 v02r01, "SAR Evaluation Procedures for Portable Devices with Wireless Router Capabilities", Oct 2015.
- [12] FCC KDB 865664 D01 v01r04, "SAR Measurement Requirements for 100 MHz to 6 GHz", Aug 2015.
- [13] FCC KDB 865664 D02 v01r02, "RF Exposure Compliance Reporting and Documentation Considerations" Oct 2015.



Appendix A. Plots of System Performance Check

The plots are shown as follows.

System Check_Head_750MHz

DUT: D750V3-1012

Communication System: CW; Frequency: 750 MHz; Duty Cycle: 1:1

Medium: HSL_750_160831 Medium parameters used: $f = 750 \text{ MHz}$; $\sigma = 0.9 \text{ S/m}$; $\epsilon_r = 42.423$; $\rho = 1000 \text{ kg/m}^3$

Ambient Temperature : $23.4 \text{ }^\circ\text{C}$; Liquid Temperature : $22.4 \text{ }^\circ\text{C}$

DASY5 Configuration

- Probe: EX3DV4 - SN3925; ConvF(10.37, 10.37, 10.37); Calibrated: 2016/5/26;
- Sensor-Surface: 1.4mm (Mechanical Surface Detection)
- Electronics: DAE3 Sn495; Calibrated: 2016/5/27
- Phantom: SAM_Right; Type: QD000P40CD; Serial: S/N:1801
- Measurement SW: DASY52, Version 52.8 (8); SEMCAD X Version 14.6.10 (7373)

Pin=250mW/Area Scan (61x61x1): Interpolated grid: dx=1.500 mm, dy=1.500 mm

Maximum value of SAR (interpolated) = 2.65 W/kg

Pin=250mW/Zoom Scan (5x5x7)/Cube 0: Measurement grid: dx=8mm, dy=8mm, dz=5mm

Reference Value = 55.42 V/m; Power Drift = -0.07 dB

Peak SAR (extrapolated) = 3.09 W/kg

SAR(1 g) = 2.08 W/kg; SAR(10 g) = 1.37 W/kg

Maximum value of SAR (measured) = 2.63 W/kg

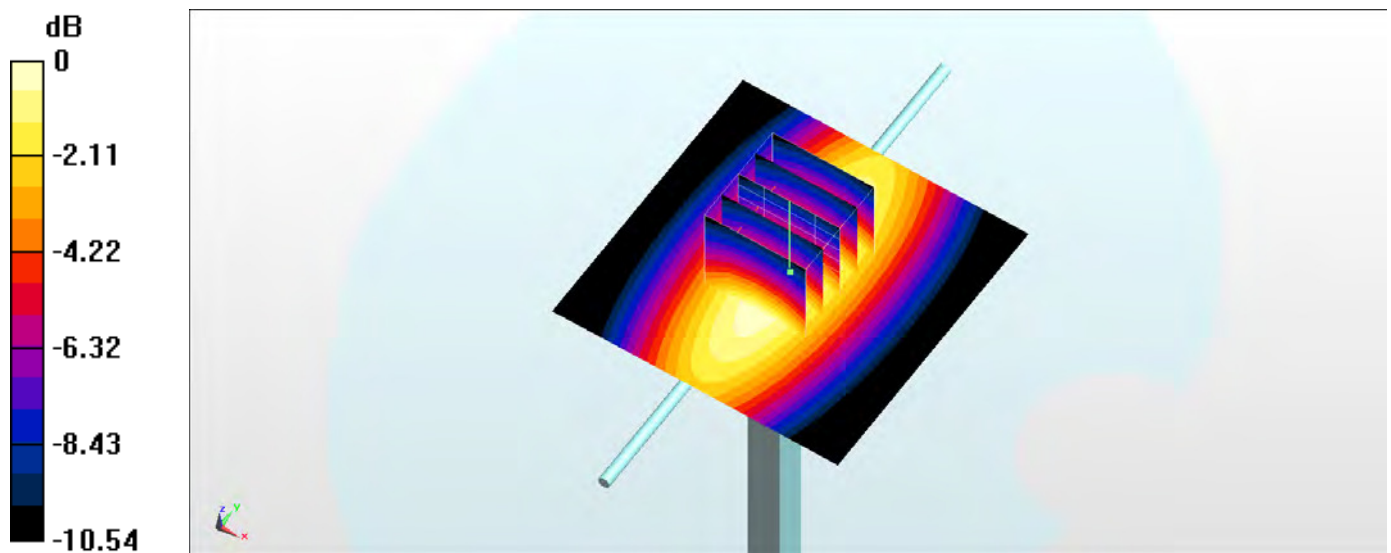

0 dB = 2.63 W/kg = 4.20 dBW/kg

System Check_Body_750MHz

DUT: D750V3-1012

Communication System: CW; Frequency: 750 MHz; Duty Cycle: 1:1

Medium: MSL_750_160905 Medium parameters used: $f = 750$ MHz; $\sigma = 0.961$ S/m; $\epsilon_r = 56.354$; $\rho = 1000$ kg/m³

Ambient Temperature : 23.2 °C; Liquid Temperature : 22.2 °C

DASY5 Configuration

- Probe: EX3DV4 - SN3925; ConvF(10.18, 10.18, 10.18); Calibrated: 2016/5/26;
- Sensor-Surface: 1.4mm (Mechanical Surface Detection)
- Electronics: DAE3 Sn495; Calibrated: 2016/5/27
- Phantom: SAM_Left; Type: QD000P40CD; Serial: S/N:1796
- Measurement SW: DASY52, Version 52.8 (8); SEMCAD X Version 14.6.10 (7373)

Pin=250mW/Area Scan (61x61x1): Interpolated grid: dx=1.500 mm, dy=1.500 mm

Maximum value of SAR (interpolated) = 2.87 W/kg

Pin=250mW/Zoom Scan (5x5x7)/Cube 0: Measurement grid: dx=8mm, dy=8mm, dz=5mm

Reference Value = 55.72 V/m; Power Drift = -0.08 dB

Peak SAR (extrapolated) = 3.29 W/kg

SAR(1 g) = 2.29 W/kg; SAR(10 g) = 1.55 W/kg

Maximum value of SAR (measured) = 2.82 W/kg

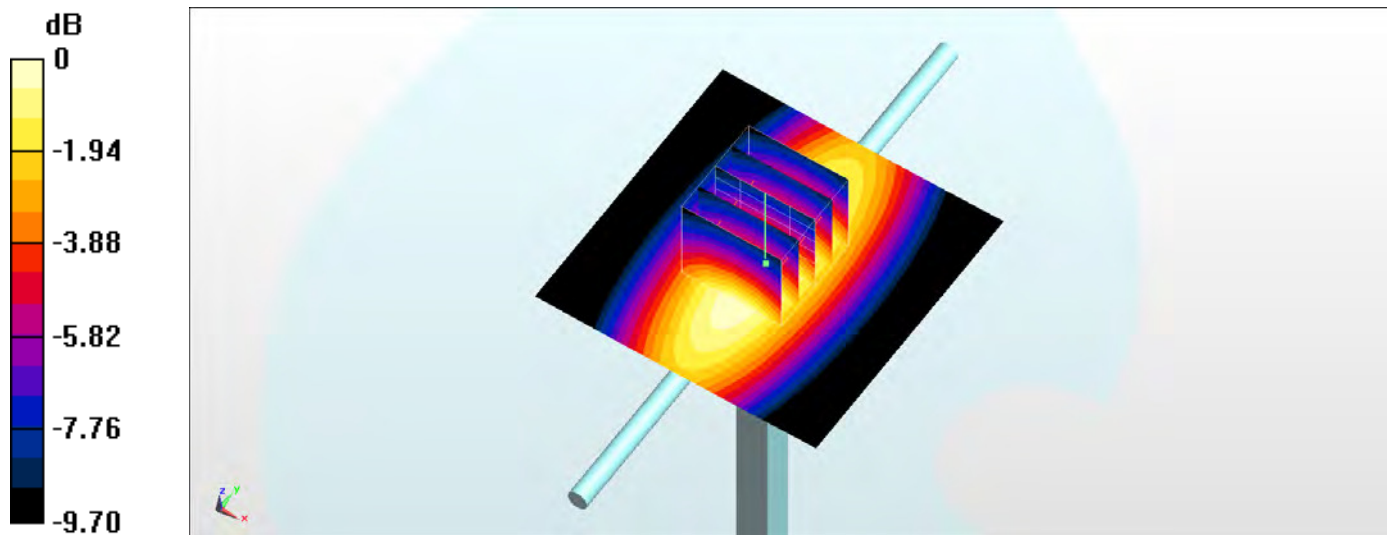

0 dB = 2.82 W/kg = 4.50 dBW/kg

System Check_Head_835MHz

DUT: D835V2-499

Communication System: CW; Frequency: 835 MHz; Duty Cycle: 1:1

Medium: HSL_850_160830 Medium parameters used: $f = 835 \text{ MHz}$; $\sigma = 0.898 \text{ S/m}$; $\epsilon_r = 43.054$; $\rho = 1000 \text{ kg/m}^3$

Ambient Temperature : $23.4 \text{ }^\circ\text{C}$; Liquid Temperature : $22.4 \text{ }^\circ\text{C}$

DASY5 Configuration

- Probe: EX3DV4 - SN3925; ConvF(9.92, 9.92, 9.92); Calibrated: 2016/5/26;
- Sensor-Surface: 1.4mm (Mechanical Surface Detection)
- Electronics: DAE3 Sn495; Calibrated: 2016/5/27
- Phantom: SAM_Right; Type: QD000P40CD; Serial: S/N:1801
- Measurement SW: DASY52, Version 52.8 (8); SEMCAD X Version 14.6.10 (7373)

Pin=250mW/Area Scan (61x61x1): Interpolated grid: $dx=1.500 \text{ mm}$, $dy=1.500 \text{ mm}$

Maximum value of SAR (interpolated) = 3.25 W/kg

Pin=250mW/Zoom Scan (5x5x7)/Cube 0: Measurement grid: $dx=8\text{mm}$, $dy=8\text{mm}$, $dz=5\text{mm}$

Reference Value = 62.43 V/m ; Power Drift = 0.00 dB

Peak SAR (extrapolated) = 3.66 W/kg

SAR(1 g) = 2.43 W/kg ; SAR(10 g) = 1.6 W/kg

Maximum value of SAR (measured) = 3.25 W/kg

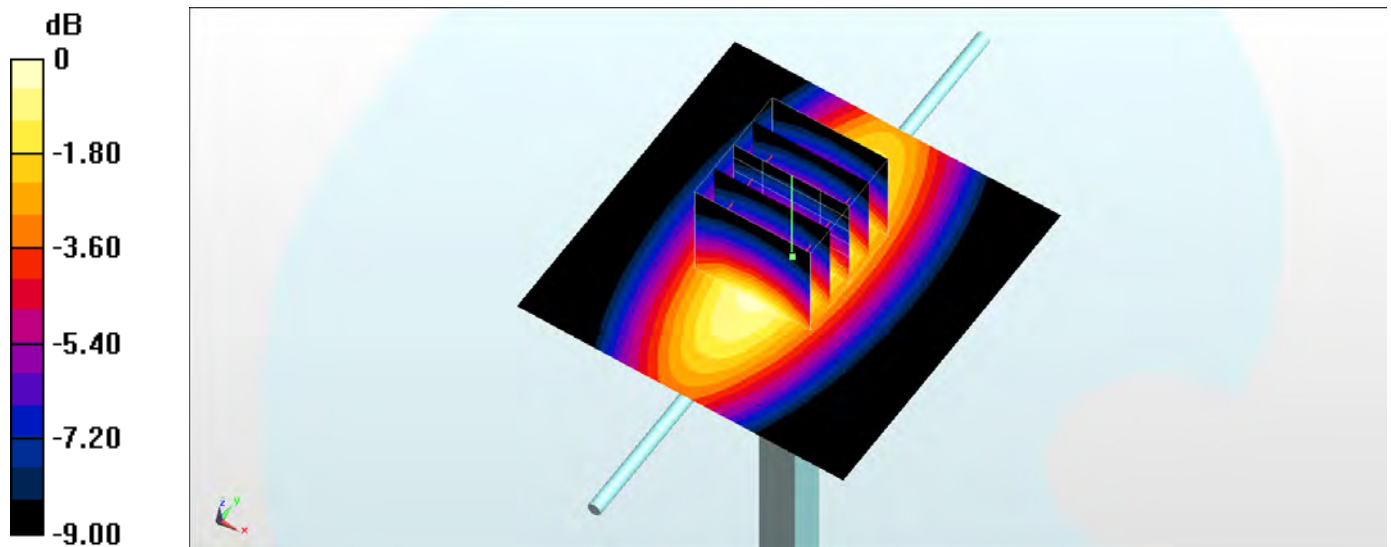

0 dB = 3.25 W/kg = 5.12 dBW/kg

System Check_Head_835MHz

DUT: D835V2-499

Communication System: CW; Frequency: 835 MHz; Duty Cycle: 1:1

Medium: HSL_850_160901 Medium parameters used: $f = 835$ MHz; $\sigma = 0.891$ S/m; $\epsilon_r = 41.127$; $\rho = 1000$ kg/m³

Ambient Temperature : 23.2 °C; Liquid Temperature : 22.2 °C

DASY5 Configuration

- Probe: EX3DV4 - SN3925; ConvF(9.92, 9.92, 9.92); Calibrated: 2016/5/26;
- Sensor-Surface: 1.4mm (Mechanical Surface Detection)
- Electronics: DAE3 Sn495; Calibrated: 2016/5/27
- Phantom: SAM_Right; Type: QD000P40CD; Serial: S/N:1801
- Measurement SW: DASY52, Version 52.8 (8); SEMCAD X Version 14.6.10 (7373)

Pin=250mW/Area Scan (61x61x1): Interpolated grid: dx=1.500 mm, dy=1.500 mm

Maximum value of SAR (interpolated) = 3.30 W/kg

Pin=250mW/Zoom Scan (5x5x7)/Cube 0: Measurement grid: dx=8mm, dy=8mm, dz=5mm

Reference Value = 63.42 V/m; Power Drift = -0.13 dB

Peak SAR (extrapolated) = 3.47 W/kg

SAR(1 g) = 2.31 W/kg; SAR(10 g) = 1.52 W/kg

Maximum value of SAR (measured) = 3.06 W/kg

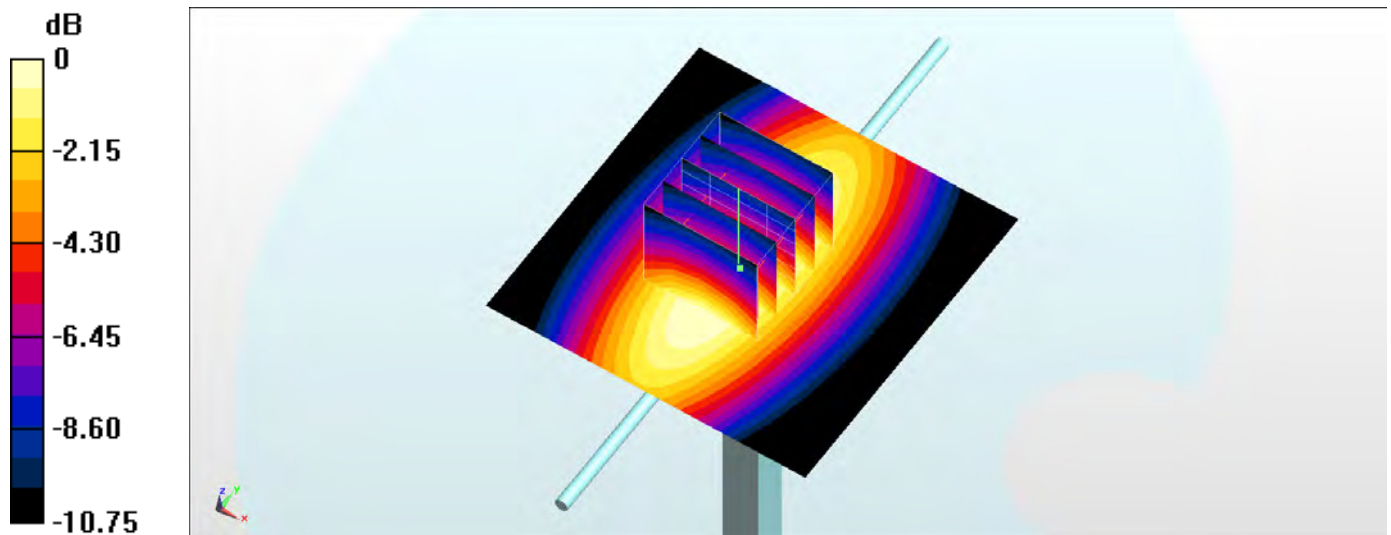

0 dB = 3.06 W/kg = 4.86 dBW/kg

System Check_Body_835MHz

DUT: D835V2-499

Communication System: CW; Frequency: 835 MHz; Duty Cycle: 1:1

Medium: MSL_850_160905 Medium parameters used: $f = 835 \text{ MHz}$; $\sigma = 0.992 \text{ S/m}$; $\epsilon_r = 56.767$; $\rho = 1000 \text{ kg/m}^3$

Ambient Temperature : $23.9 \text{ }^\circ\text{C}$; Liquid Temperature : $22.9 \text{ }^\circ\text{C}$

DASY5 Configuration

- Probe: EX3DV4 - SN3925; ConvF(9.91, 9.91, 9.91); Calibrated: 2016/5/26;
- Sensor-Surface: 1.4mm (Mechanical Surface Detection)
- Electronics: DAE3 Sn495; Calibrated: 2016/5/27
- Phantom: SAM_Left; Type: QD000P40CD; Serial: S/N:1796
- Measurement SW: DASY52, Version 52.8 (8); SEMCAD X Version 14.6.10 (7373)

Pin=250mW/Area Scan (61x61x1): Interpolated grid: $dx=1.500 \text{ mm}$, $dy=1.500 \text{ mm}$

Maximum value of SAR (interpolated) = 3.33 W/kg

Pin=250mW/Zoom Scan (5x5x7)/Cube 0: Measurement grid: $dx=8\text{mm}$, $dy=8\text{mm}$, $dz=5\text{mm}$

Reference Value = 59.81 V/m ; Power Drift = 0.04 dB

Peak SAR (extrapolated) = 3.71 W/kg

SAR(1 g) = 2.54 W/kg ; SAR(10 g) = 1.68 W/kg

Maximum value of SAR (measured) = 3.31 W/kg

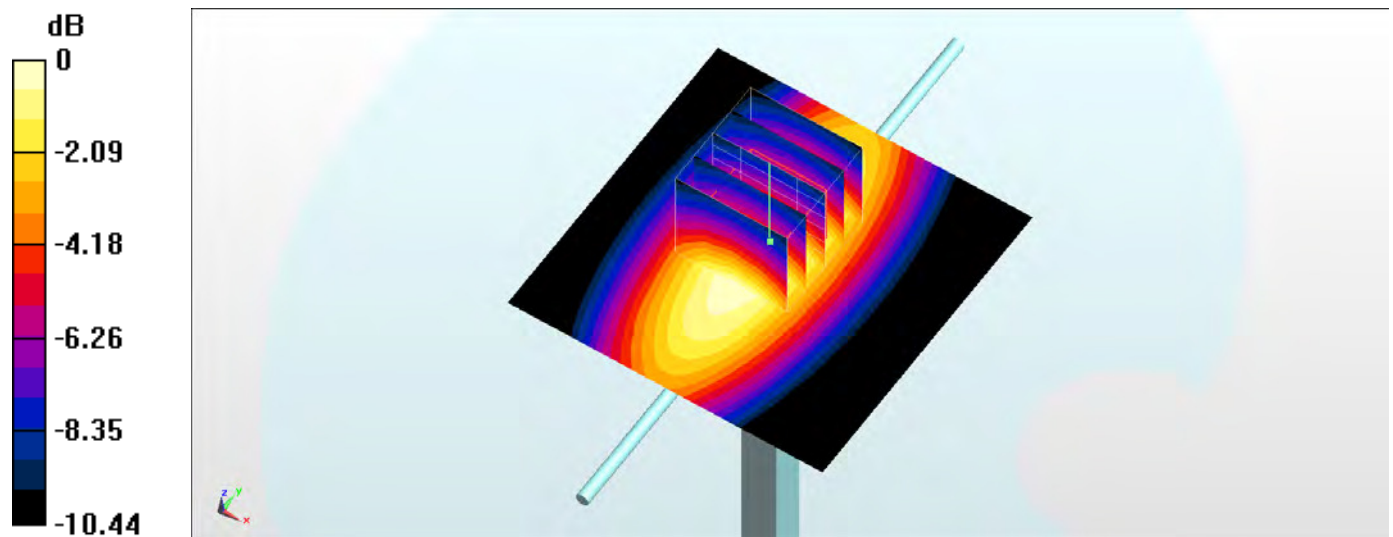

0 dB = $3.31 \text{ W/kg} = 5.20 \text{ dBW/kg}$

System Check_Head_1750MHz

DUT: D1750V2-1068

Communication System: CW; Frequency: 1750 MHz; Duty Cycle: 1:1

Medium: HSL_1750_160902 Medium parameters used: $f = 1750$ MHz; $\sigma = 1.374$ S/m; $\epsilon_r = 40.35$; $\rho = 1000$ kg/m³

Ambient Temperature : 23.6 °C; Liquid Temperature : 22.6 °C

DASY5 Configuration

- Probe: EX3DV4 - SN3925; ConvF(8.57, 8.57, 8.57); Calibrated: 2016/5/26;
- Sensor-Surface: 1.4mm (Mechanical Surface Detection)
- Electronics: DAE3 Sn495; Calibrated: 2016/5/27
- Phantom: SAM_Left; Type: QD000P40CD; Serial: S/N:1796
- Measurement SW: DASY52, Version 52.8 (8); SEMCAD X Version 14.6.10 (7373)

Pin=250mW/Area Scan (61x61x1): Interpolated grid: dx=1.500 mm, dy=1.500 mm

Maximum value of SAR (interpolated) = 13.1 W/kg

Pin=250mW/Zoom Scan (5x5x7)/Cube 0: Measurement grid: dx=8mm, dy=8mm, dz=5mm

Reference Value = 96.70 V/m; Power Drift = 0.13 dB

Peak SAR (extrapolated) = 16.6 W/kg

SAR(1 g) = 9.32 W/kg; SAR(10 g) = 5 W/kg

Maximum value of SAR (measured) = 13.0 W/kg

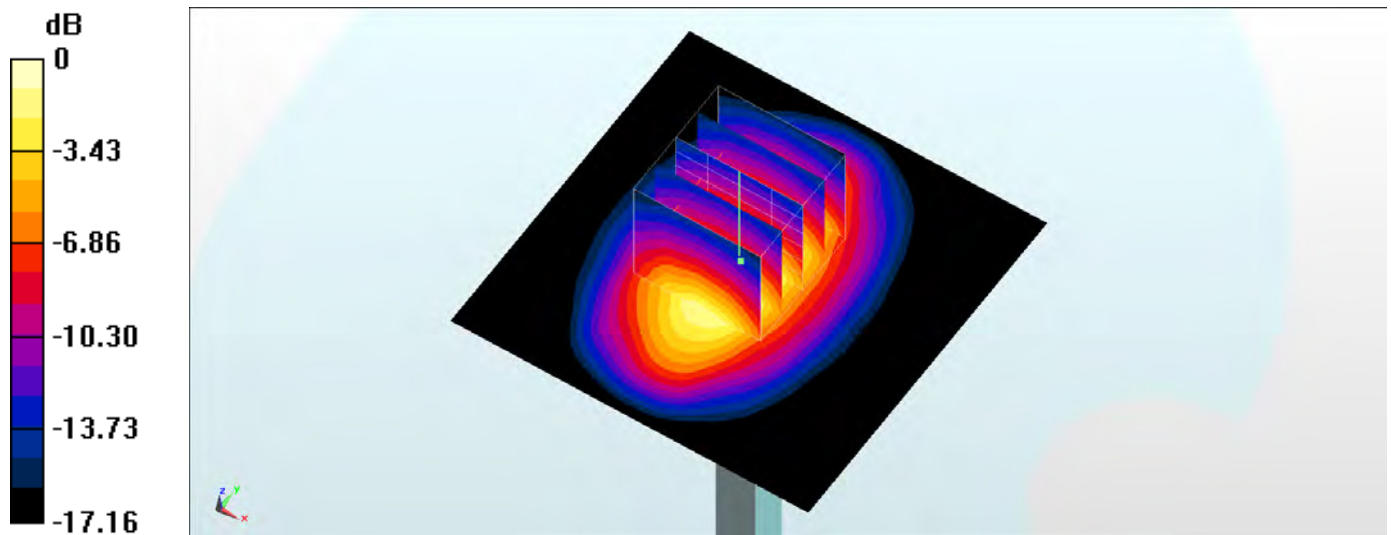

0 dB = 13.0 W/kg = 11.14 dBW/kg

System Check_Body_1750MHz

DUT: D1750V2-1068

Communication System: CW; Frequency: 1750 MHz; Duty Cycle: 1:1

Medium: MSL_1750_160904 Medium parameters used: $f = 1750$ MHz; $\sigma = 1.459$ S/m; $\epsilon_r = 55.69$; $\rho = 1000$ kg/m³

Ambient Temperature : 23.8 °C; Liquid Temperature : 22.8 °C

DASY5 Configuration

- Probe: EX3DV4 - SN3925; ConvF(8.3, 8.3, 8.3); Calibrated: 2016/5/26;
- Sensor-Surface: 1.4mm (Mechanical Surface Detection)
- Electronics: DAE3 Sn495; Calibrated: 2016/5/27
- Phantom: SAM_Right; Type: QD000P40CD; Serial: S/N:1801
- Measurement SW: DASY52, Version 52.8 (8); SEMCAD X Version 14.6.10 (7373)

Pin=250mW/Area Scan (61x61x1): Interpolated grid: dx=1.500 mm, dy=1.500 mm

Maximum value of SAR (interpolated) = 13.2 W/kg

Pin=250mW/Zoom Scan (5x5x7)/Cube 0: Measurement grid: dx=8mm, dy=8mm, dz=5mm

Reference Value = 97.60 V/m; Power Drift = -0.04 dB

Peak SAR (extrapolated) = 15.5 W/kg

SAR(1 g) = 8.82 W/kg; SAR(10 g) = 4.77 W/kg

Maximum value of SAR (measured) = 13.1 W/kg

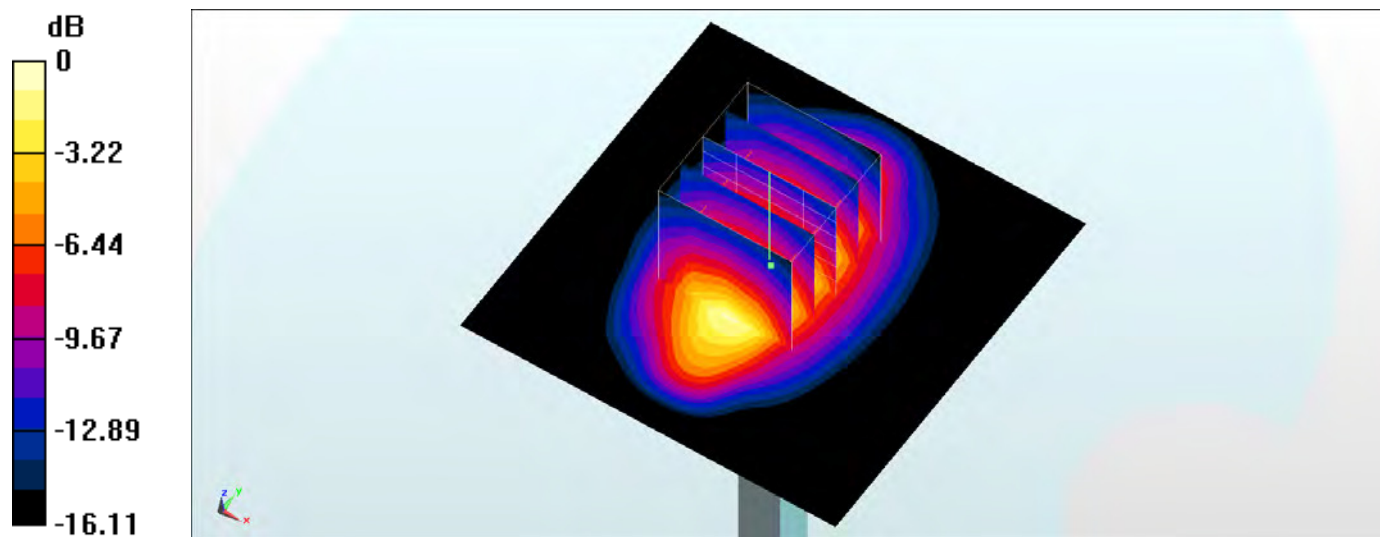

0 dB = 13.1 W/kg = 11.17 dBW/kg

System Check_Head_1900MHz

DUT: D1900V2-5d041

Communication System: CW; Frequency: 1900 MHz; Duty Cycle: 1:1

Medium: HSL_1900_160901 Medium parameters used: $f = 1900$ MHz; $\sigma = 1.432$ S/m; $\epsilon_r = 38.309$; $\rho = 1000$ kg/m³

Ambient Temperature : 23.6 °C; Liquid Temperature : 22.6 °C

DASY5 Configuration

- Probe: EX3DV4 - SN3925; ConvF(8.3, 8.3, 8.3); Calibrated: 2016/5/26;
- Sensor-Surface: 1.4mm (Mechanical Surface Detection)
- Electronics: DAE3 Sn495; Calibrated: 2016/5/27
- Phantom: SAM_Left; Type: QD000P40CD; Serial: S/N:1796
- Measurement SW: DASY52, Version 52.8 (8); SEMCAD X Version 14.6.10 (7373)

Pin=250mW/Area Scan (61x61x1): Interpolated grid: dx=1.500 mm, dy=1.500 mm

Maximum value of SAR (interpolated) = 15.8 W/kg

Pin=250mW/Zoom Scan (5x5x7)/Cube 0: Measurement grid: dx=8mm, dy=8mm, dz=5mm

Reference Value = 107.9 V/m; Power Drift = -0.09 dB

Peak SAR (extrapolated) = 19.0 W/kg

SAR(1 g) = 9.98 W/kg; SAR(10 g) = 5.15 W/kg

Maximum value of SAR (measured) = 15.5 W/kg

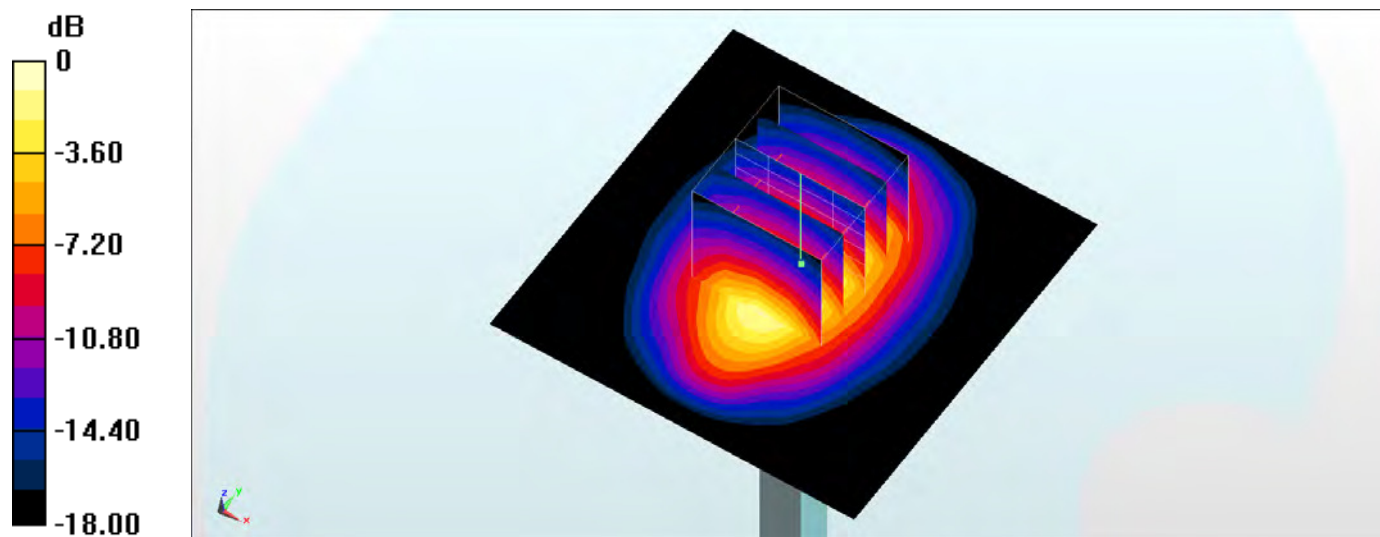

0 dB = 15.5 W/kg = 11.90 dBW/kg

System Check_Body_1900MHz

DUT: D1900V2-5d041

Communication System: CW; Frequency: 1900 MHz; Duty Cycle: 1:1

Medium: MSL_1900_160903 Medium parameters used: $f = 1900$ MHz; $\sigma = 1.575$ S/m; $\epsilon_r = 55.365$; $\rho = 1000$ kg/m³

Ambient Temperature : 23.6 °C; Liquid Temperature : 22.6 °C

DASY5 Configuration

- Probe: EX3DV4 - SN3925; ConvF(8, 8, 8); Calibrated: 2016/5/26;
- Sensor-Surface: 1.4mm (Mechanical Surface Detection)
- Electronics: DAE3 Sn495; Calibrated: 2016/5/27
- Phantom: SAM_Right; Type: QD000P40CD; Serial: S/N:1801
- Measurement SW: DASY52, Version 52.8 (8); SEMCAD X Version 14.6.10 (7373)

Pin=250mW/Area Scan (61x61x1): Interpolated grid: dx=1.500 mm, dy=1.500 mm

Maximum value of SAR (interpolated) = 16.5 W/kg

Pin=250mW/Zoom Scan (5x5x7)/Cube 0: Measurement grid: dx=8mm, dy=8mm, dz=5mm

Reference Value = 105.7 V/m; Power Drift = -0.13 dB

Peak SAR (extrapolated) = 18.4 W/kg

SAR(1 g) = 10.2 W/kg; SAR(10 g) = 5.34 W/kg

Maximum value of SAR (measured) = 15.5 W/kg

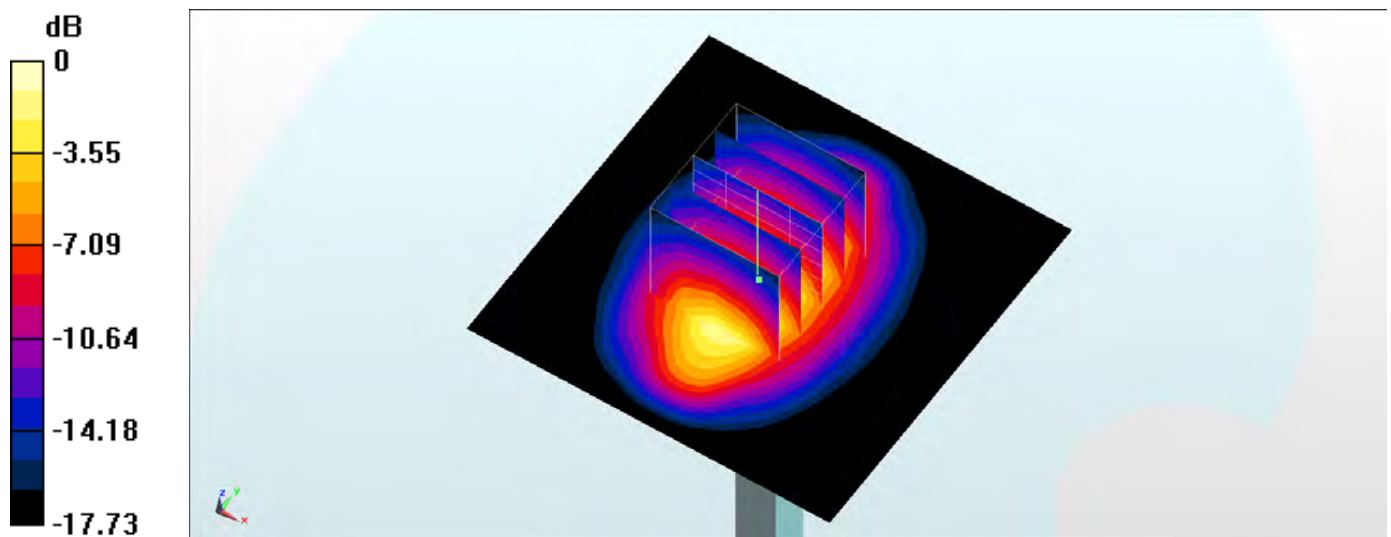

0 dB = 15.5 W/kg = 11.90 dBW/kg

System Check_Head_2450MHz

DUT: D2450V2-926

Communication System: CW; Frequency: 2450 MHz; Duty Cycle: 1:1

Medium: HSL_2450_160820 Medium parameters used: $f = 2450$ MHz; $\sigma = 1.748$ S/m; $\epsilon_r = 38.342$; $\rho = 1000$ kg/m³

Ambient Temperature : 23.3 °C; Liquid Temperature : 22.3 °C

DASY5 Configuration

- Probe: EX3DV4 - SN3955; ConvF(7.36, 7.36, 7.36); Calibrated: 2015/11/24;
- Sensor-Surface: 1.4mm (Mechanical Surface Detection)
- Electronics: DAE4 Sn778; Calibrated: 2016/5/12
- Phantom: SAM_RIGHT; Type: QD000P40CD; Serial: 1719
- Measurement SW: DASY52, Version 52.8 (8); SEMCAD X Version 14.6.10 (7373)

Pin=250mW/Area Scan (71x71x1): Interpolated grid: dx=1.200 mm, dy=1.200 mm

Maximum value of SAR (interpolated) = 20.4 W/kg

Pin=250mW/Zoom Scan (7x7x7)/Cube 0: Measurement grid: dx=5mm, dy=5mm, dz=5mm

Reference Value = 111.7 V/m; Power Drift = 0.08 dB

Peak SAR (extrapolated) = 27.2 W/kg

SAR(1 g) = 12.8 W/kg; SAR(10 g) = 5.84 W/kg

Maximum value of SAR (measured) = 21.8 W/kg

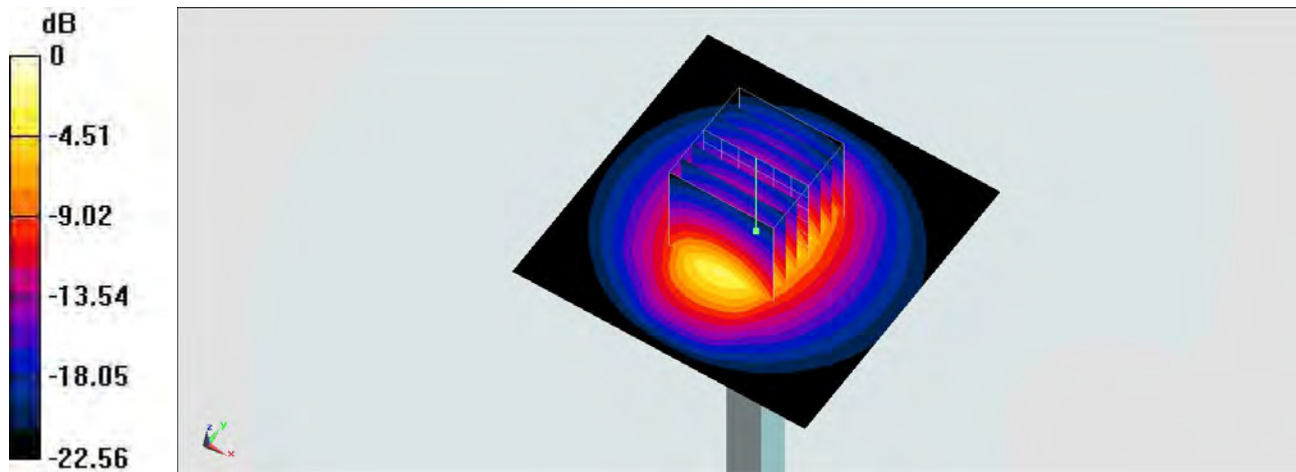

0 dB = 21.8 W/kg = 13.38 dBW/kg

System Check_Head_2450MHz

DUT: D2450V2-926

Communication System: CW ; Frequency: 2450 MHz;Duty Cycle: 1:1

Medium: HSL_2450_160914 Medium parameters used: $f = 2450$ MHz; $\sigma = 1.77$ S/m; $\epsilon_r = 40.225$; $\rho = 1000$ kg/m³

Ambient Temperature : 23.5 °C; Liquid Temperature : 22.5 °C

DASY5 Configuration:

- Probe: EX3DV4 - SN3925; ConvF(7.47, 7.47, 7.47); Calibrated: 2016/5/26;
- Sensor-Surface: 1.4mm (Mechanical Surface Detection)
- Electronics: DAE3 Sn495; Calibrated: 2016/5/27
- Phantom: SAM_Right; Type: QD000P40CD; Serial: TP:1383
- ;Postprocessing SW: SEMCAD, V1.8 Build 159

Pin=250mW/Area Scan (61x61x1): Interpolated grid: dx=1.200 mm, dy=1.200 mm

Maximum value of SAR (interpolated) = 19.2 W/kg

Pin=250mW/Zoom Scan (7x7x7)/Cube 0: Measurement grid: dx=5mm, dy=5mm, dz=5mm

Reference Value = 105.5 V/m; Power Drift = 0.01 dB

Peak SAR (extrapolated) = 25.9 W/kg

SAR(1 g) = 12.5 W/kg; SAR(10 g) = 5.78 W/kg

Maximum value of SAR (measured) = 19.2 W/kg

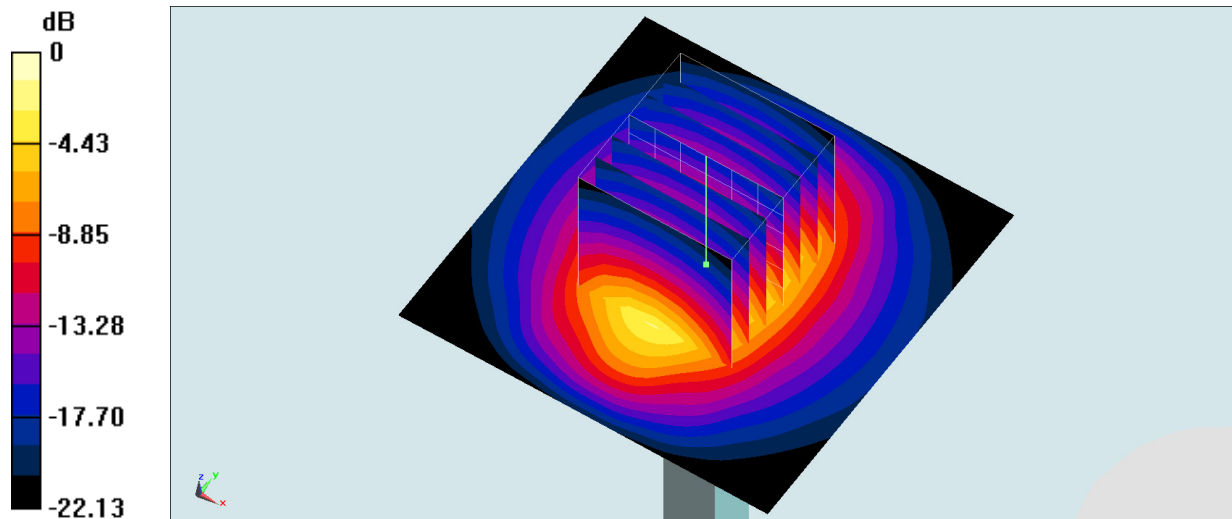

System Check_Body_2450MHz

DUT: **D2450V2-926**

Communication System: CW; Frequency: 2450 MHz; Duty Cycle: 1:1

Medium: MSL_2450_160823 Medium parameters used: $f = 2450$ MHz; $\sigma = 1.954$ S/m; $\epsilon_r = 52.459$; $\rho = 1000$ kg/m³

Ambient Temperature : 23.7 °C; Liquid Temperature : 22.7 °C

DASY5 Configuration:

- Probe: EX3DV4 - SN3931; ConvF(7.54, 7.54, 7.54); Calibrated: 2015/10/1;
- Sensor-Surface: 1.4mm (Mechanical Surface Detection)
- Electronics: DAE3 Sn577; Calibrated: 2015/9/24
- Phantom: SAM_Left; Type: QD000P40CD; Serial: TP:1644
- Measurement SW: DASY52, Version 52.8 (8); SEMCAD X Version 14.6.10 (7373)

Pin=250mW/Area Scan (61x61x1): Interpolated grid: dx=1.200 mm, dy=1.200 mm

Maximum value of SAR (interpolated) = 21.1 W/kg

Pin=250mW/Zoom Scan (7x7x7)/Cube 0: Measurement grid: dx=5mm, dy=5mm, dz=5mm

Reference Value = 105.0 V/m; Power Drift = 0.03 dB

Peak SAR (extrapolated) = 25.8 W/kg

SAR(1 g) = 13 W/kg; SAR(10 g) = 6.13 W/kg

Maximum value of SAR (measured) = 21.0 W/kg

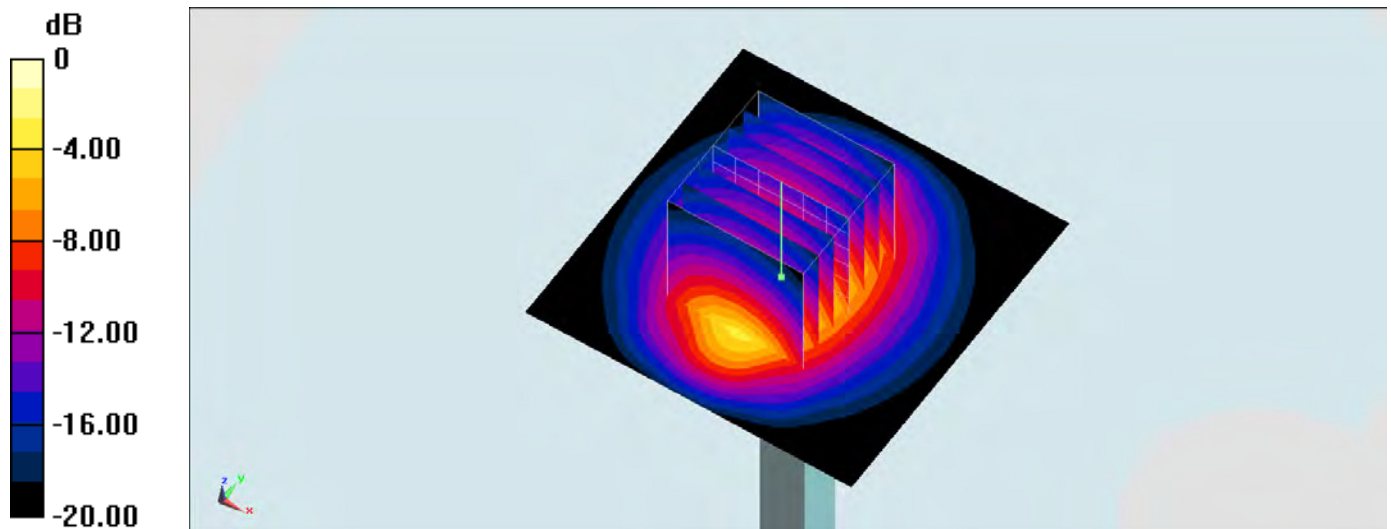

0 dB = 21.1 W/kg = 13.24 dBW/kg

System Check_Body_2450MHz

DUT: D2450V2-926

Communication System: CW; Frequency: 2450 MHz; Duty Cycle: 1:1

Medium: MSL_2450_160906 Medium parameters used: $f = 2450$ MHz; $\sigma = 1.952$ S/m; $\epsilon_r = 51.922$; $\rho = 1000$ kg/m³

Ambient Temperature : 23.5 °C; Liquid Temperature : 22.5 °C

DASY5 Configuration

- Probe: ES3DV3 - SN3270; ConvF(4.28, 4.28, 4.28); Calibrated: 2016/8/26;
- Sensor-Surface: 3mm (Mechanical Surface Detection)
- Electronics: DAE4 Sn1399; Calibrated: 2015/11/23
- Phantom: SAM_Left; Type: QD000P40CD; Serial: S/N:1796
- Measurement SW: DASY52, Version 52.8 (8); SEMCAD X Version 14.6.10 (7373)

Pin=250mW/Area Scan (61x61x1): Interpolated grid: dx=1.200 mm, dy=1.200 mm

Maximum value of SAR (interpolated) = 16.5 W/kg

Pin=250mW/Zoom Scan (7x7x7)/Cube 0: Measurement grid: dx=5mm, dy=5mm, dz=5mm

Reference Value = 94.08 V/m; Power Drift = 0.04 dB

Peak SAR (extrapolated) = 25.0 W/kg

SAR(1 g) = 12.5 W/kg; SAR(10 g) = 5.84 W/kg

Maximum value of SAR (measured) = 16.4 W/kg

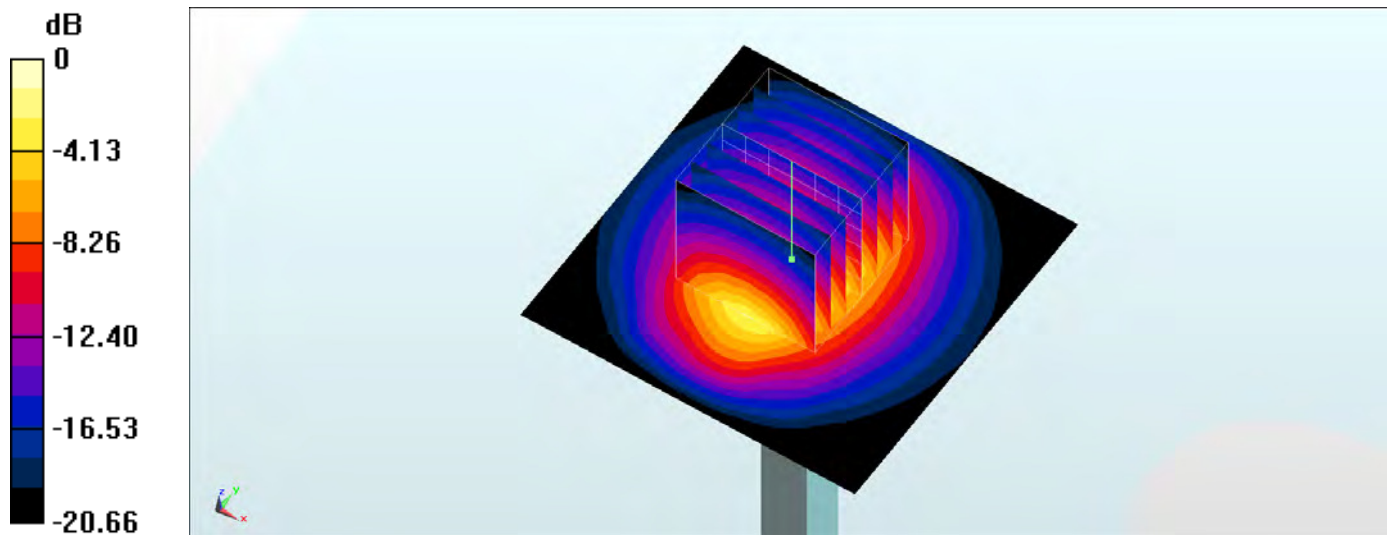

0 dB = 16.4 W/kg = 12.15 dBW/kg

System Check_Head_2600MHz

DUT: D2600V2-1058

Communication System: CW; Frequency: 2600 MHz; Duty Cycle: 1:1

Medium: HSL_2600_160826 Medium parameters used: $f = 2600$ MHz; $\sigma = 1.94$ S/m; $\epsilon_r = 39.136$; $\rho = 1000$ kg/m³

Ambient Temperature : 23.2 °C; Liquid Temperature : 22.2 °C

DASY5 Configuration

- Probe: EX3DV4 - SN3925; ConvF(7.28, 7.28, 7.28); Calibrated: 2016/5/26;
- Sensor-Surface: 1.4mm (Mechanical Surface Detection)
- Electronics: DAE3 Sn495; Calibrated: 2016/5/27
- Phantom: SAM_Left; Type: QD000P40CD; Serial: S/N:1796
- Measurement SW: DASY52, Version 52.8 (8); SEMCAD X Version 14.6.10 (7373)

Pin=250mW/Area Scan (61x61x1): Interpolated grid: dx=1.200 mm, dy=1.200 mm

Maximum value of SAR (interpolated) = 20.7 W/kg

Pin=250mW/Zoom Scan (7x7x7)/Cube 0: Measurement grid: dx=5mm, dy=5mm, dz=5mm

Reference Value = 105.0 V/m; Power Drift = -0.05 dB

Peak SAR (extrapolated) = 27.6 W/kg

SAR(1 g) = 13.3 W/kg; SAR(10 g) = 5.92 W/kg

Maximum value of SAR (measured) = 20.6 W/kg

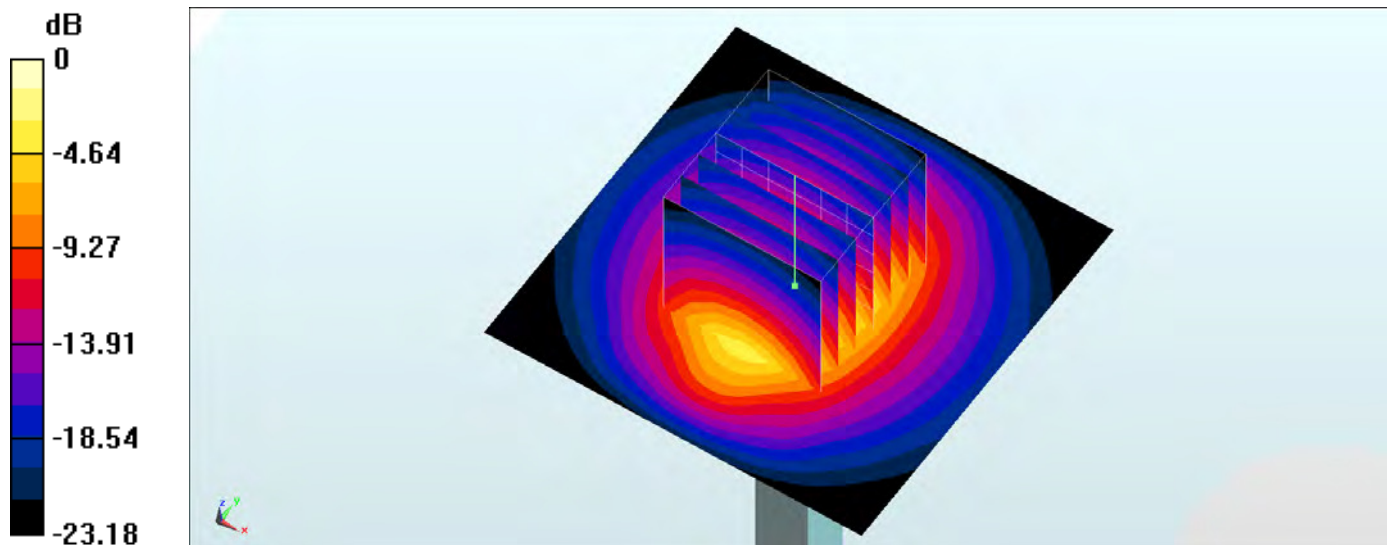

0 dB = 20.6 W/kg = 13.14 dBW/kg

System Check_Head_2600MHz

DUT: D2600V2-1058

Communication System: CW; Frequency: 2600 MHz; Duty Cycle: 1:1

Medium: HSL_2600_160902 Medium parameters used: $f = 2600$ MHz; $\sigma = 1.95$ mho/m; $\epsilon_r = 37.9$; $\rho = 1000$ kg/m³

Ambient Temperature : 23.4 °C ; Liquid Temperature : 22.4 °C

DASY4 Configuration:

- Probe: EX3DV4 - SN3955; ConvF(7.2, 7.2, 7.2); Calibrated: 2015/11/24
- Sensor-Surface: 1.4mm (Mechanical Surface Detection)
- Electronics: DAE4 Sn778; Calibrated: 2016/5/12
- Phantom: SAM_Right; Type: SAM_Right; Serial: TP-1303
- ;Postprocessing SW: SEMCAD, V1.8 Build 159

Pin=250mW/Area Scan (61x61x1): Measurement grid: dx=12mm, dy=12mm

Maximum value of SAR (interpolated) = 24.7 mW/g

Pin=250mW/Zoom Scan (7x7x7)/Cube 0: Measurement grid: dx=5mm, dy=5mm, dz=5mm

Reference Value = 116.3 V/m; Power Drift = -0.021 dB

Peak SAR (extrapolated) = 31.4 W/kg

SAR(1 g) = 13.9 mW/g; SAR(10 g) = 6.09 mW/g

Maximum value of SAR (measured) = 24.4 mW/g

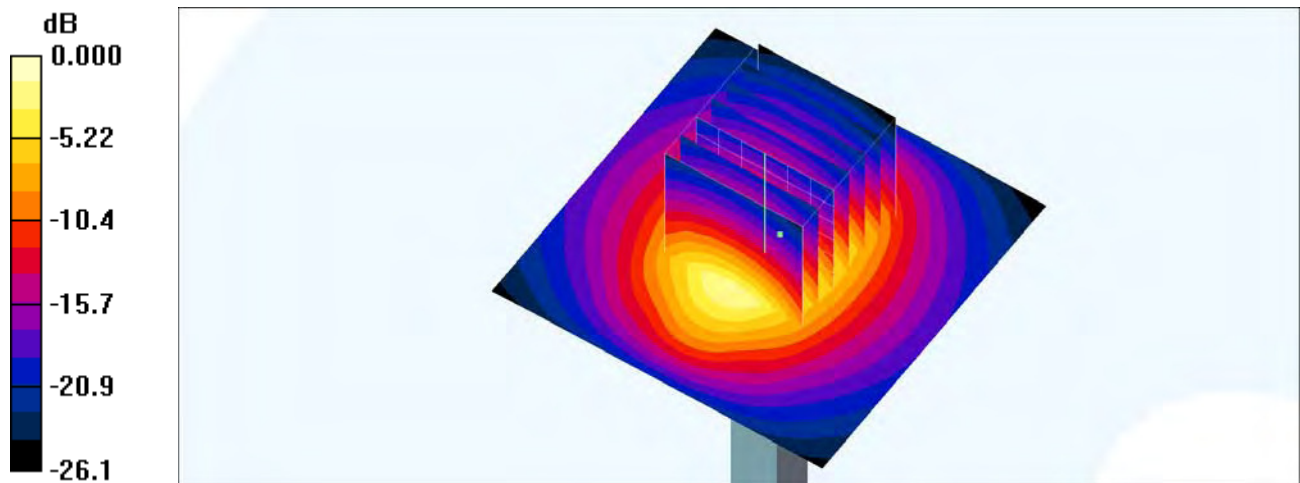

0 dB = 24.4mW/g

System Check_Head_2600MHz

DUT: D2600V2-1058

Communication System: CW; Frequency: 2600 MHz; Duty Cycle: 1:1

Medium: HSL_2600_160906 Medium parameters used: $f = 2600$ MHz; $\sigma = 1.924$ S/m; $\epsilon_r = 37.251$; $\rho = 1000$ kg/m³

Ambient Temperature : 23.9 °C; Liquid Temperature : 22.9 °C

DASY5 Configuration

- Probe: EX3DV4 - SN3925; ConvF(7.28, 7.28, 7.28); Calibrated: 2016/5/26;
- Sensor-Surface: 1.4mm (Mechanical Surface Detection)
- Electronics: DAE3 Sn495; Calibrated: 2016/5/27
- Phantom: SAM_Right; Type: QD000P40CD; Serial: S/N:1801
- Measurement SW: DASY52, Version 52.8 (8); SEMCAD X Version 14.6.10 (7373)

Pin=250mW/Area Scan (61x61x1): Interpolated grid: dx=1.200 mm, dy=1.200 mm

Maximum value of SAR (interpolated) = 20.5 W/kg

Pin=250mW/Zoom Scan (7x7x7)/Cube 0: Measurement grid: dx=5mm, dy=5mm, dz=5mm

Reference Value = 105.0 V/m; Power Drift = -0.05 dB

Peak SAR (extrapolated) = 27.4 W/kg

SAR(1 g) = 13.2 W/kg; SAR(10 g) = 5.88 W/kg

Maximum value of SAR (measured) = 20.4 W/kg

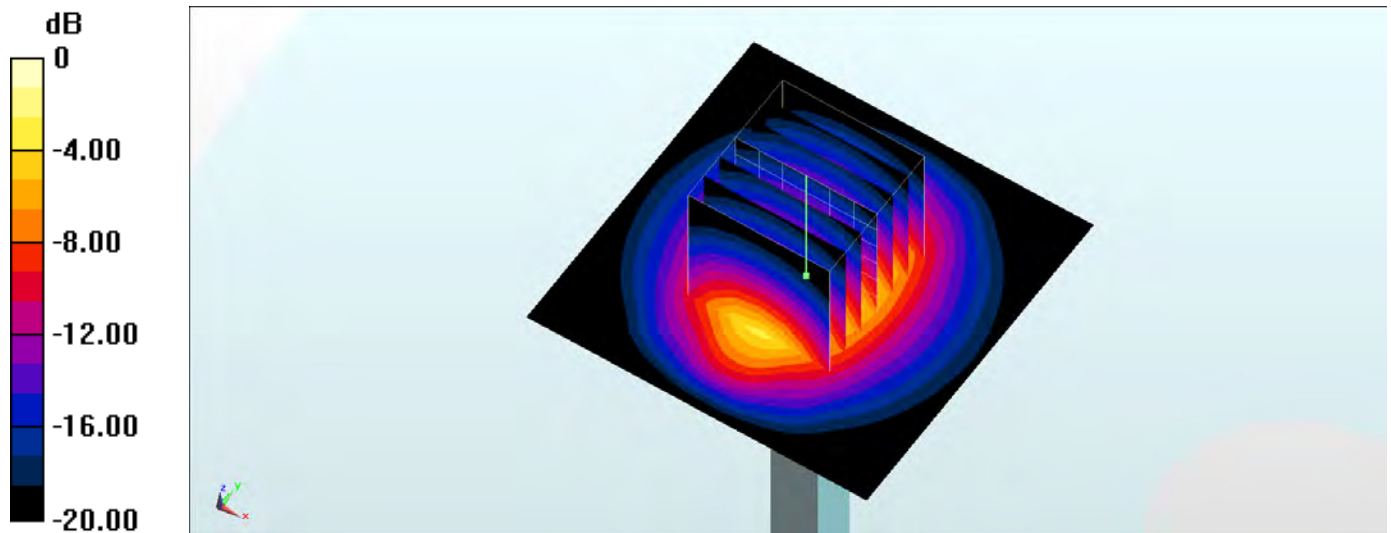

0 dB = 20.4 W/kg = 13.10 dBW/kg

System Check_Head_2600MHz

DUT: D2600V2-1058

Communication System: CW; Frequency: 2600 MHz; Duty Cycle: 1:1

Medium: HSL_2600_160906 Medium parameters used: $f = 2600$ MHz; $\sigma = 1.924$ S/m; $\epsilon_r = 37.251$; $\rho = 1000$ kg/m³

Ambient Temperature : 23.9 °C; Liquid Temperature : 22.9 °C

DASY5 Configuration

- Probe: ES3DV3 - SN3270; ConvF(4.37, 4.37, 4.37); Calibrated: 2016/8/26;
- Sensor-Surface: 3mm (Mechanical Surface Detection)
- Electronics: DAE4 Sn1399; Calibrated: 2015/11/23
- Phantom: SAM_Right; Type: QD000P40CD; Serial: S/N:1801
- Measurement SW: DASY52, Version 52.8 (8); SEMCAD X Version 14.6.10 (7373)

Pin=250mW/Area Scan (81x81x1): Interpolated grid: dx=1.200 mm, dy=1.200 mm

Maximum value of SAR (interpolated) = 21.6 W/kg

Pin=250mW/Zoom Scan (7x7x7)/Cube 0: Measurement grid: dx=5mm, dy=5mm, dz=5mm

Reference Value = 113.7 V/m; Power Drift = 0.15 dB

Peak SAR (extrapolated) = 30.1 W/kg

SAR(1 g) = **13.9 W/kg**; SAR(10 g) = **6.18 W/kg**

Maximum value of SAR (measured) = 21.7 W/kg

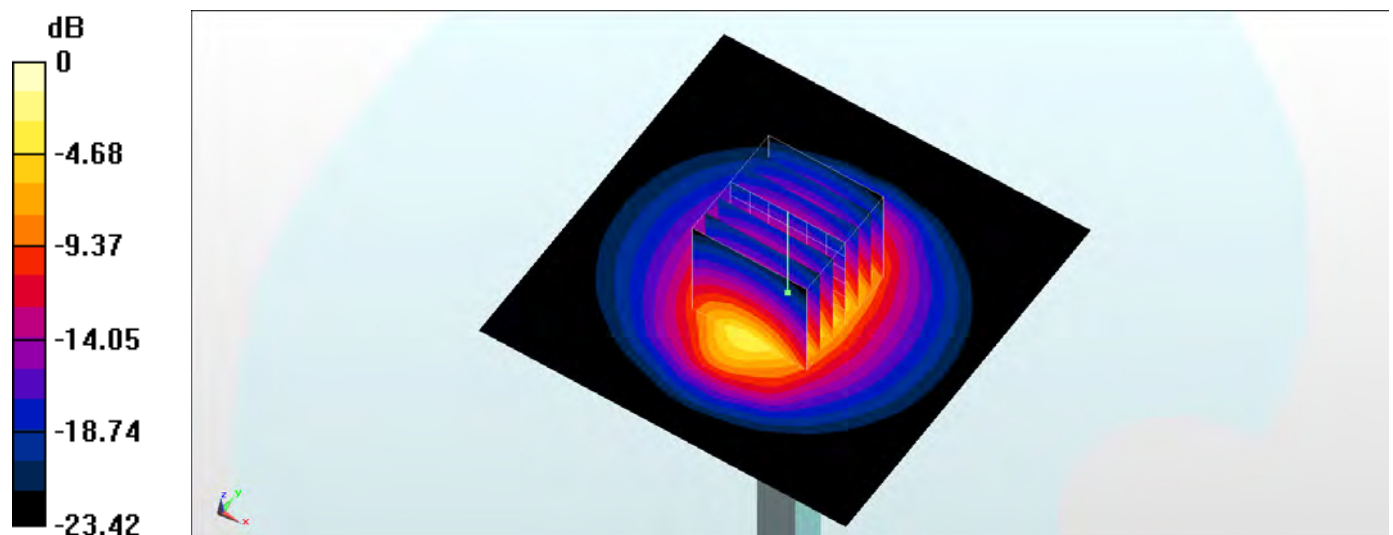

0 dB = 21.7 W/kg = 13.36 dBW/kg

System Check_Body_2600MHz

DUT: D2600V2-1058

Communication System: CW; Frequency: 2600 MHz; Duty Cycle: 1:1

Medium: MSL_2600_160825 Medium parameters used: $f = 2600$ MHz; $\sigma = 2.103$ S/m; $\epsilon_r = 51.672$; $\rho = 1000$ kg/m³

Ambient Temperature : 23.2 °C; Liquid Temperature : 22.2 °C

DASY5 Configuration

- Probe: EX3DV4 - SN3925; ConvF(7.38, 7.38, 7.38); Calibrated: 2016/5/26;
- Sensor-Surface: 1.4mm (Mechanical Surface Detection)
- Electronics: DAE3 Sn495; Calibrated: 2016/5/27
- Phantom: SAM_Right; Type: QD000P40CD; Serial: S/N:1801
- Measurement SW: DASY52, Version 52.8 (8); SEMCAD X Version 14.6.10 (7373)

Pin=250mW/Area Scan (61x61x1): Interpolated grid: dx=1.200 mm, dy=1.200 mm

Maximum value of SAR (interpolated) = 23.6 W/kg

Pin=250mW/Zoom Scan (7x7x7)/Cube 0: Measurement grid: dx=5mm, dy=5mm, dz=5mm

Reference Value = 108.3 V/m; Power Drift = 0.07 dB

Peak SAR (extrapolated) = 30.0 W/kg

SAR(1 g) = 13.8 W/kg; SAR(10 g) = 6.15 W/kg

Maximum value of SAR (measured) = 23.9 W/kg

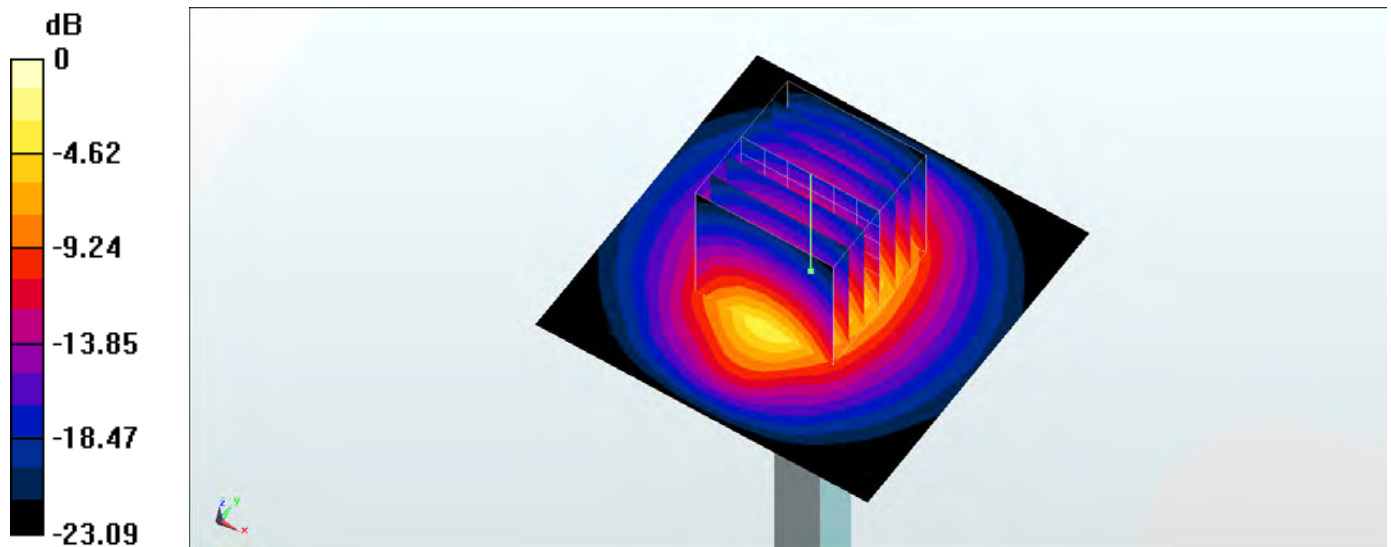

0 dB = 23.9 W/kg = 13.78 dBW/kg

System Check_Body_2600MHz

DUT: D2600V2-1058

Communication System: CW; Frequency: 2600 MHz; Duty Cycle: 1:1

Medium: MSL_2600_160904 Medium parameters used: $f = 2600$ MHz; $\sigma = 2.176$ S/m; $\epsilon_r = 53.028$; $\rho = 1000$ kg/m³

Ambient Temperature : 23.6 °C; Liquid Temperature : 22.6 °C

DASY5 Configuration:

- Probe: EX3DV4 - SN3955; ConvF(7.23, 7.23, 7.23); Calibrated: 2015/11/24;
- Sensor-Surface: 1.4mm (Mechanical Surface Detection)
- Electronics: DAE4 Sn778; Calibrated: 2016/5/12
- Phantom: SAM-Right; Type: SAM; Serial: 1795
- Measurement SW: DASY52, Version 52.8 (8); SEMCAD X Version 14.6.10 (7373)

Pin=250mW/Area Scan (71x71x1): Interpolated grid: dx=1.200 mm, dy=1.200 mm

Maximum value of SAR (interpolated) = 23.5 W/kg

Pin=250mW/Zoom Scan (7x7x7)/Cube 0: Measurement grid: dx=5mm, dy=5mm, dz=5mm

Reference Value = 106.7 V/m; Power Drift = 0.02 dB

Peak SAR (extrapolated) = 29.7 W/kg

SAR(1 g) = 13.5 W/kg; SAR(10 g) = 5.95 W/kg

Maximum value of SAR (measured) = 23.4 W/kg

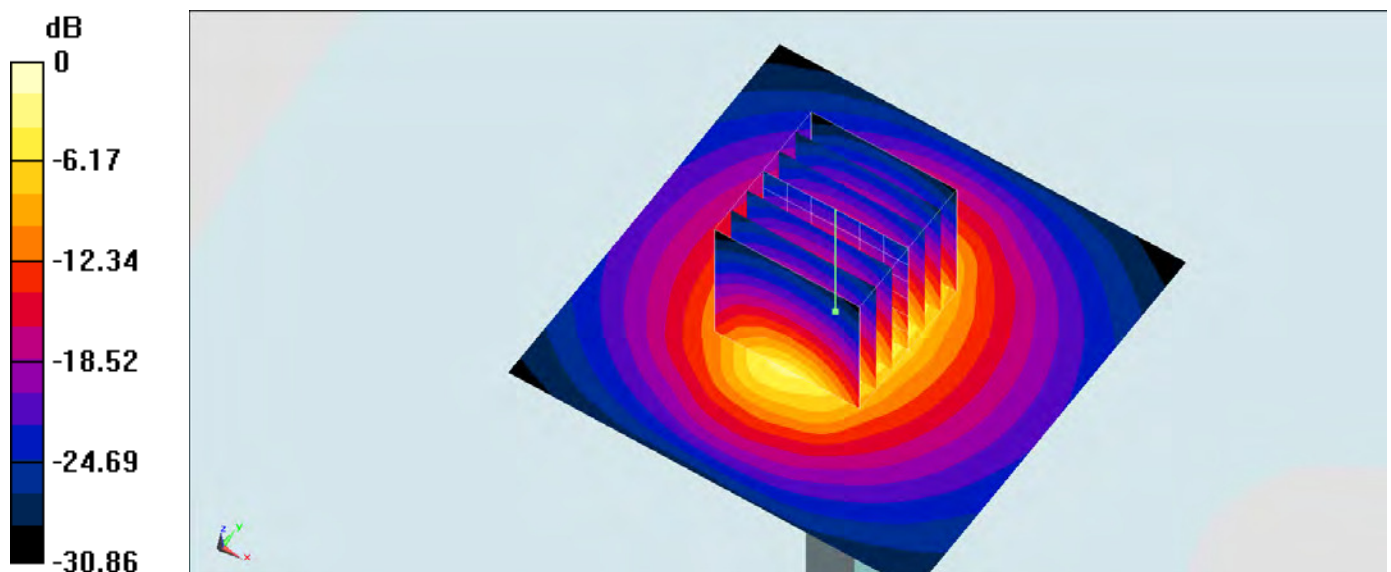

0 dB = 23.5 W/kg = 13.71 dBW/kg

System Check_Body_2600MHz

DUT: D2600V2-1058

Communication System: CW; Frequency: 2600 MHz; Duty Cycle: 1:1

Medium: MSL_2600_160906 Medium parameters used: $f = 2600$ MHz; $\sigma = 2.15$ S/m; $\epsilon_r = 51.411$; $\rho = 1000$ kg/m³

Ambient Temperature : 23.5 °C; Liquid Temperature : 22.5 °C

DASY5 Configuration

- Probe: ES3DV3 - SN3270; ConvF(4.12, 4.12, 4.12); Calibrated: 2016/8/26;
- Sensor-Surface: 3mm (Mechanical Surface Detection)
- Electronics: DAE4 Sn1399; Calibrated: 2015/11/23
- Phantom: SAM_Left; Type: QD000P40CD; Serial: S/N:1796
- Measurement SW: DASY52, Version 52.8 (8); SEMCAD X Version 14.6.10 (7373)

Pin=250mW/Area Scan (71x71x1): Interpolated grid: dx=1.200 mm, dy=1.200 mm

Maximum value of SAR (interpolated) = 20.2 W/kg

Pin=250mW/Zoom Scan (7x7x7)/Cube 0: Measurement grid: dx=5mm, dy=5mm, dz=5mm

Reference Value = 106.4 V/m; Power Drift = 0.13 dB

Peak SAR (extrapolated) = 28.4 W/kg

SAR(1 g) = 13.4 W/kg; SAR(10 g) = 5.99 W/kg

Maximum value of SAR (measured) = 20.7 W/kg

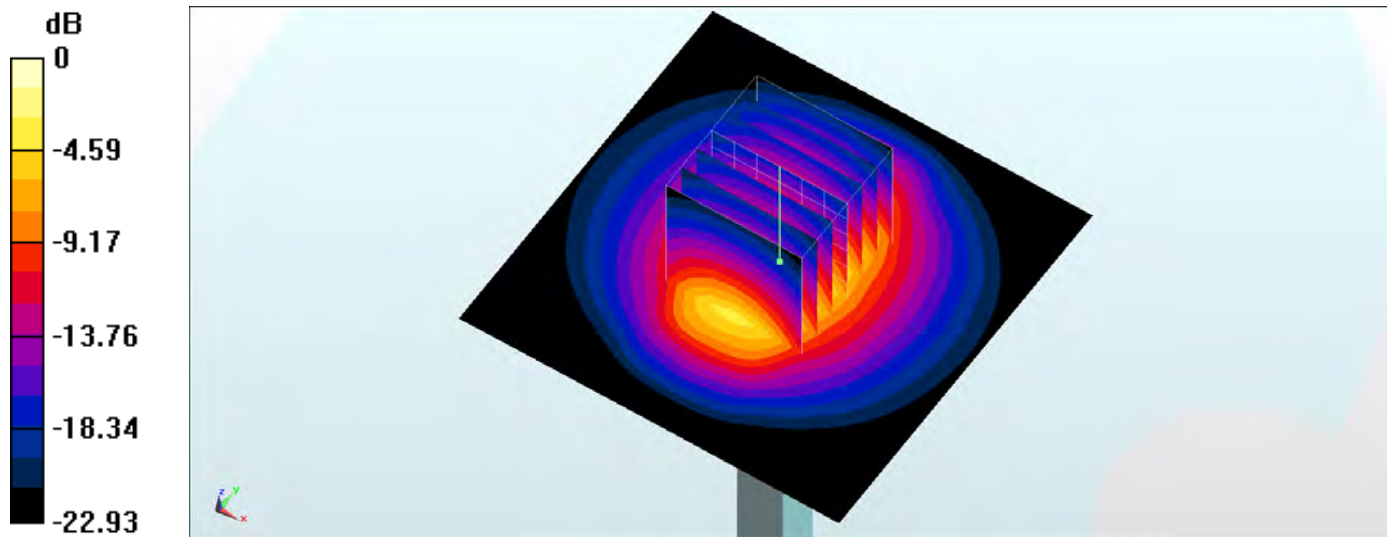

System Check_Head_5200MHz

DUT: D5GHzV2-1006

Communication System: CW; Frequency: 5200 MHz; Duty Cycle: 1:1

Medium: HSL_5G_160914 Medium parameters used: $f = 5200$ MHz; $\sigma = 4.45$ mho/m; $\epsilon_r = 35.6$; $\rho = 1000$ kg/m³

Ambient Temperature : 23.5 °C; Liquid Temperature : 22.5 °C

DASY4 Configuration:

- Probe: EX3DV4 - SN3925; ConvF(5.31, 5.31, 5.31); Calibrated: 2016/5/26
- Sensor-Surface: 1.4mm (Mechanical Surface Detection)
- Electronics: DAE3 Sn495; Calibrated: 2016/5/27
- Phantom: SAM_Right; Type: QD000P40CD; Serial: TP:1383
- ;Postprocessing SW: SEMCAD, V1.8 Build 159

Pin=100mW/Area Scan (71x71x1): Measurement grid: dx=10mm, dy=10mm

Maximum value of SAR (interpolated) = 17.9 mW/g

Pin=100mW/Zoom Scan (7x7x7)/Cube 0: Measurement grid: dx=4mm, dy=4mm, dz=1.4mm

Reference Value = 35.9 V/m; Power Drift = 0.026 dB

Peak SAR (extrapolated) = 31.5 W/kg

SAR(1 g) = 7.69 mW/g; SAR(10 g) = 2.13 mW/g

Maximum value of SAR (measured) = 18.9 mW/g

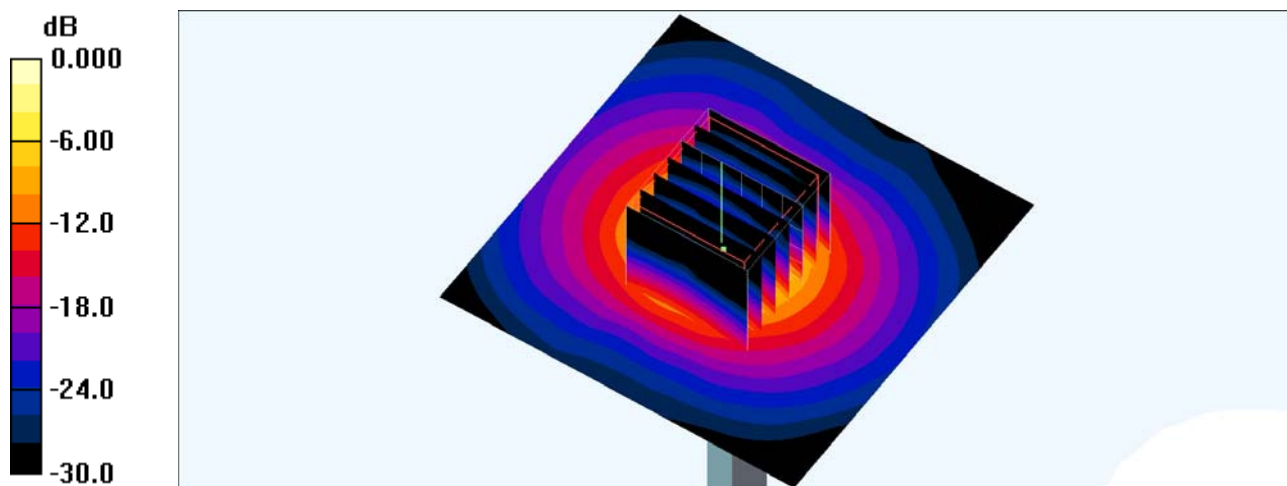

System Check_Head_5250MHz

DUT: D5GHzV2-1128

Communication System: CW ; Frequency: 5250 MHz;Duty Cycle: 1:1

Medium: HSL_5G_160912 Medium parameters used: $f = 5250$ MHz; $\sigma = 4.508$ S/m; $\epsilon_r = 35.614$; $\rho = 1000$ kg/m³

Ambient Temperature : 23.5 °C ; Liquid Temperature : 22.5 °C

DASY5 Configuration:

- Probe: EX3DV4 - SN3931; ConvF(5.13, 5.13, 5.13); Calibrated: 2015/10/1;
- Sensor-Surface: 1.4mm (Mechanical Surface Detection)
- Electronics: DAE3 Sn577; Calibrated: 2015/9/24
- Phantom: SAM-Right; Type: SAM; Serial: 1795
- Measurement SW: DASY52, Version 52.8 (8);SEMCAD X Version 14.6.10 (7373)

Pin=100mW/Area Scan (71x71x1): Interpolated grid: dx=1.000 mm, dy=1.000 mm

Maximum value of SAR (interpolated) = 18.4 W/kg

Pin=100mW/Zoom Scan (7x7x7)/Cube 0: Measurement grid: dx=4mm, dy=4mm, dz=1.4mm

Reference Value = 71.62 V/m; Power Drift = -0.15 dB

Peak SAR (extrapolated) = 27.3 W/kg

SAR(1 g) = 8.02 W/kg; SAR(10 g) = 2.36 W/kg

Maximum value of SAR (measured) = 18.8 W/kg

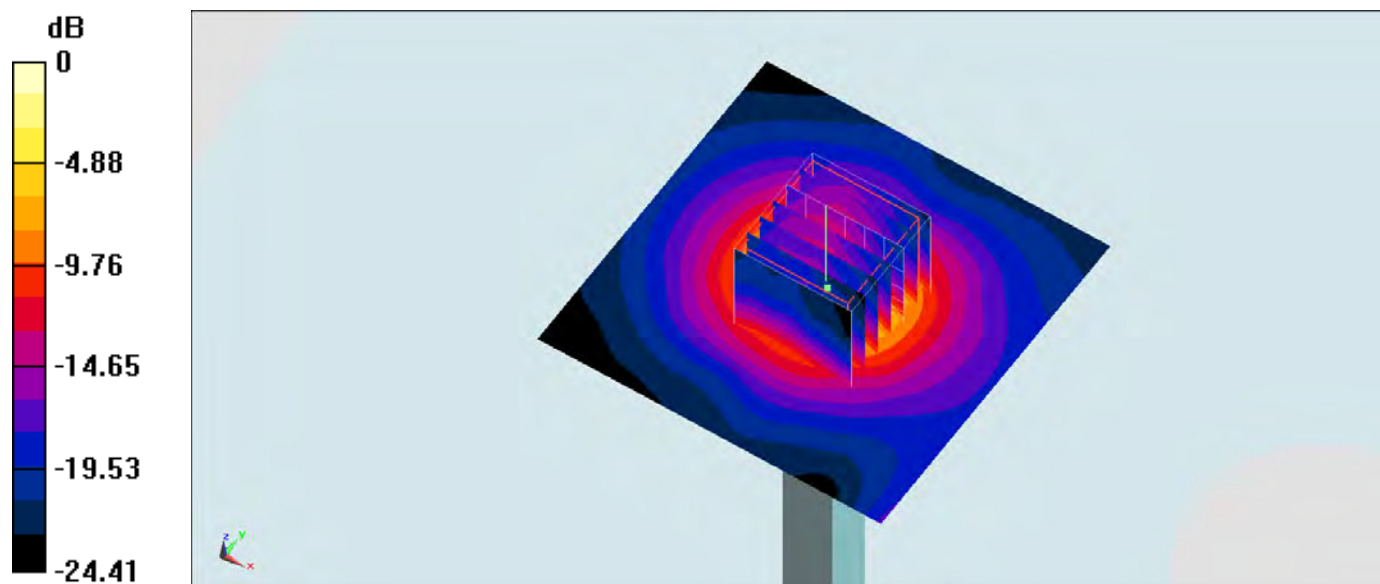

0 dB = 18.4 W/kg = 12.65 dBW/kg

System Check_Body_5250MHz

DUT: D5GHzV2-1128

Communication System: CW; Frequency: 5250 MHz; Duty Cycle: 1:1

Medium: MSL_5G_160827 Medium parameters used: $f = 5250$ MHz; $\sigma = 5.492$ S/m; $\epsilon_r = 46.888$; $\rho = 1000$ kg/m³

Ambient Temperature : 23.5 °C ; Liquid Temperature : 22.5 °C

DASY5 Configuration:

- Probe: EX3DV4 - SN3931; ConvF(4.48, 4.48, 4.48); Calibrated: 2015/10/1;
- Sensor-Surface: 1.4mm (Mechanical Surface Detection)
- Electronics: DAE3 Sn577; Calibrated: 2015/9/24
- Phantom: SAM-Right; Type: SAM; Serial: 1795
- Measurement SW: DASY52, Version 52.8 (8); SEMCAD X Version 14.6.10 (7373)

Pin=100mW/Area Scan (71x71x1): Interpolated grid: dx=1.000 mm, dy=1.000 mm

Maximum value of SAR (interpolated) = 18.3 W/kg

Pin=100mW/Zoom Scan (7x7x7)/Cube 0: Measurement grid: dx=4mm, dy=4mm, dz=1.4mm

Reference Value = 66.27 V/m; Power Drift = -0.10 dB

Peak SAR (extrapolated) = 28.3 W/kg

SAR(1 g) = 7.08 W/kg; SAR(10 g) = 1.93 W/kg

Maximum value of SAR (measured) = 17.5 W/kg

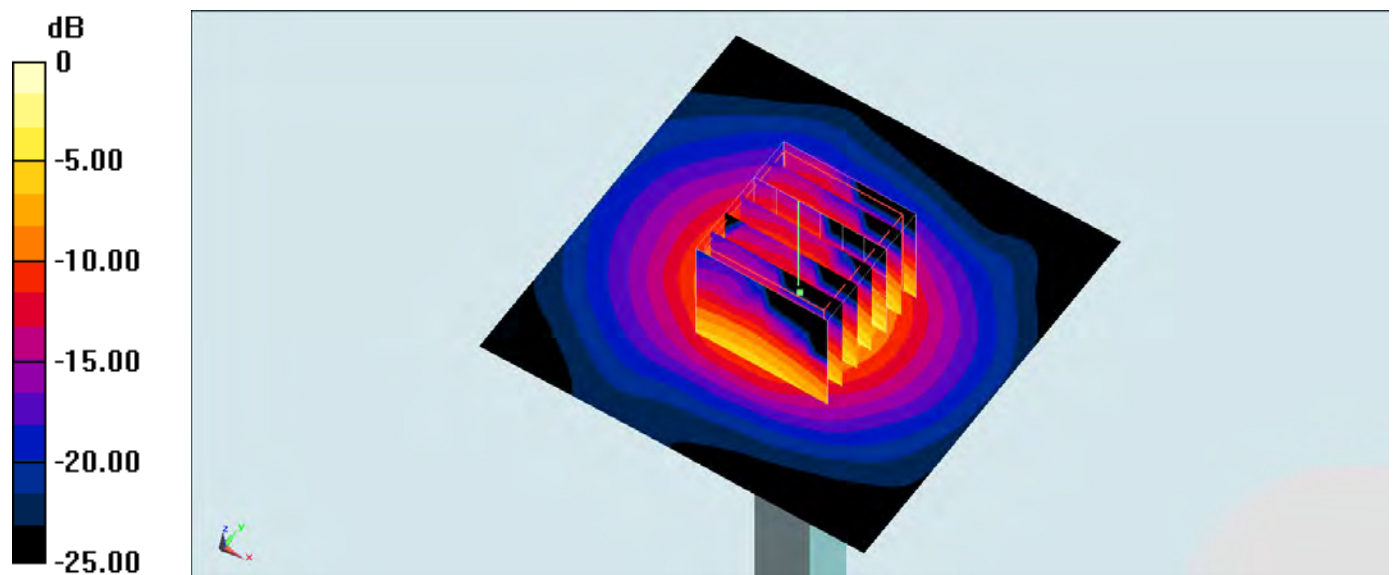

0 dB = 18.3 W/kg = 12.62 dBW/kg

System Check_Body_5250MHz

DUT: D5GHzV2-1128

Communication System: CW; Frequency: 5250 MHz; Duty Cycle: 1:1

Medium: MSL_5G_160905 Medium parameters used: $f = 5250 \text{ MHz}$; $\sigma = 5.4 \text{ mho/m}$; $\epsilon_r = 46.7$; $\rho = 1000 \text{ kg/m}^3$

Ambient Temperature : $23.4 \text{ }^\circ\text{C}$; Liquid Temperature : $22.4 \text{ }^\circ\text{C}$

DASY4 Configuration:

- Probe: EX3DV4 - SN3931; ConvF(4.48, 4.48, 4.48); Calibrated: 2015/10/1
- Sensor-Surface: 1.4mm (Mechanical Surface Detection)
- Electronics: DAE3 Sn577; Calibrated: 2015/9/24
- Phantom: SAM_Right; Type: SAM_Right; Serial: TP-1303
- ;Postprocessing SW: SEMCAD, V1.8 Build 159

Pin=100mW/Area Scan (71x71x1): Measurement grid: $dx=10\text{mm}$, $dy=10\text{mm}$

Maximum value of SAR (interpolated) = 18.6 mW/g

Pin=100mW/Zoom Scan (7x7x7)/Cube 0: Measurement grid: $dx=4\text{mm}$, $dy=4\text{mm}$, $dz=1.4\text{mm}$

Reference Value = 68.8 V/m ; Power Drift = -0.050 dB

Peak SAR (extrapolated) = 31.7 W/kg

SAR(1 g) = 7.62 mW/g ; SAR(10 g) = 2.08 mW/g

Maximum value of SAR (measured) = 19.3 mW/g

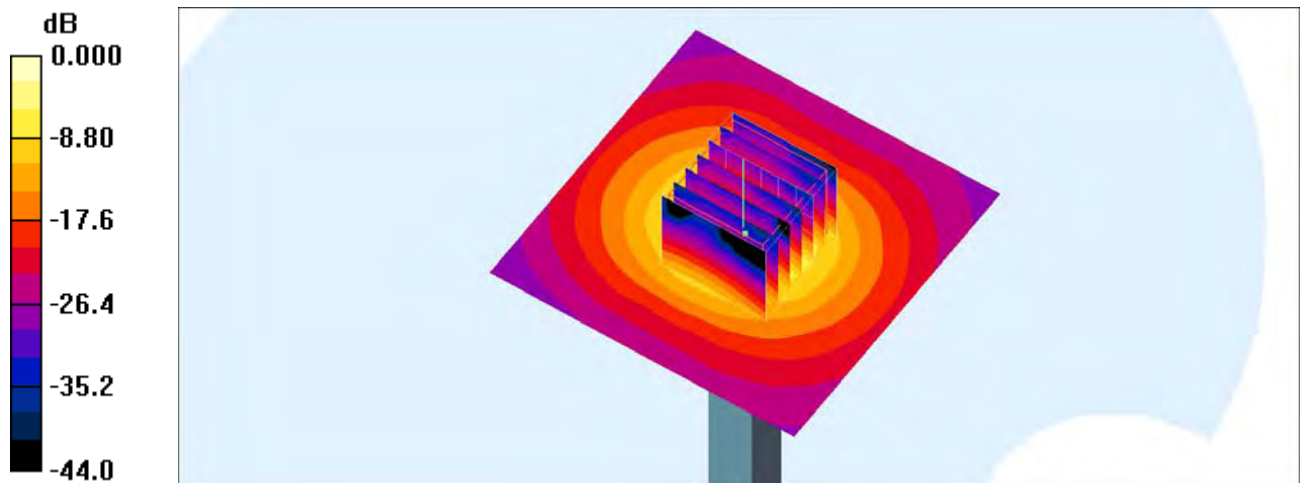

0 dB = 19.3mW/g

System Check_Body_5250MHz

DUT: D5GHzV2-1128

Communication System: CW; Frequency: 5250 MHz; Duty Cycle: 1:1

Medium: MSL_5G_160912 Medium parameters used: $f = 5250 \text{ MHz}$; $\sigma = 5.477 \text{ S/m}$; $\epsilon_r = 46.848$; $\rho = 1000 \text{ kg/m}^3$

Ambient Temperature : $23.5 \text{ }^\circ\text{C}$; Liquid Temperature : $22.5 \text{ }^\circ\text{C}$

DASY5 Configuration:

- Probe: EX3DV4 - SN3931; ConvF(4.48, 4.48, 4.48); Calibrated: 2015/10/1;
- Sensor-Surface: 1.4mm (Mechanical Surface Detection)
- Electronics: DAE3 Sn577; Calibrated: 2015/9/24
- Phantom: SAM-Right; Type: SAM; Serial: 1795
- Measurement SW: DASY52, Version 52.8 (8); SEMCAD X Version 14.6.10 (7373)

Pin=100mW/Area Scan (71x71x1): Interpolated grid: $dx=1.000 \text{ mm}$, $dy=1.000 \text{ mm}$

Maximum value of SAR (interpolated) = 18.3 W/kg

Pin=100mW/Zoom Scan (7x7x7)/Cube 0: Measurement grid: $dx=4\text{mm}$, $dy=4\text{mm}$, $dz=1.4\text{mm}$

Reference Value = 67.83 V/m ; Power Drift = 0.04 dB

Peak SAR (extrapolated) = 30.7 W/kg

SAR(1 g) = 7.84 W/kg ; SAR(10 g) = 2.18 W/kg

Maximum value of SAR (measured) = 19.1 W/kg

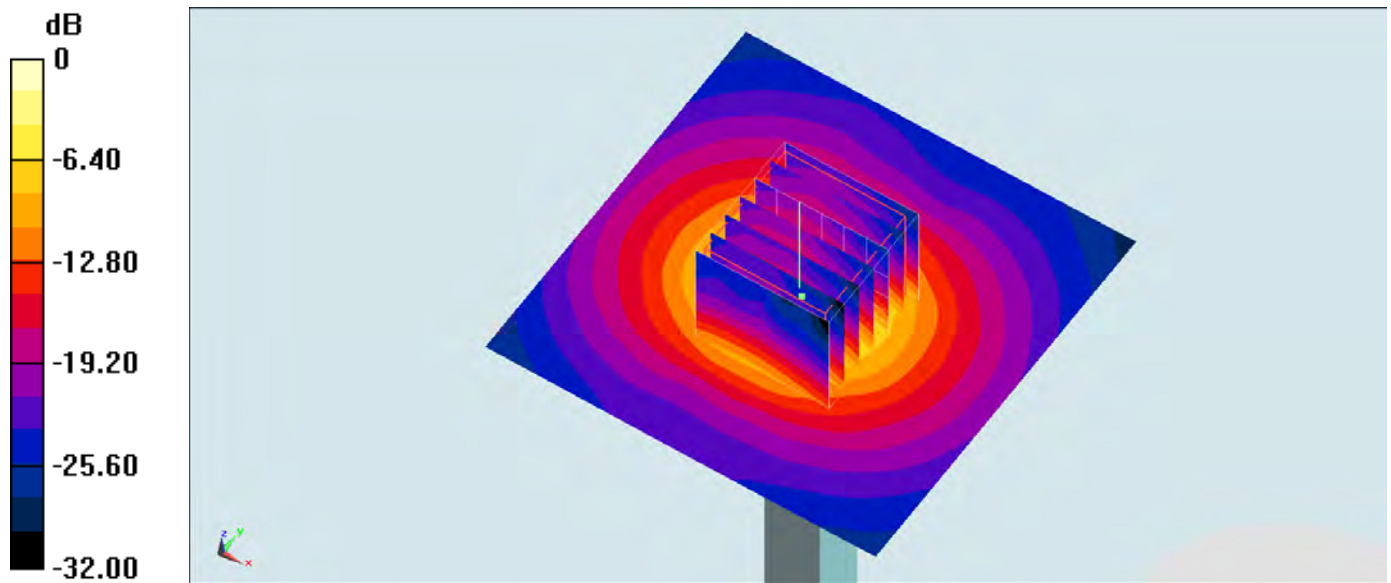

0 dB = $18.3 \text{ W/kg} = 12.62 \text{ dBW/kg}$

System Check_Head_5600MHz

DUT: D5GHzV2-1128

Communication System: CW ; Frequency: 5600 MHz;Duty Cycle: 1:1

Medium: HSL_5G_160824 Medium parameters used: $f = 5600$ MHz; $\sigma = 4.979$ S/m; $\epsilon_r = 35.931$; $\rho = 1000$ kg/m³

Ambient Temperature : 23.7 °C ; Liquid Temperature : 22.7 °C

DASY5 Configuration:

- Probe: EX3DV4 - SN3931; ConvF(4.42, 4.42, 4.42); Calibrated: 2015/10/1;
- Sensor-Surface: 1.4mm (Mechanical Surface Detection)
- Electronics: DAE3 Sn577; Calibrated: 2015/9/24
- Phantom: SAM-Right; Type: SAM; Serial: 1795
- Measurement SW: DASY52, Version 52.8 (8);SEMCAD X Version 14.6.10 (7373)

Pin=100mW/Area Scan (71x71x1): Interpolated grid: dx=1.000 mm, dy=1.000 mm

Maximum value of SAR (interpolated) = 18.4 W/kg

Pin=100mW/Zoom Scan (7x7x7)/Cube 0: Measurement grid: dx=4mm, dy=4mm, dz=1.4mm

Reference Value = 68.42 V/m; Power Drift = -0.14 dB

Peak SAR (extrapolated) = 27.3 W/kg

SAR(1 g) = 7.67 W/kg; SAR(10 g) = 2.26 W/kg

Maximum value of SAR (measured) = 18.4 W/kg

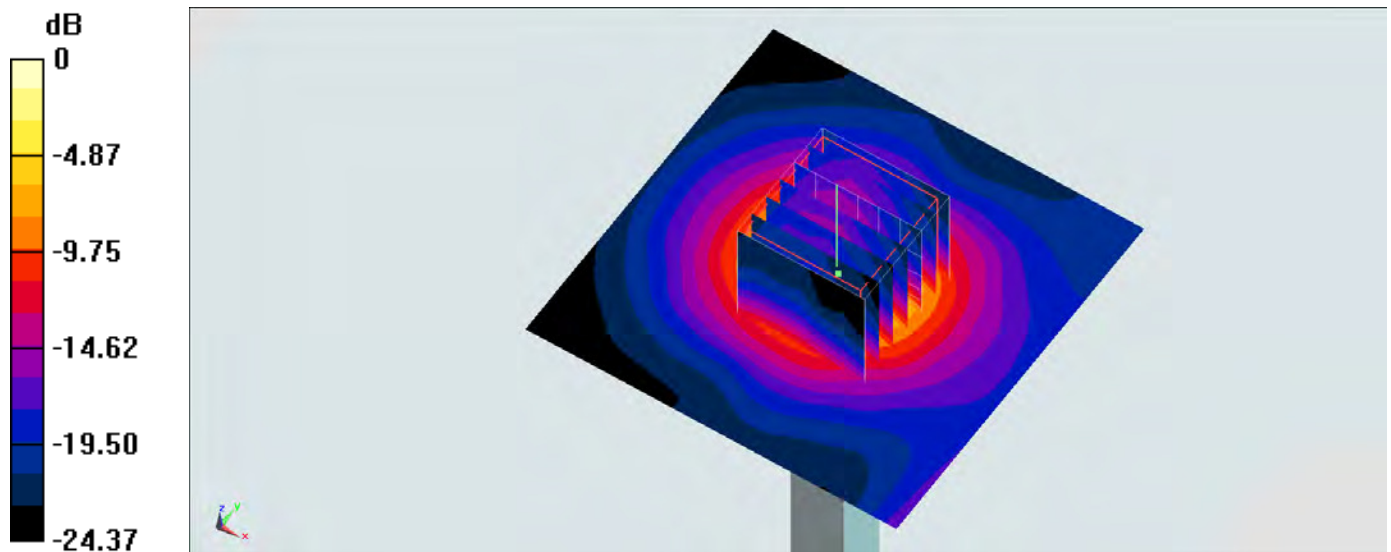

0 dB = 18.4 W/kg = 12.65 dBW/kg

System Check_Head_5600MHz

DUT: D5GHzV2-1128

Communication System: CW; Frequency: 5600 MHz; Duty Cycle: 1:1

Medium: HSL_5G_160905 Medium parameters used: $f = 5600 \text{ MHz}$; $\sigma = 4.83 \text{ mho/m}$; $\epsilon_r = 35.8$; $\rho = 1000 \text{ kg/m}^3$

Ambient Temperature : $23.4 \text{ }^\circ\text{C}$; Liquid Temperature : $22.4 \text{ }^\circ\text{C}$

DASY4 Configuration:

- Probe: EX3DV4 - SN3931; ConvF(4.42, 4.42, 4.42); Calibrated: 2015/10/1
- Sensor-Surface: 1.4mm (Mechanical Surface Detection)
- Electronics: DAE3 Sn577; Calibrated: 2015/9/24
- Phantom: SAM_Right; Type: SAM_Right; Serial: TP-1303
- ;Postprocessing SW: SEMCAD, V1.8 Build 159

Pin=100mW/Area Scan (71x71x1): Measurement grid: $dx=10\text{mm}$, $dy=10\text{mm}$

Maximum value of SAR (interpolated) = 21.0 mW/g

Pin=100mW/Zoom Scan (7x7x7)/Cube 0: Measurement grid: $dx=4\text{mm}$, $dy=4\text{mm}$, $dz=1.4\text{mm}$

Reference Value = 72.8 V/m ; Power Drift = -0.061 dB

Peak SAR (extrapolated) = 33.4 W/kg

SAR(1 g) = 8.14 mW/g ; SAR(10 g) = 2.24 mW/g

Maximum value of SAR (measured) = 19.9 mW/g

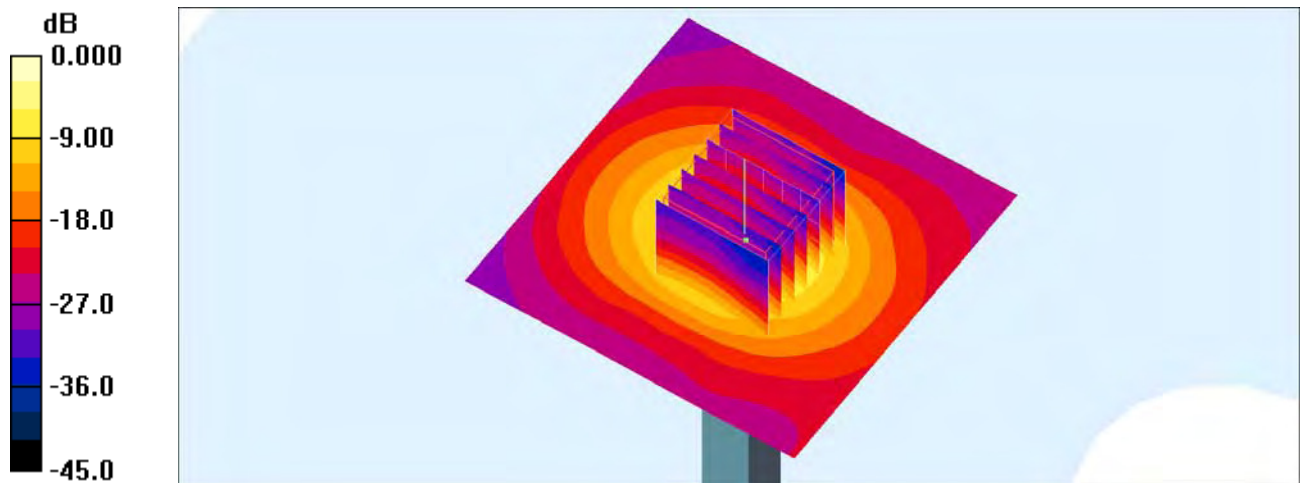

0 dB = 19.9mW/g

System Check_Head_5600MHz

DUT: D5GHzV2-1006

Communication System: CW; Frequency: 5600 MHz; Duty Cycle: 1:1

Medium: HSL_5G_160914 Medium parameters used: $f = 5600$ MHz; $\sigma = 4.84$ mho/m; $\epsilon_r = 35$; $\rho = 1000$ kg/m³

Ambient Temperature : 23.5 °C; Liquid Temperature : 22.5 °C

DASY4 Configuration:

- Probe: EX3DV4 - SN3925; ConvF(4.47, 4.47, 4.47); Calibrated: 2016/5/26
- Sensor-Surface: 1.4mm (Mechanical Surface Detection)
- Electronics: DAE3 Sn495; Calibrated: 2016/5/27
- Phantom: SAM_Right; Type: QD000P40CD; Serial: TP:1383
- ;Postprocessing SW: SEMCAD, V1.8 Build 159

Pin=100mW/Area Scan (71x71x1): Measurement grid: dx=10mm, dy=10mm

Maximum value of SAR (interpolated) = 19.9 mW/g

Pin=100mW/Zoom Scan (7x7x7)/Cube 0: Measurement grid: dx=4mm, dy=4mm, dz=1.4mm

Reference Value = 71.5 V/m; Power Drift = 0.136 dB

Peak SAR (extrapolated) = 32.9 W/kg

SAR(1 g) = 8.14 mW/g; SAR(10 g) = 2.23 mW/g

Maximum value of SAR (measured) = 20.6 mW/g

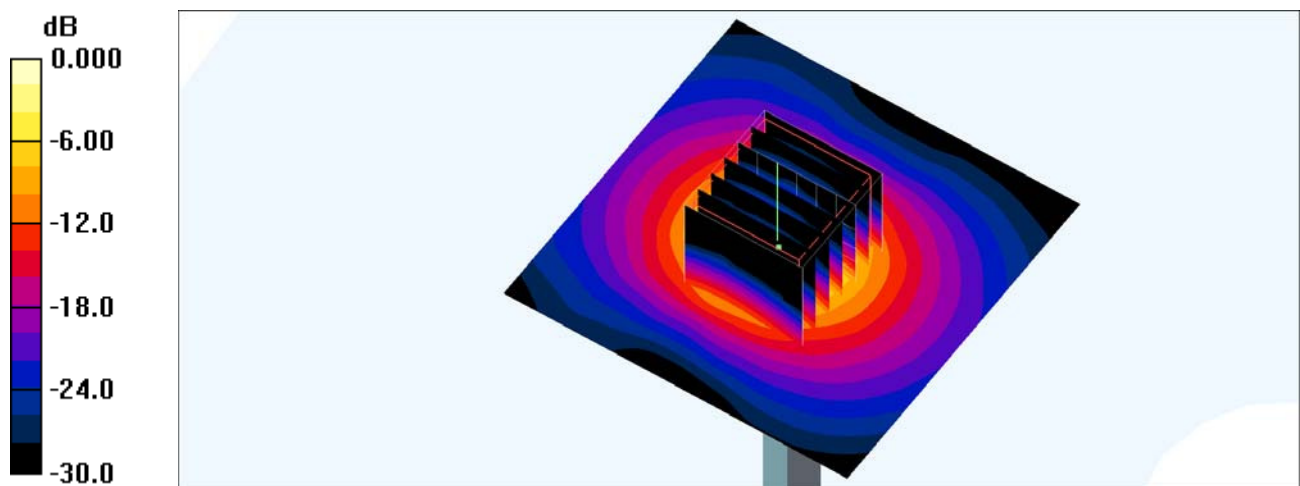

0 dB = 20.6mW/g

System Check_Body_5600MHz

DUT: D5GHzV2-1128

Communication System: CW; Frequency: 5600 MHz; Duty Cycle: 1:1

Medium: MSL_5G_160827 Medium parameters used: $f = 5600 \text{ MHz}$; $\sigma = 5.946 \text{ S/m}$; $\epsilon_r = 46.272$; $\rho = 1000 \text{ kg/m}^3$

Ambient Temperature : $23.5 \text{ }^\circ\text{C}$; Liquid Temperature : $22.5 \text{ }^\circ\text{C}$

DASY5 Configuration:

- Probe: EX3DV4 - SN3931; ConvF(3.84, 3.84, 3.84); Calibrated: 2015/10/1;
- Sensor-Surface: 1.4mm (Mechanical Surface Detection)
- Electronics: DAE3 Sn577; Calibrated: 2015/9/24
- Phantom: SAM-Right; Type: SAM; Serial: 1795
- Measurement SW: DASY52, Version 52.8 (8); SEMCAD X Version 14.6.10 (7373)

Pin=100mW/Area Scan (71x71x1): Interpolated grid: dx=1.000 mm, dy=1.000 mm

Maximum value of SAR (interpolated) = 23.5 W/kg

Pin=100mW/Zoom Scan (7x7x7)/Cube 0: Measurement grid: dx=4mm, dy=4mm, dz=1.4mm

Reference Value = 71.92 V/m ; Power Drift = -0.18 dB

Peak SAR (extrapolated) = 36.2 W/kg

SAR(1 g) = 8.31 W/kg ; SAR(10 g) = 2.26 W/kg

Maximum value of SAR (measured) = 21.1 W/kg

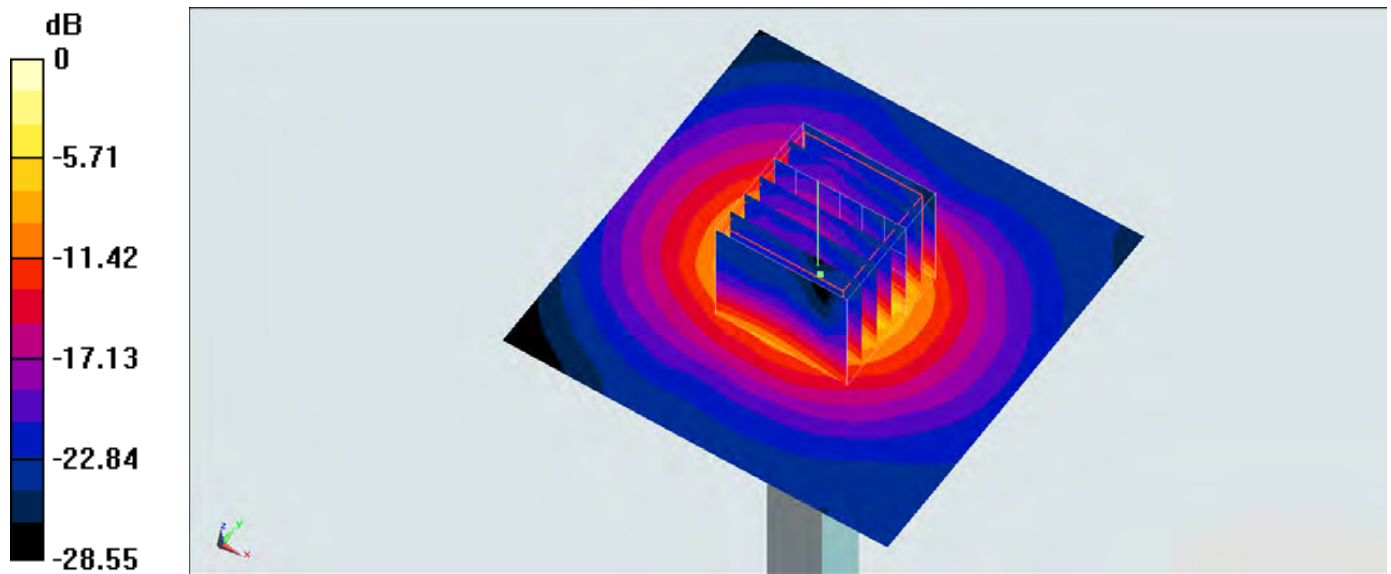

0 dB = $23.5 \text{ W/kg} = 13.71 \text{ dBW/kg}$

System Check_Body_5600MHz

DUT: D5GHzV2-1128

Communication System: CW; Frequency: 5600 MHz; Duty Cycle: 1:1

Medium: MSL_5G_160905 Medium parameters used: $f = 5600$ MHz; $\sigma = 5.85$ mho/m; $\epsilon_r = 46.2$; $\rho = 1000$ kg/m³

Ambient Temperature : 23.4 °C; Liquid Temperature : 22.4 °C

DASY4 Configuration:

- Probe: EX3DV4 - SN3931; ConvF(3.84, 3.84, 3.84); Calibrated: 2015/10/1
- Sensor-Surface: 1.4mm (Mechanical Surface Detection)
- Electronics: DAE3 Sn577; Calibrated: 2015/9/24
- Phantom: SAM_Right; Type: SAM_Right; Serial: TP-1303
- ;Postprocessing SW: SEMCAD, V1.8 Build 159

Pin=100mW/Area Scan (71x71x1): Measurement grid: dx=10mm, dy=10mm

Maximum value of SAR (interpolated) = 20.2 mW/g

Pin=100mW/Zoom Scan (7x7x7)/Cube 0: Measurement grid: dx=4mm, dy=4mm, dz=1.4mm

Reference Value = 64.2 V/m; Power Drift = -0.012 dB

Peak SAR (extrapolated) = 33.6 W/kg

SAR(1 g) = 7.75 mW/g; SAR(10 g) = 2.06 mW/g

Maximum value of SAR (measured) = 19.6 mW/g

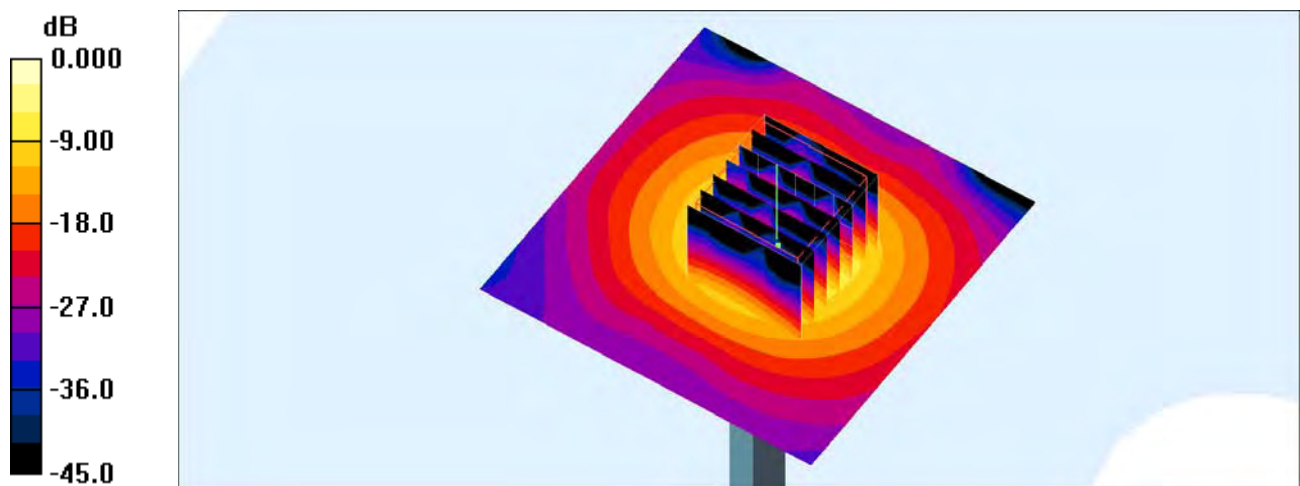

System Check_Head_5750MHz

DUT: D5GHzV2-1128

Communication System: CW ; Frequency: 5750 MHz;Duty Cycle: 1:1

Medium: HSL_5G_160824 Medium parameters used: $f = 5750$ MHz; $\sigma = 5.14$ S/m; $\epsilon_r = 35.708$; $\rho = 1000$ kg/m³

Ambient Temperature : 23.7 °C ; Liquid Temperature : 22.7 °C

DASY5 Configuration:

- Probe: EX3DV4 - SN3931; ConvF(4.58, 4.58, 4.58); Calibrated: 2015/10/1;
- Sensor-Surface: 1.4mm (Mechanical Surface Detection)
- Electronics: DAE3 Sn577; Calibrated: 2015/9/24
- Phantom: SAM-Right; Type: SAM; Serial: 1795
- Measurement SW: DASY52, Version 52.8 (8);SEMCAD X Version 14.6.10 (7373)

Pin=100mW/Area Scan (71x71x1): Interpolated grid: dx=1.000 mm, dy=1.000 mm

Maximum value of SAR (interpolated) = 19.4 W/kg

Pin=100mW/Zoom Scan (7x7x7)/Cube 0: Measurement grid: dx=4mm, dy=4mm, dz=1.4mm

Reference Value = 69.92 V/m; Power Drift = -0.09 dB

Peak SAR (extrapolated) = 33.5 W/kg

SAR(1 g) = 7.97 W/kg; SAR(10 g) = 2.21 W/kg

Maximum value of SAR (measured) = 20.5 W/kg

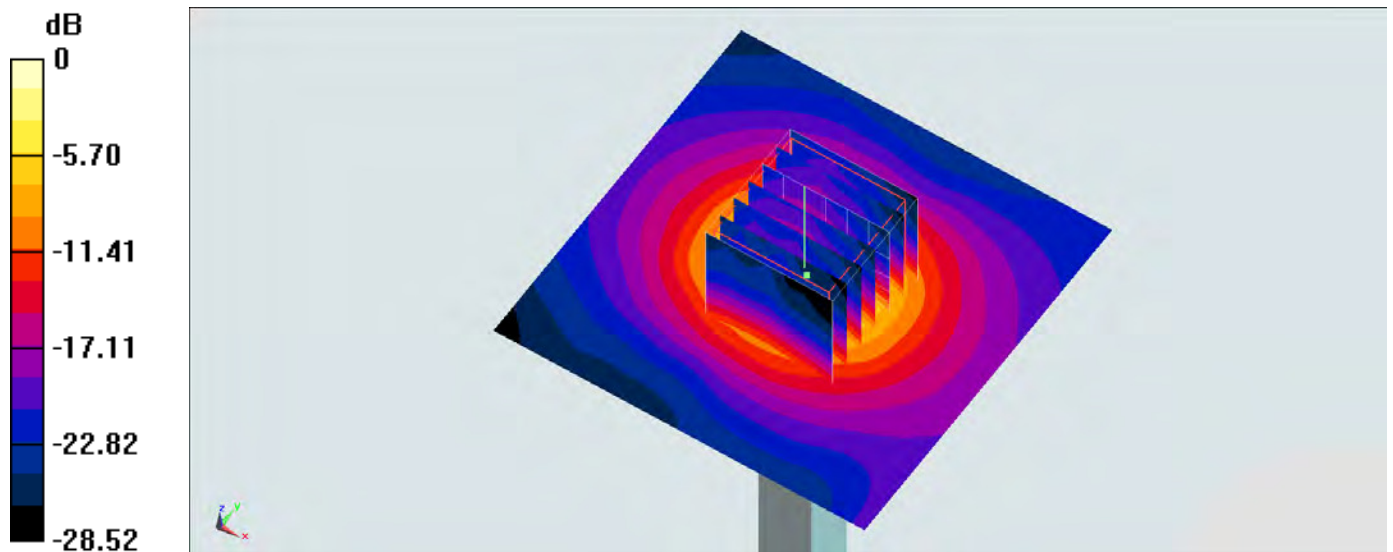

0 dB = 19.4 W/kg = 12.88 dBW/kg

System Check_Body_5750MHz

DUT: D5GHzV2-1128

Communication System: CW; Frequency: 5750 MHz; Duty Cycle: 1:1

Medium: MSL_5G_160827 Medium parameters used: $f = 5750$ MHz; $\sigma = 6.145$ S/m; $\epsilon_r = 46.009$; $\rho = 1000$ kg/m³

Ambient Temperature : 23.5 °C; Liquid Temperature : 22.5 °C

DASY5 Configuration:

- Probe: EX3DV4 - SN3931; ConvF(3.98, 3.98, 3.98); Calibrated: 2015/10/1;
- Sensor-Surface: 1.4mm (Mechanical Surface Detection)
- Electronics: DAE3 Sn577; Calibrated: 2015/9/24
- Phantom: SAM-Right; Type: SAM; Serial: 1795
- Measurement SW: DASY52, Version 52.8 (8); SEMCAD X Version 14.6.10 (7373)

Pin=100mW/Area Scan (71x71x1): Interpolated grid: dx=1.000 mm, dy=1.000 mm

Maximum value of SAR (interpolated) = 18.3 W/kg

Pin=100mW/Zoom Scan (7x7x7)/Cube 0: Measurement grid: dx=4mm, dy=4mm, dz=1.4mm

Reference Value = 64.76 V/m; Power Drift = -0.04 dB

Peak SAR (extrapolated) = 32.7 W/kg

SAR(1 g) = 7.39 W/kg; SAR(10 g) = 2.06 W/kg

Maximum value of SAR (measured) = 18.9 W/kg

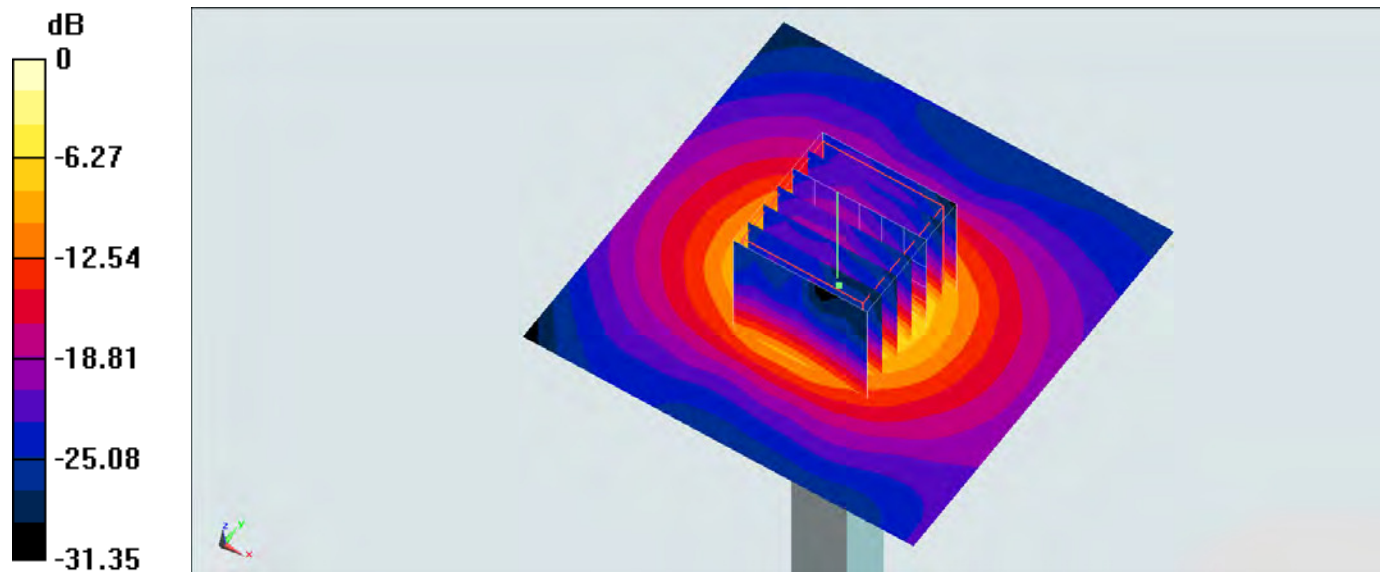

0 dB = 18.3 W/kg = 12.62 dBW/kg

System Check_Body_5750MHz

DUT: D5GHzV2-1128

Communication System: CW; Frequency: 5750 MHz; Duty Cycle: 1:1

Medium: MSL_5G_160905 Medium parameters used: $f = 5750 \text{ MHz}$; $\sigma = 6.04 \text{ mho/m}$; $\epsilon_r = 46$; $\rho = 1000 \text{ kg/m}^3$

Ambient Temperature : $23.4 \text{ }^\circ\text{C}$; Liquid Temperature : $22.4 \text{ }^\circ\text{C}$

DASY4 Configuration:

- Probe: EX3DV4 - SN3931; ConvF(3.98, 3.98, 3.98); Calibrated: 2015/10/1
- Sensor-Surface: 1.4mm (Mechanical Surface Detection)
- Electronics: DAE3 Sn577; Calibrated: 2015/9/24
- Phantom: SAM_Right; Type: SAM_Right; Serial: TP-1303
- ;Postprocessing SW: SEMCAD, V1.8 Build 159

Pin=100mW/Area Scan (71x71x1): Measurement grid: $dx=10\text{mm}$, $dy=10\text{mm}$

Maximum value of SAR (interpolated) = 19.0 mW/g

Pin=100mW/Zoom Scan (7x7x7)/Cube 0: Measurement grid: $dx=4\text{mm}$, $dy=4\text{mm}$, $dz=1.4\text{mm}$

Reference Value = 67.6 V/m ; Power Drift = 0.005 dB

Peak SAR (extrapolated) = 34.9 W/kg

SAR(1 g) = 7.69 mW/g ; SAR(10 g) = 2.08 mW/g

Maximum value of SAR (measured) = 20.1 mW/g

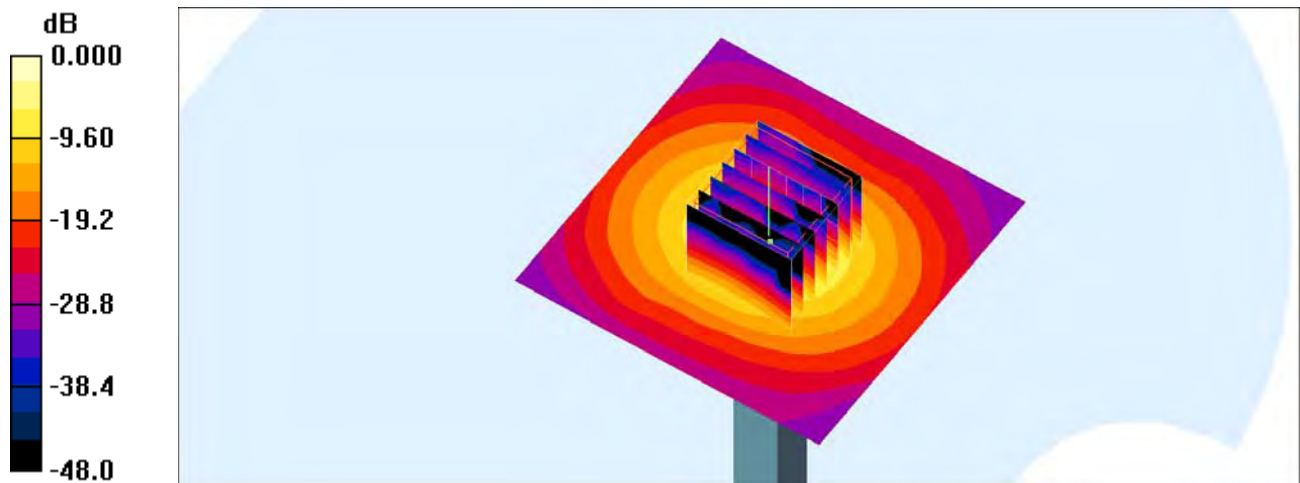

0 dB = 20.1mW/g

System Check_Head_5800MHz

DUT: D5GHzV2-1006

Communication System: CW; Frequency: 5800 MHz; Duty Cycle: 1:1

Medium: HSL_5G_160914 Medium parameters used: $f = 5800 \text{ MHz}$; $\sigma = 5.04 \text{ mho/m}$; $\epsilon_r = 34.8$; $\rho = 1000 \text{ kg/m}^3$

Ambient Temperature : $23.5 \text{ }^\circ\text{C}$; Liquid Temperature : $22.5 \text{ }^\circ\text{C}$

DASY4 Configuration:

- Probe: EX3DV4 - SN3925; ConvF(4.51, 4.51, 4.51); Calibrated: 2016/5/26
- Sensor-Surface: 1.4mm (Mechanical Surface Detection)
- Electronics: DAE3 Sn495; Calibrated: 2016/5/27
- Phantom: SAM_Right; Type: QD000P40CD; Serial: TP:1383
- ;Postprocessing SW: SEMCAD, V1.8 Build 159

Pin=100mW/Area Scan (71x71x1): Measurement grid: $dx=10\text{mm}$, $dy=10\text{mm}$

Maximum value of SAR (interpolated) = 20.6 mW/g

Pin=100mW/Zoom Scan (7x7x7)/Cube 0: Measurement grid: $dx=4\text{mm}$, $dy=4\text{mm}$, $dz=1.4\text{mm}$

Reference Value = 70.7 V/m ; Power Drift = 0.013 dB

Peak SAR (extrapolated) = 34.3 W/kg

SAR(1 g) = 8.31 mW/g ; SAR(10 g) = 2.25 mW/g

Maximum value of SAR (measured) = 21.0 mW/g

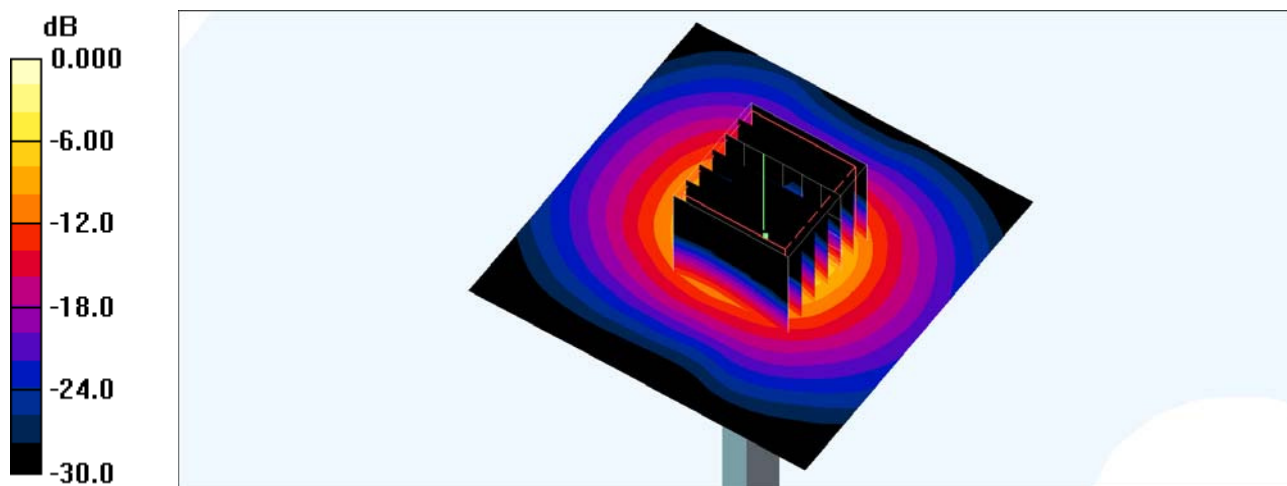

0 dB = 21.0mW/g



Appendix B. Plots of SAR Measurement

The plots are shown as follows.

#01_GSM850_GPRS (4 Tx slots)_Right Cheek_Ch251;ANT1

Communication System: GSM850 ; Frequency: 848.8 MHz; Duty Cycle: 1:2.08

Medium: HSL_850_160830 Medium parameters used: $f = 849$ MHz; $\sigma = 0.911$ S/m; $\epsilon_r = 42.867$; $\rho = 1000$ kg/m³

Ambient Temperature : 23.4 °C ; Liquid Temperature : 22.4 °C

DASY5 Configuration

- Probe: EX3DV4 - SN3925; ConvF(9.92, 9.92, 9.92); Calibrated: 2016/5/26;
- Sensor-Surface: 1.4mm (Mechanical Surface Detection)
- Electronics: DAE3 Sn495; Calibrated: 2016/5/27
- Phantom: SAM_Right; Type: QD000P40CD; Serial: S/N:1801
- Measurement SW: DASY52, Version 52.8 (8); SEMCAD X Version 14.6.10 (7373)

Area Scan (61x111x1): Interpolated grid: dx=1.500 mm, dy=1.500 mm

Maximum value of SAR (interpolated) = 0.254 W/kg

Zoom Scan (5x5x7)/Cube 0: Measurement grid: dx=8mm, dy=8mm, dz=5mm

Reference Value = 14.56 V/m; Power Drift = -0.02 dB

Peak SAR (extrapolated) = 0.361 W/kg

SAR(1 g) = 0.188 W/kg; SAR(10 g) = 0.109 W/kg

Maximum value of SAR (measured) = 0.269 W/kg

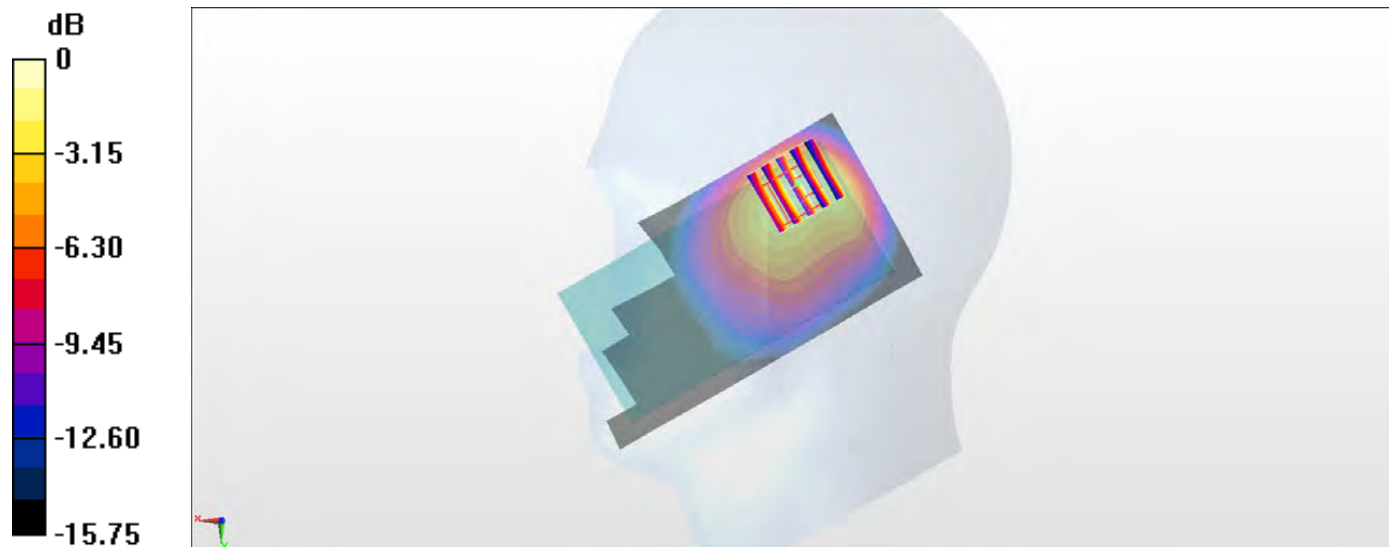

0 dB = 0.269 W/kg = -5.70 dBW/kg

#02_GSM1900_GPRS (4 Tx slots)_Right Cheek_Ch661;ANT1

Communication System: PCS; Frequency: 1880 MHz; Duty Cycle: 1:2.08

Medium: HSL_1900_160901 Medium parameters used: $f = 1880$ MHz; $\sigma = 1.411$ S/m; $\epsilon_r = 38.401$; $\rho = 1000$ kg/m³

Ambient Temperature : 23.6 °C ; Liquid Temperature : 22.6 °C

DASY5 Configuration

- Probe: EX3DV4 - SN3925; ConvF(8.3, 8.3, 8.3); Calibrated: 2016/5/26;
- Sensor-Surface: 1.4mm (Mechanical Surface Detection)
- Electronics: DAE3 Sn495; Calibrated: 2016/5/27
- Phantom: SAM_Left; Type: QD000P40CD; Serial: S/N:1796
- Measurement SW: DASY52, Version 52.8 (8); SEMCAD X Version 14.6.10 (7373)

Area Scan (61x111x1): Interpolated grid: dx=1.500 mm, dy=1.500 mm

Maximum value of SAR (interpolated) = 0.482 W/kg

Zoom Scan (5x5x7)/Cube 0: Measurement grid: dx=8mm, dy=8mm, dz=5mm

Reference Value = 15.93 V/m; Power Drift = -0.00 dB

Peak SAR (extrapolated) = 0.492 W/kg

SAR(1 g) = 0.272 W/kg; SAR(10 g) = 0.140 W/kg

Maximum value of SAR (measured) = 0.410 W/kg

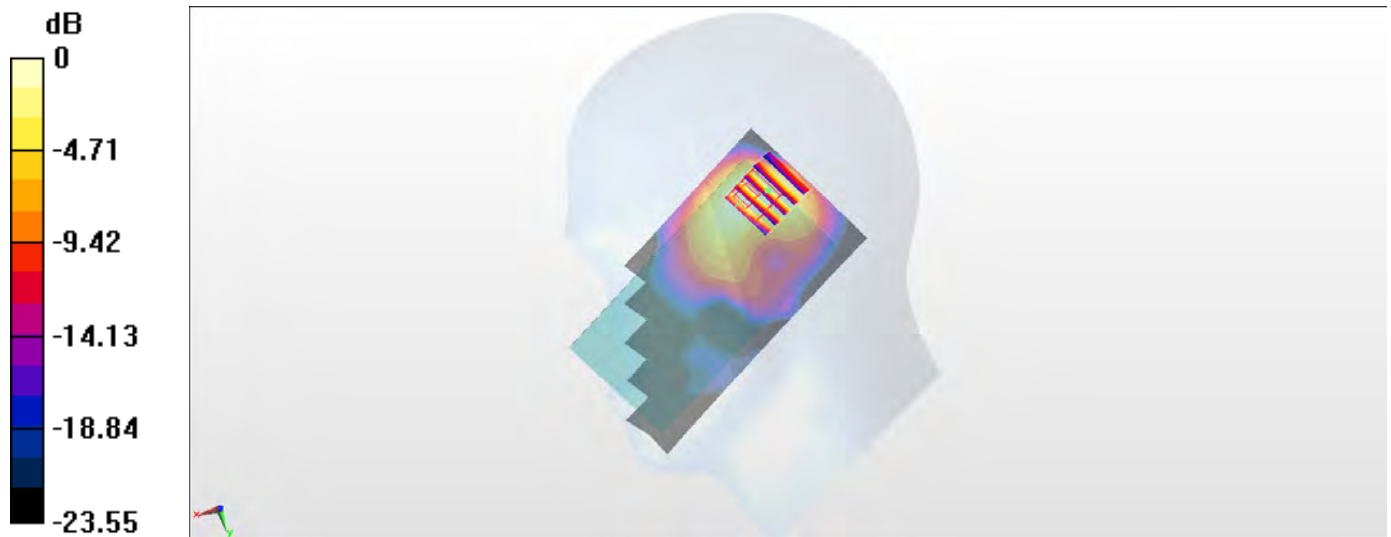

0 dB = 0.410 W/kg = -3.87 dBW/kg

#03_WCDMA II_RMC 12.2Kbps_Right Cheek_ANT1;Sample 2

Communication System: WCDMA; Frequency: 1907.6 MHz; Duty Cycle: 1:1

Medium: HSL_1900_160901 Medium parameters used: $f = 1908$ MHz; $\sigma = 1.44$ S/m; $\epsilon_r = 38.274$; $\rho = 1000$ kg/m³

Ambient Temperature : 23.6 °C ; Liquid Temperature : 22.6 °C

DASY5 Configuration

- Probe: EX3DV4 - SN3925; ConvF(8.3, 8.3, 8.3); Calibrated: 2016/5/26;
- Sensor-Surface: 1.4mm (Mechanical Surface Detection)
- Electronics: DAE3 Sn495; Calibrated: 2016/5/27
- Phantom: SAM_Left; Type: QD000P40CD; Serial: S/N:1796
- Measurement SW: DASY52, Version 52.8 (8); SEMCAD X Version 14.6.10 (7373)

Area Scan (61x111x1): Interpolated grid: dx=1.500 mm, dy=1.500 mm

Maximum value of SAR (interpolated) = 0.719 W/kg

Zoom Scan (5x5x7)/Cube 0: Measurement grid: dx=8mm, dy=8mm, dz=5mm

Reference Value = 20.02 V/m; Power Drift = 0.02 dB

Peak SAR (extrapolated) = 0.744 W/kg

SAR(1 g) = 0.420 W/kg; SAR(10 g) = 0.222 W/kg

Maximum value of SAR (measured) = 0.600 W/kg

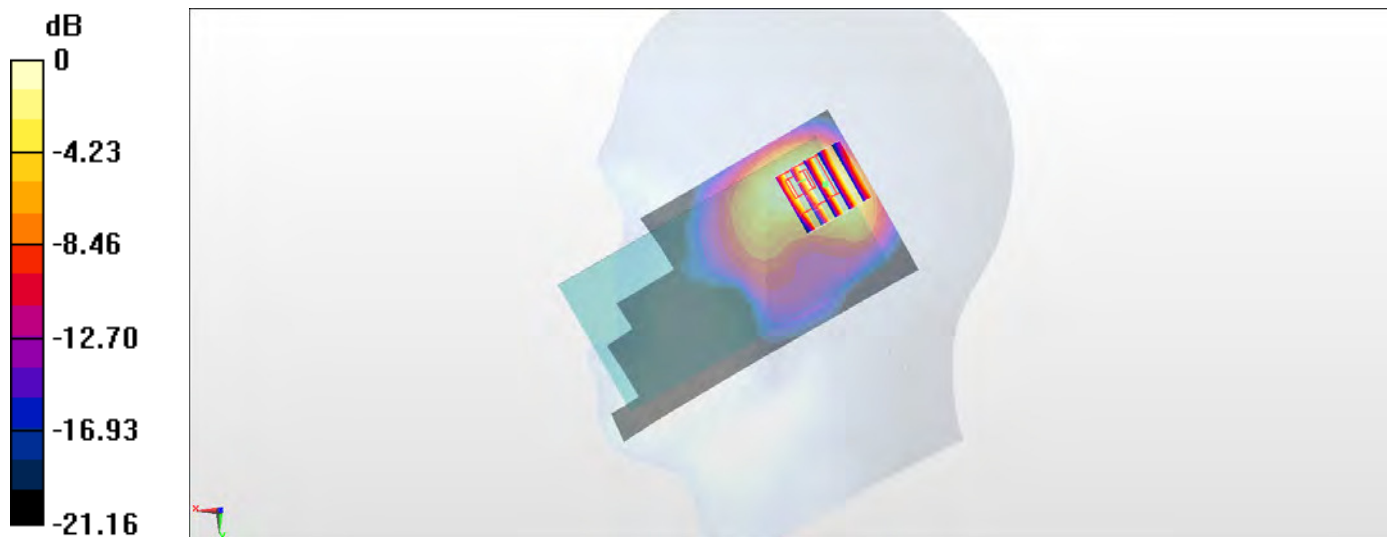

0 dB = 0.600 W/kg = -2.22 dBW/kg

#04_WCDMA IV_RMC 12.2Kbps_Right Cheek_Ch1312;ANT1;Sample 2

Communication System: WCDMA; Frequency: 1712.4 MHz; Duty Cycle: 1:1

Medium: HSL_1750_160902 Medium parameters used: $f = 1712.4$ MHz; $\sigma = 1.338$ S/m; $\epsilon_r = 40.551$;

$\rho = 1000$ kg/m³

Ambient Temperature : 23.6 °C ; Liquid Temperature : 22.6 °C

DASY5 Configuration

- Probe: EX3DV4 - SN3925; ConvF(8.57, 8.57, 8.57); Calibrated: 2016/5/26;

- Sensor-Surface: 1.4mm (Mechanical Surface Detection)

- Electronics: DAE3 Sn495; Calibrated: 2016/5/27

- Phantom: SAM_Left; Type: QD000P40CD; Serial: S/N:1796

- Measurement SW: DASY52, Version 52.8 (8); SEMCAD X Version 14.6.10 (7373)

Area Scan (61x111x1): Interpolated grid: dx=1.500 mm, dy=1.500 mm

Maximum value of SAR (interpolated) = 0.722 W/kg

Zoom Scan (5x5x7)/Cube 0: Measurement grid: dx=8mm, dy=8mm, dz=5mm

Reference Value = 25.18 V/m; Power Drift = 0.09 dB

Peak SAR (extrapolated) = 1.02 W/kg

SAR(1 g) = 0.506 W/kg; SAR(10 g) = 0.253 W/kg

Maximum value of SAR (measured) = 0.753 W/kg

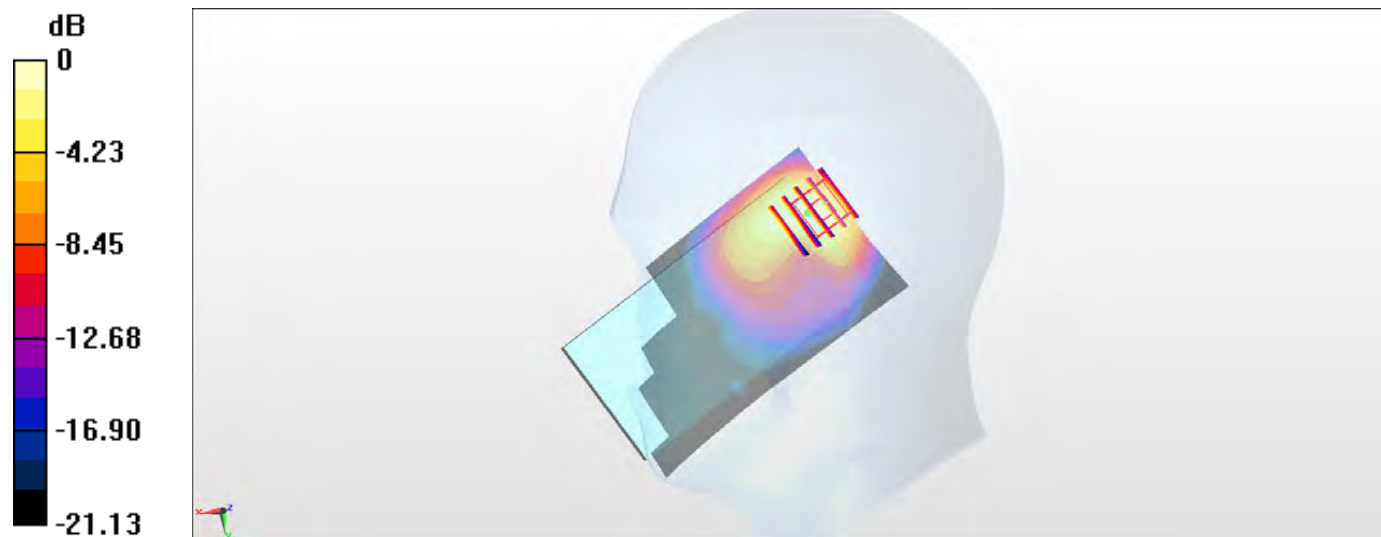

0 dB = 0.753 W/kg = -1.23 dBW/kg

#05_WCDMA V_RMC 12.2Kbps_Right Cheek_ANT1

Communication System: WCDMA ; Frequency: 826.4 MHz;Duty Cycle: 1:1

Medium: HSL_850_160830 Medium parameters used : $f = 826.4$ MHz; $\sigma = 0.889$ S/m; $\epsilon_r = 43.167$; $\rho = 1000$ kg/m³

Ambient Temperature : 23.4 °C ; Liquid Temperature : 22.4 °C

DASY5 Configuration

- Probe: EX3DV4 - SN3925; ConvF(9.92, 9.92, 9.92); Calibrated: 2016/5/26;
- Sensor-Surface: 1.4mm (Mechanical Surface Detection)
- Electronics: DAE3 Sn495; Calibrated: 2016/5/27
- Phantom: SAM_Right; Type: QD000P40CD; Serial: S/N:1801
- Measurement SW: DASY52, Version 52.8 (8); SEMCAD X Version 14.6.10 (7373)

Area Scan (61x111x1): Interpolated grid: dx=1.500 mm, dy=1.500 mm

Maximum value of SAR (interpolated) = 0.108 W/kg

Zoom Scan (5x5x7)/Cube 0: Measurement grid: dx=8mm, dy=8mm, dz=5mm

Reference Value = 9.179 V/m; Power Drift = 0.15 dB

Peak SAR (extrapolated) = 0.157 W/kg

SAR(1 g) = 0.078 W/kg; SAR(10 g) = 0.044 W/kg

Maximum value of SAR (measured) = 0.113 W/kg



0 dB = 0.113 W/kg = -9.47 dBW/kg

#06_LTE Band 2_20M_QPSK_1_0_Right Cheek_Ant1;Sample 2

Communication System: LTE ; Frequency: 1880 MHz;Duty Cycle: 1:1

Medium: HSL_1900_160901 Medium parameters used: $f = 1880$ MHz; $\sigma = 1.411$ S/m; $\epsilon_r = 38.401$; $\rho = 1000$ kg/m³

Ambient Temperature : 23.6 °C ; Liquid Temperature : 22.6 °C

DASY5 Configuration

- Probe: EX3DV4 - SN3925; ConvF(8.3, 8.3, 8.3); Calibrated: 2016/5/26;
- Sensor-Surface: 1.4mm (Mechanical Surface Detection)
- Electronics: DAE3 Sn495; Calibrated: 2016/5/27
- Phantom: SAM_Left; Type: QD000P40CD; Serial: S/N:1796
- Measurement SW: DASY52, Version 52.8 (8); SEMCAD X Version 14.6.10 (7373)

Area Scan (61x111x1): Interpolated grid: dx=1.500 mm, dy=1.500 mm

Maximum value of SAR (interpolated) = 0.792 W/kg

Zoom Scan (5x5x7)/Cube 0: Measurement grid: dx=8mm, dy=8mm, dz=5mm

Reference Value = 20.35 V/m; Power Drift = -0.04 dB

Peak SAR (extrapolated) = 0.807 W/kg

SAR(1 g) = 0.433 W/kg; SAR(10 g) = 0.236 W/kg

Maximum value of SAR (measured) = 0.637 W/kg

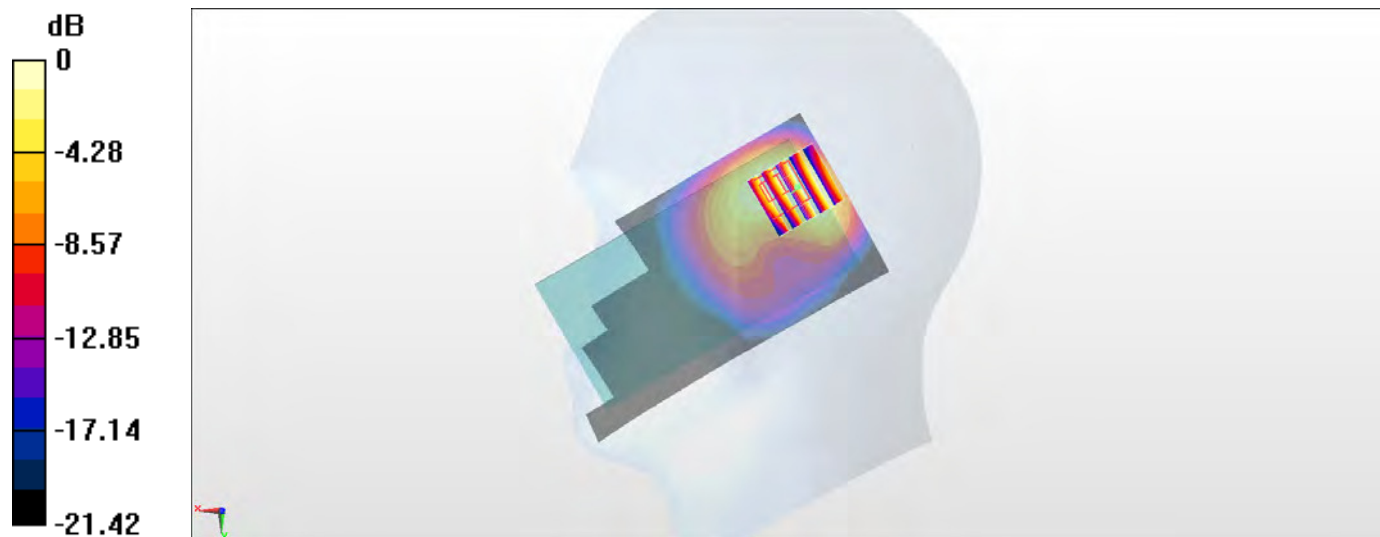

0 dB = 0.637 W/kg = -1.96 dBW/kg

#07_LTE Band 4_20M_QPSK_1_0_Right Cheek_Ch20175;ANT1;Sample 2

Communication System: LTE ; Frequency: 1732.5 MHz;Duty Cycle: 1:1

Medium: HSL_1750_160902 Medium parameters used: $f = 1732.5$ MHz; $\sigma = 1.357$ S/m; $\epsilon_r = 40.443$;

$\rho = 1000$ kg/m³

Ambient Temperature : 23.6 °C ; Liquid Temperature : 22.6 °C

DASY5 Configuration

- Probe: EX3DV4 - SN3925; ConvF(8.57, 8.57, 8.57); Calibrated: 2016/5/26;

- Sensor-Surface: 1.4mm (Mechanical Surface Detection)

- Electronics: DAE3 Sn495; Calibrated: 2016/5/27

- Phantom: SAM_Left; Type: QD000P40CD; Serial: S/N:1796

- Measurement SW: DASY52, Version 52.8 (8); SEMCAD X Version 14.6.10 (7373)

Area Scan (61x111x1): Interpolated grid: dx=1.500 mm, dy=1.500 mm

Maximum value of SAR (interpolated) = 0.854 W/kg

Zoom Scan (5x5x7)/Cube 0: Measurement grid: dx=8mm, dy=8mm, dz=5mm

Reference Value = 23.78 V/m; Power Drift = -0.02 dB

Peak SAR (extrapolated) = 0.962 W/kg

SAR(1 g) = 0.484 W/kg; SAR(10 g) = 0.242 W/kg

Maximum value of SAR (measured) = 0.800 W/kg

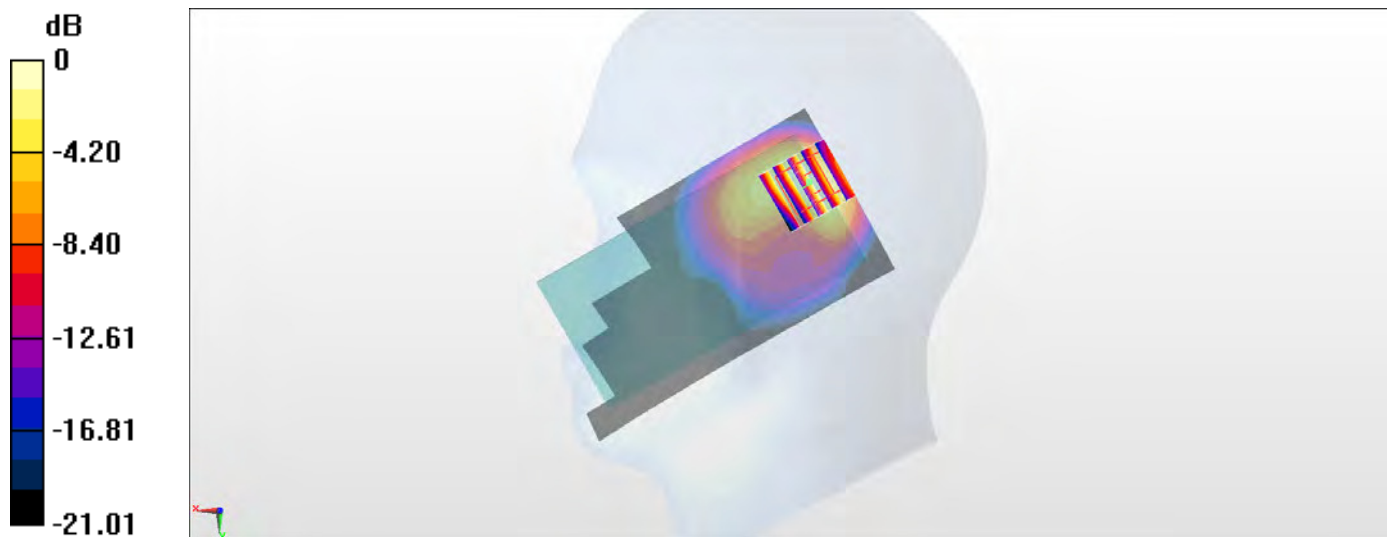

0 dB = 0.800 W/kg = -0.97 dBW/kg

#08_LTE Band 5_10M_QPSK_1_0_Left Cheek_Ch20525;ANT0;Sample 2

Communication System: LTE; Frequency: 836.5 MHz; Duty Cycle: 1:1

Medium: HSL_850_160901 Medium parameters used: $f = 836.5$ MHz; $\sigma = 0.892$ S/m; $\epsilon_r = 41.107$; $\rho = 1000$ kg/m³

Ambient Temperature : 23.2 °C ; Liquid Temperature : 22.2 °C

DASY5 Configuration

- Probe: EX3DV4 - SN3925; ConvF(9.92, 9.92, 9.92); Calibrated: 2016/5/26;
- Sensor-Surface: 1.4mm (Mechanical Surface Detection)
- Electronics: DAE3 Sn495; Calibrated: 2016/5/27
- Phantom: SAM_Right; Type: QD000P40CD; Serial: S/N:1801
- Measurement SW: DASY52, Version 52.8 (8); SEMCAD X Version 14.6.10 (7373)

Area Scan (61x111x1): Interpolated grid: dx=1.500 mm, dy=1.500 mm

Maximum value of SAR (interpolated) = 0.0688 W/kg

Zoom Scan (5x5x7)/Cube 0: Measurement grid: dx=8mm, dy=8mm, dz=5mm

Reference Value = 8.145 V/m; Power Drift = -0.01 dB

Peak SAR (extrapolated) = 0.0710 W/kg

SAR(1 g) = 0.055 W/kg; SAR(10 g) = 0.039 W/kg

Maximum value of SAR (measured) = 0.0664 W/kg

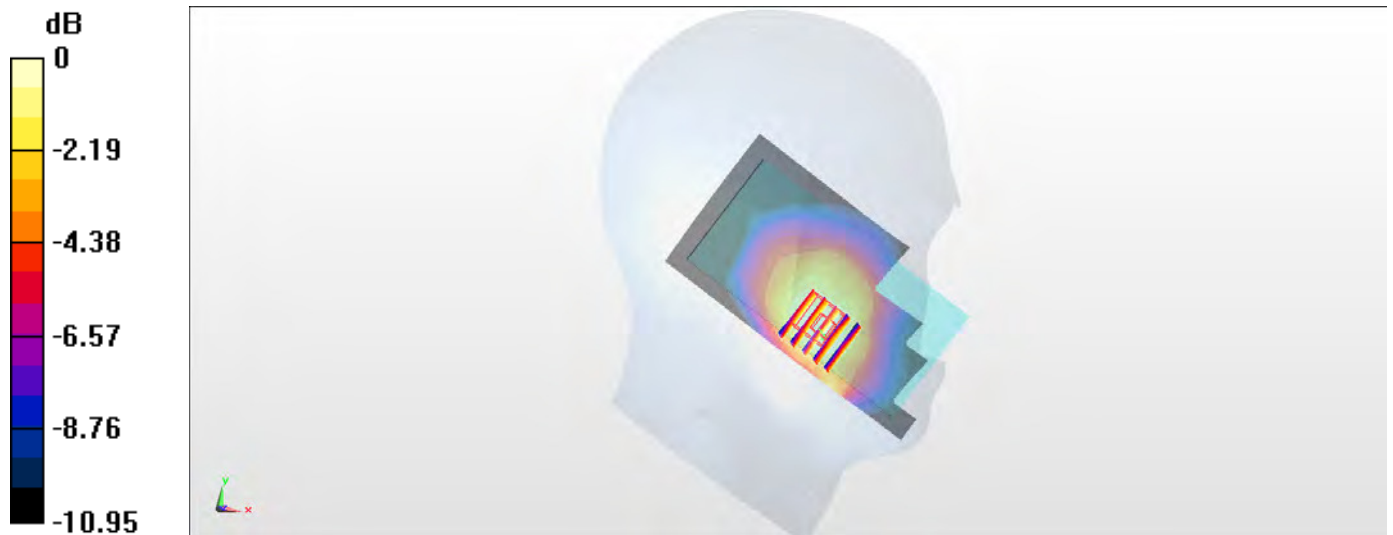

0 dB = 0.0664 W/kg = -11.78 dBW/kg

#09_LTE Band 7_20M_QPSK_1_99_Right Cheek_Ch21350;ANT 1

Communication System: LTE; Frequency: 2560 MHz; Duty Cycle: 1:1

Medium: HSL_2600_160902 Medium parameters used: $f = 2560$ MHz; $\sigma = 1.9$ mho/m; $\epsilon_r = 38$; $\rho = 1000$ kg/m³

Ambient Temperature : 23.4 °C ; Liquid Temperature : 22.4 °C

DASY4 Configuration:

- Probe: EX3DV4 - SN3955; ConvF(7.2, 7.2, 7.2); Calibrated: 2015/11/24
- Sensor-Surface: 1.4mm (Mechanical Surface Detection)
- Electronics: DAE4 Sn778; Calibrated: 2016/5/12
- Phantom: SAM_Right; Type: SAM_Right; Serial: TP-1303
- ;Postprocessing SW: SEMCAD, V1.8 Build 159

Area Scan (81x141x1): Measurement grid: dx=12mm, dy=12mm

Maximum value of SAR (interpolated) = 1.29 mW/g

Zoom Scan (7x7x7)/Cube 0: Measurement grid: dx=5mm, dy=5mm, dz=5mm

Reference Value = 21.9 V/m; Power Drift = -0.064 dB

Peak SAR (extrapolated) = 1.45 W/kg

SAR(1 g) = 0.762 mW/g; SAR(10 g) = 0.381 mW/g

Maximum value of SAR (measured) = 1.18 mW/g

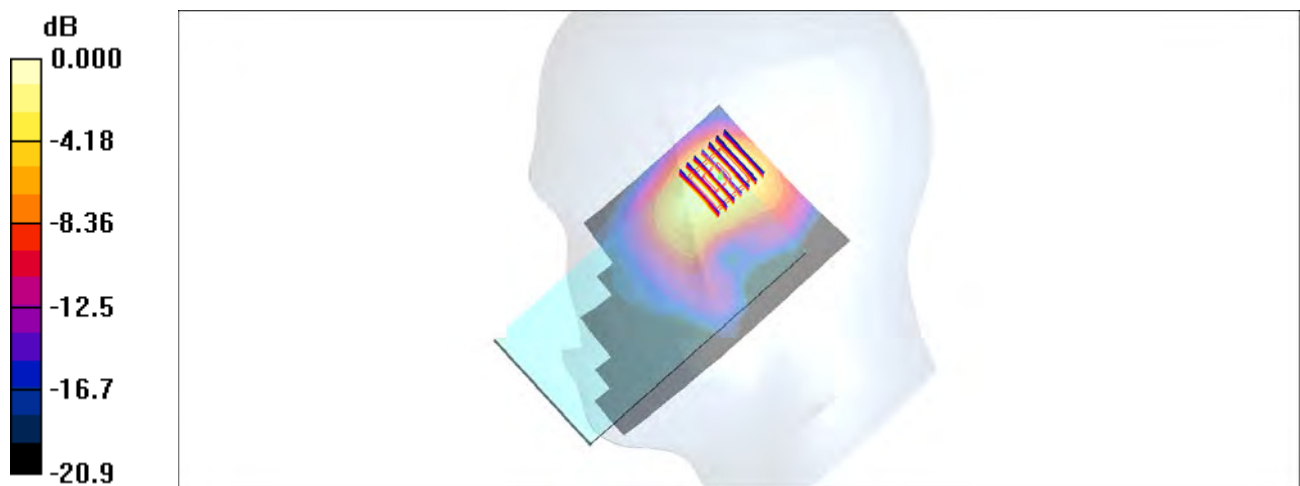

0 dB = 1.18mW/g

#10_LTE Band 12_10M_QPSK_1_49_Left Cheek_Ch23095;ANT0;Sample 2

Communication System: LTE; Frequency: 707.5 MHz; Duty Cycle: 1:1

Medium: HSL_750_160831 Medium parameters used: $f = 707.5$ MHz; $\sigma = 0.86$ S/m; $\epsilon_r = 43.049$; $\rho = 1000$ kg/m³

Ambient Temperature : 23.4 °C ; Liquid Temperature : 22.4 °C

DASY5 Configuration

- Probe: EX3DV4 - SN3925; ConvF(10.37, 10.37, 10.37); Calibrated: 2016/5/26;
- Sensor-Surface: 1.4mm (Mechanical Surface Detection)
- Electronics: DAE3 Sn495; Calibrated: 2016/5/27
- Phantom: SAM_Right; Type: QD000P40CD; Serial: S/N:1801
- Measurement SW: DASY52, Version 52.8 (8); SEMCAD X Version 14.6.10 (7373)

Area Scan (61x111x1): Interpolated grid: dx=1.500 mm, dy=1.500 mm

Maximum value of SAR (interpolated) = 0.0666 W/kg

Zoom Scan (5x5x7)/Cube 0: Measurement grid: dx=8mm, dy=8mm, dz=5mm

Reference Value = 8.828 V/m; Power Drift = 0.02 dB

Peak SAR (extrapolated) = 0.0710 W/kg

SAR(1 g) = 0.055 W/kg; SAR(10 g) = 0.044 W/kg

Maximum value of SAR (measured) = 0.0647 W/kg

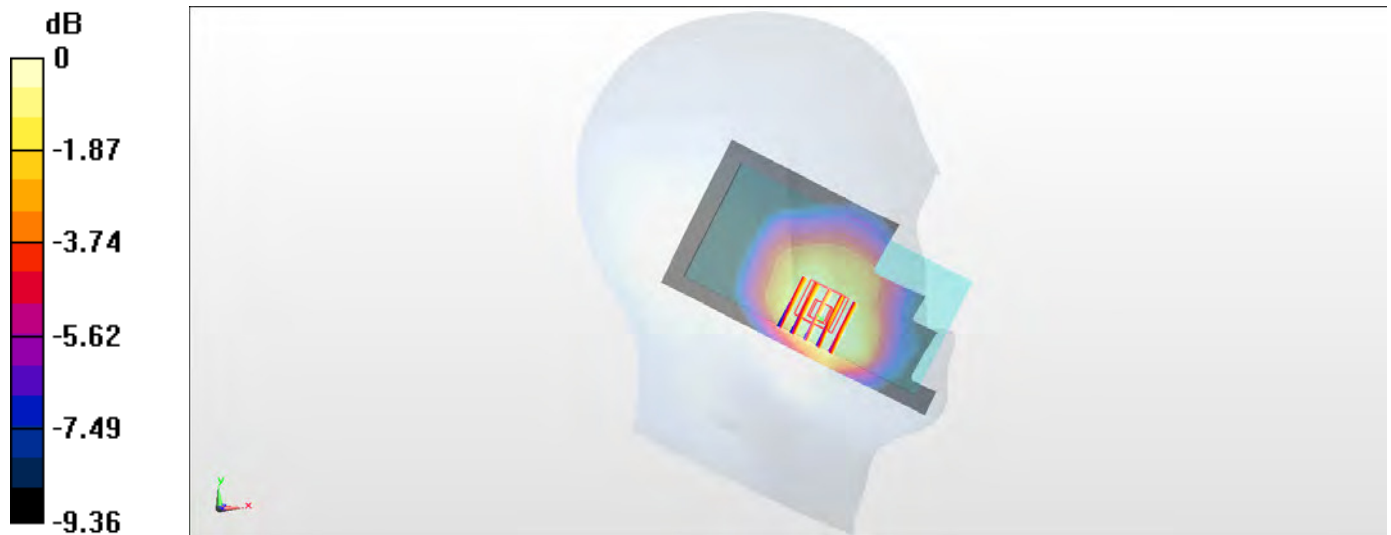

0 dB = 0.0647 W/kg = -11.89 dBW/kg

#11_LTE Band 38_20M_QPSK_50_0_Right Cheek_Ch37850;ANT 1;Sample 2

Communication System: LTE ; Frequency: 2580 MHz;Duty Cycle: 1:1.59

Medium: HSL_2600_160906 Medium parameters used: $f = 2580$ MHz; $\sigma = 1.901$ S/m; $\epsilon_r = 37.319$; $\rho = 1000$ kg/m³

Ambient Temperature : 23.9 °C; Liquid Temperature : 22.9 °C

DASY5 Configuration

- Probe: ES3DV3 - SN3270; ConvF(4.37, 4.37, 4.37); Calibrated: 2016/8/26;
- Sensor-Surface: 3mm (Mechanical Surface Detection)
- Electronics: DAE4 Sn1399; Calibrated: 2015/11/23
- Phantom: SAM_Right; Type: QD000P40CD; Serial: S/N:1801
- Measurement SW: DASY52, Version 52.8 (8); SEMCAD X Version 14.6.10 (7373)

Area Scan (81x141x1): Interpolated grid: dx=1.200 mm, dy=1.200 mm

Maximum value of SAR (interpolated) = 0.757 W/kg

Zoom Scan (7x7x7)/Cube 0: Measurement grid: dx=5mm, dy=5mm, dz=5mm

Reference Value = 17.53 V/m; Power Drift = -0.02 dB

Peak SAR (extrapolated) = 1.18 W/kg

SAR(1 g) = 0.592 W/kg; SAR(10 g) = 0.299 W/kg

Maximum value of SAR (measured) = 0.734 W/kg

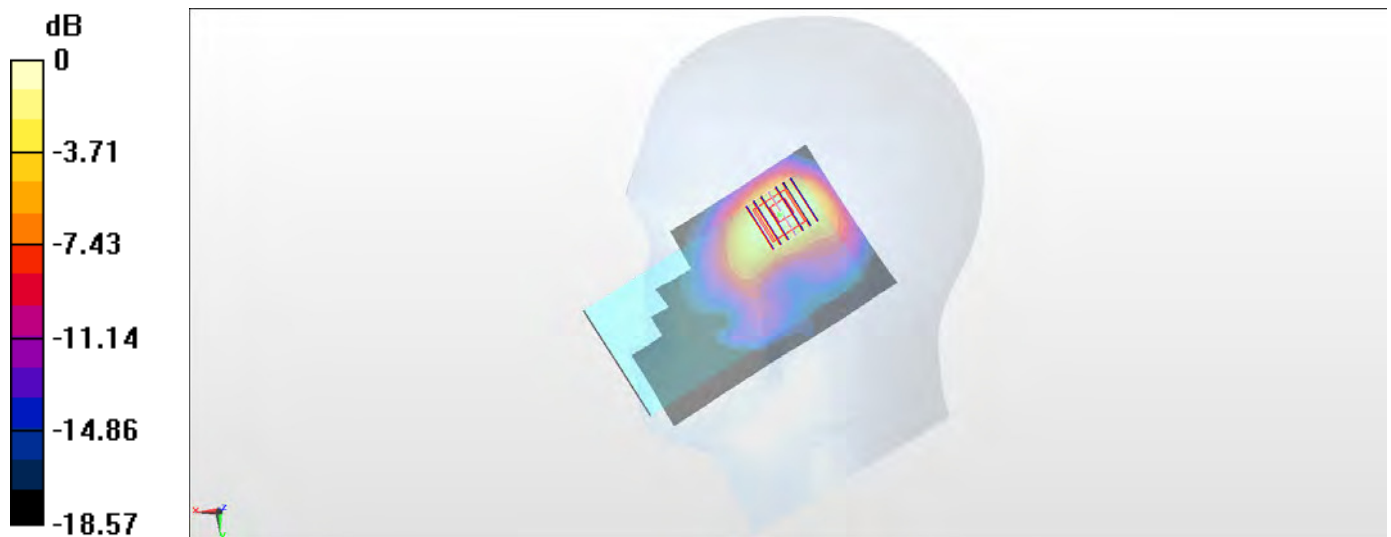

0 dB = 0.734 W/kg = -1.34 dBW/kg

#12_WLAN2.4GHz_802.11b 1Mbps_Left Cheek_Ch11

Communication System: 802.11b ; Frequency: 2462 MHz; Duty Cycle: 1:1

Medium: HSL_2450_160820 Medium parameters used: $f = 2462$ MHz; $\sigma = 1.763$ S/m; $\epsilon_r = 38.301$; $\rho = 1000$ kg/m³

Ambient Temperature : 23.3 °C; Liquid Temperature : 22.3 °C

DASY5 Configuration

- Probe: EX3DV4 - SN3955; ConvF(7.36, 7.36, 7.36); Calibrated: 2015/11/24;
- Sensor-Surface: 1.4mm (Mechanical Surface Detection)
- Electronics: DAE4 Sn778; Calibrated: 2016/5/12
- Phantom: SAM_RIGHT; Type: QD000P40CD; Serial: 1719
- Measurement SW: DASY52, Version 52.8 (8); SEMCAD X Version 14.6.10 (7373)

Area Scan (81x151x1): Interpolated grid: dx=1.200 mm, dy=1.200 mm

Maximum value of SAR (interpolated) = 0.911 W/kg

Zoom Scan (8x8x7)/Cube 0: Measurement grid: dx=5mm, dy=5mm, dz=5mm

Reference Value = 11.05 V/m; Power Drift = 0.04 dB

Peak SAR (extrapolated) = 1.56 W/kg

SAR(1 g) = 0.536 W/kg; SAR(10 g) = 0.207 W/kg

Maximum value of SAR (measured) = 1.10 W/kg



0 dB = 1.10 W/kg = 0.41 dBW/kg

#13_WLAN5GHz_802.11a 6Mbps_Left Cheek_Ch48

Communication System: 802.11a; Frequency: 5240 MHz; Duty Cycle: 1:1.029

Medium: HSL_5G_160912 Medium parameters used: $f = 5240$ MHz; $\sigma = 4.503$ S/m; $\epsilon_r = 35.62$; $\rho = 1000$ kg/m³

Ambient Temperature : 23.5 °C; Liquid Temperature : 22.5 °C

DASY5 Configuration:

- Probe: EX3DV4 - SN3931; ConvF(5.13, 5.13, 5.13); Calibrated: 2015/10/1;
- Sensor-Surface: 1.4mm (Mechanical Surface Detection)
- Electronics: DAE3 Sn577; Calibrated: 2015/9/24
- Phantom: SAM-Right; Type: SAM; Serial: 1795
- Measurement SW: DASY52, Version 52.8 (8); SEMCAD X Version 14.6.10 (7373)

Area Scan (101x181x1): Interpolated grid: dx=1.000 mm, dy=1.000 mm

Maximum value of SAR (interpolated) = 0.606 W/kg

Zoom Scan (7x7x7)/Cube 0: Measurement grid: dx=4mm, dy=4mm, dz=1.4mm

Reference Value = 6.963 V/m; Power Drift = 0.14 dB

Peak SAR (extrapolated) = 1.16 W/kg

SAR(1 g) = 0.245 W/kg; SAR(10 g) = 0.073 W/kg

Maximum value of SAR (measured) = 0.645 W/kg

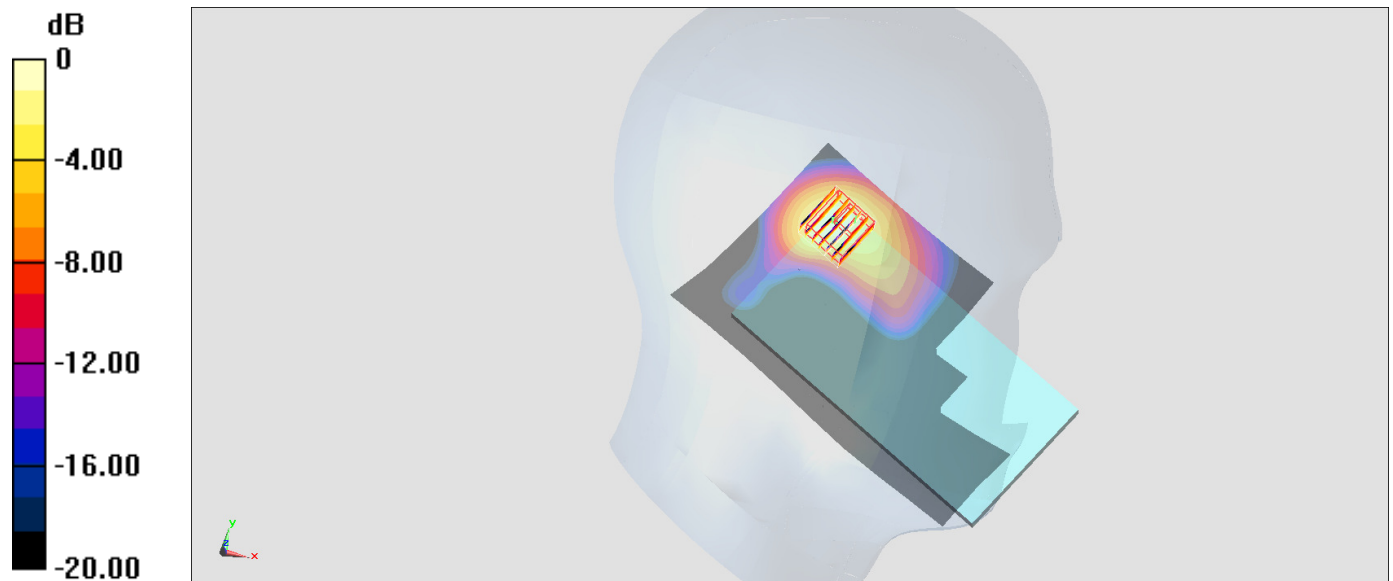

0 dB = 0.606 W/kg = -2.18 dBW/kg

#14_WLAN5GHz_802.11n-HT20 MCS0_Left Tilted_Ch132

Communication System: 802.11n; Frequency: 5660 MHz; Duty Cycle: 1:1.031

Medium: HSL_5G_160905 Medium parameters used: $f = 5660$ MHz; $\sigma = 4.89$ mho/m; $\epsilon_r = 35.8$; $\rho = 1000$ kg/m³

Ambient Temperature : 23.4 °C ; Liquid Temperature : 22.4 °C

DASY4 Configuration:

- Probe: EX3DV4 - SN3931; ConvF(4.42, 4.42, 4.42); Calibrated: 2015/10/1
- Sensor-Surface: 1.4mm (Mechanical Surface Detection)
- Electronics: DAE3 Sn577; Calibrated: 2015/9/24
- Phantom: SAM_Right; Type: SAM_Right; Serial: TP-1303
- ;Postprocessing SW: SEMCAD, V1.8 Build 159

Area Scan (101x181x1): Measurement grid: dx=10mm, dy=10mm

Maximum value of SAR (interpolated) = 0.558 mW/g

Zoom Scan (7x7x7)/Cube 0: Measurement grid: dx=4mm, dy=4mm, dz=1.4mm

Reference Value = 4.48 V/m; Power Drift = 0.180 dB

Peak SAR (extrapolated) = 1.39 W/kg

SAR(1 g) = 0.315 mW/g; SAR(10 g) = 0.069 mW/g

Maximum value of SAR (measured) = 0.822 mW/g

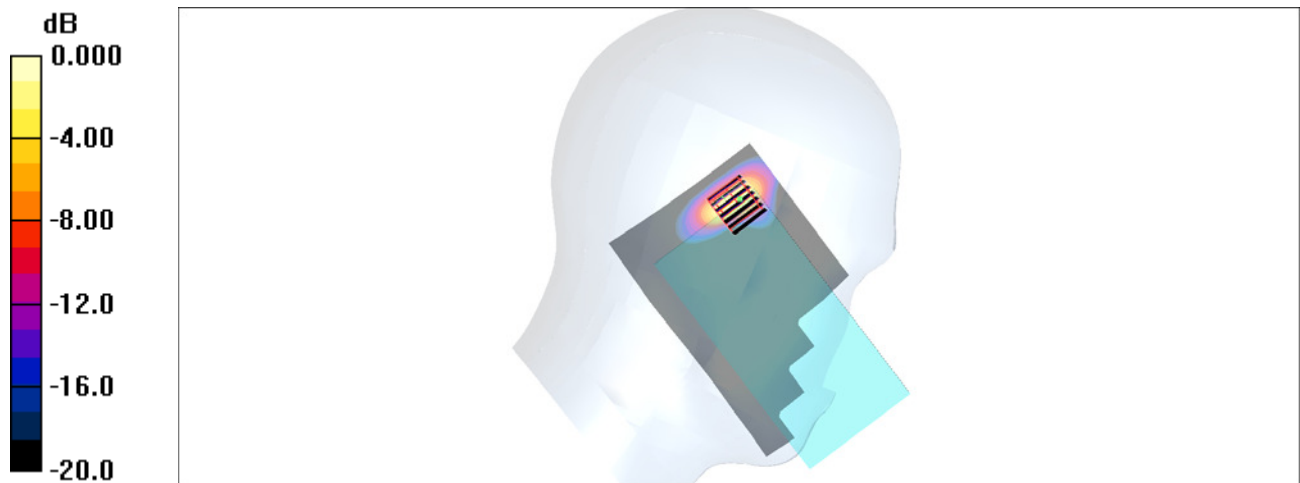

0 dB = 0.822mW/g

#15_WLAN5GHz_802.11n-HT40 MCS0_Left Tilted_Ch159

Communication System: 802.11n; Frequency: 5795 MHz; Duty Cycle: 1:1.065

Medium: HSL_5G_160824 Medium parameters used: $f = 5795$ MHz; $\sigma = 5.183$ S/m; $\epsilon_r = 35.69$; $\rho = 1000$ kg/m³

Ambient Temperature : 23.7 °C; Liquid Temperature : 22.7 °C

DASY5 Configuration:

- Probe: EX3DV4 - SN3931; ConvF(4.58, 4.58, 4.58); Calibrated: 2015/10/1;
- Sensor-Surface: 1.4mm (Mechanical Surface Detection)
- Electronics: DAE3 Sn577; Calibrated: 2015/9/24
- Phantom: SAM-Right; Type: SAM; Serial: 1795
- Measurement SW: DASY52, Version 52.8 (8); SEMCAD X Version 14.6.10 (7373)

Area Scan (101x181x1): Interpolated grid: dx=1.000 mm, dy=1.000 mm

Maximum value of SAR (interpolated) = 0.795 W/kg

Zoom Scan (7x7x7)/Cube 0: Measurement grid: dx=4mm, dy=4mm, dz=1.4mm

Reference Value = 4.548 V/m; Power Drift = 0.19 dB

Peak SAR (extrapolated) = 1.77 W/kg

SAR(1 g) = 0.440 W/kg; SAR(10 g) = 0.096 W/kg

Maximum value of SAR (measured) = 1.14 W/kg

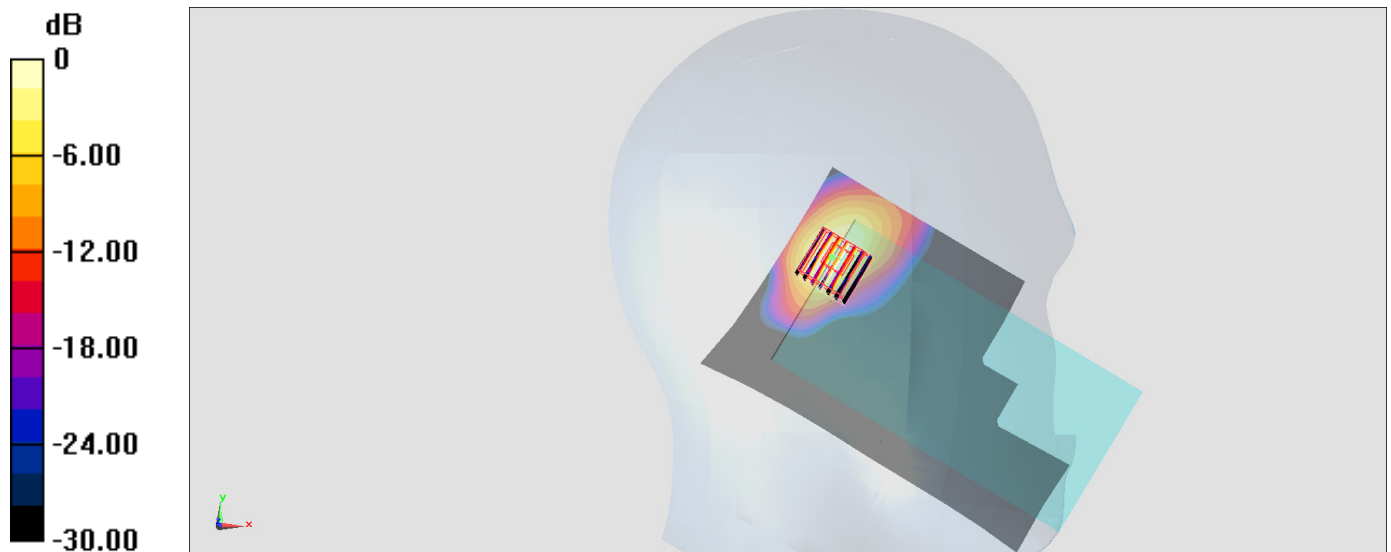

0 dB = 0.795 W/kg = -1.00 dBW/kg

#16_GSM850_GPRS (4 Tx slots)_Back_10mm_Ch251;ANT0;;Sample 2

Communication System: GSM850 ; Frequency: 848.8 MHz;Duty Cycle: 1:2.08

Medium: MSL_850_160905 Medium parameters used: $f = 849 \text{ MHz}$; $\sigma = 1.006 \text{ S/m}$; $\epsilon_r = 56.622$; $\rho = 1000 \text{ kg/m}^3$

Ambient Temperature : $23.9 \text{ }^\circ\text{C}$; Liquid Temperature : $22.9 \text{ }^\circ\text{C}$

DASY5 Configuration

- Probe: EX3DV4 - SN3925; ConvF(9.91, 9.91, 9.91); Calibrated: 2016/5/26;
- Sensor-Surface: 1.4mm (Mechanical Surface Detection)
- Electronics: DAE3 Sn495; Calibrated: 2016/5/27
- Phantom: SAM_Left; Type: QD000P40CD; Serial: S/N:1796
- Measurement SW: DASY52, Version 52.8 (8); SEMCAD X Version 14.6.10 (7373)

Area Scan (61x121x1): Interpolated grid: $dx=1.500 \text{ mm}$, $dy=1.500 \text{ mm}$

Maximum value of SAR (interpolated) = 0.482 W/kg

Zoom Scan (5x5x7)/Cube 0: Measurement grid: $dx=8\text{mm}$, $dy=8\text{mm}$, $dz=5\text{mm}$

Reference Value = 8.556 V/m ; Power Drift = 0.00 dB

Peak SAR (extrapolated) = 0.575 W/kg

SAR(1 g) = 0.321 W/kg ; SAR(10 g) = 0.176 W/kg

Maximum value of SAR (measured) = 0.490 W/kg

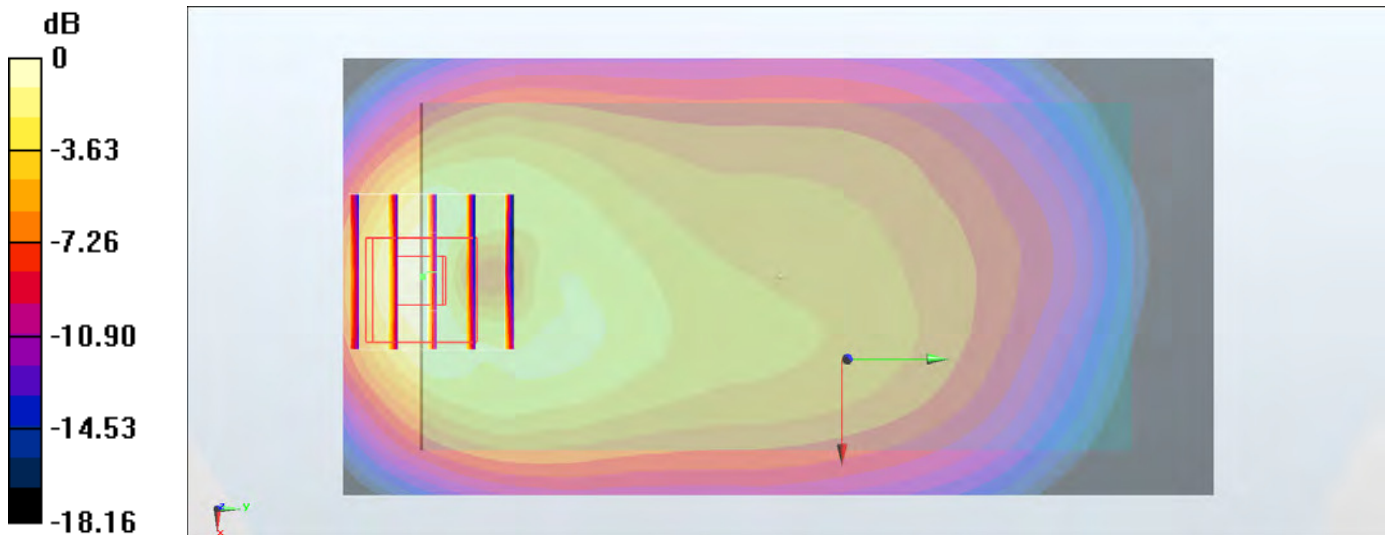

0 dB = 0.490 W/kg = -3.10 dBW/kg

#17_GSM1900_GPRS (4 Tx slots)_Back_10mm_Ch661;ANT0

Communication System: PCS; Frequency: 1880 MHz; Duty Cycle: 1:2.08

Medium: MSL_1900_160903 Medium parameters used: $f = 1880$ MHz; $\sigma = 1.55$ S/m; $\epsilon_r = 55.448$; $\rho = 1000$ kg/m³

Ambient Temperature : 23.6 °C ; Liquid Temperature : 22.6 °C

DASY5 Configuration

- Probe: EX3DV4 - SN3925; ConvF(8, 8, 8); Calibrated: 2016/5/26;
- Sensor-Surface: 1.4mm (Mechanical Surface Detection)
- Electronics: DAE3 Sn495; Calibrated: 2016/5/27
- Phantom: SAM_Right; Type: QD000P40CD; Serial: S/N:1801
- Measurement SW: DASY52, Version 52.8 (8); SEMCAD X Version 14.6.10 (7373)

Area Scan (61x111x1): Interpolated grid: dx=1.500 mm, dy=1.500 mm

Maximum value of SAR (interpolated) = 0.128 W/kg

Zoom Scan (5x5x7)/Cube 0: Measurement grid: dx=8mm, dy=8mm, dz=5mm

Reference Value = 4.589 V/m; Power Drift = 0.13 dB

Peak SAR (extrapolated) = 0.152 W/kg

SAR(1 g) = 0.085 W/kg; SAR(10 g) = 0.044 W/kg

Maximum value of SAR (measured) = 0.128 W/kg

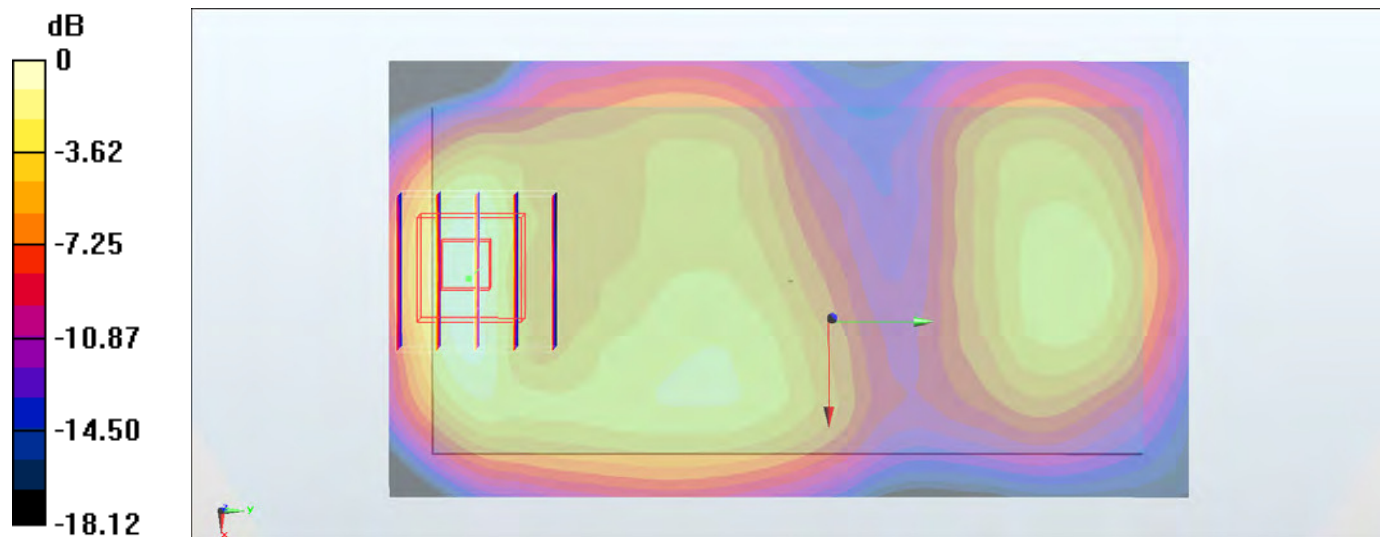

0 dB = 0.128 W/kg = -8.93 dBW/kg

#18_WCDMA II_RMC 12.2Kbps_Back_10mm_Ch9538;ANT0

Communication System: WCDMA ; Frequency: 1907.6 MHz; Duty Cycle: 1:1

Medium: MSL_1900_160903 Medium parameters used: $f = 1908$ MHz; $\sigma = 1.584$ S/m; $\epsilon_r = 55.33$; $\rho = 1000$ kg/m³

Ambient Temperature : 23.6 °C ; Liquid Temperature : 22.6 °C

DASY5 Configuration

- Probe: EX3DV4 - SN3925; ConvF(8, 8, 8); Calibrated: 2016/5/26;
- Sensor-Surface: 1.4mm (Mechanical Surface Detection)
- Electronics: DAE3 Sn495; Calibrated: 2016/5/27
- Phantom: SAM_Right; Type: QD000P40CD; Serial: S/N:1801
- Measurement SW: DASY52, Version 52.8 (8); SEMCAD X Version 14.6.10 (7373)

Area Scan (61x111x1): Interpolated grid: dx=1.500 mm, dy=1.500 mm

Maximum value of SAR (interpolated) = 0.164 W/kg

Zoom Scan (5x5x7)/Cube 0: Measurement grid: dx=8mm, dy=8mm, dz=5mm

Reference Value = 6.711 V/m; Power Drift = -0.05 dB

Peak SAR (extrapolated) = 0.200 W/kg

SAR(1 g) = 0.110 W/kg; SAR(10 g) = 0.055 W/kg

Maximum value of SAR (measured) = 0.164 W/kg

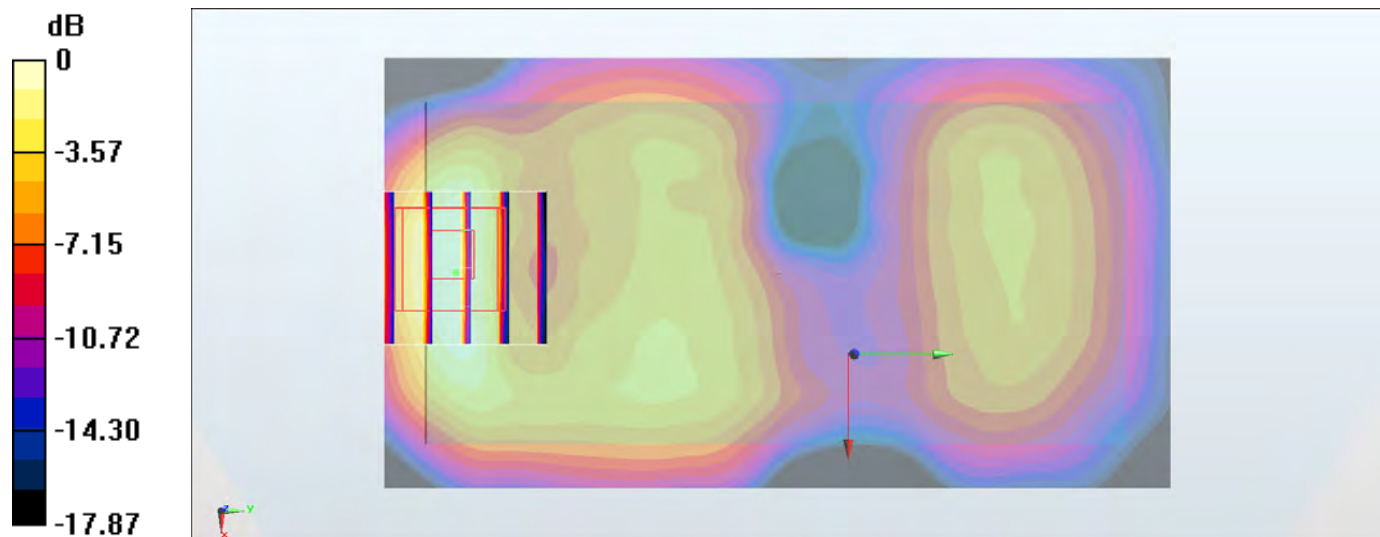

0 dB = 0.164 W/kg = -7.85 dBW/kg

#19_WCDMA IV_RMC 12.2Kbps_Back_10mm_Ch1312;ANT1

Communication System: WCDMA; Frequency: 1712.4 MHz; Duty Cycle: 1:1

Medium: MSL_1750_160904 Medium parameters used : $f = 1712.4$ MHz; $\sigma = 1.419$ S/m; $\epsilon_r =$

55.806 ; $\rho = 1000$ kg/m³

Ambient Temperature : 23.8 °C ; Liquid Temperature : 22.8 °C

DASY5 Configuration

- Probe: EX3DV4 - SN3925; ConvF(8.3, 8.3, 8.3); Calibrated: 2016/5/26;
- Sensor-Surface: 1.4mm (Mechanical Surface Detection)
- Electronics: DAE3 Sn495; Calibrated: 2016/5/27
- Phantom: SAM_Right; Type: QD000P40CD; Serial: S/N:1801
- Measurement SW: DASY52, Version 52.8 (8); SEMCAD X Version 14.6.10 (7373)

Area Scan (61x121x1): Interpolated grid: dx=1.500 mm, dy=1.500 mm

Maximum value of SAR (interpolated) = 0.275 W/kg

Zoom Scan (5x5x7)/Cube 0: Measurement grid: dx=8mm, dy=8mm, dz=5mm

Reference Value = 8.797 V/m; Power Drift = -0.12 dB

Peak SAR (extrapolated) = 0.287 W/kg

SAR(1 g) = 0.160 W/kg; SAR(10 g) = 0.085 W/kg

Maximum value of SAR (measured) = 0.237 W/kg

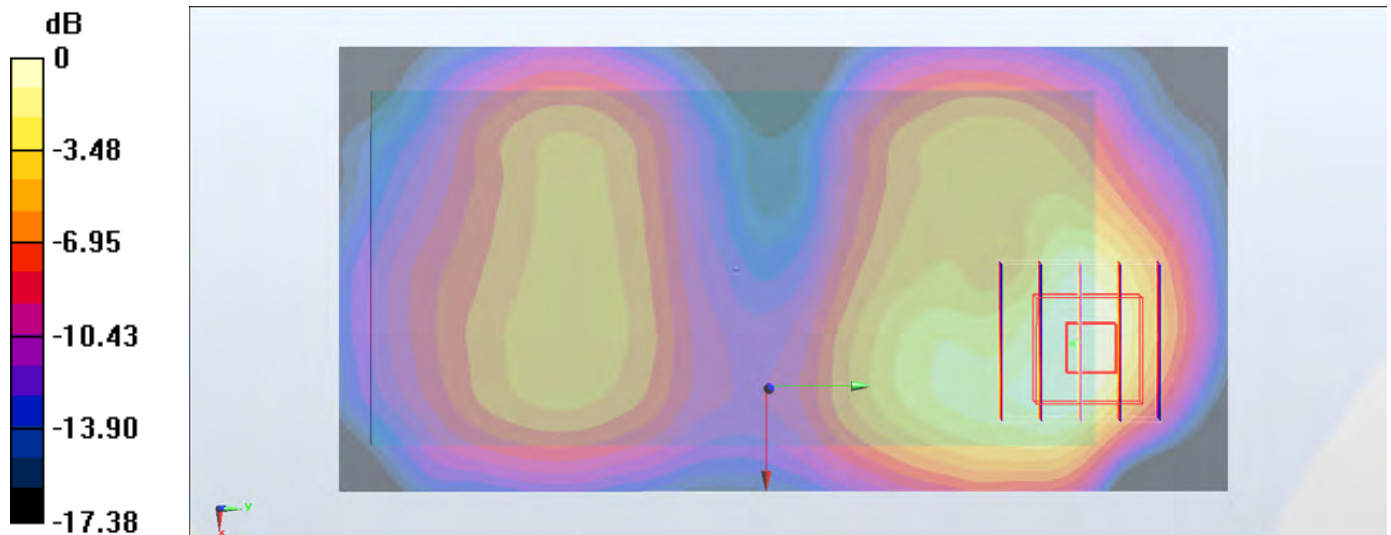

0 dB = 0.237 W/kg = -6.25 dBW/kg

#20_WCDMA V_RMC 12.2Kbps_Back_10mm_Ch4132;ANT0;Sample 2

Communication System: WCDMA ; Frequency: 826.4 MHz;Duty Cycle: 1:1

Medium: MSL_850_160905 Medium parameters used : $f = 826.4$ MHz; $\sigma = 0.983$ S/m; $\epsilon_r = 56.84$; $\rho = 1000$ kg/m³

Ambient Temperature : 23.9 °C ; Liquid Temperature : 22.9 °C

DASY5 Configuration

- Probe: EX3DV4 - SN3925; ConvF(9.91, 9.91, 9.91); Calibrated: 2016/5/26;
- Sensor-Surface: 1.4mm (Mechanical Surface Detection)
- Electronics: DAE3 Sn495; Calibrated: 2016/5/27
- Phantom: SAM_Left; Type: QD000P40CD; Serial: S/N:1796
- Measurement SW: DASY52, Version 52.8 (8); SEMCAD X Version 14.6.10 (7373)

Area Scan (61x121x1): Interpolated grid: dx=1.500 mm, dy=1.500 mm

Maximum value of SAR (interpolated) = 0.183 W/kg

Zoom Scan (5x5x7)/Cube 0: Measurement grid: dx=8mm, dy=8mm, dz=5mm

Reference Value = 10.48 V/m; Power Drift = -0.10 dB

Peak SAR (extrapolated) = 0.221 W/kg

SAR(1 g) = 0.121 W/kg; SAR(10 g) = 0.066 W/kg

Maximum value of SAR (measured) = 0.188 W/kg

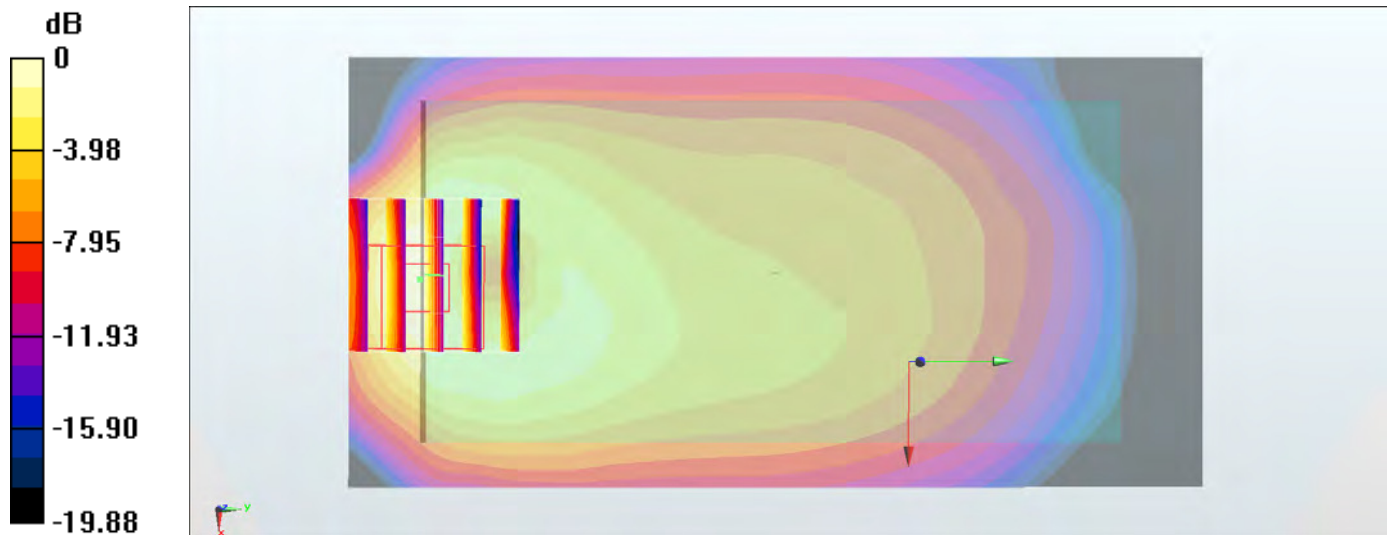

0 dB = 0.188 W/kg = -7.26 dBW/kg

#21_LTE Band 2_20M_QPSK_1_0_Back_10mm_Ch18900;ANT1;Sample 2

Communication System: LTE; Frequency: 1880 MHz;Duty Cycle: 1:1

Medium: MSL_1900_160903 Medium parameters used: $f = 1880$ MHz; $\sigma = 1.55$ S/m; $\epsilon_r = 55.448$; $\rho = 1000$ kg/m³

Ambient Temperature : 23.6 °C ; Liquid Temperature : 22.6 °C

DASY5 Configuration

- Probe: EX3DV4 - SN3925; ConvF(8, 8, 8); Calibrated: 2016/5/26;
- Sensor-Surface: 1.4mm (Mechanical Surface Detection)
- Electronics: DAE3 Sn495; Calibrated: 2016/5/27
- Phantom: SAM_Right; Type: QD000P40CD; Serial: S/N:1801
- Measurement SW: DASY52, Version 52.8 (8); SEMCAD X Version 14.6.10 (7373)

Area Scan (61x111x1): Interpolated grid: dx=1.500 mm, dy=1.500 mm

Maximum value of SAR (interpolated) = 0.210 W/kg

Zoom Scan (5x5x7)/Cube 0: Measurement grid: dx=8mm, dy=8mm, dz=5mm

Reference Value = 8.118 V/m; Power Drift = -0.16 dB

Peak SAR (extrapolated) = 0.262 W/kg

SAR(1 g) = 0.139 W/kg; SAR(10 g) = 0.068 W/kg

Maximum value of SAR (measured) = 0.200 W/kg

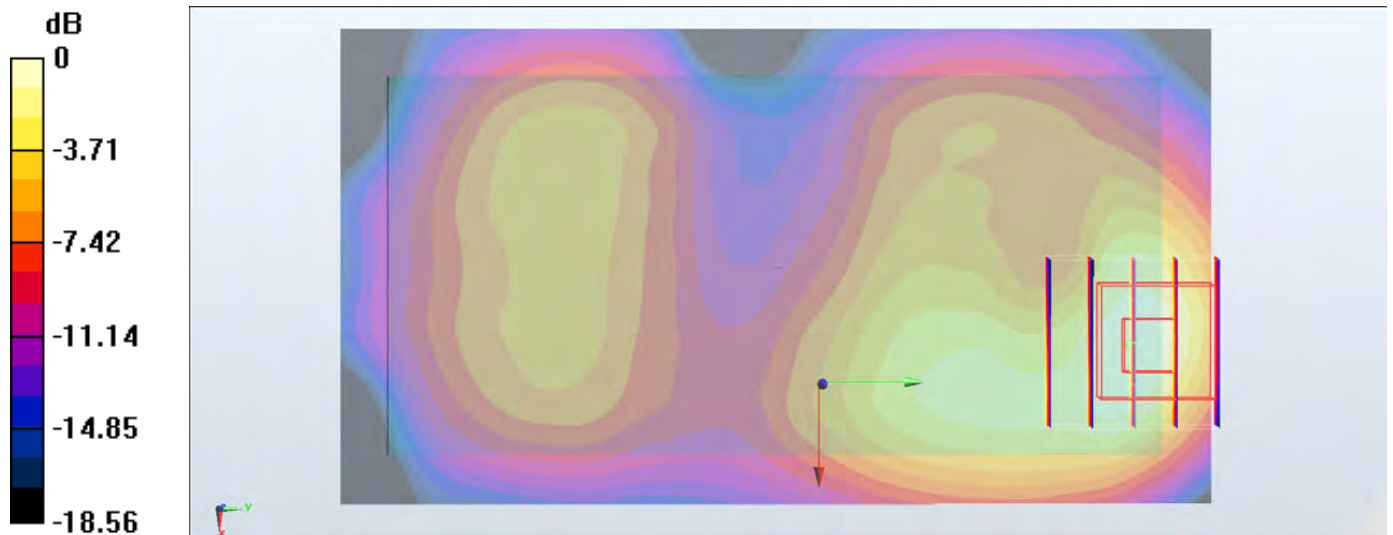

0 dB = 0.200 W/kg = -6.99 dBW/kg

#22_LTE Band 4_20M_QPSK_1_0_Back_10mm_Ch20175;ANT1;Sample 2

Communication System: LTE; Frequency: 1732.5 MHz;Duty Cycle: 1:1

Medium: MSL_1750_160904 Medium parameters used : $f = 1732.5$ MHz; $\sigma = 1.44$ S/m; $\epsilon_r = 55.742$;

$\rho = 1000$ kg/m³

Ambient Temperature : 23.8 °C ; Liquid Temperature : 22.8 °C

DASY5 Configuration

- Probe: EX3DV4 - SN3925; ConvF(8.3, 8.3, 8.3); Calibrated: 2016/5/26;
- Sensor-Surface: 1.4mm (Mechanical Surface Detection)
- Electronics: DAE3 Sn495; Calibrated: 2016/5/27
- Phantom: SAM_Right; Type: QD000P40CD; Serial: S/N:1801
- Measurement SW: DASY52, Version 52.8 (8); SEMCAD X Version 14.6.10 (7373)

Area Scan (61x121x1): Interpolated grid: dx=1.500 mm, dy=1.500 mm

Maximum value of SAR (interpolated) = 0.276 W/kg

Zoom Scan (5x5x7)/Cube 0: Measurement grid: dx=8mm, dy=8mm, dz=5mm

Reference Value = 8.870 V/m; Power Drift = -0.10 dB

Peak SAR (extrapolated) = 0.310 W/kg

SAR(1 g) = 0.173 W/kg; SAR(10 g) = 0.090 W/kg

Maximum value of SAR (measured) = 0.259 W/kg

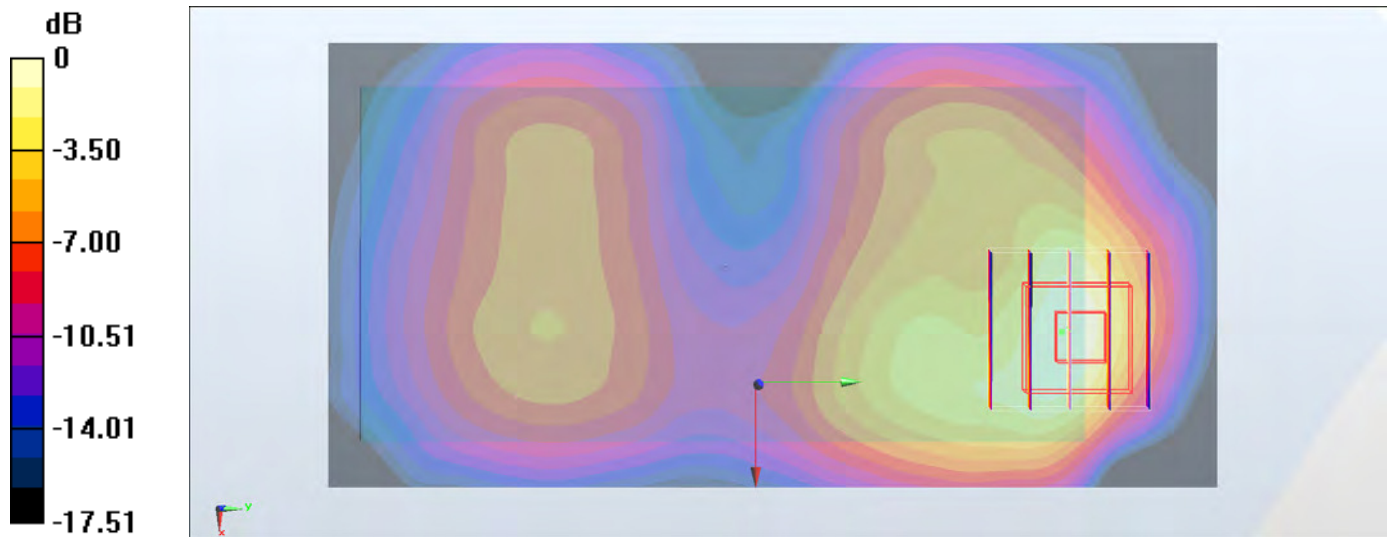

0 dB = 0.259 W/kg = -5.87 dBW/kg

#23_LTE Band 5_10M_QPSK_1_0_Back_10mm_Ch20525;ANT0;Sample 2

Communication System: LTE ; Frequency: 836.5 MHz;Duty Cycle: 1:1

Medium: MSL_850_160905 Medium parameters used : $f = 836.5$ MHz; $\sigma = 0.993$ S/m; $\epsilon_r = 56.754$; $\rho = 1000$ kg/m³

Ambient Temperature : 23.9 °C ; Liquid Temperature : 22.9 °C

DASY5 Configuration

- Probe: EX3DV4 - SN3925; ConvF(9.91, 9.91, 9.91); Calibrated: 2016/5/26;
- Sensor-Surface: 1.4mm (Mechanical Surface Detection)
- Electronics: DAE3 Sn495; Calibrated: 2016/5/27
- Phantom: SAM_Left; Type: QD000P40CD; Serial: S/N:1796
- Measurement SW: DASY52, Version 52.8 (8); SEMCAD X Version 14.6.10 (7373)

Area Scan (61x121x1): Interpolated grid: dx=1.500 mm, dy=1.500 mm

Maximum value of SAR (interpolated) = 0.205 W/kg

Zoom Scan (5x5x7)/Cube 0: Measurement grid: dx=8mm, dy=8mm, dz=5mm

Reference Value = 9.321 V/m; Power Drift = -0.11 dB

Peak SAR (extrapolated) = 0.254 W/kg

SAR(1 g) = 0.140 W/kg; SAR(10 g) = 0.076 W/kg

Maximum value of SAR (measured) = 0.214 W/kg

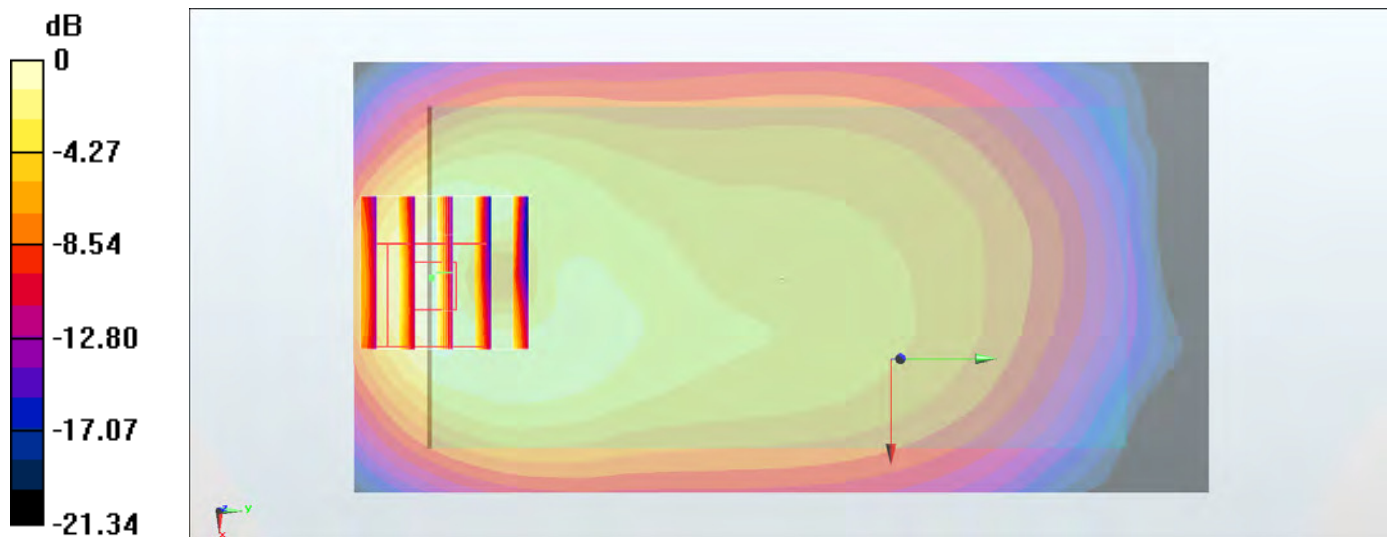

0 dB = 0.214 W/kg = -6.70 dBW/kg

#24_LTE Band 7_20M_QPSK_1_99_Back_10mm_Ch20850;ANT0

Communication System: LTE ; Frequency: 2510 MHz;Duty Cycle: 1:1

Medium: MSL_2600_160825 Medium parameters used: $f = 2510$ MHz; $\sigma = 1.986$ S/m; $\epsilon_r = 51.966$; $\rho = 1000$ kg/m³

Ambient Temperature : 23.2 °C ; Liquid Temperature : 22.2 °C

DASY5 Configuration

- Probe: EX3DV4 - SN3925; ConvF(7.38, 7.38, 7.38); Calibrated: 2016/5/26;
- Sensor-Surface: 1.4mm (Mechanical Surface Detection)
- Electronics: DAE3 Sn495; Calibrated: 2016/5/27
- Phantom: SAM_Right; Type: QD000P40CD; Serial: S/N:1801
- Measurement SW: DASY52, Version 52.8 (8); SEMCAD X Version 14.6.10 (7373)

Area Scan (81x141x1): Interpolated grid: dx=1.200 mm, dy=1.200 mm

Maximum value of SAR (interpolated) = 0.284 W/kg

Zoom Scan (8x10x7)/Cube 0: Measurement grid: dx=5mm, dy=5mm, dz=5mm

Reference Value = 10.74 V/m; Power Drift = -0.15 dB

Peak SAR (extrapolated) = 0.371 W/kg

SAR(1 g) = 0.189 W/kg; SAR(10 g) = 0.095 W/kg

Maximum value of SAR (measured) = 0.295 W/kg

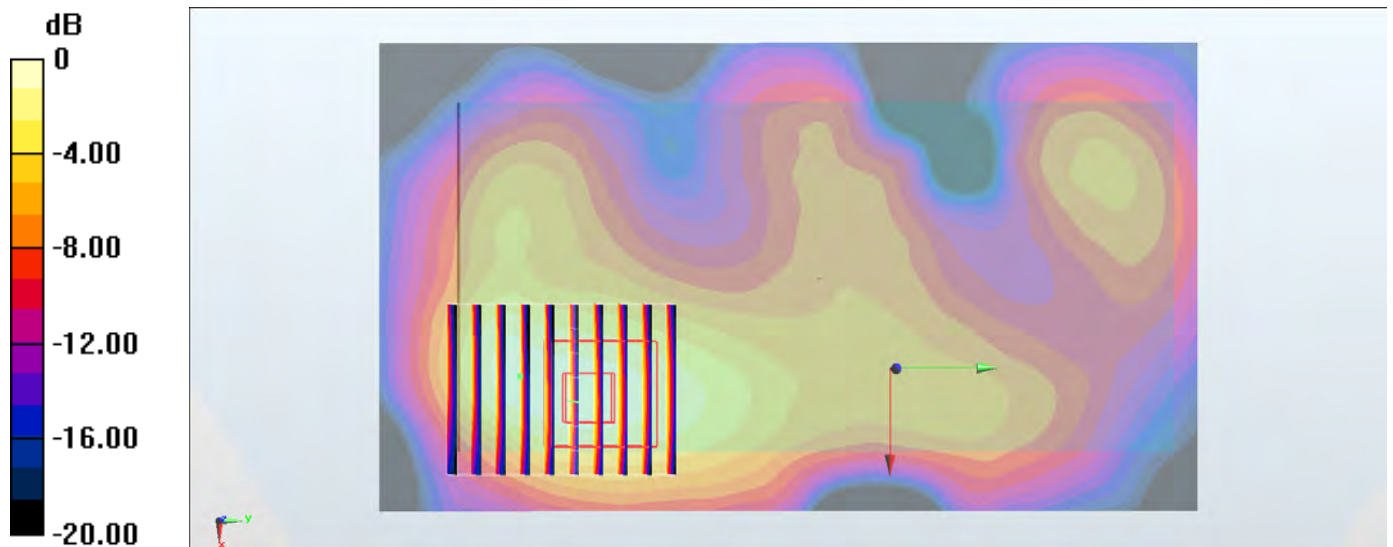

0 dB = 0.295 W/kg = -5.30 dBW/kg

#25_LTE Band 12_10M_QPSK_1_49_Back_10mm_Ch23095;ANT0;;Sample 2

Communication System: LTE ; Frequency: 707.5 MHz;Duty Cycle: 1:1

Medium: MSL_750_160905 Medium parameters used : $f = 707.5$ MHz; $\sigma = 0.921$ S/m; $\epsilon_r = 56.827$; $\rho = 1000$ kg/m³

Ambient Temperature : 23.2 °C ; Liquid Temperature : 22.2 °C

DASY5 Configuration

- Probe: EX3DV4 - SN3925; ConvF(10.18, 10.18, 10.18); Calibrated: 2016/5/26;
- Sensor-Surface: 1.4mm (Mechanical Surface Detection)
- Electronics: DAE3 Sn495; Calibrated: 2016/5/27
- Phantom: SAM_Left; Type: QD000P40CD; Serial: S/N:1796
- Measurement SW: DASY52, Version 52.8 (8); SEMCAD X Version 14.6.10 (7373)

Area Scan (61x121x1): Interpolated grid: dx=1.500 mm, dy=1.500 mm

Maximum value of SAR (interpolated) = 0.231 W/kg

Zoom Scan (5x5x7)/Cube 0: Measurement grid: dx=8mm, dy=8mm, dz=5mm

Reference Value = 11.43 V/m; Power Drift = 0.00 dB

Peak SAR (extrapolated) = 0.280 W/kg

SAR(1 g) = 0.152 W/kg; SAR(10 g) = 0.085 W/kg

Maximum value of SAR (measured) = 0.234 W/kg

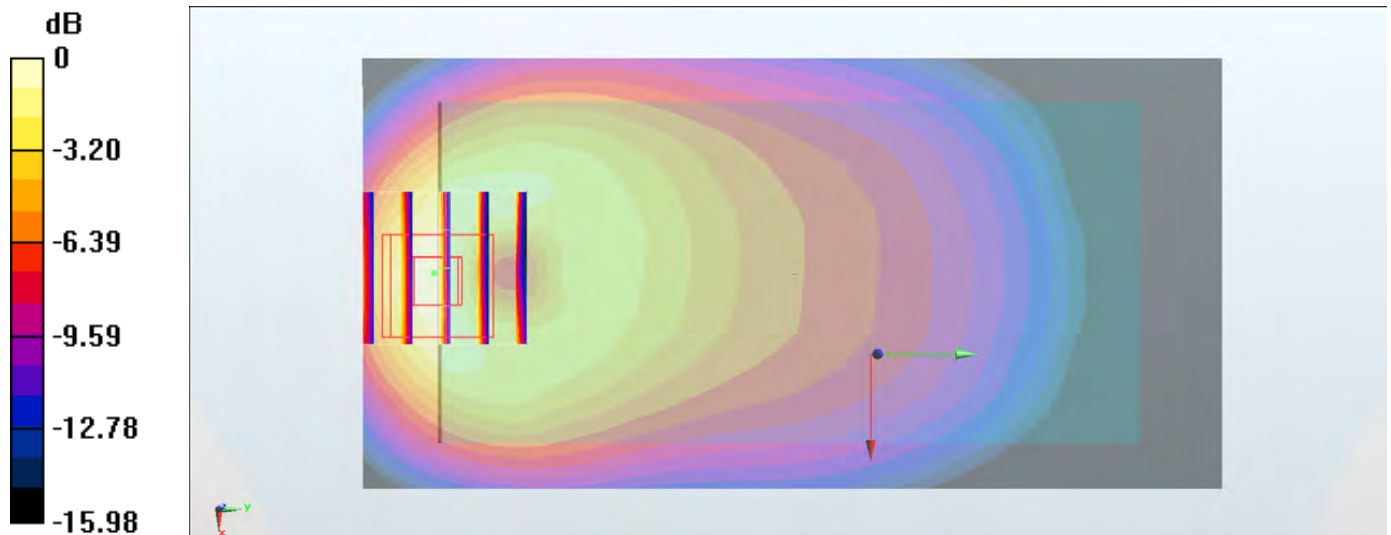

0 dB = 0.234 W/kg = -6.31 dBW/kg

#26_LTE Band 38_20M_QPSK_50_0_Back_10mm_Ch37850;ANT1

Communication System: LTE; Frequency: 2580 MHz; Duty Cycle: 1:1.59

Medium: MSL_2600_160906 Medium parameters used: $f = 2580$ MHz; $\sigma = 2.122$ S/m; $\epsilon_r = 51.471$; $\rho = 1000$ kg/m³

Ambient Temperature : 23.5 °C ; Liquid Temperature : 22.5 °C

DASY5 Configuration

- Probe: ES3DV3 - SN3270; ConvF(4.12, 4.12, 4.12); Calibrated: 2016/8/26;
- Sensor-Surface: 3mm (Mechanical Surface Detection)
- Electronics: DAE4 Sn1399; Calibrated: 2015/11/23
- Phantom: SAM_Left; Type: QD000P40CD; Serial: S/N:1796
- Measurement SW: DASY52, Version 52.8 (8); SEMCAD X Version 14.6.10 (7373)

Area Scan (81x141x1): Interpolated grid: dx=1.200 mm, dy=1.200 mm

Maximum value of SAR (interpolated) = 0.171 W/kg

Zoom Scan (7x7x7)/Cube 0: Measurement grid: dx=5mm, dy=5mm, dz=5mm

Reference Value = 8.611 V/m; Power Drift = -0.06 dB

Peak SAR (extrapolated) = 0.263 W/kg

SAR(1 g) = 0.135 W/kg; SAR(10 g) = 0.071 W/kg

Maximum value of SAR (measured) = 0.170 W/kg

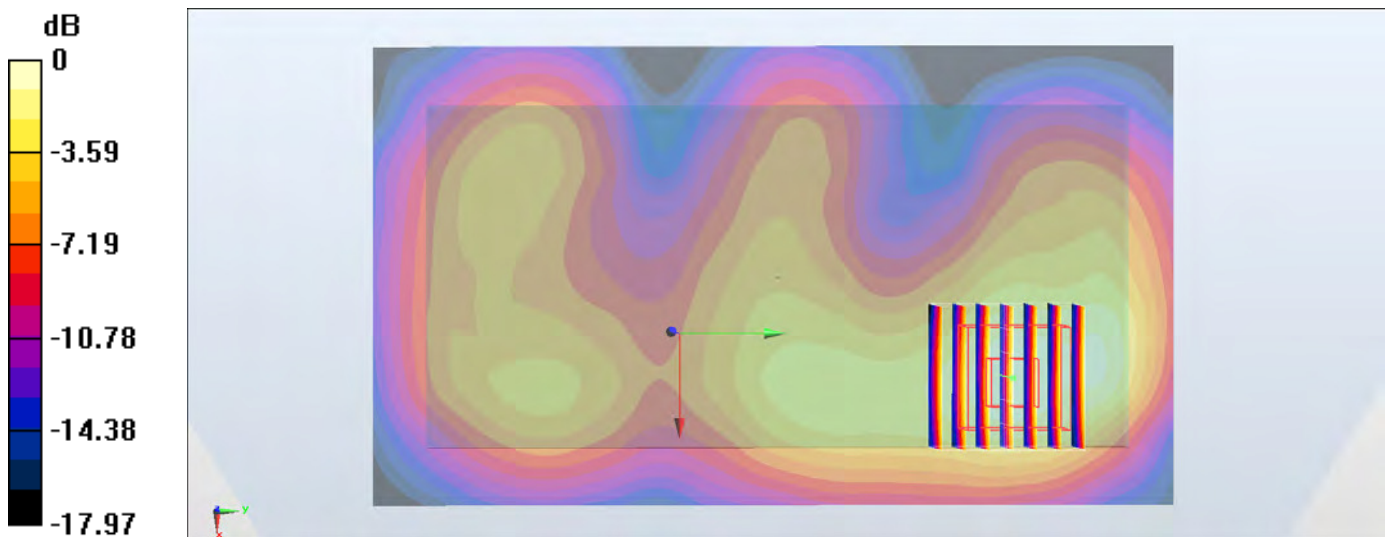

0 dB = 0.170 W/kg = -7.70 dBW/kg

#27_WLAN2.4GHz_802.11b 1Mbps_Front_10mm_Ch11

Communication System: 802.11b ; Frequency: 2462 MHz;Duty Cycle: 1:1

Medium: MSL_2450_160823 Medium parameters used: $f = 2462$ MHz; $\sigma = 1.97$ S/m; $\epsilon_r = 52.42$; $\rho = 1000$ kg/m³

Ambient Temperature : 23.7 °C ; Liquid Temperature : 22.7 °C

DASY5 Configuration:

- Probe: EX3DV4 - SN3931; ConvF(7.54, 7.54, 7.54); Calibrated: 2015/10/1;
- Sensor-Surface: 1.4mm (Mechanical Surface Detection)
- Electronics: DAE3 Sn577; Calibrated: 2015/9/24
- Phantom: SAM_Left; Type: QD000P40CD; Serial: TP:1644
- Measurement SW: DASY52, Version 52.8 (8);SEMCAD X Version 14.6.10 (7373)

Area Scan (81x151x1): Interpolated grid: dx=1.200 mm, dy=1.200 mm

Maximum value of SAR (interpolated) = 0.107 W/kg

Zoom Scan (7x9x7)/Cube 0: Measurement grid: dx=5mm, dy=5mm, dz=5mm

Reference Value = 2.842 V/m; Power Drift = 0.01 dB

Peak SAR (extrapolated) = 0.0930 W/kg

SAR(1 g) = 0.046 W/kg; SAR(10 g) = 0.022 W/kg

Maximum value of SAR (measured) = 0.0741 W/kg

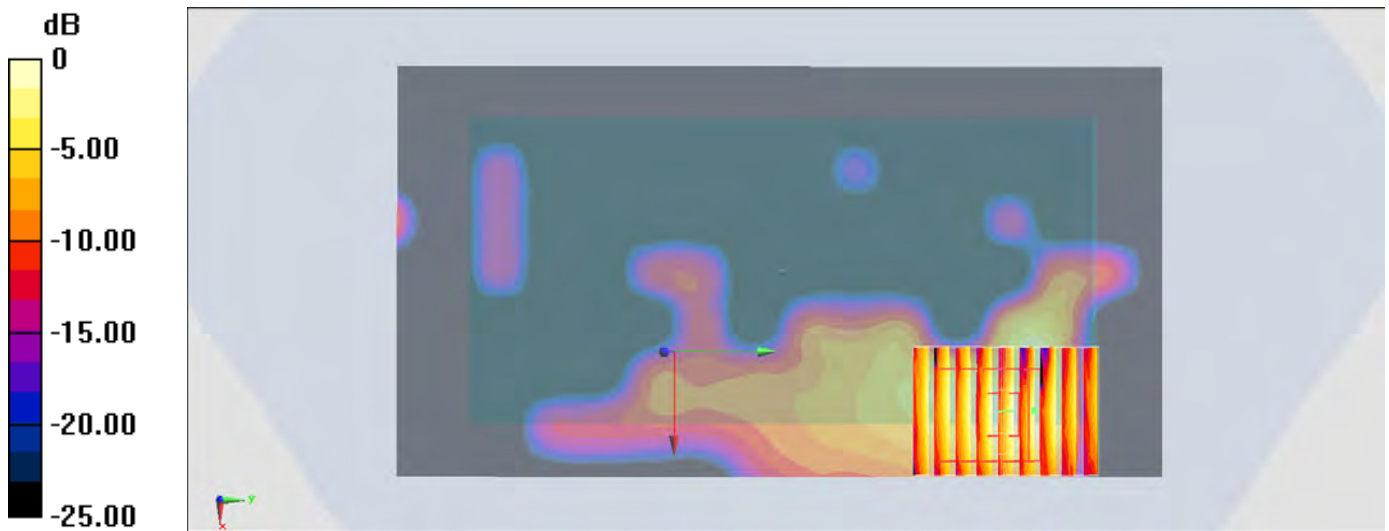

0 dB = 0.107 W/kg = -9.71 dBW/kg

Test Laboratory: Sporton International Inc. SAR/HAC Testing Lab

Date: 2016/9/5

#28_WLAN5GHz_802.11a 6Mbps_Right Side_10mm_Ch48 ;Samp

#29_WLAN5GHz_802.11n-HT40 MCS0_Front_10mm_Ch159 ;Sample 2

Communication System: 802.11n; Frequency: 5795 MHz;Duty Cycle: 1:1.065

Medium: MSL_5G_160905 Medium parameters used: $f = 5795$ MHz; $\sigma = 6.09$ mho/m; $\epsilon_r = 45.9$; $\rho = 1000$ kg/m³

Ambient Temperature : 23.4 °C ; Liquid Temperature : 22.4 °C

DASY4 Configuration:

- Probe: EX3DV4 - SN3931; ConvF(3.98, 3.98, 3.98); Calibrated: 2015/10/1
- Sensor-Surface: 1.4mm (Mechanical Surface Detection)
- Electronics: DAE3 Sn577; Calibrated: 2015/9/24
- Phantom: SAM_Right; Type: SAM_Right; Serial: TP-1303
- ;Postprocessing SW: SEMCAD, V1.8 Build 159

Area Scan (101x181x1): Measurement grid: dx=10mm, dy=10mm

Maximum value of SAR (interpolated) = 0.232 mW/g

Zoom Scan (7x7x7)/Cube 0: Measurement grid: dx=4mm, dy=4mm, dz=1.4mm

Reference Value = 1.31 V/m; Power Drift = 0.169 dB

Peak SAR (extrapolated) = 1.14 W/kg

SAR(1 g) = 0.102 mW/g; SAR(10 g) = 0.028 mW/g

Maximum value of SAR (measured) = 0.258 mW/g



0 dB = 0.258mW/g

#30_GSM850_GPRS (4 Tx slots)_Back_10mm_Ch251;ANT0;Sample 2

Communication System: GSM850 ; Frequency: 848.8 MHz;Duty Cycle: 1:2.08

Medium: MSL_850_160905 Medium parameters used: $f = 849$ MHz; $\sigma = 1.006$ S/m; $\epsilon_r = 56.622$; $\rho = 1000$ kg/m³

Ambient Temperature : 23.9 °C ; Liquid Temperature : 22.9 °C

DASY5 Configuration

- Probe: EX3DV4 - SN3925; ConvF(9.91, 9.91, 9.91); Calibrated: 2016/5/26;
- Sensor-Surface: 1.4mm (Mechanical Surface Detection)
- Electronics: DAE3 Sn495; Calibrated: 2016/5/27
- Phantom: SAM_Left; Type: QD000P40CD; Serial: S/N:1796
- Measurement SW: DASY52, Version 52.8 (8); SEMCAD X Version 14.6.10 (7373)

Area Scan (61x121x1): Interpolated grid: dx=1.500 mm, dy=1.500 mm

Maximum value of SAR (interpolated) = 0.482 W/kg

Zoom Scan (5x5x7)/Cube 0: Measurement grid: dx=8mm, dy=8mm, dz=5mm

Reference Value = 8.556 V/m; Power Drift = 0.00 dB

Peak SAR (extrapolated) = 0.575 W/kg

SAR(1 g) = 0.321 W/kg; SAR(10 g) = 0.176 W/kg

Maximum value of SAR (measured) = 0.490 W/kg

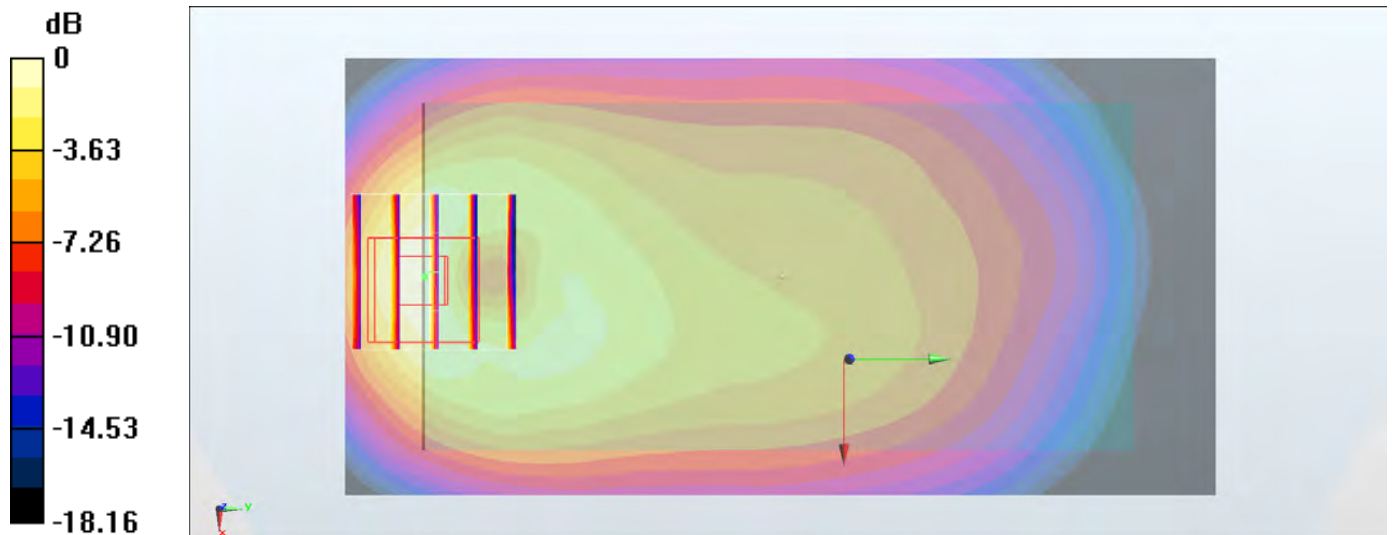

0 dB = 0.490 W/kg = -3.10 dBW/kg

#31_GSM1900_GPRS (4 Tx slots)_Back_10mm_Ch661;ANT0

Communication System: PCS; Frequency: 1880 MHz; Duty Cycle: 1:2.08

Medium: MSL_1900_160903 Medium parameters used: $f = 1880$ MHz; $\sigma = 1.55$ S/m; $\epsilon_r = 55.448$; $\rho = 1000$ kg/m³

Ambient Temperature : 23.6 °C ; Liquid Temperature : 22.6 °C

DASY5 Configuration

- Probe: EX3DV4 - SN3925; ConvF(8, 8, 8); Calibrated: 2016/5/26;
- Sensor-Surface: 1.4mm (Mechanical Surface Detection)
- Electronics: DAE3 Sn495; Calibrated: 2016/5/27
- Phantom: SAM_Right; Type: QD000P40CD; Serial: S/N:1801
- Measurement SW: DASY52, Version 52.8 (8); SEMCAD X Version 14.6.10 (7373)

Area Scan (61x111x1): Interpolated grid: dx=1.500 mm, dy=1.500 mm

Maximum value of SAR (interpolated) = 0.128 W/kg

Zoom Scan (5x5x7)/Cube 0: Measurement grid: dx=8mm, dy=8mm, dz=5mm

Reference Value = 4.589 V/m; Power Drift = 0.13 dB

Peak SAR (extrapolated) = 0.152 W/kg

SAR(1 g) = 0.085 W/kg; SAR(10 g) = 0.044 W/kg

Maximum value of SAR (measured) = 0.128 W/kg

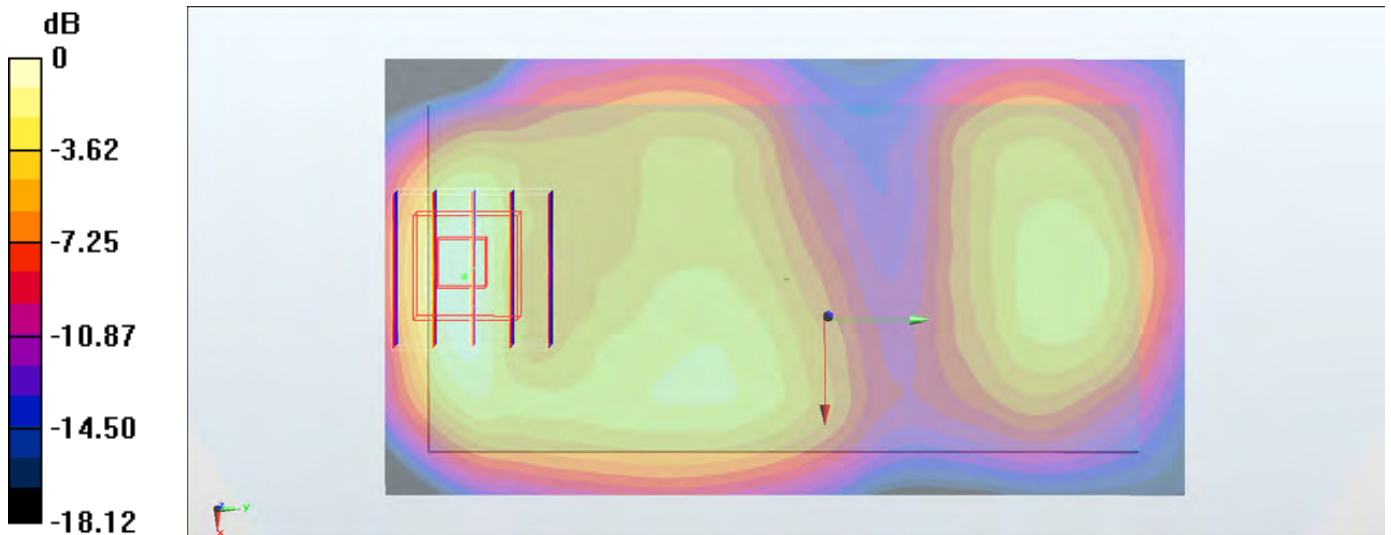

0 dB = 0.128 W/kg = -8.93 dBW/kg

#32_WCDMA II_RMC 12.2Kbps_Back_10mm_Ch9538;ANT0

Communication System: WCDMA ; Frequency: 1907.6 MHz; Duty Cycle: 1:1

Medium: MSL_1900_160903 Medium parameters used: $f = 1908 \text{ MHz}$; $\sigma = 1.584 \text{ S/m}$; $\epsilon_r = 55.33$; $\rho = 1000 \text{ kg/m}^3$

Ambient Temperature : $23.6 \text{ }^\circ\text{C}$; Liquid Temperature : $22.6 \text{ }^\circ\text{C}$

DASY5 Configuration

- Probe: EX3DV4 - SN3925; ConvF(8, 8, 8); Calibrated: 2016/5/26;
- Sensor-Surface: 1.4mm (Mechanical Surface Detection)
- Electronics: DAE3 Sn495; Calibrated: 2016/5/27
- Phantom: SAM_Right; Type: QD000P40CD; Serial: S/N:1801
- Measurement SW: DASY52, Version 52.8 (8); SEMCAD X Version 14.6.10 (7373)

Area Scan (61x111x1): Interpolated grid: $dx=1.500 \text{ mm}$, $dy=1.500 \text{ mm}$

Maximum value of SAR (interpolated) = 0.164 W/kg

Zoom Scan (5x5x7)/Cube 0: Measurement grid: $dx=8\text{mm}$, $dy=8\text{mm}$, $dz=5\text{mm}$

Reference Value = 6.711 V/m ; Power Drift = -0.05 dB

Peak SAR (extrapolated) = 0.200 W/kg

SAR(1 g) = 0.110 W/kg ; SAR(10 g) = 0.055 W/kg

Maximum value of SAR (measured) = 0.164 W/kg

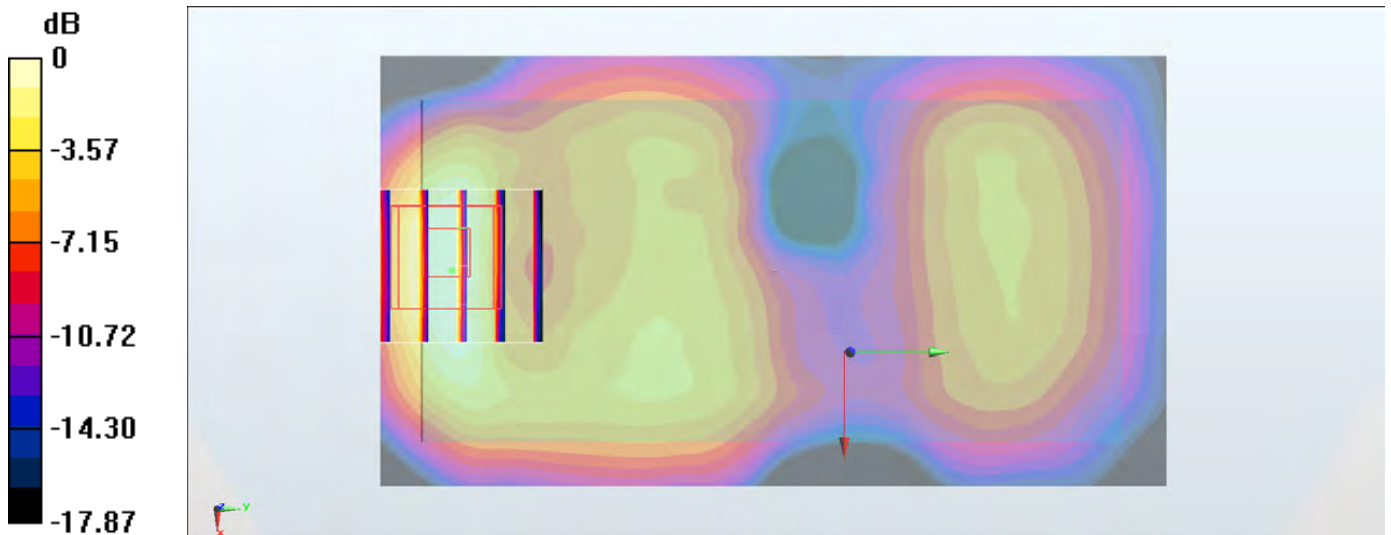

0 dB = 0.164 W/kg = -7.85 dBW/kg

#33_WCDMA IV_RMC 12.2Kbps_Back_10mm_Ch1312;ANT1

Communication System: WCDMA; Frequency: 1712.4 MHz; Duty Cycle: 1:1

Medium: MSL_1750_160904 Medium parameters used : $f = 1712.4$ MHz; $\sigma = 1.419$ S/m; $\epsilon_r =$

55.806 ; $\rho = 1000$ kg/m³

Ambient Temperature : 23.8 °C ; Liquid Temperature : 22.8 °C

DASY5 Configuration

- Probe: EX3DV4 - SN3925; ConvF(8.3, 8.3, 8.3); Calibrated: 2016/5/26;
- Sensor-Surface: 1.4mm (Mechanical Surface Detection)
- Electronics: DAE3 Sn495; Calibrated: 2016/5/27
- Phantom: SAM_Right; Type: QD000P40CD; Serial: S/N:1801
- Measurement SW: DASY52, Version 52.8 (8); SEMCAD X Version 14.6.10 (7373)

Area Scan (61x121x1): Interpolated grid: dx=1.500 mm, dy=1.500 mm

Maximum value of SAR (interpolated) = 0.275 W/kg

Zoom Scan (5x5x7)/Cube 0: Measurement grid: dx=8mm, dy=8mm, dz=5mm

Reference Value = 8.797 V/m; Power Drift = -0.12 dB

Peak SAR (extrapolated) = 0.287 W/kg

SAR(1 g) = 0.160 W/kg; SAR(10 g) = 0.085 W/kg

Maximum value of SAR (measured) = 0.237 W/kg

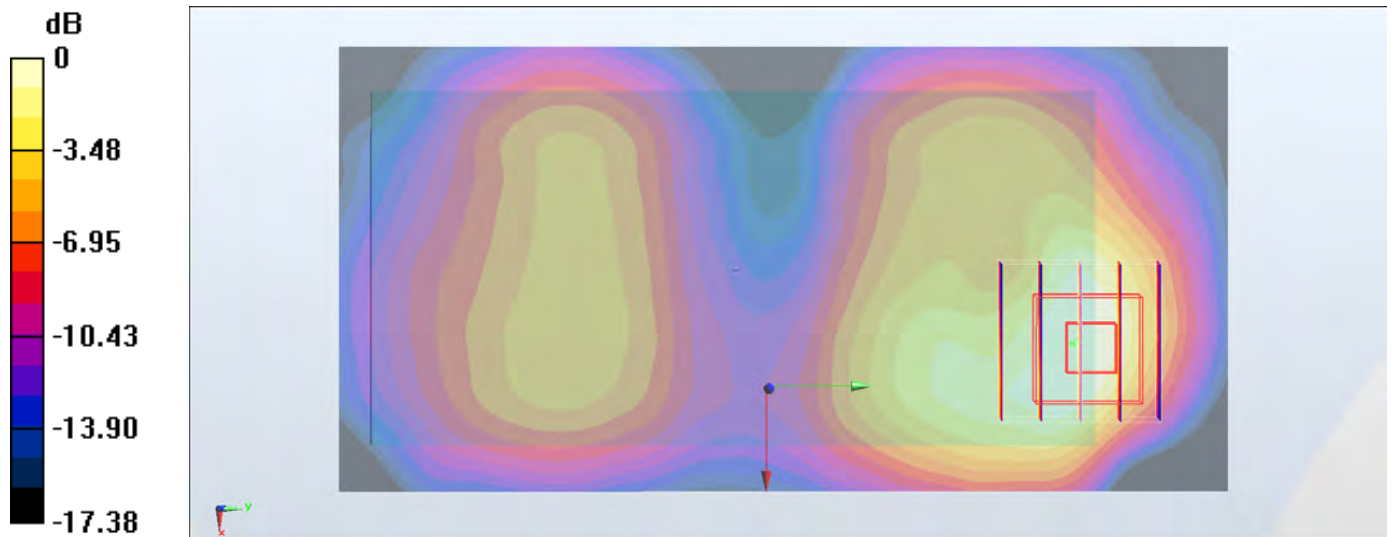

0 dB = 0.237 W/kg = -6.25 dBW/kg

#34_WCDMA V_RMC 12.2Kbps_Back_10mm_Ch4132;ANT0;Sample 2

Communication System: WCDMA ; Frequency: 826.4 MHz;Duty Cycle: 1:1

Medium: MSL_850_160905 Medium parameters used : $f = 826.4$ MHz; $\sigma = 0.983$ S/m; $\epsilon_r = 56.84$; $\rho = 1000$ kg/m³

Ambient Temperature : 23.9 °C ; Liquid Temperature : 22.9 °C

DASY5 Configuration

- Probe: EX3DV4 - SN3925; ConvF(9.91, 9.91, 9.91); Calibrated: 2016/5/26;
- Sensor-Surface: 1.4mm (Mechanical Surface Detection)
- Electronics: DAE3 Sn495; Calibrated: 2016/5/27
- Phantom: SAM_Left; Type: QD000P40CD; Serial: S/N:1796
- Measurement SW: DASY52, Version 52.8 (8); SEMCAD X Version 14.6.10 (7373)

Area Scan (61x121x1): Interpolated grid: dx=1.500 mm, dy=1.500 mm

Maximum value of SAR (interpolated) = 0.183 W/kg

Zoom Scan (5x5x7)/Cube 0: Measurement grid: dx=8mm, dy=8mm, dz=5mm

Reference Value = 10.48 V/m; Power Drift = -0.10 dB

Peak SAR (extrapolated) = 0.221 W/kg

SAR(1 g) = 0.121 W/kg; SAR(10 g) = 0.066 W/kg

Maximum value of SAR (measured) = 0.188 W/kg

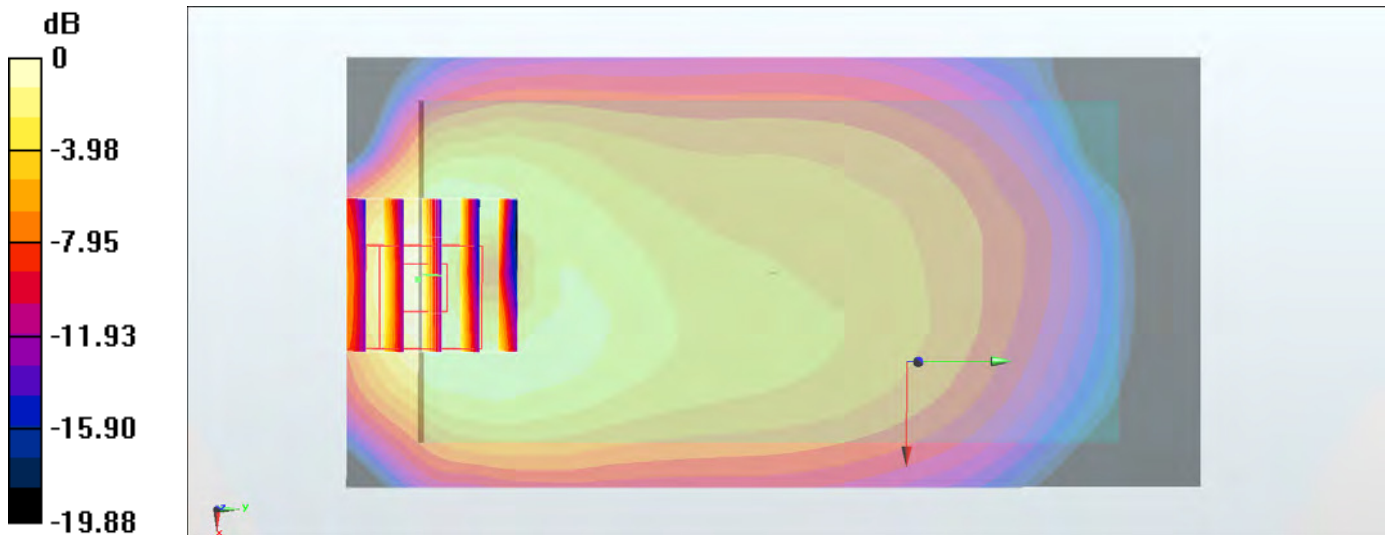

0 dB = 0.188 W/kg = -7.26 dBW/kg

#35_LTE Band 2_20M_QPSK_1_0_Back_10mm_Ch18900;ANT1;Sample 2

Communication System: LTE; Frequency: 1880 MHz; Duty Cycle: 1:1

Medium: MSL_1900_160903 Medium parameters used: $f = 1880$ MHz; $\sigma = 1.55$ S/m; $\epsilon_r = 55.448$; $\rho = 1000$ kg/m³

Ambient Temperature : 23.6 °C ; Liquid Temperature : 22.6 °C

DASY5 Configuration

- Probe: EX3DV4 - SN3925; ConvF(8, 8, 8); Calibrated: 2016/5/26;
- Sensor-Surface: 1.4mm (Mechanical Surface Detection)
- Electronics: DAE3 Sn495; Calibrated: 2016/5/27
- Phantom: SAM_Right; Type: QD000P40CD; Serial: S/N:1801
- Measurement SW: DASY52, Version 52.8 (8); SEMCAD X Version 14.6.10 (7373)

Area Scan (61x111x1): Interpolated grid: dx=1.500 mm, dy=1.500 mm

Maximum value of SAR (interpolated) = 0.210 W/kg

Zoom Scan (5x5x7)/Cube 0: Measurement grid: dx=8mm, dy=8mm, dz=5mm

Reference Value = 8.118 V/m; Power Drift = -0.16 dB

Peak SAR (extrapolated) = 0.262 W/kg

SAR(1 g) = 0.139 W/kg; SAR(10 g) = 0.068 W/kg

Maximum value of SAR (measured) = 0.200 W/kg

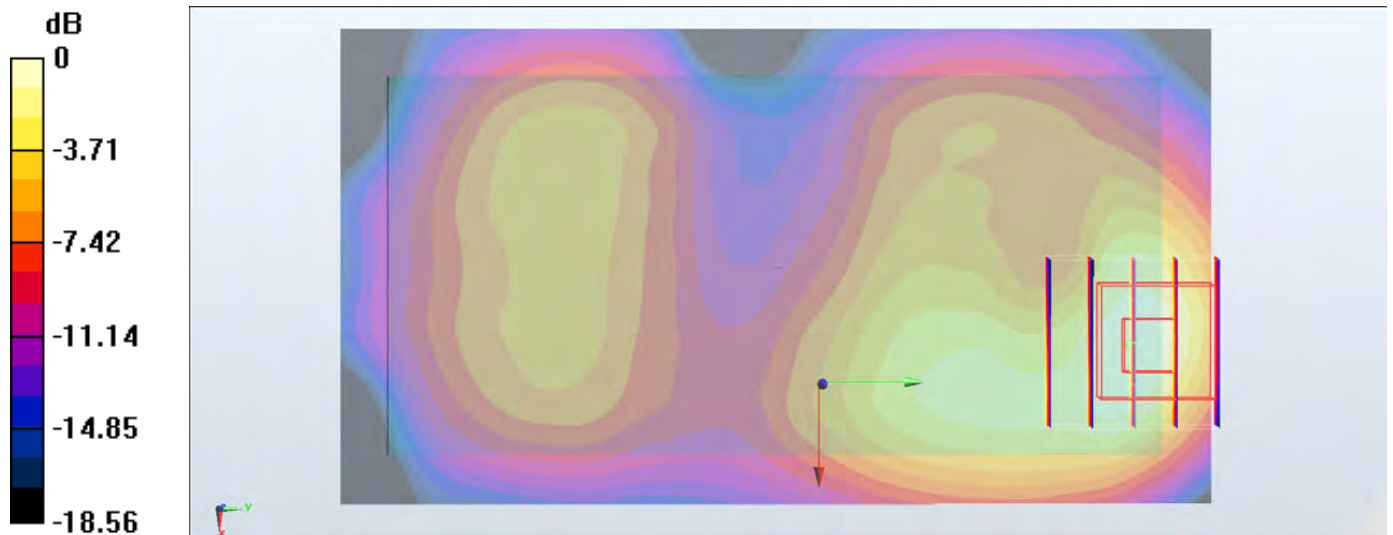

0 dB = 0.200 W/kg = -6.99 dBW/kg

#36_LTE Band 4_20M_QPSK_1_0_Back_10mm_Ch20175;ANT1;Sample 2

Communication System: LTE; Frequency: 1732.5 MHz;Duty Cycle: 1:1
 Medium: MSL_1750_160904 Medium parameters used : $f = 1732.5$ MHz; $\sigma = 1.44$ S/m; $\epsilon_r = 55.742$;
 $\rho = 1000$ kg/m³
 Ambient Temperature : 23.8 °C ; Liquid Temperature : 22.8 °C

DASY5 Configuration

- Probe: EX3DV4 - SN3925; ConvF(8.3, 8.3, 8.3); Calibrated: 2016/5/26;
- Sensor-Surface: 1.4mm (Mechanical Surface Detection)
- Electronics: DAE3 Sn495; Calibrated: 2016/5/27
- Phantom: SAM_Right; Type: QD000P40CD; Serial: S/N:1801
- Measurement SW: DASY52, Version 52.8 (8); SEMCAD X Version 14.6.10 (7373)

Area Scan (61x121x1): Interpolated grid: dx=1.500 mm, dy=1.500 mm
 Maximum value of SAR (interpolated) = 0.276 W/kg

Zoom Scan (5x5x7)/Cube 0: Measurement grid: dx=8mm, dy=8mm, dz=5mm
 Reference Value = 8.870 V/m; Power Drift = -0.10 dB
 Peak SAR (extrapolated) = 0.310 W/kg
 SAR(1 g) = 0.173 W/kg; SAR(10 g) = 0.090 W/kg
 Maximum value of SAR (measured) = 0.259 W/kg

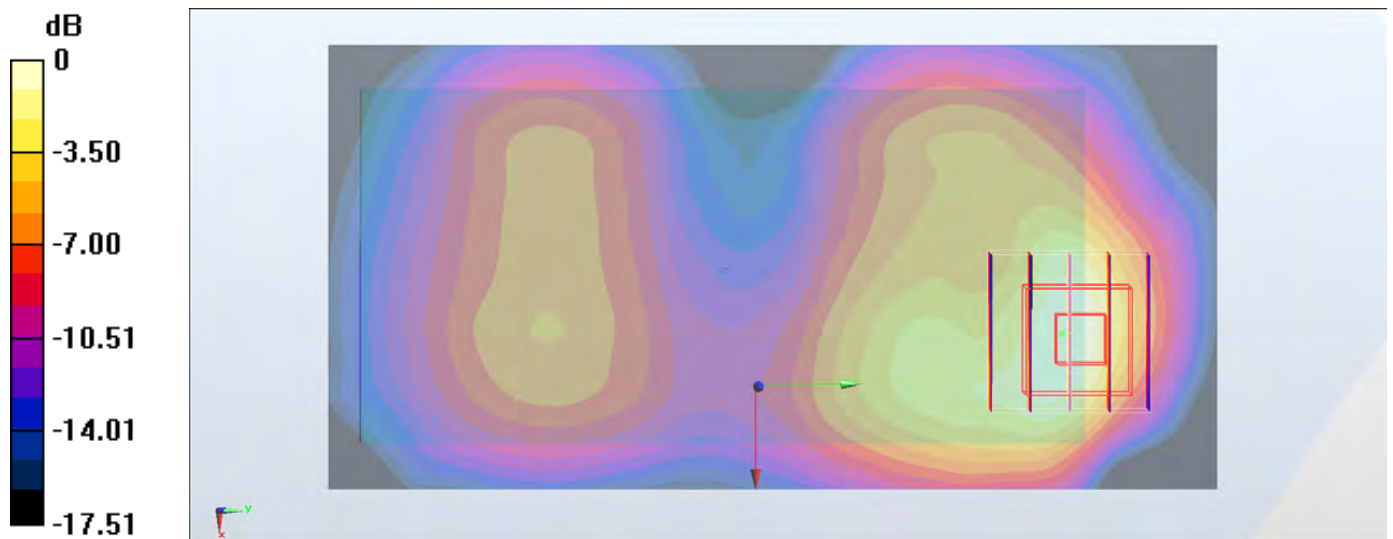

0 dB = 0.259 W/kg = -5.87 dBW/kg

#37_LTE Band 5_10M_QPSK_1_0_Back_10mm_Ch20525;ANT0;Sample 2

Communication System: LTE ; Frequency: 836.5 MHz;Duty Cycle: 1:1

Medium: MSL_850_160905 Medium parameters used : $f = 836.5$ MHz; $\sigma = 0.993$ S/m; $\epsilon_r = 56.754$; $\rho = 1000$ kg/m³

Ambient Temperature : 23.9 °C ; Liquid Temperature : 22.9 °C

DASY5 Configuration

- Probe: EX3DV4 - SN3925; ConvF(9.91, 9.91, 9.91); Calibrated: 2016/5/26;
- Sensor-Surface: 1.4mm (Mechanical Surface Detection)
- Electronics: DAE3 Sn495; Calibrated: 2016/5/27
- Phantom: SAM_Left; Type: QD000P40CD; Serial: S/N:1796
- Measurement SW: DASY52, Version 52.8 (8); SEMCAD X Version 14.6.10 (7373)

Area Scan (61x121x1): Interpolated grid: dx=1.500 mm, dy=1.500 mm

Maximum value of SAR (interpolated) = 0.205 W/kg

Zoom Scan (5x5x7)/Cube 0: Measurement grid: dx=8mm, dy=8mm, dz=5mm

Reference Value = 9.321 V/m; Power Drift = -0.11 dB

Peak SAR (extrapolated) = 0.254 W/kg

SAR(1 g) = 0.140 W/kg; SAR(10 g) = 0.076 W/kg

Maximum value of SAR (measured) = 0.214 W/kg

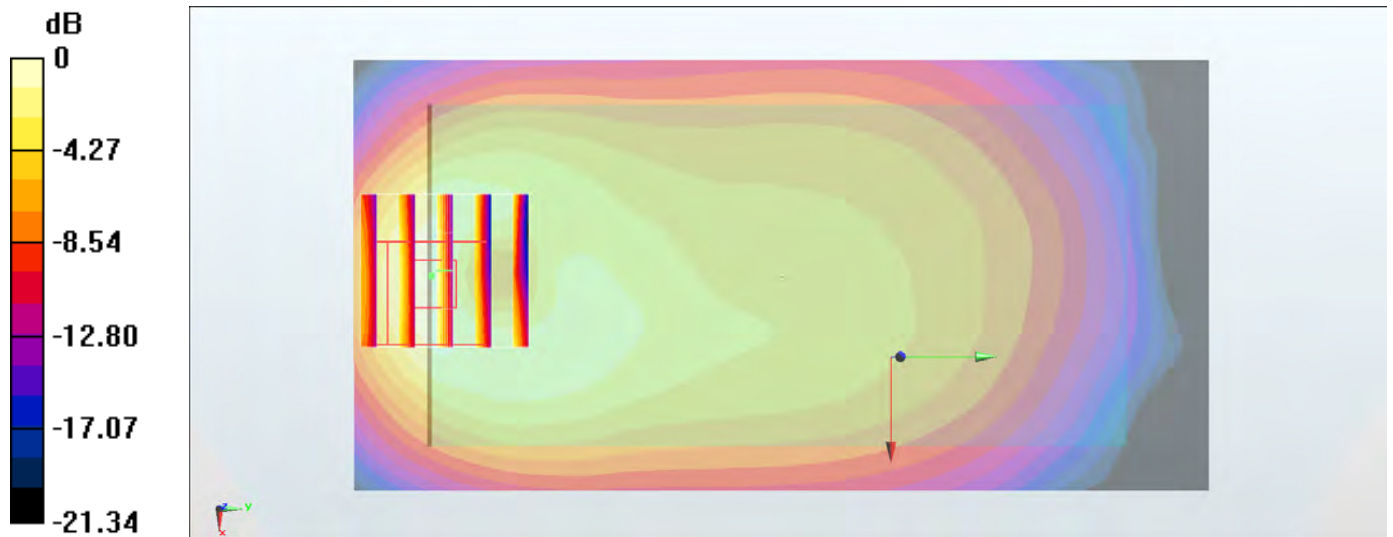

0 dB = 0.214 W/kg = -6.70 dBW/kg

#38_LTE Band 7_20M_QPSK_1_99_Back_10mm_Ch20850;Ant 0

Communication System: LTE ; Frequency: 2510 MHz;Duty Cycle: 1:1

Medium: MSL_2600_160825 Medium parameters used: $f = 2510$ MHz; $\sigma = 1.986$ S/m; $\epsilon_r = 51.966$; $\rho = 1000$ kg/m³

Ambient Temperature : 23.2 °C ; Liquid Temperature : 22.2 °C

DASY5 Configuration

- Probe: EX3DV4 - SN3925; ConvF(7.38, 7.38, 7.38); Calibrated: 2016/5/26;
- Sensor-Surface: 1.4mm (Mechanical Surface Detection)
- Electronics: DAE3 Sn495; Calibrated: 2016/5/27
- Phantom: SAM_Right; Type: QD000P40CD; Serial: S/N:1801
- Measurement SW: DASY52, Version 52.8 (8); SEMCAD X Version 14.6.10 (7373)

Area Scan (81x141x1): Interpolated grid: dx=1.200 mm, dy=1.200 mm

Maximum value of SAR (interpolated) = 0.284 W/kg

Zoom Scan (8x10x7)/Cube 0: Measurement grid: dx=5mm, dy=5mm, dz=5mm

Reference Value = 10.74 V/m; Power Drift = -0.15 dB

Peak SAR (extrapolated) = 0.371 W/kg

SAR(1 g) = 0.189 W/kg; SAR(10 g) = 0.095 W/kg

Maximum value of SAR (measured) = 0.295 W/kg

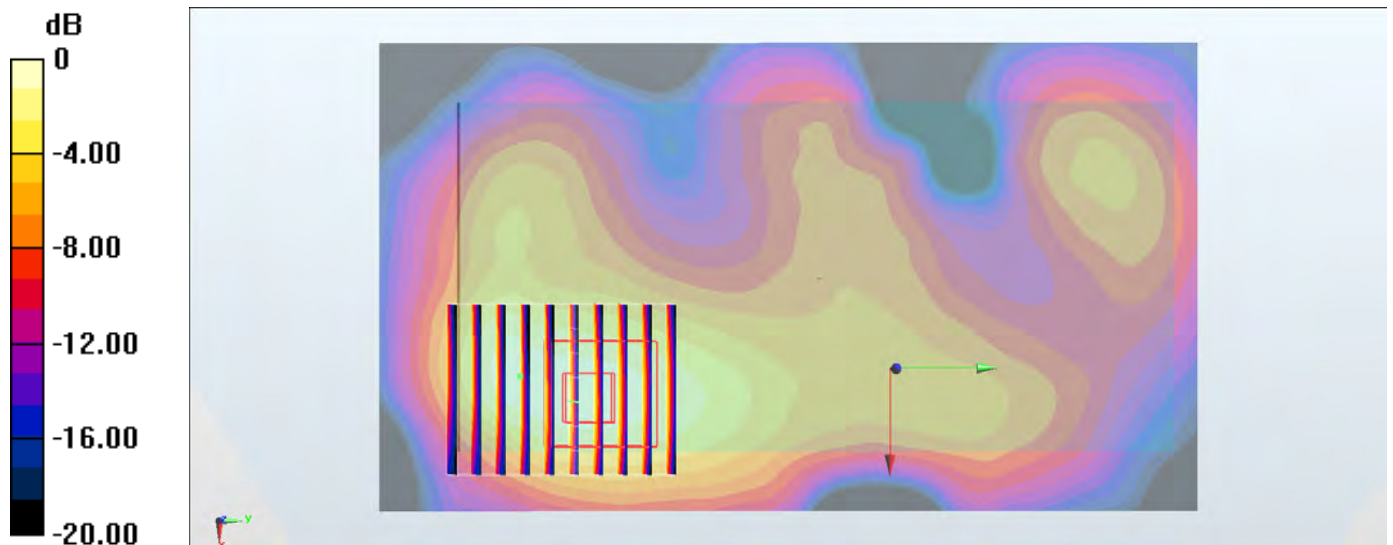

0 dB = 0.295 W/kg = -5.30 dBW/kg

#39_LTE Band 12_10M_QPSK_1_49_Back_10mm_Ch23095;ANT0;Sample 2

Communication System: LTE ; Frequency: 707.5 MHz;Duty Cycle: 1:1

Medium: MSL_750_160905 Medium parameters used : $f = 707.5 \text{ MHz}$; $\sigma = 0.921 \text{ S/m}$; $\epsilon_r = 56.827$; $\rho = 1000 \text{ kg/m}^3$

Ambient Temperature : 23.2 °C ; Liquid Temperature : 22.2 °C

DASY5 Configuration

- Probe: EX3DV4 - SN3925; ConvF(10.18, 10.18, 10.18); Calibrated: 2016/5/26;
- Sensor-Surface: 1.4mm (Mechanical Surface Detection)
- Electronics: DAE3 Sn495; Calibrated: 2016/5/27
- Phantom: SAM_Left; Type: QD000P40CD; Serial: S/N:1796
- Measurement SW: DASY52, Version 52.8 (8); SEMCAD X Version 14.6.10 (7373)

Area Scan (61x121x1): Interpolated grid: $dx=1.500 \text{ mm}$, $dy=1.500 \text{ mm}$

Maximum value of SAR (interpolated) = 0.231 W/kg

Zoom Scan (5x5x7)/Cube 0: Measurement grid: $dx=8\text{mm}$, $dy=8\text{mm}$, $dz=5\text{mm}$

Reference Value = 11.43 V/m; Power Drift = 0.00 dB

Peak SAR (extrapolated) = 0.280 W/kg

SAR(1 g) = 0.152 W/kg; SAR(10 g) = 0.085 W/kg

Maximum value of SAR (measured) = 0.234 W/kg

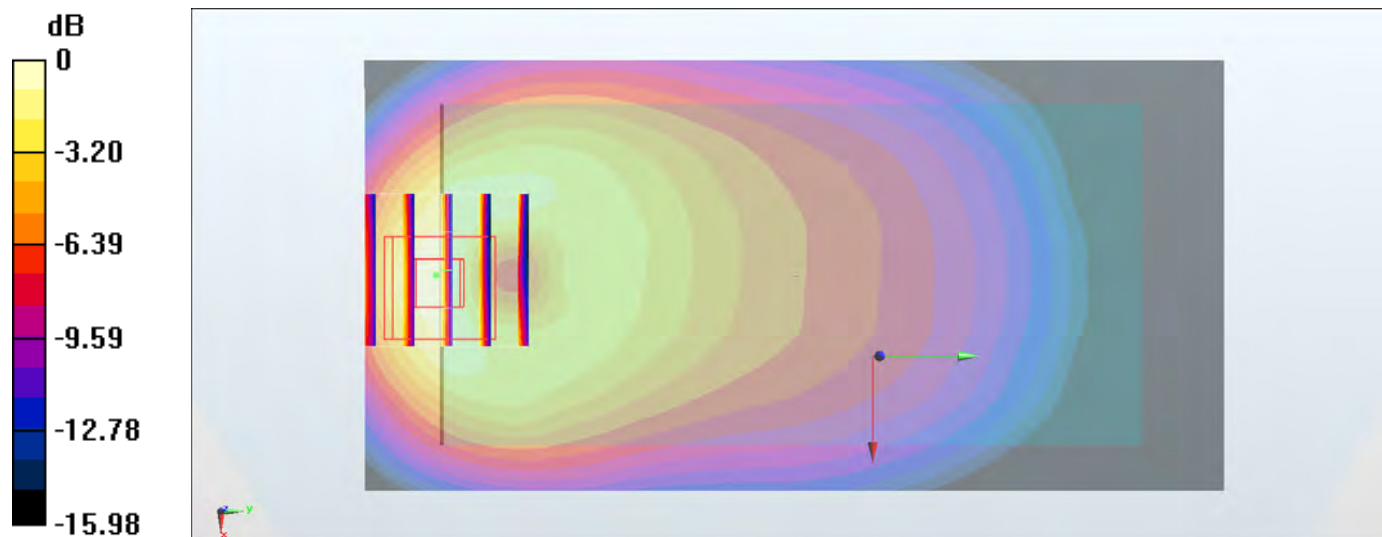

0 dB = 0.234 W/kg = -6.31 dBW/kg

#40_LTE Band 38_20M_QPSK_50_0_Back_10mm_Ch37850;ANT1

Communication System: LTE; Frequency: 2580 MHz;Duty Cycle: 1:1.59

Medium: MSL_2600_160906 Medium parameters used: $f = 2580$ MHz; $\sigma = 2.122$ S/m; $\epsilon_r = 51.471$; $\rho = 1000$ kg/m³

Ambient Temperature : 23.5 °C ; Liquid Temperature : 22.5 °C

DASY5 Configuration

- Probe: ES3DV3 - SN3270; ConvF(4.12, 4.12, 4.12); Calibrated: 2016/8/26;
- Sensor-Surface: 3mm (Mechanical Surface Detection)
- Electronics: DAE4 Sn1399; Calibrated: 2015/11/23
- Phantom: SAM_Left; Type: QD000P40CD; Serial: S/N:1796
- Measurement SW: DASY52, Version 52.8 (8); SEMCAD X Version 14.6.10 (7373)

Area Scan (81x141x1): Interpolated grid: dx=1.200 mm, dy=1.200 mm

Maximum value of SAR (interpolated) = 0.171 W/kg

Zoom Scan (7x7x7)/Cube 0: Measurement grid: dx=5mm, dy=5mm, dz=5mm

Reference Value = 8.611 V/m; Power Drift = -0.06 dB

Peak SAR (extrapolated) = 0.263 W/kg

SAR(1 g) = 0.135 W/kg; SAR(10 g) = 0.071 W/kg

Maximum value of SAR (measured) = 0.170 W/kg

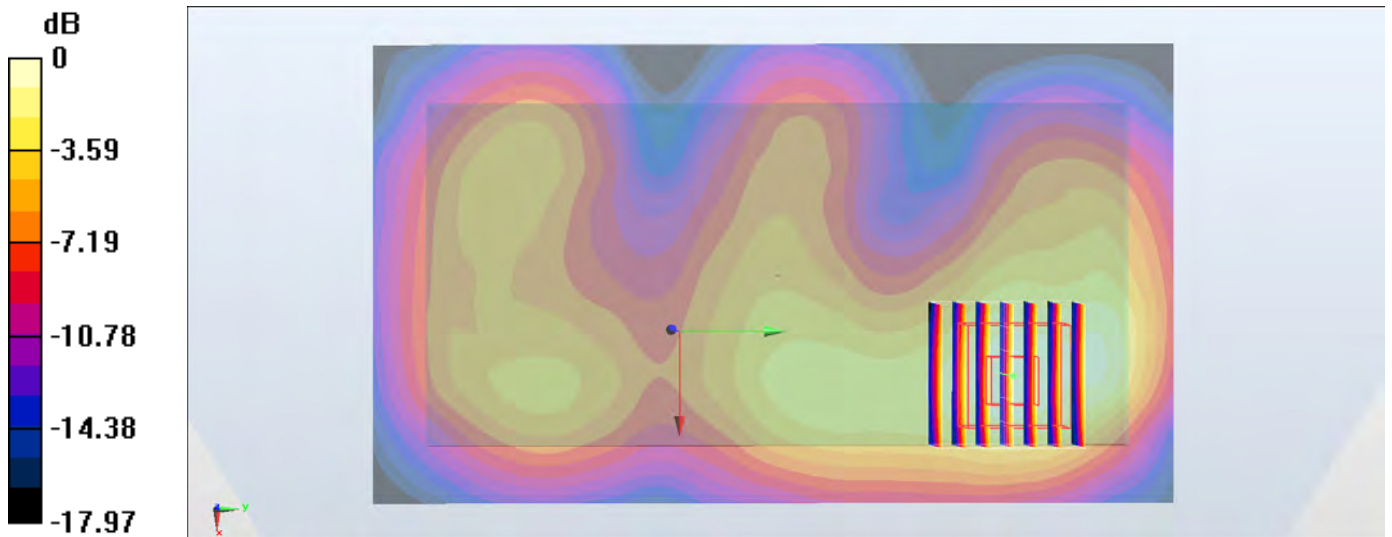

0 dB = 0.170 W/kg = -7.70 dBW/kg

#41_WLAN2.4GHz_802.11b 1Mbps_Front_10mm_Ch11

Communication System: 802.11b ; Frequency: 2462 MHz;Duty Cycle: 1:1

Medium: MSL_2450_160823 Medium parameters used: $f = 2462$ MHz; $\sigma = 1.97$ S/m; $\epsilon_r = 52.42$; $\rho = 1000$ kg/m³

Ambient Temperature : 23.7 °C ; Liquid Temperature : 22.7 °C

DASY5 Configuration:

- Probe: EX3DV4 - SN3931; ConvF(7.54, 7.54, 7.54); Calibrated: 2015/10/1;
- Sensor-Surface: 1.4mm (Mechanical Surface Detection)
- Electronics: DAE3 Sn577; Calibrated: 2015/9/24
- Phantom: SAM_Left; Type: QD000P40CD; Serial: TP:1644
- Measurement SW: DASY52, Version 52.8 (8);SEMCAD X Version 14.6.10 (7373)

Area Scan (81x151x1): Interpolated grid: dx=1.200 mm, dy=1.200 mm

Maximum value of SAR (interpolated) = 0.107 W/kg

Zoom Scan (7x9x7)/Cube 0: Measurement grid: dx=5mm, dy=5mm, dz=5mm

Reference Value = 2.842 V/m; Power Drift = 0.01 dB

Peak SAR (extrapolated) = 0.0930 W/kg

SAR(1 g) = 0.046 W/kg; SAR(10 g) = 0.022 W/kg

Maximum value of SAR (measured) = 0.0741 W/kg

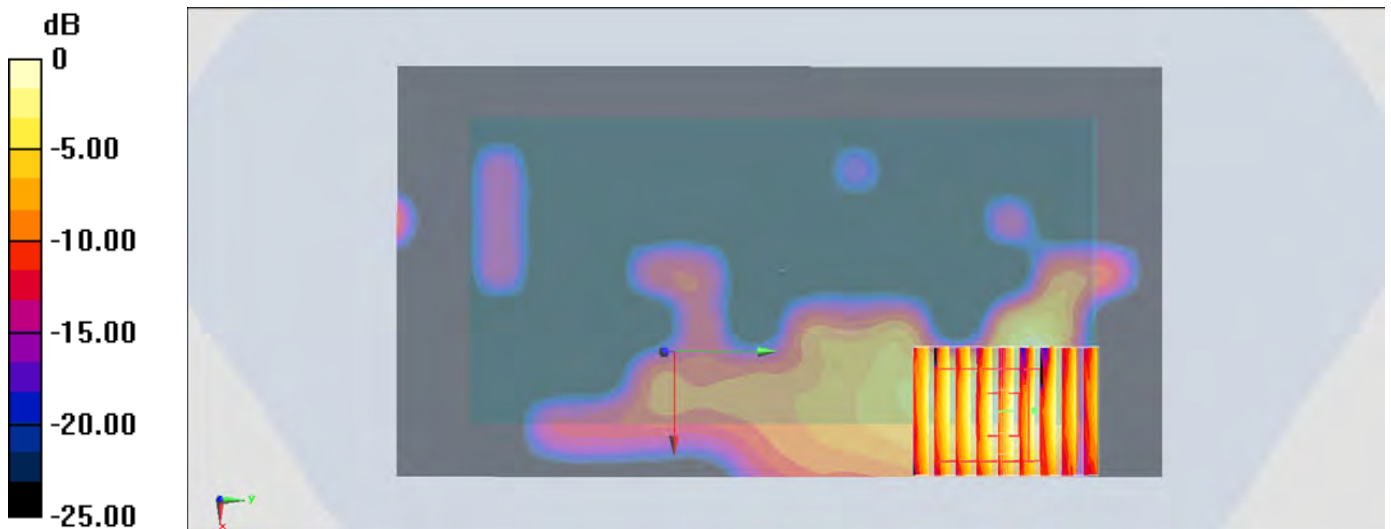

0 dB = 0.107 W/kg = -9.71 dBW/kg

#42_WLAN5GHz_802.11a 6Mbps_Front_10mm_Ch48;Sample 2

Communication System: 802.11a; Frequency: 5240 MHz;Duty Cycle: 1:1.029

Medium: MSL_5G_160912 Medium parameters used: $f = 5240$ MHz; $\sigma = 5.468$ S/m; $\epsilon_r = 46.859$; $\rho = 1000$ kg/m³

Ambient Temperature : 23.5 °C ; Liquid Temperature : 22.5 °C

DASY5 Configuration:

- Probe: EX3DV4 - SN3931; ConvF(4.48, 4.48, 4.48); Calibrated: 2015/10/1;
- Sensor-Surface: 1.4mm (Mechanical Surface Detection)
- Electronics: DAE3 Sn577; Calibrated: 2015/9/24
- Phantom: SAM-Right; Type: SAM; Serial: 1795
- Measurement SW: DASY52, Version 52.8 (8);SEMCAD X Version 14.6.10 (7373)

Area Scan (101x181x1): Interpolated grid: dx=1.000 mm, dy=1.000 mm

Maximum value of SAR (interpolated) = 0.179 W/kg

Zoom Scan (7x7x7)/Cube 0: Measurement grid: dx=4mm, dy=4mm, dz=1.4mm

Reference Value = 2.604 V/m; Power Drift = -0.07 dB

Peak SAR (extrapolated) = 0.208 W/kg

SAR(1 g) = 0.051 W/kg; SAR(10 g) = 0.016 W/kg

Maximum value of SAR (measured) = 0.130 W/kg

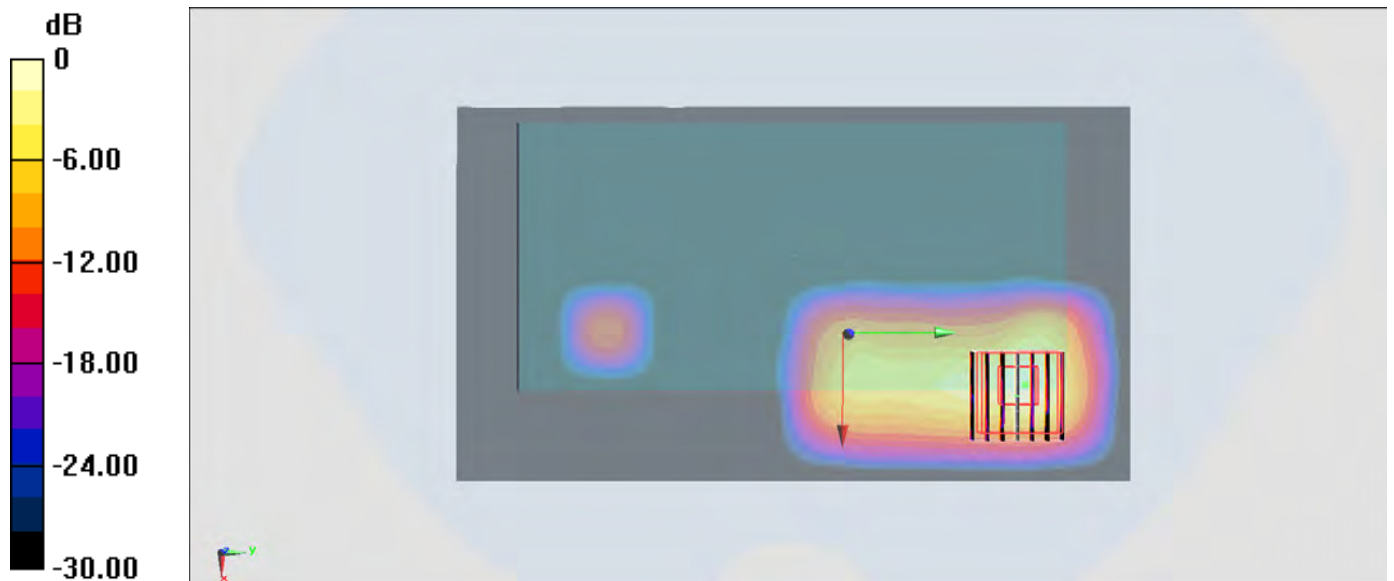

0 dB = 0.179 W/kg = -7.47 dBW/kg

#43_WLAN5GHz_802.11n-HT20 MCS0_Front_10mm_Ch132 ;Sample 2

Communication System: 802.11n; Frequency: 5660 MHz;Duty Cycle: 1:1.031

Medium: MSL_5G_160905 Medium parameters used: $f = 5660$ MHz; $\sigma = 5.92$ mho/m; $\epsilon_r = 46.1$; $\rho = 1000$ kg/m³

Ambient Temperature : 23.4 °C ; Liquid Temperature : 22.4 °C

DASY4 Configuration:

- Probe: EX3DV4 - SN3931; ConvF(3.84, 3.84, 3.84); Calibrated: 2015/10/1
- Sensor-Surface: 1.4mm (Mechanical Surface Detection)
- Electronics: DAE3 Sn577; Calibrated: 2015/9/24
- Phantom: SAM_Right; Type: SAM_Right; Serial: TP-1303
- ;Postprocessing SW: SEMCAD, V1.8 Build 159

Area Scan (101x181x1): Measurement grid: dx=10mm, dy=10mm

Maximum value of SAR (interpolated) = 0.370 mW/g

Zoom Scan (7x7x7)/Cube 0: Measurement grid: dx=4mm, dy=4mm, dz=1.4mm

Reference Value = 2.43 V/m; Power Drift = -0.119 dB

Peak SAR (extrapolated) = 0.838 W/kg

SAR(1 g) = 0.140 mW/g; SAR(10 g) = 0.041 mW/g

Maximum value of SAR (measured) = 0.339 mW/g



0 dB = 0.339mW/g

#44_WLAN5GHz_802.11n-HT40 MCS0_Front_10mm_Ch159 ;Sample 2

Communication System: 802.11n; Frequency: 5795 MHz; Duty Cycle: 1:1.065

Medium: MSL_5G_160905 Medium parameters used: $f = 5795 \text{ MHz}$; $\sigma = 6.09 \text{ mho/m}$; $\epsilon_r = 45.9$; $\rho = 1000 \text{ kg/m}^3$

Ambient Temperature : $23.4 \text{ }^\circ\text{C}$; Liquid Temperature : $22.4 \text{ }^\circ\text{C}$

DASY4 Configuration:

- Probe: EX3DV4 - SN3931; ConvF(3.98, 3.98, 3.98); Calibrated: 2015/10/1
- Sensor-Surface: 1.4mm (Mechanical Surface Detection)
- Electronics: DAE3 Sn577; Calibrated: 2015/9/24
- Phantom: SAM_Right; Type: SAM_Right; Serial: TP-1303
- ;Postprocessing SW: SEMCAD, V1.8 Build 159

Area Scan (101x181x1): Measurement grid: $dx=10\text{mm}$, $dy=10\text{mm}$

Maximum value of SAR (interpolated) = 0.232 mW/g

Zoom Scan (7x7x7)/Cube 0: Measurement grid: $dx=4\text{mm}$, $dy=4\text{mm}$, $dz=1.4\text{mm}$

Reference Value = 1.31 V/m ; Power Drift = 0.169 dB

Peak SAR (extrapolated) = 1.14 W/kg

SAR(1 g) = 0.102 mW/g ; SAR(10 g) = 0.028 mW/g

Maximum value of SAR (measured) = 0.258 mW/g

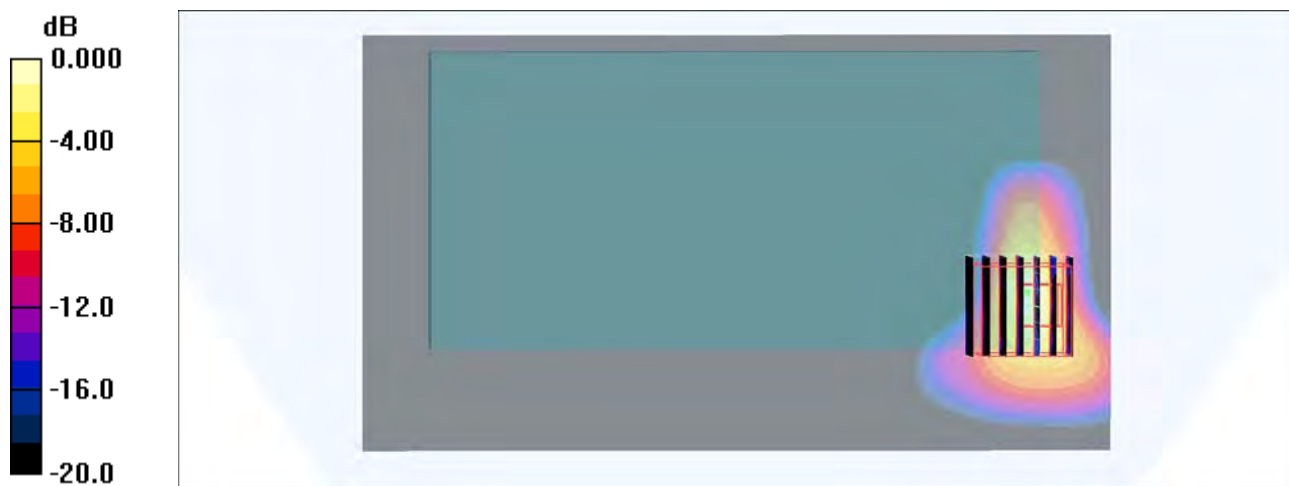

0 dB = 0.258mW/g