



Test Report No.: RE160217W003-5



FCC TEST REPORT (PART 27)

Product: Smartphone
Model Name: 2PVG200
FCC ID: NM82PVG200
Applicant: HTC Corporation
Address: 1F, 6-3 Baoqiang Road, Xindian District, New Taipei City, Taiwan 231
Manufacturer: Shanghai Huaqin Telecom Technology Limited Company
Address: NO.1 Building, 399 Keyuan Road, Zhangjiang Hi-Tech Park, Pudong New Area, Shanghai, China 201203
Prepared by: Bureau Veritas Shenzhen Co., Ltd. Dongguan Branch
Lab Location: No. 34, Chenwulu Section, Guantai Rd., Houjie Town, Dongguan City, Guangdong 523942, China
TEL: +86 769 8593 5656
FAX: +86 769 8593 1080
E-MAIL: customerservice.dg@cn.bureauveritas.com
Report No.: RF160217W003-5
Received Date: Feb. 17, 2016
Test Date: Feb. 18, 2016 ~ Mar. 17, 2016
Issued Date: Mar. 18, 2016

This report should not be used by the client to claim product certification, approval, or endorsement by A2LA or any government agencies.

This report is for your exclusive use. Any copying or replication of this report to or for any other person or entity, or use of our name or trademark, is permitted only with our prior written permission. This report sets forth our findings solely with respect to the test samples identified herein. The results set forth in this report are not indicative or representative of the quality or characteristics of the lot from which a test sample was taken or any similar or identical product unless specifically and expressly noted. Our report includes all of the tests requested by you and the results thereof based upon the information that you provided to us. You have 60 days from date of issuance of this report to notify us of any material error or omission caused by our negligence, provided, however, that such notice shall be in writing and shall specifically address the issue you wish to raise. A failure to raise such issue within the prescribed time shall constitute your unqualified acceptance of the completeness of this report, the tests conducted and the correctness of the report contents. Unless specific mention, the uncertainty of measurement has been explicitly taken into account to declare the compliance or non-compliance to the specification

Bureau Veritas Shenzhen Co., Ltd.
Dongguan Branch

No. 34, Chenwulu Section, Guantai Rd.,
Houjie Town, Dongguan City,
Guangdong 523942, China

Tel: +86 769 8593 5656
Fax: +86 769 8593 1080
Email: customerservice.dg@cn.bureauveritas.com



TABLE OF CONTENTS

RELEASE CONTROL RECORD	4
1 CERTIFICATION	5
2 SUMMARY OF TEST RESULTS	6
2.1 MEASUREMENT UNCERTAINTY	6
2.2 TEST SITE AND INSTRUMENTS	7
3 GENERAL INFORMATION.....	8
3.1 GENERAL DESCRIPTION OF EUT	8
3.2 CONFIGURATION OF SYSTEM UNDER TEST	11
3.3 DESCRIPTION OF SUPPORT UNITS	12
3.4 DESCRIPTION OF TEST MODES	12
3.5 GENERAL DESCRIPTION OF APPLIED STANDARDS	15
4 TEST TYPES AND RESULTS	16
4.1 OUTPUT POWER MEASUREMENT	16
4.1.1 LIMITS OF OUTPUT POWER MEASUREMENT	16
4.1.2 TEST PROCEDURES	16
4.1.3 TEST SETUP	17
4.1.4 TEST RESULTS	18
4.2 FREQUENCY STABILITY MEASUREMENT	30
4.2.1 LIMITS OF FREQUENCY STABILITY MEASUREMENT	30
4.2.2 TEST PROCEDURE	30
4.2.3 TEST SETUP	30
4.2.4 TEST RESULTS	31
4.3 OCCUPIED BANDWIDTH MEASUREMENT	32
4.3.1 LIMITS OF OCCUPIED BANDWIDTH MEASUREMENT	32
4.3.2 TEST SETUP	32
4.3.3 TEST PROCEDURES	32
4.3.4 TEST RESULTS	33
4.4 PEAK TO AVERAGE RATIO	37
4.4.1 LIMITS OF PEAK TO AVERAGE RATIO MEASUREMENT	37
4.4.2 TEST SETUP	37
4.4.3 TEST PROCEDURES	37
4.4.4 TEST RESULTS	38
4.5 BAND EDGE MEASUREMENT	42
4.5.1 LIMITS OF BAND EDGE MEASUREMENT	42
4.5.2 TEST SETUP	42
4.5.3 TEST PROCEDURES	42
4.5.4 TEST RESULTS	44
4.6 CONDUCTED SPURIOUS EMISSIONS	51
4.6.1 LIMITS OF CONDUCTED SPURIOUS EMISSIONS MEASUREMENT	51
4.6.2 TEST PROCEDURE	51
4.6.3 TEST SETUP	51
4.6.4 TEST RESULTS	52
4.7 RADIATED EMISSION MEASUREMENT	55
4.7.1 LIMITS OF RADIATED EMISSION MEASUREMENT	55
4.7.2 TEST PROCEDURES	55
4.7.3 DEVIATION FROM TEST STANDARD	55
4.7.4 TEST SETUP	56



**BUREAU
VERITAS**

Test Report No.: RE160217W003-5

4.7.5	TEST RESULTS	57
5	INFORMATION ON THE TESTING LABORATORIES	73
6	APPENDIX A – MODIFICATIONS RECORDERS FOR ENGINEERING CHANGES TO THE EUT BY THE LAB	74



Test Report No.: RE160217W003-5

RELEASE CONTROL RECORD

ISSUE NO.	REASON FOR CHANGE	DATE ISSUED
RE160217W003-5	Original release	Mar. 18, 2016



Test Report No.: RF160217W003-5

1 CERTIFICATION

PRODUCT: Smartphone
BRAND NAME: HTC
MODEL NAME: 2PVG200
APPLICANT: HTC Corporation
TESTED: Feb. 18, 2016 ~ Mar. 17, 2016
TEST SAMPLE: Production unit
TEST STANDARDS: **FCC Part 27, Subpart C, L**
FCC Part 2
ANSI/TIA/EIA-603-D

The above equipment has been tested by **Bureau Veritas Shenzhen Co., Ltd. Dongguan Branch**, and found compliance with the requirement of the above standards. The test record, data evaluation & Equipment Under Test (EUT) configurations represented herein are true and accurate accounts of the measurements of the sample's EMC characteristics under the conditions specified in this report.

PREPARED BY :  , **DATE:** Mar. 18, 2016
(Amyee Qian / Engineer)

APPROVED BY :  , **DATE:** Mar. 18, 2016
(William Chung / Manager)

2 SUMMARY OF TEST RESULTS

The EUT has been tested according to the following specifications:

APPLIED STANDARD: FCC Part 27 & Part 2			
STANDARD SECTION	TEST TYPE AND LIMIT	RESULT	REMARK
2.1046 27.50(d)(4)	Maximum Peak Output Power	PASS	Meet the requirement of limit.
2.1055 27.54	Frequency Stability	PASS	Meet the requirement of limit.
2.1049 27.53(h)	Occupied Bandwidth	PASS	Meet the requirement of limit.
27.50(d)(5)	Peak to average ratio	PASS	Meet the requirement of limit.
27.53(h)	Band Edge Measurements	PASS	Meet the requirement of limit.
2.1051 27.53(h)	Conducted Spurious Emissions	PASS	Meet the requirement of limit.
2.1053 27.53(h)	Radiated Spurious Emissions	PASS	Meet the requirement of limit. Minimum passing margin is -26.33dB at 5186.00MHz.

2.1 MEASUREMENT UNCERTAINTY

Where relevant, the following measurement uncertainty levels have been estimated for tests performed on the EUT as specified in CISPR 16-4-2:

MEASUREMENT	FREQUENCY	UNCERTAINTY
Conducted emissions	9kHz~30MHz	2.66dB
Radiated emissions	9KHz ~ 30MHz	2.74dB
	30MHz ~ 1GMHz	3.55dB
	1GHz ~ 18GHz	4.84dB
	18GHz ~ 40GHz	1.94dB

This uncertainty represents an expanded uncertainty expressed at approximately the 95% confidence level using a coverage factor of k=2.

2.2 TEST SITE AND INSTRUMENTS

Equipment	Manufacturer	Model No.	Serial No.	Last Cal.	Next Cal.
EMI Test Receiver	Rohde&Schwarz	ESR7	101494	Apr. 27,15	Apr. 26,16
Signal and Spectrum Analyzer	Rohde&Schwarz	FSV40	101094	Apr. 23,15	Apr. 22,16
Bilog Antenna 1	Teseq	CBL 6111D	30643	Jun. 25,15	Jun. 24,16
Bilog Antenna 2	Teseq	CBL 6111D	27089	Jun. 25,15	Jun. 24,16
Horn Antenna	ETS-Lindgren	3117	00062558	May 30,14	May 29,16
Horn Antenna (15GHz-40GHz)	SCHWARZBECK	BBHA 9170	BBHA9170147	Jan. 21,14	Jan. 20,17
Amplifier (9kHz-1GHz)	SONOMA	310D	186955	Mar. 04,15	Mar. 03, 17
Pre-Amplifier (0.5~18GHz)	SCHWARZBECK	BBV 9718	9718-266	Mar 26,14	Mar. 25,16
Pre-Amplifier (18GHz-40GHz)	EMCI	EMC 184045	980102	Nov. 19,15	Nov. 18,16
GPS Generator+ Antenna	TOJOIN	GNSS-5000A	E1-010119	Aug. 08, 14	Aug. 07, 16
3m Semi-anechoic Chamber	ETS-LINDGREN	9m*6m*6m	NSEMC003	April. 19,14	April. 18,16
Test Software	ADT	ADT_Radiated_V7.6.15.9.2	N/A	N/A	N/A
Power Meter	Anritsu	ML2495A	1139001	Feb. 20,15	Feb. 19,16
Power Sensor	Anritsu	MA2411B	1126068	Feb. 20,15	Feb. 19,16
Power Sensor	Keysight	U2021XA	MY55060016	Feb. 18,15	Feb. 17,16
Power Sensor	Keysight	U2021XA	MY55060018	Feb. 18,15	Feb. 17,16
Digital Multimeter	FLUKE	15B	A1220010DG	Oct. 12, 15	Oct. 11, 16
Humid & Temp Programmable Tester	Haida	HD-2257	110807201	Sep.07,15	Sep. 06,16
Oscilloscope	Agilent	DSO9254A	MY51260160	Nov. 27,15	Nov. 26,16
Signal Analyzer	Rohde & Schwarz	FSV7	102331	Nov. 09,15	Nov. 08,16
Signal Generator	Agilent	N5183A	MY50140980	Nov. 09,15	Nov. 08,16
ESG Vector Signal Generator	Agilent	E4438C	MY49072505	Apr. 22, 15	Apr. 21, 16
BLUETOOTH TESTER	Rohde&Schwarz	CBT32	100811	Sep. 01,15	Aug. 31,16

- NOTE:**
1. The calibration interval of the above test instruments is 12 months or 24 months and the calibrations are traceable to CEPREI/CHINA, GRGT/CHINA and NIM/CHINA.
 2. The test was performed in Dongguan 966 Chamber.
 3. The horn antenna are used only for the measurement of emission frequency above 1GHz if tested.
 4. The FCC Site Registration No. is 502831.



3 GENERAL INFORMATION

3.1 GENERAL DESCRIPTION OF EUT

PRODUCT	Smartphone	
MODEL NAME	2PVG200	
POWER SUPPLY	5.0Vdc (adapter or host equipment) 3.85Vdc (battery)	
MODULATION TECHNOLOGY	WCDMA	BPSK,QPSK
	LTE Band 4	QPSK, 16QAM
FREQUENCY RANGE	WCDMA	1712.4MHz ~ 1752.6MHz
	LTE Band 4 Channel Bandwidth: 1.4MHz	1710.7MHz ~ 1754.3MHz
	LTE Band 4 Channel Bandwidth: 3MHz	1711.5MHz ~ 1753.5MHz
	LTE Band 4 Channel Bandwidth: 5MHz	1712.5MHz ~ 1752.5MHz
	LTE Band 4 Channel Bandwidth: 10MHz	1715.0MHz ~ 1750.0MHz
	LTE Band 4 Channel Bandwidth: 15MHz	1717.5MHz ~ 1747.5MHz
	LTE Band 4 Channel Bandwidth: 20MHz	1720.0MHz ~ 1745.0MHz
	EMISSION DESIGNATOR	WCDMA
LTE Band 4 Channel Bandwidth: 1.4MHz		QPSK: 1M09G7D
		16QAM: 1M08W7D
LTE Band 4 Channel Bandwidth: 3MHz		QPSK: 2M68G7D
		16QAM: 2M68W7D
LTE Band 4 Channel Bandwidth: 5MHz		QPSK: 4M49G7D
		16QAM: 4M47W7D
LTE Band 4 Channel Bandwidth: 10MHz		QPSK: 8M93G7D
	16QAM: 8M93W7D	
LTE Band 4 Channel Bandwidth: 15MHz	QPSK: 13M4G7D	
	16QAM: 13M4W7D	
LTE Band 4 Channel Bandwidth: 20MHz	QPSK: 17M9G7D	
	16QAM: 17M9W7D	
MAX. ERP/EIRP POWER	WCDMA	279mW
	LTE Band 4 Channel Bandwidth: 1.4MHz	281mW
	LTE Band 4 Channel Bandwidth: 3MHz	280mW



BUREAU
VERITAS

Test Report No.: RF160217W003-5

	LTE Band 4 Channel Bandwidth: 5MHz	283mW
	LTE Band 4 Channel Bandwidth: 10MHz	298mW
	LTE Band 4 Channel Bandwidth: 15MHz	280mW
	LTE Band 4 Channel Bandwidth: 20MHz	252mW
ANTENNA TYPE	Fixed Internal antenna with -5.1dBi gain	
HW VERSION	3.10.65 queen@scmbuild #1	
SW VERSION	MOLY.LR9.W1444.MD.LWTG.MO.V16.P2	
I/O PORTS	Refer to user's manual	
DATA CABLE	USB Cable: Shielded, Detachable, 1.0m Earphone Cable: Shielded, Detachable, 1.1m	

NOTE:

- For a more detailed features description, please refer to the manufacturer's specifications or the user's manual.
- There are Main/2nd Source Samples for this project, They are completely the same except the Battery, LCD Panel and SIM card, as follows.

SAMPLE	CONFIGURATION
Main Sample(A)	Battery 1 + LCM 1 + Single SIM
2nd Sample(B)	Battery 2 + LCM 2 + Single SIM

- For the test results, the EUT had been tested with all conditions. But only the worst case was shown in test report.



Test Report No.: RF160217W003-5

LIST OF ACCESSORIES:

ACCESSORIES	BRAND	MANUFACTURER	MODEL	SPECIFICATION
AC Adapter 1	HTC	Deevan	TC P900-US, TC P900-EU, TC P900-IN, TC P900-US	I/P:100-240Vac, 200mA O/P:5Vdc, 1.5A
AC Adapter 2	HTC	Phihong	TC P900-US, TC P900-EU, TC P900-UK, TC P900-AU	I/P:100-240Vac, 200mA O/P:5Vdc, 1.5A
AC Adapter 3	HTC	Salcomp	TC P900-US, TC P900-EU, TC P900-UK, TC P900-AU	I/P:100-240Vac, 200mA O/P:5Vdc, 1.5A
Battery 1	HTC	Amperex Technology Limited	B2PST100	Rating: 3.85Vdc, 2200mAh
Battery 2	HTC	BYD	B2PST100	Rating: 3.85Vdc, 2200mAh
Earphone	HTC	SIYOTO	HS S270	1.1m non-shielded cable w/o core
USB Cable 1	HTC	Luxshare	DC MSR600	1.0m non-shielded cable w/o core
USB Cable 2	HTC	Foxconn	DC MSR600	1.0m non-shielded cable w/o core
USB Cable 3	HTC	COXOC	DC MSR600	1.0m non-shielded cable w/o core
LCD Panel 1	Truly	--	TDO-HD0499K71143	--
LCD Panel 2	Truly	--	TDO-HD0499K71230	--

3.2 CONFIGURATION OF SYSTEM UNDER TEST

FOR RADIATION EMISSION TEST

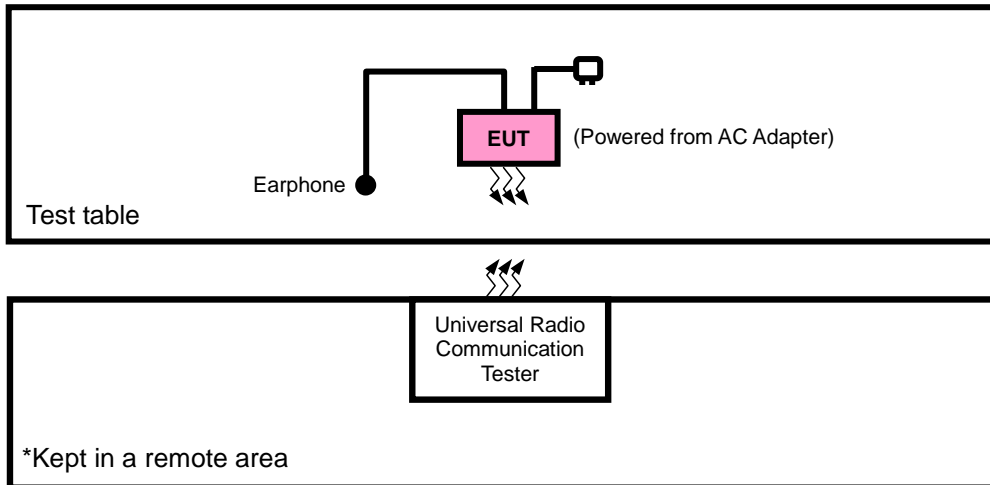

FOR E.R.P./E.I.R.P TEST

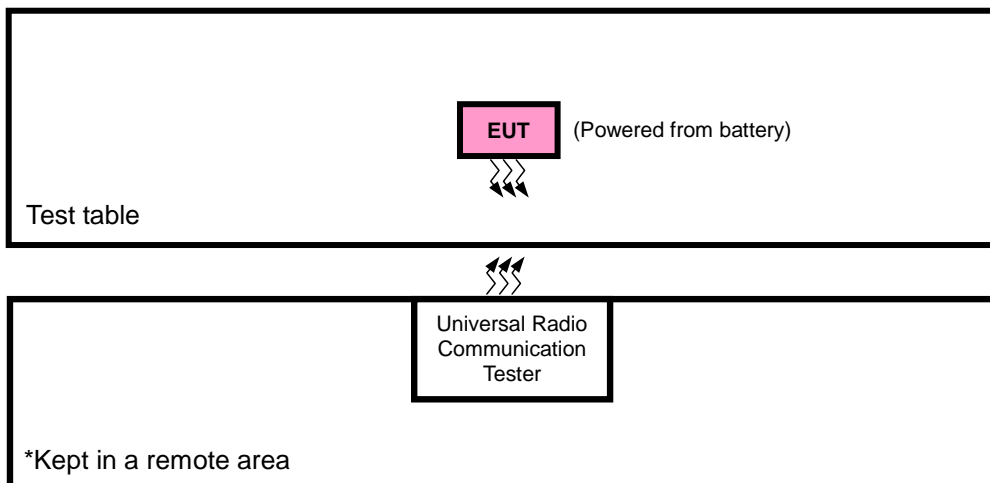

3.3 DESCRIPTION OF SUPPORT UNITS

The EUT has been tested as an independent unit together with other necessary accessories or support units. The following support units or accessories were used to form a representative test configuration during the tests.

NO.	PRODUCT	BRAND	MODEL NO.	SERIAL NO.	FCC ID
1	DC source	LONG WEI	PS-6403D	010934269	N/A
2	PC	HP	A6608CN	3CR83825X3	N/A

NO.	SIGNAL CABLE DESCRIPTION OF THE ABOVE SUPPORT UNITS
1	DC Line: Unshielded, Detachable 1.0m
2	AC Line: Unshielded, Detachable 1.5m

NOTE:

1. All power cords of the above support units are non shielded (1.8m).

3.4 DESCRIPTION OF TEST MODES

Pre-Scan has been conducted to determine the worst-case mode from all possible combinations between available modulations, data rates, XYZ axis and antenna ports. The worst case was found when positioned on X-plane for ERP/EIRP and X-axis for radiated emission. Following channel(s) was (were) selected for the final test as listed below:

EUT CONFIGURE MODE	DESCRIPTION
A	EUT + Adapter + Earphone with LTE link
B	EUT + Battery + Earphone with LTE link

WCDMA MODE

EUT CONFIGURE MODE	TEST ITEM	AVAILABLE CHANNEL	TESTED CHANNEL	MODE
B	ERP	1312 to 1513	1312, 1413, 1513	WCDMA
B	FREQUENCY STABILITY	1312 to 1513	1413	WCDMA
B	OCCUPIED BANDWIDTH	1312 to 1513	1312, 1413, 1513	WCDMA
B	BAND EDGE	1312 to 1513	1312, 1513	WCDMA
B	CONDCUDED EMISSION	1312 to 1513	1312, 1413, 1513	WCDMA
A	RADIATED EMISSION	1312 to 1513	1413	WCDMA



**BUREAU
VERITAS**

Test Report No.: RF160217W003-5

LTE BAND 4

EUT CONFIGURE MODE	TEST ITEM	AVAILABLE CHANNEL	TESTED CHANNEL	CHANNEL BANDWIDTH	MODULATION	MODE
B	EIRP	19957 to 20393	19957, 20175, 20393	1.4MHz	QPSK, 16QAM	1 RB / 0 RB Offset
		19965 to 20385	19965, 20175, 20385	3MHz	QPSK, 16QAM	1 RB / 0 RB Offset
		19975 to 20375	19975, 20175, 20375	5MHz	QPSK, 16QAM	1 RB / 0 RB Offset
		20000 to 20350	20000, 20175, 20350	10MHz	QPSK, 16QAM	1 RB / 0 RB Offset
		20025 to 20325	20025, 20175, 20325	15MHz	QPSK, 16QAM	1 RB / 0 RB Offset
		20050 to 20300	20050, 20175, 20300	20MHz	QPSK, 16QAM	1 RB / 0 RB Offset
B	FREQUENCY STABILITY	19957 to 20393	20175	1.4MHz	QPSK	1 RB / 0 RB Offset
		19965 to 20385	20175	3MHz	QPSK	1 RB / 0 RB Offset
		19975 to 20375	20175	5MHz	QPSK	1 RB / 0 RB Offset
		20000 to 20350	20175	10MHz	QPSK	1 RB / 0 RB Offset
		20025 to 20325	20175	15MHz	QPSK	1 RB / 0 RB Offset
		20050 to 20300	20175	20MHz	QPSK	1 RB / 0 RB Offset
B	OCCUPIED BANDWIDTH	19957 to 20393	19957, 20175, 20393	1.4MHz	QPSK, 16QAM	6 RB / 0 RB Offset
		19965 to 20385	19965, 20175, 20385	3MHz	QPSK, 16QAM	15 RB / 0 RB Offset
		19975 to 20375	19975, 20175, 20375	5MHz	QPSK, 16QAM	25 RB / 0 RB Offset
		20000 to 20350	20000, 20175, 20350	10MHz	QPSK, 16QAM	50 RB / 0 RB Offset
		20025 to 20325	20025, 20175, 20325	15MHz	QPSK, 16QAM	75 RB / 0 RB Offset
		20050 to 20300	20050, 20175, 20300	20MHz	QPSK, 16QAM	100 RB / 0 RB Offset
B	PEAK TO AVERAGE RATIO	19957 to 20393	19957, 20175, 20393	1.4MHz	QPSK, 16QAM	1 RB / 0 RB Offset
		19965 to 20385	19965, 20175, 20385	3MHz	QPSK, 16QAM	1 RB / 0 RB Offset
		19975 to 20375	19975, 20175, 20375	5MHz	QPSK, 16QAM	1 RB / 0 RB Offset
		20000 to 20350	20000, 20175, 20350	10MHz	QPSK, 16QAM	1 RB / 0 RB Offset
		20025 to 20325	20025, 20175, 20325	15MHz	QPSK, 16QAM	1 RB / 0 RB Offset
		20050 to 20300	20050, 20175, 20300	20MHz	QPSK, 16QAM	1 RB / 0 RB Offset
B	BAND EDGE	19957 to 20393	19957	1.4MHz	QPSK	1 RB / 0 RB Offset 6 RB / 0 RB Offset
			20393	1.4MHz	QPSK	1 RB / 5 RB Offset 6 RB / 0 RB Offset
		19965 to 20385	19965	3MHz	QPSK	1 RB / 0 RB Offset 15 RB / 0 RB Offset
			20385	3MHz	QPSK	1 RB / 14 RB Offset 15 RB / 0 RB Offset
		19975 to 20375	19975	5MHz	QPSK	1 RB / 0 RB Offset 25 RB / 0 RB Offset
			20375	5MHz	QPSK	1 RB / 24 RB Offset 25 RB / 0 RB Offset
		20000 to 20350	20000	10MHz	QPSK	1 RB / 0 RB Offset 50 RB / 0 RB Offset
			20350	10MHz	QPSK	1 RB / 49 RB Offset 50 RB / 0 RB Offset



**BUREAU
VERITAS**

Test Report No.: RF160217W003-5

B	BAND EDGE	20025 to 20325	20025	15MHz	QPSK	1 RB / 0 RB Offset
			20325	15MHz	QPSK	75 RB / 0 RB Offset
		20050 to 20300	20050	20MHz	QPSK	1 RB / 74 RB Offset
			20300	20MHz	QPSK	75 RB / 0 RB Offset
B	CONDCUDETED EMISSION	19957 to 20393	20175	1.4MHz	QPSK	1 RB / 0 RB Offset
		19965 to 20385	20175	3MHz	QPSK	1 RB / 0 RB Offset
		19975 to 20375	20175	5MHz	QPSK	1 RB / 0 RB Offset
		20000 to 20350	20175	10MHz	QPSK	1 RB / 0 RB Offset
		20025 to 20325	20175	15MHz	QPSK	1 RB / 0 RB Offset
		20050 to 20300	20175	20MHz	QPSK	1 RB / 0 RB Offset
A	RADIATED EMISSION	19957 to 20393	20175	1.4MHz	QPSK	1 RB / 0 RB Offset
		19965 to 20385	20175	3MHz	QPSK	1 RB / 0 RB Offset
		19975 to 20375	20175	5MHz	QPSK	1 RB / 0 RB Offset
		20000 to 20350	20175	10MHz	QPSK	1 RB / 0 RB Offset
		20025 to 20325	20175	15MHz	QPSK	1 RB / 0 RB Offset
		20050 to 20300	20175	20MHz	QPSK	1 RB / 0 RB Offset

Note: This device was tested under all bandwidths, RB configurations and modulations. The worst case was found in QPSK modulation.

TEST CONDITION:

TEST ITEM	ENVIRONMENTAL CONDITIONS	INPUT POWER	TESTED BY
EIRP(ERP)	24deg. C, 60%RH	3.85Vdc from Battery	Blue Zheng
FREQUENCY STABILITY	24deg. C, 61%RH	3.85Vdc from Battery	Yuqiang Yin
OCCUPIED BANDWIDTH	24deg. C, 61%RH	3.85Vdc from Battery	Yuqiang Yin
PEAK TO AVERAGE RATIO	24deg. C, 61%RH	3.85Vdc from Battery	Yuqiang Yin
BAND EDGE	24deg. C, 61%RH	3.85Vdc from Battery	Yuqiang Yin
CONDCUDETED EMISSION	24deg. C, 61%RH	3.85Vdc from Battery	Yuqiang Yin
RADIATED EMISSION	24deg. C, 60%RH	5Vdc from adapter	Blue Zheng



Test Report No.: RF160217W003-5

3.5 GENERAL DESCRIPTION OF APPLIED STANDARDS

The EUT is a RF product. According to the specifications of the manufacturer, it must comply with the requirements of the following standards:

FCC 47 CFR Part 2

FCC 47 CFR Part 27

ANSI/TIA/EIA-603-D

NOTE: All test items have been performed and recorded as per the above standards.



4 TEST TYPES AND RESULTS

4.1 OUTPUT POWER MEASUREMENT

4.1.1 LIMITS OF OUTPUT POWER MEASUREMENT

Fixed, mobile, and portable (hand-held) stations operating in the 1710–1755 MHz band are limited to 1 watt EIRP.

Portable stations (hand-held devices) operating in the 699-716 MHz band are limited to 3 watts ERP.

4.1.2 TEST PROCEDURES

EIRP / ERP MEASUREMENT:

- a. The EUT was set up for the maximum power with LTE link data modulation. The power was measured with R&S Spectrum Analyzer. All measurements were done at 3 channels (low, middle and high operational frequency range). RBW and VBW is 10MHz for LTE.
- b. E.I.R.P power measurement. In the semi-anechoic chamber, EUT placed on the 0.8m height of Turn Table, rotated the table around 360 degrees to search the maximum radiation power and receiver antenna shall be rotated vertical and horizontal polarization and moved height from 1m to 4m to find the maximum polar radiated power. The “Read Value” is the spectrum reading the maximum power value.
- c. The substitution horn antenna is substituted for EUT at the same position and signals generator export the CW signal to the substitution antenna via a TX cable. Rotated the Turn Table and moved receiving antenna to find the maximum radiation power. Adjust output power level of S.G to get a Value of spectrum reading equal to “Read Value” of step a. Record the power level of S.G
- d. $EIRP = \text{Output power level of S.G} - \text{TX cable loss} + \text{Antenna gain of substitution horn}$
- e. $E.R.P = E.I.R.P - 2.15 \text{ dB}$

CONDUCTED POWER MEASUREMENT:

- a. The EUT was set up for the maximum power with LTE link data modulation and link up with simulator.
- b. Set the EUT to transmit under low, middle and high channel and record the power level shown on simulator.

4.1.3 TEST SETUP

EIRP / ERP MEASUREMENT:

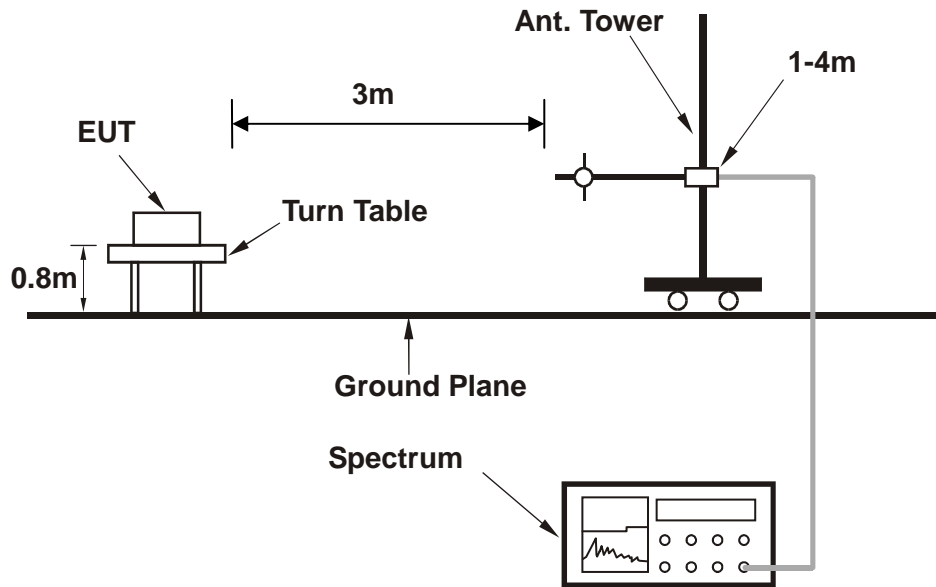

For the actual test configuration, please refer to the attached file (Test Setup Photo).

CONDUCTED POWER MEASUREMENT:

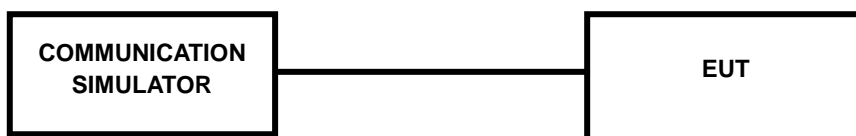

For the actual test configuration, please refer to the attached file (Test Setup Photo).



Test Report No.: RF160217W003-5

4.1.4 TEST RESULTS

CONDUCTED OUTPUT POWER (dBm)

Band	WCDMA IV		
	1312	1413	1513
Channel	1712.4	1732.6	1752.4
Frequency (MHz)	1712.4	1732.6	1752.4
RMC 12.2K	22.49	22.78	22.46
HSPA			
HSDPA Subtest-1	22.49	22.78	22.46
HSDPA Subtest-2	20.54	20.85	20.50
HSDPA Subtest-3	20.52	20.79	20.49
HSDPA Subtest-4	20.53	20.79	20.50
HSUPA Subtest-1	20.52	20.77	20.45
HSUPA Subtest-2	19.68	19.75	19.66
HSUPA Subtest-3	19.49	19.46	19.46
HSUPA Subtest-4	20.39	20.36	20.36
HSUPA Subtest-5	18.96	19.26	18.98

LTE Band 4							
BW	Modulation	RB Size	RB Offset	Low CH 19957	Mid CH 20175	High CH 20393	MPR
				Frequency 1710.7 MHz	Frequency 1732.5 MHz	Frequency 1754.3 MHz	
1.4MHz	QPSK	1	0	22.45	22.66	22.52	0
		1	2	22.28	22.46	22.42	0
		1	5	22.23	22.60	22.48	0
		3	0	22.43	22.64	22.50	0
		3	1	22.26	22.44	22.40	0
		3	3	22.21	22.58	22.46	0
		6	0	21.35	21.69	21.47	1
	16QAM	1	0	21.38	21.64	21.47	1
		1	2	21.42	21.63	21.53	1
		1	5	21.52	21.68	21.65	1
		3	0	21.37	21.63	21.46	1
		3	1	21.41	21.62	21.52	1
		3	3	21.51	21.67	21.64	1
		6	0	20.33	20.70	20.46	2

LTE Band 4							
BW	Modulation	RB Size	RB Offset	Low CH 19965	Mid CH 20175	High CH 20385	MPR
				Frequency 1711.5 MHz	Frequency 1732.5 MHz	Frequency 1753.5 MHz	
3 MHz	QPSK	1	0	22.46	22.67	22.53	0
		1	7	22.29	22.47	22.43	0
		1	14	22.24	22.61	22.49	0
		8	0	21.39	21.75	21.53	1
		8	3	21.35	21.73	21.49	1
		8	7	21.30	21.70	21.45	1
		15	0	21.36	21.70	21.48	1
	16QAM	1	0	21.39	21.65	21.48	1
		1	7	21.43	21.64	21.54	1
		1	14	21.53	21.69	21.66	1
		8	0	20.38	20.74	20.53	2
		8	3	20.35	20.78	20.45	2
		8	7	20.28	20.73	20.55	2
		15	0	20.34	20.71	20.47	2
BW	Modulation	RB Size	RB Offset	Low CH 19975	Mid CH 20175	High CH 20375	MPR
				Frequency 1712.5 MHz	Frequency 1732.5 MHz	Frequency 1752.5 MHz	
5 MHz	QPSK	1	0	22.49	22.70	22.56	0
		1	12	22.32	22.50	22.46	0
		1	24	22.27	22.64	22.52	0
		12	0	21.42	21.78	21.56	1
		12	6	21.38	21.76	21.52	1
		12	13	21.33	21.73	21.48	1
		25	0	21.39	21.73	21.51	1
	16QAM	1	0	21.42	21.68	21.51	1
		1	12	21.46	21.67	21.57	1
		1	24	21.56	21.72	21.69	1
		12	0	20.41	20.77	20.56	2
		12	6	20.38	20.81	20.48	2
		12	13	20.31	20.76	20.58	2
		25	0	20.37	20.74	20.50	2

LTE Band 4							
BW	Modulation	RB Size	RB Offset	Low CH 20000	Mid CH 20175	High CH 20350	MPR
				Frequency 1715 MHz	Frequency 1732.5 MHz	Frequency 1750 MHz	
10 MHz	QPSK	1	0	22.53	22.74	22.60	0
		1	24	22.36	22.54	22.50	0
		1	49	22.31	22.68	22.56	0
		25	0	21.46	21.82	21.60	1
		25	12	21.42	21.80	21.56	1
		25	25	21.37	21.77	21.52	1
		50	0	21.43	21.77	21.55	1
	16QAM	1	0	21.46	21.72	21.55	1
		1	24	21.50	21.71	21.61	1
		1	49	21.60	21.76	21.73	1
		25	0	20.45	20.81	20.60	2
		25	12	20.42	20.85	20.52	2
		25	25	20.35	20.80	20.62	2
		50	0	20.41	20.78	20.54	2
BW	Modulation	RB Size	RB Offset	Low CH 20025	Mid CH 20175	High CH 20325	MPR
				Frequency 1717.5 MHz	Frequency 1732.5 MHz	Frequency 1747.5 MHz	
15 MHz	QPSK	1	0	22.59	22.80	22.66	0
		1	37	22.42	22.60	22.56	0
		1	74	22.37	22.74	22.62	0
		36	0	21.52	21.88	21.66	1
		36	19	21.48	21.86	21.62	1
		36	39	21.43	21.83	21.58	1
		75	0	21.49	21.83	21.61	1
	16QAM	1	0	21.52	21.78	21.61	1
		1	37	21.56	21.77	21.67	1
		1	74	21.66	21.82	21.79	1
		36	0	20.51	20.87	20.66	2
		36	19	20.48	20.91	20.58	2
		36	39	20.41	20.86	20.68	2
		75	0	20.47	20.84	20.60	2

LTE Band 4							
BW	Modulation	RB Size	RB Offset	Low CH 20050	Mid CH 20175	High CH 20300	MPR
				Frequency 1720 MHz	Frequency 1732.5 MHz	Frequency 1745 MHz	
20MHz	QPSK	1	0	22.62	22.83	22.69	0
		1	50	22.45	22.63	22.59	0
		1	99	22.40	22.77	22.65	0
		50	0	21.55	21.91	21.69	1
		50	25	21.51	21.89	21.65	1
		50	50	21.46	21.86	21.61	1
		100	0	21.52	21.86	21.64	1
	16QAM	1	0	21.55	21.81	21.64	1
		1	50	21.59	21.80	21.70	1
		1	99	21.69	21.85	21.82	1
		50	0	20.54	20.90	20.69	2
		50	25	20.51	20.94	20.61	2
		50	50	20.44	20.89	20.71	2
		100	0	20.50	20.87	20.63	2



BUREAU
VERITAS

Test Report No.: RF160217W003-5

EIRP

WCDMA BAND IV

Channel	Frequency (MHz)	LVL (dBm)	Correction Factor(dB)	EIRP(dBm)	EIRP(mW)	Polarization (H/V)	LIMIT (W)
1312	1712.4	-18.44	41.39	22.95	197.20	H	1
1413	1732.6	-18.31	41.36	23.05	201.84	H	1
1513	1752.6	-18.18	42.63	24.45	278.55	H	1
1312	1712.4	-24.33	44.17	19.84	96.29	V	1
1413	1732.6	-24.54	44.20	19.66	92.47	V	1
1513	1752.6	-24.68	44.35	19.67	92.58	V	1



BUREAU
VERITAS

Test Report No.: RF160217W003-5

LTE BAND 4

CHANNEL BANDWIDTH: 1.4MHz QPSK

Channel	Frequency (MHz)	LVL (dBm)	Correction Factor(dB)	EIRP(dBm)	EIRP(mW)	Polarization (H/V)	LIMIT (W)
19957	1710.7	-22.32	41.29	18.97	78.96	H	1
20175	1732.5	-22.34	41.36	19.02	79.80	H	1
20393	1754.3	-22.33	42.74	20.41	109.85	H	1
19957	1710.7	-19.81	44.25	24.44	277.65	V	1
20175	1732.5	-19.71	44.20	24.49	281.19	V	1
20393	1754.3	-19.92	44.09	24.17	260.92	V	1

NOTE: EIRP (dBm) = LVL (dBm) + Correction Factor (dB)

CHANNEL BANDWIDTH: 1.4MHz 16QAM

Channel	Frequency (MHz)	LVL (dBm)	Correction Factor(dB)	EIRP(dBm)	EIRP(mW)	Polarization (H/V)	LIMIT (W)
19957	1710.7	-23.19	41.29	18.10	64.62	H	1
20175	1732.5	-23.27	41.36	18.09	64.42	H	1
20393	1754.3	-23.29	42.74	19.45	88.06	H	1
19957	1710.7	-20.68	44.25	23.57	227.25	V	1
20175	1732.5	-20.64	44.20	23.56	226.99	V	1
20393	1754.3	-20.88	44.09	23.21	209.17	V	1

NOTE: EIRP (dBm) = LVL (dBm) + Correction Factor (dB)



BUREAU
VERITAS

Test Report No.: RF160217W003-5

LTE BAND 4

CHANNEL BANDWIDTH: 3MHz QPSK

Channel	Frequency (MHz)	LVL (dBm)	Correction Factor(dB)	EIRP(dBm)	EIRP(mW)	Polarization (H/V)	LIMIT (W)
19965	1711.5	-22.30	41.27	18.97	78.83	H	1
20175	1732.5	-22.40	41.36	18.96	78.70	H	1
20385	1753.5	-22.28	42.76	20.48	111.61	H	1
19965	1711.5	-19.79	44.26	24.47	280.03	V	1
20175	1732.5	-19.77	44.20	24.43	277.33	V	1
20385	1753.5	-19.87	44.23	24.36	273.02	V	1

NOTE: EIRP (dBm) = LVL (dBm) + Correction Factor (dB)

CHANNEL BANDWIDTH: 3MHz 16QAM

Channel	Frequency (MHz)	LVL (dBm)	Correction Factor(dB)	EIRP(dBm)	EIRP(mW)	Polarization (H/V)	LIMIT (W)
19965	1711.5	-23.37	41.27	17.90	61.62	H	1
20175	1732.5	-23.29	41.36	18.07	64.12	H	1
20385	1753.5	-23.27	42.76	19.49	88.86	H	1
19965	1711.5	-20.86	44.26	23.40	218.88	V	1
20175	1732.5	-20.66	44.20	23.54	225.94	V	1
20385	1753.5	-20.86	44.23	23.37	217.37	V	1

NOTE: EIRP (dBm) = LVL (dBm) + Correction Factor (dB)



BUREAU
VERITAS

Test Report No.: RF160217W003-5

LTE BAND 4

CHANNEL BANDWIDTH: 5MHz QPSK

Channel	Frequency (MHz)	LVL (dBm)	Correction Factor(dB)	EIRP(dBm)	EIRP(mW)	Polarization (H/V)	LIMIT (W)
19975	1712.5	-22.36	41.39	19.03	79.97	H	1
20175	1732.5	-22.35	41.36	19.01	79.62	H	1
20375	1752.5	-22.23	42.63	20.40	109.62	H	1
19975	1712.5	-19.85	44.17	24.32	270.15	V	1
20175	1732.5	-19.72	44.20	24.48	280.54	V	1
20375	1752.5	-19.82	44.35	24.53	283.47	V	1

NOTE: EIRP (dBm) = LVL (dBm) + Correction Factor (dB)

CHANNEL BANDWIDTH: 5MHz 16QAM

Channel	Frequency (MHz)	LVL (dBm)	Correction Factor(dB)	EIRP(dBm)	EIRP(mW)	Polarization (H/V)	LIMIT (W)
19975	1712.5	-23.19	41.39	18.20	66.05	H	1
20175	1732.5	-23.37	41.36	17.99	62.95	H	1
20375	1752.5	-23.33	42.63	19.30	85.09	H	1
19975	1712.5	-20.68	44.17	23.49	223.15	V	1
20175	1732.5	-20.74	44.20	23.46	221.82	V	1
20375	1752.5	-20.92	44.35	23.43	220.04	V	1

NOTE: EIRP (dBm) = LVL (dBm) + Correction Factor (dB)



LTE BAND 4

CHANNEL BANDWIDTH: 10MHz QPSK

Channel	Frequency (MHz)	LVL (dBm)	Correction Factor(dB)	EIRP(dBm)	EIRP(mW)	Polarization (H/V)	LIMIT (W)
20000	1715.0	-22.17	41.49	19.32	85.43	H	1
20175	1732.5	-22.29	41.36	19.07	80.72	H	1
20350	1750.0	-22.10	42.28	20.18	104.30	H	1
20000	1715.0	-19.66	44.06	24.40	275.61	V	1
20175	1732.5	-19.66	44.20	24.54	284.45	V	1
20350	1750.0	-19.69	44.43	24.74	297.85	V	1

NOTE: EIRP (dBm) = LVL (dBm) + Correction Factor (dB)

CHANNEL BANDWIDTH: 10MHz 16QAM

Channel	Frequency (MHz)	LVL (dBm)	Correction Factor(dB)	EIRP(dBm)	EIRP(mW)	Polarization (H/V)	LIMIT (W)
20000	1715.0	-23.32	41.49	18.17	65.55	H	1
20175	1732.5	-23.39	41.36	17.97	62.66	H	1
20350	1750.0	-23.26	42.28	19.02	79.85	H	1
20000	1715.0	-20.81	44.06	23.25	211.49	V	1
20175	1732.5	-20.76	44.20	23.44	220.80	V	1
20350	1750.0	-20.85	44.43	23.58	228.03	V	1

NOTE: EIRP (dBm) = LVL (dBm) + Correction Factor (dB)



BUREAU
VERITAS

Test Report No.: RF160217W003-5

LTE BAND 4

CHANNEL BANDWIDTH: 15MHz QPSK

Channel	Frequency (MHz)	LVL (dBm)	Correction Factor(dB)	EIRP(dBm)	EIRP(mW)	Polarization (H/V)	LIMIT (W)
20025	1717.5	-22.18	41.34	19.16	82.38	H	1
20175	1732.5	-22.36	41.36	19.00	79.43	H	1
20325	1747.5	-22.17	42.09	19.92	98.08	H	1
20025	1717.5	-19.67	44.04	24.37	273.78	V	1
20175	1732.5	-19.73	44.20	24.47	279.90	V	1
20325	1747.5	-19.76	44.22	24.46	278.93	V	1

NOTE: EIRP (dBm) = LVL (dBm) + Correction Factor (dB)

CHANNEL BANDWIDTH: 15MHz 16QAM

Channel	Frequency (MHz)	LVL (dBm)	Correction Factor(dB)	EIRP(dBm)	EIRP(mW)	Polarization (H/V)	LIMIT (W)
20025	1717.5	-23.04	41.34	18.30	67.58	H	1
20175	1732.5	-23.23	41.36	18.13	65.01	H	1
20325	1747.5	-23.02	42.09	19.07	80.65	H	1
20025	1717.5	-20.53	44.04	23.51	224.59	V	1
20175	1732.5	-20.60	44.20	23.60	229.09	V	1
20325	1747.5	-20.61	44.22	23.61	229.35	V	1

NOTE: EIRP (dBm) = LVL (dBm) + Correction Factor (dB)



LTE BAND 4

CHANNEL BANDWIDTH: 20MHz QPSK

Channel	Frequency (MHz)	LVL (dBm)	Correction Factor(dB)	EIRP(dBm)	EIRP(mW)	Polarization (H/V)	LIMIT (W)
20050	1720.0	-22.76	41.28	18.52	71.14	H	1
20175	1732.5	-22.81	41.36	18.55	71.63	H	1
20300	1745.0	-22.75	41.96	19.21	83.31	H	1
20050	1720.0	-20.25	44.14	23.89	244.62	V	1
20175	1732.5	-20.18	44.20	24.02	252.12	V	1
20300	1745.0	-20.34	43.88	23.54	226.05	V	1

NOTE: EIRP (dBm) = LVL (dBm) + Correction Factor (dB)

CHANNEL BANDWIDTH: 20MHz 16QAM

Channel	Frequency (MHz)	LVL (dBm)	Correction Factor(dB)	EIRP(dBm)	EIRP(mW)	Polarization (H/V)	LIMIT (W)
20050	1720.0	-23.69	41.28	17.59	57.42	H	1
20175	1732.5	-23.88	41.36	17.48	55.99	H	1
20300	1745.0	-23.58	41.96	18.38	68.82	H	1
20050	1720.0	-21.18	44.14	22.96	197.47	V	1
20175	1732.5	-21.25	44.20	22.95	197.06	V	1
20300	1745.0	-21.17	43.88	22.71	186.72	V	1

NOTE: EIRP (dBm) = LVL (dBm) + Correction Factor (dB)

4.2 FREQUENCY STABILITY MEASUREMENT

4.2.1 LIMITS OF FREQUENCY STABILITY MEASUREMENT

The frequency stability shall be sufficient to ensure that the fundamental emissions stay within the authorized bands of operation.

4.2.2 TEST PROCEDURE

- a. Device is placed at the oven room. The oven room could control the temperatures and humidity. Power warm up is at least 15 min and power applied should perform before recording frequency error.
- b. EUT is connected the external power supply to control the DC input power. The test voltage range is from minimum to maximum working voltage. Each step shall be record the frequency error rate.
- c. The temperature range step is 10 degrees in this test items. All temperature levels shall be hold the $\pm 0.5^{\circ}\text{C}$ during the measurement testing. The each temperature step shall be at least 0.5 hours, consider the EUT could be test under the stability condition.

NOTE: The frequency error was recorded frequency error from the communication simulator.

4.2.3 TEST SETUP

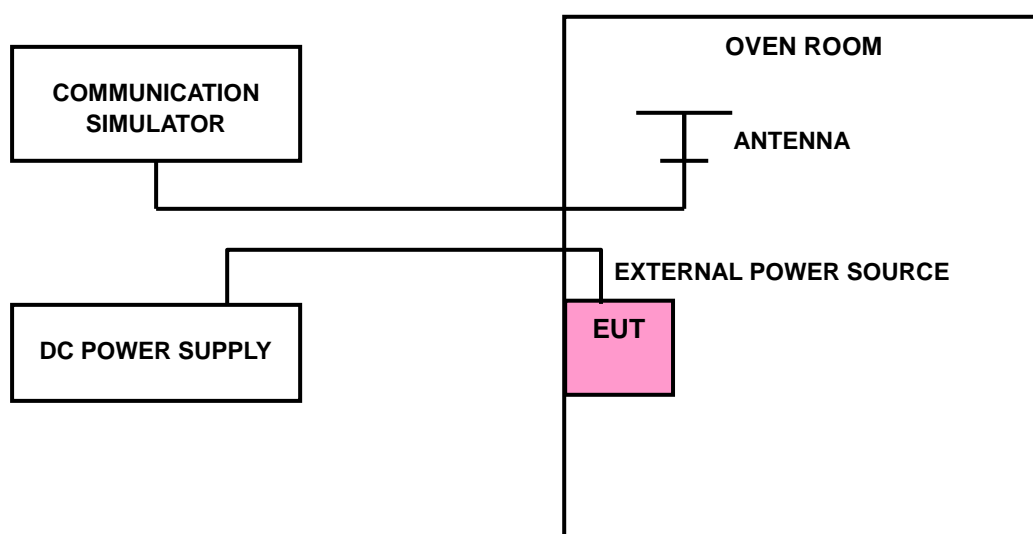

4.2.4 TEST RESULTS

FREQUENCY ERROR VS. VOLTAGE

AFC FREQUENCY ERROR vs. VOLTAGE								
VOLTAGE (Volts)	WCDMA	FREQUENCY ERROR (ppm)						LIMIT (ppm)
		1.4MHz	3MHz	5MHz	10MHz	15MHz	20MHz	
3.8	0.0005	0.0007	-0.0001	0.0006	0.0002	0.0001	0.0002	2.5
3.4	-0.0013	-0.0028	-0.0031	-0.0020	-0.0019	-0.0013	-0.0013	2.5
4.4	-0.0018	-0.0029	-0.0023	-0.0022	-0.0016	-0.0018	-0.0018	2.5

NOTE: The applicant defined the normal working voltage of the battery is from 3.4Vdc to 4.4Vdc.

FREQUENCY ERROR vs. TEMPERATURE.

AFC FREQUENCY ERROR vs. TEMPERATURE								
TEMP. (°C)	WCDMA	FREQUENCY ERROR (ppm)						LIMIT (ppm)
		1.4MHz	3MHz	5MHz	10MHz	15MHz	20MHz	
-30	-0.0051	-0.0071	-0.0071	-0.0066	-0.0074	-0.0068	-0.0066	2.5
-20	-0.0044	-0.0060	-0.0060	-0.5784	-0.0066	-0.0062	-0.0063	2.5
-10	-0.0038	-0.0053	-0.0053	-0.0053	-0.0060	-0.0054	-0.0054	2.5
0	-0.0034	-0.0047	-0.0046	-0.0045	-0.0052	-0.0046	-0.0044	2.5
10	-0.0025	-0.0043	-0.0041	-0.0037	-0.0043	-0.0042	-0.0037	2.5
20	-0.0017	-0.0032	-0.0031	-0.0031	-0.0037	-0.0035	-0.0029	2.5
30	-0.0012	-0.0019	-0.0025	-0.0022	-0.0028	-0.0025	-0.0022	2.5
40	-0.0005	-0.0008	-0.0019	-0.0012	-0.0017	-0.0017	-0.0013	2.5
50	0.0001	-0.0002	-0.0008	-0.0008	-0.0009	-0.0006	-0.0006	2.5
60	0.0007	0.0002	-0.0003	-0.0004	-0.0001	-0.0003	-0.0003	2.5

4.3 OCCUPIED BANDWIDTH MEASUREMENT

4.3.1 LIMITS OF OCCUPIED BANDWIDTH MEASUREMENT

The width of a frequency band such that, below the lower and above the upper frequency limits, the mean powers emitted are each equal to a specified percentage 0.5 %of the total mean power of a given emission.

4.3.2 TEST SETUP

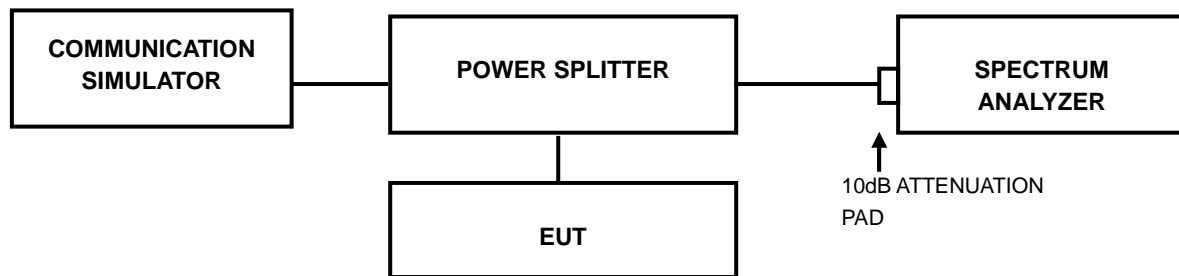

4.3.3 TEST PROCEDURES

- The conducted occupied bandwidth used the power splitter via EUT RF power connector between simulation base station and spectrum analyzer.
- Use OBW measurement function of Spectrum analyzer to measure 99 % occupied bandwidth.

4.3.4 TEST RESULTS

CHANNEL	Frequency (MHz)	99% OCCUPIED Bandwidth (MHz)
		WCDMA
1312	1712.4	4.20
1513	1732.6	4.21
4233	1752.6	4.21

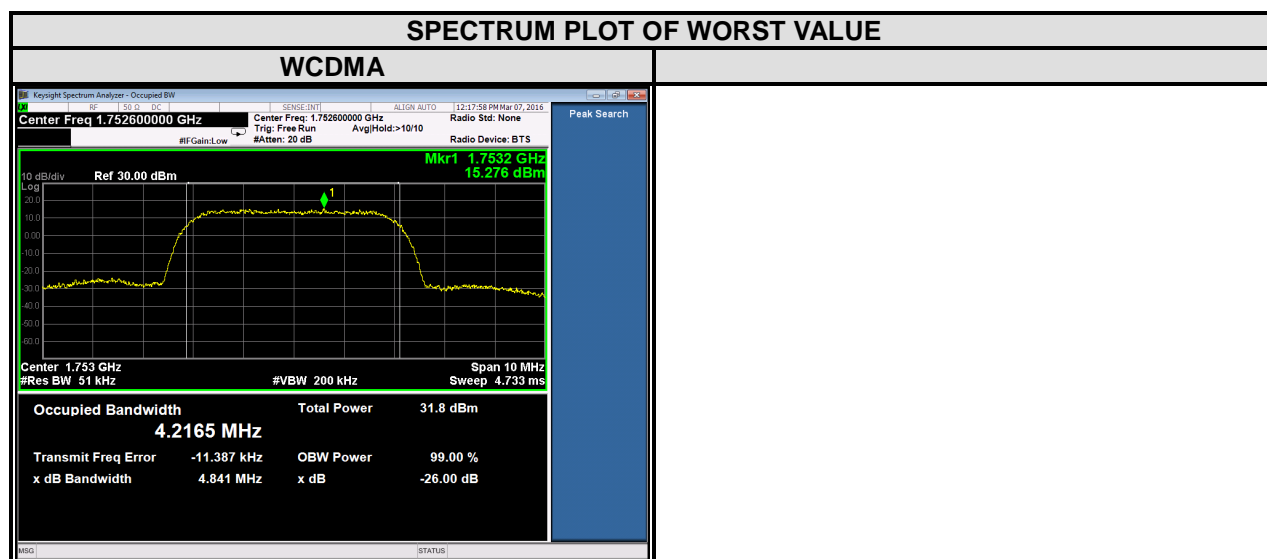



**BUREAU
VERITAS**

Test Report No.: RF160217W003-5

LTE BAND 4

CHANNEL BANDWIDTH: 1.4MHz				CHANNEL BANDWIDTH: 3MHz			
CHANNEL	Frequency (MHz)	99% OCCUPIED Bandwidth (MHz)		CHANNEL	Frequency (MHz)	99% OCCUPIED Bandwidth (MHz)	
		QPSK	16QAM			QPSK	16QAM
19957	1710.7	1.09	1.08	19965	1711.5	2.68	2.68
20175	1732.5	1.09	1.08	20175	1732.5	2.68	2.68
20393	1754.3	1.09	1.08	20385	1753.5	2.68	2.68

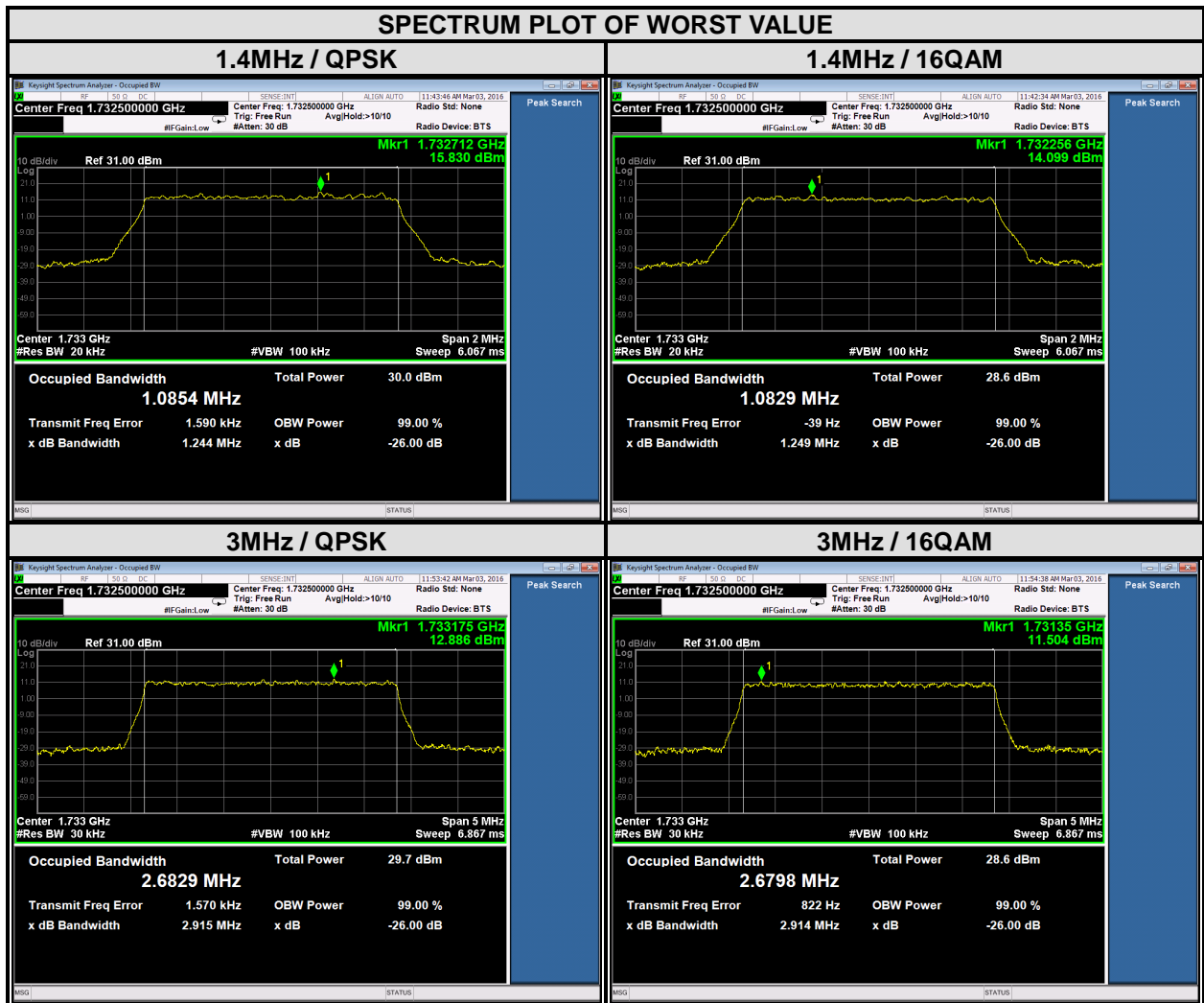

Bureau Veritas Shenzhen Co., Ltd.
Dongguan Branch

No. 34, Chenwulu Section, Guantai Rd.,
Houjie Town, Dongguan City,
Guangdong 523942, China

Tel: +86 769 8593 5656
Fax: +86 769 8593 1080
Email: customerservice.dg@cn.bureauveritas.com



**BUREAU
VERITAS**

Test Report No.: RF160217W003-5

LTE BAND 4

CHANNEL BANDWIDTH: 5MHz				CHANNEL BANDWIDTH: 10MHz			
CHANNEL	Frequency (MHz)	99% OCCUPIED Bandwidth (MHz)		CHANNEL	Frequency (MHz)	99% OCCUPIED Bandwidth (MHz)	
		QPSK	16QAM			QPSK	16QAM
19975	1712.5	4.49	4.47	20000	1715	8.93	8.92
20175	1732.5	4.48	4.47	20175	1732.5	8.93	8.93
20375	1752.5	4.48	4.47	20350	1750	8.93	8.93



Bureau Veritas Shenzhen Co., Ltd.
Dongguan Branch

No. 34, Chenwulu Section, Guantai Rd.,
Houjie Town, Dongguan City,
Guangdong 523942, China

Tel: +86 769 8593 5656
Fax: +86 769 8593 1080
Email: customerservice.dg@cn.bureauveritas.com



**BUREAU
VERITAS**

Test Report No.: RF160217W003-5

LTE BAND 4

CHANNEL BANDWIDTH: 15MHz				CHANNEL BANDWIDTH: 20MHz			
CHANNEL	FREQUENCY (MHz)	99% OCCUPIED BANDWIDTH (MHz)		CHANNEL	FREQUENCY (MHz)	99% OCCUPIED BANDWIDTH (MHz)	
		QPSK	16QAM			QPSK	16QAM
20025	1717.5	13.44	13.41	20050	1720	17.89	17.84
20175	1732.5	13.43	13.43	20175	1732.5	17.93	17.87
20325	1747.5	13.42	13.42	20300	1745	17.90	17.83





4.4 PEAK TO AVERAGE RATIO

4.4.1 LIMITS OF PEAK TO AVERAGE RATIO MEASUREMENT

In measuring transmissions in this band using an average power technique, the peak to-average ratio (PAR) of the transmission may not exceed 13 dB

4.4.2 TEST SETUP

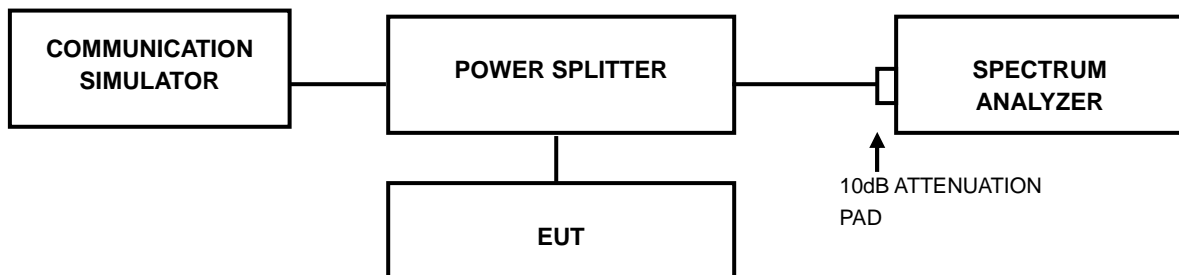

4.4.3 TEST PROCEDURES

1. Set resolution/measurement bandwidth \geq signal's occupied bandwidth;
2. Set the number of counts to a value that stabilizes the measured CCDF curve;
3. Record the maximum PAPR level associated with a probability of 0.1%.



4.4.4 TEST RESULTS

WCDMA

CHANNEL	FREQUENCY (MHz)	PEAK TO AVERAGE RATIO (dB)
1413	1732.6	2.85

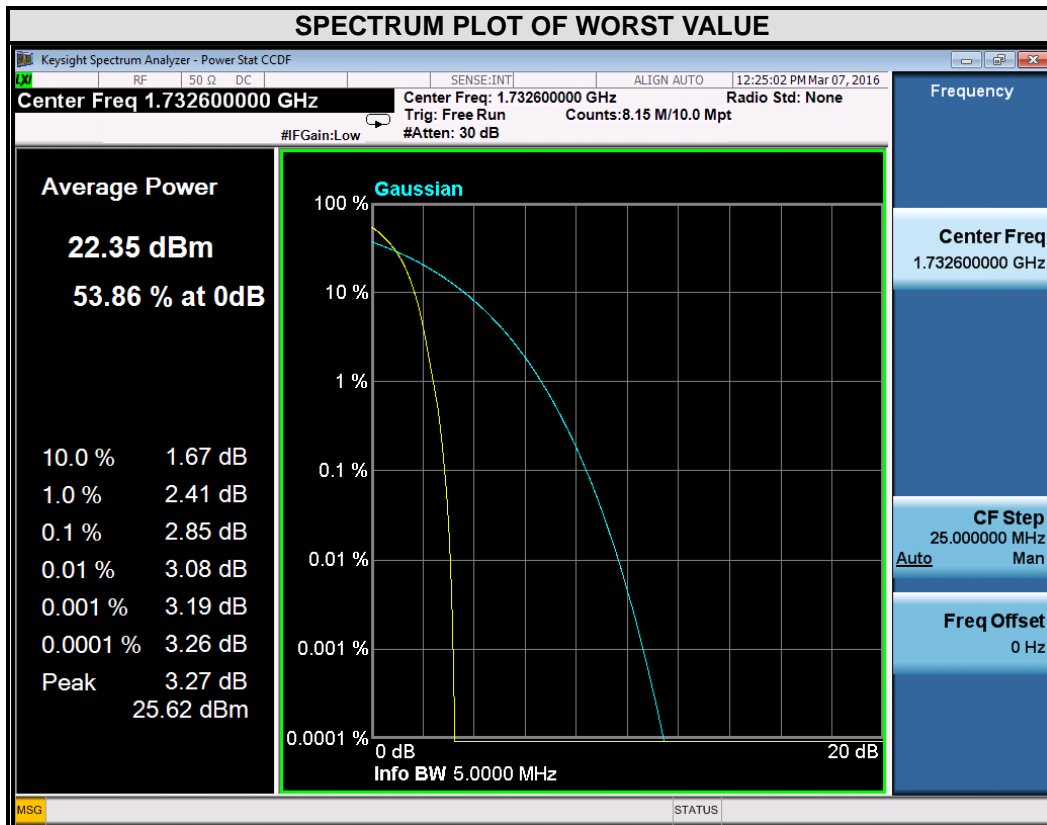



**BUREAU
VERITAS**

Test Report No.: RF160217W003-5

LTE BAND 4

CHANNEL BANDWIDTH: 1.4MHz				CHANNEL BANDWIDTH: 3MHz			
CHANNEL	FREQUENCY (MHz)	PEAK TO AVERAGE RATIO (dB)		CHANNEL	FREQUENCY (MHz)	PEAK TO AVERAGE RATIO (dB)	
		QPSK	16QAM			QPSK	16QAM
19957	1710.7	5.18	5.95	19965	1711.5	5.40	6.04
20175	1732.5	5.33	6.05	20175	1732.5	5.47	6.09
20393	1754.3	5.01	5.75	20385	1753.5	5.24	5.95

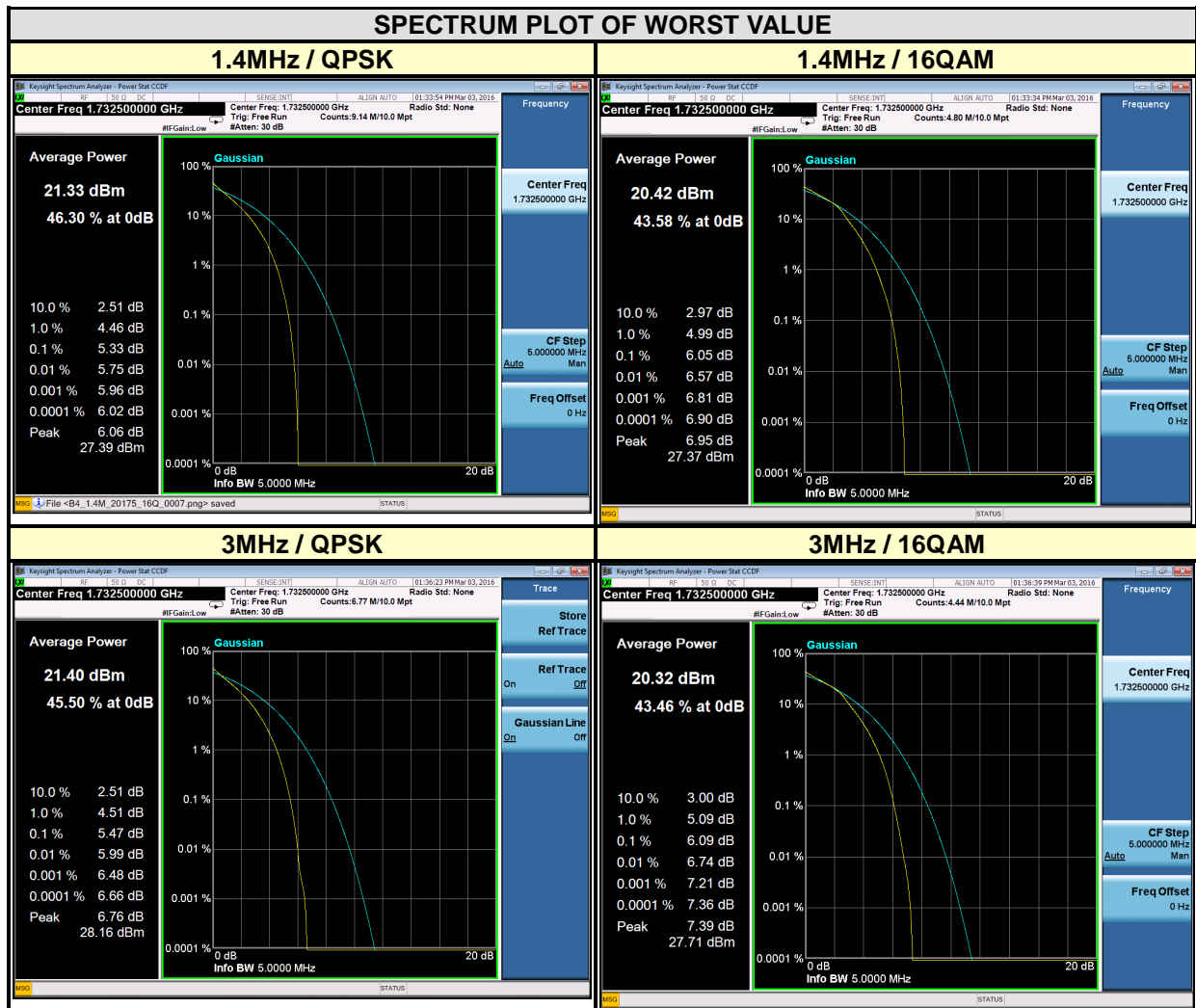

CHANNEL BANDWIDTH: 5MHz				CHANNEL BANDWIDTH: 10MHz			
CHANNEL	FREQUENCY (MHz)	PEAK TO AVERAGE RATIO (dB)		CHANNEL	FREQUENCY (MHz)	PEAK TO AVERAGE RATIO (dB)	
		QPSK	16QAM			QPSK	16QAM
19975	1712.5	5.55	6.21	20000	1715	5.29	6.00
20175	1732.5	5.61	6.28	20175	1732.5	5.45	6.15
20375	1752.5	5.49	6.19	20350	1750	5.38	6.07





**BUREAU
VERITAS**

Test Report No.: RF160217W003-5

CHANNEL BANDWIDTH: 15MHz				CHANNEL BANDWIDTH: 20MHz			
CHANNEL	FREQUENCY (MHz)	PEAK TO AVERAGE RATIO (dB)		CHANNEL	FREQUENCY (MHz)	PEAK TO AVERAGE RATIO (dB)	
		QPSK	16QAM			QPSK	16QAM
20025	1717.5	5.29	6.05	20050	1720	5.44	6.21
20175	1732.5	5.54	6.22	20175	1732.5	5.59	6.30
20325	1747.5	5.54	6.24	20300	1745	5.59	6.35

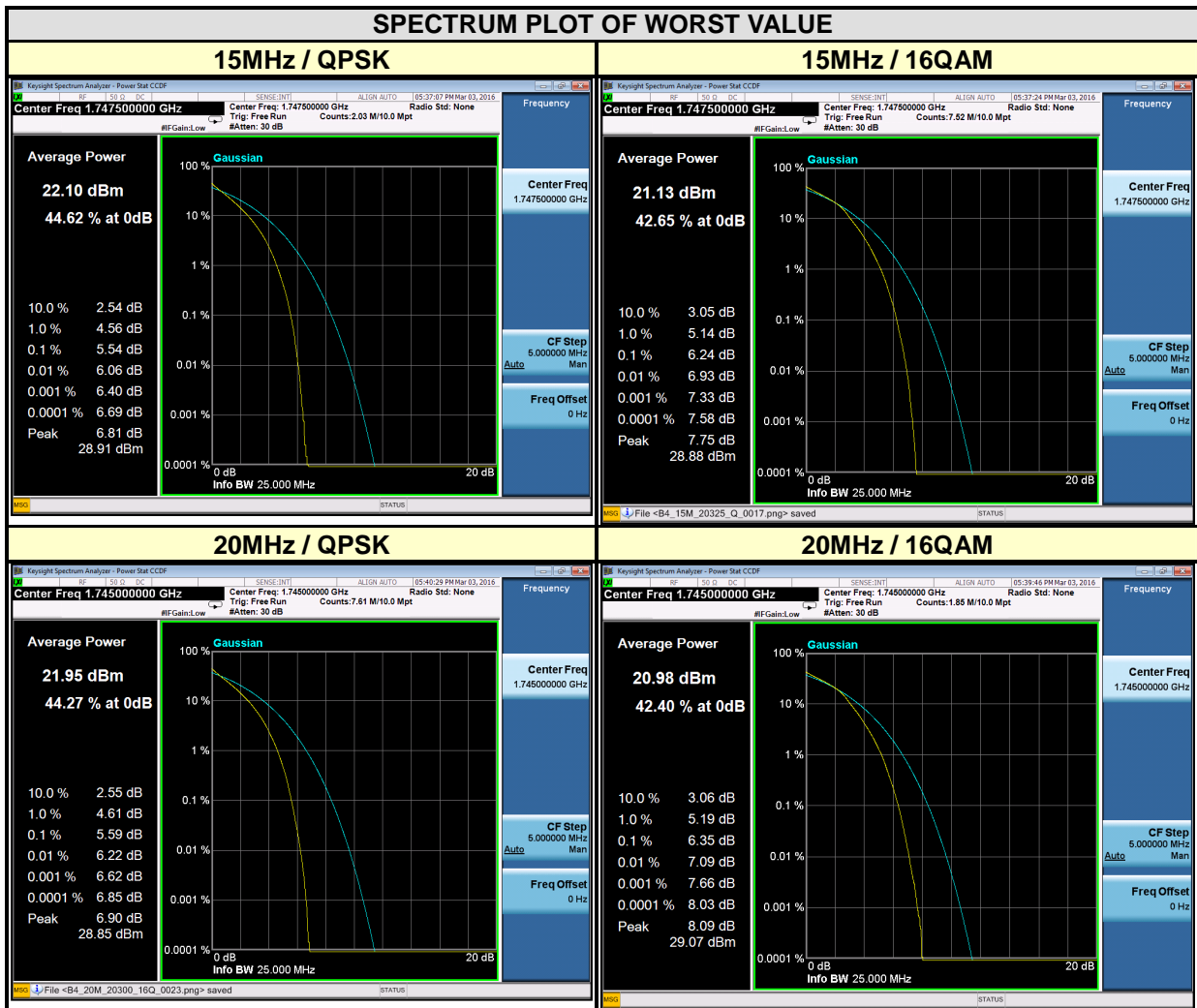

4.5 BAND EDGE MEASUREMENT

4.5.1 LIMITS OF BAND EDGE MEASUREMENT

The power of any emission outside a licensee's frequency band(s) of operation shall be attenuated below the transmitter power (P) within the licensed band(s) of operation, measured in watts, by at least $43 + 10 \log (P)$ dB. Compliance with this provision is based on the use of measurement instrumentation employing a resolution bandwidth of 100 kilohertz or greater.

However, in the 100 kilohertz bands immediately outside and adjacent to a licensee's frequency block, a resolution bandwidth of at least 30 kHz may be employed.

4.5.2 TEST SETUP

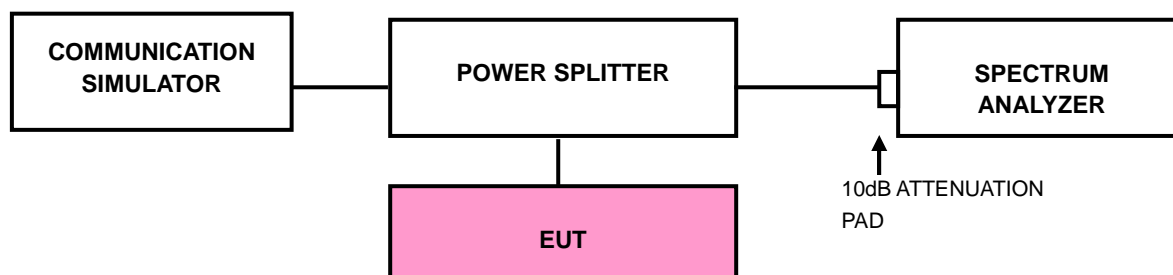

4.5.3 TEST PROCEDURES

- The EUT was set up for the maximum peak power with LTE link data modulation. The power was measured with R&S Spectrum Analyzer. All measurements were done at 2 channels (low and high operational frequency range.).
- The band edge measurement used the power splitter via EUT RF power connector between simulation base station and spectrum analyzer.
- The center frequency of spectrum is the band edge frequency and span is 10MHz. RBW of the spectrum is 50kHz and VBW of the spectrum is 200kHz (WCDMA).
- The center frequency of spectrum is the band edge frequency and span is 1~5 MHz. RB of the spectrum is 20kHz and VB of the spectrum is 100 kHz. (LTE bandwidth 1.4MHz)



**BUREAU
VERITAS**

Test Report No.: RF160217W003-5

- e. The center frequency of spectrum is the band edge frequency and span is 1~5 MHz. RB of the spectrum is 30kHz and VB of the spectrum is 100kHz. (LTE bandwidth 3MHz)
- f. The center frequency of spectrum is the band edge frequency and span is 1~5 MHz. RB of the spectrum is 50kHz and VB of the spectrum is 200kHz. (LTE bandwidth 5MHz)
- g. The center frequency of spectrum is the band edge frequency and span is 1~5 MHz. RB of the spectrum is 100kHz and VB of the spectrum is 300kHz. (LTE bandwidth 10MHz)
- h. The center frequency of spectrum is the band edge frequency and span is 1~5 MHz. RB of the spectrum is 200kHz and VB of the spectrum is 1MHz. (LTE bandwidth 15MHz)
- i. The center frequency of spectrum is the band edge frequency and span is 1~5 MHz. RB of the spectrum is 200kHz and VB of the spectrum is 1MHz. (LTE bandwidth 20MHz)
- j. Record the max trace plot into the test report.



4.5.4 TEST RESULTS

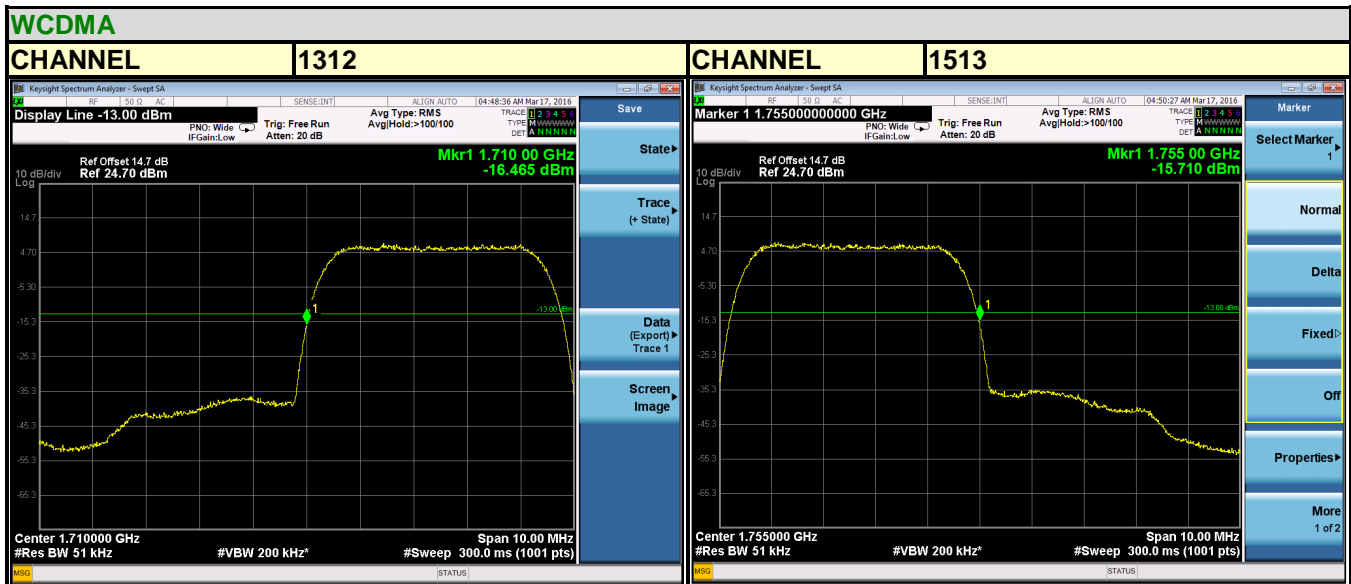





Test Report No.: RF160217W003-5

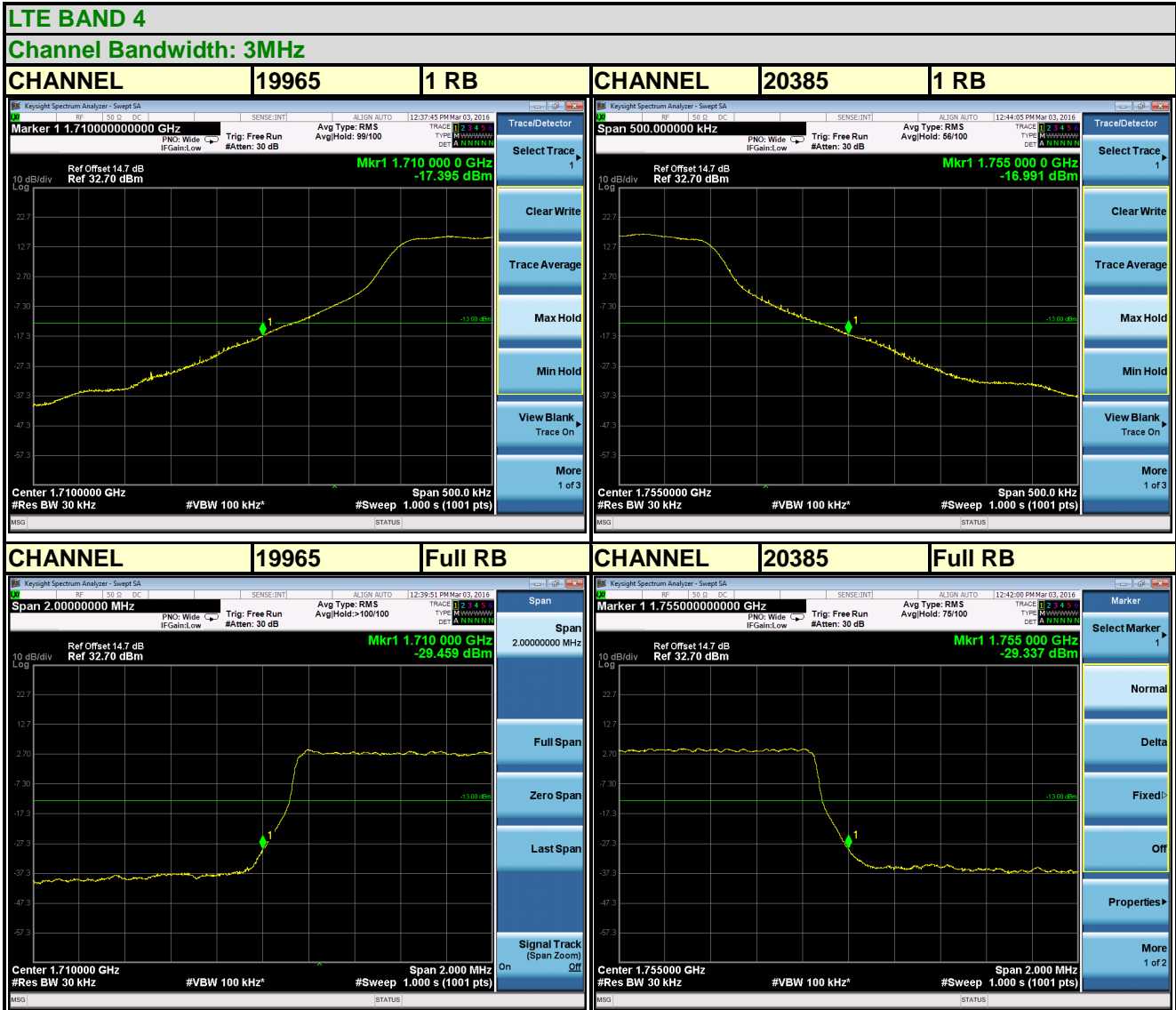

Bureau Veritas Shenzhen Co., Ltd.
 Dongguan Branch

No. 34, Chenwulu Section, Guantai Rd.,
 Houjie Town, Dongguan City,
 Guangdong 523942, China

Tel: +86 769 8593 5656
 Fax: +86 769 8593 1080
 Email: customerservice.dg@cn.bureauveritas.com







Test Report No.: RF160217W003-5

LTE BAND 4
Channel Bandwidth: 15MHz

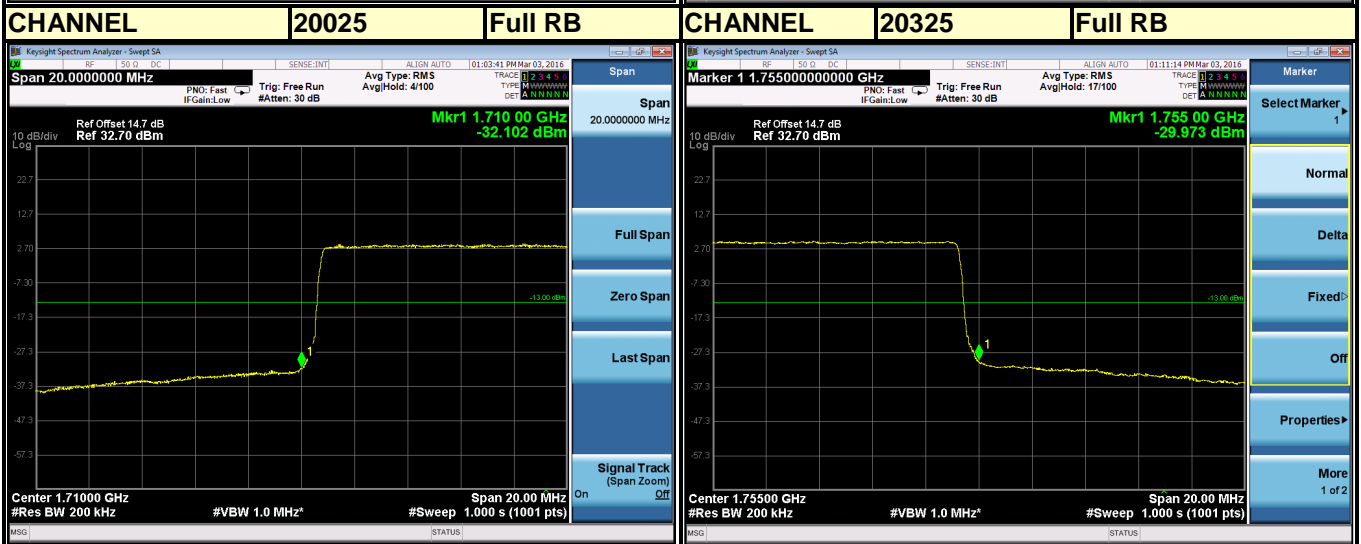
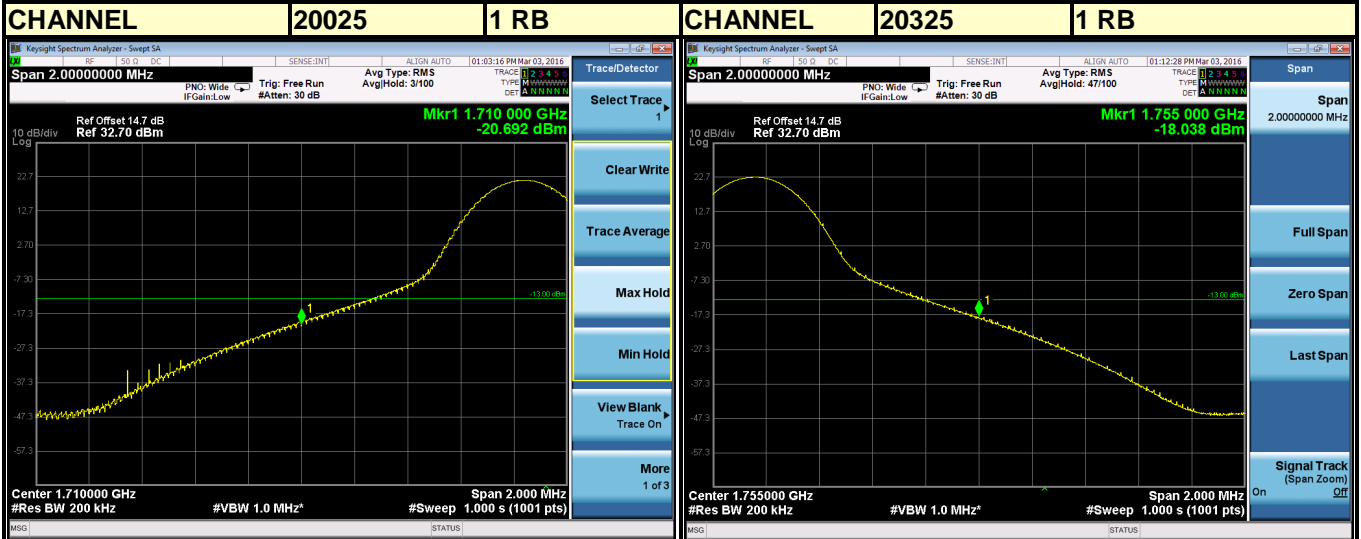



Test Report No.: RF160217W003-5



Bureau Veritas Shenzhen Co., Ltd.
 Dongguan Branch

No. 34, Chenwulu Section, Guantai Rd.,
 Houjie Town, Dongguan City,
 Guangdong 523942, China

Tel: +86 769 8593 5656
 Fax: +86 769 8593 1080
 Email: customerservice.dg@cn.bureauveritas.com

4.6 CONDUCTED SPURIOUS EMISSIONS

4.6.1 LIMITS OF CONDUCTED SPURIOUS EMISSIONS MEASUREMENT

The power of any emission outside a licensee's frequency block shall be attenuated below the transmitter power (P) by at least $43 + 10 \log_{10}(P)$ dB. The limit of emission equal to -13dBm

4.6.2 TEST PROCEDURE

- a. The EUT makes a phone call to the communication simulator. All measurements were done at middle operational frequency range.
- b. Measuring frequency range is from 30 MHz to 19.1GHz, 10dB attenuation pad is connected with spectrum. RBW=1MHz and VBW=3MHz are used for conducted emission measurement.

4.6.3 TEST SETUP

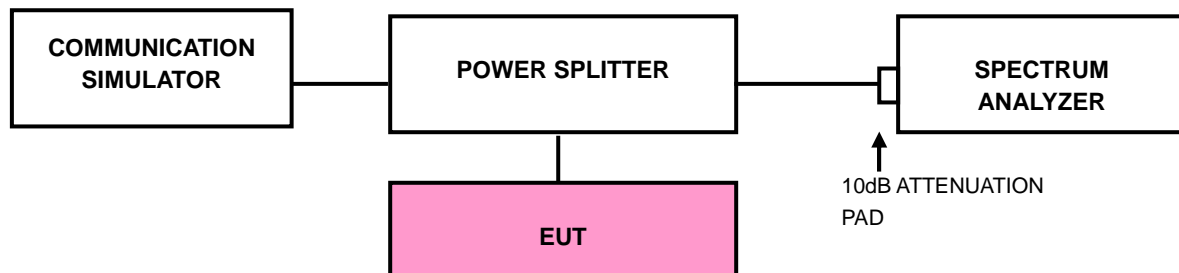



BUREAU VERITAS

Test Report No.: RF160217W003-5

4.6.4 TEST RESULTS

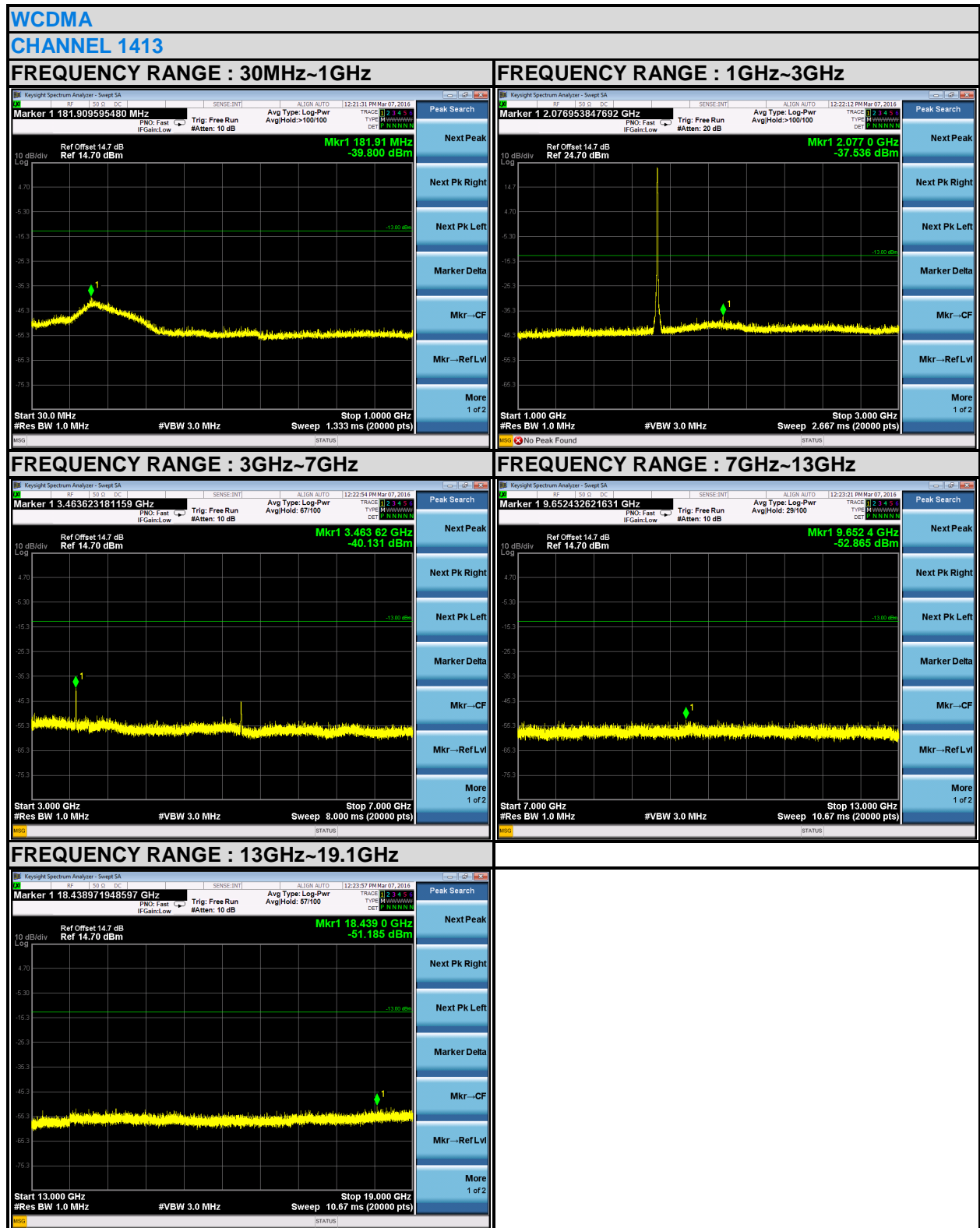

Bureau Veritas Shenzhen Co., Ltd.
Dongguan Branch

No. 34, Chenwulu Section, Guantai Rd.,
Houjie Town, Dongguan City,
Guangdong 523942, China

Tel: +86 769 8593 5656
Fax: +86 769 8593 1080
Email: customerservice.dg@cn.bureauveritas.com



BUREAU VERITAS

Test Report No.: RF160217W003-5

LTE BAND 4

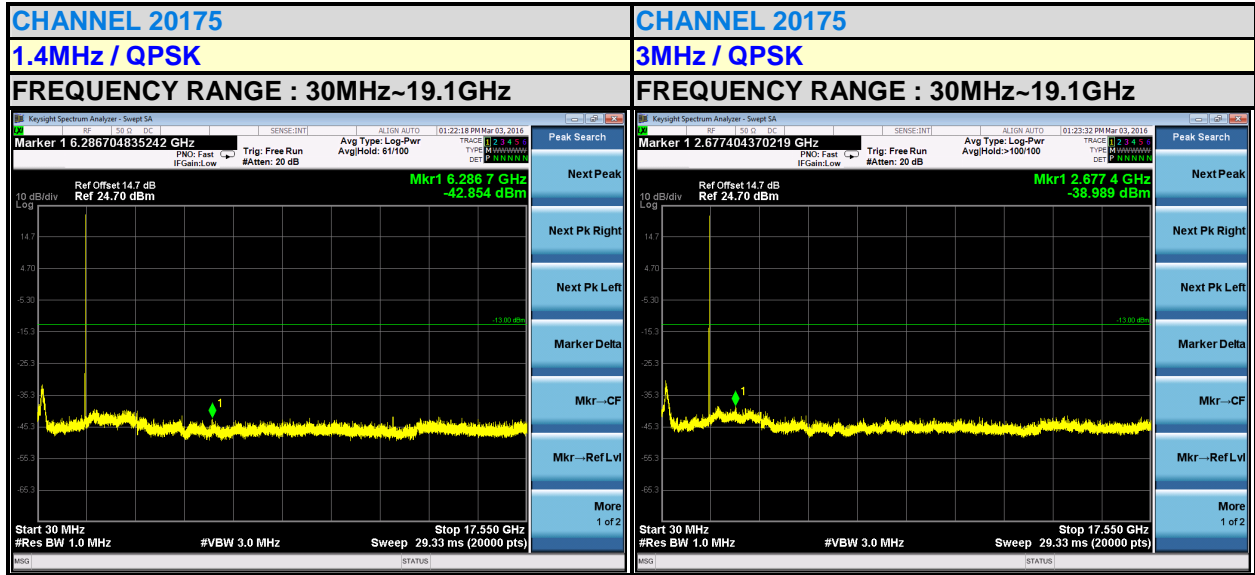

LTE BAND 4

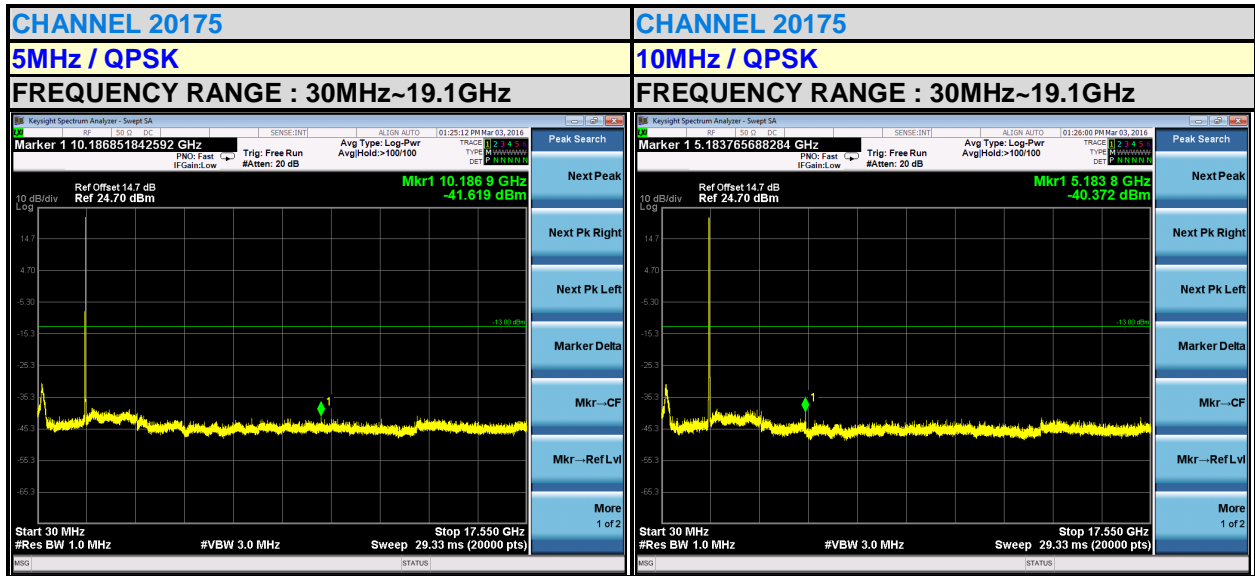

Bureau Veritas Shenzhen Co., Ltd.
Dongguan Branch

No. 34, Chenwulu Section, Guantai Rd.,
Houjie Town, Dongguan City,
Guangdong 523942, China

Tel: +86 769 8593 5656
Fax: +86 769 8593 1080
Email: customerservice.dg@cn.bureauveritas.com



Test Report No.: RF160217W003-5

LTE BAND 4

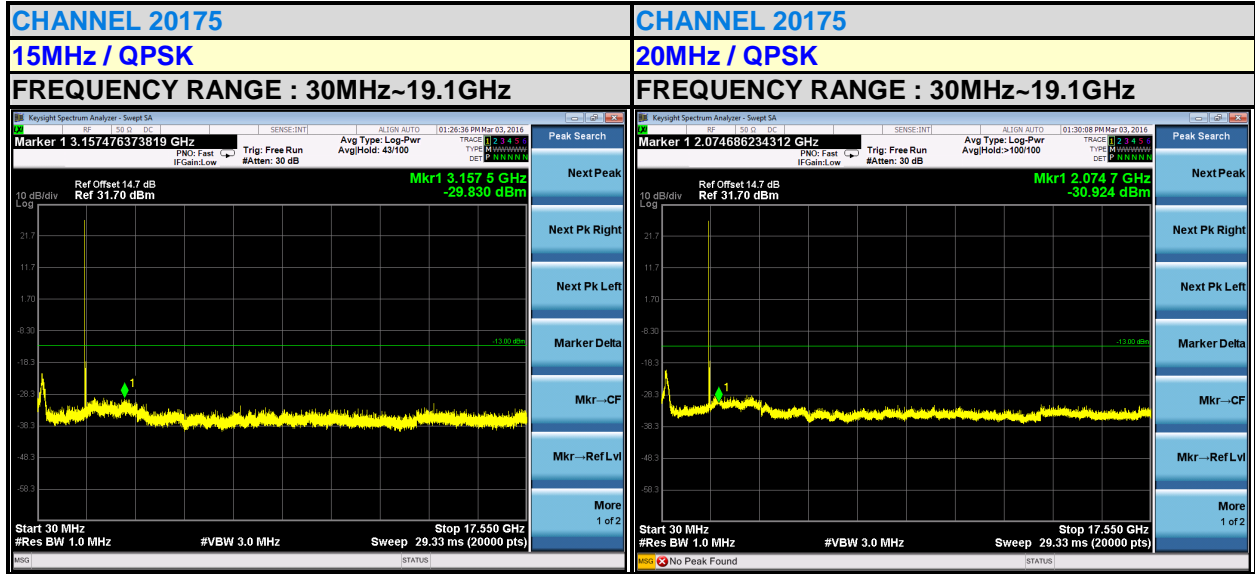

Bureau Veritas Shenzhen Co., Ltd.
Dongguan Branch

No. 34, Chenwulu Section, Guantai Rd.,
Houjie Town, Dongguan City,
Guangdong 523942, China

Tel: +86 769 8593 5656
Fax: +86 769 8593 1080
Email: customerservice.dg@cn.bureauveritas.com



4.7 RADIATED EMISSION MEASUREMENT

4.7.1 LIMITS OF RADIATED EMISSION MEASUREMENT

The power of any emission outside a licensee's frequency block shall be attenuated below the transmitter power (P) by at least $43 + 10 \log_{10}(P)$ dB. The limit of emission equal to -13dBm

4.7.2 TEST PROCEDURES

- a. Substitution method is used for E.I.R.P measurement. In the semi-anechoic chamber, EUT placed on the 0.8m height of Turn Table, rotated the table around 360 degrees to search the maximum radiation power and receiver antenna shall be rotated vertical and horizontal polarization and moved height from 1m to 4m to find the maximum polar radiated power. The "Read Value" is the spectrum reading the maximum power value.
- b. The substitution horn antenna is substituted for EUT at the same position and signals generator export the CW signal to the substitution antenna via a TX cable. Rotated the Turn Table and moved receiving antenna to find the maximum radiation power. Adjust output power level of S.G to get a Value of spectrum reading equal to "Read Value" of step a. Record the power level of S.G
- c. $\text{EIRP} = \text{Output power level of S.G} - \text{TX cable loss} + \text{Antenna gain of substitution horn.}$
- d. E.R.P power can be calculated form E.I.R.P power by subtracting the gain of dipole, $\text{E.R.P power} = \text{E.I.P.R power} - 2.15\text{dBi.}$

NOTE: The resolution bandwidth of spectrum analyzer is 1 MHz and the video bandwidth is 3 MHz.

4.7.3 DEVIATION FROM TEST STANDARD

No deviation

4.7.4 TEST SETUP

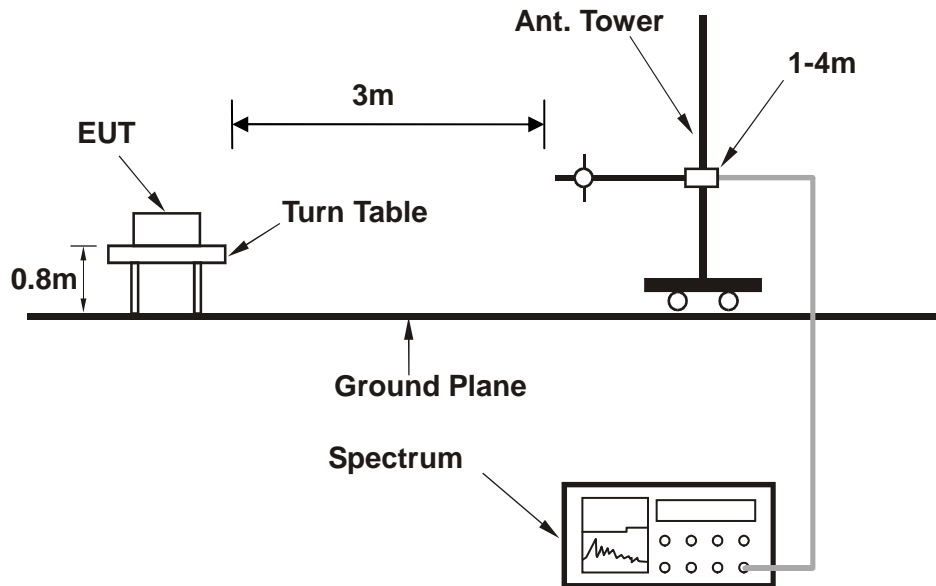

For the actual test configuration, please refer to the attached file (Test Setup Photo).

4.7.5 TEST RESULTS

BELOW 1GHz WORST-CASE DATA

LTE Band 4:

MODE	TX channel20175	FREQUENCY RANGE	Below 1000MHz
ENVIRONMENTAL CONDITIONS	26deg. C, 56%RH	INPUT POWER	DC 5V from adapter
TESTED BY	Alex Chen		
ANTENNA POLARITY & TEST DISTANCE: HORIZONTAL AT 3 M			

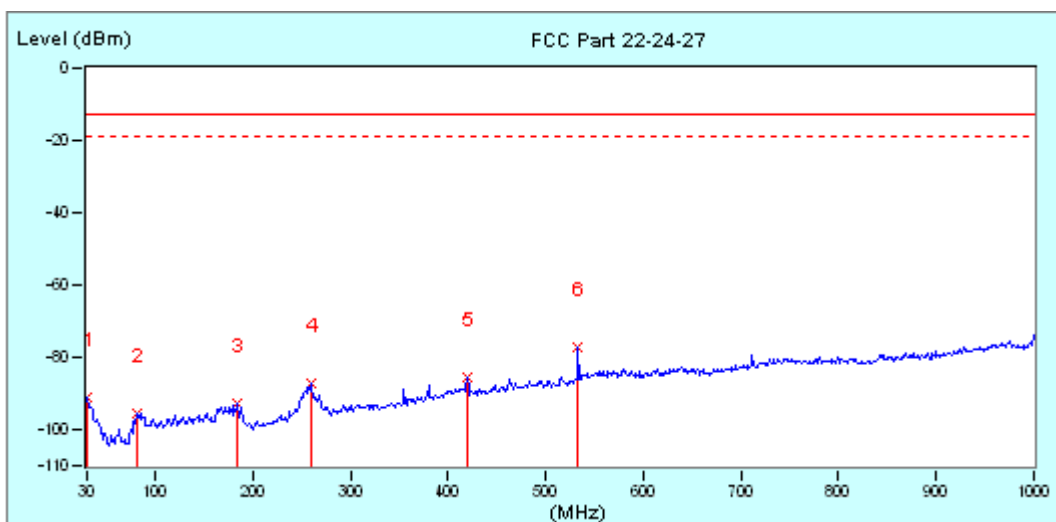

No.	Frequency MHz	Factor dB	Reading dBm	Emission dBm	Limit dBm	Margin dB	Tower / Table cm deg
1	30.00	-12.55	-78.30	-90.85	-13.00	-77.85	100 0
2	82.01	-23.15	-72.51	-95.66	-13.00	-82.66	100 0
3	184.84	-20.50	-72.03	-92.53	-13.00	-79.53	100 0
4	259.14	-15.67	-71.38	-87.05	-13.00	-74.05	100 0
5	419.41	-10.87	-74.71	-85.58	-13.00	-72.58	100 0
* 6	533.28	-7.56	-69.91	-77.47	-13.00	-64.47	100 0



Test Report No.: RF160217W003-5

MODE	TX channel20175	FREQUENCY RANGE	Below 1000MHz
ENVIRONMENTAL CONDITIONS	26deg. C, 56%RH	INPUT POWER	DC 5V from adapter
TESTED BY	Alex Chen		
ANTENNA POLARITY & TEST DISTANCE: VERTICAL AT 3 M			

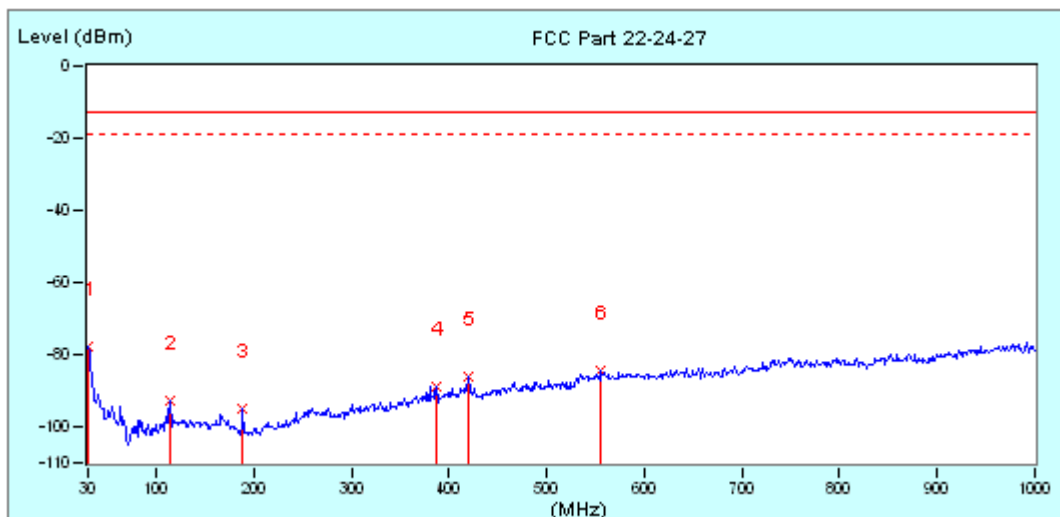

No.	Frequency MHz	Factor dB	Reading dBm	Emission dBm	Limit dBm	Margin dB	Tower / Table cm deg	
*	1	-12.55	-65.47	-78.02	-13.00	-65.02	100	0
	2	-19.01	-73.57	-92.58	-13.00	-79.58	100	0
	3	-20.84	-73.96	-94.80	-13.00	-81.80	100	0
	4	-12.50	-76.37	-88.87	-13.00	-75.87	100	0
	5	-10.87	-75.18	-86.05	-13.00	-73.05	100	0
	6	-6.12	-78.58	-84.70	-13.00	-71.70	100	0



Test Report No.: RF160217W003-5

ABOVE 1GHz

WCDMA Band IV:

MODE	TX channel 1413	FREQUENCY RANGE	Above 1000MHz
ENVIRONMENTAL CONDITIONS	26deg. C, 56%RH	INPUT POWER	DC 5V from adapter
TESTED BY	Alex Chen		
ANTENNA POLARITY & TEST DISTANCE: HORIZONTAL AT 3 M			

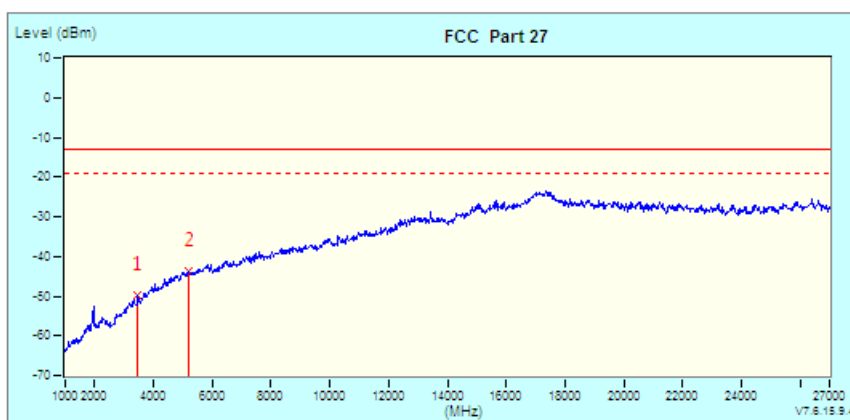

No.	Frequency MHz	Factor dB	Reading dBm	Emission dBm	Limit dBm	Margin dB	Tower / Table cm deg	
1	3470.00 (PK)	2.05	-51.97	-49.92	-13.00	-36.92	386	360
* 2	5186.00 (PK)	8.59	-52.14	-43.55	-13.00	-30.55	386	360



Test Report No.: RF160217W003-5

MODE	TX channel 1413	FREQUENCY RANGE	Above 1000MHz
ENVIRONMENTAL CONDITIONS	26deg. C, 56%RH	INPUT POWER	DC 5V from adapter
TESTED BY	Alex Chen		
ANTENNA POLARITY & TEST DISTANCE: VERTICAL AT 3 M			

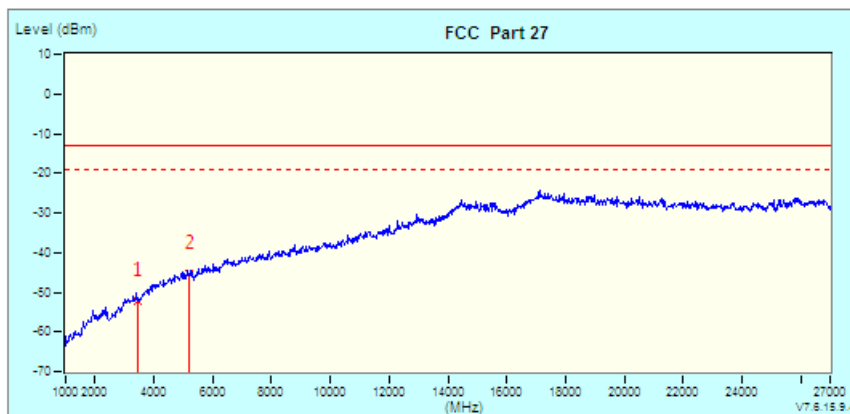

No.	Frequency MHz	Factor dB	Reading dBm	Emission dBm	Limit dBm	Margin dB	Tower / Table	
							cm	deg
1	3470.00 (PK)	2.53	-54.76	-52.23	-13.00	-39.23	100	360
2	5186.00 (PK)	7.98	-53.34	-45.36	-13.00	-32.36	100	360



Test Report No.: RF160217W003-5

LTE BAND 4

CHANNEL BANDWIDTH: 1.4MHz / QPSK

MODE	TX channel 20175	FREQUENCY RANGE	Above 1000MHz
ENVIRONMENTAL CONDITIONS	26deg. C, 56%RH	INPUT POWER	DC 5V from adapter
TESTED BY	Alex Chen		
ANTENNA POLARITY & TEST DISTANCE: HORIZONTAL AT 3 M			

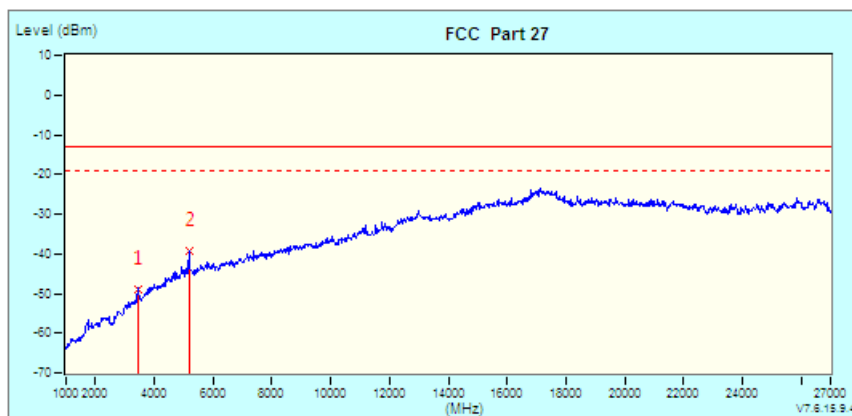

No.	Frequency MHz	Factor dB	Reading dBm	Emission dBm	Limit dBm	Margin dB	Tower / Table cm deg
1	3470.00 (PK)	2.05	-50.87	-48.82	-13.00	-35.82	298 0
2	5186.00 (PK)	8.59	-47.92	-39.33	-13.00	-26.33	298 0



Test Report No.: RF160217W003-5

MODE	TX channel 20175	FREQUENCY RANGE	Above 1000MHz
ENVIRONMENTAL CONDITIONS	26deg. C, 56%RH	INPUT POWER	DC 5V from adapter
TESTED BY	Alex Chen		
ANTENNA POLARITY & TEST DISTANCE: VERTICAL AT 3 M			

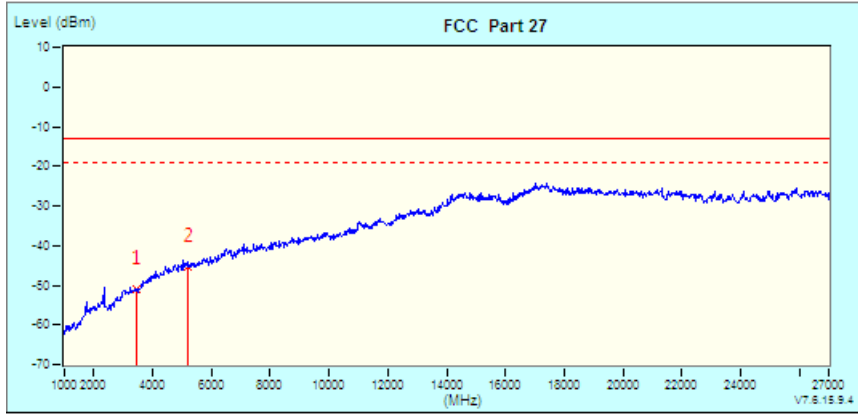

No.	Frequency MHz	Factor dB	Reading dBm	Emission dBm	Limit dBm	Margin dB	Tower / Table cm deg	
1	3470.00 (PK)	2.53	-53.43	-50.90	-13.00	-37.90	100	360
* 2	5186.00 (PK)	7.98	-53.48	-45.50	-13.00	-32.50	100	360

CHANNEL BANDWIDTH: 3MHz / QPSK

MODE	TX channel 20175	FREQUENCY RANGE	Above 1000MHz
ENVIRONMENTAL CONDITIONS	26deg. C, 56%RH	INPUT POWER	DC 5V from adapter
TESTED BY	Alex Chen		
ANTENNA POLARITY & TEST DISTANCE: HORIZONTAL AT 3 M			

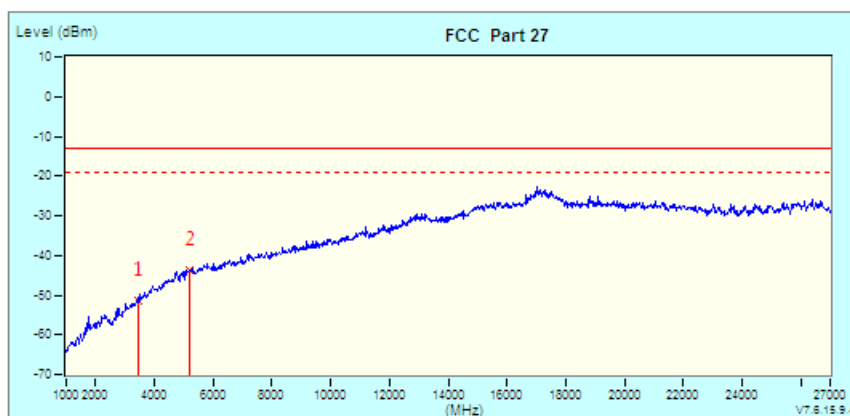

No.	Frequency MHz	Factor dB	Reading dBm	Emission dBm	Limit dBm	Margin dB	Tower / Table cm deg	
1	3470.00 (PK)	2.05	-53.46	-51.41	-13.00	-38.41	100	360
* 2	5186.00 (PK)	8.59	-52.50	-43.91	-13.00	-30.91	100	360



Test Report No.: RF160217W003-5

MODE	TX channel 20175	FREQUENCY RANGE	Above 1000MHz
ENVIRONMENTAL CONDITIONS	26deg. C, 56%RH	INPUT POWER	DC 5V from adapter
TESTED BY	Alex Chen		
ANTENNA POLARITY & TEST DISTANCE: VERTICAL AT 3 M			

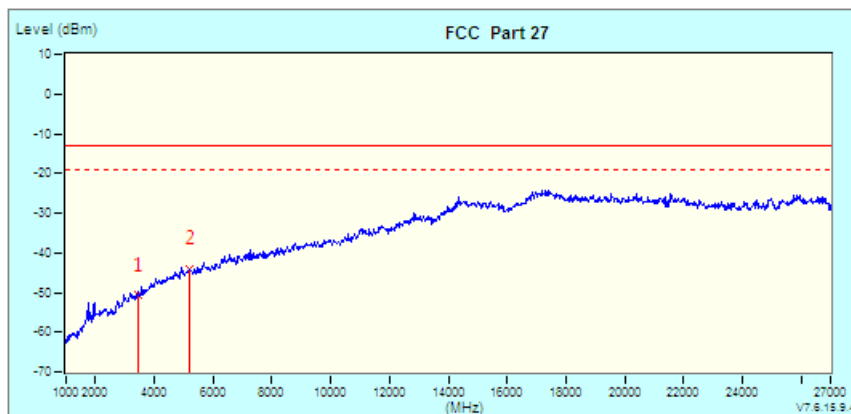

No.	Frequency MHz	Factor dB	Reading dBm	Emission dBm	Limit dBm	Margin dB	Tower / Table	
							cm	deg
1	3470.00 (PK)	2.53	-53.34	-50.81	-13.00	-37.81	100	0
* 2	5186.00 (PK)	7.98	-52.14	-44.16	-13.00	-31.16	100	0



Test Report No.: RF160217W003-5

CHANNEL BANDWIDTH: 5MHz / QPSK

MODE	TX channel 20175	FREQUENCY RANGE	Above 1000MHz
ENVIRONMENTAL CONDITIONS	26deg. C, 56%RH	INPUT POWER	DC 5V from adapter
TESTED BY	Bob Chen		
ANTENNA POLARITY & TEST DISTANCE: HORIZONTAL AT 3 M			

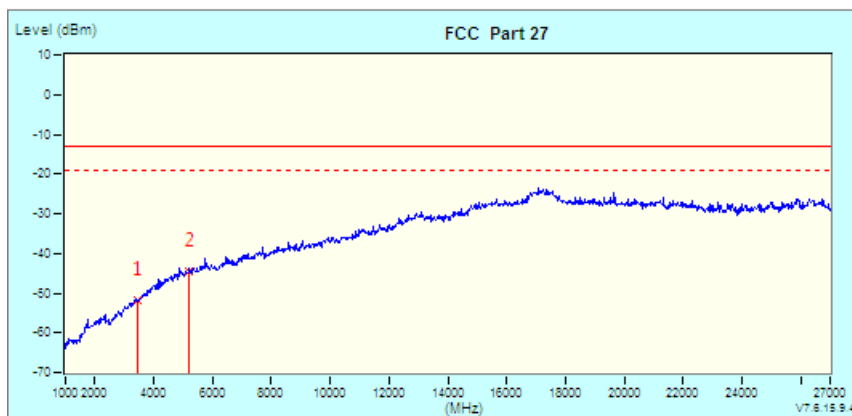

No.	Frequency MHz	Factor dB	Reading dBm	Emission dBm	Limit dBm	Margin dB	Tower / Table	
							cm	deg
1	3470.00 (PK)	2.05	-53.68	-51.63	-13.00	-38.63	300	0
* 2	5186.00 (PK)	8.59	-53.25	-44.66	-13.00	-31.66	300	0



Test Report No.: RF160217W003-5

MODE	TX channel 20175	FREQUENCY RANGE	Above 1000MHz
ENVIRONMENTAL CONDITIONS	26deg. C, 56%RH	INPUT POWER	DC 5V from adapter
TESTED BY	Alex Chen		
ANTENNA POLARITY & TEST DISTANCE: VERTICAL AT 3 M			

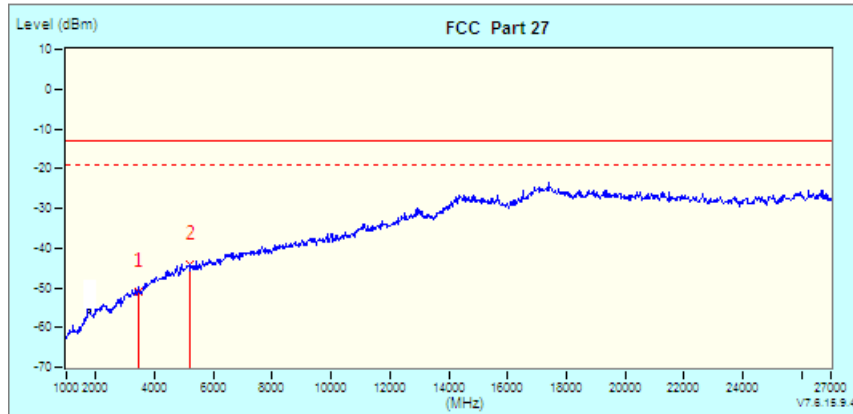

No.	Frequency MHz	Factor dB	Reading dBm	Emission dBm	Limit dBm	Margin dB	Tower / Table cm deg	
1	3470.00 (PK)	2.53	-53.46	-50.93	-13.00	-37.93	100	360
* 2	5186.00 (PK)	7.98	-52.16	-44.18	-13.00	-31.18	100	360



Test Report No.: RF160217W003-5

CHANNEL BANDWIDTH: 10MHz / QPSK

MODE	TX channel 20175	FREQUENCY RANGE	Above 1000MHz
ENVIRONMENTAL CONDITIONS	26deg. C, 56%RH	INPUT POWER	DC 5V from adapter
TESTED BY	Alex Chen		
ANTENNA POLARITY & TEST DISTANCE: HORIZONTAL AT 3 M			

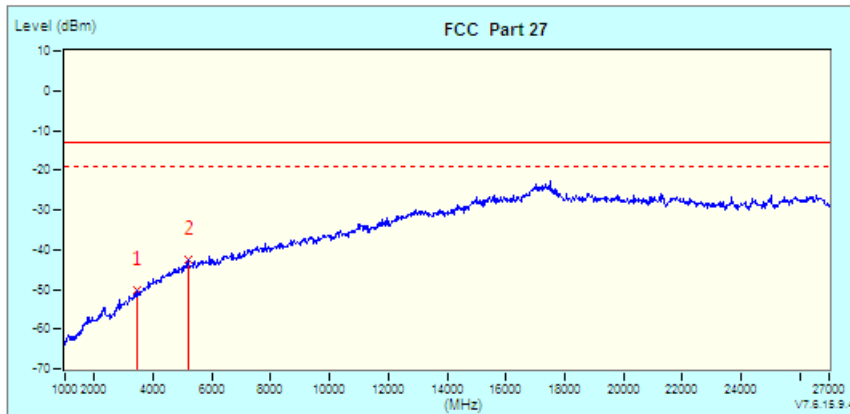

No.	Frequency MHz	Factor dB	Reading dBm	Emission dBm	Limit dBm	Margin dB	Tower / Table cm deg	
1	3470.00 (PK)	2.05	-52.17	-50.12	-13.00	-37.12	100	360
2	5186.00 (PK)	8.59	-50.99	-42.40	-13.00	-29.40	100	360



Test Report No.: RF160217W003-5

MODE	TX channel 20175	FREQUENCY RANGE	Above 1000MHz
ENVIRONMENTAL CONDITIONS	26deg. C, 56%RH	INPUT POWER	DC 5V from adapter
TESTED BY	Alex Chen		
ANTENNA POLARITY & TEST DISTANCE: VERTICAL AT 3 M			

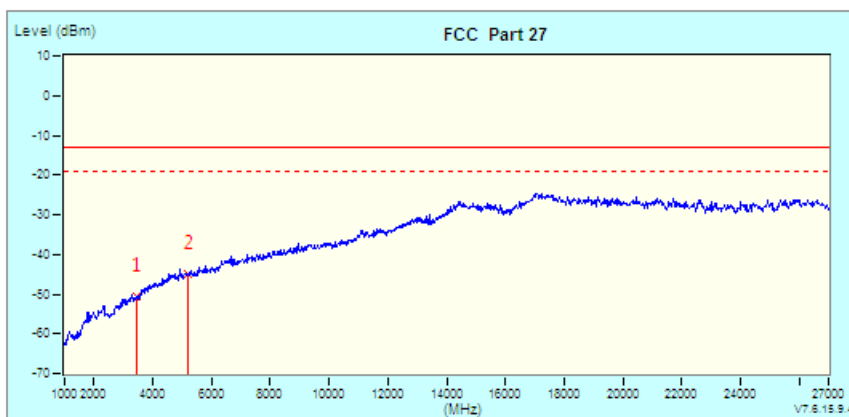

No.	Frequency MHz	Factor dB	Reading dBm	Emission dBm	Limit dBm	Margin dB	Tower / Table cm deg	
1	3470.00 (PK)	2.53	-53.10	-50.57	-13.00	-37.57	100	0
* 2	5186.00 (PK)	7.98	-52.91	-44.93	-13.00	-31.93	100	0



Test Report No.: RF160217W003-5

CHANNEL BANDWIDTH: 15MHz / QPSK

MODE	TX channel 20175	FREQUENCY RANGE	Above 1000MHz
ENVIRONMENTAL CONDITIONS	26deg. C, 56%RH	INPUT POWER	DC 5V from adapter
TESTED BY	Alex Chen		
ANTENNA POLARITY & TEST DISTANCE: HORIZONTAL AT 3 M			

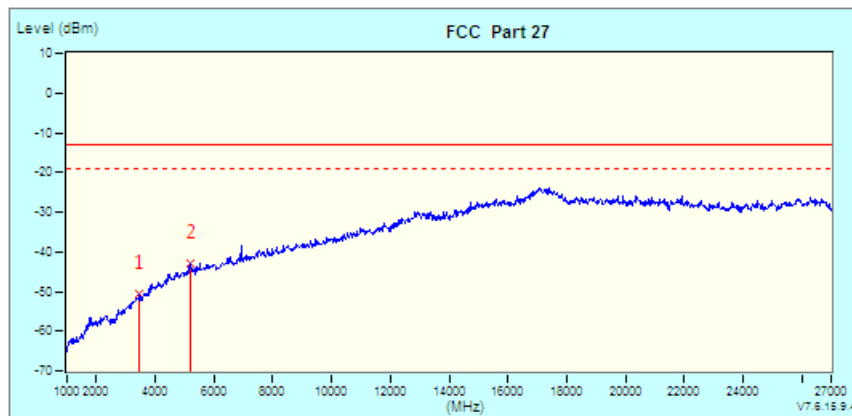

No.	Frequency MHz	Factor dB	Reading dBm	Emission dBm	Limit dBm	Margin dB	Tower / Table	
							cm	deg
1	3470.00 (PK)	2.05	-52.74	-50.69	-13.00	-37.69	281	0
* 2	5186.00 (PK)	8.59	-51.52	-42.93	-13.00	-29.93	281	0



Test Report No.: RF160217W003-5

MODE	TX channel 20175	FREQUENCY RANGE	Above 1000MHz
ENVIRONMENTAL CONDITIONS	26deg. C, 56%RH	INPUT POWER	DC 5V from adapter
TESTED BY	Alex Chen		
ANTENNA POLARITY & TEST DISTANCE: VERTICAL AT 3 M			

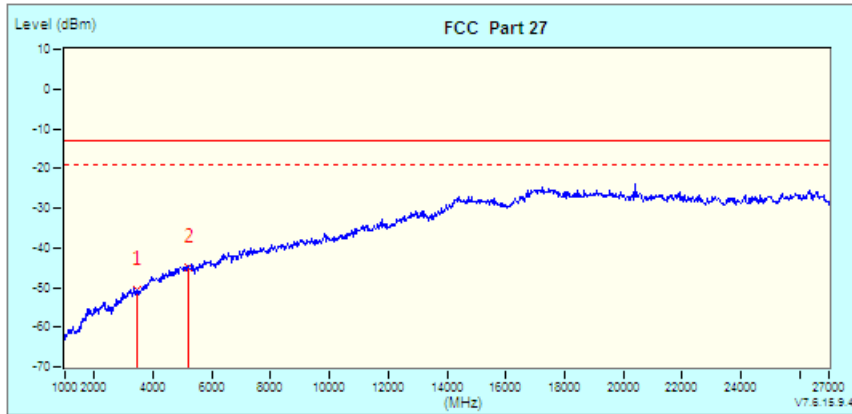

No.	Frequency MHz	Factor dB	Reading dBm	Emission dBm	Limit dBm	Margin dB	Tower / Table	
							cm	deg
1	3470.00 (PK)	2.53	-53.18	-50.65	-13.00	-37.65	100	360
* 2	5186.00 (PK)	7.98	-53.11	-45.13	-13.00	-32.13	100	360



Test Report No.: RF160217W003-5

CHANNEL BANDWIDTH: 20MHz / QPSK

MODE	TX channel 20175	FREQUENCY RANGE	Above 1000MHz
ENVIRONMENTAL CONDITIONS	26deg. C, 56%RH	INPUT POWER	DC 5V from adapter
TESTED BY	Alex Chen		
ANTENNA POLARITY & TEST DISTANCE: HORIZONTAL AT 3 M			

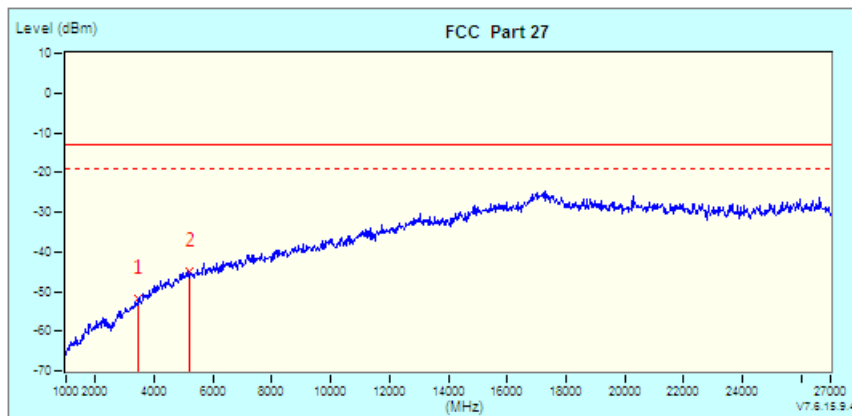

No.	Frequency MHz	Factor dB	Reading dBm	Emission dBm	Limit dBm	Margin dB	Tower / Table cm deg
1	3470.00 (PK)	2.05	-54.07	-52.02	-13.00	-39.02	100 0
* 2	5186.00 (PK)	8.59	-53.47	-44.88	-13.00	-31.88	100 0



Test Report No.: RF160217W003-5

MODE	TX channel 20175	FREQUENCY RANGE	Above 1000MHz
ENVIRONMENTAL CONDITIONS	26deg. C, 56%RH	INPUT POWER	DC 5V from adapter
TESTED BY	Alex Chen		
ANTENNA POLARITY & TEST DISTANCE: VERTICAL AT 3 M			

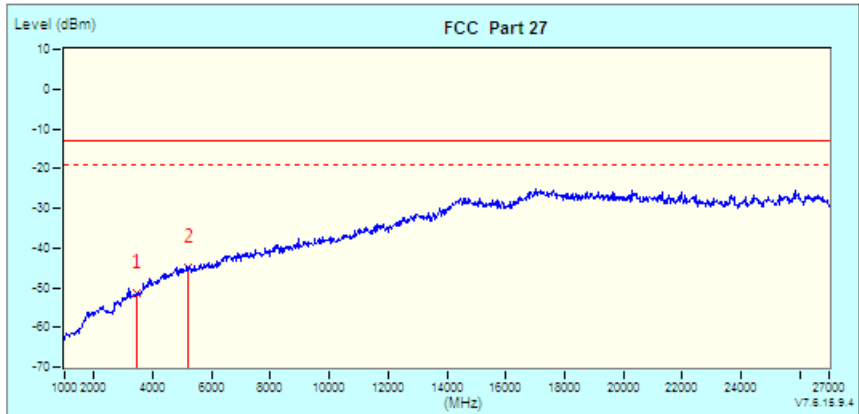

No.	Frequency MHz	Factor dB	Reading dBm	Emission dBm	Limit dBm	Margin dB	Tower / Table	
							cm	deg
1	3470.00 (PK)	2.53	-53.89	-51.36	-13.00	-38.36	100	203
* 2	5186.00 (PK)	7.98	-52.85	-44.87	-13.00	-31.87	100	138



**BUREAU
VERITAS**

Test Report No.: RF160217W003-5

5 INFORMATION ON THE TESTING LABORATORIES

We, Bureau Veritas Shenzhen Co., Ltd. Dongguan Branch, were founded in 2002 to provide our best service in EMC, Radio, Telecom and Safety consultation. Our laboratories are accredited and approved according to ISO/IEC 17025.

If you have any comments, please feel free to contact us at the following:

Dongguan EMC/RF Lab:

Tel: +86-769-85935656

Fax: +86-769-85931080

Email: customerservice.dg@cn.bureauveritas.com

Web Site: www.adt.com.tw

The address and road map of all our labs can be found in our web site also.



Test Report No.: RF160217W003-5

6 APPENDIX A – MODIFICATIONS RECORDERS FOR ENGINEERING CHANGES TO THE EUT BY THE LAB

No modifications were made to the EUT by the lab during the test.

---END---