

## FCC Test Report

**Report No.:** RF160621C25

**FCC ID:** NM82PUK220

**Test Model:** 2PUK220

**Received Date:** Jun. 21, 2016

**Test Date:** Jun. 28, 2016 ~ Jul. 14, 2016

**Issued Date:** Jul. 26, 2016

**Applicant:** HTC Corporation

**Address:** 1F, 6-3 Baoqiang Road, Xindian District, New Taipei City, Taiwan 231

**Issued By:** Bureau Veritas Consumer Products Services (H.K.) Ltd., Taoyuan Branch

**Lab Address:** No. 47-2, 14th Ling, Chia Pau Vil., Lin Kou Dist., New Taipei City, Taiwan ( R.O.C )

**Test Location (1):** No. 19, Hwa Ya 2nd Rd, Wen Hwa Tsuen, Kwei Shan Hsiang, Taoyuan Hsien 333, Taiwan, R.O.C.

**Test Location (2):** No.215, Sec. 3, Beixin Rd., Xindian Dist., New Taipei City 231, Taiwan, R.O.C



This report is for your exclusive use. Any copying or replication of this report to or for any other person or entity, or use of our name or trademark, is permitted only with our prior written permission. This report sets forth our findings solely with respect to the test samples identified herein. The results set forth in this report are not indicative or representative of the quality or characteristics of the lot from which a test sample was taken or any similar or identical product unless specifically and expressly noted. Our report includes all of the tests requested by you and the results thereof based upon the information that you provided to us. You have 60 days from date of issuance of this report to notify us of any material error or omission caused by our negligence, provided, however, that such notice shall be in writing and shall specifically address the issue you wish to raise. A failure to raise such issue within the prescribed time shall constitute your unqualified acceptance of the completeness of this report, the tests conducted and the correctness of the report contents. Unless specific mention, the uncertainty of measurement has been explicitly taken into account to declare the compliance or non-compliance to the specification.

## Table of Contents

<b>Release Control Record .....</b>	<b>4</b>
<b>1 Certificate of Conformity .....</b>	<b>5</b>
<b>2 Summary of Test Results.....</b>	<b>6</b>
2.1 Measurement Uncertainty.....	6
2.2 Modification Record .....	6
<b>3 General Information .....</b>	<b>7</b>
3.1 General Description of EUT .....	7
3.2 Description of Test Modes.....	8
3.2.1 Test Mode Applicability and Tested Channel Detail.....	9
3.3 Duty Cycle of Test Signal .....	11
3.4 Description of Support Units .....	12
3.4.1 Configuration of System under Test .....	12
3.5 General Description of Applied Standards.....	12
<b>4 Test Types and Results.....</b>	<b>13</b>
4.1 Radiated Emission and Bandedge Measurement .....	13
4.1.1 Limits of Radiated Emission and Bandedge Measurement .....	13
4.1.2 Test Instruments .....	14
4.1.3 Test Procedures.....	15
4.1.4 Deviation from Test Standard .....	15
4.1.5 Test Set Up .....	16
4.1.6 EUT Operating Conditions.....	16
4.1.7 Test Results .....	17
4.2 Conducted Emission Measurement.....	32
4.2.1 Limits of Conducted Emission Measurement .....	32
4.2.2 Test Instruments .....	32
4.2.3 Test Procedures.....	33
4.2.4 Deviation from Test Standard .....	33
4.2.5 Test Setup.....	33
4.2.6 EUT Operating Conditions.....	33
4.2.7 Test Results .....	34
4.3 6 dB Bandwidth Measurement.....	38
4.3.1 Limits of 6 dB Bandwidth Measurement.....	38
4.3.2 Test Setup.....	38
4.3.3 Test Instruments .....	38
4.3.4 Test Procedure .....	38
4.3.5 Deviation from Test Standard .....	38
4.3.6 EUT Operating Conditions.....	38
4.3.7 Test Result .....	39
4.4 Conducted Output Power Measurement .....	41
4.4.1 Limits of Conducted Output Power Measurement.....	41
4.4.2 Test Setup.....	41
4.4.3 Test Instruments .....	41
4.4.4 Test Procedures.....	41
4.4.5 Deviation from Test Standard .....	41
4.4.6 EUT Operating Conditions.....	41
4.4.7 Test Results .....	42
4.5 Power Spectral Density Measurement .....	43
4.5.1 Limits of Power Spectral Density Measurement.....	43
4.5.2 Test Setup.....	43
4.5.3 Test Instruments .....	43
4.5.4 Test Procedure .....	43
4.5.5 Deviation from Test Standard .....	43
4.5.6 EUT Operating Condition .....	43

4.5.7 Test Results .....	44
4.6 Conducted Out of Band Emission Measurement .....	46
4.6.1 Limits of Conducted Out of Band Emission Measurement.....	46
4.6.2 Test Setup.....	46
4.6.3 Test Instruments .....	46
4.6.4 Test Procedure .....	46
4.6.5 Deviation from Test Standard .....	46
4.6.6 EUT Operating Condition .....	46
4.6.7 Test Results .....	47
<b>5 Pictures of Test Arrangements.....</b>	<b>55</b>
<b>Appendix – Information on the Testing Laboratories .....</b>	<b>56</b>

### Release Control Record

Issue No.	Description	Date Issued
RF160621C25	Original Release	Jul. 26, 2016

## 1 Certificate of Conformity

**Product:** Smartphone

**Brand:** HTC

**Test Model:** 2PUK220

**Sample Status:** Production Unit

**Applicant:** HTC Corporation

**Test Date:** Jun. 28, 2016 ~ Jul. 14, 2016

**Standards:** 47 CFR FCC Part 15, Subpart C (Section 15.247)  
ANSI C63.10:2013

The above equipment has been tested by **Bureau Veritas Consumer Products Services (H.K.) Ltd., Taoyuan Branch**, and found compliance with the requirement of the above standards. The test record, data evaluation & Equipment Under Test (EUT) configurations represented herein are true and accurate accounts of the measurements of the sample's EMC characteristics under the conditions specified in this report.

**Prepared by :**                     *Vera Huang*                     , **Date:**                     Jul. 26, 2016                    

Vera Huang / Specialist

**Approved by :**                     *Stanley Wu*                     , **Date:**                     Jul. 26, 2016                    

Stanley Wu / Assistant Manager

## 2 Summary of Test Results

47 CFR FCC Part 15, Subpart C (Section 15.247)			
FCC Clause	Test Item	Result	Remarks
15.207	AC Power Conducted Emission	Pass	Meet the requirement of limit. Minimum passing margin is -2.03 dB at 0.43516 MHz.
15.205 / 15.209 / 15.247(d)	Radiated Emissions and Band Edge Measurement	Pass	Meet the requirement of limit. Minimum passing margin is -1.03 dB at 2390 MHz.
15.247(d)	Antenna Port Emission	Pass	Meet the requirement of limit.
15.247(a)(2)	6 dB Bandwidth	Pass	Meet the requirement of limit.
15.247(b)	Conducted power	Pass	Meet the requirement of limit.
15.247(e)	Power Spectral Density	Pass	Meet the requirement of limit.
15.203	Antenna Requirement	Pass	No antenna connector is used.

### 2.1 Measurement Uncertainty

Where relevant, the following measurement uncertainty levels have been estimated for tests performed on the EUT:

The listed uncertainties are the worst case uncertainty for the entire range of measurement. Please note that the uncertainty values are provided for informational purposes only and are not used in determining the PASS/FAIL results.

Measurement	Frequency	Expanded Uncertainty (k=2) (±)
Conducted Emissions at mains ports	150 kHz ~ 30 MHz	2.44 dB
Radiated Emissions up to 1 GHz	30 MHz ~ 200 MHz	2.0153 dB
	200 MHz ~ 1000 MHz	2.0224 dB
Radiated Emissions above 1 GHz	1 GHz ~ 18 GHz	1.0121 dB
	18 GHz ~ 40 GHz	1.1508 dB

### 2.2 Modification Record

There were no modifications required for compliance.

### 3 General Information

#### 3.1 General Description of EUT

<b>Product</b>	Smartphone
<b>Brand</b>	HTC
<b>Test Model</b>	2PUK220
<b>Status of EUT</b>	Production Unit
<b>Power Supply Rating</b>	5.0 Vdc (adapter or host equipment) 3.85 Vdc (Li-ion battery)
<b>Modulation Type</b>	CCK, DQPSK, DBPSK for DSSS 64QAM, 16QAM, QPSK, BPSK for OFDM
<b>Modulation Technology</b>	DSSS, OFDM
<b>Transfer Rate</b>	802.11b: 11.0 / 5.5 / 2.0 / 1.0 Mbps 802.11g: 54.0 / 48.0 / 36.0 / 24.0 / 18.0 / 12.0 / 9.0 / 6.0 Mbps 802.11n: up to MCS7
<b>Operating Frequency</b>	2412 ~ 2462 MHz
<b>Number of Channel</b>	11 for 802.11b, 802.11g, 802.11n (HT20) 7 for 802.11n (HT40)
<b>Output Power</b>	196.79 mW
<b>Antenna Type</b>	PIFA antenna with 0 dBi gain
<b>Antenna Connector</b>	N/A
<b>Accessory Device</b>	Refer to Note as below
<b>Data Cable Supplied</b>	Refer to Note as below

Note:

1. The EUT provides one completed transmitter and one receiver.

Modulation Mode	TX Function
802.11b	1TX
802.11g	1TX
802.11n (HT20)	1TX
802.11n (HT40)	1TX

2. The EUT's accessories list refers to Ext. Pho.
3. The device has 2 configurations as below.  
Main sample (A): LCD Panel 1 + Battery 1  
2nd sample (B): LCD Panel 2 + Battery 2
4. The above EUT information is declared by manufacturer and for more detailed features description, please refer to the manufacturer's specifications or user's manual.

### 3.2 Description of Test Modes

11 channels are provided for 802.11b, 802.11g and 802.11n (HT20):

Channel	Frequency (MHz)	Channel	Frequency (MHz)
1	2412	7	2442
2	2417	8	2447
3	2422	9	2452
4	2427	10	2457
5	2432	11	2462
6	2437		

7 channels are provided for 802.11n (HT40):

Channel	Frequency (MHz)	Channel	Frequency (MHz)
3	2422	7	2442
4	2427	8	2447
5	2432	9	2452
6	2437		



### 3.2.1 Test Mode Applicability and Tested Channel Detail

EUT Configure Mode	Applicable To				Description
	RE $\geq$ 1G	RE<1G	PLC	APCM	
A	√	√	√	√	Sample A
B	√	√	√	-	Sample B

Where **RE $\geq$ 1G**: Radiated Emission above 1 GHz      **RE<1G**: Radiated Emission below 1 GHz  
**PLC**: Power Line Conducted Emission      **APCM**: Antenna Port Conducted Measurement

**NOTE:** The EUT had been pre-tested on the positioned of each 3 axis. The worst case was found when positioned on **Z-plane**.  
**NOTE:** “-” means no effect.

#### **Radiated Emission Test (Above 1 GHz):**

- Pre-Scan has been conducted to determine the worst-case mode from all possible combinations between available modulations, data rates and antenna ports (if EUT with antenna diversity architecture).
- Following channel(s) was (were) selected for the final test as listed below.

EUT Configure Mode	Mode	Available Channel	Tested Channel	Modulation Technology	Modulation Type	Data Rate (Mbps)
A	802.11b	1 to 11	1, 6, 11	DSSS	DBPSK	1.0
	802.11g	1 to 11	1, 6, 11	OFDM	BPSK	6.0
	802.11n (HT20)	1 to 11	1, 6, 11	OFDM	BPSK	MCS0
	802.11n (HT40)	3 to 9	3, 6, 9	OFDM	BPSK	MCS0
B	802.11n (HT40)	3 to 9	3	OFDM	BPSK	MCS0

#### **Radiated Emission Test (Below 1 GHz):**

- Pre-Scan has been conducted to determine the worst-case mode from all possible combinations between available modulations, data rates and antenna ports (if EUT with antenna diversity architecture).
- Following channel(s) was (were) selected for the final test as listed below.

EUT Configure Mode	Mode	Available Channel	Tested Channel	Modulation Technology	Modulation Type	Data Rate (Mbps)
A, B	802.11n (HT40)	3 to 9	3	OFDM	BPSK	MCS0

#### **Power Line Conducted Emission Test:**

- Pre-Scan has been conducted to determine the worst-case mode from all possible combinations between available modulations, data rates and antenna ports (if EUT with antenna diversity architecture).
- Following channel(s) was (were) selected for the final test as listed below.

EUT Configure Mode	Mode	Available Channel	Tested Channel	Modulation Technology	Modulation Type	Data Rate (Mbps)
A, B	802.11n (HT40)	3 to 9	3	OFDM	BPSK	MCS0

### **Bandedge Measurement:**

- Pre-Scan has been conducted to determine the worst-case mode from all possible combinations between available modulations, data rates and antenna ports (if EUT with antenna diversity architecture).
- Following channel(s) was (were) selected for the final test as listed below.

EUT Configure Mode	Mode	Available Channel	Tested Channel	Modulation Technology	Modulation Type	Data Rate (Mbps)
A	802.11b	1 to 11	1, 11	DSSS	DBPSK	1.0
	802.11g	1 to 11	1, 11	OFDM	BPSK	6.0
	802.11n (HT20)	1 to 11	1, 11	OFDM	BPSK	MCS0
	802.11n (HT40)	3 to 9	3, 9	OFDM	BPSK	MCS0

### **Antenna Port Conducted Measurement:**

- This item includes all test value of each mode, but only includes spectrum plot of worst value of each mode.
- Pre-Scan has been conducted to determine the worst-case mode from all possible combinations between available modulations, data rates and antenna ports (if EUT with antenna diversity architecture).
- Following channel(s) was (were) selected for the final test as listed below.

EUT Configure Mode	Mode	Available Channel	Tested Channel	Modulation Technology	Modulation Type	Data Rate (Mbps)
A	802.11b	1 to 11	1, 6, 11	DSSS	DBPSK	1.0
	802.11g	1 to 11	1, 6, 11	OFDM	BPSK	6.0
	802.11n (HT20)	1 to 11	1, 6, 11	OFDM	BPSK	MCS0
	802.11n (HT40)	3 to 9	3, 6, 9	OFDM	BPSK	MCS0

### **Test Condition:**

Applicable To	Environmental Conditions	Input Power	Tested by
RE $\geq$ 1G	25 deg. C, 65 % RH	120 Vac, 60 Hz	Karl Lee
RE<1G	25 deg. C, 65 % RH	120 Vac, 60 Hz	Karl Lee
PLC	25 deg. C, 65 % RH	120 Vac, 60 Hz	Toby Tian
APCM	25 deg. C, 65 % RH	3.85 Vdc	Taylor Liu

### 3.3 Duty Cycle of Test Signal

**802.11b:** Duty cycle of test signal is > 98 %

**802.11g:** Duty cycle of test signal is > 98 %

**802.11n (HT20):** Duty cycle of test signal is > 98 %

**802.11n (HT40):** Duty cycle =  $637.50/653.52 = 0.975$ , Duty factor =  $10 * \log(1/0.975) = 0.11$

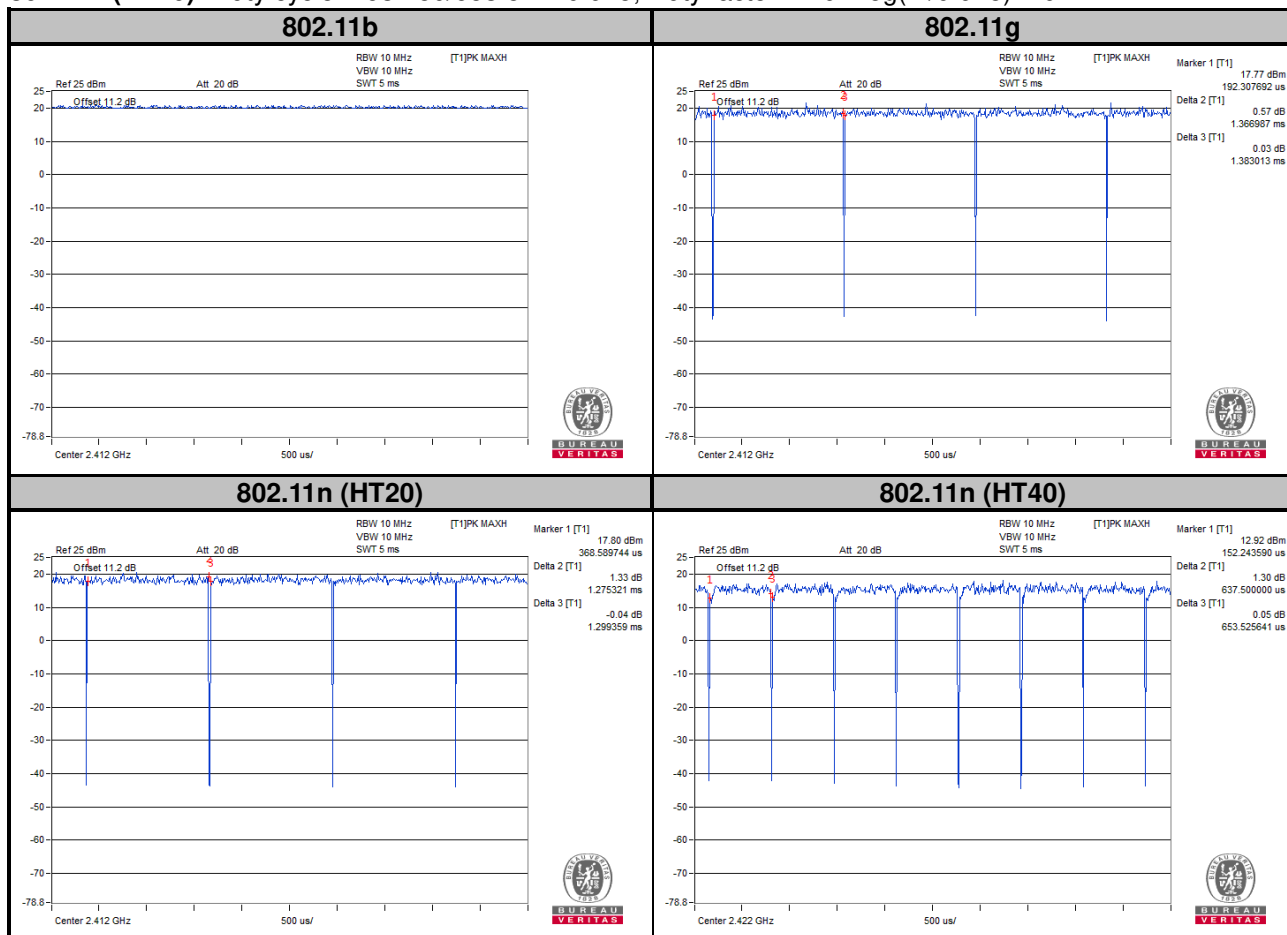

### 3.4 Description of Support Units

The EUT has been tested as an independent unit together with other necessary accessories or support units.

#### 3.4.1 Configuration of System under Test

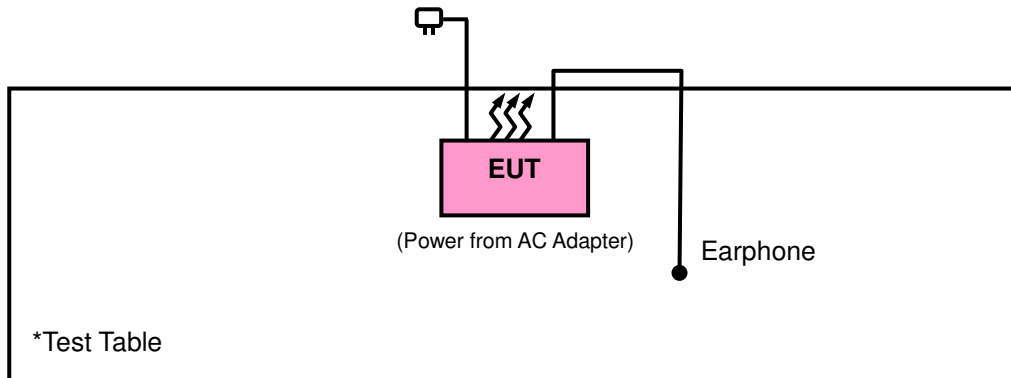

### 3.5 General Description of Applied Standards

The EUT is a RF Product. According to the specifications of the manufacturer, it must comply with the requirements of the following standards:

**FCC Part 15, Subpart C (15.247)**

**558074 D01 DTS Meas Guidance v03r05**

ANSI C63.10-2013

All test items have been performed and recorded as per the above standards.

**NOTE:** The EUT has been verified to comply with the requirements of FCC Part 15, Subpart B, Class B (DoC).  
The test report has been issued separately.

## 4 Test Types and Results

### 4.1 Radiated Emission and Bandedge Measurement

#### 4.1.1 Limits of Radiated Emission and Bandedge Measurement

Radiated emissions which fall in the restricted bands must comply with the radiated emission limits specified as below table. Other emissions shall be at least 20 dB below the highest level of the desired power:

Frequencies (MHz)	Field Strength (microvolts/meter)	Measurement Distance (meters)
0.009 ~ 0.490	2400/F (kHz)	300
0.490 ~ 1.705	24000/F (kHz)	30
1.705 ~ 30.0	30	30
30 ~ 88	100	3
88 ~ 216	150	3
216 ~ 960	200	3
Above 960	500	3

**NOTE:**

1. The lower limit shall apply at the transition frequencies.
2. Emission level (dBuV/m) = 20 log Emission level (uV/m).
3. For frequencies above 1000 MHz, the field strength limits are based on average detector, however, the peak field strength of any emission shall not exceed the maximum permitted average limits, specified above by more than 20 dB under any condition of modulation.

## 4.1.2 Test Instruments

Description & Manufacturer	Model No.	Serial No.	Date of Calibration	Due Date of Calibration
Test Receiver Agilent Technologies	N9038A	MY51210203	Jan. 21, 2016	Jan. 20, 2017
Spectrum Analyzer ROHDE & SCHWARZ	FSU43	101261	Dec. 17, 2015	Dec. 16, 2016
BILOG Antenna SCHWARZBECK	VULB9168	9168-472	Jan. 07, 2016	Jan. 06, 2017
HORN Antenna ETS-Lindgren	3117	00143293	Jan. 04, 2016	Jan. 03, 2017
HORN Antenna SCHWARZBECK	BBHA 9170	9170-480	Jan. 04, 2016	Jan. 03, 2017
Bluetooth Tester	CBT	100980	Apr. 27, 2015	Apr. 26, 2017
Loop Antenna	EM-6879	269	Jul. 31, 2015	Jul. 30, 2016
Agilent Communications Tester-Wireless	8960 Series 10	MY53201073	Jul. 03, 2015	Jul. 02, 2017
Preamplifier Agilent	310N	187246	Aug. 03, 2015	Aug. 02, 2016
Preamplifier Agilent	83017A	MY39501373	Aug. 03, 2015	Aug. 02, 2016
Power Meter Anritsu	ML2495A	1232002	Sep. 21, 2015	Sep. 20, 2016
Power Sensor Anritsu	MA2411B	1207325	Sep. 21, 2015	Sep. 20, 2016
RF signal cable ETS-LINDGREN	5D-FB	Cable-RF1-01 (RFC-SMS-100-S MS-120+MY1337 9/4)	Oct. 08, 2015	Oct. 07, 2016
RF signal cable ETS-LINDGREN	8D-FB	Cable-RF1-02 (RFC-SMS-100-N MS-120+8120_51 40_2911)	Oct. 08, 2015	Oct. 07, 2016
Software BV ADT	E3 8.130425b	NA	NA	NA
Antenna Tower MF	NA	NA	NA	NA
Turn Table MF	NA	NA	NA	NA
Antenna Tower & Turn Table Controller MF	MF-7802	NA	NA	NA

- Note: 1. The calibration interval of the above test instruments is 12 months and the calibrations are traceable to NML/ROC and NIST/USA.
2. The test was performed in HsinTien Chamber 1.
3. The horn antenna and preamplifier (model: 83017A) are used only for the measurement of emission frequency above 1 GHz if tested.
4. The FCC Site Registration No. is 149147.
5. The IC Site Registration No. is IC7450I-1.

#### 4.1.3 Test Procedures

- a. The EUT was placed on the top of a rotating table 0.8 meters (for below 1 GHz) / 1.5 meters (for above 1 GHz) above the ground at 3 meter chamber room for test. The table was rotated 360 degrees to determine the position of the highest radiation.
- b. The EUT was set 3 meters away from the interference-receiving antenna, which was mounted on the top of a variable-height antenna tower.
- c. The height of antenna is varied from one meter to four meters above the ground to determine the maximum value of the field strength. Both horizontal and vertical polarizations of the antenna are set to make the measurement.
- d. For each suspected emission, the EUT was arranged to its worst case and then the antenna was tuned to heights from 1 meter to 4 meters and the rotatable table was turned from 0 degrees to 360 degrees to find the maximum reading.
- e. The test-receiver system was set to quasi-peak detect function and specified bandwidth with maximum hold mode when the test frequency is below 1 GHz.
- f. The test-receiver system was set to peak and average detected function and specified bandwidth with maximum hold mode when the test frequency is above 1 GHz. If the peak reading value also meets average limit, measurement with the average detector is unnecessary.

**Note:**

1. The resolution bandwidth and video bandwidth of test receiver/spectrum analyzer is 120 kHz for Quasi-peak detection (QP) at frequency below 1 GHz.
2. The resolution bandwidth of test receiver/spectrum analyzer is 1 MHz and the video bandwidth is 3 MHz for Peak detection (PK) at frequency above 1 GHz.
3. The resolution bandwidth of test receiver/spectrum analyzer is 1 MHz and the video bandwidth is 3 MHz for RMS Average (Duty cycle < 98 %) for Average detection (AV) at frequency above 1 GHz, then the measurement results was added to a correction factor ( $10 \log(1/\text{duty cycle})$ ).
4. The resolution bandwidth of test receiver/spectrum analyzer is 1MHz and the video bandwidth is 10 Hz (Duty cycle  $\geq 98$  %) for Average detection (AV) at frequency above 1 GHz.
5. All modes of operation were investigated and the worst-case emissions are reported.

#### 4.1.4 Deviation from Test Standard

No deviation.

#### 4.1.5 Test Set Up

##### <Frequency Range below 1 GHz>

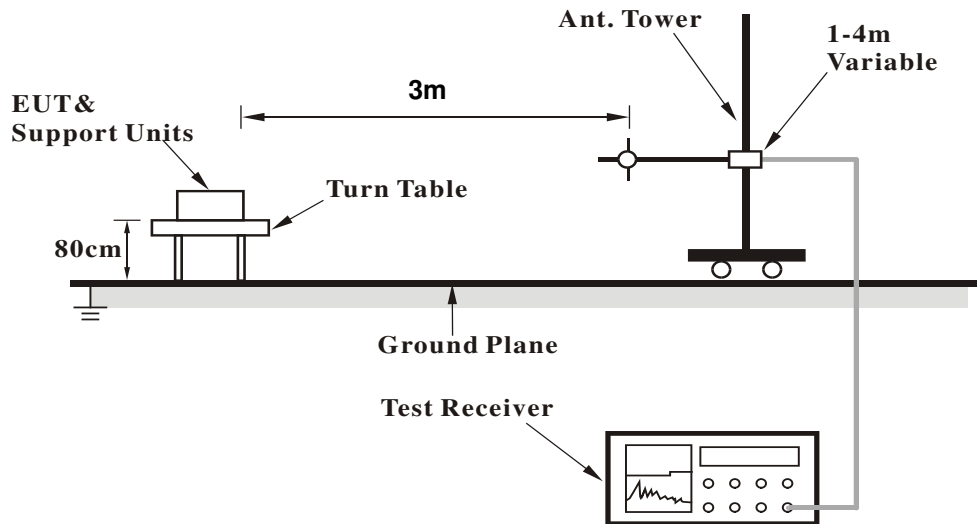

##### <Frequency Range above 1 GHz>

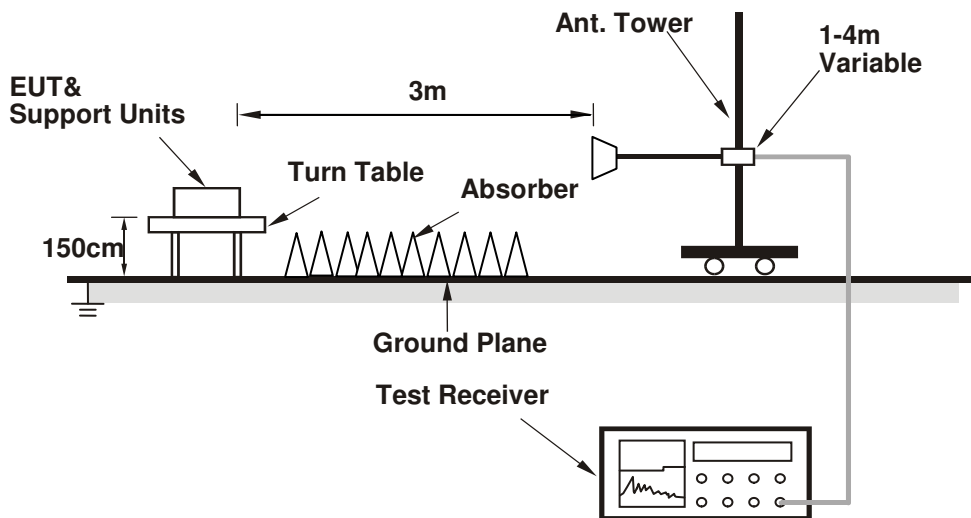

For the actual test configuration, please refer to the attached file (Test Setup Photo).

#### 4.1.6 EUT Operating Conditions

- Placed the EUT on a testing table.
- Use the software to control the EUT under transmission condition continuously at specific channel frequency.



## 4.1.7 Test Results

## Mode A

## Above 1 GHz Data :

## 802.11b

EUT Test Condition		Measurement Detail	
Channel	Channel 1	Frequency Range	1 GHz ~ 25 GHz
Input Power	120 Vac, 60 Hz	Detector Function	Peak (PK) Average (AV)
Environmental Conditions	25 deg. C, 65 % RH	Tested By	Karl Lee

Antennal Polarity & Test Distance: Horizontal at 3 m										
Frequency (MHz)	Emission Level (dBuV/m)	Read Level (dBuV)	Limit (dBuV/m)	Margin (dB)	Antenna Factor (dB/m)	Cable Loss (dB)	Preamp Factor (dB)	Antenna Height (cm)	Table Angle (Degree)	Remark
2374	39.43	37.77	54	-14.57	31.78	5.37	35.49	128	7	Average
2374	55.56	53.9	74	-18.44	31.78	5.37	35.49	128	7	Peak
2412	96.66	94.89			31.81	5.43	35.47	128	7	Average
2412	99.81	98.04			31.81	5.43	35.47	128	7	Peak
2500	39.74	37.72	54	-14.26	31.9	5.53	35.41	128	7	Average
2500	56.45	54.43	74	-17.55	31.9	5.53	35.41	128	7	Peak
Antennal Polarity & Test Distance: Vertical at 3 m										
Frequency (MHz)	Emission Level (dBuV/m)	Read Level (dBuV)	Limit (dBuV/m)	Margin (dB)	Antenna Factor (dB/m)	Cable Loss (dB)	Preamp Factor (dB)	Antenna Height (cm)	Table Angle (Degree)	Remark
2378	39.85	38.19	54	-14.15	31.78	5.37	35.49	246	5	Average
2378	57.14	55.48	74	-16.86	31.78	5.37	35.49	246	5	Peak
2412	100.95	99.18			31.81	5.43	35.47	246	5	Average
2412	103.84	102.07			31.81	5.43	35.47	246	5	Peak
2492	39.77	37.75	54	-14.23	31.9	5.53	35.41	246	5	Average
2492	55.95	53.93	74	-18.05	31.9	5.53	35.41	246	5	Peak

## Remarks:

- Emission Level = Read Level + Antenna Factor + Cable Loss - Preamp Factor  
Margin value = Emission level – Limit value
- 2412 MHz: Fundamental frequency.

EUT Test Condition		Measurement Detail	
Channel	Channel 6	Frequency Range	1 GHz ~ 25 GHz
Input Power	120 Vac, 60 Hz	Detector Function	Peak (PK) Average (AV)
Environmental Conditions	25 deg. C, 65 % RH	Tested By	Karl Lee

Antennal Polarity & Test Distance: Horizontal at 3 m										
Frequency (MHz)	Emission Level (dBuV/m)	Read Level (dBuV)	Limit (dBuV/m)	Margin (dB)	Antenna Factor (dB/m)	Cable Loss (dB)	Preamp Factor (dB)	Antenna Height (cm)	Table Angle (Degree)	Remark
2344	40.05	38.48	54	-13.95	31.74	5.33	35.5	128	194	Average
2344	55.94	54.37	74	-18.06	31.74	5.33	35.5	128	194	Peak
2437	98.17	96.32			31.85	5.46	35.46	128	194	Average
2437	100.86	99.01			31.85	5.46	35.46	128	194	Peak
2498	40.9	38.88	54	-13.1	31.9	5.53	35.41	128	194	Average
2498	56.17	54.15	74	-17.83	31.9	5.53	35.41	128	194	Peak

Antennal Polarity & Test Distance: Vertical at 3 m										
Frequency (MHz)	Emission Level (dBuV/m)	Read Level (dBuV)	Limit (dBuV/m)	Margin (dB)	Antenna Factor (dB/m)	Cable Loss (dB)	Preamp Factor (dB)	Antenna Height (cm)	Table Angle (Degree)	Remark
2372	40.16	38.5	54	-13.84	31.78	5.37	35.49	237	73	Average
2372	56.66	55	74	-17.34	31.78	5.37	35.49	237	73	Peak
2437	101.06	99.21			31.85	5.46	35.46	237	73	Average
2437	103.74	101.89			31.85	5.46	35.46	237	73	Peak
2500	40.85	38.83	54	-13.15	31.9	5.53	35.41	237	73	Average
2500	56.65	54.63	74	-17.35	31.9	5.53	35.41	237	73	Peak

Remarks:

- Emission Level = Read Level + Antenna Factor + Cable Loss - Preamp Factor  
Margin value = Emission level – Limit value
- 2437 MHz: Fundamental frequency.

EUT Test Condition		Measurement Detail	
Channel	Channel 11	Frequency Range	1 GHz ~ 25 GHz
Input Power	120 Vac, 60 Hz	Detector Function	Peak (PK) Average (AV)
Environmental Conditions	25 deg. C, 65 % RH	Tested By	Karl Lee

Antennal Polarity & Test Distance: Horizontal at 3 m										
Frequency (MHz)	Emission Level (dBuV/m)	Read Level (dBuV)	Limit (dBuV/m)	Margin (dB)	Antenna Factor (dB/m)	Cable Loss (dB)	Preamp Factor (dB)	Antenna Height (cm)	Table Angle (Degree)	Remark
2346	39.17	37.6	54	-14.83	31.74	5.33	35.5	176	186	Average
2346	56.8	55.23	74	-17.2	31.74	5.33	35.5	176	186	Peak
2462	96.86	94.93			31.87	5.5	35.44	176	186	Average
2462	99.78	97.85			31.87	5.5	35.44	176	186	Peak
2490	40.3	38.29	54	-13.7	31.9	5.53	35.42	176	186	Average
2490	56.64	54.63	74	-17.36	31.9	5.53	35.42	176	186	Peak
Antennal Polarity & Test Distance: Vertical at 3 m										
Frequency (MHz)	Emission Level (dBuV/m)	Read Level (dBuV)	Limit (dBuV/m)	Margin (dB)	Antenna Factor (dB/m)	Cable Loss (dB)	Preamp Factor (dB)	Antenna Height (cm)	Table Angle (Degree)	Remark
2328	39.13	37.62	54	-14.87	31.73	5.3	35.52	279	69	Average
2328	56.02	54.51	74	-17.98	31.73	5.3	35.52	279	69	Peak
2462	100.06	98.13			31.87	5.5	35.44	279	69	Average
2462	103.15	101.22			31.87	5.5	35.44	279	69	Peak
2492	41.19	39.17	54	-12.81	31.9	5.53	35.41	279	69	Average
2492	56.77	54.75	74	-17.23	31.9	5.53	35.41	279	69	Peak

Remarks:

- Emission Level = Read Level + Antenna Factor + Cable Loss - Preamp Factor  
Margin value = Emission level – Limit value
- 2462 MHz: Fundamental frequency.

## 802.11g

EUT Test Condition		Measurement Detail	
Channel	Channel 1	Frequency Range	1 GHz ~ 25 GHz
Input Power	120 Vac, 60 Hz	Detector Function	Peak (PK) Average (AV)
Environmental Conditions	25 deg. C, 65 % RH	Tested By	Karl Lee

**Antennal Polarity & Test Distance: Horizontal at 3 m**

Frequency (MHz)	Emission Level (dBuV/m)	Read Level (dBuV)	Limit (dBuV/m)	Margin (dB)	Antenna Factor (dB/m)	Cable Loss (dB)	Preamp Factor (dB)	Antenna Height (cm)	Table Angle (Degree)	Remark
2390	40.42	38.69	54	-13.58	31.8	5.4	35.47	128	202	Average
2390	61.84	60.11	74	-12.16	31.8	5.4	35.47	128	202	Peak
2412	91.96	90.19			31.81	5.43	35.47	128	202	Average
2412	100.92	99.15			31.81	5.43	35.47	128	202	Peak
2494	40.65	38.63	54	-13.35	31.9	5.53	35.41	128	202	Average
2494	56.36	54.34	74	-17.64	31.9	5.53	35.41	128	202	Peak

**Antennal Polarity & Test Distance: Vertical at 3 m**

Frequency (MHz)	Emission Level (dBuV/m)	Read Level (dBuV)	Limit (dBuV/m)	Margin (dB)	Antenna Factor (dB/m)	Cable Loss (dB)	Preamp Factor (dB)	Antenna Height (cm)	Table Angle (Degree)	Remark
2390	45.54	43.81	54	-8.46	31.8	5.4	35.47	290	71	Average
2390	62.46	60.73	74	-11.54	31.8	5.4	35.47	290	71	Peak
2412	94.26	92.49			31.81	5.43	35.47	290	71	Average
2412	103.07	101.3			31.81	5.43	35.47	290	71	Peak
2500	40.55	38.53	54	-13.45	31.9	5.53	35.41	290	71	Average
2500	57.13	55.11	74	-16.87	31.9	5.53	35.41	290	71	Peak

## Remarks:

- Emission Level = Read Level + Antenna Factor + Cable Loss - Preamp Factor  
Margin value = Emission level – Limit value
- 2412 MHz: Fundamental frequency.

EUT Test Condition		Measurement Detail	
Channel	Channel 6	Frequency Range	1 GHz ~ 25 GHz
Input Power	120 Vac, 60 Hz	Detector Function	Peak (PK) Average (AV)
Environmental Conditions	25 deg. C, 65 % RH	Tested By	Karl Lee

Antennal Polarity & Test Distance: Horizontal at 3 m										
Frequency (MHz)	Emission Level (dBuV/m)	Read Level (dBuV)	Limit (dBuV/m)	Margin (dB)	Antenna Factor (dB/m)	Cable Loss (dB)	Preamp Factor (dB)	Antenna Height (cm)	Table Angle (Degree)	Remark
2380	40.43	38.77	54	-13.57	31.78	5.37	35.49	128	202	Average
2380	55.99	54.33	74	-18.01	31.78	5.37	35.49	128	202	Peak
2437	92.3	90.45			31.85	5.46	35.46	128	202	Average
2437	100.69	98.84			31.85	5.46	35.46	128	202	Peak
2488	40.95	38.94	54	-13.05	31.9	5.53	35.42	128	202	Average
2488	55.95	53.94	74	-18.05	31.9	5.53	35.42	128	202	Peak

Antennal Polarity & Test Distance: Vertical at 3 m										
Frequency (MHz)	Emission Level (dBuV/m)	Read Level (dBuV)	Limit (dBuV/m)	Margin (dB)	Antenna Factor (dB/m)	Cable Loss (dB)	Preamp Factor (dB)	Antenna Height (cm)	Table Angle (Degree)	Remark
2324	40.08	38.57	54	-13.92	31.73	5.3	35.52	237	71	Average
2324	56.26	54.75	74	-17.74	31.73	5.3	35.52	237	71	Peak
2437	93.87	92.02			31.85	5.46	35.46	237	71	Average
2437	103.15	101.3			31.85	5.46	35.46	237	71	Peak
2488	41.38	39.37	54	-12.62	31.9	5.53	35.42	237	71	Average
2488	56.42	54.41	74	-17.58	31.9	5.53	35.42	237	71	Peak

Remarks:

- Emission Level = Read Level + Antenna Factor + Cable Loss - Preamp Factor  
Margin value = Emission level – Limit value
- 2437 MHz: Fundamental frequency.

EUT Test Condition		Measurement Detail	
Channel	Channel 11	Frequency Range	1 GHz ~ 25 GHz
Input Power	120 Vac, 60 Hz	Detector Function	Peak (PK) Average (AV)
Environmental Conditions	25 deg. C, 65 % RH	Tested By	Karl Lee

Antennal Polarity & Test Distance: Horizontal at 3 m										
Frequency (MHz)	Emission Level (dBuV/m)	Read Level (dBuV)	Limit (dBuV/m)	Margin (dB)	Antenna Factor (dB/m)	Cable Loss (dB)	Preamp Factor (dB)	Antenna Height (cm)	Table Angle (Degree)	Remark
2390	40.19	38.46	54	-13.81	31.8	5.4	35.47	176	186	Average
2390	55.63	53.9	74	-18.37	31.8	5.4	35.47	176	186	Peak
2462	92.33	90.4			31.87	5.5	35.44	176	186	Average
2462	101.27	99.34			31.87	5.5	35.44	176	186	Peak
2484	45.71	43.75	54	-8.29	31.88	5.5	35.42	176	186	Average
2484	66.7	64.74	74	-7.3	31.88	5.5	35.42	176	186	Peak
Antennal Polarity & Test Distance: Vertical at 3 m										
Frequency (MHz)	Emission Level (dBuV/m)	Read Level (dBuV)	Limit (dBuV/m)	Margin (dB)	Antenna Factor (dB/m)	Cable Loss (dB)	Preamp Factor (dB)	Antenna Height (cm)	Table Angle (Degree)	Remark
2390	40.3	38.57	54	-13.7	31.8	5.4	35.47	279	69	Average
2390	57.23	55.5	74	-16.77	31.8	5.4	35.47	279	69	Peak
2462	94.6	92.67			31.87	5.5	35.44	279	69	Average
2462	103.96	102.03			31.87	5.5	35.44	279	69	Peak
2484	49.71	47.75	54	-4.29	31.88	5.5	35.42	279	69	Average
2484	68.45	66.49	74	-5.55	31.88	5.5	35.42	279	69	Peak

Remarks:

- Emission Level = Read Level + Antenna Factor + Cable Loss - Preamp Factor  
Margin value = Emission level – Limit value
- 2462 MHz: Fundamental frequency.

### 802.11n (HT20)

EUT Test Condition		Measurement Detail	
Channel	Channel 1	Frequency Range	1 GHz ~ 25 GHz
Input Power	120 Vac, 60 Hz	Detector Function	Peak (PK) Average (AV)
Environmental Conditions	25 deg. C, 65 % RH	Tested By	Karl Lee

#### Antennal Polarity & Test Distance: Horizontal at 3 m

Frequency (MHz)	Emission Level (dBuV/m)	Read Level (dBuV)	Limit (dBuV/m)	Margin (dB)	Antenna Factor (dB/m)	Cable Loss (dB)	Preamp Factor (dB)	Antenna Height (cm)	Table Angle (Degree)	Remark
2390	44.19	42.46	54	-9.81	31.8	5.4	35.47	128	196	Average
2390	60.93	59.2	74	-13.07	31.8	5.4	35.47	128	196	Peak
2412	91.68	89.91			31.81	5.43	35.47	128	196	Average
2412	99.85	98.08			31.81	5.43	35.47	128	196	Peak
2498	40.76	38.74	54	-13.24	31.9	5.53	35.41	128	196	Average
2498	56.76	54.74	74	-17.24	31.9	5.53	35.41	128	196	Peak

#### Antennal Polarity & Test Distance: Vertical at 3 m

Frequency (MHz)	Emission Level (dBuV/m)	Read Level (dBuV)	Limit (dBuV/m)	Margin (dB)	Antenna Factor (dB/m)	Cable Loss (dB)	Preamp Factor (dB)	Antenna Height (cm)	Table Angle (Degree)	Remark
2390	47.17	45.44	54	-6.83	31.8	5.4	35.47	290	71	Average
2390	65.34	63.61	74	-8.66	31.8	5.4	35.47	290	71	Peak
2412	94.1	92.33			31.81	5.43	35.47	290	71	Average
2412	102.99	101.22			31.81	5.43	35.47	290	71	Peak
2496	40.79	38.77	54	-13.21	31.9	5.53	35.41	290	71	Average
2496	56.43	54.41	74	-17.57	31.9	5.53	35.41	290	71	Peak

#### Remarks:

- Emission Level = Read Level + Antenna Factor + Cable Loss - Preamp Factor  
Margin value = Emission level – Limit value
- 2412 MHz: Fundamental frequency.

EUT Test Condition		Measurement Detail	
Channel	Channel 6	Frequency Range	1 GHz ~ 25 GHz
Input Power	120 Vac, 60 Hz	Detector Function	Peak (PK) Average (AV)
Environmental Conditions	25 deg. C, 65 % RH	Tested By	Karl Lee

Antennal Polarity & Test Distance: Horizontal at 3 m										
Frequency (MHz)	Emission Level (dBuV/m)	Read Level (dBuV)	Limit (dBuV/m)	Margin (dB)	Antenna Factor (dB/m)	Cable Loss (dB)	Preamp Factor (dB)	Antenna Height (cm)	Table Angle (Degree)	Remark
2390	40.64	38.91	54	-13.36	31.8	5.4	35.47	128	202	Average
2390	56.75	55.02	74	-17.25	31.8	5.4	35.47	128	202	Peak
2437	91.27	89.42			31.85	5.46	35.46	128	202	Average
2437	100.07	98.22			31.85	5.46	35.46	128	202	Peak
2498	40.94	38.92	54	-13.06	31.9	5.53	35.41	128	202	Average
2498	56.43	54.41	74	-17.57	31.9	5.53	35.41	128	202	Peak
Antennal Polarity & Test Distance: Vertical at 3 m										
Frequency (MHz)	Emission Level (dBuV/m)	Read Level (dBuV)	Limit (dBuV/m)	Margin (dB)	Antenna Factor (dB/m)	Cable Loss (dB)	Preamp Factor (dB)	Antenna Height (cm)	Table Angle (Degree)	Remark
2368	40.18	38.54	54	-13.82	31.76	5.37	35.49	237	71	Average
2368	56.6	54.96	74	-17.4	31.76	5.37	35.49	237	71	Peak
2437	93.68	91.83			31.85	5.46	35.46	237	71	Average
2437	102.64	100.79			31.85	5.46	35.46	237	71	Peak
2500	41.49	39.47	54	-12.51	31.9	5.53	35.41	237	71	Average
2500	55.95	53.93	74	-18.05	31.9	5.53	35.41	237	71	Peak

Remarks:

- Emission Level = Read Level + Antenna Factor + Cable Loss - Preamp Factor  
Margin value = Emission level – Limit value
- 2437 MHz: Fundamental frequency.



EUT Test Condition		Measurement Detail	
Channel	Channel 11	Frequency Range	1 GHz ~ 25 GHz
Input Power	120 Vac, 60 Hz	Detector Function	Peak (PK) Average (AV)
Environmental Conditions	25 deg. C, 65 % RH	Tested By	Karl Lee

Antennal Polarity & Test Distance: Horizontal at 3 m										
Frequency (MHz)	Emission Level (dBuV/m)	Read Level (dBuV)	Limit (dBuV/m)	Margin (dB)	Antenna Factor (dB/m)	Cable Loss (dB)	Preamp Factor (dB)	Antenna Height (cm)	Table Angle (Degree)	Remark
2380	39.98	38.32	54	-14.02	31.78	5.37	35.49	176	186	Average
2380	56.4	54.74	74	-17.6	31.78	5.37	35.49	176	186	Peak
2462	91.54	89.61			31.87	5.5	35.44	176	186	Average
2462	100.09	98.16			31.87	5.5	35.44	176	186	Peak
2484	46.05	44.09	54	-7.95	31.88	5.5	35.42	176	186	Average
2484	63.21	61.25	74	-10.79	31.88	5.5	35.42	176	186	Peak
Antennal Polarity & Test Distance: Vertical at 3 m										
Frequency (MHz)	Emission Level (dBuV/m)	Read Level (dBuV)	Limit (dBuV/m)	Margin (dB)	Antenna Factor (dB/m)	Cable Loss (dB)	Preamp Factor (dB)	Antenna Height (cm)	Table Angle (Degree)	Remark
2334	40.18	38.64	54	-13.82	31.73	5.33	35.52	279	69	Average
2334	56.08	54.54	74	-17.92	31.73	5.33	35.52	279	69	Peak
2462	93.76	91.83			31.87	5.5	35.44	279	69	Average
2462	102.44	100.51			31.87	5.5	35.44	279	69	Peak
2484	50.43	48.47	54	-3.57	31.88	5.5	35.42	279	69	Average
2484	68.41	66.45	74	-5.59	31.88	5.5	35.42	279	69	Peak

Remarks:

- Emission Level = Read Level + Antenna Factor + Cable Loss - Preamp Factor  
Margin value = Emission level – Limit value
- 2462 MHz: Fundamental frequency.

### 802.11n (HT40)

EUT Test Condition		Measurement Detail	
Channel	Channel 3	Frequency Range	1 GHz ~ 25 GHz
Input Power	120 Vac, 60 Hz	Detector Function	Peak (PK) Average (AV)
Environmental Conditions	25 deg. C, 65 % RH	Tested By	Karl Lee

#### Antennal Polarity & Test Distance: Horizontal at 3 m

Frequency (MHz)	Emission Level (dBuV/m)	Read Level (dBuV)	Limit (dBuV/m)	Margin (dB)	Antenna Factor (dB/m)	Cable Loss (dB)	Preamp Factor (dB)	Antenna Height (cm)	Table Angle (Degree)	Remark
2390	50.14	48.41	54	-3.86	31.8	5.4	35.47	128	196	Average
2390	63.02	61.29	74	-10.98	31.8	5.4	35.47	128	196	Peak
2422	88.77	86.97			31.83	5.43	35.46	128	196	Average
2422	96.92	95.12			31.83	5.43	35.46	128	196	Peak
2494	41.31	39.29	54	-12.69	31.9	5.53	35.41	128	196	Average
2494	55.8	53.78	74	-18.2	31.9	5.53	35.41	128	196	Peak

#### Antennal Polarity & Test Distance: Vertical at 3 m

Frequency (MHz)	Emission Level (dBuV/m)	Read Level (dBuV)	Limit (dBuV/m)	Margin (dB)	Antenna Factor (dB/m)	Cable Loss (dB)	Preamp Factor (dB)	Antenna Height (cm)	Table Angle (Degree)	Remark
<b>2390</b>	<b>52.97</b>	<b>51.24</b>	<b>54</b>	<b>-1.03</b>	<b>31.8</b>	<b>5.4</b>	<b>35.47</b>	<b>290</b>	<b>71</b>	<b>Average</b>
2390	68.22	66.49	74	-5.78	31.8	5.4	35.47	290	71	Peak
2422	91.44	89.64			31.83	5.43	35.46	290	71	Average
2422	100.53	98.73			31.83	5.43	35.46	290	71	Peak
2486	41.15	39.16	54	-12.85	31.88	5.53	35.42	290	71	Average
2486	56.76	54.77	74	-17.24	31.88	5.53	35.42	290	71	Peak

#### Remarks:

- Emission Level = Read Level + Antenna Factor + Cable Loss - Preamp Factor  
Margin value = Emission level – Limit value
- 2422 MHz: Fundamental frequency.

EUT Test Condition		Measurement Detail	
Channel	Channel 6	Frequency Range	1 GHz ~ 25 GHz
Input Power	120 Vac, 60 Hz	Detector Function	Peak (PK) Average (AV)
Environmental Conditions	25 deg. C, 65 % RH	Tested By	Karl Lee

Antennal Polarity & Test Distance: Horizontal at 3 m										
Frequency (MHz)	Emission Level (dBuV/m)	Read Level (dBuV)	Limit (dBuV/m)	Margin (dB)	Antenna Factor (dB/m)	Cable Loss (dB)	Preamp Factor (dB)	Antenna Height (cm)	Table Angle (Degree)	Remark
2390	44.67	42.94	54	-9.33	31.8	5.4	35.47	128	194	Average
2390	62.17	60.44	74	-11.83	31.8	5.4	35.47	128	194	Peak
2437	88.1	86.25			31.85	5.46	35.46	128	194	Average
2437	97.01	95.16			31.85	5.46	35.46	128	194	Peak
2484	41.92	39.96	54	-12.08	31.88	5.5	35.42	128	194	Average
2484	57.01	55.05	74	-16.99	31.88	5.5	35.42	128	194	Peak

Antennal Polarity & Test Distance: Vertical at 3 m										
Frequency (MHz)	Emission Level (dBuV/m)	Read Level (dBuV)	Limit (dBuV/m)	Margin (dB)	Antenna Factor (dB/m)	Cable Loss (dB)	Preamp Factor (dB)	Antenna Height (cm)	Table Angle (Degree)	Remark
2390	43.15	41.42	54	-10.85	31.8	5.4	35.47	237	71	Average
2390	61.63	59.9	74	-12.37	31.8	5.4	35.47	237	71	Peak
2437	91.48	89.63			31.85	5.46	35.46	237	71	Average
2437	100.53	98.68			31.85	5.46	35.46	237	71	Peak
2488	43.72	41.71	54	-10.28	31.9	5.53	35.42	237	71	Average
2488	63.16	61.15	74	-10.84	31.9	5.53	35.42	237	71	Peak

Remarks:

- Emission Level = Read Level + Antenna Factor + Cable Loss - Preamp Factor  
Margin value = Emission level – Limit value
- 2437 MHz: Fundamental frequency.

EUT Test Condition		Measurement Detail	
Channel	Channel 9	Frequency Range	1 GHz ~ 25 GHz
Input Power	120 Vac, 60 Hz	Detector Function	Peak (PK) Average (AV)
Environmental Conditions	25 deg. C, 65 % RH	Tested By	Karl Lee

Antennal Polarity & Test Distance: Horizontal at 3 m										
Frequency (MHz)	Emission Level (dBuV/m)	Read Level (dBuV)	Limit (dBuV/m)	Margin (dB)	Antenna Factor (dB/m)	Cable Loss (dB)	Preamp Factor (dB)	Antenna Height (cm)	Table Angle (Degree)	Remark
2320	40.8	39.29	54	-13.2	31.73	5.3	35.52	176	186	Average
2320	55.99	54.48	74	-18.01	31.73	5.3	35.52	176	186	Peak
2452	88.45	86.58			31.85	5.46	35.44	176	186	Average
2452	97.54	95.67			31.85	5.46	35.44	176	186	Peak
2484	49.2	47.24	54	-4.8	31.88	5.5	35.42	176	186	Average
2484	63.8	61.84	74	-10.2	31.88	5.5	35.42	176	186	Peak

Antennal Polarity & Test Distance: Vertical at 3 m										
Frequency (MHz)	Emission Level (dBuV/m)	Read Level (dBuV)	Limit (dBuV/m)	Margin (dB)	Antenna Factor (dB/m)	Cable Loss (dB)	Preamp Factor (dB)	Antenna Height (cm)	Table Angle (Degree)	Remark
2386	40.54	38.83	54	-13.46	31.8	5.4	35.49	279	69	Average
2386	55.98	54.27	74	-18.02	31.8	5.4	35.49	279	69	Peak
2452	91.34	89.47			31.85	5.46	35.44	279	69	Average
2452	100.49	98.62			31.85	5.46	35.44	279	69	Peak
2486	52.91	50.92	54	-1.09	31.88	5.53	35.42	279	69	Average
2486	68.62	66.63	74	-5.38	31.88	5.53	35.42	279	69	Peak

Remarks:

- Emission Level = Read Level + Antenna Factor + Cable Loss - Preamp Factor  
Margin value = Emission level – Limit value
- 2452 MHz: Fundamental frequency.

**9 kHz ~ 30 MHz DATA:**

The amplitude of spurious emissions attenuated more than 20 dB below the permissible value is not required to be report.

**30 MHz ~ 1 GHz WORST-CASE DATA:**

**802.11n (HT40)**

EUT Test Condition		Measurement Detail	
Channel	Channel 3	Frequency Range	30 MHz ~ 1 GHz
Input Power	120 Vac, 60 Hz	Detector Function	Peak (PK) Quasi-peak (QP)
Environmental Conditions	25 deg. C, 65 % RH	Tested By	Karl Lee

Antennal Polarity & Test Distance: Horizontal at 3 m										
Frequency (MHz)	Emission Level (dBuV/m)	Read Level (dBuV)	Limit (dBuV/m)	Margin (dB)	Antenna Factor (dB/m)	Cable Loss (dB)	Preamp Factor (dB)	Antenna Height (cm)	Table Angle (Degree)	Remark
92.1	27.85	49.5	43.5	-15.65	9.06	1.11	31.82	191	21	Peak
147.72	27.91	48.74	43.5	-15.59	9.92	1.52	32.27	199	153	Peak
199.29	26.98	46.79	43.5	-16.52	10.84	1.65	32.3	108	109	Peak
519.1	20.6	29.71	46	-25.4	20.32	2.7	32.13	120	233	Peak
625.5	22.84	29.98	46	-23.16	22.1	2.93	32.17	170	357	Peak
762.7	24.44	29.99	46	-21.56	23.35	3.22	32.12	127	226	Peak
Antennal Polarity & Test Distance: Vertical at 3 m										
Frequency (MHz)	Emission Level (dBuV/m)	Read Level (dBuV)	Limit (dBuV/m)	Margin (dB)	Antenna Factor (dB/m)	Cable Loss (dB)	Preamp Factor (dB)	Antenna Height (cm)	Table Angle (Degree)	Remark
48.36	33.82	56.83	40	-6.18	8.31	0.9	32.22	148	226	Peak
55.38	32.97	57.06	40	-7.03	7.24	0.9	32.23	118	118	Peak
149.34	24.53	45.24	43.5	-18.97	10.04	1.52	32.27	180	100	Peak
531	21.1	29.95	46	-24.9	20.61	2.7	32.16	170	206	Peak
618.5	21.97	29.41	46	-24.03	21.81	2.93	32.18	168	258	Peak
786.5	25.11	29.87	46	-20.89	24.05	3.27	32.08	125	24	Peak

Remarks:

- Emission Level = Read Level + Antenna Factor + Cable Loss - Preamp Factor  
Margin value = Emission level – Limit value

### Mode B

Above 1 GHz Data :

802.11n (HT40)

EUT Test Condition		Measurement Detail	
Channel	Channel 3	Frequency Range	1 GHz ~ 25 GHz
Input Power	120 Vac, 60 Hz	Detector Function	Peak (PK) Average (AV)
Environmental Conditions	25 deg. C, 65 % RH	Tested By	Karl Lee

#### Antennal Polarity & Test Distance: Horizontal at 3 m

Frequency (MHz)	Emission Level (dBuV/m)	Read Level (dBuV)	Limit (dBuV/m)	Margin (dB)	Antenna Factor (dB/m)	Cable Loss (dB)	Preamp Factor (dB)	Antenna Height (cm)	Table Angle (Degree)	Remark
2390	52.94	51.21	54	-1.06	31.8	5.4	35.47	268	17	Average
2390	69.2	67.47	74	-4.8	31.8	5.4	35.47	268	17	Peak
2422	94.54	92.74			31.83	5.43	35.46	268	17	Average
2422	102.53	100.73			31.83	5.43	35.46	268	17	Peak
2492	41.49	39.47	54	-12.51	31.9	5.53	35.41	268	17	Average
2492	56.63	54.61	74	-17.37	31.9	5.53	35.41	268	17	Peak

#### Antennal Polarity & Test Distance: Vertical at 3 m

Frequency (MHz)	Emission Level (dBuV/m)	Read Level (dBuV)	Limit (dBuV/m)	Margin (dB)	Antenna Factor (dB/m)	Cable Loss (dB)	Preamp Factor (dB)	Antenna Height (cm)	Table Angle (Degree)	Remark
2390	51.42	49.69	54	-2.58	31.8	5.4	35.47	100	0	Average
2390	67.44	65.71	74	-6.56	31.8	5.4	35.47	100	0	Peak
2422	91.34	89.54			31.83	5.43	35.46	100	0	Average
2422	100.14	98.34			31.83	5.43	35.46	100	0	Peak
2488	41.39	39.38	54	-12.61	31.9	5.53	35.42	100	0	Average
2488	56.29	54.28	74	-17.71	31.9	5.53	35.42	100	0	Peak

Remarks:

- Emission Level = Read Level + Antenna Factor + Cable Loss - Preamp Factor  
Margin value = Emission level – Limit value
- 2422 MHz: Fundamental frequency.

**9 kHz ~ 30 MHz DATA:**

The amplitude of spurious emissions attenuated more than 20 dB below the permissible value is not required to be report.

**30 MHz ~ 1 GHz WORST-CASE DATA:**

**802.11n (HT40)**

EUT Test Condition		Measurement Detail	
Channel	Channel 3	Frequency Range	30 MHz ~ 1 GHz
Input Power	120 Vac, 60 Hz	Detector Function	Peak (PK) Quasi-peak (QP)
Environmental Conditions	25 deg. C, 65 % RH	Tested By	Karl Lee

Antennal Polarity & Test Distance: Horizontal at 3 m										
Frequency (MHz)	Emission Level (dBuV/m)	Read Level (dBuV)	Limit (dBuV/m)	Margin (dB)	Antenna Factor (dB/m)	Cable Loss (dB)	Preamp Factor (dB)	Antenna Height (cm)	Table Angle (Degree)	Remark
97.77	27.64	49.01	43.5	-15.86	9.5	1.28	32.15	195	128	Peak
158.79	25.29	45.3	43.5	-18.21	10.74	1.52	32.27	167	180	Peak
207.66	26.39	45.79	43.5	-17.11	11.22	1.65	32.27	177	13	Peak
590.5	20.69	29.28	46	-25.31	20.73	2.87	32.19	159	105	Peak
694.1	24.39	30.23	46	-21.61	23.14	3.11	32.09	115	320	Peak
791.4	25.17	29.74	46	-20.83	24.23	3.27	32.07	171	215	Peak

Antennal Polarity & Test Distance: Vertical at 3 m										
Frequency (MHz)	Emission Level (dBuV/m)	Read Level (dBuV)	Limit (dBuV/m)	Margin (dB)	Antenna Factor (dB/m)	Cable Loss (dB)	Preamp Factor (dB)	Antenna Height (cm)	Table Angle (Degree)	Remark
51.33	31.54	55.22	40	-8.46	7.65	0.9	32.23	190	3	Peak
91.56	19.61	41.25	43.5	-23.89	9.02	1.11	31.77	115	249	Peak
204.96	19.19	38.74	43.5	-24.31	11.08	1.65	32.28	180	204	Peak
606.6	19.69	27.62	46	-26.31	21.39	2.87	32.19	121	280	Peak
753.6	22.26	27.93	46	-23.74	23.25	3.22	32.14	136	228	Peak
881.7	25.79	29.02	46	-20.21	24.88	3.49	31.6	180	315	Peak

Remarks:

- Emission Level = Read Level + Antenna Factor + Cable Loss - Preamp Factor  
Margin value = Emission level – Limit value

## 4.2 Conducted Emission Measurement

### 4.2.1 Limits of Conducted Emission Measurement

Frequency (MHz)	Conducted Limit (dBuV)	
	Quasi-peak	Average
0.15 - 0.5	66 - 56	56 - 46
0.50 - 5.0	56	46
5.0 - 30.0	60	50

Note: 1. The lower limit shall apply at the transition frequencies.

2. The limit decreases in line with the logarithm of the frequency in the range of 0.15 to 0.50 MHz.

### 4.2.2 Test Instruments

Description & Manufacturer	Model No.	Serial No.	Date of Calibration	Due Date of Calibration
Test Receiver ROHDE & SCHWARZ	ESCS30	100289	Dec. 23, 2015	Dec. 22, 2016
RF signal cable (with 10dB PAD) Woken	5D-FB	Cable-cond2-01	Dec. 26, 2015	Dec. 25, 2016
LISN ROHDE & SCHWARZ (EUT)	ESH2-Z5	100100	Jan. 11, 2016	Jan. 10, 2017
LISN ROHDE & SCHWARZ (Peripheral)	ESH3-Z5	100312	Jul. 21, 2015	Jul. 20, 2016
Software ADT	BV ADT_Cond_ V7.3.7.3	NA	NA	NA

Note: 1. The calibration interval of the above test instruments is 12 months and the calibrations are traceable to NML/ROC and NIST/USA.

2. The test was performed in HwaYa Shielded Room 2.

3. The VCCI Site Registration No. is C-2047.



#### 4.2.3 Test Procedures

- The EUT was placed 0.4 meters from the conducting wall of the shielded room with EUT being connected to the power mains through a line impedance stabilization network (LISN). Other support units were connected to the power mains through another LISN. The two LISNs provide 50 ohm/50 uH of coupling impedance for the measuring instrument.
- Both lines of the power mains connected to the EUT were checked for maximum conducted interference.
- The frequency range from 150 kHz to 30 MHz was searched. Emission levels under (Limit – 20 dB) was not recorded.

**NOTE:** All modes of operation were investigated and the worst-case emissions are reported.

#### 4.2.4 Deviation from Test Standard

No deviation.

#### 4.2.5 Test Setup

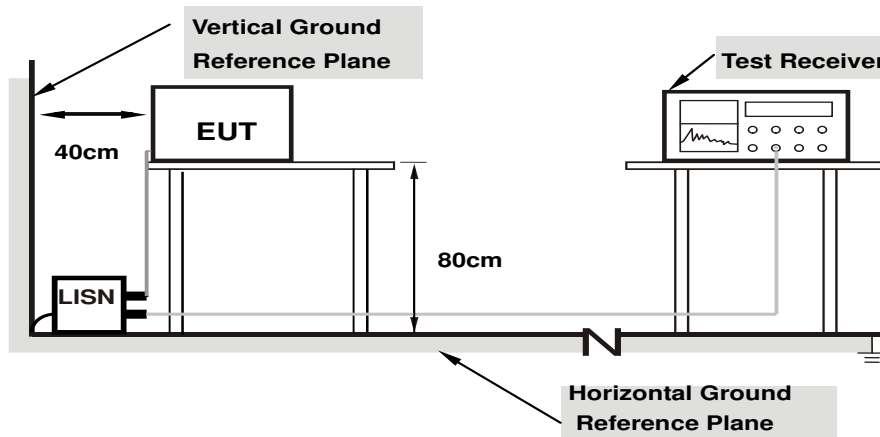

**Note: 1.Support units were connected to second LISN.**

For the actual test configuration, please refer to the attached file (Test Setup Photo).

#### 4.2.6 EUT Operating Conditions

- Placed the EUT on a testing table.
- Use the software to control the EUT under transmission condition continuously at specific channel frequency.

#### 4.2.7 Test Results

##### Mode A

Frequency Range	150kHz ~ 30MHz	Detector Function & Resolution Bandwidth	Quasi-Peak (QP) / Average (AV), 9kHz
Input Power	120Vac, 60Hz	Environmental Conditions	25°C, 65%RH
Tested by	Toby Tian	Test Date	2016/7/2

Phase Of Power : Line (L)										
No	Frequency (MHz)	Correction Factor (dB)	Reading Value (dBuV)		Emission Level (dBuV)		Limit (dBuV)		Margin (dB)	
			Q.P.	AV.	Q.P.	AV.	Q.P.	AV.	Q.P.	AV.
1	0.43516	10.19	41.36	34.93	51.55	45.12	57.15	47.15	-5.60	-2.03
2	0.53672	10.20	32.33	16.46	42.53	26.66	56.00	46.00	-13.47	-19.34
3	0.87656	10.21	37.70	31.51	47.91	41.72	56.00	46.00	-8.09	-4.28
4	1.36719	10.24	30.52	12.94	40.76	23.18	56.00	46.00	-15.24	-22.82
5	2.42188	10.29	29.02	17.87	39.31	28.16	56.00	46.00	-16.69	-17.84
6	3.11719	10.32	35.61	24.49	45.93	34.81	56.00	46.00	-10.07	-11.19

#### Remarks:

1. Q.P. and AV. are abbreviations of quasi-peak and average individually.
2. The emission levels of other frequencies were very low against the limit.
3. Margin value = Emission level – Limit value
4. Correction factor = Insertion loss + Cable loss
5. Emission Level = Correction Factor + Reading Value

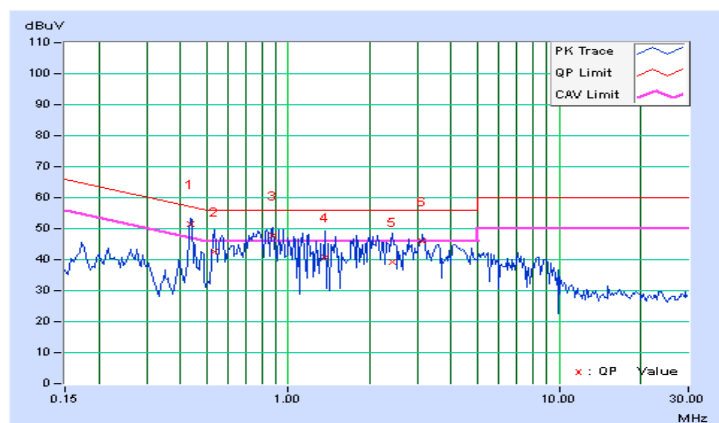

Frequency Range	150kHz ~ 30MHz	Detector Function & Resolution Bandwidth	Quasi-Peak (QP) / Average (AV), 9kHz
Input Power	120Vac, 60Hz	Environmental Conditions	25°C, 65%RH
Tested by	Toby Tian	Test Date	2016/7/2

Phase Of Power : Neutral (N)										
No	Frequency (MHz)	Correction Factor (dB)	Reading Value (dBuV)		Emission Level (dBuV)		Limit (dBuV)		Margin (dB)	
			Q.P.	AV.	Q.P.	AV.	Q.P.	AV.	Q.P.	AV.
1	0.15000	10.13	41.61	25.09	51.74	35.22	66.00	56.00	-14.26	-20.78
2	0.20859	10.16	38.14	24.59	48.30	34.75	63.26	53.26	-14.96	-18.51
3	0.42344	10.19	35.36	27.23	45.55	37.42	57.38	47.38	-11.83	-9.96
4	0.54844	10.19	32.96	27.60	43.15	37.79	56.00	46.00	-12.85	-8.21
5	0.83750	10.20	30.25	20.94	40.45	31.14	56.00	46.00	-15.55	-14.86
6	2.59766	10.33	26.62	19.82	36.95	30.15	56.00	46.00	-19.05	-15.85

Remarks:

1. Q.P. and AV. are abbreviations of quasi-peak and average individually.
2. The emission levels of other frequencies were very low against the limit.
3. Margin value = Emission level – Limit value
4. Correction factor = Insertion loss + Cable loss
5. Emission Level = Correction Factor + Reading Value

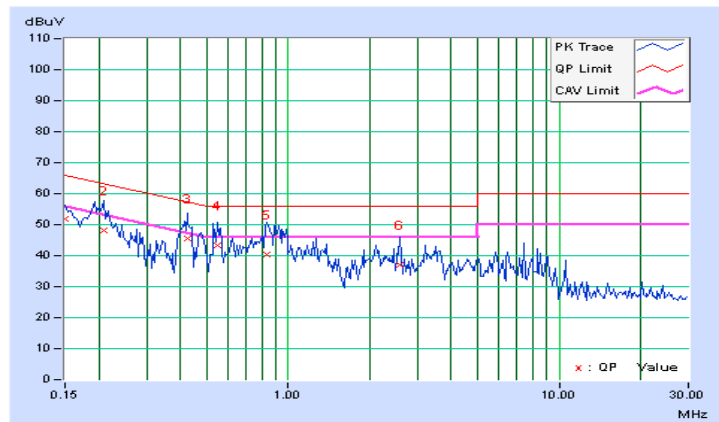

**Mode B**

Frequency Range	150kHz ~ 30MHz	Detector Function & Resolution Bandwidth	Quasi-Peak (QP) / Average (AV), 9kHz
Input Power	120Vac, 60Hz	Environmental Conditions	25°C, 65%RH
Tested by	Toby Tian	Test Date	2016/7/2

Phase Of Power : Line (L)										
No	Frequency (MHz)	Correction Factor (dB)	Reading Value (dBuV)		Emission Level (dBuV)		Limit (dBuV)		Margin (dB)	
			Q.P.	AV.	Q.P.	AV.	Q.P.	AV.	Q.P.	AV.
1	0.44297	10.19	39.83	34.03	50.02	44.22	57.01	47.01	-6.99	-2.79
2	0.54063	10.20	30.86	19.16	41.06	29.36	56.00	46.00	-14.94	-16.64
3	0.82578	10.21	32.75	24.82	42.96	35.03	56.00	46.00	-13.04	-10.97
4	0.94688	10.22	33.56	24.23	43.78	34.45	56.00	46.00	-12.22	-11.55
5	1.70703	10.26	29.69	16.01	39.95	26.27	56.00	46.00	-16.05	-19.73
6	2.93359	10.31	29.32	17.89	39.63	28.20	56.00	46.00	-16.37	-17.80

Remarks:

1. Q.P. and AV. are abbreviations of quasi-peak and average individually.
2. The emission levels of other frequencies were very low against the limit.
3. Margin value = Emission level – Limit value
4. Correction factor = Insertion loss + Cable loss
5. Emission Level = Correction Factor + Reading Value

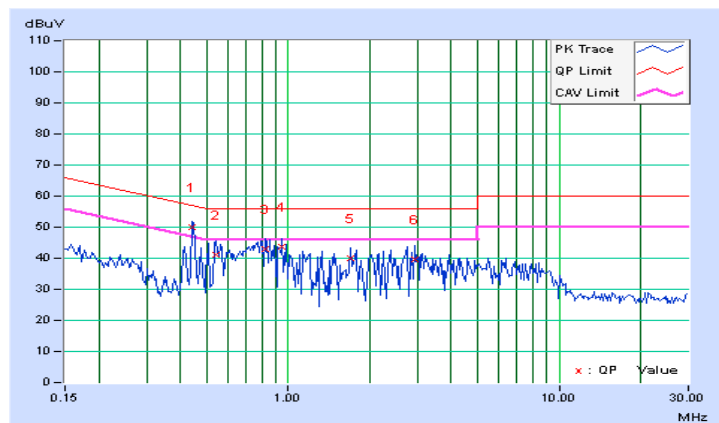

Frequency Range	150kHz ~ 30MHz	Detector Function & Resolution Bandwidth	Quasi-Peak (QP) / Average (AV), 9kHz
Input Power	120Vac, 60Hz	Environmental Conditions	25°C, 65%RH
Tested by	Toby Tian	Test Date	2016/7/2

Phase Of Power : Neutral (N)										
No	Frequency (MHz)	Correction Factor (dB)	Reading Value (dBuV)		Emission Level (dBuV)		Limit (dBuV)		Margin (dB)	
			Q.P.	AV.	Q.P.	AV.	Q.P.	AV.	Q.P.	AV.
1	0.45859	10.19	36.30	29.97	46.49	40.16	56.72	46.72	-10.23	-6.56
2	0.56406	10.20	27.05	20.61	37.25	30.81	56.00	46.00	-18.75	-15.19
3	0.84141	10.20	26.92	16.42	37.12	26.62	56.00	46.00	-18.88	-19.38
4	1.54297	10.26	22.85	18.55	33.11	28.81	56.00	46.00	-22.89	-17.19
5	2.47656	10.32	22.16	12.22	32.48	22.54	56.00	46.00	-23.52	-23.46
6	3.70703	10.38	20.99	13.50	31.37	23.88	56.00	46.00	-24.63	-22.12

Remarks:

1. Q.P. and AV. are abbreviations of quasi-peak and average individually.
2. The emission levels of other frequencies were very low against the limit.
3. Margin value = Emission level – Limit value
4. Correction factor = Insertion loss + Cable loss
5. Emission Level = Correction Factor + Reading Value

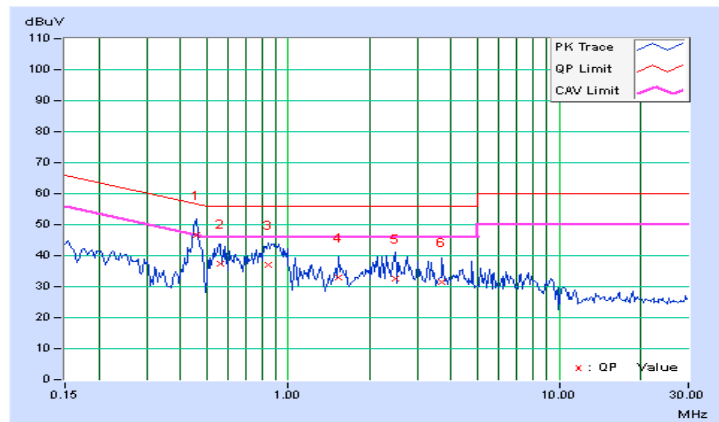

### 4.3 6 dB Bandwidth Measurement

#### 4.3.1 Limits of 6 dB Bandwidth Measurement

The minimum of 6 dB Bandwidth Measurement is 0.5 MHz.

#### 4.3.2 Test Setup

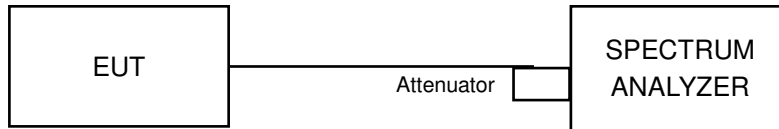

#### 4.3.3 Test Instruments

Refer to section 4.1.2 to get information of above instrument.

#### 4.3.4 Test Procedure

- Set resolution bandwidth (RBW) = 100 kHz
- Set the video bandwidth (VBW)  $\geq 3 \times$  RBW, Detector = Peak.
- Trace mode = max hold.
- Sweep = auto couple.
- Measure the maximum width of the emission that is constrained by the frequencies associated with the two amplitude points (upper and lower) that are attenuated by 6 dB relative to the maximum level measured in the fundamental emission

#### 4.3.5 Deviation from Test Standard

No deviation.

#### 4.3.6 EUT Operating Conditions

The software provided by client to enable the EUT under transmission condition continuously at lowest, middle and highest channel frequencies individually.

## 4.3.7 Test Result

## 802.11b

Channel	Frequency (MHz)	6 dB Bandwidth (MHz)	Minimum Limit (MHz)	Pass / Fail
1	2412	8.58	0.5	Pass
6	2437	8.58	0.5	Pass
11	2462	8.56	0.5	Pass

## 802.11g

Channel	Frequency (MHz)	6 dB Bandwidth (MHz)	Minimum Limit (MHz)	Pass / Fail
1	2412	16.36	0.5	Pass
6	2437	16.40	0.5	Pass
11	2462	16.38	0.5	Pass

## 802.11n (HT20)

Channel	Frequency (MHz)	6 dB Bandwidth (MHz)	Minimum Limit (MHz)	Pass / Fail
1	2412	17.17	0.5	Pass
6	2437	17.62	0.5	Pass
11	2462	17.61	0.5	Pass

## 802.11n (HT40)

Channel	Frequency (MHz)	6 dB Bandwidth (MHz)	Minimum Limit (MHz)	Pass / Fail
3	2422	35.24	0.5	Pass
6	2437	35.52	0.5	Pass
9	2452	35.25	0.5	Pass

### Spectrum Plot of Worst Value

#### 802.11b

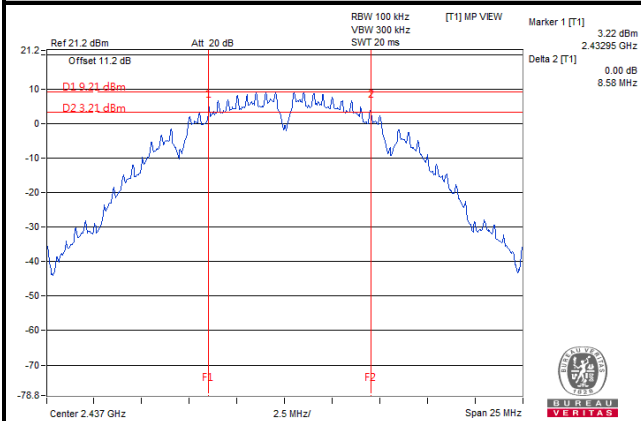

#### 802.11g

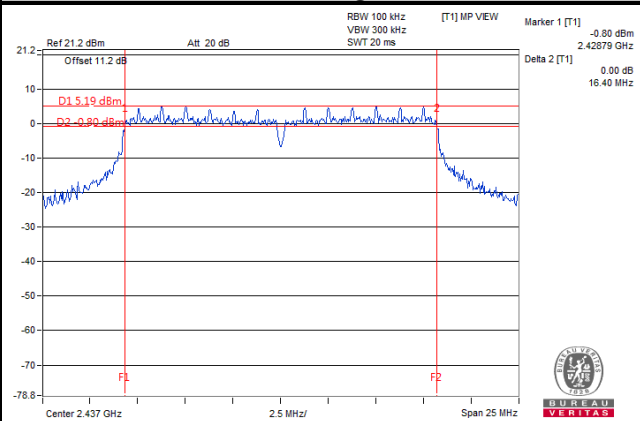

#### 802.11n (HT20)

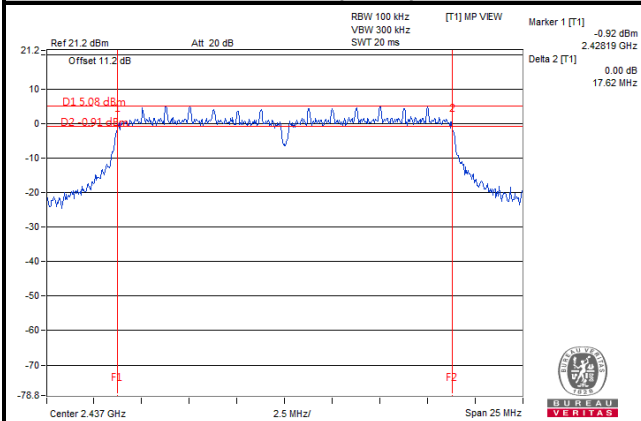

#### 802.11n (HT40)

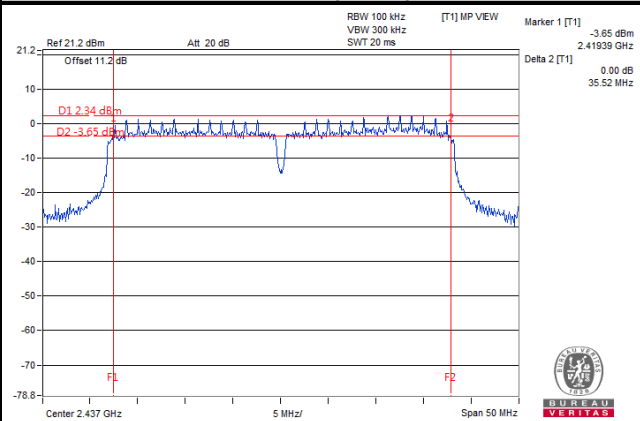



## 4.4 Conducted Output Power Measurement

### 4.4.1 Limits of Conducted Output Power Measurement

For systems using digital modulation in the 2400–2483.5 MHz bands: 1 Watt (30 dBm)

### 4.4.2 Test Setup

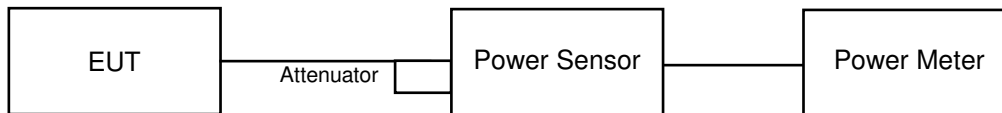

### 4.4.3 Test Instruments

Refer to section 4.1.2 to get information of above instrument.

### 4.4.4 Test Procedures

A peak power sensor was used on the output port of the EUT. A power meter was used to read the response of the peak power sensor. Record the power level.

### 4.4.5 Deviation from Test Standard

No deviation.

### 4.4.6 EUT Operating Conditions

The software provided by client to enable the EUT under transmission condition continuously at lowest, middle and highest channel frequencies individually.

#### 4.4.7 Test Results

##### 802.11b

Channel	Frequency (MHz)	Peak Power (mW)	Peak Power (dBm)	Limit (dBm)	Pass / Fail
1	2412	105.68	20.24	30	Pass
6	2437	109.65	20.40	30	Pass
11	2462	112.46	20.51	30	Pass

##### 802.11g

Channel	Frequency (MHz)	Peak Power (mW)	Peak Power (dBm)	Limit (dBm)	Pass / Fail
1	2412	186.64	22.71	30	Pass
6	2437	196.79	22.94	30	Pass
11	2462	184.50	22.66	30	Pass

##### 802.11n (HT20)

Channel	Frequency (MHz)	Peak Power (mW)	Peak Power (dBm)	Limit (dBm)	Pass / Fail
1	2412	175.79	22.45	30	Pass
6	2437	183.65	22.64	30	Pass
11	2462	179.47	22.54	30	Pass

##### 802.11n (HT40)

Channel	Frequency (MHz)	Peak Power (mW)	Peak Power (dBm)	Limit (dBm)	Pass / Fail
3	2422	175.79	22.45	30	Pass
6	2437	184.50	22.66	30	Pass
9	2452	172.19	22.36	30	Pass

## 4.5 Power Spectral Density Measurement

### 4.5.1 Limits of Power Spectral Density Measurement

The Maximum of Power Spectral Density Measurement is 8 dBm.

### 4.5.2 Test Setup

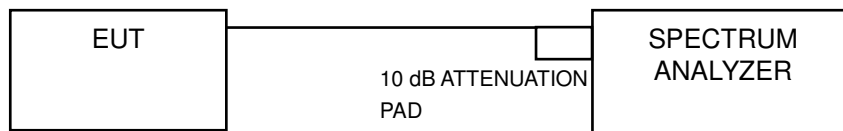

### 4.5.3 Test Instruments

Refer to section 4.1.2 to get information of above instrument.

### 4.5.4 Test Procedure

- Set analyzer center frequency to DTS channel center frequency.
- Set the span to 1.5 times the DTS bandwidth.
- Set the RBW to:  $3 \text{ kHz} \leq \text{RBW} \leq 100 \text{ kHz}$ .
- Set the VBW  $\geq 3 \times \text{RBW}$ .
- Detector = peak.
- Sweep time = auto couple.
- Trace mode = max hold.
- Allow trace to fully stabilize.
- Use the peak marker function to determine the maximum amplitude level within the RBW.

### 4.5.5 Deviation from Test Standard

No deviation.

### 4.5.6 EUT Operating Condition

The software provided by client to enable the EUT under transmission condition continuously at lowest, middle and highest channel frequencies individually.

#### 4.5.7 Test Results

##### 802.11b

Channel	Frequency (MHz)	PSD (dBm)	Limit (dBm)	Pass / Fail
1	2412	-5.28	8	Pass
6	2437	-5.61	8	Pass
11	2462	-5.87	8	Pass

##### 802.11g

Channel	Frequency (MHz)	PSD (dBm)	Limit (dBm)	Pass / Fail
1	2412	-9.43	8	Pass
6	2437	-9.37	8	Pass
11	2462	-9.48	8	Pass

##### 802.11n (HT20)

Channel	Frequency (MHz)	PSD (dBm)	Limit (dBm)	Pass / Fail
1	2412	-10.42	8	Pass
6	2437	-10.01	8	Pass
11	2462	-9.95	8	Pass

##### 802.11n (HT40)

Channel	Frequency (MHz)	PSD (dBm)	Limit (dBm)	Pass / Fail
3	2422	-12.74	8	Pass
6	2437	-12.48	8	Pass
9	2452	-12.64	8	Pass

### Spectrum Plot of Worst Value

#### 802.11b

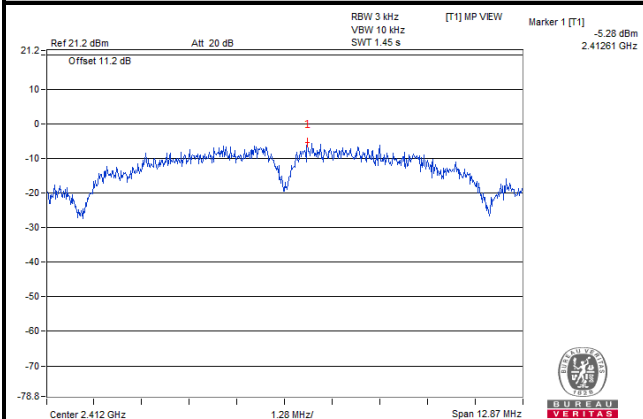

#### 802.11g

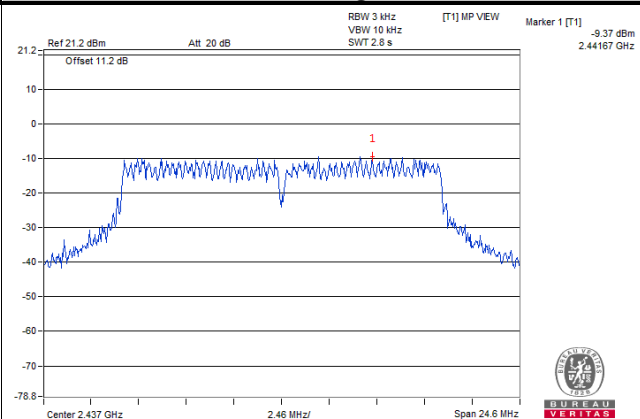

#### 802.11n (HT20)

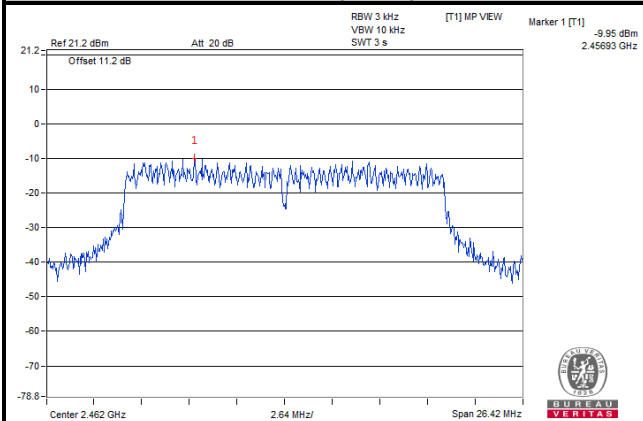

#### 802.11n (HT40)

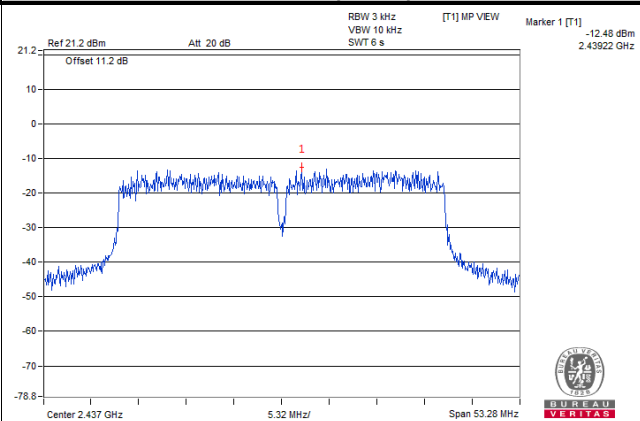

## 4.6 Conducted Out of Band Emission Measurement

### 4.6.1 Limits of Conducted Out of Band Emission Measurement

Below 20 dB of the highest emission level of operating band (in 100 kHz Resolution Bandwidth).

### 4.6.2 Test Setup

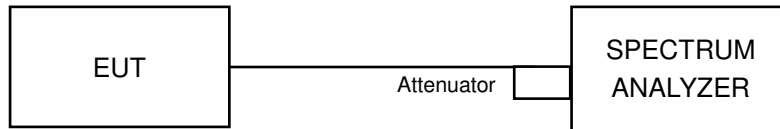

### 4.6.3 Test Instruments

Refer to section 4.1.2 to get information of above instrument.

### 4.6.4 Test Procedure

#### MEASUREMENT PROCEDURE REF

1. Set the RBW = 100 kHz.
2. Set the VBW  $\geq$  300 kHz.
3. Detector = peak.
4. Sweep time = auto couple.
5. Trace mode = max hold.
6. Allow trace to fully stabilize.
7. Use the peak marker function to determine the maximum power level in any 100 kHz band segment within the fundamental EBW.

#### MEASUREMENT PROCEDURE OOB

1. Set RBW = 100 kHz.
2. Set VBW  $\geq$  300 kHz.
3. Detector = peak.
4. Sweep = auto couple.
5. Trace Mode = max hold.
6. Allow trace to fully stabilize.
7. Use the peak marker function to determine the maximum amplitude level.

### 4.6.5 Deviation from Test Standard

No deviation.

### 4.6.6 EUT Operating Condition

The software provided by client to enable the EUT under transmission condition continuously at lowest, middle and highest channel frequencies individually.

### 4.6.7 Test Results

The spectrum plots are attached on the following images. D1 line indicates the highest level, and D2 line indicates the 20 dB offset below D1. It shows compliance with the requirement.

#### 802.11b

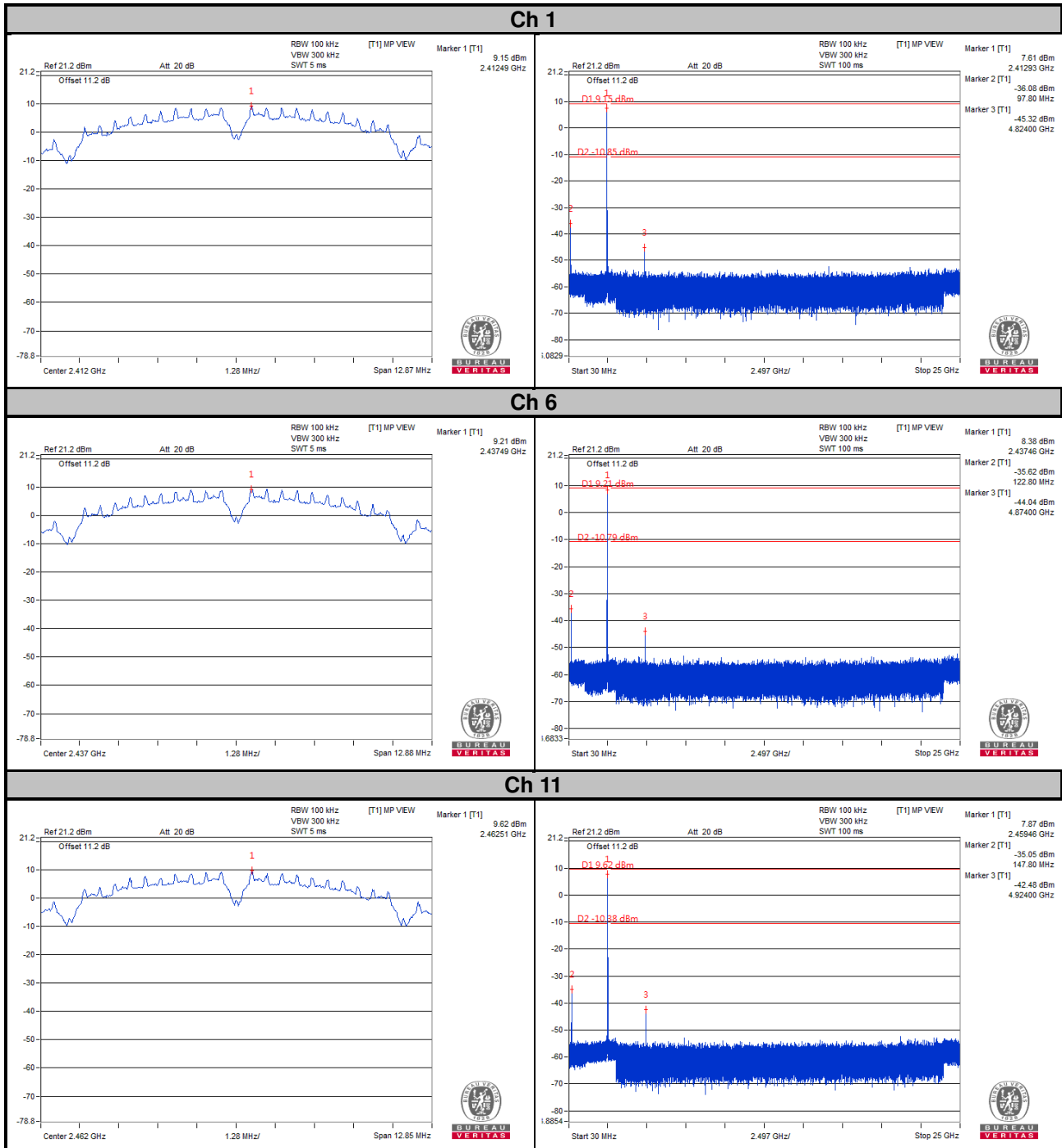

### Ch 1 Band Edge

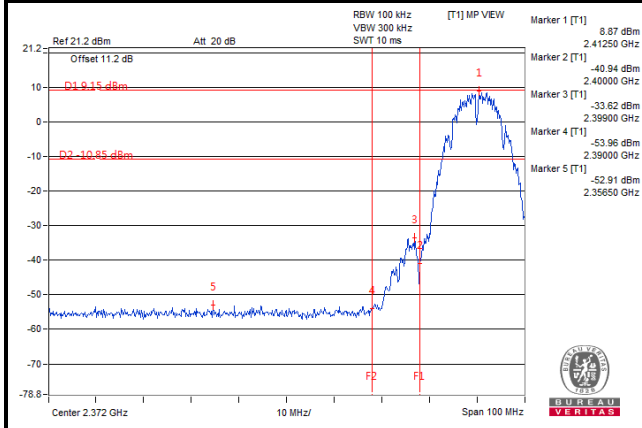

### Ch 11 Band Edge

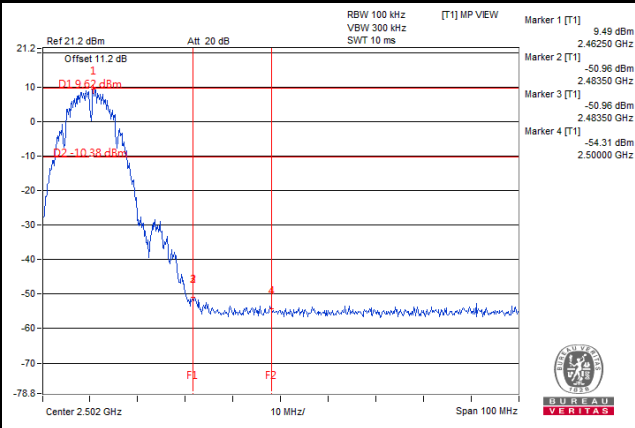



802.11g

Ch 1

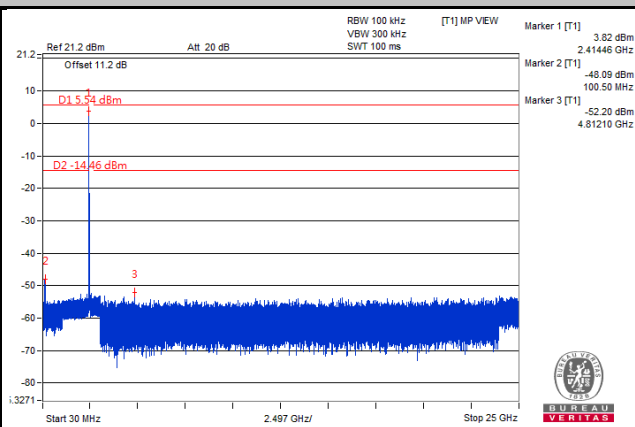
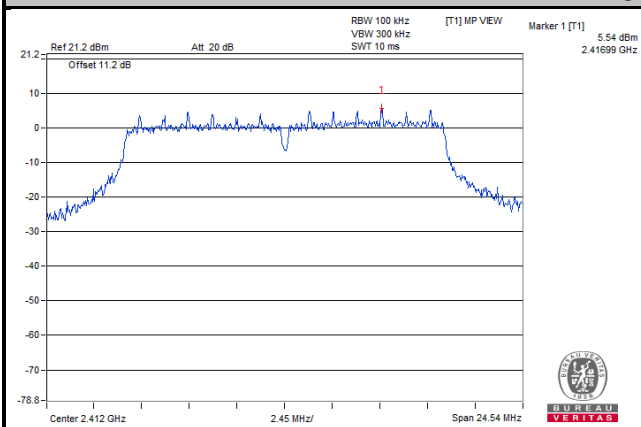

Ch 6

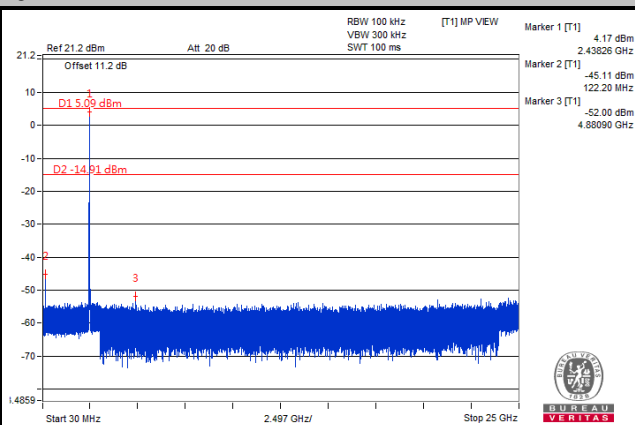
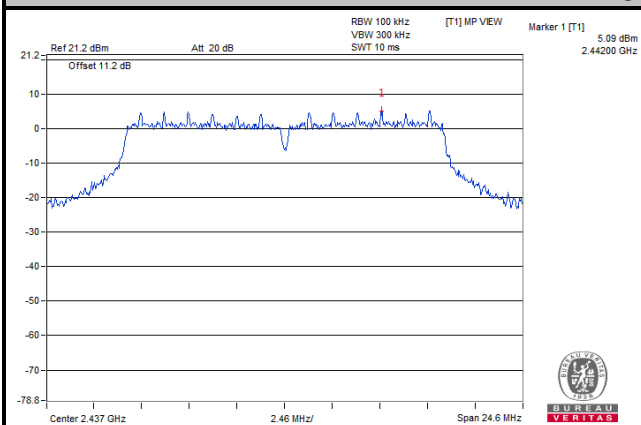

Ch 11

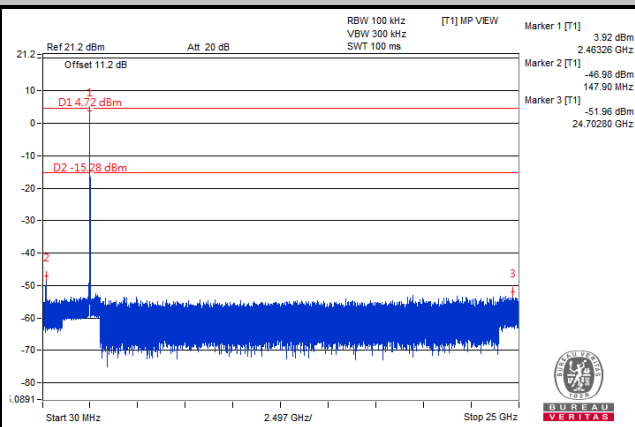
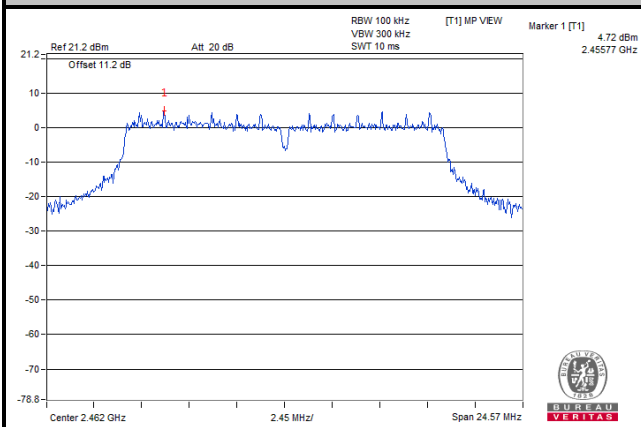

### Ch 1 Band Edge

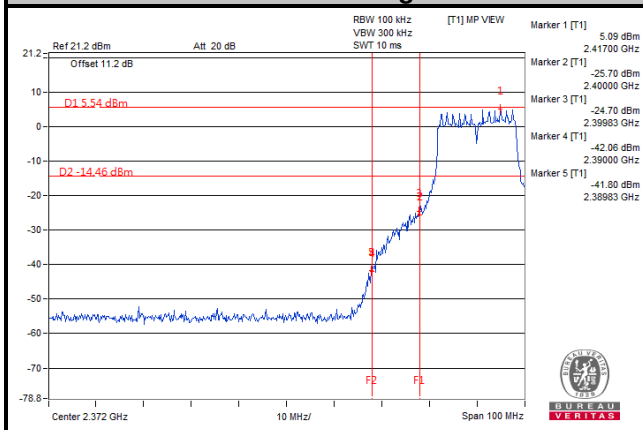

### Ch 11 Band Edge

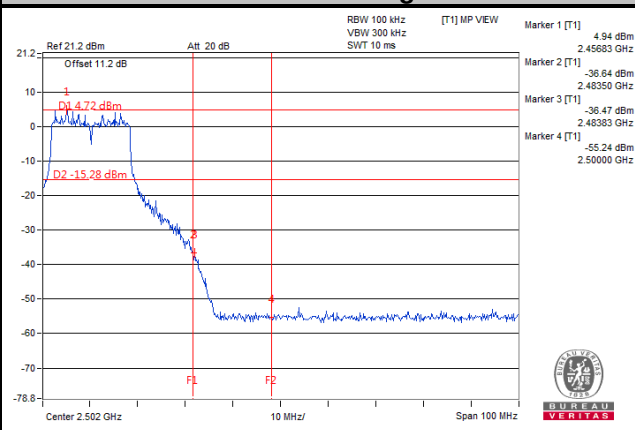

# 802.11n (HT20)

## Ch 1

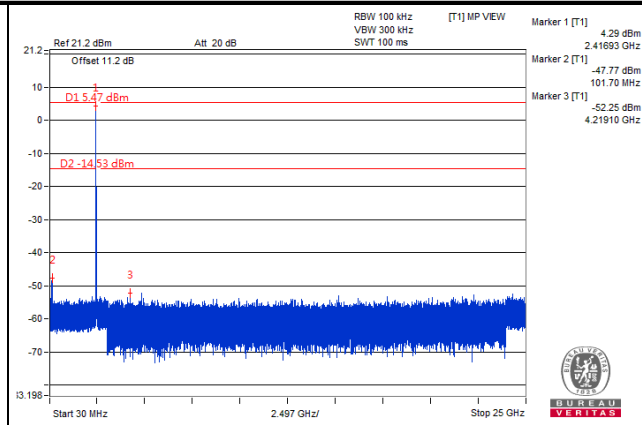
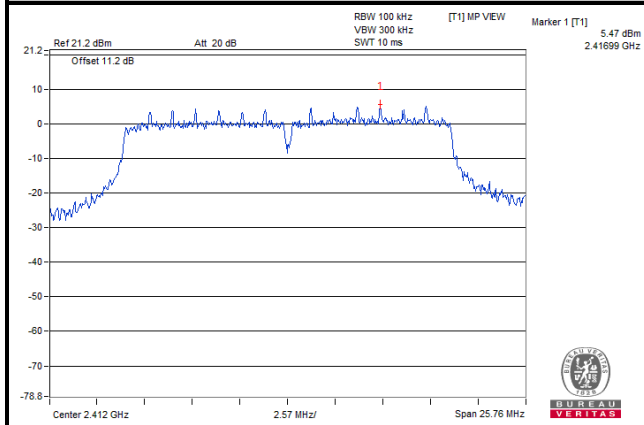

## Ch 6

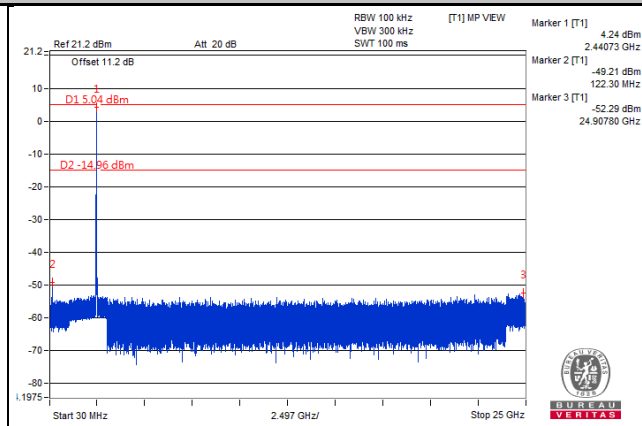
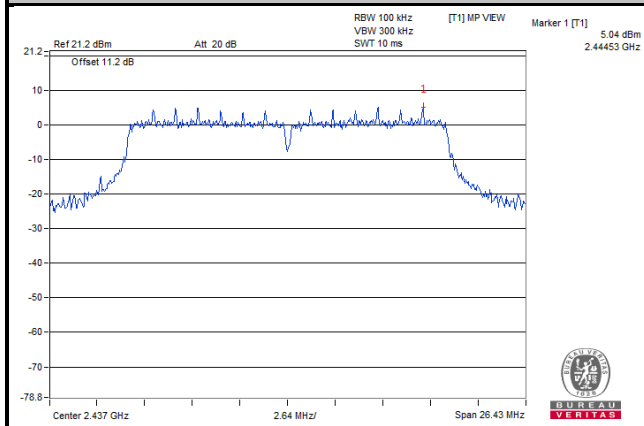

## Ch 11

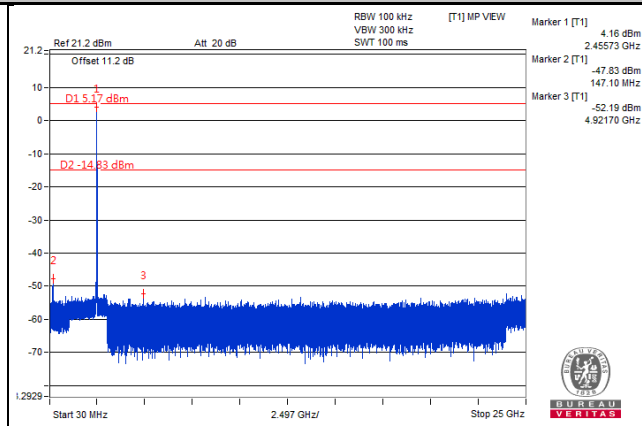
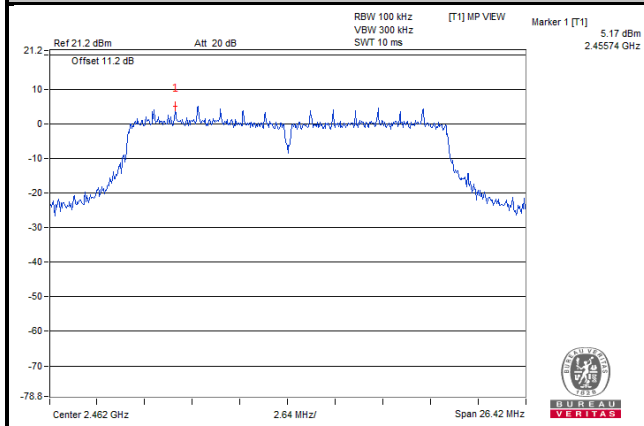

### Ch 1 Band Edge

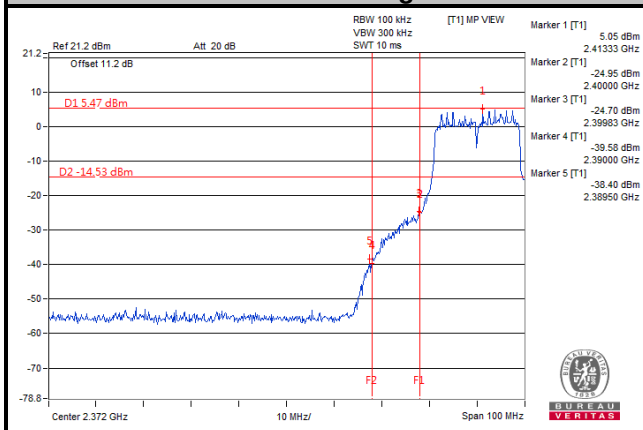

### Ch 11 Band Edge

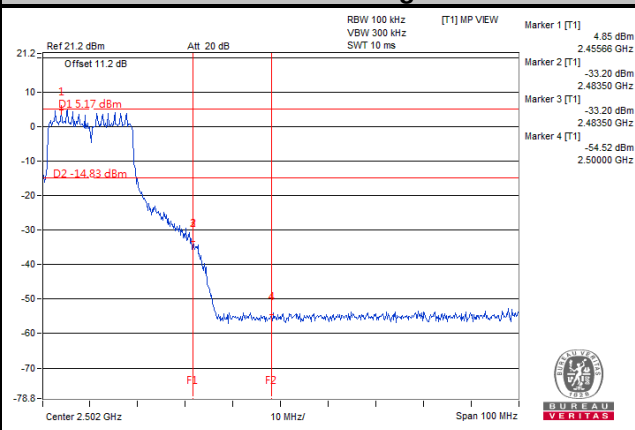

802.11n (HT40)

Ch 3

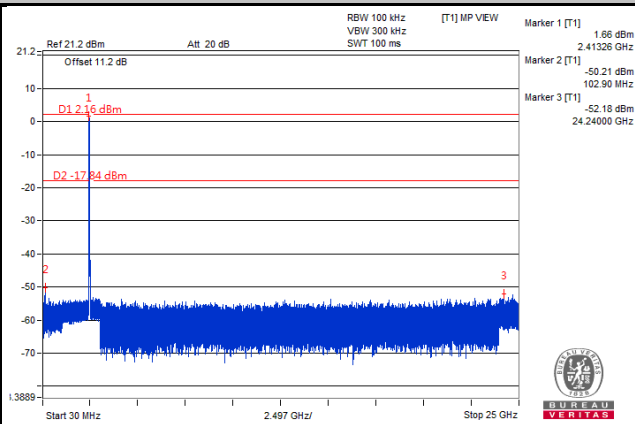
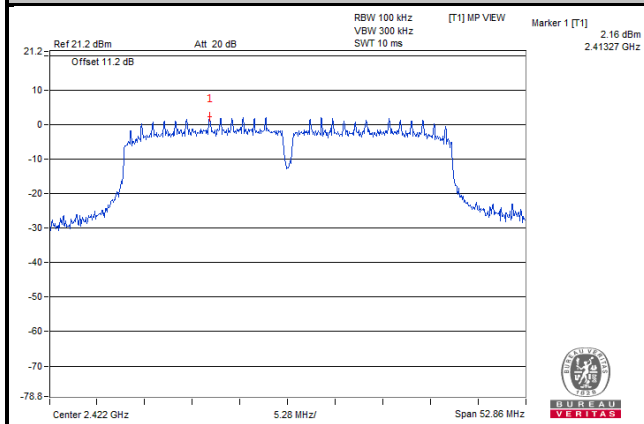

Ch 6

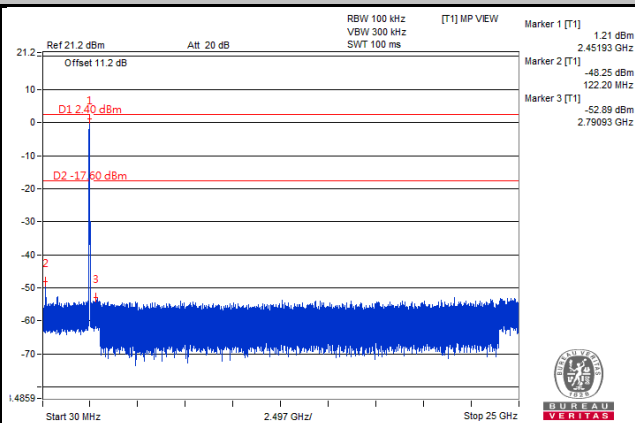
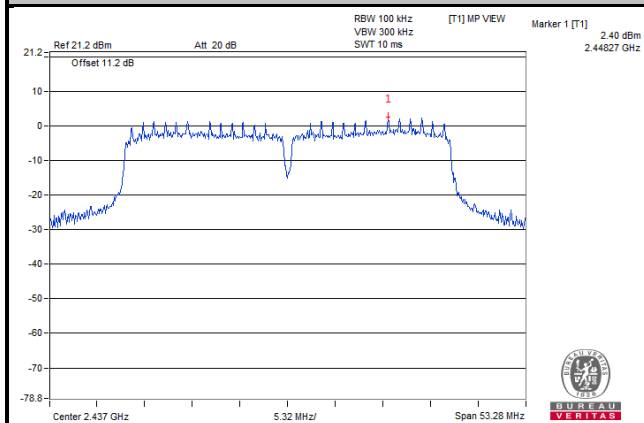

Ch 9

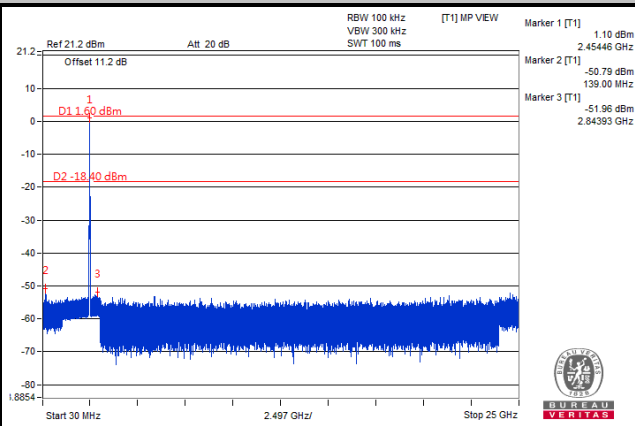
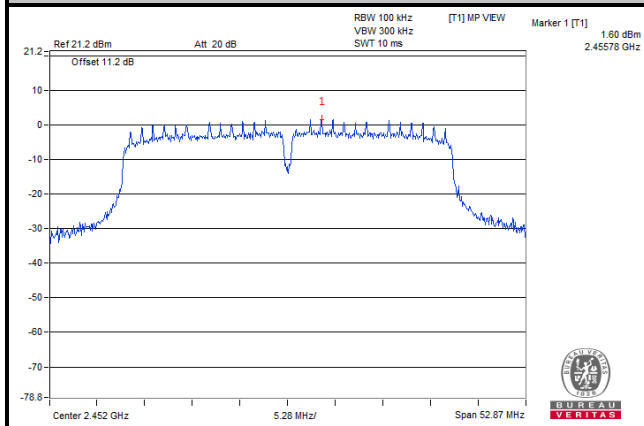

### Ch 3 Band Edge

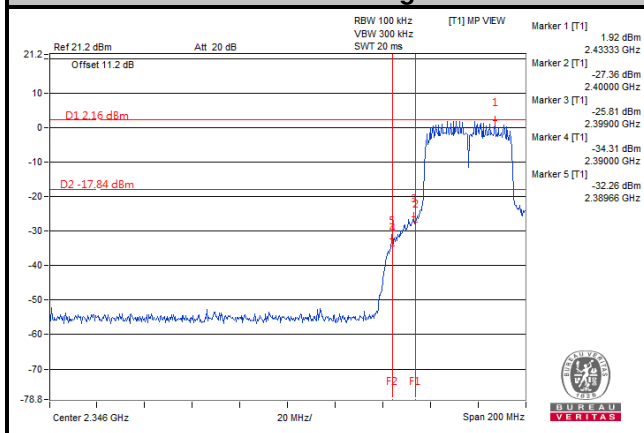

### Ch 9 Band Edge

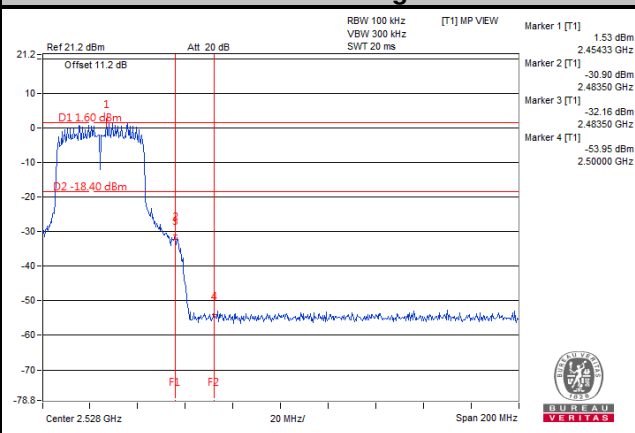

## 5 Pictures of Test Arrangements

Please refer to the attached file (Test Setup Photo).

## Appendix – Information on the Testing Laboratories

We, Bureau Veritas Consumer Products Services (H.K.) Ltd., Taoyuan Branch, were founded in 1988 to provide our best service in EMC, Radio, Telecom and Safety consultation. Our laboratories are accredited and approved according to ISO/IEC 17025.

If you have any comments, please feel free to contact us at the following:

**Linko EMC/RF Lab**

Tel: 886-2-26052180

Fax: 886-2-26051924

**Hsin Chu EMC/RF/Telecom Lab**

Tel: 886-3-6668565

Fax: 886-3-6668323

**Hwa Ya EMC/RF/Safety Lab**

Tel: 886-3-3183232

Fax: 886-3-3270892

**Email:** [service.adt@tw.bureauveritas.com](mailto:service.adt@tw.bureauveritas.com)

**Web Site:** [www.bureauveritas-adt.com](http://www.bureauveritas-adt.com)

The address and road map of all our labs can be found in our web site also.

--- END ---