

FCC Test Report

(PART 27)

Report No.: RF160317C12-2

FCC ID: NM82PST300

Test Model: 2PST300

Received Date: Mar. 17, 2016

Test Date: Apr. 04, 2016 ~ Apr. 22, 2016

Issued Date: May 04, 2016

Applicant: HTC Corporation

Address: 1F, 6-3 Baoqiang Road, Xindian City, Taipei County 231, Taiwan

Issued By: Bureau Veritas Consumer Products Services (H.K.) Ltd., Taoyuan Branch

Lab Address: No. 47-2, 14th Ling, Chia Pau Vil., Lin Kou Dist., New Taipei City, Taiwan
(R.O.C)

Test Location (1): No. 19, Hwa Ya 2nd Rd, Wen Hwa Tsuen, Kwei Shan Hsiang, Taoyuan
Hsien 333, Taiwan, R.O.C.

Test Location (2): No.215, Sec. 3, Beixin Rd., Xindian Dist., New Taipei City 231, Taiwan,
R.O.C



This report is for your exclusive use. Any copying or replication of this report to or for any other person or entity, or use of our name or trademark, is permitted only with our prior written permission. This report sets forth our findings solely with respect to the test samples identified herein. The results set forth in this report are not indicative or representative of the quality or characteristics of the lot from which a test sample was taken or any similar or identical product unless specifically and expressly noted. Our report includes all of the tests requested by you and the results thereof based upon the information that you provided to us. You have 60 days from date of issuance of this report to notify us of any material error or omission caused by our negligence, provided, however, that such notice shall be in writing and shall specifically address the issue you wish to raise. A failure to raise such issue within the prescribed time shall constitute your unqualified acceptance of the completeness of this report, the tests conducted and the correctness of the report contents. Unless specific mention, the uncertainty of measurement has been explicitly taken into account to declare the compliance or non-compliance to the specification. The report must not be used by the client to claim product certification, approval, or endorsement by TAF or any government agency

Table of Contents

Release Control Record	3
1 Certificate of Conformity	4
2 Summary of Test Results	5
2.1 Measurement Uncertainty	6
2.2 Test Site and Instruments	7
3 General Information	8
3.1 General Description of EUT	8
3.2 Configuration of System under Test	9
3.2.1 Description of Support Units	9
3.3 Test Mode Applicability and Tested Channel Detail	10
3.4 EUT Operating Conditions	13
3.5 General Description of Applied Standards	13
4 Test Types and Results	14
4.1 Output Power Measurement	14
4.1.1 Limits of Output Power Measurement	14
4.1.2 Test Procedures	14
4.1.3 Test Setup	15
4.1.4 Test Results	16
4.2 Frequency Stability Measurement	24
4.2.1 Limits of Frequency Stability Measurement	24
4.2.2 Test Procedure	24
4.2.3 Test Setup	24
4.2.4 Test Results	25
4.3 Occupied Bandwidth Measurement	26
4.3.1 Limits of Occupied Bandwidth Measurement	26
4.3.2 Test Procedure	26
4.3.3 Test Setup	26
4.3.4 Test Result	27
4.4 Band Edge Measurement	31
4.4.1 Limits of Band Edge Measurement	31
4.4.2 Test Setup	31
4.4.3 Test Procedures	31
4.4.4 Test Results	32
4.5 Peak to Average Ratio	40
4.5.1 Limits of Peak to Average Ratio Measurement	40
4.5.2 Test Setup	40
4.5.3 Test Procedures	40
4.5.4 Test Results	41
4.6 Conducted Spurious Emissions	45
4.6.1 Limits of Conducted Spurious Emissions Measurement	45
4.6.2 Test Setup	45
4.6.3 Test Procedure	45
4.6.4 Test Results	45
4.7 Radiated Emission Measurement	47
4.7.1 Limits of Radiated Emission Measurement	47
4.7.2 Test Procedure	47
4.7.3 Deviation from Test Standard	47
4.7.4 Test Setup	47
4.7.5 Test Results	48
5 Pictures of Test Arrangements	56
Appendix – Information on the Testing Laboratories	57

Release Control Record

Issue No.	Description	Date Issued
RF160317C12-2	Original Release	May 04, 2016

1 Certificate of Conformity

Product: Smartphone

Brand: HTC

Test Model: 2PST300

Sample Status: Identical Prototype

Applicant: HTC Corporation

Test Date: Apr. 04, 2016 ~ Apr. 22, 2016

Standards: FCC Part 27, Subpart C, L

The above equipment has been tested by **Bureau Veritas Consumer Products Services (H.K.) Ltd., Taoyuan Branch**, and found compliance with the requirement of the above standards. The test record, data evaluation & Equipment Under Test (EUT) configurations represented herein are true and accurate accounts of the measurements of the sample's EMC characteristics under the conditions specified in this report.

Prepared by : , **Date:** May 04, 2016
Ivonne Wu / Supervisor

Approved by : , **Date:** May 04, 2016
Stanley Wu / Assistant Manager

2 Summary of Test Results

Applied Standard: FCC Part 27 & Part 2 (LTE 4)			
FCC Clause	Test Item	Result	Remarks
2.1046 27.50(d)(4)	Maximum Peak Output Power	Pass	Meet the requirement of limit.
2.1055 27.54	Frequency Stability	Pass	Meet the requirement of limit.
2.1049 27.53(h)	Occupied Bandwidth	Pass	Meet the requirement of limit.
27.50(d)(5)	Peak to Average Ratio	Pass	Meet the requirement of limit.
27.53(h)	Band Edge Measurements	Pass	Meet the requirement of limit.
2.1051 27.53(h)	Conducted Spurious Emissions	Pass	Meet the requirement of limit.
2.1053 27.53(h)	Radiated Spurious Emissions	Pass	Meet the requirement of limit. Minimum passing margin is -25.26 dB at 5197.50 MHz.

Applied Standard: FCC Part 27 & Part 2 (LTE 13)			
FCC Clause	Test Item	Result	Remarks
2.1046 27.50(b)(10)	Maximum Peak Output Power	Pass	Meet the requirement of limit.
2.1055 27.54	Frequency Stability	Pass	Meet the requirement of limit.
2.1049 27.53(g)	Occupied Bandwidth	Pass	Meet the requirement of limit.
27.50(d)(5)	Peak to Average Ratio	Pass	Meet the requirement of limit.
27.53(g)	Band Edge Measurements	Pass	Meet the requirement of limit.
2.1051 27.53(g)	Conducted Spurious Emissions	Pass	Meet the requirement of limit.
2.1053 27.53(g)	Radiated Spurious Emissions	Pass	Meet the requirement of limit. Minimum passing margin is -17.71 dB at 1564.00 MHz.

2.1 Measurement Uncertainty

Where relevant, the following measurement uncertainty levels have been estimated for tests performed on the EUT as specified in CISPR 16-4-2:

Measurement	Frequency	Expanded Uncertainty (k=2) (±)
Conducted Emissions at mains ports	150 kHz ~ 30 MHz	2.44 dB
Radiated Emissions up to 1 GHz	30 MHz ~ 200 MHz	2.0153 dB
	200 MHz ~ 1000 MHz	2.0224 dB
Radiated Emissions above 1 GHz	1 GHz ~ 18 GHz	1.0121 dB
	18 GHz ~ 40 GHz	1.1508 dB

2.2 Test Site and Instruments

Description & Manufacturer	Model No.	Serial No.	Date of Calibration	Due Date of Calibration
Test Receiver Agilent Technologies	N9038A	MY52260177	May 19, 2015	May 18, 2016
Spectrum Analyzer ROHDE & SCHWARZ	FSU43	101261	Dec. 17, 2015	Dec. 16, 2016
BILOG Antenna SCHWARZBECK	VULB9168	9168-472	Jan. 07, 2016	Jan. 06, 2017
HORN Antenna ETS-Lindgren	3117	00143293	Jan. 04, 2016	Jan. 03, 2017
Double Ridge Guide Horn Antenna EMCO	3115	5619	Jan. 04, 2016	Jan. 03, 2017
BILOG Antenna SCHWARZBECK	VULB 9168	9168-153	Jan. 07, 2016	Jan. 06, 2017
Agilent Communications Tester-Wireless	8960 Series 10	MY53201073	Jul. 03, 2015	Jul. 02, 2017
Preamplifier Agilent	310N	187226	Jun. 29, 2015	Jun. 28, 2016
Preamplifier Agilent	83017A	MY39501357	Jun. 29, 2015	Jun. 28, 2016
Power Meter Anritsu	ML2495A	1232002	Sep. 21, 2015	Sep. 20, 2016
Power Sensor Anritsu	MA2411B	1207325	Sep. 21, 2015	Sep. 20, 2016
RF signal cable ETS-LINDGREN	5D-FB	Cable-CH1-01(R FC-SMS-100-SM S-120+RFC-SMS -100-SMS-400)	Jun. 27, 2015	Jun. 26, 2016
RF signal cable ETS-LINDGREN	8D-FB	Cable-CH1-02(R FC-SMS-100-SM S-24)	Jun. 27, 2015	Jun. 26, 2016
Software BV ADT	E3 8.130425b	NA	NA	NA
Antenna Tower MF	NA	NA	NA	NA
Turn Table MF	NA	NA	NA	NA
Antenna Tower & Turn Table Controller MF	MF-7802	NA	NA	NA
Communications Tester-Wireless Agilent	8960 Series 10	MY53201073	Jul. 03, 2015	Jul. 02, 2017
Radio Communication Analyzer Anritsu	MT8820C	6201300640	Aug. 10, 2015	Aug. 09, 2017

- Note: 1. The calibration interval of the above test instruments is 12 / 24 months and the calibrations are traceable to NML/ROC and NIST/USA.
2. The test was performed in HsinTien Chamber 1.
3. The horn antenna and preamplifier (model: 83017A) are used only for the measurement of emission frequency above 1 GHz if tested.
4. The FCC Site Registration No. is 149147.
5. The IC Site Registration No. is IC7450I-1.

3 General Information

3.1 General Description of EUT

Product	Smartphone	
Brand	HTC	
Test Model	2PST300	
Status of EUT	Identical Prototype	
Power Supply Rating	5.0 Vdc (adapter or host equipment) 3.85 Vdc (Li-ion battery)	
Modulation Type	LTE	QPSK, 16QAM
Frequency Range	LTE Band 4 (Channel Bandwidth: 1.4 MHz)	1710.7 ~ 1754.3 MHz
	LTE Band 4 (Channel Bandwidth: 3 MHz)	1711.5 ~ 1753.5 MHz
	LTE Band 4 (Channel Bandwidth: 5 MHz)	1712.5 ~ 1752.5 MHz
	LTE Band 4 (Channel Bandwidth: 10 MHz)	1715.0 ~ 1750.0 MHz
	LTE Band 4 (Channel Bandwidth: 15 MHz)	1717.5 ~ 1747.5 MHz
	LTE Band 4 (Channel Bandwidth: 20 MHz)	1720.0 ~ 1745.0 MHz
	LTE Band 13 (Channel Bandwidth: 5 MHz)	779.5 ~ 784.5 MHz
	LTE Band 13 (Channel Bandwidth: 10 MHz)	782.0 MHz
Emission Designator	LTE Band 4 (Channel Bandwidth: 1.4 MHz)	1M09G7D
	LTE Band 4 (Channel Bandwidth: 3 MHz)	2M70W7D
	LTE Band 4 (Channel Bandwidth: 5 MHz)	4M50G7D
	LTE Band 4 (Channel Bandwidth: 10 MHz)	8M97G7D
	LTE Band 4 (Channel Bandwidth: 15 MHz)	13M5G7D
	LTE Band 4 (Channel Bandwidth: 20 MHz)	18M0G7D
	LTE Band 13 (Channel Bandwidth: 5 MHz)	4M50G7D
	LTE Band 13 (Channel Bandwidth: 10 MHz)	8M94G7D
Max. ERP Power	LTE Band 13 (Channel Bandwidth: 5 MHz)	60.97mW
	LTE Band 13 (Channel Bandwidth: 10 MHz)	59.80mW
Max. EIRP Power	LTE Band 4 (Channel Bandwidth: 1.4 MHz)	110.92mW
	LTE Band 4 (Channel Bandwidth: 3 MHz)	111.10mW
	LTE Band 4 (Channel Bandwidth: 5 MHz)	118.77mW
	LTE Band 4 (Channel Bandwidth: 10 MHz)	115.48mW
	LTE Band 4 (Channel Bandwidth: 15 MHz)	117.90mW
	LTE Band 4 (Channel Bandwidth: 20 MHz)	116.82mW
Antenna Type	Fixed Internal Antenna	
Accessory Device	Refer to Note as below	
Data Cable Supplied	Refer to Note as below	

Note:

- There're 2 configurations for the EUT listed as below.
Main Sample: EUT + Battery 1 + LCM 1
2nd Sample: EUT + Battery 2 + LCM 2
✧ Only the worst test data was presented in the report.
- The EUT's accessories list refers to Ext. Pho.
- The above EUT information is declared by manufacturer and for more detailed features description, please refer to the manufacturer's specifications or user's manual.

3.2 Configuration of System under Test

<Radiated Emission Test>

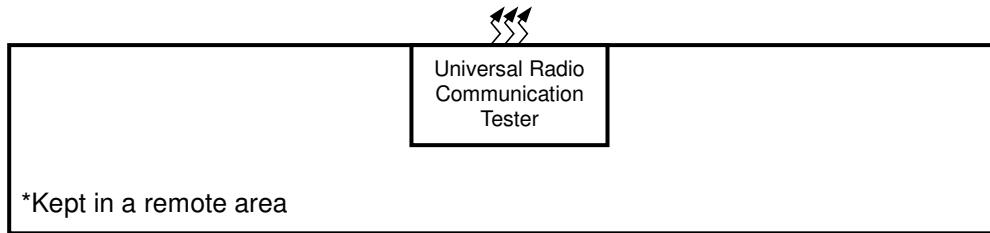
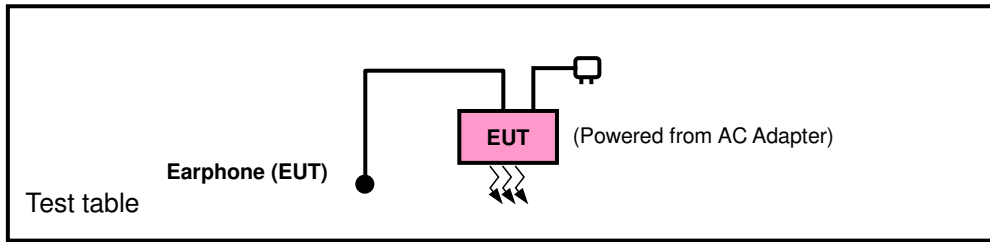

<E.R.P. / E.I.R.P. Test>

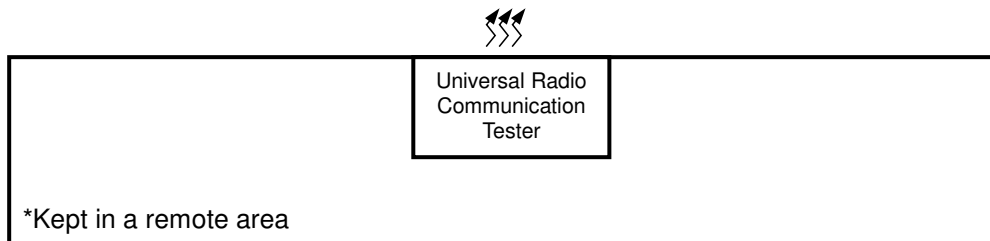
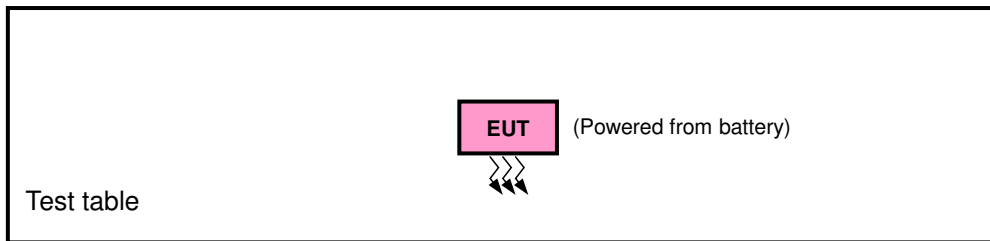

3.2.1 Description of Support Units

The EUT has been tested as an independent unit together with other necessary accessories or support units.

3.3 Test Mode Applicability and Tested Channel Detail

Pre-Scan has been conducted to determine the worst-case mode from all possible combinations between available modulations, data rates, XYZ axis, and antenna ports

The worst case was found when positioned as the table below. Following channel(s) was (were) selected for the final test as listed below:

EUT Configure Mode	Test Item
A	Main Sample
B	2 nd Sample

Band	ERP / EIRP	Radiated Emission
LTE Band 4	Z-plane	Z-axis
LTE Band 13	Z-plane	Z-axis

LTE Band 4

EUT Configure Mode	Test Item	Available Channel	Tested Channel	Channel Bandwidth	Modulation	Mode
A	EIRP	19957 to 20393	19957, 20175, 20393	1.4 MHz	QPSK, 16QAM	1 RB / 0 RB Offset
		19965 to 20385	19965, 20175, 20385	3 MHz	QPSK, 16QAM	1 RB / 0 RB Offset
		19975 to 20375	19975, 20175, 20375	5 MHz	QPSK, 16QAM	1 RB / 0 RB Offset
		20000 to 20350	20000, 20175, 20350	10 MHz	QPSK, 16QAM	1 RB / 0 RB Offset
		20025 to 20325	20025, 20175, 20325	15 MHz	QPSK, 16QAM	1 RB / 0 RB Offset
		20050 to 20300	20050, 20175, 20300	20 MHz	QPSK, 16QAM	1 RB / 0 RB Offset
B	EIRP	20050 to 20300	20050, 20175, 20300	20 MHz	QPSK, 16QAM	1 RB / 0 RB Offset
A	Frequency Stability	19957 to 20393	20175	1.4 MHz	QPSK	1 RB / 0 RB Offset
		19965 to 20385	20175	3 MHz	QPSK	1 RB / 0 RB Offset
		19975 to 20375	20175	5 MHz	QPSK	1 RB / 0 RB Offset
		20000 to 20350	20175	10 MHz	QPSK	1 RB / 0 RB Offset
		20025 to 20325	20175	15 MHz	QPSK	1 RB / 0 RB Offset
		20050 to 20300	20175	20 MHz	QPSK	1 RB / 0 RB Offset
A	Occupied Bandwidth	19957 to 20393	19957, 20175, 20393	1.4 MHz	QPSK, 16QAM	6 RB / 0 RB Offset
		19965 to 20385	19965, 20175, 20385	3 MHz	QPSK, 16QAM	15 RB / 0 RB Offset
		19975 to 20375	19975, 20175, 20375	5 MHz	QPSK, 16QAM	25 RB / 0 RB Offset
		20000 to 20350	20000, 20175, 20350	10 MHz	QPSK, 16QAM	50 RB / 0 RB Offset
		20025 to 20325	20025, 20175, 20325	15 MHz	QPSK, 16QAM	75 RB / 0 RB Offset
		20050 to 20300	20050, 20175, 20300	20 MHz	QPSK, 16QAM	100 RB / 0 RB Offset
A	Peak to Average Ratio	19957 to 20393	19957, 20175, 20393	1.4 MHz	QPSK, 16QAM	1 RB / 0 RB Offset
		19965 to 20385	19965, 20175, 20385	3 MHz	QPSK, 16QAM	1 RB / 0 RB Offset
		19975 to 20375	19975, 20175, 20375	5 MHz	QPSK, 16QAM	1 RB / 0 RB Offset
		20000 to 20350	20000, 20175, 20350	10 MHz	QPSK, 16QAM	1 RB / 0 RB Offset
		20025 to 20325	20025, 20175, 20325	15 MHz	QPSK, 16QAM	1 RB / 0 RB Offset
		20050 to 20300	20050, 20175, 20300	20 MHz	QPSK, 16QAM	1 RB / 0 RB Offset

EUT Configure Mode	Test Item	Available Channel	Tested Channel	Channel Bandwidth	Modulation	Mode		
A	Band Edge	19957 to 20393	19957	1.4 MHz	QPSK	1 RB / 0 RB Offset 6 RB / 0 RB Offset		
			20393	1.4 MHz	QPSK	1 RB / 5 RB Offset 6 RB / 0 RB Offset		
		19965 to 20385	19965	3 MHz	QPSK	1 RB / 0 RB Offset 15 RB / 0 RB Offset		
			20385	3 MHz	QPSK	1 RB / 14 RB Offset 15 RB / 0 RB Offset		
		19975 to 20375	19975	5 MHz	QPSK	1 RB / 0 RB Offset 25 RB / 0 RB Offset		
			20375	5 MHz	QPSK	1 RB / 24 RB Offset 25 RB / 0 RB Offset		
		20000 to 20350	20000	10 MHz	QPSK	1 RB / 0 RB Offset 50 RB / 0 RB Offset		
			20350	10 MHz	QPSK	1 RB / 49 RB Offset 50 RB / 0 RB Offset		
		20025 to 20325	20025	15 MHz	QPSK	1 RB / 0 RB Offset 75 RB / 0 RB Offset		
			20325	15 MHz	QPSK	1 RB / 74 RB Offset 75 RB / 0 RB Offset		
		20050 to 20300	20050	20 MHz	QPSK	1 RB / 0 RB Offset 100 RB / 0 RB Offset		
			20300	20 MHz	QPSK	1 RB / 99 RB Offset 100 RB / 0 RB Offset		
		A	Conducted Emission	19957 to 20393	20175	1.4 MHz	QPSK	1 RB / 0 RB Offset
				19965 to 20385	20175	3 MHz	QPSK	1 RB / 0 RB Offset
				19975 to 20375	20175	5 MHz	QPSK	1 RB / 0 RB Offset
				20000 to 20350	20175	10 MHz	QPSK	1 RB / 0 RB Offset
20025 to 20325	20175			15 MHz	QPSK	1 RB / 0 RB Offset		
20050 to 20300	20175			20 MHz	QPSK	1 RB / 0 RB Offset		
A, B	Radiated Emission	20050 to 20300	20175	20 MHz	QPSK	1 RB / 0 RB Offset		

Note: This device was tested under all bandwidths, RB configurations and modulations. The worst case was found in QPSK modulation.

LTE Band 13

EUT Configure Mode	Test Item	Available Channel	Tested Channel	Channel Bandwidth	Modulation	Mode
A	ERP	23205 to 23255	23205, 23230, 23255	5 MHz	QPSK, 16QAM	1 RB / 0 RB Offset
		23230	23230	10 MHz	QPSK, 16QAM	1 RB / 24 RB Offset
B	ERP	23205 to 23255	23205, 23230, 23255	5 MHz	QPSK, 16QAM	1 RB / 0 RB Offset
A	Frequency Stability	23205 to 23255	23230	5 MHz	QPSK	1 RB / 0 RB Offset
		23230	23230	10 MHz	QPSK	1 RB / 24 RB Offset
A	Occupied Bandwidth	23205 to 23255	23205, 23230, 23255	5 MHz	QPSK, 16QAM	25 RB / 0 RB Offset
		23230	23230	10 MHz	QPSK, 16QAM	50 RB / 0 RB Offset
A	Peak to Average Ratio	23205 to 23255	23205, 23230, 23255	5 MHz	QPSK, 16QAM	1 RB / 0 RB Offset
		23230	23230	10 MHz	QPSK, 16QAM	1 RB / 24 RB Offset
A	Band Edge	23205 to 23255	23205	5 MHz	QPSK	1 RB / 0 RB Offset
			23255	5 MHz	QPSK	25 RB / 0 RB Offset
		23230	23230	10 MHz	QPSK	1 RB / 24 RB Offset
			23230	10 MHz	QPSK	25 RB / 0 RB Offset
			23230	10 MHz	QPSK	1 RB / 0 RB Offset
			23230	10 MHz	QPSK	50 RB / 0 RB Offset
A	Conducted Emission	23205 to 23255	23230	5 MHz	QPSK	1 RB / 0 RB Offset
		23230	23230	10 MHz	QPSK	1 RB / 24 RB Offset
A, B	Radiated Emission	23205 to 23255	23230	5 MHz	QPSK	1 RB / 0 RB Offset

Note: This device was tested under all bandwidths, RB configurations and modulations. The worst case was found in QPSK modulation.

Test Condition:

Test Item	Environmental Conditions	Input Power	Tested By
ERP / EIRP	25 deg. C, 65 % RH	3.85 Vdc	Karl Lee
Frequency Stability	25 deg. C, 65 % RH	3.85 Vdc	Wayne Lin
Occupied Bandwidth	25 deg. C, 65 % RH	3.85 Vdc	Wayne Lin
Band Edge	25 deg. C, 65 % RH	3.85 Vdc	Wayne Lin
Peak to Average Ratio	25 deg. C, 65 % RH	3.85 Vdc	Wayne Lin
Condcudeted Emission	25 deg. C, 65 % RH	3.85 Vdc	Wayne Lin
Radiated Emission	25 deg. C, 65 % RH	120 Vac, 60 Hz	Karl Lee / Charles Hsiao

3.4 EUT Operating Conditions

The EUT makes a call to the communication simulator. The communication simulator station system controlled a EUT to export maximum output power under transmission mode and specific channel frequency

3.5 General Description of Applied Standards

The EUT is a RF Product. According to the specifications of the manufacturer, it must comply with the requirements of the following standards:

FCC 47 CFR Part 2

FCC 47 CFR Part 27

KDB 971168 D01 Power Meas License Digital Systems v02r02

ANSI/TIA/EIA-603-D 2010

Note: All test items have been performed and recorded as per the above standards.

4 Test Types and Results

4.1 Output Power Measurement

4.1.1 Limits of Output Power Measurement

Fixed, mobile, and portable (hand-held) stations operating in the 1710–1755 MHz band are limited to 1 watt EIRP.

Portable stations (hand-held devices) operating in the 776-787 MHz band are limited to 3 watts ERP

4.1.2 Test Procedures

EIRP / ERP Measurement:

- a. All measurements were done at low, middle and high operational frequency range. RBW and VBW is 10 MHz for LTE mode.
- b. Substitution method is used for E.I.R.P measurement. In the semi-anechoic chamber, EUT placed on the 0.8 m height of Turn Table, rotated the table around 360 degrees to search the maximum radiation power and receiver antenna shall be rotated vertical and horizontal polarization and moved height from 1 m to 4 m to find the maximum polar radiated power. The “Read Value” is the spectrum reading the maximum power value.
- c. The substitution horn antenna is substituted for EUT at the same position and signals generator export the CW signal to the substitution antenna via a tx cable. Rotated the Turn Table and moved receiving antenna to find the maximum radiation power. Adjust output power level of S.G to get a Value of spectrum reading equal to “Read Value” of step b. Record the power level of S.G.
- d. $EIRP = \text{Output power level of S.G} - \text{TX cable loss} + \text{Antenna gain of substitution horn}$. E.R.P power can be calculated form E.I.R.P power by subtracting the gain of dipole, $E.R.P \text{ power} = E.I.P.R \text{ power} - 2.15 \text{ dBi}$.

Conducted Power Measurement:

- a. The EUT was set up for the maximum power with LTE link data modulation and link up with simulator.
- b. Set the EUT to transmit under low, middle and high channel and record the power level shown on simulator.

4.1.3 Test Setup

EIRP / ERP Measurement:

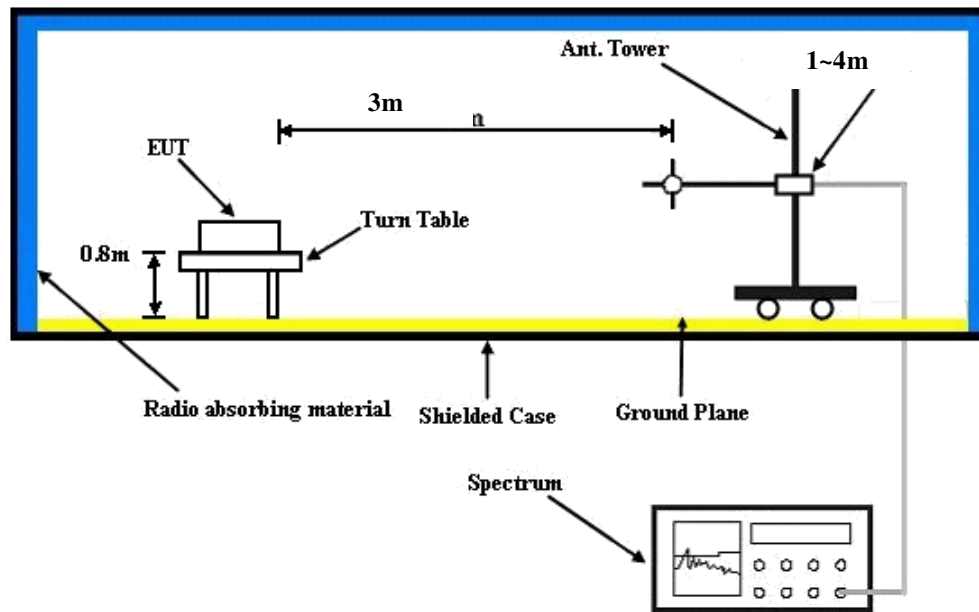

For the actual test configuration, please refer to the attached file (Test Setup Photo).

Conducted Power Measurement:



4.1.4 Test Results

Conducted Output Power (dBm)

Band / BW	RB Size	RB Offset	QPSK			3GPP MPR (dB)	16QAM			3GPP MPR (dB)
			Low Ch 19957	Mid Ch 20175	High Ch 20393		Low Ch 19957	Mid Ch 20175	High Ch 20393	
			1710.7 MHz	1732.5 MHz	1754.3 MHz		1710.7 MHz	1732.5 MHz	1754.3 MHz	
4 / 1.4M	1	0	22.46	22.42	22.39	0	21.40	21.36	21.33	1
	1	2	22.26	22.22	22.19	0	21.20	21.16	21.13	1
	1	5	22.26	22.22	22.19	0	21.20	21.16	21.13	1
	3	0	21.70	21.66	21.63	0	20.64	20.60	20.57	1
	3	1	21.54	21.60	21.57	0	20.58	20.54	20.51	1
	3	3	21.53	21.56	21.53	0	20.64	20.60	20.57	1
	6	0	21.61	21.57	21.54	1	20.55	20.51	20.48	2

Band / BW	RB Size	RB Offset	QPSK			3GPP MPR (dB)	16QAM			3GPP MPR (dB)
			Low Ch 19965	Mid Ch 20175	High Ch 20385		Low Ch 19965	Mid Ch 20175	High Ch 20385	
			1711.5 MHz	1732.5 MHz	1753.5 MHz		1711.5 MHz	1732.5 MHz	1753.5 MHz	
4 / 3M	1	0	22.54	22.50	22.47	0	21.48	21.44	21.41	1
	1	7	22.34	22.30	22.27	0	21.28	21.24	21.21	1
	1	14	22.34	22.30	22.27	0	21.28	21.24	21.21	1
	8	0	21.78	21.74	21.71	1	20.72	20.68	20.65	2
	8	3	21.62	21.58	21.55	1	20.56	20.52	20.49	2
	8	7	21.58	21.54	21.51	1	20.52	20.48	20.45	2
	15	0	21.69	21.65	21.62	1	20.63	20.59	20.56	2

Band / BW	RB Size	RB Offset	QPSK			3GPP MPR (dB)	16QAM			3GPP MPR (dB)
			Low Ch 19975	Mid Ch 20175	High Ch 20375		Low CH 19975	Mid CH 20175	High CH 20375	
			1712.5 MHz	1732.5 MHz	1752.5 MHz		1712.5 MHz	1732.5 MHz	1752.5 MHz	
4 / 5M	1	0	22.59	22.55	22.52	0	21.53	21.49	21.46	1
	1	12	22.39	22.35	22.32	0	21.33	21.29	21.26	1
	1	24	22.39	22.35	22.32	0	21.33	21.29	21.26	1
	12	0	21.83	21.79	21.76	1	20.77	20.73	20.70	2
	12	6	21.67	21.63	21.60	1	20.61	20.57	20.54	2
	12	13	21.63	21.59	21.56	1	20.57	20.53	20.50	2
	25	0	21.74	21.70	21.67	1	20.68	20.64	20.61	2

Band / BW	RB Size	RB Offset	QPSK			3GPP MPR (dB)	16QAM			3GPP MPR (dB)
			Low Ch 20000	Mid Ch 20175	High Ch 20350		Low Ch 20000	Mid Ch 20175	High Ch 20350	
			1715.0 MHz	1732.5 MHz	1750.0 MHz		1715.0 MHz	1732.5 MHz	1750.0 MHz	
4 / 10M	1	0	22.66	22.62	22.59	0	21.60	21.56	21.53	1
	1	24	22.46	22.42	22.39	0	21.40	21.36	21.33	1
	1	49	22.46	22.42	22.39	0	21.40	21.36	21.33	1
	25	0	21.90	21.86	21.83	1	20.84	20.80	20.77	2
	25	12	21.74	21.70	21.67	1	20.68	20.64	20.61	2
	25	25	21.70	21.66	21.63	1	20.64	20.60	20.57	2
	50	0	21.81	21.77	21.74	1	20.75	20.71	20.68	2

Band / BW	RB Size	RB Offset	QPSK			3GPP MPR (dB)	16QAM			3GPP MPR (dB)
			Low Ch 20025	Mid Ch 20175	High Ch 20325		Low Ch 20025	Mid Ch 20175	High Ch 20325	
			1717.5 MHz	1732.5 MHz	1747.5 MHz		1717.5 MHz	1732.5 MHz	1747.5 MHz	
4 / 15M	1	0	22.72	22.68	22.65	0	21.66	21.62	21.59	1
	1	37	22.52	22.48	22.45	0	21.46	21.42	21.39	1
	1	74	22.52	22.48	22.45	0	21.46	21.42	21.39	1
	36	0	21.96	21.92	21.89	1	20.90	20.86	20.83	2
	36	19	21.80	21.76	21.73	1	20.74	20.70	20.67	2
	36	39	21.76	21.72	21.69	1	20.70	20.66	20.63	2
	75	0	21.87	21.83	21.80	1	20.81	20.77	20.74	2

Band / BW	RB Size	RB Offset	QPSK			3GPP MPR (dB)	16QAM			3GPP MPR (dB)
			Low Ch 20050	Mid Ch 20175	High Ch 20300		Low Ch 20050	Mid Ch 20175	High Ch 20300	
			1720.0 MHz	1732.5 MHz	1745.0 MHz		1720.0 MHz	1732.5 MHz	1745.0 MHz	
4 / 20M	1	0	22.76	22.72	22.69	0	21.70	21.66	21.63	1
	1	50	22.56	22.52	22.49	0	21.50	21.46	21.43	1
	1	99	22.56	22.52	22.49	0	21.50	21.46	21.43	1
	50	0	22.00	21.96	21.93	1	20.94	20.90	20.87	2
	50	25	21.84	21.80	21.77	1	20.78	20.74	20.71	2
	50	50	21.80	21.76	21.73	1	20.74	20.70	20.67	2
	100	0	21.91	21.87	21.84	1	20.85	20.81	20.78	2

Band / BW	RB Size	RB Offset	QPSK			3GPP MPR (dB)	16QAM			3GPP MPR (dB)
			Low Ch 23205	Mid Ch 23230	High Ch 23255		Low Ch 23205	Mid Ch 23230	High Ch 23255	
			779.5 MHz	782.0 MHz	784.5 MHz		779.5 MHz	782.0 MHz	784.5 MHz	
13 / 5M	1	0	22.47	22.87	22.82	0	21.40	21.80	21.75	1
	1	12	22.43	22.83	22.78	0	21.36	21.76	21.71	1
	1	24	22.37	22.77	22.72	0	21.30	21.70	21.65	1
	12	0	21.30	21.70	21.65	1	20.23	20.63	20.58	2
	12	6	21.22	21.62	21.57	1	20.15	20.55	20.50	2
	12	13	21.19	21.59	21.54	1	20.12	20.52	20.47	2
	25	0	21.17	21.57	21.52	1	20.10	20.50	20.45	2

Band / BW	RB Size	RB Offset	QPSK		3GPP MPR (dB)	16QAM		3GPP MPR (dB)
			Mid Ch 23230			Mid Ch 23230		
			782.0 MHz			782.0 MHz		
13 / 10M	1	0	22.49		0	21.74		1
	1	24	22.68		0	21.98		1
	1	49	22.52		0	21.78		1
	25	0	21.73		1	20.86		2
	25	12	21.68		1	20.61		2
	25	25	21.52		1	20.53		2
	50	0	21.59		1	20.64		2

ERP Power (dBm)

Mode A

LTE Band 13							
Channel Bandwidth: 5 MHz / QPSK							
Plane	Channel	Frequency (MHz)	LVL (dBm)	Correction Factor (dB)	ERP (dBm)	ERP (mW)	Polarization (H/V)
Z	23205	779.5	-12.85	32.771	17.77	59.85	H
	23230	782.0	-12.74	32.741	17.85	60.97	
	23255	784.5	-12.91	32.854	17.79	60.17	
	23205	779.5	-16.88	32.5	13.47	22.23	V
	23230	782.0	-16.72	32.52	13.65	23.17	
	23255	784.5	-16.61	32.62	13.86	24.32	
Channel Bandwidth: 5 MHz / 16QAM							
Z	23205	779.5	-13.72	32.771	16.90	48.99	H
	23230	782.0	-13.81	32.741	16.78	47.65	
	23255	784.5	-13.82	32.854	16.88	48.80	
	23205	779.5	-17.58	32.5	12.77	18.92	V
	23230	782.0	-17.69	32.52	12.68	18.54	
	23255	784.5	-17.56	32.62	12.91	19.54	

LTE Band 13							
Channel Bandwidth: 10 MHz / QPSK							
Plane	Channel	Frequency (MHz)	LVL (dBm)	Correction Factor (dB)	ERP (dBm)	ERP (mW)	Polarization (H/V)
Z	23230	782.0	-12.82	32.737	17.77	59.80	H
	23230	782.0	-16.81	32.52	13.56	22.70	V
Channel Bandwidth: 10 MHz / 16QAM							
Z	23230	782.0	-13.67	32.737	16.92	49.17	H
	23230	782.0	-17.91	32.52	12.46	17.62	V

Mode B

LTE Band 13							
Channel Bandwidth: 5 MHz / QPSK							
Plane	Channel	Frequency (MHz)	LVL (dBm)	Correction Factor (dB)	ERP (dBm)	ERP (mW)	Polarization (H/V)
Z	23205	779.5	-13.21	32.771	17.41	55.09	H
	23230	782.0	-13.17	32.741	17.42	55.22	
	23255	784.5	-13.56	32.854	17.14	51.81	
	23205	779.5	-17.22	32.5	13.13	20.56	V
	23230	782.0	-17.64	32.52	12.73	18.75	
	23255	784.5	-17.58	32.62	12.89	19.45	
Channel Bandwidth: 5 MHz / 16QAM							
Z	23205	779.5	-14.20	32.771	16.42	43.86	H
	23230	782.0	-14.62	32.741	15.97	39.55	
	23255	784.5	-14.78	32.854	15.92	39.12	
	23205	779.5	-18.23	32.5	12.12	16.29	V
	23230	782.0	-18.59	32.52	11.78	15.07	
	23255	784.5	-18.71	32.62	11.76	15.00	

EIRP Power (dBm)
Mode A

LTE Band 4							
Channel Bandwidth: 1.4 MHz / QPSK							
Plane	Channel	Frequency (MHz)	LVL (dBm)	Correction Factor (dB)	EIRP (dBm)	EIRP (mW)	Polarization (H/V)
Z	19957	1710.7	-22.10	42.49	20.39	109.27	H
	20175	1732.5	-22.31	42.33	20.02	100.39	
	20393	1754.3	-21.65	42.10	20.45	110.92	
	19957	1710.7	-28.23	42.99	14.76	29.92	V
	20175	1732.5	-28.16	42.74	14.58	28.71	
	20393	1754.3	-28.06	42.21	14.15	26.00	
Channel Bandwidth: 1.4 MHz / 16QAM							
Z	19957	1710.7	-23.47	42.49	19.02	79.71	H
	20175	1732.5	-23.15	42.33	19.18	82.74	
	20393	1754.3	-22.87	42.10	19.23	83.75	
	19957	1710.7	-29.34	42.99	13.65	23.17	V
	20175	1732.5	-29.22	42.74	13.52	22.49	
	20393	1754.3	-28.87	42.21	13.34	21.58	

LTE Band 4							
Channel Bandwidth: 3 MHz / QPSK							
Plane	Channel	Frequency (MHz)	LVL (dBm)	Correction Factor (dB)	EIRP (dBm)	EIRP (mW)	Polarization (H/V)
Z	19965	1711.5	-22.23	42.49	20.26	106.05	H
	20175	1732.5	-21.87	42.33	20.46	111.10	
	20385	1753.5	-21.81	42.10	20.29	106.91	
	19965	1711.5	-28.36	42.99	14.63	29.04	V
	20175	1732.5	-28.51	42.74	14.23	26.49	
	20385	1753.5	-27.55	42.21	14.66	29.24	
Channel Bandwidth: 3 MHz / 16QAM							
Z	19965	1711.5	-23.15	42.49	19.34	85.80	H
	20175	1732.5	-22.87	42.33	19.46	88.25	
	20385	1753.5	-22.81	42.10	19.29	84.92	
	19965	1711.5	-29.68	42.99	13.31	21.43	V
	20175	1732.5	-28.90	42.74	13.84	24.21	
	20385	1753.5	-28.99	42.21	13.22	20.99	

LTE Band 4							
Channel Bandwidth: 5 MHz / QPSK							
Plane	Channel	Frequency (MHz)	LVL (dBm)	Correction Factor (dB)	EIRP (dBm)	EIRP (mW)	Polarization (H/V)
Z	19975	1712.5	-22.37	42.49	20.12	102.68	H
	20175	1732.5	-21.58	42.33	20.75	118.77	
	20375	1752.5	-21.92	42.10	20.18	104.23	
	19975	1712.5	-28.62	42.99	14.37	27.35	V
	20175	1732.5	-28.72	42.74	14.02	25.23	
	20375	1752.5	-27.67	42.21	14.54	28.44	
Channel Bandwidth: 5 MHz / 16QAM							
Z	19975	1712.5	-23.17	42.49	19.32	85.41	H
	20175	1732.5	-22.76	42.33	19.57	90.51	
	20375	1752.5	-22.55	42.10	19.55	90.16	
	19975	1712.5	-29.37	42.99	13.62	23.01	V
	20175	1732.5	-29.44	42.74	13.30	21.38	
	20375	1752.5	-28.87	42.21	13.34	21.58	

LTE Band 4							
Channel Bandwidth: 10 MHz / QPSK							
Plane	Channel	Frequency (MHz)	LVL (dBm)	Correction Factor (dB)	EIRP (dBm)	EIRP (mW)	Polarization (H/V)
Z	20000	1715.0	-21.86	42.49	20.63	115.48	H
	20175	1732.5	-22.23	42.33	20.10	102.26	
	20350	1750.0	-22.01	42.10	20.09	102.09	
	20000	1715.0	-28.36	42.99	14.63	29.04	V
	20175	1732.5	-27.89	42.74	14.85	30.55	
	20350	1750.0	-28.17	42.21	14.04	25.35	
Channel Bandwidth: 10 MHz / 16QAM							
Z	20000	1715.0	-22.96	42.49	19.53	89.64	H
	20175	1732.5	-23.17	42.33	19.16	82.36	
	20350	1750.0	-23.04	42.10	19.06	80.54	
	20000	1715.0	-29.51	42.99	13.48	22.28	V
	20175	1732.5	-28.88	42.74	13.86	24.32	
	20350	1750.0	-28.97	42.21	13.24	21.09	

LTE Band 4							
Channel Bandwidth: 15 MHz / QPSK							
Plane	Channel	Frequency (MHz)	LVL (dBm)	Correction Factor (dB)	EIRP (dBm)	EIRP (mW)	Polarization (H/V)
Z	20025	1717.5	-21.77	42.49	20.72	117.90	H
	20175	1732.5	-21.86	42.33	20.47	111.35	
	20325	1747.5	-21.75	42.10	20.35	108.39	
	20025	1717.5	-28.42	42.99	14.57	28.64	V
	20175	1732.5	-27.84	42.74	14.90	30.90	
	20325	1747.5	-27.67	42.21	14.54	28.44	
Channel Bandwidth: 15 MHz / 16QAM							
Z	20025	1717.5	-22.58	42.49	19.91	97.84	H
	20175	1732.5	-22.76	42.33	19.57	90.51	
	20325	1747.5	-22.96	42.10	19.14	82.04	
	20025	1717.5	-29.23	42.99	13.76	23.77	V
	20175	1732.5	-28.76	42.74	13.98	25.00	
	20325	1747.5	-28.91	42.21	13.30	21.38	

LTE Band 4							
Channel Bandwidth: 20 MHz / QPSK							
Plane	Channel	Frequency (MHz)	LVL (dBm)	Correction Factor (dB)	EIRP (dBm)	EIRP (mW)	Polarization (H/V)
Z	20050	1720.0	-21.81	42.49	20.68	116.82	H
	20175	1732.5	-21.92	42.33	20.41	109.82	
	20300	1745.0	-21.82	42.10	20.28	106.66	
	20050	1720.0	-28.31	42.99	14.68	29.38	V
	20175	1732.5	-27.99	42.74	14.75	29.85	
	20300	1745.0	-28.21	42.21	14.00	25.12	
Channel Bandwidth: 20 MHz / 16QAM							
Z	20050	1720.0	-22.67	42.49	19.82	95.83	H
	20175	1732.5	-22.59	42.33	19.74	94.12	
	20300	1745.0	-22.99	42.10	19.11	81.55	
	20050	1720.0	-29.26	42.99	13.73	23.60	V
	20175	1732.5	-28.95	42.74	13.79	23.93	
	20300	1745.0	-29.01	42.21	13.20	20.89	

Mode B

LTE Band 4							
Channel Bandwidth: 20 MHz / QPSK							
Plane	Channel	Frequency (MHz)	LVL (dBm)	Correction Factor (dB)	EIRP (dBm)	EIRP (mW)	Polarization (H/V)
Z	20050	1720.0	-22.36	42.49	20.13	102.92	H
	20175	1732.5	-22.84	42.33	19.49	88.86	
	20300	1745.0	-22.71	42.10	19.39	86.90	
	20050	1720.0	-29.23	42.99	13.76	23.77	V
	20175	1732.5	-28.95	42.74	13.79	23.93	
	20300	1745.0	-29.02	42.21	13.19	20.84	
Channel Bandwidth: 20 MHz / 16QAM							
Z	20050	1720.0	-23.21	42.49	19.28	84.63	H
	20175	1732.5	-23.14	42.33	19.19	82.93	
	20300	1745.0	-23.54	42.10	18.56	71.78	
	20050	1720.0	-30.26	42.99	12.73	18.75	V
	20175	1732.5	-29.81	42.74	12.93	19.63	
	20300	1745.0	-29.87	42.21	12.34	17.14	

4.2 Frequency Stability Measurement

4.2.1 Limits of Frequency Stability Measurement

The frequency stability shall be sufficient to ensure that the fundamental emissions stay within the authorized bands of operation.

4.2.2 Test Procedure

- a. Device is placed at the oven room. The oven room could control the temperatures and humidity. Power warm up is at least 15 min and power applied should perform before recording frequency error.
- b. EUT is connected the external power supply to control the DC input power. The test voltage range is from minimum to maximum working voltage. Each step shall be record the frequency error rate.
- c. The temperature range step is 10 degrees in this test items. All temperature levels shall be hold the ± 0.5 °C during the measurement testing. The each temperature step shall be at least 0.5 hours, consider the EUT could be test under the stability condition.

Note: The frequency error was recorded frequency error from the communication simulator.

4.2.3 Test Setup

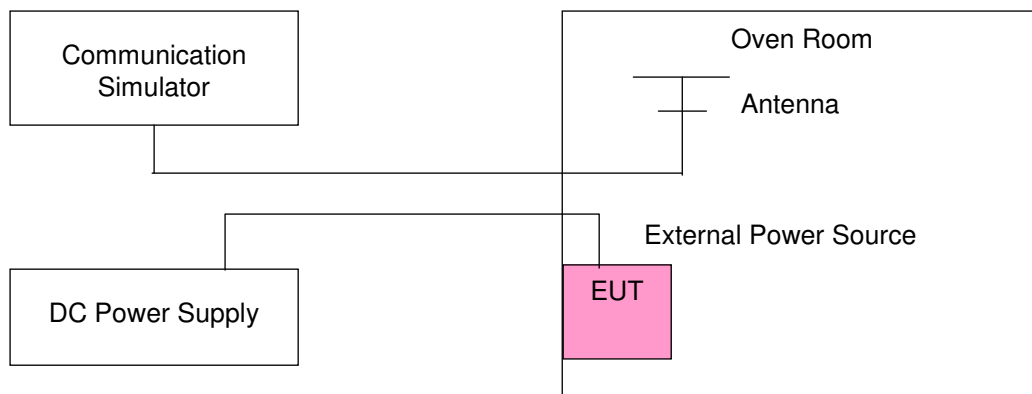

4.2.4 Test Results

Frequency Error vs. Voltage

Voltage (Volts)	Frequency Error (ppm)								Limit (ppm)
	LTE Band 4						LTE Band 13		
	1.4 MHz	3 MHz	5 MHz	10 MHz	15 MHz	20 MHz	5 MHz	10 MHz	
3.85	0.0012	0.0008	0.0015	0.0016	0.0005	0.0016	0.0015	0.0035	2.5
3.6	0.0014	0.0016	0.0004	0.0006	0.0004	0.0007	0.0020	0.0024	2.5
4.4	0.0008	0.0017	0.0002	0.0010	0.0014	0.0002	0.0014	0.0003	2.5

Note: The applicant defined the normal working voltage of the battery is from 3.6 Vdc to 4.4 Vdc.

Frequency Error vs. Temperature

Temp. (°C)	Frequency Error (ppm)								Limit (ppm)
	LTE Band 4						LTE Band 13		
	1.4 MHz	3 MHz	5 MHz	10 MHz	15 MHz	20 MHz	5 MHz	10 MHz	
-30	0.0017	0.0007	0.0018	0.0020	0.0019	0.0015	0.0013	0.0046	2.5
-20	0.0018	0.0018	0.0017	0.0016	0.0020	0.0013	0.0004	0.0040	2.5
-10	0.0017	0.0020	0.0009	0.0004	0.0011	0.0014	0.0023	0.0040	2.5
0	0.0013	0.0021	0.0009	0.0007	0.0002	0.0001	0.0004	0.0004	2.5
10	0.0022	0.0008	0.0003	0.0005	0.0004	0.0002	0.0003	0.0018	2.5
20	-0.0003	-0.0013	-0.0016	-0.0018	-0.0005	-0.0018	-0.0026	-0.0051	2.5
30	-0.0004	-0.0002	-0.0010	-0.0018	-0.0014	-0.0016	-0.0026	-0.0009	2.5
40	-0.0004	-0.0021	-0.0023	-0.0023	-0.0006	-0.0003	-0.0046	-0.0052	2.5
50	-0.0007	-0.0006	-0.0013	-0.0017	-0.0014	-0.0009	-0.0027	-0.0047	2.5
60	-0.0019	-0.0010	-0.0023	-0.0002	-0.0008	-0.0004	-0.0004	-0.0043	2.5

4.3 Occupied Bandwidth Measurement

4.3.1 Limits of Occupied Bandwidth Measurement

The width of a frequency band such that, below the lower and above the upper frequency limits, the mean powers emitted are each equal to a specified percentage 0.5 % of the total mean power of a given emission.

4.3.2 Test Procedure

- The conducted occupied bandwidth used the power splitter via EUT RF power connector between simulation base station and spectrum analyzer.
- Use OBW measurement function of Spectrum analyzer to measure 99 % occupied bandwidth.

4.3.3 Test Setup

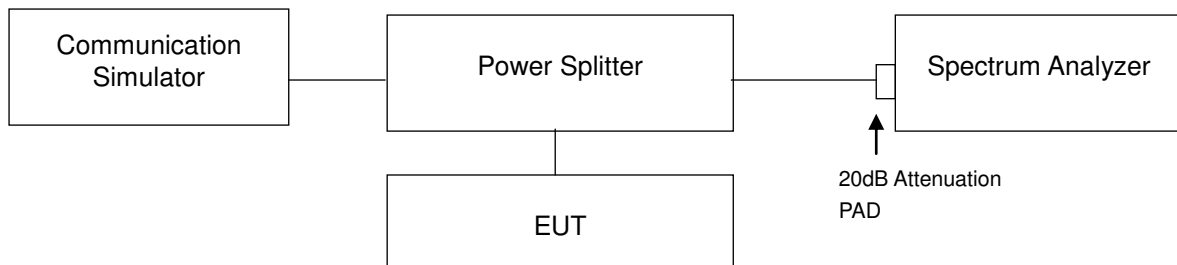

4.3.4 Test Result

LTE Band 4							
Channel Bandwidth: 1.4 MHz				Channel Bandwidth: 3 MHz			
Channel	Frequency (MHz)	99 % Occupied Bandwidth (MHz)		Channel	Frequency (MHz)	99 % Occupied Bandwidth (MHz)	
		QPSK	16QAM			QPSK	16QAM
19957	1710.7	1.0926	1.0886	19965	1711.5	2.6950	2.6998
20175	1732.5	1.0916	1.0907	20175	1732.5	2.6954	2.6948
20393	1754.3	1.0921	1.0886	20385	1753.5	2.6943	2.6965

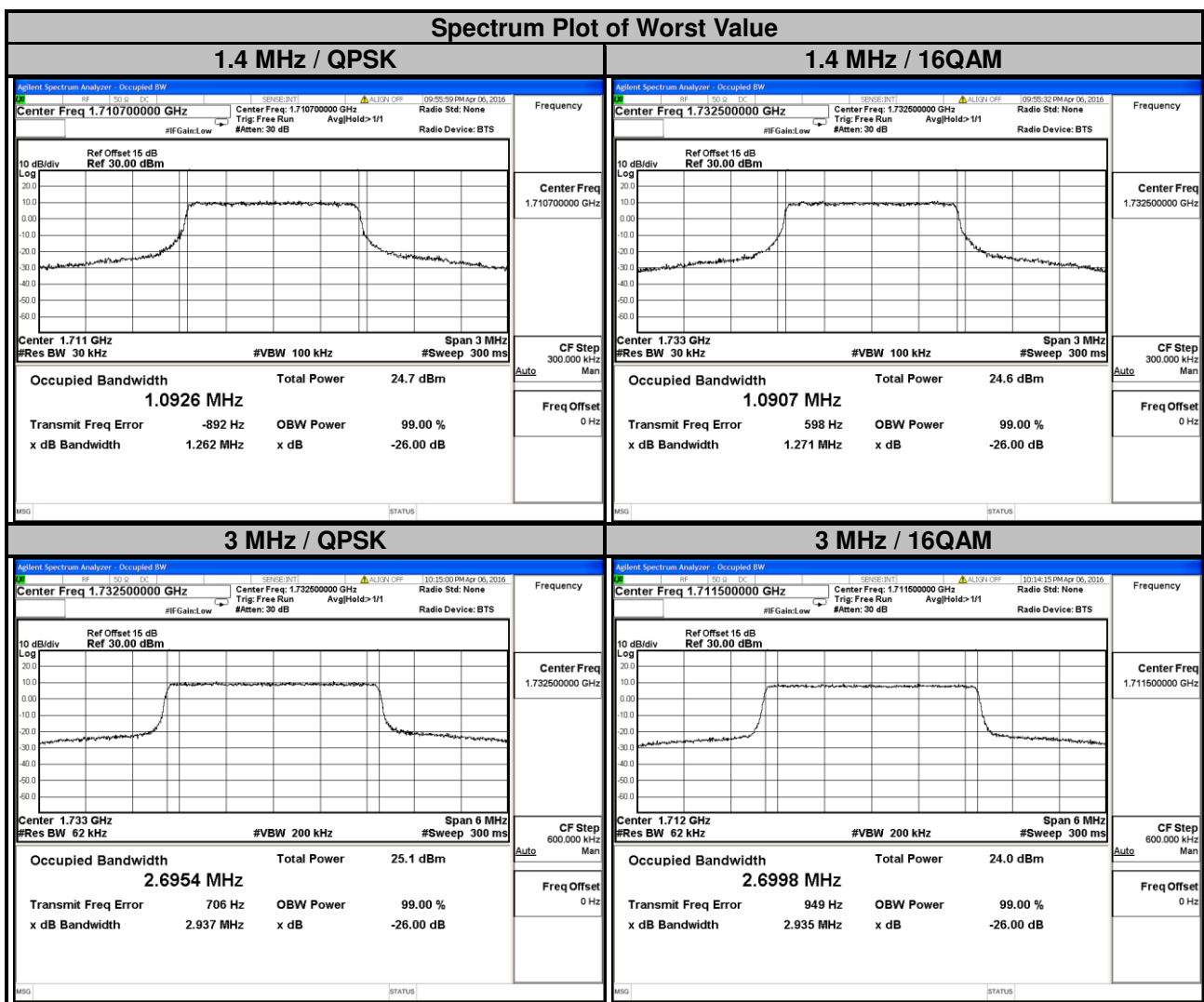

LTE Band 4

Channel Bandwidth: 5 MHz				Channel Bandwidth: 10 MHz			
Channel	Frequency (MHz)	99 % Occupied Bandwidth (MHz)		Channel	Frequency (MHz)	99 % Occupied Bandwidth (MHz)	
		QPSK	16QAM			QPSK	16QAM
19975	1712.5	4.4995	4.4957	20000	1715.0	8.9672	8.9711
20175	1732.5	4.4984	4.4977	20175	1732.5	8.9642	8.9608
20375	1752.5	4.4945	4.4900	20350	1750.0	8.9727	8.9612

Spectrum Plot of Worst Value

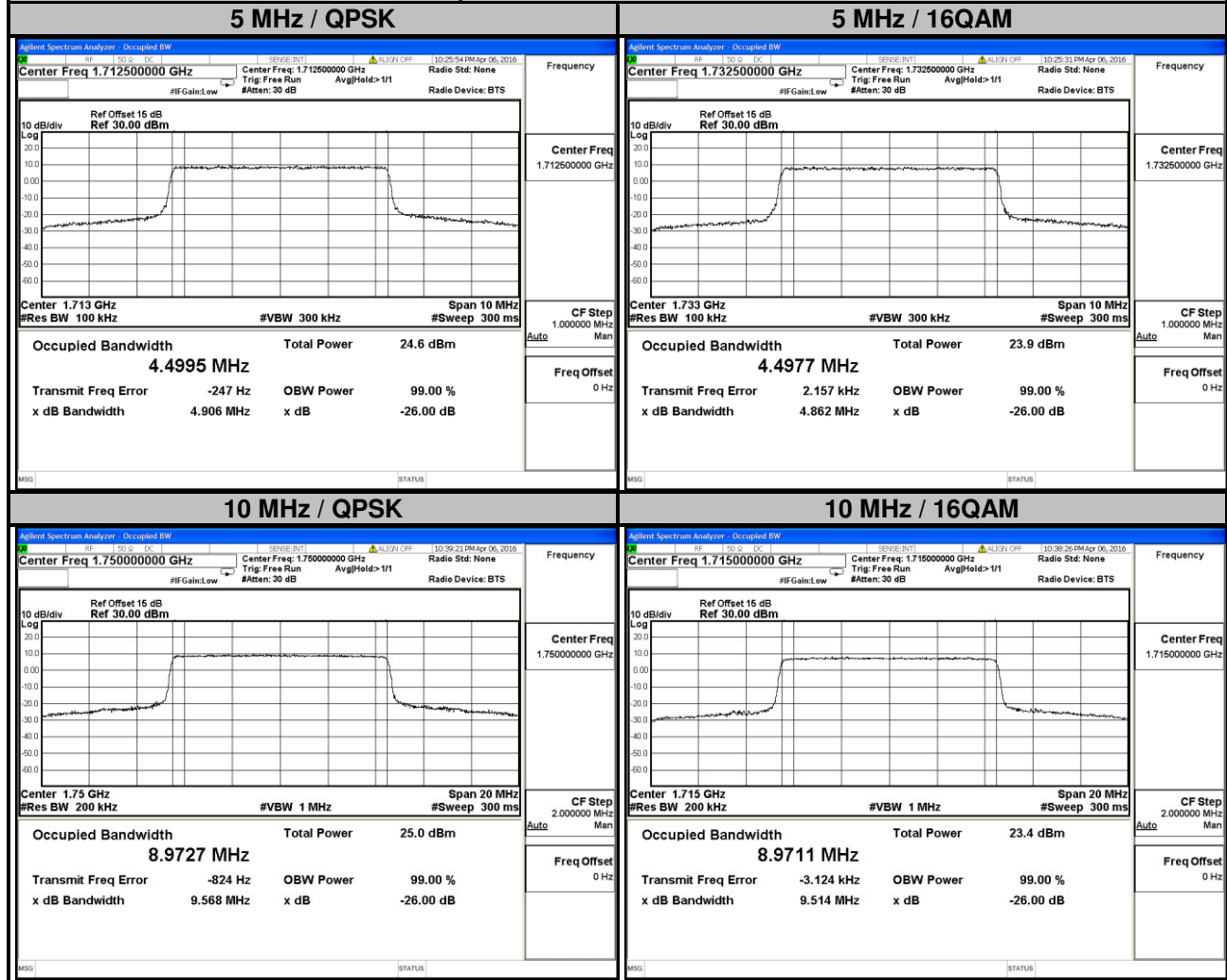

LTE Band 4

Channel Bandwidth: 15 MHz

Channel Bandwidth: 20 MHz

Channel	Frequency (MHz)	99 % Occupied Bandwidth (MHz)		Channel	Frequency (MHz)	99 % Occupied Bandwidth (MHz)	
		QPSK	16QAM			QPSK	16QAM
20025	1717.5	13.470	13.464	20050	1720.0	17.953	17.940
20175	1732.5	13.464	13.465	20175	1732.5	17.947	17.946
20325	1747.5	13.455	13.464	20300	1745.0	17.942	17.941

Spectrum Plot of Worst Value

15 MHz / QPSK

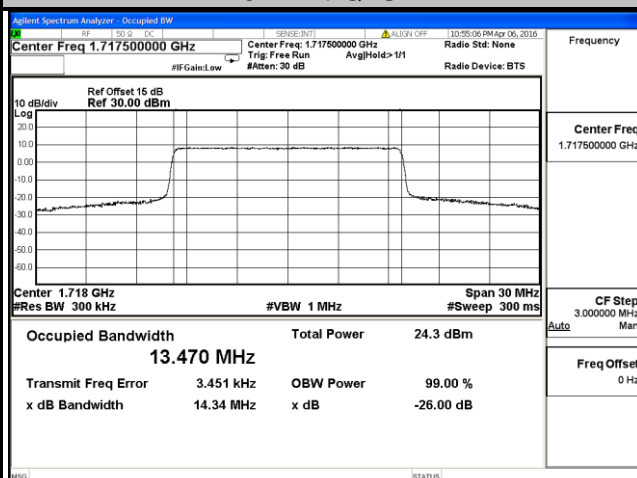

15 MHz / 16QAM

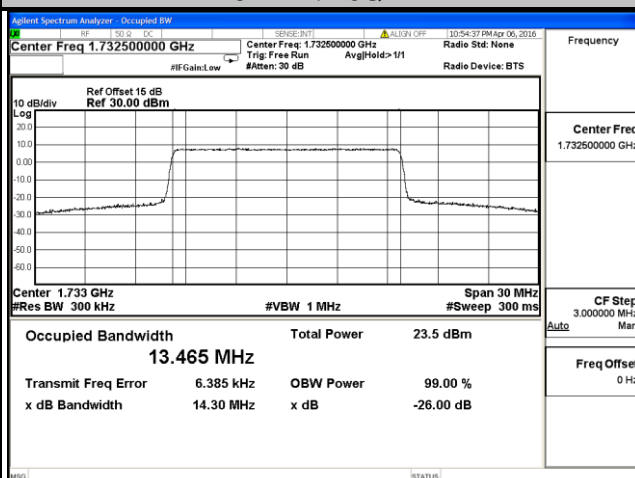

20 MHz / QPSK

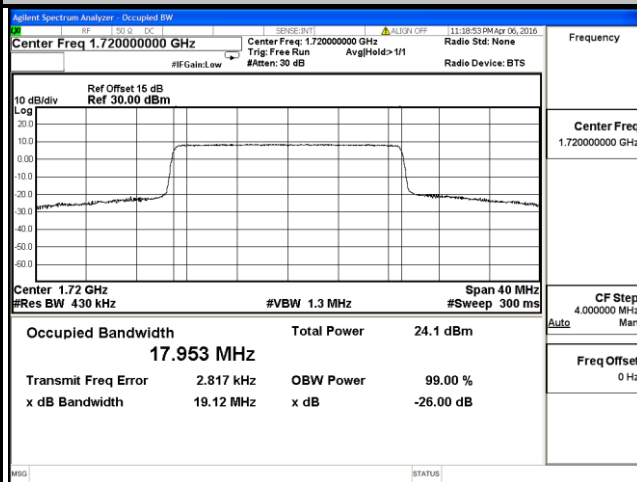

20 MHz / 16QAM

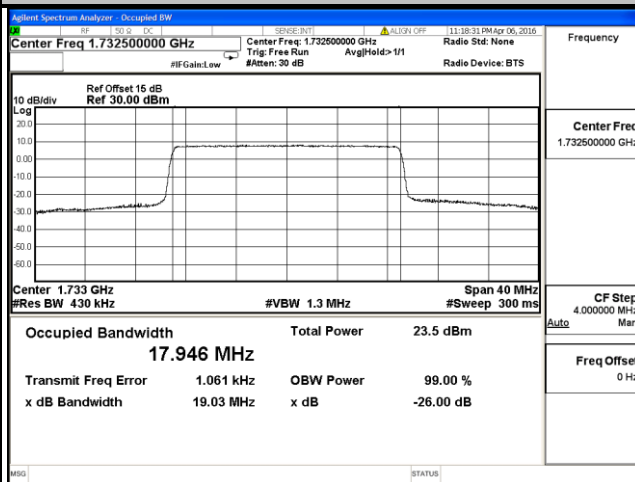

LTE Band 13

Channel Bandwidth: 5 MHz				Channel Bandwidth: 10 MHz			
Channel	Frequency (MHz)	99 % Occupied Bandwidth (MHz)		Channel	Frequency (MHz)	99 % Occupied Bandwidth (MHz)	
		QPSK	16QAM			QPSK	16QAM
23205	779.5	4.4951	4.4959	23230	782.0	8.9442	8.9404
23230	782.0	4.4978	4.4926				
23255	784.5	4.4949	4.4947				

Spectrum Plot of Worst Value

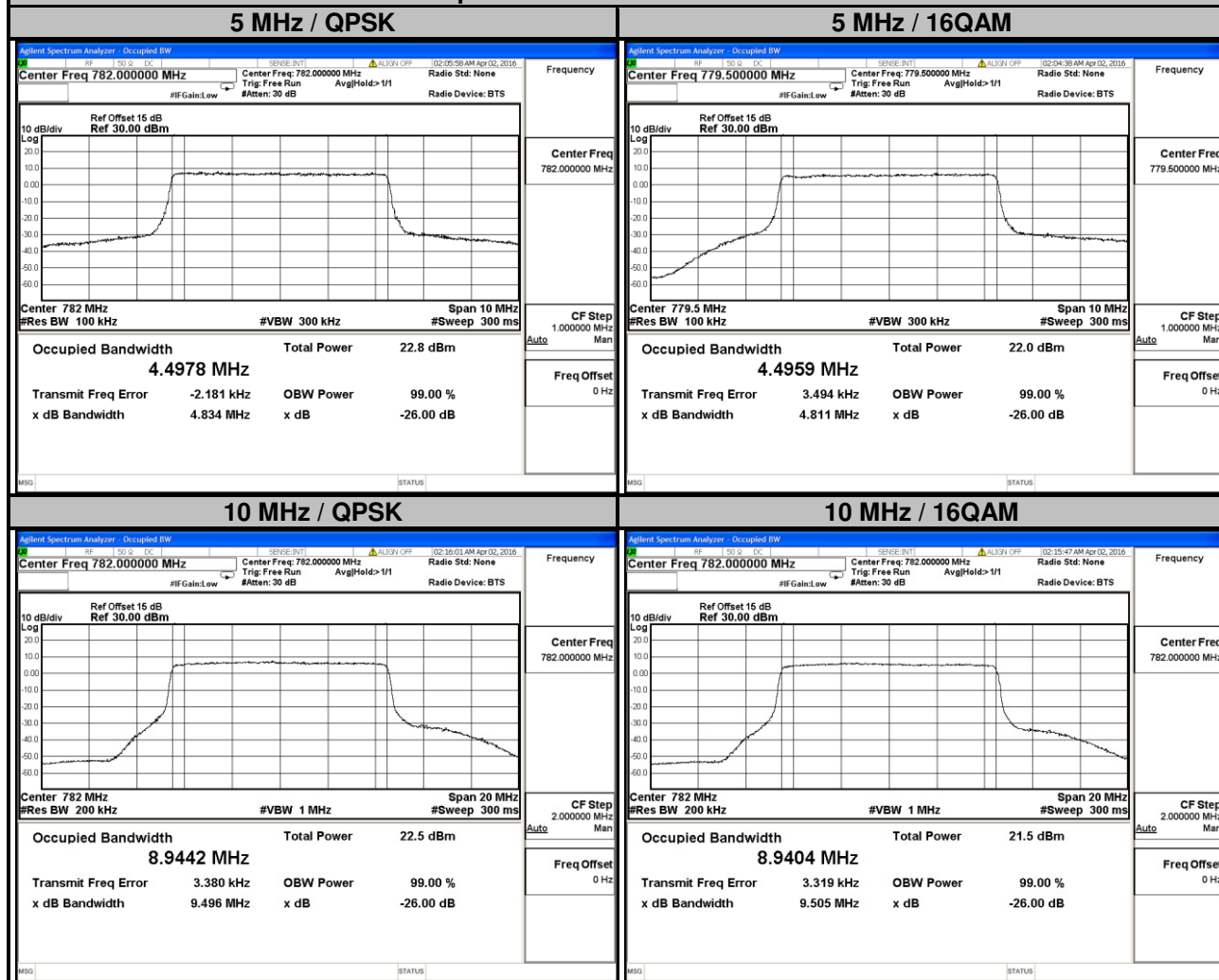

4.4 Band Edge Measurement

4.4.1 Limits of Band Edge Measurement

For operations in the 776-787 MHz band, the power of any emission outside a licensee's frequency band(s) of operation shall be attenuated below the transmitter power (P) within the licensed band(s) of operation, measured in watts, by at least $43 + 10 \log(P)$ dB. Compliance with this provision is based on the use of measurement instrumentation employing a resolution bandwidth of 100 kilohertz or greater.

However, in the 100 kilohertz bands immediately outside and adjacent to a licensee's frequency block, a resolution bandwidth of at least 30 kHz may be employed.

For operations in the 1710–1755 MHz bands, the power of any emission outside a licensee's frequency block shall be attenuated below the transmitter power (P) by at least $43 + 10 \log_{10}(P)$ dB.

4.4.2 Test Setup

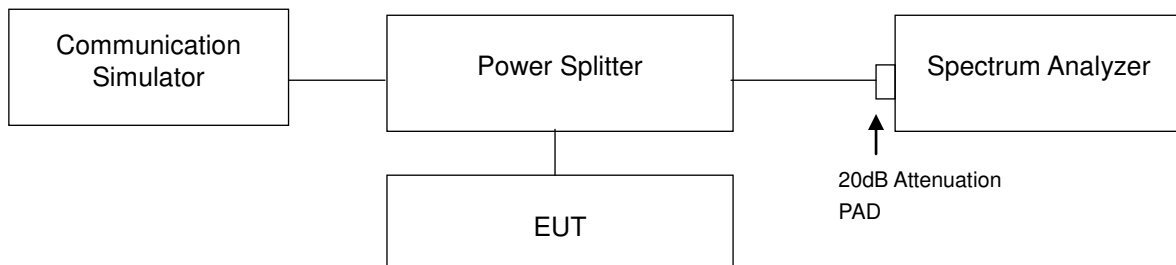

4.4.3 Test Procedures

- a. All measurements were done at low and high operational frequency range.
- b. The center frequency of spectrum is the band edge frequency and span is 1 MHz. RB of the spectrum is 13 kHz and VB of the spectrum is 51 kHz (LTE Bandwidth 1.4 MHz).
- c. The center frequency of spectrum is the band edge frequency and span is 1 MHz. RB of the spectrum is 30 kHz and VB of the spectrum is 100 kHz (LTE Bandwidth 3 MHz).
- d. The center frequency of spectrum is the band edge frequency and span is 1 MHz. RB of the spectrum is 100 kHz and VB of the spectrum is 300 kHz (LTE Bandwidth 5 MHz/10 MHz).
- e. The center frequency of spectrum is the band edge frequency and span is 1 MHz. RB of the spectrum is 150 kHz and VB of the spectrum is 470 kHz (LTE Bandwidth 15 MHz).
- f. The center frequency of spectrum is the band edge frequency and span is 1 MHz. RB of the spectrum is 180 kHz and VB of the spectrum is 560 kHz (LTE Bandwidth 20 MHz).
- g. Record the max trace plot into the test report.

4.4.4 Test Results

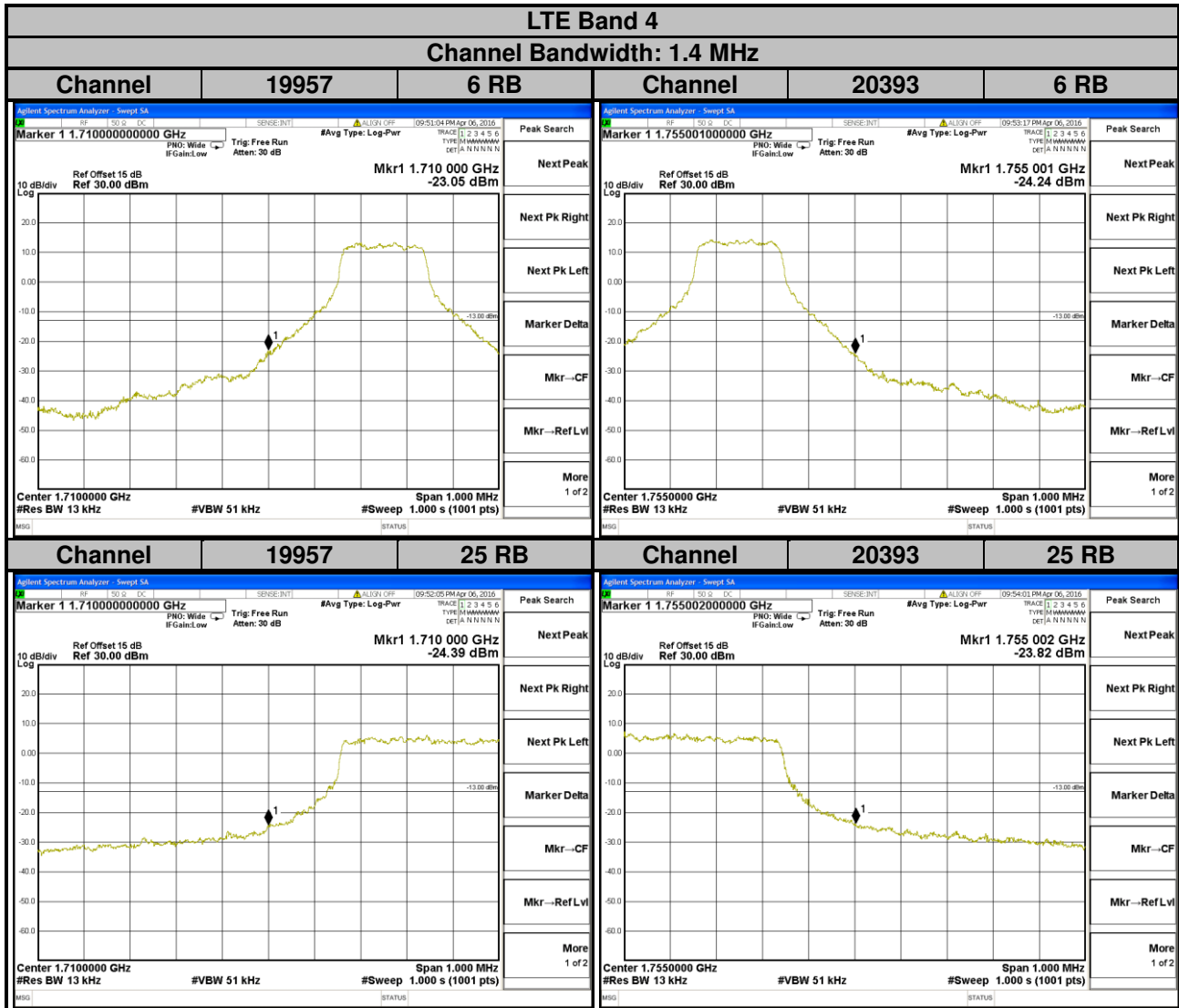

LTE Band 4
Channel Bandwidth: 3 MHz

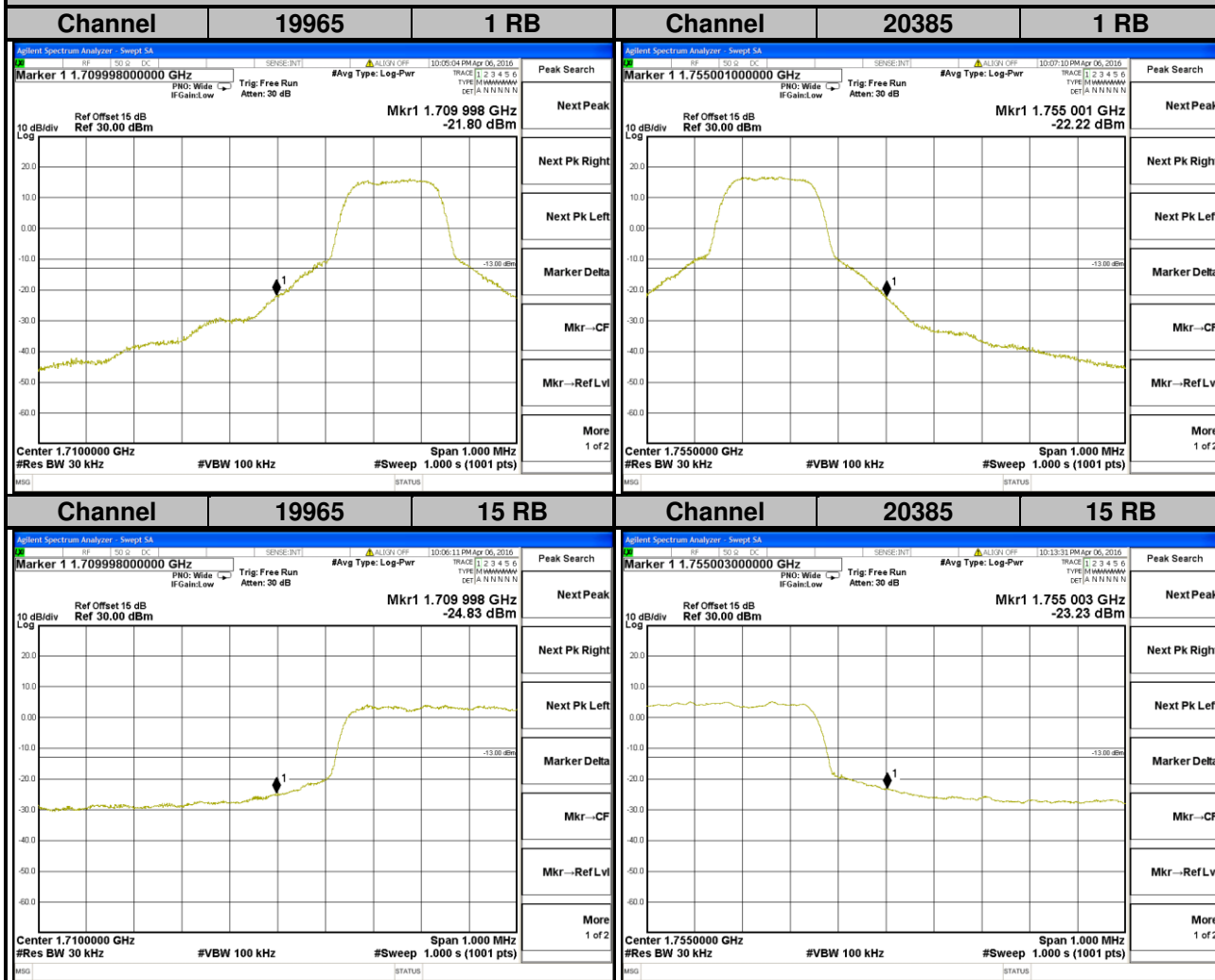

LTE Band 4
Channel Bandwidth: 5 MHz

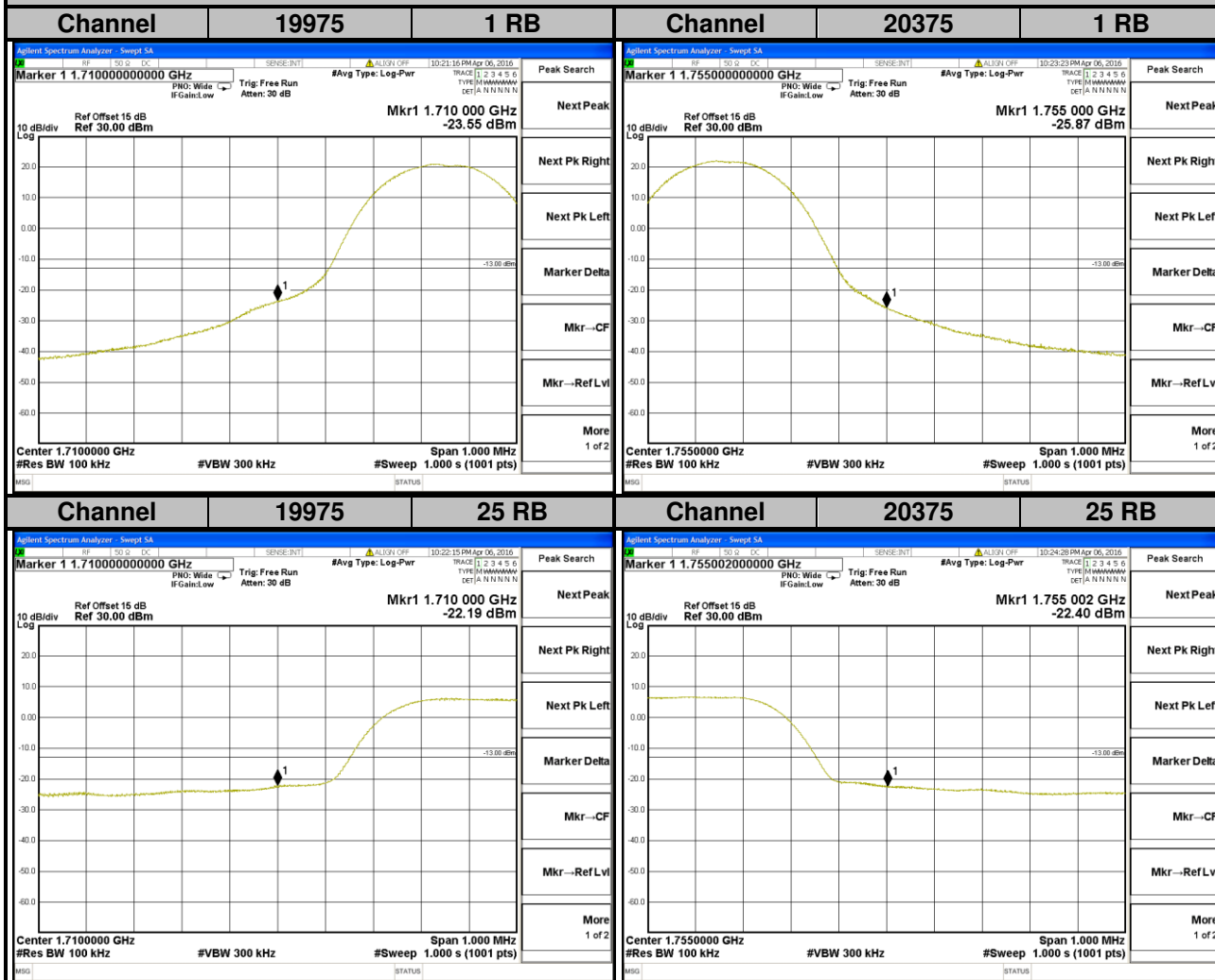

LTE Band 4
Channel Bandwidth: 10 MHz

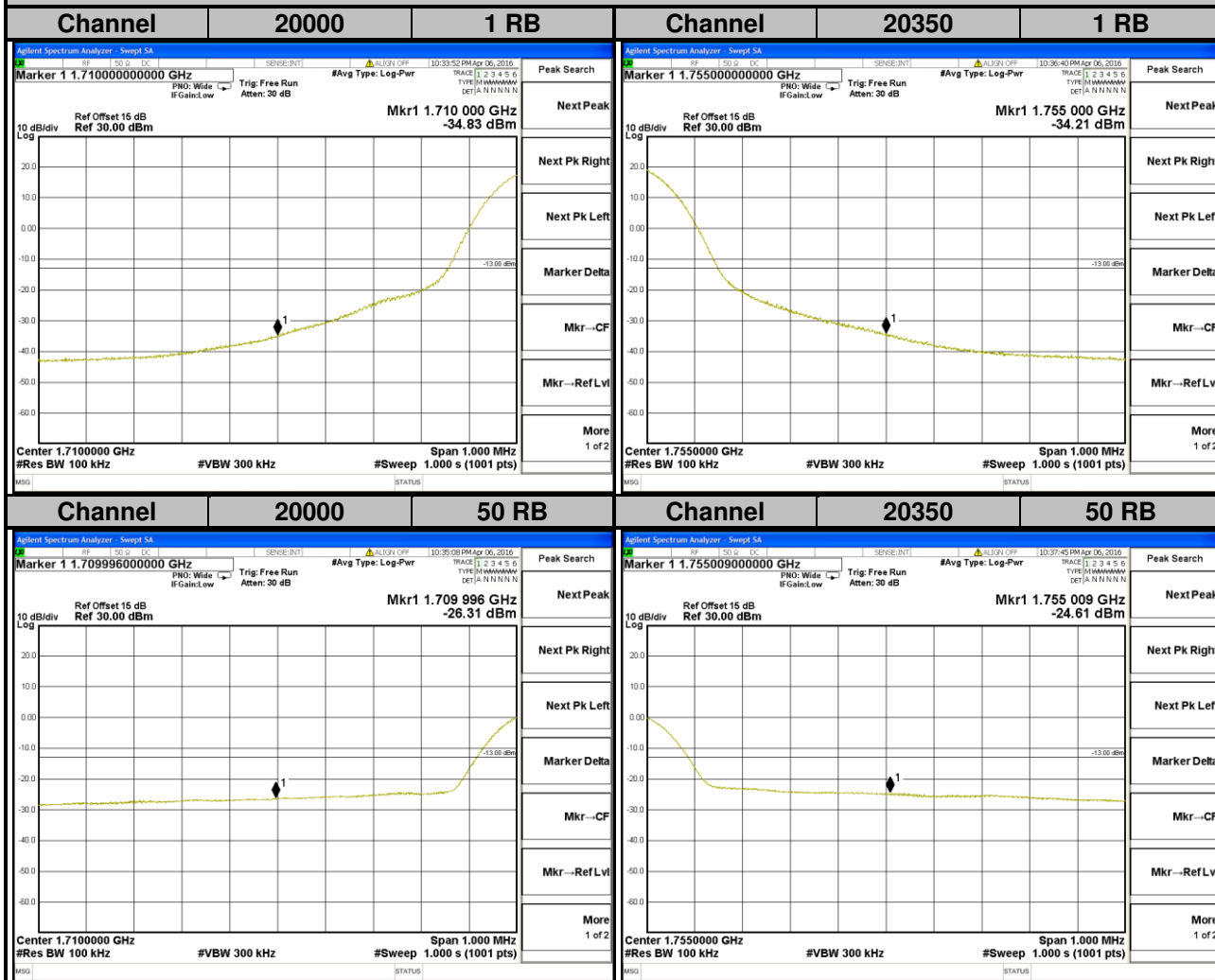

LTE Band 4
Channel Bandwidth: 15 MHz

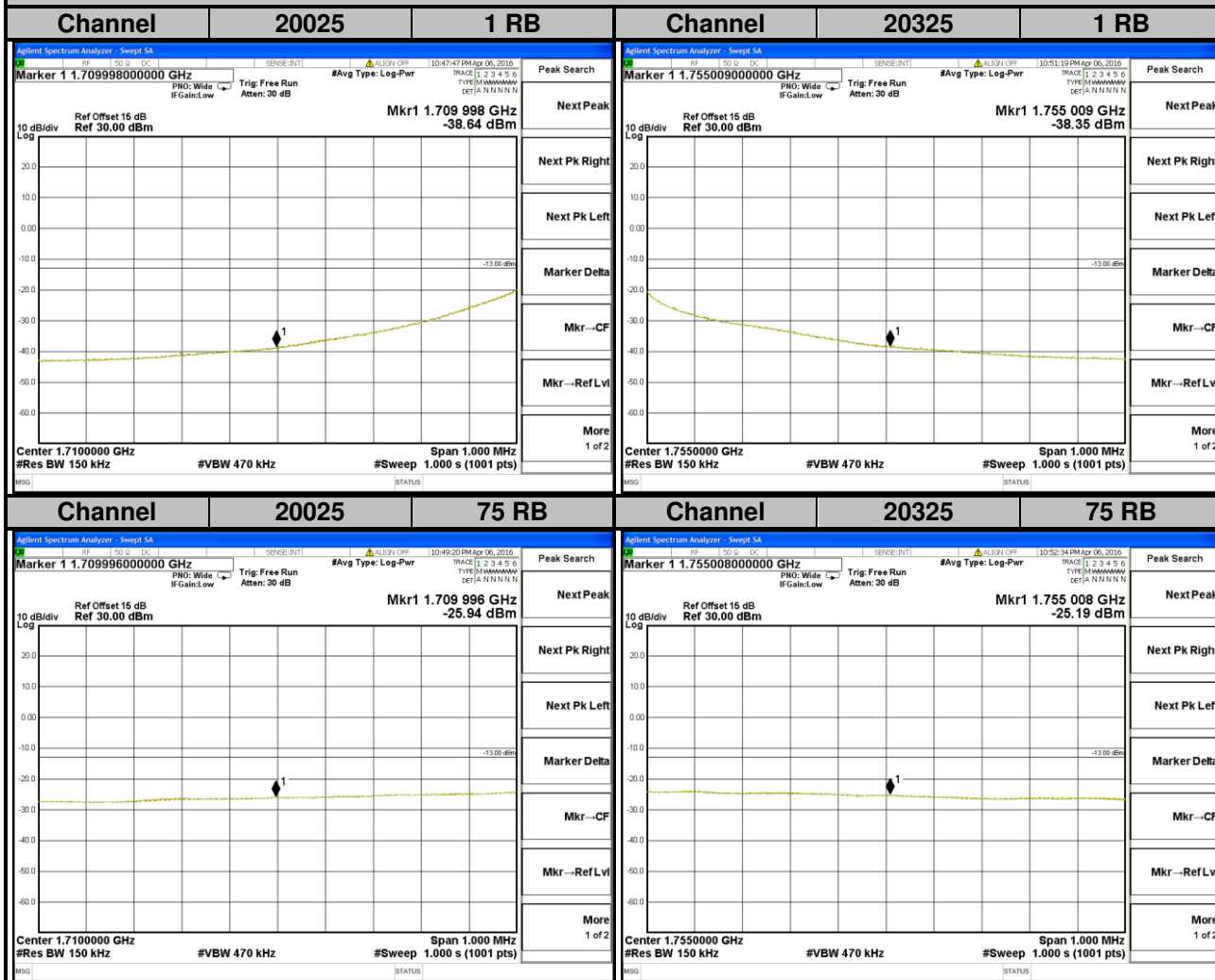

LTE Band 4
Channel Bandwidth: 20 MHz

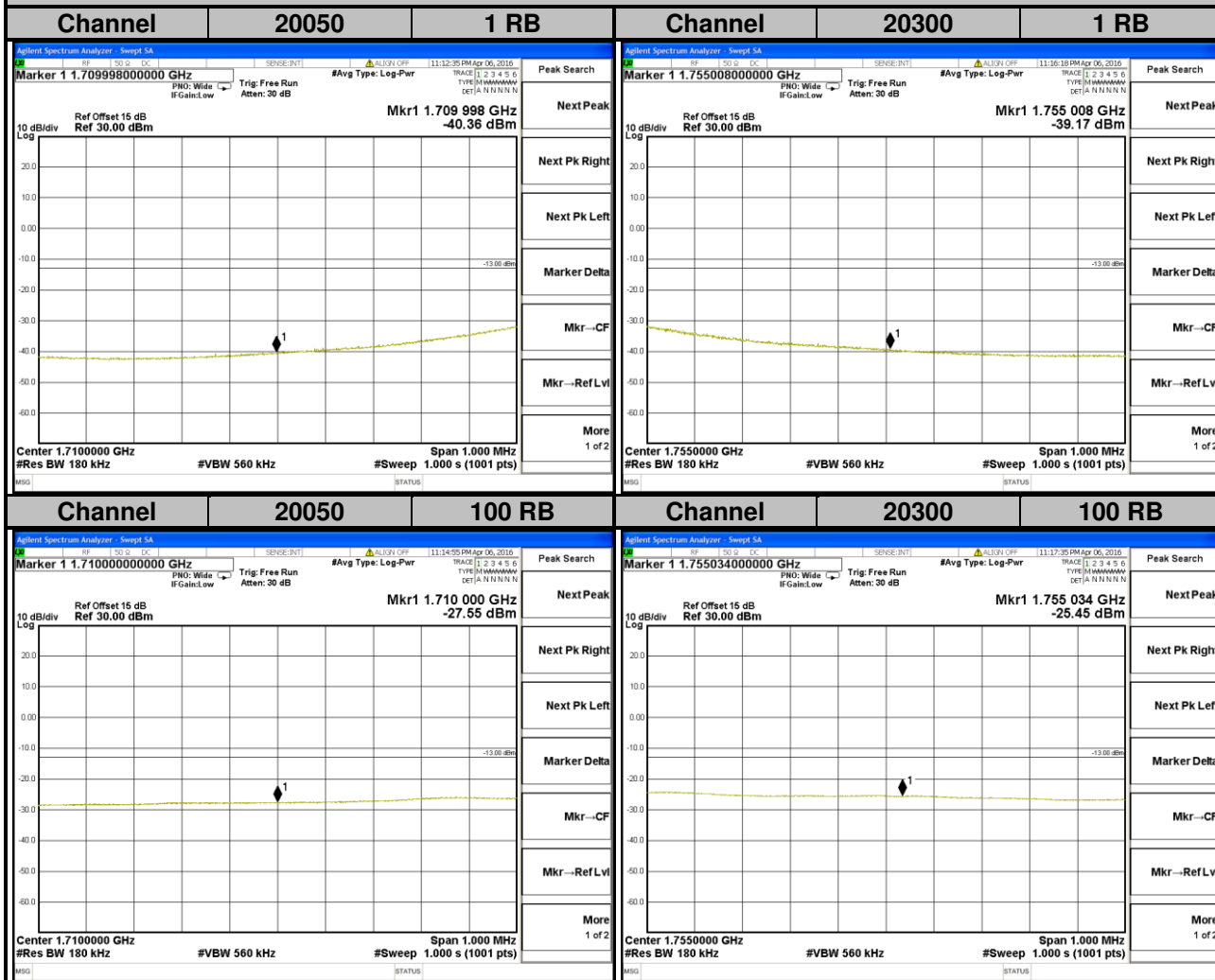

LTE Band 13
Channel Bandwidth: 5 MHz

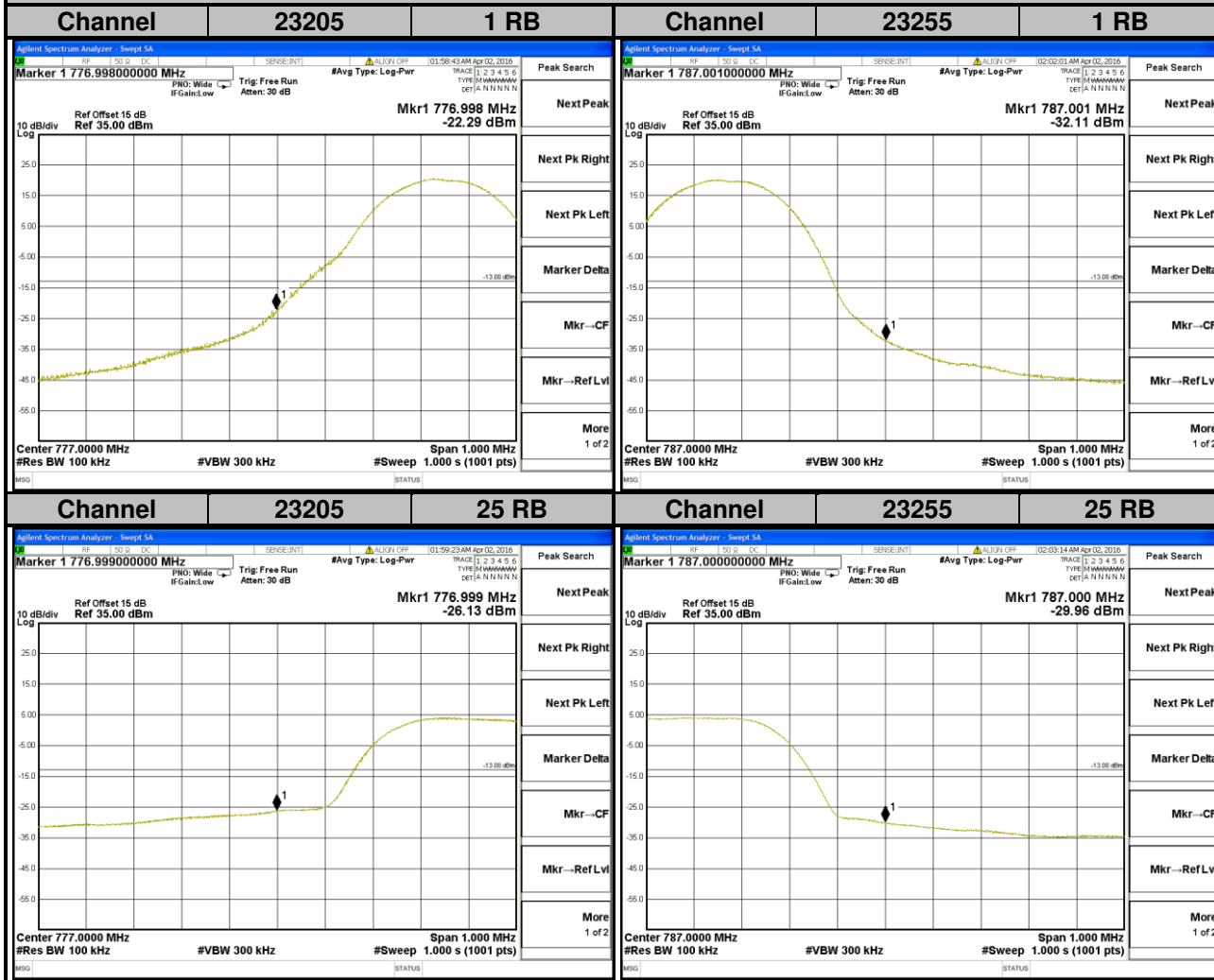

LTE Band 13
Channel Bandwidth: 10 MHz

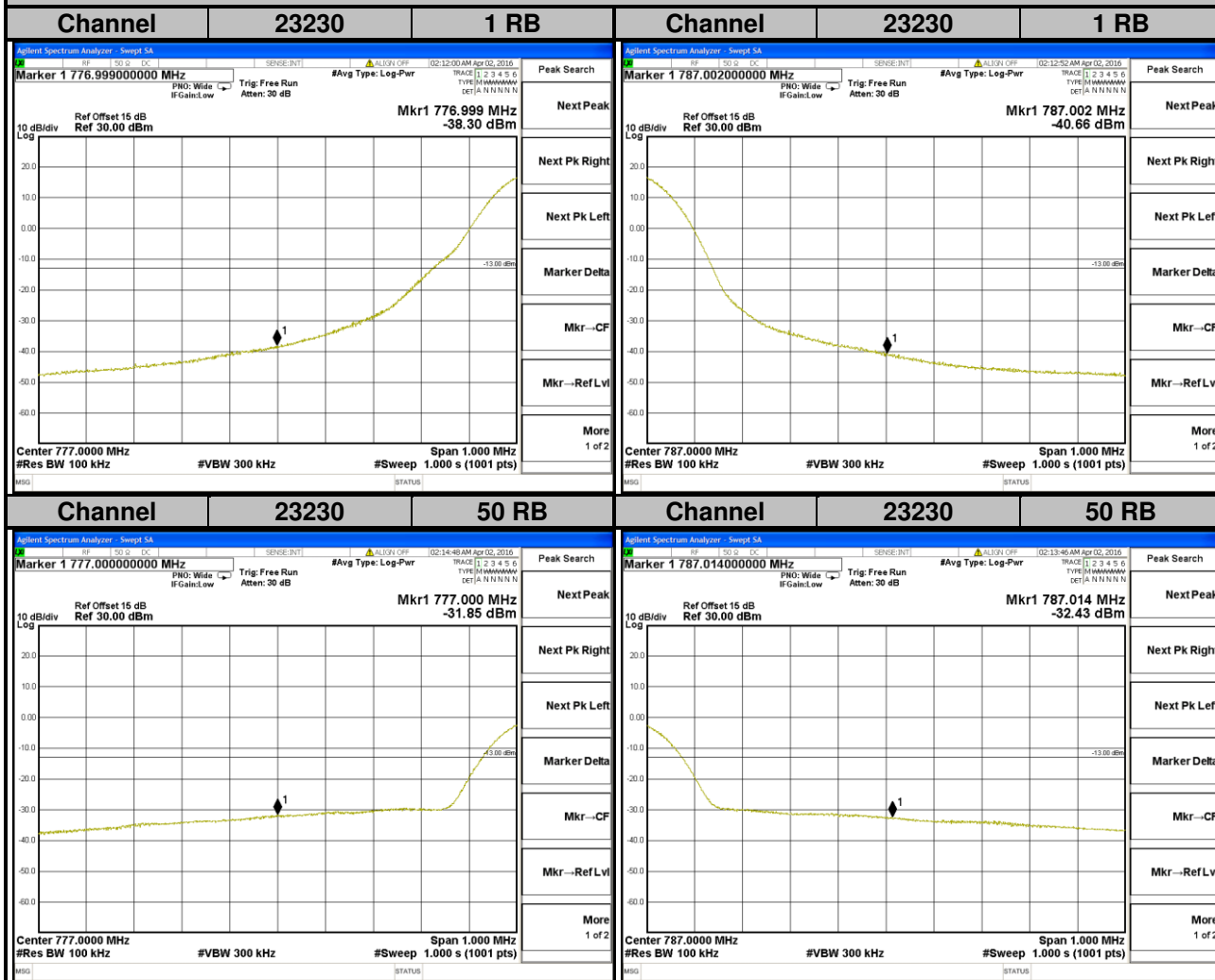

4.5 Peak to Average Ratio

4.5.1 Limits of Peak to Average Ratio Measurement

In measuring transmissions in this band using an average power technique, the peak to-average ratio (PAR) of the transmission may not exceed 13 dB.

4.5.2 Test Setup

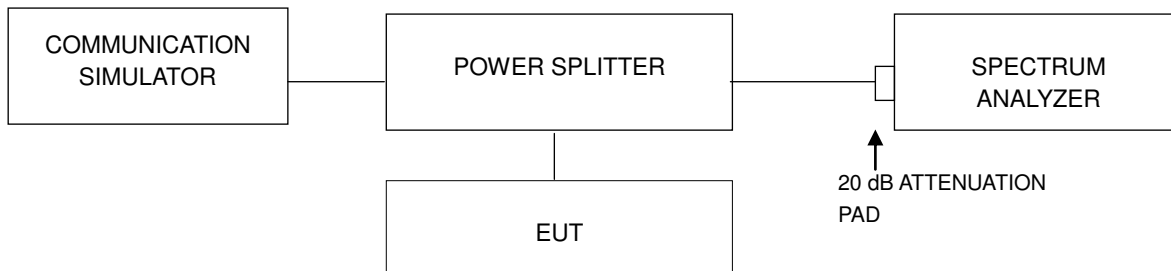

4.5.3 Test Procedures

1. Set resolution/measurement bandwidth \geq signal's occupied bandwidth;
2. Set the number of counts to a value that stabilizes the measured CCDF curve;
3. Record the maximum PAPR level associated with a probability of 0.1 %.

4.5.4 Test Results

LTE Band 4							
Channel Bandwidth: 1.4 MHz				Channel Bandwidth: 3 MHz			
Channel	Frequency (MHz)	Peak to Average Ratio (dB)		Channel	Frequency (MHz)	Peak to Average Ratio (dB)	
		QPSK	16QAM			QPSK	16QAM
19957	1710.7	4.50	3.93	19965	1711.5	4.42	4.71
20175	1732.5	3.85	4.47	20175	1732.5	4.26	3.87
20393	1754.3	3.62	3.93	20385	1753.5	3.92	3.65

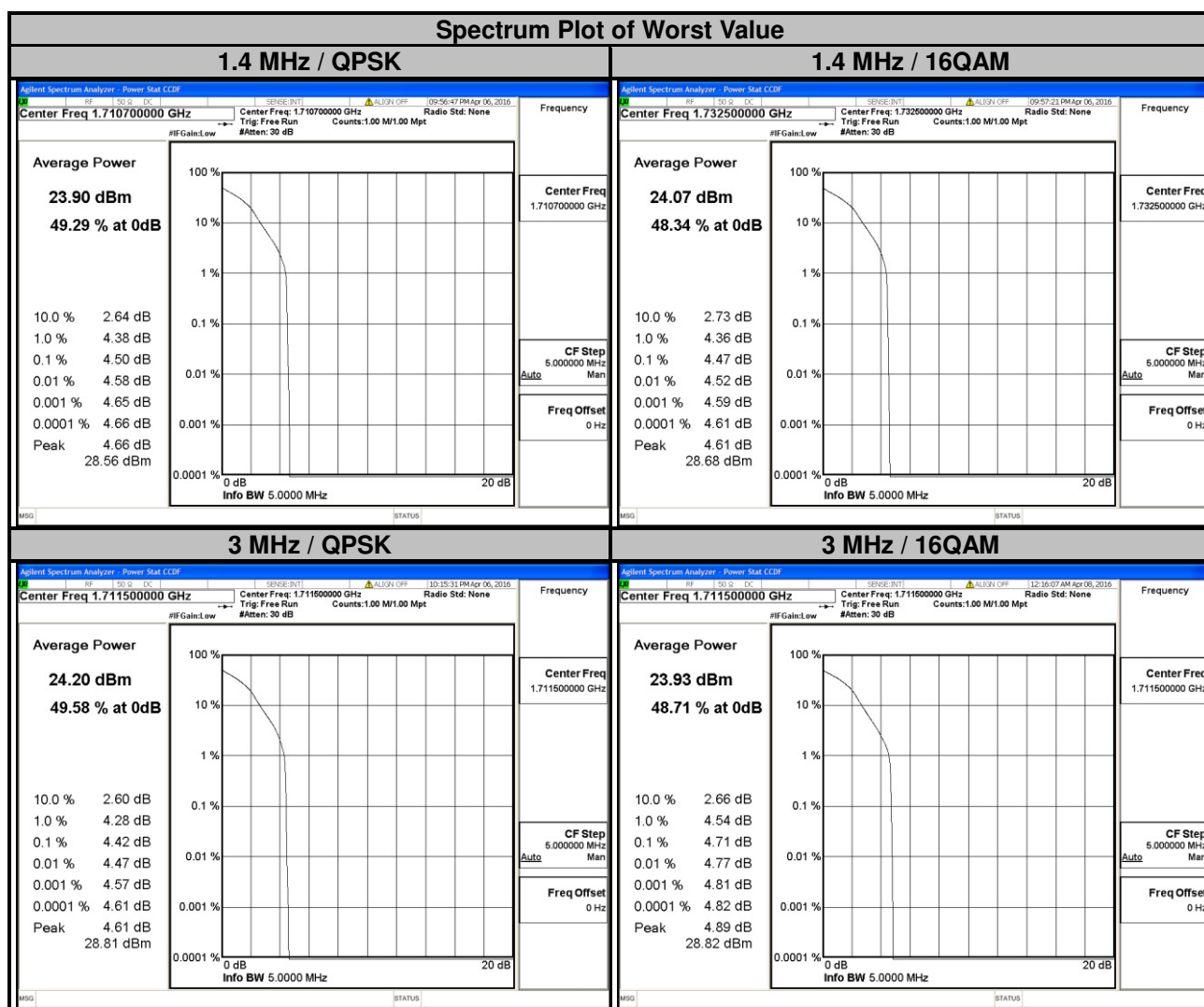

LTE Band 4

Channel Bandwidth: 5 MHz				Channel Bandwidth: 10 MHz			
Channel	Frequency (MHz)	Peak to Average Ratio (dB)		Channel	Frequency (MHz)	Peak to Average Ratio (dB)	
		QPSK	16QAM			QPSK	16QAM
19975	1712.5	3.84	4.49	20000	1715.0	3.89	4.41
20175	1732.5	3.80	4.25	20175	1732.5	3.86	4.29
20375	1752.5	3.54	3.86	20350	1750.0	3.42	3.73

Spectrum Plot of Worst Value

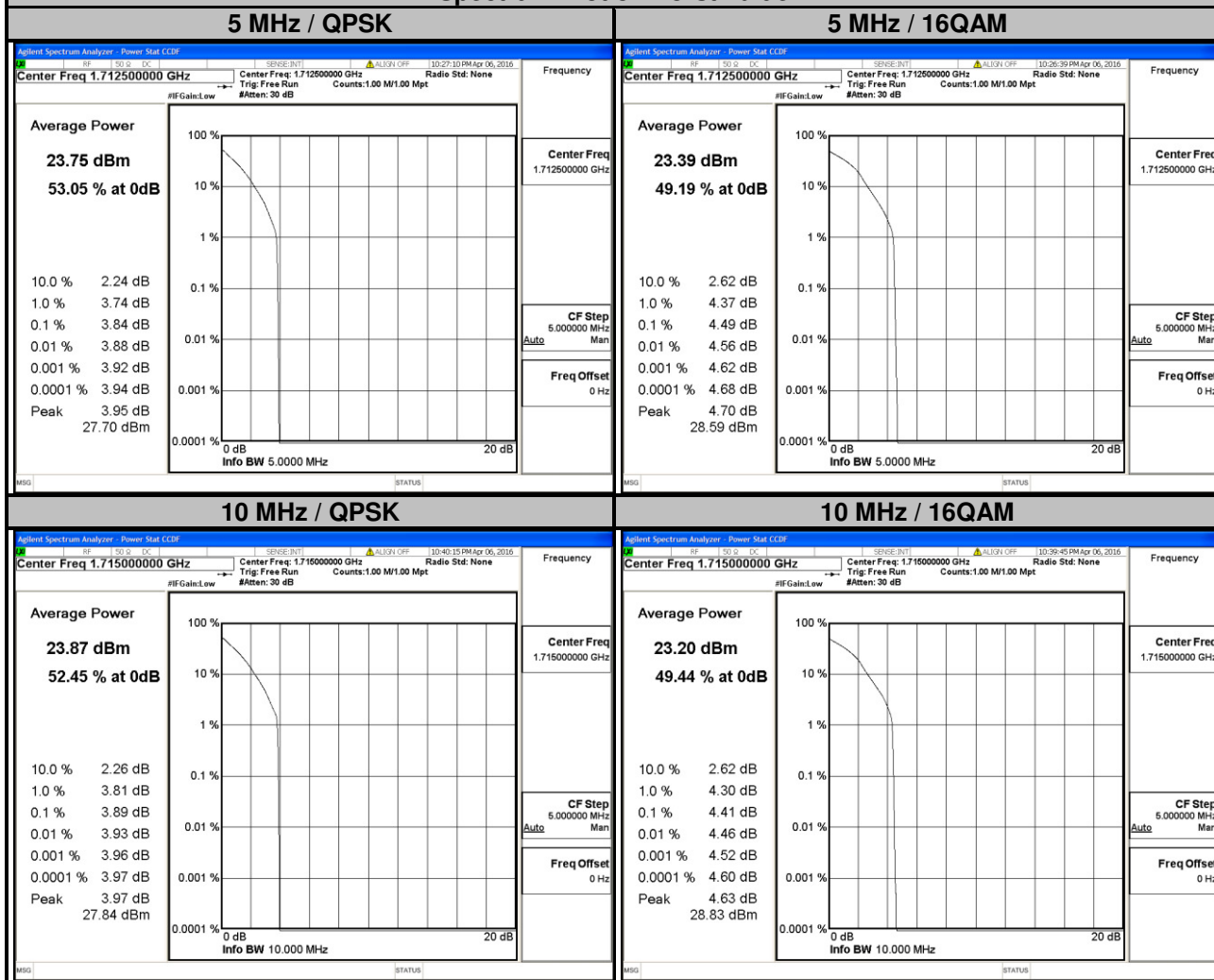

LTE Band 4

Channel Bandwidth: 15 MHz				Channel Bandwidth: 20 MHz			
Channel	Frequency (MHz)	Peak to Average Ratio (dB)		Channel	Frequency (MHz)	Peak to Average Ratio (dB)	
		QPSK	16QAM			QPSK	16QAM
20025	1717.5	3.79	4.32	20050	1720.0	3.83	4.29
20175	1732.5	3.87	4.35	20175	1732.5	3.84	4.36
20325	1747.5	3.59	3.79	20300	1745.0	3.65	3.96

Spectrum Plot of Worst Value

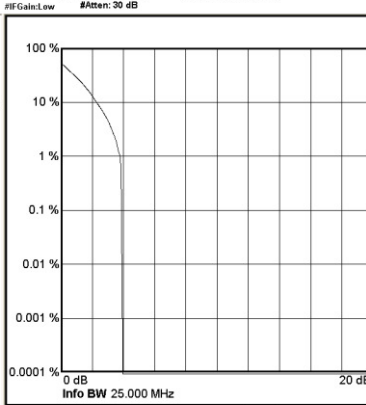
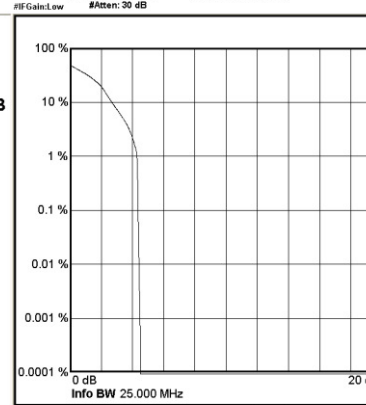
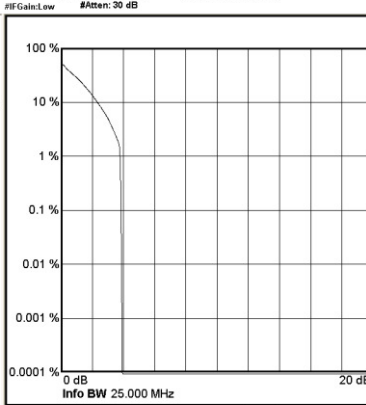
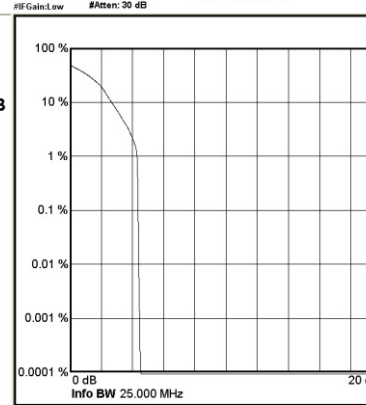
15 MHz / QPSK		15 MHz / 16QAM																															
<p>Average Power</p> <p>24.45 dBm</p> <p>51.75 % at 0dB</p> <table border="1" style="width: 100%; font-size: small;"> <tr><td>10.0 %</td><td>2.26 dB</td></tr> <tr><td>1.0 %</td><td>3.77 dB</td></tr> <tr><td>0.1 %</td><td>3.87 dB</td></tr> <tr><td>0.01 %</td><td>3.90 dB</td></tr> <tr><td>0.001 %</td><td>3.94 dB</td></tr> <tr><td>0.0001 %</td><td>3.96 dB</td></tr> <tr><td>Peak</td><td>4.03 dB</td></tr> <tr><td></td><td>28.48 dBm</td></tr> </table>  <p style="font-size: x-small;">Info BW 25.000 MHz</p>	10.0 %	2.26 dB	1.0 %	3.77 dB	0.1 %	3.87 dB	0.01 %	3.90 dB	0.001 %	3.94 dB	0.0001 %	3.96 dB	Peak	4.03 dB		28.48 dBm	<p>Average Power</p> <p>24.40 dBm</p> <p>48.50 % at 0dB</p> <table border="1" style="width: 100%; font-size: small;"> <tr><td>10.0 %</td><td>2.66 dB</td></tr> <tr><td>1.0 %</td><td>4.28 dB</td></tr> <tr><td>0.1 %</td><td>4.35 dB</td></tr> <tr><td>0.01 %</td><td>4.41 dB</td></tr> <tr><td>0.001 %</td><td>4.48 dB</td></tr> <tr><td>0.0001 %</td><td>4.50 dB</td></tr> <tr><td>Peak</td><td>4.54 dB</td></tr> <tr><td></td><td>28.94 dBm</td></tr> </table>  <p style="font-size: x-small;">Info BW 25.000 MHz</p>	10.0 %	2.66 dB	1.0 %	4.28 dB	0.1 %	4.35 dB	0.01 %	4.41 dB	0.001 %	4.48 dB	0.0001 %	4.50 dB	Peak	4.54 dB		28.94 dBm
10.0 %	2.26 dB																																
1.0 %	3.77 dB																																
0.1 %	3.87 dB																																
0.01 %	3.90 dB																																
0.001 %	3.94 dB																																
0.0001 %	3.96 dB																																
Peak	4.03 dB																																
	28.48 dBm																																
10.0 %	2.66 dB																																
1.0 %	4.28 dB																																
0.1 %	4.35 dB																																
0.01 %	4.41 dB																																
0.001 %	4.48 dB																																
0.0001 %	4.50 dB																																
Peak	4.54 dB																																
	28.94 dBm																																
<p>Average Power</p> <p>24.42 dBm</p> <p>51.74 % at 0dB</p> <table border="1" style="width: 100%; font-size: small;"> <tr><td>10.0 %</td><td>2.32 dB</td></tr> <tr><td>1.0 %</td><td>3.78 dB</td></tr> <tr><td>0.1 %</td><td>3.84 dB</td></tr> <tr><td>0.01 %</td><td>3.87 dB</td></tr> <tr><td>0.001 %</td><td>3.91 dB</td></tr> <tr><td>0.0001 %</td><td>3.93 dB</td></tr> <tr><td>Peak</td><td>3.94 dB</td></tr> <tr><td></td><td>28.36 dBm</td></tr> </table>  <p style="font-size: x-small;">Info BW 25.000 MHz</p>	10.0 %	2.32 dB	1.0 %	3.78 dB	0.1 %	3.84 dB	0.01 %	3.87 dB	0.001 %	3.91 dB	0.0001 %	3.93 dB	Peak	3.94 dB		28.36 dBm	<p>Average Power</p> <p>24.41 dBm</p> <p>48.83 % at 0dB</p> <table border="1" style="width: 100%; font-size: small;"> <tr><td>10.0 %</td><td>2.64 dB</td></tr> <tr><td>1.0 %</td><td>4.28 dB</td></tr> <tr><td>0.1 %</td><td>4.36 dB</td></tr> <tr><td>0.01 %</td><td>4.39 dB</td></tr> <tr><td>0.001 %</td><td>4.46 dB</td></tr> <tr><td>0.0001 %</td><td>4.50 dB</td></tr> <tr><td>Peak</td><td>4.55 dB</td></tr> <tr><td></td><td>28.96 dBm</td></tr> </table>  <p style="font-size: x-small;">Info BW 25.000 MHz</p>	10.0 %	2.64 dB	1.0 %	4.28 dB	0.1 %	4.36 dB	0.01 %	4.39 dB	0.001 %	4.46 dB	0.0001 %	4.50 dB	Peak	4.55 dB		28.96 dBm
10.0 %	2.32 dB																																
1.0 %	3.78 dB																																
0.1 %	3.84 dB																																
0.01 %	3.87 dB																																
0.001 %	3.91 dB																																
0.0001 %	3.93 dB																																
Peak	3.94 dB																																
	28.36 dBm																																
10.0 %	2.64 dB																																
1.0 %	4.28 dB																																
0.1 %	4.36 dB																																
0.01 %	4.39 dB																																
0.001 %	4.46 dB																																
0.0001 %	4.50 dB																																
Peak	4.55 dB																																
	28.96 dBm																																

LTE Band 13

Channel Bandwidth: 5 MHz				Channel Bandwidth: 10 MHz			
Channel	Frequency (MHz)	Peak to Average Ratio (dB)		Channel	Frequency (MHz)	Peak to Average Ratio (dB)	
		QPSK	16QAM			QPSK	16QAM
23205	779.5	2.07	2.80	23230	782.0	2.28	3.14
23230	782.0	3.82	4.61				
23255	784.5	3.96	4.75				

Spectrum Plot of Worst Value

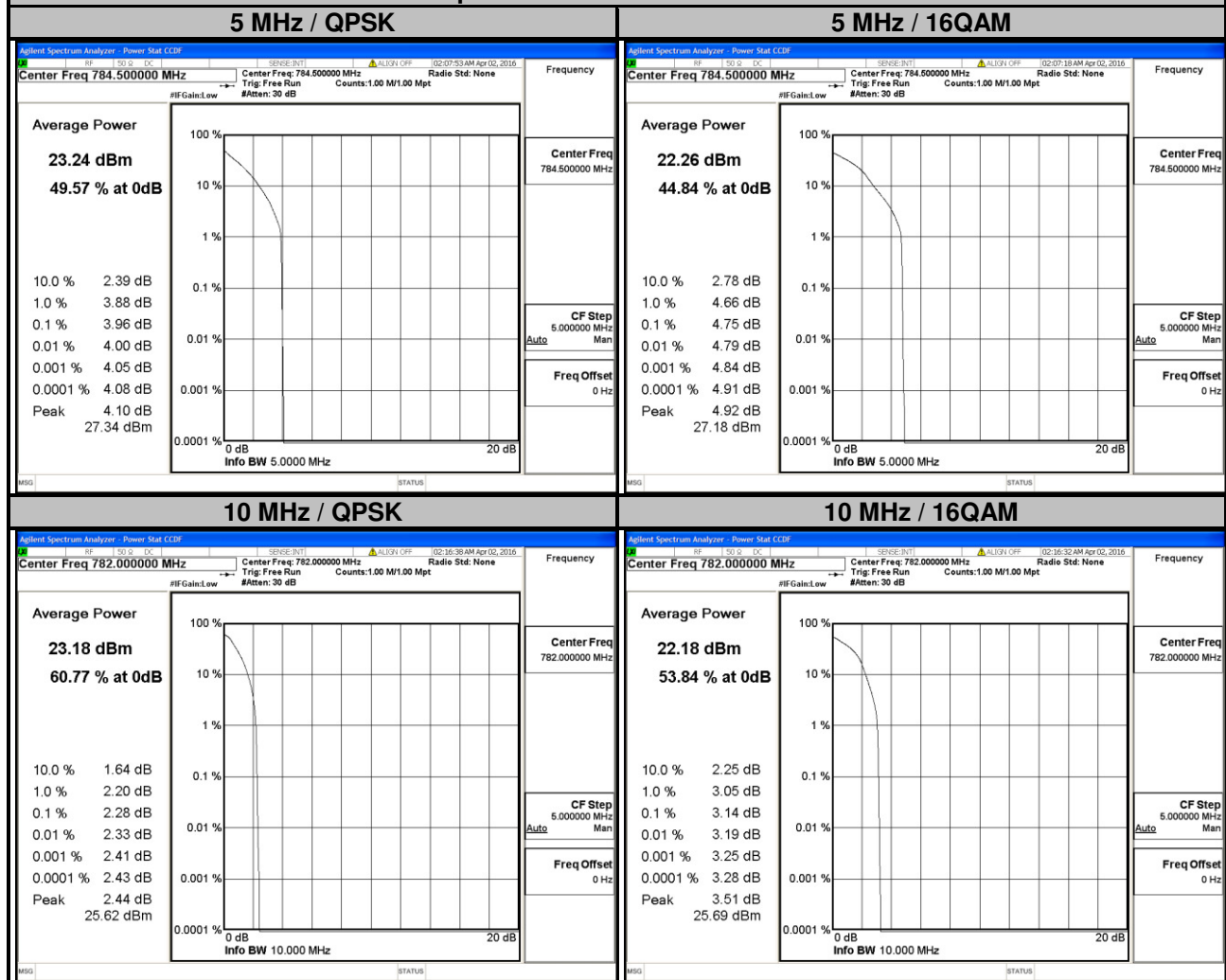

4.6 Conducted Spurious Emissions

4.6.1 Limits of Conducted Spurious Emissions Measurement

The power of any emission outside a licensee's frequency block shall be attenuated below the transmitter power (P) by at least $43 + 10 \log_{10}(P)$ dB. The limit of emission is equal to -13 dBm.

4.6.2 Test Setup

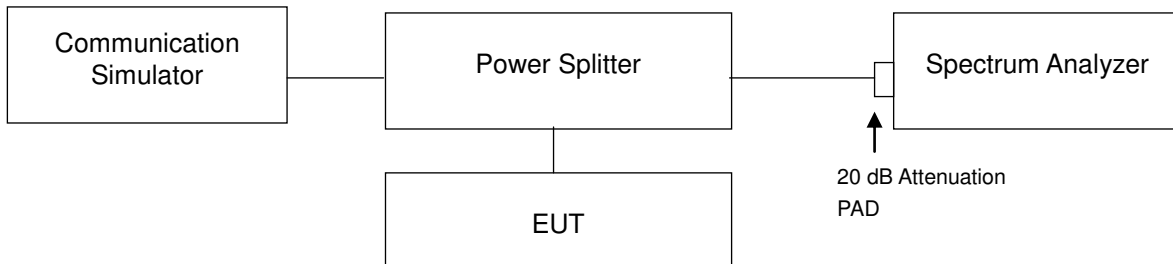

4.6.3 Test Procedure

- The EUT makes a phone call to the communication simulator. All measurements were done at low, middle and high operational frequency range.
- Measuring frequency range is from 30 MHz to 8 GHz for LTE Band 13 and from 30 MHz to 18 GHz for LTE Band 4. 10 dB attenuation pad is connected with spectrum. RBW=1 MHz and VBW=3 MHz are used for conducted emission measurement.

4.6.4 Test Results

Frequency Range: 30 MHz ~ 8 GHz

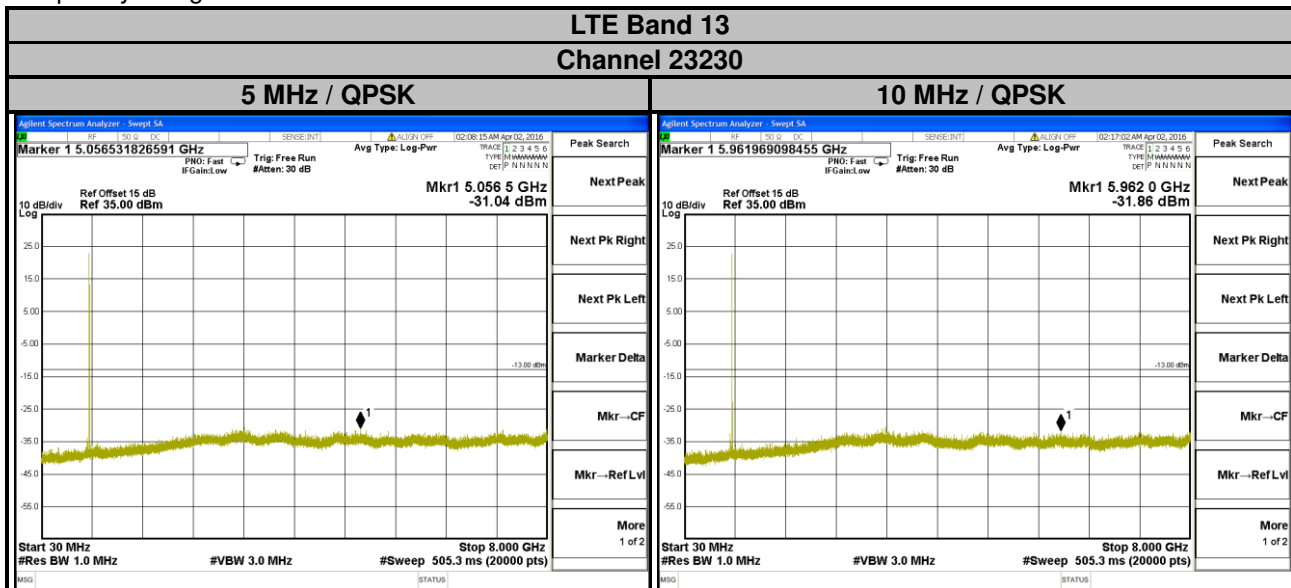

Frequency Range: 30 MHz ~ 18 GHz

LTE Band 4
Channel 20175

1.4 MHz / QPSK

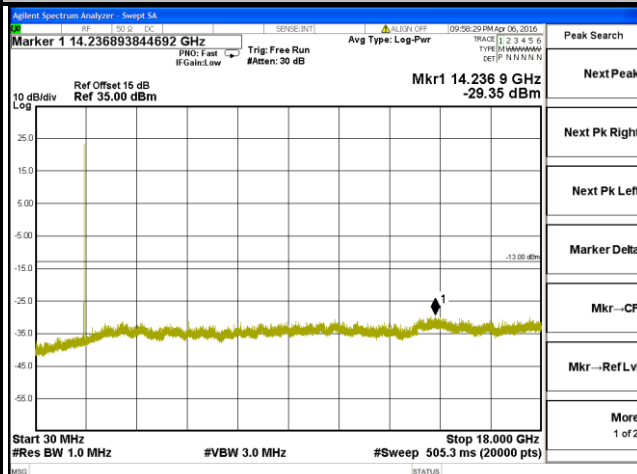

3 MHz / QPSK

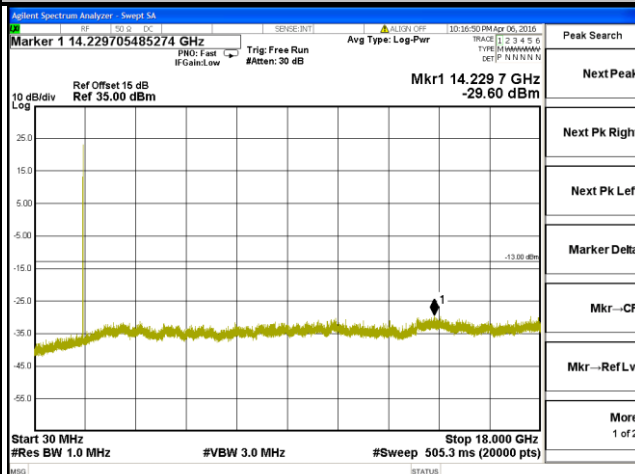

5 MHz / QPSK

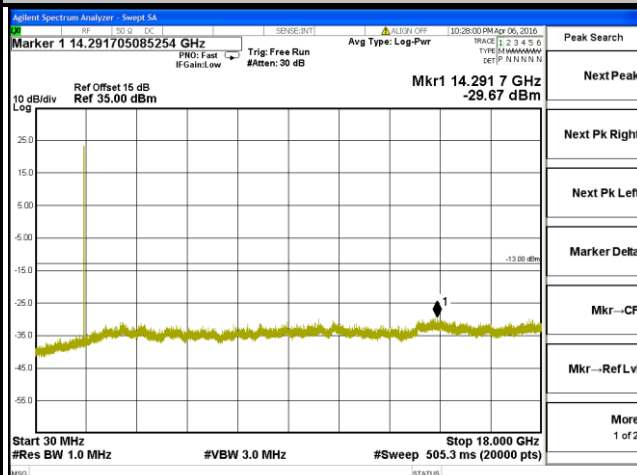

10 MHz / QPSK

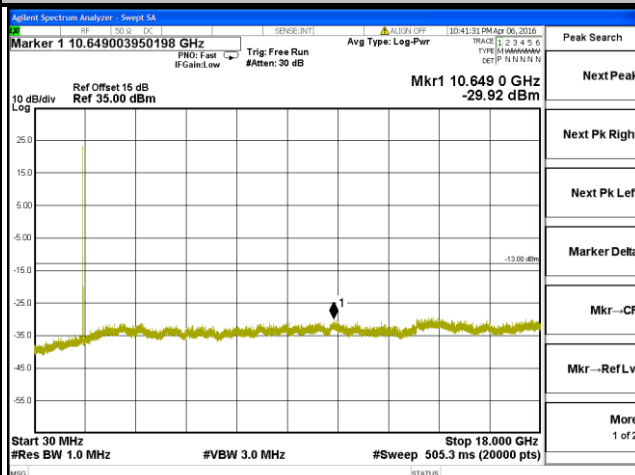

15 MHz / QPSK

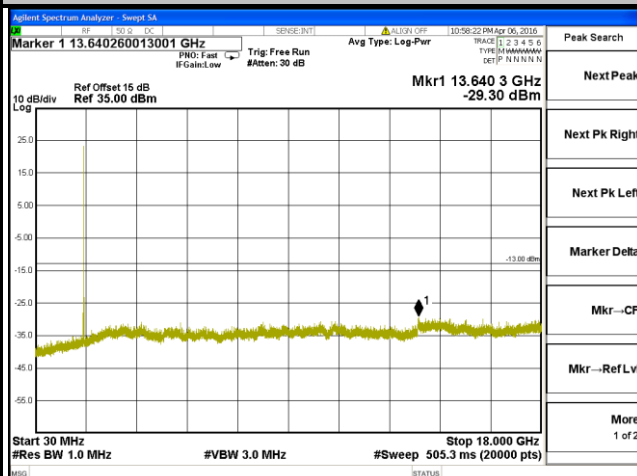

20 MHz / QPSK

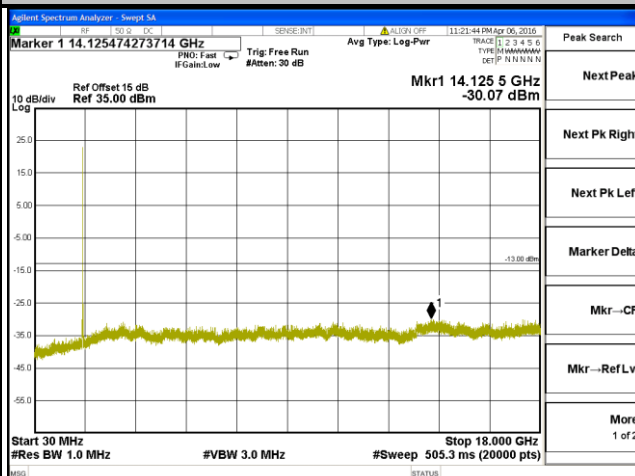

4.7 Radiated Emission Measurement

4.7.1 Limits of Radiated Emission Measurement

The power of any emission outside a licensee's frequency block shall be attenuated below the transmitter power (P) by at least $43 + 10 \log_{10}(P)$ dB. The limit of emission is equal to -13 dBm.

4.7.2 Test Procedure

- Substitution method is used for E.I.R.P measurement. In the semi-anechoic chamber, EUT placed on the 0.8 m height of Turn Table, rotated the table around 360 degrees to search the maximum radiation power and receiver antenna shall be rotated vertical and horizontal polarization and moved height from 1 m to 4 m to find the maximum polar radiated power. The "Read Value" is the spectrum reading the maximum power value.
- The substitution horn antenna is substituted for EUT at the same position and signals generator export the CW signal to the substitution antenna via a TX cable. Rotated the Turn Table and moved receiving antenna to find the maximum radiation power. Adjust output power level of S.G to get a Value of spectrum reading equal to "Read Value" of step a. Record the power level of S.G.
- $EIRP = \text{Output power level of S.G} - \text{TX cable loss} + \text{Antenna gain of substitution horn}$.
- E.R.P power can be calculated form E.I.R.P power by subtracting the gain of dipole, $E.R.P \text{ power} = E.I.P.R \text{ power} - 2.15 \text{ dBi}$.

Note: The resolution bandwidth of spectrum analyzer is 1 MHz and the video bandwidth is 3 MHz.

4.7.3 Deviation from Test Standard

No deviation.

4.7.4 Test Setup

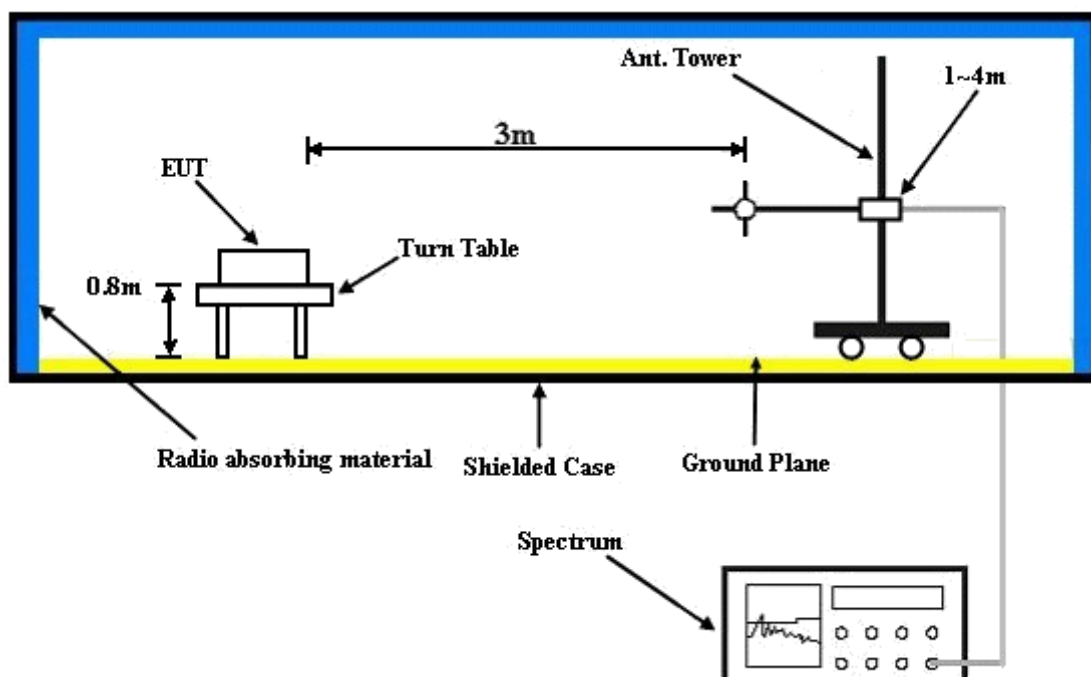

For the actual test configuration, please refer to the attached file (Test Setup Photo).

4.7.5 Test Results

Mode A

LTE Band 4

Channel Bandwidth: 20 MHz / QPSK



Bureau Veritas Consumer Products Services Ltd., Taoyuan Branch

A D T

Data: 13

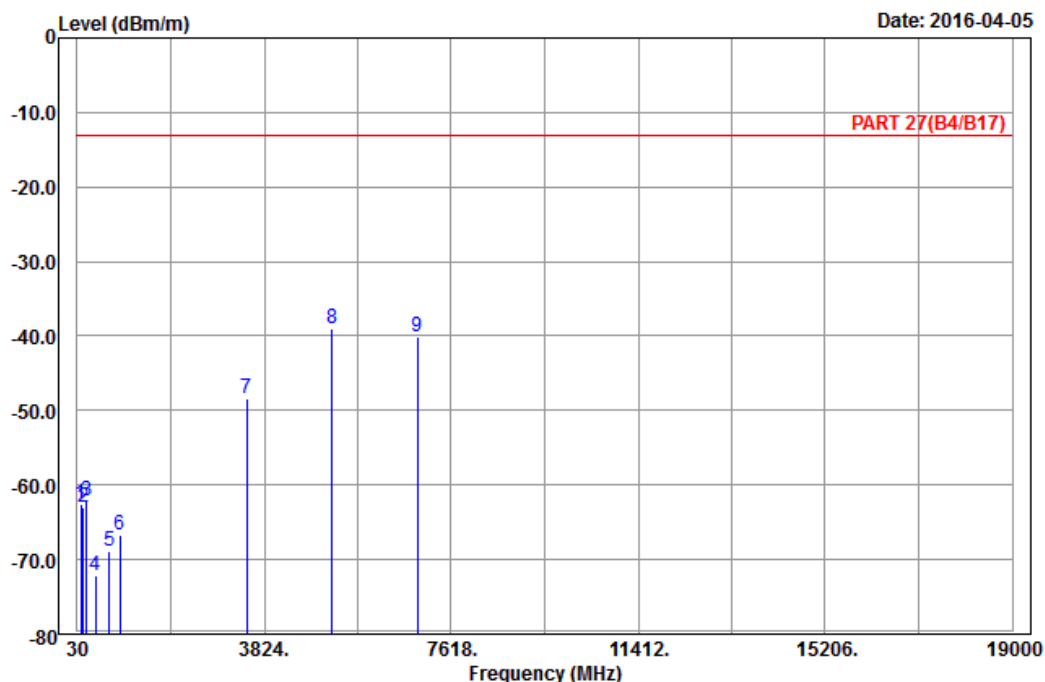

Site : 966 chamber 1
 Condition: PART 27(B4/B17) 3m Horizontal
 Remark : LTE_Band 4_QPSK(1,0)_20M_CH20175
 Tested by: Karl Lee

	Freq	Level	Read Level	Limit	Over	Factor	Remark
	MHz	dBm/m	dBm	dBm/m	dB	dB/m	
1	96.15	-62.48	-52.14	-13.00	-49.48	-10.34	Peak
2	147.45	-62.90	-55.02	-13.00	-49.90	-7.88	Peak
3	217.38	-62.04	-56.09	-13.00	-49.04	-5.95	Peak
4	403.60	-72.18	-69.35	-13.00	-59.18	-2.83	Peak
5	687.10	-68.95	-68.64	-13.00	-55.95	-0.31	Peak
6	888.00	-66.67	-69.22	-13.00	-53.67	2.55	Peak
7	3465.00	-48.46	-62.80	-13.00	-35.46	14.34	Peak
8 pp	5197.50	-39.02	-59.14	-13.00	-26.02	20.12	Peak
9	6930.00	-40.21	-63.08	-13.00	-27.21	22.87	Peak



Bureau Veritas Consumer Products Services Ltd., Taoyuan Branch

A D T

Data: 14

Date: 2016-04-05

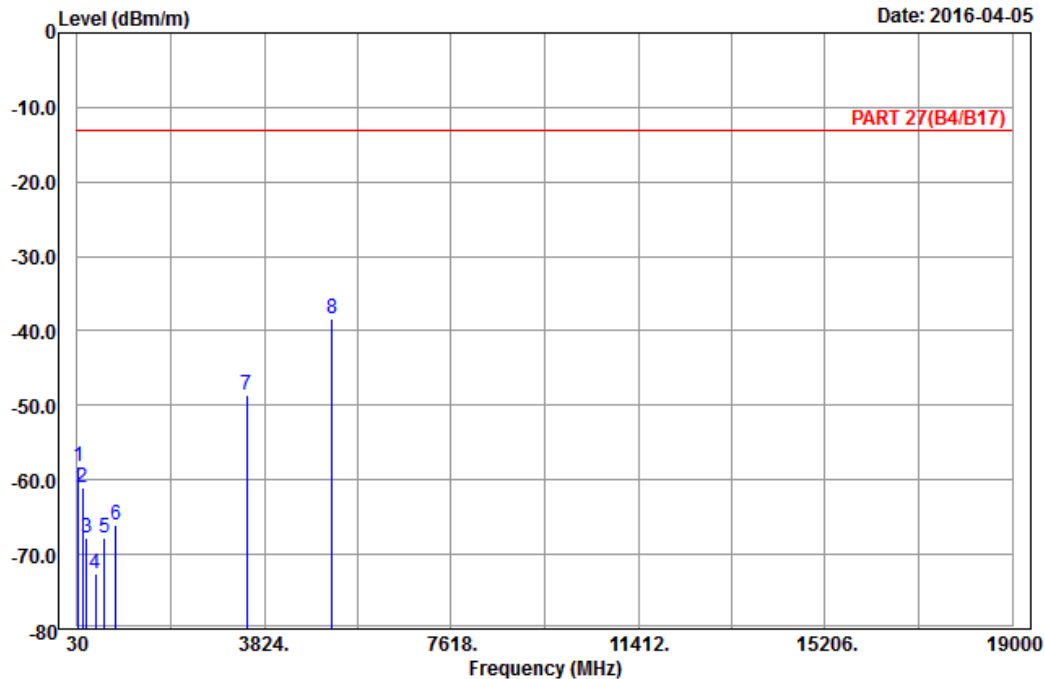

Site : 966 chamber 1
 Condition: PART 27(B4/B17) 3m Vertical
 Remark : LTE_Band 4_QPSK(1,0)_20M_CH20175
 Tested by: Karl Lee

	Freq	Level	Read Level	Limit Line	Over Limit	Factor	Remark
	MHz	dBm/m	dBm	dBm/m	dB	dB/m	
1	48.63	-58.30	-44.87	-13.00	-45.30	-13.43	Peak
2	142.05	-61.02	-53.26	-13.00	-48.02	-7.76	Peak
3	217.65	-67.70	-61.75	-13.00	-54.70	-5.95	Peak
4	404.30	-72.56	-69.71	-13.00	-59.56	-2.85	Peak
5	575.80	-67.84	-67.26	-13.00	-54.84	-0.58	Peak
6	813.80	-65.95	-67.81	-13.00	-52.95	1.86	Peak
7	3465.00	-48.54	-62.88	-13.00	-35.54	14.34	Peak
8 pp	5197.50	-38.26	-58.38	-13.00	-25.26	20.12	Peak

LTE Band 13
Channel Bandwidth: 5 MHz / QPSK



Bureau Veritas Consumer Products Services Ltd., Taoyuan Branch

A D T

Data: 9

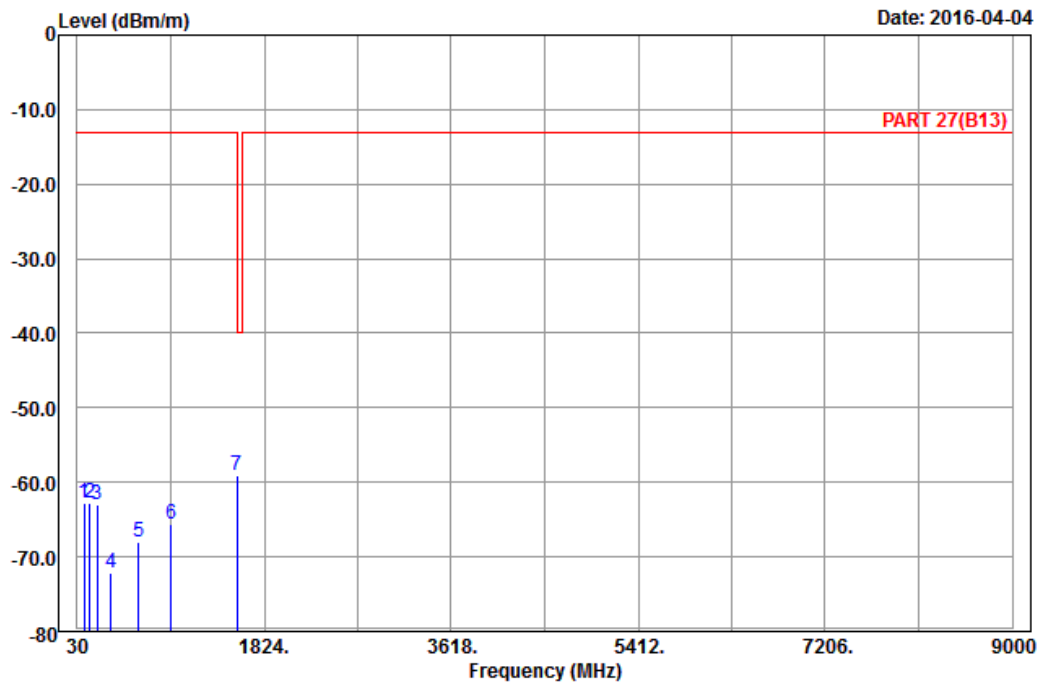

Site : 966 chamber 1
Condition: PART 27(B13) 3m Horizontal
Remark : LTE_Band 13_Link_CH23230
Tested by: Karl Lee

	Freq	Level	Read Level	Limit Line	Over Limit	Factor	Remark
	MHz	dBm/m	dBm	dBm/m	dB	dB/m	
1	97.23	-62.88	-52.59	-13.00	-49.88	-10.29	Peak
2	152.58	-62.85	-54.96	-13.00	-49.85	-7.89	Peak
3	220.08	-63.04	-57.13	-13.00	-50.04	-5.91	Peak
4	357.40	-72.09	-67.13	-13.00	-59.09	-4.96	Peak
5	619.90	-67.99	-68.20	-13.00	-54.99	0.21	Peak
6	930.00	-65.71	-69.95	-13.00	-52.71	4.24	Peak
7 pp	1564.00	-59.07	-65.93	-40.00	-19.07	6.86	Peak



Bureau Veritas Consumer Products Services Ltd., Taoyuan Branch

A D T

Data: 10

Date: 2016-04-04

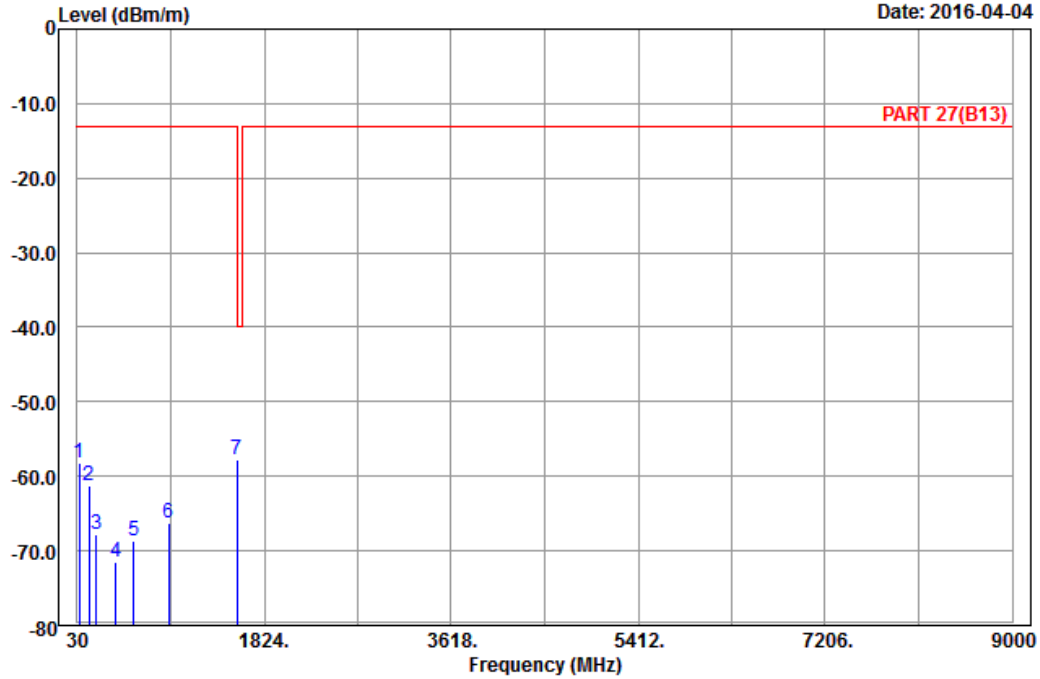

Site : 966 chamber 1
 Condition: PART 27(B13) 3m Vertical
 Remark : LTE_Band 13_Link_CH23230
 Tested by: Karl Lee

	Freq	Level	Read Level	Limit Line	Over Limit	Factor	Remark
	MHz	dBm/m	dBm	dBm/m	dB	dB/m	
1	47.82	-58.24	-45.13	-13.00	-45.24	-13.11	Peak
2	144.75	-61.34	-53.53	-13.00	-48.34	-7.81	Peak
3	215.76	-67.78	-61.82	-13.00	-54.78	-5.96	Peak
4	402.90	-71.55	-68.75	-13.00	-58.55	-2.80	Peak
5	575.10	-68.57	-67.95	-13.00	-55.57	-0.62	Peak
6	909.70	-66.22	-69.54	-13.00	-53.22	3.32	Peak
7 pp	1564.00	-57.71	-64.57	-40.00	-17.71	6.86	Peak

Mode B
 LTE Band 4
 Channel Bandwidth: 20 MHz / QPSK



Bureau Veritas Consumer Products Services Ltd., Taoyuan Branch

A D T

Data: 13

Date: 2016-04-22

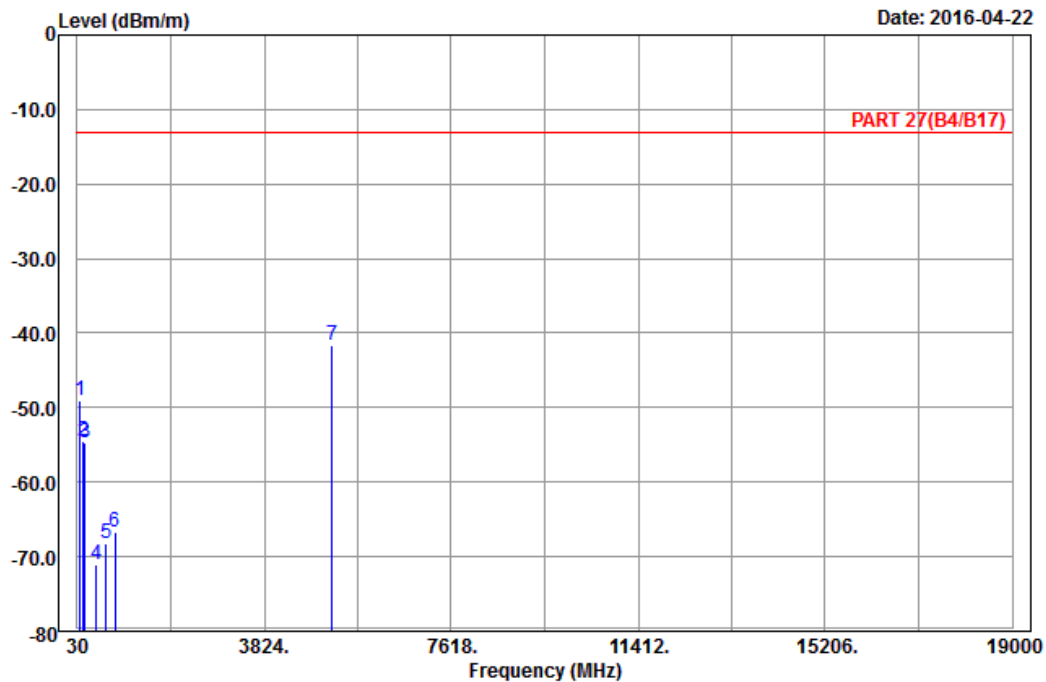

Site : 966 chamber 1
 Condition: PART 27(B4/B17) 3m Horizontal
 Remark : LTE_Band 4_Link_CH20175
 Tested by: Charles Hsiao

	Freq	Level	Read Level	Limit Line	Over Limit	Factor	Remark
	MHz	dBm/m	dBm	dBm/m	dB	dB/m	
1	92.91	-49.10	-38.59	-13.00	-36.10	-10.51	Peak
2	147.45	-54.50	-46.62	-13.00	-41.50	-7.88	Peak
3	193.08	-54.78	-48.91	-13.00	-41.78	-5.87	Peak
4	416.20	-70.99	-67.89	-13.00	-57.99	-3.10	Peak
5	619.90	-68.21	-68.42	-13.00	-55.21	0.21	Peak
6	800.50	-66.64	-68.65	-13.00	-53.64	2.01	Peak
7 pp	5197.50	-41.58	-61.70	-13.00	-28.58	20.12	Peak



A D T

Data: 14

Date: 2016-04-22

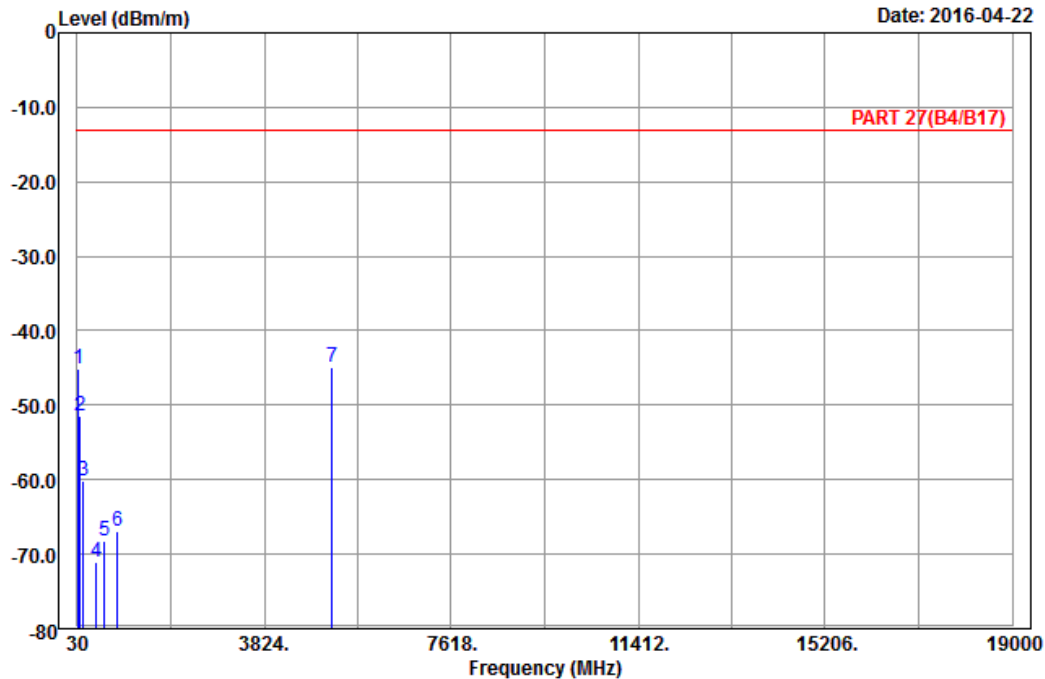

Site : 966 chamber 1
 Condition: PART 27(B4/B17) 3m Vertical
 Remark : LTE_Band 4_Link_CH20175
 Tested by: Charles Hsiao

	Freq	Level	Read Level	Limit Line	Over Limit	Factor	Remark
	MHz	dBm/m	dBm	dBm/m	dB	dB/m	
1	47.28	-45.17	-32.06	-13.00	-32.17	-13.11	Peak
2	91.02	-51.43	-40.81	-13.00	-38.43	-10.62	Peak
3	147.99	-60.25	-52.35	-13.00	-47.25	-7.90	Peak
4	421.10	-71.13	-67.92	-13.00	-58.13	-3.21	Peak
5	584.20	-68.16	-67.90	-13.00	-55.16	-0.26	Peak
6	841.80	-66.98	-68.52	-13.00	-53.98	1.54	Peak
7 pp	5197.50	-44.90	-65.02	-13.00	-31.90	20.12	Peak

LTE Band 13
Channel Bandwidth: 5 MHz / QPSK



Bureau Veritas Consumer Products Services Ltd., Taoyuan Branch

A D T

Data: 9

Date: 2016-04-22

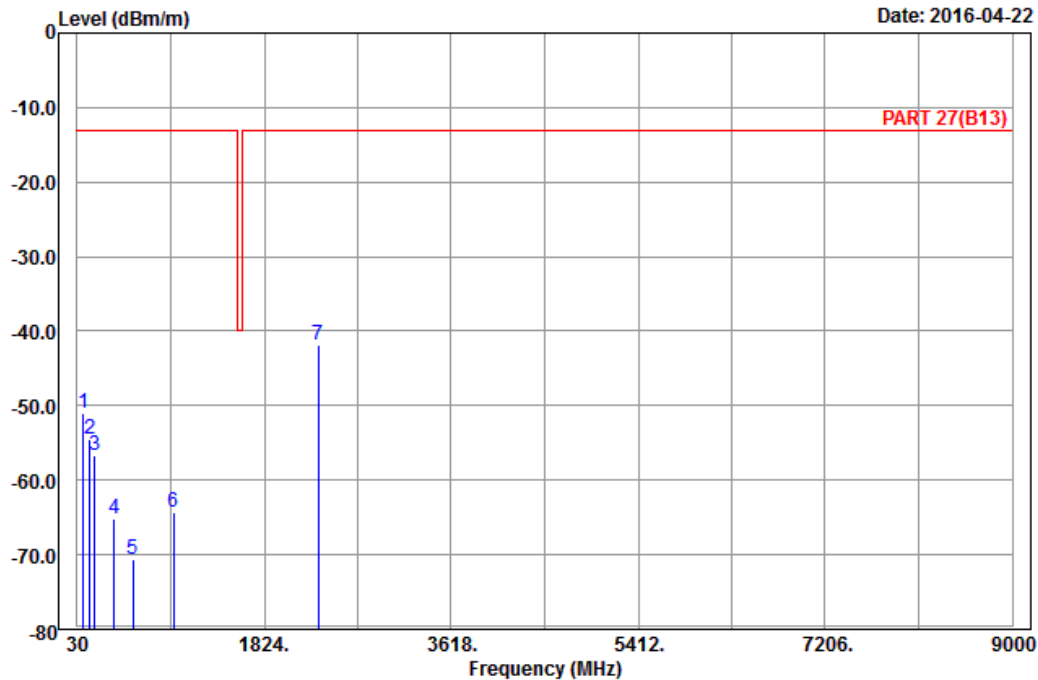

Site : 966 chamber 1
Condition: PART 27(B13) 3m Horizontal
Remark : LTE_Band 13_Link_CH23230
Tested by: Charles Hsiao

	Freq	Level	Read Level	Limit Line	Over Limit	Factor	Remark
	MHz	dBm/m	dBm	dBm/m	dB	dB/m	
1	92.37	-50.94	-40.38	-13.00	-37.94	-10.56	Peak
2	147.45	-54.58	-46.70	-13.00	-41.58	-7.88	Peak
3	197.94	-56.76	-50.67	-13.00	-43.76	-6.09	Peak
4	384.00	-65.21	-61.64	-13.00	-52.21	-3.57	Peak
5	561.80	-70.68	-69.50	-13.00	-57.68	-1.18	Peak
6	958.00	-64.24	-69.37	-13.00	-51.24	5.13	Peak
7 pp	2346.00	-41.86	-52.80	-13.00	-28.86	10.94	Peak



A D T

Data: 10

Date: 2016-04-22

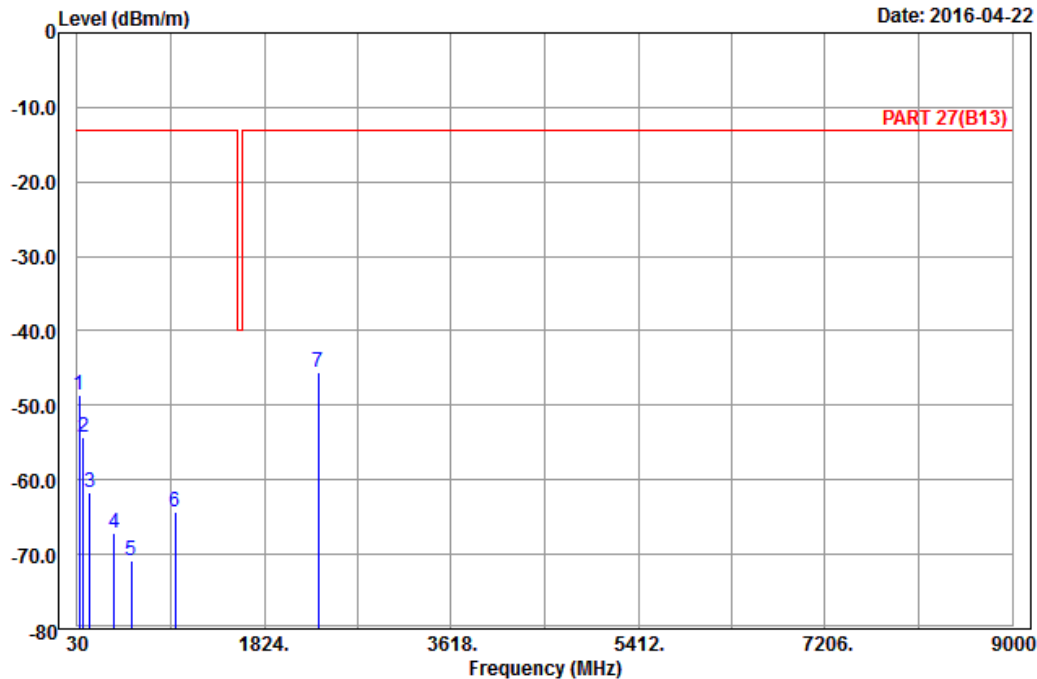

Site : 966 chamber 1
 Condition: PART 27(B13) 3m Vertical
 Remark : LTE_Band 13_Link_CH23230
 Tested by: Charles Hsiao

	Freq	Level	Read Level	Limit Line	Over Limit	Factor	Remark
	MHz	dBm/m	dBm	dBm/m	dB	dB/m	
1	47.28	-48.64	-35.53	-13.00	-35.64	-13.11	Peak
2	91.29	-54.33	-43.71	-13.00	-41.33	-10.62	Peak
3	148.53	-61.70	-53.80	-13.00	-48.70	-7.90	Peak
4	384.00	-67.10	-63.53	-13.00	-54.10	-3.57	Peak
5	552.00	-70.77	-69.19	-13.00	-57.77	-1.58	Peak
6	971.30	-64.25	-69.42	-13.00	-51.25	5.17	Peak
7 pp	2346.00	-45.58	-56.52	-13.00	-32.58	10.94	Peak

5 Pictures of Test Arrangements

Please refer to the attached file (Test Setup Photo).

Appendix – Information on the Testing Laboratories

We, Bureau Veritas Consumer Products Services (H.K.) Ltd., Taoyuan Branch, were founded in 1988 to provide our best service in EMC, Radio, Telecom and Safety consultation. Our laboratories are accredited and approved according to ISO/IEC 17025.

If you have any comments, please feel free to contact us at the following:

Linko EMC/RF Lab

Tel: 886-2-26052180

Fax: 886-2-26051924

Hsin Chu EMC/RF/Telecom Lab

Tel: 886-3-6668565

Fax: 886-3-6668323

Hwa Ya EMC/RF/Safety

Tel: 886-3-3183232

Fax: 886-3-3270892

Email: service.adt@tw.bureauveritas.com

Web Site: www.bureauveritas-adt.com

The address and road map of all our labs can be found in our web site also.

--- END ---