

## FCC Test Report

**Report No.:** RF1603177C12-5

**FCC ID:** NM82PST300

**Test Model:** 2PST300

**Received Date:** Mar. 17, 2016

**Test Date:** Mar. 29, 2016 ~ Apr. 22, 2016

**Issued Date:** May 04, 2016

**Applicant:** HTC Corporation

**Address:** 1F, 6-3 Baoqiang Road, Xindian City, Taipei County 231, Taiwan

**Issued By:** Bureau Veritas Consumer Products Services (H.K.) Ltd., Taoyuan Branch

**Lab Address:** No. 47-2, 14th Ling, Chia Pau Vil., Lin Kou Dist., New Taipei City, Taiwan  
( R.O.C )

**Test Location (1):** No. 19, Hwa Ya 2nd Rd, Wen Hwa Tsuen, Kwei Shan Hsiang, Taoyuan  
Hsien 333, Taiwan, R.O.C.

**Test Location (2):** No.215, Sec. 3, Beixin Rd., Xindian Dist., New Taipei City 231, Taiwan,  
R.O.C



This report is for your exclusive use. Any copying or replication of this report to or for any other person or entity, or use of our name or trademark, is permitted only with our prior written permission. This report sets forth our findings solely with respect to the test samples identified herein. The results set forth in this report are not indicative or representative of the quality or characteristics of the lot from which a test sample was taken or any similar or identical product unless specifically and expressly noted. Our report includes all of the tests requested by you and the results thereof based upon the information that you provided to us. You have 60 days from date of issuance of this report to notify us of any material error or omission caused by our negligence, provided, however, that such notice shall be in writing and shall specifically address the issue you wish to raise. A failure to raise such issue within the prescribed time shall constitute your unqualified acceptance of the completeness of this report, the tests conducted and the correctness of the report contents. Unless specific mention, the uncertainty of measurement has been explicitly taken into account to declare the compliance or non-compliance to the specification.

## Table of Contents

<b>Release Control Record</b> .....	<b>4</b>
<b>1 Certificate of Conformity</b> .....	<b>5</b>
<b>2 Summary of Test Results</b> .....	<b>6</b>
2.1 Measurement Uncertainty .....	6
2.2 Modification Record .....	6
<b>3 General Information</b> .....	<b>7</b>
3.1 General Description of EUT .....	7
3.2 Description of Test Modes.....	8
3.2.1 Test Mode Applicability and Tested Channel Detail .....	9
3.3 Duty Cycle of Test Signal .....	11
3.4 Description of Support Units .....	12
3.4.1 Configuration of System under Test .....	12
3.5 General Description of Applied Standards.....	12
<b>4 Test Types and Results</b> .....	<b>13</b>
4.1 Radiated Emission and Bandedge Measurement .....	13
4.1.1 Limits of Radiated Emission and Bandedge Measurement .....	13
4.1.2 Test Instruments .....	14
4.1.3 Test Procedures.....	15
4.1.4 Deviation from Test Standard .....	15
4.1.5 Test Set Up .....	16
4.1.6 EUT Operating Conditions.....	16
4.1.7 Test Results .....	17
4.2 Conducted Emission Measurement.....	32
4.2.1 Limits of Conducted Emission Measurement .....	32
4.2.2 Test Instruments .....	32
4.2.3 Test Procedures.....	33
4.2.4 Deviation from Test Standard .....	33
4.2.5 Test Setup.....	33
4.2.6 EUT Operating Conditions.....	33
4.2.7 Test Results .....	34
4.3 6dB Bandwidth Measurement.....	38
4.3.1 Limits of 6dB Bandwidth Measurement.....	38
4.3.2 Test Setup.....	38
4.3.3 Test Instruments .....	38
4.3.4 Test Procedure .....	38
4.3.5 Deviation from Test Standard .....	38
4.3.6 EUT Operating Conditions.....	38
4.3.7 Test Result .....	39
4.4 Conducted Output Power Measurement .....	41
4.4.1 Limits of Conducted Output Power Measurement.....	41
4.4.2 Test Setup.....	41
4.4.3 Test Instruments .....	41
4.4.4 Test Procedures.....	41
4.4.5 Deviation from Test Standard .....	41
4.4.6 EUT Operating Conditions.....	41
4.4.7 Test Results .....	42
4.5 Power Spectral Density Measurement .....	43
4.5.1 Limits of Power Spectral Density Measurement.....	43
4.5.2 Test Setup.....	43
4.5.3 Test Instruments .....	43
4.5.4 Test Procedure .....	43
4.5.5 Deviation from Test Standard .....	43
4.5.6 EUT Operating Condition .....	43



4.5.7 Test Results .....	44
4.6 Conducted Out of Band Emission Measurement .....	46
4.6.1 Limits of Conducted Out of Band Emission Measurement.....	46
4.6.2 Test Setup.....	46
4.6.3 Test Instruments .....	46
4.6.4 Test Procedure .....	46
4.6.5 Deviation from Test Standard .....	46
4.6.6 EUT Operating Condition .....	46
4.6.7 Test Results .....	47
<b>5 Pictures of Test Arrangements.....</b>	<b>55</b>
<b>Appendix – Information on the Testing Laboratories .....</b>	<b>56</b>



A D T

### Release Control Record

Issue No.	Description	Date Issued
RF1603177C12-5	Original Release	May 04, 2016



**1 Certificate of Conformity**

**Product:** Smartphone  
**Brand:** HTC  
**Test Model:** 2PST300  
**Sample Status:** Identical Prototype  
**Applicant:** HTC Corporation  
**Test Date:** Mar. 29, 2016 ~ Apr. 22, 2016  
**Standards:** 47 CFR FCC Part 15, Subpart C (Section 15.247)  
ANSI C63.10:2013

The above equipment has been tested by **Bureau Veritas Consumer Products Services (H.K.) Ltd., Taoyuan Branch**, and found compliance with the requirement of the above standards. The test record, data evaluation & Equipment Under Test (EUT) configurations represented herein are true and accurate accounts of the measurements of the sample's EMC characteristics under the conditions specified in this report.

**Prepared by :** Ivonne Wu , **Date:** May 04, 2016  
Ivonne Wu / Supervisor

**Approved by :** Stanley Wu , **Date:** May 04, 2016  
Stanley Wu / Assistant Manager

## 2 Summary of Test Results

47 CFR FCC Part 15, Subpart C (Section 15.247)			
FCC Clause	Test Item	Result	Remarks
15.207	AC Power Conducted Emission	Pass	Meet the requirement of limit. Minimum passing margin is -11.91 dB at 1.04200 MHz.
15.205 / 15.209 / 15.247(d)	Radiated Emissions and Band Edge Measurement	Pass	Meet the requirement of limit. Minimum passing margin is -1.04 dB at 2484 MHz.
15.247(d)	Antenna Port Emission	Pass	Meet the requirement of limit.
15.247(a)(2)	6 dB Bandwidth	Pass	Meet the requirement of limit.
15.247(b)	Conducted power	Pass	Meet the requirement of limit.
15.247(e)	Power Spectral Density	Pass	Meet the requirement of limit.
15.203	Antenna Requirement	Pass	No antenna connector is used.

### 2.1 Measurement Uncertainty

Where relevant, the following measurement uncertainty levels have been estimated for tests performed on the EUT:

The listed uncertainties are the worst case uncertainty for the entire range of measurement. Please note that the uncertainty values are provided for informational purposes only and are not used in determining the PASS/FAIL results.

Measurement	Frequency	Expanded Uncertainty (k=2) (±)
Conducted Emissions at mains ports	150 kHz ~ 30 MHz	2.44 dB
Radiated Emissions up to 1 GHz	30 MHz ~ 200 MHz	2.0153 dB
	200 MHz ~1000 MHz	2.0224 dB
Radiated Emissions above 1 GHz	1 GHz ~ 18 GHz	1.0121 dB
	18 GHz ~ 40 GHz	1.1508 dB

### 2.2 Modification Record

There were no modifications required for compliance.

### 3 General Information

#### 3.1 General Description of EUT

<b>Product</b>	Smartphone
<b>Brand</b>	HTC
<b>Test Model</b>	2PST300
<b>Status of EUT</b>	Identical Prototype
<b>Power Supply Rating</b>	5.0 Vdc (adapter or host equipment) 3.85 Vdc (Li-ion battery)
<b>Modulation Type</b>	CCK, DQPSK, DBPSK for DSSS 64QAM, 16QAM, QPSK, BPSK for OFDM
<b>Modulation Technology</b>	DSSS, OFDM
<b>Transfer Rate</b>	802.11b: 11.0 / 5.5 / 2.0 / 1.0 Mbps 802.11g: 54.0 / 48.0 / 36.0 / 24.0 / 18.0 / 12.0 / 9.0 / 6.0 Mbps 802.11n: up to MCS7
<b>Operating Frequency</b>	2412 ~ 2462 MHz
<b>Number of Channel</b>	11 for 802.11b, 802.11g, 802.11n (HT20) 7 for 802.11n (HT40)
<b>Output Power</b>	230.14 mW
<b>Antenna Type</b>	PIFA antenna with -0.5 dBi gain
<b>Antenna Connector</b>	N/A
<b>Accessory Device</b>	Refer to Note as below
<b>Data Cable Supplied</b>	Refer to Note as below

Note:

- There're 2 configurations for the EUT listed as below.  
Main Sample: EUT + Battery 1 + LCM 1  
2<sup>nd</sup> Sample: EUT + Battery 2 + LCM 2  
✧ Only the worst test data was presented in the report.
- The EUT's accessories list refers to Ext. Pho.
- The above EUT information is declared by manufacturer and for more detailed features description, please refer to the manufacturer's specifications or user's manual.

### 3.2 Description of Test Modes

11 channels are provided for 802.11b, 802.11g and 802.11n (HT20):

Channel	Frequency (MHz)	Channel	Frequency (MHz)
1	2412	7	2442
2	2417	8	2447
3	2422	9	2452
4	2427	10	2457
5	2432	11	2462
6	2437		

7 channels are provided for 802.11n (HT40):

Channel	Frequency (MHz)	Channel	Frequency (MHz)
3	2422	7	2442
4	2427	8	2447
5	2432	9	2452
6	2437		



### 3.2.1 Test Mode Applicability and Tested Channel Detail

EUT Configure Mode	Applicable To				Description
	RE $\geq$ 1G	RE<1G	PLC	APCM	
A	√	√	√	√	Main Sample
B	√	√	√	-	2 <sup>nd</sup> Sample

Where **RE $\geq$ 1G**: Radiated Emission above 1 GHz      **RE<1G**: Radiated Emission below 1 GHz  
**PLC**: Power Line Conducted Emission      **APCM**: Antenna Port Conducted Measurement

**NOTE:** The EUT had been pre-tested on the positioned of each 3 axis. The worst case was found when positioned on **Y-plane**.  
**NOTE:** "-" means no effect.

#### **Radiated Emission Test (Above 1 GHz):**

- Pre-Scan has been conducted to determine the worst-case mode from all possible combinations between available modulations, data rates and antenna ports (if EUT with antenna diversity architecture).
- Following channel(s) was (were) selected for the final test as listed below.

EUT Configure Mode	Mode	Available Channel	Tested Channel	Modulation Technology	Modulation Type	Data Rate (Mbps)
A	802.11b	1 to 11	1, 6, 11	DSSS	DBPSK	1.0
	802.11g	1 to 11	1, 6, 11	OFDM	BPSK	6.0
	802.11n (HT20)	1 to 11	1, 6, 11	OFDM	BPSK	MCS0
	802.11n (HT40)	3 to 9	3, 6, 9	OFDM	BPSK	MCS0
B	802.11n (HT20)	1 to 11	11	OFDM	BPSK	MCS0

#### **Radiated Emission Test (Below 1 GHz):**

- Pre-Scan has been conducted to determine the worst-case mode from all possible combinations between available modulations, data rates and antenna ports (if EUT with antenna diversity architecture).
- Following channel(s) was (were) selected for the final test as listed below.

EUT Configure Mode	Mode	Available Channel	Tested Channel	Modulation Technology	Modulation Type	Data Rate (Mbps)
A, B	802.11n (HT20)	1 to 11	11	OFDM	BPSK	MCS0

#### **Power Line Conducted Emission Test:**

- Pre-Scan has been conducted to determine the worst-case mode from all possible combinations between available modulations, data rates and antenna ports (if EUT with antenna diversity architecture).
- Following channel(s) was (were) selected for the final test as listed below.

EUT Configure Mode	Mode	Available Channel	Tested Channel	Modulation Technology	Modulation Type	Data Rate (Mbps)
A, B	802.11n (HT20)	1 to 11	11	OFDM	BPSK	MCS0

**Bandedge Measurement:**

- Pre-Scan has been conducted to determine the worst-case mode from all possible combinations between available modulations, data rates and antenna ports (if EUT with antenna diversity architecture).
- Following channel(s) was (were) selected for the final test as listed below.

EUT Configure Mode	Mode	Available Channel	Tested Channel	Modulation Technology	Modulation Type	Data Rate (Mbps)
A	802.11b	1 to 11	1, 11	DSSS	DBPSK	1.0
	802.11g	1 to 11	1, 11	OFDM	BPSK	6.0
	802.11n (HT20)	1 to 11	1, 11	OFDM	BPSK	MCS0
	802.11n (HT40)	3 to 9	3, 9	OFDM	BPSK	MCS0

**Antenna Port Conducted Measurement:**

- This item includes all test value of each mode, but only includes spectrum plot of worst value of each mode.
- Pre-Scan has been conducted to determine the worst-case mode from all possible combinations between available modulations, data rates and antenna ports (if EUT with antenna diversity architecture).
- Following channel(s) was (were) selected for the final test as listed below.

EUT Configure Mode	Mode	Available Channel	Tested Channel	Modulation Technology	Modulation Type	Data Rate (Mbps)
A	802.11b	1 to 11	1, 6, 11	DSSS	DBPSK	1.0
	802.11g	1 to 11	1, 6, 11	OFDM	BPSK	6.0
	802.11n (HT20)	1 to 11	1, 6, 11	OFDM	BPSK	MCS0
	802.11n (HT40)	3 to 9	3, 6, 9	OFDM	BPSK	MCS0

**Test Condition:**

Applicable To	Environmental Conditions	Input Power	Tested by
<b>RE≥1G</b>	25 deg. C, 65 % RH	120 Vac, 60 Hz	Karl Lee
<b>RE&lt;1G</b>	25 deg. C, 65 % RH	120 Vac, 60 Hz	Karl Lee
<b>PLC</b>	25 deg. C, 65 % RH	120 Vac, 60 Hz	Toby Tian
<b>APCM</b>	25 deg. C, 65 % RH	3.85 Vdc	Carlos Chen

### 3.3 Duty Cycle of Test Signal

**802.11b:** Duty cycle of test signal is 100 %

**802.11g:** Duty cycle =  $1.342/1.558 = 0.861$ , Duty factor =  $10 * \log(1/0.861) = 0.65$

**802.11n (HT20):** Duty cycle =  $1.225/1.467 = 0.835$ , Duty factor =  $10 * \log(1/0.835) = 0.78$

**802.11n (HT40):** Duty cycle =  $591.67/833.33 = 0.710$ , Duty factor =  $10 * \log(1/0.710) = 1.49$

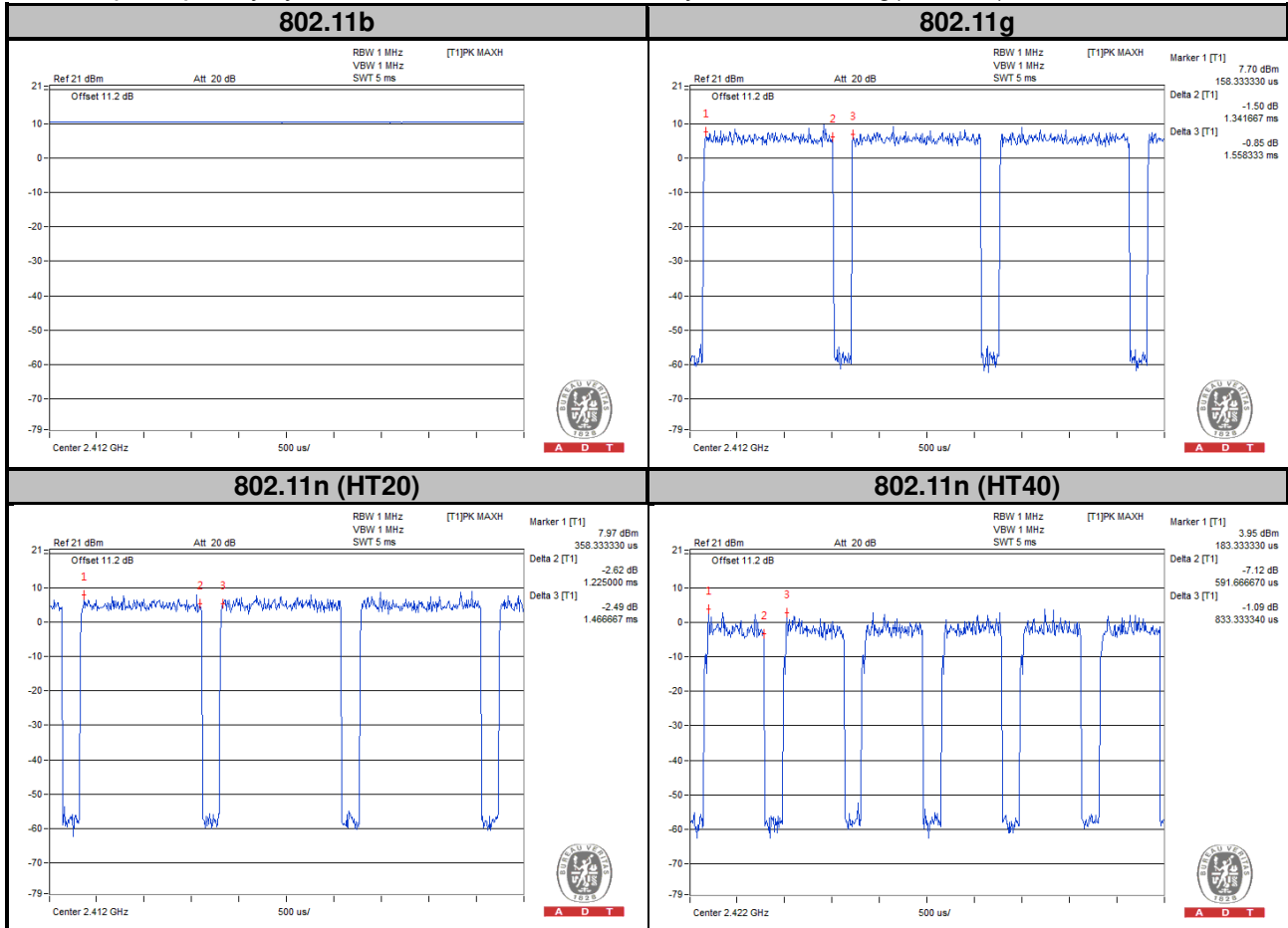

### 3.4 Description of Support Units

The EUT has been tested as an independent unit together with other necessary accessories or support units.

#### 3.4.1 Configuration of System under Test

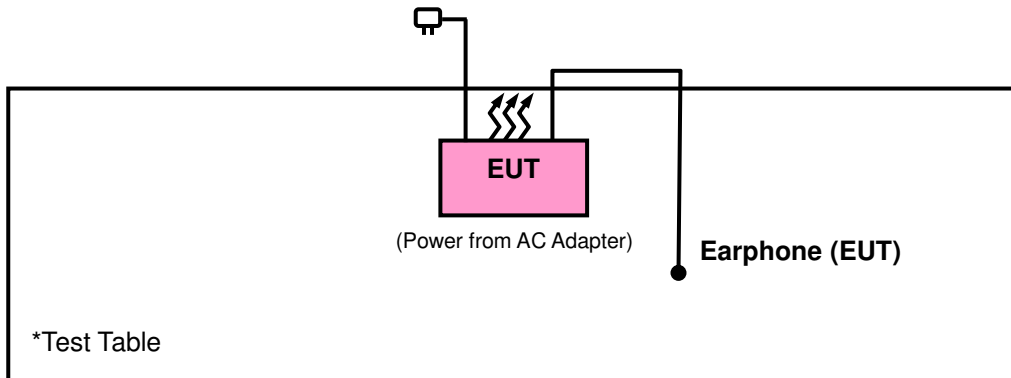

### 3.5 General Description of Applied Standards

The EUT is a RF Product. According to the specifications of the manufacturer, it must comply with the requirements of the following standards:

**FCC Part 15, Subpart C (15.247)**

**558074 D01 DTS Meas Guidance v03r05**

ANSI C63.10-2013

All test items have been performed and recorded as per the above standards.

**NOTE:** The EUT has been verified to comply with the requirements of FCC Part 15, Subpart B, Class B (DoC).  
The test report has been issued separately.

## 4 Test Types and Results

### 4.1 Radiated Emission and Bandedge Measurement

#### 4.1.1 Limits of Radiated Emission and Bandedge Measurement

Radiated emissions which fall in the restricted bands must comply with the radiated emission limits specified as below table. Other emissions shall be at least 20 dB below the highest level of the desired power:

Frequencies (MHz)	Field Strength (microvolts/meter)	Measurement Distance (meters)
0.009 ~ 0.490	2400/F (kHz)	300
0.490 ~ 1.705	24000/F (kHz)	30
1.705 ~ 30.0	30	30
30 ~ 88	100	3
88 ~ 216	150	3
216 ~ 960	200	3
Above 960	500	3

**NOTE:**

1. The lower limit shall apply at the transition frequencies.
2. Emission level (dBuV/m) = 20 log Emission level (uV/m).
3. For frequencies above 1000 MHz, the field strength limits are based on average detector, however, the peak field strength of any emission shall not exceed the maximum permitted average limits, specified above by more than 20 dB under any condition of modulation.



A D T

## 4.1.2 Test Instruments

Description & Manufacturer	Model No.	Serial No.	Date of Calibration	Due Date of Calibration
Test Receiver Agilent Technologies	N9038A	MY52260177	May 19, 2015	May 18, 2016
Spectrum Analyzer ROHDE & SCHWARZ	FSU43	101261	Dec. 17, 2015	Dec. 16, 2016
BILOG Antenna SCHWARZBECK	VULB9168	9168-472	Jan. 07, 2016	Jan. 06, 2017
HORN Antenna ETS-Lindgren	3117	00143293	Jan. 04, 2016	Jan. 03, 2017
HORN Antenna SCHWARZBECK	BBHA 9170	9170-480	Jan. 04, 2016	Jan. 03, 2017
Bluetooth Tester	CBT	100980	Apr. 27, 2015	Apr. 26, 2017
Loop Antenna	EM-6879	269	Jul. 31, 2015	Jul. 30, 2016
Agilent Communications Tester-Wireless	8960 Series 10	MY53201073	Jul. 03, 2015	Jul. 02, 2017
Preamplifier Agilent	310N	187226	Jun. 29, 2015	Jun. 28, 2016
Preamplifier Agilent	83017A	MY39501357	Jun. 29, 2015	Jun. 28, 2016
Power Meter Anritsu	ML2495A	1232002	Sep. 21, 2015	Sep. 20, 2016
Power Sensor Anritsu	MA2411B	1207325	Sep. 21, 2015	Sep. 20, 2016
RF signal cable ETS-LINDGREN	5D-FB	Cable-CH1-01(R FC-SMS-100-SM S-120+RFC-SMS -100-SMS-400)	Jun. 27, 2015	Jun. 26, 2016
RF signal cable ETS-LINDGREN	8D-FB	Cable-CH1-02(R FC-SMS-100-SM S-24)	Jun. 27, 2015	Jun. 26, 2016
Software BV ADT	E3 8.130425b	NA	NA	NA
Antenna Tower MF	NA	NA	NA	NA
Turn Table MF	NA	NA	NA	NA
Antenna Tower & Turn Table Controller MF	MF-7802	NA	NA	NA

- Note: 1. The calibration interval of the above test instruments is 12 / 24 months and the calibrations are traceable to NML/ROC and NIST/USA.
2. The test was performed in HsinTien Chamber 1.
3. The horn antenna and preamplifier (model: 83017A) are used only for the measurement of emission frequency above 1 GHz if tested.
4. The FCC Site Registration No. is 149147.
5. The IC Site Registration No. is IC7450I-1.

#### 4.1.3 Test Procedures

- a. The EUT was placed on the top of a rotating table 0.8 meters (for below 1 GHz) / 1.5 meters (for above 1 GHz) above the ground at 3 meter chamber room for test. The table was rotated 360 degrees to determine the position of the highest radiation.
- b. The EUT was set 3 meters away from the interference-receiving antenna, which was mounted on the top of a variable-height antenna tower.
- c. The height of antenna is varied from one meter to four meters above the ground to determine the maximum value of the field strength. Both horizontal and vertical polarizations of the antenna are set to make the measurement.
- d. For each suspected emission, the EUT was arranged to its worst case and then the antenna was tuned to heights from 1 meter to 4 meters and the rotatable table was turned from 0 degrees to 360 degrees to find the maximum reading.
- e. The test-receiver system was set to quasi-peak detect function and specified bandwidth with maximum hold mode when the test frequency is below 1 GHz.
- f. The test-receiver system was set to peak and average detected function and specified bandwidth with maximum hold mode when the test frequency is above 1 GHz. If the peak reading value also meets average limit, measurement with the average detector is unnecessary.

**Note:**

1. The resolution bandwidth and video bandwidth of test receiver/spectrum analyzer is 120 kHz for Quasi-peak detection (QP) at frequency below 1 GHz.
2. The resolution bandwidth of test receiver/spectrum analyzer is 1 MHz and the video bandwidth is 3 MHz for Peak detection (PK) at frequency above 1 GHz.
3. The resolution bandwidth of test receiver/spectrum analyzer is 1 MHz and the video bandwidth is 3 MHz for RMS Average (Duty cycle < 98 %) for Average detection (AV) at frequency above 1 GHz, then the measurement results was added to a correction factor ( $10 \log(1/\text{duty cycle})$ ).
4. The resolution bandwidth of test receiver/spectrum analyzer is 1MHz and the video bandwidth is 10 Hz (Duty cycle  $\geq 98 \%$ ) for Average detection (AV) at frequency above 1 GHz.
5. All modes of operation were investigated and the worst-case emissions are reported.

#### 4.1.4 Deviation from Test Standard

No deviation.

#### 4.1.5 Test Set Up

##### <Frequency Range below 1 GHz>

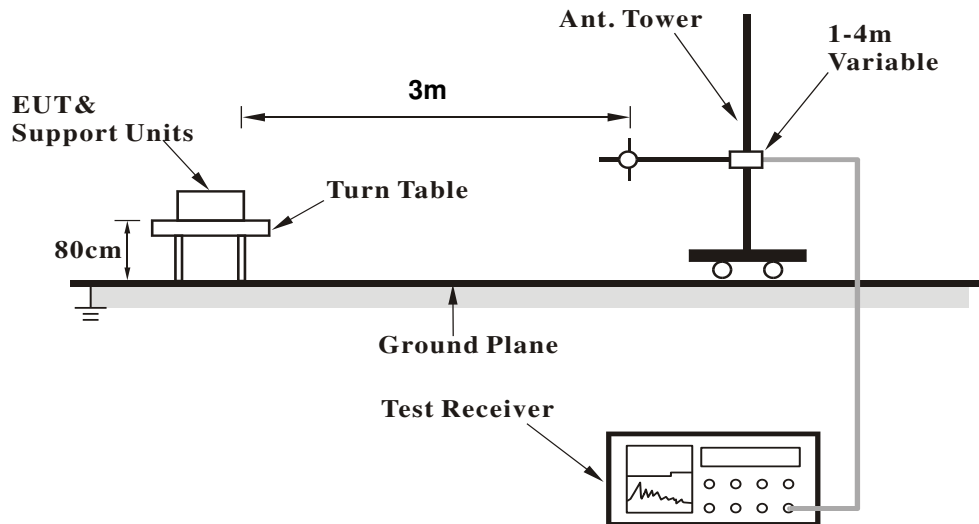

##### <Frequency Range above 1 GHz>

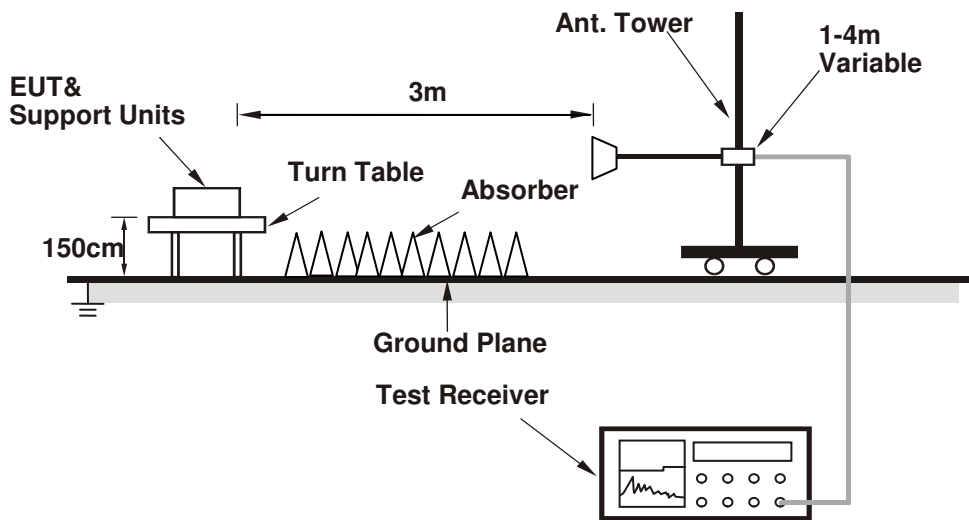

For the actual test configuration, please refer to the attached file (Test Setup Photo).

#### 4.1.6 EUT Operating Conditions

- a. Placed the EUT on a testing table.
- b. Use the software to control the EUT under transmission condition continuously at specific channel frequency.



**4.1.7 Test Results**
**Above 1 GHz Data :**
**Mode A**
**802.11b**

EUT Test Condition		Measurement Detail	
Channel	Channel 1	Frequency Range	1 GHz ~ 25 GHz
Input Power	120 Vac, 60 Hz	Detector Function	Peak (PK) Average (AV)
Environmental Conditions	25 deg. C, 65 % RH	Tested By	Karl Lee

**Antennal Polarity & Test Distance: Horizontal at 3 m**

Frequency (MHz)	Emission Level (dBuV/m)	Read Level (dBuV)	Limit (dBuV/m)	Margin (dB)	Antenna Factor (dB/m)	Cable Loss (dB)	Preamp Factor (dB)	Antenna Height (cm)	Table Angle (Degree)	Remark
2390	42.2	40.47	54	-11.8	31.8	5.4	35.47	111	175	Average
2390	55.69	53.96	74	-18.31	31.8	5.4	35.47	111	175	Peak
2412	104.84	103.07			31.81	5.43	35.47	111	175	Average
2412	107.28	105.51			31.81	5.43	35.47	111	175	Peak
2494	40.13	38.11	54	-13.87	31.9	5.53	35.41	111	175	Average
2494	55.5	53.48	74	-18.5	31.9	5.53	35.41	111	175	Peak
4824	49.99	41.86	54	-4.01	33.97	8.26	34.1	100	181	Average
4824	54.81	46.68	74	-19.19	33.97	8.26	34.1	100	181	Peak

**Antennal Polarity & Test Distance: Vertical at 3 m**

Frequency (MHz)	Emission Level (dBuV/m)	Read Level (dBuV)	Limit (dBuV/m)	Margin (dB)	Antenna Factor (dB/m)	Cable Loss (dB)	Preamp Factor (dB)	Antenna Height (cm)	Table Angle (Degree)	Remark
2356	40.72	39.09	54	-13.28	31.76	5.37	35.5	119	269	Average
2356	56.61	54.98	74	-17.39	31.76	5.37	35.5	119	269	Peak
2412	102.04	100.27			31.81	5.43	35.47	119	269	Average
2412	104.59	102.82			31.81	5.43	35.47	119	269	Peak
2500	39.57	37.55	54	-14.43	31.9	5.53	35.41	119	269	Average
2500	55.42	53.4	74	-18.58	31.9	5.53	35.41	119	269	Peak
4824	43.73	35.6	54	-10.27	33.97	8.26	34.1	102	160	Average
4824	50.39	42.26	74	-23.61	33.97	8.26	34.1	102	160	Peak

**Remarks:**

- Emission Level = Read Level + Antenna Factor + Cable Loss - Preamp Factor  
Margin value = Emission level – Limit value
- 2412 MHz: Fundamental frequency.

EUT Test Condition		Measurement Detail	
Channel	Channel 6	Frequency Range	1 GHz ~ 25 GHz
Input Power	120 Vac, 60 Hz	Detector Function	Peak (PK) Average (AV)
Environmental Conditions	25 deg. C, 65 % RH	Tested By	Karl Lee

Antennal Polarity & Test Distance: Horizontal at 3 m										
Frequency (MHz)	Emission Level (dBuV/m)	Read Level (dBuV)	Limit (dBuV/m)	Margin (dB)	Antenna Factor (dB/m)	Cable Loss (dB)	Preamp Factor (dB)	Antenna Height (cm)	Table Angle (Degree)	Remark
2376	39.43	37.77	54	-14.57	31.78	5.37	35.49	113	215	Average
2376	55.88	54.22	74	-18.12	31.78	5.37	35.49	113	215	Peak
2437	105.83	103.98			31.85	5.46	35.46	113	215	Average
2437	108.49	106.64			31.85	5.46	35.46	113	215	Peak
2484	39.67	37.71	54	-14.33	31.88	5.5	35.42	113	215	Average
2484	54.88	52.92	74	-19.12	31.88	5.5	35.42	113	215	Peak
4874	46.45	38.26	54	-7.55	33.98	8.27	34.06	100	184	Average
4874	52.13	43.94	74	-21.87	33.98	8.27	34.06	100	184	Peak

Antennal Polarity & Test Distance: Vertical at 3 m										
Frequency (MHz)	Emission Level (dBuV/m)	Read Level (dBuV)	Limit (dBuV/m)	Margin (dB)	Antenna Factor (dB/m)	Cable Loss (dB)	Preamp Factor (dB)	Antenna Height (cm)	Table Angle (Degree)	Remark
2358	39.21	37.58	54	-14.79	31.76	5.37	35.5	119	269	Average
2358	55.43	53.8	74	-18.57	31.76	5.37	35.5	119	269	Peak
2437	103.23	101.38			31.85	5.46	35.46	119	269	Average
2437	105.86	104.01			31.85	5.46	35.46	119	269	Peak
2498	39.53	37.51	54	-14.47	31.9	5.53	35.41	119	269	Average
2498	55.85	53.83	74	-18.15	31.9	5.53	35.41	119	269	Peak
4874	42.34	34.15	54	-11.66	33.98	8.27	34.06	100	70	Average
4874	49.72	41.53	74	-24.28	33.98	8.27	34.06	100	70	Peak

Remarks:

- Emission Level = Read Level + Antenna Factor + Cable Loss - Preamp Factor  
Margin value = Emission level – Limit value
- 2437 MHz: Fundamental frequency.



A D T

EUT Test Condition		Measurement Detail	
Channel	Channel 11	Frequency Range	1 GHz ~ 25 GHz
Input Power	120 Vac, 60 Hz	Detector Function	Peak (PK) Average (AV)
Environmental Conditions	25 deg. C, 65 % RH	Tested By	Karl Lee

Antennal Polarity & Test Distance: Horizontal at 3 m										
Frequency (MHz)	Emission Level (dBuV/m)	Read Level (dBuV)	Limit (dBuV/m)	Margin (dB)	Antenna Factor (dB/m)	Cable Loss (dB)	Preamp Factor (dB)	Antenna Height (cm)	Table Angle (Degree)	Remark
2348	39.25	37.68	54	-14.75	31.74	5.33	35.5	111	215	Average
2348	55.31	53.74	74	-18.69	31.74	5.33	35.5	111	215	Peak
2462	104.43	102.5			31.87	5.5	35.44	111	215	Average
2462	106.97	105.04			31.87	5.5	35.44	111	215	Peak
2484	47.7	45.74	54	-6.3	31.88	5.5	35.42	111	215	Average
2484	58.18	56.22	74	-15.82	31.88	5.5	35.42	111	215	Peak

Antennal Polarity & Test Distance: Vertical at 3 m										
Frequency (MHz)	Emission Level (dBuV/m)	Read Level (dBuV)	Limit (dBuV/m)	Margin (dB)	Antenna Factor (dB/m)	Cable Loss (dB)	Preamp Factor (dB)	Antenna Height (cm)	Table Angle (Degree)	Remark
2382	39.13	37.44	54	-14.87	31.78	5.4	35.49	131	269	Average
2382	55.65	53.96	74	-18.35	31.78	5.4	35.49	131	269	Peak
2462	102.68	100.75			31.87	5.5	35.44	131	269	Average
2462	105.27	103.34			31.87	5.5	35.44	131	269	Peak
2484	45.31	43.35	54	-8.69	31.88	5.5	35.42	131	269	Average
2484	58.05	56.09	74	-15.95	31.88	5.5	35.42	131	269	Peak

Remarks:

- Emission Level = Read Level + Antenna Factor + Cable Loss - Preamp Factor  
Margin value = Emission level – Limit value
- 2462 MHz: Fundamental frequency.

**802.11g**

EUT Test Condition		Measurement Detail	
Channel	Channel 1	Frequency Range	1 GHz ~ 25 GHz
Input Power	120 Vac, 60 Hz	Detector Function	Peak (PK) Average (AV)
Environmental Conditions	25 deg. C, 65 % RH	Tested By	Karl Lee

**Antennal Polarity & Test Distance: Horizontal at 3 m**

Frequency (MHz)	Emission Level (dBuV/m)	Read Level (dBuV)	Limit (dBuV/m)	Margin (dB)	Antenna Factor (dB/m)	Cable Loss (dB)	Preamp Factor (dB)	Antenna Height (cm)	Table Angle (Degree)	Remark
2390	52.54	50.81	54	-1.46	31.8	5.4	35.47	111	175	Average
2390	71.6	69.87	74	-2.4	31.8	5.4	35.47	111	175	Peak
2412	99.19	97.42			31.81	5.43	35.47	111	175	Average
2412	107.55	105.78			31.81	5.43	35.47	111	175	Peak
2486	40.68	38.69	54	-13.32	31.88	5.53	35.42	111	175	Average
2486	56.19	54.2	74	-17.81	31.88	5.53	35.42	111	175	Peak

**Antennal Polarity & Test Distance: Vertical at 3 m**

Frequency (MHz)	Emission Level (dBuV/m)	Read Level (dBuV)	Limit (dBuV/m)	Margin (dB)	Antenna Factor (dB/m)	Cable Loss (dB)	Preamp Factor (dB)	Antenna Height (cm)	Table Angle (Degree)	Remark
2390	50.17	48.44	54	-3.83	31.8	5.4	35.47	119	269	Average
2390	69.83	68.1	74	-4.17	31.8	5.4	35.47	119	269	Peak
2412	96.96	95.19			31.81	5.43	35.47	119	269	Average
2412	104.38	102.61			31.81	5.43	35.47	119	269	Peak
2500	40.49	38.47	54	-13.51	31.9	5.53	35.41	119	269	Average
2500	55.48	53.46	74	-18.52	31.9	5.53	35.41	119	269	Peak

**Remarks:**

- Emission Level = Read Level + Antenna Factor + Cable Loss - Preamp Factor  
Margin value = Emission level – Limit value
- 2412 MHz: Fundamental frequency.

EUT Test Condition		Measurement Detail	
Channel	Channel 6	Frequency Range	1 GHz ~ 25 GHz
Input Power	120 Vac, 60 Hz	Detector Function	Peak (PK) Average (AV)
Environmental Conditions	25 deg. C, 65 % RH	Tested By	Karl Lee

Antennal Polarity & Test Distance: Horizontal at 3 m										
Frequency (MHz)	Emission Level (dBuV/m)	Read Level (dBuV)	Limit (dBuV/m)	Margin (dB)	Antenna Factor (dB/m)	Cable Loss (dB)	Preamp Factor (dB)	Antenna Height (cm)	Table Angle (Degree)	Remark
2390	41.07	39.34	54	-12.93	31.8	5.4	35.47	113	215	Average
2390	55.95	54.22	74	-18.05	31.8	5.4	35.47	113	215	Peak
2437	101.36	99.51			31.85	5.46	35.46	113	215	Average
2437	109.69	107.84			31.85	5.46	35.46	113	215	Peak
2492	41.31	39.29	54	-12.69	31.9	5.53	35.41	113	215	Average
2492	55.93	53.91	74	-18.07	31.9	5.53	35.41	113	215	Peak

Antennal Polarity & Test Distance: Vertical at 3 m										
Frequency (MHz)	Emission Level (dBuV/m)	Read Level (dBuV)	Limit (dBuV/m)	Margin (dB)	Antenna Factor (dB/m)	Cable Loss (dB)	Preamp Factor (dB)	Antenna Height (cm)	Table Angle (Degree)	Remark
2384	40.44	38.75	54	-13.56	31.78	5.4	35.49	119	269	Average
2384	55.4	53.71	74	-18.6	31.78	5.4	35.49	119	269	Peak
2437	98.32	96.47			31.85	5.46	35.46	119	269	Average
2437	107.1	105.25			31.85	5.46	35.46	119	269	Peak
2488	40.75	38.74	54	-13.25	31.9	5.53	35.42	119	269	Average
2488	55.82	53.81	74	-18.18	31.9	5.53	35.42	119	269	Peak

**Remarks:**

- Emission Level = Read Level + Antenna Factor + Cable Loss - Preamp Factor  
Margin value = Emission level – Limit value
- 2437 MHz: Fundamental frequency.



EUT Test Condition		Measurement Detail	
Channel	Channel 11	Frequency Range	1 GHz ~ 25 GHz
Input Power	120 Vac, 60 Hz	Detector Function	Peak (PK) Average (AV)
Environmental Conditions	25 deg. C, 65 % RH	Tested By	Karl Lee

Antennal Polarity & Test Distance: Horizontal at 3 m										
Frequency (MHz)	Emission Level (dBuV/m)	Read Level (dBuV)	Limit (dBuV/m)	Margin (dB)	Antenna Factor (dB/m)	Cable Loss (dB)	Preamp Factor (dB)	Antenna Height (cm)	Table Angle (Degree)	Remark
2362	40.04	38.41	54	-13.96	31.76	5.37	35.5	111	215	Average
2362	55.34	53.71	74	-18.66	31.76	5.37	35.5	111	215	Peak
2462	98.58	96.65			31.87	5.5	35.44	111	215	Average
2462	107.11	105.18			31.87	5.5	35.44	111	215	Peak
2484	52.75	50.79	54	-1.25	31.88	5.5	35.42	111	215	Average
2484	68.7	66.74	74	-5.3	31.88	5.5	35.42	111	215	Peak

Antennal Polarity & Test Distance: Vertical at 3 m										
Frequency (MHz)	Emission Level (dBuV/m)	Read Level (dBuV)	Limit (dBuV/m)	Margin (dB)	Antenna Factor (dB/m)	Cable Loss (dB)	Preamp Factor (dB)	Antenna Height (cm)	Table Angle (Degree)	Remark
2388	40.08	38.37	54	-13.92	31.8	5.4	35.49	131	269	Average
2388	55.31	53.6	74	-18.69	31.8	5.4	35.49	131	269	Peak
2462	96.47	94.54			31.87	5.5	35.44	131	269	Average
2462	104.89	102.96			31.87	5.5	35.44	131	269	Peak
2484	49.8	47.84	54	-4.2	31.88	5.5	35.42	131	269	Average
2484	70.36	68.4	74	-3.64	31.88	5.5	35.42	131	269	Peak

Remarks:

- Emission Level = Read Level + Antenna Factor + Cable Loss - Preamp Factor  
Margin value = Emission level – Limit value
- 2462 MHz: Fundamental frequency.

**802.11n (HT20)**

EUT Test Condition		Measurement Detail	
Channel	Channel 1	Frequency Range	1 GHz ~ 25 GHz
Input Power	120 Vac, 60 Hz	Detector Function	Peak (PK) Average (AV)
Environmental Conditions	25 deg. C, 65 % RH	Tested By	Karl Lee

**Antennal Polarity & Test Distance: Horizontal at 3 m**

Frequency (MHz)	Emission Level (dBuV/m)	Read Level (dBuV)	Limit (dBuV/m)	Margin (dB)	Antenna Factor (dB/m)	Cable Loss (dB)	Preamp Factor (dB)	Antenna Height (cm)	Table Angle (Degree)	Remark
2390	52.36	50.63	54	-1.64	31.8	5.4	35.47	111	175	Average
2390	71.8	70.07	74	-2.2	31.8	5.4	35.47	111	175	Peak
2412	98.08	96.31			31.81	5.43	35.47	111	175	Average
2412	105.95	104.18			31.81	5.43	35.47	111	175	Peak
2486	40.82	38.83	54	-13.18	31.88	5.53	35.42	111	175	Average
2486	55.69	53.7	74	-18.31	31.88	5.53	35.42	111	175	Peak

**Antennal Polarity & Test Distance: Vertical at 3 m**

Frequency (MHz)	Emission Level (dBuV/m)	Read Level (dBuV)	Limit (dBuV/m)	Margin (dB)	Antenna Factor (dB/m)	Cable Loss (dB)	Preamp Factor (dB)	Antenna Height (cm)	Table Angle (Degree)	Remark
2390	49.91	48.18	54	-4.09	31.8	5.4	35.47	119	269	Average
2390	69	67.27	74	-5	31.8	5.4	35.47	119	269	Peak
2412	95.63	93.86			31.81	5.43	35.47	119	269	Average
2412	103.63	101.86			31.81	5.43	35.47	119	269	Peak
2498	40.47	38.45	54	-13.53	31.9	5.53	35.41	119	269	Average
2498	54.79	52.77	74	-19.21	31.9	5.53	35.41	119	269	Peak

## Remarks:

- Emission Level = Read Level + Antenna Factor + Cable Loss - Preamp Factor  
Margin value = Emission level – Limit value
- 2412 MHz: Fundamental frequency.



A D T

EUT Test Condition		Measurement Detail	
Channel	Channel 6	Frequency Range	1 GHz ~ 25 GHz
Input Power	120 Vac, 60 Hz	Detector Function	Peak (PK) Average (AV)
Environmental Conditions	25 deg. C, 65 % RH	Tested By	Karl Lee

Antennal Polarity & Test Distance: Horizontal at 3 m										
Frequency (MHz)	Emission Level (dBuV/m)	Read Level (dBuV)	Limit (dBuV/m)	Margin (dB)	Antenna Factor (dB/m)	Cable Loss (dB)	Preamp Factor (dB)	Antenna Height (cm)	Table Angle (Degree)	Remark
2388	41.85	40.14	54	-12.15	31.8	5.4	35.49	113	215	Average
2388	55.75	54.04	74	-18.25	31.8	5.4	35.49	113	215	Peak
2437	101.24	99.39			31.85	5.46	35.46	113	215	Average
2437	109.44	107.59			31.85	5.46	35.46	113	215	Peak
2484	41.5	39.54	54	-12.5	31.88	5.5	35.42	113	215	Average
2484	55.97	54.01	74	-18.03	31.88	5.5	35.42	113	215	Peak

Antennal Polarity & Test Distance: Vertical at 3 m										
Frequency (MHz)	Emission Level (dBuV/m)	Read Level (dBuV)	Limit (dBuV/m)	Margin (dB)	Antenna Factor (dB/m)	Cable Loss (dB)	Preamp Factor (dB)	Antenna Height (cm)	Table Angle (Degree)	Remark
2386	40.72	39.01	54	-13.28	31.8	5.4	35.49	119	269	Average
2386	55.94	54.23	74	-18.06	31.8	5.4	35.49	119	269	Peak
2437	98.14	96.29			31.85	5.46	35.46	119	269	Average
2437	106.05	104.2			31.85	5.46	35.46	119	269	Peak
2492	40.62	38.6	54	-13.38	31.9	5.53	35.41	119	269	Average
2492	56.24	54.22	74	-17.76	31.9	5.53	35.41	119	269	Peak

Remarks:

- Emission Level = Read Level + Antenna Factor + Cable Loss - Preamp Factor  
Margin value = Emission level – Limit value
- 2437 MHz: Fundamental frequency.





EUT Test Condition		Measurement Detail	
Channel	Channel 11	Frequency Range	1 GHz ~ 25 GHz
Input Power	120 Vac, 60 Hz	Detector Function	Peak (PK) Average (AV)
Environmental Conditions	25 deg. C, 65 % RH	Tested By	Karl Lee

**Antennal Polarity & Test Distance: Horizontal at 3 m**

Frequency (MHz)	Emission Level (dBuV/m)	Read Level (dBuV)	Limit (dBuV/m)	Margin (dB)	Antenna Factor (dB/m)	Cable Loss (dB)	Preamp Factor (dB)	Antenna Height (cm)	Table Angle (Degree)	Remark
2346	39.88	38.31	54	-14.12	31.74	5.33	35.5	111	215	Average
2346	55.59	54.02	74	-18.41	31.74	5.33	35.5	111	215	Peak
2462	97.84	95.91			31.87	5.5	35.44	111	215	Average
2462	106.54	104.61			31.87	5.5	35.44	111	215	Peak
2484	52.96	51	54	-1.04	31.88	5.5	35.42	111	215	Average
2484	72.94	70.98	74	-1.06	31.88	5.5	35.42	111	215	Peak

**Antennal Polarity & Test Distance: Vertical at 3 m**

Frequency (MHz)	Emission Level (dBuV/m)	Read Level (dBuV)	Limit (dBuV/m)	Margin (dB)	Antenna Factor (dB/m)	Cable Loss (dB)	Preamp Factor (dB)	Antenna Height (cm)	Table Angle (Degree)	Remark
2390	39.94	38.21	54	-14.06	31.8	5.4	35.47	131	269	Average
2390	55.52	53.79	74	-18.48	31.8	5.4	35.47	131	269	Peak
2462	95.68	93.75			31.87	5.5	35.44	131	269	Average
2462	104.03	102.1			31.87	5.5	35.44	131	269	Peak
2484	50.62	48.66	54	-3.38	31.88	5.5	35.42	131	269	Average
2484	70.42	68.46	74	-3.58	31.88	5.5	35.42	131	269	Peak

Remarks:

- Emission Level = Read Level + Antenna Factor + Cable Loss - Preamp Factor  
Margin value = Emission level – Limit value
- 2462 MHz: Fundamental frequency.

**802.11n (HT40)**

EUT Test Condition		Measurement Detail	
Channel	Channel 3	Frequency Range	1 GHz ~ 25 GHz
Input Power	120 Vac, 60 Hz	Detector Function	Peak (PK) Average (AV)
Environmental Conditions	25 deg. C, 65 % RH	Tested By	Karl Lee

**Antennal Polarity & Test Distance: Horizontal at 3 m**

Frequency (MHz)	Emission Level (dBuV/m)	Read Level (dBuV)	Limit (dBuV/m)	Margin (dB)	Antenna Factor (dB/m)	Cable Loss (dB)	Preamp Factor (dB)	Antenna Height (cm)	Table Angle (Degree)	Remark
2390	52.88	51.15	54	-1.12	31.8	5.4	35.47	111	175	Average
2390	67.4	65.67	74	-6.6	31.8	5.4	35.47	111	175	Peak
2422	96.19	94.39			31.83	5.43	35.46	111	175	Average
2422	104.77	102.97			31.83	5.43	35.46	111	175	Peak
2484	42.78	40.82	54	-11.22	31.88	5.5	35.42	111	175	Average
2484	55.74	53.78	74	-18.26	31.88	5.5	35.42	111	175	Peak

**Antennal Polarity & Test Distance: Vertical at 3 m**

Frequency (MHz)	Emission Level (dBuV/m)	Read Level (dBuV)	Limit (dBuV/m)	Margin (dB)	Antenna Factor (dB/m)	Cable Loss (dB)	Preamp Factor (dB)	Antenna Height (cm)	Table Angle (Degree)	Remark
2390	50.43	48.7	54	-3.57	31.8	5.4	35.47	119	269	Average
2390	64.06	62.33	74	-9.94	31.8	5.4	35.47	119	269	Peak
2422	93.3	91.5			31.83	5.43	35.46	119	269	Average
2422	101.87	100.07			31.83	5.43	35.46	119	269	Peak
2496	40.75	38.73	54	-13.25	31.9	5.53	35.41	119	269	Average
2496	55.6	53.58	74	-18.4	31.9	5.53	35.41	119	269	Peak

**Remarks:**

- Emission Level = Read Level + Antenna Factor + Cable Loss - Preamp Factor  
Margin value = Emission level – Limit value
- 2422 MHz: Fundamental frequency.



A D T

EUT Test Condition		Measurement Detail	
Channel	Channel 6	Frequency Range	1 GHz ~ 25 GHz
Input Power	120 Vac, 60 Hz	Detector Function	Peak (PK) Average (AV)
Environmental Conditions	25 deg. C, 65 % RH	Tested By	Karl Lee

Antennal Polarity & Test Distance: Horizontal at 3 m										
Frequency (MHz)	Emission Level (dBuV/m)	Read Level (dBuV)	Limit (dBuV/m)	Margin (dB)	Antenna Factor (dB/m)	Cable Loss (dB)	Preamp Factor (dB)	Antenna Height (cm)	Table Angle (Degree)	Remark
2390	51.58	49.85	54	-2.42	31.8	5.4	35.47	113	215	Average
2390	69.6	67.87	74	-4.4	31.8	5.4	35.47	113	215	Peak
2437	98.59	96.74			31.85	5.46	35.46	113	215	Average
2437	107.15	105.3			31.85	5.46	35.46	113	215	Peak
2484	52.41	50.45	54	-1.59	31.88	5.5	35.42	113	215	Average
2484	68.9	66.94	74	-5.1	31.88	5.5	35.42	113	215	Peak
Antennal Polarity & Test Distance: Vertical at 3 m										
Frequency (MHz)	Emission Level (dBuV/m)	Read Level (dBuV)	Limit (dBuV/m)	Margin (dB)	Antenna Factor (dB/m)	Cable Loss (dB)	Preamp Factor (dB)	Antenna Height (cm)	Table Angle (Degree)	Remark
2390	49.43	47.7	54	-4.57	31.8	5.4	35.47	119	269	Average
2390	63.3	61.57	74	-10.7	31.8	5.4	35.47	119	269	Peak
2437	95.73	93.88			31.85	5.46	35.46	119	269	Average
2437	104.27	102.42			31.85	5.46	35.46	119	269	Peak
2484	47.37	45.41	54	-6.63	31.88	5.5	35.42	119	269	Average
2484	64.46	62.5	74	-9.54	31.88	5.5	35.42	119	269	Peak

Remarks:

- Emission Level = Read Level + Antenna Factor + Cable Loss - Preamp Factor  
Margin value = Emission level – Limit value
- 2437 MHz: Fundamental frequency.



A D T

EUT Test Condition		Measurement Detail	
Channel	Channel 9	Frequency Range	1 GHz ~ 25 GHz
Input Power	120 Vac, 60 Hz	Detector Function	Peak (PK) Average (AV)
Environmental Conditions	25 deg. C, 65 % RH	Tested By	Karl Lee

Antennal Polarity & Test Distance: Horizontal at 3 m										
Frequency (MHz)	Emission Level (dBuV/m)	Read Level (dBuV)	Limit (dBuV/m)	Margin (dB)	Antenna Factor (dB/m)	Cable Loss (dB)	Preamp Factor (dB)	Antenna Height (cm)	Table Angle (Degree)	Remark
2326	40.28	38.77	54	-13.72	31.73	5.3	35.52	111	215	Average
2326	54.9	53.39	74	-19.1	31.73	5.3	35.52	111	215	Peak
2452	93.79	91.92			31.85	5.46	35.44	111	215	Average
2452	102.06	100.19			31.85	5.46	35.44	111	215	Peak
2484	52.94	50.98	54	-1.06	31.88	5.5	35.42	111	215	Average
2484	68.95	66.99	74	-5.05	31.88	5.5	35.42	111	215	Peak

Antennal Polarity & Test Distance: Vertical at 3 m										
Frequency (MHz)	Emission Level (dBuV/m)	Read Level (dBuV)	Limit (dBuV/m)	Margin (dB)	Antenna Factor (dB/m)	Cable Loss (dB)	Preamp Factor (dB)	Antenna Height (cm)	Table Angle (Degree)	Remark
2384	40.5	38.81	54	-13.5	31.78	5.4	35.49	131	269	Average
2384	54.95	53.26	74	-19.05	31.78	5.4	35.49	131	269	Peak
2452	91.69	89.82			31.85	5.46	35.44	131	269	Average
2452	100.25	98.38			31.85	5.46	35.44	131	269	Peak
2484	50.06	48.1	54	-3.94	31.88	5.5	35.42	131	269	Average
2484	64.23	62.27	74	-9.77	31.88	5.5	35.42	131	269	Peak

Remarks:

- Emission Level = Read Level + Antenna Factor + Cable Loss - Preamp Factor  
Margin value = Emission level – Limit value
- 2452 MHz: Fundamental frequency.

**Mode B**
**802.11n (HT20)**

EUT Test Condition		Measurement Detail	
Channel	Channel 11	Frequency Range	1 GHz ~ 25 GHz
Input Power	120 Vac, 60 Hz	Detector Function	Peak (PK) Average (AV)
Environmental Conditions	25 deg. C, 65 % RH	Tested By	Karl Lee

**Antennal Polarity & Test Distance: Horizontal at 3 m**

Frequency (MHz)	Emission Level (dBuV/m)	Read Level (dBuV)	Limit (dBuV/m)	Margin (dB)	Antenna Factor (dB/m)	Cable Loss (dB)	Preamp Factor (dB)	Antenna Height (cm)	Table Angle (Degree)	Remark
2350	40.36	38.79	54	-13.64	31.74	5.33	35.5	159	235	Average
2350	56.73	55.16	74	-17.27	31.74	5.33	35.5	159	235	Peak
2462	98.69	96.76			31.87	5.5	35.44	159	235	Average
2462	107.39	105.46			31.87	5.5	35.44	159	235	Peak
2484	52.33	50.37	54	-1.67	31.88	5.5	35.42	159	235	Average
2484	72.46	70.5	74	-1.54	31.88	5.5	35.42	159	235	Peak

**Antennal Polarity & Test Distance: Vertical at 3 m**

Frequency (MHz)	Emission Level (dBuV/m)	Read Level (dBuV)	Limit (dBuV/m)	Margin (dB)	Antenna Factor (dB/m)	Cable Loss (dB)	Preamp Factor (dB)	Antenna Height (cm)	Table Angle (Degree)	Remark
2370	40.37	38.71	54	-13.63	31.78	5.37	35.49	131	271	Average
2370	56.3	54.64	74	-17.7	31.78	5.37	35.49	131	271	Peak
2462	97.16	95.23			31.87	5.5	35.44	131	271	Average
2462	105.68	103.75			31.87	5.5	35.44	131	271	Peak
2484	51.29	49.33	54	-2.71	31.88	5.5	35.42	131	271	Average
2484	69.46	67.5	74	-4.54	31.88	5.5	35.42	131	271	Peak

**Remarks:**

- Emission Level = Read Level + Antenna Factor + Cable Loss - Preamp Factor  
Margin value = Emission level – Limit value
- 2462 MHz: Fundamental frequency.

**9 kHz ~ 30 MHz DATA:**

The amplitude of spurious emissions attenuated more than 20 dB below the permissible value is not required to be report.

**30 MHz ~ 1 GHz WORST-CASE DATA:**
**Mode A**
**802.11n (HT20)**

EUT Test Condition		Measurement Detail	
Channel	Channel 11	Frequency Range	30 MHz ~ 1 GHz
Input Power	120 Vac, 60 Hz	Detector Function	Peak (PK) Quasi-peak (QP)
Environmental Conditions	25 deg. C, 65 % RH	Tested By	Karl Lee

Antennal Polarity & Test Distance: Horizontal at 3 m										
Frequency (MHz)	Emission Level (dBuV/m)	Read Level (dBuV)	Limit (dBuV/m)	Margin (dB)	Antenna Factor (dB/m)	Cable Loss (dB)	Preamp Factor (dB)	Antenna Height (cm)	Table Angle (Degree)	Remark
54.57	26.52	50.52	40	-13.48	7.33	0.9	32.23	151	347	Peak
105.6	28.92	50.38	43.5	-14.58	9.52	1.28	32.26	195	255	Peak
153.39	30.66	51.08	43.5	-12.84	10.33	1.52	32.27	108	199	Peak
307	25.16	40.85	46	-20.84	14.33	2.11	32.13	155	251	Peak
617.1	22.05	29.49	46	-23.95	21.81	2.93	32.18	121	121	Peak
732.6	24.53	30.17	46	-21.47	23.33	3.16	32.13	123	165	Peak
Antennal Polarity & Test Distance: Vertical at 3 m										
Frequency (MHz)	Emission Level (dBuV/m)	Read Level (dBuV)	Limit (dBuV/m)	Margin (dB)	Antenna Factor (dB/m)	Cable Loss (dB)	Preamp Factor (dB)	Antenna Height (cm)	Table Angle (Degree)	Remark
55.38	35.34	59.43	40	-4.66	7.24	0.9	32.23	109	72	Peak
98.04	22.58	43.91	43.5	-20.92	9.54	1.28	32.15	198	4	Peak
152.85	19.2	39.62	43.5	-24.3	10.33	1.52	32.27	103	333	Peak
384	22.16	34.95	46	-23.84	17.05	2.34	32.18	175	234	Peak
524	21.27	30.01	46	-24.73	20.7	2.7	32.14	107	204	Peak
669.6	23.3	29.2	46	-22.7	23.18	3.05	32.13	183	305	Peak

**Remarks:**

- Emission Level = Read Level + Antenna Factor + Cable Loss - Preamp Factor  
Margin value = Emission level – Limit value

**Mode B**
**802.11n (HT20)**

EUT Test Condition		Measurement Detail	
Channel	Channel 11	Frequency Range	30 MHz ~ 1 GHz
Input Power	120 Vac, 60 Hz	Detector Function	Peak (PK) Quasi-peak (QP)
Environmental Conditions	25 deg. C, 65 % RH	Tested By	Karl Lee

**Antennal Polarity & Test Distance: Horizontal at 3 m**

Frequency (MHz)	Emission Level (dBuV/m)	Read Level (dBuV)	Limit (dBuV/m)	Margin (dB)	Antenna Factor (dB/m)	Cable Loss (dB)	Preamp Factor (dB)	Antenna Height (cm)	Table Angle (Degree)	Remark
95.07	29.16	50.57	43.5	-14.34	9.3	1.28	31.99	103	69	Peak
153.66	22.91	43.27	43.5	-20.59	10.39	1.52	32.27	197	167	Peak
206.58	20.76	40.21	43.5	-22.74	11.17	1.65	32.27	102	358	Peak
412.7	23.38	35.29	46	-22.62	17.88	2.41	32.2	136	102	Peak
647.9	22.87	29.93	46	-23.13	22.1	2.99	32.15	170	10	Peak
796.3	24.79	29.11	46	-21.21	24.42	3.32	32.06	124	222	Peak

**Antennal Polarity & Test Distance: Vertical at 3 m**

Frequency (MHz)	Emission Level (dBuV/m)	Read Level (dBuV)	Limit (dBuV/m)	Margin (dB)	Antenna Factor (dB/m)	Cable Loss (dB)	Preamp Factor (dB)	Antenna Height (cm)	Table Angle (Degree)	Remark
30.81	36.14	50.47	40	-3.86	17.19	0.74	32.26	137	308	Peak
47.01	35.74	58.32	40	-4.26	8.74	0.9	32.22	157	114	Peak
92.91	22.79	44.42	43.5	-20.71	9.14	1.11	31.88	190	139	Peak
384	24.96	37.75	46	-21.04	17.05	2.34	32.18	170	124	Peak
550.6	23.24	32.38	46	-22.76	20.3	2.76	32.2	124	222	Peak
826.4	25.91	30.9	46	-20.09	23.55	3.38	31.92	138	338	Peak

**Remarks:**

1. Emission Level = Read Level + Antenna Factor + Cable Loss - Preamp Factor

Margin value = Emission level – Limit value

## 4.2 Conducted Emission Measurement

### 4.2.1 Limits of Conducted Emission Measurement

Frequency (MHz)	Conducted Limit (dBuV)	
	Quasi-peak	Average
0.15 - 0.5	66 - 56	56 - 46
0.50 - 5.0	56	46
5.0 - 30.0	60	50

Note: 1. The lower limit shall apply at the transition frequencies.

2. The limit decreases in line with the logarithm of the frequency in the range of 0.15 to 0.50 MHz.

### 4.2.2 Test Instruments

Description & Manufacturer	Model No.	Serial No.	Date of Calibration	Due Date of Calibration
Test Receiver ROHDE & SCHWARZ	ESCI	100613	Nov. 16, 2015	Nov. 15, 2016
RF signal cable (with 10dB PAD) Woken	5D-FB	Cable-cond1-01	Dec. 26, 2015	Dec. 25, 2016
LISN ROHDE & SCHWARZ (EUT)	ESH3-Z5	835239/001	Feb. 26, 2016	Feb. 25, 2017
LISN ROHDE & SCHWARZ (Peripheral)	ESH3-Z5	100311	Jul. 24, 2015	Jul. 23, 2016
Software ADT	BV ADT_Cond_ V7.3.7.3	NA	NA	NA

Note: 1. The calibration interval of the above test instruments is 12 months and the calibrations are traceable to NML/ROC and NIST/USA.

2. The test was performed in HwaYa Shielded Room 1.

3. The VCCI Site Registration No. is C-2040.



#### 4.2.3 Test Procedures

- a. The EUT was placed 0.4 meters from the conducting wall of the shielded room with EUT being connected to the power mains through a line impedance stabilization network (LISN). Other support units were connected to the power mains through another LISN. The two LISNs provide 50 ohm/50 uH of coupling impedance for the measuring instrument.
- b. Both lines of the power mains connected to the EUT were checked for maximum conducted interference.
- c. The frequency range from 150 kHz to 30 MHz was searched. Emission levels under (Limit – 20 dB) was not recorded.

**NOTE:** All modes of operation were investigated and the worst-case emissions are reported.

#### 4.2.4 Deviation from Test Standard

No deviation.

#### 4.2.5 Test Setup

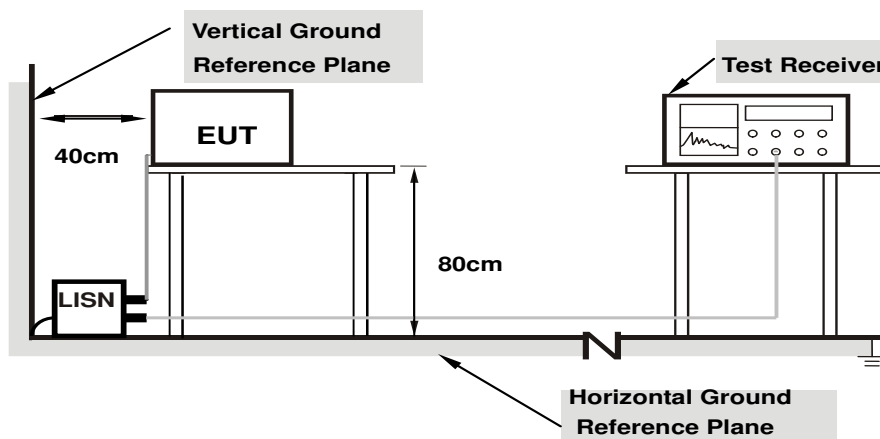

**Note:** 1.Support units were connected to second LISN.

For the actual test configuration, please refer to the attached file (Test Setup Photo).

#### 4.2.6 EUT Operating Conditions

- a. Placed the EUT on a testing table.
- b. Use the software to control the EUT under transmission condition continuously at specific channel frequency.

#### 4.2.7 Test Results

##### Mode A

Frequency Range	150kHz ~ 30MHz	Detector Function & Resolution Bandwidth	Quasi-Peak (QP) / Average (AV), 9kHz
Input Power	120Vac, 60Hz	Environmental Conditions	25°C, 65%RH
Tested by	Toby Tian	Test Date	2016/4/16

Phase Of Power : Line (L)										
No	Frequency (MHz)	Correction Factor (dB)	Reading Value (dBuV)		Emission Level (dBuV)		Limit (dBuV)		Margin (dB)	
			Q.P.	AV.	Q.P.	AV.	Q.P.	AV.	Q.P.	AV.
1	0.39032	10.12	27.37	17.80	37.49	27.92	58.06	48.06	-20.57	-20.14
2	0.57800	10.14	29.86	20.09	40.00	30.23	56.00	46.00	-16.00	-15.77
3	0.71923	10.16	27.98	18.72	38.14	28.88	56.00	46.00	-17.86	-17.12
4	0.91400	10.19	29.01	20.25	39.20	30.44	56.00	46.00	-16.80	-15.56
5	1.40600	10.23	26.67	17.68	36.90	27.91	56.00	46.00	-19.10	-18.09
6	2.44600	10.30	22.92	14.57	33.22	24.87	56.00	46.00	-22.78	-21.13

##### Remarks:

1. Q.P. and AV. are abbreviations of quasi-peak and average individually.
2. The emission levels of other frequencies were very low against the limit.
3. Margin value = Emission level – Limit value
4. Correction factor = Insertion loss + Cable loss
5. Emission Level = Correction Factor + Reading Value

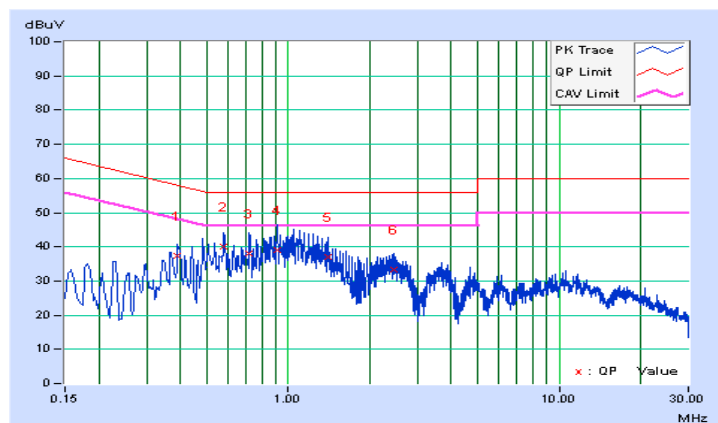

Frequency Range	150kHz ~ 30MHz	Detector Function & Resolution Bandwidth	Quasi-Peak (QP) / Average (AV), 9kHz
Input Power	120Vac, 60Hz	Environmental Conditions	25°C, 65%RH
Tested by	Toby Tian	Test Date	2016/4/16

Phase Of Power : Neutral (N)										
No	Frequency (MHz)	Correction Factor (dB)	Reading Value (dBuV)		Emission Level (dBuV)		Limit (dBuV)		Margin (dB)	
			Q.P.	AV.	Q.P.	AV.	Q.P.	AV.	Q.P.	AV.
1	0.28602	10.08	26.96	17.24	37.04	27.32	60.64	50.64	-23.60	-23.32
2	0.38218	10.12	30.29	20.97	40.41	31.09	58.23	48.23	-17.82	-17.14
3	0.57400	10.15	31.38	22.42	41.53	32.57	56.00	46.00	-14.47	-13.43
4	1.04200	10.21	33.80	23.88	44.01	34.09	56.00	46.00	-11.99	-11.91
5	1.32600	10.23	31.34	21.59	41.57	31.82	56.00	46.00	-14.43	-14.18
6	2.29000	10.30	26.89	17.86	37.19	28.16	56.00	46.00	-18.81	-17.84

Remarks:

1. Q.P. and AV. are abbreviations of quasi-peak and average individually.
2. The emission levels of other frequencies were very low against the limit.
3. Margin value = Emission level – Limit value
4. Correction factor = Insertion loss + Cable loss
5. Emission Level = Correction Factor + Reading Value

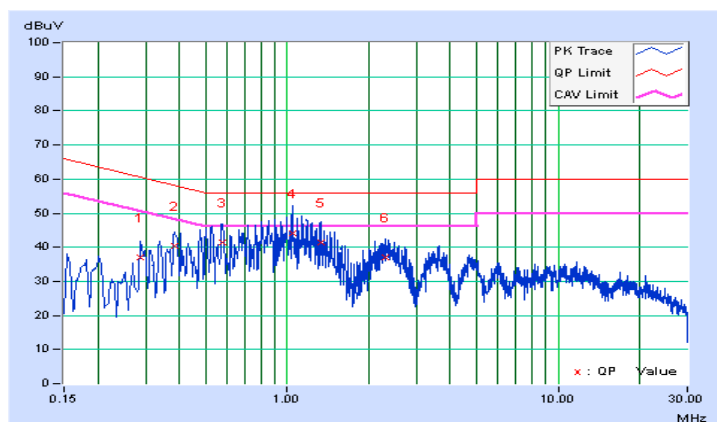

**Mode B**

Frequency Range	150kHz ~ 30MHz	Detector Function & Resolution Bandwidth	Quasi-Peak (QP) / Average (AV), 9kHz
Input Power	120Vac, 60Hz	Environmental Conditions	25°C, 65%RH
Tested by	Toby Tian	Test Date	2016/4/19

Phase Of Power : Line (L)										
No	Frequency (MHz)	Correction Factor (dB)	Reading Value (dBuV)		Emission Level (dBuV)		Limit (dBuV)		Margin (dB)	
			Q.P.	AV.	Q.P.	AV.	Q.P.	AV.	Q.P.	AV.
1	0.15000	10.01	29.24	16.30	39.25	26.31	66.00	56.00	-26.75	-29.69
2	0.19000	10.03	26.65	14.00	36.68	24.03	64.04	54.04	-27.36	-30.01
3	0.38200	10.11	24.93	15.67	35.04	25.78	58.24	48.24	-23.19	-22.45
4	0.58872	10.15	27.36	16.93	37.51	27.08	56.00	46.00	-18.49	-18.92
5	1.23000	10.22	27.21	18.31	37.43	28.53	56.00	46.00	-18.57	-17.47
6	2.47800	10.30	21.29	13.04	31.59	23.34	56.00	46.00	-24.41	-22.66

Remarks:

1. Q.P. and AV. are abbreviations of quasi-peak and average individually.
2. The emission levels of other frequencies were very low against the limit.
3. Margin value = Emission level – Limit value
4. Correction factor = Insertion loss + Cable loss
5. Emission Level = Correction Factor + Reading Value

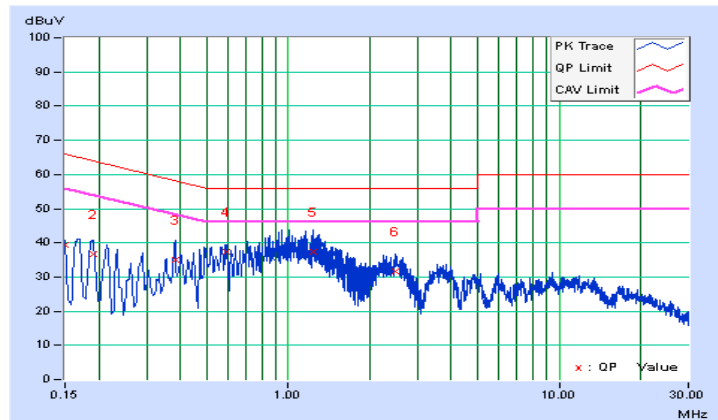

Frequency Range	150kHz ~ 30MHz	Detector Function & Resolution Bandwidth	Quasi-Peak (QP) / Average (AV), 9kHz
Input Power	120Vac, 60Hz	Environmental Conditions	25°C, 65%RH
Tested by	Toby Tian	Test Date	2016/4/19

Phase Of Power : Neutral (N)										
No	Frequency (MHz)	Correction Factor (dB)	Reading Value (dBuV)		Emission Level (dBuV)		Limit (dBuV)		Margin (dB)	
			Q.P.	AV.	Q.P.	AV.	Q.P.	AV.	Q.P.	AV.
1	0.15000	10.03	41.32	27.17	51.35	37.20	66.00	56.00	-14.65	-18.80
2	0.21238	10.05	34.57	21.55	44.62	31.60	63.11	53.11	-18.50	-21.52
3	0.28527	10.08	28.84	18.48	38.92	28.56	60.66	50.66	-21.74	-22.10
4	0.50000	10.14	31.33	20.07	41.47	30.21	56.00	46.00	-14.53	-15.79
5	1.12200	10.22	30.71	23.45	40.93	33.67	56.00	46.00	-15.07	-12.33
6	2.15000	10.29	24.86	16.07	35.15	26.36	56.00	46.00	-20.85	-19.64

Remarks:

1. Q.P. and AV. are abbreviations of quasi-peak and average individually.
2. The emission levels of other frequencies were very low against the limit.
3. Margin value = Emission level – Limit value
4. Correction factor = Insertion loss + Cable loss
5. Emission Level = Correction Factor + Reading Value

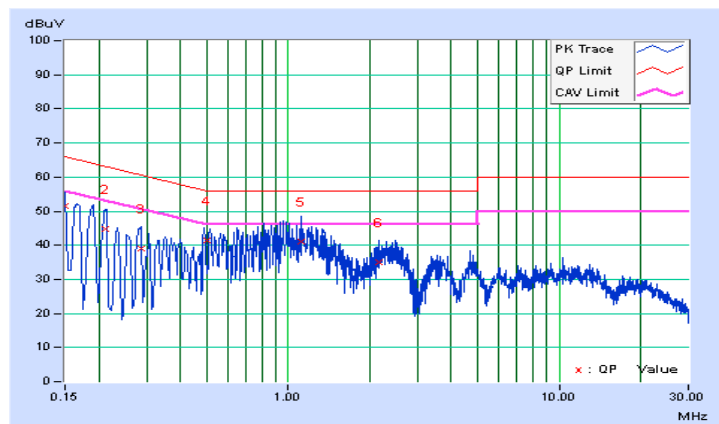

### 4.3 6 dB Bandwidth Measurement

#### 4.3.1 Limits of 6 dB Bandwidth Measurement

The minimum of 6 dB Bandwidth Measurement is 0.5 MHz.

#### 4.3.2 Test Setup

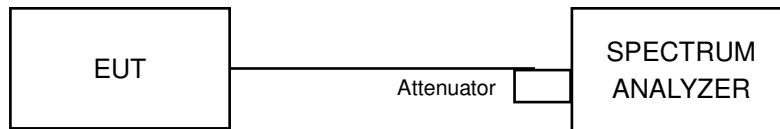

#### 4.3.3 Test Instruments

Refer to section 4.1.2 to get information of above instrument.

#### 4.3.4 Test Procedure

- Set resolution bandwidth (RBW) = 100 kHz
- Set the video bandwidth (VBW)  $\geq 3 \times$  RBW, Detector = Peak.
- Trace mode = max hold.
- Sweep = auto couple.
- Measure the maximum width of the emission that is constrained by the frequencies associated with the two amplitude points (upper and lower) that are attenuated by 6 dB relative to the maximum level measured in the fundamental emission

#### 4.3.5 Deviation from Test Standard

No deviation.

#### 4.3.6 EUT Operating Conditions

The software provided by client to enable the EUT under transmission condition continuously at lowest, middle and highest channel frequencies individually.

## 4.3.7 Test Result

## 802.11b

Channel	Frequency (MHz)	6 dB Bandwidth (MHz)	Minimum Limit (MHz)	Pass / Fail
1	2412	8.06	0.5	Pass
6	2437	8.57	0.5	Pass
11	2462	8.10	0.5	Pass

## 802.11g

Channel	Frequency (MHz)	6 dB Bandwidth (MHz)	Minimum Limit (MHz)	Pass / Fail
1	2412	16.36	0.5	Pass
6	2437	16.45	0.5	Pass
11	2462	16.41	0.5	Pass

## 802.11n (HT20)

Channel	Frequency (MHz)	6 dB Bandwidth (MHz)	Minimum Limit (MHz)	Pass / Fail
1	2412	17.59	0.5	Pass
6	2437	17.66	0.5	Pass
11	2462	17.63	0.5	Pass

## 802.11n (HT40)

Channel	Frequency (MHz)	6 dB Bandwidth (MHz)	Minimum Limit (MHz)	Pass / Fail
3	2422	35.35	0.5	Pass
6	2437	35.77	0.5	Pass
9	2452	35.28	0.5	Pass

### Spectrum Plot of Worst Value

#### 802.11b

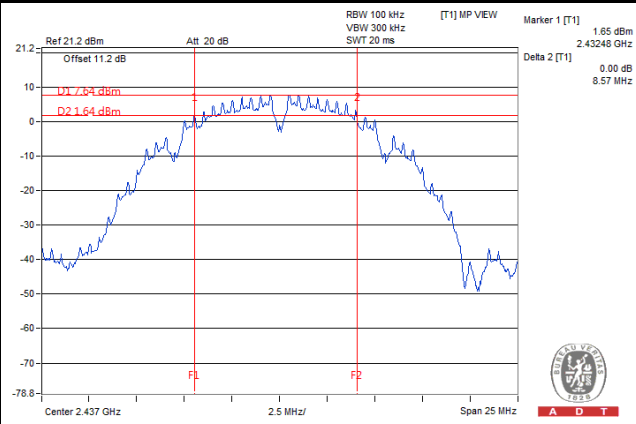

#### 802.11g

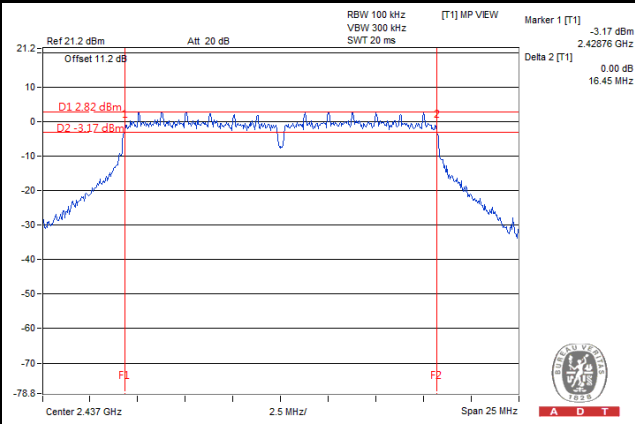

#### 802.11n (HT20)

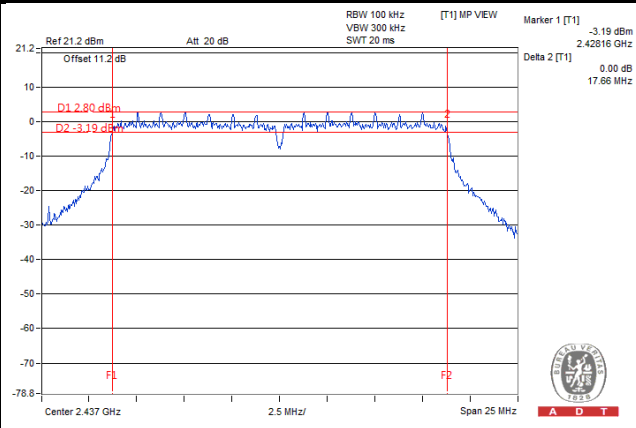

#### 802.11n (HT40)

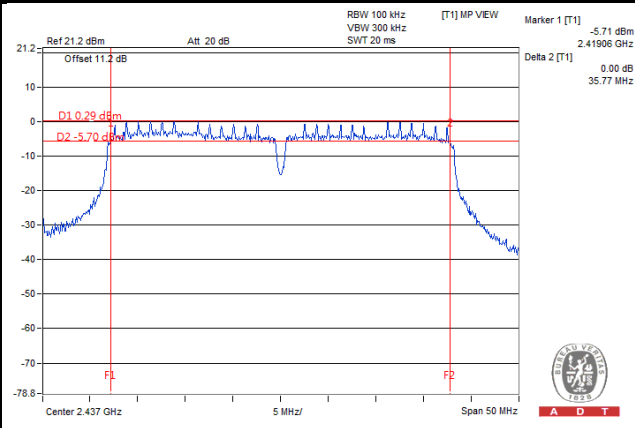



## 4.4 Conducted Output Power Measurement

### 4.4.1 Limits of Conducted Output Power Measurement

For systems using digital modulation in the 2400–2483.5 MHz bands: 1 Watt (30 dBm)

### 4.4.2 Test Setup

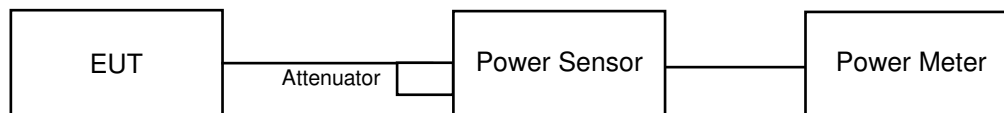

### 4.4.3 Test Instruments

Refer to section 4.1.2 to get information of above instrument.

### 4.4.4 Test Procedures

A peak power sensor was used on the output port of the EUT. A power meter was used to read the response of the peak power sensor. Record the power level.

### 4.4.5 Deviation from Test Standard

No deviation.

### 4.4.6 EUT Operating Conditions

The software provided by client to enable the EUT under transmission condition continuously at lowest, middle and highest channel frequencies individually.

#### 4.4.7 Test Results

##### 802.11b

Channel	Frequency (MHz)	Peak Power (mW)	Peak Power (dBm)	Limit (dBm)	Pass / Fail
1	2412	95.50	19.8	30	Pass
6	2437	91.20	19.6	30	Pass
11	2462	96.83	19.86	30	Pass

##### 802.11g

Channel	Frequency (MHz)	Peak Power (mW)	Peak Power (dBm)	Limit (dBm)	Pass / Fail
1	2412	217.77	23.38	30	Pass
6	2437	212.32	23.27	30	Pass
11	2462	206.54	23.15	30	Pass

##### 802.11n (HT20)

Channel	Frequency (MHz)	Peak Power (mW)	Peak Power (dBm)	Limit (dBm)	Pass / Fail
1	2412	205.59	23.13	30	Pass
6	2437	220.29	23.43	30	Pass
11	2462	210.38	23.23	30	Pass

##### 802.11n (HT40)

Channel	Frequency (MHz)	Peak Power (mW)	Peak Power (dBm)	Limit (dBm)	Pass / Fail
3	2422	230.14	23.62	30	Pass
6	2437	224.39	23.51	30	Pass
9	2452	228.56	23.59	30	Pass

## 4.5 Power Spectral Density Measurement

### 4.5.1 Limits of Power Spectral Density Measurement

The Maximum of Power Spectral Density Measurement is 8 dBm.

### 4.5.2 Test Setup

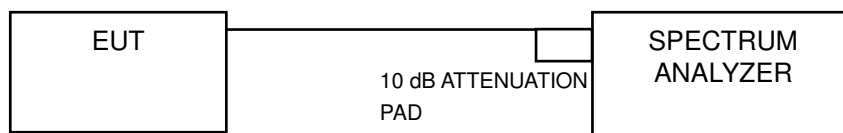

### 4.5.3 Test Instruments

Refer to section 4.1.2 to get information of above instrument.

### 4.5.4 Test Procedure

- Set analyzer center frequency to DTS channel center frequency.
- Set the span to 1.5 times the DTS bandwidth.
- Set the RBW to:  $3 \text{ kHz} \leq \text{RBW} \leq 100 \text{ kHz}$ .
- Set the VBW  $\geq 3 \times \text{RBW}$ .
- Detector = peak.
- Sweep time = auto couple.
- Trace mode = max hold.
- Allow trace to fully stabilize.
- Use the peak marker function to determine the maximum amplitude level within the RBW.

### 4.5.5 Deviation from Test Standard

No deviation.

### 4.5.6 EUT Operating Condition

The software provided by client to enable the EUT under transmission condition continuously at lowest, middle and highest channel frequencies individually.

## 4.5.7 Test Results

## 802.11b

Channel	Frequency (MHz)	PSD (dBm)	Limit (dBm)	Pass / Fail
1	2412	-6.16	8	Pass
6	2437	-6.23	8	Pass
11	2462	-6.64	8	Pass

## 802.11g

Channel	Frequency (MHz)	PSD (dBm)	Limit (dBm)	Pass / Fail
1	2412	-10.78	8	Pass
6	2437	-11.74	8	Pass
11	2462	-11.33	8	Pass

## 802.11n (HT20)

Channel	Frequency (MHz)	PSD (dBm)	Limit (dBm)	Pass / Fail
1	2412	-11.68	8	Pass
6	2437	-10.44	8	Pass
11	2462	-10.88	8	Pass

## 802.11n (HT40)

Channel	Frequency (MHz)	PSD (dBm)	Limit (dBm)	Pass / Fail
3	2422	-15.19	8	Pass
6	2437	-15.67	8	Pass
9	2452	-15.39	8	Pass

### Spectrum Plot of Worst Value

#### 802.11b

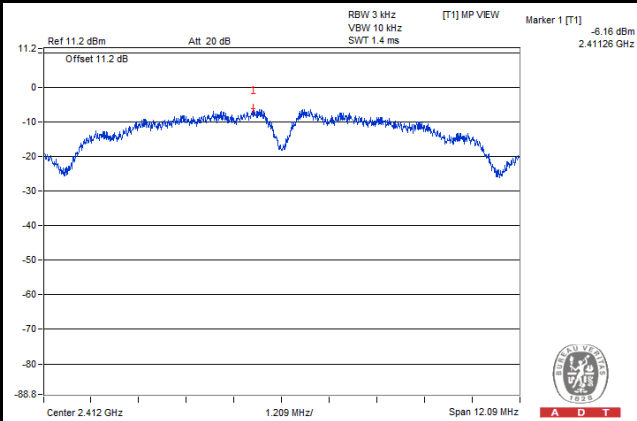

#### 802.11g

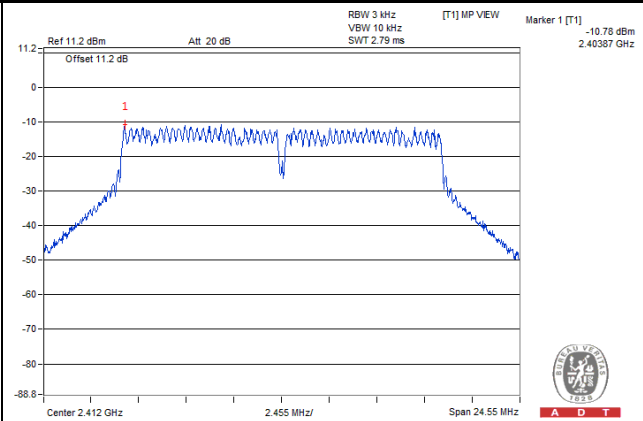

#### 802.11n (HT20)

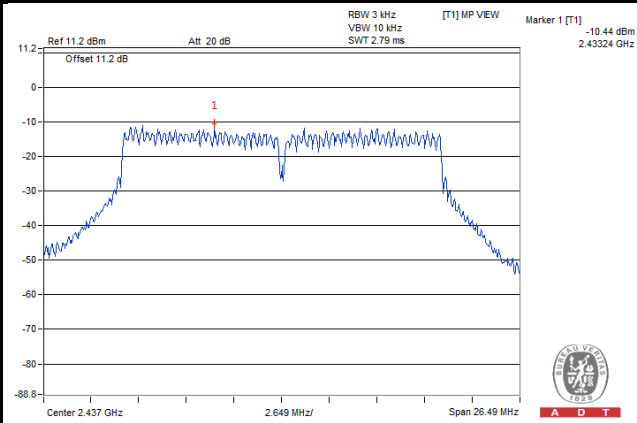

#### 802.11n (HT40)

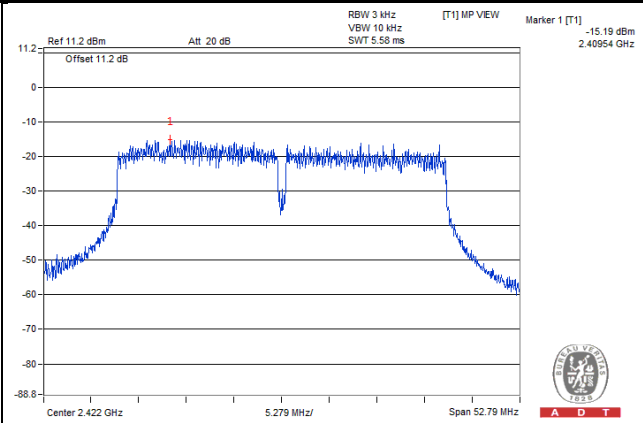

## 4.6 Conducted Out of Band Emission Measurement

### 4.6.1 Limits of Conducted Out of Band Emission Measurement

Below 20 dB of the highest emission level of operating band (in 100 kHz Resolution Bandwidth).

### 4.6.2 Test Setup

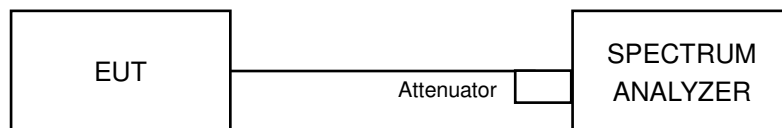

### 4.6.3 Test Instruments

Refer to section 4.1.2 to get information of above instrument.

### 4.6.4 Test Procedure

#### MEASUREMENT PROCEDURE REF

1. Set the RBW = 100 kHz.
2. Set the VBW  $\geq$  300 kHz.
3. Detector = peak.
4. Sweep time = auto couple.
5. Trace mode = max hold.
6. Allow trace to fully stabilize.
7. Use the peak marker function to determine the maximum power level in any 100 kHz band segment within the fundamental EBW.

#### MEASUREMENT PROCEDURE OOB

1. Set RBW = 100 kHz.
2. Set VBW  $\geq$  300 kHz.
3. Detector = peak.
4. Sweep = auto couple.
5. Trace Mode = max hold.
6. Allow trace to fully stabilize.
7. Use the peak marker function to determine the maximum amplitude level.

### 4.6.5 Deviation from Test Standard

No deviation.

### 4.6.6 EUT Operating Condition

The software provided by client to enable the EUT under transmission condition continuously at lowest, middle and highest channel frequencies individually.

### 4.6.7 Test Results

The spectrum plots are attached on the following images. D1 line indicates the highest level, and D2 line indicates the 20 dB offset below D1. It shows compliance with the requirement.

#### 802.11b

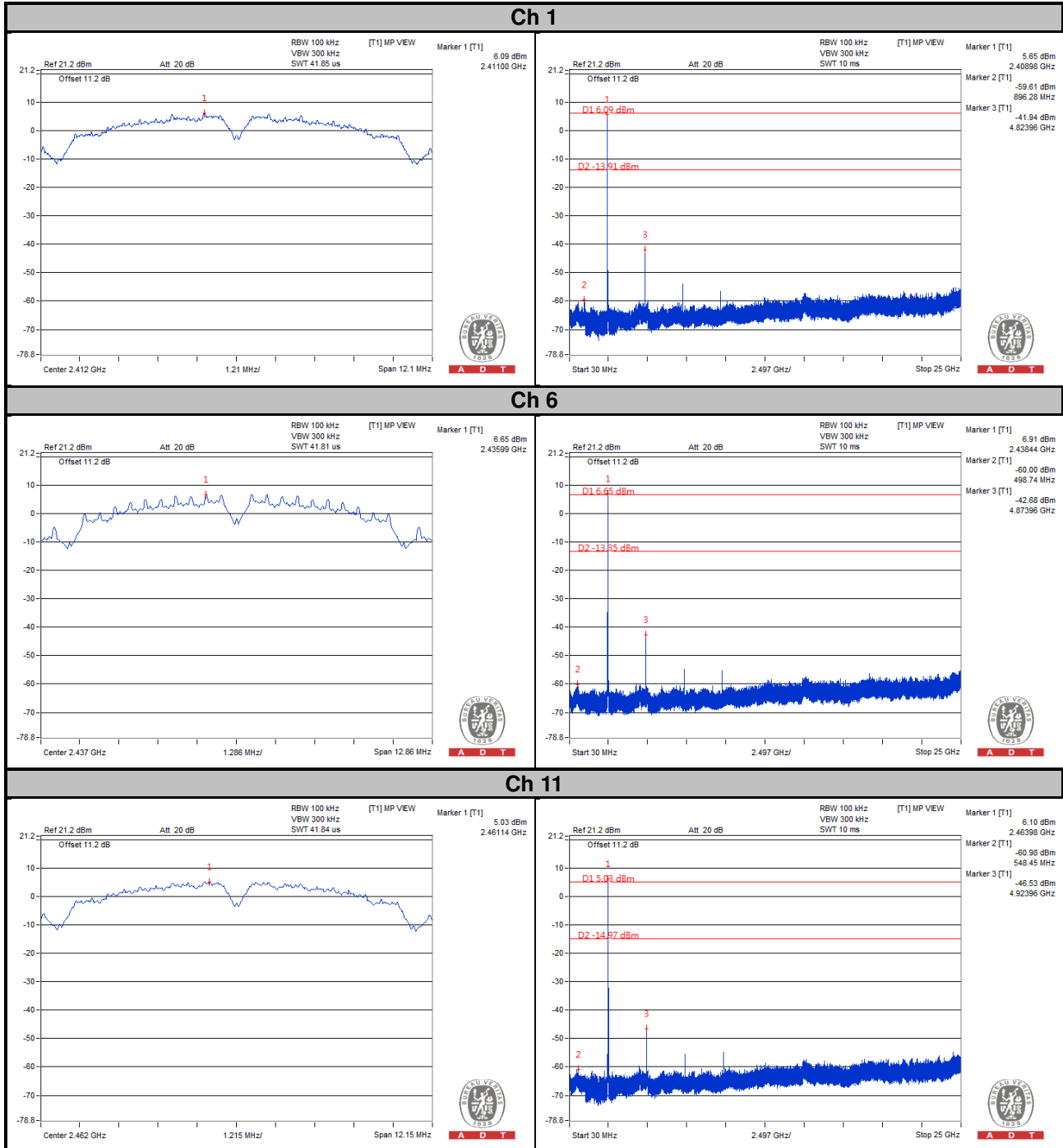

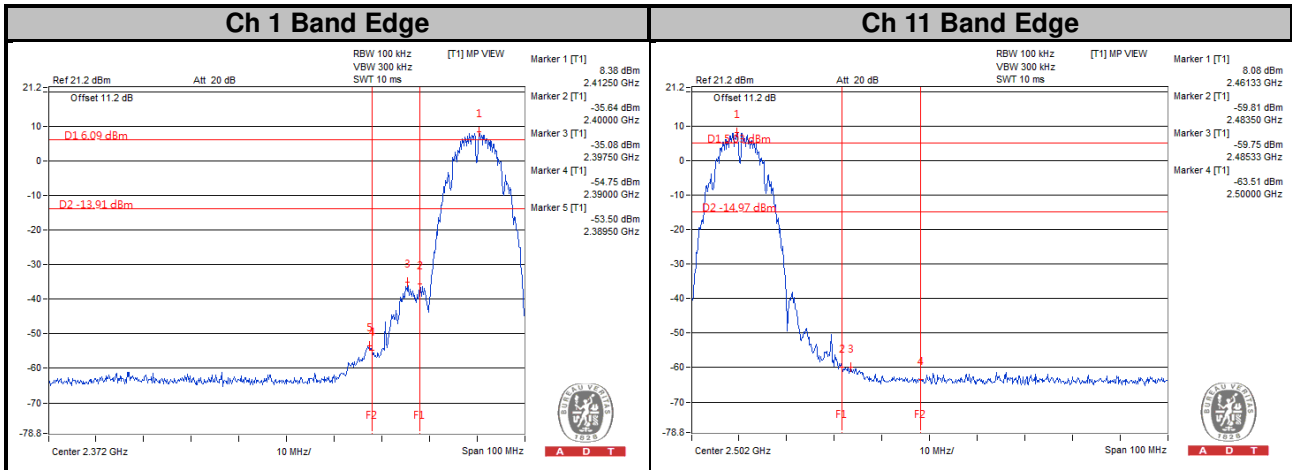



802.11g

Ch 1

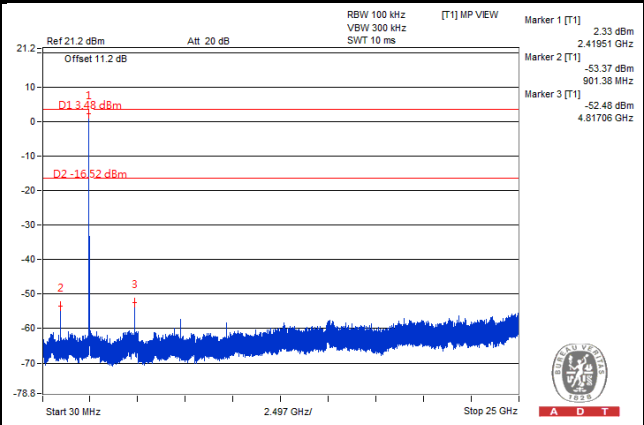
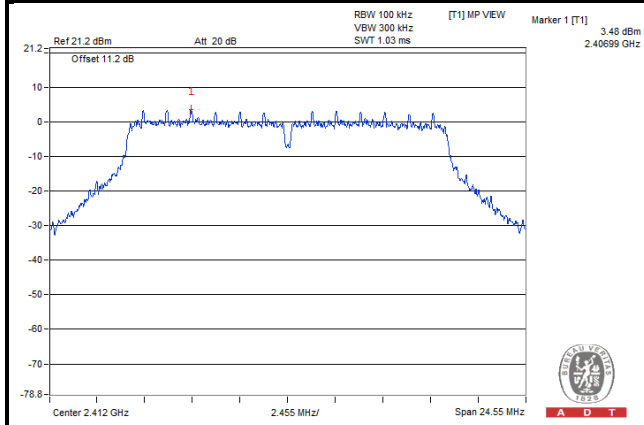

Ch 6

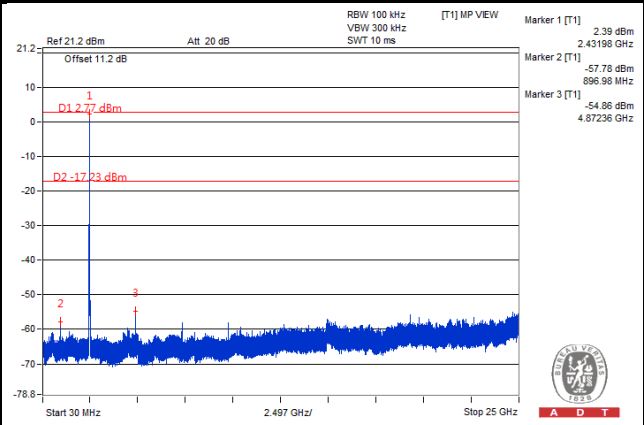
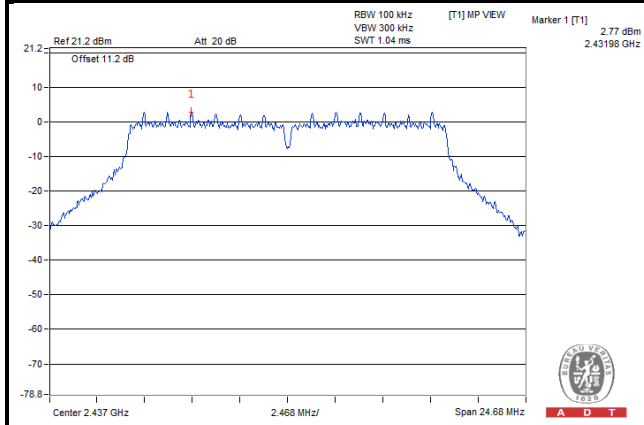

Ch 11

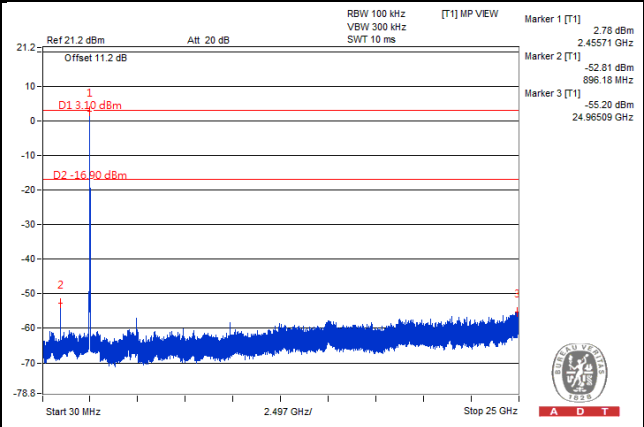
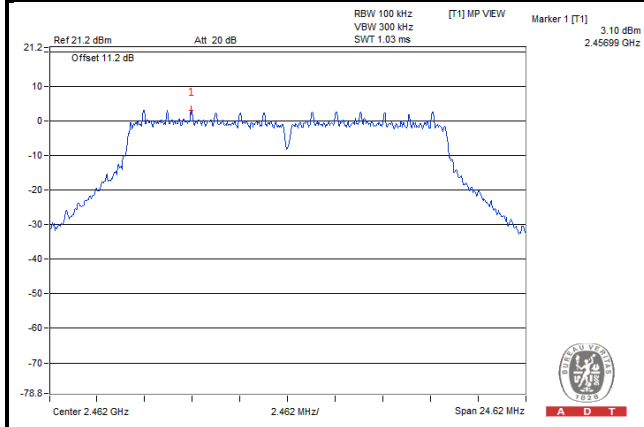

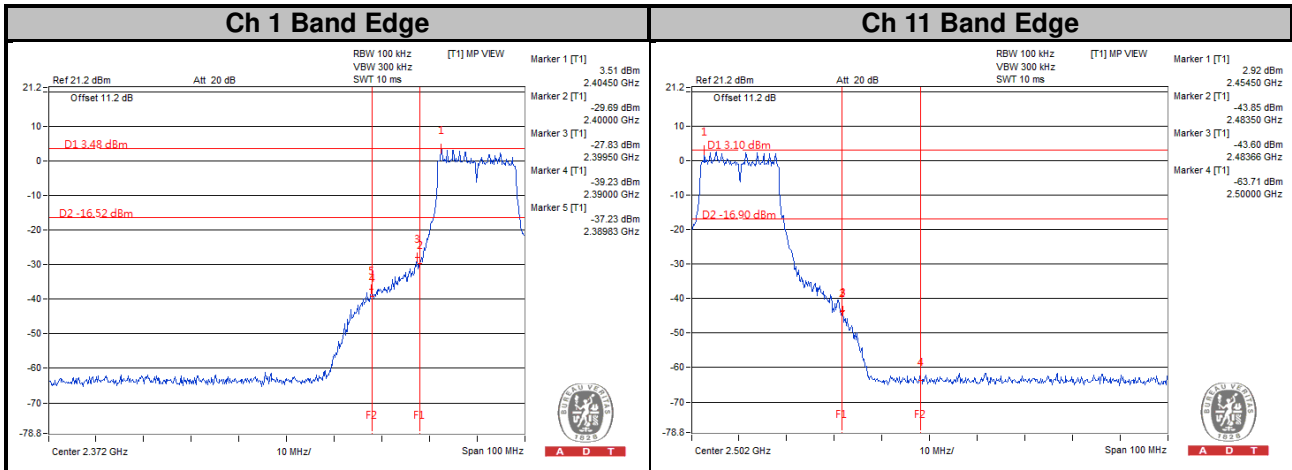

# 802.11n (HT20)

## Ch 1

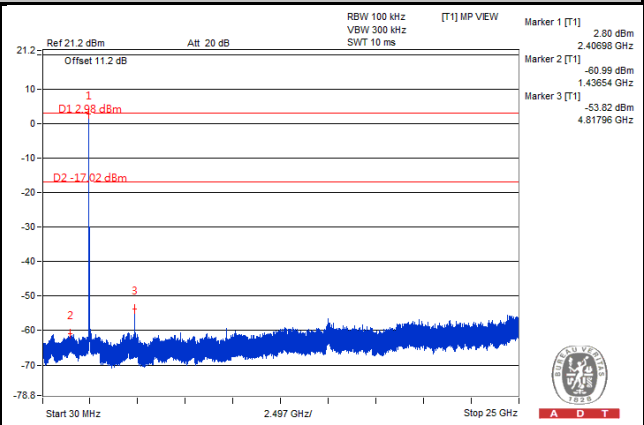
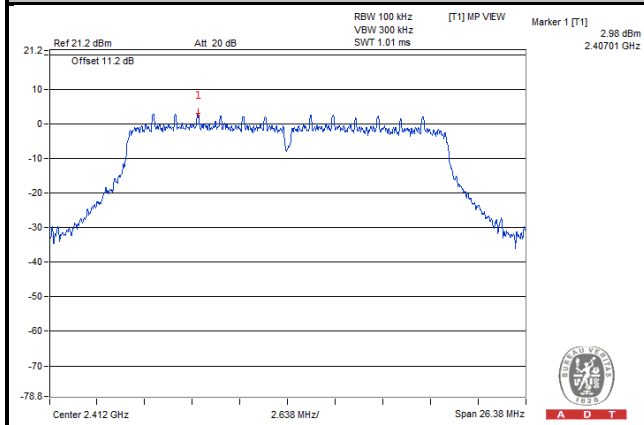

## Ch 6

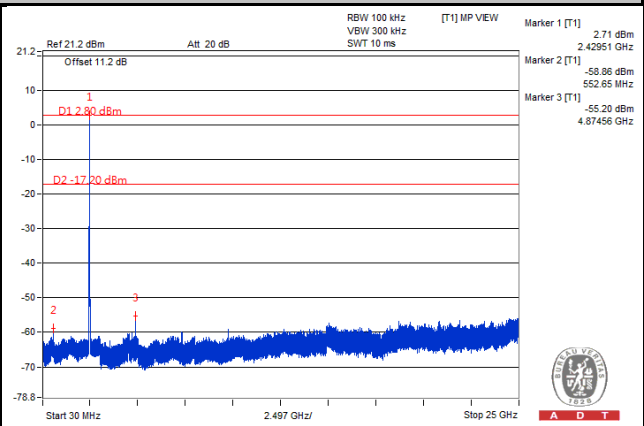
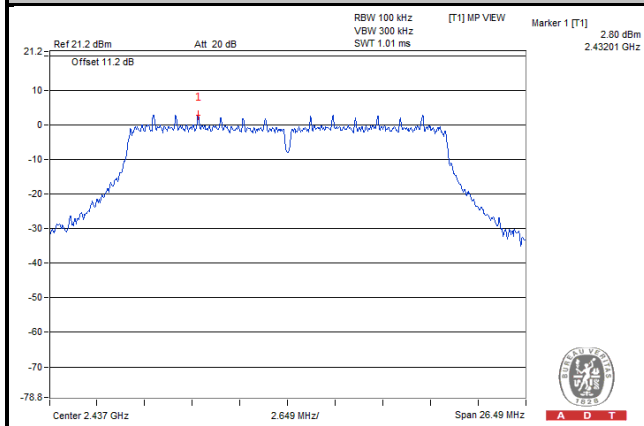

## Ch 11

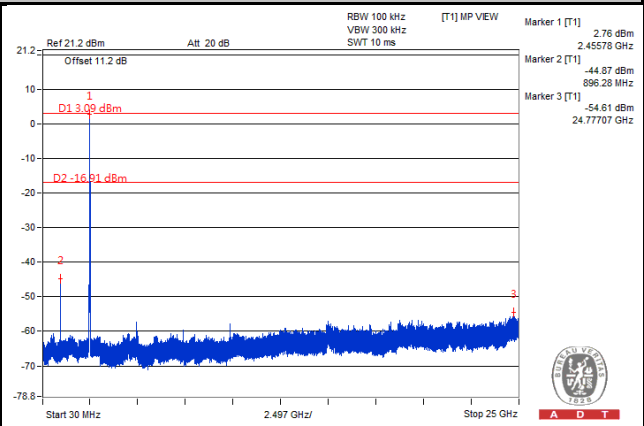
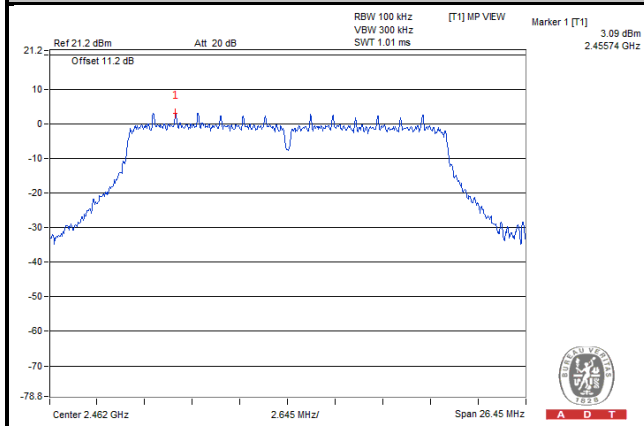

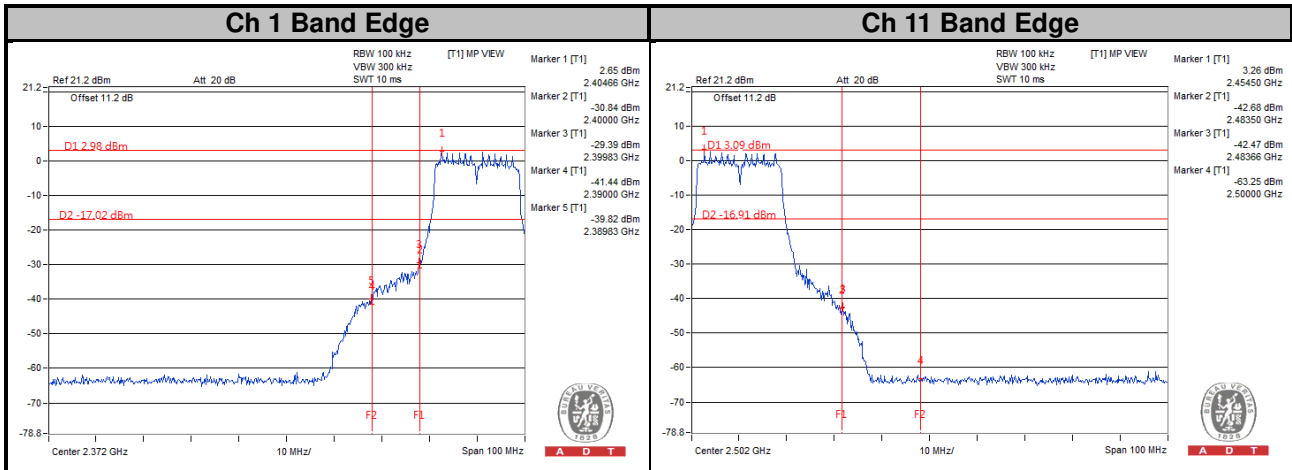

802.11n (HT40)

Ch 3

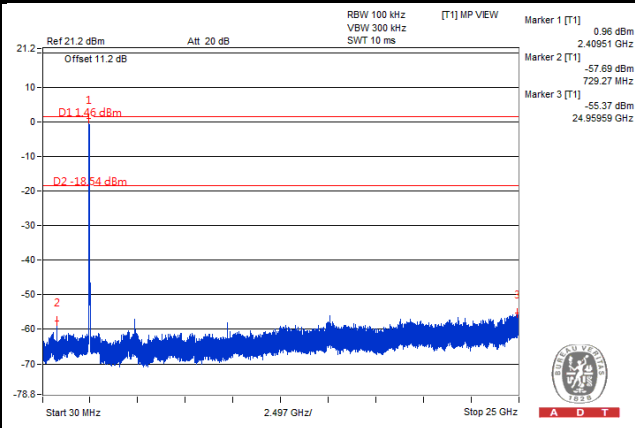
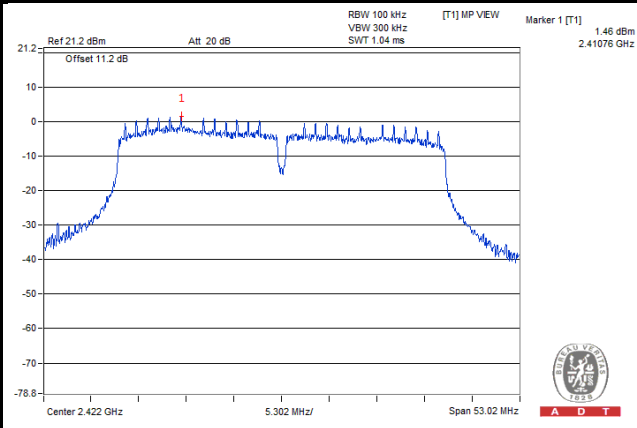

Ch 6

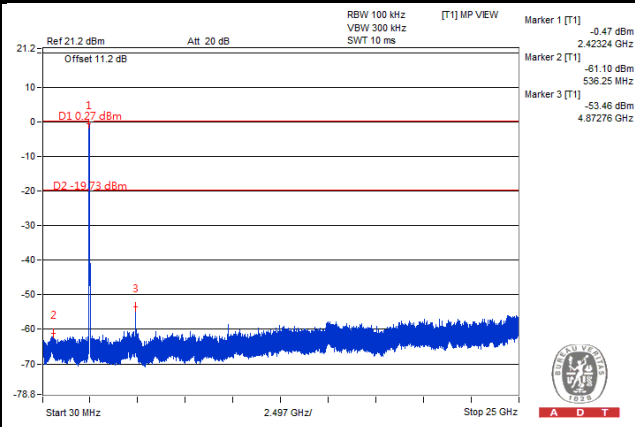
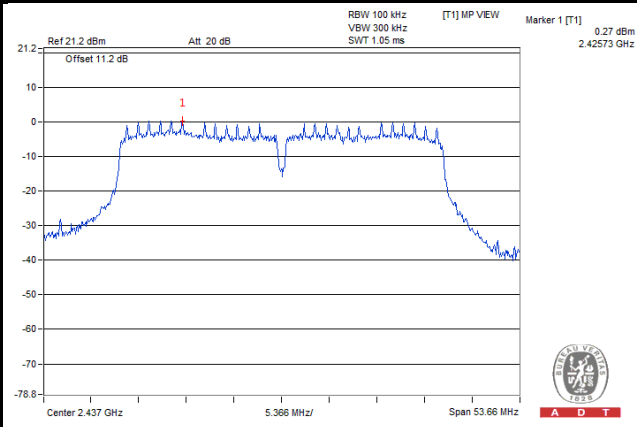

Ch 9

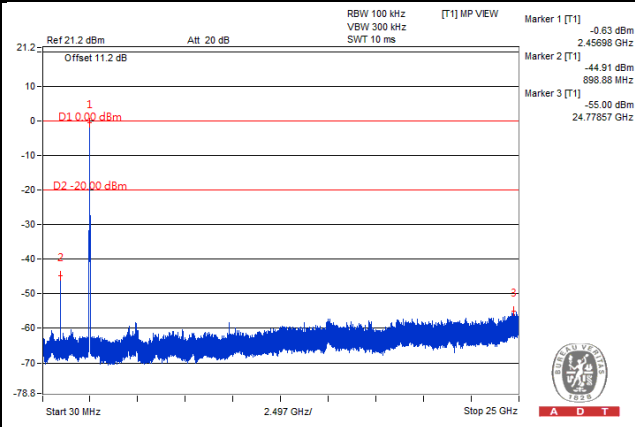
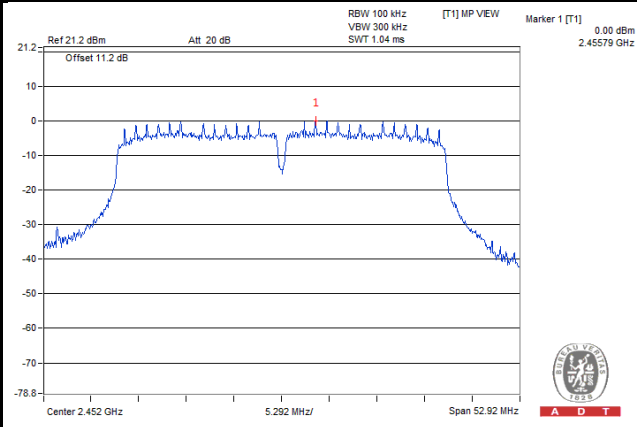

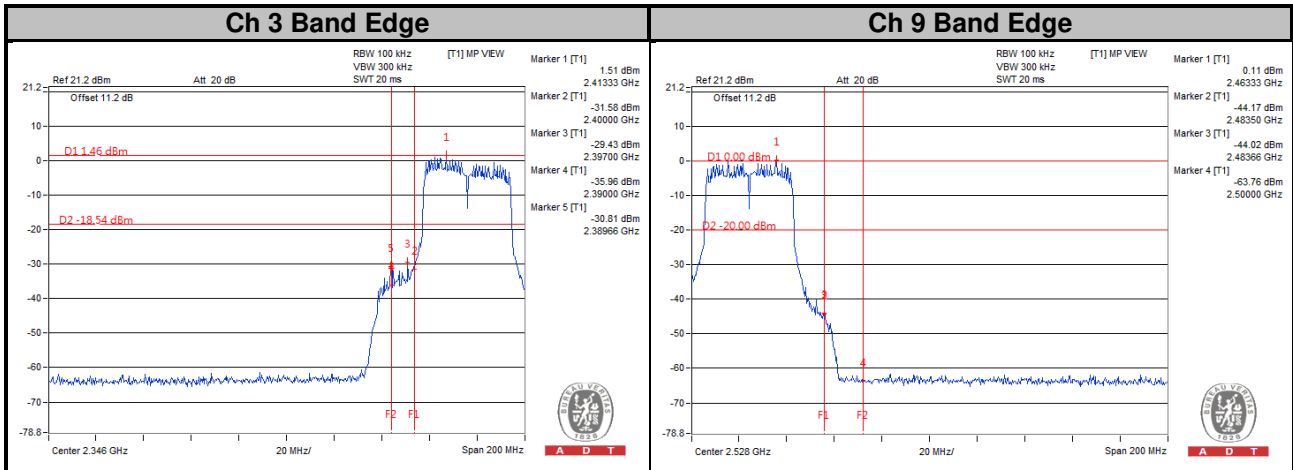



## 5 Pictures of Test Arrangements

Please refer to the attached file (Test Setup Photo).



A D T

## Appendix – Information on the Testing Laboratories

We, Bureau Veritas Consumer Products Services (H.K.) Ltd., Taoyuan Branch, were founded in 1988 to provide our best service in EMC, Radio, Telecom and Safety consultation. Our laboratories are accredited and approved according to ISO/IEC 17025.

If you have any comments, please feel free to contact us at the following:

### **Linko EMC/RF Lab**

Tel: 886-2-26052180

Fax: 886-2-26051924

### **Hsin Chu EMC/RF/Telecom Lab**

Tel: 886-3-6668565

Fax: 886-3-6668323

### **Hwa Ya EMC/RF/Safety Lab**

Tel: 886-3-3183232

Fax: 886-3-3270892

**Email:** [service.adt@tw.bureauveritas.com](mailto:service.adt@tw.bureauveritas.com)

**Web Site:** [www.bureauveritas-adt.com](http://www.bureauveritas-adt.com)

The address and road map of all our labs can be found in our web site also.

--- END ---