

FCC Test Report

Report No.: RF160303C04-8

FCC ID: NM82PS6700A

Test Model: 2PS6700A

Received Date: Mar. 03, 2016

Test Date: Mar. 14, 2016 ~ Mar. 24, 2016

Issued Date: Apr. 14, 2016

Applicant: HTC Corporation

Address: 1F, 6-3 Baoqiang Road, Xindian District, New Taipei City, Taiwan 231

Issued By: Bureau Veritas Consumer Products Services (H.K.) Ltd., Taoyuan Branch

Lab Address: No. 47-2, 14th Ling, Chia Pau Vil., Lin Kou Dist., New Taipei City, Taiwan (R.O.C)

Test Location (1): No. 19, Hwa Ya 2nd Rd, Wen Hwa Tsuen, Kwei Shan Hsiang, Taoyuan Hsien 333, Taiwan, R.O.C.

Test Location (2): No.215, Sec. 3, Beixin Rd., Xindian Dist., New Taipei City 231, Taiwan, R.O.C



This report is for your exclusive use. Any copying or replication of this report to or for any other person or entity, or use of our name or trademark, is permitted only with our prior written permission. This report sets forth our findings solely with respect to the test samples identified herein. The results set forth in this report are not indicative or representative of the quality or characteristics of the lot from which a test sample was taken or any similar or identical product unless specifically and expressly noted. Our report includes all of the tests requested by you and the results thereof based upon the information that you provided to us. You have 60 days from date of issuance of this report to notify us of any material error or omission caused by our negligence, provided, however, that such notice shall be in writing and shall specifically address the issue you wish to raise. A failure to raise such issue within the prescribed time shall constitute your unqualified acceptance of the completeness of this report, the tests conducted and the correctness of the report contents. Unless specific mention, the uncertainty of measurement has been explicitly taken into account to declare the compliance or non-compliance to the specification.

Table of Contents

Release Control Record	4
1 Certificate of Conformity	5
2 Summary of Test Results.....	6
2.1 Measurement Uncertainty.....	6
2.2 Modification Record	6
3 General Information	7
3.1 General Description of EUT	7
3.2 Description of Test Modes.....	8
3.2.1 Test Mode Applicability and Tested Channel Detail.....	9
3.3 Duty Cycle of Test Signal	11
3.4 Description of Support Units	12
3.4.1 Configuration of System under Test	12
3.5 General Description of Applied Standards.....	12
4 Test Types and Results	13
4.1 Radiated Emission and Bandedge Measurement	13
4.1.1 Limits of Radiated Emission and Bandedge Measurement	13
4.1.2 Test Instruments	14
4.1.3 Test Procedures.....	15
4.1.4 Deviation from Test Standard	15
4.1.5 Test Set Up	16
4.1.6 EUT Operating Conditions.....	16
4.1.7 Test Results	17
4.2 Conducted Emission Measurement.....	36
4.2.1 Limits of Conducted Emission Measurement	36
4.2.2 Test Instruments	36
4.2.3 Test Procedures.....	37
4.2.4 Deviation from Test Standard	37
4.2.5 Test Setup.....	37
4.2.6 EUT Operating Conditions.....	37
4.2.7 Test Results	38
4.3 6dB Bandwidth Measurement.....	40
4.3.1 Limits of 6dB Bandwidth Measurement.....	40
4.3.2 Test Setup.....	40
4.3.3 Test Instruments	40
4.3.4 Test Procedure	40
4.3.5 Deviation from Test Standard	40
4.3.6 EUT Operating Conditions.....	40
4.3.7 Test Result	41
4.4 Conducted Output Power Measurement	44
4.4.1 Limits of Conducted Output Power Measurement.....	44
4.4.2 Test Setup.....	44
4.4.3 Test Instruments	44
4.4.4 Test Procedures.....	44
4.4.5 Deviation from Test Standard	44
4.4.6 EUT Operating Conditions.....	44
4.4.7 Test Results	45
4.5 Power Spectral Density Measurement	47
4.5.1 Limits of Power Spectral Density Measurement.....	47
4.5.2 Test Setup.....	47
4.5.3 Test Instruments	47
4.5.4 Test Procedure	47
4.5.5 Deviation from Test Standard	47
4.5.6 EUT Operating Condition	47



4.5.7 Test Results	48
4.6 Conducted Out of Band Emission Measurement	51
4.6.1 Limits of Conducted Out of Band Emission Measurement.....	51
4.6.2 Test Setup.....	51
4.6.3 Test Instruments	51
4.6.4 Test Procedure	51
4.6.5 Deviation from Test Standard	51
4.6.6 EUT Operating Condition	51
4.6.7 Test Results	52
5 Pictures of Test Arrangements.....	68
Appendix – Information on the Testing Laboratories	69



A D T

Release Control Record

Issue No.	Description	Date Issued
RF160303C04-8	Original Release	Apr. 14, 2016



1 **Certificate of Conformity**

Product: Smartphone
Brand: HTC
Test Model: 2PS6700A
Sample Status: Production Unit
Applicant: HTC Corporation
Test Date: Mar. 14, 2016 ~ Mar. 24, 2016
Standards: 47 CFR FCC Part 15, Subpart C (Section 15.247)
ANSI C63.10:2013

The above equipment has been tested by **Bureau Veritas Consumer Products Services (H.K.) Ltd., Taoyuan Branch**, and found compliance with the requirement of the above standards. The test record, data evaluation & Equipment Under Test (EUT) configurations represented herein are true and accurate accounts of the measurements of the sample's EMC characteristics under the conditions specified in this report.

Prepared by :  , **Date:** Apr. 14, 2016
Ivonne Wu / Supervisor

Approved by :  , **Date:** Apr. 14, 2016
Stanley Wu / Assistant Manager

2 Summary of Test Results

47 CFR FCC Part 15, Subpart C (Section 15.247)			
FCC Clause	Test Item	Result	Remarks
15.207	AC Power Conducted Emission	Pass	Meet the requirement of limit. Minimum passing margin is -18.46 dB at 0.15000 MHz.
15.205 / 15.209 / 15.247(d)	Radiated Emissions and Band Edge Measurement	Pass	Meet the requirement of limit. Minimum passing margin is -1.00 dB at 2484 MHz.
15.247(d)	Antenna Port Emission	Pass	Meet the requirement of limit.
15.247(a)(2)	6 dB Bandwidth	Pass	Meet the requirement of limit.
15.247(b)	Conducted power	Pass	Meet the requirement of limit.
15.247(e)	Power Spectral Density	Pass	Meet the requirement of limit.
15.203	Antenna Requirement	Pass	No antenna connector is used.

2.1 Measurement Uncertainty

Where relevant, the following measurement uncertainty levels have been estimated for tests performed on the EUT:

The listed uncertainties are the worst case uncertainty for the entire range of measurement. Please note that the uncertainty values are provided for informational purposes only and are not used in determining the PASS/FAIL results.

Measurement	Frequency	Expanded Uncertainty (k=2) (±)
Conducted Emissions at mains ports	150 kHz ~ 30 MHz	2.44 dB
Radiated Emissions up to 1 GHz	30 MHz ~ 200 MHz	2.0153 dB
	200 MHz ~ 1000 MHz	2.0224 dB
Radiated Emissions above 1 GHz	1 GHz ~ 18 GHz	1.0121 dB
	18 GHz ~ 40 GHz	1.1508 dB

2.2 Modification Record

There were no modifications required for compliance.

3 General Information

3.1 General Description of EUT

Product	Smartphone
Brand	HTC
Test Model	2PS6700A
Status of EUT	Production Unit
Power Supply Rating	5.0 Vdc (adapter or host equipment) 3.85 Vdc (Li-ion battery)
Modulation Type	CCK, DQPSK, DBPSK for DSSS 64QAM, 16QAM, QPSK, BPSK for OFDM
Modulation Technology	DSSS, OFDM
Transfer Rate	802.11b: 11.0 / 5.5 / 2.0 / 1.0 Mbps 802.11g: 54.0 / 48.0 / 36.0 / 24.0 / 18.0 / 12.0 / 9.0 / 6.0 Mbps 802.11n: up to MCS15
Operating Frequency	2412 ~ 2462 MHz
Number of Channel	11 for 802.11b, 802.11g, 802.11n (HT20) 7 for 802.11n (HT40)
Output Power	314.788 mW
Antenna Type	PIFA antenna with -2 dBi gain
Antenna Connector	N/A
Accessory Device	Refer to Note as below
Data Cable Supplied	Refer to Note as below

Note:

1. The EUT incorporates a MIMO function. Physically, the EUT provides two completed transmitters and two receivers.

Modulation Mode	TX Function
802.11b	1TX
802.11g	1TX
802.11n (HT20)	1TX / 2TX
802.11n (HT40)	1TX / 2TX

2. The EUT's accessories list refers to Ext. Pho.
3. The above EUT information is declared by manufacturer and for more detailed features description, please refer to the manufacturer's specifications or user's manual.

3.2 Description of Test Modes

11 channels are provided for 802.11b, 802.11g and 802.11n (HT20):

Channel	Frequency (MHz)	Channel	Frequency (MHz)
1	2412	7	2442
2	2417	8	2447
3	2422	9	2452
4	2427	10	2457
5	2432	11	2462
6	2437		

7 channels are provided for 802.11n (HT40):

Channel	Frequency (MHz)	Channel	Frequency (MHz)
3	2422	7	2442
4	2427	8	2447
5	2432	9	2452
6	2437		

3.2.1 Test Mode Applicability and Tested Channel Detail

EUT Configure Mode	Applicable To				Description
	RE \geq 1G	RE<1G	PLC	APCM	
A	√	√	√	√	1TX
B	√	-	-	√	2TX

Where **RE \geq 1G**: Radiated Emission above 1 GHz **RE<1G**: Radiated Emission below 1 GHz
PLC: Power Line Conducted Emission **APCM**: Antenna Port Conducted Measurement

NOTE: The EUT had been pre-tested on the positioned of each 3 axis. The worst case was found when positioned on **X-plane** for 1TX and **Y-plane** for 2TX.

NOTE: "-" means no effect.

Radiated Emission Test (Above 1 GHz):

- Pre-Scan has been conducted to determine the worst-case mode from all possible combinations between available modulations, data rates and antenna ports (if EUT with antenna diversity architecture).
- Following channel(s) was (were) selected for the final test as listed below.

EUT Configure Mode	Mode	Available Channel	Tested Channel	Modulation Technology	Modulation Type	Data Rate (Mbps)
A	802.11b	1 to 11	1, 6, 11	DSSS	DBPSK	1.0
	802.11g	1 to 11	1, 6, 11	OFDM	BPSK	6.0
	802.11n (HT20)	1 to 11	1, 6, 11	OFDM	BPSK	MCS0
	802.11n (HT40)	3 to 9	3, 6, 9	OFDM	BPSK	MCS0
B	802.11n (HT20)	1 to 11	1, 6, 11	OFDM	BPSK	MCS8
	802.11n (HT40)	3 to 9	3, 6, 9	OFDM	BPSK	MCS8

Radiated Emission Test (Below 1 GHz):

- Pre-Scan has been conducted to determine the worst-case mode from all possible combinations between available modulations, data rates and antenna ports (if EUT with antenna diversity architecture).
- Following channel(s) was (were) selected for the final test as listed below.

EUT Configure Mode	Mode	Available Channel	Tested Channel	Modulation Technology	Modulation Type	Data Rate (Mbps)
A	802.11n (HT40)	3 to 9	9	OFDM	BPSK	MCS0

Power Line Conducted Emission Test:

- Pre-Scan has been conducted to determine the worst-case mode from all possible combinations between available modulations, data rates and antenna ports (if EUT with antenna diversity architecture).
- Following channel(s) was (were) selected for the final test as listed below.

EUT Configure Mode	Mode	Available Channel	Tested Channel	Modulation Technology	Modulation Type	Data Rate (Mbps)
A	802.11n (HT40)	3 to 9	9	OFDM	BPSK	MCS0

Bandedge Measurement:

- Pre-Scan has been conducted to determine the worst-case mode from all possible combinations between available modulations, data rates and antenna ports (if EUT with antenna diversity architecture).
- Following channel(s) was (were) selected for the final test as listed below.

EUT Configure Mode	Mode	Available Channel	Tested Channel	Modulation Technology	Modulation Type	Data Rate (Mbps)
A	802.11b	1 to 11	1, 11	DSSS	DBPSK	1.0
	802.11g	1 to 11	1, 11	OFDM	BPSK	6.0
	802.11n (HT20)	1 to 11	1, 11	OFDM	BPSK	MCS0
	802.11n (HT40)	3 to 9	3, 9	OFDM	BPSK	MCS0
B	802.11n (HT20)	1 to 11	1, 6, 11	OFDM	BPSK	MCS8
	802.11n (HT40)	3 to 9	3, 6, 9	OFDM	BPSK	MCS8

Antenna Port Conducted Measurement:

- This item includes all test value of each mode, but only includes spectrum plot of worst value of each mode.
- Pre-Scan has been conducted to determine the worst-case mode from all possible combinations between available modulations, data rates and antenna ports (if EUT with antenna diversity architecture).
- Following channel(s) was (were) selected for the final test as listed below.

EUT Configure Mode	Mode	Available Channel	Tested Channel	Modulation Technology	Modulation Type	Data Rate (Mbps)
A	802.11b	1 to 11	1, 6, 11	DSSS	DBPSK	1.0
	802.11g	1 to 11	1, 6, 11	OFDM	BPSK	6.0
	802.11n (HT20)	1 to 11	1, 6, 11	OFDM	BPSK	MCS0
	802.11n (HT40)	3 to 9	3, 6, 9	OFDM	BPSK	MCS0
B	802.11n (HT20)	1 to 11	1, 6, 11	OFDM	BPSK	MCS8
	802.11n (HT40)	3 to 9	3, 6, 9	OFDM	BPSK	MCS8

Test Condition:

Applicable To	Environmental Conditions	Input Power	Tested by
RE≥1G	25 deg. C, 65 % RH	120 Vac, 60 Hz	Charles Hsiao
RE<1G	25 deg. C, 65 % RH	120 Vac, 60 Hz	Charles Hsiao
PLC	25 deg. C, 65 % RH	120 Vac, 60 Hz	Toby Tian
APCM	25 deg. C, 65 % RH	3.85 Vdc	Taylor Liu

3.3 Duty Cycle of Test Signal

<1TX>

802.11b: Duty cycle of test signal is 100 %

802.11g: Duty cycle = $2.054/2.166 = 0.948$, Duty factor = $10 * \log(1/0.948) = 0.23$

802.11n (HT20): Duty cycle = $1.923/2.027 = 0.948$, Duty factor = $10 * \log(1/0.948) = 0.23$

802.11n (HT40): Duty cycle = $0.901/1.054 = 0.855$, Duty factor = $10 * \log(1/0.855) = 0.68$

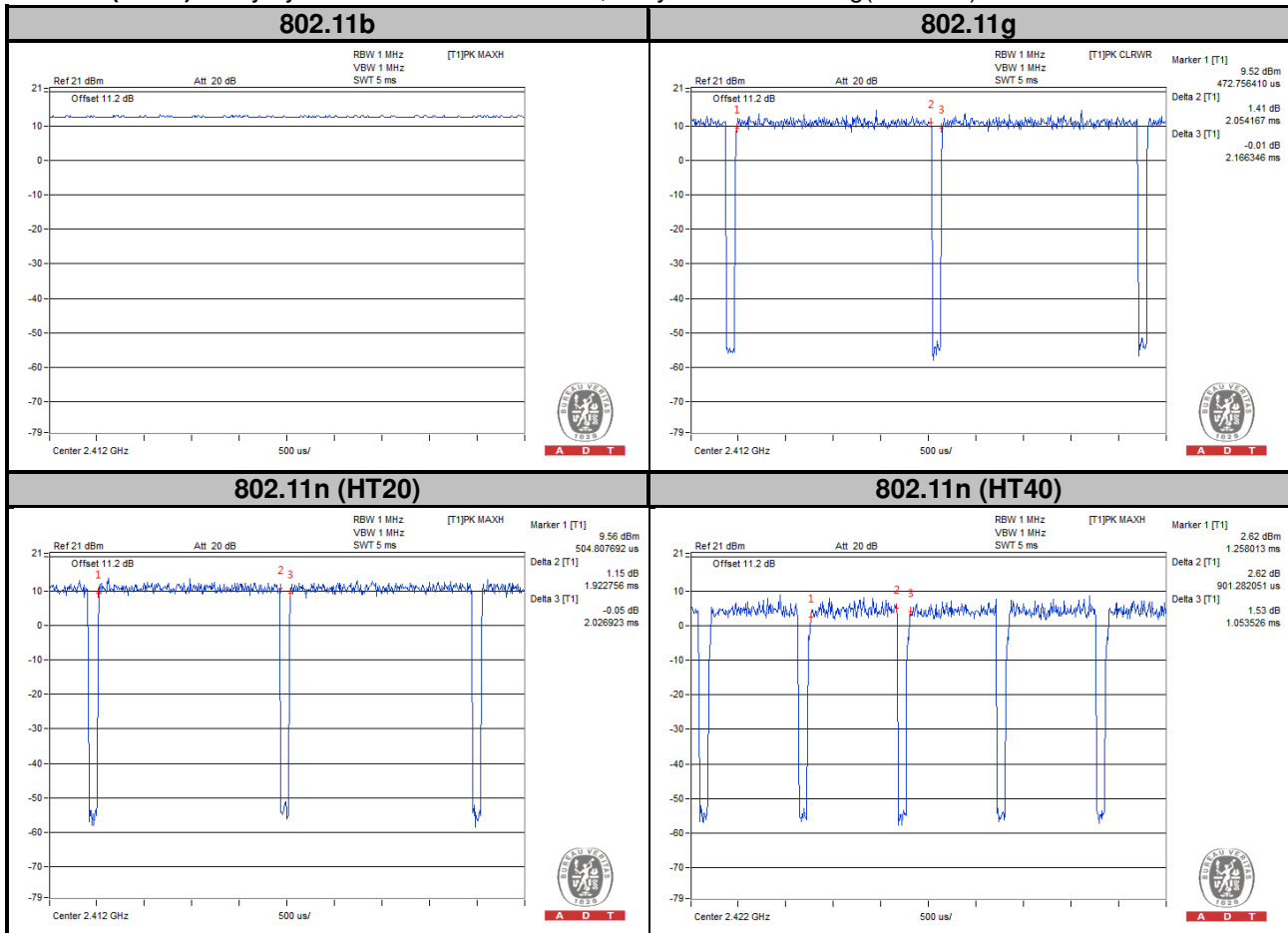

<2TX>

802.11n (HT20): Duty cycle = $1.915/2.027 = 0.945$, Duty factor = $10 * \log(1/0.945) = 0.25$

802.11n (HT40): Duty cycle = $0.918/1.054 = 0.871$, Duty factor = $10 * \log(1/0.871) = 0.60$

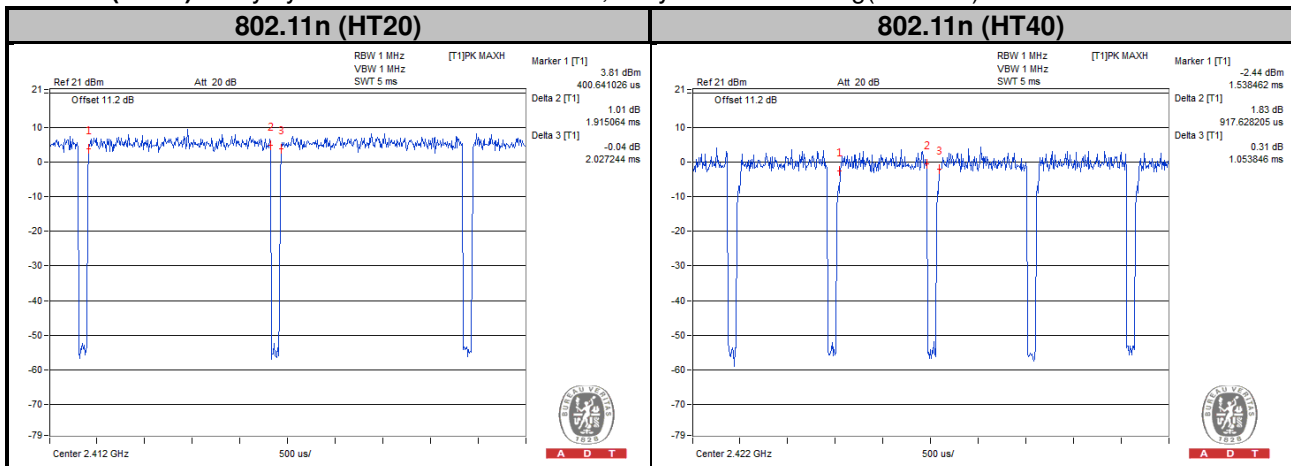

3.4 Description of Support Units

The EUT has been tested as an independent unit together with other necessary accessories or support units.

3.4.1 Configuration of System under Test

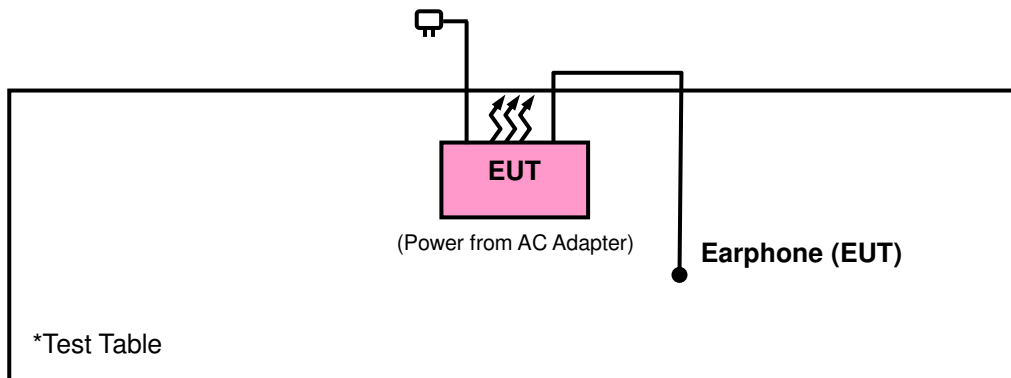

3.5 General Description of Applied Standards

The EUT is a RF Product. According to the specifications of the manufacturer, it must comply with the requirements of the following standards:

FCC Part 15, Subpart C (15.247)

558074 D01 DTS Meas Guidance v03r05

662911 D01 Multiple Transmitter Output v02r01

ANSI C63.10-2013

All test items have been performed and recorded as per the above standards.

NOTE: The EUT has been verified to comply with the requirements of FCC Part 15, Subpart B, Class B (DoC).
The test report has been issued separately.

4 Test Types and Results

4.1 Radiated Emission and Bandedge Measurement

4.1.1 Limits of Radiated Emission and Bandedge Measurement

Radiated emissions which fall in the restricted bands must comply with the radiated emission limits specified as below table. Other emissions shall be at least 20 dB below the highest level of the desired power:

Frequencies (MHz)	Field Strength (microvolts/meter)	Measurement Distance (meters)
0.009 ~ 0.490	2400/F (kHz)	300
0.490 ~ 1.705	24000/F (kHz)	30
1.705 ~ 30.0	30	30
30 ~ 88	100	3
88 ~ 216	150	3
216 ~ 960	200	3
Above 960	500	3

NOTE:

1. The lower limit shall apply at the transition frequencies.
2. Emission level (dBuV/m) = 20 log Emission level (uV/m).
3. For frequencies above 1000 MHz, the field strength limits are based on average detector, however, the peak field strength of any emission shall not exceed the maximum permitted average limits, specified above by more than 20 dB under any condition of modulation.



4.1.2 Test Instruments

Description & Manufacturer	Model No.	Serial No.	Date of Calibration	Due Date of Calibration
Test Receiver Agilent Technologies	N9038A	MY52260177	May 19, 2015	May 18, 2016
Spectrum Analyzer ROHDE & SCHWARZ	FSU43	101261	Dec. 17, 2015	Dec. 16, 2016
BILOG Antenna SCHWARZBECK	VULB9168	9168-472	Jan. 07, 2016	Jan. 06, 2017
HORN Antenna ETS-Lindgren	3117	00143293	Jan. 04, 2016	Jan. 03, 2017
HORN Antenna SCHWARZBECK	BBHA 9170	9170-480	Jan. 04, 2016	Jan. 03, 2017
Bluetooth Tester	CBT	100980	Apr. 27, 2015	Apr. 26, 2017
Loop Antenna	EM-6879	269	Jul. 31, 2015	Jul. 30, 2016
Agilent Communications Tester-Wireless	8960 Series 10	MY53201073	Jul. 03, 2015	Jul. 02, 2017
Preamplifier Agilent	310N	187226	Jun. 29, 2015	Jun. 28, 2016
Preamplifier Agilent	83017A	MY39501357	Jun. 29, 2015	Jun. 28, 2016
Power Meter Anritsu	ML2495A	1232002	Sep. 21, 2015	Sep. 20, 2016
Power Sensor Anritsu	MA2411B	1207325	Sep. 21, 2015	Sep. 20, 2016
RF signal cable ETS-LINDGREN	5D-FB	Cable-CH1-01(R FC-SMS-100-SM S-120+RFC-SMS -100-SMS-400)	Jun. 27, 2015	Jun. 26, 2016
RF signal cable ETS-LINDGREN	8D-FB	Cable-CH1-02(R FC-SMS-100-SM S-24)	Jun. 27, 2015	Jun. 26, 2016
Software BV ADT	E3 8.130425b	NA	NA	NA
Antenna Tower MF	NA	NA	NA	NA
Turn Table MF	NA	NA	NA	NA
Antenna Tower & Turn Table Controller MF	MF-7802	NA	NA	NA

- Note: 1. The calibration interval of the above test instruments is 12 months and the calibrations are traceable to NML/ROC and NIST/USA.
2. The test was performed in HsinTien Chamber 1.
 3. The horn antenna and preamplifier (model: 83017A) are used only for the measurement of emission frequency above 1 GHz if tested.
 4. The FCC Site Registration No. is 149147.
 5. The IC Site Registration No. is IC7450I-1.

4.1.3 Test Procedures

- a. The EUT was placed on the top of a rotating table 0.8 meters (for below 1 GHz) / 1.5 meters (for above 1 GHz) above the ground at 3 meter chamber room for test. The table was rotated 360 degrees to determine the position of the highest radiation.
- b. The EUT was set 3 meters away from the interference-receiving antenna, which was mounted on the top of a variable-height antenna tower.
- c. The height of antenna is varied from one meter to four meters above the ground to determine the maximum value of the field strength. Both horizontal and vertical polarizations of the antenna are set to make the measurement.
- d. For each suspected emission, the EUT was arranged to its worst case and then the antenna was tuned to heights from 1 meter to 4 meters and the rotatable table was turned from 0 degrees to 360 degrees to find the maximum reading.
- e. The test-receiver system was set to quasi-peak detect function and specified bandwidth with maximum hold mode when the test frequency is below 1 GHz.
- f. The test-receiver system was set to peak and average detected function and specified bandwidth with maximum hold mode when the test frequency is above 1 GHz. If the peak reading value also meets average limit, measurement with the average detector is unnecessary.

Note:

1. The resolution bandwidth and video bandwidth of test receiver/spectrum analyzer is 120 kHz for Quasi-peak detection (QP) at frequency below 1 GHz.
2. The resolution bandwidth of test receiver/spectrum analyzer is 1 MHz and the video bandwidth is 3 MHz for Peak detection (PK) at frequency above 1 GHz.
3. The resolution bandwidth of test receiver/spectrum analyzer is 1 MHz and the video bandwidth is 3 MHz for RMS Average (Duty cycle < 98 %) for Average detection (AV) at frequency above 1 GHz, then the measurement results was added to a correction factor ($10 \log(1/\text{duty cycle})$).
4. The resolution bandwidth of test receiver/spectrum analyzer is 1MHz and the video bandwidth is 10 Hz (Duty cycle $\geq 98 \%$) for Average detection (AV) at frequency above 1 GHz.
5. All modes of operation were investigated and the worst-case emissions are reported.

4.1.4 Deviation from Test Standard

No deviation.

4.1.5 Test Set Up

<Frequency Range below 1 GHz>

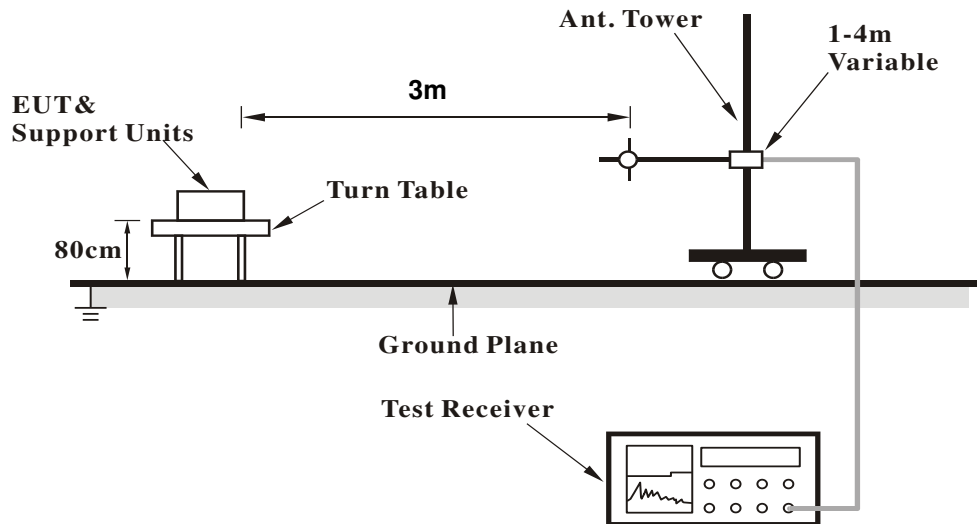

<Frequency Range above 1 GHz>

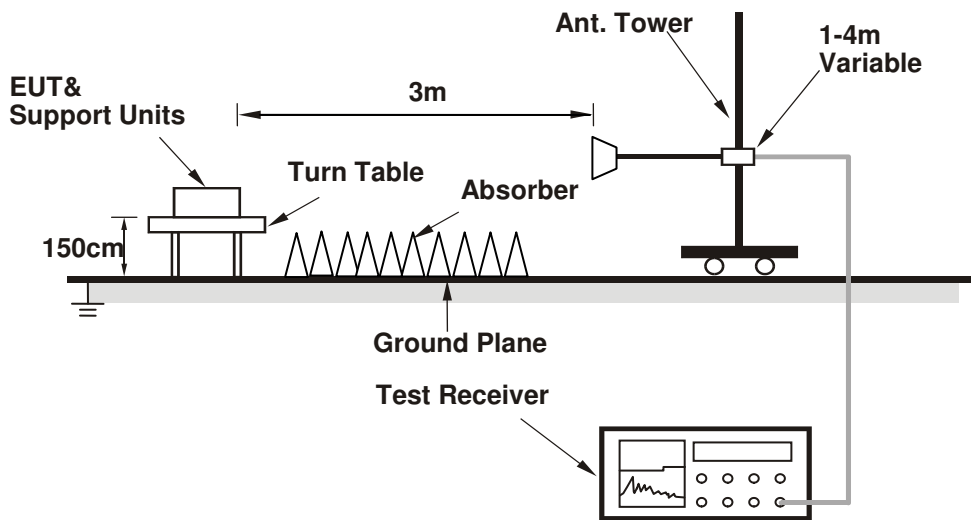

For the actual test configuration, please refer to the attached file (Test Setup Photo).

4.1.6 EUT Operating Conditions

- Placed the EUT on a testing table.
- Use the software to control the EUT under transmission condition continuously at specific channel frequency.

4.1.7 Test Results

Above 1 GHz Data :

<1TX>

802.11b

EUT Test Condition		Measurement Detail	
Channel	Channel 1	Frequency Range	1 GHz ~ 25 GHz
Input Power	120 Vac, 60 Hz	Detector Function	Peak (PK) Average (AV)
Environmental Conditions	25 deg. C, 65 % RH	Tested By	Charles Hsiao

Antennal Polarity & Test Distance: Horizontal at 3 m										
Frequency (MHz)	Emission Level (dBuV/m)	Read Level (dBuV)	Limit (dBuV/m)	Margin (dB)	Antenna Factor (dB/m)	Cable Loss (dB)	Preamp Factor (dB)	Antenna Height (cm)	Table Angle (Degree)	Remark
2386	42.9	41.19	54	-11.1	31.8	5.4	35.49	125	8	Average
2386	55.71	54	74	-18.29	31.8	5.4	35.49	125	8	Peak
2412	100.25	98.48			31.81	5.43	35.47	125	8	Average
2412	103.15	101.38			31.81	5.43	35.47	125	8	Peak
2490	39.73	37.72	54	-14.27	31.9	5.53	35.42	125	8	Average
2490	55.71	53.7	74	-18.29	31.9	5.53	35.42	125	8	Peak

Antennal Polarity & Test Distance: Vertical at 3 m										
Frequency (MHz)	Emission Level (dBuV/m)	Read Level (dBuV)	Limit (dBuV/m)	Margin (dB)	Antenna Factor (dB/m)	Cable Loss (dB)	Preamp Factor (dB)	Antenna Height (cm)	Table Angle (Degree)	Remark
2376	40.65	38.99	54	-13.35	31.78	5.37	35.49	284	360	Average
2376	55.65	53.99	74	-18.35	31.78	5.37	35.49	284	360	Peak
2412	95.78	94.01			31.81	5.43	35.47	284	360	Average
2412	98.82	97.05			31.81	5.43	35.47	284	360	Peak
2490	39.58	37.57	54	-14.42	31.9	5.53	35.42	284	360	Average
2490	55.56	53.55	74	-18.44	31.9	5.53	35.42	284	360	Peak

Remarks:

- Emission Level = Read Level + Antenna Factor + Cable Loss - Preamp Factor
Margin value = Emission level – Limit value
- 2412 MHz: Fundamental frequency.



A D T

EUT Test Condition		Measurement Detail	
Channel	Channel 6	Frequency Range	1 GHz ~ 25 GHz
Input Power	120 Vac, 60 Hz	Detector Function	Peak (PK) Average (AV)
Environmental Conditions	25 deg. C, 65 % RH	Tested By	Charles Hsiao

Antennal Polarity & Test Distance: Horizontal at 3 m										
Frequency (MHz)	Emission Level (dBuV/m)	Read Level (dBuV)	Limit (dBuV/m)	Margin (dB)	Antenna Factor (dB/m)	Cable Loss (dB)	Preamp Factor (dB)	Antenna Height (cm)	Table Angle (Degree)	Remark
2342	39.32	37.75	54	-14.68	31.74	5.33	35.5	128	8	Average
2342	55.85	54.28	74	-18.15	31.74	5.33	35.5	128	8	Peak
2437	104.33	102.48			31.85	5.46	35.46	128	8	Average
2437	107.03	105.18			31.85	5.46	35.46	128	8	Peak
2484	39.62	37.66	54	-14.38	31.88	5.5	35.42	128	8	Average
2484	55.16	53.2	74	-18.84	31.88	5.5	35.42	128	8	Peak

Antennal Polarity & Test Distance: Vertical at 3 m										
Frequency (MHz)	Emission Level (dBuV/m)	Read Level (dBuV)	Limit (dBuV/m)	Margin (dB)	Antenna Factor (dB/m)	Cable Loss (dB)	Preamp Factor (dB)	Antenna Height (cm)	Table Angle (Degree)	Remark
2316	39.36	37.87	54	-14.64	31.71	5.3	35.52	284	360	Average
2316	55.25	53.76	74	-18.75	31.71	5.3	35.52	284	360	Peak
2437	99.77	97.92			31.85	5.46	35.46	284	360	Average
2437	102.46	100.61			31.85	5.46	35.46	284	360	Peak
2486	39.76	37.77	54	-14.24	31.88	5.53	35.42	284	360	Average
2486	55.2	53.21	74	-18.8	31.88	5.53	35.42	284	360	Peak

Remarks:

- Emission Level = Read Level + Antenna Factor + Cable Loss - Preamp Factor
Margin value = Emission level – Limit value
- 2437 MHz: Fundamental frequency.



A D T

EUT Test Condition		Measurement Detail	
Channel	Channel 11	Frequency Range	1 GHz ~ 25 GHz
Input Power	120 Vac, 60 Hz	Detector Function	Peak (PK) Average (AV)
Environmental Conditions	25 deg. C, 65 % RH	Tested By	Charles Hsiao

Antennal Polarity & Test Distance: Horizontal at 3 m

Frequency (MHz)	Emission Level (dBuV/m)	Read Level (dBuV)	Limit (dBuV/m)	Margin (dB)	Antenna Factor (dB/m)	Cable Loss (dB)	Preamp Factor (dB)	Antenna Height (cm)	Table Angle (Degree)	Remark
2362	39.44	37.81	54	-14.56	31.76	5.37	35.5	128	8	Average
2362	55.78	54.15	74	-18.22	31.76	5.37	35.5	128	8	Peak
2462	101.61	99.68			31.87	5.5	35.44	128	8	Average
2462	104.75	102.82			31.87	5.5	35.44	128	8	Peak
2494	42.73	40.71	54	-11.27	31.9	5.53	35.41	128	8	Average
2494	56.27	54.25	74	-17.73	31.9	5.53	35.41	128	8	Peak

Antennal Polarity & Test Distance: Vertical at 3 m

Frequency (MHz)	Emission Level (dBuV/m)	Read Level (dBuV)	Limit (dBuV/m)	Margin (dB)	Antenna Factor (dB/m)	Cable Loss (dB)	Preamp Factor (dB)	Antenna Height (cm)	Table Angle (Degree)	Remark
2356	39.32	37.69	54	-14.68	31.76	5.37	35.5	280	0	Average
2356	55.53	53.9	74	-18.47	31.76	5.37	35.5	280	0	Peak
2462	96.46	94.53			31.87	5.5	35.44	280	0	Average
2462	99.76	97.83			31.87	5.5	35.44	280	0	Peak
2484	42.08	40.12	54	-11.92	31.88	5.5	35.42	280	0	Average
2484	55.4	53.44	74	-18.6	31.88	5.5	35.42	280	0	Peak

Remarks:

- Emission Level = Read Level + Antenna Factor + Cable Loss - Preamp Factor
Margin value = Emission level – Limit value
- 2462 MHz: Fundamental frequency.

802.11g

EUT Test Condition		Measurement Detail	
Channel	Channel 1	Frequency Range	1 GHz ~ 25 GHz
Input Power	120 Vac, 60 Hz	Detector Function	Peak (PK) Average (AV)
Environmental Conditions	25 deg. C, 65 % RH	Tested By	Charles Hsiao

Antennal Polarity & Test Distance: Horizontal at 3 m

Frequency (MHz)	Emission Level (dBuV/m)	Read Level (dBuV)	Limit (dBuV/m)	Margin (dB)	Antenna Factor (dB/m)	Cable Loss (dB)	Preamp Factor (dB)	Antenna Height (cm)	Table Angle (Degree)	Remark
2390	46.97	45.24	54	-7.03	31.8	5.4	35.47	125	8	Average
2390	62.86	61.13	74	-11.14	31.8	5.4	35.47	125	8	Peak
2412	97.15	95.38			31.81	5.43	35.47	125	8	Average
2412	104.6	102.83			31.81	5.43	35.47	125	8	Peak
2484	40.16	38.2	54	-13.84	31.88	5.5	35.42	125	8	Average
2484	56.02	54.06	74	-17.98	31.88	5.5	35.42	125	8	Peak

Antennal Polarity & Test Distance: Vertical at 3 m

Frequency (MHz)	Emission Level (dBuV/m)	Read Level (dBuV)	Limit (dBuV/m)	Margin (dB)	Antenna Factor (dB/m)	Cable Loss (dB)	Preamp Factor (dB)	Antenna Height (cm)	Table Angle (Degree)	Remark
2390	43.5	41.77	54	-10.5	31.8	5.4	35.47	284	0	Average
2390	57.7	55.97	74	-16.3	31.8	5.4	35.47	284	0	Peak
2412	92.81	91.04			31.81	5.43	35.47	284	0	Average
2412	99.03	97.26			31.81	5.43	35.47	284	0	Peak
2500	40.43	38.41	54	-13.57	31.9	5.53	35.41	284	0	Average
2500	55.42	53.4	74	-18.58	31.9	5.53	35.41	284	0	Peak

Remarks:

- Emission Level = Read Level + Antenna Factor + Cable Loss - Preamp Factor
Margin value = Emission level – Limit value
- 2412 MHz: Fundamental frequency.



A D T

EUT Test Condition		Measurement Detail	
Channel	Channel 6	Frequency Range	1 GHz ~ 25 GHz
Input Power	120 Vac, 60 Hz	Detector Function	Peak (PK) Average (AV)
Environmental Conditions	25 deg. C, 65 % RH	Tested By	Charles Hsiao

Antennal Polarity & Test Distance: Horizontal at 3 m										
Frequency (MHz)	Emission Level (dBuV/m)	Read Level (dBuV)	Limit (dBuV/m)	Margin (dB)	Antenna Factor (dB/m)	Cable Loss (dB)	Preamp Factor (dB)	Antenna Height (cm)	Table Angle (Degree)	Remark
2364	39.61	37.98	54	-14.39	31.76	5.37	35.5	126	8	Average
2364	55.66	54.03	74	-18.34	31.76	5.37	35.5	126	8	Peak
2437	98.48	96.63			31.85	5.46	35.46	126	8	Average
2437	105.02	103.17			31.85	5.46	35.46	126	8	Peak
2500	39.91	37.89	54	-14.09	31.9	5.53	35.41	126	8	Average
2500	55.66	53.64	74	-18.34	31.9	5.53	35.41	126	8	Peak

Antennal Polarity & Test Distance: Vertical at 3 m										
Frequency (MHz)	Emission Level (dBuV/m)	Read Level (dBuV)	Limit (dBuV/m)	Margin (dB)	Antenna Factor (dB/m)	Cable Loss (dB)	Preamp Factor (dB)	Antenna Height (cm)	Table Angle (Degree)	Remark
2378	39.74	38.08	54	-14.26	31.78	5.37	35.49	284	0	Average
2378	55.16	53.5	74	-18.84	31.78	5.37	35.49	284	0	Peak
2437	93.36	91.51			31.85	5.46	35.46	284	0	Average
2437	100.17	98.32			31.85	5.46	35.46	284	0	Peak
2492	40.02	38	54	-13.98	31.9	5.53	35.41	284	0	Average
2492	54.76	52.74	74	-19.24	31.9	5.53	35.41	284	0	Peak

Remarks:

- Emission Level = Read Level + Antenna Factor + Cable Loss - Preamp Factor
Margin value = Emission level – Limit value
- 2437 MHz: Fundamental frequency.



A D T

EUT Test Condition		Measurement Detail	
Channel	Channel 11	Frequency Range	1 GHz ~ 25 GHz
Input Power	120 Vac, 60 Hz	Detector Function	Peak (PK) Average (AV)
Environmental Conditions	25 deg. C, 65 % RH	Tested By	Charles Hsiao

Antennal Polarity & Test Distance: Horizontal at 3 m										
Frequency (MHz)	Emission Level (dBuV/m)	Read Level (dBuV)	Limit (dBuV/m)	Margin (dB)	Antenna Factor (dB/m)	Cable Loss (dB)	Preamp Factor (dB)	Antenna Height (cm)	Table Angle (Degree)	Remark
2340	39.71	38.14	54	-14.29	31.74	5.33	35.5	141	8	Average
2340	55.37	53.8	74	-18.63	31.74	5.33	35.5	141	8	Peak
2462	98.86	96.93			31.87	5.5	35.44	141	8	Average
2462	105.62	103.69			31.87	5.5	35.44	141	8	Peak
2484	52.88	50.92	54	-1.12	31.88	5.5	35.42	141	8	Average
2484	70.84	68.88	74	-3.16	31.88	5.5	35.42	141	8	Peak

Antennal Polarity & Test Distance: Vertical at 3 m										
Frequency (MHz)	Emission Level (dBuV/m)	Read Level (dBuV)	Limit (dBuV/m)	Margin (dB)	Antenna Factor (dB/m)	Cable Loss (dB)	Preamp Factor (dB)	Antenna Height (cm)	Table Angle (Degree)	Remark
2324	39.63	38.12	54	-14.37	31.73	5.3	35.52	280	0	Average
2324	54.86	53.35	74	-19.14	31.73	5.3	35.52	280	0	Peak
2462	93.24	91.31			31.87	5.5	35.44	280	0	Average
2462	100.05	98.12			31.87	5.5	35.44	280	0	Peak
2484	47.01	45.05	54	-6.99	31.88	5.5	35.42	280	0	Average
2484	63.62	61.66	74	-10.38	31.88	5.5	35.42	280	0	Peak

Remarks:

- Emission Level = Read Level + Antenna Factor + Cable Loss - Preamp Factor
Margin value = Emission level – Limit value
- 2462 MHz: Fundamental frequency.

802.11n (HT20)

EUT Test Condition		Measurement Detail	
Channel	Channel 1	Frequency Range	1 GHz ~ 25 GHz
Input Power	120 Vac, 60 Hz	Detector Function	Peak (PK) Average (AV)
Environmental Conditions	25 deg. C, 65 % RH	Tested By	Charles Hsiao

Antennal Polarity & Test Distance: Horizontal at 3 m

Frequency (MHz)	Emission Level (dBuV/m)	Read Level (dBuV)	Limit (dBuV/m)	Margin (dB)	Antenna Factor (dB/m)	Cable Loss (dB)	Preamp Factor (dB)	Antenna Height (cm)	Table Angle (Degree)	Remark
2390	48.43	46.7	54	-5.57	31.8	5.4	35.47	125	8	Average
2390	64.02	62.29	74	-9.98	31.8	5.4	35.47	125	8	Peak
2412	97.35	95.58			31.81	5.43	35.47	125	8	Average
2412	104.8	103.03			31.81	5.43	35.47	125	8	Peak
2490	40.53	38.52	54	-13.47	31.9	5.53	35.42	125	8	Average
2490	55.22	53.21	74	-18.78	31.9	5.53	35.42	125	8	Peak

Antennal Polarity & Test Distance: Vertical at 3 m

Frequency (MHz)	Emission Level (dBuV/m)	Read Level (dBuV)	Limit (dBuV/m)	Margin (dB)	Antenna Factor (dB/m)	Cable Loss (dB)	Preamp Factor (dB)	Antenna Height (cm)	Table Angle (Degree)	Remark
2390	43.5	41.77	54	-10.5	31.8	5.4	35.47	284	0	Average
2390	56.06	54.33	74	-17.94	31.8	5.4	35.47	284	0	Peak
2412	92.65	90.88			31.81	5.43	35.47	284	0	Average
2412	99.34	97.57			31.81	5.43	35.47	284	0	Peak
2490	40.22	38.21	54	-13.78	31.9	5.53	35.42	284	0	Average
2490	54.87	52.86	74	-19.13	31.9	5.53	35.42	284	0	Peak

Remarks:

- Emission Level = Read Level + Antenna Factor + Cable Loss - Preamp Factor
Margin value = Emission level – Limit value
- 2412 MHz: Fundamental frequency.



A D T

EUT Test Condition		Measurement Detail	
Channel	Channel 6	Frequency Range	1 GHz ~ 25 GHz
Input Power	120 Vac, 60 Hz	Detector Function	Peak (PK) Average (AV)
Environmental Conditions	25 deg. C, 65 % RH	Tested By	Charles Hsiao

Antennal Polarity & Test Distance: Horizontal at 3 m										
Frequency (MHz)	Emission Level (dBuV/m)	Read Level (dBuV)	Limit (dBuV/m)	Margin (dB)	Antenna Factor (dB/m)	Cable Loss (dB)	Preamp Factor (dB)	Antenna Height (cm)	Table Angle (Degree)	Remark
2364	39.99	38.36	54	-14.01	31.76	5.37	35.5	126	8	Average
2364	56.09	54.46	74	-17.91	31.76	5.37	35.5	126	8	Peak
2437	98.47	96.62			31.85	5.46	35.46	126	8	Average
2437	105.61	103.76			31.85	5.46	35.46	126	8	Peak
2486	40.27	38.28	54	-13.73	31.88	5.53	35.42	126	8	Average
2486	55.22	53.23	74	-18.78	31.88	5.53	35.42	126	8	Peak

Antennal Polarity & Test Distance: Vertical at 3 m										
Frequency (MHz)	Emission Level (dBuV/m)	Read Level (dBuV)	Limit (dBuV/m)	Margin (dB)	Antenna Factor (dB/m)	Cable Loss (dB)	Preamp Factor (dB)	Antenna Height (cm)	Table Angle (Degree)	Remark
2380	39.83	38.17	54	-14.17	31.78	5.37	35.49	284	0	Average
2380	55.3	53.64	74	-18.7	31.78	5.37	35.49	284	0	Peak
2437	93.31	91.46			31.85	5.46	35.46	284	0	Average
2437	100.96	99.11			31.85	5.46	35.46	284	0	Peak
2484	40.06	38.1	54	-13.94	31.88	5.5	35.42	284	0	Average
2484	54.75	52.79	74	-19.25	31.88	5.5	35.42	284	0	Peak

Remarks:

- Emission Level = Read Level + Antenna Factor + Cable Loss - Preamp Factor
Margin value = Emission level – Limit value
- 2437 MHz: Fundamental frequency.



A D T

EUT Test Condition		Measurement Detail	
Channel	Channel 11	Frequency Range	1 GHz ~ 25 GHz
Input Power	120 Vac, 60 Hz	Detector Function	Peak (PK) Average (AV)
Environmental Conditions	25 deg. C, 65 % RH	Tested By	Charles Hsiao

Antennal Polarity & Test Distance: Horizontal at 3 m										
Frequency (MHz)	Emission Level (dBuV/m)	Read Level (dBuV)	Limit (dBuV/m)	Margin (dB)	Antenna Factor (dB/m)	Cable Loss (dB)	Preamp Factor (dB)	Antenna Height (cm)	Table Angle (Degree)	Remark
2360	39.62	37.99	54	-14.38	31.76	5.37	35.5	107	8	Average
2360	54.93	53.3	74	-19.07	31.76	5.37	35.5	107	8	Peak
2462	97.53	95.6			31.87	5.5	35.44	107	8	Average
2462	104.45	102.52			31.87	5.5	35.44	107	8	Peak
2484	52.48	50.52	54	-1.52	31.88	5.5	35.42	107	8	Average
2484	68.55	66.59	74	-5.45	31.88	5.5	35.42	107	8	Peak

Antennal Polarity & Test Distance: Vertical at 3 m										
Frequency (MHz)	Emission Level (dBuV/m)	Read Level (dBuV)	Limit (dBuV/m)	Margin (dB)	Antenna Factor (dB/m)	Cable Loss (dB)	Preamp Factor (dB)	Antenna Height (cm)	Table Angle (Degree)	Remark
2340	39.64	38.07	54	-14.36	31.74	5.33	35.5	280	0	Average
2340	55.34	53.77	74	-18.66	31.74	5.33	35.5	280	0	Peak
2462	92.54	90.61			31.87	5.5	35.44	280	0	Average
2462	99.66	97.73			31.87	5.5	35.44	280	0	Peak
2484	43.88	41.92	54	-10.12	31.88	5.5	35.42	280	0	Average
2484	57.91	55.95	74	-16.09	31.88	5.5	35.42	280	0	Peak

Remarks:

- Emission Level = Read Level + Antenna Factor + Cable Loss - Preamp Factor
Margin value = Emission level – Limit value
- 2462 MHz: Fundamental frequency.

802.11n (HT40)

EUT Test Condition		Measurement Detail	
Channel	Channel 3	Frequency Range	1 GHz ~ 25 GHz
Input Power	120 Vac, 60 Hz	Detector Function	Peak (PK) Average (AV)
Environmental Conditions	25 deg. C, 65 % RH	Tested By	Charles Hsiao

Antennal Polarity & Test Distance: Horizontal at 3 m

Frequency (MHz)	Emission Level (dBuV/m)	Read Level (dBuV)	Limit (dBuV/m)	Margin (dB)	Antenna Factor (dB/m)	Cable Loss (dB)	Preamp Factor (dB)	Antenna Height (cm)	Table Angle (Degree)	Remark
2390	49.4	47.67	54	-4.6	31.8	5.4	35.47	125	8	Average
2390	64.37	62.64	74	-9.63	31.8	5.4	35.47	125	8	Peak
2422	92.37	90.57			31.83	5.43	35.46	125	8	Average
2422	100.56	98.76			31.83	5.43	35.46	125	8	Peak
2484	40.07	38.11	54	-13.93	31.88	5.5	35.42	125	8	Average
2484	55.4	53.44	74	-18.6	31.88	5.5	35.42	125	8	Peak

Antennal Polarity & Test Distance: Vertical at 3 m

Frequency (MHz)	Emission Level (dBuV/m)	Read Level (dBuV)	Limit (dBuV/m)	Margin (dB)	Antenna Factor (dB/m)	Cable Loss (dB)	Preamp Factor (dB)	Antenna Height (cm)	Table Angle (Degree)	Remark
2390	47.1	45.37	54	-6.9	31.8	5.4	35.47	287	0	Average
2390	61.72	59.99	74	-12.28	31.8	5.4	35.47	287	0	Peak
2422	88.72	86.92			31.83	5.43	35.46	287	0	Average
2422	95.2	93.4			31.83	5.43	35.46	287	0	Peak
2498	40.76	38.74	54	-13.24	31.9	5.53	35.41	287	0	Average
2498	55.66	53.64	74	-18.34	31.9	5.53	35.41	287	0	Peak

Remarks:

- Emission Level = Read Level + Antenna Factor + Cable Loss - Preamp Factor
Margin value = Emission level – Limit value
- 2422 MHz: Fundamental frequency.



A D T

EUT Test Condition		Measurement Detail	
Channel	Channel 6	Frequency Range	1 GHz ~ 25 GHz
Input Power	120 Vac, 60 Hz	Detector Function	Peak (PK) Average (AV)
Environmental Conditions	25 deg. C, 65 % RH	Tested By	Charles Hsiao

Antennal Polarity & Test Distance: Horizontal at 3 m										
Frequency (MHz)	Emission Level (dBuV/m)	Read Level (dBuV)	Limit (dBuV/m)	Margin (dB)	Antenna Factor (dB/m)	Cable Loss (dB)	Preamp Factor (dB)	Antenna Height (cm)	Table Angle (Degree)	Remark
2390	44.8	43.07	54	-9.2	31.8	5.4	35.47	126	8	Average
2390	57.23	55.5	74	-16.77	31.8	5.4	35.47	126	8	Peak
2437	93.31	91.46			31.85	5.46	35.46	126	8	Average
2437	100.54	98.69			31.85	5.46	35.46	126	8	Peak
2484	45.28	43.32	54	-8.72	31.88	5.5	35.42	126	8	Average
2484	59.51	57.55	74	-14.49	31.88	5.5	35.42	126	8	Peak

Antennal Polarity & Test Distance: Vertical at 3 m										
Frequency (MHz)	Emission Level (dBuV/m)	Read Level (dBuV)	Limit (dBuV/m)	Margin (dB)	Antenna Factor (dB/m)	Cable Loss (dB)	Preamp Factor (dB)	Antenna Height (cm)	Table Angle (Degree)	Remark
2386	40.5	38.79	54	-13.5	31.8	5.4	35.49	278	0	Average
2386	55.57	53.86	74	-18.43	31.8	5.4	35.49	278	0	Peak
2437	88.21	86.36			31.85	5.46	35.46	278	0	Average
2437	95.88	94.03			31.85	5.46	35.46	278	0	Peak
2484	42.68	40.72	54	-11.32	31.88	5.5	35.42	278	0	Average
2484	58.37	56.41	74	-15.63	31.88	5.5	35.42	278	0	Peak

Remarks:

- Emission Level = Read Level + Antenna Factor + Cable Loss - Preamp Factor
Margin value = Emission level – Limit value
- 2437 MHz: Fundamental frequency.



A D T

EUT Test Condition		Measurement Detail	
Channel	Channel 9	Frequency Range	1 GHz ~ 25 GHz
Input Power	120 Vac, 60 Hz	Detector Function	Peak (PK) Average (AV)
Environmental Conditions	25 deg. C, 65 % RH	Tested By	Charles Hsiao

Antennal Polarity & Test Distance: Horizontal at 3 m										
Frequency (MHz)	Emission Level (dBuV/m)	Read Level (dBuV)	Limit (dBuV/m)	Margin (dB)	Antenna Factor (dB/m)	Cable Loss (dB)	Preamp Factor (dB)	Antenna Height (cm)	Table Angle (Degree)	Remark
2334	40.18	38.64	54	-13.82	31.73	5.33	35.52	108	8	Average
2334	55.13	53.59	74	-18.87	31.73	5.33	35.52	108	8	Peak
2452	93.41	91.54			31.85	5.46	35.44	108	8	Average
2452	100.7	98.83			31.85	5.46	35.44	108	8	Peak
2484	53	51.04	54	-1	31.88	5.5	35.42	108	8	Average
2484	71.67	69.71	74	-2.33	31.88	5.5	35.42	108	8	Peak

Antennal Polarity & Test Distance: Vertical at 3 m										
Frequency (MHz)	Emission Level (dBuV/m)	Read Level (dBuV)	Limit (dBuV/m)	Margin (dB)	Antenna Factor (dB/m)	Cable Loss (dB)	Preamp Factor (dB)	Antenna Height (cm)	Table Angle (Degree)	Remark
2376	40.01	38.35	54	-13.99	31.78	5.37	35.49	280	0	Average
2376	54.89	53.23	74	-19.11	31.78	5.37	35.49	280	0	Peak
2452	88.31	86.44			31.85	5.46	35.44	280	0	Average
2452	95.45	93.58			31.85	5.46	35.44	280	0	Peak
2484	45.58	43.62	54	-8.42	31.88	5.5	35.42	280	0	Average
2484	59.13	57.17	74	-14.87	31.88	5.5	35.42	280	0	Peak

Remarks:

- Emission Level = Read Level + Antenna Factor + Cable Loss - Preamp Factor
Margin value = Emission level – Limit value
- 2452 MHz: Fundamental frequency.

<2TX>

802.11n (HT20)

EUT Test Condition		Measurement Detail	
Channel	Channel 1	Frequency Range	1 GHz ~ 25 GHz
Input Power	120 Vac, 60 Hz	Detector Function	Peak (PK) Average (AV)
Environmental Conditions	25 deg. C, 65 % RH	Tested By	Charles Hsiao

Antennal Polarity & Test Distance: Horizontal at 3 m

Frequency (MHz)	Emission Level (dBuV/m)	Read Level (dBuV)	Limit (dBuV/m)	Margin (dB)	Antenna Factor (dB/m)	Cable Loss (dB)	Preamp Factor (dB)	Antenna Height (cm)	Table Angle (Degree)	Remark
2390	46.12	44.39	54	-7.88	31.8	5.4	35.47	100	324	Average
2390	58.31	56.58	74	-15.69	31.8	5.4	35.47	100	324	Peak
2412	93.47	91.7			31.81	5.43	35.47	100	323	Average
2412	101.31	99.54			31.81	5.43	35.47	100	323	Peak
2488	40.85	38.84	54	-13.15	31.9	5.53	35.42	100	323	Average
2488	55.07	53.06	74	-18.93	31.9	5.53	35.42	100	323	Peak

Antennal Polarity & Test Distance: Vertical at 3 m

Frequency (MHz)	Emission Level (dBuV/m)	Read Level (dBuV)	Limit (dBuV/m)	Margin (dB)	Antenna Factor (dB/m)	Cable Loss (dB)	Preamp Factor (dB)	Antenna Height (cm)	Table Angle (Degree)	Remark
2390	45.5	43.77	54	-8.5	31.8	5.4	35.47	104	283	Average
2390	57.49	55.76	74	-16.51	31.8	5.4	35.47	104	283	Peak
2412	92.55	90.78			31.81	5.43	35.47	104	283	Average
2412	100.36	98.59			31.81	5.43	35.47	104	283	Peak
2488	40.49	38.48	54	-13.51	31.9	5.53	35.42	104	283	Average
2488	55.45	53.44	74	-18.55	31.9	5.53	35.42	104	283	Peak

Remarks:

- Emission Level = Read Level + Antenna Factor + Cable Loss - Preamp Factor
Margin value = Emission level – Limit value
- 2412 MHz: Fundamental frequency.



A D T

EUT Test Condition		Measurement Detail	
Channel	Channel 6	Frequency Range	1 GHz ~ 25 GHz
Input Power	120 Vac, 60 Hz	Detector Function	Peak (PK) Average (AV)
Environmental Conditions	25 deg. C, 65 % RH	Tested By	Charles Hsiao

Antennal Polarity & Test Distance: Horizontal at 3 m										
Frequency (MHz)	Emission Level (dBuV/m)	Read Level (dBuV)	Limit (dBuV/m)	Margin (dB)	Antenna Factor (dB/m)	Cable Loss (dB)	Preamp Factor (dB)	Antenna Height (cm)	Table Angle (Degree)	Remark
2372	40.31	38.65	54	-13.69	31.78	5.37	35.49	113	323	Average
2372	55.32	53.66	74	-18.68	31.78	5.37	35.49	113	323	Peak
2437	94.42	92.57			31.85	5.46	35.46	113	323	Average
2437	102.69	100.84			31.85	5.46	35.46	113	323	Peak
2496	40.59	38.57	54	-13.41	31.9	5.53	35.41	113	323	Average
2496	55.28	53.26	74	-18.72	31.9	5.53	35.41	113	323	Peak

Antennal Polarity & Test Distance: Vertical at 3 m										
Frequency (MHz)	Emission Level (dBuV/m)	Read Level (dBuV)	Limit (dBuV/m)	Margin (dB)	Antenna Factor (dB/m)	Cable Loss (dB)	Preamp Factor (dB)	Antenna Height (cm)	Table Angle (Degree)	Remark
2376	40.21	38.55	54	-13.79	31.78	5.37	35.49	105	283	Average
2376	55.11	53.45	74	-18.89	31.78	5.37	35.49	105	283	Peak
2437	93.61	91.76			31.85	5.46	35.46	105	283	Average
2437	101.41	99.56			31.85	5.46	35.46	105	283	Peak
2500	40.49	38.47	54	-13.51	31.9	5.53	35.41	105	283	Average
2500	55.33	53.31	74	-18.67	31.9	5.53	35.41	105	283	Peak

Remarks:

- Emission Level = Read Level + Antenna Factor + Cable Loss - Preamp Factor
Margin value = Emission level – Limit value
- 2437 MHz: Fundamental frequency.



A D T

EUT Test Condition		Measurement Detail	
Channel	Channel 11	Frequency Range	1 GHz ~ 25 GHz
Input Power	120 Vac, 60 Hz	Detector Function	Peak (PK) Average (AV)
Environmental Conditions	25 deg. C, 65 % RH	Tested By	Charles Hsiao

Antennal Polarity & Test Distance: Horizontal at 3 m										
Frequency (MHz)	Emission Level (dBuV/m)	Read Level (dBuV)	Limit (dBuV/m)	Margin (dB)	Antenna Factor (dB/m)	Cable Loss (dB)	Preamp Factor (dB)	Antenna Height (cm)	Table Angle (Degree)	Remark
2380	40.24	38.58	54	-13.76	31.78	5.37	35.49	111	323	Average
2380	54.95	53.29	74	-19.05	31.78	5.37	35.49	111	323	Peak
2462	93.9	91.97			31.87	5.5	35.44	111	323	Average
2462	101.89	99.96			31.87	5.5	35.44	111	323	Peak
2484	48.54	46.58	54	-5.46	31.88	5.5	35.42	110	323	Average
2484	64.16	62.2	74	-9.84	31.88	5.5	35.42	110	323	Peak
Antennal Polarity & Test Distance: Vertical at 3 m										
Frequency (MHz)	Emission Level (dBuV/m)	Read Level (dBuV)	Limit (dBuV/m)	Margin (dB)	Antenna Factor (dB/m)	Cable Loss (dB)	Preamp Factor (dB)	Antenna Height (cm)	Table Angle (Degree)	Remark
2364	40.28	38.65	54	-13.72	31.76	5.37	35.5	105	283	Average
2364	56.6	54.97	74	-17.4	31.76	5.37	35.5	105	283	Peak
2462	92.26	90.33			31.87	5.5	35.44	105	283	Average
2462	100.6	98.67			31.87	5.5	35.44	105	283	Peak
2484	49.18	47.22	54	-4.82	31.88	5.5	35.42	102	283	Average
2484	65.05	63.09	74	-8.95	31.88	5.5	35.42	102	283	Peak

Remarks:

- Emission Level = Read Level + Antenna Factor + Cable Loss - Preamp Factor
Margin value = Emission level – Limit value
- 2462 MHz: Fundamental frequency.

802.11n (HT40)

EUT Test Condition		Measurement Detail	
Channel	Channel 3	Frequency Range	1 GHz ~ 25 GHz
Input Power	120 Vac, 60 Hz	Detector Function	Peak (PK) Average (AV)
Environmental Conditions	25 deg. C, 65 % RH	Tested By	Charles Hsiao

Antennal Polarity & Test Distance: Horizontal at 3 m

Frequency (MHz)	Emission Level (dBuV/m)	Read Level (dBuV)	Limit (dBuV/m)	Margin (dB)	Antenna Factor (dB/m)	Cable Loss (dB)	Preamp Factor (dB)	Antenna Height (cm)	Table Angle (Degree)	Remark
2390	49.9	48.17	54	-4.1	31.8	5.4	35.47	100	323	Average
2390	65.61	63.88	74	-8.39	31.8	5.4	35.47	100	323	Peak
2422	91.5	89.7			31.83	5.43	35.46	112	323	Average
2422	99.81	98.01			31.83	5.43	35.46	112	323	Peak
2498	41.13	39.11	54	-12.87	31.9	5.53	35.41	112	323	Average
2498	55.66	53.64	74	-18.34	31.9	5.53	35.41	112	323	Peak

Antennal Polarity & Test Distance: Vertical at 3 m

Frequency (MHz)	Emission Level (dBuV/m)	Read Level (dBuV)	Limit (dBuV/m)	Margin (dB)	Antenna Factor (dB/m)	Cable Loss (dB)	Preamp Factor (dB)	Antenna Height (cm)	Table Angle (Degree)	Remark
2390	49.22	47.49	54	-4.78	31.8	5.4	35.47	104	282	Average
2390	65.4	63.67	74	-8.6	31.8	5.4	35.47	104	282	Peak
2422	90.46	88.66			31.83	5.43	35.46	104	283	Average
2422	98.82	97.02			31.83	5.43	35.46	104	283	Peak
2496	40.99	38.97	54	-13.01	31.9	5.53	35.41	104	283	Average
2496	56.19	54.17	74	-17.81	31.9	5.53	35.41	104	283	Peak

Remarks:

- Emission Level = Read Level + Antenna Factor + Cable Loss - Preamp Factor
Margin value = Emission level – Limit value
- 2422 MHz: Fundamental frequency.



EUT Test Condition		Measurement Detail	
Channel	Channel 6	Frequency Range	1 GHz ~ 25 GHz
Input Power	120 Vac, 60 Hz	Detector Function	Peak (PK) Average (AV)
Environmental Conditions	25 deg. C, 65 % RH	Tested By	Charles Hsiao

Antennal Polarity & Test Distance: Horizontal at 3 m										
Frequency (MHz)	Emission Level (dBuV/m)	Read Level (dBuV)	Limit (dBuV/m)	Margin (dB)	Antenna Factor (dB/m)	Cable Loss (dB)	Preamp Factor (dB)	Antenna Height (cm)	Table Angle (Degree)	Remark
2390	42.86	41.13	54	-11.14	31.8	5.4	35.47	111	323	Average
2390	56.09	54.36	74	-17.91	31.8	5.4	35.47	111	323	Peak
2437	91.67	89.82			31.85	5.46	35.46	111	323	Average
2437	99.23	97.38			31.85	5.46	35.46	111	323	Peak
2484	47.28	45.32	54	-6.72	31.88	5.5	35.42	109	323	Average
2484	64.22	62.26	74	-9.78	31.88	5.5	35.42	109	323	Peak
Antennal Polarity & Test Distance: Vertical at 3 m										
Frequency (MHz)	Emission Level (dBuV/m)	Read Level (dBuV)	Limit (dBuV/m)	Margin (dB)	Antenna Factor (dB/m)	Cable Loss (dB)	Preamp Factor (dB)	Antenna Height (cm)	Table Angle (Degree)	Remark
2390	44.2	42.47	54	-9.8	31.8	5.4	35.47	102	283	Average
2390	57.47	55.74	74	-16.53	31.8	5.4	35.47	102	283	Peak
2437	90.71	88.86			31.85	5.46	35.46	103	283	Average
2437	98.64	96.79			31.85	5.46	35.46	103	283	Peak
2484	47.75	45.79	54	-6.25	31.88	5.5	35.42	103	282	Average
2484	65.07	63.11	74	-8.93	31.88	5.5	35.42	103	282	Peak

Remarks:

- Emission Level = Read Level + Antenna Factor + Cable Loss - Preamp Factor
Margin value = Emission level – Limit value
- 2437 MHz: Fundamental frequency.



A D T

EUT Test Condition		Measurement Detail	
Channel	Channel 9	Frequency Range	1 GHz ~ 25 GHz
Input Power	120 Vac, 60 Hz	Detector Function	Peak (PK) Average (AV)
Environmental Conditions	25 deg. C, 65 % RH	Tested By	Charles Hsiao

Antennal Polarity & Test Distance: Horizontal at 3 m										
Frequency (MHz)	Emission Level (dBuV/m)	Read Level (dBuV)	Limit (dBuV/m)	Margin (dB)	Antenna Factor (dB/m)	Cable Loss (dB)	Preamp Factor (dB)	Antenna Height (cm)	Table Angle (Degree)	Remark
2318	40.58	39.07	54	-13.42	31.73	5.3	35.52	111	323	Average
2318	54.8	53.29	74	-19.2	31.73	5.3	35.52	111	323	Peak
2452	91.31	89.44			31.85	5.46	35.44	111	323	Average
2452	99.42	97.55			31.85	5.46	35.44	111	323	Peak
2484	52.28	50.32	54	-1.72	31.88	5.5	35.42	108	323	Average
2484	69.6	67.64	74	-4.4	31.88	5.5	35.42	108	323	Peak

Antennal Polarity & Test Distance: Vertical at 3 m										
Frequency (MHz)	Emission Level (dBuV/m)	Read Level (dBuV)	Limit (dBuV/m)	Margin (dB)	Antenna Factor (dB/m)	Cable Loss (dB)	Preamp Factor (dB)	Antenna Height (cm)	Table Angle (Degree)	Remark
2390	40.63	38.9	54	-13.37	31.8	5.4	35.47	105	283	Average
2390	55.65	53.92	74	-18.35	31.8	5.4	35.47	105	283	Peak
2452	90.85	88.98			31.85	5.46	35.44	105	283	Average
2452	98.57	96.7			31.85	5.46	35.44	105	283	Peak
2484	52.78	50.82	54	-1.22	31.88	5.5	35.42	102	283	Average
2484	70.7	68.74	74	-3.3	31.88	5.5	35.42	102	283	Peak

Remarks:

- Emission Level = Read Level + Antenna Factor + Cable Loss - Preamp Factor
Margin value = Emission level – Limit value
- 2452 MHz: Fundamental frequency.

9 kHz ~ 30 MHz DATA:

The amplitude of spurious emissions attenuated more than 20 dB below the permissible value is not required to be report.

30 MHz ~ 1 GHz WORST-CASE DATA:

802.11n (HT40)

EUT Test Condition		Measurement Detail	
Channel	Channel 9	Frequency Range	30 MHz ~ 1 GHz
Input Power	120 Vac, 60 Hz	Detector Function	Peak (PK) Quasi-peak (QP)
Environmental Conditions	25 deg. C, 65 % RH	Tested By	Charles Hsiao

Antennal Polarity & Test Distance: Horizontal at 3 m										
Frequency (MHz)	Emission Level (dBuV/m)	Read Level (dBuV)	Limit (dBuV/m)	Margin (dB)	Antenna Factor (dB/m)	Cable Loss (dB)	Preamp Factor (dB)	Antenna Height (cm)	Table Angle (Degree)	Remark
61.86	20.94	45.24	40	-19.06	7.03	0.9	32.23	136	256	Peak
100.47	30.99	52.27	43.5	-12.51	9.7	1.28	32.26	112	154	Peak
142.32	35.23	56.64	43.5	-8.27	9.48	1.38	32.27	185	175	Peak
404.3	18.93	30.78	46	-27.07	18.03	2.34	32.22	196	185	Peak
586.3	21.36	30.13	46	-24.64	20.6	2.82	32.19	178	166	Peak
790.7	25.77	30.34	46	-20.23	24.23	3.27	32.07	183	265	Peak

Antennal Polarity & Test Distance: Vertical at 3 m										
Frequency (MHz)	Emission Level (dBuV/m)	Read Level (dBuV)	Limit (dBuV/m)	Margin (dB)	Antenna Factor (dB/m)	Cable Loss (dB)	Preamp Factor (dB)	Antenna Height (cm)	Table Angle (Degree)	Remark
31.35	38.11	52.81	40	-1.89	16.82	0.74	32.26	184	152	Peak
97.5	27.13	48.5	43.5	-16.37	9.5	1.28	32.15	136	142	Peak
151.5	29.22	49.75	43.5	-14.28	10.22	1.52	32.27	155	23	Peak
440	18.33	30.11	46	-27.67	17.89	2.49	32.16	163	265	Peak
620.6	22.41	29.69	46	-23.59	21.96	2.93	32.17	198	171	Peak
805.4	26.13	30.46	46	-19.87	24.38	3.32	32.03	108	165	Peak

Remarks:

- Emission Level = Read Level + Antenna Factor + Cable Loss - Preamp Factor
Margin value = Emission level – Limit value

4.2 Conducted Emission Measurement

4.2.1 Limits of Conducted Emission Measurement

Frequency (MHz)	Conducted Limit (dBuV)	
	Quasi-peak	Average
0.15 - 0.5	66 - 56	56 - 46
0.50 - 5.0	56	46
5.0 - 30.0	60	50

Note: 1. The lower limit shall apply at the transition frequencies.

2. The limit decreases in line with the logarithm of the frequency in the range of 0.15 to 0.50 MHz.

4.2.2 Test Instruments

Description & Manufacturer	Model No.	Serial No.	Date of Calibration	Due Date of Calibration
Test Receiver ROHDE & SCHWARZ	ESCI	100613	Nov. 16, 2015	Nov. 15, 2016
RF signal cable (with 10dB PAD) Woken	5D-FB	Cable-cond1-01	Dec. 26, 2015	Dec. 25, 2016
LISN ROHDE & SCHWARZ (EUT)	ESH3-Z5	835239/001	Feb. 26, 2016	Feb. 25, 2017
LISN ROHDE & SCHWARZ (Peripheral)	ESH3-Z5	100311	Jul. 24, 2015	Jul. 23, 2016
Software ADT	BV ADT_Cond_ V7.3.7.3	NA	NA	NA

Note: 1. The calibration interval of the above test instruments is 12 months and the calibrations are traceable to NML/ROC and NIST/USA.

2. The test was performed in HwaYa Shielded Room 1.

3. The VCCI Site Registration No. is C-2040.

4.2.3 Test Procedures

- The EUT was placed 0.4 meters from the conducting wall of the shielded room with EUT being connected to the power mains through a line impedance stabilization network (LISN). Other support units were connected to the power mains through another LISN. The two LISNs provide 50 ohm/50 uH of coupling impedance for the measuring instrument.
- Both lines of the power mains connected to the EUT were checked for maximum conducted interference.
- The frequency range from 150 kHz to 30 MHz was searched. Emission levels under (Limit – 20 dB) was not recorded.

NOTE: All modes of operation were investigated and the worst-case emissions are reported.

4.2.4 Deviation from Test Standard

No deviation.

4.2.5 Test Setup

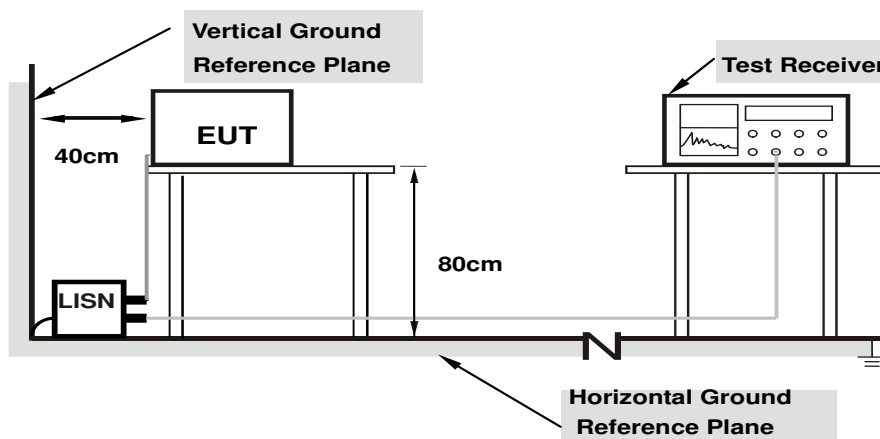

Note: 1.Support units were connected to second LISN.

For the actual test configuration, please refer to the attached file (Test Setup Photo).

4.2.6 EUT Operating Conditions

- Placed the EUT on a testing table.
- Use the software to control the EUT under transmission condition continuously at specific channel frequency.

4.2.7 Test Results

Frequency Range	150kHz ~ 30MHz	Detector Function & Resolution Bandwidth	Quasi-Peak (QP) / Average (AV), 9kHz
Input Power	120Vac, 60Hz	Environmental Conditions	25°C, 65%RH
Tested by	Toby Tian	Test Date	2016/3/24

Phase Of Power : Line (L)										
No	Frequency (MHz)	Correction Factor (dB)	Reading Value (dBuV)		Emission Level (dBuV)		Limit (dBuV)		Margin (dB)	
			Q.P.	AV.	Q.P.	AV.	Q.P.	AV.	Q.P.	AV.
1	0.15400	10.02	32.80	21.18	42.82	31.20	65.78	55.78	-22.96	-24.58
2	0.19676	10.11	30.07	18.48	40.18	28.59	63.75	53.75	-23.56	-25.15
3	0.29800	10.12	22.91	11.43	33.03	21.55	60.30	50.30	-27.26	-28.74
4	0.67400	10.20	21.89	9.47	32.09	19.67	56.00	46.00	-23.91	-26.33
5	1.09000	10.29	20.37	7.13	30.66	17.42	56.00	46.00	-25.34	-28.58
6	14.37400	10.89	20.62	14.28	31.51	25.17	60.00	50.00	-28.49	-24.83

Remarks:

1. Q.P. and AV. are abbreviations of quasi-peak and average individually.
2. The emission levels of other frequencies were very low against the limit.
3. Margin value = Emission level – Limit value
4. Correction factor = Insertion loss + Cable loss
5. Emission Level = Correction Factor + Reading Value

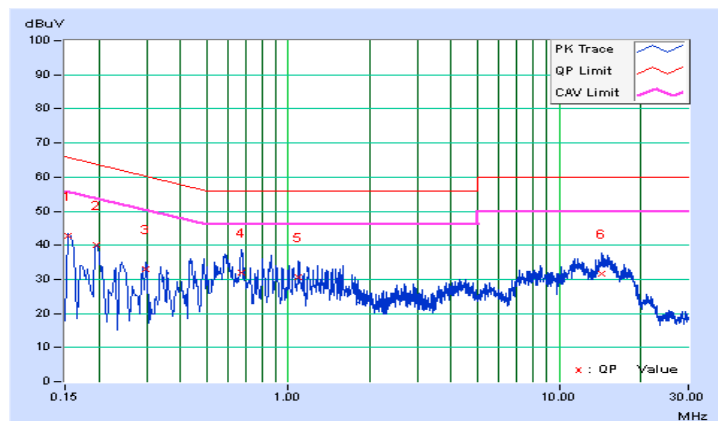

Frequency Range	150kHz ~ 30MHz	Detector Function & Resolution Bandwidth	Quasi-Peak (QP) / Average (AV), 9kHz
Input Power	120Vac, 60Hz	Environmental Conditions	25°C, 65%RH
Tested by	Toby Tian	Test Date	2016/3/24

Phase Of Power : Neutral (N)										
No	Frequency (MHz)	Correction Factor (dB)	Reading Value (dBuV)		Emission Level (dBuV)		Limit (dBuV)		Margin (dB)	
			Q.P.	AV.	Q.P.	AV.	Q.P.	AV.	Q.P.	AV.
1	0.15000	10.00	37.54	26.29	47.54	36.29	66.00	56.00	-18.46	-19.71
2	0.20200	10.04	32.18	18.63	42.22	28.67	63.53	53.53	-21.31	-24.86
3	0.29400	10.09	25.12	14.53	35.21	24.62	60.41	50.41	-25.20	-25.79
4	0.57796	10.17	25.13	12.42	35.30	22.59	56.00	46.00	-20.70	-23.41
5	1.17800	10.24	17.24	5.52	27.48	15.76	56.00	46.00	-28.52	-30.24
6	14.66200	10.77	22.43	15.70	33.20	26.47	60.00	50.00	-26.80	-23.53

Remarks:

1. Q.P. and AV. are abbreviations of quasi-peak and average individually.
2. The emission levels of other frequencies were very low against the limit.
3. Margin value = Emission level – Limit value
4. Correction factor = Insertion loss + Cable loss
5. Emission Level = Correction Factor + Reading Value

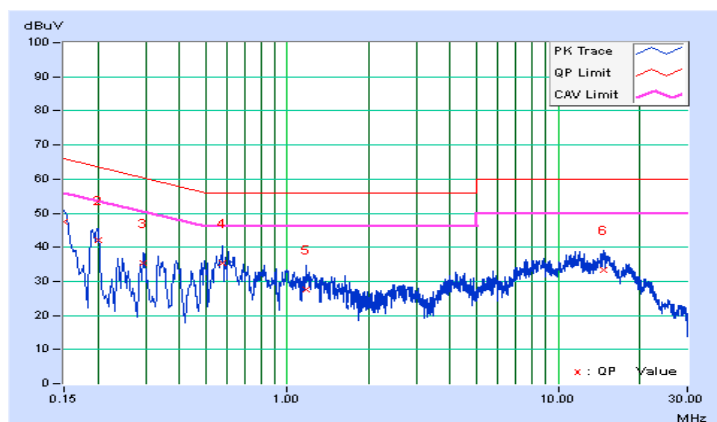

4.3 6 dB Bandwidth Measurement

4.3.1 Limits of 6 dB Bandwidth Measurement

The minimum of 6 dB Bandwidth Measurement is 0.5 MHz.

4.3.2 Test Setup

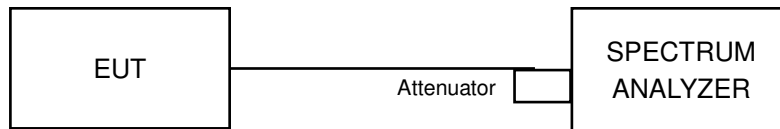

4.3.3 Test Instruments

Refer to section 4.1.2 to get information of above instrument.

4.3.4 Test Procedure

- Set resolution bandwidth (RBW) = 100 kHz
- Set the video bandwidth (VBW) $\geq 3 \times$ RBW, Detector = Peak.
- Trace mode = max hold.
- Sweep = auto couple.
- Measure the maximum width of the emission that is constrained by the frequencies associated with the two amplitude points (upper and lower) that are attenuated by 6 dB relative to the maximum level measured in the fundamental emission

4.3.5 Deviation from Test Standard

No deviation.

4.3.6 EUT Operating Conditions

The software provided by client to enable the EUT under transmission condition continuously at lowest, middle and highest channel frequencies individually.

4.3.7 Test Result

<1TX>

802.11b

Channel	Frequency (MHz)	6 dB Bandwidth (MHz)	Minimum Limit (MHz)	Pass / Fail
1	2412	7.11	0.5	Pass
6	2437	7.55	0.5	Pass
11	2462	7.10	0.5	Pass

802.11g

Channel	Frequency (MHz)	6 dB Bandwidth (MHz)	Minimum Limit (MHz)	Pass / Fail
1	2412	15.54	0.5	Pass
6	2437	16.12	0.5	Pass
11	2462	15.78	0.5	Pass

802.11n (HT20)

Channel	Frequency (MHz)	6 dB Bandwidth (MHz)	Minimum Limit (MHz)	Pass / Fail
1	2412	16.69	0.5	Pass
6	2437	17.33	0.5	Pass
11	2462	16.12	0.5	Pass

802.11n (HT40)

Channel	Frequency (MHz)	6 dB Bandwidth (MHz)	Minimum Limit (MHz)	Pass / Fail
3	2422	35.21	0.5	Pass
6	2437	36.36	0.5	Pass
9	2452	35.26	0.5	Pass

<2TX>

802.11n (HT20)

Channel	Frequency (MHz)	6 dB Bandwidth (MHz)		Minimum Limit (MHz)	Pass / Fail
		Chain 0	Chain 1		
1	2412	17.57	17.62	0.5	Pass
6	2437	17.64	17.63	0.5	Pass
11	2462	17.22	17.64	0.5	Pass

802.11n (HT40)

Channel	Frequency (MHz)	6 dB Bandwidth (MHz)		Minimum Limit (MHz)	Pass / Fail
		Chain 0	Chain 1		
3	2422	35.61	36.47	0.5	Pass
6	2437	36.44	36.43	0.5	Pass
9	2452	35.77	35.42	0.5	Pass

Spectrum Plot of Worst Value

802.11b

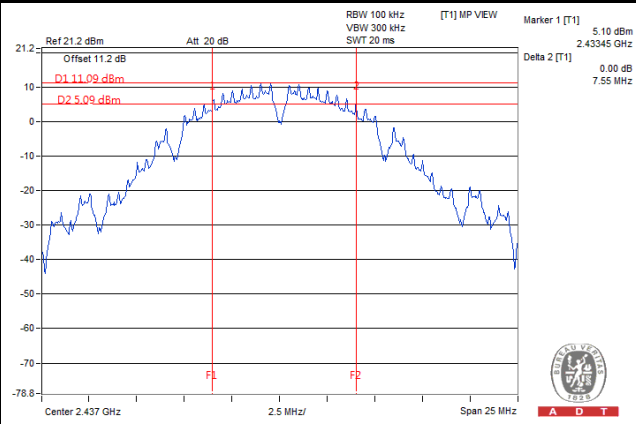

802.11g

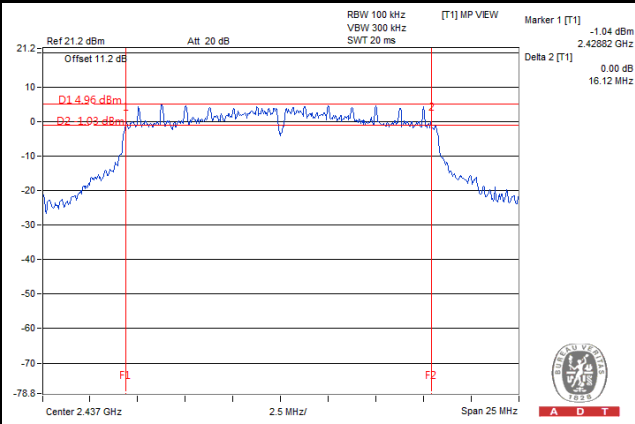

802.11n (HT20)

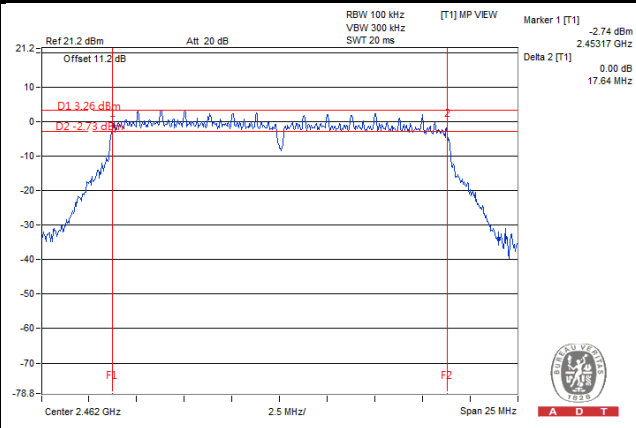

802.11n (HT40)

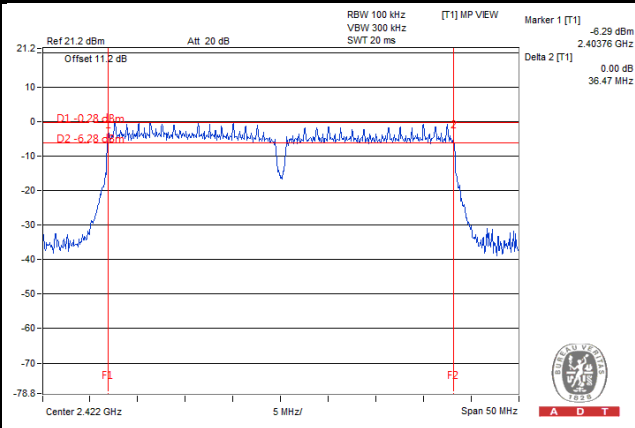

4.4 Conducted Output Power Measurement

4.4.1 Limits of Conducted Output Power Measurement

For systems using digital modulation in the 2400–2483.5 MHz bands: 1 Watt (30 dBm)

Per KDB 662911 D01 Multiple Transmitter Output Method of conducted output power measurement on IEEE 802.11 devices,

Array Gain = 0 dB (i.e., no array gain) for NANT \leq 4;

Array Gain = 0 dB (i.e., no array gain) for channel widths \geq 40 MHz for any NANT;

Array Gain = $5 \log(\text{NANT}/\text{NSS})$ dB or 3 dB, whichever is less for 20 MHz channel widths with NANT \geq 5.

For power measurements on all other devices: Array Gain = $10 \log(\text{NANT}/\text{NSS})$ dB.

4.4.2 Test Setup

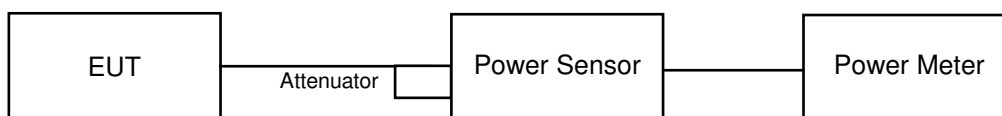

4.4.3 Test Instruments

Refer to section 4.1.2 to get information of above instrument.

4.4.4 Test Procedures

A peak power sensor was used on the output port of the EUT. A power meter was used to read the response of the peak power sensor. Record the power level.

4.4.5 Deviation from Test Standard

No deviation.

4.4.6 EUT Operating Conditions

The software provided by client to enable the EUT under transmission condition continuously at lowest, middle and highest channel frequencies individually.

4.4.7 Test Results

<1TX>

802.11b

Channel	Frequency (MHz)	Peak Power (mW)	Peak Power (dBm)	Limit (dBm)	Pass / Fail
1	2412	125.31	20.98	30	Pass
6	2437	121.62	20.85	30	Pass
11	2462	127.64	21.06	30	Pass

802.11g

Channel	Frequency (MHz)	Peak Power (mW)	Peak Power (dBm)	Limit (dBm)	Pass / Fail
1	2412	185.35	22.68	30	Pass
6	2437	175.79	22.45	30	Pass
11	2462	182.39	22.61	30	Pass

802.11n (HT20)

Channel	Frequency (MHz)	Peak Power (mW)	Peak Power (dBm)	Limit (dBm)	Pass / Fail
1	2412	188.36	22.75	30	Pass
6	2437	178.24	22.51	30	Pass
11	2462	179.06	22.53	30	Pass

802.11n (HT40)

Channel	Frequency (MHz)	Peak Power (mW)	Peak Power (dBm)	Limit (dBm)	Pass / Fail
3	2422	200.91	23.03	30	Pass
6	2437	177.83	22.5	30	Pass
9	2452	164.82	22.17	30	Pass

<2TX>

802.11n (HT20)

Channel	Frequency (MHz)	Peak Power (dBm)		Total Power (mW)	Total Power (dBm)	Limit (dBm)	Pass / Fail
		Chain 0	Chain 1				
1	2412	21.43	22.45	314.788	24.98	30	Pass
6	2437	21.38	21.18	268.624	24.29	30	Pass
11	2462	21.23	22.29	302.173	24.80	30	Pass

802.11n (HT40)

Channel	Frequency (MHz)	Peak Power (dBm)		Total Power (mW)	Total Power (dBm)	Limit (dBm)	Pass / Fail
		Chain 0	Chain 1				
3	2422	21.56	21.54	285.780	24.56	30	Pass
6	2437	20.96	21.45	264.375	24.22	30	Pass
9	2452	20.86	21.77	272.213	24.35	30	Pass

4.5 Power Spectral Density Measurement

4.5.1 Limits of Power Spectral Density Measurement

The Maximum of Power Spectral Density Measurement is 8 dBm.

4.5.2 Test Setup

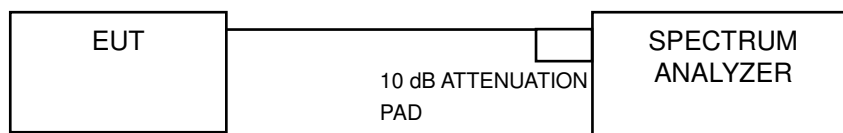

4.5.3 Test Instruments

Refer to section 4.1.2 to get information of above instrument.

4.5.4 Test Procedure

- a. Set analyzer center frequency to DTS channel center frequency.
- b. Set the span to 1.5 times the DTS bandwidth.
- c. Set the RBW to: $3 \text{ kHz} \leq \text{RBW} \leq 100 \text{ kHz}$.
- d. Set the VBW $\geq 3 \times \text{RBW}$.
- e. Detector = peak.
- f. Sweep time = auto couple.
- g. Trace mode = max hold.
- h. Allow trace to fully stabilize.
- i. Use the peak marker function to determine the maximum amplitude level within the RBW.

4.5.5 Deviation from Test Standard

No deviation.

4.5.6 EUT Operating Condition

The software provided by client to enable the EUT under transmission condition continuously at lowest, middle and highest channel frequencies individually.

4.5.7 Test Results

<1TX>

802.11b

Channel	Frequency (MHz)	PSD (dBm)	Limit (dBm)	Pass / Fail
1	2412	-4.39	8	Pass
6	2437	-3.71	8	Pass
11	2462	-3.17	8	Pass

802.11g

Channel	Frequency (MHz)	PSD (dBm)	Limit (dBm)	Pass / Fail
1	2412	-6.68	8	Pass
6	2437	-6.75	8	Pass
11	2462	-6.76	8	Pass

802.11n (HT20)

Channel	Frequency (MHz)	PSD (dBm)	Limit (dBm)	Pass / Fail
1	2412	-6.60	8	Pass
6	2437	-7.60	8	Pass
11	2462	-7.18	8	Pass

802.11n (HT40)

Channel	Frequency (MHz)	PSD (dBm)	Limit (dBm)	Pass / Fail
3	2422	-10.28	8	Pass
6	2437	-11.17	8	Pass
9	2452	-11.28	8	Pass

<2TX>

802.11n (HT20)

TX Chain	Channel	Freq. (MHz)	PSD (dBm)	10 log (N=2) dB	Total PSD (dBm)	Limit (dBm)	Pass / Fail
0	1	2412	-10.81	3.01	-7.80	8	Pass
	6	2437	-11.10	3.01	-8.09	8	Pass
	11	2462	-11.29	3.01	-8.28	8	Pass
1	1	2412	-10.64	3.01	-7.63	8	Pass
	6	2437	-10.85	3.01	-7.84	8	Pass
	11	2462	-11.32	3.01	-8.31	8	Pass

NOTE: Directional gain = -2 dBi + 10log(2) = 1.01 dBi < 6 dBi, so the limit no need to reduced.

802.11n (HT40)

TX Chain	Channel	Freq. (MHz)	PSD (dBm)	10 log (N=2) dB	Total PSD (dBm)	Limit (dBm)	Pass / Fail
0	3	2422	-12.24	3.01	-9.23	8	Pass
	6	2437	-13.80	3.01	-10.79	8	Pass
	9	2452	-13.52	3.01	-10.51	8	Pass
1	3	2422	-13.82	3.01	-10.81	8	Pass
	6	2437	-14.24	3.01	-11.23	8	Pass
	9	2452	-13.31	3.01	-10.30	8	Pass

NOTE: Directional gain = -2 dBi + 10log(2) = 1.01 dBi < 6 dBi, so the limit no need to reduced.

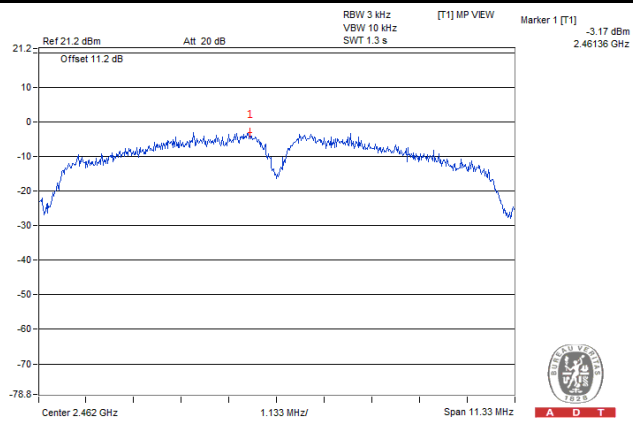
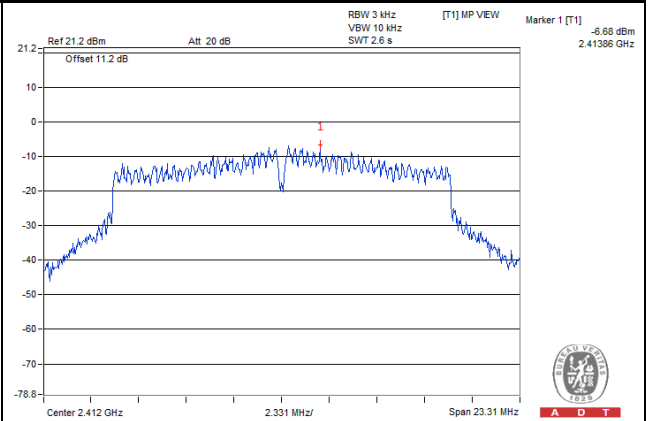
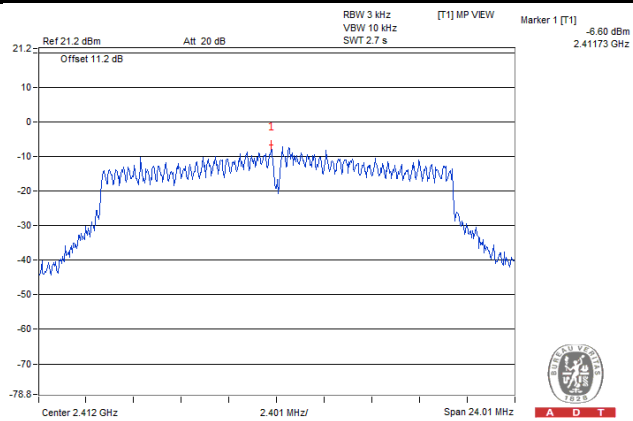
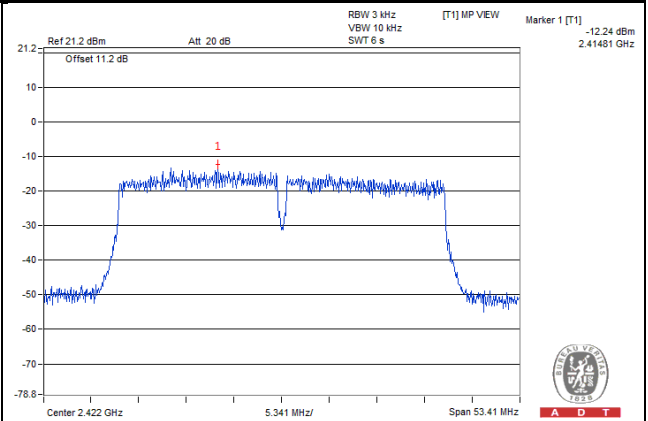
Spectrum Plot of Worst Value**802.11b****802.11g****802.11n (HT20)****802.11n (HT40)**

4.6 Conducted Out of Band Emission Measurement

4.6.1 Limits of Conducted Out of Band Emission Measurement

Below 20 dB of the highest emission level of operating band (in 100 kHz Resolution Bandwidth).

4.6.2 Test Setup

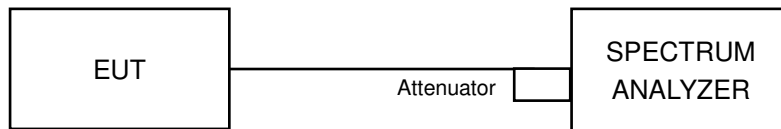

4.6.3 Test Instruments

Refer to section 4.1.2 to get information of above instrument.

4.6.4 Test Procedure

MEASUREMENT PROCEDURE REF

1. Set the RBW = 100 kHz.
2. Set the VBW \geq 300 kHz.
3. Detector = peak.
4. Sweep time = auto couple.
5. Trace mode = max hold.
6. Allow trace to fully stabilize.
7. Use the peak marker function to determine the maximum power level in any 100 kHz band segment within the fundamental EBW.

MEASUREMENT PROCEDURE OOB

1. Set RBW = 100 kHz.
2. Set VBW \geq 300 kHz.
3. Detector = peak.
4. Sweep = auto couple.
5. Trace Mode = max hold.
6. Allow trace to fully stabilize.
7. Use the peak marker function to determine the maximum amplitude level.

4.6.5 Deviation from Test Standard

No deviation.

4.6.6 EUT Operating Condition

The software provided by client to enable the EUT under transmission condition continuously at lowest, middle and highest channel frequencies individually.

4.6.7 Test Results

The conducted emission test is performed on each TX port of operating mode without summing or adding 10log (N) since the limit is relative emission limit.

The spectrum plots are attached on the following images. D1 line indicates the highest level, and D2 line indicates the 20 dB offset below D1. It shows compliance with the requirement.

<1TX>
802.11b

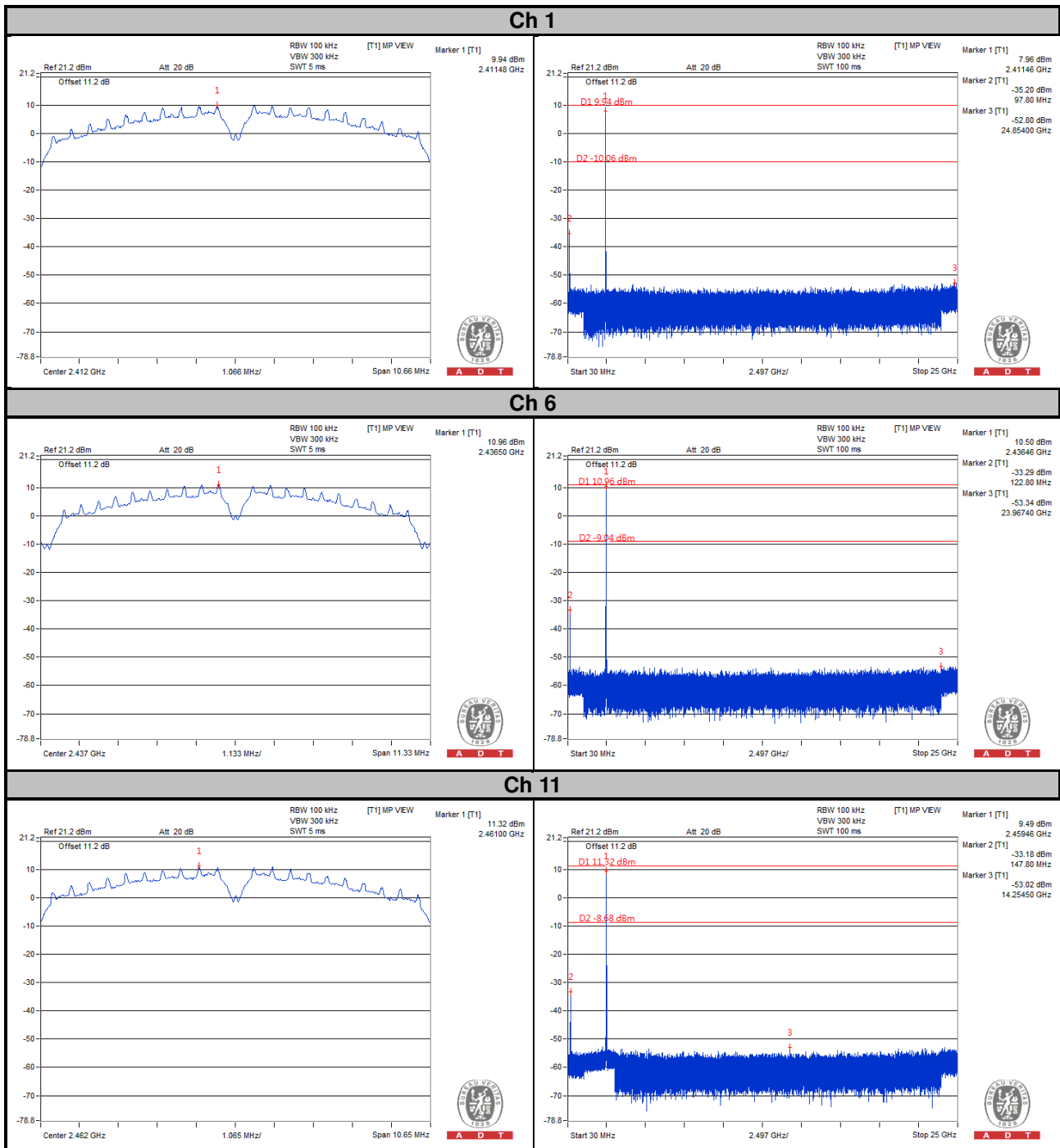

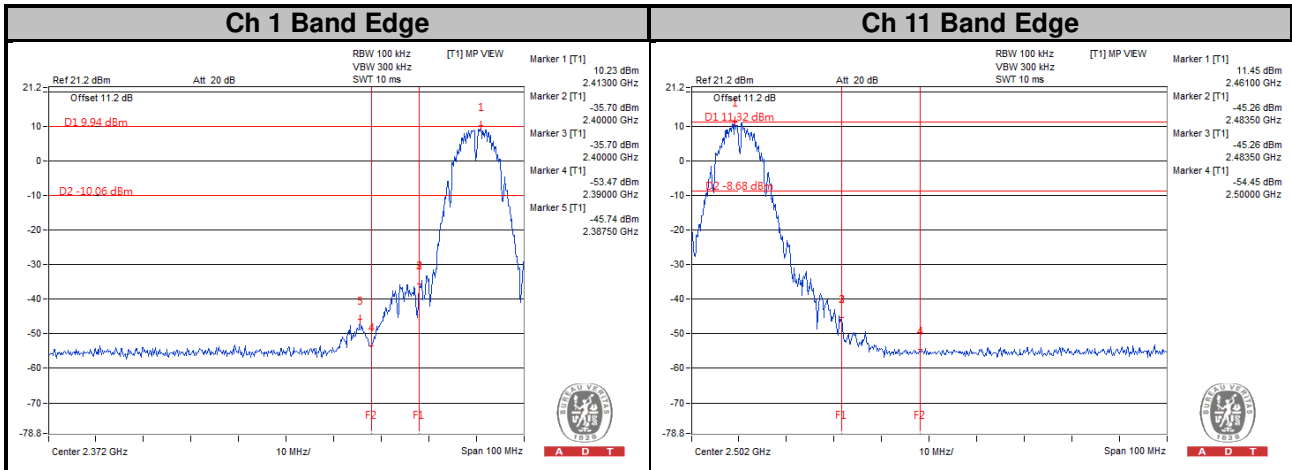

802.11g

Ch 1

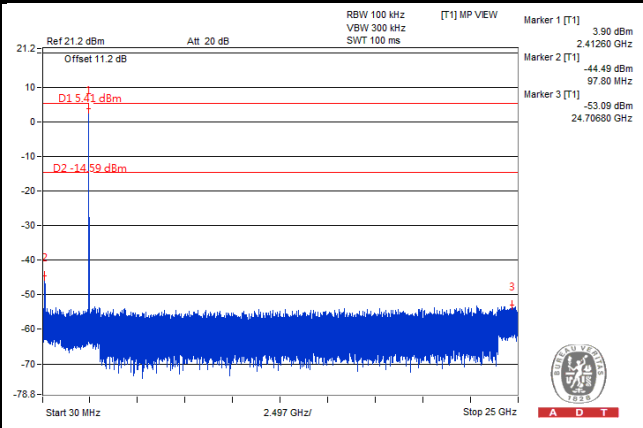
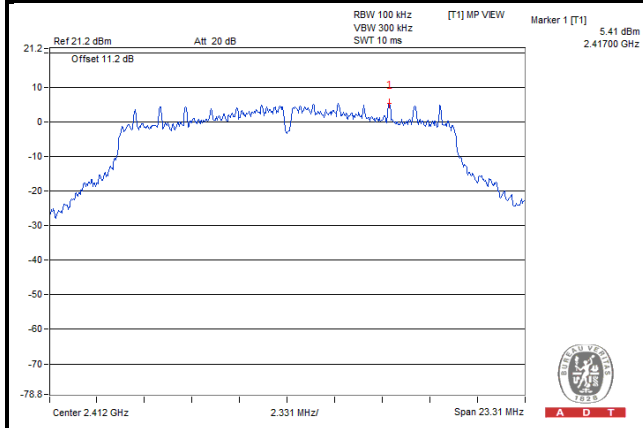

Ch 6

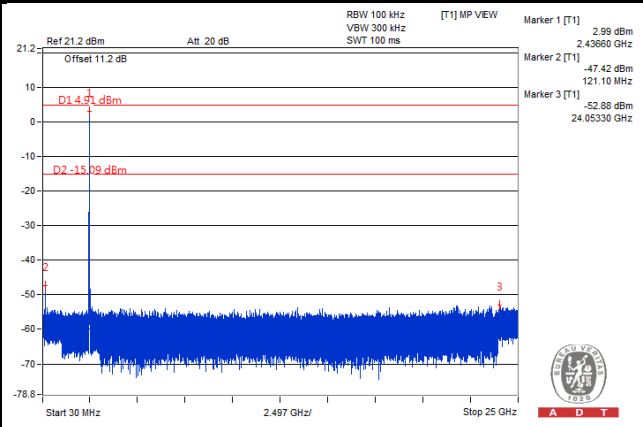
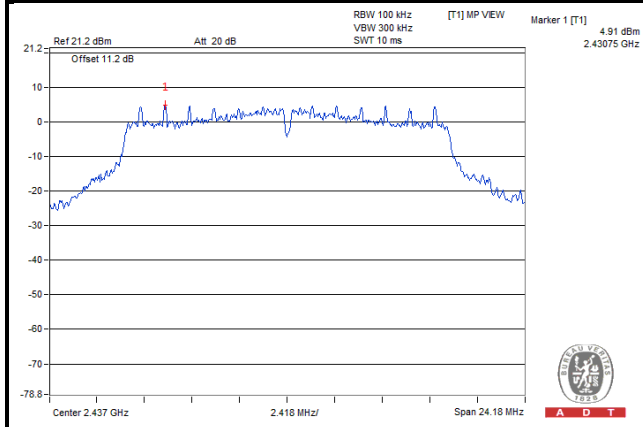

Ch 11

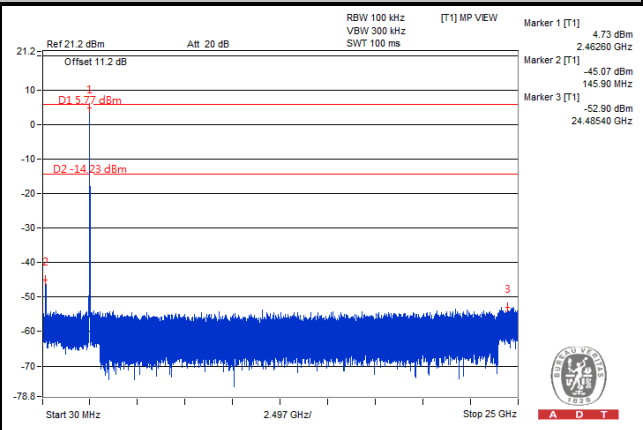
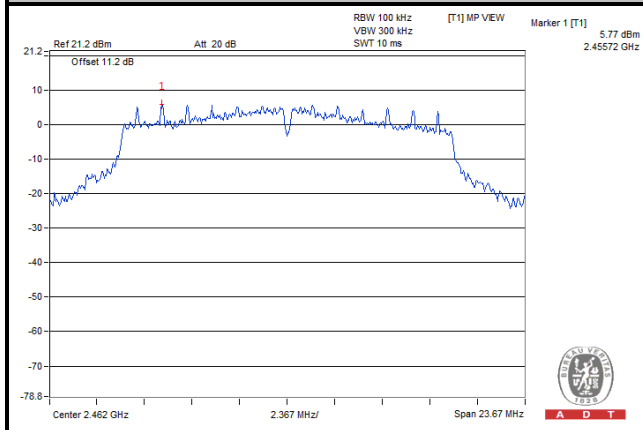

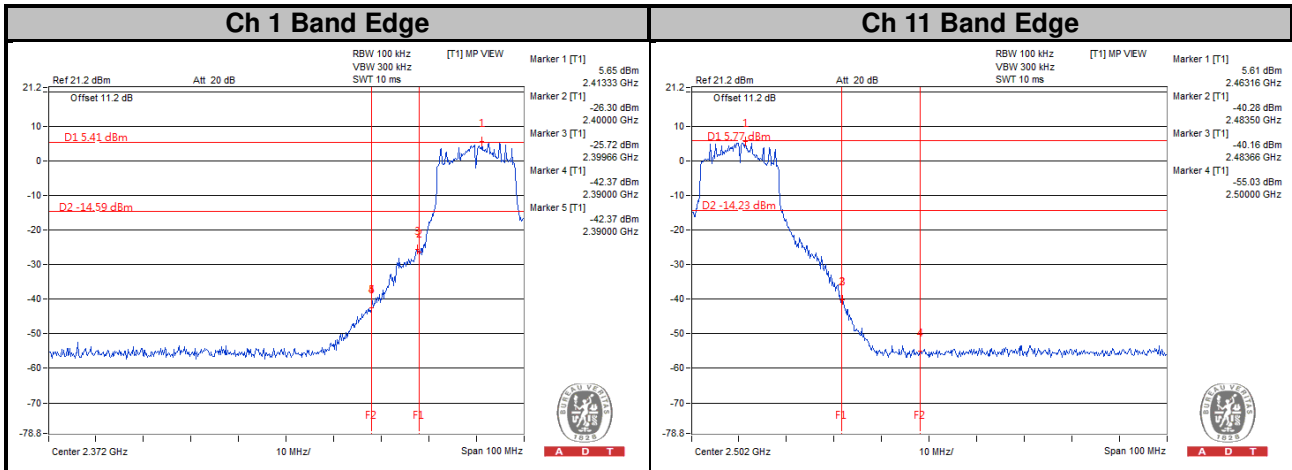

802.11n (HT20)

Ch 1

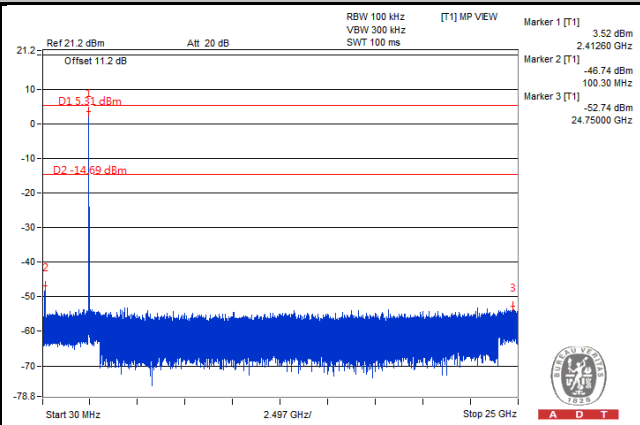
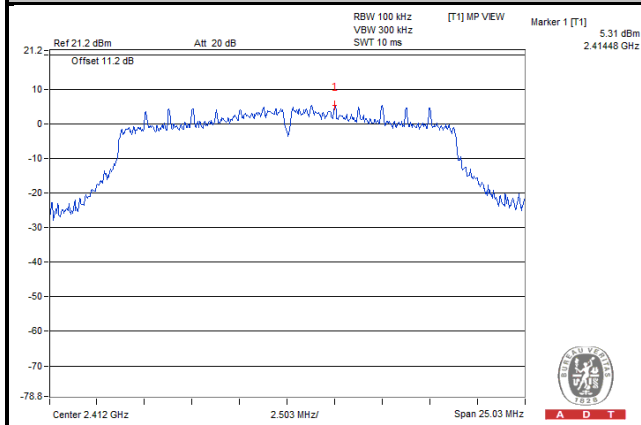

Ch 6

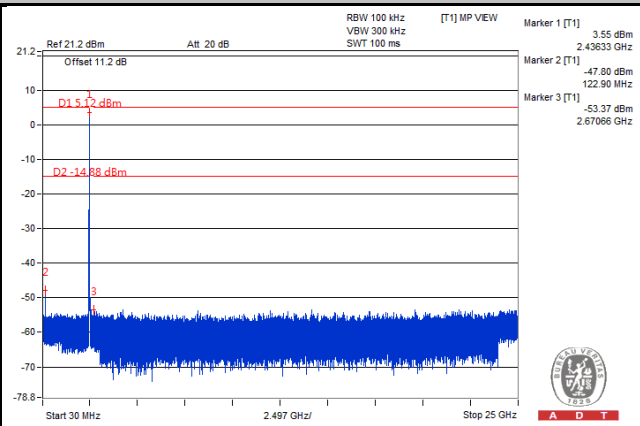
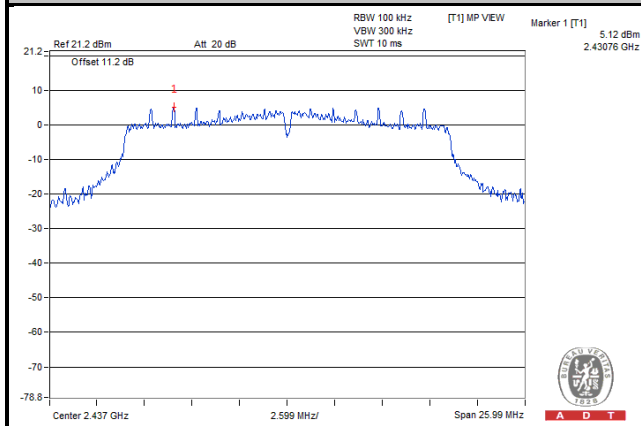

Ch 11

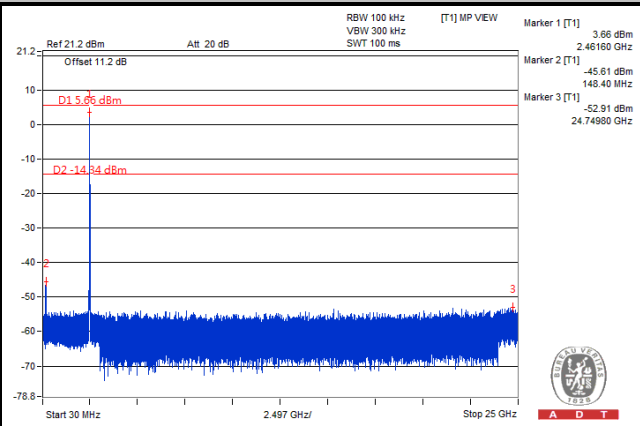
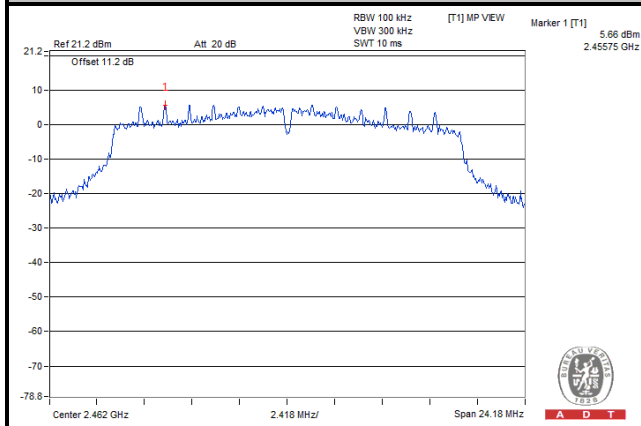

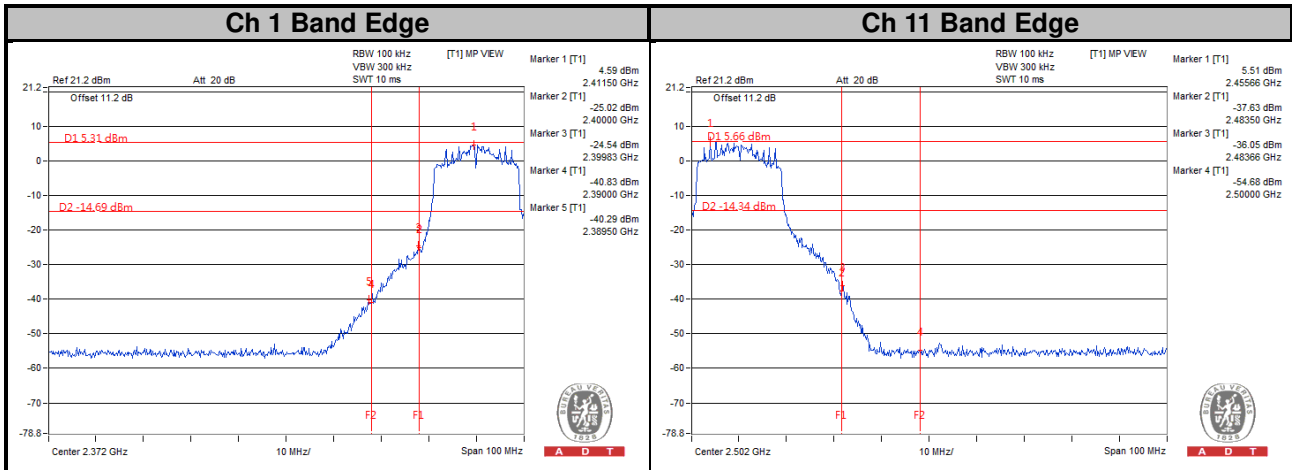

802.11n (HT40)

Ch 3

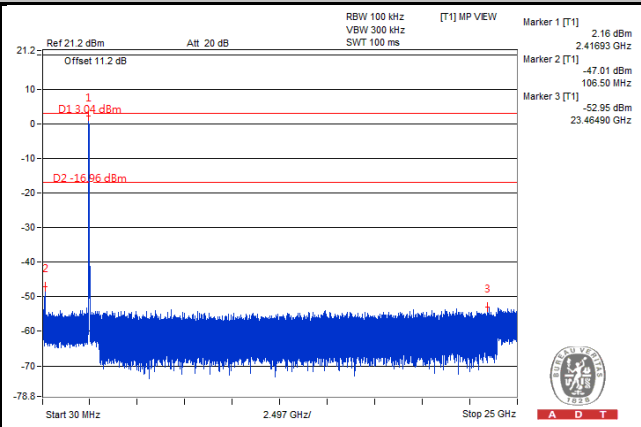
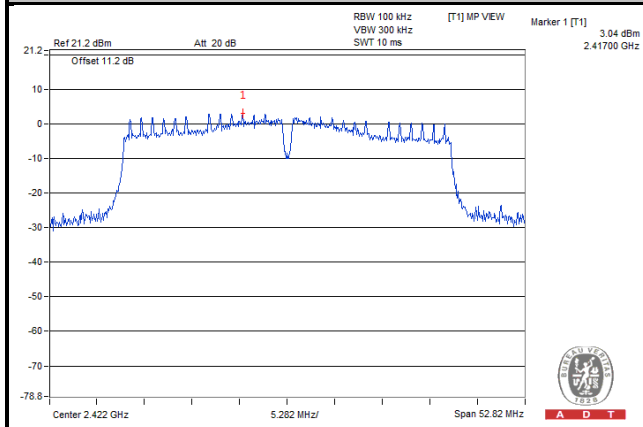

Ch 6

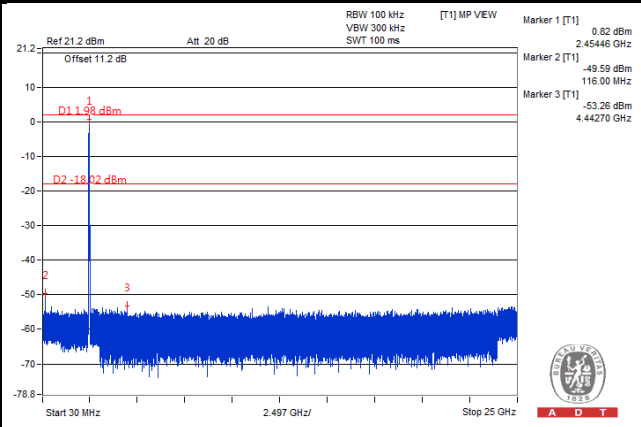
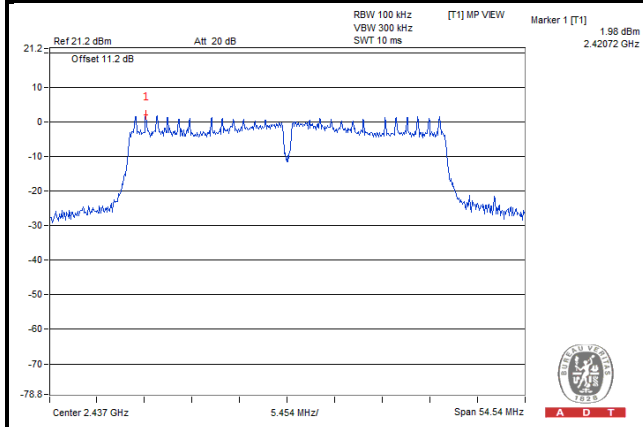

Ch 9

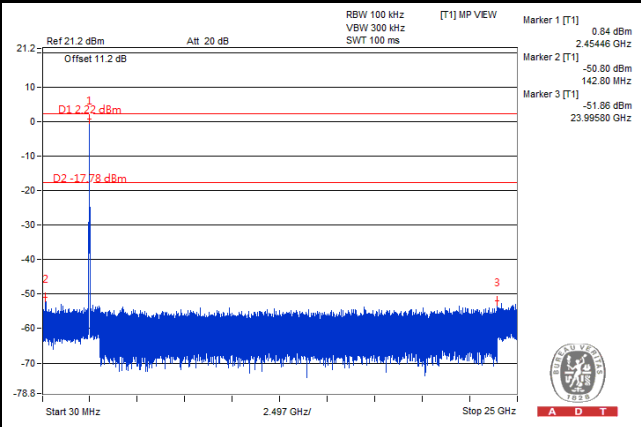
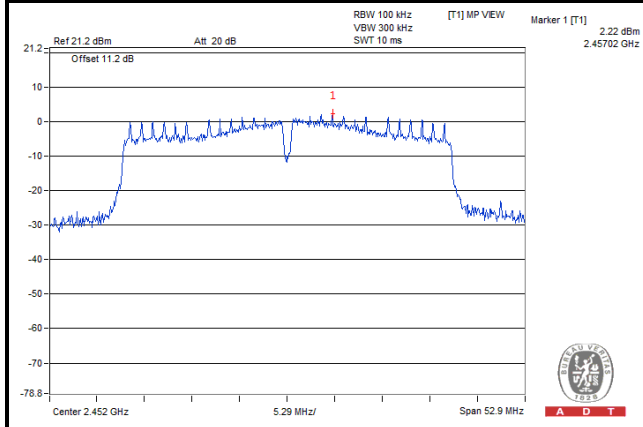

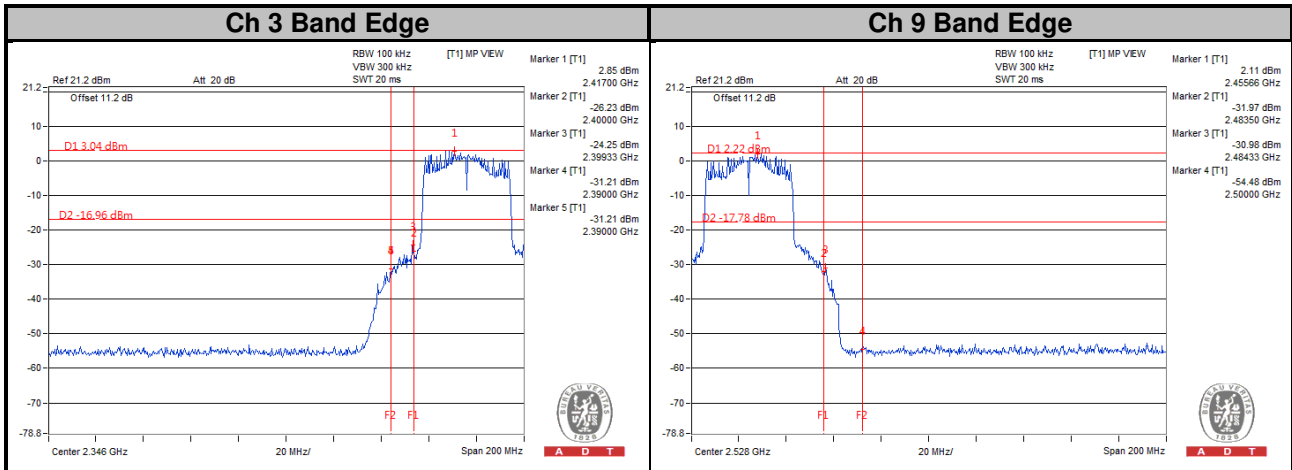

<2TX>
802.11n (HT20)
CHAIN 0

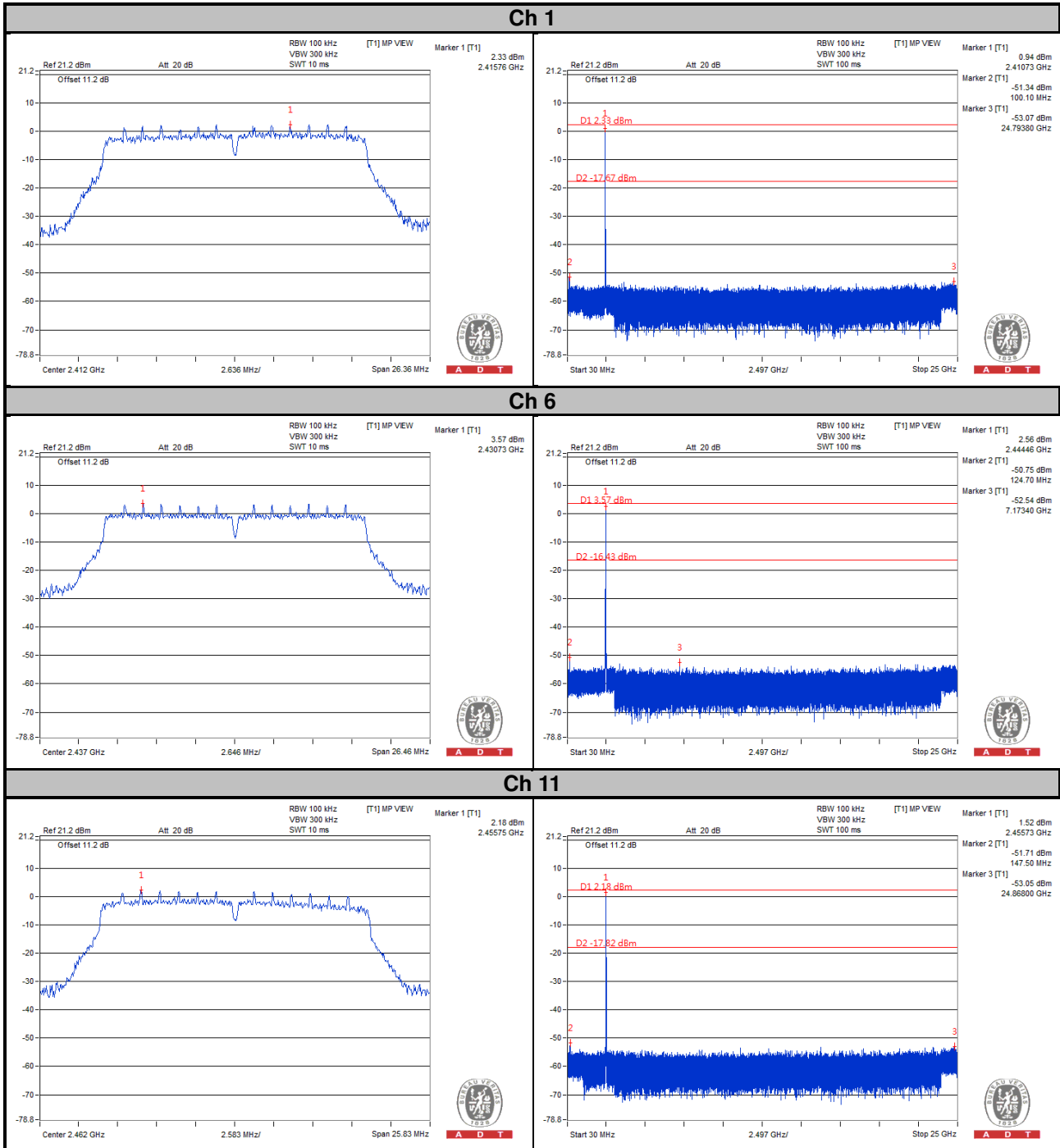

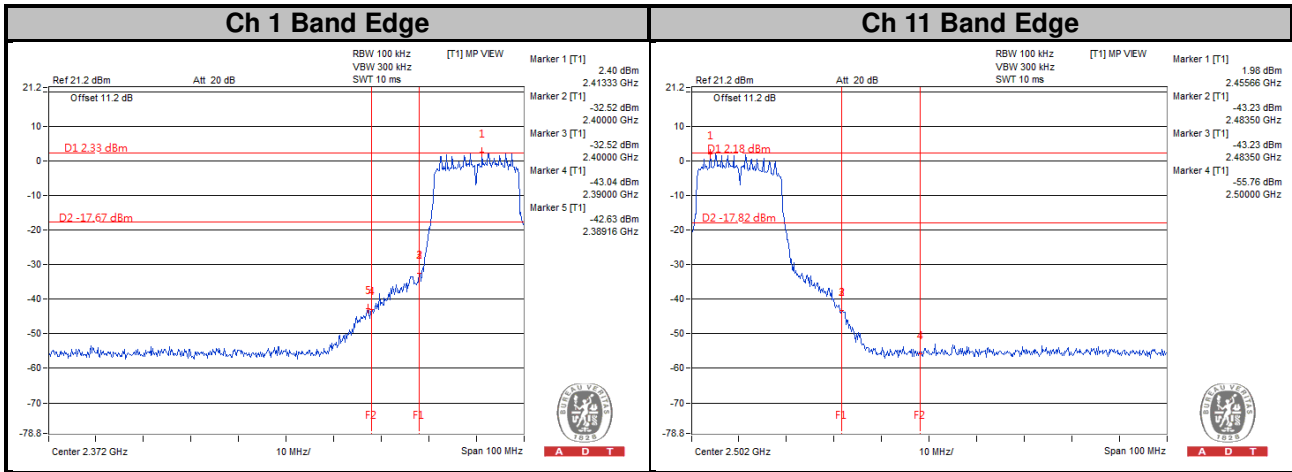

CHAIN 1

Ch 1

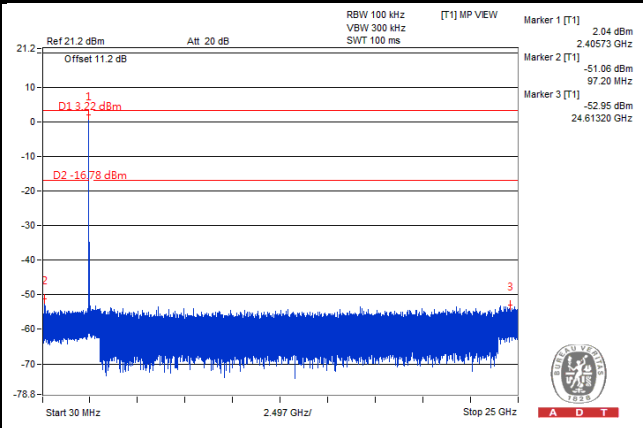
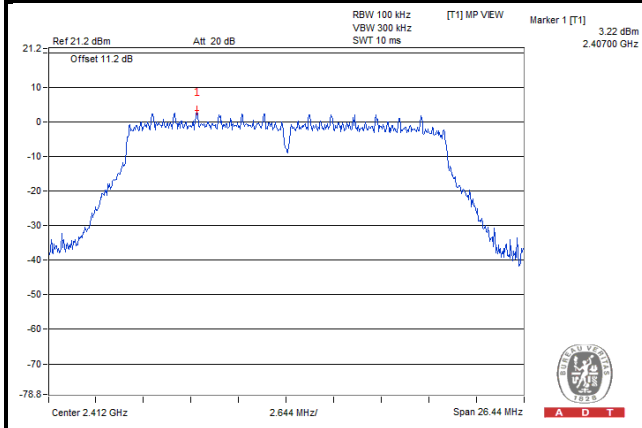

Ch 6

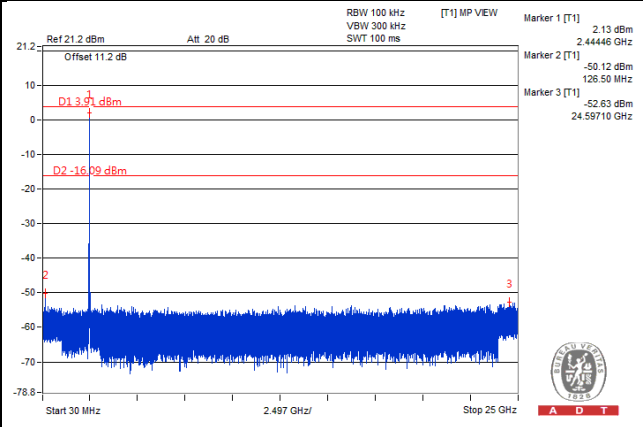
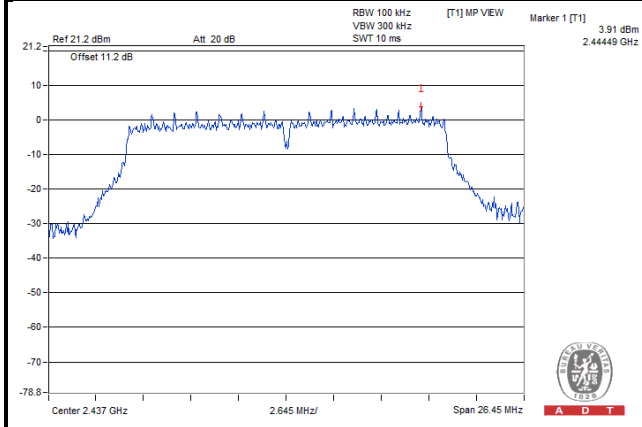

Ch 11

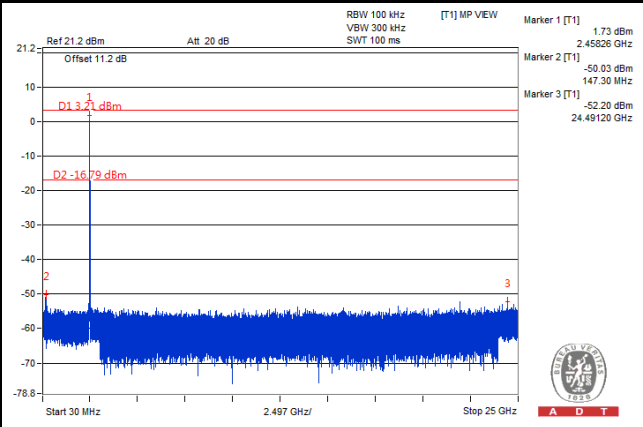
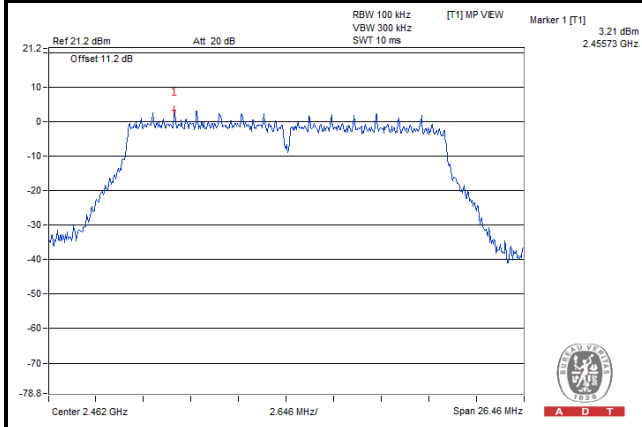

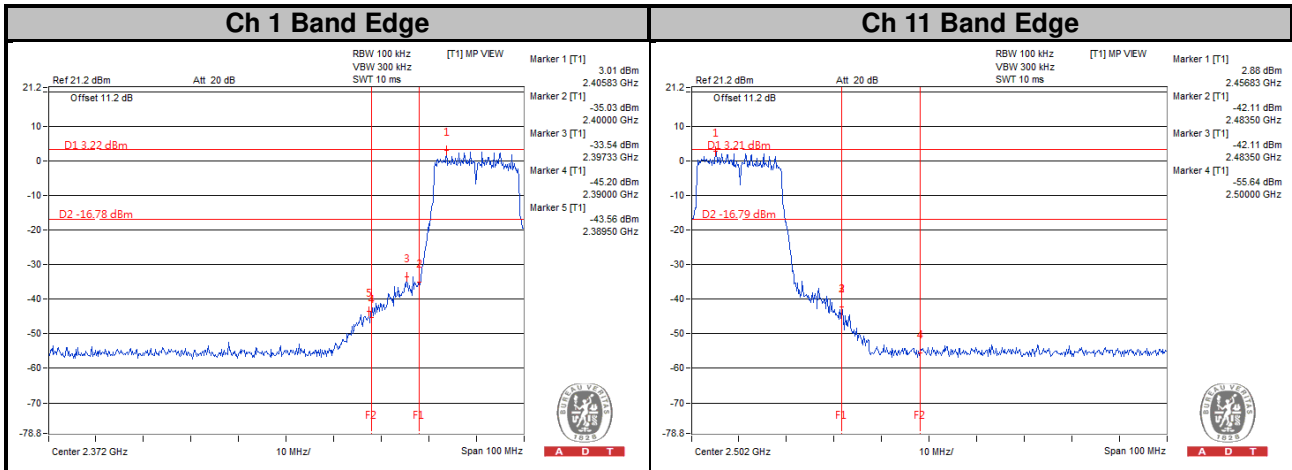

802.11n (HT40)
CHAIN 0

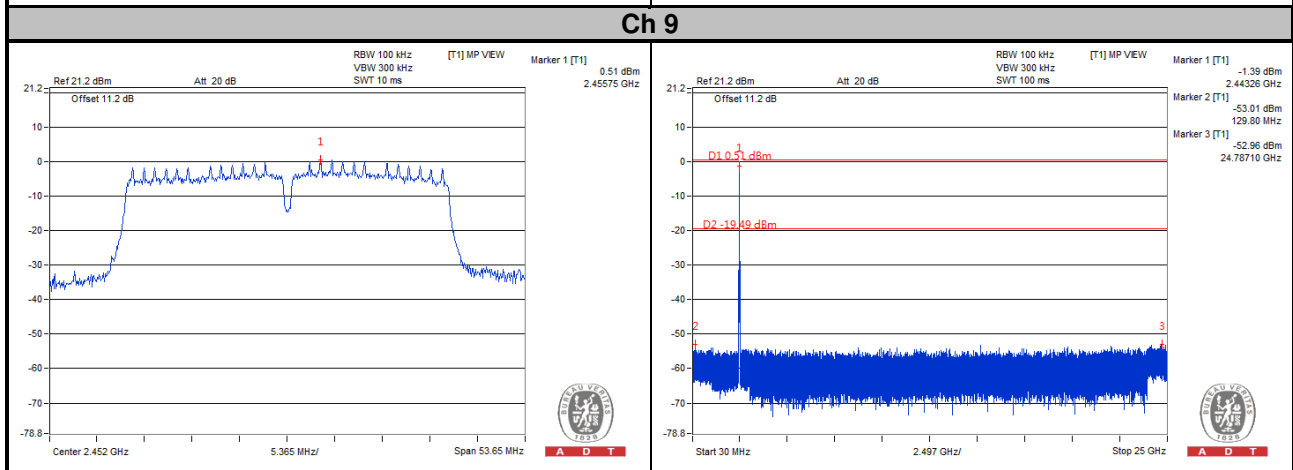
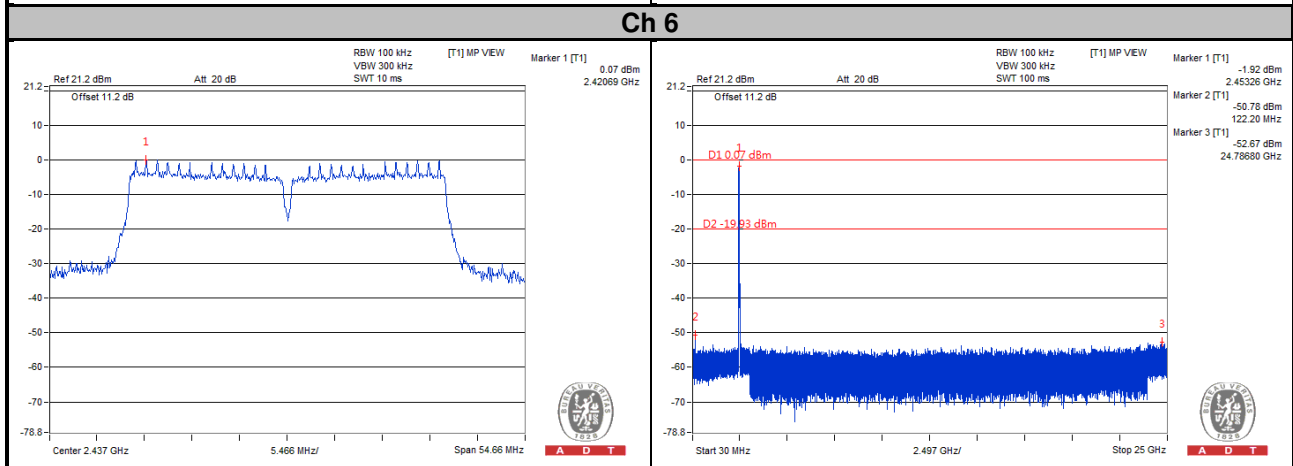
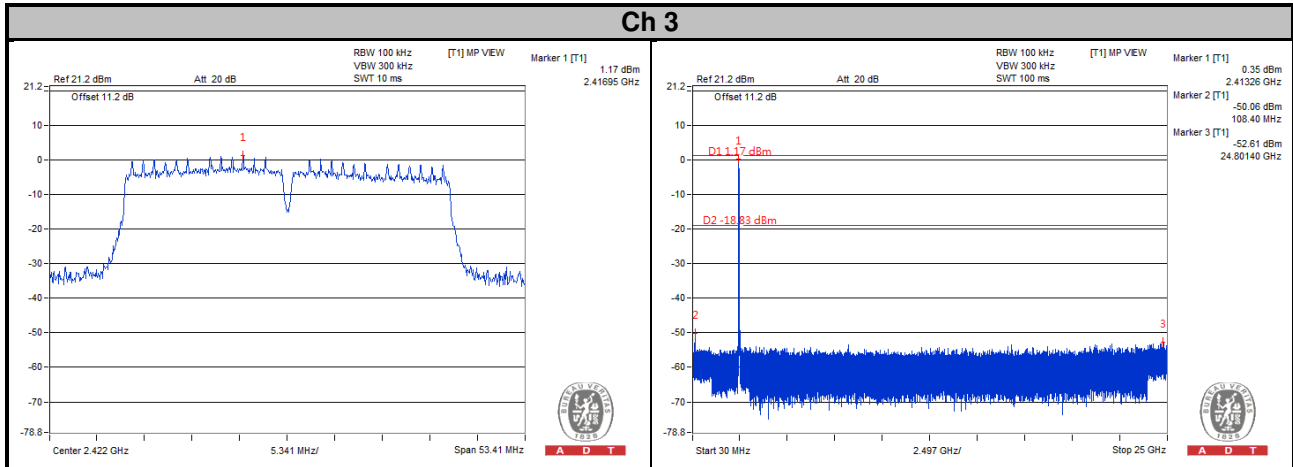

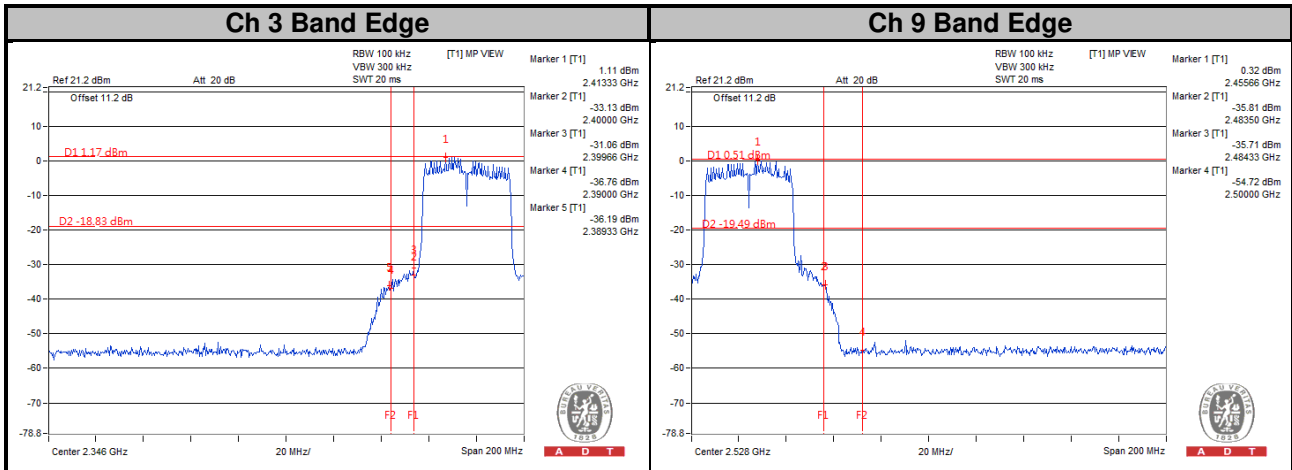

CHAIN 1

Ch 3

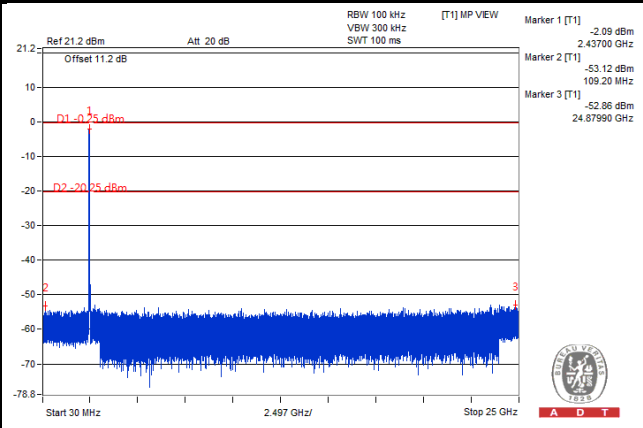
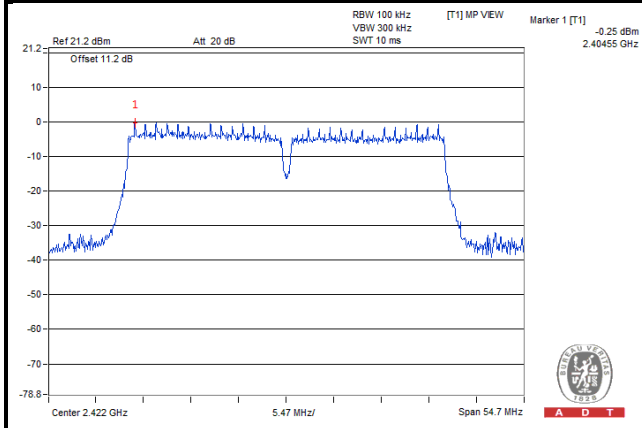

Ch 6

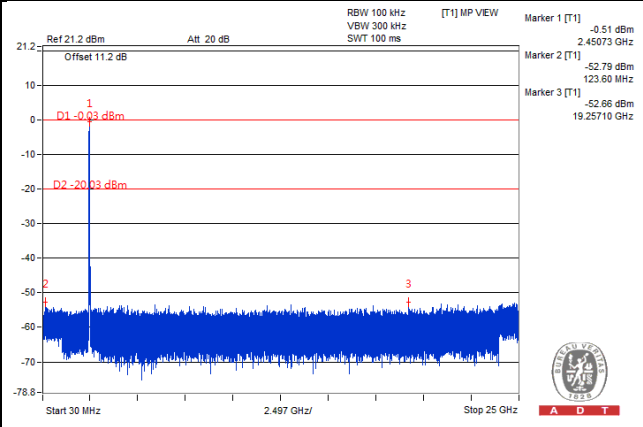
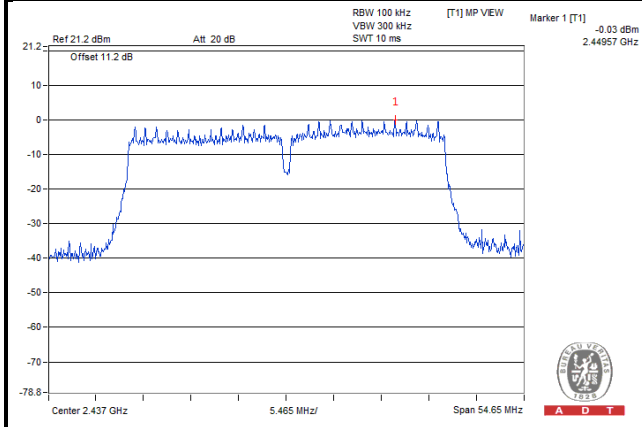

Ch 9

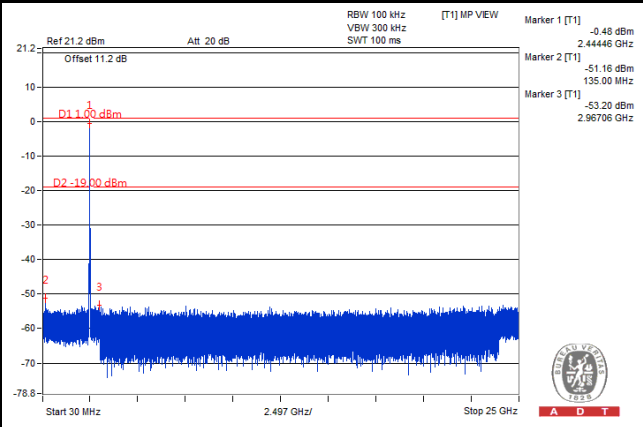
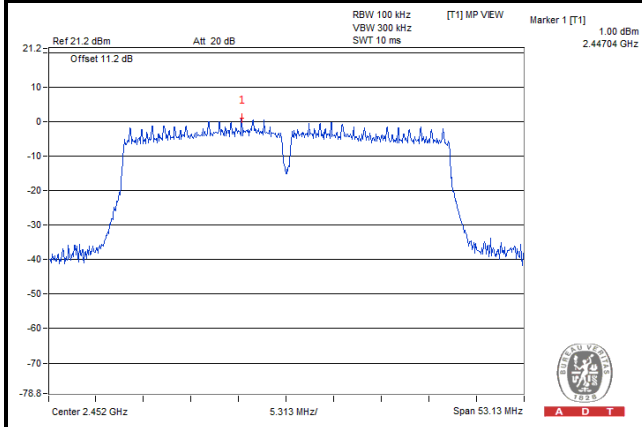

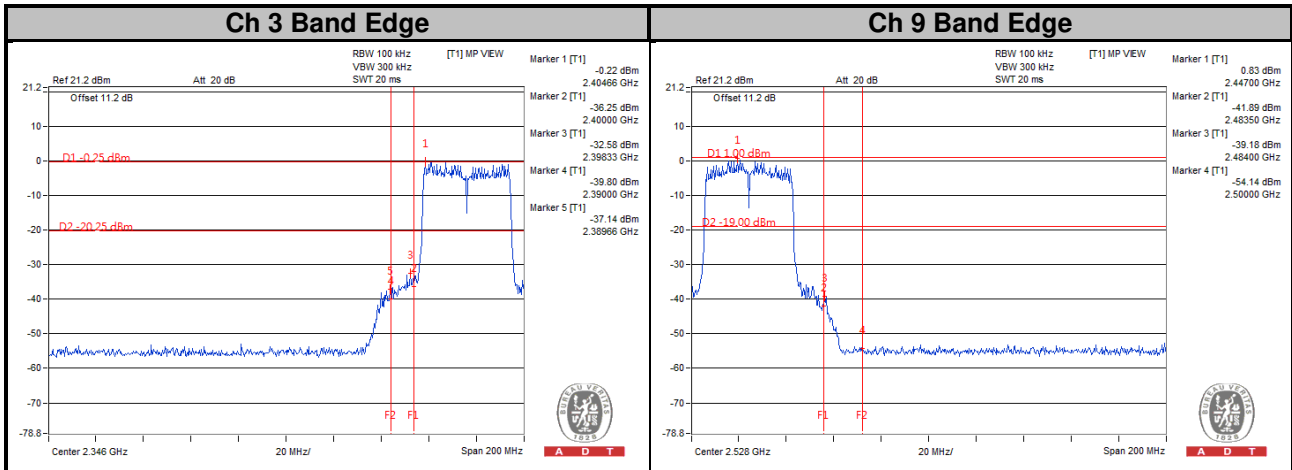



5 Pictures of Test Arrangements

Please refer to the attached file (Test Setup Photo).



Appendix – Information on the Testing Laboratories

We, Bureau Veritas Consumer Products Services (H.K.) Ltd., Taoyuan Branch, were founded in 1988 to provide our best service in EMC, Radio, Telecom and Safety consultation. Our laboratories are accredited and approved according to ISO/IEC 17025.

If you have any comments, please feel free to contact us at the following:

Linko EMC/RF Lab

Tel: 886-2-26052180

Fax: 886-2-26051924

Hsin Chu EMC/RF/Telecom Lab

Tel: 886-3-6668565

Fax: 886-3-6668323

Hwa Ya EMC/RF/Safety Lab

Tel: 886-3-3183232

Fax: 886-3-3270892

Email: service.adt@tw.bureauveritas.com

Web Site: www.bureauveritas-adt.com

The address and road map of all our labs can be found in our web site also.

--- END ---