

# FCC Test Report

## (PART 24)

**Report No.:** RF160303C04-1

**FCC ID:** NM82PS6700A

**Test Model:** 2PS6700A

**Received Date:** Mar. 03, 2016

**Test Date:** Mar. 17, 2016 ~ Mar. 22, 2016

**Issued Date:** Apr. 14, 2016

**Applicant:** HTC Corporation

**Address:** 1F, 6-3 Baoqiang Road, Xindian District, New Taipei City, Taiwan 231

**Issued By:** Bureau Veritas Consumer Products Services (H.K.) Ltd., Taoyuan Branch

**Lab Address:** No. 47-2, 14th Ling, Chia Pau Vil., Lin Kou Dist., New Taipei City, Taiwan ( R.O.C )

**Test Location (1):** No. 19, Hwa Ya 2nd Rd, Wen Hwa Tsuen, Kwei Shan Hsiang, Taoyuan Hsien 333, Taiwan, R.O.C.

**Test Location (2):** No.215, Sec. 3, Beixin Rd., Xindian Dist., New Taipei City 231, Taiwan, R.O.C



This report is for your exclusive use. Any copying or replication of this report to or for any other person or entity, or use of our name or trademark, is permitted only with our prior written permission. This report sets forth our findings solely with respect to the test samples identified herein. The results set forth in this report are not indicative or representative of the quality or characteristics of the lot from which a test sample was taken or any similar or identical product unless specifically and expressly noted. Our report includes all of the tests requested by you and the results thereof based upon the information that you provided to us. You have 60 days from date of issuance of this report to notify us of any material error or omission caused by our negligence, provided, however, that such notice shall be in writing and shall specifically address the issue you wish to raise. A failure to raise such issue within the prescribed time shall constitute your unqualified acceptance of the completeness of this report, the tests conducted and the correctness of the report contents. Unless specific mention, the uncertainty of measurement has been explicitly taken into account to declare the compliance or non-compliance to the specification. The report must not be used by the client to claim product certification, approval, or endorsement by TAF or any government agencies.

## Table of Contents

<b>Release Control Record .....</b>	<b>3</b>
<b>1 Certificate of Conformity .....</b>	<b>4</b>
<b>2 Summary of Test Results.....</b>	<b>5</b>
2.1 Measurement Uncertainty.....	5
2.2 Test Site And Instruments .....	6
<b>3 General Information .....</b>	<b>7</b>
3.1 General Description of EUT .....	7
3.2 Configuration of System under Test.....	8
3.2.1 Description of Support Units .....	8
3.3 Test Mode Applicability and Tested Channel Detail .....	9
3.4 EUT Operating Conditions .....	10
3.5 General Description of Applied Standards.....	10
<b>4 Test Types and Results .....</b>	<b>11</b>
4.1 Output Power Measurement.....	11
4.1.1 Limits of Output Power Measurement .....	11
4.1.2 Test Procedures.....	11
4.1.3 Test Setup.....	12
4.1.4 Test Results .....	13
4.2 Frequency Stability Measurement .....	15
4.2.1 Limits of Frequency Stability Measurement.....	15
4.2.2 Test Procedure .....	15
4.2.3 Test Setup.....	15
4.2.4 Test Results .....	16
4.3 Occupied Bandwidth Measurement.....	17
4.3.1 Test Procedure .....	17
4.3.2 Test Setup.....	17
4.3.3 Test Result .....	18
4.4 Band Edge Measurement .....	19
4.4.1 Limits of Band Edge Measurement .....	19
4.4.2 Test Setup.....	19
4.4.3 Test Procedures.....	19
4.4.4 Test Results .....	20
4.5 Peak to Average Ratio .....	21
4.5.1 Limits of Peak to Average Ratio Measurement .....	21
4.5.2 Test Setup.....	21
4.5.3 Test Procedures.....	21
4.5.4 Test Results .....	22
4.6 Conducted Spurious Emissions.....	23
4.6.1 Limits of Conducted Spurious Emissions Measurement.....	23
4.6.2 Test Setup.....	23
4.6.3 Test Procedure .....	23
4.6.4 Test Results .....	24
4.7 Radiated Emission Measurement.....	25
4.7.1 Limits of Radiated Emission Measurement .....	25
4.7.2 Test Procedure .....	25
4.7.3 Deviation from Test Standard .....	25
4.7.4 Test Setup.....	25
4.7.5 Test Results .....	26
<b>5 Pictures of Test Arrangements.....</b>	<b>32</b>
<b>Appendix – Information on the Testing Laboratories .....</b>	<b>33</b>



A D T

### Release Control Record

Issue No.	Description	Date Issued
RF160303C04-1	Original Release	Apr. 14, 2016



**1 Certificate of Conformity**

**Product:** Smartphone  
**Brand:** HTC  
**Test Model:** 2PS6700A  
**Sample Status:** Production Unit  
**Applicant:** HTC Corporation  
**Test Date:** Mar. 17, 2016 ~ Mar. 22, 2016  
**Standards:** FCC Part 24, Subpart E

The above equipment has been tested by **Bureau Veritas Consumer Products Services (H.K.) Ltd., Taoyuan Branch**, and found compliance with the requirement of the above standards. The test record, data evaluation & Equipment Under Test (EUT) configurations represented herein are true and accurate accounts of the measurements of the sample's EMC characteristics under the conditions specified in this report.

**Prepared by :** Ivonne Wu , **Date:** Apr. 14, 2016  
Ivonne Wu / Supervisor

**Approved by :** Stanley Wu , **Date:** Apr. 14, 2016  
Stanley Wu / Assistant Manager

## 2 Summary of Test Results

Applied Standard: FCC Part 24 & Part 2			
FCC Clause	Test Item	Result	Remarks
2.1046 24.232	Effective Isotropic Radiated Power	Pass	Meet the requirement of limit.
2.1046 24.232(d)	Peak to Average Ratio	Pass	Meet the requirement of limit.
2.1055 24.235	Frequency Stability	Pass	Meet the requirement of limit.
2.1049 24.238(b)	Occupied Bandwidth	Pass	Meet the requirement of limit.
24.238(b)	Band Edge Measurements	Pass	Meet the requirement of limit.
2.1051 24.238	Conducted Spurious Emissions	Pass	Meet the requirement of limit.
2.1053 24.238	Radiated Spurious Emissions	Pass	Meet the requirement of limit. Minimum passing margin is -31.54 dB at 5640.00 MHz.

### 2.1 Measurement Uncertainty

Where relevant, the following measurement uncertainty levels have been estimated for tests performed on the EUT as specified in CISPR 16-4-2:

Measurement	Frequency	Expanded Uncertainty (k=2) (±)
Conducted Emissions at mains ports	150 kHz ~ 30 MHz	2.44 dB
Radiated Emissions up to 1 GHz	30 MHz ~ 200 MHz	2.0153 dB
	200 MHz ~ 1000 MHz	2.0224 dB
Radiated Emissions above 1 GHz	1 GHz ~ 18 GHz	1.0121 dB
	18 GHz ~ 40 GHz	1.1508 dB

## 2.2 Test Site And Instruments

Description & Manufacturer	Model No.	Serial No.	Date of Calibration	Due Date of Calibration
Test Receiver Agilent Technologies	N9038A	MY52260177	May 19, 2015	May 18, 2016
Spectrum Analyzer ROHDE & SCHWARZ	FSU43	101261	Dec. 17, 2015	Dec. 16, 2016
BILOG Antenna SCHWARZBECK	VULB9168	9168-472	Jan. 07, 2016	Jan. 06, 2017
HORN Antenna ETS-Lindgren	3117	00143293	Jan. 04, 2016	Jan. 03, 2017
Double Ridge Guide Horn Antenna EMCO	3115	5619	Jan. 04, 2016	Jan. 03, 2017
BILOG Antenna SCHWARZBECK	VULB 9168	9168-153	Jan. 07, 2016	Jan. 06, 2017
Agilent Communications Tester-Wireless	8960 Series 10	MY53201073	Jul. 03, 2015	Jul. 02, 2017
Preamplifier Agilent	310N	187226	Jun. 29, 2015	Jun. 28, 2016
Preamplifier Agilent	83017A	MY39501357	Jun. 29, 2015	Jun. 28, 2016
Power Meter Anritsu	ML2495A	1232002	Sep. 21, 2015	Sep. 20, 2016
Power Sensor Anritsu	MA2411B	1207325	Sep. 21, 2015	Sep. 20, 2016
RF signal cable ETS-LINDGREN	5D-FB	Cable-CH1-01(R FC-SMS-100-SM S-120+RFC-SMS -100-SMS-400)	Jun. 27, 2015	Jun. 26, 2016
RF signal cable ETS-LINDGREN	8D-FB	Cable-CH1-02(R FC-SMS-100-SM S-24)	Jun. 27, 2015	Jun. 26, 2016
Software BV ADT	E3 8.130425b	NA	NA	NA
Antenna Tower MF	NA	NA	NA	NA
Turn Table MF	NA	NA	NA	NA
Antenna Tower & Turn Table Controller MF	MF-7802	NA	NA	NA
Communications Tester-Wireless Agilent	8960 Series 10	MY53201073	Jul. 03, 2015	Jul. 02, 2017
Radio Communication Analyzer Anritsu	MT8820C	6201240432	Jul. 06, 2015	Jul. 05, 2017

Note: 1. The calibration interval of the above test instruments is 12 / 24 months and the calibrations are traceable to NML/ROC and NIST/USA.

2. The test was performed in HsinTien Chamber 1.

3. The horn antenna and preamplifier (model: 83017A) are used only for the measurement of emission frequency above 1 GHz if tested.

4. The FCC Site Registration No. is 149147.

5. The IC Site Registration No. is IC7450I-1.

### 3 General Information

#### 3.1 General Description of EUT

<b>Product</b>	Smartphone	
<b>Brand</b>	HTC	
<b>Test Model</b>	2PS6700A	
<b>Status of EUT</b>	Production Unit	
<b>Power Supply Rating</b>	5.0 Vdc (adapter or host equipment) 3.85 Vdc (Li-ion battery)	
<b>Modulation Type</b>	GSM/GPRS	GMSK
	EDGE	GMSK, 8PSK
	WCDMA	BPSK
<b>Frequency Range</b>	GSM/GPRS/EDGE	1850.2 ~ 1909.8 MHz
	WCDMA	1852.4 ~ 1907.6 MHz
<b>Max. EIRP Power</b>	GSM/GPRS	672.98 mW
	EDGE	285.10 mW
	WCDMA	136.14 mW
<b>Emission Designator</b>	GSM/GPRS	246KGXW
	EDGE	246KG7W
	WCDMA	4M16F9W
<b>Antenna Type</b>	Fixed Internal Antenna	
<b>Accessory Device</b>	Refer to Note as below	
<b>Data Cable Supplied</b>	Refer to Note as below	

Note:

1. The EUT's accessories list refers to Ext. Pho.
2. The above EUT information is declared by manufacturer and for more detailed features description, please refer to the manufacturer's specifications or user's manual.

### 3.2 Configuration of System under Test

#### <Radiated Emission Test>

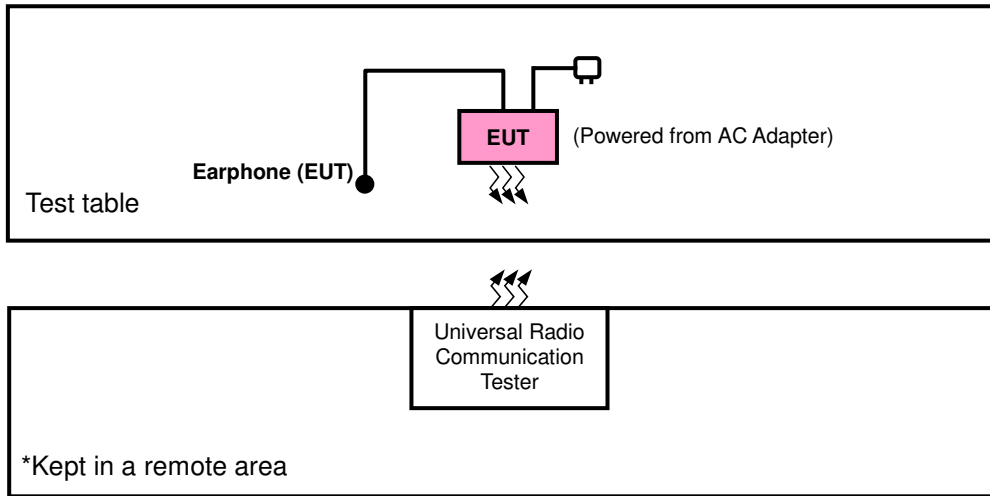

#### <E.I.R.P. Test>

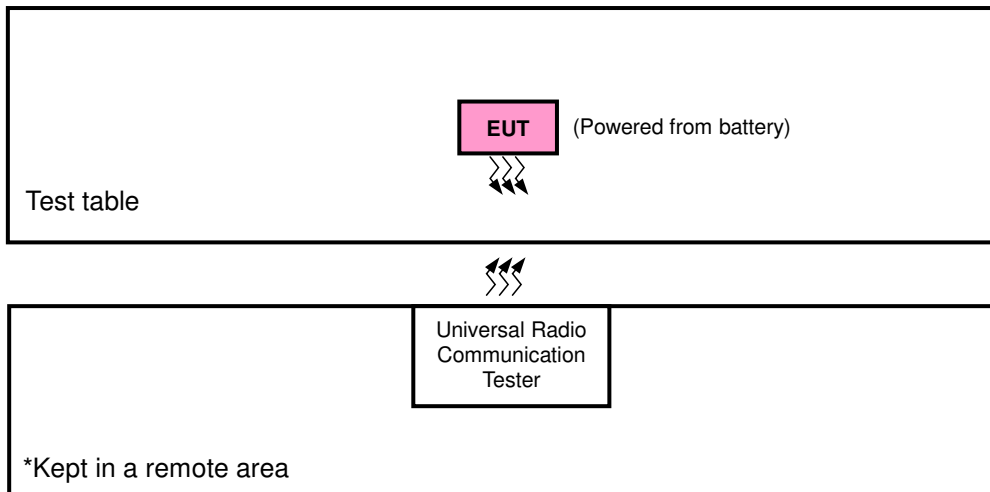

#### 3.2.1 Description of Support Units

The EUT has been tested as an independent unit together with other necessary accessories or support units.



### 3.3 Test Mode Applicability and Tested Channel Detail

Pre-Scan has been conducted to determine the worst-case mode from all possible combinations between available modulations, data rates, XYZ axis, and antenna ports.

The worst case was found when positioned as the table below. Following channel(s) was (were) selected for the final test as listed below:

Band	EIRP	Radiated Emission
GSM	Y-plane	X-axis
EDGE	Y-plane	X-axis
WCDMA	Y-plane	X-axis

#### GSM

EUT Configure Mode	Test Item	Available Channel	Tested Channel	Mode
-	EIRP	512 to 810	512, 661, 810	GSM, EDGE
-	Frequency Stability	512 to 810	661	GSM, EDGE
-	Occupied Bandwidth	512 to 810	512, 661, 810	GSM, EDGE
-	Band Edge	512 to 810	512, 810	GSM, EDGE
-	Peak to Average Ratio	512 to 810	512, 661, 810	GSM, EDGE
-	Condcudeted Emission	512 to 810	661	GSM, EDGE
-	Radiated Emission	512 to 810	661	GSM, EDGE

#### WCDMA

EUT Configure Mode	Test Item	Available Channel	Tested Channel	Mode
-	EIRP	9262 to 9538	9262, 9400, 9538	WCDMA
-	Frequency Stability	9262 to 9538	9400	WCDMA
-	Occupied Bandwidth	9262 to 9538	9262, 9400, 9538	WCDMA
-	Band Edge	9262 to 9538	9262, 9538	WCDMA
-	Peak to Average Ratio	9262 to 9538	9262, 9400, 9538	WCDMA
-	Condcudeted Emission	9262 to 9538	9400	WCDMA
-	Radiated Emission	9262 to 9538	9400	WCDMA

**Test Condition:**

Test Item	Environmental Conditions	Input Power	Tested By
EIRP	26 deg. C, 58 % RH	3.85 Vdc	Carlos Chen
Frequency Stability	26 deg. C, 58 % RH	3.85 Vdc	Carlos Chen
Occupied Bandwidth	26 deg. C, 58 % RH	3.85 Vdc	Carlos Chen
Band Edge	26 deg. C, 58 % RH	3.85 Vdc	Carlos Chen
Peak to Average Ratio	26 deg. C, 58 % RH	3.85 Vdc	Carlos Chen
Condcudeted Emission	26 deg. C, 58 % RH	3.85 Vdc	Carlos Chen
Radiated Emission	25 deg. C, 65 % RH	120 Vac, 60 Hz	Charles Hsiao

**3.4 EUT Operating Conditions**

The EUT makes a call to the communication simulator. The communication simulator station system controlled a EUT to export maximum output power under transmission mode and specific channel frequency

**3.5 General Description of Applied Standards**

The EUT is a RF Product. According to the specifications of the manufacturer, it must comply with the requirements of the following standards:

**FCC 47 CFR Part 2**

**FCC 47 CFR Part 24**

**KDB 971168 D01 Power Meas License Digital Systems v02r02**

**ANSI/TIA/EIA-603-D 2010**

**NOTE:** All test items have been performed and recorded as per the above standards.

## 4 Test Types and Results

### 4.1 Output Power Measurement

#### 4.1.1 Limits of Output Power Measurement

Mobile / Portable station are limited to 2 watts e.i.r.p.

#### 4.1.2 Test Procedures

##### **EIRP / ERP Measurement:**

- a. All measurements were done at low, middle and high operational frequency range. RBW and VBW is 1 MHz for GSM, GPRS & EDGE, and 5 MHz for WCDMA mode.
- b. Substitution method is used for E.I.R.P measurement. In the semi-anechoic chamber, EUT placed on the 0.8 m height of Turn Table, rotated the table around 360 degrees to search the maximum radiation power and receiver antenna shall be rotated vertical and horizontal polarization and moved height from 1m to 4m to find the maximum polar radiated power. The "Read Value" is the spectrum reading the maximum power value.
- c. The substitution horn antenna is substituted for EUT at the same position and signals generator export the CW signal to the substitution antenna via a tx cable. Rotated the Turn Table and moved receiving antenna to find the maximum radiation power. Adjust output power level of S.G to get a Value of spectrum reading equal to "Read Value" of step b. Record the power level of S.G.
- d.  $EIRP = \text{Output power level of S.G} - \text{TX cable loss} + \text{Antenna gain of substitution horn}$ . E.R.P power can be calculated form E.I.R.P power by subtracting the gain of dipole,  $E.R.P \text{ power} = E.I.P.R \text{ power} - 2.15 \text{ dBi}$ .

##### **Conducted Power Measurement:**

The EUT was set up for the maximum power with GSM, GPRS, EDGE, and WCDMA link data modulation and link up with simulator. Set the EUT to transmit under low, middle and high channel and record the power level shown on simulator.

### 4.1.3 Test Setup

#### EIRP / ERP Measurement:

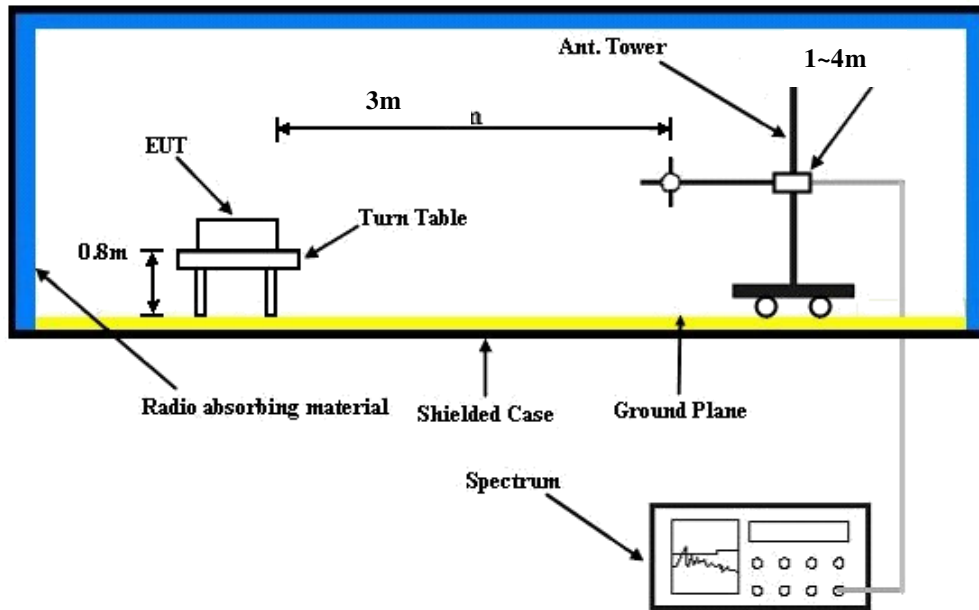

For the actual test configuration, please refer to the attached file (Test Setup Photo).

#### Conducted Power Measurement:



#### 4.1.4 Test Results

##### Conducted Output Power (dBm)

Band	GSM1900		
Channel	512	661	810
Frequency (MHz)	1850.2	1880.0	1909.8
GSM (GMSK, 1Tx-slot)	29.83	29.41	29.29
GPRS (GMSK, 1Tx-slot)	29.81	29.39	29.23
GPRS (GMSK, 2Tx-slot)	28.06	27.67	27.60
GPRS (GMSK, 3Tx-slot)	25.77	25.44	25.24
GPRS (GMSK, 4Tx-slot)	25.44	24.96	24.85
EDGE (8PSK, 1Tx-slot)	25.43	25.01	24.89
EDGE (8PSK, 2Tx-slot)	25.35	24.93	24.81
EDGE (8PSK, 3Tx-slot)	23.79	23.37	23.25
EDGE (8PSK, 4Tx-slot)	23.04	22.62	22.50

Band	WCDMA II		
Channel	9262	9400	9538
Frequency (MHz)	1852.4	1880.0	1907.6
RMC 12.2K	22.57	22.62	22.60
HSDPA Subtest-1	21.91	22.01	21.98
HSDPA Subtest-2	21.66	21.80	21.78
HSDPA Subtest-3	21.34	21.39	21.37
HSDPA Subtest-4	21.35	21.41	21.39
HSUPA Subtest-1	21.82	21.88	21.85
HSUPA Subtest-2	20.04	20.09	20.07
HSUPA Subtest-3	21.06	21.11	21.09
HSUPA Subtest-4	20.06	20.10	20.08
HSUPA Subtest-5	21.86	21.98	21.96

**EIRP Power (dBm)**

GSM							
Plane	Channel	Frequency (MHz)	LVL (dBm)	Correction Factor (dB)	EIRP (dBm)	EIRP (mW)	Polarization (H/V)
Y	512	1850.2	-16.42	44.70	28.28	672.98	H
	661	1880.0	-16.52	44.70	28.18	657.66	
	810	1909.8	-16.32	44.57	28.25	668.81	
	512	1850.2	-20.36	44.27	23.91	246.04	V
	661	1880.0	-21.54	44.87	23.33	215.28	
	810	1909.8	-20.75	44.61	23.86	243.39	

EDGE							
Plane	Channel	Frequency (MHz)	LVL (dBm)	Correction Factor (dB)	EIRP (dBm)	EIRP (mW)	Polarization (H/V)
Y	512	1850.2	-20.15	44.70	24.55	285.10	H
	661	1880.0	-20.36	44.70	24.34	271.64	
	810	1909.8	-20.23	44.57	24.34	271.83	
	512	1850.2	-24.56	44.27	19.71	93.54	V
	661	1880.0	-25.23	44.87	19.64	92.04	
	810	1909.8	-24.96	44.61	19.65	92.32	

WCDMA							
Plane	Channel	Frequency (MHz)	LVL (dBm)	Correction Factor (dB)	EIRP (dBm)	EIRP (mW)	Polarization (H/V)
Y	9262	1852.4	-23.64	44.70	21.06	127.64	H
	9400	1880.0	-23.36	44.70	21.34	136.14	
	9538	1907.6	-23.55	44.57	21.02	126.56	
	9262	1852.4	-28.12	44.27	16.15	41.21	V
	9400	1880.0	-27.90	44.87	16.97	49.77	
	9538	1907.6	-28.33	44.61	16.28	42.49	

## 4.2 Frequency Stability Measurement

### 4.2.1 Limits of Frequency Stability Measurement

The frequency stability shall be sufficient to ensure that the fundamental emission stays within the authorized frequency block.

### 4.2.2 Test Procedure

- Device is placed at the oven room. The oven room could control the temperatures and humidity. Power warm up is at least 15 min and power applied should perform before recording frequency error.
- EUT is connected the external power supply to control the DC input power. The test voltage range is from minimum to maximum working voltage. Each step shall be record the frequency error rate.
- The temperature range step is 10 degrees in this test items. All temperature levels shall be hold the  $\pm 0.5$  °C during the measurement testing. The each temperature step shall be at least 0.5 hours, consider the EUT could be test under the stability condition.

**NOTE:** The frequency error was recorded frequency error from the communication simulator.

### 4.2.3 Test Setup

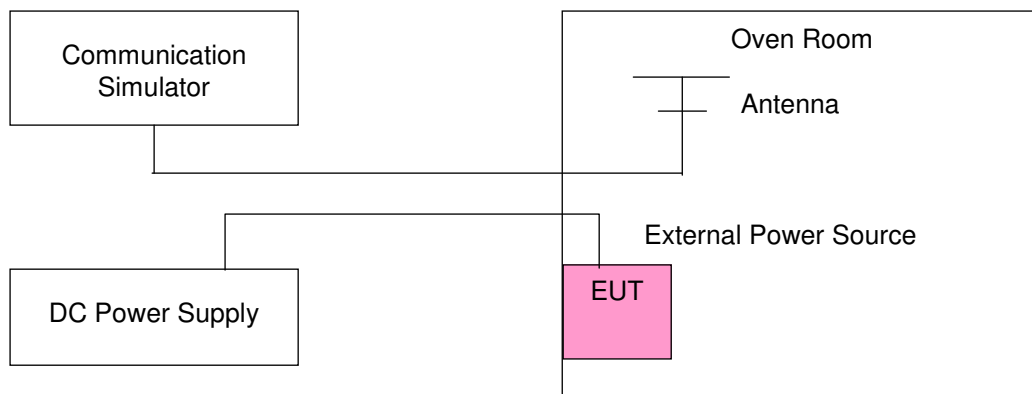

#### 4.2.4 Test Results

##### Frequency Error vs. Voltage

Voltage (Volts)	Frequency Error (ppm)			Limit (ppm)
	GSM	EDGE	WCDMA	
3.85	0.0015	0.0015	0.0002	2.5
3.6	0.0013	0.0011	0.0012	2.5
4.4	0.0002	0.0011	0.0008	2.5

**NOTE:** The applicant defined the normal working voltage of the battery is from 3.6 Vdc to 4.4 Vdc.

##### Frequency Error vs. Temperature

Temp. (°C)	Frequency Error (ppm)			Limit (ppm)
	GSM	EDGE	WCDMA	
-30	0.0014	0.0006	0.0009	2.5
-20	0.0020	0.0009	0.0004	2.5
-10	0.0011	0.0019	0.0011	2.5
0	0.0013	0.0000	0.0008	2.5
10	0.0020	0.0004	0.0017	2.5
20	-0.0021	-0.0019	-0.0019	2.5
30	-0.0017	-0.0010	-0.0010	2.5
40	-0.0007	-0.0015	-0.0013	2.5
50	-0.0012	-0.0019	-0.0018	2.5
55	-0.0013	-0.0015	-0.0003	2.5



### 4.3 Occupied Bandwidth Measurement

#### 4.3.1 Test Procedure

The EUT makes a call to the communication simulator. All measurements were done at low, middle and high operational frequency range. The communication simulator station system controlled a EUT to export maximum output power under transmission mode and specific channel frequency. Use OBW measurement function of Spectrum analyzer to measure 99 % occupied bandwidth.

#### 4.3.2 Test Setup

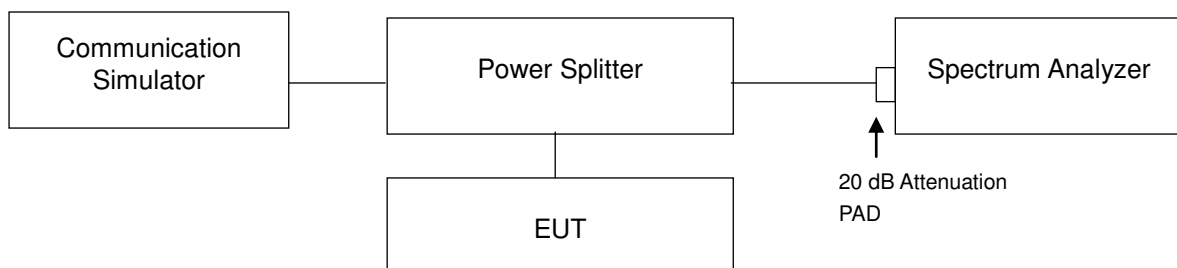

### 4.3.3 Test Result

Channel	Frequency (MHz)	99 % Occupied Bandwidth (kHz)		Channel	Frequency (MHz)	99 % Occupied Bandwidth (MHz)
		GSM	EDGE			WCDMA
512	1850.2	245.07	245.54	9262	1852.4	4.1621
661	1880.0	246.04	244.87	9400	1880.0	4.1620
810	1909.8	245.29	243.82	9538	1907.6	4.1645

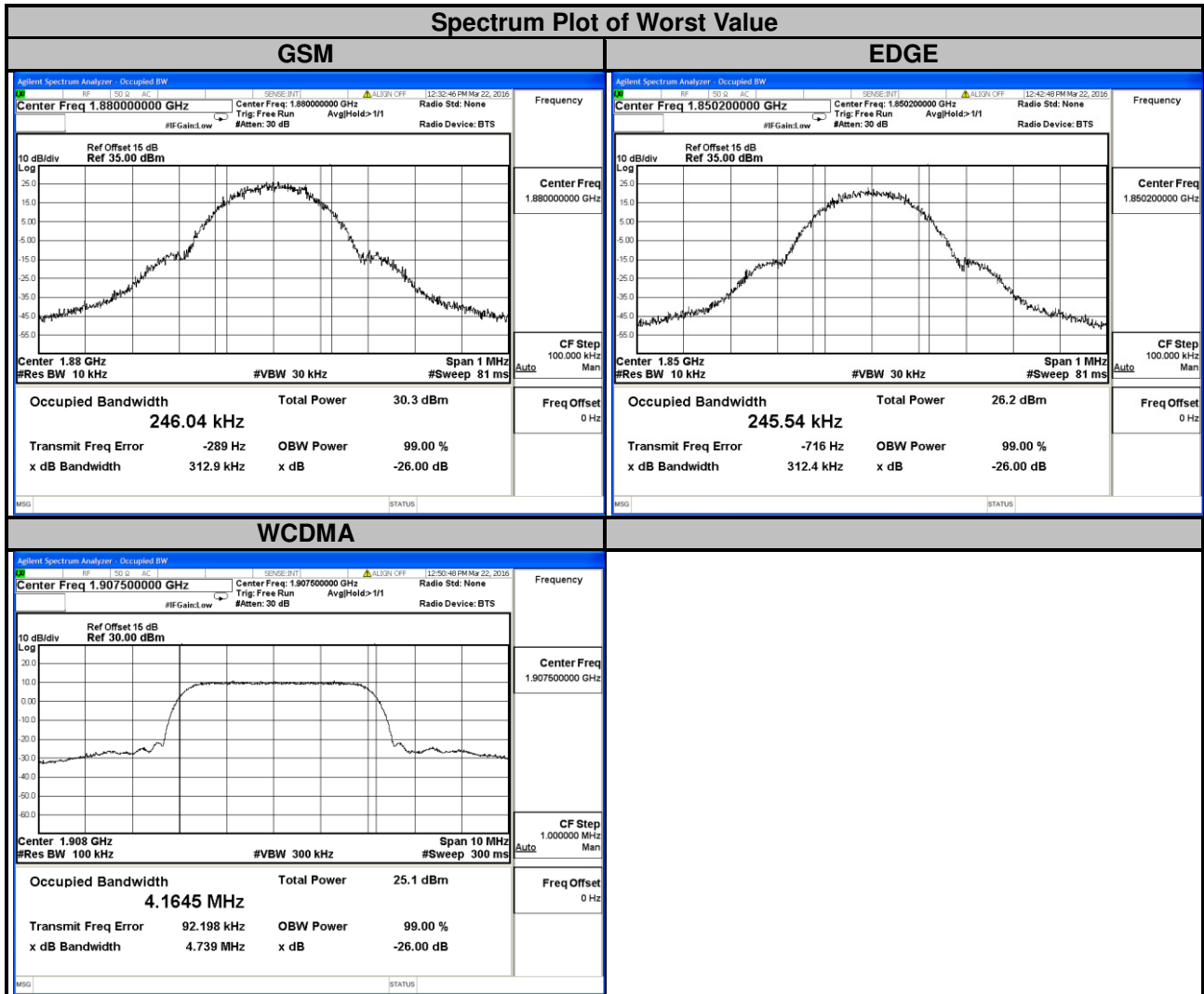

## 4.4 Band Edge Measurement

### 4.4.1 Limits of Band Edge Measurement

Power of any emission outside of the authorized operating frequency ranges must be attenuated below the transmitting power (P) by a factor of at least  $43 + 10 \log(P)$  dB. In the 1 MHz bands immediately outside and adjacent to the frequency block a resolution bandwidth of at least one percent of the emission bandwidth of the fundamental emission of the transmitter may be employed.

### 4.4.2 Test Setup

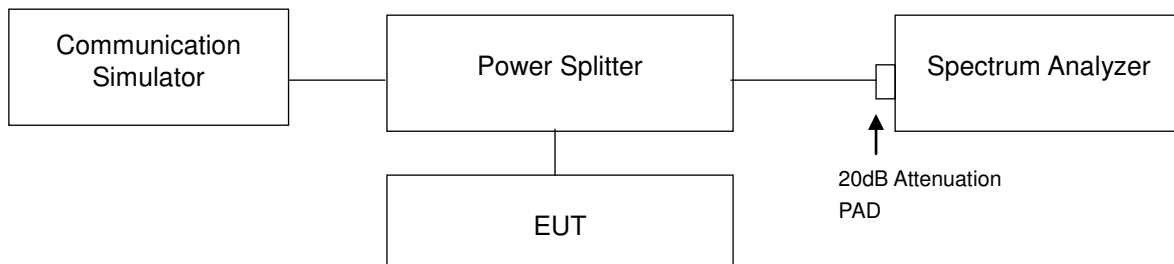

### 4.4.3 Test Procedures

- All measurements were done at low and high operational frequency range.
- The center frequency of spectrum is the band edge frequency and span is 1 MHz. RB of the spectrum is 10 kHz and VB of the spectrum is 30 kHz (GSM/GPRS/EDGE).
- The center frequency of spectrum is the band edge frequency and span is 5 MHz. RB of the spectrum is 100 kHz and VB of the spectrum is 300 kHz (WCDMA).
- Record the max trace plot into the test report.

### 4.4.4 Test Results

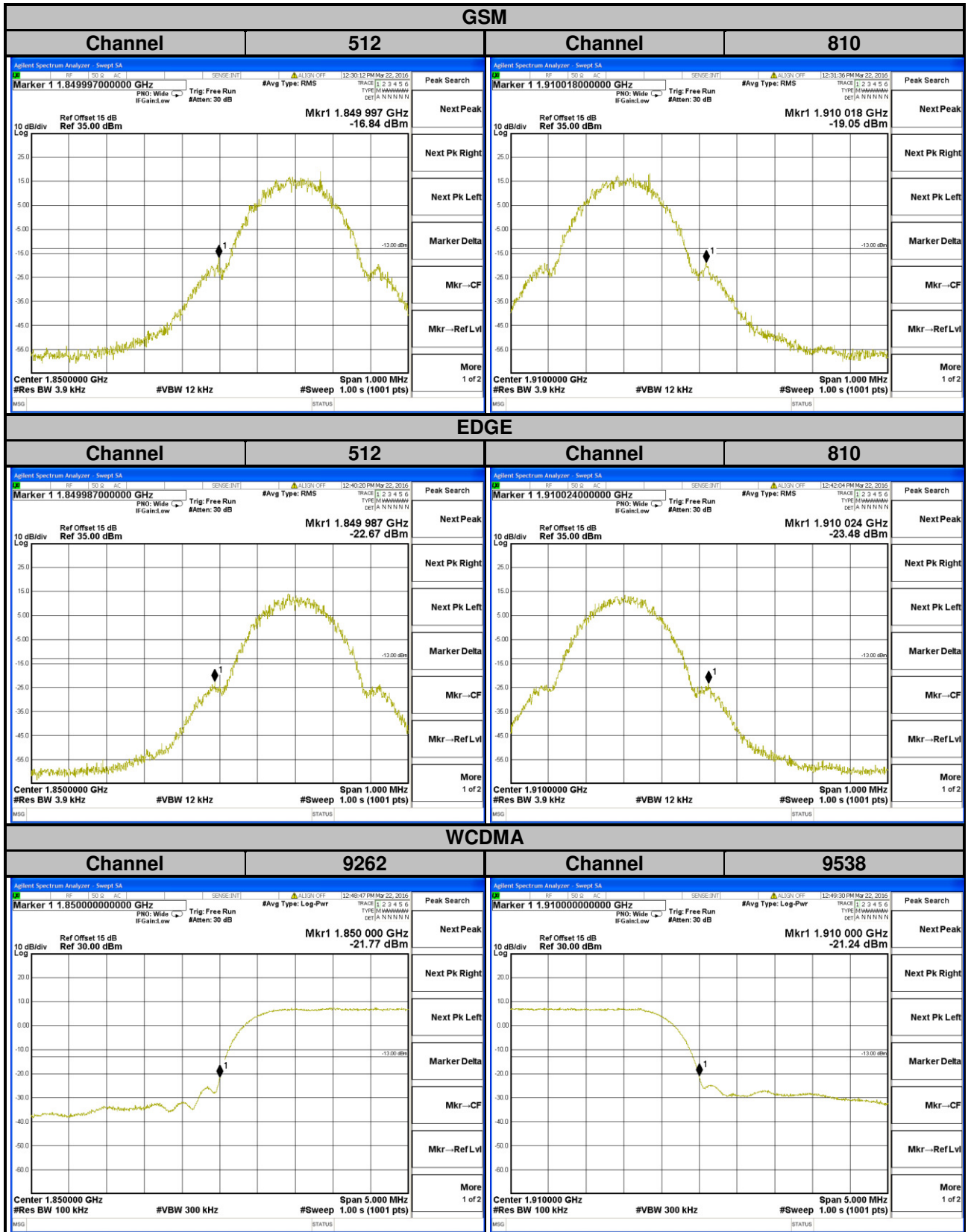

## 4.5 Peak to Average Ratio

### 4.5.1 Limits of Peak to Average Ratio Measurement

In measuring transmissions in this band using an average power technique, the peak to-average ratio (PAR) of the transmission may not exceed 13 dB.

### 4.5.2 Test Setup

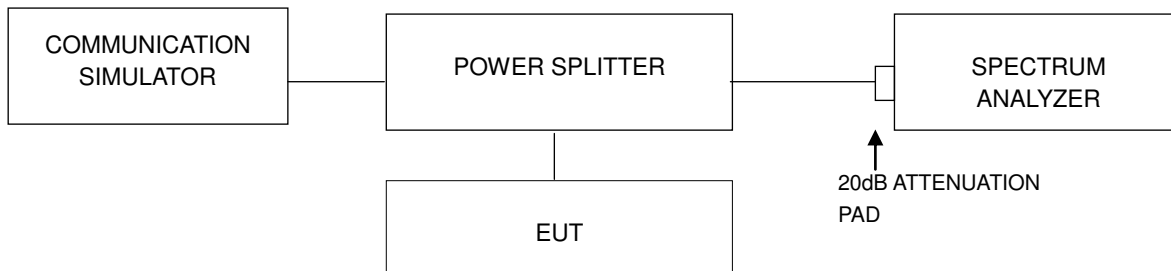

### 4.5.3 Test Procedures

1. Set resolution/measurement bandwidth  $\geq$  signal's occupied bandwidth;
2. Set the number of counts to a value that stabilizes the measured CCDF curve;
3. Record the maximum PAPR level associated with a probability of 0.1 %.

4.5.4 Test Results

Channel	Frequency (MHz)	Peak to Average Ratio (dB)		Channel	Frequency (MHz)	Peak to Average Ratio (dB)
		GSM	EDGE			WCDMA
512	1850.2	0.13	0.12	9262	1852.4	3.12
661	1880.0	0.13	0.13	9400	1880.0	3.14
810	1909.8	0.13	0.13	9538	1907.6	3.10

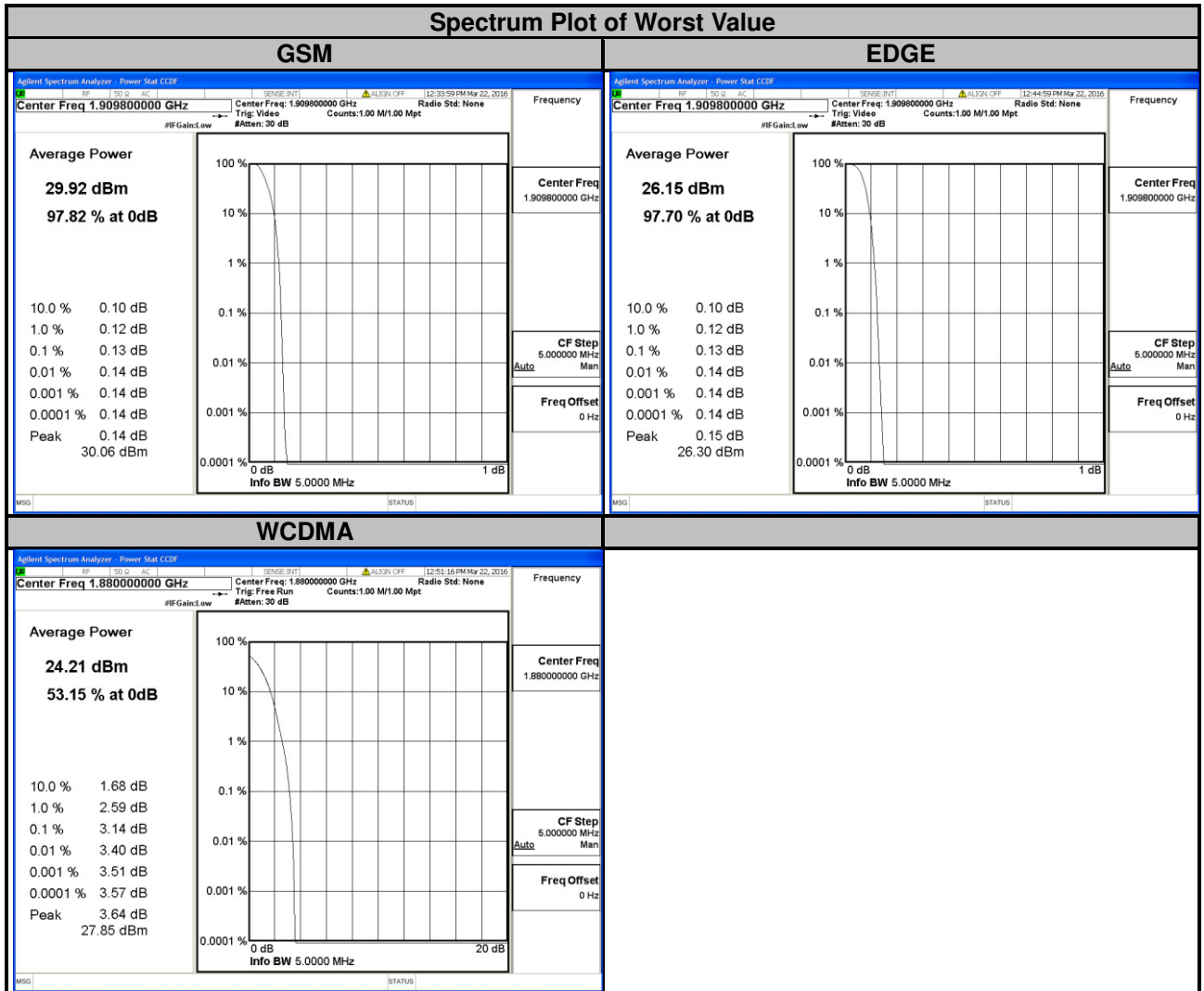

## 4.6 Conducted Spurious Emissions

### 4.6.1 Limits of Conducted Spurious Emissions Measurement

The power of any emission outside of the authorized operating frequency ranges must be attenuated below the transmitting power (P) by a factor of at least  $43 + 10 \log(P)$  dB. The emission limit equal to  $-13$  dBm.

### 4.6.2 Test Setup

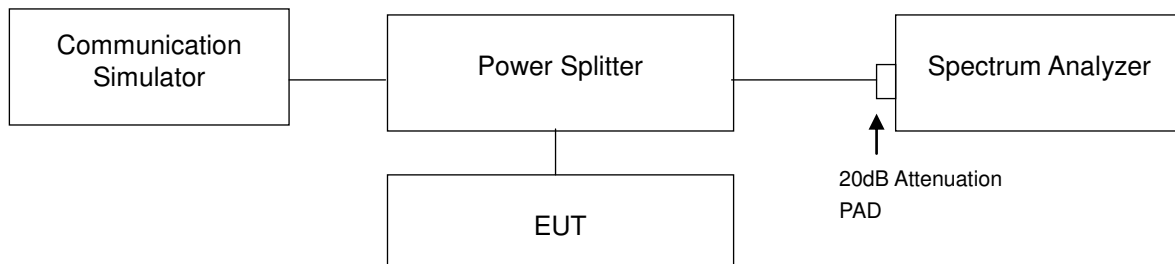

### 4.6.3 Test Procedure

- The EUT makes a phone call to the communication simulator. All measurements were done at low, middle and high operational frequency range.
- Measuring frequency range is from 9 kHz to 9 GHz. 20 dB attenuation pad is connected with spectrum. RBW=1 MHz and VBW=3 MHz is used for conducted emission measurement.



A D T

### 4.6.4 Test Results

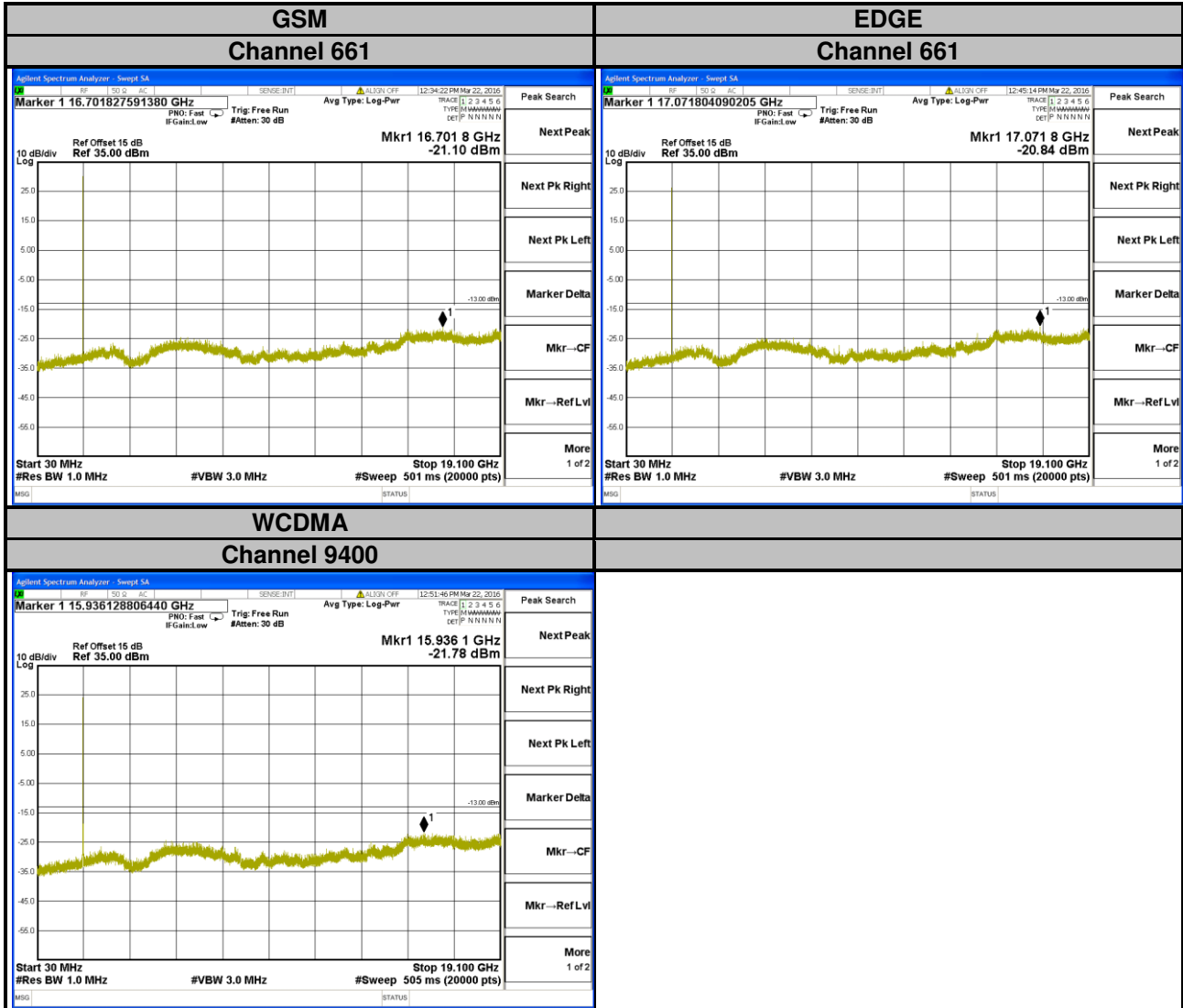



## 4.7 Radiated Emission Measurement

### 4.7.1 Limits of Radiated Emission Measurement

The power of any emission outside of the authorized operating frequency ranges must be attenuated below the transmitting power (P) by a factor of at least  $43 + 10 \log(P)$  dB. The emission limit is equal to  $-13$  dBm.

### 4.7.2 Test Procedure

- Substitution method is used for E.I.R.P measurement. In the semi-anechoic chamber, EUT placed on the 0.8 m height of Turn Table, rotated the table around 360 degrees to search the maximum radiation power and receiver antenna shall be rotated vertical and horizontal polarization and moved height from 1 m to 4 m to find the maximum polar radiated power. The "Read Value" is the spectrum reading the maximum power value.
- The substitution horn antenna is substituted for EUT at the same position and signals generator export the CW signal to the substitution antenna via a TX cable. Rotated the Turn Table and moved receiving antenna to find the maximum radiation power. Adjust output power level of S.G to get a Value of spectrum reading equal to "Read Value" of step a. Record the power level of S.G.
- $EIRP = \text{Output power level of S.G} - \text{TX cable loss} + \text{Antenna gain of substitution horn}$ .
- E.R.P power can be calculated form E.I.R.P power by subtracting the gain of dipole,  $E.R.P \text{ power} = E.I.P.R \text{ power} - 2.15 \text{ dBi}$ .

**NOTE:** The resolution bandwidth and video bandwidth of test receiver/spectrum analyzer is 1 MHz/3 MHz.

### 4.7.3 Deviation from Test Standard

No deviation.

### 4.7.4 Test Setup

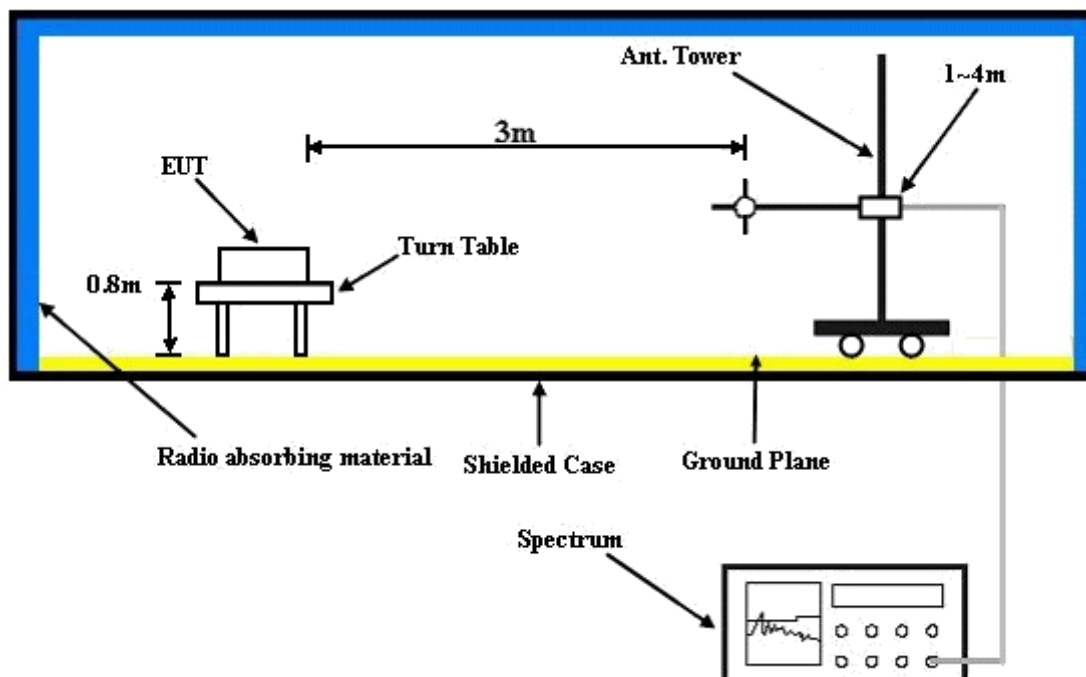

For the actual test configuration, please refer to the attached file (Test Setup Photo).

4.7.5 Test Results

GSM:



Bureau Veritas Consumer Products Services Ltd., Taoyuan Branch

A D T

Data: 13

Date: 2016-03-17

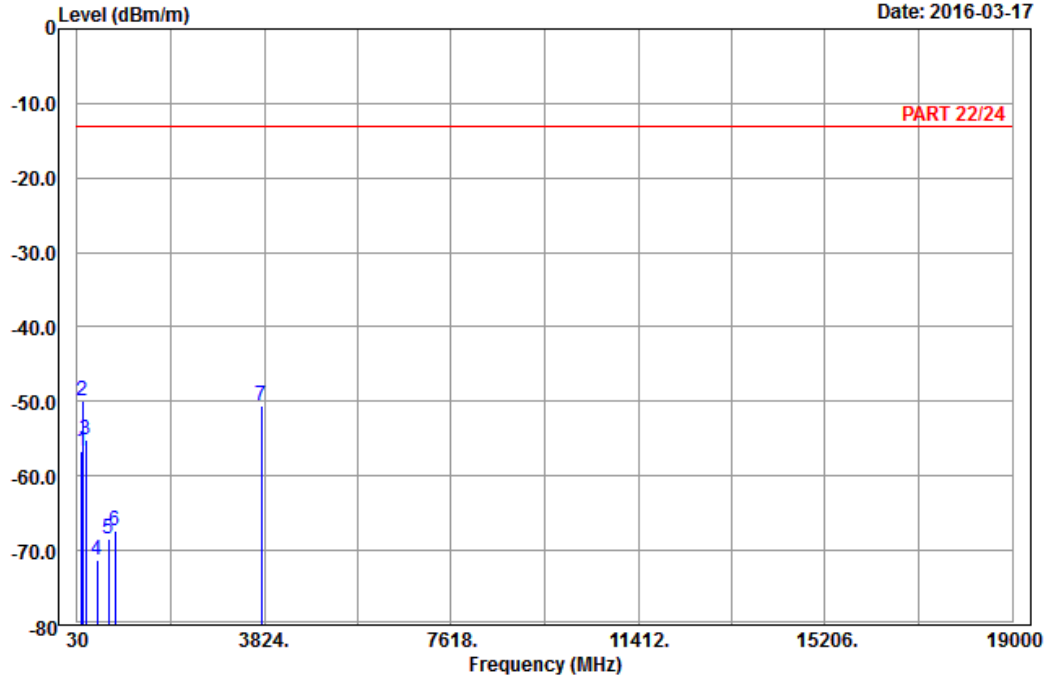

Site : 966 chamber 1  
 Condition: PART 22/24 3m Horizontal  
 Remark : PCS 1900\_Link\_CH661  
 Tested by: Charles Hsiao

	Freq	Level	Read Level	Limit Line	Over Limit	Factor	Remark
	MHz	dBm/m	dBm	dBm/m	dB	dB/m	
1	125.58	-56.67	-48.78	-13.00	-43.67	-7.89	Peak
2	pp 139.62	-49.98	-42.29	-13.00	-36.98	-7.69	Peak
3	199.02	-55.15	-49.01	-13.00	-42.15	-6.14	Peak
4	430.20	-71.38	-67.96	-13.00	-58.38	-3.42	Peak
5	659.10	-68.37	-68.19	-13.00	-55.37	-0.18	Peak
6	790.00	-67.47	-68.84	-13.00	-54.47	1.37	Peak
7	3760.00	-50.55	-66.69	-13.00	-37.55	16.14	Peak



Bureau Veritas Consumer Products Services Ltd., Taoyuan Branch

A D T

Data: 14

Date: 2016-03-17

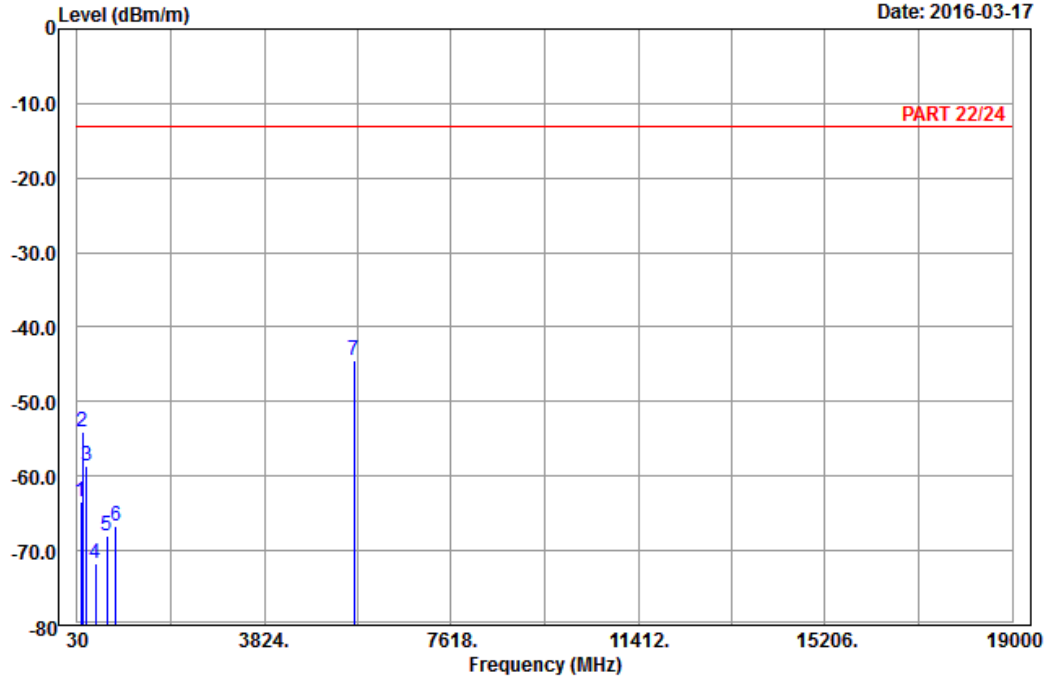

Site : 966 chamber 1  
 Condition: PART 22/24 3m Vertical  
 Remark : PCS 1900\_Link\_CH661  
 Tested by: Charles Hsiao

	Freq	Level	Read Level	Limit Line	Over Limit	Factor	Remark
	MHz	dBm/m	dBm	dBm/m	dB	dB/m	
1	104.25	-63.50	-53.97	-13.00	-50.50	-9.53	Peak
2	144.75	-54.07	-46.26	-13.00	-41.07	-7.81	Peak
3	213.60	-58.73	-52.73	-13.00	-45.73	-6.00	Peak
4	394.50	-71.74	-68.74	-13.00	-58.74	-3.00	Peak
5	633.20	-68.09	-68.14	-13.00	-55.09	0.05	Peak
6	813.80	-66.75	-68.61	-13.00	-53.75	1.86	Peak
7 pp	5640.00	-44.54	-65.01	-13.00	-31.54	20.47	Peak



A D T

EDGE:



Bureau Veritas Consumer Products Services Ltd., Taoyuan Branch

A D T

Data: 9

Date: 2016-03-17

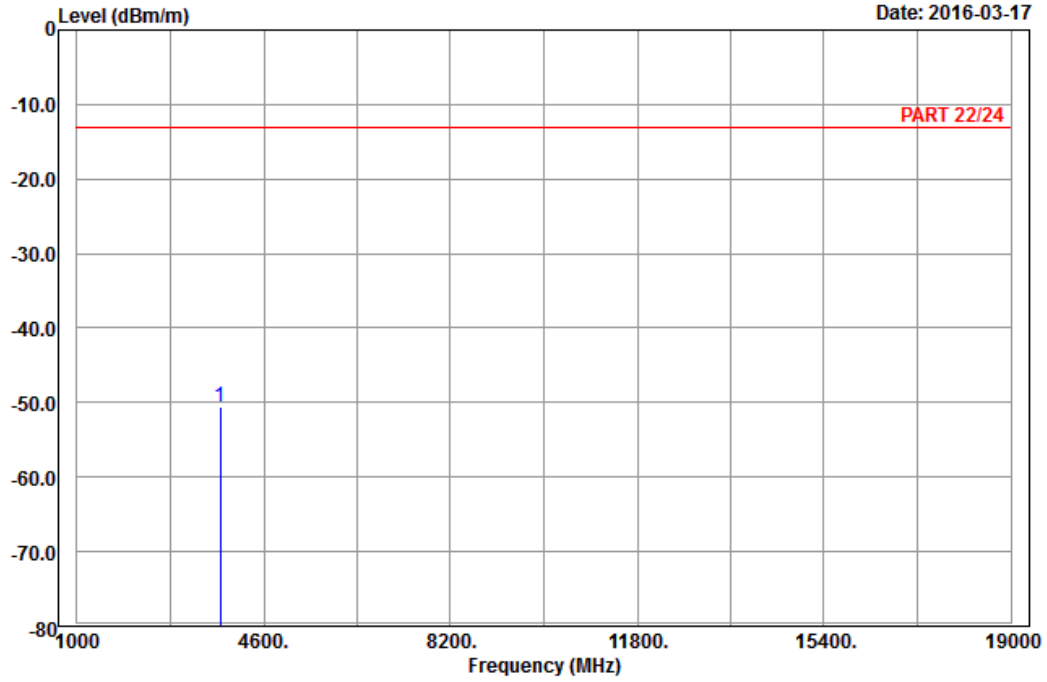

Site : 966 chamber 1  
 Condition: PART 22/24 3m Horizontal  
 Remark : EDGE 1900\_Link\_CH661  
 Tested by: Charles Hsiao

Freq	Level	Read Level	Limit Line	Over Limit	Factor	Remark
MHz	dBm/m	dBm	dBm/m	dB	dB/m	
1 pp 3760.00	-50.59	-66.73	-13.00	-37.59	16.14	Peak



A D T



Bureau Veritas Consumer Products Services Ltd., Taoyuan Branch

A D T

Data: 10

Date: 2016-03-17

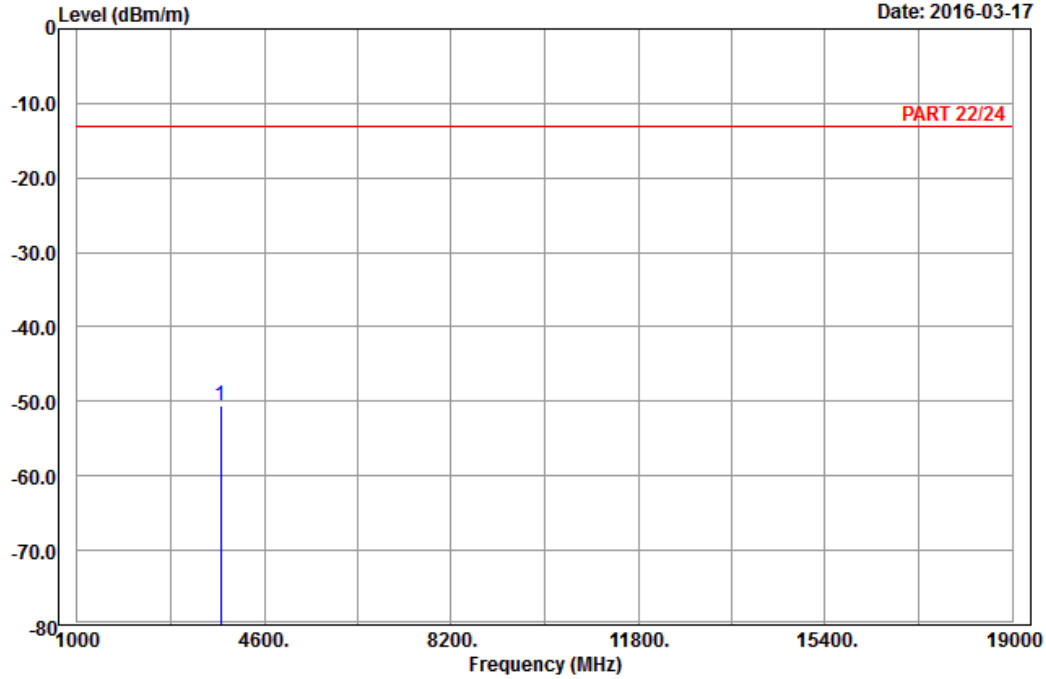

Site : 966 chamber 1  
 Condition: PART 22/24 3m Vertical  
 Remark : EDGE 1900\_Link\_CH661  
 Tested by: Charles Hsiao

	Freq	Level	Read Level	Limit Line	Over Limit	Factor	Remark
	MHz	dBm/m	dBm	dBm/m	dB	dB/m	
1	pp 3760.00	-50.52	-66.66	-13.00	-37.52	16.14	Peak

WCDMA:



Bureau Veritas Consumer Products Services Ltd., Taoyuan Branch

A D T

Data: 9

Date: 2016-03-17

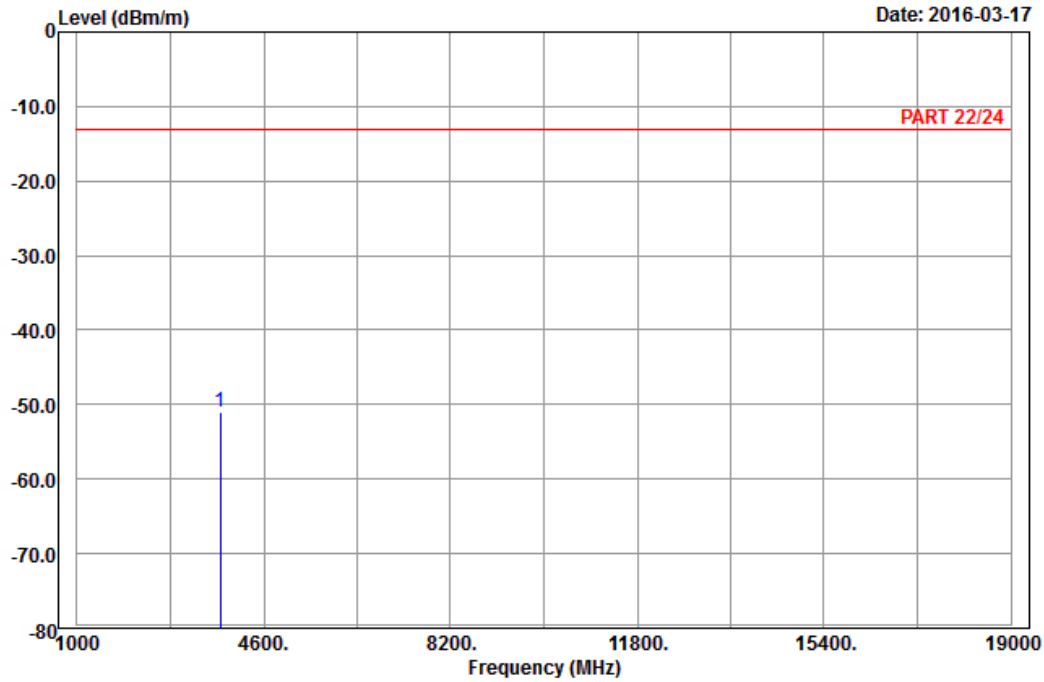

Site : 966 chamber 1  
 Condition: PART 22/24 3m Horizontal  
 Remark : Band II\_Link\_CH9400  
 Tested by: Charles Hsiao

Freq	Level	Read Level	Limit	Over	Factor	Remark
MHz	dBm/m	dBm	dBm/m	dB	dB/m	
1 pp 3760.00	-50.93	-67.07	-13.00	-37.93	16.14	Peak



A D T



Bureau Veritas Consumer Products Services Ltd., Taoyuan Branch

A D T

Data: 10

Date: 2016-03-17

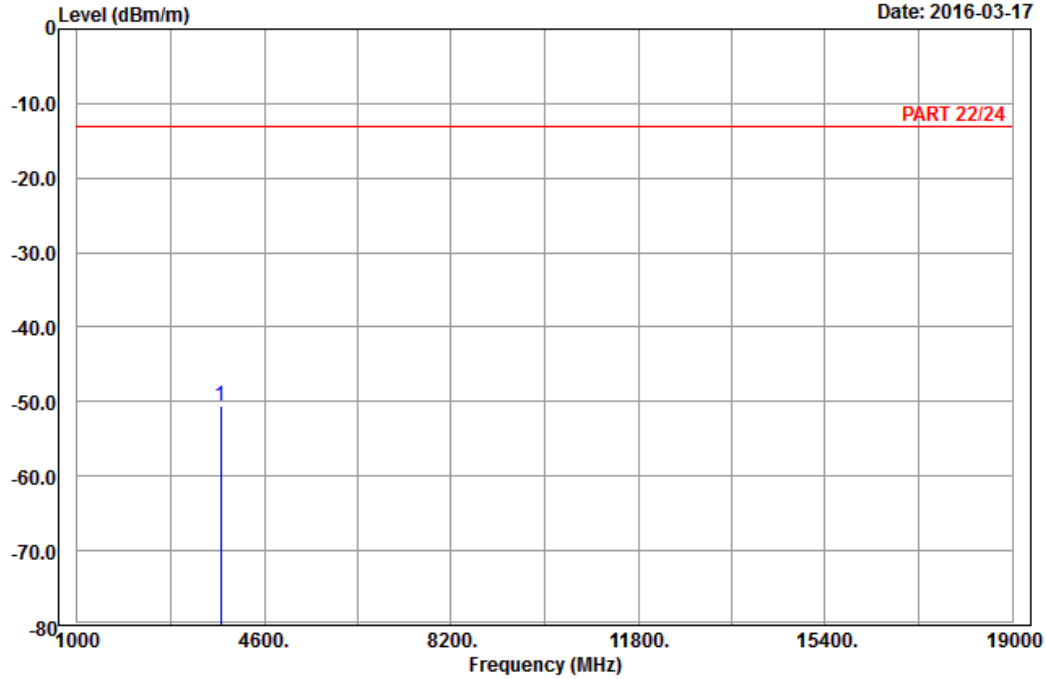

Site : 966 chamber 1  
 Condition: PART 22/24 3m Vertical  
 Remark : Band II\_Link\_CH9400  
 Tested by: Charles Hsiao

	Freq	Level	Read Level	Limit Line	Over Limit	Factor	Remark
	MHz	dBm/m	dBm	dBm/m	dB	dB/m	
1	pp 3760.00	-50.60	-66.74	-13.00	-37.60	16.14	Peak



## 5 Pictures of Test Arrangements

Please refer to the attached file (Test Setup Photo).





A D T

## Appendix – Information on the Testing Laboratories

We, Bureau Veritas Consumer Products Services (H.K.) Ltd., Taoyuan Branch, were founded in 1988 to provide our best service in EMC, Radio, Telecom and Safety consultation. Our laboratories are accredited and approved according to ISO/IEC 17025.

If you have any comments, please feel free to contact us at the following:

### **Linko EMC/RF Lab**

Tel: 886-2-26052180

Fax: 886-2-26051924

### **Hsin Chu EMC/RF/Telecom Lab**

Tel: 886-3-6668565

Fax: 886-3-6668323

### **Hwa Ya EMC/RF/Safety**

Tel: 886-3-3183232

Fax: 886-3-3270892

**Email:** [service.adt@tw.bureauveritas.com](mailto:service.adt@tw.bureauveritas.com)

**Web Site:** [www.bureauveritas-adt.com](http://www.bureauveritas-adt.com)

The address and road map of all our labs can be found in our web site also.

--- END ---