

FCC Test Report

Report No.: RF151221C02-8

FCC ID: NM82PS6500

Test Model: 2PS6500

Received Date: Dec. 21, 2015

Test Date: Jan. 20, 2016 ~ Feb. 06, 2016

Issued Date: Feb. 25, 2016

Applicant: HTC Corporation

Address: 1F, 6-3 Baoqiang Road, Xindian District, New Taipei City, Taiwan 231

Issued By: Bureau Veritas Consumer Products Services (H.K.) Ltd., Taoyuan Branch

Lab Address: No. 47-2, 14th Ling, Chia Pau Vil., Lin Kou Dist., New Taipei City, Taiwan (R.O.C)

Test Location (1): No. 19, Hwa Ya 2nd Rd, Wen Hwa Tsuen, Kwei Shan Hsiang, Taoyuan Hsien 333, Taiwan, R.O.C.

Test Location (2): No.215, Sec. 3, Beixin Rd., Xindian Dist., New Taipei City 231, Taiwan, R.O.C



This report is for your exclusive use. Any copying or replication of this report to or for any other person or entity, or use of our name or trademark, is permitted only with our prior written permission. This report sets forth our findings solely with respect to the test samples identified herein. The results set forth in this report are not indicative or representative of the quality or characteristics of the lot from which a test sample was taken or any similar or identical product unless specifically and expressly noted. Our report includes all of the tests requested by you and the results thereof based upon the information that you provided to us. You have 60 days from date of issuance of this report to notify us of any material error or omission caused by our negligence, provided, however, that such notice shall be in writing and shall specifically address the issue you wish to raise. A failure to raise such issue within the prescribed time shall constitute your unqualified acceptance of the completeness of this report, the tests conducted and the correctness of the report contents. Unless specific mention, the uncertainty of measurement has been explicitly taken into account to declare the compliance or non-compliance to the specification.

Table of Contents

Release Control Record	4
1 Certificate of Conformity	5
2 Summary of Test Results	6
2.1 Measurement Uncertainty	6
2.2 Modification Record	6
3 General Information	7
3.1 General Description of EUT	7
3.2 Description of Test Modes	8
3.2.1 Test Mode Applicability and Tested Channel Detail	9
3.3 Duty Cycle of Test Signal	11
3.4 Description of Support Units	12
3.4.1 Configuration of System under Test	12
3.5 General Description of Applied Standards	12
4 Test Types and Results	13
4.1 Radiated Emission and Bandedge Measurement	13
4.1.1 Limits of Radiated Emission and Bandedge Measurement	13
4.1.2 Test Instruments	14
4.1.3 Test Procedures	15
4.1.4 Deviation from Test Standard	15
4.1.5 Test Set Up	16
4.1.6 EUT Operating Conditions	16
4.1.7 Test Results	17
4.2 Conducted Emission Measurement	36
4.2.1 Limits of Conducted Emission Measurement	36
4.2.2 Test Instruments	36
4.2.3 Test Procedures	37
4.2.4 Deviation from Test Standard	37
4.2.5 Test Setup	37
4.2.6 EUT Operating Conditions	37
4.2.7 Test Results	38
4.3 6dB Bandwidth Measurement	40
4.3.1 Limits of 6dB Bandwidth Measurement	40
4.3.2 Test Setup	40
4.3.3 Test Instruments	40
4.3.4 Test Procedure	40
4.3.5 Deviation from Test Standard	40
4.3.6 EUT Operating Conditions	40
4.3.7 Test Result	41
4.4 Conducted Output Power Measurement	44
4.4.1 Limits of Conducted Output Power Measurement	44
4.4.2 Test Setup	44
4.4.3 Test Instruments	44
4.4.4 Test Procedures	44
4.4.5 Deviation from Test Standard	44
4.4.6 EUT Operating Conditions	44
4.4.7 Test Results	45
4.5 Power Spectral Density Measurement	47
4.5.1 Limits of Power Spectral Density Measurement	47
4.5.2 Test Setup	47
4.5.3 Test Instruments	47
4.5.4 Test Procedure	47
4.5.5 Deviation from Test Standard	47
4.5.6 EUT Operating Condition	47



4.5.7 Test Results	48
4.6 Conducted Out of Band Emission Measurement	51
4.6.1 Limits of Conducted Out of Band Emission Measurement.....	51
4.6.2 Test Setup.....	51
4.6.3 Test Instruments	51
4.6.4 Test Procedure	51
4.6.5 Deviation from Test Standard	51
4.6.6 EUT Operating Condition	51
4.6.7 Test Results	52
5 Pictures of Test Arrangements.....	68
Appendix – Information on the Testing Laboratories	69



A D T

Release Control Record

Issue No.	Description	Date Issued
RF151221C02-8	Original Release	Feb. 25, 2016

1 Certificate of Conformity
Product: Smartphone

Brand: HTC

Test Model: 2PS6500

Sample Status: Production Unit

Applicant: HTC Corporation

Test Date: Jan. 20, 2016 ~ Feb. 06, 2016

Standards: 47 CFR FCC Part 15, Subpart C (Section 15.247)
ANSI C63.10:2013

The above equipment has been tested by **Bureau Veritas Consumer Products Services (H.K.) Ltd., Taoyuan Branch**, and found compliance with the requirement of the above standards. The test record, data evaluation & Equipment Under Test (EUT) configurations represented herein are true and accurate accounts of the measurements of the sample's EMC characteristics under the conditions specified in this report.

Prepared by : Ivonne Wu , **Date:** Feb. 25, 2016
Ivonne Wu / Supervisor

Approved by : Stanley Wu , **Date:** Feb. 25, 2016
Stanley Wu / Assistant Manager

2 Summary of Test Results

47 CFR FCC Part 15, Subpart C (Section 15.247)			
FCC Clause	Test Item	Result	Remarks
15.207	AC Power Conducted Emission	Pass	Meet the requirement of limit. Minimum passing margin is -3.29 dB at 13.56130 MHz.
15.205 / 15.209 / 15.247(d)	Radiated Emissions and Band Edge Measurement	Pass	Meet the requirement of limit. Minimum passing margin is -1.06 dB at 2390 MHz.
15.247(d)	Antenna Port Emission	Pass	Meet the requirement of limit.
15.247(a)(2)	6 dB Bandwidth	Pass	Meet the requirement of limit.
15.247(b)	Conducted power	Pass	Meet the requirement of limit.
15.247(e)	Power Spectral Density	Pass	Meet the requirement of limit.
15.203	Antenna Requirement	Pass	No antenna connector is used.

2.1 Measurement Uncertainty

Where relevant, the following measurement uncertainty levels have been estimated for tests performed on the EUT:

The listed uncertainties are the worst case uncertainty for the entire range of measurement. Please note that the uncertainty values are provided for informational purposes only and are not used in determining the PASS/FAIL results.

Measurement	Frequency	Expanded Uncertainty (k=2) (±)
Conducted Emissions at mains ports	150 kHz ~ 30 MHz	2.44 dB
Radiated Emissions up to 1 GHz	30 MHz ~ 200 MHz	2.0153 dB
	200 MHz ~ 1000 MHz	2.0224 dB
Radiated Emissions above 1 GHz	1 GHz ~ 18 GHz	1.0121 dB
	18 GHz ~ 40 GHz	1.1508 dB

2.2 Modification Record

There were no modifications required for compliance.

3 General Information

3.1 General Description of EUT

Product	Smartphone
Brand	HTC
Test Model	2PS6500
Status of EUT	Production Unit
Power Supply Rating	5.0 Vdc (adapter or host equipment) 3.85 Vdc (Li-ion battery)
Modulation Type	CCK, DQPSK, DBPSK for DSSS 64QAM, 16QAM, QPSK, BPSK for OFDM
Modulation Technology	DSSS, OFDM
Transfer Rate	802.11b: 11.0 / 5.5 / 2.0 / 1.0 Mbps 802.11g: 54.0 / 48.0 / 36.0 / 24.0 / 18.0 / 12.0 / 9.0 / 6.0 Mbps 802.11n: up to MCS15
Operating Frequency	2412 ~ 2462 MHz
Number of Channel	11 for 802.11b, 802.11g, 802.11n (HT20) 7 for 802.11n (HT40)
Output Power	330.564 mW
Antenna Type	PIFA antenna with -2 dBi gain
Antenna Connector	N/A
Accessory Device	Refer to Note as below
Data Cable Supplied	Refer to Note as below

Note:

1. The EUT incorporates a MIMO function. Physically, the EUT provides two completed transmitters and two receivers.

Modulation Mode	TX Function
802.11b	1TX
802.11g	1TX
802.11n (HT20)	1TX / 2TX
802.11n (HT40)	1TX / 2TX

2. The EUT's accessories list refers to Ext. Pho.
3. The above EUT information is declared by manufacturer and for more detailed features description, please refer to the manufacturer's specifications or user's manual.

3.2 Description of Test Modes

11 channels are provided for 802.11b, 802.11g and 802.11n (HT20):

Channel	Frequency (MHz)	Channel	Frequency (MHz)
1	2412	7	2442
2	2417	8	2447
3	2422	9	2452
4	2427	10	2457
5	2432	11	2462
6	2437		

7 channels are provided for 802.11n (HT40):

Channel	Frequency (MHz)	Channel	Frequency (MHz)
3	2422	7	2442
4	2427	8	2447
5	2432	9	2452
6	2437		

3.2.1 Test Mode Applicability and Tested Channel Detail

EUT Configure Mode	Applicable To				Description
	RE \geq 1G	RE<1G	PLC	APCM	
A	√	√	√	√	1TX
B	√	-	-	√	2TX

Where **RE \geq 1G**: Radiated Emission above 1 GHz **RE<1G**: Radiated Emission below 1 GHz
PLC: Power Line Conducted Emission **APCM**: Antenna Port Conducted Measurement

NOTE: The EUT had been pre-tested on the positioned of each 3 axis. The worst case was found when positioned on **Y-plane** for 1TX and X-plane for 2TX.

NOTE: "-" means no effect.

Radiated Emission Test (Above 1 GHz):

- Pre-Scan has been conducted to determine the worst-case mode from all possible combinations between available modulations, data rates and antenna ports (if EUT with antenna diversity architecture).
- Following channel(s) was (were) selected for the final test as listed below.

EUT Configure Mode	Mode	Available Channel	Tested Channel	Modulation Technology	Modulation Type	Data Rate (Mbps)
A	802.11b	1 to 11	1, 6, 11	DSSS	DBPSK	1.0
	802.11g	1 to 11	1, 6, 11	OFDM	BPSK	6.0
	802.11n (HT20)	1 to 11	1, 6, 11	OFDM	BPSK	MCS0
	802.11n (HT40)	3 to 9	3, 6, 9	OFDM	BPSK	MCS0
B	802.11n (HT20)	1 to 11	1, 6, 11	OFDM	BPSK	MCS8
	802.11n (HT40)	3 to 9	3, 6, 9	OFDM	BPSK	MCS8

Radiated Emission Test (Below 1 GHz):

- Pre-Scan has been conducted to determine the worst-case mode from all possible combinations between available modulations, data rates and antenna ports (if EUT with antenna diversity architecture).
- Following channel(s) was (were) selected for the final test as listed below.

EUT Configure Mode	Mode	Available Channel	Tested Channel	Modulation Technology	Modulation Type	Data Rate (Mbps)
A	802.11n (HT40)	3 to 9	3	OFDM	BPSK	MCS0

Power Line Conducted Emission Test:

- Pre-Scan has been conducted to determine the worst-case mode from all possible combinations between available modulations, data rates and antenna ports (if EUT with antenna diversity architecture).
- Following channel(s) was (were) selected for the final test as listed below.

EUT Configure Mode	Mode	Available Channel	Tested Channel	Modulation Technology	Modulation Type	Data Rate (Mbps)
A	802.11n (HT40)	3 to 9	3	OFDM	BPSK	MCS0

Bandedge Measurement:

- Pre-Scan has been conducted to determine the worst-case mode from all possible combinations between available modulations, data rates and antenna ports (if EUT with antenna diversity architecture).
- Following channel(s) was (were) selected for the final test as listed below.

EUT Configure Mode	Mode	Available Channel	Tested Channel	Modulation Technology	Modulation Type	Data Rate (Mbps)
A	802.11b	1 to 11	1, 11	DSSS	DBPSK	1.0
	802.11g	1 to 11	1, 11	OFDM	BPSK	6.0
	802.11n (HT20)	1 to 11	1, 11	OFDM	BPSK	MCS0
	802.11n (HT40)	3 to 9	3, 9	OFDM	BPSK	MCS0
B	802.11n (HT20)	1 to 11	1, 6, 11	OFDM	BPSK	MCS8
	802.11n (HT40)	3 to 9	3, 6, 9	OFDM	BPSK	MCS8

Antenna Port Conducted Measurement:

- This item includes all test value of each mode, but only includes spectrum plot of worst value of each mode.
- Pre-Scan has been conducted to determine the worst-case mode from all possible combinations between available modulations, data rates and antenna ports (if EUT with antenna diversity architecture).
- Following channel(s) was (were) selected for the final test as listed below.

EUT Configure Mode	Mode	Available Channel	Tested Channel	Modulation Technology	Modulation Type	Data Rate (Mbps)
A	802.11b	1 to 11	1, 6, 11	DSSS	DBPSK	1.0
	802.11g	1 to 11	1, 6, 11	OFDM	BPSK	6.0
	802.11n (HT20)	1 to 11	1, 6, 11	OFDM	BPSK	MCS0
	802.11n (HT40)	3 to 9	3, 6, 9	OFDM	BPSK	MCS0
B	802.11n (HT20)	1 to 11	1, 6, 11	OFDM	BPSK	MCS8
	802.11n (HT40)	3 to 9	3, 6, 9	OFDM	BPSK	MCS8

Test Condition:

Applicable To	Environmental Conditions	Input Power	Tested by
RE≥1G	25 deg. C, 65 % RH	120 Vac, 60 Hz	Charles Hsiao
RE<1G	25 deg. C, 65 % RH	120 Vac, 60 Hz	Charles Hsiao
PLC	25 deg. C, 65 % RH	120 Vac, 60 Hz	Toby Tian
APCM	25 deg. C, 65 % RH	3.85 Vdc	Luke Chen

3.3 Duty Cycle of Test Signal

<1TX>

802.11b: Duty cycle of test signal is 100 %

802.11g: Duty cycle = $2.054/2.166 = 0.948$, Duty factor = $10 * \log(1/0.948) = 0.23$

802.11n (HT20): Duty cycle = $1.923/2.027 = 0.948$, Duty factor = $10 * \log(1/0.948) = 0.23$

802.11n (HT40): Duty cycle = $0.901/1.054 = 0.855$, Duty factor = $10 * \log(1/0.855) = 0.68$

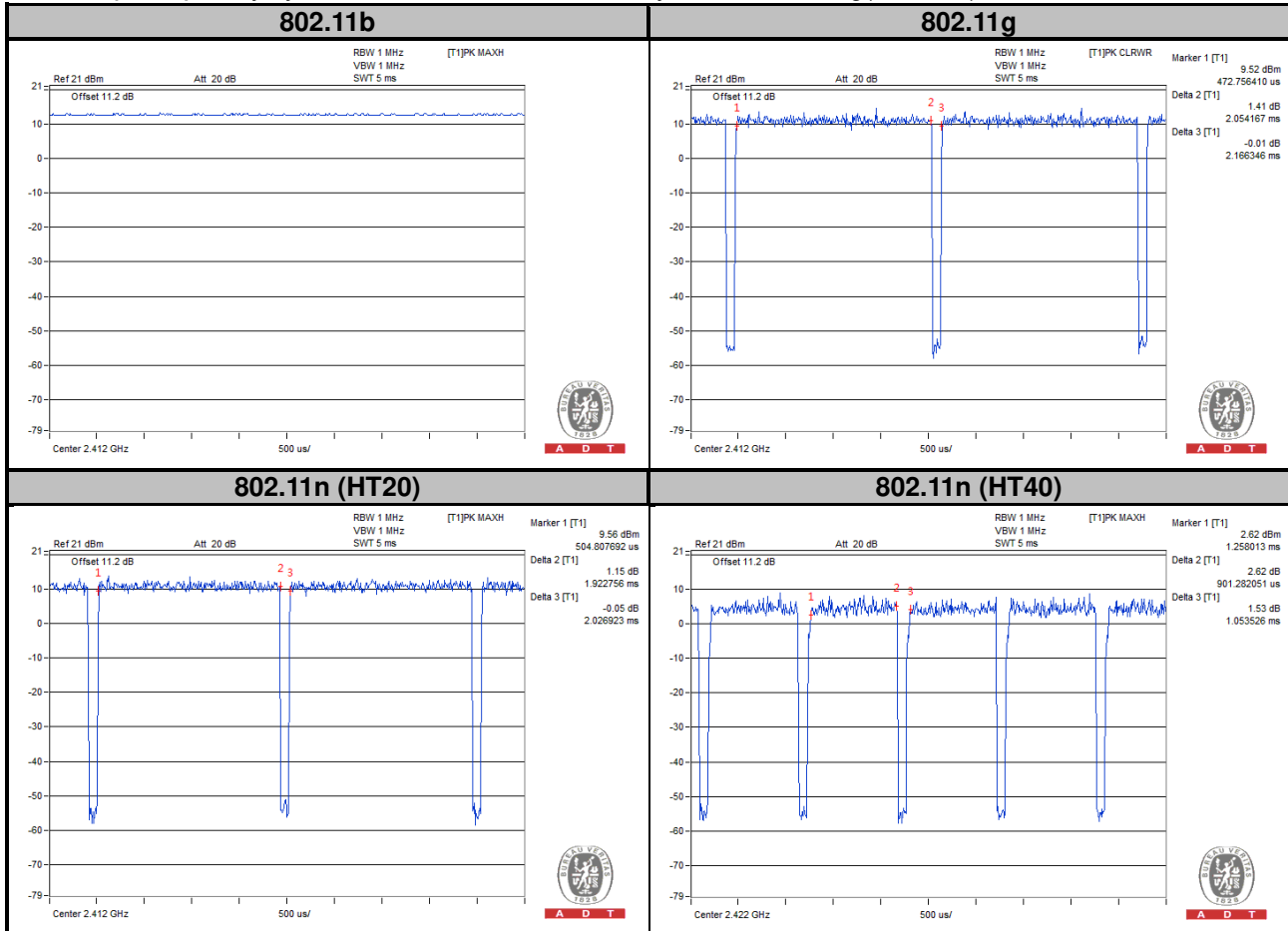

<2TX>

802.11n (HT20): Duty cycle = $1.915/2.027 = 0.945$, Duty factor = $10 * \log(1/0.945) = 0.25$

802.11n (HT40): Duty cycle = $0.918/1.054 = 0.871$, Duty factor = $10 * \log(1/0.871) = 0.60$

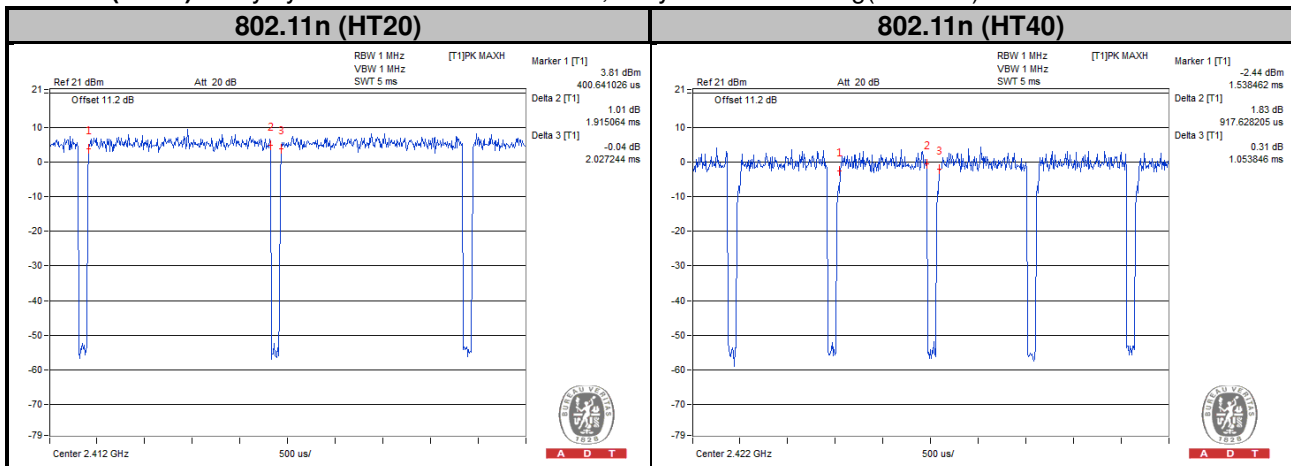

3.4 Description of Support Units

The EUT has been tested as an independent unit together with other necessary accessories or support units.

3.4.1 Configuration of System under Test

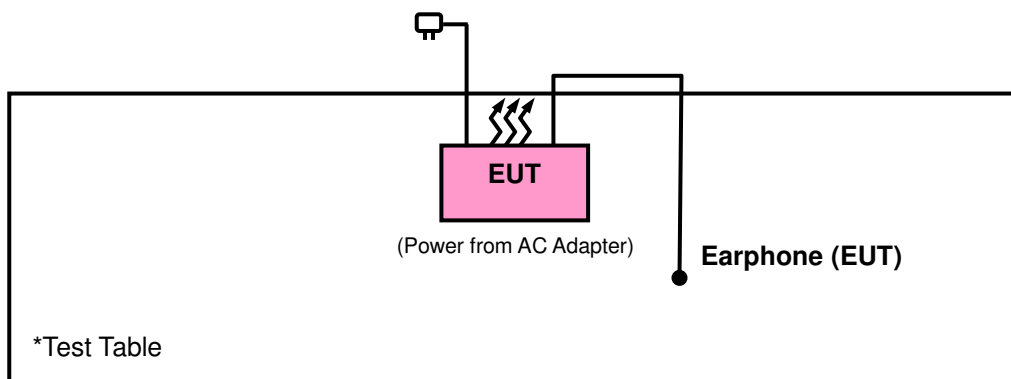

3.5 General Description of Applied Standards

The EUT is a RF Product. According to the specifications of the manufacturer, it must comply with the requirements of the following standards:

FCC Part 15, Subpart C (15.247)

558074 D01 DTS Meas Guidance v03r04

662911 D01 Multiple Transmitter Output v02r01

ANSI C63.10-2013

All test items have been performed and recorded as per the above standards.

NOTE: The EUT has been verified to comply with the requirements of FCC Part 15, Subpart B, Class B (DoC).
The test report has been issued separately.

4 Test Types and Results

4.1 Radiated Emission and Bandedge Measurement

4.1.1 Limits of Radiated Emission and Bandedge Measurement

Radiated emissions which fall in the restricted bands must comply with the radiated emission limits specified as below table. Other emissions shall be at least 20 dB below the highest level of the desired power:

Frequencies (MHz)	Field Strength (microvolts/meter)	Measurement Distance (meters)
0.009 ~ 0.490	2400/F (kHz)	300
0.490 ~ 1.705	24000/F (kHz)	30
1.705 ~ 30.0	30	30
30 ~ 88	100	3
88 ~ 216	150	3
216 ~ 960	200	3
Above 960	500	3

NOTE:

1. The lower limit shall apply at the transition frequencies.
2. Emission level (dBuV/m) = 20 log Emission level (uV/m).
3. For frequencies above 1000 MHz, the field strength limits are based on average detector, however, the peak field strength of any emission shall not exceed the maximum permitted average limits, specified above by more than 20 dB under any condition of modulation.

4.1.2 Test Instruments

Description & Manufacturer	Model No.	Serial No.	Date of Calibration	Due Date of Calibration
Test Receiver Agilent Technologies	N9038A	MY52260177	May 19, 2015	May 18, 2016
Spectrum Analyzer ROHDE & SCHWARZ	FSU43	101261	Dec. 17, 2015	Dec. 16, 2016
BILOG Antenna SCHWARZBECK	VULB9168	9168-472	Jan. 07, 2016	Jan. 06, 2017
HORN Antenna ETS-Lindgren	3117	00143293	Jan. 04, 2016	Jan. 03, 2017
HORN Antenna SCHWARZBECK	BBHA 9170	9170-480	Jan. 04, 2016	Jan. 03, 2017
Bluetooth Tester	CBT	100980	Apr. 27, 2015	Apr. 26, 2017
Loop Antenna	EM-6879	269	Jul. 31, 2015	Jul. 30, 2016
Agilent Communications Tester-Wireless	8960 Series 10	MY53201073	Jul. 03, 2015	Jul. 02, 2017
Preamplifier Agilent	310N	187226	Jun. 29, 2015	Jun. 28, 2016
Preamplifier Agilent	83017A	MY39501357	Jun. 29, 2015	Jun. 28, 2016
Power Meter Anritsu	ML2495A	1232002	Sep. 21, 2015	Sep. 20, 2016
Power Sensor Anritsu	MA2411B	1207325	Sep. 21, 2015	Sep. 20, 2016
RF signal cable ETS-LINDGREN	5D-FB	Cable-CH1-01(R FC-SMS-100-SM S-120+RFC-SMS -100-SMS-400)	Jun. 27, 2015	Jun. 26, 2016
RF signal cable ETS-LINDGREN	8D-FB	Cable-CH1-02(R FC-SMS-100-SM S-24)	Jun. 27, 2015	Jun. 26, 2016
Software BV ADT	E3 8.130425b	NA	NA	NA
Antenna Tower MF	NA	NA	NA	NA
Turn Table MF	NA	NA	NA	NA
Antenna Tower & Turn Table Controller MF	MF-7802	NA	NA	NA

- Note: 1. The calibration interval of the above test instruments is 12 months and the calibrations are traceable to NML/ROC and NIST/USA.
2. The test was performed in HsinTien Chamber 1.
3. The horn antenna and preamplifier (model: 83017A) are used only for the measurement of emission frequency above 1 GHz if tested.
4. The FCC Site Registration No. is 149147.
5. The IC Site Registration No. is IC7450I-1.

4.1.3 Test Procedures

- a. The EUT was placed on the top of a rotating table 0.8 meters (for below 1 GHz) / 1.5 meters (for above 1 GHz) above the ground at 3 meter chamber room for test. The table was rotated 360 degrees to determine the position of the highest radiation.
- b. The EUT was set 3 meters away from the interference-receiving antenna, which was mounted on the top of a variable-height antenna tower.
- c. The height of antenna is varied from one meter to four meters above the ground to determine the maximum value of the field strength. Both horizontal and vertical polarizations of the antenna are set to make the measurement.
- d. For each suspected emission, the EUT was arranged to its worst case and then the antenna was tuned to heights from 1 meter to 4 meters and the rotatable table was turned from 0 degrees to 360 degrees to find the maximum reading.
- e. The test-receiver system was set to quasi-peak detect function and specified bandwidth with maximum hold mode when the test frequency is below 1 GHz.
- f. The test-receiver system was set to peak and average detected function and specified bandwidth with maximum hold mode when the test frequency is above 1 GHz. If the peak reading value also meets average limit, measurement with the average detector is unnecessary.

Note:

1. The resolution bandwidth and video bandwidth of test receiver/spectrum analyzer is 120 kHz for Quasi-peak detection (QP) at frequency below 1 GHz.
2. The resolution bandwidth of test receiver/spectrum analyzer is 1 MHz and the video bandwidth is 3 MHz for Peak detection (PK) at frequency above 1 GHz.
3. The resolution bandwidth of test receiver/spectrum analyzer is 1 MHz and the video bandwidth is 3 MHz for RMS Average (Duty cycle < 98 %) for Average detection (AV) at frequency above 1 GHz, then the measurement results was added to a correction factor ($10 \log(1/\text{duty cycle})$).
4. The resolution bandwidth of test receiver/spectrum analyzer is 1MHz and the video bandwidth is 10 Hz (Duty cycle ≥ 98 %) for Average detection (AV) at frequency above 1 GHz.
5. All modes of operation were investigated and the worst-case emissions are reported.

4.1.4 Deviation from Test Standard

No deviation.

4.1.5 Test Set Up

<Frequency Range below 1 GHz>

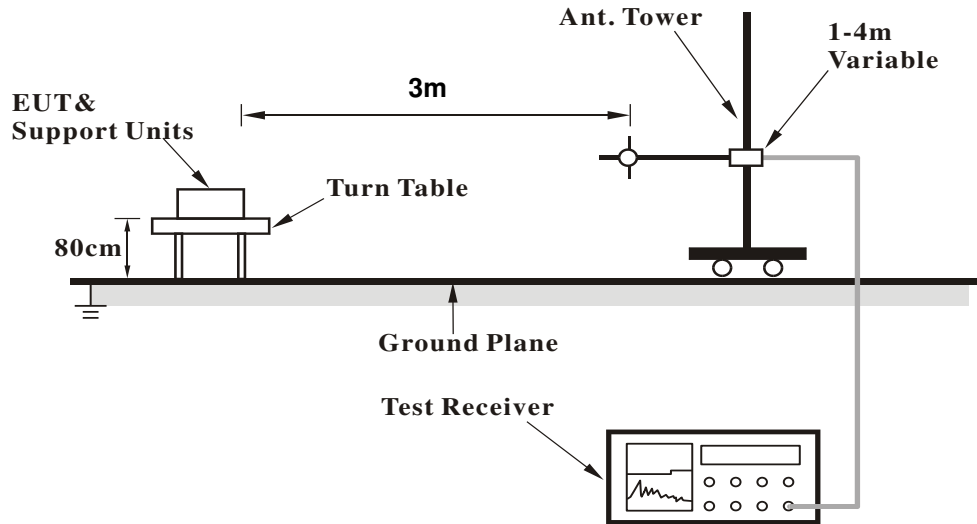

<Frequency Range above 1 GHz>

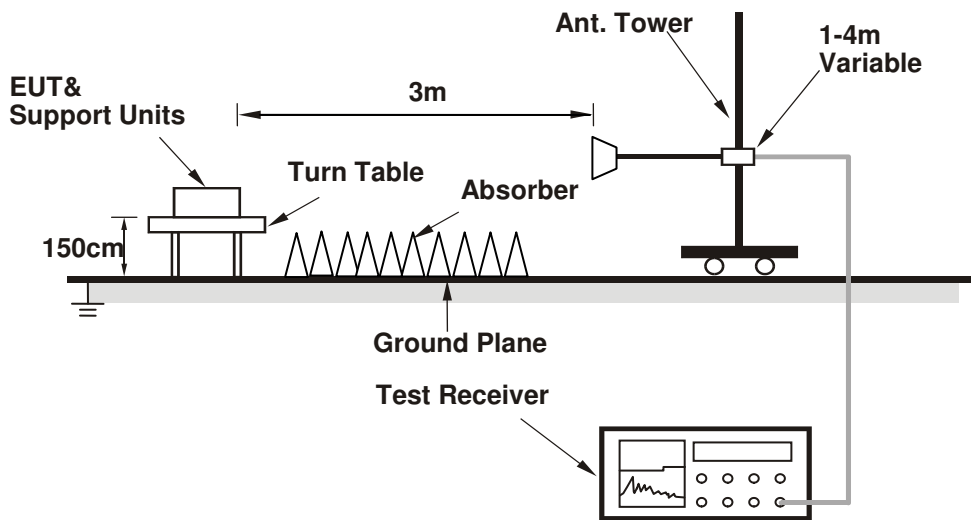

For the actual test configuration, please refer to the attached file (Test Setup Photo).

4.1.6 EUT Operating Conditions

- a. Placed the EUT on a testing table.
- b. Use the software to control the EUT under transmission condition continuously at specific channel frequency.

4.1.7 Test Results

Above 1 GHz Data :

<1TX>

802.11b

EUT Test Condition		Measurement Detail	
Channel	Channel 1	Frequency Range	1 GHz ~ 25 GHz
Input Power	120 Vac, 60 Hz	Detector Function	Peak (PK) Average (AV)
Environmental Conditions	25 deg. C, 65 % RH	Tested By	Charles Hsiao

Antennal Polarity & Test Distance: Horizontal at 3 m										
Frequency (MHz)	Emission Level (dBuV/m)	Read Level (dBuV)	Limit (dBuV/m)	Margin (dB)	Antenna Factor (dB/m)	Cable Loss (dB)	Preamp Factor (dB)	Antenna Height (cm)	Table Angle (Degree)	Remark
2386	43.92	42.21	54	-10.08	31.8	5.4	35.49	129	236	Average
2386	55.56	53.85	74	-18.44	31.8	5.4	35.49	129	236	Peak
2412	99.4	97.63			31.81	5.43	35.47	129	236	Average
2412	102.93	101.16			31.81	5.43	35.47	129	236	Peak
2500	39.72	37.7	54	-14.28	31.9	5.53	35.41	129	236	Average
2500	55.51	53.49	74	-18.49	31.9	5.53	35.41	129	236	Peak

Antennal Polarity & Test Distance: Vertical at 3 m										
Frequency (MHz)	Emission Level (dBuV/m)	Read Level (dBuV)	Limit (dBuV/m)	Margin (dB)	Antenna Factor (dB/m)	Cable Loss (dB)	Preamp Factor (dB)	Antenna Height (cm)	Table Angle (Degree)	Remark
2358	41.79	40.16	54	-12.21	31.76	5.37	35.5	166	301	Average
2358	56.84	55.21	74	-17.16	31.76	5.37	35.5	166	301	Peak
2412	98.47	96.7			31.81	5.43	35.47	166	301	Average
2412	101.96	100.19			31.81	5.43	35.47	166	301	Peak
2498	39.71	37.69	54	-14.29	31.9	5.53	35.41	166	301	Average
2498	56.03	54.01	74	-17.97	31.9	5.53	35.41	166	301	Peak

Remarks:

- Emission Level = Read Level + Antenna Factor + Cable Loss - Preamp Factor
Margin value = Emission level – Limit value
- 2412 MHz: Fundamental frequency.



A D T

EUT Test Condition		Measurement Detail	
Channel	Channel 6	Frequency Range	1 GHz ~ 25 GHz
Input Power	120 Vac, 60 Hz	Detector Function	Peak (PK) Average (AV)
Environmental Conditions	25 deg. C, 65 % RH	Tested By	Charles Hsiao

Antennal Polarity & Test Distance: Horizontal at 3 m										
Frequency (MHz)	Emission Level (dBuV/m)	Read Level (dBuV)	Limit (dBuV/m)	Margin (dB)	Antenna Factor (dB/m)	Cable Loss (dB)	Preamp Factor (dB)	Antenna Height (cm)	Table Angle (Degree)	Remark
2390	41.2	39.47	54	-12.8	31.8	5.4	35.47	144	236	Average
2390	55.88	54.15	74	-18.12	31.8	5.4	35.47	144	236	Peak
2437	101.11	99.26			31.85	5.46	35.46	144	236	Average
2437	104.83	102.98			31.85	5.46	35.46	144	236	Peak
2484	39.98	38.02	54	-14.02	31.88	5.5	35.42	144	236	Average
2484	56	54.04	74	-18	31.88	5.5	35.42	144	236	Peak

Antennal Polarity & Test Distance: Vertical at 3 m										
Frequency (MHz)	Emission Level (dBuV/m)	Read Level (dBuV)	Limit (dBuV/m)	Margin (dB)	Antenna Factor (dB/m)	Cable Loss (dB)	Preamp Factor (dB)	Antenna Height (cm)	Table Angle (Degree)	Remark
2330	39.26	37.72	54	-14.74	31.73	5.33	35.52	166	301	Average
2330	55.27	53.73	74	-18.73	31.73	5.33	35.52	166	301	Peak
2437	100.87	99.02			31.85	5.46	35.46	166	301	Average
2437	103.69	101.84			31.85	5.46	35.46	166	301	Peak
2498	39.63	37.61	54	-14.37	31.9	5.53	35.41	166	301	Average
2498	54.67	52.65	74	-19.33	31.9	5.53	35.41	166	301	Peak

Remarks:

- Emission Level = Read Level + Antenna Factor + Cable Loss - Preamp Factor
Margin value = Emission level – Limit value
- 2437 MHz: Fundamental frequency.



A D T

EUT Test Condition		Measurement Detail	
Channel	Channel 11	Frequency Range	1 GHz ~ 25 GHz
Input Power	120 Vac, 60 Hz	Detector Function	Peak (PK) Average (AV)
Environmental Conditions	25 deg. C, 65 % RH	Tested By	Charles Hsiao

Antennal Polarity & Test Distance: Horizontal at 3 m										
Frequency (MHz)	Emission Level (dBuV/m)	Read Level (dBuV)	Limit (dBuV/m)	Margin (dB)	Antenna Factor (dB/m)	Cable Loss (dB)	Preamp Factor (dB)	Antenna Height (cm)	Table Angle (Degree)	Remark
2340	39.48	37.91	54	-14.52	31.74	5.33	35.5	159	236	Average
2340	56.35	54.78	74	-17.65	31.74	5.33	35.5	159	236	Peak
2462	100.56	98.63			31.87	5.5	35.44	159	236	Average
2462	103.36	101.43			31.87	5.5	35.44	159	236	Peak
2492	41.13	39.11	54	-12.87	31.9	5.53	35.41	159	236	Average
2492	56.96	54.94	74	-17.04	31.9	5.53	35.41	159	236	Peak

Antennal Polarity & Test Distance: Vertical at 3 m										
Frequency (MHz)	Emission Level (dBuV/m)	Read Level (dBuV)	Limit (dBuV/m)	Margin (dB)	Antenna Factor (dB/m)	Cable Loss (dB)	Preamp Factor (dB)	Antenna Height (cm)	Table Angle (Degree)	Remark
2382	39.63	37.94	54	-14.37	31.78	5.4	35.49	183	301	Average
2382	55.61	53.92	74	-18.39	31.78	5.4	35.49	183	301	Peak
2462	99.36	97.43			31.87	5.5	35.44	183	301	Average
2462	102.64	100.71			31.87	5.5	35.44	183	301	Peak
2498	41.1	39.08	54	-12.9	31.9	5.53	35.41	183	301	Average
2498	55.47	53.45	74	-18.53	31.9	5.53	35.41	183	301	Peak

Remarks:

- Emission Level = Read Level + Antenna Factor + Cable Loss - Preamp Factor
Margin value = Emission level – Limit value
- 2462 MHz: Fundamental frequency.

802.11g

EUT Test Condition		Measurement Detail	
Channel	Channel 1	Frequency Range	1 GHz ~ 25 GHz
Input Power	120 Vac, 60 Hz	Detector Function	Peak (PK) Average (AV)
Environmental Conditions	25 deg. C, 65 % RH	Tested By	Charles Hsiao

Antennal Polarity & Test Distance: Horizontal at 3 m										
Frequency (MHz)	Emission Level (dBuV/m)	Read Level (dBuV)	Limit (dBuV/m)	Margin (dB)	Antenna Factor (dB/m)	Cable Loss (dB)	Preamp Factor (dB)	Antenna Height (cm)	Table Angle (Degree)	Remark
2390	49.8	48.07	54	-4.2	31.8	5.4	35.47	129	236	Average
2390	61.77	60.04	74	-12.23	31.8	5.4	35.47	129	236	Peak
2412	95.35	93.58			31.81	5.43	35.47	129	236	Average
2412	103.12	101.35			31.81	5.43	35.47	129	236	Peak
2494	40.93	38.91	54	-13.07	31.9	5.53	35.41	129	236	Average
2494	54.77	52.75	74	-19.23	31.9	5.53	35.41	129	236	Peak
Antennal Polarity & Test Distance: Vertical at 3 m										
Frequency (MHz)	Emission Level (dBuV/m)	Read Level (dBuV)	Limit (dBuV/m)	Margin (dB)	Antenna Factor (dB/m)	Cable Loss (dB)	Preamp Factor (dB)	Antenna Height (cm)	Table Angle (Degree)	Remark
2390	46.7	44.97	54	-7.3	31.8	5.4	35.47	166	301	Average
2390	60.22	58.49	74	-13.78	31.8	5.4	35.47	166	301	Peak
2412	94.25	92.48			31.81	5.43	35.47	166	301	Average
2412	102.78	101.01			31.81	5.43	35.47	166	301	Peak
2488	40.83	38.82	54	-13.17	31.9	5.53	35.42	166	301	Average
2488	56.25	54.24	74	-17.75	31.9	5.53	35.42	166	301	Peak

Remarks:

- Emission Level = Read Level + Antenna Factor + Cable Loss - Preamp Factor
Margin value = Emission level – Limit value
- 2412 MHz: Fundamental frequency.



EUT Test Condition		Measurement Detail	
Channel	Channel 6	Frequency Range	1 GHz ~ 25 GHz
Input Power	120 Vac, 60 Hz	Detector Function	Peak (PK) Average (AV)
Environmental Conditions	25 deg. C, 65 % RH	Tested By	Charles Hsiao

Antennal Polarity & Test Distance: Horizontal at 3 m										
Frequency (MHz)	Emission Level (dBuV/m)	Read Level (dBuV)	Limit (dBuV/m)	Margin (dB)	Antenna Factor (dB/m)	Cable Loss (dB)	Preamp Factor (dB)	Antenna Height (cm)	Table Angle (Degree)	Remark
2390	40.7	38.97	54	-13.3	31.8	5.4	35.47	144	236	Average
2390	54.82	53.09	74	-19.18	31.8	5.4	35.47	144	236	Peak
2437	96.91	95.06			31.85	5.46	35.46	144	236	Average
2437	104.25	102.4			31.85	5.46	35.46	144	236	Peak
2492	40.73	38.71	54	-13.27	31.9	5.53	35.41	144	236	Average
2492	55.8	53.78	74	-18.2	31.9	5.53	35.41	144	236	Peak

Antennal Polarity & Test Distance: Vertical at 3 m										
Frequency (MHz)	Emission Level (dBuV/m)	Read Level (dBuV)	Limit (dBuV/m)	Margin (dB)	Antenna Factor (dB/m)	Cable Loss (dB)	Preamp Factor (dB)	Antenna Height (cm)	Table Angle (Degree)	Remark
2334	40.16	38.62	54	-13.84	31.73	5.33	35.52	166	301	Average
2334	54.94	53.4	74	-19.06	31.73	5.33	35.52	166	301	Peak
2437	95.21	93.36			31.85	5.46	35.46	166	301	Average
2437	103.84	101.99			31.85	5.46	35.46	166	301	Peak
2488	40.53	38.52	54	-13.47	31.9	5.53	35.42	166	301	Average
2488	55.54	53.53	74	-18.46	31.9	5.53	35.42	166	301	Peak

Remarks:

- Emission Level = Read Level + Antenna Factor + Cable Loss - Preamp Factor
Margin value = Emission level – Limit value
- 2437 MHz: Fundamental frequency.



A D T

EUT Test Condition		Measurement Detail	
Channel	Channel 11	Frequency Range	1 GHz ~ 25 GHz
Input Power	120 Vac, 60 Hz	Detector Function	Peak (PK) Average (AV)
Environmental Conditions	25 deg. C, 65 % RH	Tested By	Charles Hsiao

Antennal Polarity & Test Distance: Horizontal at 3 m										
Frequency (MHz)	Emission Level (dBuV/m)	Read Level (dBuV)	Limit (dBuV/m)	Margin (dB)	Antenna Factor (dB/m)	Cable Loss (dB)	Preamp Factor (dB)	Antenna Height (cm)	Table Angle (Degree)	Remark
2376	40.16	38.5	54	-13.84	31.78	5.37	35.49	159	236	Average
2376	55.84	54.18	74	-18.16	31.78	5.37	35.49	159	236	Peak
2462	95.93	94			31.87	5.5	35.44	159	236	Average
2462	103.92	101.99			31.87	5.5	35.44	159	236	Peak
2484	48.68	46.72	54	-5.32	31.88	5.5	35.42	159	236	Average
2484	62.17	60.21	74	-11.83	31.88	5.5	35.42	159	236	Peak
Antennal Polarity & Test Distance: Vertical at 3 m										
Frequency (MHz)	Emission Level (dBuV/m)	Read Level (dBuV)	Limit (dBuV/m)	Margin (dB)	Antenna Factor (dB/m)	Cable Loss (dB)	Preamp Factor (dB)	Antenna Height (cm)	Table Angle (Degree)	Remark
2386	40.2	38.49	54	-13.8	31.8	5.4	35.49	183	301	Average
2386	55.79	54.08	74	-18.21	31.8	5.4	35.49	183	301	Peak
2462	94.16	92.23			31.87	5.5	35.44	183	301	Average
2462	102.08	100.15			31.87	5.5	35.44	183	301	Peak
2484	48.63	46.67	54	-5.37	31.88	5.5	35.42	183	301	Average
2484	61.94	59.98	74	-12.06	31.88	5.5	35.42	183	301	Peak

Remarks:

- Emission Level = Read Level + Antenna Factor + Cable Loss - Preamp Factor
Margin value = Emission level – Limit value
- 2462 MHz: Fundamental frequency.

802.11n (HT20)

EUT Test Condition		Measurement Detail	
Channel	Channel 1	Frequency Range	1 GHz ~ 25 GHz
Input Power	120 Vac, 60 Hz	Detector Function	Peak (PK) Average (AV)
Environmental Conditions	25 deg. C, 65 % RH	Tested By	Charles Hsiao

Antennal Polarity & Test Distance: Horizontal at 3 m

Frequency (MHz)	Emission Level (dBuV/m)	Read Level (dBuV)	Limit (dBuV/m)	Margin (dB)	Antenna Factor (dB/m)	Cable Loss (dB)	Preamp Factor (dB)	Antenna Height (cm)	Table Angle (Degree)	Remark
2390	51.6	49.87	54	-2.4	31.8	5.4	35.47	129	236	Average
2390	66.08	64.35	74	-7.92	31.8	5.4	35.47	129	236	Peak
2412	95.35	93.58			31.81	5.43	35.47	129	236	Average
2412	103.07	101.3			31.81	5.43	35.47	129	236	Peak
2486	40.53	38.54	54	-13.47	31.88	5.53	35.42	129	236	Average
2486	55.78	53.79	74	-18.22	31.88	5.53	35.42	129	236	Peak

Antennal Polarity & Test Distance: Vertical at 3 m

Frequency (MHz)	Emission Level (dBuV/m)	Read Level (dBuV)	Limit (dBuV/m)	Margin (dB)	Antenna Factor (dB/m)	Cable Loss (dB)	Preamp Factor (dB)	Antenna Height (cm)	Table Angle (Degree)	Remark
2390	49.2	47.47	54	-4.8	31.8	5.4	35.47	166	301	Average
2390	63.2	61.47	74	-10.8	31.8	5.4	35.47	166	301	Peak
2412	94.25	92.48			31.81	5.43	35.47	166	301	Average
2412	102.22	100.45			31.81	5.43	35.47	166	301	Peak
2492	40.54	38.52	54	-13.46	31.9	5.53	35.41	166	301	Average
2492	56.15	54.13	74	-17.85	31.9	5.53	35.41	166	301	Peak

Remarks:

- Emission Level = Read Level + Antenna Factor + Cable Loss - Preamp Factor
Margin value = Emission level – Limit value
- 2412 MHz: Fundamental frequency.



EUT Test Condition		Measurement Detail	
Channel	Channel 6	Frequency Range	1 GHz ~ 25 GHz
Input Power	120 Vac, 60 Hz	Detector Function	Peak (PK) Average (AV)
Environmental Conditions	25 deg. C, 65 % RH	Tested By	Charles Hsiao

Antennal Polarity & Test Distance: Horizontal at 3 m										
Frequency (MHz)	Emission Level (dBuV/m)	Read Level (dBuV)	Limit (dBuV/m)	Margin (dB)	Antenna Factor (dB/m)	Cable Loss (dB)	Preamp Factor (dB)	Antenna Height (cm)	Table Angle (Degree)	Remark
2328	40.23	38.72	54	-13.77	31.73	5.3	35.52	144	236	Average
2328	56.2	54.69	74	-17.8	31.73	5.3	35.52	144	236	Peak
2437	96.41	94.56			31.85	5.46	35.46	144	236	Average
2437	104.23	102.38			31.85	5.46	35.46	144	236	Peak
2484	40.58	38.62	54	-13.42	31.88	5.5	35.42	144	236	Average
2484	55.71	53.75	74	-18.29	31.88	5.5	35.42	144	236	Peak
Antennal Polarity & Test Distance: Vertical at 3 m										
Frequency (MHz)	Emission Level (dBuV/m)	Read Level (dBuV)	Limit (dBuV/m)	Margin (dB)	Antenna Factor (dB/m)	Cable Loss (dB)	Preamp Factor (dB)	Antenna Height (cm)	Table Angle (Degree)	Remark
2390	40.35	38.62	54	-13.65	31.8	5.4	35.47	166	301	Average
2390	55.5	53.77	74	-18.5	31.8	5.4	35.47	166	301	Peak
2437	95.91	94.06			31.85	5.46	35.46	166	301	Average
2437	103.08	101.23			31.85	5.46	35.46	166	301	Peak
2496	40.57	38.55	54	-13.43	31.9	5.53	35.41	166	301	Average
2496	55.61	53.59	74	-18.39	31.9	5.53	35.41	166	301	Peak

Remarks:

- Emission Level = Read Level + Antenna Factor + Cable Loss - Preamp Factor
Margin value = Emission level – Limit value
- 2437 MHz: Fundamental frequency.



EUT Test Condition		Measurement Detail	
Channel	Channel 11	Frequency Range	1 GHz ~ 25 GHz
Input Power	120 Vac, 60 Hz	Detector Function	Peak (PK) Average (AV)
Environmental Conditions	25 deg. C, 65 % RH	Tested By	Charles Hsiao

Antennal Polarity & Test Distance: Horizontal at 3 m

Frequency (MHz)	Emission Level (dBuV/m)	Read Level (dBuV)	Limit (dBuV/m)	Margin (dB)	Antenna Factor (dB/m)	Cable Loss (dB)	Preamp Factor (dB)	Antenna Height (cm)	Table Angle (Degree)	Remark
2348	40.16	38.59	54	-13.84	31.74	5.33	35.5	159	236	Average
2348	54.6	53.03	74	-19.4	31.74	5.33	35.5	159	236	Peak
2462	95.86	93.93			31.87	5.5	35.44	159	236	Average
2462	103.46	101.53			31.87	5.5	35.44	159	236	Peak
2484	51.38	49.42	54	-2.62	31.88	5.5	35.42	159	236	Average
2484	68.59	66.63	74	-5.41	31.88	5.5	35.42	159	236	Peak

Antennal Polarity & Test Distance: Vertical at 3 m

Frequency (MHz)	Emission Level (dBuV/m)	Read Level (dBuV)	Limit (dBuV/m)	Margin (dB)	Antenna Factor (dB/m)	Cable Loss (dB)	Preamp Factor (dB)	Antenna Height (cm)	Table Angle (Degree)	Remark
2364	40.25	38.62	54	-13.75	31.76	5.37	35.5	166	301	Average
2364	55.8	54.17	74	-18.2	31.76	5.37	35.5	166	301	Peak
2462	94.86	92.93			31.87	5.5	35.44	166	301	Average
2462	102.01	100.08			31.87	5.5	35.44	166	301	Peak
2484	49.38	47.42	54	-4.62	31.88	5.5	35.42	166	301	Average
2484	66.88	64.92	74	-7.12	31.88	5.5	35.42	166	301	Peak

Remarks:

- Emission Level = Read Level + Antenna Factor + Cable Loss - Preamp Factor
Margin value = Emission level – Limit value
- 2462 MHz: Fundamental frequency.

802.11n (HT40)

EUT Test Condition		Measurement Detail	
Channel	Channel 3	Frequency Range	1 GHz ~ 25 GHz
Input Power	120 Vac, 60 Hz	Detector Function	Peak (PK) Average (AV)
Environmental Conditions	25 deg. C, 65 % RH	Tested By	Charles Hsiao

Antennal Polarity & Test Distance: Horizontal at 3 m

Frequency (MHz)	Emission Level (dBuV/m)	Read Level (dBuV)	Limit (dBuV/m)	Margin (dB)	Antenna Factor (dB/m)	Cable Loss (dB)	Preamp Factor (dB)	Antenna Height (cm)	Table Angle (Degree)	Remark
2390	48.26	46.53	54	-5.74	31.8	5.4	35.47	162	218	Average
2390	59.97	58.24	74	-14.03	31.8	5.4	35.47	162	218	Peak
2422	94.67	92.87			31.83	5.43	35.46	162	218	Average
2422	102.12	100.32			31.83	5.43	35.46	162	218	Peak
2496	41.09	39.07	54	-12.91	31.9	5.53	35.41	162	218	Average
2496	55.46	53.44	74	-18.54	31.9	5.53	35.41	162	218	Peak

Antennal Polarity & Test Distance: Vertical at 3 m

Frequency (MHz)	Emission Level (dBuV/m)	Read Level (dBuV)	Limit (dBuV/m)	Margin (dB)	Antenna Factor (dB/m)	Cable Loss (dB)	Preamp Factor (dB)	Antenna Height (cm)	Table Angle (Degree)	Remark
2390	52.94	51.21	54	-1.06	31.8	5.4	35.47	119	267	Average
2390	64.83	63.1	74	-9.17	31.8	5.4	35.47	119	267	Peak
2422	94.04	92.24			31.83	5.43	35.46	119	267	Average
2422	101.46	99.66			31.83	5.43	35.46	119	267	Peak
2494	41.49	39.47	54	-12.51	31.9	5.53	35.41	119	267	Average
2494	55	52.98	74	-19	31.9	5.53	35.41	119	267	Peak

Remarks:

- Emission Level = Read Level + Antenna Factor + Cable Loss - Preamp Factor
Margin value = Emission level – Limit value
- 2422 MHz: Fundamental frequency.



A D T

EUT Test Condition		Measurement Detail	
Channel	Channel 6	Frequency Range	1 GHz ~ 25 GHz
Input Power	120 Vac, 60 Hz	Detector Function	Peak (PK) Average (AV)
Environmental Conditions	25 deg. C, 65 % RH	Tested By	Charles Hsiao

Antennal Polarity & Test Distance: Horizontal at 3 m

Frequency (MHz)	Emission Level (dBuV/m)	Read Level (dBuV)	Limit (dBuV/m)	Margin (dB)	Antenna Factor (dB/m)	Cable Loss (dB)	Preamp Factor (dB)	Antenna Height (cm)	Table Angle (Degree)	Remark
2390	48.7	46.97	54	-5.3	31.8	5.4	35.47	144	236	Average
2390	61.01	59.28	74	-12.99	31.8	5.4	35.47	144	236	Peak
2437	95.81	93.96			31.85	5.46	35.46	144	236	Average
2437	102.68	100.83			31.85	5.46	35.46	144	236	Peak
2486	47.43	45.44	54	-6.57	31.88	5.53	35.42	144	236	Average
2486	63.95	61.96	74	-10.05	31.88	5.53	35.42	144	236	Peak

Antennal Polarity & Test Distance: Vertical at 3 m

Frequency (MHz)	Emission Level (dBuV/m)	Read Level (dBuV)	Limit (dBuV/m)	Margin (dB)	Antenna Factor (dB/m)	Cable Loss (dB)	Preamp Factor (dB)	Antenna Height (cm)	Table Angle (Degree)	Remark
2390	49.28	47.55	54	-4.72	31.8	5.4	35.47	104	301	Average
2390	61.11	59.38	74	-12.89	31.8	5.4	35.47	104	301	Peak
2437	94.31	92.46			31.85	5.46	35.46	104	301	Average
2437	101.54	99.69			31.85	5.46	35.46	104	301	Peak
2484	47.49	45.53	54	-6.51	31.88	5.5	35.42	104	301	Average
2484	64.19	62.23	74	-9.81	31.88	5.5	35.42	104	301	Peak

Remarks:

- Emission Level = Read Level + Antenna Factor + Cable Loss - Preamp Factor
Margin value = Emission level – Limit value
- 2437 MHz: Fundamental frequency.

EUT Test Condition		Measurement Detail	
Channel	Channel 9	Frequency Range	1 GHz ~ 25 GHz
Input Power	120 Vac, 60 Hz	Detector Function	Peak (PK) Average (AV)
Environmental Conditions	25 deg. C, 65 % RH	Tested By	Charles Hsiao

Antennal Polarity & Test Distance: Horizontal at 3 m										
Frequency (MHz)	Emission Level (dBuV/m)	Read Level (dBuV)	Limit (dBuV/m)	Margin (dB)	Antenna Factor (dB/m)	Cable Loss (dB)	Preamp Factor (dB)	Antenna Height (cm)	Table Angle (Degree)	Remark
2387	42.16	40.45	54	-11.84	31.8	5.4	35.49	146	218	Average
2387	56.26	54.55	74	-17.74	31.8	5.4	35.49	146	218	Peak
2452	94.69	92.82			31.85	5.46	35.44	146	218	Average
2452	102.24	100.37			31.85	5.46	35.44	146	218	Peak
2484	52.13	50.17	54	-1.87	31.88	5.5	35.42	146	218	Average
2484	68.1	66.14	74	-5.9	31.88	5.5	35.42	146	218	Peak
Antennal Polarity & Test Distance: Vertical at 3 m										
Frequency (MHz)	Emission Level (dBuV/m)	Read Level (dBuV)	Limit (dBuV/m)	Margin (dB)	Antenna Factor (dB/m)	Cable Loss (dB)	Preamp Factor (dB)	Antenna Height (cm)	Table Angle (Degree)	Remark
2334	43.95	42.41	54	-10.05	31.73	5.33	35.52	126	297	Average
2334	54.12	52.58	74	-19.88	31.73	5.33	35.52	126	297	Peak
2452	93.46	91.59			31.85	5.46	35.44	126	297	Average
2452	101.64	99.77			31.85	5.46	35.44	126	297	Peak
2484	51.04	49.08	54	-2.96	31.88	5.5	35.42	126	297	Average
2484	68.27	66.31	74	-5.73	31.88	5.5	35.42	126	297	Peak

Remarks:

- Emission Level = Read Level + Antenna Factor + Cable Loss - Preamp Factor
Margin value = Emission level – Limit value
- 2452 MHz: Fundamental frequency.

<2TX>

802.11n (HT20)

EUT Test Condition		Measurement Detail	
Channel	Channel 1	Frequency Range	1 GHz ~ 25 GHz
Input Power	120 Vac, 60 Hz	Detector Function	Peak (PK) Average (AV)
Environmental Conditions	25 deg. C, 65 % RH	Tested By	Charles Hsiao

Antennal Polarity & Test Distance: Horizontal at 3 m

Frequency (MHz)	Emission Level (dBuV/m)	Read Level (dBuV)	Limit (dBuV/m)	Margin (dB)	Antenna Factor (dB/m)	Cable Loss (dB)	Preamp Factor (dB)	Antenna Height (cm)	Table Angle (Degree)	Remark
2390	51.64	49.91	54	-2.36	31.8	5.4	35.47	271	59	Average
2390	66.01	64.28	74	-7.99	31.8	5.4	35.47	271	59	Peak
2412	92.85	91.08			31.81	5.43	35.47	286	59	Average
2412	101.25	99.48			31.81	5.43	35.47	286	59	Peak
2484	40.76	38.8	54	-13.24	31.88	5.5	35.42	286	59	Average
2484	56	54.04	74	-18	31.88	5.5	35.42	286	59	Peak

Antennal Polarity & Test Distance: Vertical at 3 m

Frequency (MHz)	Emission Level (dBuV/m)	Read Level (dBuV)	Limit (dBuV/m)	Margin (dB)	Antenna Factor (dB/m)	Cable Loss (dB)	Preamp Factor (dB)	Antenna Height (cm)	Table Angle (Degree)	Remark
2390	48.53	46.8	54	-5.47	31.8	5.4	35.47	321	353	Average
2390	62.6	60.87	74	-11.4	31.8	5.4	35.47	321	353	Peak
2412	89.93	88.16			31.81	5.43	35.47	321	353	Average
2412	98.59	96.82			31.81	5.43	35.47	321	353	Peak
2486	40.68	38.69	54	-13.32	31.88	5.53	35.42	321	353	Average
2486	56.96	54.97	74	-17.04	31.88	5.53	35.42	321	353	Peak

Remarks:

- Emission Level = Read Level + Antenna Factor + Cable Loss - Preamp Factor
Margin value = Emission level – Limit value
- 2412 MHz: Fundamental frequency.



A D T

EUT Test Condition		Measurement Detail	
Channel	Channel 6	Frequency Range	1 GHz ~ 25 GHz
Input Power	120 Vac, 60 Hz	Detector Function	Peak (PK) Average (AV)
Environmental Conditions	25 deg. C, 65 % RH	Tested By	Charles Hsiao

Antennal Polarity & Test Distance: Horizontal at 3 m										
Frequency (MHz)	Emission Level (dBuV/m)	Read Level (dBuV)	Limit (dBuV/m)	Margin (dB)	Antenna Factor (dB/m)	Cable Loss (dB)	Preamp Factor (dB)	Antenna Height (cm)	Table Angle (Degree)	Remark
2386	40.89	39.18	54	-13.11	31.8	5.4	35.49	318	15	Average
2386	55.31	53.6	74	-18.69	31.8	5.4	35.49	318	15	Peak
2437	95.04	93.19			31.85	5.46	35.46	318	15	Average
2437	103.64	101.79			31.85	5.46	35.46	318	15	Peak
2486	40.81	38.82	54	-13.19	31.88	5.53	35.42	318	15	Average
2486	55.97	53.98	74	-18.03	31.88	5.53	35.42	318	15	Peak

Antennal Polarity & Test Distance: Vertical at 3 m										
Frequency (MHz)	Emission Level (dBuV/m)	Read Level (dBuV)	Limit (dBuV/m)	Margin (dB)	Antenna Factor (dB/m)	Cable Loss (dB)	Preamp Factor (dB)	Antenna Height (cm)	Table Angle (Degree)	Remark
2366	40.25	38.61	54	-13.75	31.76	5.37	35.49	285	354	Average
2366	55.32	53.68	74	-18.68	31.76	5.37	35.49	285	354	Peak
2437	92.47	90.62			31.85	5.46	35.46	285	354	Average
2437	100.26	98.41			31.85	5.46	35.46	285	354	Peak
2494	40.8	38.78	54	-13.2	31.9	5.53	35.41	285	354	Average
2494	55.55	53.53	74	-18.45	31.9	5.53	35.41	285	354	Peak

Remarks:

- Emission Level = Read Level + Antenna Factor + Cable Loss - Preamp Factor
Margin value = Emission level – Limit value
- 2437 MHz: Fundamental frequency.



A D T

EUT Test Condition		Measurement Detail	
Channel	Channel 11	Frequency Range	1 GHz ~ 25 GHz
Input Power	120 Vac, 60 Hz	Detector Function	Peak (PK) Average (AV)
Environmental Conditions	25 deg. C, 65 % RH	Tested By	Charles Hsiao

Antennal Polarity & Test Distance: Horizontal at 3 m										
Frequency (MHz)	Emission Level (dBuV/m)	Read Level (dBuV)	Limit (dBuV/m)	Margin (dB)	Antenna Factor (dB/m)	Cable Loss (dB)	Preamp Factor (dB)	Antenna Height (cm)	Table Angle (Degree)	Remark
2322	40.02	38.51	54	-13.98	31.73	5.3	35.52	255	15	Average
2322	55.15	53.64	74	-18.85	31.73	5.3	35.52	255	15	Peak
2462	93.15	91.22			31.87	5.5	35.44	255	15	Average
2462	101.58	99.65			31.87	5.5	35.44	255	15	Peak
2484	47.91	45.95	54	-6.09	31.88	5.5	35.42	241	22	Average
2484	64.25	62.29	74	-9.75	31.88	5.5	35.42	241	22	Peak

Antennal Polarity & Test Distance: Vertical at 3 m										
Frequency (MHz)	Emission Level (dBuV/m)	Read Level (dBuV)	Limit (dBuV/m)	Margin (dB)	Antenna Factor (dB/m)	Cable Loss (dB)	Preamp Factor (dB)	Antenna Height (cm)	Table Angle (Degree)	Remark
2326	39.91	38.4	54	-14.09	31.73	5.3	35.52	308	354	Average
2326	55.2	53.69	74	-18.8	31.73	5.3	35.52	308	354	Peak
2462	91.05	89.12			31.87	5.5	35.44	308	354	Average
2462	98.74	96.81			31.87	5.5	35.44	308	354	Peak
2484	44.74	42.78	54	-9.26	31.88	5.5	35.42	308	354	Average
2484	58.83	56.87	74	-15.17	31.88	5.5	35.42	308	354	Peak

Remarks:

- Emission Level = Read Level + Antenna Factor + Cable Loss - Preamp Factor
Margin value = Emission level – Limit value
- 2462 MHz: Fundamental frequency.

802.11n (HT40)

EUT Test Condition		Measurement Detail	
Channel	Channel 3	Frequency Range	1 GHz ~ 25 GHz
Input Power	120 Vac, 60 Hz	Detector Function	Peak (PK) Average (AV)
Environmental Conditions	25 deg. C, 65 % RH	Tested By	Charles Hsiao

Antennal Polarity & Test Distance: Horizontal at 3 m

Frequency (MHz)	Emission Level (dBuV/m)	Read Level (dBuV)	Limit (dBuV/m)	Margin (dB)	Antenna Factor (dB/m)	Cable Loss (dB)	Preamp Factor (dB)	Antenna Height (cm)	Table Angle (Degree)	Remark
2390	50.27	48.54	54	-3.73	31.8	5.4	35.47	121	268	Average
2390	63.11	61.38	74	-10.89	31.8	5.4	35.47	121	268	Peak
2422	92.58	90.78			31.83	5.43	35.46	108	354	Average
2422	100.38	98.58			31.83	5.43	35.46	108	354	Peak
2492	41.07	39.05	54	-12.93	31.9	5.53	35.41	108	354	Average
2492	55.51	53.49	74	-18.49	31.9	5.53	35.41	108	354	Peak

Antennal Polarity & Test Distance: Vertical at 3 m

Frequency (MHz)	Emission Level (dBuV/m)	Read Level (dBuV)	Limit (dBuV/m)	Margin (dB)	Antenna Factor (dB/m)	Cable Loss (dB)	Preamp Factor (dB)	Antenna Height (cm)	Table Angle (Degree)	Remark
2390	52.58	50.85	54	-1.42	31.8	5.4	35.47	100	266	Average
2390	64.95	63.22	74	-9.05	31.8	5.4	35.47	100	266	Peak
2422	89.1	87.3			31.83	5.43	35.46	100	266	Average
2422	97.78	95.98			31.83	5.43	35.46	100	266	Peak
2494	41.6	39.58	54	-12.4	31.9	5.53	35.41	100	266	Average
2494	56.09	54.07	74	-17.91	31.9	5.53	35.41	100	266	Peak

Remarks:

- Emission Level = Read Level + Antenna Factor + Cable Loss - Preamp Factor
Margin value = Emission level – Limit value
- 2422 MHz: Fundamental frequency.



A D T

EUT Test Condition		Measurement Detail	
Channel	Channel 6	Frequency Range	1 GHz ~ 25 GHz
Input Power	120 Vac, 60 Hz	Detector Function	Peak (PK) Average (AV)
Environmental Conditions	25 deg. C, 65 % RH	Tested By	Charles Hsiao

Antennal Polarity & Test Distance: Horizontal at 3 m										
Frequency (MHz)	Emission Level (dBuV/m)	Read Level (dBuV)	Limit (dBuV/m)	Margin (dB)	Antenna Factor (dB/m)	Cable Loss (dB)	Preamp Factor (dB)	Antenna Height (cm)	Table Angle (Degree)	Remark
2390	48.14	46.41	54	-5.86	31.8	5.4	35.47	283	17	Average
2390	61.59	59.86	74	-12.41	31.8	5.4	35.47	283	17	Peak
2437	92.46	90.61			31.85	5.46	35.46	318	15	Average
2437	100.63	98.78			31.85	5.46	35.46	318	15	Peak
2484	44.75	42.79	54	-9.25	31.88	5.5	35.42	276	17	Average
2484	61.53	59.57	74	-12.47	31.88	5.5	35.42	276	17	Peak

Antennal Polarity & Test Distance: Vertical at 3 m										
Frequency (MHz)	Emission Level (dBuV/m)	Read Level (dBuV)	Limit (dBuV/m)	Margin (dB)	Antenna Factor (dB/m)	Cable Loss (dB)	Preamp Factor (dB)	Antenna Height (cm)	Table Angle (Degree)	Remark
2390	45.05	43.32	54	-8.95	31.8	5.4	35.47	285	354	Average
2390	56.26	54.53	74	-17.74	31.8	5.4	35.47	285	354	Peak
2437	89.14	87.29			31.85	5.46	35.46	285	354	Average
2437	97.02	95.17			31.85	5.46	35.46	285	354	Peak
2484	42.33	40.37	54	-11.67	31.88	5.5	35.42	285	354	Average
2484	56.27	54.31	74	-17.73	31.88	5.5	35.42	285	354	Peak

Remarks:

- Emission Level = Read Level + Antenna Factor + Cable Loss - Preamp Factor
Margin value = Emission level – Limit value
- 2437 MHz: Fundamental frequency.



A D T

EUT Test Condition		Measurement Detail	
Channel	Channel 9	Frequency Range	1 GHz ~ 25 GHz
Input Power	120 Vac, 60 Hz	Detector Function	Peak (PK) Average (AV)
Environmental Conditions	25 deg. C, 65 % RH	Tested By	Charles Hsiao

Antennal Polarity & Test Distance: Horizontal at 3 m										
Frequency (MHz)	Emission Level (dBuV/m)	Read Level (dBuV)	Limit (dBuV/m)	Margin (dB)	Antenna Factor (dB/m)	Cable Loss (dB)	Preamp Factor (dB)	Antenna Height (cm)	Table Angle (Degree)	Remark
2370	42.65	40.99	54	-11.35	31.78	5.37	35.49	255	15	Average
2370	55.8	54.14	74	-18.2	31.78	5.37	35.49	255	15	Peak
2452	91.78	89.91			31.85	5.46	35.44	255	15	Average
2452	99.99	98.12			31.85	5.46	35.44	255	15	Peak
2484	52.69	50.73	54	-1.31	31.88	5.5	35.42	249	11	Average
2484	67.45	65.49	74	-6.55	31.88	5.5	35.42	249	11	Peak

Antennal Polarity & Test Distance: Vertical at 3 m										
Frequency (MHz)	Emission Level (dBuV/m)	Read Level (dBuV)	Limit (dBuV/m)	Margin (dB)	Antenna Factor (dB/m)	Cable Loss (dB)	Preamp Factor (dB)	Antenna Height (cm)	Table Angle (Degree)	Remark
2316	41.49	40	54	-12.51	31.71	5.3	35.52	308	354	Average
2316	55.59	54.1	74	-18.41	31.71	5.3	35.52	308	354	Peak
2452	89.65	87.78			31.85	5.46	35.44	308	354	Average
2452	97.66	95.79			31.85	5.46	35.44	308	354	Peak
2484	48.5	46.54	54	-5.5	31.88	5.5	35.42	308	354	Average
2484	62.5	60.54	74	-11.5	31.88	5.5	35.42	308	354	Peak

Remarks:

- Emission Level = Read Level + Antenna Factor + Cable Loss - Preamp Factor
Margin value = Emission level – Limit value
- 2452 MHz: Fundamental frequency.

9 kHz ~ 30 MHz DATA:

The amplitude of spurious emissions attenuated more than 20 dB below the permissible value is not required to be report.

30 MHz ~ 1 GHz WORST-CASE DATA:
802.11n (HT40)

EUT Test Condition		Measurement Detail	
Channel	Channel 3	Frequency Range	30 MHz ~ 1 GHz
Input Power	120 Vac, 60 Hz	Detector Function	Peak (PK) Quasi-peak (QP)
Environmental Conditions	25 deg. C, 65 % RH	Tested By	Charles Hsiao

Antennal Polarity & Test Distance: Horizontal at 3 m

Frequency (MHz)	Emission Level (dBuV/m)	Read Level (dBuV)	Limit (dBuV/m)	Margin (dB)	Antenna Factor (dB/m)	Cable Loss (dB)	Preamp Factor (dB)	Antenna Height (cm)	Table Angle (Degree)	Remark
108.57	22.97	44.5	43.5	-20.53	9.44	1.28	32.25	154	108	Peak
177.96	27.21	47.55	43.5	-16.29	10.29	1.61	32.24	139	127	Peak
251.13	19.92	37.04	46	-26.08	13.04	1.94	32.1	145	108	Peak
444.2	18.21	29.92	46	-27.79	17.95	2.49	32.15	123	174	Peak
678	24.69	30.39	46	-21.31	23.36	3.05	32.11	134	128	Peak
967.1	28.99	30.27	54	-25.01	25.88	3.67	30.83	139	217	Peak

Antennal Polarity & Test Distance: Vertical at 3 m

Frequency (MHz)	Emission Level (dBuV/m)	Read Level (dBuV)	Limit (dBuV/m)	Margin (dB)	Antenna Factor (dB/m)	Cable Loss (dB)	Preamp Factor (dB)	Antenna Height (cm)	Table Angle (Degree)	Remark
48.09	22.44	45.36	40	-17.56	8.4	0.9	32.22	139	264	Peak
150.42	19.6	40.19	43.5	-23.9	10.16	1.52	32.27	134	211	Peak
223.86	17.24	35.94	46	-28.76	11.85	1.65	32.2	166	341	Peak
409.2	17.61	29.49	46	-28.39	17.92	2.41	32.21	136	211	Peak
764.8	25.7	31.25	46	-20.3	23.35	3.22	32.12	198	284	Peak
918.8	27.74	29.59	46	-18.26	25.96	3.53	31.34	126	210	Peak

Remarks:

- Emission Level = Read Level + Antenna Factor + Cable Loss - Preamp Factor
Margin value = Emission level – Limit value

4.2 Conducted Emission Measurement

4.2.1 Limits of Conducted Emission Measurement

Frequency (MHz)	Conducted Limit (dBuV)	
	Quasi-peak	Average
0.15 - 0.5	66 - 56	56 - 46
0.50 - 5.0	56	46
5.0 - 30.0	60	50

Note: 1. The lower limit shall apply at the transition frequencies.

2. The limit decreases in line with the logarithm of the frequency in the range of 0.15 to 0.50 MHz.

4.2.2 Test Instruments

Description & Manufacturer	Model No.	Serial No.	Date of Calibration	Due Date of Calibration
Test Receiver ROHDE & SCHWARZ	ESCI	100613	Nov. 16, 2015	Nov. 15, 2016
RF signal cable (with 10dB PAD) Woken	5D-FB	Cable-cond1-01	Dec. 26, 2015	Dec. 25, 2016
LISN ROHDE & SCHWARZ (EUT)	ESH3-Z5	835239/001	Feb. 26, 2015	Feb. 25, 2016
LISN ROHDE & SCHWARZ (Peripheral)	ESH3-Z5	100311	Jul. 24, 2015	Jul. 23, 2016
Software ADT	BV ADT_Cond_ V7.3.7.3	NA	NA	NA

Note: 1. The calibration interval of the above test instruments is 12 months and the calibrations are traceable to NML/ROC and NIST/USA.

2. The test was performed in HwaYa Shielded Room 1.

3. The VCCI Site Registration No. is C-2040.

4.2.3 Test Procedures

- a. The EUT was placed 0.4 meters from the conducting wall of the shielded room with EUT being connected to the power mains through a line impedance stabilization network (LISN). Other support units were connected to the power mains through another LISN. The two LISNs provide 50 ohm/50 uH of coupling impedance for the measuring instrument.
- b. Both lines of the power mains connected to the EUT were checked for maximum conducted interference.
- c. The frequency range from 150 kHz to 30 MHz was searched. Emission levels under (Limit – 20 dB) was not recorded.

NOTE: All modes of operation were investigated and the worst-case emissions are reported.

4.2.4 Deviation from Test Standard

No deviation.

4.2.5 Test Setup

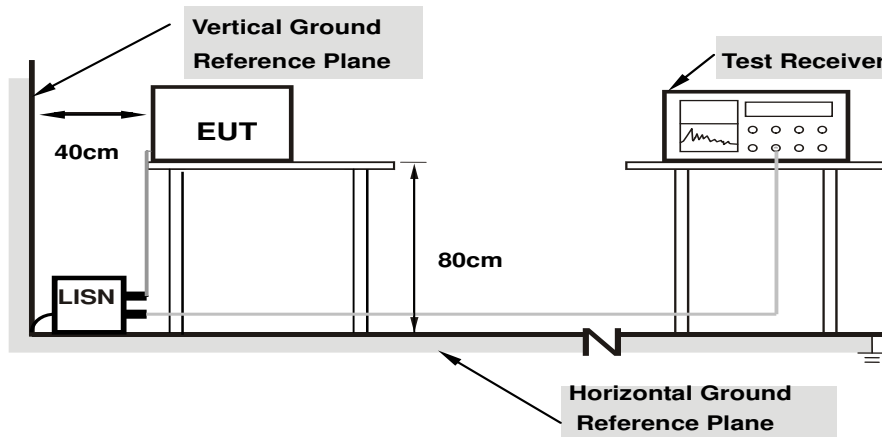

Note: 1.Support units were connected to second LISN.

For the actual test configuration, please refer to the attached file (Test Setup Photo).

4.2.6 EUT Operating Conditions

- a. Placed the EUT on a testing table.
- b. Use the software to control the EUT under transmission condition continuously at specific channel frequency.

4.2.7 Test Results

Frequency Range	150kHz ~ 30MHz	Detector Function & Resolution Bandwidth	Quasi-Peak (QP) / Average (AV), 9kHz
Input Power	120Vac, 60Hz	Environmental Conditions	25°C, 65%RH
Tested by	Toby Tian	Test Date	2016/1/20

Phase Of Power : Line (L)										
No	Frequency (MHz)	Correction Factor (dB)	Reading Value (dBuV)		Emission Level (dBuV)		Limit (dBuV)		Margin (dB)	
			Q.P.	AV.	Q.P.	AV.	Q.P.	AV.	Q.P.	AV.
1	0.15000	9.93	35.57	28.89	45.50	38.82	66.00	56.00	-20.50	-17.18
2	0.19305	9.95	29.17	15.32	39.12	25.27	63.90	53.90	-24.79	-28.64
3	0.48678	10.04	27.16	13.02	37.20	23.06	56.22	46.22	-19.02	-23.16
4	0.58792	10.06	27.64	16.26	37.70	26.32	56.00	46.00	-18.30	-19.68
5	0.93200	10.10	23.94	10.58	34.04	20.68	56.00	46.00	-21.96	-25.32
6	13.25632	10.73	23.39	16.47	34.12	27.20	60.00	50.00	-25.88	-22.80

Remarks:

1. Q.P. and AV. are abbreviations of quasi-peak and average individually.
2. The emission levels of other frequencies were very low against the limit.
3. Margin value = Emission level – Limit value
4. Correction factor = Insertion loss + Cable loss
5. Emission Level = Correction Factor + Reading Value

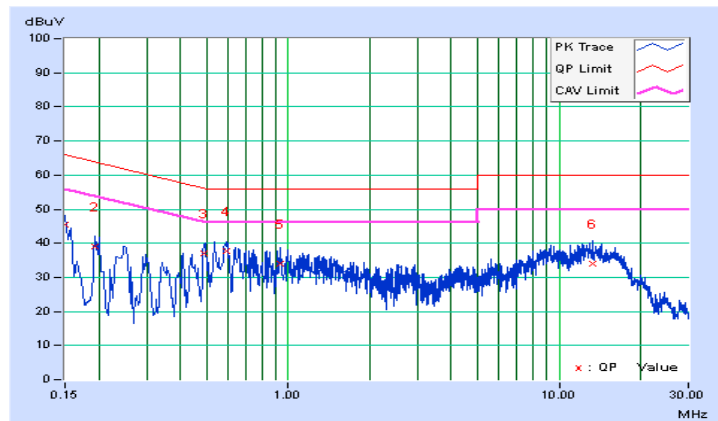

Frequency Range	150kHz ~ 30MHz	Detector Function & Resolution Bandwidth	Quasi-Peak (QP) / Average (AV), 9kHz
Input Power	120Vac, 60Hz	Environmental Conditions	25°C, 65%RH
Tested by	Toby Tian	Test Date	2016/1/20

Phase Of Power : Neutral (N)										
No	Frequency (MHz)	Correction Factor (dB)	Reading Value (dBuV)		Emission Level (dBuV)		Limit (dBuV)		Margin (dB)	
			Q.P.	AV.	Q.P.	AV.	Q.P.	AV.	Q.P.	AV.
1	0.15000	9.92	38.54	31.01	48.46	40.93	66.00	56.00	-17.54	-15.07
2	0.20031	9.94	31.40	20.75	41.34	30.69	63.60	53.60	-22.26	-22.91
3	0.29858	9.98	27.34	15.18	37.32	25.16	60.28	50.28	-22.96	-25.12
4	0.49408	10.04	26.46	11.42	36.50	21.46	56.10	46.10	-19.60	-24.64
5	0.63484	10.06	24.85	9.78	34.91	19.84	56.00	46.00	-21.09	-26.16
6	1.17056	10.12	20.00	8.30	30.12	18.42	56.00	46.00	-25.88	-27.58

Remarks:

1. Q.P. and AV. are abbreviations of quasi-peak and average individually.
2. The emission levels of other frequencies were very low against the limit.
3. Margin value = Emission level – Limit value
4. Correction factor = Insertion loss + Cable loss
5. Emission Level = Correction Factor + Reading Value

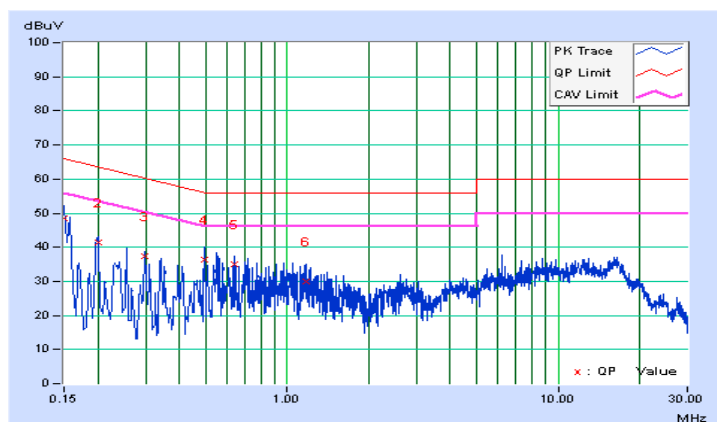

4.3 6 dB Bandwidth Measurement

4.3.1 Limits of 6 dB Bandwidth Measurement

The minimum of 6 dB Bandwidth Measurement is 0.5 MHz.

4.3.2 Test Setup

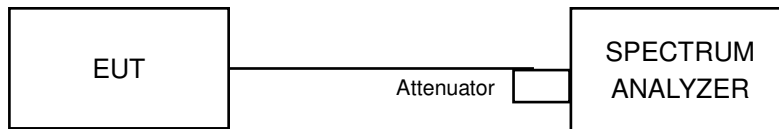

4.3.3 Test Instruments

Refer to section 4.1.2 to get information of above instrument.

4.3.4 Test Procedure

- Set resolution bandwidth (RBW) = 100 kHz
- Set the video bandwidth (VBW) $\geq 3 \times$ RBW, Detector = Peak.
- Trace mode = max hold.
- Sweep = auto couple.
- Measure the maximum width of the emission that is constrained by the frequencies associated with the two amplitude points (upper and lower) that are attenuated by 6 dB relative to the maximum level measured in the fundamental emission

4.3.5 Deviation from Test Standard

No deviation.

4.3.6 EUT Operating Conditions

The software provided by client to enable the EUT under transmission condition continuously at lowest, middle and highest channel frequencies individually.

4.3.7 Test Result

<1TX>

802.11b

Channel	Frequency (MHz)	6 dB Bandwidth (MHz)	Minimum Limit (MHz)	Pass / Fail
1	2412	7.11	0.5	Pass
6	2437	7.55	0.5	Pass
11	2462	7.10	0.5	Pass

802.11g

Channel	Frequency (MHz)	6 dB Bandwidth (MHz)	Minimum Limit (MHz)	Pass / Fail
1	2412	15.54	0.5	Pass
6	2437	16.12	0.5	Pass
11	2462	15.78	0.5	Pass

802.11n (HT20)

Channel	Frequency (MHz)	6 dB Bandwidth (MHz)	Minimum Limit (MHz)	Pass / Fail
1	2412	16.69	0.5	Pass
6	2437	17.33	0.5	Pass
11	2462	16.12	0.5	Pass

802.11n (HT40)

Channel	Frequency (MHz)	6 dB Bandwidth (MHz)	Minimum Limit (MHz)	Pass / Fail
3	2422	35.21	0.5	Pass
6	2437	36.36	0.5	Pass
9	2452	35.26	0.5	Pass

<2TX>

802.11n (HT20)

Channel	Frequency (MHz)	6 dB Bandwidth (MHz)		Minimum Limit (MHz)	Pass / Fail
		Chain 0	Chain 1		
1	2412	17.57	17.62	0.5	Pass
6	2437	17.64	17.63	0.5	Pass
11	2462	17.22	17.64	0.5	Pass

802.11n (HT40)

Channel	Frequency (MHz)	6 dB Bandwidth (MHz)		Minimum Limit (MHz)	Pass / Fail
		Chain 0	Chain 1		
3	2422	35.61	36.47	0.5	Pass
6	2437	36.44	36.43	0.5	Pass
9	2452	35.77	35.42	0.5	Pass

Spectrum Plot of Worst Value

802.11b

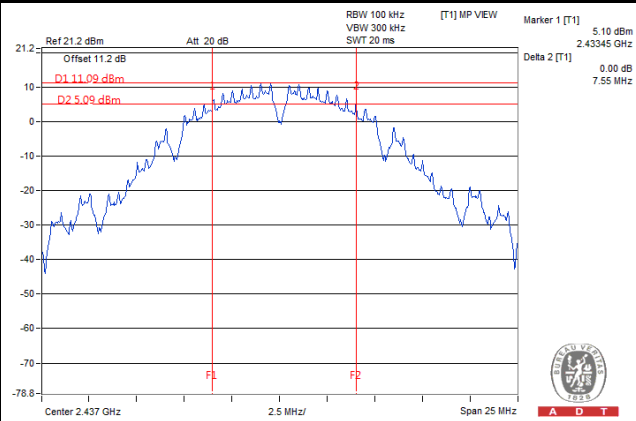

802.11g

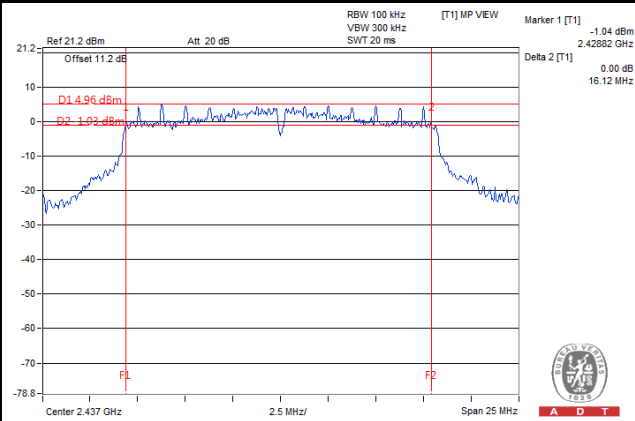

802.11n (HT20)

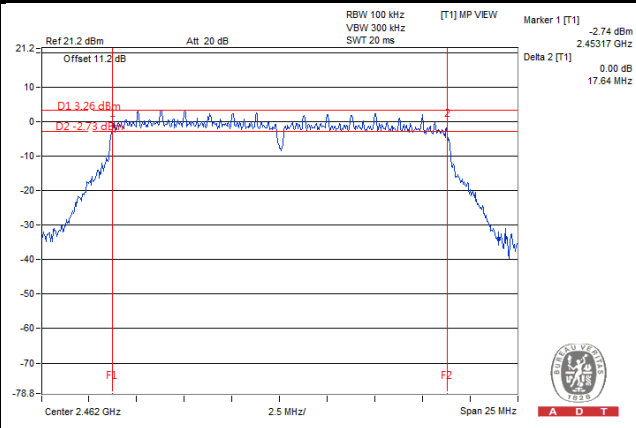

802.11n (HT40)

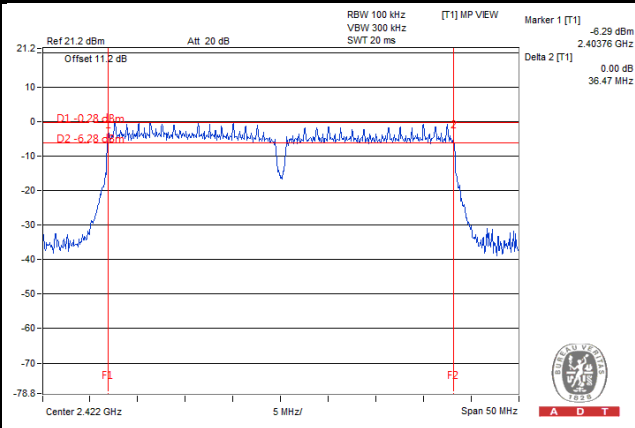

4.4 Conducted Output Power Measurement

4.4.1 Limits of Conducted Output Power Measurement

For systems using digital modulation in the 2400–2483.5 MHz bands: 1 Watt (30 dBm)

Per KDB 662911 D01 Multiple Transmitter Output Method of conducted output power measurement on IEEE 802.11 devices,

Array Gain = 0 dB (i.e., no array gain) for $NANT \leq 4$;

Array Gain = 0 dB (i.e., no array gain) for channel widths ≥ 40 MHz for any NANT;

Array Gain = $5 \log(NANT/NSS)$ dB or 3 dB, whichever is less for 20 MHz channel widths with $NANT \geq 5$.

For power measurements on all other devices: Array Gain = $10 \log(NANT/NSS)$ dB.

4.4.2 Test Setup

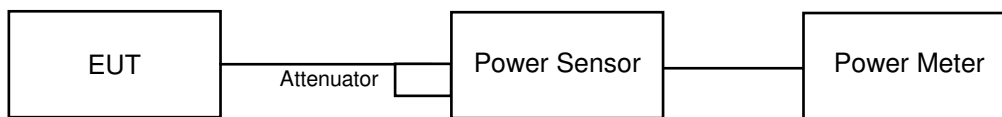

4.4.3 Test Instruments

Refer to section 4.1.2 to get information of above instrument.

4.4.4 Test Procedures

A peak power sensor was used on the output port of the EUT. A power meter was used to read the response of the peak power sensor. Record the power level.

4.4.5 Deviation from Test Standard

No deviation.

4.4.6 EUT Operating Conditions

The software provided by client to enable the EUT under transmission condition continuously at lowest, middle and highest channel frequencies individually.

4.4.7 Test Results

<1TX>

802.11b

Channel	Frequency (MHz)	Peak Power (mW)	Peak Power (dBm)	Limit (dBm)	Pass / Fail
1	2412	129.12	21.11	30	Pass
6	2437	125.89	21	30	Pass
11	2462	130.62	21.16	30	Pass

802.11g

Channel	Frequency (MHz)	Peak Power (mW)	Peak Power (dBm)	Limit (dBm)	Pass / Fail
1	2412	215.77	23.34	30	Pass
6	2437	189.67	22.78	30	Pass
11	2462	188.80	22.76	30	Pass

802.11n (HT20)

Channel	Frequency (MHz)	Peak Power (mW)	Peak Power (dBm)	Limit (dBm)	Pass / Fail
1	2412	202.77	23.07	30	Pass
6	2437	181.97	22.6	30	Pass
11	2462	180.72	22.57	30	Pass

802.11n (HT40)

Channel	Frequency (MHz)	Peak Power (mW)	Peak Power (dBm)	Limit (dBm)	Pass / Fail
3	2422	206.54	23.15	30	Pass
6	2437	183.65	22.64	30	Pass
9	2452	170.22	22.31	30	Pass

<2TX>

802.11n (HT20)

Channel	Frequency (MHz)	Peak Power (dBm)		Total Power (mW)	Total Power (dBm)	Limit (dBm)	Pass / Fail
		Chain 0	Chain 1				
1	2412	21.62	22.68	330.564	25.19	30	Pass
6	2437	21.58	21.39	281.601	24.50	30	Pass
11	2462	21.42	22.46	314.873	24.98	30	Pass

802.11n (HT40)

Channel	Frequency (MHz)	Peak Power (dBm)		Total Power (mW)	Total Power (dBm)	Limit (dBm)	Pass / Fail
		Chain 0	Chain 1				
3	2422	21.76	21.78	300.629	24.78	30	Pass
6	2437	21.13	21.67	276.611	24.42	30	Pass
9	2452	21.09	21.93	284.484	24.54	30	Pass

4.5 Power Spectral Density Measurement

4.5.1 Limits of Power Spectral Density Measurement

The Maximum of Power Spectral Density Measurement is 8 dBm.

4.5.2 Test Setup

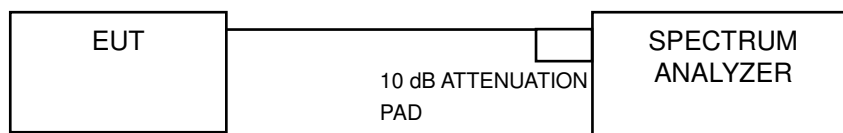

4.5.3 Test Instruments

Refer to section 4.1.2 to get information of above instrument.

4.5.4 Test Procedure

- Set analyzer center frequency to DTS channel center frequency.
- Set the span to 1.5 times the DTS bandwidth.
- Set the RBW to: $3 \text{ kHz} \leq \text{RBW} \leq 100 \text{ kHz}$.
- Set the VBW $\geq 3 \times \text{RBW}$.
- Detector = peak.
- Sweep time = auto couple.
- Trace mode = max hold.
- Allow trace to fully stabilize.
- Use the peak marker function to determine the maximum amplitude level within the RBW.

4.5.5 Deviation from Test Standard

No deviation.

4.5.6 EUT Operating Condition

The software provided by client to enable the EUT under transmission condition continuously at lowest, middle and highest channel frequencies individually.

4.5.7 Test Results

<1TX>

802.11b

Channel	Frequency (MHz)	PSD (dBm)	Limit (dBm)	Pass / Fail
1	2412	-4.39	8	Pass
6	2437	-3.71	8	Pass
11	2462	-3.17	8	Pass

802.11g

Channel	Frequency (MHz)	PSD (dBm)	Limit (dBm)	Pass / Fail
1	2412	-6.68	8	Pass
6	2437	-6.75	8	Pass
11	2462	-6.76	8	Pass

802.11n (HT20)

Channel	Frequency (MHz)	PSD (dBm)	Limit (dBm)	Pass / Fail
1	2412	-6.60	8	Pass
6	2437	-7.60	8	Pass
11	2462	-7.18	8	Pass

802.11n (HT40)

Channel	Frequency (MHz)	PSD (dBm)	Limit (dBm)	Pass / Fail
3	2422	-10.28	8	Pass
6	2437	-11.17	8	Pass
9	2452	-11.28	8	Pass

<2TX>

802.11n (HT20)

TX Chain	Channel	Freq. (MHz)	PSD (dBm)	10 log (N=2) dB	Total PSD (dBm)	Limit (dBm)	Pass / Fail
0	1	2412	-10.81	3.01	-7.80	8	Pass
	6	2437	-11.10	3.01	-8.09	8	Pass
	11	2462	-11.29	3.01	-8.28	8	Pass
1	1	2412	-10.64	3.01	-7.63	8	Pass
	6	2437	-10.85	3.01	-7.84	8	Pass
	11	2462	-11.32	3.01	-8.31	8	Pass

NOTE: Directional gain = -2 dBi + 10log(2) = 1.01 dBi < 6 dBi, so the limit no need to reduced.

802.11n (HT40)

TX Chain	Channel	Freq. (MHz)	PSD (dBm)	10 log (N=2) dB	Total PSD (dBm)	Limit (dBm)	Pass / Fail
0	3	2422	-12.24	3.01	-9.23	8	Pass
	6	2437	-13.80	3.01	-10.79	8	Pass
	9	2452	-13.52	3.01	-10.51	8	Pass
1	3	2422	-13.82	3.01	-10.81	8	Pass
	6	2437	-14.24	3.01	-11.23	8	Pass
	9	2452	-13.31	3.01	-10.30	8	Pass

NOTE: Directional gain = -2 dBi + 10log(2) = 1.01 dBi < 6 dBi, so the limit no need to reduced.

Spectrum Plot of Worst Value

802.11b

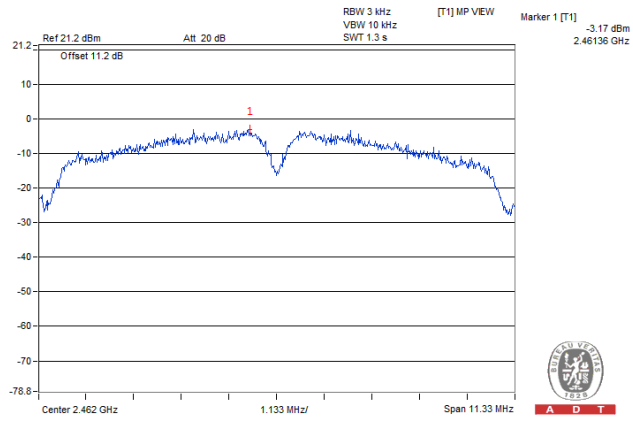

802.11g

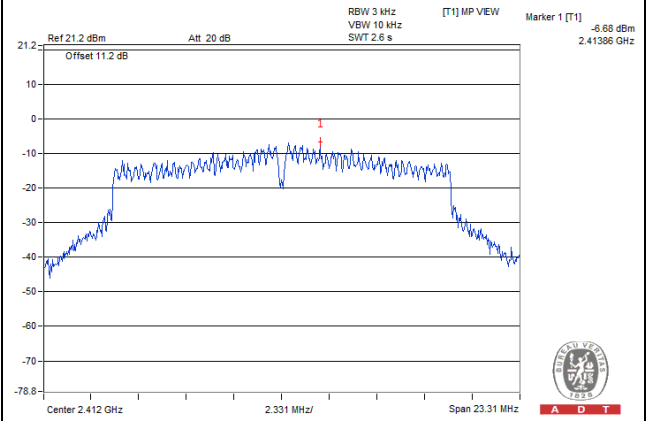

802.11n (HT20)

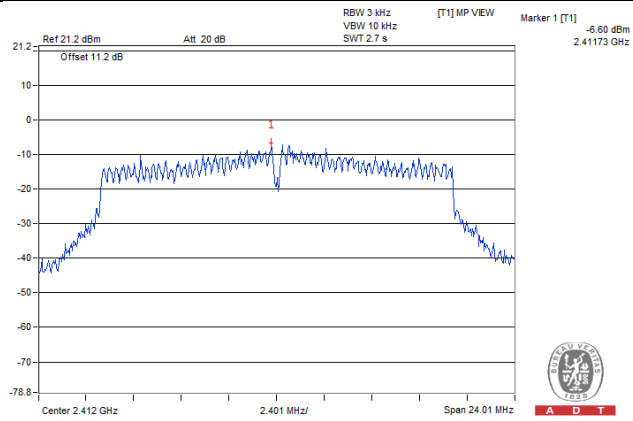

802.11n (HT40)

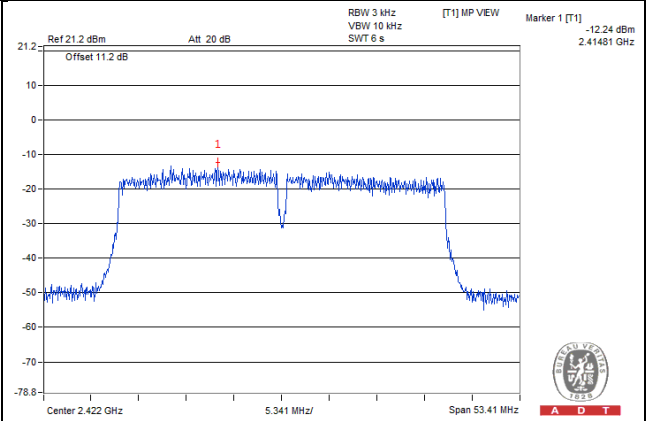

4.6 Conducted Out of Band Emission Measurement

4.6.1 Limits of Conducted Out of Band Emission Measurement

Below 20 dB of the highest emission level of operating band (in 100 kHz Resolution Bandwidth).

4.6.2 Test Setup

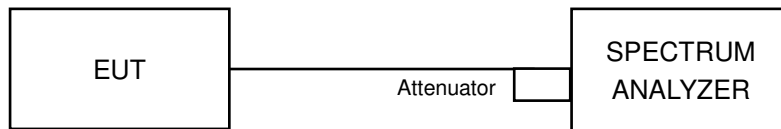

4.6.3 Test Instruments

Refer to section 4.1.2 to get information of above instrument.

4.6.4 Test Procedure

MEASUREMENT PROCEDURE REF

1. Set the RBW = 100 kHz.
2. Set the VBW \geq 300 kHz.
3. Detector = peak.
4. Sweep time = auto couple.
5. Trace mode = max hold.
6. Allow trace to fully stabilize.
7. Use the peak marker function to determine the maximum power level in any 100 kHz band segment within the fundamental EBW.

MEASUREMENT PROCEDURE OOB

1. Set RBW = 100 kHz.
2. Set VBW \geq 300 kHz.
3. Detector = peak.
4. Sweep = auto couple.
5. Trace Mode = max hold.
6. Allow trace to fully stabilize.
7. Use the peak marker function to determine the maximum amplitude level.

4.6.5 Deviation from Test Standard

No deviation.

4.6.6 EUT Operating Condition

The software provided by client to enable the EUT under transmission condition continuously at lowest, middle and highest channel frequencies individually.

4.6.7 Test Results

The conducted emission test is performed on each TX port of operating mode without summing or adding 10log (N) since the limit is relative emission limit.

The spectrum plots are attached on the following images. D1 line indicates the highest level, and D2 line indicates the 20 dB offset below D1. It shows compliance with the requirement.

<1TX>
802.11b

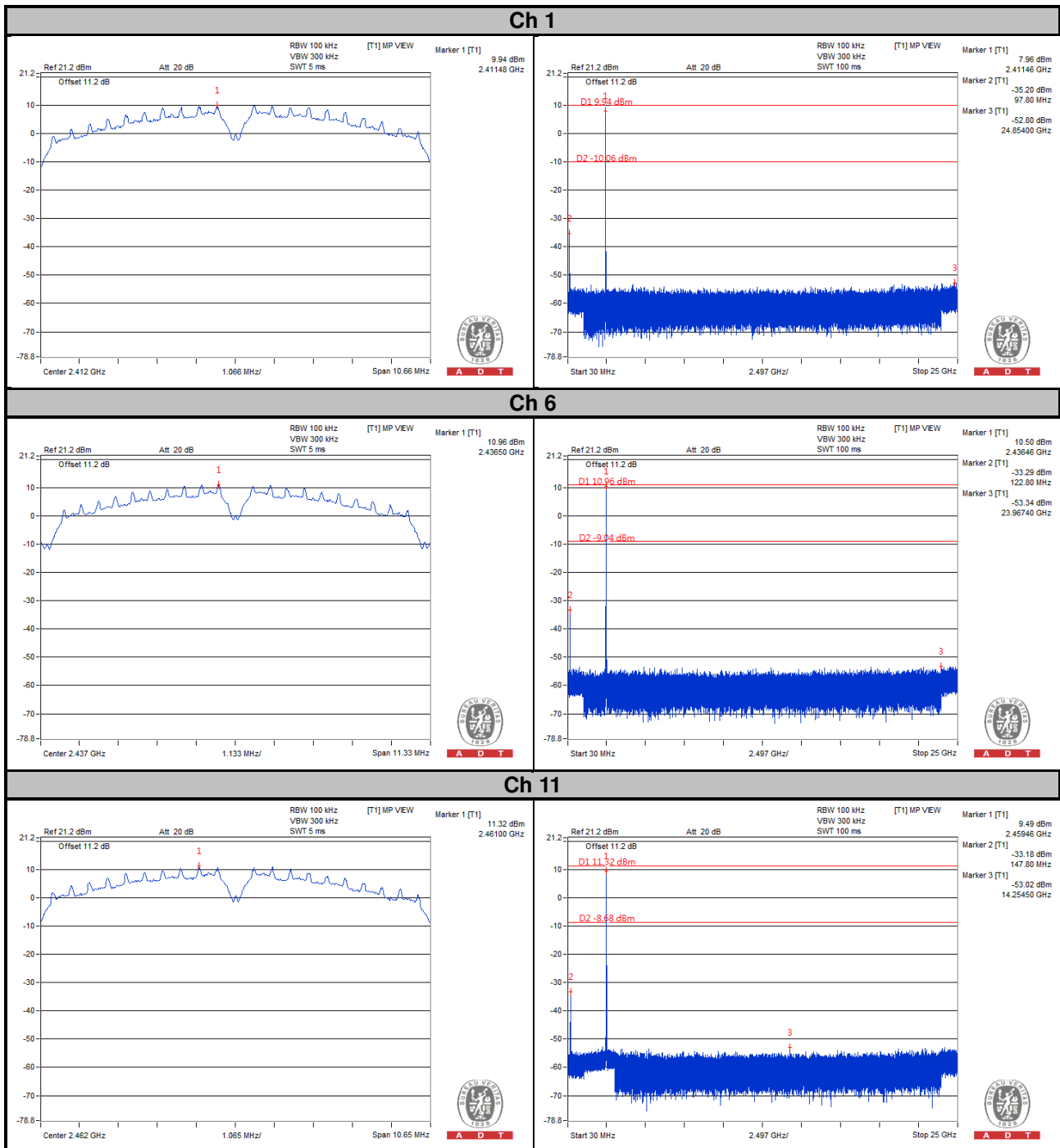

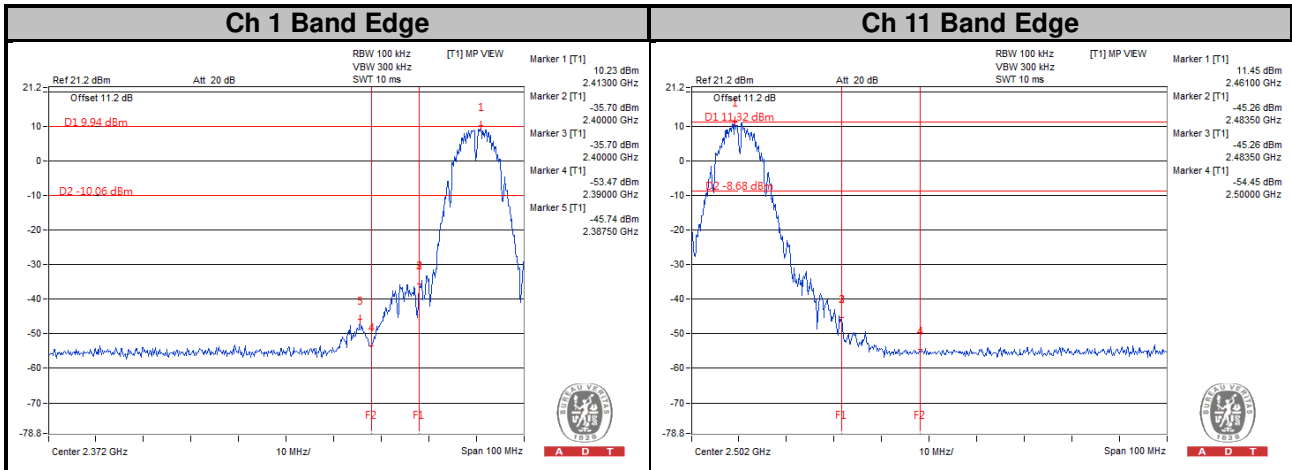

802.11g

Ch 1

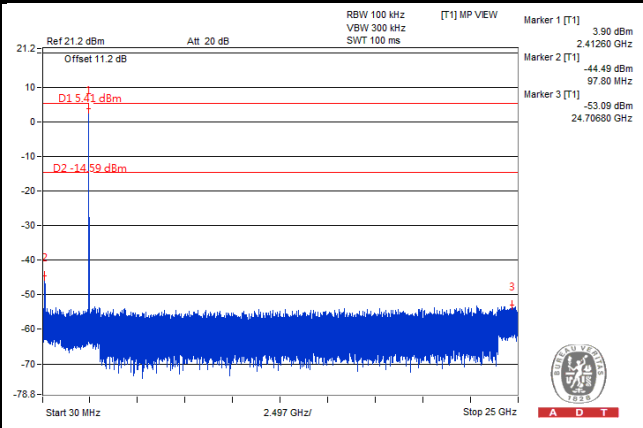
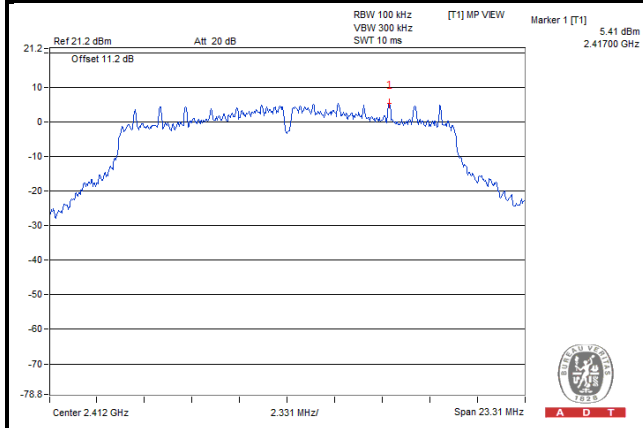

Ch 6

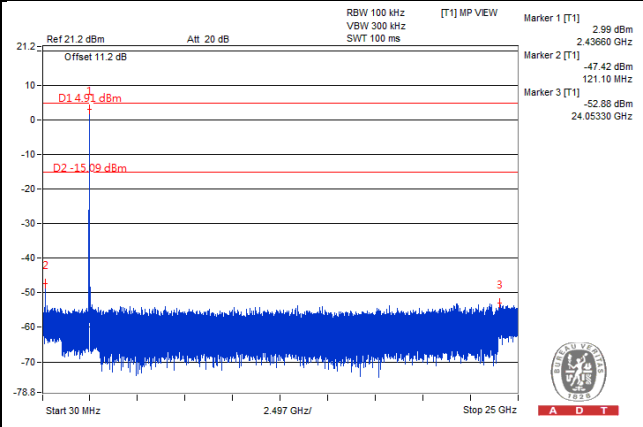
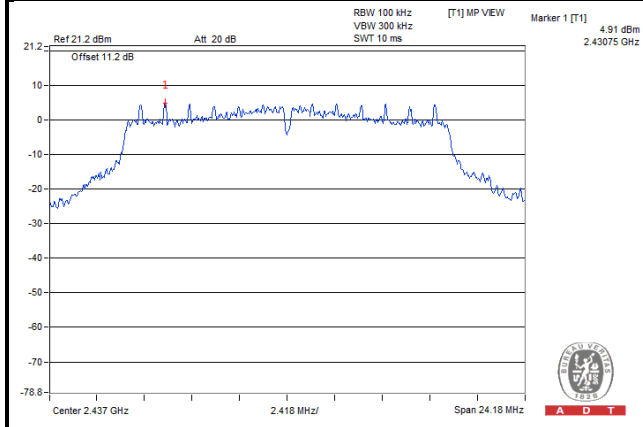

Ch 11

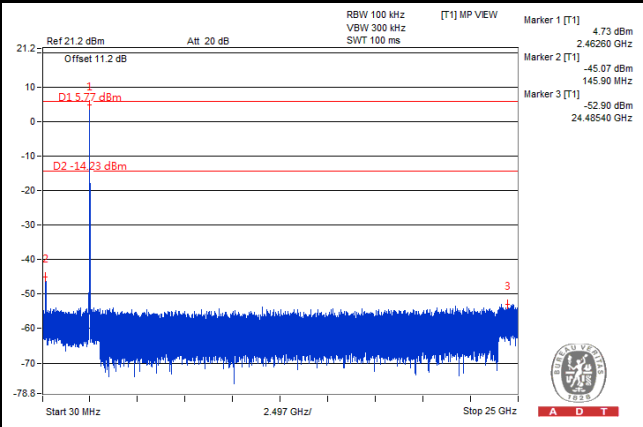
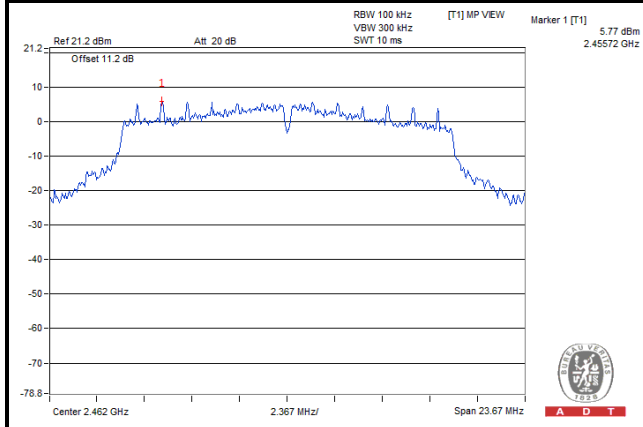

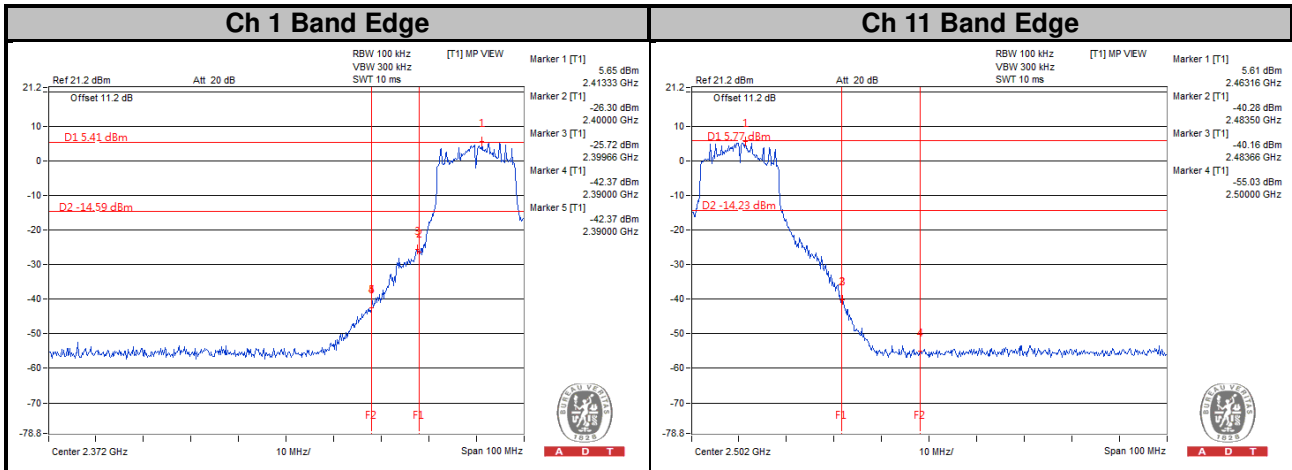

802.11n (HT20)

Ch 1

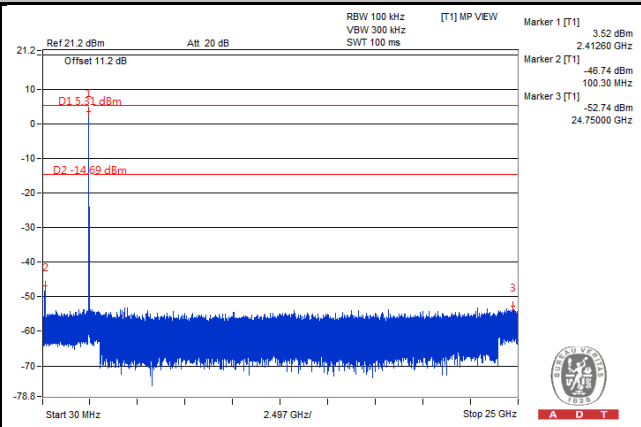
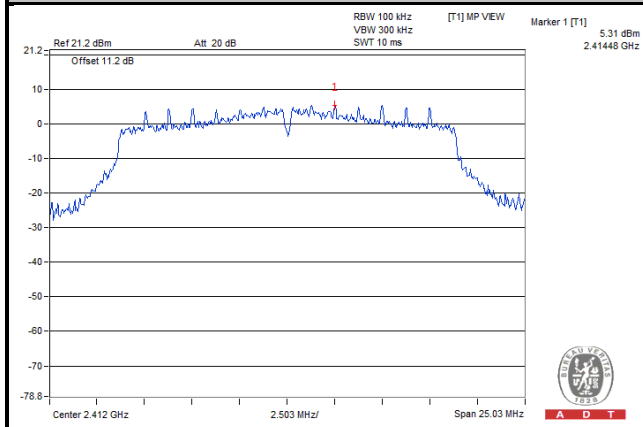

Ch 6

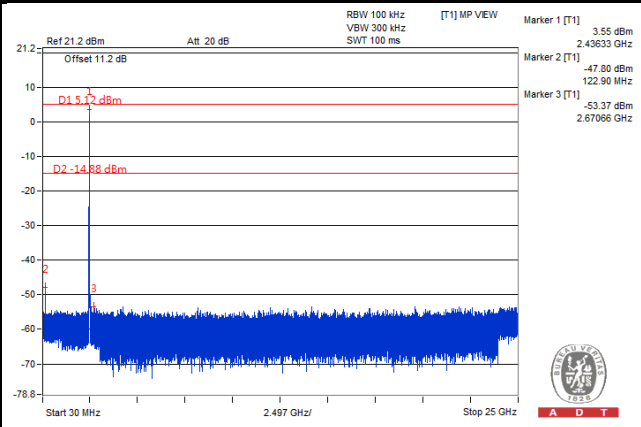
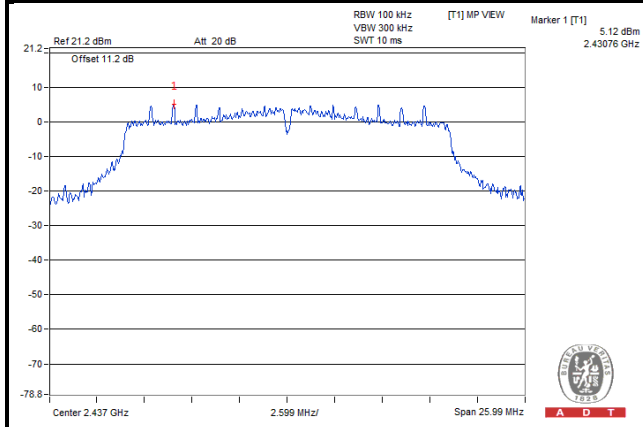

Ch 11

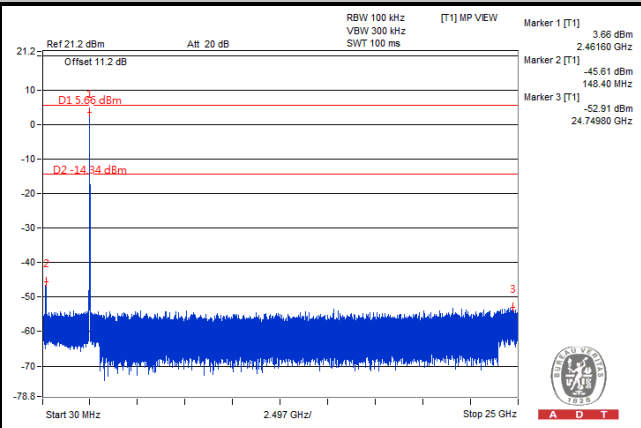
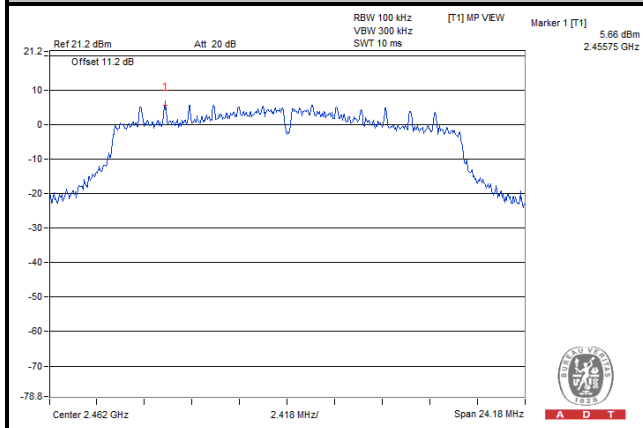

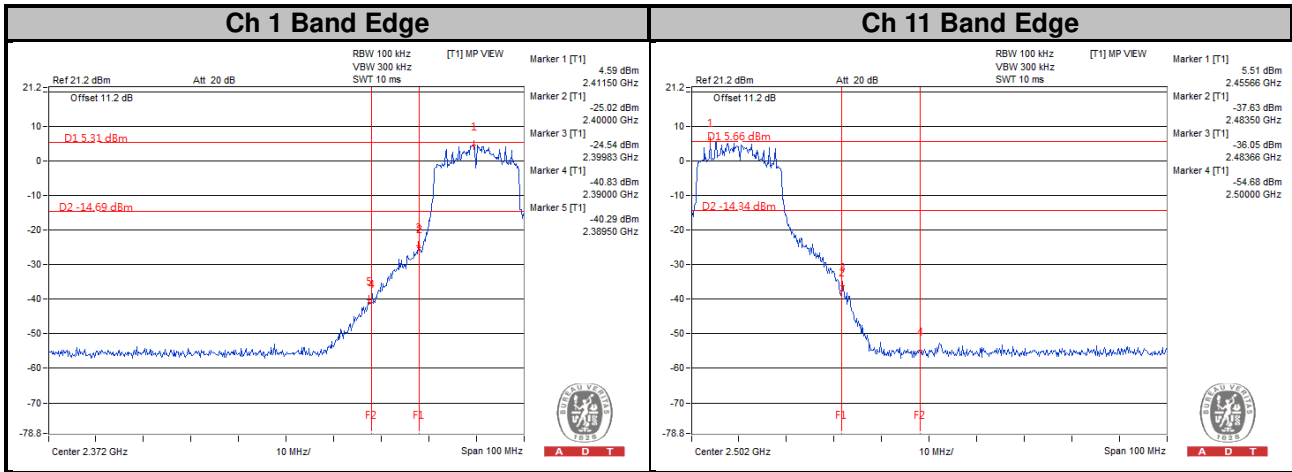

802.11n (HT40)

Ch 3

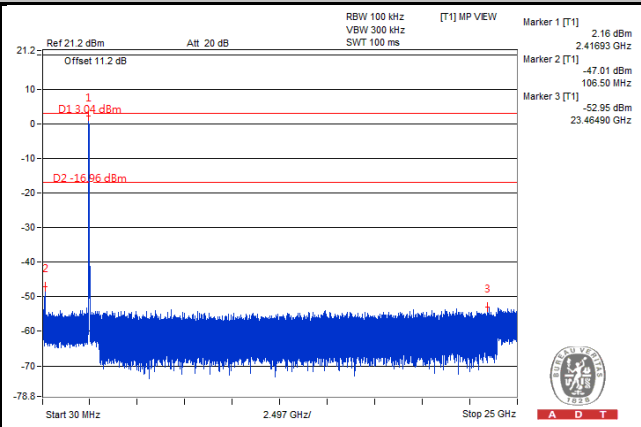
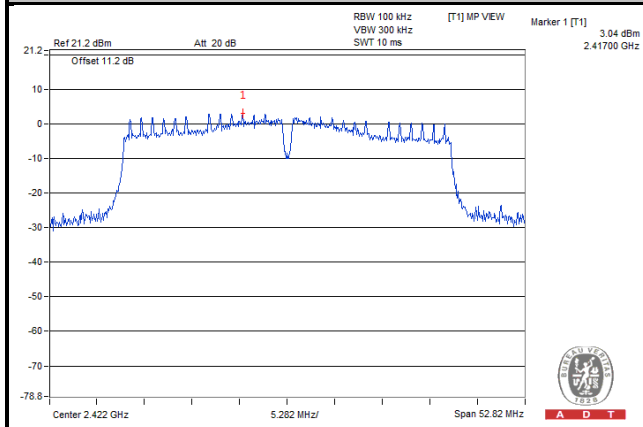

Ch 6

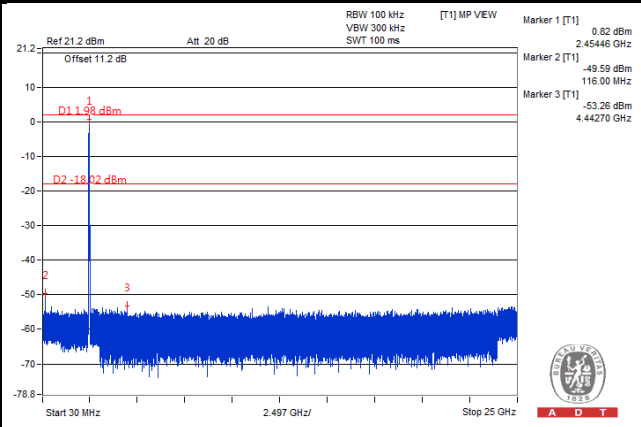
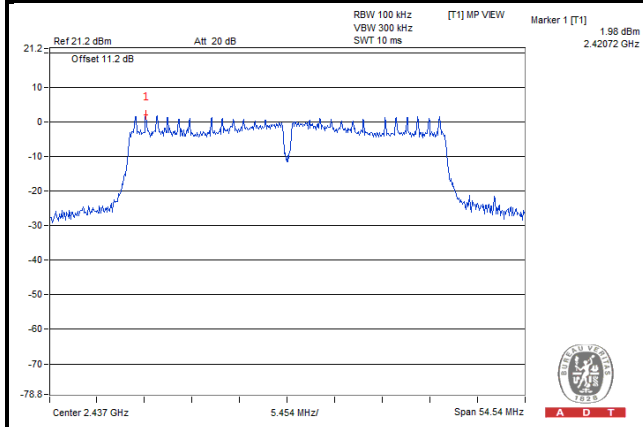

Ch 9

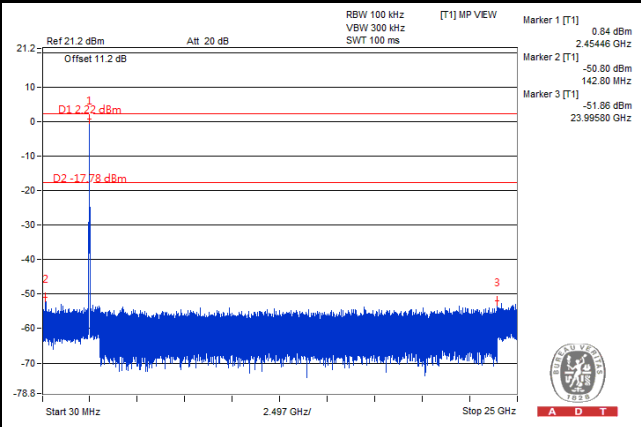
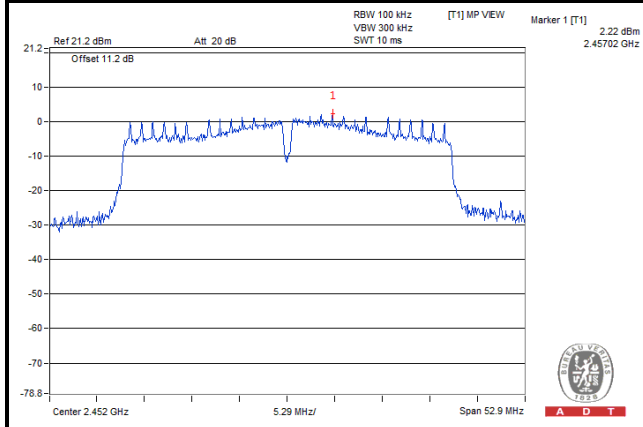

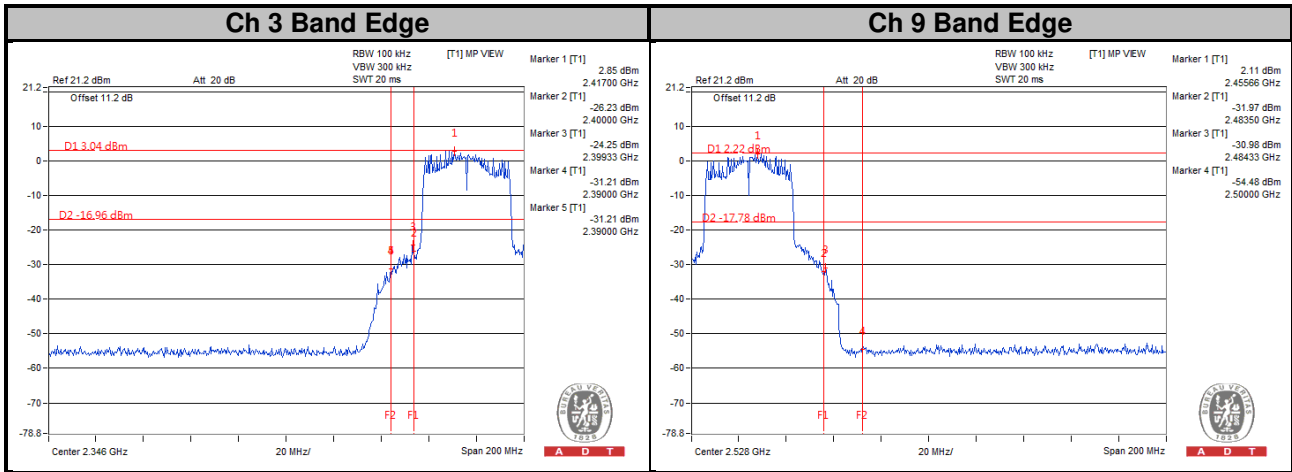

<2TX>
 802.11n (HT20)
 CHAIN 0

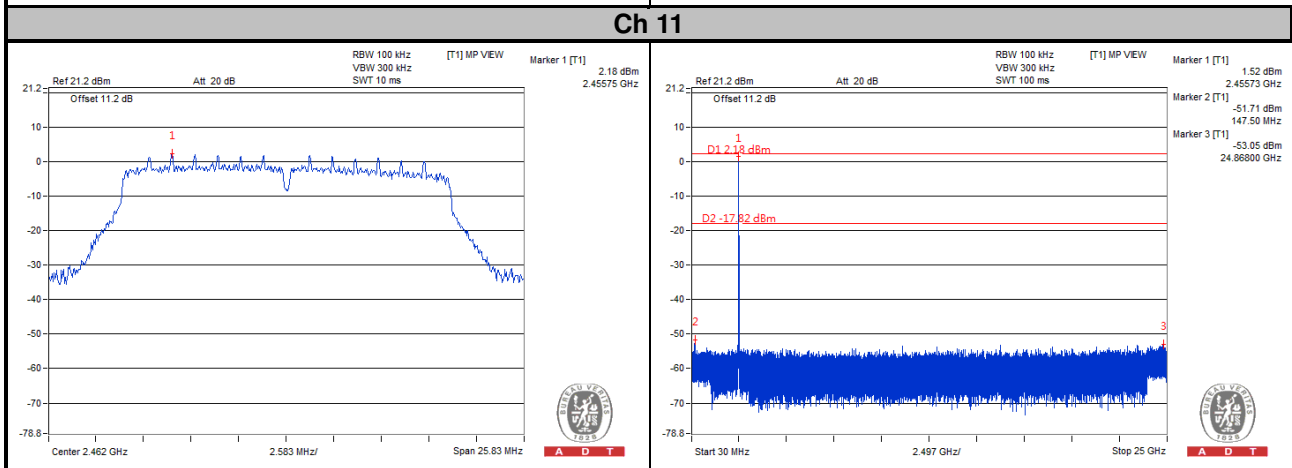
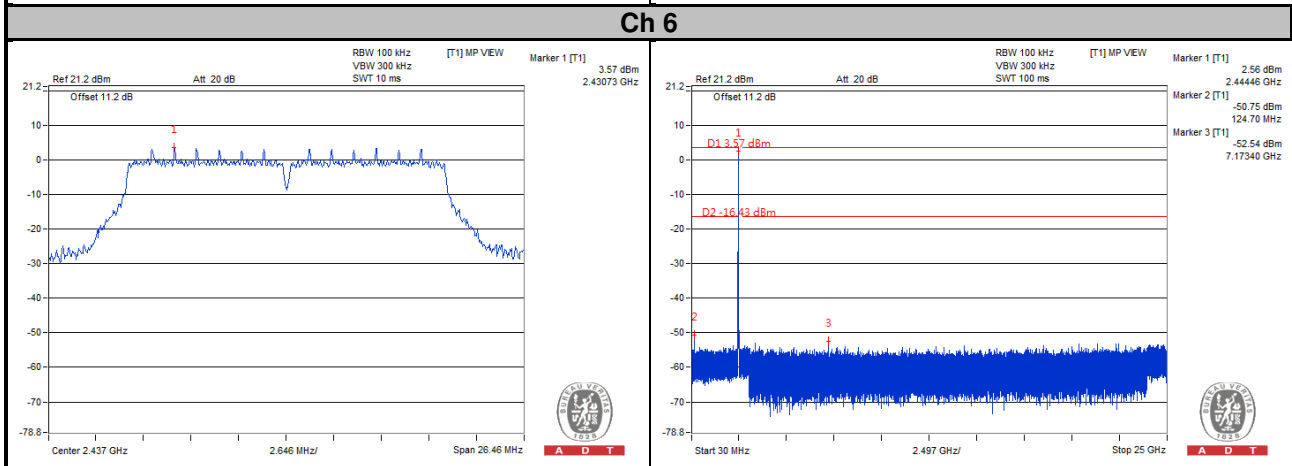
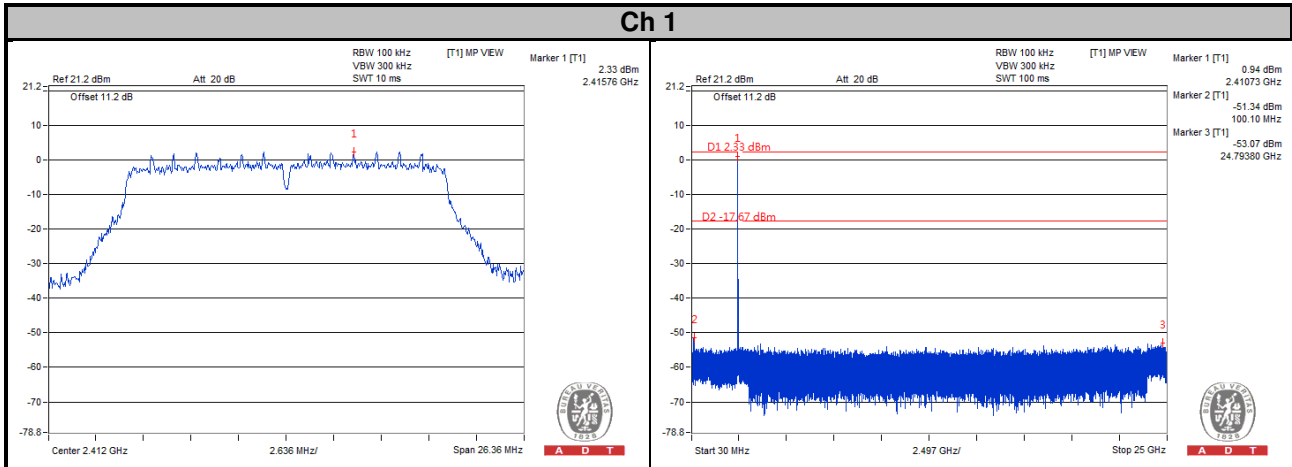

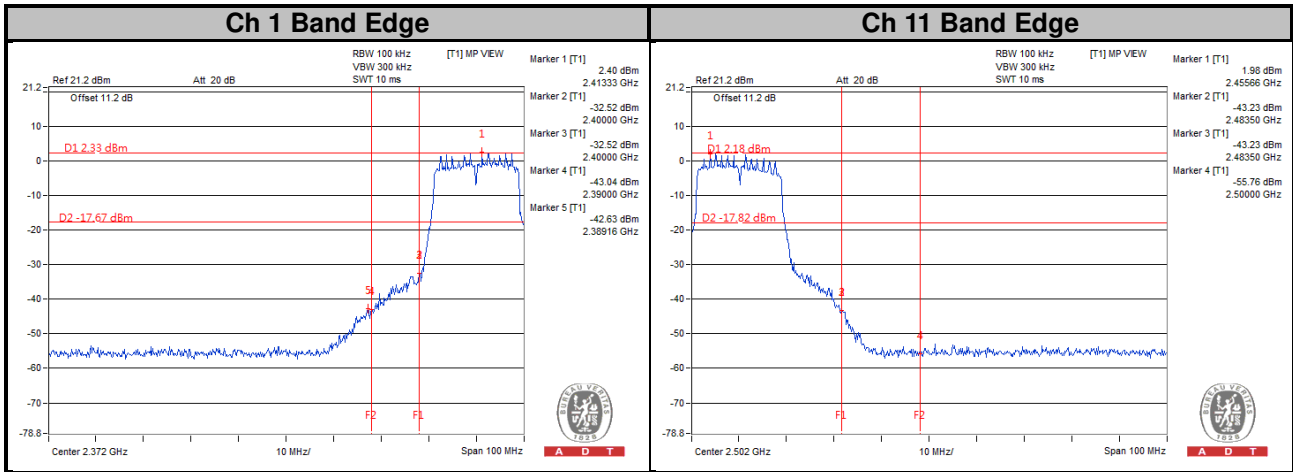

CHAIN 1

Ch 1

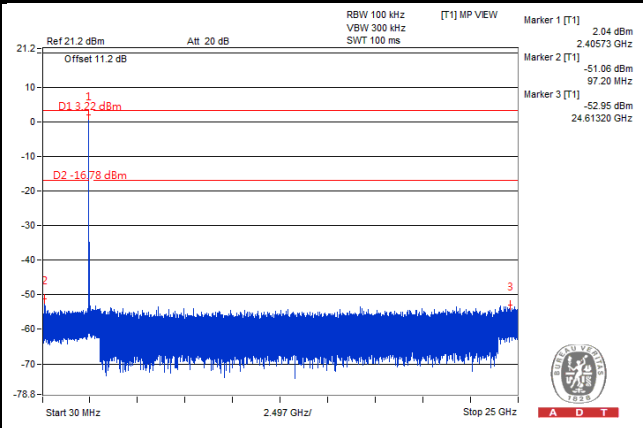
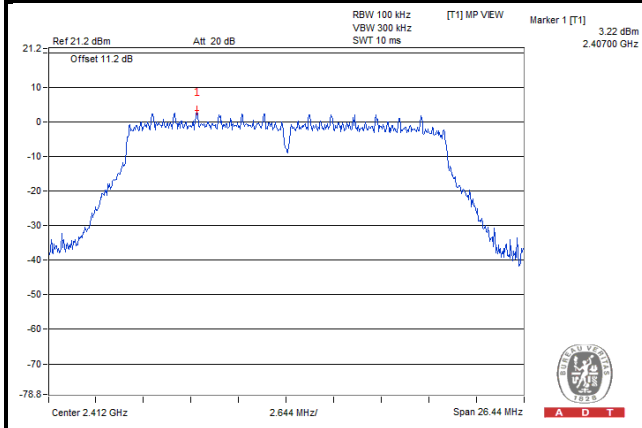

Ch 6

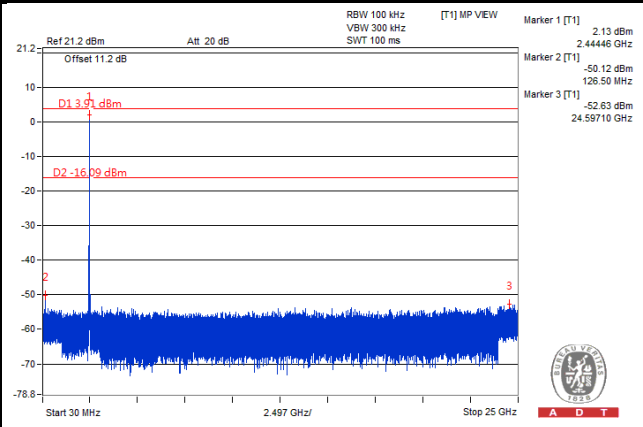
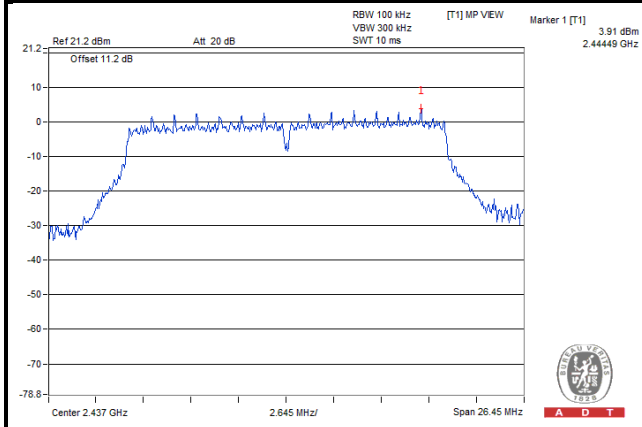

Ch 11

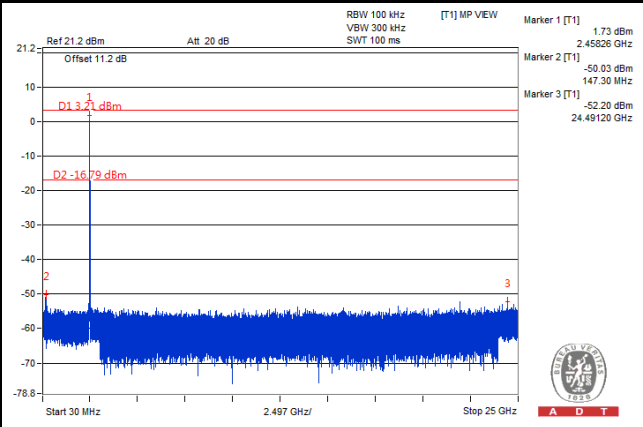
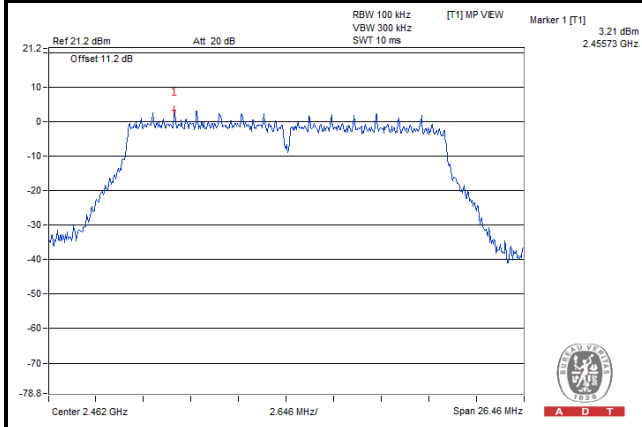

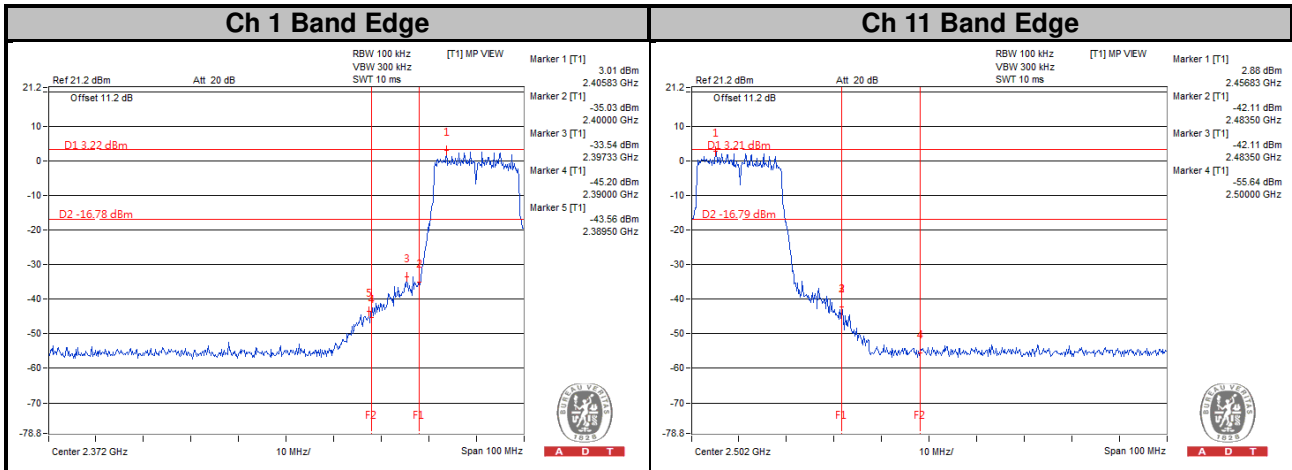

802.11n (HT40)
CHAIN 0

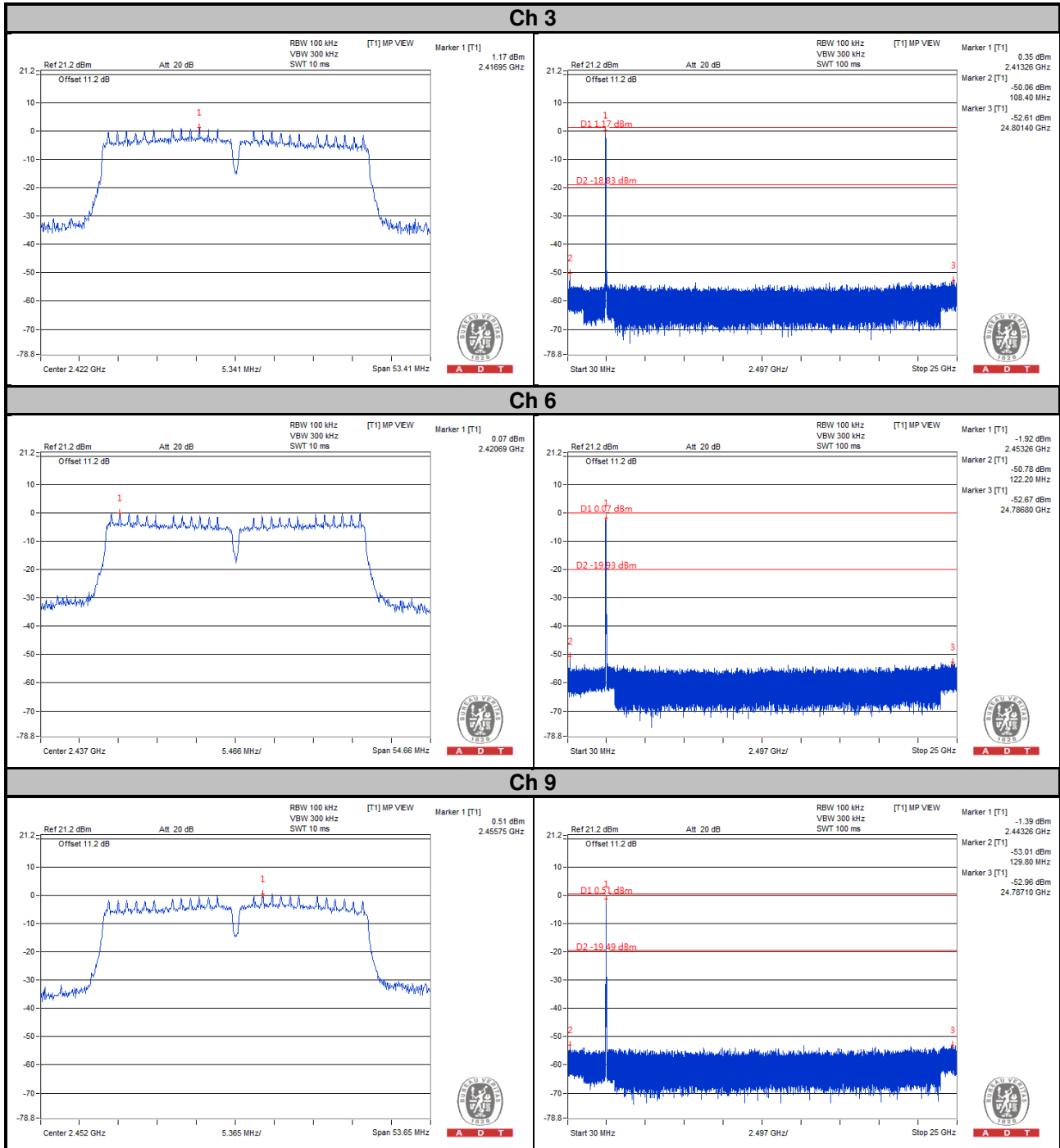

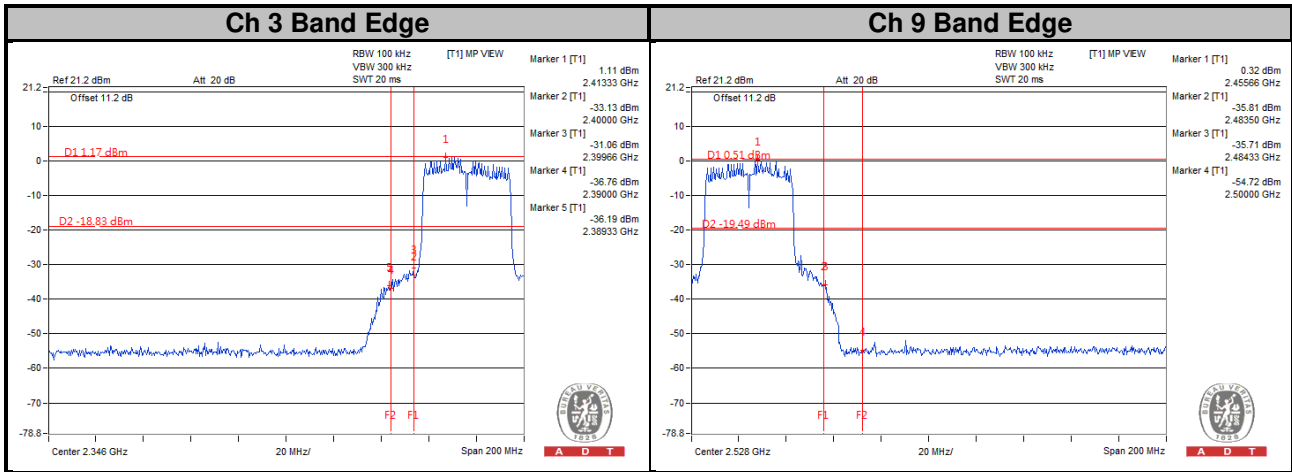

CHAIN 1

Ch 3

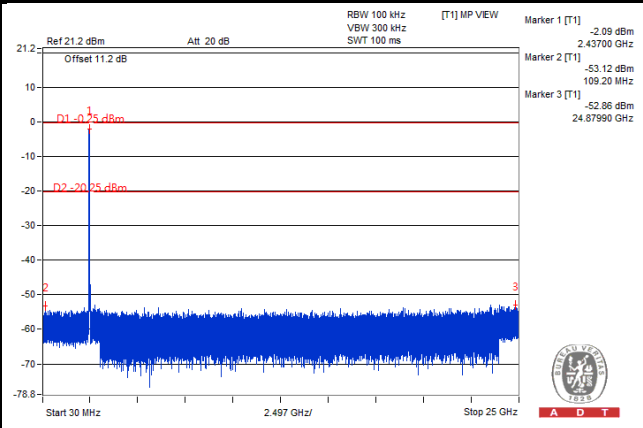
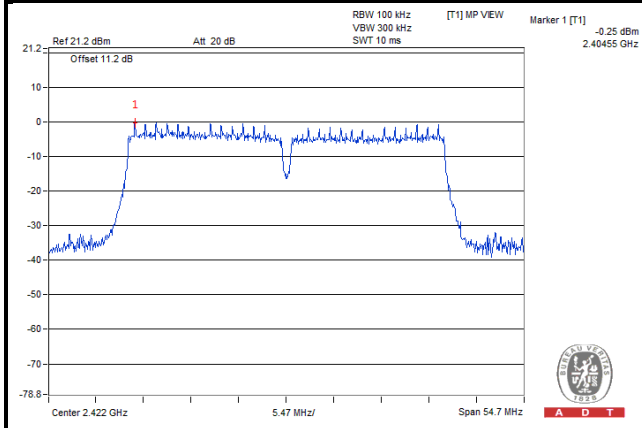

Ch 6

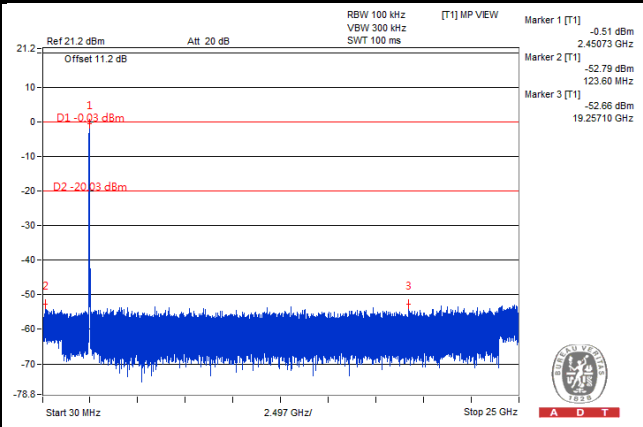
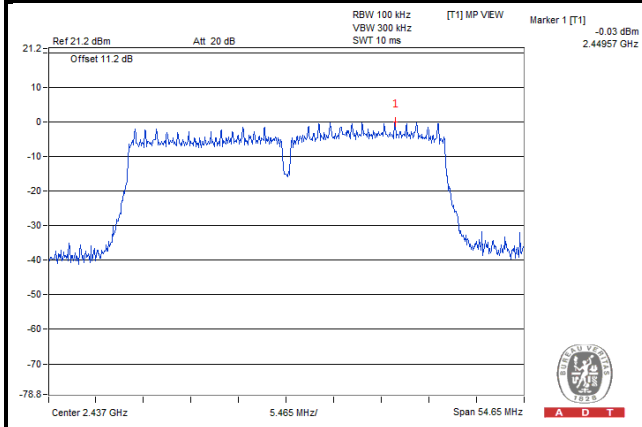

Ch 9

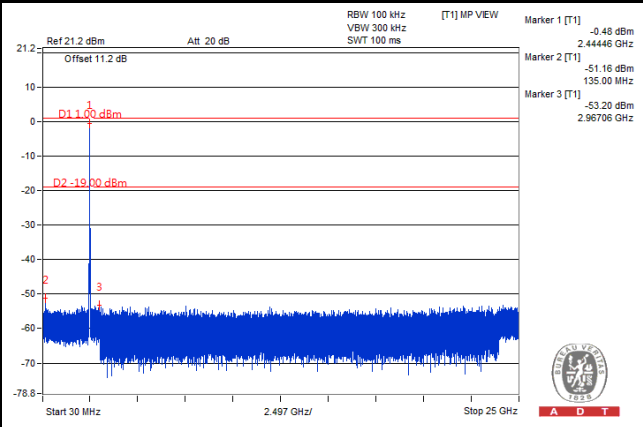
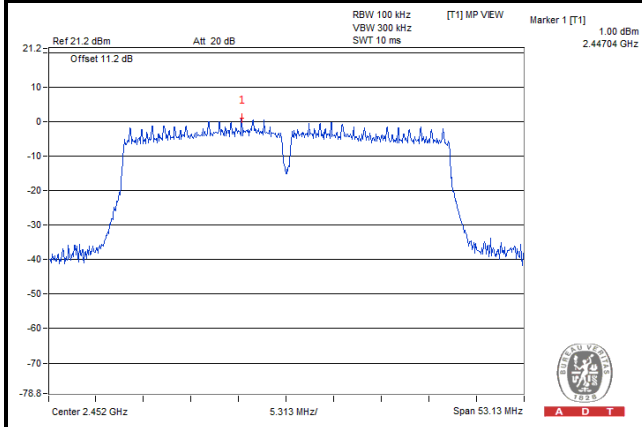

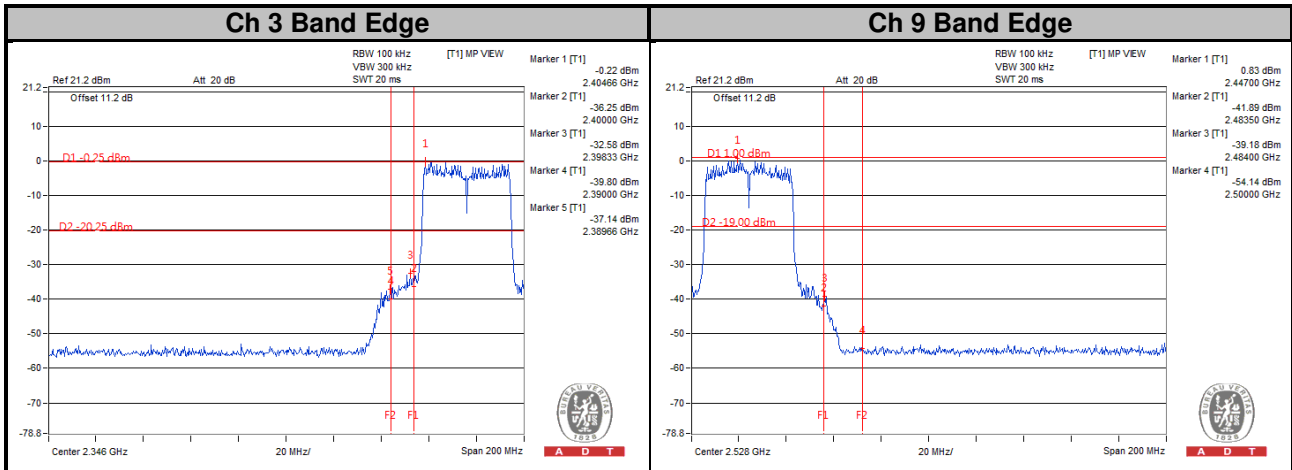



5 Pictures of Test Arrangements

Please refer to the attached file (Test Setup Photo).



A D T

Appendix – Information on the Testing Laboratories

We, Bureau Veritas Consumer Products Services (H.K.) Ltd., Taoyuan Branch, were founded in 1988 to provide our best service in EMC, Radio, Telecom and Safety consultation. Our laboratories are accredited and approved according to ISO/IEC 17025.

If you have any comments, please feel free to contact us at the following:

Linko EMC/RF Lab

Tel: 886-2-26052180

Fax: 886-2-26051924

Hsin Chu EMC/RF/Telecom Lab

Tel: 886-3-6668565

Fax: 886-3-6668323

Hwa Ya EMC/RF/Safety Lab

Tel: 886-3-3183232

Fax: 886-3-3270892

Email: service.adt@tw.bureauveritas.com

Web Site: www.bureauveritas-adt.com

The address and road map of all our labs can be found in our web site also.

--- END ---