

FCC Test Report

(PART 27)

Report No.: RF151221C02-3

FCC ID: NM82PS6500

Test Model: 2PS6500

Received Date: Dec. 21, 2015

Test Date: Jan. 20, 2016 ~ Jan. 28, 2016

Issued Date: Feb. 25, 2016

Applicant: HTC Corporation

Address: 1F, 6-3 Baoqiang Road, Xindian District, New Taipei City, Taiwan 231

Issued By: Bureau Veritas Consumer Products Services (H.K.) Ltd., Taoyuan Branch

Lab Address: No. 47-2, 14th Ling, Chia Pau Vil., Lin Kou Dist., New Taipei City, Taiwan (R.O.C)

Test Location (1): No. 19, Hwa Ya 2nd Rd, Wen Hwa Tsuen, Kwei Shan Hsiang, Taoyuan Hsien 333, Taiwan, R.O.C.

Test Location (2): No.215, Sec. 3, Beixin Rd., Xindian Dist., New Taipei City 231, Taiwan, R.O.C



This report is for your exclusive use. Any copying or replication of this report to or for any other person or entity, or use of our name or trademark, is permitted only with our prior written permission. This report sets forth our findings solely with respect to the test samples identified herein. The results set forth in this report are not indicative or representative of the quality or characteristics of the lot from which a test sample was taken or any similar or identical product unless specifically and expressly noted. Our report includes all of the tests requested by you and the results thereof based upon the information that you provided to us. You have 60 days from date of issuance of this report to notify us of any material error or omission caused by our negligence, provided, however, that such notice shall be in writing and shall specifically address the issue you wish to raise. A failure to raise such issue within the prescribed time shall constitute your unqualified acceptance of the completeness of this report, the tests conducted and the correctness of the report contents. Unless specific mention, the uncertainty of measurement has been explicitly taken into account to declare the compliance or non-compliance to the specification. The report must not be used by the client to claim product certification, approval, or endorsement by TAF or any government agency

Table of Contents

Release Control Record	3
1 Certificate of Conformity	4
2 Summary of Test Results	5
2.1 Measurement Uncertainty	5
2.2 Test Site and Instruments	6
3 General Information	8
3.1 General Description of EUT	8
3.2 Configuration of System under Test	9
3.2.1 Description of Support Units	9
3.3 Test Mode Applicability and Tested Channel Detail	10
3.4 EUT Operating Conditions	11
3.5 General Description of Applied Standards	11
4 Test Types and Results	12
4.1 Output Power Measurement	12
4.1.1 Limits of Output Power Measurement	12
4.1.2 Test Procedures	12
4.1.3 Test Setup	13
4.1.4 Test Results	14
4.2 Frequency Stability Measurement	17
4.2.1 Limits of Frequency Stability Measurement	17
4.2.2 Test Procedure	17
4.2.3 Test Setup	17
4.2.4 Test Results	18
4.3 Occupied Bandwidth Measurement	19
4.3.1 Limits of Occupied Bandwidth Measurement	19
4.3.2 Test Procedure	19
4.3.3 Test Setup	19
4.3.4 Test Result	20
4.4 Band Edge Measurement	22
4.4.1 Limits of Band Edge Measurement	22
4.4.2 Test Setup	22
4.4.3 Test Procedures	22
4.4.4 Test Results	23
4.5 Peak to Average Ratio	31
4.5.1 Limits of Peak to Average Ratio Measurement	31
4.5.2 Test Setup	31
4.5.3 Test Procedures	31
4.5.4 Test Results	32
4.6 Conducted Spurious Emissions	34
4.6.1 Limits of Conducted Spurious Emissions Measurement	34
4.6.2 Test Setup	34
4.6.3 Test Procedure	34
4.6.4 Test Results	35
4.7 Radiated Emission Measurement	37
4.7.1 Limits of Radiated Emission Measurement	37
4.7.2 Test Procedure	37
4.7.3 Deviation from Test Standard	37
4.7.4 Test Setup	37
4.7.5 Test Results	38
5 Pictures of Test Arrangements	40
Appendix – Information on the Testing Laboratories	41



A D T

Release Control Record

Issue No.	Description	Date Issued
RF151221C02-3	Original Release	Feb. 25, 2016



1 Certificate of Conformity

Product: Smartphone
Brand: HTC
Test Model: 2PS6500
Sample Status: Production Unit
Applicant: HTC Corporation
Test Date: Jan. 20, 2016 ~ Jan. 28, 2016
Standards: FCC Part 27, Subpart C, M

The above equipment has been tested by **Bureau Veritas Consumer Products Services (H.K.) Ltd., Taoyuan Branch**, and found compliance with the requirement of the above standards. The test record, data evaluation & Equipment Under Test (EUT) configurations represented herein are true and accurate accounts of the measurements of the sample's EMC characteristics under the conditions specified in this report.

Prepared by :  , **Date:** Feb. 25, 2016
Ivonne Wu / Supervisor

Approved by :  , **Date:** Feb. 25, 2016
Stanley Wu / Assistant Manager

2 Summary of Test Results

Applied Standard: FCC Part 27 & Part 2			
FCC Clause	Test Item	Result	Remarks
2.1046 27.50(h)	Equivalent Isotropic Radiated Power	Pass	Meet the requirement of limit.
2.1055 27.54	Frequency Stability	Pass	Meet the requirement of limit.
2.1049	Occupied Bandwidth	Pass	Meet the requirement of limit.
	Peak to Average Ratio	Pass	Meet the requirement of limit.
2.1051 27.53(l)	Band Edge Measurements	Pass	Meet the requirement of limit.
2.1051 27.53(m)	Conducted Spurious Emissions	Pass	Meet the requirement of limit.
2.1053 27.53(m)	Radiated Spurious Emissions	Pass	Meet the requirement of limit. Minimum passing margin is -21.87 dB at 5070.00 MHz.

2.1 Measurement Uncertainty

Where relevant, the following measurement uncertainty levels have been estimated for tests performed on the EUT as specified in CISPR 16-4-2:

Measurement	Frequency	Expanded Uncertainty (k=2) (±)
Conducted Emissions at mains ports	150 kHz ~ 30 MHz	2.44 dB
Radiated Emissions up to 1 GHz	30 MHz ~ 200 MHz	2.0153 dB
	200 MHz ~ 1000 MHz	2.0224 dB
Radiated Emissions above 1 GHz	1 GHz ~ 18 GHz	1.0121 dB
	18 GHz ~ 40 GHz	1.1508 dB

2.2 Test Site and Instruments

Description & Manufacturer	Model No.	Serial No.	Date of Calibration	Due Date of Calibration
Test Receiver Agilent Technologies	N9038A	MY52260177	May 19, 2015	May 18, 2016
Spectrum Analyzer ROHDE & SCHWARZ	FSU43	101261	Dec. 17, 2015	Dec. 16, 2016
BILOG Antenna SCHWARZBECK	VULB9168	9168-472	Jan. 07, 2016	Jan. 06, 2017
HORN Antenna ETS-Lindgren	3117	00143293	Jan. 04, 2016	Jan. 03, 2017
Double Ridge Guide Horn Antenna EMCO	3115	5619	Jan. 04, 2016	Jan. 03, 2017
BILOG Antenna SCHWARZBECK	VULB 9168	9168-153	Jan. 07, 2016	Jan. 06, 2017
Bluetooth Tester	CBT	100980	Apr. 27, 2015	Apr. 26, 2017
Agilent Communications Tester-Wireless	8960 Series 10	MY53201073	Jul. 03, 2015	Jul. 02, 2017
Preamplifier Agilent	310N	187226	Jun. 29, 2015	Jun. 28, 2016
Preamplifier Agilent	83017A	MY39501357	Jun. 29, 2015	Jun. 28, 2016
Power Meter Anritsu	ML2495A	1232002	Sep. 21, 2015	Sep. 20, 2016
Power Sensor Anritsu	MA2411B	1207325	Sep. 21, 2015	Sep. 20, 2016
RF signal cable ETS-LINDGREN	5D-FB	Cable-CH1-01(R FC-SMS-100-SM S-120+RFC-SMS -100-SMS-400)	Jun. 27, 2015	Jun. 26, 2016
RF signal cable ETS-LINDGREN	8D-FB	Cable-CH1-02(R FC-SMS-100-SM S-24)	Jun. 27, 2015	Jun. 26, 2016
Software BV ADT	E3 8.130425b	NA	NA	NA
Antenna Tower MF	NA	NA	NA	NA
Turn Table MF	NA	NA	NA	NA
Antenna Tower & Turn Table Controller MF	MF-7802	NA	NA	NA
Communications Tester-Wireless Agilent	8960 Series 10	MY53201073	Jul. 03, 2015	Jul. 02, 2017
Radio Communication Analyzer Anritsu	MT8820C	6201240432	Jul. 06, 2015	Jul. 05, 2017



- Note:
1. The calibration interval of the above test instruments is 12 months and the calibrations are traceable to NML/ROC and NIST/USA.
 2. The test was performed in HsinTien Chamber 1.
 3. The horn antenna and preamplifier (model: 83017A) are used only for the measurement of emission frequency above 1 GHz if tested.
 4. The FCC Site Registration No. is 149147.
 5. The IC Site Registration No. is IC7450I-1.



3 General Information

3.1 General Description of EUT

Product	Smartphone	
Brand	HTC	
Test Model	2PS6500	
Status of EUT	Production Unit	
Power Supply Rating	5.0 Vdc (adapter or host equipment) 3.85 Vdc (Li-ion battery)	
Modulation Type	QPSK, 16QAM	
Frequency Range	LTE Band 7 (Channel Bandwidth: 5 MHz)	2502.5 ~ 2567.5 MHz
	LTE Band 7 (Channel Bandwidth: 10 MHz)	2505 ~ 2565 MHz
	LTE Band 7 (Channel Bandwidth: 15 MHz)	2507.5 ~ 2562.5 MHz
	LTE Band 7 (Channel Bandwidth: 20 MHz)	2510 ~ 2560 MHz
Max. EIRP Power	LTE Band 7 (Channel Bandwidth: 5 MHz)	194.58 mW
	LTE Band 7 (Channel Bandwidth: 10 MHz)	194.22 mW
	LTE Band 7 (Channel Bandwidth: 15 MHz)	198.52 mW
	LTE Band 7 (Channel Bandwidth: 20 MHz)	198.47 mW
Emission Designator	LTE Band 7 (Channel Bandwidth: 5 MHz)	4M50G7D
	LTE Band 7 (Channel Bandwidth: 10 MHz)	8M97G7D
	LTE Band 7 (Channel Bandwidth: 15 MHz)	13M5G7D
	LTE Band 7 (Channel Bandwidth: 20 MHz)	18M0G7D
Antenna Type	Fixed Internal Antenna	
Accessory Device	Refer to Note as below	
Data Cable Supplied	Refer to Note as below	

Note:

1. The EUT's accessories list refers to Ext. Pho.
2. The above EUT information is declared by manufacturer and for more detailed features description, please refer to the manufacturer's specifications or user's manual.

3.2 Configuration of System under Test

<Radiated Emission Test>

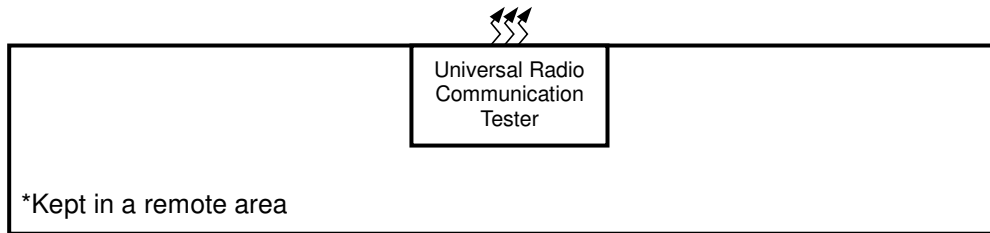
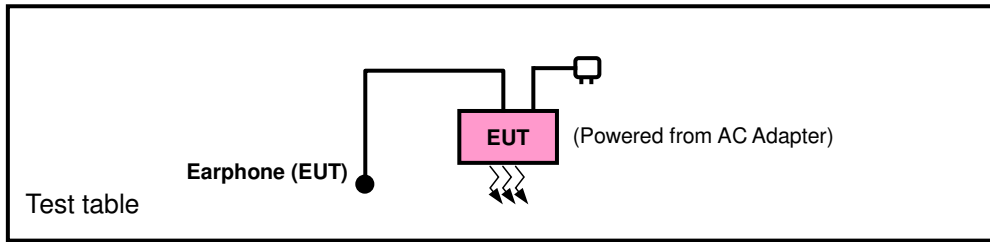

<E.I.R.P. Test>

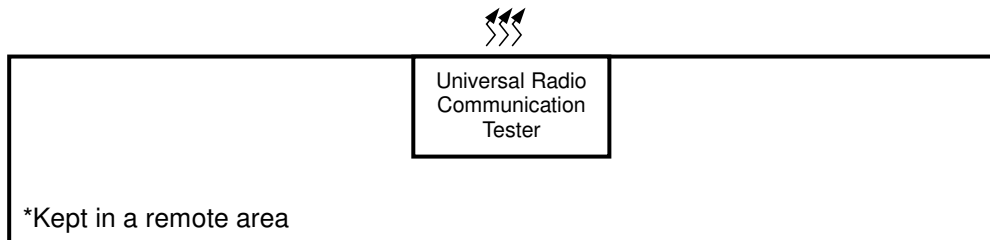
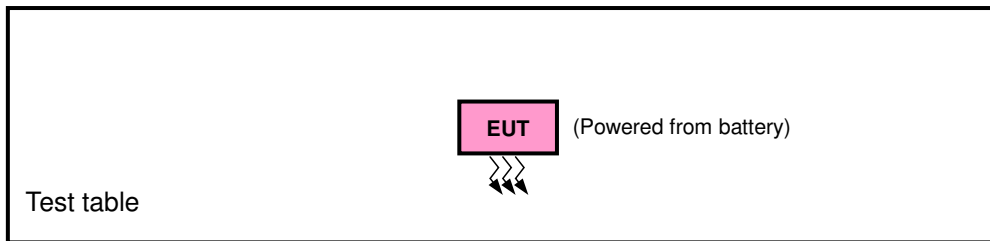

3.2.1 Description of Support Units

The EUT has been tested as an independent unit together with other necessary accessories or support units.

3.3 Test Mode Applicability and Tested Channel Detail

Pre-Scan has been conducted to determine the worst-case mode from all possible combinations between available modulations, data rates, XYZ axis, and antenna ports.

The worst case was found when positioned as the table below. Following channel(s) was (were) selected for the final test as listed below:

Band	EIRP	Radiated Emission
LTE Band 7	Y-plane	X-axis

LTE Band 7

EUT Configure Mode	Test Item	Available Channel	Tested Channel	Channel Bandwidth	Modulation	Mode
-	EIRP	20775 to 21425	20775, 21100, 21425	5 MHz	QPSK, 16QAM	1 RB / 0 RB Offset
		20800 to 21400	20800, 21100, 21400	10 MHz	QPSK, 16QAM	1 RB / 0 RB Offset
		20825 to 21375	20825, 21100, 21375	15 MHz	QPSK, 16QAM	1 RB / 0 RB Offset
		20850 to 21350	20850, 21100 21350	20 MHz	QPSK, 16QAM	1 RB / 0 RB Offset
-	Frequency Stability	20775 to 21425	21100	5 MHz	QPSK	1 RB / 0 RB Offset
		20800 to 21400	21100	10 MHz	QPSK	1 RB / 0 RB Offset
		20825 to 21375	21100	15 MHz	QPSK	1 RB / 0 RB Offset
		20850 to 21350	21100	20 MHz	QPSK	1 RB / 0 RB Offset
-	Occupied Bandwidth	20775 to 21425	20775, 21100, 21425	5 MHz	QPSK, 16QAM	25 RB / 0 RB Offset
		20800 to 21400	20800, 21100, 21400	10 MHz	QPSK, 16QAM	50 RB / 0 RB Offset
		20825 to 21375	20825, 21100, 21375	15 MHz	QPSK, 16QAM	75 RB / 0 RB Offset
		20850 to 21350	20850, 21100 21350	20 MHz	QPSK, 16QAM	100 RB / 0 RB Offset
-	Peak to Average Ratio	20775 to 21425	20775, 21100, 21425	5 MHz	QPSK, 16QAM	1 RB / 0 RB Offset
		20800 to 21400	20800, 21100, 21400	10 MHz	QPSK, 16QAM	1 RB / 0 RB Offset
		20825 to 21375	20825, 21100, 21375	15 MHz	QPSK, 16QAM	1 RB / 0 RB Offset
		20850 to 21350	20850, 21100 21350	20 MHz	QPSK, 16QAM	1 RB / 0 RB Offset
-	Band Edge	20775 to 21425	20775, 21425	5 MHz	QPSK, 16QAM	25 RB / 0 RB Offset
		20800 to 21400	20800, 21400	10 MHz	QPSK, 16QAM	50 RB / 0 RB Offset
		20825 to 21375	20825, 21375	15 MHz	QPSK, 16QAM	75 RB / 0 RB Offset
		20850 to 21350	20850, 21350	20 MHz	QPSK, 16QAM	100 RB / 0 RB Offset
-	Conducted Emission	20775 to 21425	21100	5 MHz	QPSK	1 RB / 0 RB Offset
		20800 to 21400	21100	10 MHz	QPSK	1 RB / 0 RB Offset
		20825 to 21375	21100	15 MHz	QPSK	1 RB / 0 RB Offset
		20850 to 21350	21100	20 MHz	QPSK	1 RB / 0 RB Offset
-	Radiated Emission	20850 to 21350	21100	20 MHz	QPSK	1 RB / 0 RB Offset

Note: This device was tested under all bandwidths, RB configurations and modulations. The worst case was found in QPSK modulation.

Test Condition:

Test Item	Environmental Conditions	Input Power	Tested By
EIRP	25 deg. C, 65 % RH	3.85 Vdc	Carlos Chen
Frequency Stability	25 deg. C, 65 % RH	3.85 Vdc	Carlos Chen
Occupied Bandwidth	25 deg. C, 65 % RH	3.85 Vdc	Carlos Chen
Band Edge	25 deg. C, 65 % RH	3.85 Vdc	Carlos Chen
Peak to Average Ratio	25 deg. C, 65 % RH	3.85 Vdc	Carlos Chen
Conducuted Emission	25 deg. C, 65 % RH	3.85 Vdc	Carlos Chen
Radiated Emission	25 deg. C, 65 % RH	120 Vac, 60 Hz	Charles Hsiao

3.4 EUT Operating Conditions

The EUT makes a call to the communication simulator. The communication simulator station system controlled a EUT to export maximum output power under transmission mode and specific channel frequency

3.5 General Description of Applied Standards

The EUT is a RF Product. According to the specifications of the manufacturer, it must comply with the requirements of the following standards:

FCC 47 CFR Part 2

FCC 47 CFR Part 27

KDB 971168 D01 Power Meas License Digital Systems v02r02

ANSI/TIA/EIA-603-D 2010

NOTE: All test items have been performed and recorded as per the above standards.

4 Test Types and Results

4.1 Output Power Measurement

4.1.1 Limits of Output Power Measurement

The radiated peak output power shall be according to the specific rule Part 27.50(h)(2) that “User stations are limited to 2 watts” and 27.50(i) specific that “Peak transmit power must be measure over any interval of continuous transmission using instrumentation calibration in terms of rms-equivalent voltage.”

4.1.2 Test Procedures

EIRP Measurement:

- a. All measurements were done at low, middle and high operational frequency range. RBW and VBW is 10 MHz for LTE mode.
- b. Substitution method is used for E.I.R.P measurement. In the semi-anechoic chamber, EUT placed on the 0.8 m height of Turn Table, rotated the table around 360 degrees to search the maximum radiation power and receiver antenna shall be rotated vertical and horizontal polarization and moved height from 1 m to 4 m to find the maximum polar radiated power. The “Read Value” is the spectrum reading the maximum power value.
- c. The substitution horn antenna is substituted for EUT at the same position and signals generator export the CW signal to the substitution antenna via a tx cable. Rotated the Turn Table and moved receiving antenna to find the maximum radiation power. Adjust output power level of S.G to get a Value of spectrum reading equal to “Read Value” of step b. Record the power level of S.G
- d. $EIRP = \text{Output power level of S.G} - \text{TX cable loss} + \text{Antenna gain of substitution horn.}$

Conducted Power Measurement:

- a. The EUT was set up for the maximum power with LTE link data modulation and link up with simulator.
- b. Set the EUT to transmit under low, middle and high channel and record the power level shown on simulator.

4.1.3 Test Setup

EIRP / ERP Measurement:

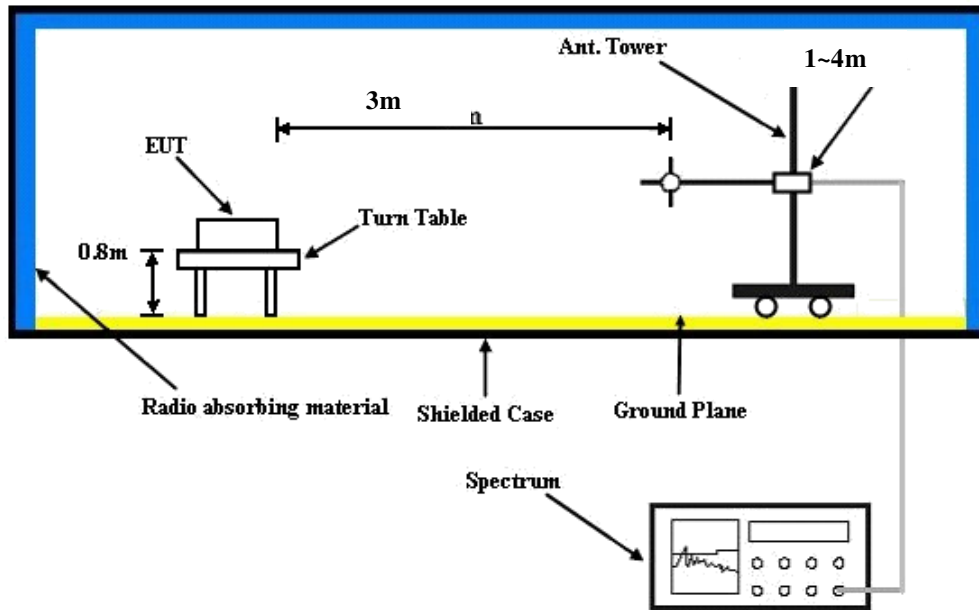

For the actual test configuration, please refer to the attached file (Test Setup Photo).

Conducted Power Measurement:



4.1.4 Test Results

Conducted Output Power (dBm)

Band / BW	RB Size	RB Offset	QPSK			3GPP MPR (dB)	16QAM			3GPP MPR (dB)
			Low Ch 20775	Mid Ch 21100	High Ch 21425		Low Ch 20775	Mid Ch 21100	High Ch 21425	
			2502.5 MHz	2535.0 MHz	2567.5 MHz		2502.5 MHz	2535.0 MHz	2567.5 MHz	
7 / 5M	1	0	22.75	23.04	22.63	0	22.00	22.29	21.88	1
	1	12	22.39	22.45	21.99	0	21.64	21.70	21.24	1
	1	24	22.60	22.51	22.24	0	21.85	21.76	21.49	1
	12	0	21.68	21.65	21.38	1	20.93	20.90	20.63	2
	12	6	21.59	21.56	21.39	1	20.84	20.81	20.64	2
	12	13	21.54	21.48	21.24	1	20.79	20.73	20.49	2
	25	0	21.69	21.57	21.11	1	20.94	20.82	20.36	2

Band / BW	RB Size	RB Offset	QPSK			3GPP MPR (dB)	16QAM			3GPP MPR (dB)
			Low Ch 20800	Mid Ch 21100	High Ch 21400		Low Ch 20800	Mid Ch 21100	High Ch 21400	
			2505.0 MHz	2535.0 MHz	2565.0 MHz		2505.0 MHz	2535.0 MHz	2565.0 MHz	
7 / 10M	1	0	22.86	23.15	22.74	0	22.06	22.35	21.94	1
	1	24	22.50	22.56	22.10	0	21.70	21.76	21.30	1
	1	49	22.71	22.62	22.35	0	21.91	21.82	21.55	1
	25	0	21.79	21.76	21.49	1	20.99	20.96	20.69	2
	25	12	21.70	21.67	21.50	1	20.90	20.87	20.70	2
	25	25	21.65	21.59	21.35	1	20.85	20.79	20.55	2
	50	0	21.80	21.68	21.22	1	21.00	20.88	20.42	2

Band / BW	RB Size	RB Offset	QPSK			3GPP MPR (dB)	16QAM			3GPP MPR (dB)
			Low Ch 20825	Mid Ch 21100	High Ch 21375		Low Ch 20825	Mid Ch 21100	High Ch 21375	
			2507.5 MHz	2535.0 MHz	2562.5 MHz		2507.5 MHz	2535.0 MHz	2562.5 MHz	
7 / 15M	1	0	23.02	23.31	22.90	0	22.09	22.38	21.97	1
	1	37	22.66	22.72	22.26	0	21.73	21.79	21.33	1
	1	74	22.87	22.78	22.51	0	21.94	21.85	21.58	1
	36	0	21.95	21.92	21.65	1	21.02	20.99	20.72	2
	36	19	21.86	21.83	21.66	1	20.93	20.90	20.73	2
	36	39	21.81	21.75	21.51	1	20.88	20.82	20.58	2
	75	0	21.96	21.84	21.38	1	21.03	20.91	20.45	2

Band / BW	RB Size	RB Offset	QPSK			3GPP MPR (dB)	16QAM			3GPP MPR (dB)
			Low Ch 20850	Mid Ch 21100	High Ch 21350		Low Ch 20850	Mid Ch 21100	High Ch 21350	
			2510.0 MHz	2535.0 MHz	2560.0 MHz		2510.0 MHz	2535.0 MHz	2560.0 MHz	
7 / 20M	1	0	23.20	23.49	23.08	0	22.16	22.45	22.04	1
	1	50	22.84	22.90	22.44	0	21.80	21.86	21.40	1
	1	99	23.05	22.96	22.69	0	22.01	21.92	21.65	1
	50	0	22.13	22.10	21.83	1	21.09	21.06	20.79	2
	50	25	22.04	22.01	21.84	1	21.00	20.97	20.80	2
	50	50	21.99	21.93	21.69	1	20.95	20.89	20.65	2
	100	0	22.14	22.02	21.56	1	21.10	20.98	20.52	2



EIRP Power (dBm)

LTE Band 7							
Channel Bandwidth: 5 MHz / QPSK							
Plane	Channel	Frequency (MHz)	LVL (dBm)	Correction Factor (dB)	EIRP (dBm)	EIRP (mW)	Polarization (H/V)
Y	20775	2502.5	-21.84	44.24	22.40	173.70	H
	21100	2535.0	-21.75	44.20	22.45	175.67	
	21425	2567.5	-21.91	44.80	22.89	194.58	
	20775	2502.5	-26.28	44.19	17.91	61.82	V
	21100	2535.0	-26.37	44.09	17.72	59.13	
	21425	2567.5	-26.85	44.50	17.65	58.20	
Channel Bandwidth: 5 MHz / 16QAM							
Y	20775	2502.5	-22.81	44.24	21.43	138.93	H
	21100	2535.0	-22.68	44.20	21.52	141.81	
	21425	2567.5	-22.98	44.80	21.82	152.09	
	20775	2502.5	-27.88	44.19	16.31	42.77	V
	21100	2535.0	-27.85	44.09	16.24	42.05	
	21425	2567.5	-27.86	44.50	16.64	46.12	

LTE Band 7							
Channel Bandwidth: 10 MHz / QPSK							
Plane	Channel	Frequency (MHz)	LVL (dBm)	Correction Factor (dB)	EIRP (dBm)	EIRP (mW)	Polarization (H/V)
Y	20800	2505.0	-21.67	44.34	22.67	184.97	H
	21100	2535.0	-21.77	44.20	22.43	174.86	
	21400	2565.0	-21.84	44.72	22.88	194.22	
	20800	2505.0	-26.59	44.23	17.64	58.02	V
	21100	2535.0	-26.51	44.09	17.58	57.25	
	21400	2565.0	-26.84	44.41	17.57	57.10	
Channel Bandwidth: 10 MHz / 16QAM							
Y	20800	2505.0	-22.80	44.34	21.54	142.59	H
	21100	2535.0	-22.85	44.20	21.35	136.36	
	21400	2565.0	-22.98	44.72	21.74	149.38	
	20800	2505.0	-27.65	44.23	16.58	45.46	V
	21100	2535.0	-27.88	44.09	16.21	41.76	
	21400	2565.0	-27.48	44.41	16.93	49.27	

LTE Band 7							
Channel Bandwidth: 15 MHz / QPSK							
Plane	Channel	Frequency (MHz)	LVL (dBm)	Correction Factor (dB)	EIRP (dBm)	EIRP (mW)	Polarization (H/V)
Y	20825	2507.5	-21.57	44.32	22.75	188.28	H
	21100	2535.0	-21.61	44.20	22.59	181.43	
	21375	2562.5	-21.87	44.85	22.98	198.52	
	20825	2507.5	-26.81	43.99	17.18	52.26	V
	21100	2535.0	-26.55	44.09	17.54	56.73	
	21375	2562.5	-26.76	44.51	17.75	59.57	
Channel Bandwidth: 15 MHz / 16QAM							
Y	20825	2507.5	-22.58	44.32	21.74	149.21	H
	21100	2535.0	-22.67	44.20	21.53	142.13	
	21375	2562.5	-23.10	44.85	21.75	149.55	
	20825	2507.5	-27.61	43.99	16.38	43.47	V
	21100	2535.0	-27.44	44.09	16.65	46.22	
	21375	2562.5	-27.82	44.51	16.69	46.67	

LTE Band 7							
Channel Bandwidth: 20 MHz / QPSK							
Plane	Channel	Frequency (MHz)	LVL (dBm)	Correction Factor (dB)	EIRP (dBm)	EIRP (mW)	Polarization (H/V)
Y	20850.0	2510.0	-21.82	44.16	22.34	171.40	H
	21100.0	2535.0	-21.70	44.20	22.50	177.71	
	21350.0	2560.0	-21.83	44.81	22.98	198.47	
	20850.0	2510.0	-26.98	44.78	17.80	60.26	V
	21100.0	2535.0	-26.47	44.09	17.62	57.78	
	21350.0	2560.0	-26.81	44.72	17.91	61.80	
Channel Bandwidth: 20 MHz / 16QAM							
Y	20850.0	2510.0	-22.37	44.16	21.79	151.01	H
	21100.0	2535.0	-22.48	44.20	21.72	148.49	
	21350.0	2560.0	-22.98	44.81	21.83	152.30	
	20850.0	2510.0	-27.99	44.78	16.79	47.75	V
	21100.0	2535.0	-27.81	44.09	16.28	42.44	
	21350.0	2560.0	-27.87	44.72	16.85	48.42	

4.2 Frequency Stability Measurement

4.2.1 Limits of Frequency Stability Measurement

The frequency stability shall be sufficient to ensure that the fundamental emissions stay within the authorized bands of operation.

4.2.2 Test Procedure

- a. Device is placed at the oven room. The oven room could control the temperatures and humidity. Power warm up is at least 15 min and power applied should perform before recording frequency error.
- b. EUT is connected the external power supply to control the DC input power. The test voltage range is from minimum to maximum working voltage. Each step shall be record the frequency error rate.
- c. The temperature range step is 10 degrees in this test items. All temperature levels shall be hold the ± 0.5 °C during the measurement testing. The each temperature step shall be at least 0.5 hours, consider the EUT could be test under the stability condition.

NOTE: The frequency error was recorded frequency error from the communication simulator.

4.2.3 Test Setup

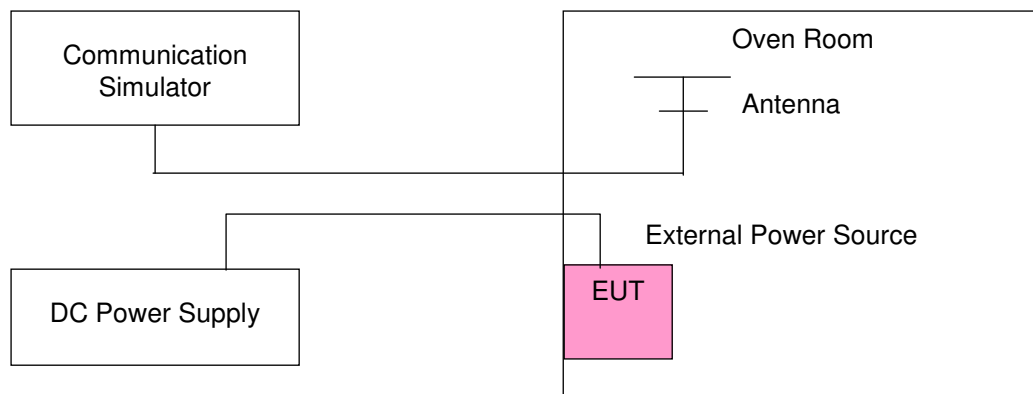

4.2.4 Test Results

Frequency Error vs. Voltage

Voltage (Volts)	Frequency Error (ppm)				Limit (ppm)
	LTE Band 7				
	5 MHz	10 MHz	15 MHz	20 MHz	
3.85	0.0008	0.0008	0.0010	0.0006	2.5
3.6	0.0005	0.0007	0.0006	0.0011	2.5
4.4	0.0007	0.0009	0.0010	0.0008	2.5

NOTE: The applicant defined the normal working voltage of the battery is from 3.6 Vdc to 4.4 Vdc.

Frequency Error vs. Temperature

Temp. (°C)	Frequency Error (ppm)				Limit (ppm)
	LTE Band 7				
	5 MHz	10 MHz	15 MHz	20 MHz	
-30	0.0009	0.0006	0.0007	0.0009	2.5
-20	0.0002	0.0003	0.0006	0.0006	2.5
-10	0.0005	0.0004	0.0006	0.0007	2.5
0	0.0007	0.0013	0.0013	0.0011	2.5
10	0.0009	0.0006	0.0011	0.0005	2.5
20	-0.0009	-0.0007	-0.0003	-0.0002	2.5
30	-0.0001	-0.0014	-0.0004	-0.0013	2.5
40	-0.0015	-0.0008	-0.0014	-0.0013	2.5
50	-0.0016	-0.0004	-0.0006	-0.0013	2.5
55	-0.0004	-0.0015	-0.0005	-0.0012	2.5

4.3 Occupied Bandwidth Measurement

4.3.1 Limits of Occupied Bandwidth Measurement

The width of a frequency band such that, below the lower and above the upper frequency limits, the mean powers emitted are each equal to a specified percentage 0.5 % of the total mean power of a given emission.

4.3.2 Test Procedure

- a. The conducted occupied bandwidth used the power splitter via EUT RF power connector between simulation base station and spectrum analyzer.
- b. Use OBW measurement function of Spectrum analyzer to measure 99 % occupied bandwidth.

4.3.3 Test Setup

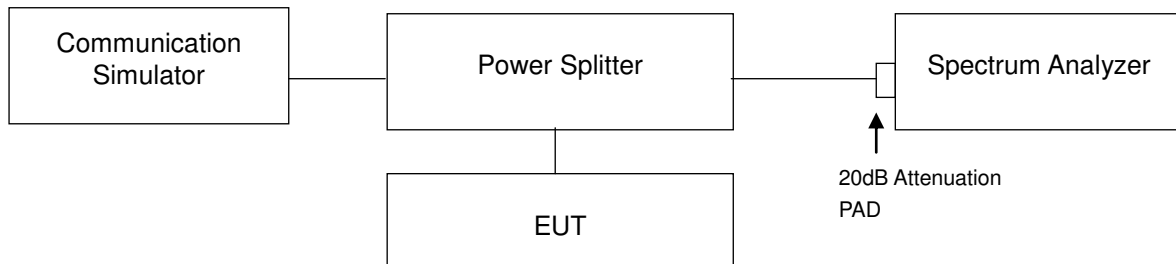

4.3.4 Test Result

LTE Band 7							
Channel Bandwidth: 5 MHz				Channel Bandwidth: 10 MHz			
Channel	Frequency (MHz)	99 % Occupied Bandwidth (MHz)		Channel	Frequency (MHz)	99 % Occupied Bandwidth (MHz)	
		QPSK	16QAM			QPSK	16QAM
20775	2502.5	4.4945	4.4879	20800	2505.0	8.9711	8.9681
21100	2535.0	4.4933	4.4871	21100	2535.0	8.9689	8.9696
21425	2567.5	4.4958	4.4875	21400	2565.0	8.9687	8.9693

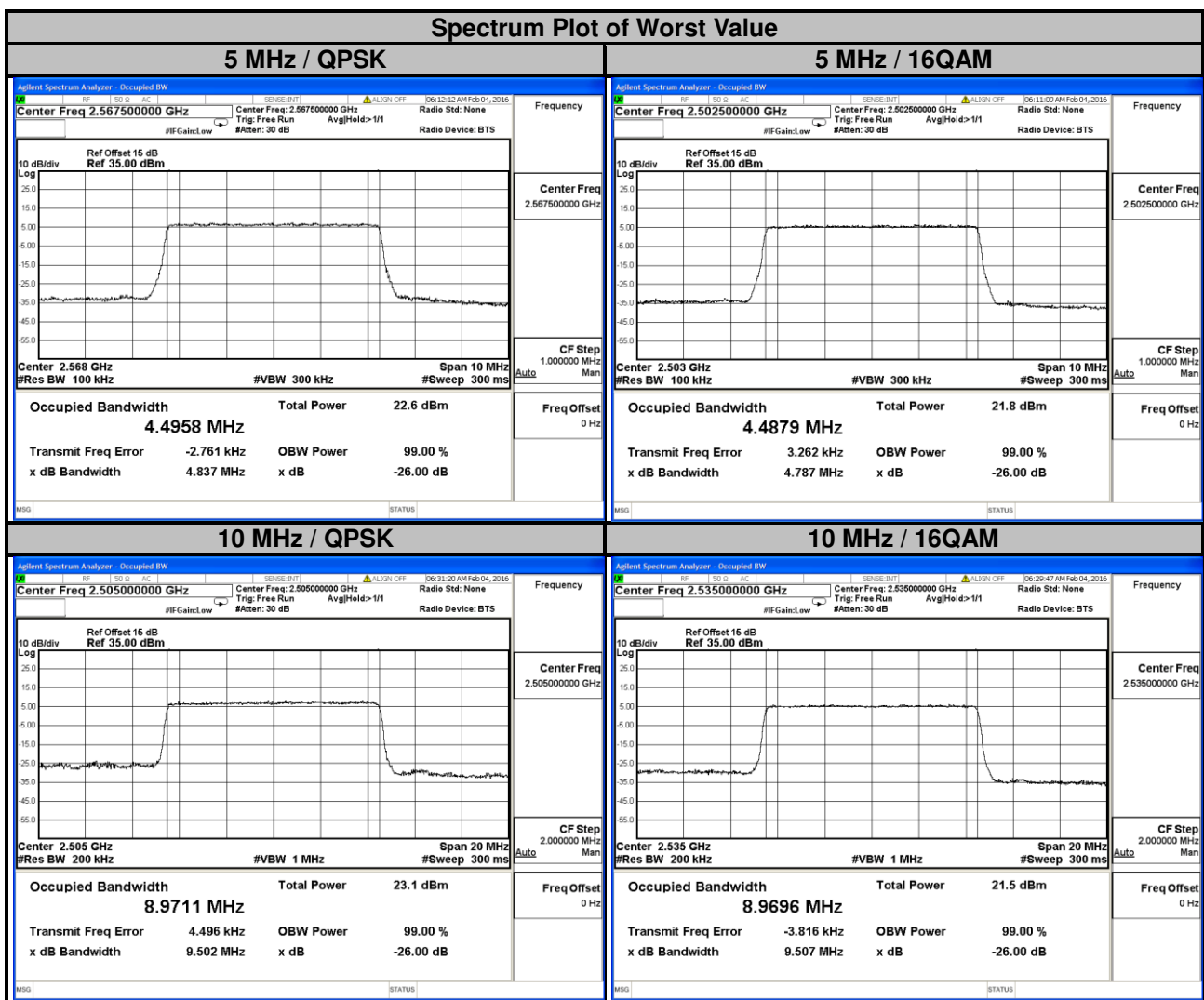



A D T

LTE Band 7

Channel Bandwidth: 15 MHz

Channel Bandwidth: 20 MHz

Channel	Frequency (MHz)	99 % Occupied Bandwidth (MHz)		Channel	Frequency (MHz)	99 % Occupied Bandwidth (MHz)	
		QPSK	16QAM			QPSK	16QAM
20825	2507.5	13.470	13.460	20850	2510.0	17.971	17.961
21100	2535.0	13.461	13.455	21100	2535.0	17.953	17.966
21375	2562.5	13.476	13.461	21350	2560.0	17.958	17.969

Spectrum Plot of Worst Value

15 MHz / QPSK

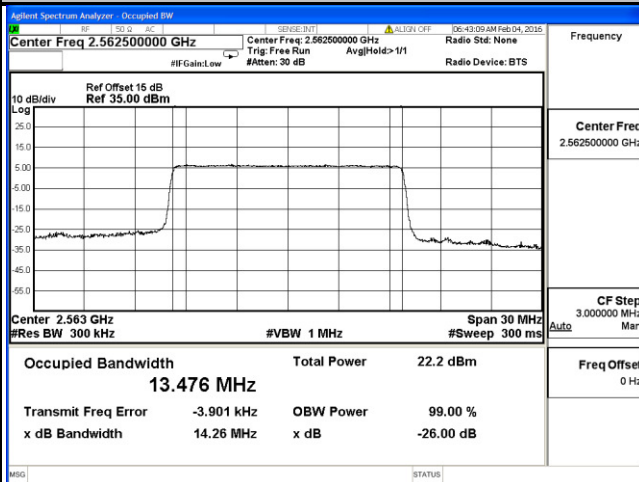

15 MHz / 16QAM

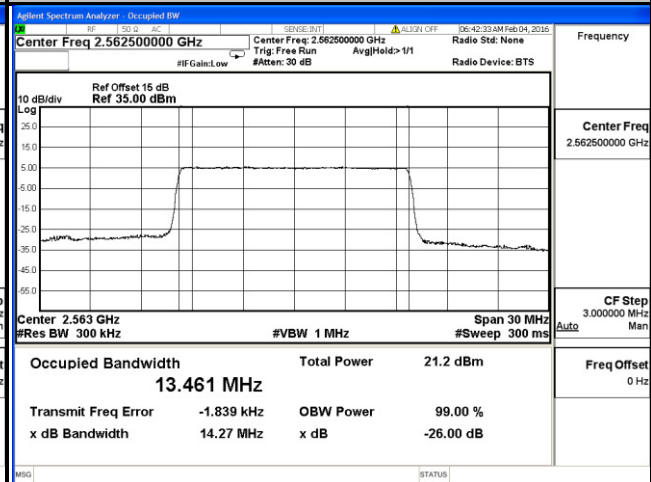

20 MHz / QPSK

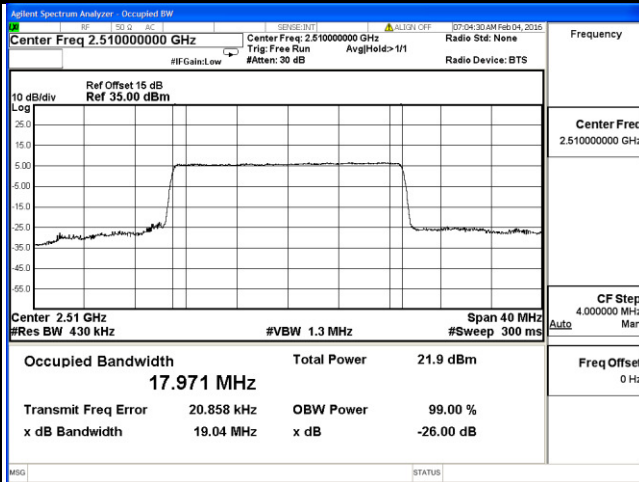

20 MHz / 16QAM

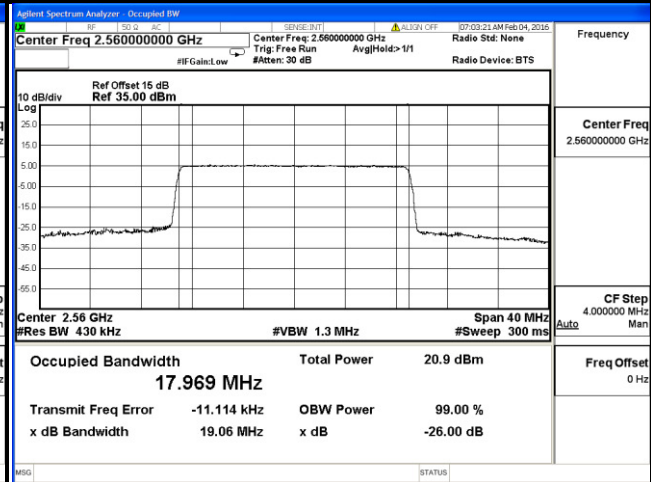

4.4 Band Edge Measurement

4.4.1 Limits of Band Edge Measurement

According to FCC 27.53(l)(4) specified that power of any emission outside of the channel edge must be attenuated below the transmitting power (P) by a factor shall be not less than $40 + 10 \log (P)$ dB on all frequencies between the channel edge and 5 megahertz from the channel edge, $43 + 10 \log (P)$ dB on all frequencies between 5 megahertz and X megahertz from the channel edge, and $55 + 10 \log (P)$ dB on all frequencies more than X megahertz from the channel edge, where X is the greater of 6 megahertz or the actual emission bandwidth. In addition, the attenuation factor shall not be less that $43 + 10 \log (P)$ dB on all frequencies between 2490.5 MHz and 2496 MHz and $55 + 10 \log (P)$ dB at or below 2490.5 MHz. In the 1 MHz bands immediately outside and adjacent to the frequency block a resolution bandwidth of at least two percent may be employed, except when the 1 megahertz band is 2495-2496 MHz, in which case a resolution bandwidth of at least one percent may be employed.

4.4.2 Test Setup

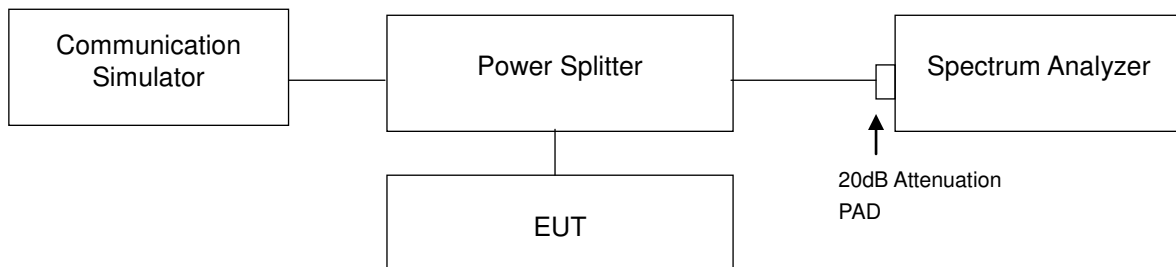

4.4.3 Test Procedures

- a. The EUT was set up for the maximum peak power with LTE link data modulation. The power was measured with R&S Spectrum Analyzer. All measurements were done at 2 channels (low and high operational frequency range.).
- b. The band edge measurement used the power splitter via EUT RF power connector between simulation base station and spectrum analyzer.
- c. The center frequency of spectrum is the band edge frequency and span is 20 MHz. RB of the spectrum is 100 kHz and VB of the spectrum is 300 kHz (Channel bandwidth 5 MHz).
- d. The center frequency of spectrum is the band edge frequency and span is 40 MHz. RB of the spectrum is 100 kHz and VB of the spectrum is 300 kHz (Channel bandwidth 10 MHz).
- e. The center frequency of spectrum is the band edge frequency and span is 60 MHz. RB of the spectrum is 200 kHz and VB of the spectrum is 1 MHz (Channel bandwidth 15 MHz).
- f. The center frequency of spectrum is the band edge frequency and span is 80 MHz. RB of the spectrum is 200 kHz and VB of the spectrum is 1 MHz (Channel bandwidth 20 MHz).
- g. Record the max trace plot into the test report.



A D T

4.4.4 Test Results

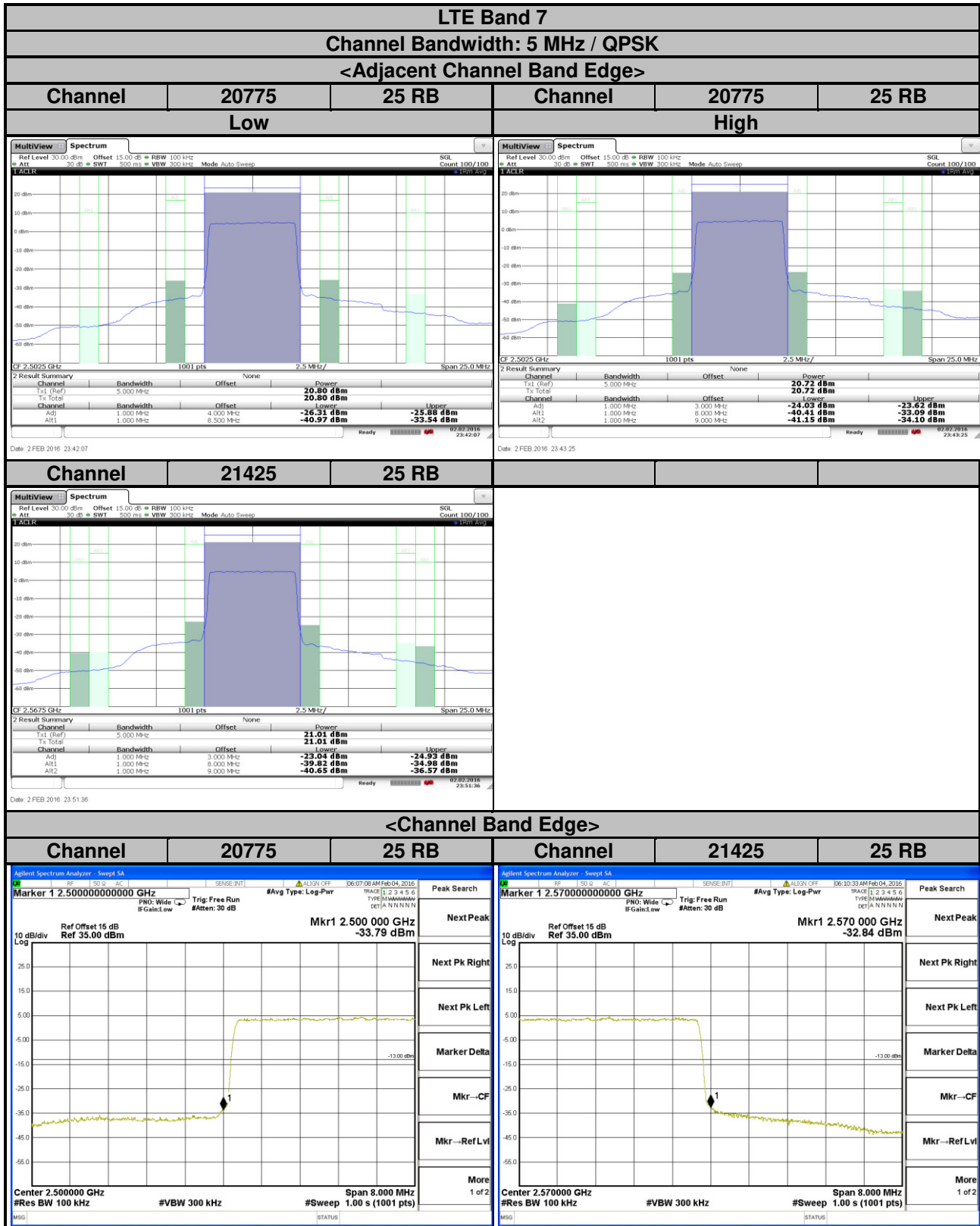



A D T

LTE Band 7
Channel Bandwidth: 5 MHz / 16QAM
<Adjacent Channel Band Edge>

Channel	20775	25 RB	Channel	20775	25 RB
	Low			High	

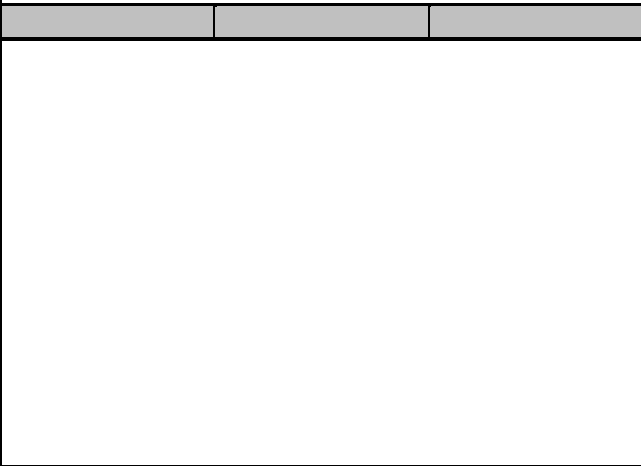
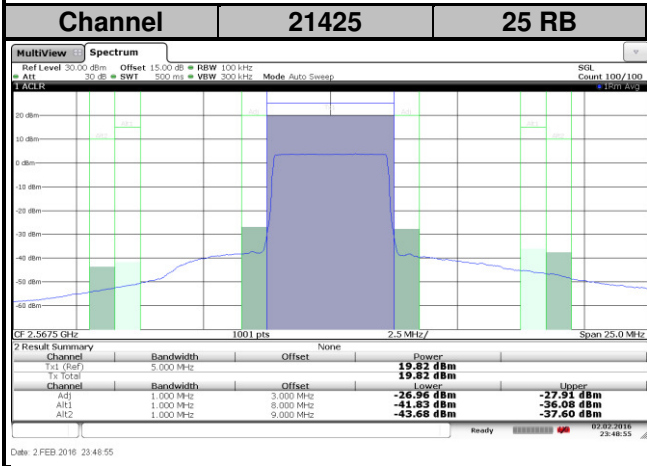
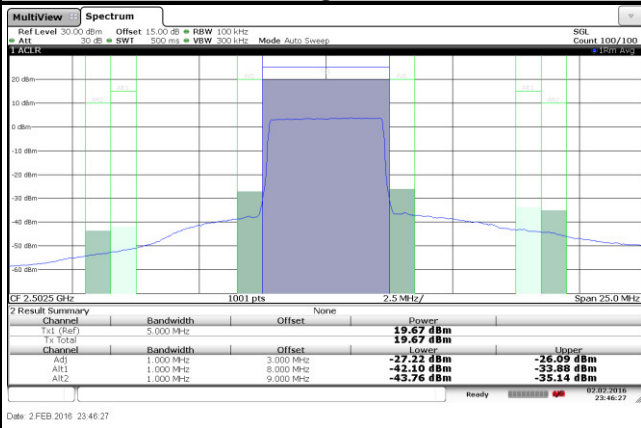
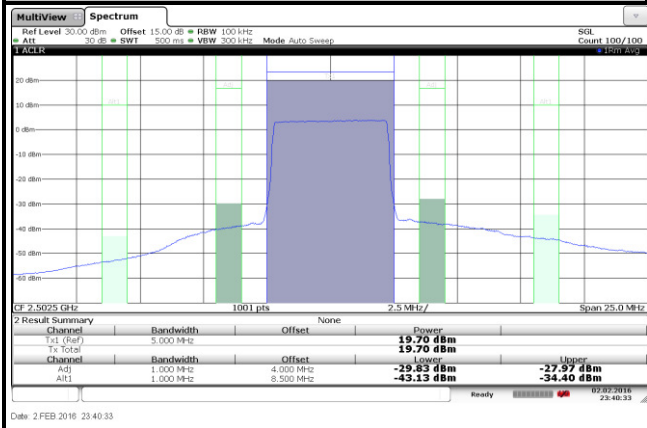

<Channel Band Edge>

Channel	20775	25 RB	Channel	21425	25 RB
---------	-------	-------	---------	-------	-------

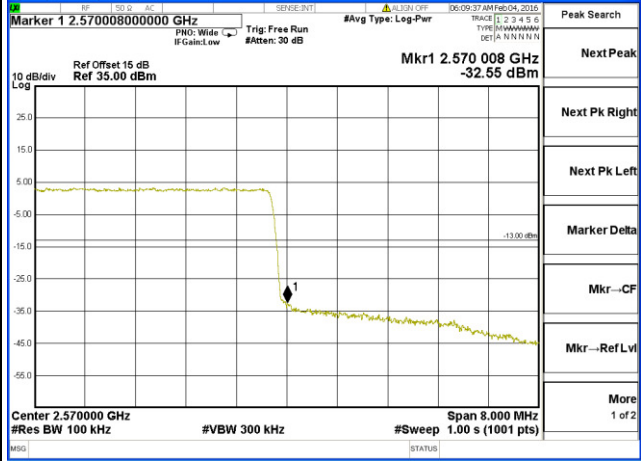
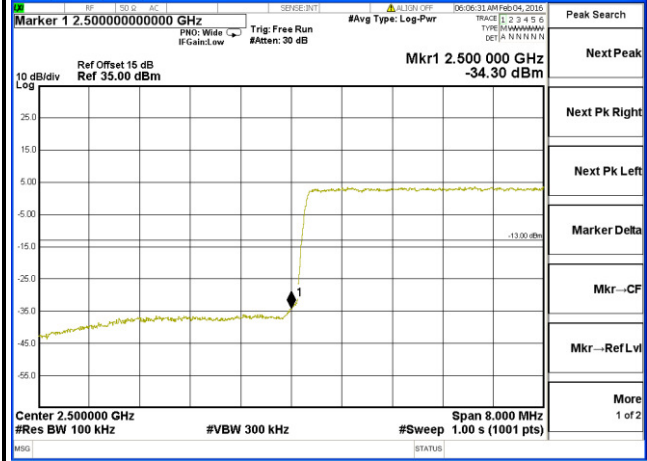



A D T

LTE Band 7
Channel Bandwidth: 10 MHz / QPSK
<Adjacent Channel Band Edge>

Channel	20800	50 RB	Channel	20800	50 RB
	Low			High	

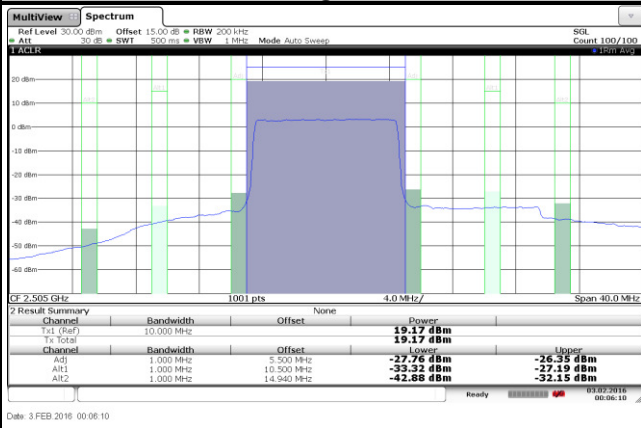
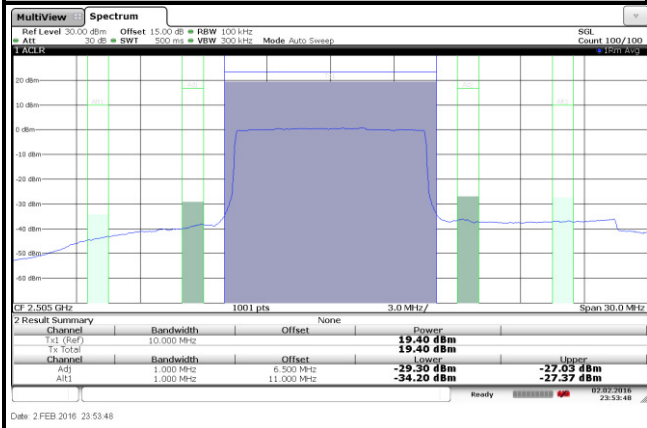

Channel	21400	50 RB			
---------	-------	-------	--	--	--

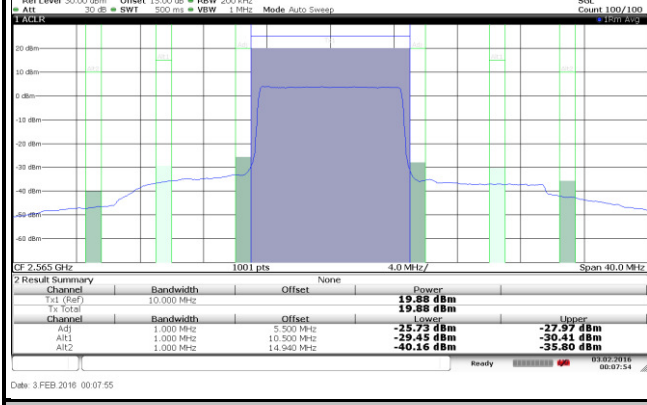

<Channel Band Edge>

Channel	20800	50 RB	Channel	21400	50 RB
---------	-------	-------	---------	-------	-------

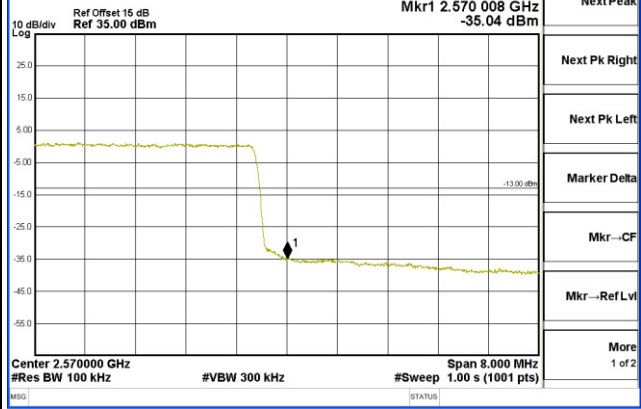
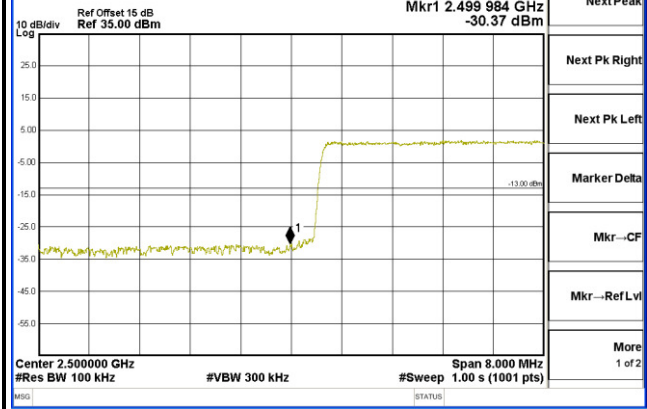



A D T

LTE Band 7
Channel Bandwidth: 10 MHz / 16QAM
<Adjacent Channel Band Edge>

Channel	20800	50 RB	Channel	20800	50 RB
	Low			High	

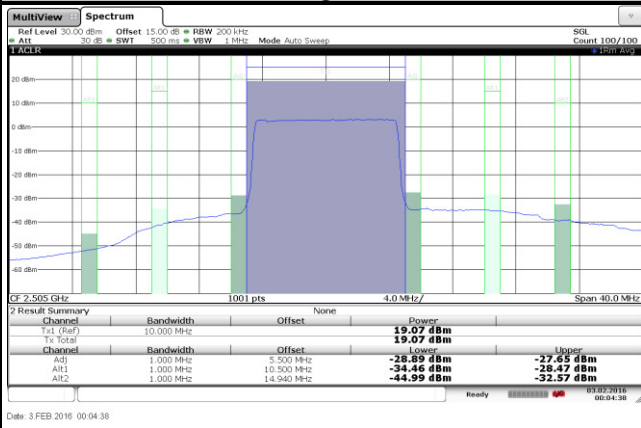
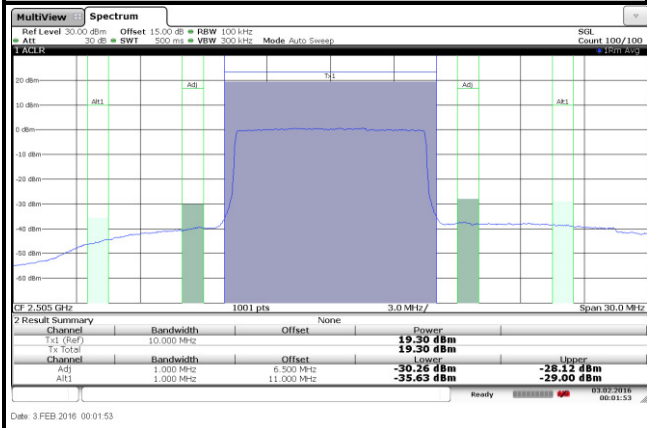

Channel	21400	50 RB			
---------	-------	-------	--	--	--

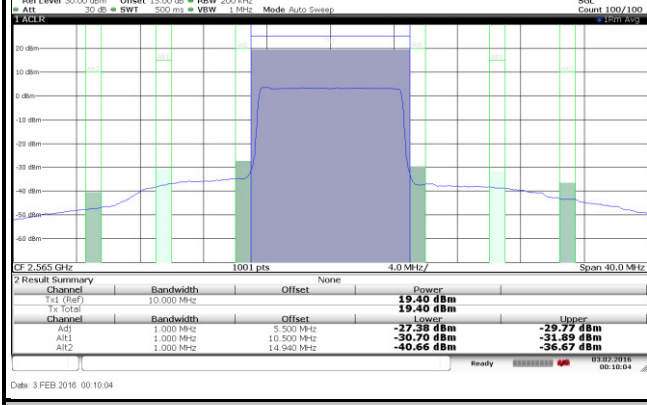

<Channel Band Edge>

Channel	20800	50 RB	Channel	21400	50 RB
---------	-------	-------	---------	-------	-------

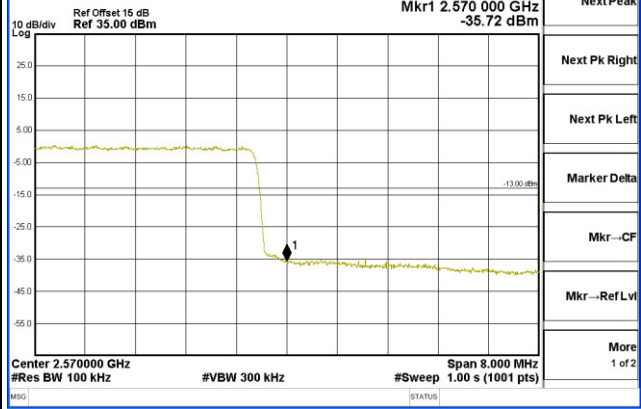
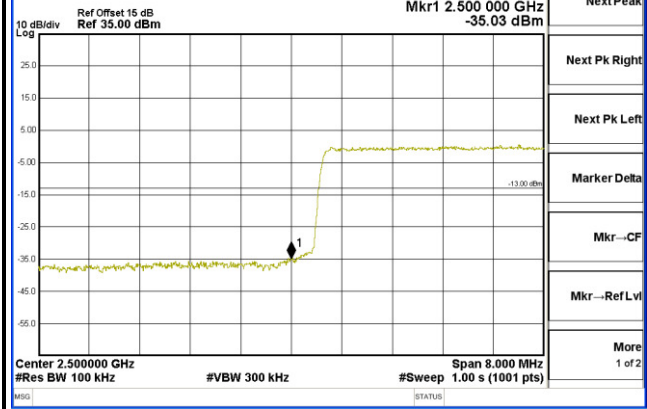



A D T

LTE Band 7
Channel Bandwidth: 15 MHz / QPSK
<Adjacent Channel Band Edge>

Channel	20825	75 RB	Channel	20825	75 RB
	Low			High	

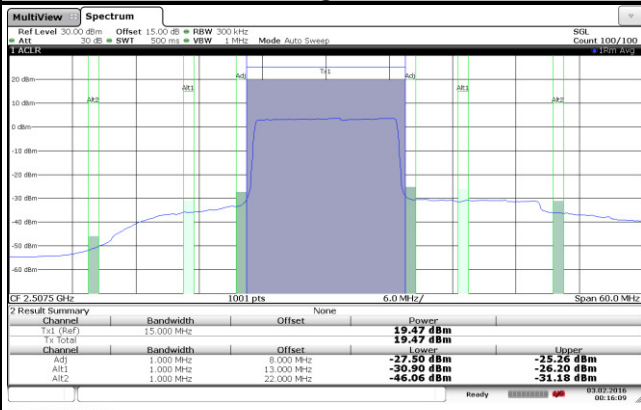

Channel	21375	75 RB			
---------	-------	-------	--	--	--

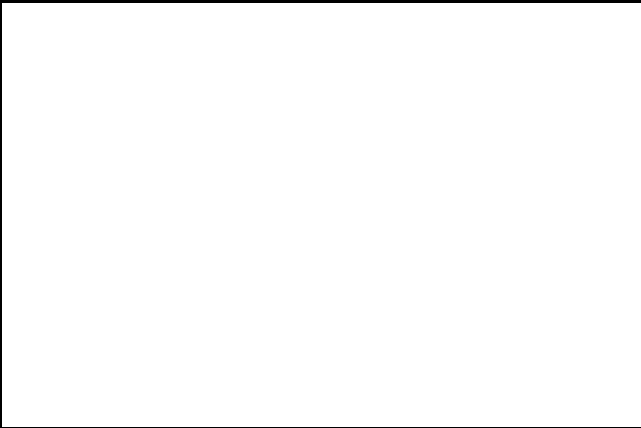
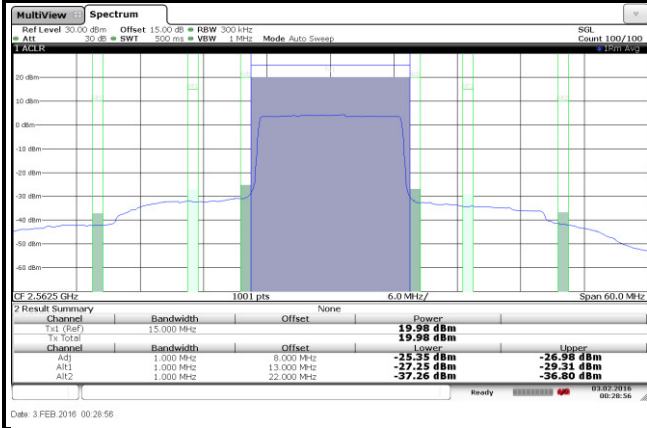

<Channel Band Edge>

Channel	20825	75 RB	Channel	21375	75 RB
---------	-------	-------	---------	-------	-------

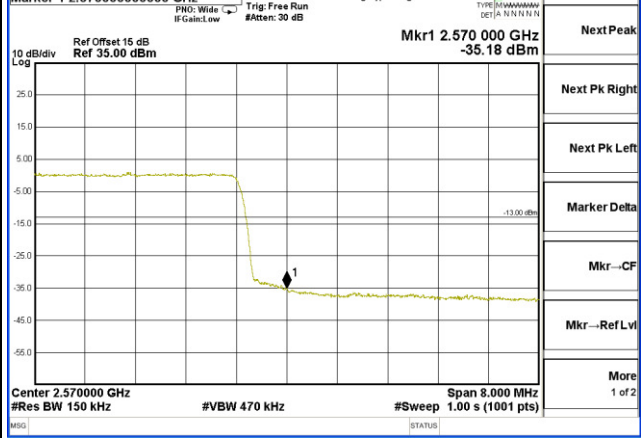
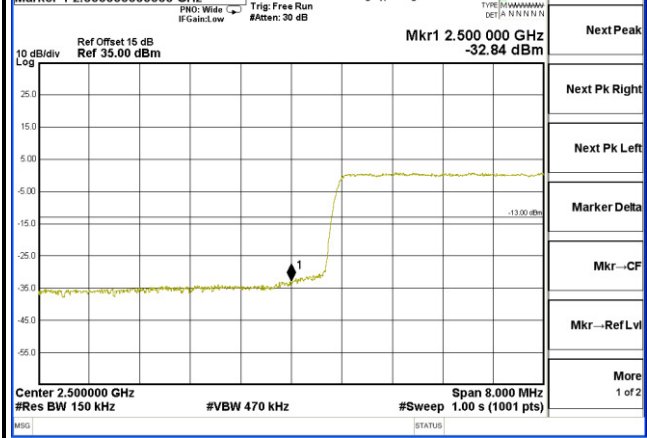



A D T

LTE Band 7
Channel Bandwidth: 15 MHz / 16QAM
<Adjacent Channel Band Edge>

Channel	20825	75 RB	Channel	20825	75 RB
	Low			High	

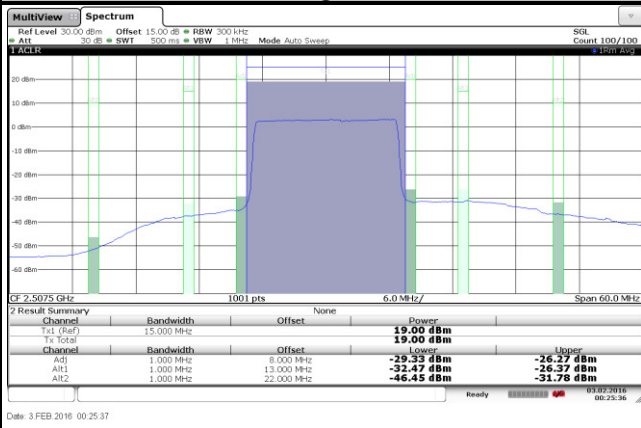
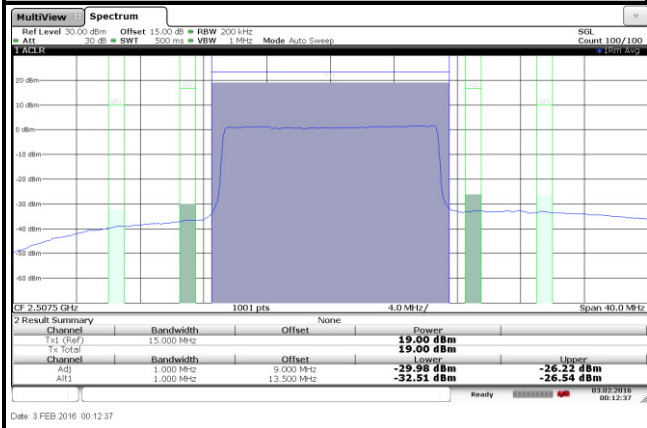

Channel	21375	75 RB			
---------	-------	-------	--	--	--

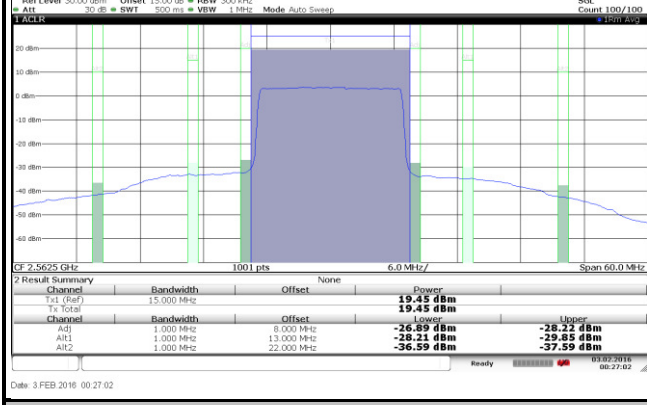

<Channel Band Edge>

Channel	20825	75 RB	Channel	21375	75 RB
---------	-------	-------	---------	-------	-------

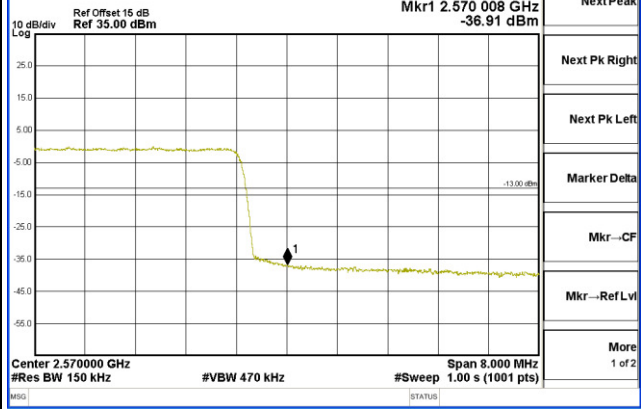
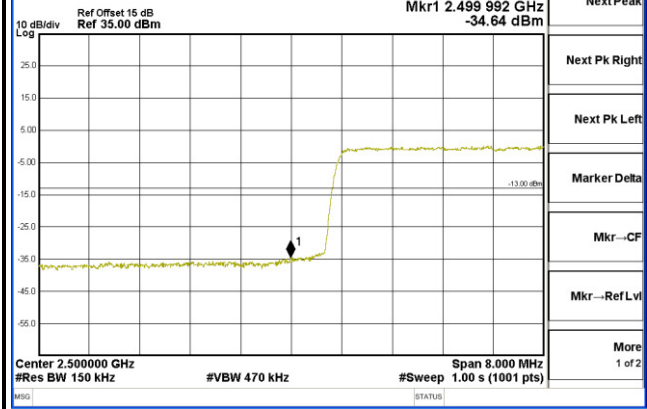



A D T

LTE Band 7
Channel Bandwidth: 20 MHz / QPSK
<Adjacent Channel Band Edge>

Channel	20850	100 RB	Channel	20850	100 RB
	Low			High	

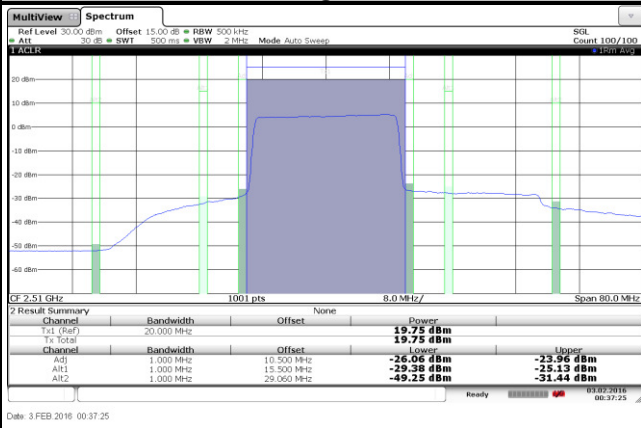
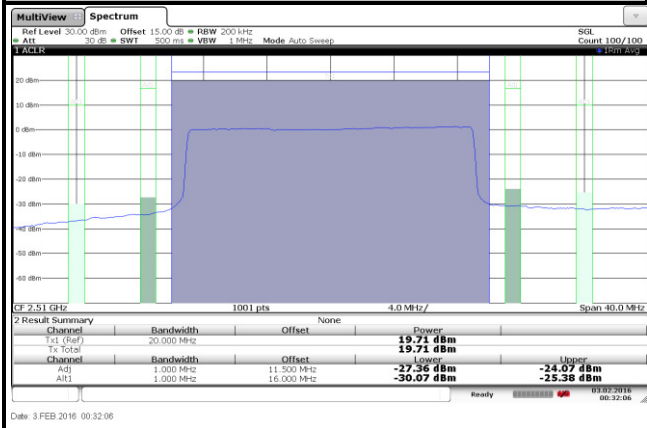

Channel	21350	100 RB			
----------------	--------------	---------------	--	--	--

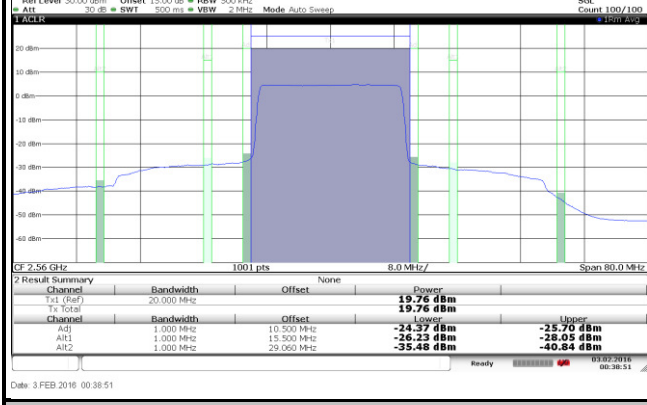

<Channel Band Edge>

Channel	20850	100 RB	Channel	21350	100 RB
----------------	--------------	---------------	----------------	--------------	---------------

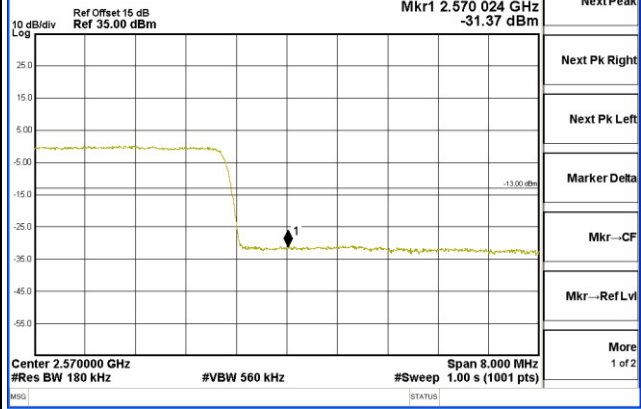
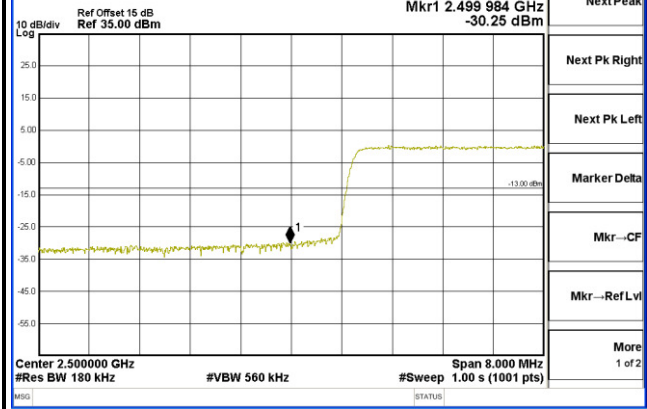



A D T

LTE Band 7
Channel Bandwidth: 20 MHz / 16QAM
<Adjacent Channel Band Edge>

Channel	20850	100 RB	Channel	20850	100 RB
	Low			High	

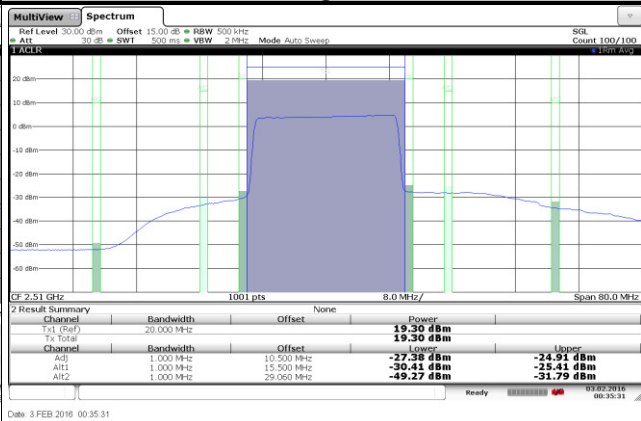
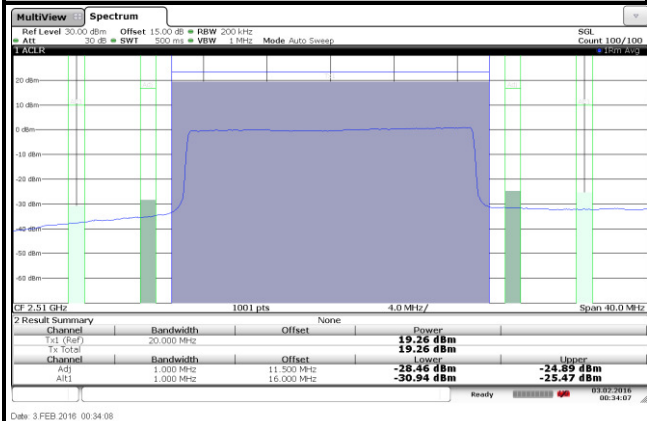

Channel	21350	100 RB	
----------------	--------------	---------------	--

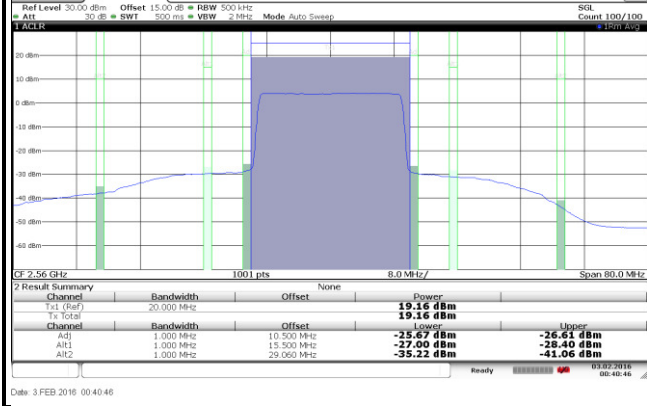

<Channel Band Edge>

Channel	20850	100 RB	Channel	21350	100 RB
----------------	--------------	---------------	----------------	--------------	---------------

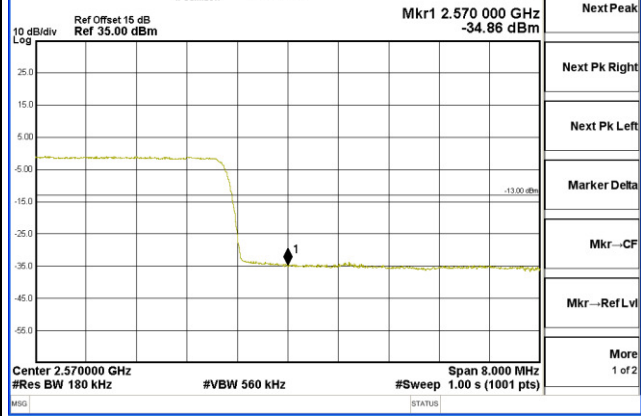
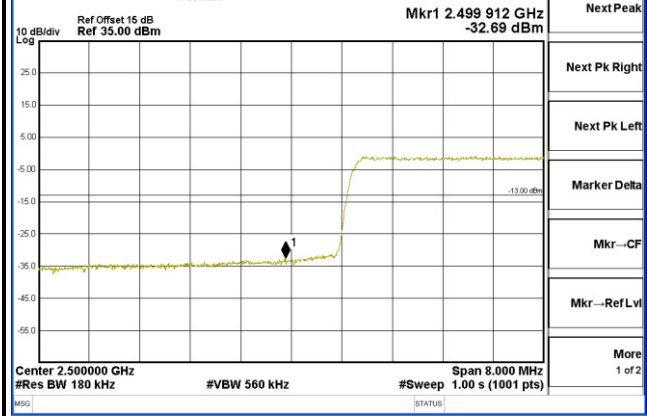

4.5 Peak to Average Ratio

4.5.1 Limits of Peak to Average Ratio Measurement

In measuring transmissions in this band using an average power technique, the peak to-average ratio (PAR) of the transmission may not exceed 13 dB

4.5.2 Test Setup

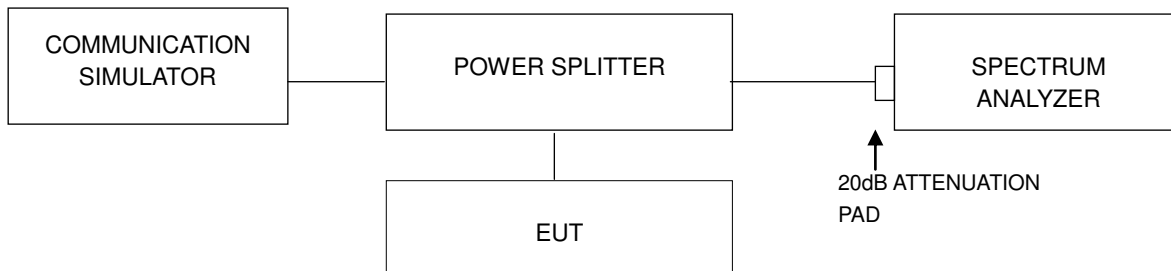

4.5.3 Test Procedures

1. Set resolution/measurement bandwidth \geq signal's occupied bandwidth;
2. Set the number of counts to a value that stabilizes the measured CCDF curve;
3. Record the maximum PAPR level associated with a probability of 0.1 %.

4.5.4 Test Results

LTE Band 7							
Channel Bandwidth: 5 MHz				Channel Bandwidth: 10 MHz			
Channel	Frequency (MHz)	Peak to Average Ratio (dB)		Channel	Frequency (MHz)	Peak to Average Ratio (dB)	
		QPSK	16QAM			QPSK	16QAM
20775	2502.5	4.62	5.76	20800	2505.0	4.38	4.48
21100	2535.0	4.40	4.94	21100	2535.0	4.03	4.77
21425	2567.5	4.28	4.82	21400	2565.0	3.80	4.73

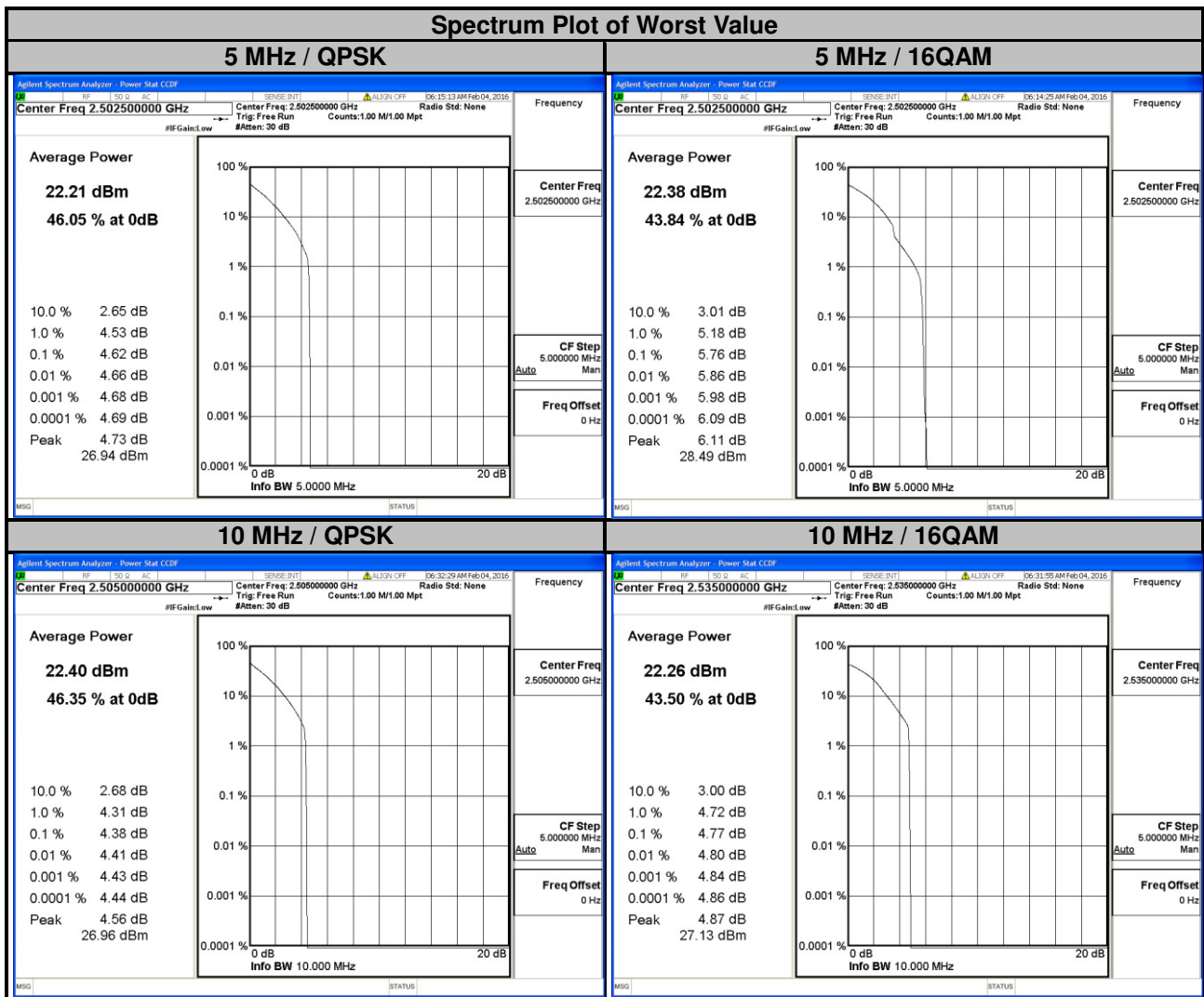



A D T

LTE Band 7							
Channel Bandwidth: 15 MHz				Channel Bandwidth: 20 MHz			
Channel	Frequency (MHz)	Peak to Average Ratio (dB)		Channel	Frequency (MHz)	Peak to Average Ratio (dB)	
		QPSK	16QAM			QPSK	16QAM
20825	2507.5	4.42	4.51	20850	2510.0	4.37	4.34
21100	2535.0	4.10	5.37	21100	2535.0	4.51	5.35
21375	2562.5	4.47	5.17	21350	2560.0	4.71	5.54

Spectrum Plot of Worst Value

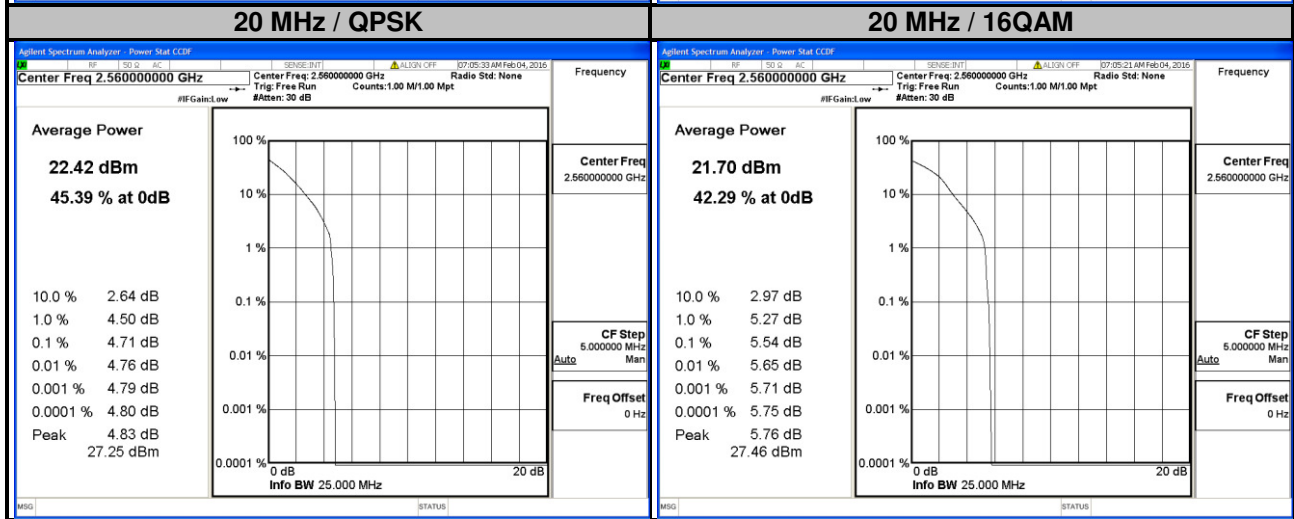
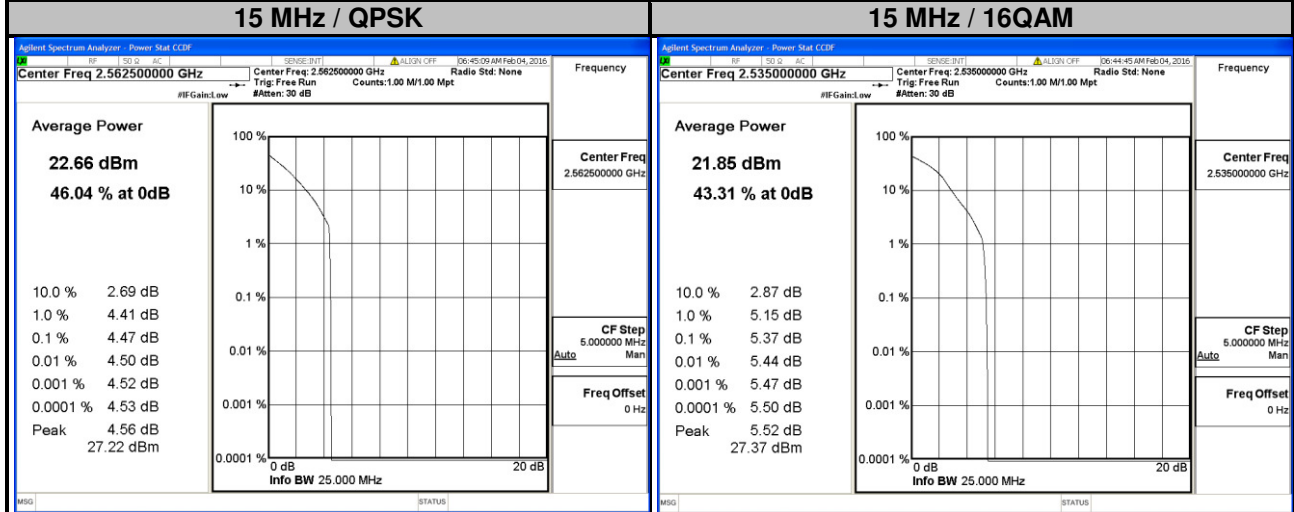

4.6 Conducted Spurious Emissions

4.6.1 Limits of Conducted Spurious Emissions Measurement

The power of any emission outside a licensee's frequency block shall be attenuated below the transmitter power (P) by at least $55 + 10 \log_{10}(P)$ dB. The limit of emission is equal to -25 dBm.

4.6.2 Test Setup

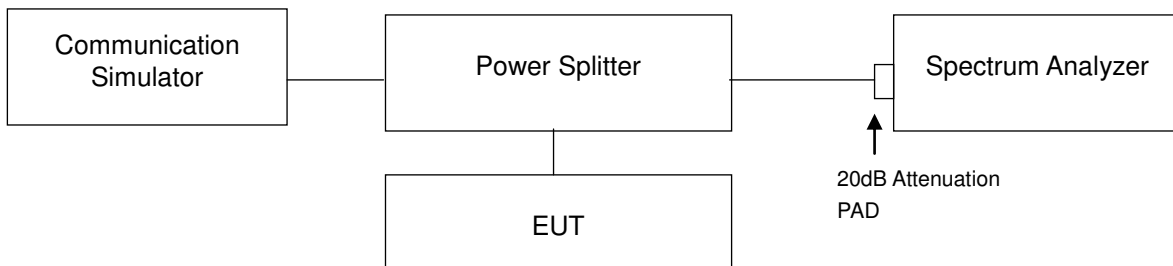

4.6.3 Test Procedure

- The EUT makes a phone call to the communication simulator. All measurements were done at low, middle and high operational frequency range.
- Measuring frequency range is from 30 MHz to 26 GHz for LTE Band 7. 10dB attenuation pad is connected with spectrum. RBW=1MHz and VBW=3MHz are used for conducted emission measurement.

4.6.4 Test Results

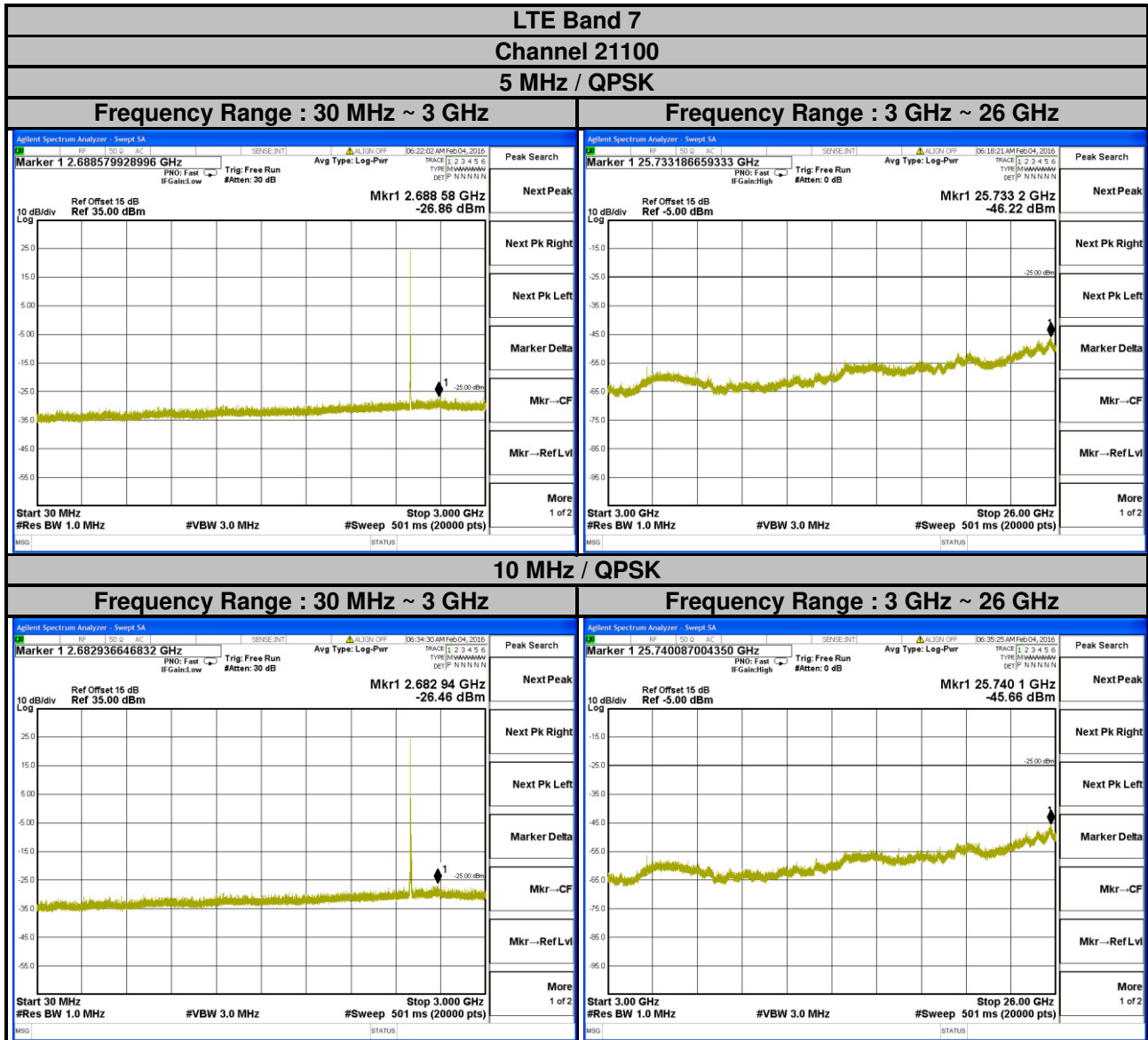



15 MHz / QPSK

Frequency Range : 30 MHz ~ 3 GHz

Frequency Range : 3 GHz ~ 26 GHz

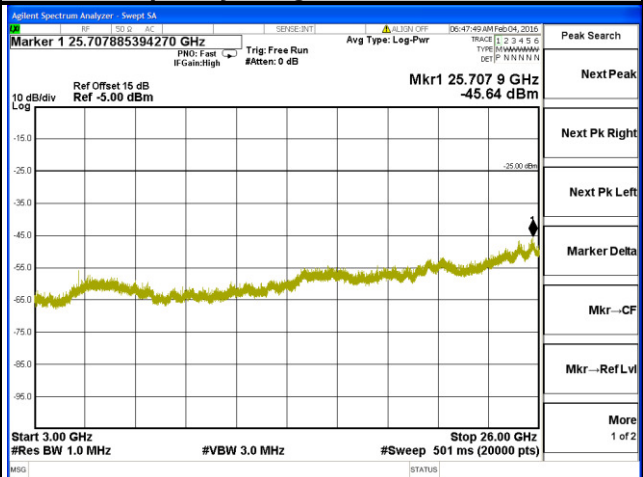
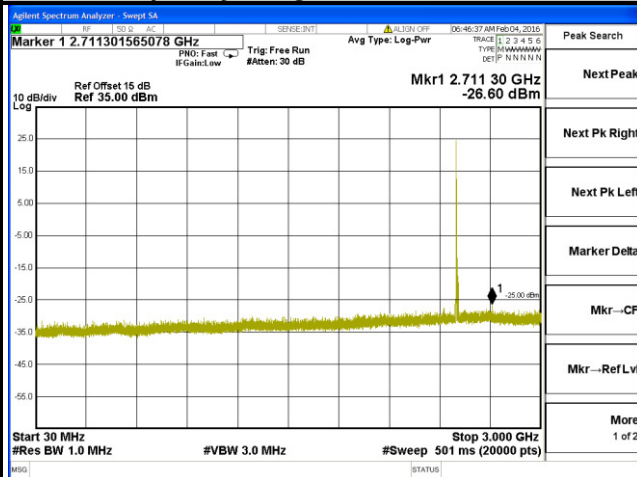

20 MHz / QPSK

Frequency Range : 30 MHz ~ 3 GHz

Frequency Range : 3 GHz ~ 26 GHz

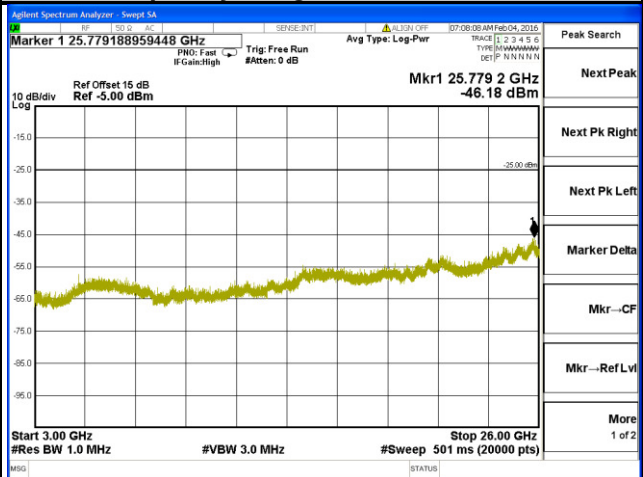
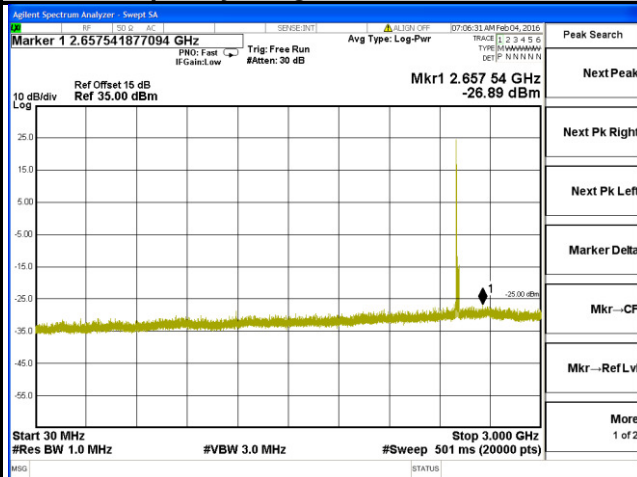

4.7 Radiated Emission Measurement

4.7.1 Limits of Radiated Emission Measurement

The power of any emission outside a licensee's frequency block shall be attenuated below the transmitter power (P) by at least $55 + 10 \log_{10}(P)$ dB. The limit of emission is equal to -25 dBm.

4.7.2 Test Procedure

- Substitution method is used for E.I.R.P measurement. In the semi-anechoic chamber, EUT placed on the 0.8 m height of Turn Table, rotated the table around 360 degrees to search the maximum radiation power and receiver antenna shall be rotated vertical and horizontal polarization and moved height from 1 m to 4 m to find the maximum polar radiated power. The "Read Value" is the spectrum reading the maximum power value.
- The substitution horn antenna is substituted for EUT at the same position and signals generator export the CW signal to the substitution antenna via a TX cable. Rotated the Turn Table and moved receiving antenna to find the maximum radiation power. Adjust output power level of S.G to get a Value of spectrum reading equal to "Read Value" of step a. Record the power level of S.G.
- $EIRP = \text{Output power level of S.G} - \text{TX cable loss} + \text{Antenna gain of substitution horn}$.
- E.R.P power can be calculated form E.I.R.P power by subtracting the gain of dipole, $E.R.P \text{ power} = E.I.P.R \text{ power} - 2.15 \text{ dBi}$.

NOTE: The resolution bandwidth of spectrum analyzer is 1 MHz and the video bandwidth is 3 MHz.

4.7.3 Deviation from Test Standard

No deviation.

4.7.4 Test Setup

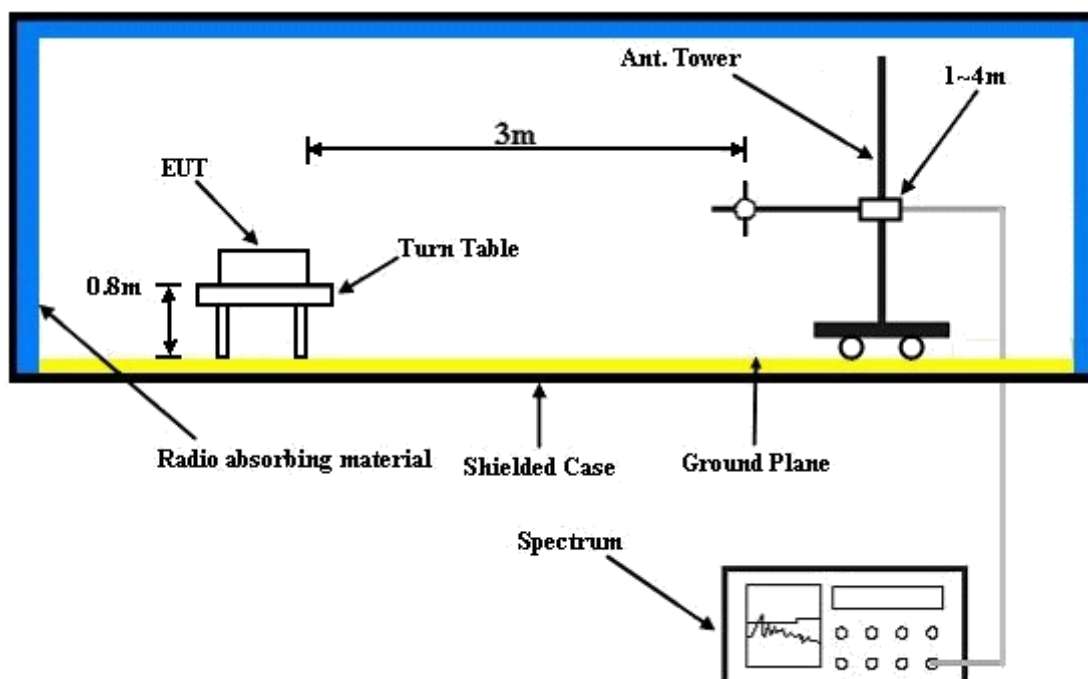

For the actual test configuration, please refer to the attached file (Test Setup Photo).

4.7.5 Test Results

LTE Band 7

Channel Bandwidth: 20 MHz / QPSK



Bureau Veritas Consumer Products Services Ltd., Taoyuan Branch

A D T

Data: 13

Date: 2016-01-28

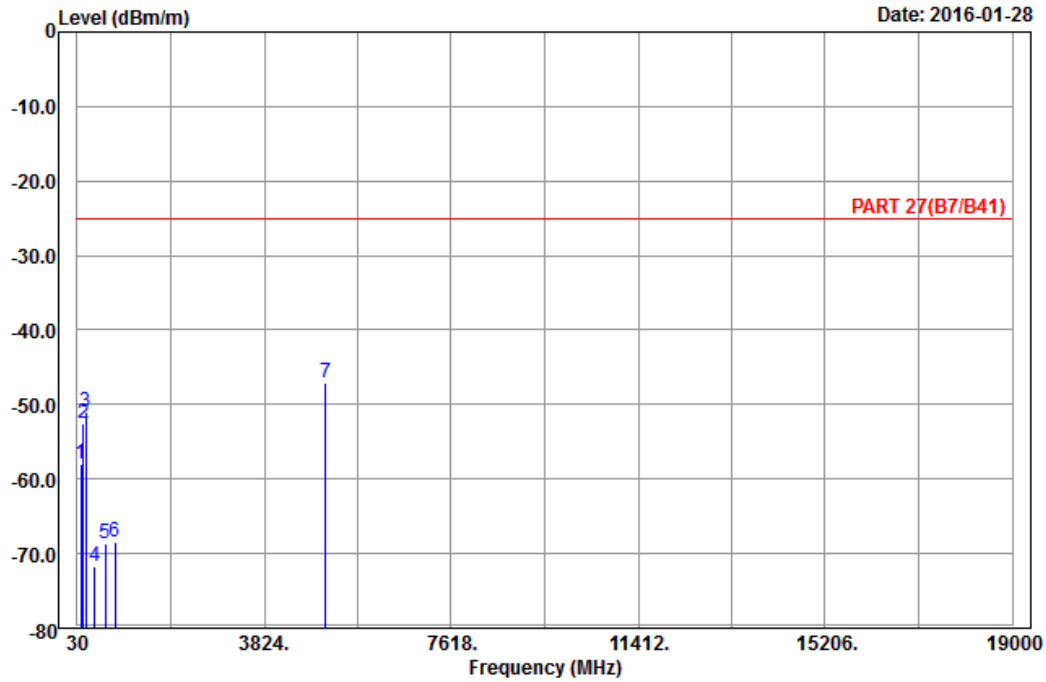

Site : 966 chamber 1
 Condition: PART 27(B7/B41) 3m Horizontal
 Remark : LTE_Band 7_QPSK(1,0)_20M_CH21100
 Tested by: Charles Hsiao
 Plane : X

	Freq	Level	Read Level	Limit Line	Over Limit	Factor	Remark
	MHz	dBm/m	dBm	dBm/m	dB	dB/m	
1	97.50	-57.95	-47.72	-25.00	-32.95	-10.23	Peak
2	161.76	-52.56	-45.09	-25.00	-27.56	-7.47	Peak
3	198.75	-50.94	-44.80	-25.00	-25.94	-6.14	Peak
4	391.00	-71.80	-68.59	-25.00	-46.80	-3.21	Peak
5	598.90	-68.74	-69.09	-25.00	-43.74	0.35	Peak
6	794.90	-68.37	-70.06	-25.00	-43.37	1.69	Peak
7 pp	5070.00	-47.10	-66.49	-25.00	-22.10	19.39	Peak



Bureau Veritas Consumer Products Services Ltd., Taoyuan Branch

A D T

Data: 14

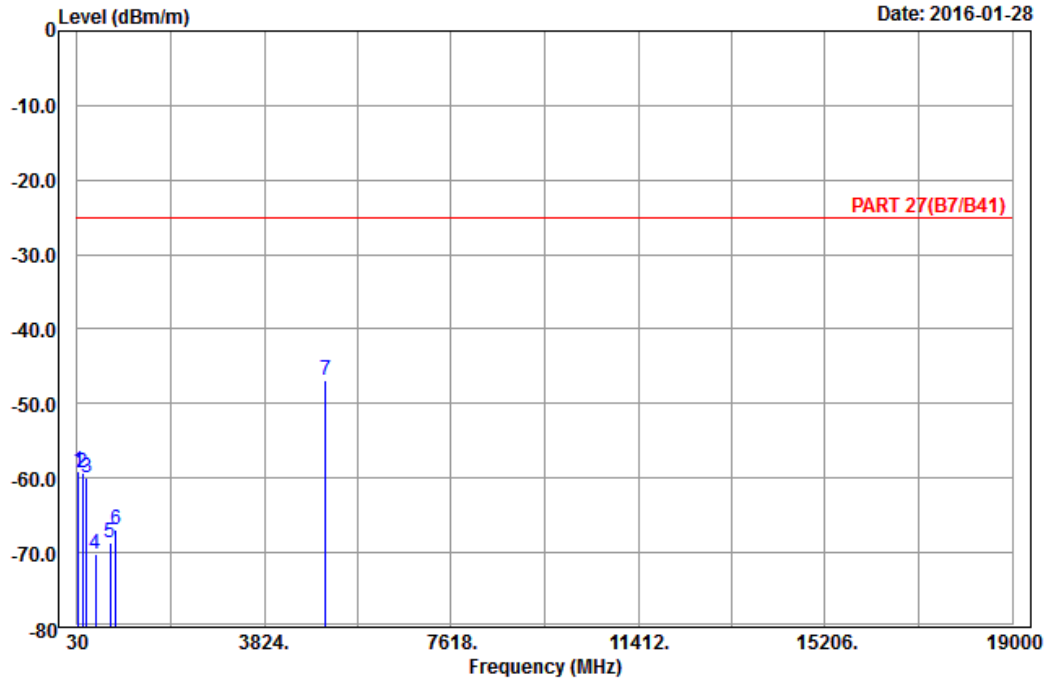

Site : 966 chamber 1
 Condition: PART 27(B7/B41) 3m Vertical
 Remark : LTE_Band 7_QPSK(1,0)_20M_CH21100
 Tested by: Charles Hsiao
 Plane : X

	Freq	Level	Read Level	Limit Line	Over Limit	Factor	Remark
	MHz	dBm/m	dBm	dBm/m	dB	dB/m	
1	47.28	-58.97	-45.86	-25.00	-33.97	-13.11	Peak
2	143.94	-59.27	-51.48	-25.00	-34.27	-7.79	Peak
3	214.68	-59.84	-53.85	-25.00	-34.84	-5.99	Peak
4	408.50	-70.19	-67.26	-25.00	-45.19	-2.93	Peak
5	700.40	-68.57	-68.19	-25.00	-43.57	-0.38	Peak
6	806.10	-66.89	-68.83	-25.00	-41.89	1.94	Peak
7 pp	5070.00	-46.87	-66.26	-25.00	-21.87	19.39	Peak



5 Pictures of Test Arrangements

Please refer to the attached file (Test Setup Photo).



A D T

Appendix – Information on the Testing Laboratories

We, Bureau Veritas Consumer Products Services (H.K.) Ltd., Taoyuan Branch, were founded in 1988 to provide our best service in EMC, Radio, Telecom and Safety consultation. Our laboratories are accredited and approved according to ISO/IEC 17025.

If you have any comments, please feel free to contact us at the following:

Linko EMC/RF Lab

Tel: 886-2-26052180

Fax: 886-2-26051924

Hsin Chu EMC/RF/Telecom Lab

Tel: 886-3-6668565

Fax: 886-3-6668323

Hwa Ya EMC/RF/Safety

Tel: 886-3-3183232

Fax: 886-3-3270892

Email: service.adt@tw.bureauveritas.com

Web Site: www.bureauveritas-adt.com

The address and road map of all our labs can be found in our web site also.

--- END ---