

FCC Test Report

(PART 27)

Report No.: RF160301C04-2

FCC ID: NM82PS6400

Test Model: 2PS6400

Received Date: Mar. 01, 2016

Test Date: Mar. 16, 2016 ~ Mar. 23, 2016

Issued Date: Apr. 12, 2016

Applicant: HTC Corporation

Address: 1F, 6-3 Baoqiang Road, Xindian District, New Taipei City, Taiwan 231

Issued By: Bureau Veritas Consumer Products Services (H.K.) Ltd., Taoyuan Branch

Lab Address: No. 47-2, 14th Ling, Chia Pau Vil., Lin Kou Dist., New Taipei City, Taiwan (R.O.C)

Test Location (1): No. 19, Hwa Ya 2nd Rd, Wen Hwa Tsuen, Kwei Shan Hsiang, Taoyuan Hsien 333, Taiwan, R.O.C.



This report is for your exclusive use. Any copying or replication of this report to or for any other person or entity, or use of our name or trademark, is permitted only with our prior written permission. This report sets forth our findings solely with respect to the test samples identified herein. The results set forth in this report are not indicative or representative of the quality or characteristics of the lot from which a test sample was taken or any similar or identical product unless specifically and expressly noted. Our report includes all of the tests requested by you and the results thereof based upon the information that you provided to us. You have 60 days from date of issuance of this report to notify us of any material error or omission caused by our negligence, provided, however, that such notice shall be in writing and shall specifically address the issue you wish to raise. A failure to raise such issue within the prescribed time shall constitute your unqualified acceptance of the completeness of this report, the tests conducted and the correctness of the report contents. Unless specific mention, the uncertainty of measurement has been explicitly taken into account to declare the compliance or non-compliance to the specification. The report must not be used by the client to claim product certification, approval, or endorsement by TAF or any government agency.



Table of Contents

Release Control Record	3
1 Certificate of Conformity	4
2 Summary of Test Results	5
2.1 Measurement Uncertainty	6
2.2 Test Site and Instruments	7
3 General Information	9
3.1 General Description of EUT	9
3.2 Configuration of System under Test	11
3.2.1 Description of Support Units	11
3.3 Test Mode Applicability and Tested Channel Detail	12
3.4 EUT Operating Conditions	16
3.5 General Description of Applied Standards	16
4 Test Types and Results	17
4.1 Output Power Measurement	17
4.1.1 Limits of Output Power Measurement	17
4.1.2 Test Procedures	17
4.1.3 Test Setup	18
4.1.4 Test Results	19
4.2 Frequency Stability Measurement	28
4.2.1 Limits of Frequency Stability Measurement	28
4.2.2 Test Procedure	28
4.2.3 Test Setup	28
4.2.4 Test Results	29
4.3 Occupied Bandwidth Measurement	31
4.3.1 Limits of Occupied Bandwidth Measurement	31
4.3.2 Test Procedure	31
4.3.3 Test Setup	31
4.3.4 Test Result	32
4.4 Band Edge Measurement	38
4.4.1 Limits of Band Edge Measurement	38
4.4.2 Test Setup	38
4.4.3 Test Procedures	38
4.4.4 Test Results	39
4.5 Peak to Average Ratio	51
4.5.1 Limits of Peak to Average Ratio Measurement	51
4.5.2 Test Setup	51
4.5.3 Test Procedures	51
4.5.4 Test Results	52
4.6 Conducted Spurious Emissions	58
4.6.1 Limits of Conducted Spurious Emissions Measurement	58
4.6.2 Test Setup	58
4.6.3 Test Procedure	58
4.6.4 Test Results	59
4.7 Radiated Emission Measurement	61
4.7.1 Limits of Radiated Emission Measurement	61
4.7.2 Test Procedure	61
4.7.3 Deviation from Test Standard	61
4.7.4 Test Setup	61
4.7.5 Test Results	62
5 Pictures of Test Arrangements	70
Appendix – Information on the Testing Laboratories	71



Release Control Record

Issue No.	Description	Date Issued
RF160301C04-2	Original Release	Apr. 12, 2016



1 Certificate of Conformity

Product: Smartphone
Brand: HTC
Test Model: 2PS6400
Sample Status: Production Unit
Applicant: HTC Corporation
Test Date: Mar. 16, 2016 ~ Mar. 23, 2016
Standards: FCC Part 27, Subpart C, L

The above equipment has been tested by **Bureau Veritas Consumer Products Services (H.K.) Ltd., Taoyuan Branch**, and found compliance with the requirement of the above standards. The test record, data evaluation & Equipment Under Test (EUT) configurations represented herein are true and accurate accounts of the measurements of the sample's EMC characteristics under the conditions specified in this report.

Prepared by : Ivonne Wu , **Date:** Apr. 12, 2016
Ivonne Wu / Supervisor

Approved by : Stanley Wu , **Date:** Apr. 12, 2016
Stanley Wu / Assistant Manager



2 Summary of Test Results

Applied Standard: FCC Part 27 & Part 2 (LTE 4)			
FCC Clause	Test Item	Result	Remarks
2.1046 27.50(d)(4)	Maximum Peak Output Power	Pass	Meet the requirement of limit.
2.1055 27.54	Frequency Stability	Pass	Meet the requirement of limit.
2.1049 27.53(h)	Occupied Bandwidth	Pass	Meet the requirement of limit.
27.50(d)(5)	Peak to Average Ratio	Pass	Meet the requirement of limit.
27.53(h)	Band Edge Measurements	Pass	Meet the requirement of limit.
2.1051 27.53(h)	Conducted Spurious Emissions	Pass	Meet the requirement of limit.
2.1053 27.53(h)	Radiated Spurious Emissions	Pass	Meet the requirement of limit. Minimum passing margin is -38.86 dB at 39.70 MHz.

Applied Standard: FCC Part 27 & Part 2 (LTE 12)			
FCC Clause	Test Item	Result	Remarks
2.1046 27.50(C)(10)	Maximum Peak Output Power	Pass	Meet the requirement of limit.
2.1055 27.54	Frequency Stability	Pass	Meet the requirement of limit.
2.1049 27.53(g)	Occupied Bandwidth	Pass	Meet the requirement of limit.
27.50(d)(5)	Peak to Average Ratio	Pass	Meet the requirement of limit.
27.53(g)	Band Edge Measurements	Pass	Meet the requirement of limit.
2.1051 27.53(g)	Conducted Spurious Emissions	Pass	Meet the requirement of limit.
2.1053 27.53(g)	Radiated Spurious Emissions	Pass	Meet the requirement of limit. Minimum passing margin is -38.45 dB at 39.70 MHz.

Applied Standard: FCC Part 27 & Part 2 (LTE 13)			
FCC Clause	Test Item	Result	Remarks
2.1046 27.50(b)(10)	Maximum Peak Output Power	Pass	Meet the requirement of limit.
2.1055 27.54	Frequency Stability	Pass	Meet the requirement of limit.
2.1049 27.53(g)	Occupied Bandwidth	Pass	Meet the requirement of limit.
27.50(d)(5)	Peak to Average Ratio	Pass	Meet the requirement of limit.
27.53(g)	Band Edge Measurements	Pass	Meet the requirement of limit.
2.1051 27.53(g)	Conducted Spurious Emissions	Pass	Meet the requirement of limit.
2.1053 27.53(g)	Radiated Spurious Emissions	Pass	Meet the requirement of limit. Minimum passing margin is -22.21 dB at 1586.00 MHz.

2.1 Measurement Uncertainty

Where relevant, the following measurement uncertainty levels have been estimated for tests performed on the EUT as specified in CISPR 16-4-2:

Measurement	Frequency	Expanded Uncertainty (k=2) (±)
Conducted Emissions at mains ports	150 kHz ~ 30 MHz	2.44 dB
Radiated Emissions up to 1 GHz	30 MHz ~ 200 MHz	2.93 dB
	200 MHz ~ 1000 MHz	2.95 dB
Radiated Emissions above 1 GHz	1 GHz ~ 18 GHz	2.26 dB
	18 GHz ~ 40 GHz	1.94 dB



2.2 Test Site and Instruments

Description & Manufacturer	Model No.	Serial No.	Date of Calibration	Due Date of Calibration
Test Receiver Agilent	N9038A	MY51210203	Jan. 21, 2016	Jan. 20, 2017
Spectrum Analyzer Agilent	N9010A	MY52220314	Sep. 03, 2015	Sep. 02, 2016
Spectrum Analyzer ROHDE & SCHWARZ	FSU43	101261	Dec. 17, 2015	Dec. 16, 2016
BILOG Antenna SCHWARZBECK	VULB9168	9168-472	Jan. 07, 2016	Jan. 06, 2017
HORN Antenna SCHWARZBECK	BBHA 9120 D	9120D-969	Jan. 04, 2016	Jan. 03, 2017
Double Ridge Guide Horn Antenna EMCO	3115	5619	Jan. 04, 2016	Jan. 03, 2017
BILOG Antenna SCHWARZBECK	VULB 9168	9168-153	Jan. 07, 2016	Jan. 06, 2017
Agilent Communications Tester-Wireless	8960 Series 10	MY53201073	Jul. 03, 2015	Jul. 02, 2017
Preamplifier EMCI	EMC 012645	980115	Dec. 21, 2015	Dec. 20, 2016
Preamplifier EMCI	EMC 184045	980116	Dec. 21, 2015	Dec. 20, 2016
Preamplifier EMCI	EMC 330H	980112	Dec. 28, 2015	Dec. 27, 2016
Power Meter Anritsu	ML2495A	1232002	Sep. 21, 2015	Sep. 20, 2016
Power Sensor Anritsu	MA2411B	1207325	Sep. 21, 2015	Sep. 20, 2016
RF signal cable HUBER+SUHNNER	SUCOFLEX 104	309219/4 2950114	Oct. 12, 2015	Oct. 11, 2016
RF signal cable HUBER+SUHNNER	SUCOFLEX 104	250130/4	Oct. 12, 2015	Oct. 11, 2016
RF Coaxial Cable Worken	8D-FB	Cable-Ch10-01	Oct. 12, 2015	Oct. 11, 2016
Software BV ADT	E3 6.120103	NA	NA	NA
Antenna Tower MF	MFA-440H	NA	NA	NA
Turn Table MF	MFT-201SS	NA	NA	NA
Antenna Tower & Turn Table Controller MF	MF-7802	NA	NA	NA
Communications Tester-Wireless Agilent	8960 Series 10	MY53201073	Jul. 03, 2015	Jul. 02, 2017
Radio Communication Analyzer Anritsu	MT8820C	6201240432	Jul. 06, 2015	Jul. 05, 2017



- Note:
1. The calibration interval of the above test instruments is 12 / 24 months and the calibrations are traceable to NML/ROC and NIST/USA.
 2. The test was performed in HwaYa Chamber 10.
 3. The horn antenna and preamplifier (model: EMC 184045) are used only for the measurement of emission frequency above 1 GHz if tested.
 4. The FCC Site Registration No. is 690701.
 5. The IC Site Registration No. is IC7450F-10.



A O T

3 General Information

3.1 General Description of EUT

Product	Smartphone	
Brand	HTC	
Test Model	2PS6400	
Status of EUT	Production Unit	
Power Supply Rating	5.0 Vdc (adapter or host equipment) 3.85 Vdc (Li-ion battery)	
Modulation Type	LTE	QPSK, 16QAM
Frequency Range	LTE Band 4 (Channel Bandwidth: 1.4 MHz)	1710.7 ~ 1754.3 MHz
	LTE Band 4 (Channel Bandwidth: 3 MHz)	1711.5 ~ 1753.5 MHz
	LTE Band 4 (Channel Bandwidth: 5 MHz)	1712.5 ~ 1752.5 MHz
	LTE Band 4 (Channel Bandwidth: 10 MHz)	1715.0 ~ 1750.0 MHz
	LTE Band 4 (Channel Bandwidth: 15 MHz)	1717.5 ~ 1747.5 MHz
	LTE Band 4 (Channel Bandwidth: 20 MHz)	1720.0 ~ 1745.0 MHz
	LTE Band 12 (Channel Bandwidth: 1.4 MHz)	699.7 ~ 715.3 MHz
	LTE Band 12 (Channel Bandwidth: 3 MHz)	700.5 ~ 714.5 MHz
	LTE Band 12 (Channel Bandwidth: 5 MHz)	701.5 ~ 713.5 MHz
	LTE Band 12 (Channel Bandwidth: 10 MHz)	704.0 ~ 711.0 MHz
	LTE Band 13 (Channel Bandwidth: 5 MHz)	779.5 ~ 784.5 MHz
	LTE Band 13 (Channel Bandwidth: 10 MHz)	782.0 MHz
	Emission Designator	LTE Band 4 (Channel Bandwidth: 1.4 MHz)
LTE Band 4 (Channel Bandwidth: 3 MHz)		2M70W7D
LTE Band 4 (Channel Bandwidth: 5 MHz)		4M49G7D
LTE Band 4 (Channel Bandwidth: 10 MHz)		8M97G7D
LTE Band 4 (Channel Bandwidth: 15 MHz)		13M5G7D
LTE Band 4 (Channel Bandwidth: 20 MHz)		18M0W7D
LTE Band 12 (Channel Bandwidth: 1.4 MHz)		1M09G7D
LTE Band 12 (Channel Bandwidth: 3 MHz)		2M70W7D
LTE Band 12 (Channel Bandwidth: 5 MHz)		4M50G7D
LTE Band 12 (Channel Bandwidth: 10 MHz)		8M99W7D
LTE Band 13 (Channel Bandwidth: 5 MHz)		4M50G7D
LTE Band 13 (Channel Bandwidth: 10 MHz)		8M95G7D
Max. ERP Power	LTE Band 12 (Channel Bandwidth: 1.4 MHz)	41.69mW
	LTE Band 12 (Channel Bandwidth: 3 MHz)	44.26mW
	LTE Band 12 (Channel Bandwidth: 5 MHz)	50.00mW
	LTE Band 12 (Channel Bandwidth: 10 MHz)	46.45mW
	LTE Band 13 (Channel Bandwidth: 5 MHz)	43.05mW
	LTE Band 13 (Channel Bandwidth: 10 MHz)	45.39mW

Max. EIRP Power	LTE Band 4 (Channel Bandwidth: 1.4 MHz)	175.39mW
	LTE Band 4 (Channel Bandwidth: 3 MHz)	182.81mW
	LTE Band 4 (Channel Bandwidth: 5 MHz)	194.54mW
	LTE Band 4 (Channel Bandwidth: 10 MHz)	195.66mW
	LTE Band 4 (Channel Bandwidth: 15 MHz)	222.84mW
	LTE Band 4 (Channel Bandwidth: 20 MHz)	254.68mW
Antenna Type	Fixed Internal Antenna	
Accessory Device	Refer to Note as below	
Data Cable Supplied	Refer to Note as below	

Note:

1. The EUT's accessories list refers to Ext. Pho.
2. The above EUT information is declared by manufacturer and for more detailed features description, please refer to the manufacturer's specifications or user's manual.

3.2 Configuration of System under Test

<Radiated Emission Test>

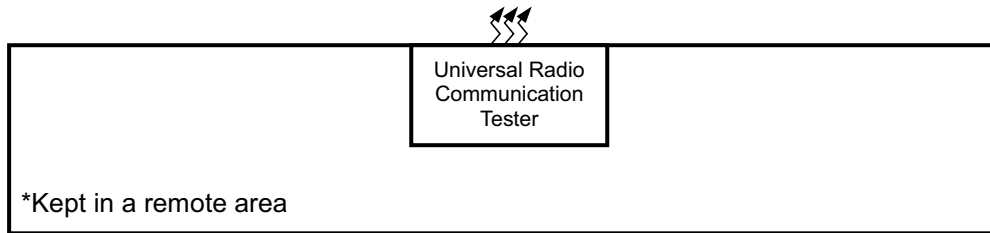
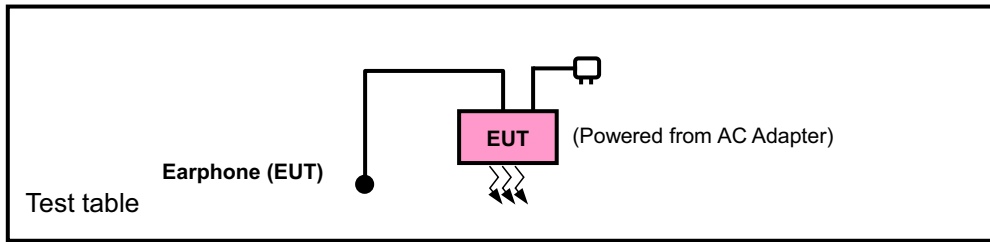

<E.R.P. / E.I.R.P. Test>

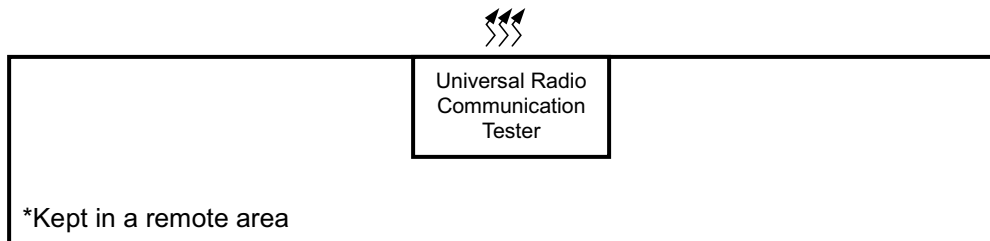
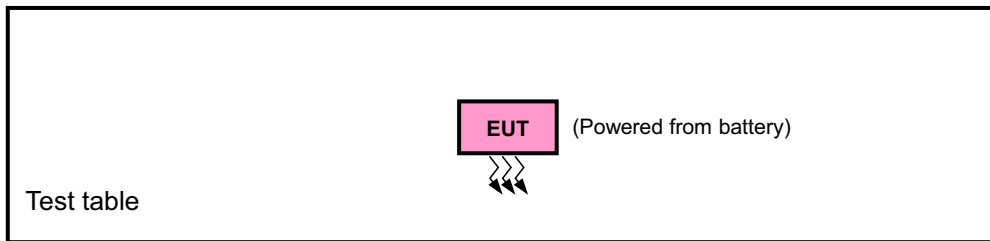

3.2.1 Description of Support Units

The EUT has been tested as an independent unit together with other necessary accessories or support units.

3.3 Test Mode Applicability and Tested Channel Detail

Pre-Scan has been conducted to determine the worst-case mode from all possible combinations between available modulations, data rates, XYZ axis, and antenna ports

The worst case was found when positioned as the table below. Following channel(s) was (were) selected for the final test as listed below:

Band	ERP / EIRP	Radiated Emission
LTE Band 4	Y-plane	Z-axis
LTE Band 12	Y-plane	Y-axis
LTE Band 13	Y-plane	Y-axis

LTE Band 4

EUT Configure Mode	Test Item	Available Channel	Tested Channel	Channel Bandwidth	Modulation	Mode
-	EIRP	19957 to 20393	19957, 20175, 20393	1.4 MHz	QPSK, 16QAM	1 RB / 0 RB Offset
		19965 to 20385	19965, 20175, 20385	3 MHz	QPSK, 16QAM	1 RB / 0 RB Offset
		19975 to 20375	19975, 20175, 20375	5 MHz	QPSK, 16QAM	1 RB / 0 RB Offset
		20000 to 20350	20000, 20175, 20350	10 MHz	QPSK, 16QAM	1 RB / 0 RB Offset
		20025 to 20325	20025, 20175, 20325	15 MHz	QPSK, 16QAM	1 RB / 0 RB Offset
		20050 to 20300	20050, 20175, 20300	20 MHz	QPSK, 16QAM	1 RB / 0 RB Offset
-	Frequency Stability	19957 to 20393	20175	1.4 MHz	QPSK	1 RB / 0 RB Offset
		19965 to 20385	20175	3 MHz	QPSK	1 RB / 0 RB Offset
		19975 to 20375	20175	5 MHz	QPSK	1 RB / 0 RB Offset
		20000 to 20350	20175	10 MHz	QPSK	1 RB / 0 RB Offset
		20025 to 20325	20175	15 MHz	QPSK	1 RB / 0 RB Offset
		20050 to 20300	20175	20 MHz	QPSK	1 RB / 0 RB Offset
-	Occupied Bandwidth	19957 to 20393	19957, 20175, 20393	1.4 MHz	QPSK, 16QAM	6 RB / 0 RB Offset
		19965 to 20385	19965, 20175, 20385	3 MHz	QPSK, 16QAM	15 RB / 0 RB Offset
		19975 to 20375	19975, 20175, 20375	5 MHz	QPSK, 16QAM	25 RB / 0 RB Offset
		20000 to 20350	20000, 20175, 20350	10 MHz	QPSK, 16QAM	50 RB / 0 RB Offset
		20025 to 20325	20025, 20175, 20325	15 MHz	QPSK, 16QAM	75 RB / 0 RB Offset
		20050 to 20300	20050, 20175, 20300	20 MHz	QPSK, 16QAM	100 RB / 0 RB Offset
-	Peak to Average Ratio	19957 to 20393	19957, 20175, 20393	1.4 MHz	QPSK, 16QAM	1 RB / 0 RB Offset
		19965 to 20385	19965, 20175, 20385	3 MHz	QPSK, 16QAM	1 RB / 0 RB Offset
		19975 to 20375	19975, 20175, 20375	5 MHz	QPSK, 16QAM	1 RB / 0 RB Offset
		20000 to 20350	20000, 20175, 20350	10 MHz	QPSK, 16QAM	1 RB / 0 RB Offset
		20025 to 20325	20025, 20175, 20325	15 MHz	QPSK, 16QAM	1 RB / 0 RB Offset
		20050 to 20300	20050, 20175, 20300	20 MHz	QPSK, 16QAM	1 RB / 0 RB Offset



EUT Configure Mode	Test Item	Available Channel	Tested Channel	Channel Bandwidth	Modulation	Mode		
-	Band Edge	19957 to 20393	19957	1.4 MHz	QPSK	1 RB / 0 RB Offset 6 RB / 0 RB Offset		
			20393	1.4 MHz	QPSK	1 RB / 5 RB Offset 6 RB / 0 RB Offset		
		19965 to 20385	19965	3 MHz	QPSK	1 RB / 0 RB Offset 15 RB / 0 RB Offset		
			20385	3 MHz	QPSK	1 RB / 14 RB Offset 15 RB / 0 RB Offset		
		19975 to 20375	19975	5 MHz	QPSK	1 RB / 0 RB Offset 25 RB / 0 RB Offset		
			20375	5 MHz	QPSK	1 RB / 24 RB Offset 25 RB / 0 RB Offset		
		20000 to 20350	20000	10 MHz	QPSK	1 RB / 0 RB Offset 50 RB / 0 RB Offset		
			20350	10 MHz	QPSK	1 RB / 49 RB Offset 50 RB / 0 RB Offset		
		20025 to 20325	20025	15 MHz	QPSK	1 RB / 0 RB Offset 75 RB / 0 RB Offset		
			20325	15 MHz	QPSK	1 RB / 74 RB Offset 75 RB / 0 RB Offset		
		20050 to 20300	20050	20 MHz	QPSK	1 RB / 0 RB Offset 100 RB / 0 RB Offset		
			20300	20 MHz	QPSK	1 RB / 99 RB Offset 100 RB / 0 RB Offset		
		-	Conducted Emission	19957 to 20393	20175	1.4 MHz	QPSK	1 RB / 0 RB Offset
				19965 to 20385	20175	3 MHz	QPSK	1 RB / 0 RB Offset
				19975 to 20375	20175	5 MHz	QPSK	1 RB / 0 RB Offset
				20000 to 20350	20175	10 MHz	QPSK	1 RB / 0 RB Offset
				20025 to 20325	20175	15 MHz	QPSK	1 RB / 0 RB Offset
				20050 to 20300	20175	20 MHz	QPSK	1 RB / 0 RB Offset
-	Radiated Emission	20050 to 20300	20175	20 MHz	QPSK	1 RB / 0 RB Offset		

Note: This device was tested under all bandwidths, RB configurations and modulations. The worst case was found in QPSK modulation.



LTE Band 12

EUT Configure Mode	Test Item	Available Channel	Tested Channel	Channel Bandwidth	Modulation	Mode		
-	ERP	23017 to 23173	23017, 23095, 23173	1.4 MHz	QPSK, 16QAM	1 RB / 5 RB Offset		
		23025 to 23165	23025, 23095, 23165	3 MHz	QPSK, 16QAM	1 RB / 14 RB Offset		
		23035 to 23155	23035, 23095, 23155	5 MHz	QPSK, 16QAM	1 RB / 24 RB Offset		
		23060 to 23130	23060, 23095, 23130	10 MHz	QPSK, 16QAM	1 RB / 49 RB Offset		
-	Frequency Stability	23017 to 23173	23095	1.4 MHz	QPSK	1 RB / 5 RB Offset		
		23025 to 23165	23095	3 MHz	QPSK	1 RB / 14 RB Offset		
		23035 to 23155	23095	5 MHz	QPSK	1 RB / 24 RB Offset		
		23060 to 23130	23095	10 MHz	QPSK	1 RB / 49 RB Offset		
-	Occupied Bandwidth	23017 to 23173	23017, 23095, 23173	1.4 MHz	QPSK, 16QAM	6 RB / 0 RB Offset		
		23025 to 23165	23025, 23095, 23165	3 MHz	QPSK, 16QAM	15 RB / 0 RB Offset		
		23035 to 23155	23035, 23095, 23155	5 MHz	QPSK, 16QAM	25 RB / 0 RB Offset		
		23060 to 23130	23060, 23095, 23130	10 MHz	QPSK, 16QAM	50 RB / 0 RB Offset		
-	Peak to Average Ratio	23017 to 23173	23017, 23095, 23173	1.4 MHz	QPSK, 16QAM	1 RB / 5 RB Offset		
		23025 to 23165	23025, 23095, 23165	3 MHz	QPSK, 16QAM	1 RB / 14 RB Offset		
		23035 to 23155	23035, 23095, 23155	5 MHz	QPSK, 16QAM	1 RB / 24 RB Offset		
		23060 to 23130	23060, 23095, 23130	10 MHz	QPSK, 16QAM	1 RB / 49 RB Offset		
-	Band Edge	23017 to 23173	23017	1.4 MHz	QPSK	1 RB / 0 RB Offset 6 RB / 0 RB Offset		
			23173	1.4 MHz	QPSK	1 RB / 5 RB Offset 6 RB / 0 RB Offset		
		23025 to 23165	23025	3 MHz	QPSK	1 RB / 0 RB Offset 15 RB / 0 RB Offset		
			23165	3 MHz	QPSK	1 RB / 14 RB Offset 15 RB / 0 RB Offset		
		23035 to 23155	23035	5 MHz	QPSK	1 RB / 0 RB Offset 25 RB / 0 RB Offset		
			23155	5 MHz	QPSK	1 RB / 24 RB Offset 25 RB / 0 RB Offset		
		23060 to 23130	23060	10 MHz	QPSK	1 RB / 0 RB Offset 50 RB / 0 RB Offset		
			23130	10 MHz	QPSK	1 RB / 49 RB Offset 50 RB / 0 RB Offset		
		-	Conducted Emission	23017 to 23173	23095	1.4 MHz	QPSK	1 RB / 5 RB Offset
				23025 to 23165	23095	3 MHz	QPSK	1 RB / 14 RB Offset
				23035 to 23155	23095	5 MHz	QPSK	1 RB / 24 RB Offset
				23060 to 23130	23095	10 MHz	QPSK	1 RB / 49 RB Offset
-	Radiated Emission	23060 to 23130	23095	10 MHz	QPSK	1 RB / 49 RB Offset		

Note: This device was tested under all bandwidths, RB configurations and modulations. The worst case was found in QPSK modulation.



LTE Band 13

EUT Configure Mode	Test Item	Available Channel	Tested Channel	Channel Bandwidth	Modulation	Mode
-	ERP	23205 to 23255	23205, 23230, 23255	5 MHz	QPSK, 16QAM	1 RB / 12 RB Offset
		23230	23230	10 MHz	QPSK, 16QAM	1 RB / 24 RB Offset
-	Frequency Stability	23205 to 23255	23230	5 MHz	QPSK	1 RB / 12 RB Offset
		23230	23230	10 MHz	QPSK	1 RB / 24 RB Offset
-	Occupied Bandwidth	23205 to 23255	23205, 23230, 23255	5 MHz	QPSK, 16QAM	25 RB / 0 RB Offset
		23230	23230	10 MHz	QPSK, 16QAM	50 RB / 0 RB Offset
-	Peak to Average Ratio	23205 to 23255	23205, 23230, 23255	5 MHz	QPSK, 16QAM	1 RB / 12 RB Offset
		23230	23230	10 MHz	QPSK, 16QAM	1 RB / 24 RB Offset
-	Band Edge	23205 to 23255	23205	5 MHz	QPSK	1 RB / 0 RB Offset
			23255	5 MHz	QPSK	25 RB / 0 RB Offset
		23230	23230	10 MHz	QPSK	1 RB / 24 RB Offset
			23230	10 MHz	QPSK	25 RB / 0 RB Offset
			23230	10 MHz	QPSK	1 RB / 0 RB Offset
			23230	10 MHz	QPSK	50 RB / 0 RB Offset
-	Conducted Emission	23205 to 23255	23230	5 MHz	QPSK	1 RB / 12 RB Offset
		23230	23230	10 MHz	QPSK	1 RB / 24 RB Offset
-	Radiated Emission	23230	23230	10 MHz	QPSK	1 RB / 12 RB Offset
						25 RB / 0 RB Offset

Note: This device was tested under all bandwidths, RB configurations and modulations. The worst case was found in QPSK modulation.

Test Condition:

Test Item	Environmental Conditions	Input Power	Tested By
ERP / EIRP	25 deg. C, 65 % RH	3.85 Vdc	Luke Chen
Frequency Stability	25 deg. C, 65 % RH	3.85 Vdc	Luke Chen
Occupied Bandwidth	25 deg. C, 65 % RH	3.85 Vdc	Luke Chen
Band Edge	25 deg. C, 65 % RH	3.85 Vdc	Luke Chen
Peak to Average Ratio	25 deg. C, 65 % RH	3.85 Vdc	Luke Chen
Condcudeted Emission	25 deg. C, 65 % RH	3.85 Vdc	Luke Chen
Radiated Emission	25 deg. C, 65 % RH	120 Vac, 60 Hz	Toby Tian

3.4 EUT Operating Conditions

The EUT makes a call to the communication simulator. The communication simulator station system controlled a EUT to export maximum output power under transmission mode and specific channel frequency

3.5 General Description of Applied Standards

The EUT is a RF Product. According to the specifications of the manufacturer, it must comply with the requirements of the following standards:

FCC 47 CFR Part 2

FCC 47 CFR Part 27

KDB 971168 D01 Power Meas License Digital Systems v02r02

ANSI/TIA/EIA-603-D 2010

NOTE: All test items have been performed and recorded as per the above standards.

4 Test Types and Results

4.1 Output Power Measurement

4.1.1 Limits of Output Power Measurement

Fixed, mobile, and portable (hand-held) stations operating in the 1710–1755 MHz band are limited to 1 watt EIRP.

Portable stations (hand-held devices) operating in the 699-787 MHz band are limited to 3 watts ERP

4.1.2 Test Procedures

EIRP / ERP Measurement:

- a. All measurements were done at low, middle and high operational frequency range. RBW and VBW is 10 MHz for LTE mode.
- b. Substitution method is used for E.I.R.P measurement. In the semi-anechoic chamber, EUT placed on the 0.8 m height of Turn Table, rotated the table around 360 degrees to search the maximum radiation power and receiver antenna shall be rotated vertical and horizontal polarization and moved height from 1 m to 4 m to find the maximum polar radiated power. The “Read Value” is the spectrum reading the maximum power value.
- c. The substitution horn antenna is substituted for EUT at the same position and signals generator export the CW signal to the substitution antenna via a tx cable. Rotated the Turn Table and moved receiving antenna to find the maximum radiation power. Adjust output power level of S.G to get a Value of spectrum reading equal to “Read Value” of step b. Record the power level of S.G.
- d. $EIRP = \text{Output power level of S.G} - \text{TX cable loss} + \text{Antenna gain of substitution horn}$. E.R.P power can be calculated form E.I.R.P power by subtracting the gain of dipole, $E.R.P \text{ power} = E.I.P.R \text{ power} - 2.15 \text{ dBi}$.

Conducted Power Measurement:

- a. The EUT was set up for the maximum power with LTE link data modulation and link up with simulator.
- b. Set the EUT to transmit under low, middle and high channel and record the power level shown on simulator.

4.1.3 Test Setup

EIRP / ERP Measurement:

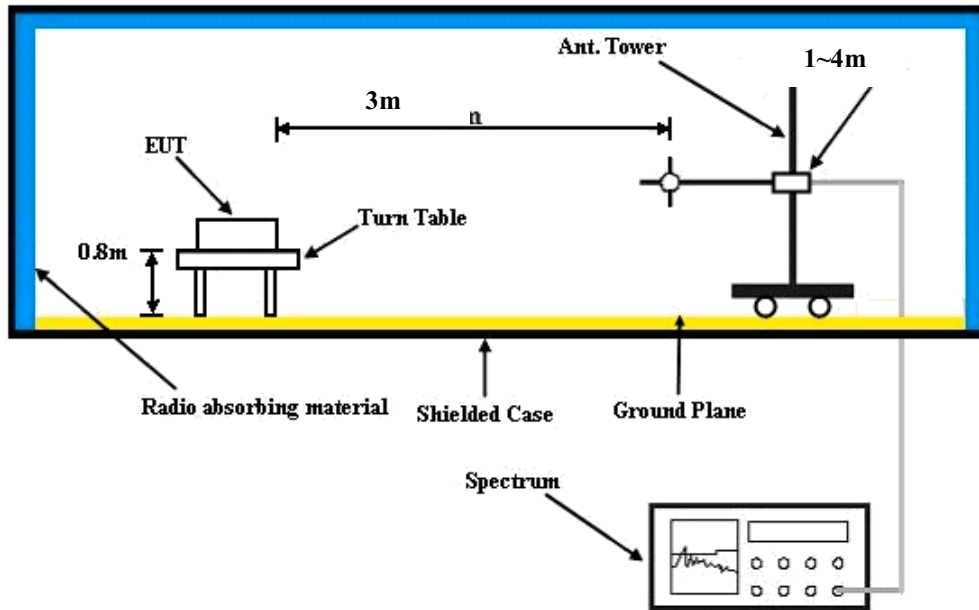

For the actual test configuration, please refer to the attached file (Test Setup Photo).

Conducted Power Measurement:





4.1.4 Test Results

Conducted Output Power (dBm)

Band / BW	RB Size	RB Offset	QPSK			3GPP MPR (dB)	16QAM			3GPP MPR (dB)
			Low Ch 19957	Mid Ch 20175	High Ch 20393		Low Ch 19957	Mid Ch 20175	High Ch 20393	
			1710.7 MHz	1732.5 MHz	1754.3 MHz		1710.7 MHz	1732.5 MHz	1754.3 MHz	
4 / 1.4M	1	0	23.63	23.70	23.29	0	22.66	22.75	22.36	1
	1	2	23.21	23.37	22.86	0	22.27	22.41	22.05	1
	1	5	22.81	22.92	22.39	0	21.86	21.94	21.50	1
	3	0	22.32	22.54	22.93	0	21.46	21.56	21.12	1
	3	1	22.19	22.10	22.68	0	21.96	21.10	21.63	1
	3	3	22.13	22.02	22.57	0	21.86	21.01	21.53	1
	6	0	22.21	22.43	21.89	1	21.25	21.41	20.79	2

Band / BW	RB Size	RB Offset	QPSK			3GPP MPR (dB)	16QAM			3GPP MPR (dB)
			Low Ch 19965	Mid Ch 20175	High Ch 20385		Low Ch 19965	Mid Ch 20175	High Ch 20385	
			1711.5 MHz	1732.5 MHz	1753.5 MHz		1711.5 MHz	1732.5 MHz	1753.5 MHz	
4 / 3M	1	0	23.68	23.74	23.38	0	22.73	22.80	22.41	1
	1	7	23.38	23.45	22.99	0	22.33	22.48	22.16	1
	1	14	22.92	23.03	22.53	0	21.89	22.02	21.70	1
	8	0	22.49	22.66	22.25	1	21.40	21.57	20.99	2
	8	3	22.21	22.29	21.78	1	21.06	21.18	20.73	2
	8	7	22.03	22.21	21.75	1	20.95	21.08	20.67	2
	15	0	22.46	22.58	22.10	1	21.44	21.49	21.12	2

Band / BW	RB Size	RB Offset	QPSK			3GPP MPR (dB)	16QAM			3GPP MPR (dB)
			Low Ch 19975	Mid Ch 20175	High Ch 20375		Low CH 19975	Mid CH 20175	High CH 20375	
			1712.5 MHz	1732.5 MHz	1752.5 MHz		1712.5 MHz	1732.5 MHz	1752.5 MHz	
4 / 5M	1	0	23.72	23.79	23.43	0	22.76	22.84	22.45	1
	1	12	23.33	23.48	23.17	0	22.34	22.50	22.19	1
	1	24	23.00	23.07	22.74	0	21.92	22.05	21.57	1
	12	0	22.61	22.68	22.22	1	21.54	21.70	21.26	2
	12	6	22.22	22.33	21.99	1	21.24	21.31	20.97	2
	12	13	22.09	22.26	21.87	1	21.10	21.26	20.85	2
	25	0	22.43	22.61	22.17	1	21.48	21.63	21.18	2

Band / BW	RB Size	RB Offset	QPSK			3GPP MPR (dB)	16QAM			3GPP MPR (dB)
			Low Ch 20000	Mid Ch 20175	High Ch 20350		Low Ch 20000	Mid Ch 20175	High Ch 20350	
			1715.0 MHz	1732.5 MHz	1750.0 MHz		1715.0 MHz	1732.5 MHz	1750.0 MHz	
4 / 10M	1	0	23.78	23.84	23.48	0	22.84	22.90	22.54	1
	1	24	23.48	23.54	23.23	0	22.51	22.59	22.31	1
	1	49	23.03	23.15	22.82	0	22.00	22.20	21.87	1
	25	0	22.67	22.77	22.51	1	21.68	21.81	21.35	2
	25	12	22.35	22.43	22.11	1	21.38	21.46	21.02	2
	25	25	22.24	22.38	22.01	1	21.28	21.40	20.97	2
	50	0	22.53	22.70	22.24	1	21.56	21.73	21.35	2



Band / BW	RB Size	RB Offset	QPSK			3GPP MPR (dB)	16QAM			3GPP MPR (dB)
			Low Ch 20025	Mid Ch 20175	High Ch 20325		Low Ch 20025	Mid Ch 20175	High Ch 20325	
			1717.5 MHz	1732.5 MHz	1747.5 MHz		1717.5 MHz	1732.5 MHz	1747.5 MHz	
4 / 15M	1	0	23.84	23.90	23.56	0	22.88	22.95	22.59	1
	1	37	23.47	23.61	23.28	0	22.55	22.64	22.22	1
	1	74	23.07	23.23	22.94	0	22.14	22.25	21.91	1
	36	0	22.83	22.88	22.52	1	21.77	21.89	21.55	2
	36	19	22.49	22.56	22.27	1	21.48	21.57	21.18	2
	36	39	22.45	22.52	22.16	1	21.41	21.50	21.12	2
	75	0	22.71	22.81	22.47	1	21.73	21.82	21.39	2

Band / BW	RB Size	RB Offset	QPSK			3GPP MPR (dB)	16QAM			3GPP MPR (dB)
			Low Ch 20050	Mid Ch 20175	High Ch 20300		Low Ch 20050	Mid Ch 20175	High Ch 20300	
			1720.0 MHz	1732.5 MHz	1745.0 MHz		1720.0 MHz	1732.5 MHz	1745.0 MHz	
4 / 20M	1	0	23.89	23.95	23.62	0	22.92	22.98	22.64	1
	1	50	23.51	23.66	23.42	0	22.54	22.69	22.29	1
	1	99	23.15	23.30	23.05	0	22.26	22.32	22.04	1
	50	0	22.91	22.98	22.59	1	21.93	21.98	21.60	2
	50	25	22.63	22.68	22.34	1	21.62	21.66	21.40	2
	50	50	22.57	22.64	22.31	1	21.54	21.62	21.26	2
	100	0	22.86	22.91	22.57	1	21.84	21.90	21.53	2

Band / BW	RB Size	RB Offset	QPSK			3GPP MPR (dB)	16QAM			3GPP MPR (dB)
			Low Ch 23017	Mid Ch 23095	High Ch 23173		Low Ch 23017	Mid Ch 23095	High Ch 23173	
			699.7 MHz	707.5 MHz	715.3 MHz		699.7 MHz	707.5 MHz	715.3 MHz	
12 / 1.4M	1	0	22.38	22.42	22.50	0	21.43	21.45	21.57	1
	1	2	22.57	22.60	22.74	0	21.55	21.66	21.74	1
	1	5	22.64	22.70	22.79	0	21.71	21.78	21.87	1
	3	0	21.72	21.75	21.88	0	20.67	20.74	20.90	1
	3	1	21.75	21.76	21.94	0	20.74	20.77	20.99	1
	3	3	21.78	21.82	21.97	0	20.79	20.83	21.01	1
	6	0	21.69	21.72	21.85	1	20.64	20.67	20.92	2

Band / BW	RB Size	RB Offset	QPSK			3GPP MPR (dB)	16QAM			3GPP MPR (dB)
			Low Ch 23025	Mid Ch 23095	High Ch 23165		Low Ch 23025	Mid Ch 23095	High Ch 23165	
			700.5 MHz	707.5 MHz	714.5 MHz		700.5 MHz	707.5 MHz	714.5 MHz	
12 / 3M	1	0	22.49	22.52	22.61	0	21.51	21.54	21.62	1
	1	7	22.62	22.69	22.81	0	21.68	21.72	21.87	1
	1	14	22.76	22.77	22.85	0	21.76	21.82	21.92	1
	8	0	21.86	21.91	22.04	1	20.84	20.91	21.05	2
	8	3	21.91	21.92	22.08	1	20.91	20.92	21.09	2
	8	7	21.95	21.98	22.10	1	20.94	20.96	21.11	2
	15	0	21.84	21.86	22.02	1	20.80	20.84	21.00	2



Band / BW	RB Size	RB Offset	QPSK			3GPP MPR (dB)	16QAM			3GPP MPR (dB)
			Low Ch 23035	Mid Ch 23095	High Ch 23155		Low Ch 23035	Mid Ch 23095	High Ch 23155	
			701.5 MHz	707.5 MHz	713.5 MHz		701.5 MHz	707.5 MHz	713.5 MHz	
12 / 5M	1	0	22.58	22.59	22.67	0	21.59	21.61	21.70	1
	1	12	22.72	22.75	22.81	0	21.76	21.79	21.89	1
	1	24	22.83	22.84	22.91	0	21.85	21.88	21.96	1
	12	0	22.01	22.02	22.13	1	20.99	21.01	21.13	2
	12	6	22.02	22.05	22.15	1	21.01	21.03	21.17	2
	12	13	22.07	22.09	22.17	1	21.06	21.07	21.20	2
	25	0	21.99	22.01	22.15	1	20.95	20.99	21.10	2

Band / BW	RB Size	RB Offset	QPSK			3GPP MPR (dB)	16QAM			3GPP MPR (dB)
			Low Ch 23060	Mid Ch 23095	High Ch 23130		Low Ch 23060	Mid Ch 23095	High Ch 23130	
			704.0 MHz	707.5 MHz	711.0 MHz		704.0 MHz	707.5 MHz	711.0 MHz	
12 / 10M	1	0	22.66	22.67	22.75	0	21.65	21.66	21.74	1
	1	24	22.76	22.82	22.89	0	21.79	21.84	21.91	1
	1	49	22.88	22.89	22.94	0	21.88	21.94	22.02	1
	25	0	22.15	22.16	22.23	1	21.10	21.12	21.22	2
	25	12	22.16	22.17	22.25	1	21.12	21.14	21.24	2
	25	25	22.18	22.19	22.27	1	21.16	21.17	21.26	2
	50	0	22.14	22.15	22.22	1	21.09	21.10	21.22	2

Band / BW	RB Size	RB Offset	QPSK			3GPP MPR (dB)	16QAM			3GPP MPR (dB)
			Low Ch 23205	Mid Ch 23230	High Ch 23255		Low Ch 23205	Mid Ch 23230	High Ch 23255	
			779.5 MHz	782.0 MHz	784.5 MHz		779.5 MHz	782.0 MHz	784.5 MHz	
13 / 5M	1	0	22.98	22.52	22.49	0	21.98	21.53	21.50	1
	1	12	22.99	22.53	22.51	0	21.99	21.55	21.52	1
	1	24	22.92	22.50	22.42	0	21.92	21.51	21.44	1
	12	0	21.99	21.59	21.56	1	20.98	20.57	20.54	2
	12	6	21.96	21.60	21.58	1	20.96	20.59	20.56	2
	12	13	21.94	21.57	21.55	1	20.90	20.55	20.49	2
	25	0	21.99	21.54	21.52	1	20.92	20.51	20.47	2

Band / BW	RB Size	RB Offset	QPSK		3GPP MPR (dB)	16QAM		3GPP MPR (dB)
			Mid Ch 23230	782.0 MHz		Mid Ch 23230	782.0 MHz	
			782.0 MHz	782.0 MHz				
13 / 10M	1	0		22.18	0		21.15	1
	1	24		22.53	0		21.57	1
	1	49		22.32	0		21.31	1
	25	0		21.58	1		20.53	2
	25	12		21.67	1		20.62	2
	25	25		21.55	1		20.50	2
	50	0		21.60	1		20.55	2



A O T

ERP Power (dBm)

LTE Band 12							
Channel Bandwidth: 1.4 MHz / QPSK							
Plane	Channel	Frequency (MHz)	LVL (dBm)	Correction Factor (dB)	ERP (dBm)	ERP (mW)	Polarization (H/V)
Y	23017	699.7	-12.26	30.36	15.95	39.36	H
	23095	707.5	-11.82	30.17	16.20	41.69	
	23173	715.3	-11.94	30.17	16.08	40.55	
	23017	699.7	-22.68	32.03	7.20	5.25	V
	23095	707.5	-22.25	31.98	7.58	5.73	
	23173	715.3	-22.78	32.06	7.13	5.16	
Channel Bandwidth: 1.4 MHz / 16QAM							
Y	23017	699.7	-13.03	30.36	15.18	32.96	H
	23095	707.5	-12.58	30.17	15.44	34.99	
	23173	715.3	-12.78	30.17	15.24	33.42	
	23017	699.7	-23.43	32.03	6.45	4.42	V
	23095	707.5	-23.26	31.98	6.57	4.54	
	23173	715.3	-23.65	32.06	6.26	4.23	

LTE Band 12							
Channel Bandwidth: 3 MHz / QPSK							
Plane	Channel	Frequency (MHz)	LVL (dBm)	Correction Factor (dB)	ERP (dBm)	ERP (mW)	Polarization (H/V)
Y	23025	700.5	-11.56	30.17	16.46	44.26	H
	23095	707.5	-11.99	30.17	16.03	40.09	
	23165	714.5	-11.78	30.18	16.25	42.17	
	23025	700.5	-22.38	31.96	7.43	5.53	V
	23095	707.5	-22.55	31.98	7.28	5.35	
	23165	714.5	-22.48	32.03	7.40	5.50	
Channel Bandwidth: 3 MHz / 16QAM							
Y	23025	700.5	-12.35	30.17	15.67	36.90	H
	23095	707.5	-12.56	30.17	15.46	35.16	
	23165	714.5	-12.84	30.18	15.19	33.04	
	23025	700.5	-23.32	31.96	6.49	4.46	V
	23095	707.5	-23.68	31.98	6.15	4.12	
	23165	714.5	-23.51	32.03	6.37	4.34	



A O T

LTE Band 12							
Channel Bandwidth: 5 MHz / QPSK							
Plane	Channel	Frequency (MHz)	LVL (dBm)	Correction Factor (dB)	ERP (dBm)	ERP (mW)	Polarization (H/V)
Y	23035	701.5	-11.36	30.17	16.66	46.34	H
	23095	707.5	-11.03	30.17	16.99	50.00	
	23155	713.5	-11.47	30.18	16.56	45.29	
	23035	701.5	-21.26	31.96	8.55	7.16	V
	23095	707.5	-21.03	31.98	8.80	7.59	
	23155	713.5	-21.45	32.03	8.43	6.97	
Channel Bandwidth: 5 MHz / 16QAM							
Y	23035	701.5	-12.81	30.17	15.21	33.19	H
	23095	707.5	-12.33	30.17	15.69	37.07	
	23155	713.5	-12.62	30.18	15.41	34.75	
	23035	701.5	-22.47	31.96	7.34	5.42	V
	23095	707.5	-22.32	31.98	7.51	5.64	
	23155	713.5	-22.78	32.03	7.10	5.13	

LTE Band 12							
Channel Bandwidth: 10 MHz / QPSK							
Plane	Channel	Frequency (MHz)	LVL (dBm)	Correction Factor (dB)	ERP (dBm)	ERP (mW)	Polarization (H/V)
Y	23060	704.0	-11.69	30.17	16.33	42.95	H
	23095	707.5	-11.47	30.17	16.55	45.19	
	23130	711.0	-11.36	30.18	16.67	46.45	
	23060	704.0	-21.56	31.96	8.25	6.68	V
	23095	707.5	-21.21	31.98	8.62	7.28	
	23130	711.0	-21.69	32.03	8.19	6.59	
Channel Bandwidth: 10 MHz / 16QAM							
Y	23060	704.0	-12.85	30.17	15.17	32.89	H
	23095	707.5	-12.74	30.17	15.28	33.73	
	23130	711.0	-12.96	30.18	15.07	32.14	
	23060	704.0	-22.32	31.96	7.49	5.61	V
	23095	707.5	-22.03	31.98	7.80	6.03	
	23130	711.0	-22.34	32.03	7.54	5.68	



A O T

LTE Band 13							
Channel Bandwidth: 5 MHz / QPSK							
Plane	Channel	Frequency (MHz)	LVL (dBm)	Correction Factor (dB)	ERP (dBm)	ERP (mW)	Polarization (H/V)
Y	23205	779.5	-13.92	32.24	16.17	41.40	H
	23230	782.0	-13.68	32.17	16.34	43.05	
	23255	784.5	-13.78	32.11	16.18	41.50	
	23205	779.5	-22.86	32.43	7.42	5.52	V
	23230	782.0	-22.56	32.42	7.71	5.90	
	23255	784.5	-22.92	32.46	7.39	5.48	
Channel Bandwidth: 5 MHz / 16QAM							
Y	23205	779.5	-14.86	32.24	15.23	33.34	H
	23230	782.0	-14.36	32.17	15.66	36.81	
	23255	784.5	-14.52	32.11	15.44	34.99	
	23205	779.5	-23.69	32.43	6.59	4.56	V
	23230	782.0	-23.25	32.42	7.02	5.04	
	23255	784.5	-23.78	32.46	6.53	4.50	

LTE Band 13							
Channel Bandwidth: 10 MHz / QPSK							
Plane	Channel	Frequency (MHz)	LVL (dBm)	Correction Factor (dB)	ERP (dBm)	ERP (mW)	Polarization (H/V)
Y	23230	782.0	-13.45	32.17	16.57	45.39	H
	23230	782.0	-22.68	32.42	7.59	5.74	V
Channel Bandwidth: 10 MHz / 16QAM							
Y	23230	782.0	-14.21	32.17	15.81	38.11	H
	23230	782.0	-23.64	32.42	6.63	4.60	V



A O T

EIRP Power (dBm)

LTE Band 4							
Channel Bandwidth: 1.4 MHz / QPSK							
Plane	Channel	Frequency (MHz)	LVL (dBm)	Correction Factor (dB)	EIRP (dBm)	EIRP (mW)	Polarization (H/V)
Y	19957	1710.7	-21.83	36.45	14.62	28.97	H
	20175	1732.5	-21.90	36.80	14.90	30.90	
	20393	1754.3	-22.22	36.94	14.72	29.67	
	19957	1710.7	-15.43	37.28	21.85	153.00	V
	20175	1732.5	-15.21	37.63	22.42	174.58	
	20393	1754.3	-15.20	37.64	22.44	175.39	
Channel Bandwidth: 1.4 MHz / 16QAM							
Y	19957	1710.7	-22.46	36.45	13.99	25.06	H
	20175	1732.5	-22.32	36.80	14.48	28.05	
	20393	1754.3	-22.13	36.94	14.81	30.29	
	19957	1710.7	-15.92	37.28	21.36	136.68	V
	20175	1732.5	-15.85	37.63	21.78	150.66	
	20393	1754.3	-16.03	37.64	21.61	144.88	

LTE Band 4							
Channel Bandwidth: 3 MHz / QPSK							
Plane	Channel	Frequency (MHz)	LVL (dBm)	Correction Factor (dB)	EIRP (dBm)	EIRP (mW)	Polarization (H/V)
Y	19965	1711.5	-21.91	36.45	14.54	28.44	H
	20175	1732.5	-21.88	36.80	14.92	31.04	
	20385	1753.5	-22.01	36.94	14.93	31.14	
	19965	1711.5	-15.26	37.28	22.02	159.11	V
	20175	1732.5	-15.01	37.63	22.62	182.81	
	20385	1753.5	-15.43	37.64	22.21	166.34	
Channel Bandwidth: 3 MHz / 16QAM							
Y	19965	1711.5	-22.27	36.45	14.18	26.18	H
	20175	1732.5	-21.96	36.80	14.84	30.47	
	20385	1753.5	-21.83	36.94	15.11	32.46	
	19965	1711.5	-15.67	37.28	21.61	144.78	V
	20175	1732.5	-15.46	37.63	22.17	164.82	
	20385	1753.5	-15.58	37.64	22.06	160.69	



A O T

LTE Band 4							
Channel Bandwidth: 5 MHz / QPSK							
Plane	Channel	Frequency (MHz)	LVL (dBm)	Correction Factor (dB)	EIRP (dBm)	EIRP (mW)	Polarization (H/V)
Y	19975	1712.5	-21.59	36.45	14.86	30.62	H
	20175	1732.5	-21.56	36.80	15.24	33.41	
	20375	1752.5	-21.93	36.94	15.01	31.72	
	19975	1712.5	-14.86	37.28	22.42	174.46	V
	20175	1732.5	-14.93	37.63	22.70	186.21	
	20375	1752.5	-14.75	37.64	22.89	194.54	
Channel Bandwidth: 5 MHz / 16QAM							
Y	19975	1712.5	-21.85	36.45	14.60	28.84	H
	20175	1732.5	-21.77	36.80	15.03	31.83	
	20375	1752.5	-21.56	36.94	15.38	34.54	
	19975	1712.5	-15.43	37.28	21.85	153.00	V
	20175	1732.5	-15.26	37.63	22.37	172.58	
	20375	1752.5	-15.55	37.64	22.09	161.81	

LTE Band 4							
Channel Bandwidth: 10 MHz / QPSK							
Plane	Channel	Frequency (MHz)	LVL (dBm)	Correction Factor (dB)	EIRP (dBm)	EIRP (mW)	Polarization (H/V)
Y	20000	1715.0	-21.13	36.64	15.51	35.56	H
	20175	1732.5	-21.07	36.80	15.73	37.37	
	20350	1750.0	-21.22	36.80	15.58	36.14	
	20000	1715.0	-14.66	37.44	22.78	189.63	V
	20175	1732.5	-14.93	37.63	22.70	186.17	
	20350	1750.0	-14.78	37.64	22.86	192.97	
Channel Bandwidth: 10 MHz / 16QAM							
Y	20000	1715.0	-21.96	36.64	14.68	29.38	H
	20175	1732.5	-21.42	36.80	15.38	34.47	
	20350	1750.0	-21.53	36.80	15.27	33.65	
	20000	1715.0	-14.96	37.44	22.48	176.97	V
	20175	1732.5	-14.89	37.63	22.74	187.89	
	20350	1750.0	-14.72	37.64	22.92	195.66	



LTE Band 4							
Channel Bandwidth: 15 MHz / QPSK							
Plane	Channel	Frequency (MHz)	LVL (dBm)	Correction Factor (dB)	EIRP (dBm)	EIRP (mW)	Polarization (H/V)
Y	20025	1717.5	-20.26	36.45	16.19	41.59	H
	20175	1732.5	-19.98	36.80	16.82	48.07	
	20325	1747.5	-20.14	36.94	16.80	47.90	
	20025	1717.5	-14.43	37.28	22.85	192.62	V
	20175	1732.5	-14.15	37.63	23.48	222.84	
	20325	1747.5	-14.59	37.64	23.05	201.84	
Channel Bandwidth: 15 MHz / 16QAM							
Y	20025	1717.5	-20.51	36.45	15.94	39.26	H
	20175	1732.5	-20.39	36.80	16.41	43.74	
	20325	1747.5	-20.46	36.94	16.48	44.49	
	20025	1717.5	-14.77	37.28	22.51	178.11	V
	20175	1732.5	-14.85	37.63	22.78	189.67	
	20325	1747.5	-14.63	37.64	23.01	199.99	

LTE Band 4							
Channel Bandwidth: 20 MHz / QPSK							
Plane	Channel	Frequency (MHz)	LVL (dBm)	Correction Factor (dB)	EIRP (dBm)	EIRP (mW)	Polarization (H/V)
Y	20050	1720.0	-20.55	36.45	15.90	38.90	H
	20175	1732.5	-20.24	36.80	16.56	45.28	
	20300	1745.0	-20.86	36.94	16.08	40.58	
	20050	1720.0	-13.22	37.28	24.06	254.51	V
	20175	1732.5	-13.57	37.63	24.06	254.68	
	20300	1745.0	-13.76	37.64	23.88	244.34	
Channel Bandwidth: 20 MHz / 16QAM							
Y	20050	1720.0	-20.88	36.45	15.57	36.06	H
	20175	1732.5	-20.95	36.80	15.85	38.45	
	20300	1745.0	-21.03	36.94	15.91	39.02	
	20050	1720.0	-14.36	37.28	22.92	195.75	V
	20175	1732.5	-14.29	37.63	23.34	215.77	
	20300	1745.0	-14.11	37.64	23.53	225.42	

4.2 Frequency Stability Measurement

4.2.1 Limits of Frequency Stability Measurement

The frequency stability shall be sufficient to ensure that the fundamental emissions stay within the authorized bands of operation.

4.2.2 Test Procedure

- a. Device is placed at the oven room. The oven room could control the temperatures and humidity. Power warm up is at least 15 min and power applied should perform before recording frequency error.
- b. EUT is connected the external power supply to control the DC input power. The test voltage range is from minimum to maximum working voltage. Each step shall be record the frequency error rate.
- c. The temperature range step is 10 degrees in this test items. All temperature levels shall be hold the ± 0.5 °C during the measurement testing. The each temperature step shall be at least 0.5 hours, consider the EUT could be test under the stability condition.

NOTE: The frequency error was recorded frequency error from the communication simulator.

4.2.3 Test Setup

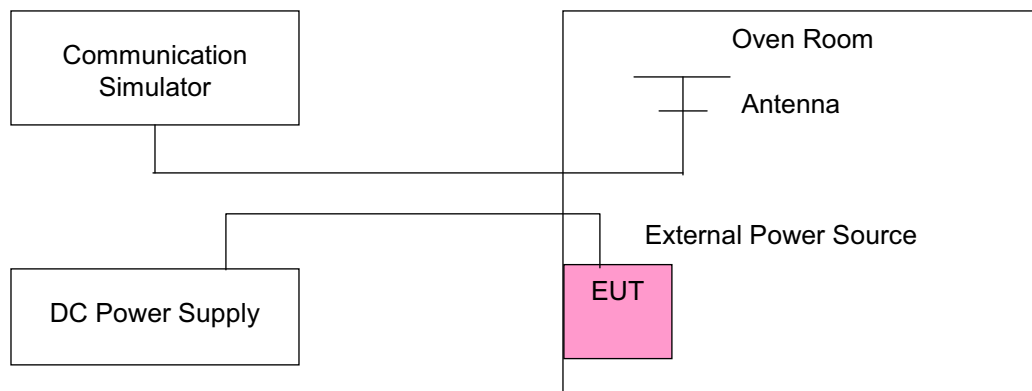



4.2.4 Test Results

Frequency Error vs. Voltage

Voltage (Volts)	Frequency Error (ppm)						Limit (ppm)
	LTE Band 4						
	1.4 MHz	3 MHz	5 MHz	10 MHz	15 MHz	20 MHz	
3.85	0.0014	0.0014	0.0014	0.0005	0.0007	0.0016	2.5
3.6	0.0005	0.0017	0.0010	0.0009	0.0012	0.0022	2.5
4.4	0.0012	0.0009	0.0003	0.0013	0.0003	0.0006	2.5

NOTE: The applicant defined the normal working voltage of the battery is from 3.6 Vdc to 4.4 Vdc.

Frequency Error vs. Temperature

Temp. (°C)	Frequency Error (ppm)						Limit (ppm)
	LTE Band 4						
	1.4 MHz	3 MHz	5 MHz	10 MHz	15 MHz	20 MHz	
-30	0.0017	0.0003	0.0008	0.0013	-0.0002	0.0021	2.5
-20	-0.0018	0.0003	0.0020	0.0007	-0.0018	0.0006	2.5
-10	-0.0023	0.0014	0.0007	0.0021	-0.0020	0.0018	2.5
0	-0.0021	0.0016	0.0009	0.0018	-0.0004	-0.0021	2.5
10	-0.0003	0.0022	0.0009	-0.0019	-0.0023	-0.0002	2.5
20	-0.0010	-0.0005	-0.0014	-0.0010	0.0021	-0.0005	2.5
30	0.0008	-0.0001	-0.0006	-0.0020	0.0014	-0.0018	2.5
40	0.0013	-0.0022	-0.0019	-0.0005	0.0020	-0.0006	2.5
50	0.0012	-0.0001	-0.0012	-0.0010	0.0013	0.0010	2.5
55	0.0003	-0.0021	0.0013	0.0015	0.0005	0.0006	2.5



Frequency Error vs. Voltage

Voltage (Volts)	Frequency Error (ppm)						Limit (ppm)
	LTE Band 12				LTE Band 13		
	1.4 MHz	3 MHz	5 MHz	10 MHz	5 MHz	10 MHz	
3.85	0.0033	0.0038	0.0021	0.0031	0.0029	0.0020	2.5
3.6	0.0014	0.0011	0.0014	0.0003	0.0013	0.0031	2.5
4.4	0.0034	0.0024	0.0028	0.0011	0.0015	0.0010	2.5

NOTE: The applicant defined the normal working voltage of the battery is from 3.6 Vdc to 4.4 Vdc.

Frequency Error vs. Temperature

Temp. (°C)	Frequency Error (ppm)						Limit (ppm)
	LTE Band 12				LTE Band 13		
	1.4 MHz	3 MHz	5 MHz	10 MHz	5 MHz	10 MHz	
-30	0.0014	0.0035	0.0038	-0.0033	0.0049	0.0012	2.5
-20	0.0048	0.0021	-0.0028	-0.0018	0.0009	0.0035	2.5
-10	-0.0048	0.0037	-0.0021	-0.0052	0.0050	0.0003	2.5
0	-0.0014	0.0044	-0.0047	-0.0021	-0.0013	0.0006	2.5
10	-0.0031	-0.0028	-0.0013	-0.0033	-0.0018	-0.0042	2.5
20	-0.0023	-0.0004	-0.0025	0.0021	-0.0008	-0.0041	2.5
30	-0.0010	-0.0055	0.0013	0.0047	-0.0049	-0.0047	2.5
40	0.0040	-0.0031	0.0042	0.0049	0.0019	-0.0028	2.5
50	0.0051	-0.0014	0.0007	0.0006	0.0013	-0.0035	2.5
55	0.0048	0.0016	0.0008	0.0021	0.0012	0.0038	2.5

4.3 Occupied Bandwidth Measurement

4.3.1 Limits of Occupied Bandwidth Measurement

The width of a frequency band such that, below the lower and above the upper frequency limits, the mean powers emitted are each equal to a specified percentage 0.5 % of the total mean power of a given emission.

4.3.2 Test Procedure

- The conducted occupied bandwidth used the power splitter via EUT RF power connector between simulation base station and spectrum analyzer.
- Use OBW measurement function of Spectrum analyzer to measure 99 % occupied bandwidth.

4.3.3 Test Setup

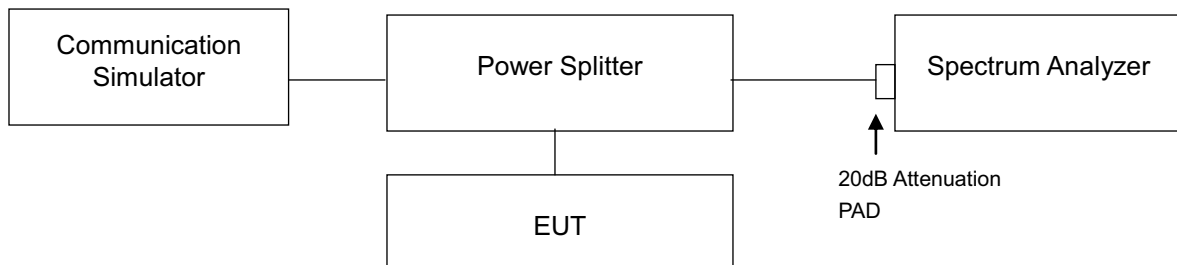



4.3.4 Test Result

LTE Band 4							
Channel Bandwidth: 1.4 MHz				Channel Bandwidth: 3 MHz			
Channel	Frequency (MHz)	99 % Occupied Bandwidth (MHz)		Channel	Frequency (MHz)	99 % Occupied Bandwidth (MHz)	
		QPSK	16QAM			QPSK	16QAM
19957	1710.7	1.0891	1.0871	19965	1711.5	2.6921	2.6989
20175	1732.5	1.0909	1.0883	20175	1732.5	2.6937	2.6928
20393	1754.3	1.0890	1.0898	20385	1753.5	2.6934	2.6945

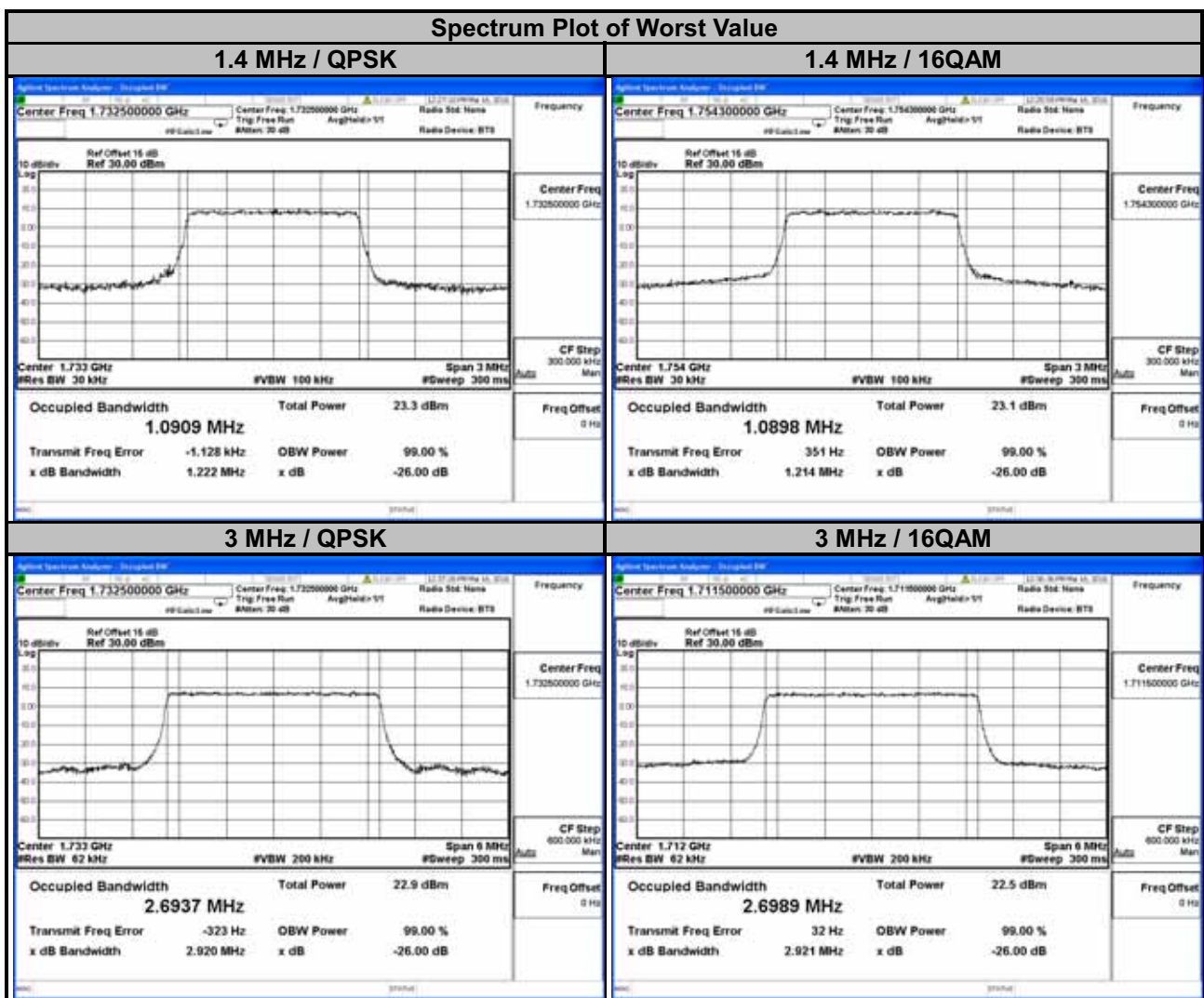



LTE Band 4							
Channel Bandwidth: 5 MHz				Channel Bandwidth: 10 MHz			
Channel	Frequency (MHz)	99 % Occupied Bandwidth (MHz)		Channel	Frequency (MHz)	99 % Occupied Bandwidth (MHz)	
		QPSK	16QAM			QPSK	16QAM
19975	1712.5	4.4887	4.4912	20000	1715.0	8.9625	8.9638
20175	1732.5	4.4915	4.4858	20175	1732.5	8.9667	8.9578
20375	1752.5	4.4885	4.4854	20350	1750.0	8.9622	8.9608

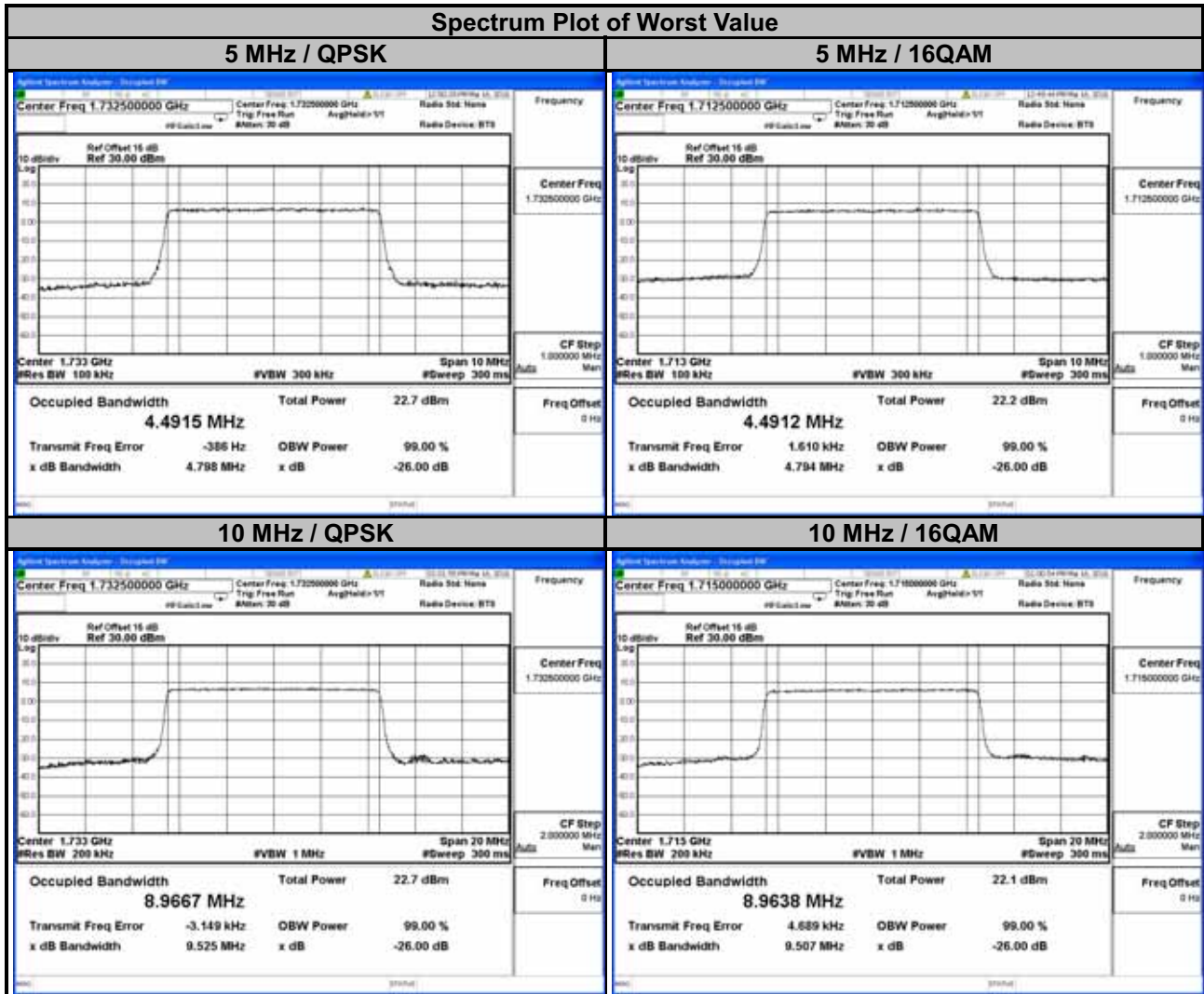



LTE BAND 4

Channel Bandwidth: 15 MHz				Channel Bandwidth: 20 MHz			
Channel	Frequency (MHz)	99 % Occupied Bandwidth (MHz)		Channel	Frequency (MHz)	99 % Occupied Bandwidth (MHz)	
		QPSK	16QAM			QPSK	16QAM
20025	1717.5	13.439	13.444	20050	1720.0	17.917	17.931
20175	1732.5	13.460	13.454	20175	1732.5	17.946	17.954
20325	1747.5	13.446	13.448	20300	1745.0	17.928	17.939

Spectrum Plot of Worst Value

15 MHz / QPSK

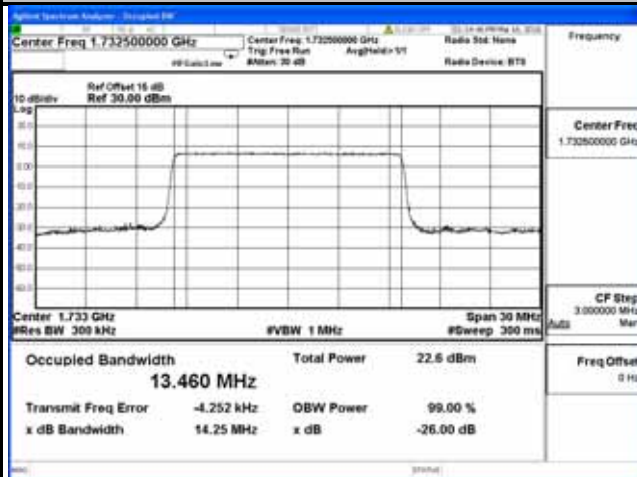

15 MHz / 16QAM

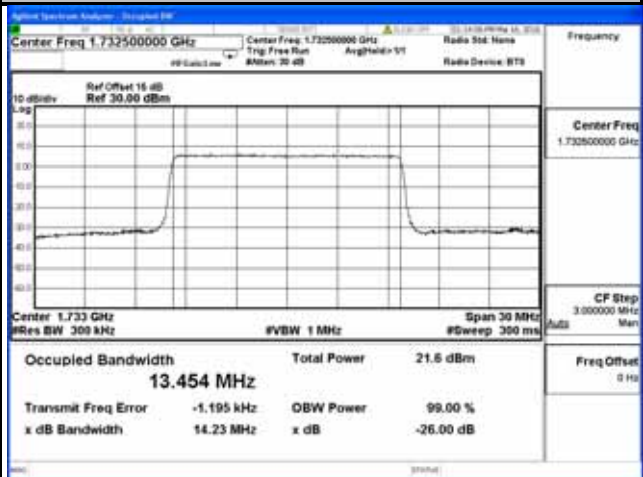

20 MHz / QPSK

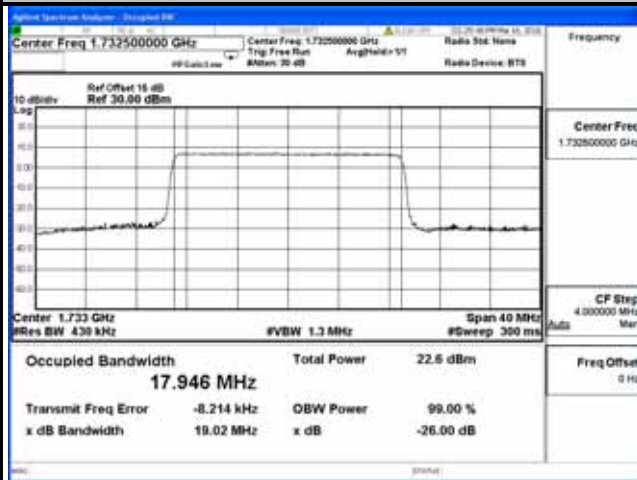

20 MHz / 16QAM

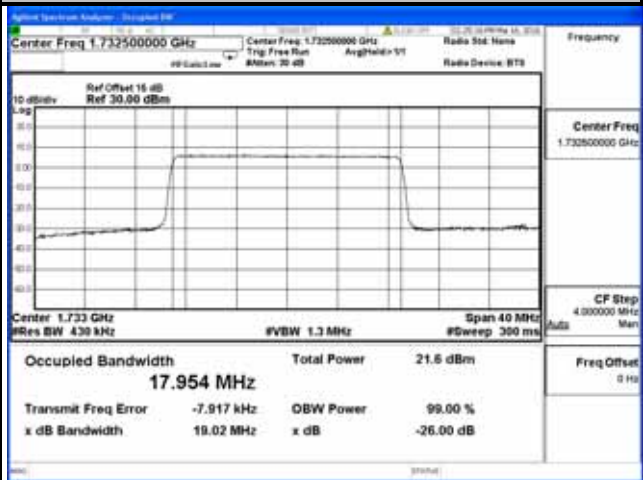



LTE Band 12							
Channel Bandwidth: 1.4 MHz				Channel Bandwidth: 3 MHz			
Channel	Frequency (MHz)	99 % Occupied Bandwidth (MHz)		Channel	Frequency (MHz)	99 % Occupied Bandwidth (MHz)	
		QPSK	16QAM			QPSK	16QAM
23017	699.7	1.0913	1.0876	23025	700.5	2.6935	2.6948
23095	707.5	1.0898	1.0908	23095	707.5	2.6982	2.7012
23173	715.3	1.0919	1.0894	23165	714.5	2.6998	2.6975

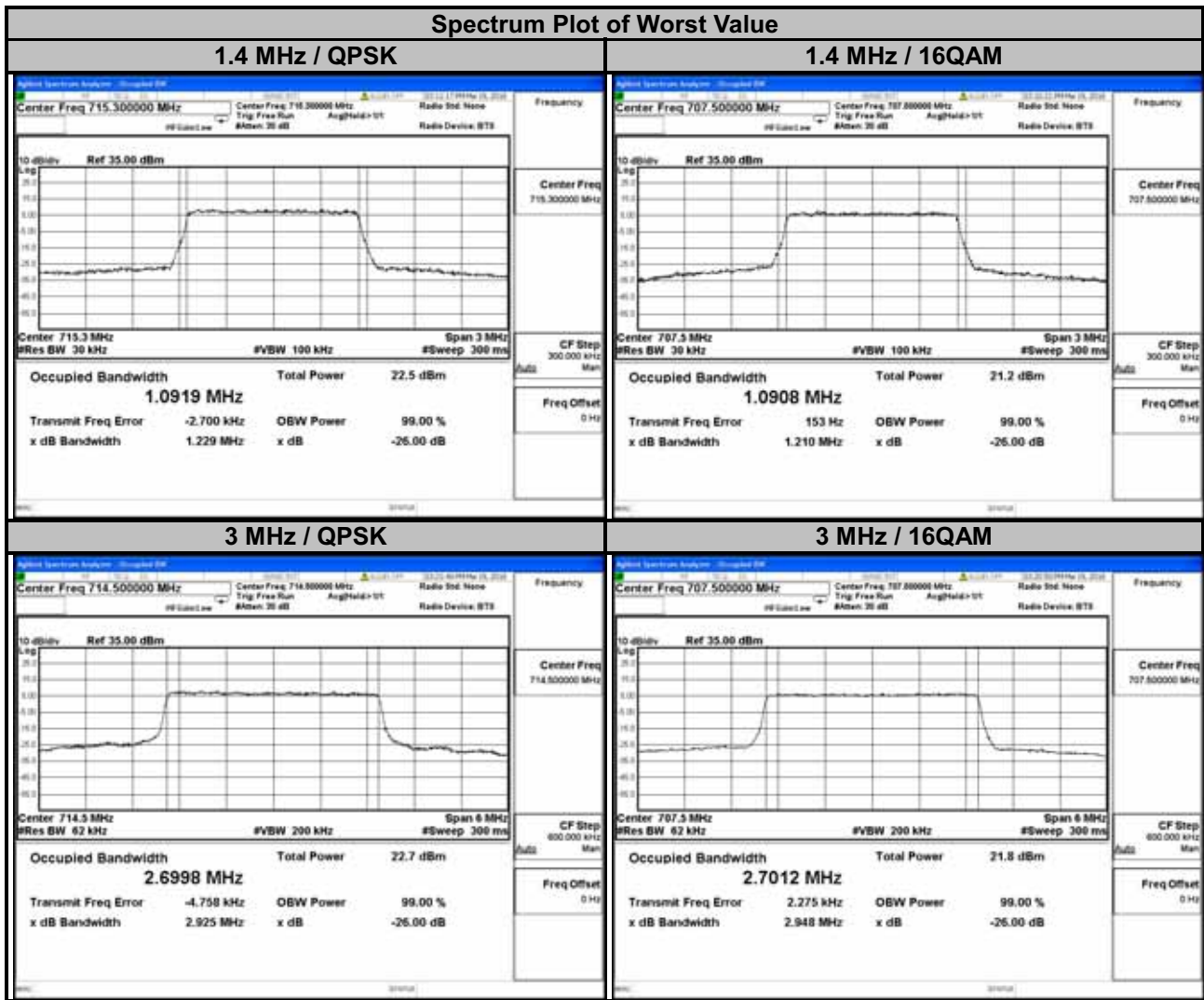



LTE Band 12							
Channel Bandwidth: 5 MHz				Channel Bandwidth: 10 MHz			
Channel	Frequency (MHz)	99 % Occupied Bandwidth (MHz)		Channel	Frequency (MHz)	99 % Occupied Bandwidth (MHz)	
		QPSK	16QAM			QPSK	16QAM
23035	701.5	4.4865	4.4838	23060	704.0	8.9794	8.9710
23095	707.5	4.4997	4.4955	23095	707.5	8.9898	8.9925
23155	713.5	4.4899	4.4874	23130	711.0	8.9354	8.9388

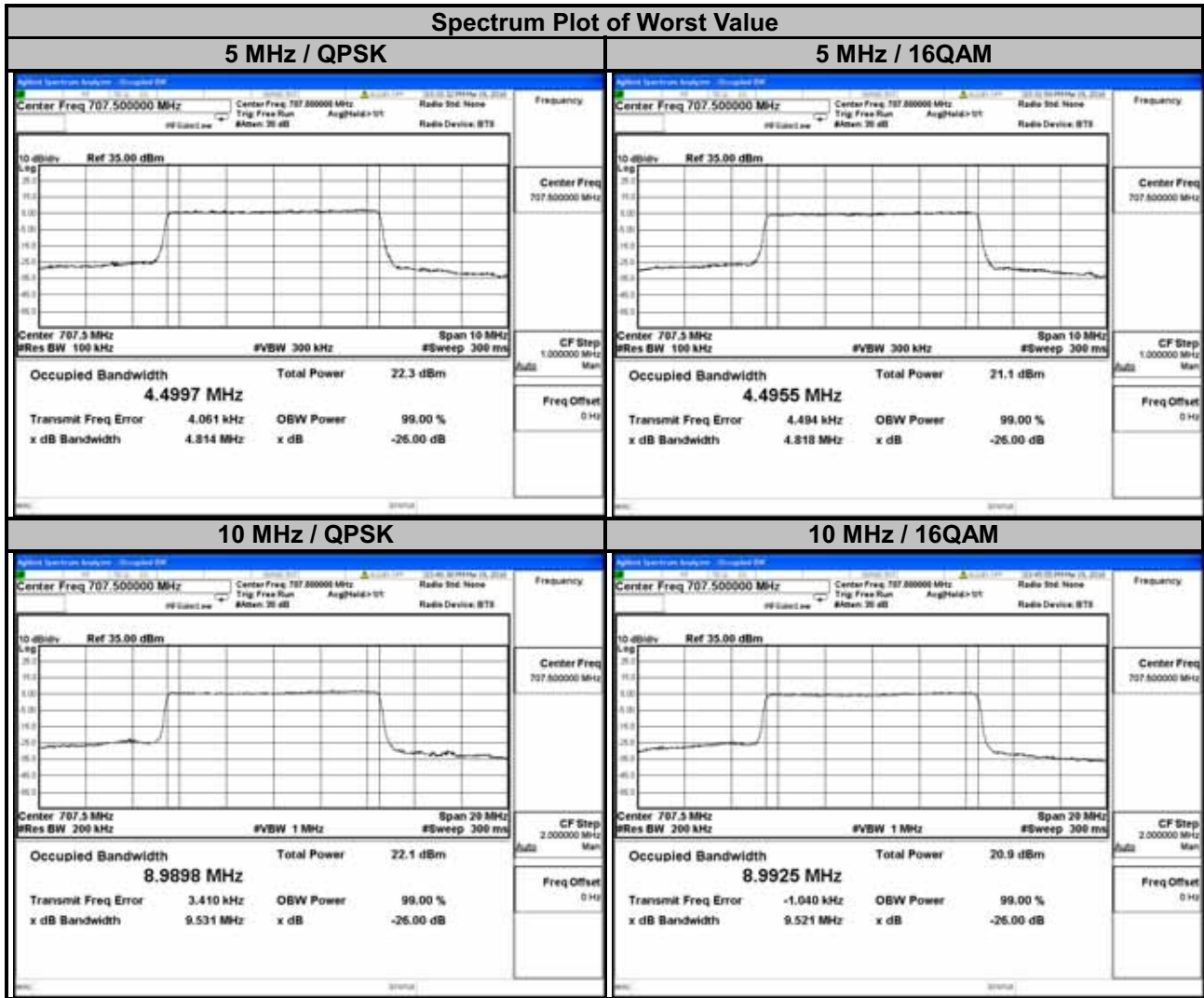



LTE Band 13							
Channel Bandwidth: 5 MHz				Channel Bandwidth: 10 MHz			
Channel	Frequency (MHz)	99 % Occupied Bandwidth (MHz)		Channel	Frequency (MHz)	99 % Occupied Bandwidth (MHz)	
		QPSK	16QAM			QPSK	16QAM
23205	779.5	4.4785	4.4755	23230	782.0	8.9513	8.9513
23230	782.0	4.4985	4.4949				
23255	784.5	4.4929	4.4894				

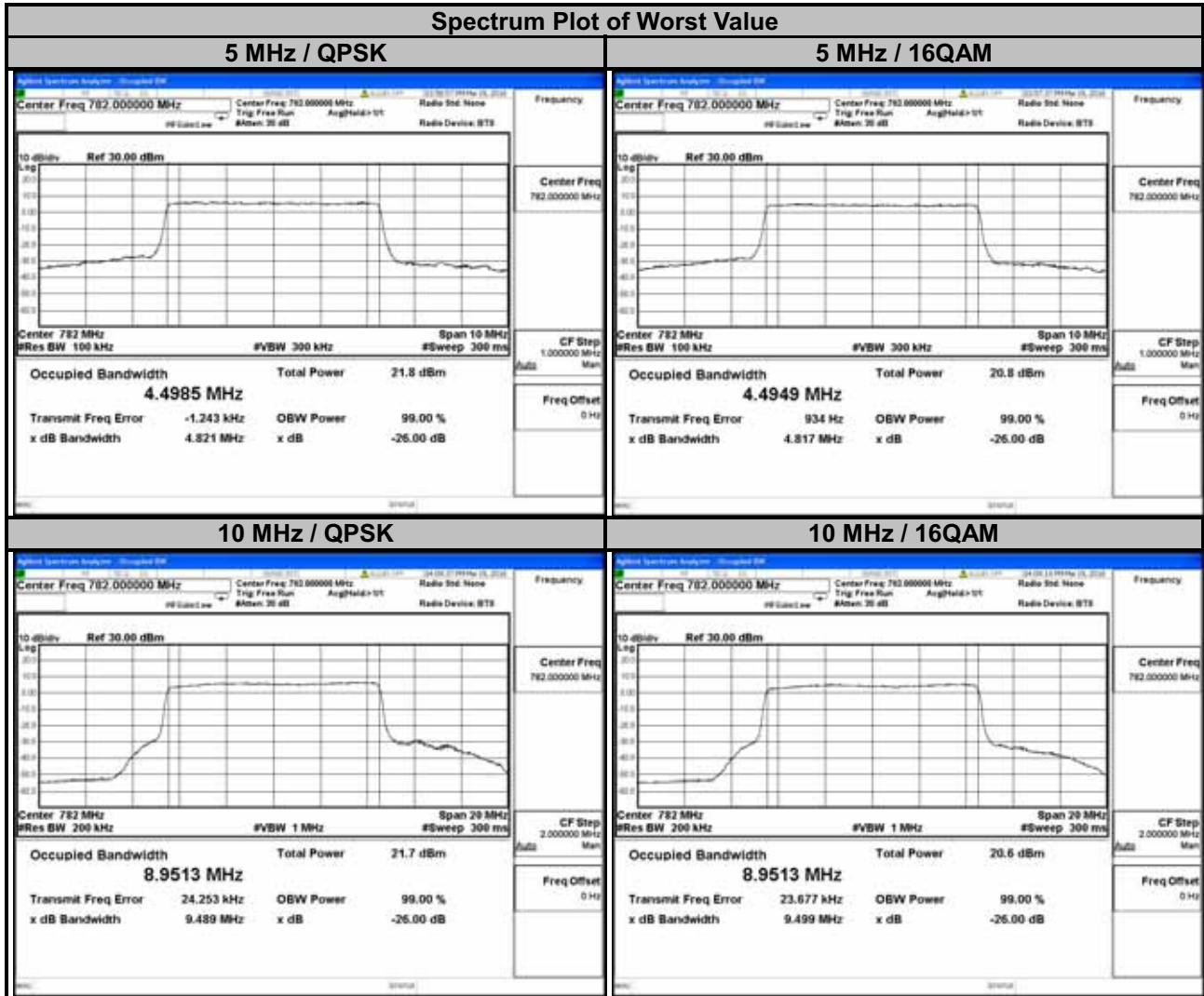

4.4 Band Edge Measurement

4.4.1 Limits of Band Edge Measurement

For operations in the 699-787 MHz band, the power of any emission outside a licensee's frequency band(s) of operation shall be attenuated below the transmitter power (P) within the licensed band(s) of operation, measured in watts, by at least $43 + 10 \log(P)$ dB. Compliance with this provision is based on the use of measurement instrumentation employing a resolution bandwidth of 100 kilohertz or greater.

However, in the 100 kilohertz bands immediately outside and adjacent to a licensee's frequency block, a resolution bandwidth of at least 30 kHz may be employed.

For operations in the 1710–1755 MHz bands, the power of any emission outside a licensee's frequency block shall be attenuated below the transmitter power (P) by at least $43 + 10 \log_{10}(P)$ dB.

4.4.2 Test Setup

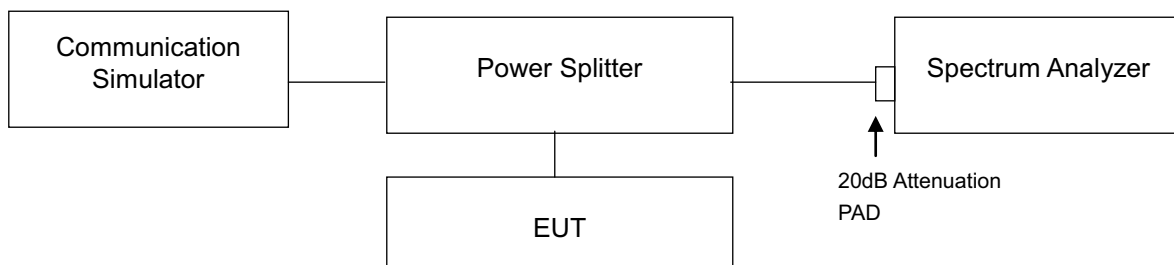

4.4.3 Test Procedures

- a. All measurements were done at low and high operational frequency range.
- b. The center frequency of spectrum is the band edge frequency and span is 1 MHz. RB of the spectrum is 13 kHz and VB of the spectrum is 51 kHz (LTE Bandwidth 1.4 MHz).
- c. The center frequency of spectrum is the band edge frequency and span is 1 MHz. RB of the spectrum is 30 kHz and VB of the spectrum is 100 kHz (LTE Bandwidth 3 MHz).
- d. The center frequency of spectrum is the band edge frequency and span is 1 MHz. RB of the spectrum is 100 kHz and VB of the spectrum is 300 kHz (LTE Bandwidth 5 MHz/10 MHz).
- e. The center frequency of spectrum is the band edge frequency and span is 1 MHz. RB of the spectrum is 150 kHz and VB of the spectrum is 470 kHz (LTE Bandwidth 15 MHz).
- f. The center frequency of spectrum is the band edge frequency and span is 1 MHz. RB of the spectrum is 180 kHz and VB of the spectrum is 560 kHz (LTE Bandwidth 20 MHz).
- g. Record the max trace plot into the test report.

4.4.4 Test Results

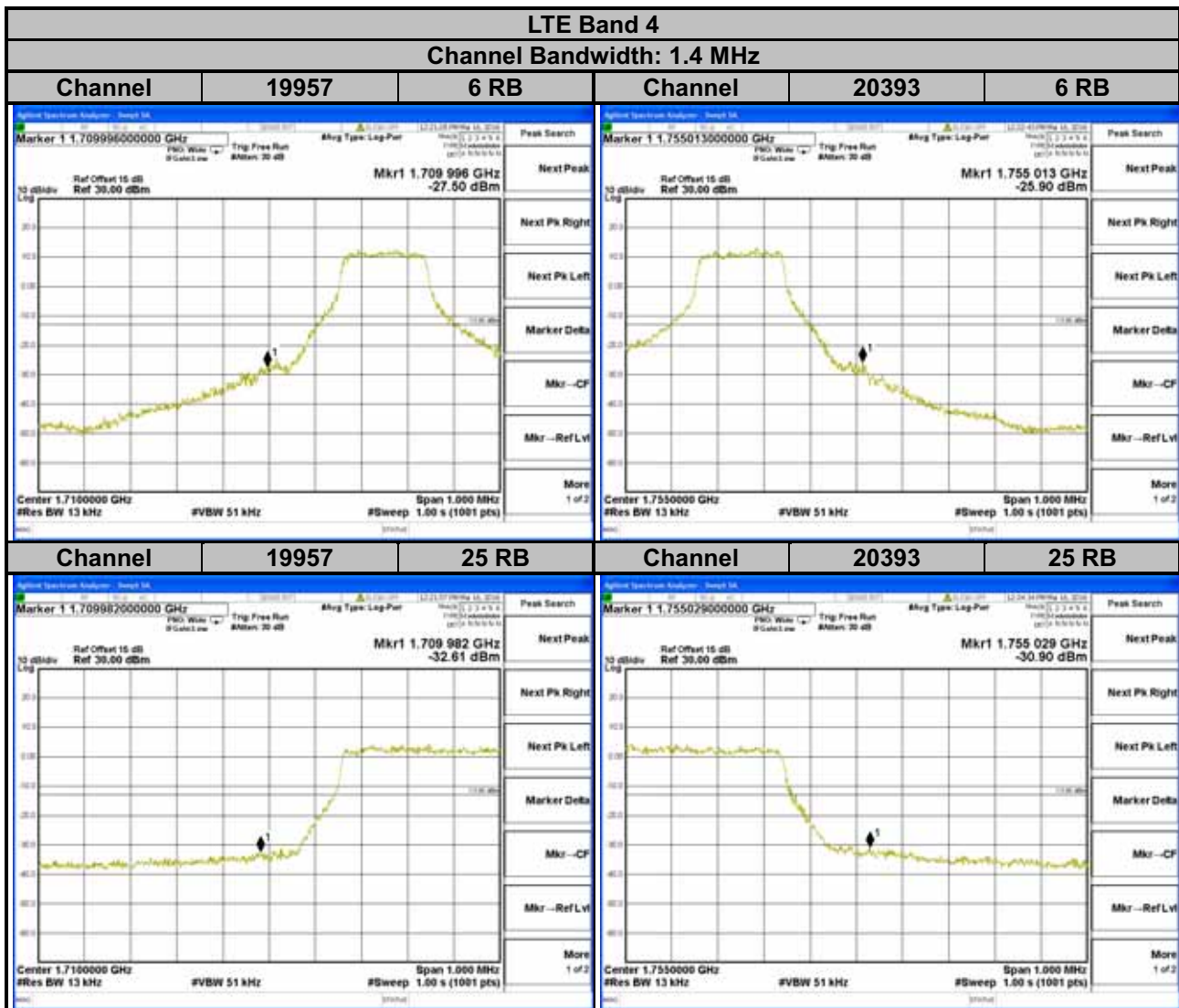



A O T

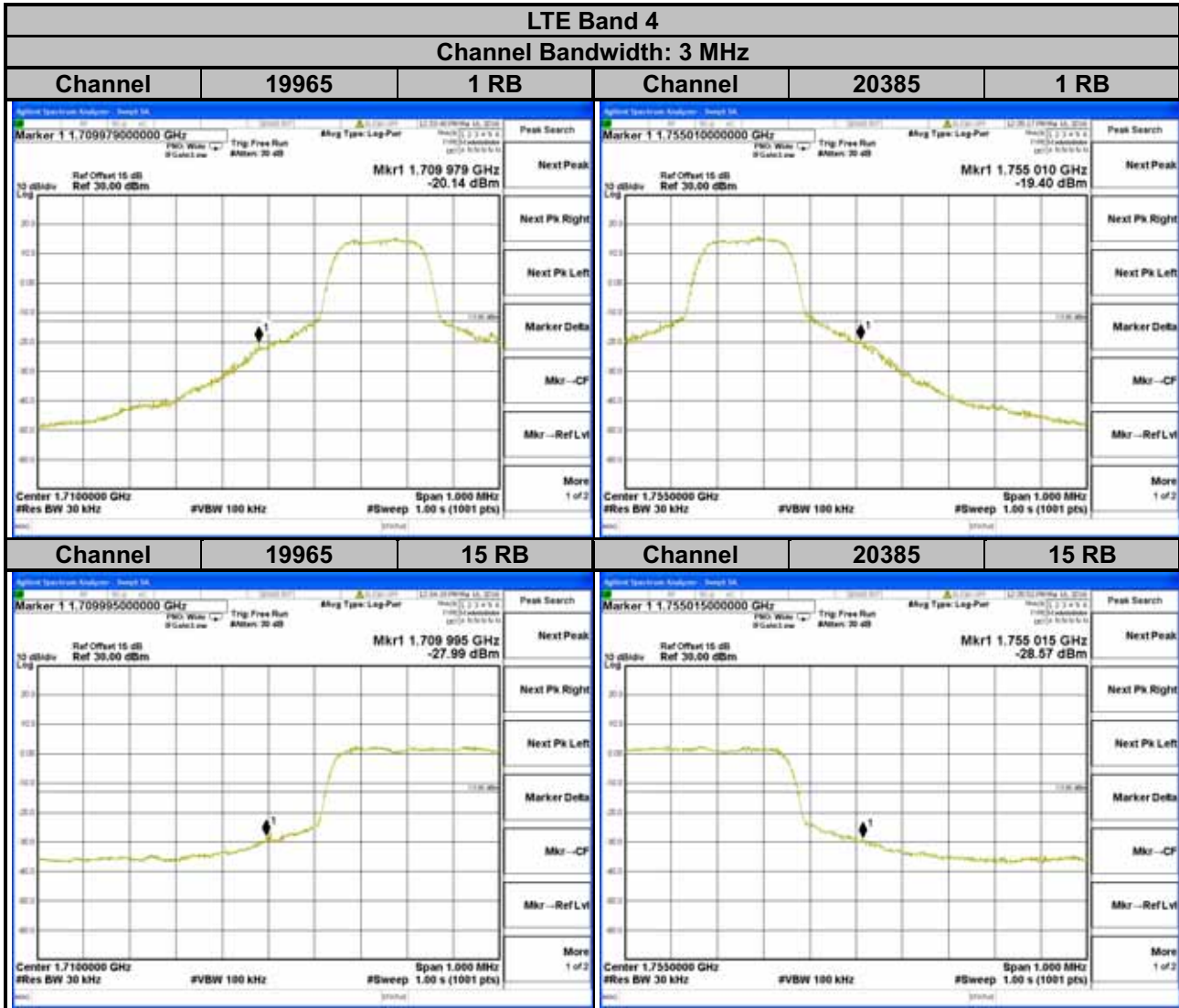



A O T

LTE Band 4
Channel Bandwidth: 5 MHz

Channel	19975	1 RB	Channel	20375	1 RB
----------------	--------------	-------------	----------------	--------------	-------------

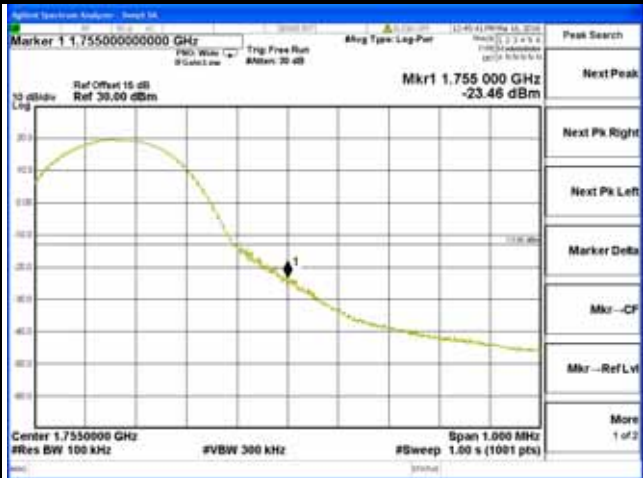

Channel	19975	25 RB	Channel	20375	25 RB
----------------	--------------	--------------	----------------	--------------	--------------

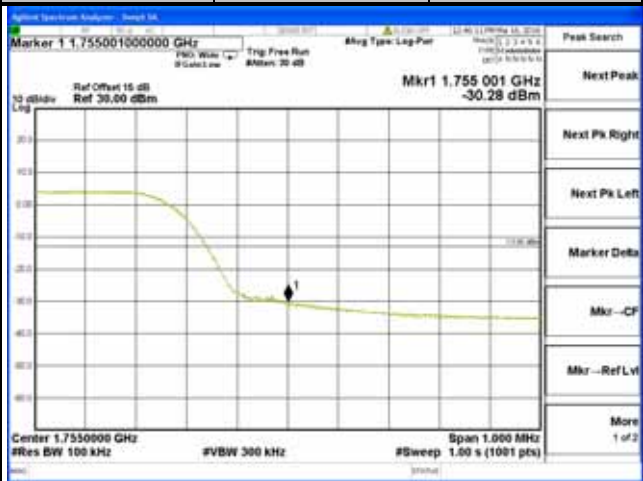
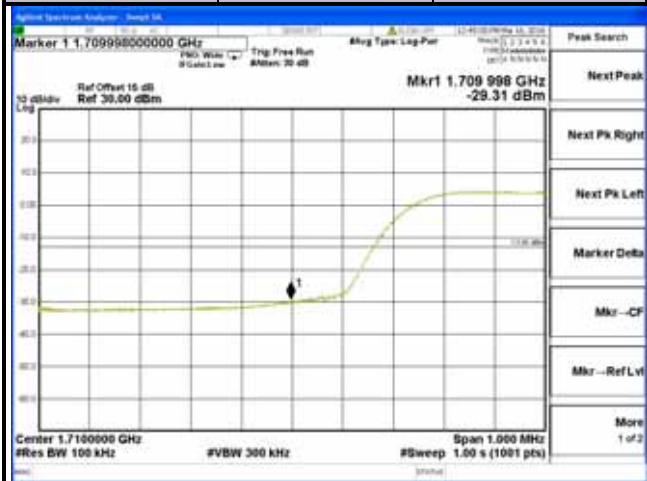



A O T

LTE Band 4
Channel Bandwidth: 10 MHz

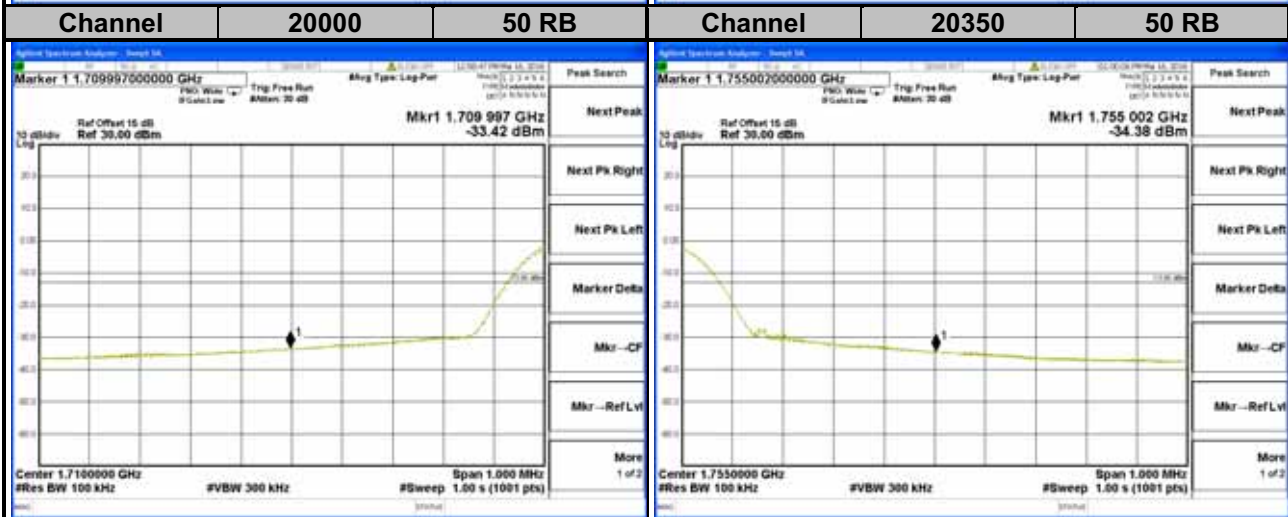
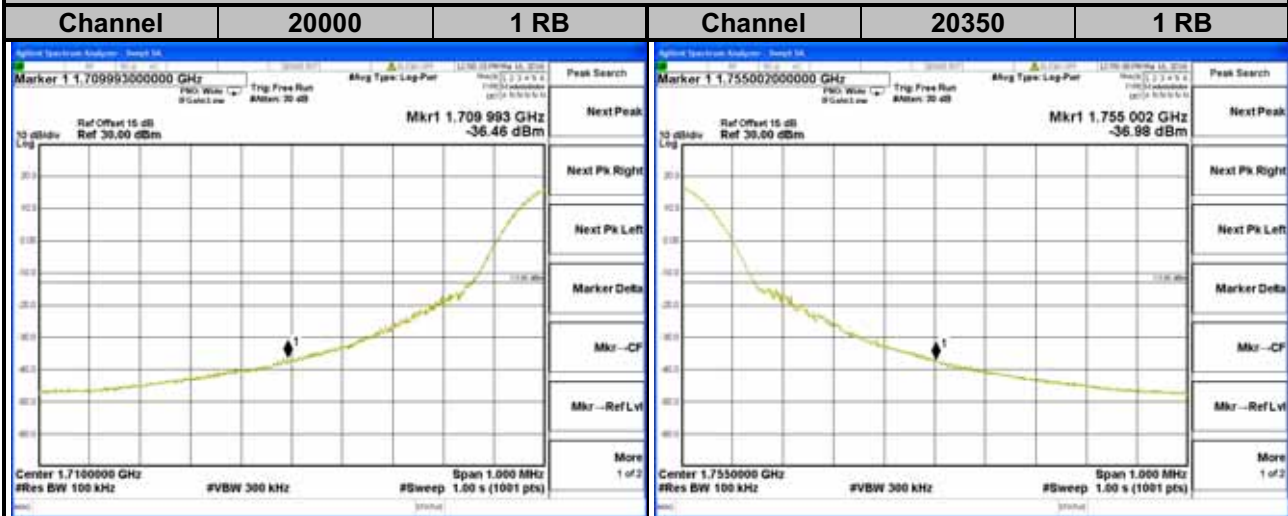



A O T

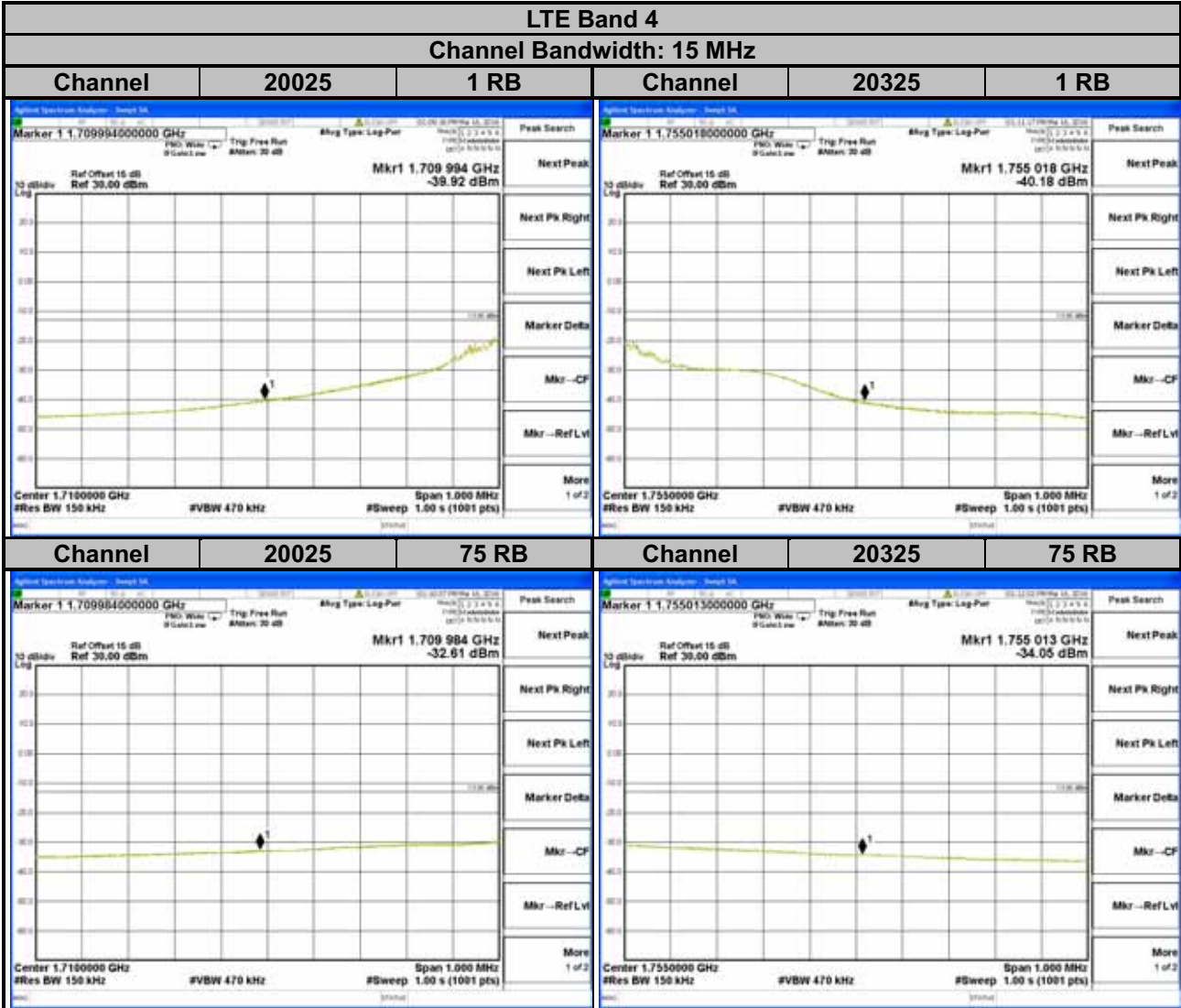



A O T

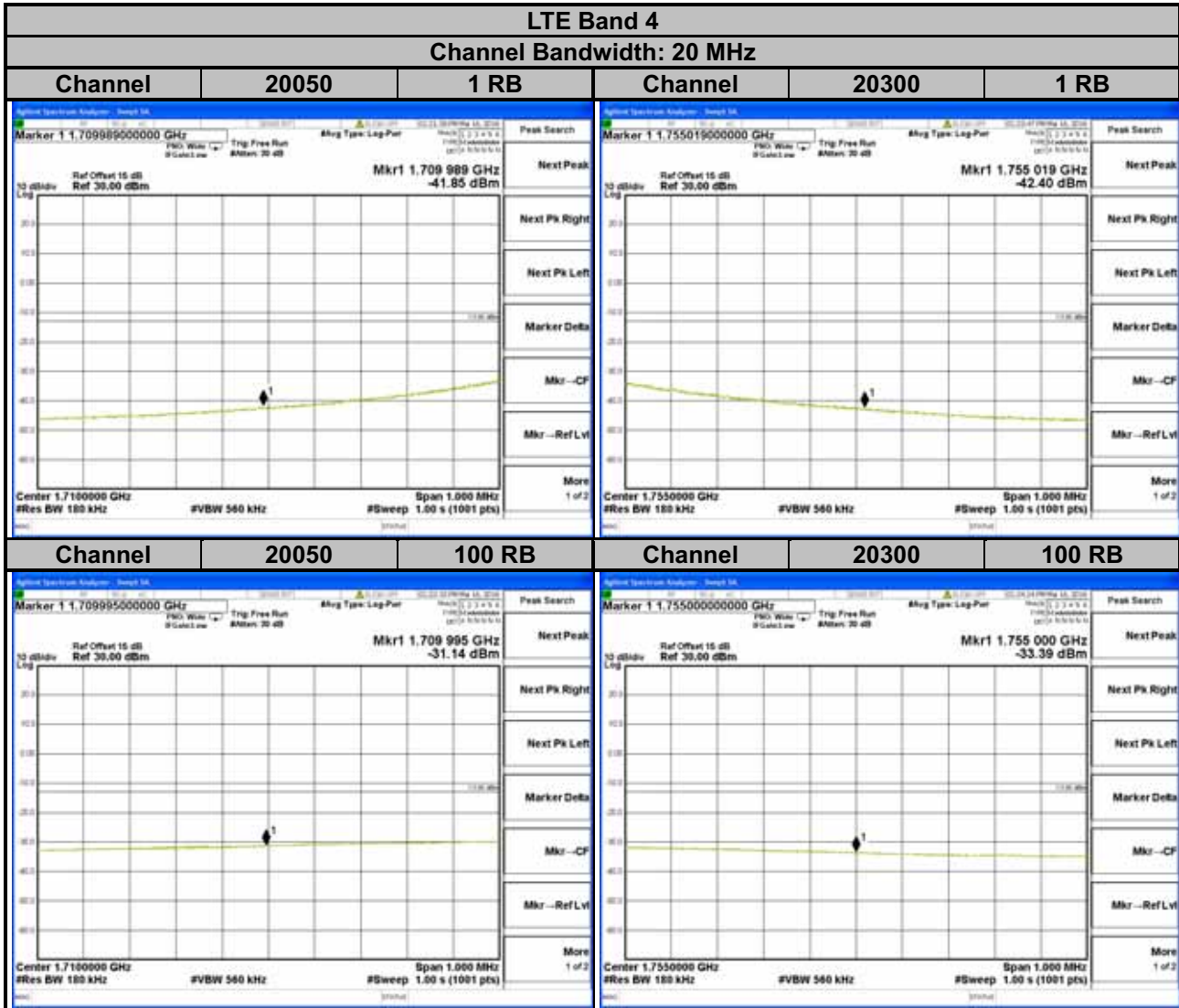



A O T

LTE Band 12
Channel Bandwidth: 1.4 MHz

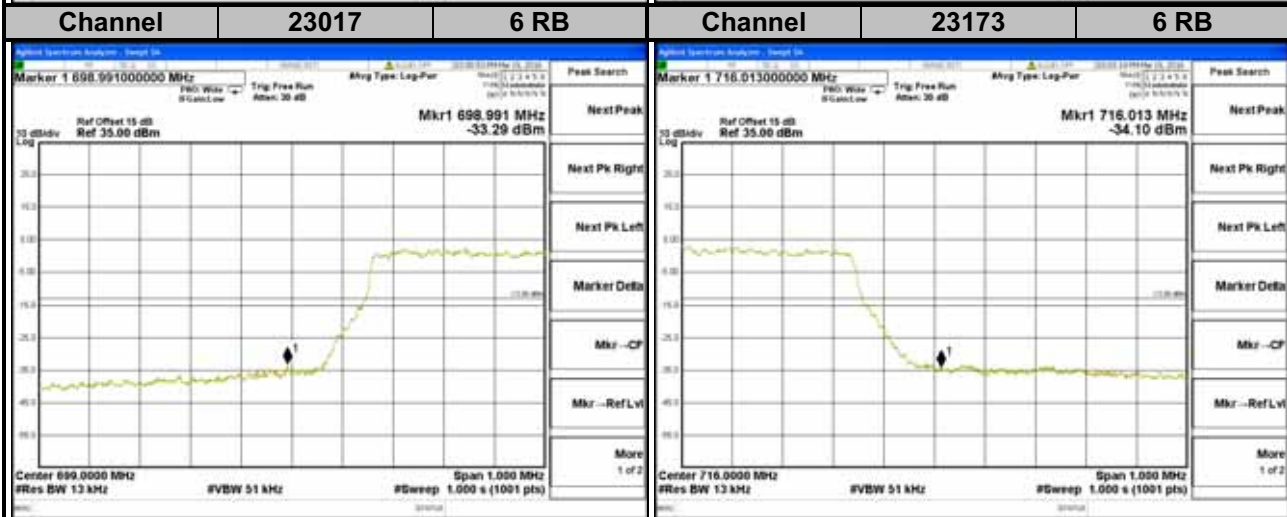
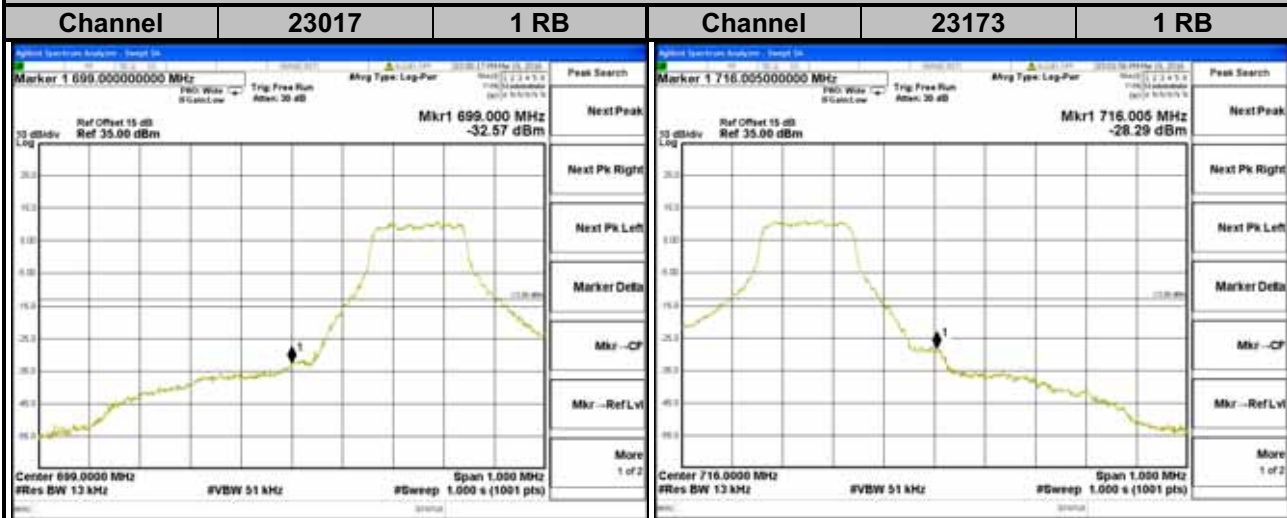



A O T

LTE Band 12

Channel Bandwidth: 3 MHz

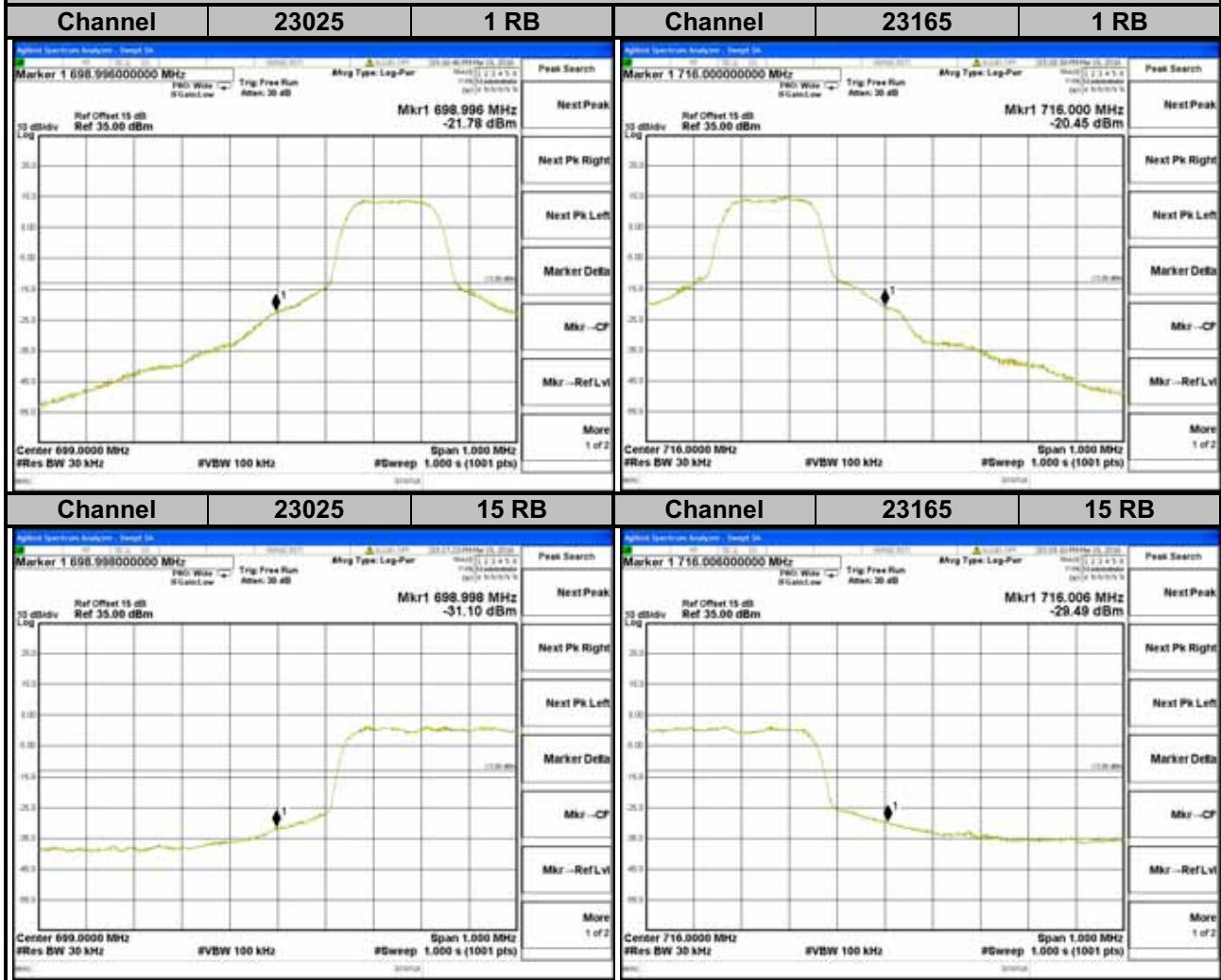



A O T

LTE Band 12

Channel Bandwidth: 5 MHz

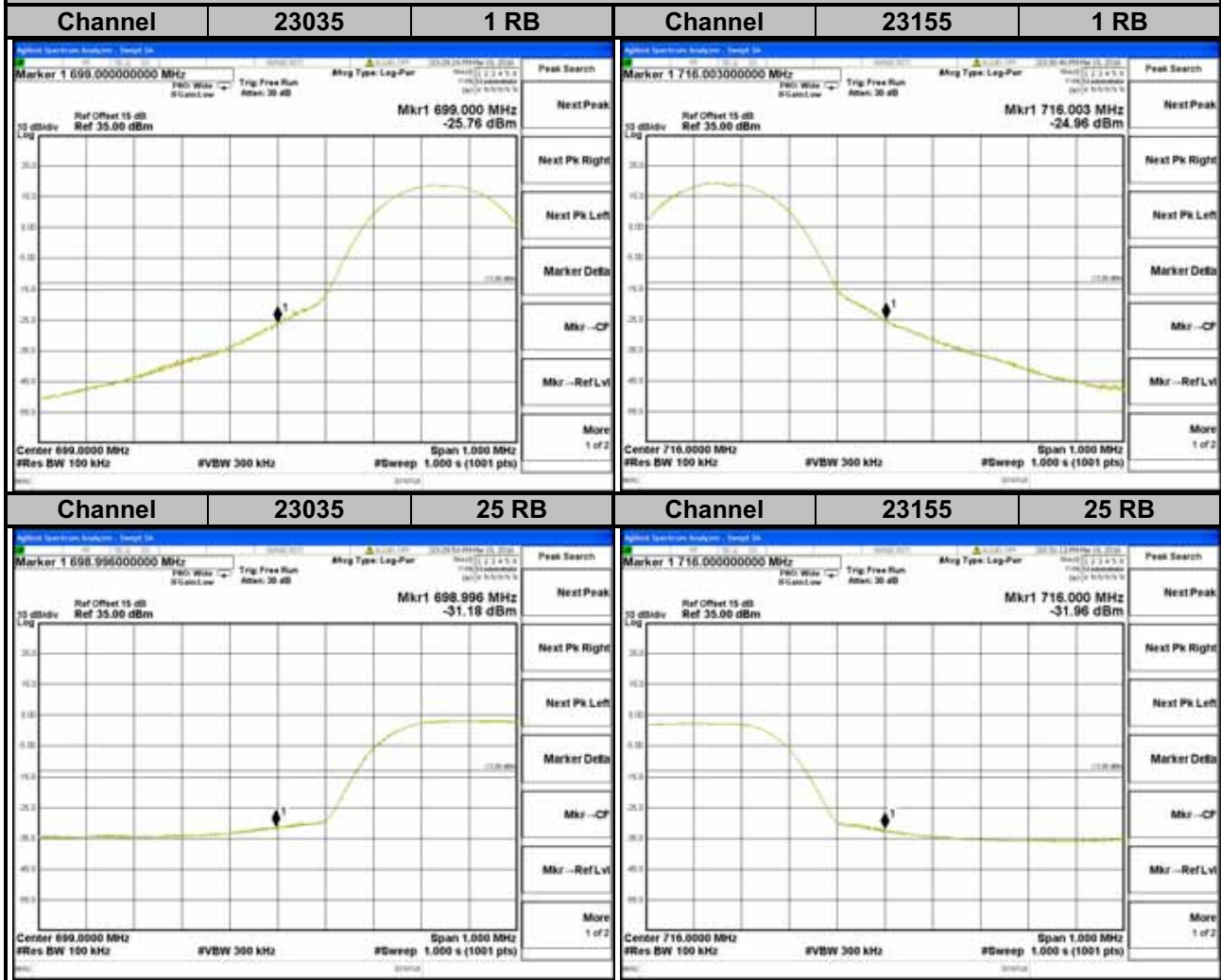



A O T

LTE Band 12

Channel Bandwidth: 10 MHz

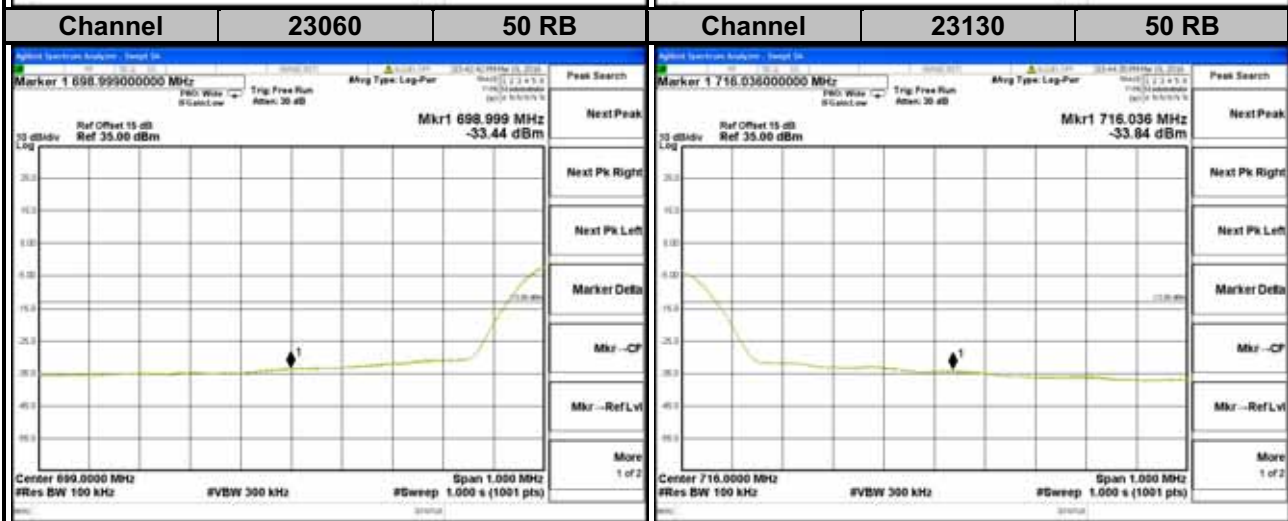
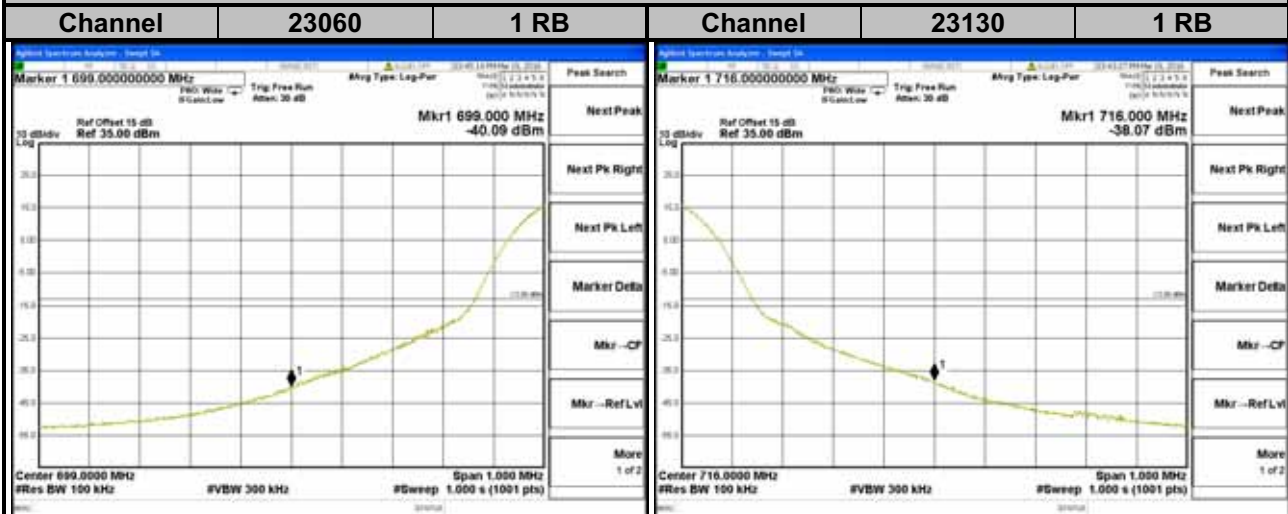



LTE Band 13

Channel Bandwidth: 5 MHz

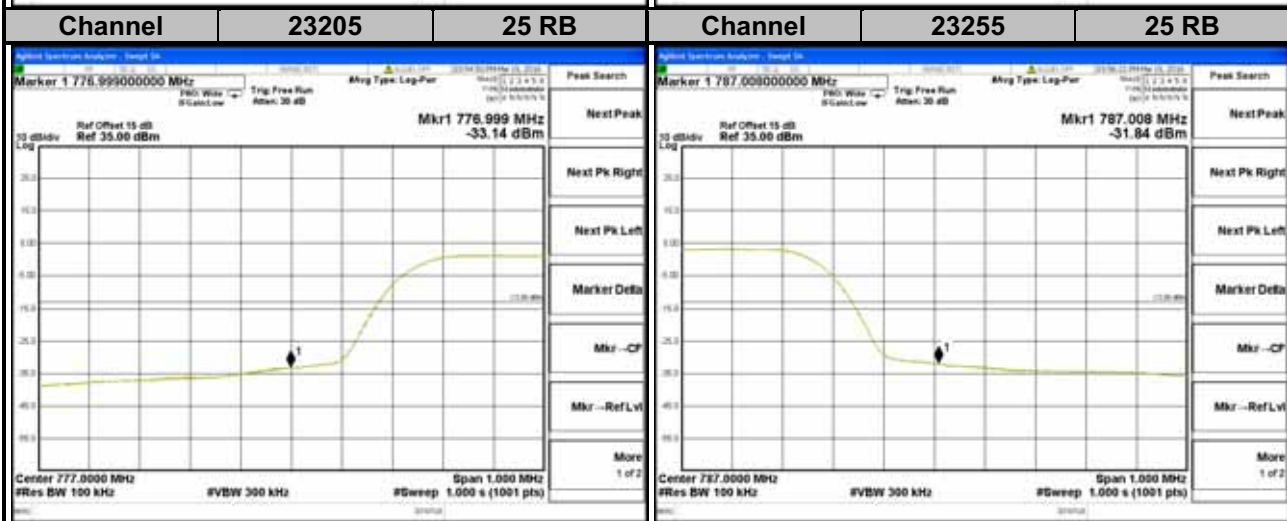
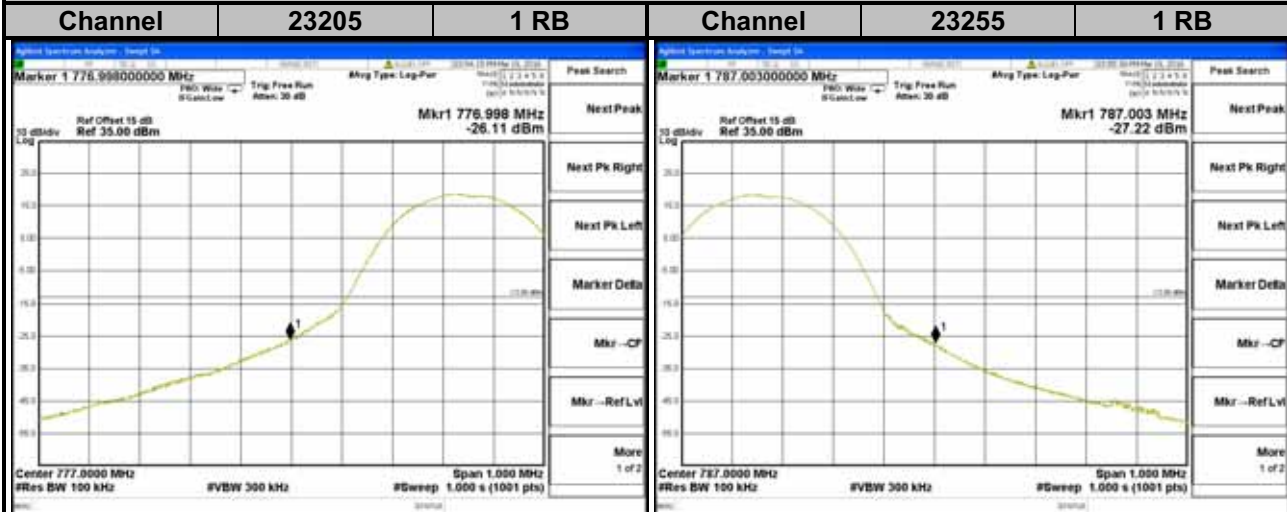



A O T

LTE Band 13

Channel Bandwidth: 10 MHz

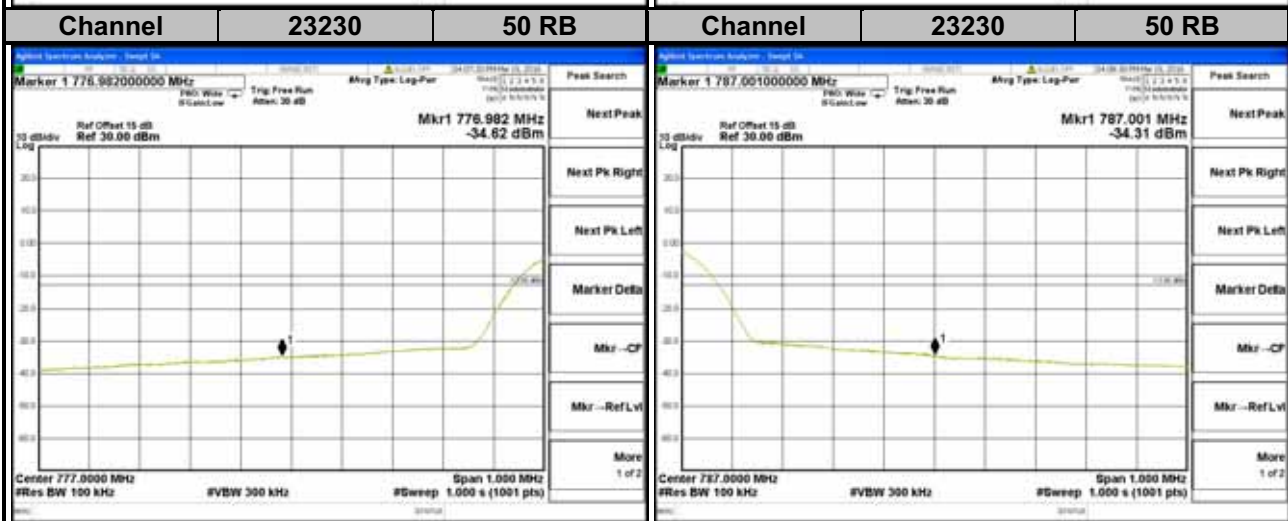
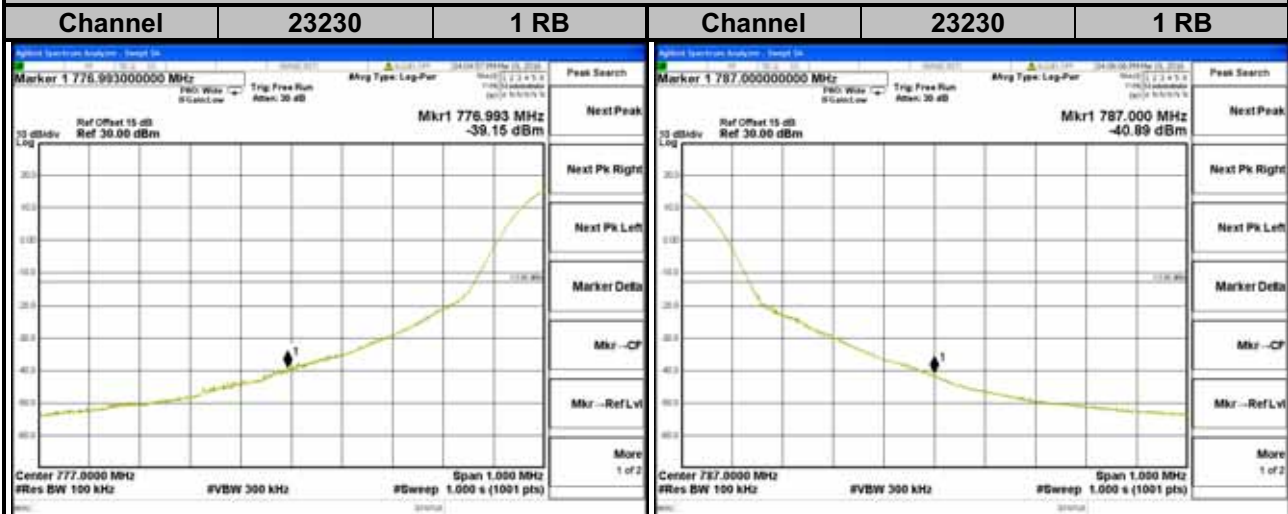

4.5 Peak to Average Ratio

4.5.1 Limits of Peak to Average Ratio Measurement

In measuring transmissions in this band using an average power technique, the peak to-average ratio (PAR) of the transmission may not exceed 13 dB.

4.5.2 Test Setup

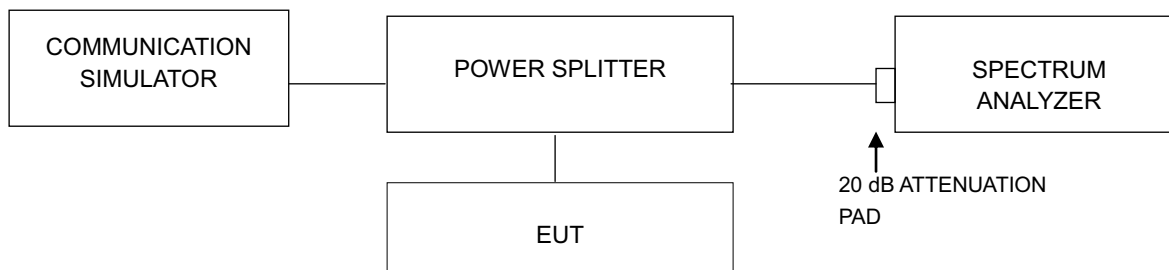

4.5.3 Test Procedures

1. Set resolution/measurement bandwidth \geq signal's occupied bandwidth;
2. Set the number of counts to a value that stabilizes the measured CCDF curve;
3. Record the maximum PAPR level associated with a probability of 0.1 %.



4.5.4 Test Results

LTE Band 4							
Channel Bandwidth: 1.4 MHz				Channel Bandwidth: 3 MHz			
Channel	Frequency (MHz)	Peak to Average Ratio (dB)		Channel	Frequency (MHz)	Peak to Average Ratio (dB)	
		QPSK	16QAM			QPSK	16QAM
19957	1710.7	3.55	4.25	19965	1711.5	3.38	4.17
20175	1732.5	3.53	4.35	20175	1732.5	3.52	4.29
20393	1754.3	3.59	4.26	20385	1753.5	3.64	4.24

Spectrum Plot of Worst Value

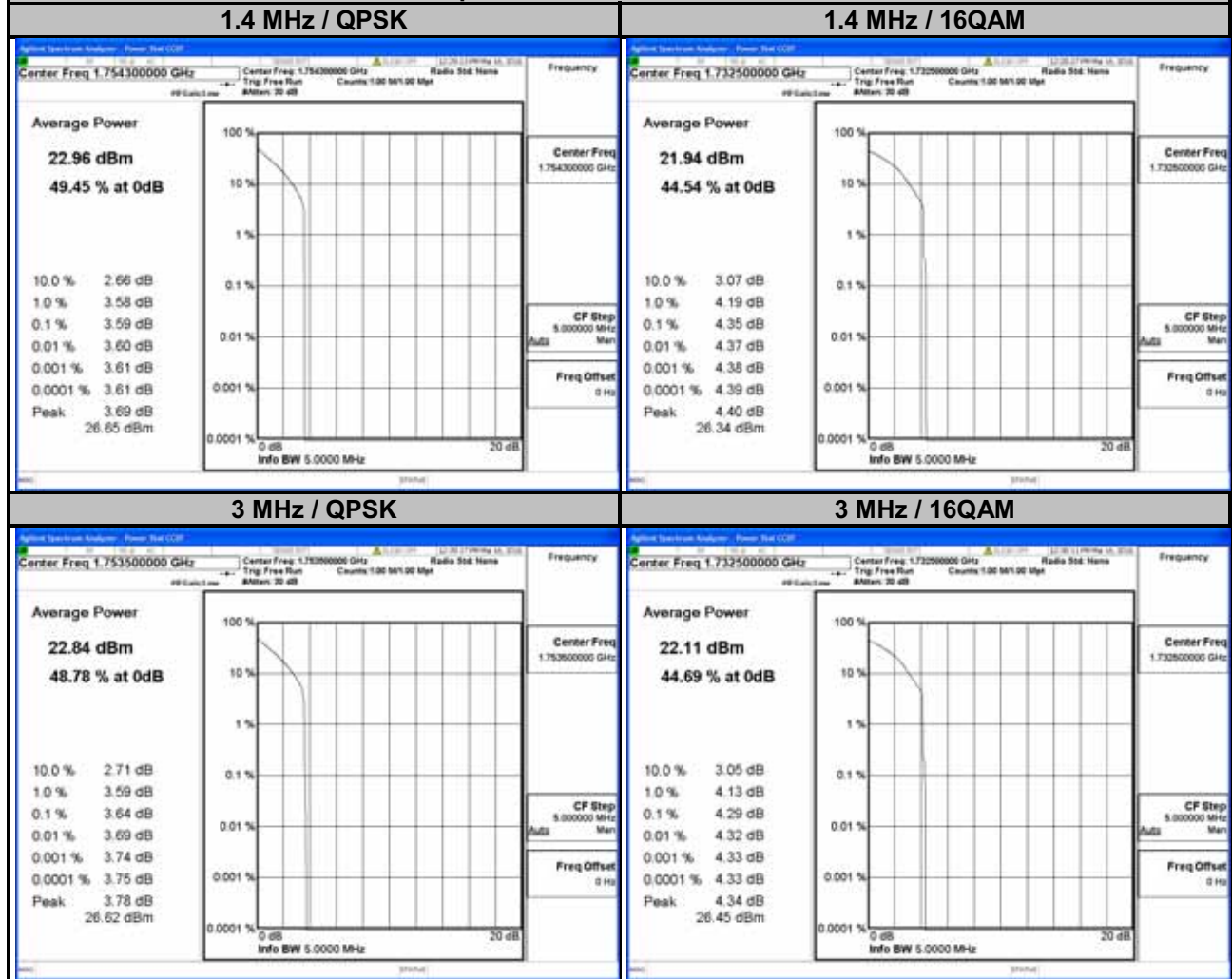



LTE Band 4

Channel Bandwidth: 5 MHz				Channel Bandwidth: 10 MHz			
Channel	Frequency (MHz)	Peak to Average Ratio (dB)		Channel	Frequency (MHz)	Peak to Average Ratio (dB)	
		QPSK	16QAM			QPSK	16QAM
19975	1712.5	3.64	4.41	20000	1715.0	3.42	4.25
20175	1732.5	4.06	4.75	20175	1732.5	3.48	4.25
20375	1752.5	3.66	4.43	20350	1750.0	3.62	4.21

Spectrum Plot of Worst Value

5 MHz / QPSK

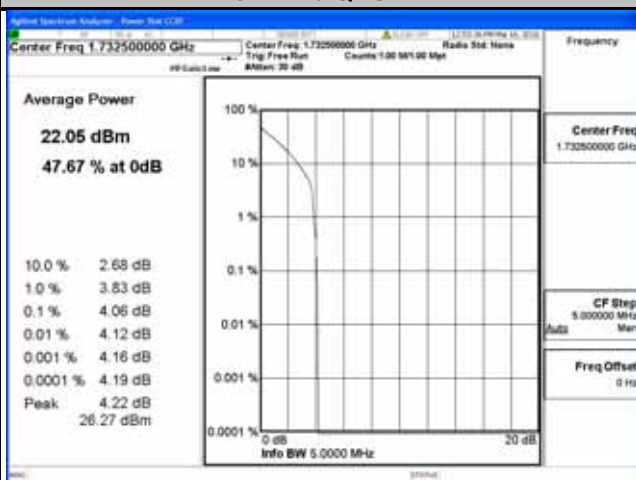

5 MHz / 16QAM

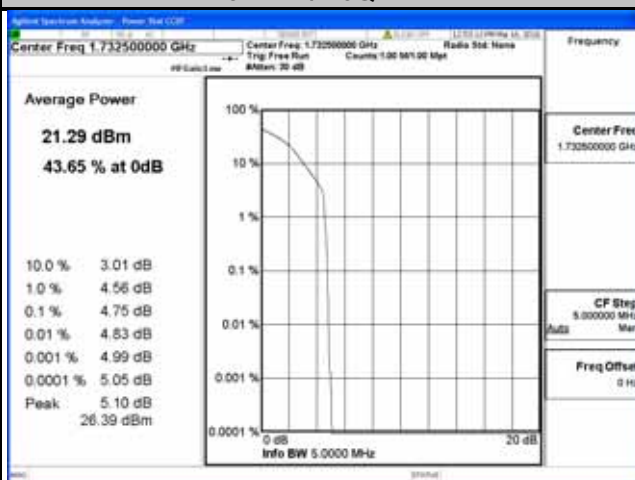

10 MHz / QPSK

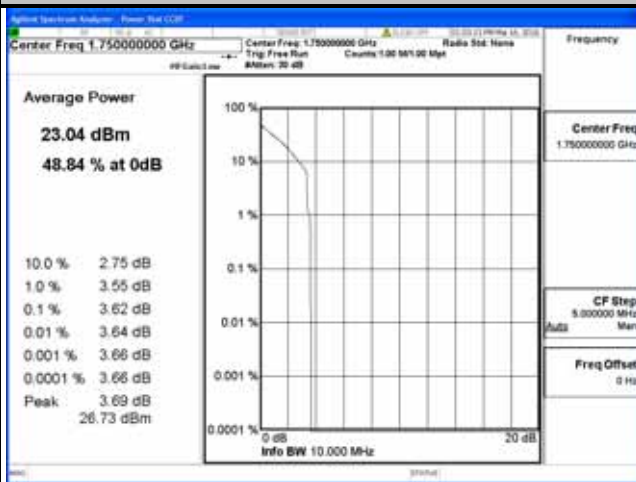

10 MHz / 16QAM

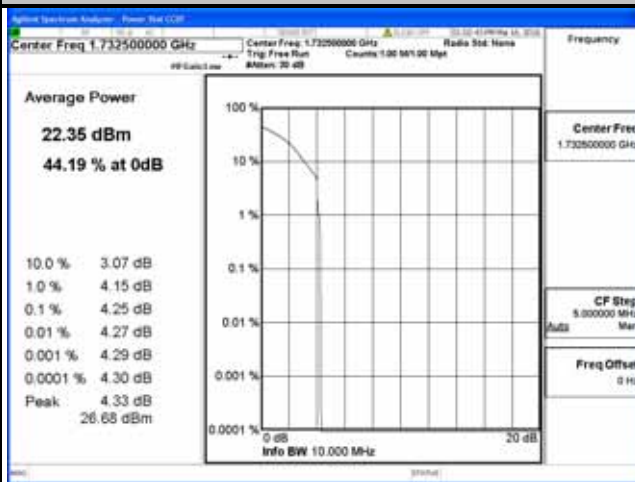



LTE Band 4							
Channel Bandwidth: 15 MHz				Channel Bandwidth: 20 MHz			
Channel	Frequency (MHz)	Peak to Average Ratio (dB)		Channel	Frequency (MHz)	Peak to Average Ratio (dB)	
		QPSK	16QAM			QPSK	16QAM
20025	1717.5	3.40	4.18	20050	1720.0	3.41	4.25
20175	1732.5	3.48	4.18	20175	1732.5	3.58	4.22
20325	1747.5	3.53	4.19	20300	1745.0	3.41	4.17

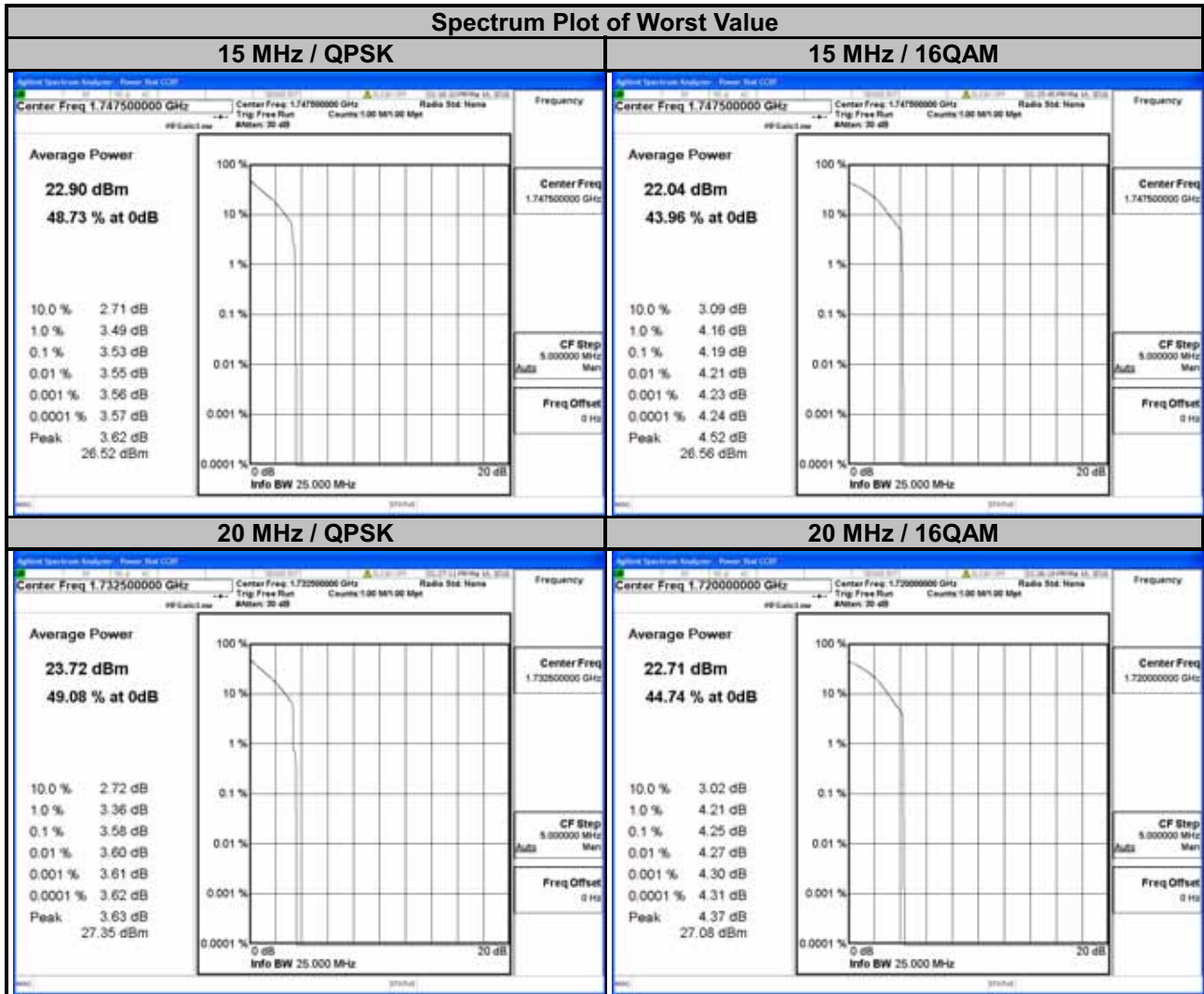



LTE Band 12							
Channel Bandwidth: 1.4 MHz				Channel Bandwidth: 3 MHz			
Channel	Frequency (MHz)	Peak to Average Ratio (dB)		Channel	Frequency (MHz)	Peak to Average Ratio (dB)	
		QPSK	16QAM			QPSK	16QAM
23017	699.7	3.75	4.58	23025	700.5	3.54	4.39
23095	707.5	3.89	4.74	23095	707.5	3.57	4.39
23173	715.3	3.11	3.86	23165	714.5	2.93	3.77

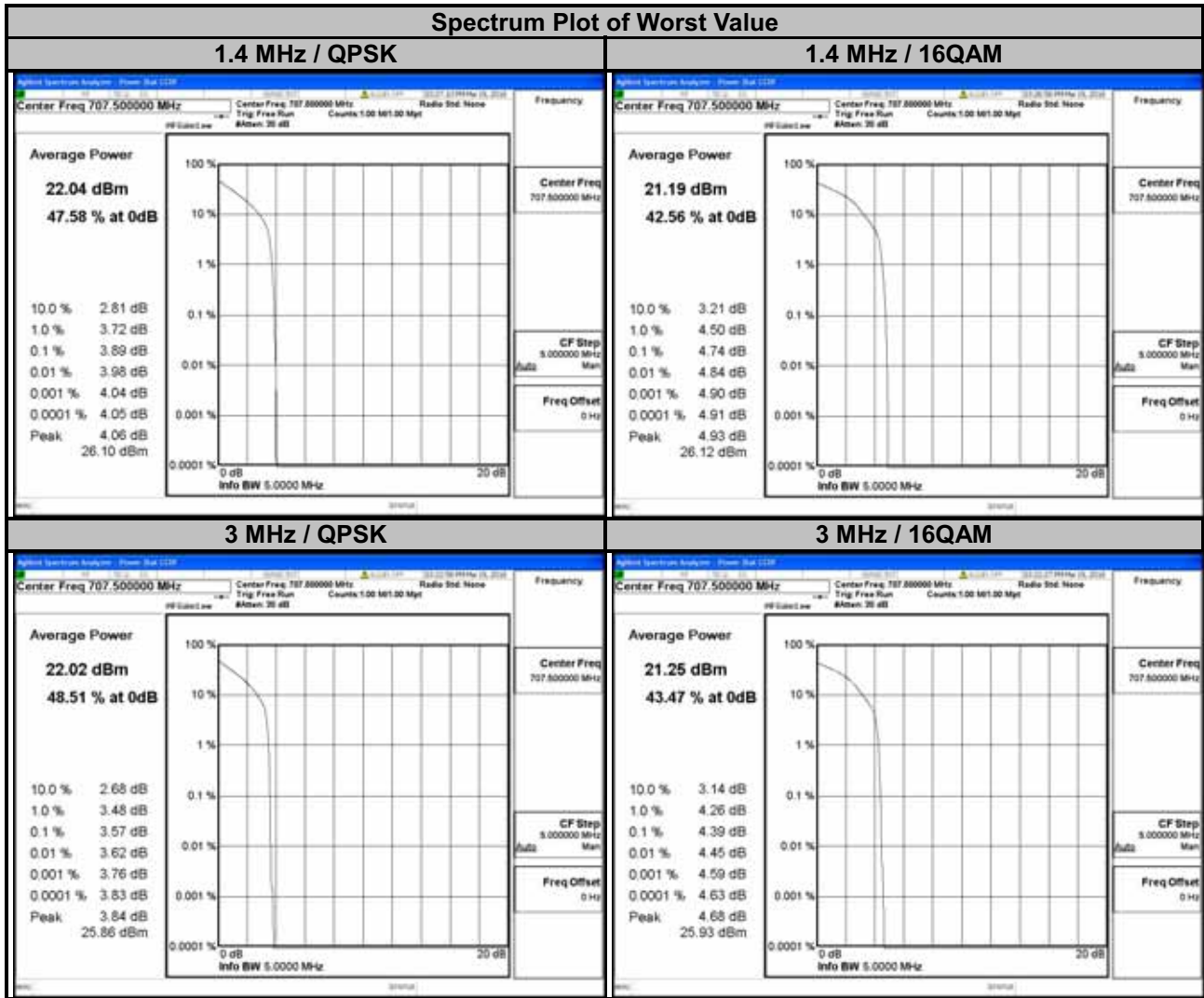



LTE Band 12

Channel Bandwidth: 5 MHz				Channel Bandwidth: 10 MHz			
Channel	Frequency (MHz)	Peak to Average Ratio (dB)		Channel	Frequency (MHz)	Peak to Average Ratio (dB)	
		QPSK	16QAM			QPSK	16QAM
23035	701.5	3.54	4.44	23060	704.0	3.44	4.26
23095	707.5	3.38	4.22	23095	707.5	3.02	3.85
23155	713.5	3.34	4.23	23130	711.0	3.54	4.39

Spectrum Plot of Worst Value

5 MHz / QPSK

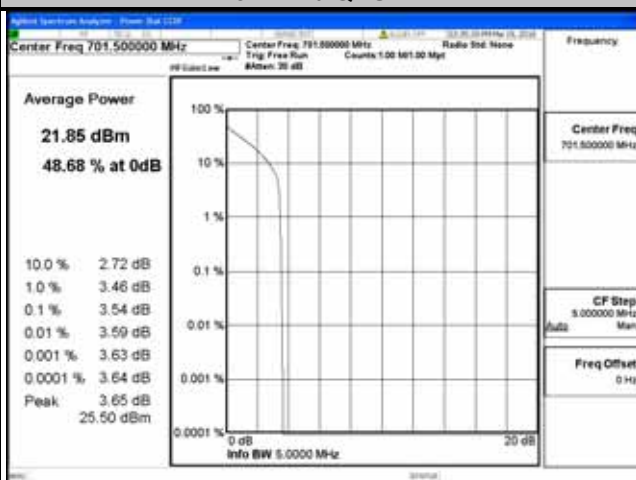

5 MHz / 16QAM

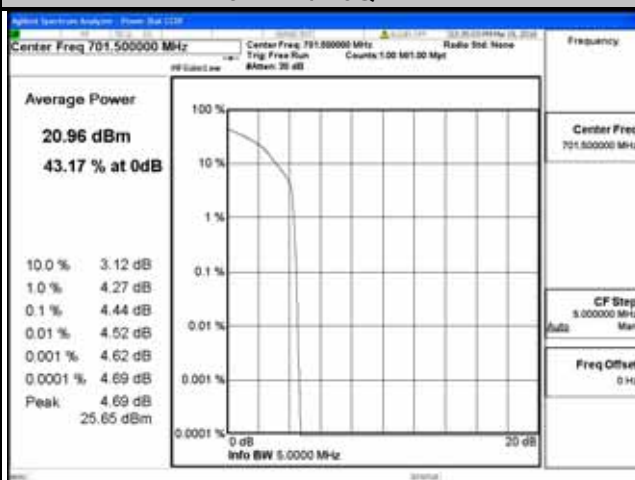

10 MHz / QPSK

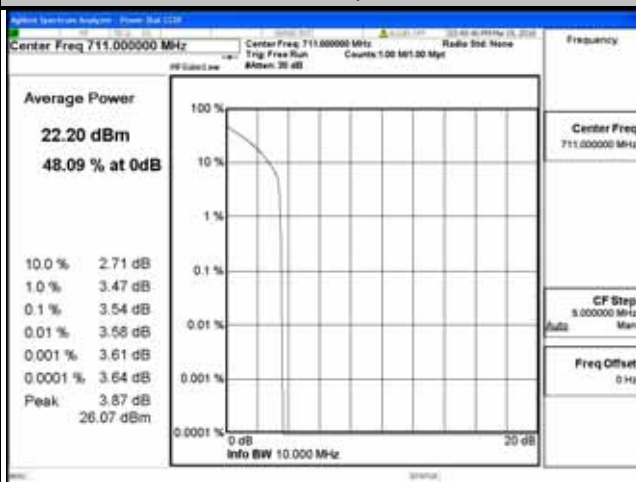

10 MHz / 16QAM

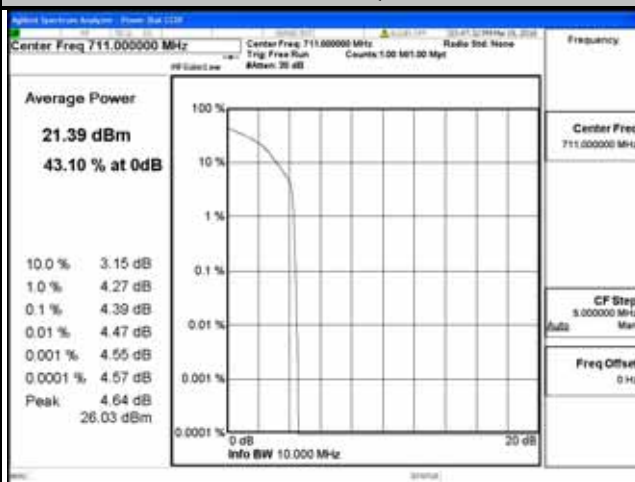



LTE Band 13							
Channel Bandwidth: 5 MHz				Channel Bandwidth: 10 MHz			
Channel	Frequency (MHz)	Peak to Average Ratio (dB)		Channel	Frequency (MHz)	Peak to Average Ratio (dB)	
		QPSK	16QAM			QPSK	16QAM
23205	779.5	2.83	3.71	23230	782.0	3.06	3.89
23230	782.0	3.04	3.87				
23255	784.5	3.71	4.51				

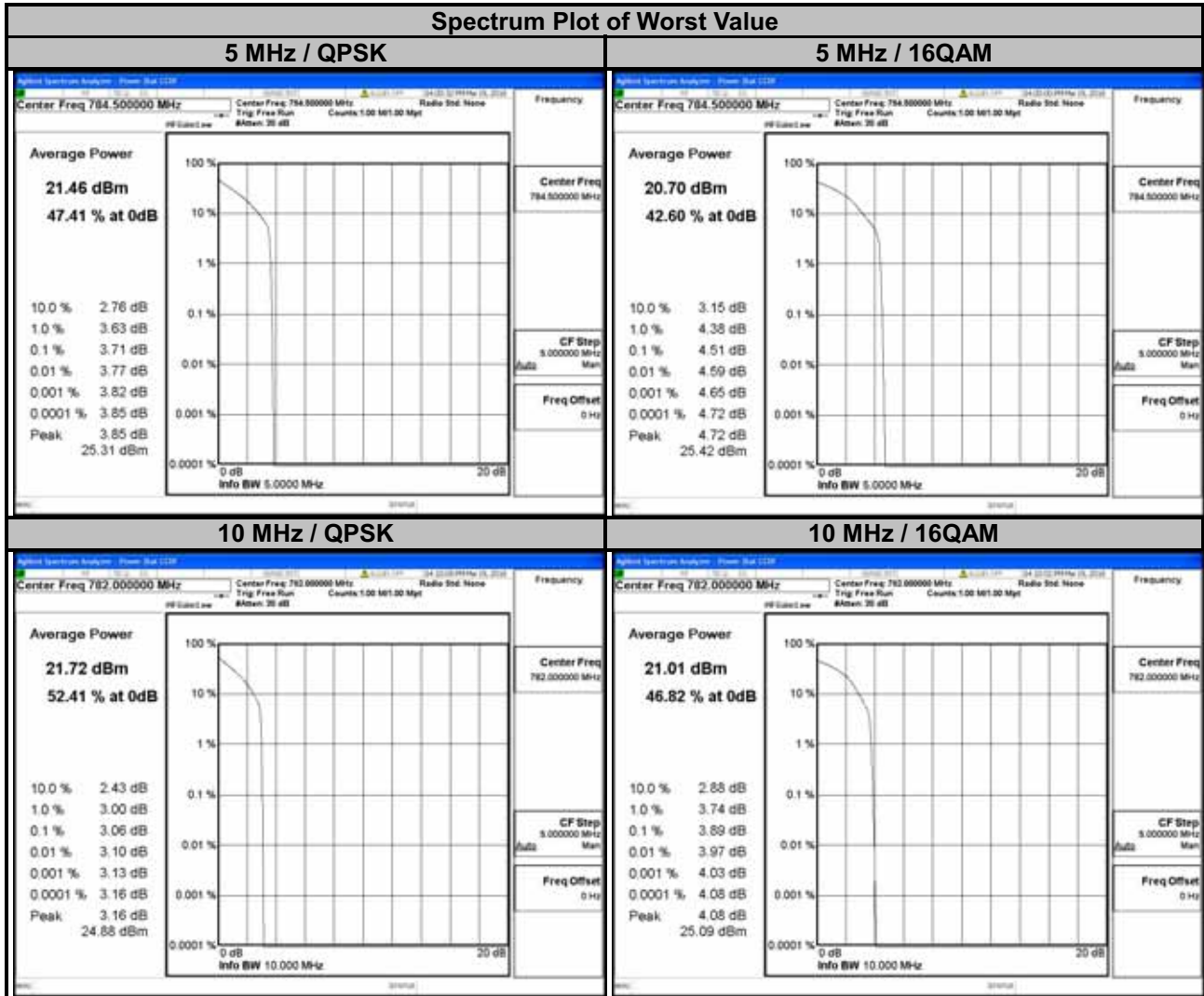

4.6 Conducted Spurious Emissions

4.6.1 Limits of Conducted Spurious Emissions Measurement

The power of any emission outside a licensee's frequency block shall be attenuated below the transmitter power (P) by at least $43 + 10 \log_{10}(P)$ dB. The limit of emission is equal to -13 dBm.

4.6.2 Test Setup

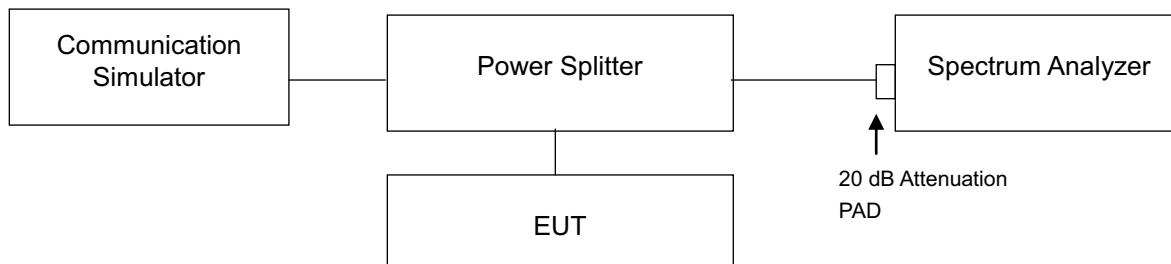

4.6.3 Test Procedure

- The EUT makes a phone call to the communication simulator. All measurements were done at low, middle and high operational frequency range.
- Measuring frequency range is from 30 MHz to 8 GHz for LTE Band 12 / 13 and from 30 MHz to 18 GHz for LTE Band 4. 10 dB attenuation pad is connected with spectrum. RBW=1 MHz and VBW=3 MHz are used for conducted emission measurement.



A O T

4.6.4 Test Results

Frequency Range: 30 MHz ~ 8 GHz

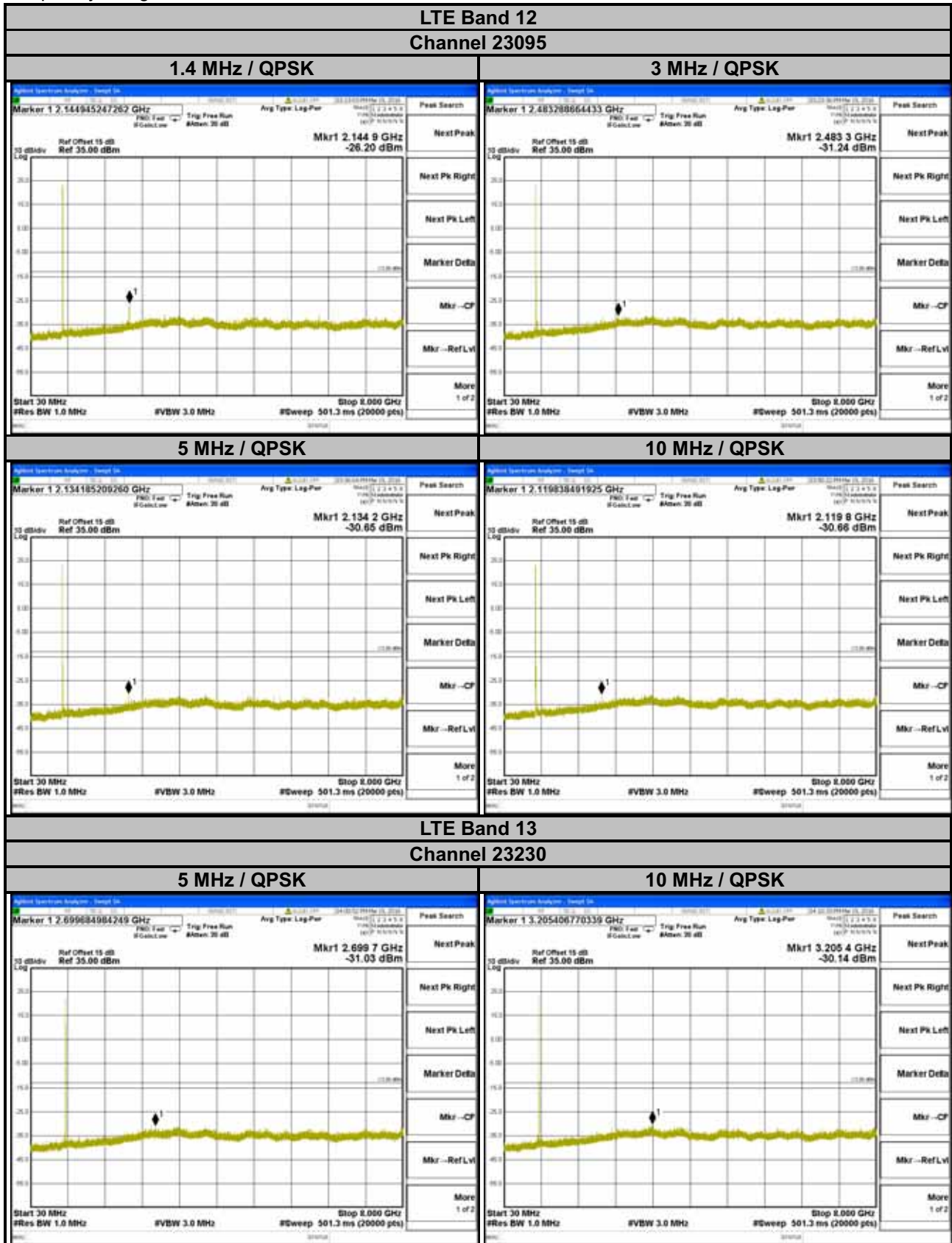



A O T

Frequency Range: 30 MHz ~ 18 GHz



4.7 Radiated Emission Measurement

4.7.1 Limits of Radiated Emission Measurement

The power of any emission outside a licensee's frequency block shall be attenuated below the transmitter power (P) by at least $43 + 10 \log_{10}(P)$ dB. The limit of emission is equal to -13 dBm.

4.7.2 Test Procedure

- Substitution method is used for E.I.R.P measurement. In the semi-anechoic chamber, EUT placed on the 0.8 m height of Turn Table, rotated the table around 360 degrees to search the maximum radiation power and receiver antenna shall be rotated vertical and horizontal polarization and moved height from 1 m to 4 m to find the maximum polar radiated power. The "Read Value" is the spectrum reading the maximum power value.
- The substitution horn antenna is substituted for EUT at the same position and signals generator export the CW signal to the substitution antenna via a TX cable. Rotated the Turn Table and moved receiving antenna to find the maximum radiation power. Adjust output power level of S.G to get a Value of spectrum reading equal to "Read Value" of step a. Record the power level of S.G.
- EIRP = Output power level of S.G – TX cable loss + Antenna gain of substitution horn.
- E.R.P power can be calculated form E.I.R.P power by subtracting the gain of dipole, E.R.P power = E.I.P.R power - 2.15 dBi.

NOTE: The resolution bandwidth of spectrum analyzer is 1 MHz and the video bandwidth is 3 MHz.

4.7.3 Deviation from Test Standard

No deviation.

4.7.4 Test Setup

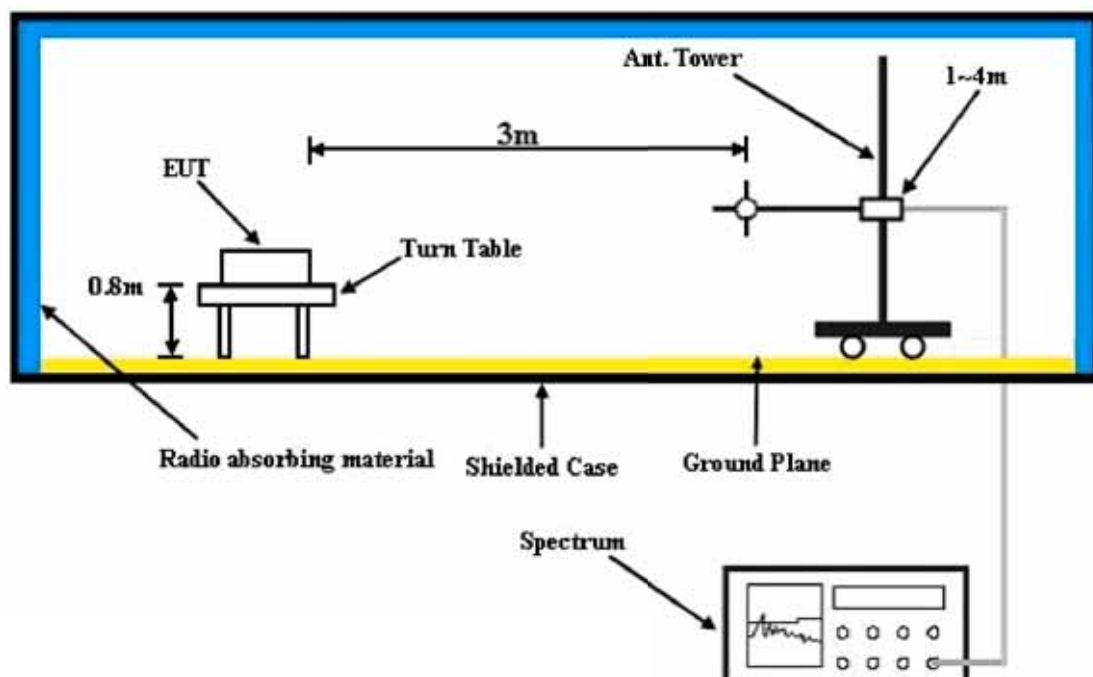

For the actual test configuration, please refer to the attached file (Test Setup Photo).

4.7.5 Test Results

LTE Band 4

Channel Bandwidth: 20 MHz / QPSK



Bureau Veritas Consumer Products Services Ltd., Taoyuan Branch

A D T

Data: 7

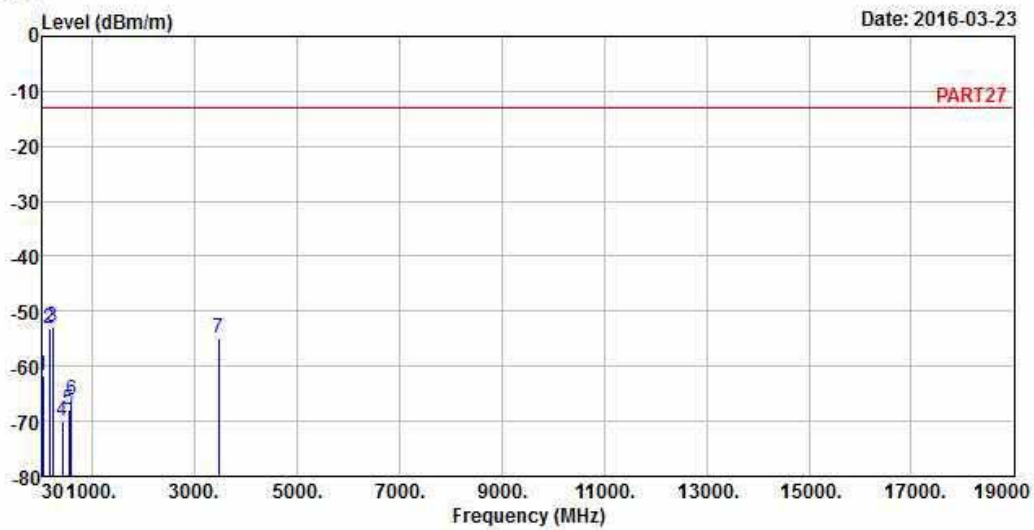

Site : 966 Chamber 5
 Condition: PART27 3m HORIZONTAL
 Remak : LTE Band 4_QPSK_20M Link
 Tested by: Toby Tian

	Freq	Level	Read Level	Limit Line	Over Limit	Factor	Remark
	MHz	dBm/m	dBm	dBm/m	dB	dB/m	
1	39.70	-61.84	-62.48	-13.00	-48.84	0.64	Peak
2	168.71	-53.27	-47.81	-13.00	-40.27	-5.46	Peak
3	220.12	-52.93	-45.73	-13.00	-39.93	-7.20	Peak
4	409.27	-70.10	-64.23	-13.00	-57.10	-5.87	Peak
5	550.89	-67.75	-64.94	-13.00	-54.75	-2.81	Peak
6	587.75	-66.22	-64.94	-13.00	-53.22	-1.28	Peak
7	3465.00	-54.90	-45.99	-13.00	-41.90	-8.91	Peak



Bureau Veritas Consumer Products Services Ltd., Taoyuan Branch

A D T

Data: 8

Date: 2016-03-23

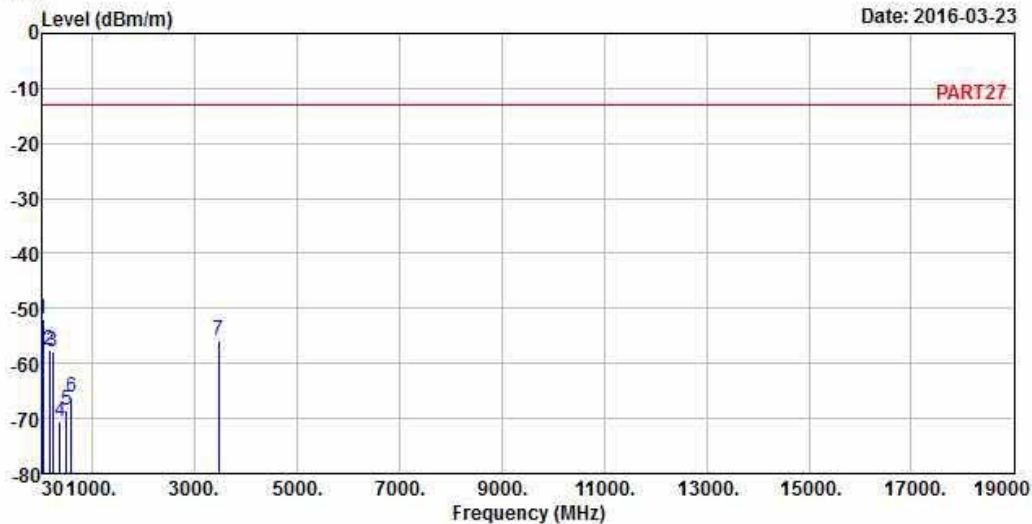

Site : 966 Chamber 5
 Condition: PART27 3m VERTICAL
 Remak : LTE Band 4_QPSK_20M Link
 Tested by: Toby Tian

	Freq	Level	Read Level	Limit Line	Over Limit	Factor	Remark
	MHz	dBm/m	dBm	dBm/m	dB	dB/m	
1 pp	39.70	-51.86	-52.50	-13.00	-38.86	0.64	Peak
2	167.74	-57.52	-52.13	-13.00	-44.52	-5.39	Peak
3	223.03	-57.90	-50.82	-13.00	-44.90	-7.08	Peak
4	371.44	-70.55	-64.44	-13.00	-57.55	-6.11	Peak
5	499.48	-68.41	-63.78	-13.00	-55.41	-4.63	Peak
6	590.66	-66.07	-64.91	-13.00	-53.07	-1.16	Peak
7	3465.00	-55.70	-46.79	-13.00	-42.70	-8.91	Peak

LTE Band 12
Channel Bandwidth: 10 MHz / QPSK



Bureau Veritas Consumer Products Services Ltd., Taoyuan Branch

A D T

Data: 5

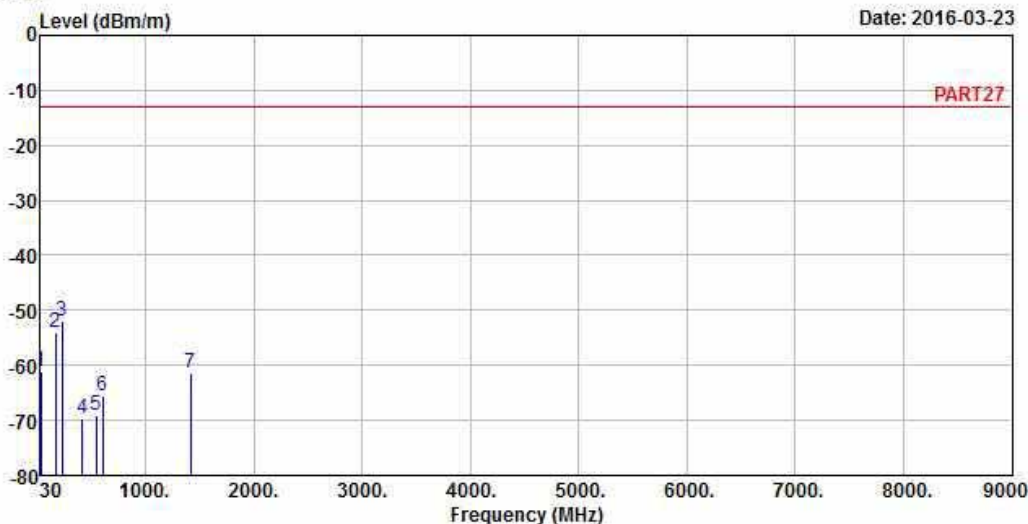

Site : 966 Chamber 5
Condition: PART27 3m HORIZONTAL
Remak : LTE Band 12_QPSK_10M Link
Tested by: Toby Tian

	Freq	Level	Read Level	Limit Line	Over Limit	Factor	Remark
	MHz	dBm/m	dBm	dBm/m	dB	dB/m	
1	30.00	-61.23	-61.61	-13.00	-48.23	0.38	Peak
2	168.71	-53.97	-48.51	-13.00	-40.97	-5.46	Peak
3 pp	224.00	-51.91	-44.86	-13.00	-38.91	-7.05	Peak
4	414.12	-69.80	-63.97	-13.00	-56.80	-5.83	Peak
5	543.13	-69.02	-65.93	-13.00	-56.02	-3.09	Peak
6	601.33	-65.59	-64.83	-13.00	-52.59	-0.76	Peak
7	1415.00	-61.41	-47.07	-13.00	-48.41	-14.34	Peak



Bureau Veritas Consumer Products Services Ltd., Taoyuan Branch

A D T

Data: 6

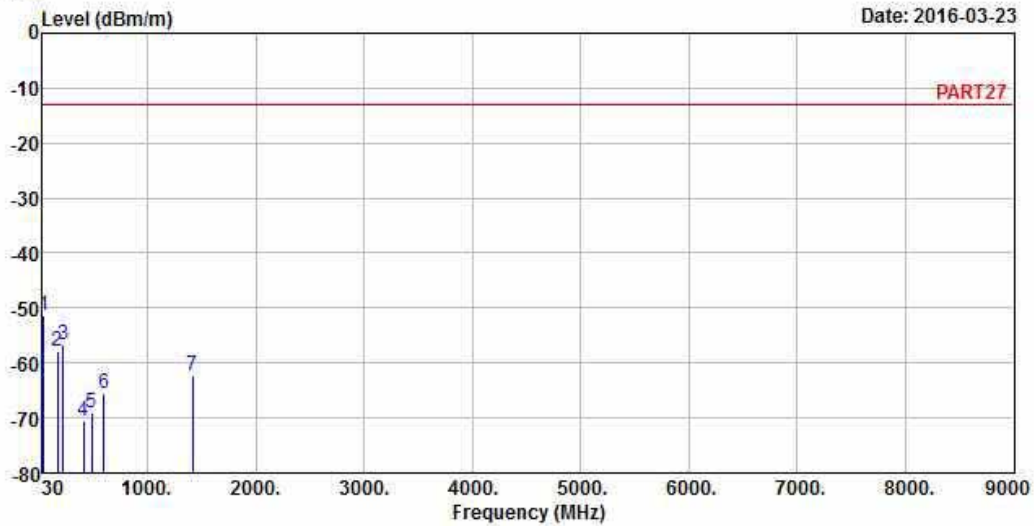

Site : 966 Chamber 5
 Condition: PART27 3m VERTICAL
 Remak : LTE Band 12_QPSK_10M Link
 Tested by: Toby Tian

	Freq	Level	Read Level	Limit Line	Over Limit	Factor	Remark
	MHz	dBm/m	dBm	dBm/m	dB	dB/m	
1 pp	39.70	-51.45	-52.09	-13.00	-38.45	0.64	Peak
2	168.71	-57.96	-52.50	-13.00	-44.96	-5.46	Peak
3	223.03	-56.78	-49.70	-13.00	-43.78	-7.08	Peak
4	405.39	-70.68	-64.78	-13.00	-57.68	-5.90	Peak
5	482.99	-68.98	-64.04	-13.00	-55.98	-4.94	Peak
6	596.48	-65.42	-64.51	-13.00	-52.42	-0.91	Peak
7	1415.00	-62.40	-48.06	-13.00	-49.40	-14.34	Peak

LTE Band 13
Channel Bandwidth: 10 MHz / QPSK



Bureau Veritas Consumer Products Services Ltd., Taoyuan Branch

A D T

Data: 5

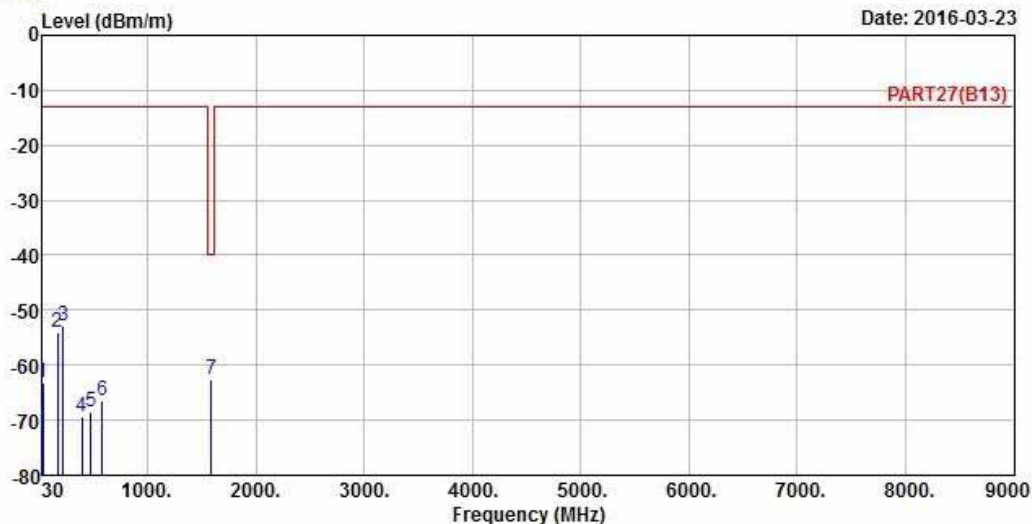

Site : 966 Chamber 5
 Condition: PART27(B13) 3m HORIZONTAL
 Remak : LTE Band 13_QPSK_5M Link
 Tested by: Toby Tian

	Freq	Level	Read Level	Limit Line	Over Limit	Factor	Remark
	MHz	dBm/m	dBm	dBm/m	dB	dB/m	
1	30.00	-63.03	-63.41	-13.00	-50.03	0.38	Peak
2	168.71	-53.89	-48.43	-13.00	-40.89	-5.46	Peak
3	222.06	-52.92	-45.80	-13.00	-39.92	-7.12	Peak
4	391.81	-69.35	-63.36	-13.00	-56.35	-5.99	Peak
5	478.14	-68.62	-63.59	-13.00	-55.62	-5.03	Peak
6	583.87	-66.52	-65.08	-13.00	-53.52	-1.44	Peak
7 pp	1586.00	-62.55	-47.65	-40.00	-22.55	-14.90	Peak



Bureau Veritas Consumer Products Services Ltd., Taoyuan Branch

A D T

Data: 6

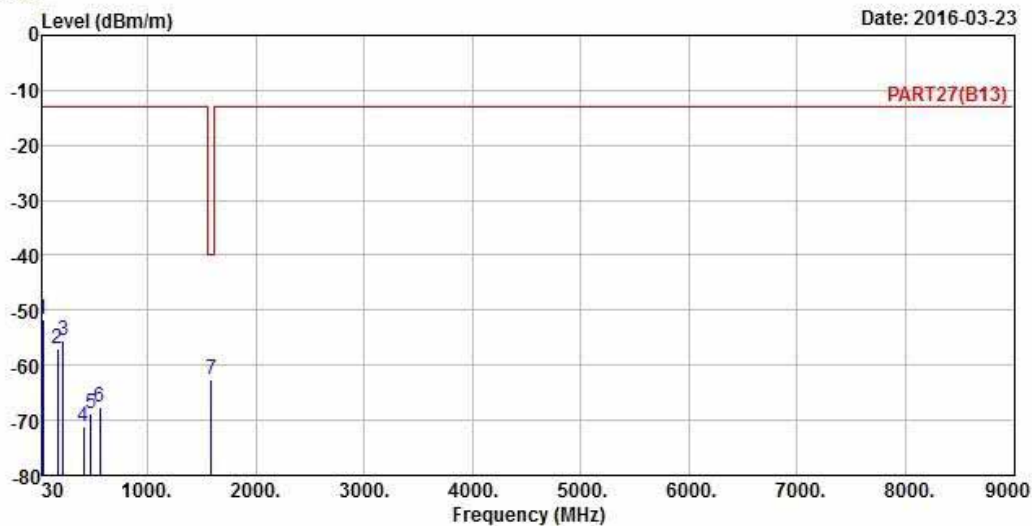

Site : 966 Chamber 5
 Condition: PART27(B13) 3m VERTICAL
 Remak : LTE Band 13_QPSK_5M Link
 Tested by: Toby Tian

	Freq	Level	Read Level	Limit Line	Over Limit	Factor	Remark
	MHz	dBm/m	dBm	dBm/m	dB	dB/m	
1	30.97	-51.59	-51.48	-13.00	-38.59	-0.11	Peak
2	166.77	-56.98	-51.66	-13.00	-43.98	-5.32	Peak
3	223.03	-55.44	-48.36	-13.00	-42.44	-7.08	Peak
4	405.39	-71.06	-65.16	-13.00	-58.06	-5.90	Peak
5	472.32	-68.83	-63.70	-13.00	-55.83	-5.13	Peak
6	560.59	-67.62	-65.21	-13.00	-54.62	-2.41	Peak
7 pp	1586.00	-62.52	-47.62	-40.00	-22.52	-14.90	Peak



Bureau Veritas Consumer Products Services Ltd., Taoyuan Branch

A D T

Data: 5

Date: 2016-03-23

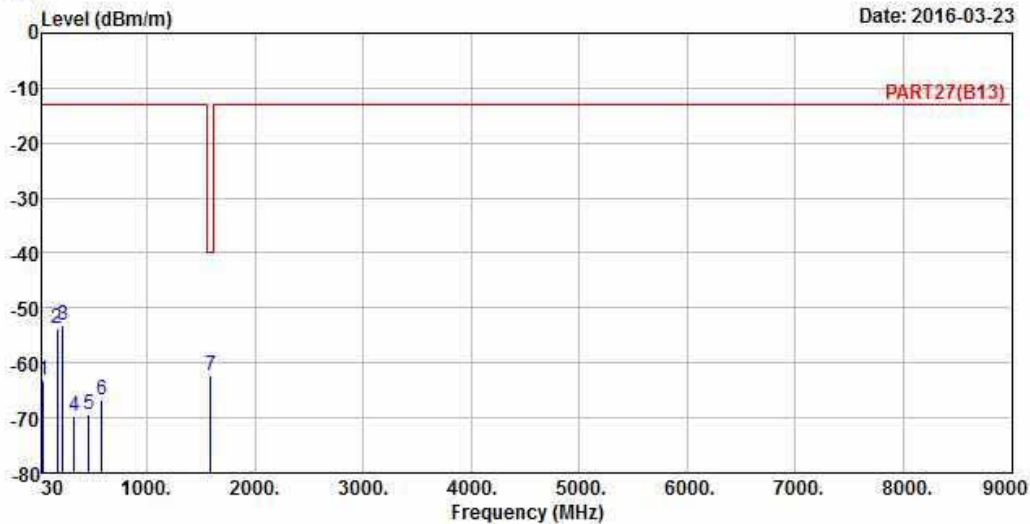

Site : 966 Chamber 5
 Condition: PART27(B13) 3m HORIZONTAL
 Remak : LTE Band 13_QPSK_5M Link
 Tested by: Toby Tian

	Freq	Level	Read Level	Limit Line	Over Limit	Factor	Remark
	MHz	dBm/m	dBm	dBm/m	dB	dB/m	
1	40.67	-63.29	-63.41	-13.00	-50.29	0.12	Peak
2	167.74	-53.75	-48.36	-13.00	-40.75	-5.39	Peak
3	223.03	-53.19	-46.11	-13.00	-40.19	-7.08	Peak
4	328.76	-69.57	-63.00	-13.00	-56.57	-6.57	Peak
5	460.68	-69.23	-63.88	-13.00	-56.23	-5.35	Peak
6	581.93	-66.75	-65.23	-13.00	-53.75	-1.52	Peak
7 pp	1586.00	-62.21	-47.31	-40.00	-22.21	-14.90	Peak



Bureau Veritas Consumer Products Services Ltd., Taoyuan Branch

A D T

Data: 6

Date: 2016-03-23

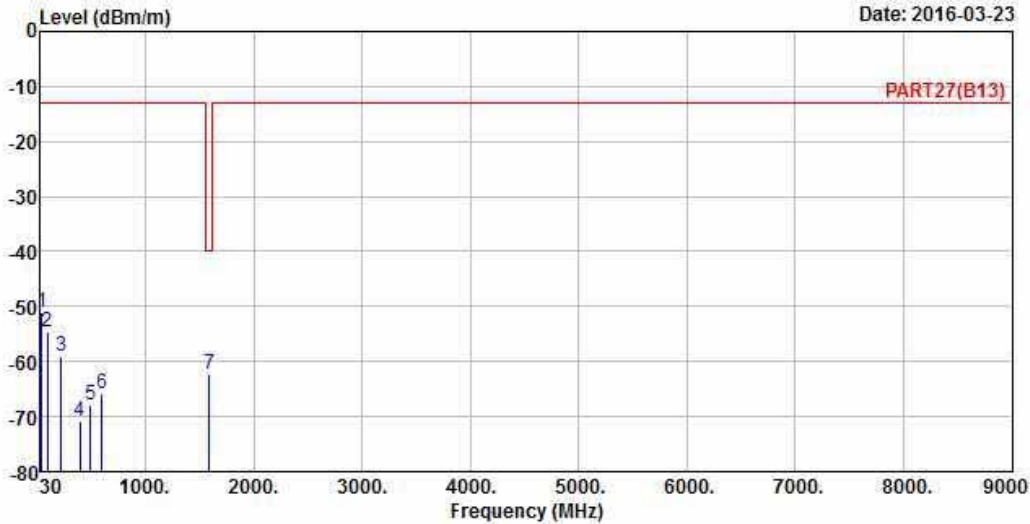

Site : 966 Chamber 5
 Condition: PART27(B13) 3m VERTICAL
 Remak : LTE Band 13_QPSK_5M Link
 Tested by: Toby Tian

	Freq	Level	Read Level	Limit Line	Over Limit	Factor	Remark
	MHz	dBm/m	dBm	dBm/m	dB	dB/m	
1	39.70	-51.16	-51.80	-13.00	-38.16	0.64	Peak
2	93.05	-54.71	-43.76	-13.00	-41.71	-10.95	Peak
3	223.03	-59.12	-52.04	-13.00	-46.12	-7.08	Peak
4	391.81	-70.88	-64.89	-13.00	-57.88	-5.99	Peak
5	489.78	-67.99	-63.18	-13.00	-54.99	-4.81	Peak
6	593.57	-65.71	-64.67	-13.00	-52.71	-1.04	Peak
7 pp	1586.00	-62.35	-47.45	-40.00	-22.35	-14.90	Peak



5 Pictures of Test Arrangements

Please refer to the attached file (Test Setup Photo).



Appendix – Information on the Testing Laboratories

We, Bureau Veritas Consumer Products Services (H.K.) Ltd., Taoyuan Branch, were founded in 1988 to provide our best service in EMC, Radio, Telecom and Safety consultation. Our laboratories are accredited and approved according to ISO/IEC 17025.

If you have any comments, please feel free to contact us at the following:

Linko EMC/RF Lab

Tel: 886-2-26052180

Fax: 886-2-26051924

Hsin Chu EMC/RF/Telecom Lab

Tel: 886-3-6668565

Fax: 886-3-6668323

Hwa Ya EMC/RF/Safety

Tel: 886-3-3183232

Fax: 886-3-3270892

Email: service.adt@tw.bureauveritas.com

Web Site: www.bureauveritas-adt.com

The address and road map of all our labs can be found in our web site also.

--- END ---