

FCC Test Report

Report No.: RF160112C17-8

FCC ID: NM82PS6200

Test Model: 2PS6200

Received Date: Dec. 21, 2015

Test Date: Jan. 20, 2016 ~ Feb. 06, 2016

Issued Date: Feb. 25, 2016

Applicant: HTC Corporation

Address: 1F, 6-3 Baoqiang Road, Xindian District, New Taipei City, Taiwan 231

Issued By: Bureau Veritas Consumer Products Services (H.K.) Ltd., Taoyuan Branch

Lab Address: No. 47-2, 14th Ling, Chia Pau Vil., Lin Kou Dist., New Taipei City, Taiwan (R.O.C)

Test Location (1): No. 19, Hwa Ya 2nd Rd, Wen Hwa Tsuen, Kwei Shan Hsiang, Taoyuan Hsien 333, Taiwan, R.O.C.

Test Location (2): No.215, Sec. 3, Beixin Rd., Xindian Dist., New Taipei City 231, Taiwan, R.O.C



This report is for your exclusive use. Any copying or replication of this report to or for any other person or entity, or use of our name or trademark, is permitted only with our prior written permission. This report sets forth our findings solely with respect to the test samples identified herein. The results set forth in this report are not indicative or representative of the quality or characteristics of the lot from which a test sample was taken or any similar or identical product unless specifically and expressly noted. Our report includes all of the tests requested by you and the results thereof based upon the information that you provided to us. You have 60 days from date of issuance of this report to notify us of any material error or omission caused by our negligence, provided, however, that such notice shall be in writing and shall specifically address the issue you wish to raise. A failure to raise such issue within the prescribed time shall constitute your unqualified acceptance of the completeness of this report, the tests conducted and the correctness of the report contents. Unless specific mention, the uncertainty of measurement has been explicitly taken into account to declare the compliance or non-compliance to the specification. The report must not be used by the client to claim product certification, approval, or endorsement by TAF or any government agencies.

Table of Contents

Release Control Record	4
1 Certificate of Conformity	5
2 Summary of Test Results.....	6
2.1 Measurement Uncertainty.....	6
2.2 Modification Record	6
3 General Information	7
3.1 General Description of EUT	7
3.2 Description of Test Modes.....	9
3.2.1 Test Mode Applicability and Tested Channel Detail.....	11
3.3 Duty Cycle of Test Signal	14
3.4 Description of Support Units	22
3.4.1 Configuration of System under Test	22
3.5 General Description of Applied Standards.....	22
4 Test Types and Results	23
4.1 Radiated Emission and Bandedge Measurement	23
4.1.1 Limits of Radiated Emission and Bandedge Measurement	23
4.1.2 Limits of Unwanted Emission Out of The Restricted Bands.....	23
4.1.3 Test Instruments	24
4.1.4 Test Procedures.....	25
4.1.5 Deviation from Test Standard	25
4.1.6 Test Set Up	26
4.1.7 EUT Operating Conditions.....	26
4.1.8 Test Results	27
4.2 Conducted Emission Measurement.....	95
4.2.1 Limits of Conducted Emission Measurement	95
4.2.2 Test Instruments	95
4.2.3 Test Procedures.....	96
4.2.4 Deviation from Test Standard	96
4.2.5 Test Setup.....	96
4.2.6 EUT Operating Conditions.....	96
4.2.7 Test Results	97
4.3 Transmit Power Measurement.....	99
4.3.1 Limits of Transmit Power Measurement	99
4.3.2 Test Setup.....	99
4.3.3 Test Instruments	100
4.3.4 Test Procedure	100
4.3.5 Deviation from Test Standard	100
4.3.6 EUT Operating Conditions.....	100
4.3.7 Test Result	101
4.4 Peak Power Spectral Density Measurement	110
4.4.1 Limits of Peak Power Spectral Density Measurement	110
4.4.2 Test Setup.....	110
4.4.3 Test Instruments	110
4.4.4 Test Procedures.....	110
4.4.5 Deviation from Test Standard	111
4.4.6 EUT Operating Conditions.....	111
4.4.7 Test Results	112
4.5 Frequency Stability	120
4.5.1 Limit of Frequency Stability Measurement	120
4.5.2 Test Setup.....	120
4.5.3 Test Instruments	120
4.5.4 Test Procedure	120
4.5.5 Deviation from Test Standard	120



4.5.6 EUT Operating Condition	120
4.5.7 Test Results	121
4.6 6dB Bandwidth Measurement.....	122
4.6.1 Limits of 6dB Bandwidth Measurement.....	122
4.6.2 Test Setup.....	122
4.6.3 Test Instruments	122
4.6.4 Test Procedure	122
4.6.5 Deviation from Test Standard	122
4.6.6 EUT Operating Condition	122
4.6.7 Test Results	123
5 Pictures of Test Arrangements.....	126
Appendix – Information on the Testing Laboratories	127



A D T

Release Control Record

Issue No.	Description	Date Issued
RF160112C17-8	Original Release	Feb. 25, 2016

2 Summary of Test Results

47 CFR FCC Part 15, Subpart E (Section 15.407)			
FCC Clause	Test Item	Result	Remarks
15.407(b)(6)	AC Power Conducted Emissions	Pass	Meet the requirement of limit. Minimum passing margin is -21.77 dB at 0.59183 MHz.
15.407(b)(1/2/3/4/6)	Radiated Emissions & Band Edge Measurement	Pass	Meet the requirement of limit. Minimum passing margin is -0.98 dB at 5470 MHz.
15.407(a)(1/2/3)	Max Average Transmit Power	Pass	Meet the requirement of limit.
15.407(a)(1/2/3)	Peak Power Spectral Density	Pass	Meet the requirement of limit.
15.407(e)	6 dB Bandwidth	Pass	Meet the requirement of limit. (U-NII-3 Band only)
15.407(g)	Frequency Stability	Pass	Meet the requirement of limit.
15.203	Antenna Requirement	Pass	No antenna connector is used.

2.1 Measurement Uncertainty

Where relevant, the following measurement uncertainty levels have been estimated for tests performed on the EUT as specified in CISPR 16-4-2:

Measurement	Frequency	Expanded Uncertainty (k=2) (±)
Conducted Emissions at mains ports	150 kHz ~ 30 MHz	2.44 dB
Radiated Emissions up to 1 GHz	30 MHz ~ 200 MHz	2.0153 dB
	200 MHz ~ 1000 MHz	2.0224 dB
Radiated Emissions above 1 GHz	1 GHz ~ 18 GHz	1.0121 dB
	18 GHz ~ 40 GHz	1.1508 dB

2.2 Modification Record

There were no modifications required for compliance.

3 General Information

3.1 General Description of EUT

Product	Smartphone
Brand	HTC
Test Model	2PS6200
Status of EUT	Production Unit
Power Supply Rating	5.0 Vdc (adapter or host equipment) 3.85 Vdc (Li-ion battery)
Modulation Type	256QAM, 64QAM, 16QAM, QPSK, BPSK
Modulation Technology	OFDM
Transfer Rate	802.11a: 54.0/ 48.0/ 36.0/ 24.0/ 18.0/ 12.0/ 9.0/ 6.0 Mbps 802.11n: up to MCS15 802.11ac: up to V9
Operating Frequency	5180 ~ 5240 MHz, 5260 ~ 5320 MHz, 5500 ~ 5700 MHz, 5745 ~ 5825 MHz
Number of Channel	5180 ~ 5240 MHz: 4 for 802.11a, 802.11n (HT20) 2 for 802.11n (HT40) 1 for 802.11ac (VHT80) 5260 ~ 5320 MHz: 4 for 802.11a, 802.11n (HT20) 2 for 802.11n (HT40) 1 for 802.11ac (VHT80) 5500 ~ 5700 MHz: 11 for 802.11a, 802.11n (HT20) 5 for 802.11n (HT40) 2 for 802.11ac (VHT80) 5745 ~ 5825 MHz: 5 for 802.11a, 802.11n (HT20) 2 for 802.11n (HT40) 1 for 802.11ac (VHT80)
Output Power	41.70 mW for 5180 ~ 5240 MHz 43.16 mW for 5260 ~ 5320 MHz 40.89 mW for 5500 ~ 5700 MHz 62.42 mW for 5745 ~ 5825 MHz
Antenna Type	PIFA antenna with -3.5 dBi gain (5180 ~ 5240 MHz) PIFA antenna with -3 dBi gain (5260 ~ 5320 MHz) PIFA antenna with -3 dBi gain (5500 ~ 5700 MHz) PIFA antenna with -3.5 dBi gain (5745 ~ 5825 MHz)
Antenna Connector	N/A
Accessory Device	Refer to Note as below
Data Cable Supplied	Refer to Note as below

Note:

1. The EUT incorporates a MIMO function. Physically, the EUT provides two completed transmitters and two receivers.

Modulation Mode	Tx Function
802.11a	1TX
802.11n (HT20)	1TX / 2TX
802.11n (HT40)	1TX / 2TX
802.11ac (VHT80)	1TX / 2TX

2. The EUT's accessories list refers to Ext. Pho.
3. The above EUT information is declared by manufacturer and for more detailed features description, please refer to the manufacturer's specifications or user's manual.

3.2 Description of Test Modes

FOR 5180 ~ 5240 MHz

4 channels are provided for 802.11a, 802.11n (HT20):

Channel	Frequency (MHz)	Channel	Frequency (MHz)
36	5180	44	5220
40	5200	48	5240

2 channels are provided for 802.11n (HT40):

Channel	Frequency (MHz)	Channel	Frequency (MHz)
38	5190	46	5230

1 channel is provided for 802.11ac (VHT80):

Channel	Frequency (MHz)
42	5210

FOR 5260 ~ 5320 MHz

4 channels are provided for 802.11a, 802.11n (HT20):

Channel	Frequency (MHz)	Channel	Frequency (MHz)
52	5260	60	5300
56	5280	64	5320

2 channels are provided for 802.11n (HT40):

Channel	Frequency (MHz)	Channel	Frequency (MHz)
54	5270	62	5310

1 channel is provided for 802.11ac (VHT80):

Channel	Frequency (MHz)
58	5290

FOR 5500 ~ 5700 MHz

11 channels are provided for 802.11a, 802.11n (HT20):

Channel	Frequency (MHz)	Channel	Frequency (MHz)
100	5500	124	5620
104	5520	128	5640
108	5540	132	5660
112	5560	136	5680
116	5580	140	5700
120	5600		

5 channels are provided for 802.11n (HT40):

Channel	Frequency (MHz)	Channel	Frequency (MHz)
102	5510	126	5630
110	5550	134	5670
118	5590		

2 channels are provided for 802.11ac (VHT80):

Channel	Frequency (MHz)	Channel	Frequency (MHz)
106	5530	122	5610

FOR 5745 ~ 5825 MHz:

5 channels are provided for 802.11a, 802.11n (HT20):

Channel	Frequency (MHz)	Channel	Frequency (MHz)
149	5745	161	5805
153	5765	165	5825
157	5785		

2 channels are provided for 802.11n (HT40):

Channel	Frequency (MHz)	Channel	Frequency (MHz)
151	5755	159	5795

1 channel is provided for 802.11ac (VHT80):

Channel	Frequency (MHz)
155	5775

3.2.1 Test Mode Applicability and Tested Channel Detail

EUT Configure Mode	Applicable To				Description
	RE \geq 1G	RE $<$ 1G	PLC	APCM	
A	√	√	√	√	1TX
B	√	-	-	√	2TX

Where **RE \geq 1G**: Radiated Emission above 1 GHz **RE $<$ 1G**: Radiated Emission below 1 GHz
PLC: Power Line Conducted Emission **APCM**: Antenna Port Conducted Measurement

NOTE:

1. The EUT had been pre-tested on the positioned of each 3 axis. The worst case was found when positioned on **Y-plane**.
2. "-" means no effect.

Radiated Emission Test (Above 1 GHz):

- Pre-Scan has been conducted to determine the worst-case mode from all possible combinations between available modulations, data rates and antenna ports (if EUT with antenna diversity architecture).
- Following channel(s) was (were) selected for the final test as listed below.

EUT Configure Mode	Mode	Frequency Band (MHz)	Available Channel	Tested Channel	Modulation Technology	Modulation Type	Data Rate (Mbps)
A	802.11a	5180-5240	36 to 48	36, 44, 48	OFDM	BPSK	6.0
	802.11n (HT20)		36 to 48	36, 44, 48	OFDM	BPSK	MCS0
	802.11n (HT40)		38 to 46	38, 46	OFDM	BPSK	MCS0
	802.11ac (VHT80)		42	42	OFDM	BPSK	V0
	802.11a	5260-5320	52 to 64	52, 60, 64	OFDM	BPSK	6.0
	802.11n (HT20)		52 to 64	52, 60, 64	OFDM	BPSK	MCS0
	802.11n (HT40)		54 to 62	54, 62	OFDM	BPSK	MCS0
	802.11ac (VHT80)		58	58	OFDM	BPSK	V0
	802.11a	5500-5700	100 to 140	100, 116, 140	OFDM	BPSK	6.0
	802.11n (HT20)		100 to 140	100, 116, 140	OFDM	BPSK	MCS0
	802.11n (HT40)		102 to 134	102, 110, 134	OFDM	BPSK	MCS0
	802.11ac (VHT80)		106 to 122	106, 122	OFDM	BPSK	V0
	802.11a	5745-5825	149 to 165	149, 157, 165	OFDM	BPSK	6.0
	802.11n (HT20)		149 to 165	149, 157, 165	OFDM	BPSK	MCS0
	802.11n (HT40)		151 to 159	151, 159	OFDM	BPSK	MCS0
	802.11ac (VHT80)		155	155	OFDM	BPSK	V0
B	802.11n (HT20)	5180-5240	36 to 48	36, 44, 48	OFDM	BPSK	MCS8
	802.11n (HT40)		38 to 46	38, 46	OFDM	BPSK	MCS8
	802.11ac (VHT80)		42	42	OFDM	BPSK	V0
	802.11n (HT20)	5260-5320	52 to 64	52, 60, 64	OFDM	BPSK	MCS8
	802.11n (HT40)		54 to 62	54, 62	OFDM	BPSK	MCS8
	802.11ac (VHT80)		58	58	OFDM	BPSK	V0
	802.11n (HT20)	5500-5700	100 to 140	100, 116, 140	OFDM	BPSK	MCS0
	802.11n (HT40)		102 to 134	102, 110, 134	OFDM	BPSK	MCS0
	802.11ac (VHT80)		106 to 122	106, 122	OFDM	BPSK	V0
	802.11n (HT20)	5745-5825	149 to 165	149, 157, 165	OFDM	BPSK	MCS0
	802.11n (HT40)		151 to 159	151, 159	OFDM	BPSK	MCS0
	802.11ac (VHT80)		155	155	OFDM	BPSK	V0

Radiated Emission Test (Below 1 GHz):

- Pre-Scan has been conducted to determine the worst-case mode from all possible combinations between available modulations, data rates and antenna ports (if EUT with antenna diversity architecture).
- Following channel(s) was (were) selected for the final test as listed below.

EUT Configure Mode	Mode	Frequency Band (MHz)	Available Channel	Tested Channel	Modulation Technology	Modulation Type	Data Rate (Mbps)
A	802.11ac (VHT80)	5180-5240	42	42	OFDM	BPSK	V0
	802.11ac (VHT80)	5260-5320	58	58	OFDM	BPSK	V0
	802.11n (HT20)	5500-5700	100 to 140	100	OFDM	BPSK	MCS0
	802.11n (HT40)	5745-5825	151 to 159	151	OFDM	BPSK	MCS0

Power Line Conducted Emission Test:

- Pre-Scan has been conducted to determine the worst-case mode from all possible combinations between available modulations, data rates and antenna ports (if EUT with antenna diversity architecture).
- Following channel(s) was (were) selected for the final test as listed below.

EUT Configure Mode	Mode	Frequency Band (MHz)	Available Channel	Tested Channel	Modulation Technology	Modulation Type	Data Rate (Mbps)
A	802.11n (HT20)	5500-5700	100 to 140	100	OFDM	BPSK	MCS0

Antenna Port Conducted Measurement:

- This item includes all test value of each mode, but only includes spectrum plot of worst value of each mode.
- Pre-Scan has been conducted to determine the worst-case mode from all possible combinations between available modulations, data rates and antenna ports (if EUT with antenna diversity architecture).
- Following channel(s) was (were) selected for the final test as listed below.

EUT Configure Mode	Mode	Frequency Band (MHz)	Available Channel	Tested Channel	Modulation Technology	Modulation Type	Data Rate (Mbps)
A	802.11a	5180-5240	36 to 48	36, 44, 48	OFDM	BPSK	6.0
	802.11n (HT20)		36 to 48	36, 44, 48	OFDM	BPSK	MCS0
	802.11n (HT40)		38 to 46	38, 46	OFDM	BPSK	MCS0
	802.11ac (VHT80)		42	42	OFDM	BPSK	V0
	802.11a	5260-5320	52 to 64	52, 60, 64	OFDM	BPSK	6.0
	802.11n (HT20)		52 to 64	52, 60, 64	OFDM	BPSK	MCS0
	802.11n (HT40)		54 to 62	54, 62	OFDM	BPSK	MCS0
	802.11ac (VHT80)		58	58	OFDM	BPSK	V0
	802.11a	5500-5700	100 to 140	100, 116, 140	OFDM	BPSK	6.0
	802.11n (HT20)		100 to 140	100, 116, 140	OFDM	BPSK	MCS0
	802.11n (HT40)		102 to 134	102, 110, 134	OFDM	BPSK	MCS0
	802.11ac (VHT80)		106 to 122	106, 122	OFDM	BPSK	V0
	802.11a	5745-5825	149 to 165	149, 157, 165	OFDM	BPSK	6.0
	802.11n (HT20)		149 to 165	149, 157, 165	OFDM	BPSK	MCS0
	802.11n (HT40)		151 to 159	151, 159	OFDM	BPSK	MCS0
	802.11ac (VHT80)		155	155	OFDM	BPSK	V0
B	802.11n (HT20)	5180-5240	36 to 48	36, 44, 48	OFDM	BPSK	MCS8
	802.11n (HT40)		38 to 46	38, 46	OFDM	BPSK	MCS8
	802.11ac (VHT80)		42	42	OFDM	BPSK	V0
	802.11n (HT20)	5260-5320	52 to 64	52, 60, 64	OFDM	BPSK	MCS8
	802.11n (HT40)		54 to 62	54, 62	OFDM	BPSK	MCS8
	802.11ac (VHT80)		58	58	OFDM	BPSK	V0
	802.11n (HT20)	5500-5700	100 to 140	100, 116, 140	OFDM	BPSK	MCS0
	802.11n (HT40)		102 to 134	102, 110, 134	OFDM	BPSK	MCS0
	802.11ac (VHT80)		106 to 122	106, 122	OFDM	BPSK	V0
	802.11n (HT20)	5745-5825	149 to 165	149, 157, 165	OFDM	BPSK	MCS0
	802.11n (HT40)		151 to 159	151, 159	OFDM	BPSK	MCS0
	802.11ac (VHT80)		155	155	OFDM	BPSK	V0

Test Condition:

Applicable To	Environmental Conditions	Input Power	Tested by
RE \geq 1G	25 deg. C, 65 % RH	120 Vac, 60 Hz	Karl Lee
RE $<$ 1G	25 deg. C, 65 % RH	120 Vac, 60 Hz	Karl Lee
PLC	25 deg. C, 65 % RH	120 Vac, 60 Hz	Toby Tian
APCM	25 deg. C, 65 % RH	3.85 Vdc	Wayne Lin

3.3 Duty Cycle of Test Signal

<ITX>

MODULATION TYPE: BPSK

Duty cycle of test signal is < 98 %, duty factor is required.

802.11a: Duty cycle = $2.059/2.179 = 0.945$, Duty factor = $10 * \log(1/0.945) = 0.25$

802.11n (HT20): Duty cycle = $1.915/2.027 = 0.945$, Duty factor = $10 * \log(1/0.945) = 0.25$

802.11n (HT40): Duty cycle = $0.913/1.050 = 0.869$, Duty factor = $10 * \log(1/0.869) = 0.60$

802.11ac (VHT80): Duty cycle = $440.70/560.90 = 0.786$, Duty factor = $10 * \log(1/0.786) = 1.05$

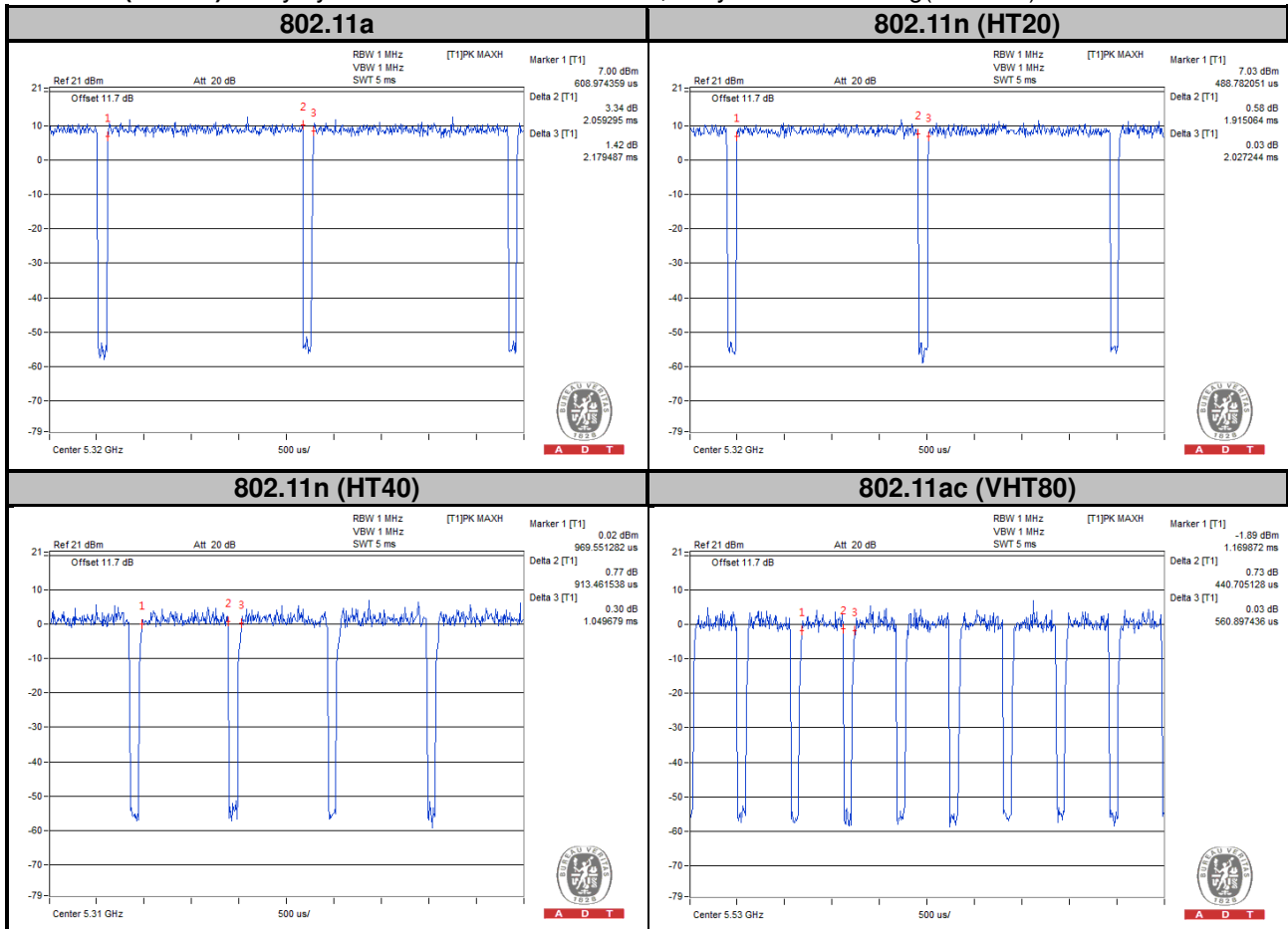

MODULATION TYPE: QPSK

Duty cycle of test signal is < 98 %, duty factor is required.

802.11a: Duty cycle = $1.033/1.154 = 0.895$, Duty factor = $10 * \log(1/0.895) = 0.48$

802.11n (HT20): Duty cycle = $0.962/1.082 = 0.889$, Duty factor = $10 * \log(1/0.889) = 0.51$

802.11n (HT40): Duty cycle = $451.92/594.55 = 0.760$, Duty factor = $10 * \log(1/0.760) = 1.19$

802.11ac (VHT80): Duty cycle = $216.35/355.77 = 0.608$, Duty factor = $10 * \log(1/0.608) = 2.16$

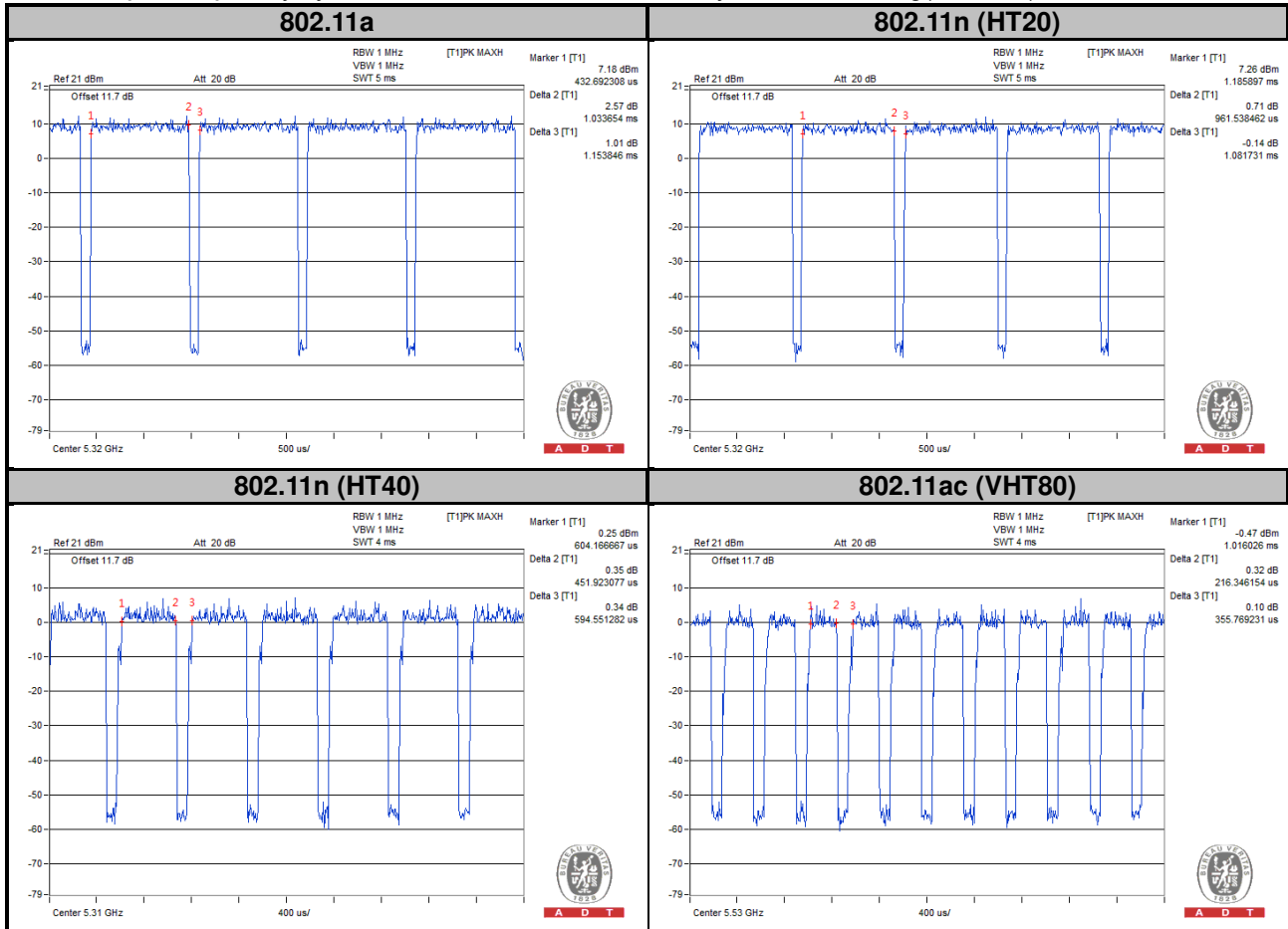

MODULATION TYPE: 16QAM

Duty cycle of test signal is < 98 %, duty factor is required.

802.11a: Duty cycle = $524.04/639.42 = 0.819$, Duty factor = $10 * \log(1/0.819) = 0.86$

802.11n (HT20): Duty cycle = $500.00/615.38 = 0.812$, Duty factor = $10 * \log(1/0.812) = 0.90$

802.11n (HT40): Duty cycle = $225.96/365.38 = 0.618$, Duty factor = $10 * \log(1/0.618) = 2.09$

802.11ac (VHT80): Duty cycle = $125.00/240.38 = 0.520$, Duty factor = $10 * \log(1/0.520) = 2.84$

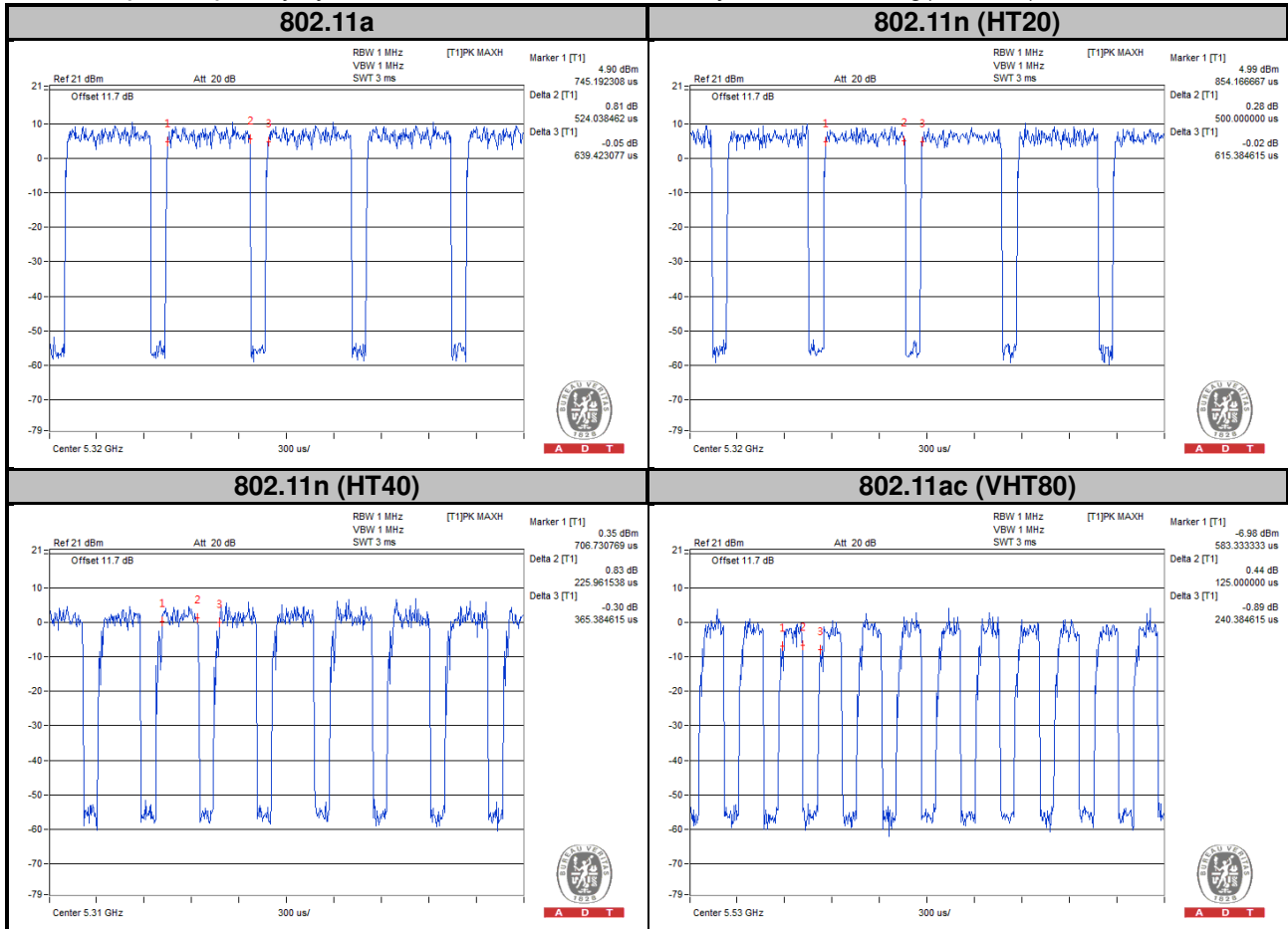

MODULATION TYPE: 64QAM

Duty cycle of test signal is < 98 %, duty factor is required.

802.11a: Duty cycle = 270.83/383.01 = 0.707, Duty factor = $10 * \log(1/0.707) = 1.51$

802.11n (HT20): Duty cycle = 262.82/375.00 = 0.701, Duty factor = $10 * \log(1/0.701) = 1.54$

802.11n (HT40): Duty cycle = 120.19/253.21 = 0.475, Duty factor = $10 * \log(1/0.475) = 3.24$

802.11ac (VHT80): Duty cycle = 73.72/198.72 = 0.372, Duty factor = $10 * \log(1/0.372) = 4.29$

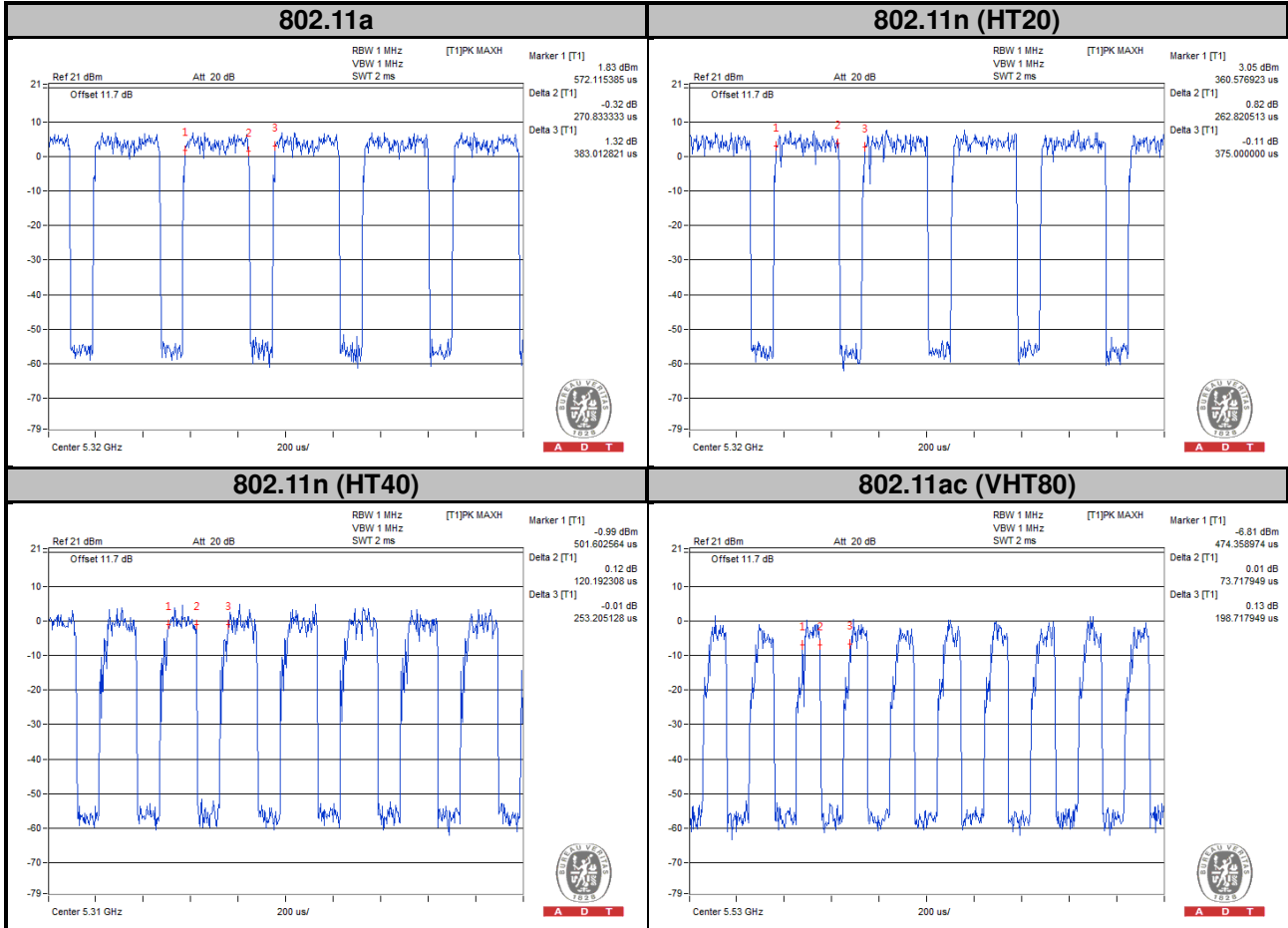

MODULATION TYPE: 256QAM

Duty cycle of test signal is < 98 %, duty factor is required.

802.11ac (VHT80): Duty cycle = 41.67/179.49 = 0.232, Duty factor = $10 * \log(1/0.232) = 6.34$

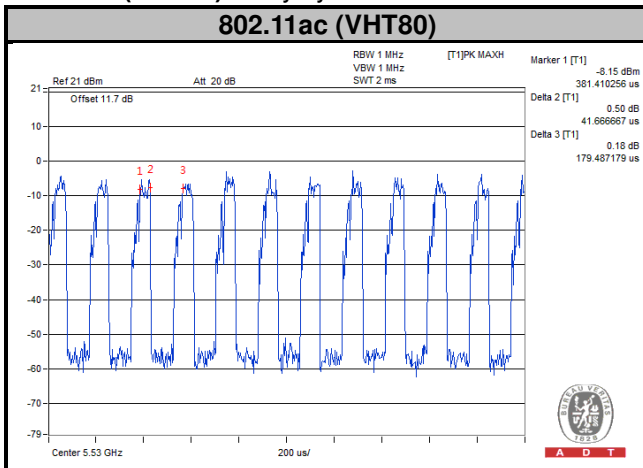

<2TX>

MODULATION TYPE: BPSK

Duty cycle of test signal is < 98 %, duty factor is required.

802.11n (HT20): Duty cycle = 0.969/1.090 = 0.889, Duty factor = $10 * \log(1/0.889) = 0.51$

802.11n (HT40): Duty cycle = 456.73/600.96 = 0.760, Duty factor = $10 * \log(1/0.760) = 1.19$

802.11ac (VHT80): Duty cycle = 208.33/360.58 = 0.578, Duty factor = $10 * \log(1/0.578) = 2.38$



MODULATION TYPE: QPSK

Duty cycle of test signal is < 98 %, duty factor is required.

802.11n (HT20): Duty cycle = 508.01/615.38 = 0.825, Duty factor = $10 * \log(1/0.825) = 0.83$

802.11n (HT40): Duty cycle = 238.78/376.60 = 0.634, Duty factor = $10 * \log(1/0.634) = 1.98$

802.11ac (VHT80): Duty cycle = 116.99/254.81 = 0.459, Duty factor = $10 * \log(1/0.459) = 3.38$



MODULATION TYPE: 16QAM

Duty cycle of test signal is < 98 %, duty factor is required.

802.11n (HT20): Duty cycle = 270.83/378.21 = 0.716, Duty factor = $10 * \log(1/0.716) = 1.45$

802.11n (HT40): Duty cycle = 118.59/251.60 = 0.471, Duty factor = $10 * \log(1/0.471) = 3.27$

802.11ac (VHT80): Duty cycle = 64.10/197.12 = 0.325, Duty factor = $10 * \log(1/0.325) = 4.88$



MODULATION TYPE: 64QAM

Duty cycle of test signal is < 98 %, duty factor is required.

802.11n (HT20): Duty cycle = 149.04/262.82 = 0.567, Duty factor = $10 * \log(1/0.567) = 2.46$

802.11n (HT40): Duty cycle = 67.31/201.92 = 0.333, Duty factor = $10 * \log(1/0.333) = 4.77$

802.11ac (VHT80): Duty cycle = 38.46/174.68 = 0.220, Duty factor = $10 * \log(1/0.220) = 6.57$

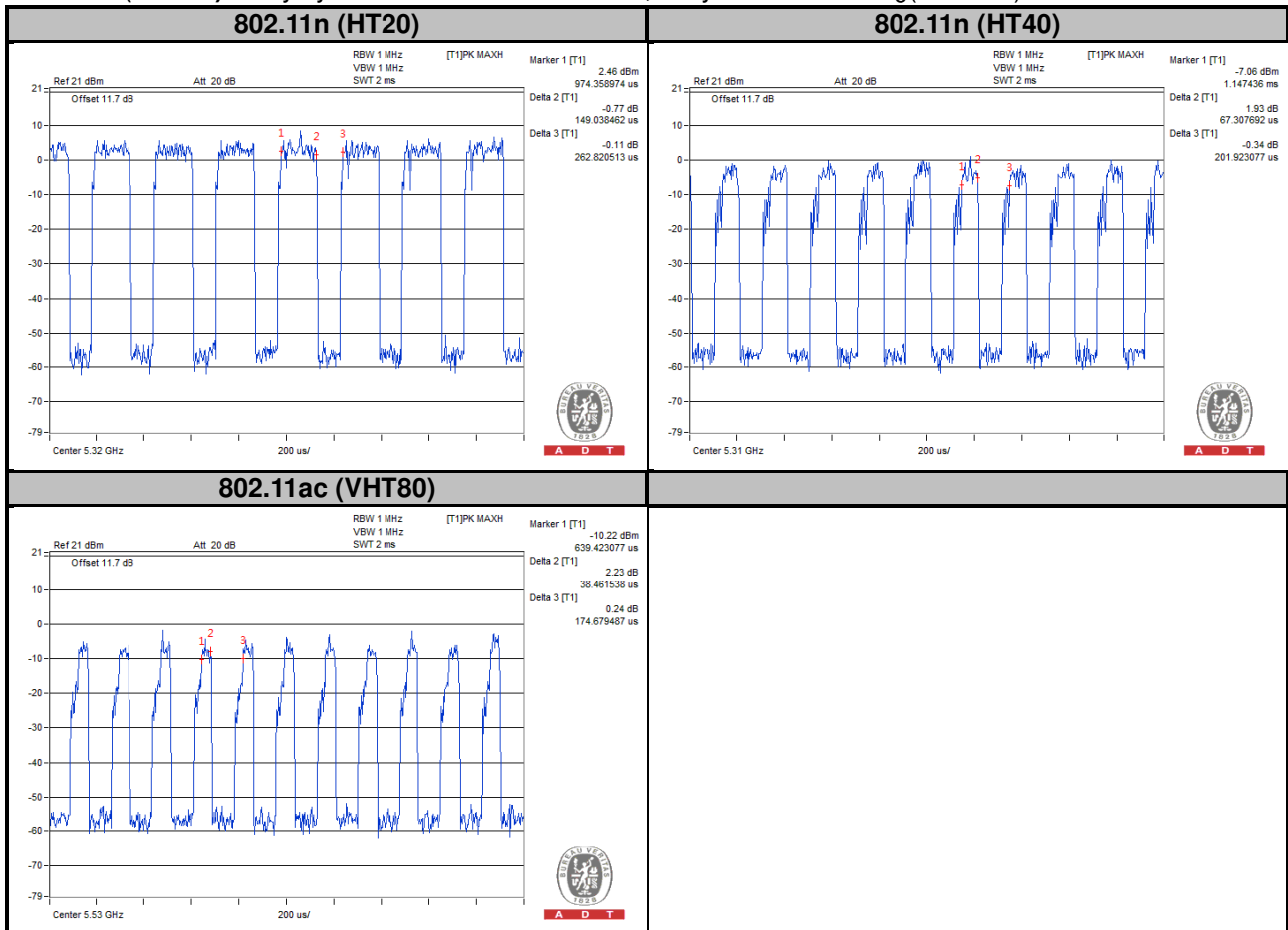

MODULATION TYPE: 256QAM

Duty cycle of test signal is < 98 %, duty factor is required.

802.11ac (VHT80): Duty cycle = 32.05/168.27 = 0.190, Duty factor = $10 * \log(1/0.190) = 7.20$

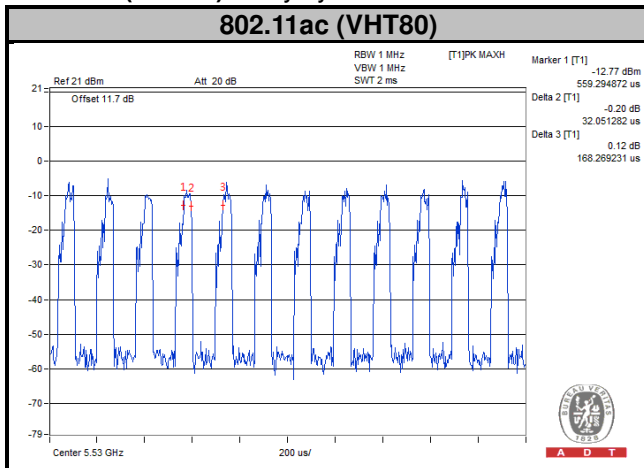

3.4 Description of Support Units

The EUT has been tested as an independent unit together with other necessary accessories or support units.

3.4.1 Configuration of System under Test

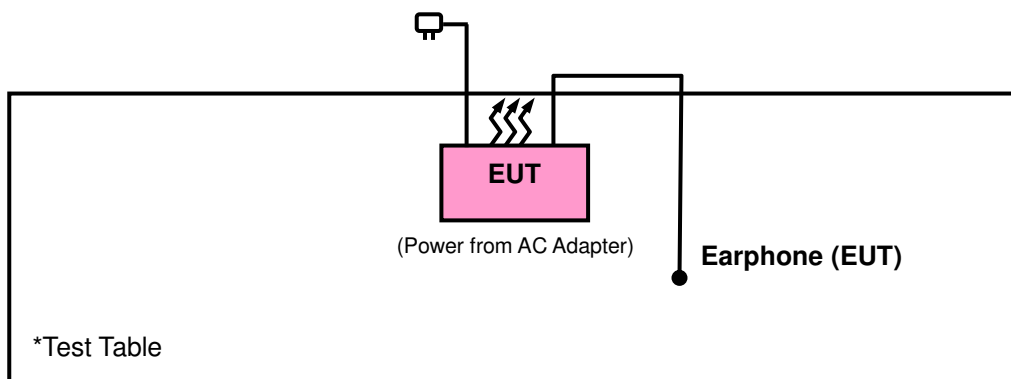

3.5 General Description of Applied Standards

The EUT is a RF Product. According to the specifications of the manufacturer, it must comply with the requirements of the following standards:

FCC Part 15, Subpart E (15.407)

789033 D02 General UNII Test Procedures New Rules v01r01

644545 D01 Guidance for IEEE 802 11ac v01r02

662911 D01 Multiple Transmitter Output v02r01

ANSI C63.10-2013

All test items have been performed and recorded as per the above standards.

NOTE: The EUT has been verified to comply with the requirements of FCC Part 15, Subpart B, Class B (DoC).
The test report has been issued separately.

4 Test Types and Results

4.1 Radiated Emission and Bandedge Measurement

4.1.1 Limits of Radiated Emission and Bandedge Measurement

Radiated emissions which fall in the restricted bands must comply with the radiated emission limits specified as below table. Other emissions shall be at least 20 dB below the highest level of the desired power:

Frequencies (MHz)	Field Strength (microvolts/meter)	Measurement Distance (meters)
0.009 ~ 0.490	2400/F (kHz)	300
0.490 ~ 1.705	24000/F (kHz)	30
1.705 ~ 30.0	30	30
30 ~ 88	100	3
88 ~ 216	150	3
216 ~ 960	200	3
Above 960	500	3

NOTE:

1. The lower limit shall apply at the transition frequencies.
2. Emission level (dBuV/m) = 20 log Emission level (uV/m).
3. For frequencies above 1000 MHz, the field strength limits are based on average detector, however, the peak field strength of any emission shall not exceed the maximum permitted average limits, specified above by more than 20 dB under any condition of modulation.

4.1.2 Limits of Unwanted Emission Out of the Restricted Bands

Applicable To	Limit	
789033 D02 General UNII Test Procedures New Rules v01	Field Strength at 3 m	
	PK: 74 (dBμV/m)	AV: 54 (dBμV/m)
Applicable To	EIRP Limit	Equivalent Field Strength at 3 m
15.407(b)(1)	PK: -27 (dBm/MHz)	PK: 68.2 (dBμV/m)
15.407(b)(2)		
15.407(b)(3)		
15.407(b)(4)	PK: -27 (dBm/MHz) ^{*1} PK: -17 (dBm/MHz) ^{*2}	PK: 68.2 (dBμV/m) ^{*1} PK: 78.2 (dBμV/m) ^{*2}

NOTE: ^{*1} beyond 10 MHz of the band edge ^{*2} within 10 MHz of band edge

The following formula is used to convert the equipment isotropic radiated power (eirp) to field strength:

$$E = \frac{1000000\sqrt{30P}}{3} \mu\text{V/m, where } P \text{ is the eirp (Watts).}$$

4.1.3 Test Instruments

Description & Manufacturer	Model No.	Serial No.	Date of Calibration	Due Date of Calibration
Test Receiver Agilent Technologies	N9038A	MY52260177	May 19, 2015	May 18, 2016
Spectrum Analyzer ROHDE & SCHWARZ	FSU43	101261	Dec. 17, 2015	Dec. 16, 2016
BILOG Antenna SCHWARZBECK	VULB9168	9168-472	Jan. 07, 2016	Jan. 06, 2017
HORN Antenna ETS-Lindgren	3117	00143293	Jan. 04, 2016	Jan. 03, 2017
HORN Antenna SCHWARZBECK	BBHA 9170	9170-480	Jan. 04, 2016	Jan. 03, 2017
Bluetooth Tester	CBT	100980	Apr. 27, 2015	Apr. 26, 2017
Loop Antenna	EM-6879	269	Jul. 31, 2015	Jul. 30, 2016
Agilent Communications Tester-Wireless	8960 Series 10	MY53201073	Jul. 03, 2015	Jul. 02, 2017
Preamplifier Agilent	310N	187226	Jun. 29, 2015	Jun. 28, 2016
Preamplifier Agilent	83017A	MY39501357	Jun. 29, 2015	Jun. 28, 2016
Power Meter Anritsu	ML2495A	1232002	Sep. 21, 2015	Sep. 20, 2016
Power Sensor Anritsu	MA2411B	1207325	Sep. 21, 2015	Sep. 20, 2016
RF signal cable ETS-LINDGREN	5D-FB	Cable-CH1-01(R FC-SMS-100-SM S-120+RFC-SMS -100-SMS-400)	Jun. 27, 2015	Jun. 26, 2016
RF signal cable ETS-LINDGREN	8D-FB	Cable-CH1-02(R FC-SMS-100-SM S-24)	Jun. 27, 2015	Jun. 26, 2016
Software BV ADT	E3 8.130425b	NA	NA	NA
Antenna Tower MF	NA	NA	NA	NA
Turn Table MF	NA	NA	NA	NA
Antenna Tower & Turn Table Controller MF	MF-7802	NA	NA	NA

Note: 1. The calibration interval of the above test instruments is 12 months and the calibrations are traceable to NML/ROC and NIST/USA.

2. The test was performed in HsinTien Chamber 1.
3. The horn antenna and preamplifier (model: 83017A) are used only for the measurement of emission frequency above 1 GHz if tested.
4. The FCC Site Registration No. is 149147.
5. The IC Site Registration No. is IC7450I-1.

4.1.4 Test Procedures

- a. The EUT was placed on the top of a rotating table 0.8 meters (for below 1 GHz) / 1.5 meters (for above 1 GHz) above the ground at 3 meter chamber room for test. The table was rotated 360 degrees to determine the position of the highest radiation.
- b. The EUT was set 3 meters away from the interference-receiving antenna, which was mounted on the top of a variable-height antenna tower.
- c. The height of antenna is varied from one meter to four meters above the ground to determine the maximum value of the field strength. Both horizontal and vertical polarizations of the antenna are set to make the measurement.
- d. For each suspected emission, the EUT was arranged to its worst case and then the antenna was tuned to heights from 1 meter to 4 meters and the rotatable table was turned from 0 degrees to 360 degrees to find the maximum reading.
- e. The test-receiver system was set to quasi-peak detect function and specified bandwidth with maximum hold mode when the test frequency is below 1 GHz.
- f. The test-receiver system was set to peak and average detected function and specified bandwidth with maximum hold mode when the test frequency is above 1 GHz. If the peak reading value also meets average limit, measurement with the average detector is unnecessary.

Note:

1. The resolution bandwidth and video bandwidth of test receiver/spectrum analyzer is 120 kHz for Quasi-peak detection (QP) at frequency below 1 GHz.
2. The resolution bandwidth of test receiver/spectrum analyzer is 1 MHz and the video bandwidth is 3 MHz for Peak detection (PK) at frequency above 1 GHz.
3. The resolution bandwidth of test receiver/spectrum analyzer is 1 MHz and the video bandwidth is 3 MHz for RMS Average (Duty cycle < 98 %) for Average detection (AV) at frequency above 1 GHz, then the measurement results was added to a correction factor ($10 \log(1/\text{duty cycle})$).
4. The resolution bandwidth of test receiver/spectrum analyzer is 1 MHz and the video bandwidth is 10 Hz (Duty cycle ≥ 98 %) for Average detection (AV) at frequency above 1 GHz.
5. All modes of operation were investigated and the worst-case emissions are reported.

4.1.5 Deviation from Test Standard

No deviation.

4.1.6 Test Set Up

<Frequency Range below 1 GHz>

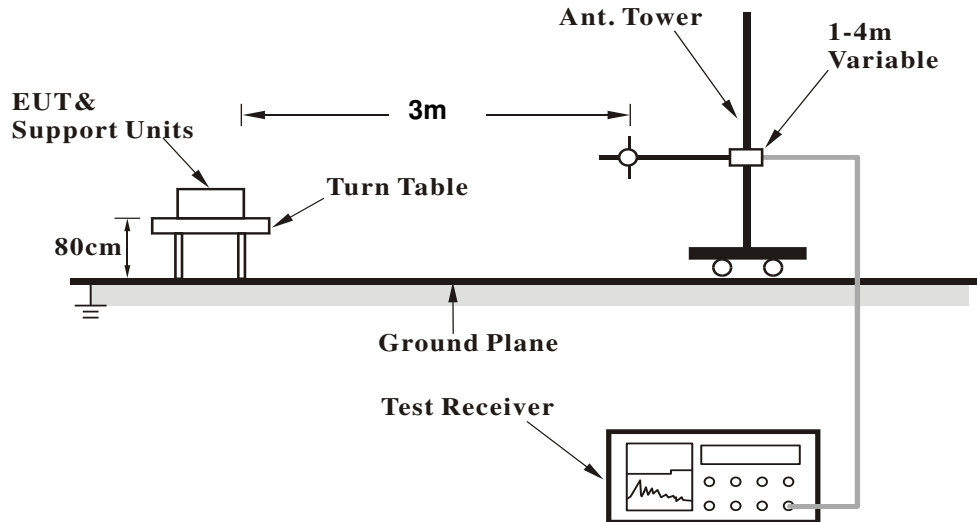

<Frequency Range above 1 GHz>

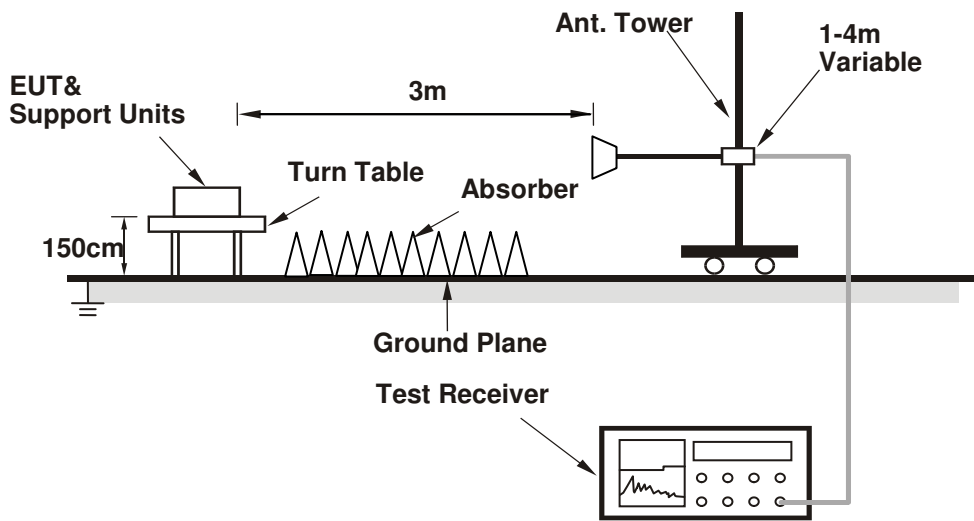

For the actual test configuration, please refer to the attached file (Test Setup Photo).

4.1.7 EUT Operating Conditions

- Placed the EUT on a testing table.
- Use the software to control the EUT under transmission condition continuously at specific channel frequency.



4.1.8 Test Results

ABOVE 1 GHz DATA :

<1TX>

802.11a

EUT Test Condition		Measurement Detail	
Channel	Channel 36	Frequency Range	1 GHz ~ 40 GHz
Input Power	120 Vac, 60 Hz	Detector Function	Peak (PK) Average (AV)
Environmental Conditions	25 deg. C, 65 % RH	Tested By	Karl Lee

Antenna Polarity & Test Distance: Horizontal at 3 m										
Frequency (MHz)	Emission Level (dBuV/m)	Read Level (dBuV)	Limit (dBuV/m)	Margin (dB)	Antenna Factor (dB/m)	Cable Loss (dB)	Preamp Factor (dB)	Antenna Height (cm)	Table Angle (Degree)	Remark
5150	47.25	39	54	-6.75	34.12	8.13	34	256	302	Average
5150	60.39	52.14	74	-13.61	34.12	8.13	34	256	302	Peak
5180	92.66	84.35			34.15	8.16	34	256	302	Average
5180	100.9	92.59			34.15	8.16	34	256	302	Peak
5436	42.67	33.88	54	-11.33	34.35	8.48	34.04	256	302	Average
5436	57.01	48.22	74	-16.99	34.35	8.48	34.04	256	302	Peak
Antenna Polarity & Test Distance: Vertical at 3 m										
Frequency (MHz)	Emission Level (dBuV/m)	Read Level (dBuV)	Limit (dBuV/m)	Margin (dB)	Antenna Factor (dB/m)	Cable Loss (dB)	Preamp Factor (dB)	Antenna Height (cm)	Table Angle (Degree)	Remark
5150	49.82	41.57	54	-4.18	34.12	8.13	34	102	334	Average
5150	64.45	56.2	74	-9.55	34.12	8.13	34	102	334	Peak
5180	95.62	87.31			34.15	8.16	34	102	334	Average
5180	103.53	95.22			34.15	8.16	34	102	334	Peak
5428	42.91	34.14	54	-11.09	34.33	8.48	34.04	102	334	Average
5428	56.75	47.98	74	-17.25	34.33	8.48	34.04	102	334	Peak

Remarks:

- Emission Level = Read Level + Antenna Factor + Cable Loss - Preamp Factor
Margin value = Emission level – Limit value
- 5180 MHz: Fundamental frequency.



EUT Test Condition		Measurement Detail	
Channel	Channel 44	Frequency Range	1 GHz ~ 40 GHz
Input Power	120 Vac, 60 Hz	Detector Function	Peak (PK) Average (AV)
Environmental Conditions	25 deg. C, 65 % RH	Tested By	Karl Lee

Antenna Polarity & Test Distance: Horizontal at 3 m										
Frequency (MHz)	Emission Level (dBuV/m)	Read Level (dBuV)	Limit (dBuV/m)	Margin (dB)	Antenna Factor (dB/m)	Cable Loss (dB)	Preamp Factor (dB)	Antenna Height (cm)	Table Angle (Degree)	Remark
5104	42.86	34.7	54	-11.14	34.08	8.07	33.99	114	344	Average
5104	56.8	48.64	74	-17.2	34.08	8.07	33.99	114	344	Peak
5220	92.59	84.2			34.17	8.22	34	114	344	Average
5220	100.14	91.75			34.17	8.22	34	114	344	Peak
5446	43.07	34.24	54	-10.93	34.36	8.51	34.04	114	344	Average
5446	58.51	49.68	74	-15.49	34.36	8.51	34.04	114	344	Peak

Antenna Polarity & Test Distance: Vertical at 3 m										
Frequency (MHz)	Emission Level (dBuV/m)	Read Level (dBuV)	Limit (dBuV/m)	Margin (dB)	Antenna Factor (dB/m)	Cable Loss (dB)	Preamp Factor (dB)	Antenna Height (cm)	Table Angle (Degree)	Remark
5090	43.46	35.29	54	-10.54	34.08	8.07	33.98	107	31	Average
5090	57.68	49.51	74	-16.32	34.08	8.07	33.98	107	31	Peak
5220	95.79	87.4			34.17	8.22	34	107	31	Average
5220	103.45	95.06			34.17	8.22	34	107	31	Peak
5440	42.95	34.16	54	-11.05	34.35	8.48	34.04	107	31	Average
5440	58.15	49.36	74	-15.85	34.35	8.48	34.04	107	31	Peak

Remarks:

- Emission Level = Read Level + Antenna Factor + Cable Loss - Preamp Factor
Margin value = Emission level – Limit value
- 5220 MHz: Fundamental frequency.

EUT Test Condition		Measurement Detail	
Channel	Channel 48	Frequency Range	1 GHz ~ 40 GHz
Input Power	120 Vac, 60 Hz	Detector Function	Peak (PK) Average (AV)
Environmental Conditions	25 deg. C, 65 % RH	Tested By	Karl Lee

Antenna Polarity & Test Distance: Horizontal at 3 m										
Frequency (MHz)	Emission Level (dBuV/m)	Read Level (dBuV)	Limit (dBuV/m)	Margin (dB)	Antenna Factor (dB/m)	Cable Loss (dB)	Preamp Factor (dB)	Antenna Height (cm)	Table Angle (Degree)	Remark
5016	42.23	34.22	54	-11.77	34.01	7.97	33.97	114	344	Average
5016	56.87	48.86	74	-17.13	34.01	7.97	33.97	114	344	Peak
5240	93.74	85.3			34.19	8.26	34.01	114	344	Average
5240	100.12	91.68			34.19	8.26	34.01	114	344	Peak
5432	43.07	34.28	54	-10.93	34.35	8.48	34.04	114	344	Average
5432	57.25	48.46	74	-16.75	34.35	8.48	34.04	114	344	Peak
Antenna Polarity & Test Distance: Vertical at 3 m										
Frequency (MHz)	Emission Level (dBuV/m)	Read Level (dBuV)	Limit (dBuV/m)	Margin (dB)	Antenna Factor (dB/m)	Cable Loss (dB)	Preamp Factor (dB)	Antenna Height (cm)	Table Angle (Degree)	Remark
5098	42.27	34.11	54	-11.73	34.08	8.07	33.99	107	31	Average
5098	57.18	49.02	74	-16.82	34.08	8.07	33.99	107	31	Peak
5240	96.24	87.8			34.19	8.26	34.01	107	31	Average
5240	103.5	95.06			34.19	8.26	34.01	107	31	Peak
5450	42.99	34.17	54	-11.01	34.36	8.51	34.05	107	31	Average
5450	57.34	48.52	74	-16.66	34.36	8.51	34.05	107	31	Peak

Remarks:

- Emission Level = Read Level + Antenna Factor + Cable Loss - Preamp Factor
Margin value = Emission level – Limit value
- 5240 MHz: Fundamental frequency.



EUT Test Condition		Measurement Detail	
Channel	Channel 52	Frequency Range	1 GHz ~ 40 GHz
Input Power	120 Vac, 60 Hz	Detector Function	Peak (PK) Average (AV)
Environmental Conditions	25 deg. C, 65 % RH	Tested By	Karl Lee

Antenna Polarity & Test Distance: Horizontal at 3 m										
Frequency (MHz)	Emission Level (dBuV/m)	Read Level (dBuV)	Limit (dBuV/m)	Margin (dB)	Antenna Factor (dB/m)	Cable Loss (dB)	Preamp Factor (dB)	Antenna Height (cm)	Table Angle (Degree)	Remark
5102	42.25	34.09	54	-11.75	34.08	8.07	33.99	100	325	Average
5102	57.28	49.12	74	-16.72	34.08	8.07	33.99	100	325	Peak
5260	93.47	85.01			34.21	8.26	34.01	100	325	Average
5260	100.14	91.68			34.21	8.26	34.01	100	325	Peak
5422	42.66	33.89	54	-11.34	34.33	8.48	34.04	100	325	Average
5422	57.76	48.99	74	-16.24	34.33	8.48	34.04	100	325	Peak
Antenna Polarity & Test Distance: Vertical at 3 m										
Frequency (MHz)	Emission Level (dBuV/m)	Read Level (dBuV)	Limit (dBuV/m)	Margin (dB)	Antenna Factor (dB/m)	Cable Loss (dB)	Preamp Factor (dB)	Antenna Height (cm)	Table Angle (Degree)	Remark
5100	42.35	34.19	54	-11.65	34.08	8.07	33.99	100	30	Average
5100	57.14	48.98	74	-16.86	34.08	8.07	33.99	100	30	Peak
5260	96.54	88.08			34.21	8.26	34.01	100	30	Average
5260	103.27	94.81			34.21	8.26	34.01	100	30	Peak
5432	42.72	33.93	54	-11.28	34.35	8.48	34.04	100	30	Average
5432	57.43	48.64	74	-16.57	34.35	8.48	34.04	100	30	Peak

Remarks:

- Emission Level = Read Level + Antenna Factor + Cable Loss - Preamp Factor
Margin value = Emission level – Limit value
- 5260 MHz: Fundamental frequency.



EUT Test Condition		Measurement Detail	
Channel	Channel 60	Frequency Range	1 GHz ~ 40 GHz
Input Power	120 Vac, 60 Hz	Detector Function	Peak (PK) Average (AV)
Environmental Conditions	25 deg. C, 65 % RH	Tested By	Karl Lee

Antenna Polarity & Test Distance: Horizontal at 3 m										
Frequency (MHz)	Emission Level (dBuV/m)	Read Level (dBuV)	Limit (dBuV/m)	Margin (dB)	Antenna Factor (dB/m)	Cable Loss (dB)	Preamp Factor (dB)	Antenna Height (cm)	Table Angle (Degree)	Remark
5094	42.38	34.22	54	-11.62	34.08	8.07	33.99	106	281	Average
5094	56.82	48.66	74	-17.18	34.08	8.07	33.99	106	281	Peak
5300	93.82	85.28			34.24	8.32	34.02	106	281	Average
5300	100.42	91.88			34.24	8.32	34.02	106	281	Peak
5354	45.06	36.43	54	-8.94	34.28	8.38	34.03	106	281	Average
5354	57.55	48.92	74	-16.45	34.28	8.38	34.03	106	281	Peak
Antenna Polarity & Test Distance: Vertical at 3 m										
Frequency (MHz)	Emission Level (dBuV/m)	Read Level (dBuV)	Limit (dBuV/m)	Margin (dB)	Antenna Factor (dB/m)	Cable Loss (dB)	Preamp Factor (dB)	Antenna Height (cm)	Table Angle (Degree)	Remark
5082	42.24	34.08	54	-11.76	34.07	8.07	33.98	113	30	Average
5082	58.9	50.74	74	-15.1	34.07	8.07	33.98	113	30	Peak
5300	96.56	88.02			34.24	8.32	34.02	113	30	Average
5300	103.62	95.08			34.24	8.32	34.02	113	30	Peak
5350	45.56	36.93	54	-8.44	34.28	8.38	34.03	113	30	Average
5350	60.5	51.87	74	-13.5	34.28	8.38	34.03	113	30	Peak

Remarks:

- Emission Level = Read Level + Antenna Factor + Cable Loss - Preamp Factor
Margin value = Emission level – Limit value
- 5300 MHz: Fundamental frequency.

EUT Test Condition		Measurement Detail	
Channel	Channel 64	Frequency Range	1 GHz ~ 40 GHz
Input Power	120 Vac, 60 Hz	Detector Function	Peak (PK) Average (AV)
Environmental Conditions	25 deg. C, 65 % RH	Tested By	Karl Lee

Antenna Polarity & Test Distance: Horizontal at 3 m										
Frequency (MHz)	Emission Level (dBuV/m)	Read Level (dBuV)	Limit (dBuV/m)	Margin (dB)	Antenna Factor (dB/m)	Cable Loss (dB)	Preamp Factor (dB)	Antenna Height (cm)	Table Angle (Degree)	Remark
5098	42.53	34.37	54	-11.47	34.08	8.07	33.99	247	346	Average
5098	57.29	49.13	74	-16.71	34.08	8.07	33.99	247	346	Peak
5320	92.54	83.96			34.25	8.35	34.02	247	346	Average
5320	100.23	91.65			34.25	8.35	34.02	247	346	Peak
5350	45.41	36.78	54	-8.59	34.28	8.38	34.03	247	346	Average
5350	59.06	50.43	74	-14.94	34.28	8.38	34.03	247	346	Peak

Antenna Polarity & Test Distance: Vertical at 3 m										
Frequency (MHz)	Emission Level (dBuV/m)	Read Level (dBuV)	Limit (dBuV/m)	Margin (dB)	Antenna Factor (dB/m)	Cable Loss (dB)	Preamp Factor (dB)	Antenna Height (cm)	Table Angle (Degree)	Remark
5142	42.66	34.4	54	-11.34	34.12	8.13	33.99	200	353	Average
5142	58.39	50.13	74	-15.61	34.12	8.13	33.99	200	353	Peak
5320	96.27	87.69			34.25	8.35	34.02	200	353	Average
5320	103.4	94.82			34.25	8.35	34.02	200	353	Peak
5350	47.5	38.87	54	-6.5	34.28	8.38	34.03	200	353	Average
5350	62.6	53.97	74	-11.4	34.28	8.38	34.03	200	353	Peak

Remarks:

- Emission Level = Read Level + Antenna Factor + Cable Loss - Preamp Factor
Margin value = Emission level – Limit value
- 5320 MHz: Fundamental frequency.

EUT Test Condition		Measurement Detail	
Channel	Channel 100	Frequency Range	1 GHz ~ 40 GHz
Input Power	120 Vac, 60 Hz	Detector Function	Peak (PK) Average (AV)
Environmental Conditions	25 deg. C, 65 % RH	Tested By	Karl Lee

Antenna Polarity & Test Distance: Horizontal at 3 m										
Frequency (MHz)	Emission Level (dBuV/m)	Read Level (dBuV)	Limit (dBuV/m)	Margin (dB)	Antenna Factor (dB/m)	Cable Loss (dB)	Preamp Factor (dB)	Antenna Height (cm)	Table Angle (Degree)	Remark
5456	46.4	37.58	54	-7.6	34.36	8.51	34.05	231	350	Average
5456	61.39	52.57	74	-12.61	34.36	8.51	34.05	231	350	Peak
5470	65.5	56.67	68.2	-2.7	34.37	8.51	34.05	231	350	Peak
5500	93.25	84.33			34.4	8.57	34.05	231	350	Average
5500	100.39	91.47			34.4	8.57	34.05	231	350	Peak
5725	56.64	47.48	68.2	-11.56	34.62	8.65	34.11	231	350	Peak
Antenna Polarity & Test Distance: Vertical at 3 m										
Frequency (MHz)	Emission Level (dBuV/m)	Read Level (dBuV)	Limit (dBuV/m)	Margin (dB)	Antenna Factor (dB/m)	Cable Loss (dB)	Preamp Factor (dB)	Antenna Height (cm)	Table Angle (Degree)	Remark
5458	46.2	37.38	54	-7.8	34.36	8.51	34.05	116	84	Average
5458	59.54	50.72	74	-14.46	34.36	8.51	34.05	116	84	Peak
5470	65.24	56.41	68.2	-2.96	34.37	8.51	34.05	116	84	Peak
5500	93.75	84.83			34.4	8.57	34.05	116	84	Average
5500	101.02	92.1			34.4	8.57	34.05	116	84	Peak
5725	57.1	47.94	68.2	-11.1	34.62	8.65	34.11	116	84	Peak

Remarks:

- Emission Level = Read Level + Antenna Factor + Cable Loss - Preamp Factor
Margin value = Emission level – Limit value
- 5500 MHz: Fundamental frequency.
- 5470 MHz & 5725 MHz: Out of restricted band

EUT Test Condition		Measurement Detail	
Channel	Channel 116	Frequency Range	1 GHz ~ 40 GHz
Input Power	120 Vac, 60 Hz	Detector Function	Peak (PK) Average (AV)
Environmental Conditions	25 deg. C, 65 % RH	Tested By	Karl Lee

Antenna Polarity & Test Distance: Horizontal at 3 m										
Frequency (MHz)	Emission Level (dBuV/m)	Read Level (dBuV)	Limit (dBuV/m)	Margin (dB)	Antenna Factor (dB/m)	Cable Loss (dB)	Preamp Factor (dB)	Antenna Height (cm)	Table Angle (Degree)	Remark
5434	42.72	33.93	54	-11.28	34.35	8.48	34.04	225	296	Average
5434	57.47	48.68	74	-16.53	34.35	8.48	34.04	225	296	Peak
5470	55.77	46.94	68.2	-12.43	34.37	8.51	34.05	225	296	Peak
5580	93.27	84.28			34.47	8.6	34.08	225	296	Average
5580	100.28	91.29			34.47	8.6	34.08	225	296	Peak
5725	56.62	47.46	68.2	-11.58	34.62	8.65	34.11	225	296	Peak
Antenna Polarity & Test Distance: Vertical at 3 m										
Frequency (MHz)	Emission Level (dBuV/m)	Read Level (dBuV)	Limit (dBuV/m)	Margin (dB)	Antenna Factor (dB/m)	Cable Loss (dB)	Preamp Factor (dB)	Antenna Height (cm)	Table Angle (Degree)	Remark
5442	42.82	34.03	54	-11.18	34.35	8.48	34.04	112	56	Average
5442	57.52	48.73	74	-16.48	34.35	8.48	34.04	112	56	Peak
5470	55.05	46.22	68.2	-13.15	34.37	8.51	34.05	112	56	Peak
5580	94.17	85.18			34.47	8.6	34.08	112	56	Average
5580	101.4	92.41			34.47	8.6	34.08	112	56	Peak
5725	54.73	45.57	68.2	-13.47	34.62	8.65	34.11	112	56	Peak

Remarks:

- Emission Level = Read Level + Antenna Factor + Cable Loss - Preamp Factor
Margin value = Emission level – Limit value
- 5580 MHz: Fundamental frequency.
- 5470 MHz & 5725 MHz: Out of restricted band

EUT Test Condition		Measurement Detail	
Channel	Channel 140	Frequency Range	1 GHz ~ 40 GHz
Input Power	120 Vac, 60 Hz	Detector Function	Peak (PK) Average (AV)
Environmental Conditions	25 deg. C, 65 % RH	Tested By	Karl Lee

Antenna Polarity & Test Distance: Horizontal at 3 m										
Frequency (MHz)	Emission Level (dBuV/m)	Read Level (dBuV)	Limit (dBuV/m)	Margin (dB)	Antenna Factor (dB/m)	Cable Loss (dB)	Preamp Factor (dB)	Antenna Height (cm)	Table Angle (Degree)	Remark
5432	42.71	33.92	54	-11.29	34.35	8.48	34.04	231	299	Average
5432	57.89	49.1	74	-16.11	34.35	8.48	34.04	231	299	Peak
5470	57.69	48.86	68.2	-10.51	34.37	8.51	34.05	231	299	Peak
5700	93.83	84.7			34.59	8.64	34.1	231	299	Average
5700	100.57	91.44			34.59	8.64	34.1	231	299	Peak
5725	59.55	50.39	68.2	-8.65	34.62	8.65	34.11	231	299	Peak
Antenna Polarity & Test Distance: Vertical at 3 m										
Frequency (MHz)	Emission Level (dBuV/m)	Read Level (dBuV)	Limit (dBuV/m)	Margin (dB)	Antenna Factor (dB/m)	Cable Loss (dB)	Preamp Factor (dB)	Antenna Height (cm)	Table Angle (Degree)	Remark
5360	42.66	34.03	54	-11.34	34.28	8.38	34.03	105	10	Average
5360	56.4	47.77	74	-17.6	34.28	8.38	34.03	105	10	Peak
5470	55.09	46.26	68.2	-13.11	34.37	8.51	34.05	105	10	Peak
5700	94.73	85.6			34.59	8.64	34.1	105	10	Average
5700	101.12	91.99			34.59	8.64	34.1	105	10	Peak
5725	57.5	48.34	68.2	-10.7	34.62	8.65	34.11	105	10	Peak

Remarks:

- Emission Level = Read Level + Antenna Factor + Cable Loss - Preamp Factor
Margin value = Emission level – Limit value
- 5700 MHz: Fundamental frequency.
- 5470 MHz & 5725 MHz: Out of restricted band



EUT Test Condition		Measurement Detail	
Channel	Channel 149	Frequency Range	1 GHz ~ 40 GHz
Input Power	120 Vac, 60 Hz	Detector Function	Peak (PK) Average (AV)
Environmental Conditions	25 deg. C, 65 % RH	Tested By	Karl Lee

Antenna Polarity & Test Distance: Horizontal at 3 m										
Frequency (MHz)	Emission Level (dBuV/m)	Read Level (dBuV)	Limit (dBuV/m)	Margin (dB)	Antenna Factor (dB/m)	Cable Loss (dB)	Preamp Factor (dB)	Antenna Height (cm)	Table Angle (Degree)	Remark
*5710	58.7	49.55	68.2	-9.5	34.61	8.65	34.11	200	0	Peak
*5724	65.08	55.92	78.2	-13.12	34.62	8.65	34.11	200	0	Peak
5745	88.4	79.21			34.64	8.66	34.11	200	0	Average
5745	95.66	86.47			34.64	8.66	34.11	200	0	Peak
*5854	56.53	47.21	78.2	-21.67	34.76	8.7	34.14	200	0	Peak
*5864	57.77	48.44	68.2	-10.43	34.76	8.71	34.14	200	0	Peak
Antenna Polarity & Test Distance: Vertical at 3 m										
Frequency (MHz)	Emission Level (dBuV/m)	Read Level (dBuV)	Limit (dBuV/m)	Margin (dB)	Antenna Factor (dB/m)	Cable Loss (dB)	Preamp Factor (dB)	Antenna Height (cm)	Table Angle (Degree)	Remark
*5714	60.35	51.2	68.2	-7.85	34.61	8.65	34.11	112	337	Peak
*5724	67.01	57.85	78.2	-11.19	34.62	8.65	34.11	112	337	Peak
5745	91.33	82.14			34.64	8.66	34.11	112	337	Average
5745	98.63	89.44			34.64	8.66	34.11	112	337	Peak
*5860	56.18	46.86	78.2	-22.02	34.76	8.7	34.14	112	337	Peak
*5868	56.43	47.1	68.2	-11.77	34.76	8.71	34.14	112	337	Peak

Remarks:

- Emission Level = Read Level + Antenna Factor + Cable Loss - Preamp Factor
Margin value = Emission level – Limit value
- 5745 MHz: Fundamental frequency.
- *: Out of restricted band

EUT Test Condition		Measurement Detail	
Channel	Channel 157	Frequency Range	1 GHz ~ 40 GHz
Input Power	120 Vac, 60 Hz	Detector Function	Peak (PK) Average (AV)
Environmental Conditions	25 deg. C, 65 % RH	Tested By	Karl Lee

Antenna Polarity & Test Distance: Horizontal at 3 m										
Frequency (MHz)	Emission Level (dBuV/m)	Read Level (dBuV)	Limit (dBuV/m)	Margin (dB)	Antenna Factor (dB/m)	Cable Loss (dB)	Preamp Factor (dB)	Antenna Height (cm)	Table Angle (Degree)	Remark
*5712	55.96	46.81	68.2	-12.24	34.61	8.65	34.11	200	0	Peak
*5720	56.91	47.75	78.2	-21.29	34.62	8.65	34.11	200	0	Peak
5785	88.2	78.97			34.68	8.68	34.13	200	0	Average
5785	95.42	86.19			34.68	8.68	34.13	200	0	Peak
*5856	57.6	48.28	78.2	-20.6	34.76	8.7	34.14	200	0	Peak
*5870	56.15	46.82	68.2	-12.05	34.76	8.71	34.14	200	0	Peak
Antenna Polarity & Test Distance: Vertical at 3 m										
Frequency (MHz)	Emission Level (dBuV/m)	Read Level (dBuV)	Limit (dBuV/m)	Margin (dB)	Antenna Factor (dB/m)	Cable Loss (dB)	Preamp Factor (dB)	Antenna Height (cm)	Table Angle (Degree)	Remark
*5714	56.99	47.84	68.2	-11.21	34.61	8.65	34.11	112	342	Peak
*5720	56.73	47.57	78.2	-21.47	34.62	8.65	34.11	112	342	Peak
5785	91.17	81.94			34.68	8.68	34.13	112	342	Average
5785	98.72	89.49			34.68	8.68	34.13	112	342	Peak
*5856	56.76	47.44	78.2	-21.44	34.76	8.7	34.14	112	342	Peak
*5868	57.19	47.86	68.2	-11.01	34.76	8.71	34.14	112	342	Peak

Remarks:

- Emission Level = Read Level + Antenna Factor + Cable Loss - Preamp Factor
Margin value = Emission level – Limit value
- 5785 MHz: Fundamental frequency.
- *: Out of restricted band



EUT Test Condition		Measurement Detail	
Channel	Channel 165	Frequency Range	1 GHz ~ 40 GHz
Input Power	120 Vac, 60 Hz	Detector Function	Peak (PK) Average (AV)
Environmental Conditions	25 deg. C, 65 % RH	Tested By	Karl Lee

Antenna Polarity & Test Distance: Horizontal at 3 m										
Frequency (MHz)	Emission Level (dBuV/m)	Read Level (dBuV)	Limit (dBuV/m)	Margin (dB)	Antenna Factor (dB/m)	Cable Loss (dB)	Preamp Factor (dB)	Antenna Height (cm)	Table Angle (Degree)	Remark
*5706	58.18	49.03	68.2	-10.02	34.61	8.65	34.11	239	347	Peak
*5718	58.34	49.18	78.2	-19.86	34.62	8.65	34.11	239	347	Peak
5825	87.67	78.38			34.73	8.69	34.13	239	347	Average
5825	95.33	86.04			34.73	8.69	34.13	239	347	Peak
*5852	61.09	51.79	78.2	-17.11	34.74	8.7	34.14	239	347	Peak
*5862	59.64	50.31	68.2	-8.56	34.76	8.71	34.14	239	347	Peak
Antenna Polarity & Test Distance: Vertical at 3 m										
Frequency (MHz)	Emission Level (dBuV/m)	Read Level (dBuV)	Limit (dBuV/m)	Margin (dB)	Antenna Factor (dB/m)	Cable Loss (dB)	Preamp Factor (dB)	Antenna Height (cm)	Table Angle (Degree)	Remark
*5708	57.88	48.73	68.2	-10.32	34.61	8.65	34.11	116	59	Peak
*5722	57.86	48.7	78.2	-20.34	34.62	8.65	34.11	116	59	Peak
5825	91.37	82.08			34.73	8.69	34.13	116	59	Average
5825	98.55	89.26			34.73	8.69	34.13	116	59	Peak
*5852	62.03	52.73	78.2	-16.17	34.74	8.7	34.14	116	59	Peak
*5868	60.62	51.29	68.2	-7.58	34.76	8.71	34.14	116	59	Peak

Remarks:

- Emission Level = Read Level + Antenna Factor + Cable Loss - Preamp Factor
Margin value = Emission level – Limit value
- 5825 MHz: Fundamental frequency.
- *: Out of restricted band

802.11n (HT20)

EUT Test Condition		Measurement Detail	
Channel	Channel 36	Frequency Range	1 GHz ~ 40 GHz
Input Power	120 Vac, 60 Hz	Detector Function	Peak (PK) Average (AV)
Environmental Conditions	25 deg. C, 65 % RH	Tested By	Karl Lee

Antenna Polarity & Test Distance: Horizontal at 3 m

Frequency (MHz)	Emission Level (dBuV/m)	Read Level (dBuV)	Limit (dBuV/m)	Margin (dB)	Antenna Factor (dB/m)	Cable Loss (dB)	Preamp Factor (dB)	Antenna Height (cm)	Table Angle (Degree)	Remark
5146	45.55	37.3	54	-8.45	34.12	8.13	34	256	302	Average
5146	58	49.75	74	-16	34.12	8.13	34	256	302	Peak
5180	92.31	84			34.15	8.16	34	256	302	Average
5180	99.53	91.22			34.15	8.16	34	256	302	Peak
5456	42.68	33.86	54	-11.32	34.36	8.51	34.05	256	302	Average
5456	56.24	47.42	74	-17.76	34.36	8.51	34.05	256	302	Peak

Antenna Polarity & Test Distance: Vertical at 3 m

Frequency (MHz)	Emission Level (dBuV/m)	Read Level (dBuV)	Limit (dBuV/m)	Margin (dB)	Antenna Factor (dB/m)	Cable Loss (dB)	Preamp Factor (dB)	Antenna Height (cm)	Table Angle (Degree)	Remark
5150	48.75	40.5	54	-5.25	34.12	8.13	34	102	334	Average
5150	63.63	55.38	74	-10.37	34.12	8.13	34	102	334	Peak
5180	95.11	86.8			34.15	8.16	34	102	334	Average
5180	102.47	94.16			34.15	8.16	34	102	334	Peak
5388	42.61	33.93	54	-11.39	34.31	8.41	34.04	102	334	Average
5388	56.69	48.01	74	-17.31	34.31	8.41	34.04	102	334	Peak

Remarks:

- Emission Level = Read Level + Antenna Factor + Cable Loss - Preamp Factor
Margin value = Emission level – Limit value
- 5180 MHz: Fundamental frequency.

EUT Test Condition		Measurement Detail	
Channel	Channel 44	Frequency Range	1 GHz ~ 40 GHz
Input Power	120 Vac, 60 Hz	Detector Function	Peak (PK) Average (AV)
Environmental Conditions	25 deg. C, 65 % RH	Tested By	Karl Lee

Antenna Polarity & Test Distance: Horizontal at 3 m										
Frequency (MHz)	Emission Level (dBuV/m)	Read Level (dBuV)	Limit (dBuV/m)	Margin (dB)	Antenna Factor (dB/m)	Cable Loss (dB)	Preamp Factor (dB)	Antenna Height (cm)	Table Angle (Degree)	Remark
5044	43.67	35.61	54	-10.33	34.04	8	33.98	114	344	Average
5044	57.59	49.53	74	-16.41	34.04	8	33.98	114	344	Peak
5220	91.03	82.64			34.17	8.22	34	114	344	Average
5220	99.37	90.98			34.17	8.22	34	114	344	Peak
5460	43.44	34.62	54	-10.56	34.36	8.51	34.05	114	344	Average
5460	57.16	48.34	74	-16.84	34.36	8.51	34.05	114	344	Peak

Antenna Polarity & Test Distance: Vertical at 3 m										
Frequency (MHz)	Emission Level (dBuV/m)	Read Level (dBuV)	Limit (dBuV/m)	Margin (dB)	Antenna Factor (dB/m)	Cable Loss (dB)	Preamp Factor (dB)	Antenna Height (cm)	Table Angle (Degree)	Remark
5040	43.21	35.14	54	-10.79	34.04	8	33.97	107	31	Average
5040	57.64	49.57	74	-16.36	34.04	8	33.97	107	31	Peak
5220	94.82	86.43			34.17	8.22	34	107	31	Average
5220	102.73	94.34			34.17	8.22	34	107	31	Peak
5436	42.75	33.96	54	-11.25	34.35	8.48	34.04	107	31	Average
5436	58.01	49.22	74	-15.99	34.35	8.48	34.04	107	31	Peak

Remarks:

- Emission Level = Read Level + Antenna Factor + Cable Loss - Preamp Factor
Margin value = Emission level – Limit value
- 5220 MHz: Fundamental frequency.

EUT Test Condition		Measurement Detail	
Channel	Channel 48	Frequency Range	1 GHz ~ 40 GHz
Input Power	120 Vac, 60 Hz	Detector Function	Peak (PK) Average (AV)
Environmental Conditions	25 deg. C, 65 % RH	Tested By	Karl Lee

Antenna Polarity & Test Distance: Horizontal at 3 m										
Frequency (MHz)	Emission Level (dBuV/m)	Read Level (dBuV)	Limit (dBuV/m)	Margin (dB)	Antenna Factor (dB/m)	Cable Loss (dB)	Preamp Factor (dB)	Antenna Height (cm)	Table Angle (Degree)	Remark
5070	42.09	33.99	54	-11.91	34.05	8.03	33.98	114	344	Average
5070	56.97	48.87	74	-17.03	34.05	8.03	33.98	114	344	Peak
5240	93.24	84.8			34.19	8.26	34.01	114	344	Average
5240	100.04	91.6			34.19	8.26	34.01	114	344	Peak
5402	42.76	34.04	54	-11.24	34.32	8.44	34.04	114	344	Average
5402	57.96	49.24	74	-16.04	34.32	8.44	34.04	114	344	Peak

Antenna Polarity & Test Distance: Vertical at 3 m										
Frequency (MHz)	Emission Level (dBuV/m)	Read Level (dBuV)	Limit (dBuV/m)	Margin (dB)	Antenna Factor (dB/m)	Cable Loss (dB)	Preamp Factor (dB)	Antenna Height (cm)	Table Angle (Degree)	Remark
5034	42.26	34.2	54	-11.74	34.03	8	33.97	107	31	Average
5034	57.3	49.24	74	-16.7	34.03	8	33.97	107	31	Peak
5240	96.64	88.2			34.19	8.26	34.01	107	31	Average
5240	103.83	95.39			34.19	8.26	34.01	107	31	Peak
5352	42.89	34.26	54	-11.11	34.28	8.38	34.03	107	31	Average
5352	57.4	48.77	74	-16.6	34.28	8.38	34.03	107	31	Peak

Remarks:

- Emission Level = Read Level + Antenna Factor + Cable Loss - Preamp Factor
Margin value = Emission level – Limit value
- 5240 MHz: Fundamental frequency.

EUT Test Condition		Measurement Detail	
Channel	Channel 52	Frequency Range	1 GHz ~ 40 GHz
Input Power	120 Vac, 60 Hz	Detector Function	Peak (PK) Average (AV)
Environmental Conditions	25 deg. C, 65 % RH	Tested By	Karl Lee

Antenna Polarity & Test Distance: Horizontal at 3 m										
Frequency (MHz)	Emission Level (dBuV/m)	Read Level (dBuV)	Limit (dBuV/m)	Margin (dB)	Antenna Factor (dB/m)	Cable Loss (dB)	Preamp Factor (dB)	Antenna Height (cm)	Table Angle (Degree)	Remark
5118	42.29	34.09	54	-11.71	34.09	8.1	33.99	100	281	Average
5118	57.61	49.41	74	-16.39	34.09	8.1	33.99	100	281	Peak
5260	93.02	84.56			34.21	8.26	34.01	100	281	Average
5260	100.65	92.19			34.21	8.26	34.01	100	281	Peak
5436	42.92	34.13	54	-11.08	34.35	8.48	34.04	100	281	Average
5436	57.06	48.27	74	-16.94	34.35	8.48	34.04	100	281	Peak
Antenna Polarity & Test Distance: Vertical at 3 m										
Frequency (MHz)	Emission Level (dBuV/m)	Read Level (dBuV)	Limit (dBuV/m)	Margin (dB)	Antenna Factor (dB/m)	Cable Loss (dB)	Preamp Factor (dB)	Antenna Height (cm)	Table Angle (Degree)	Remark
5132	42.4	34.18	54	-11.6	34.11	8.1	33.99	100	30	Average
5132	56.36	48.14	74	-17.64	34.11	8.1	33.99	100	30	Peak
5260	96.17	87.71			34.21	8.26	34.01	100	30	Average
5260	103.59	95.13			34.21	8.26	34.01	100	30	Peak
5392	42.67	33.99	54	-11.33	34.31	8.41	34.04	100	30	Average
5392	57.17	48.49	74	-16.83	34.31	8.41	34.04	100	30	Peak

Remarks:

- Emission Level = Read Level + Antenna Factor + Cable Loss - Preamp Factor
Margin value = Emission level – Limit value
- 5260 MHz: Fundamental frequency.



A D T

EUT Test Condition		Measurement Detail	
Channel	Channel 60	Frequency Range	1 GHz ~ 40 GHz
Input Power	120 Vac, 60 Hz	Detector Function	Peak (PK) Average (AV)
Environmental Conditions	25 deg. C, 65 % RH	Tested By	Karl Lee

Antenna Polarity & Test Distance: Horizontal at 3 m										
Frequency (MHz)	Emission Level (dBuV/m)	Read Level (dBuV)	Limit (dBuV/m)	Margin (dB)	Antenna Factor (dB/m)	Cable Loss (dB)	Preamp Factor (dB)	Antenna Height (cm)	Table Angle (Degree)	Remark
5142	42.3	34.04	54	-11.7	34.12	8.13	33.99	100	281	Average
5142	57.43	49.17	74	-16.57	34.12	8.13	33.99	100	281	Peak
5300	93.66	85.12			34.24	8.32	34.02	100	281	Average
5300	100.09	91.55			34.24	8.32	34.02	100	281	Peak
5446	44.27	35.44	54	-9.73	34.36	8.51	34.04	100	281	Average
5446	57.26	48.43	74	-16.74	34.36	8.51	34.04	100	281	Peak

Antenna Polarity & Test Distance: Vertical at 3 m										
Frequency (MHz)	Emission Level (dBuV/m)	Read Level (dBuV)	Limit (dBuV/m)	Margin (dB)	Antenna Factor (dB/m)	Cable Loss (dB)	Preamp Factor (dB)	Antenna Height (cm)	Table Angle (Degree)	Remark
5108	42.33	34.13	54	-11.67	34.09	8.1	33.99	113	30	Average
5108	57.44	49.24	74	-16.56	34.09	8.1	33.99	113	30	Peak
5300	96.76	88.22			34.24	8.32	34.02	113	30	Average
5300	103.27	94.73			34.24	8.32	34.02	113	30	Peak
5350	45.16	36.53	54	-8.84	34.28	8.38	34.03	113	30	Average
5350	58.28	49.65	74	-15.72	34.28	8.38	34.03	113	30	Peak

Remarks:

- Emission Level = Read Level + Antenna Factor + Cable Loss - Preamp Factor
Margin value = Emission level – Limit value
- 5300 MHz: Fundamental frequency.

EUT Test Condition		Measurement Detail	
Channel	Channel 64	Frequency Range	1 GHz ~ 40 GHz
Input Power	120 Vac, 60 Hz	Detector Function	Peak (PK) Average (AV)
Environmental Conditions	25 deg. C, 65 % RH	Tested By	Karl Lee

Antenna Polarity & Test Distance: Horizontal at 3 m										
Frequency (MHz)	Emission Level (dBuV/m)	Read Level (dBuV)	Limit (dBuV/m)	Margin (dB)	Antenna Factor (dB/m)	Cable Loss (dB)	Preamp Factor (dB)	Antenna Height (cm)	Table Angle (Degree)	Remark
5138	42.71	34.46	54	-11.29	34.11	8.13	33.99	247	346	Average
5138	57.65	49.4	74	-16.35	34.11	8.13	33.99	247	346	Peak
5320	93.2	84.62			34.25	8.35	34.02	247	346	Average
5320	100.44	91.86			34.25	8.35	34.02	247	346	Peak
5350	44.71	36.08	54	-9.29	34.28	8.38	34.03	247	346	Average
5350	61.09	52.46	74	-12.91	34.28	8.38	34.03	247	346	Peak

Antenna Polarity & Test Distance: Vertical at 3 m										
Frequency (MHz)	Emission Level (dBuV/m)	Read Level (dBuV)	Limit (dBuV/m)	Margin (dB)	Antenna Factor (dB/m)	Cable Loss (dB)	Preamp Factor (dB)	Antenna Height (cm)	Table Angle (Degree)	Remark
5140	42.7	34.44	54	-11.3	34.12	8.13	33.99	200	353	Average
5140	57.76	49.5	74	-16.24	34.12	8.13	33.99	200	353	Peak
5320	95.88	87.3			34.25	8.35	34.02	200	353	Average
5320	103.03	94.45			34.25	8.35	34.02	200	353	Peak
5350	46.73	38.1	54	-7.27	34.28	8.38	34.03	200	353	Average
5350	59.43	50.8	74	-14.57	34.28	8.38	34.03	200	353	Peak

Remarks:

- Emission Level = Read Level + Antenna Factor + Cable Loss - Preamp Factor
Margin value = Emission level – Limit value
- 5320 MHz: Fundamental frequency.



EUT Test Condition		Measurement Detail	
Channel	Channel 100	Frequency Range	1 GHz ~ 40 GHz
Input Power	120 Vac, 60 Hz	Detector Function	Peak (PK) Average (AV)
Environmental Conditions	25 deg. C, 65 % RH	Tested By	Karl Lee

Antenna Polarity & Test Distance: Horizontal at 3 m										
Frequency (MHz)	Emission Level (dBuV/m)	Read Level (dBuV)	Limit (dBuV/m)	Margin (dB)	Antenna Factor (dB/m)	Cable Loss (dB)	Preamp Factor (dB)	Antenna Height (cm)	Table Angle (Degree)	Remark
5456	47.66	38.84	54	-6.34	34.36	8.51	34.05	231	350	Average
5456	60.75	51.93	74	-13.25	34.36	8.51	34.05	231	350	Peak
5470	67.22	58.39	68.2	-0.98	34.37	8.51	34.05	231	350	Peak
5500	93.92	85			34.4	8.57	34.05	231	350	Average
5500	100.64	91.72			34.4	8.57	34.05	231	350	Peak
5725	56.41	47.25	68.2	-11.79	34.62	8.65	34.11	231	350	Peak
Antenna Polarity & Test Distance: Vertical at 3 m										
Frequency (MHz)	Emission Level (dBuV/m)	Read Level (dBuV)	Limit (dBuV/m)	Margin (dB)	Antenna Factor (dB/m)	Cable Loss (dB)	Preamp Factor (dB)	Antenna Height (cm)	Table Angle (Degree)	Remark
5456	47.16	38.34	54	-6.84	34.36	8.51	34.05	116	84	Average
5456	59.9	51.08	74	-14.1	34.36	8.51	34.05	116	84	Peak
5470	66.41	57.58	68.2	-1.79	34.37	8.51	34.05	116	84	Peak
5500	94.54	85.62			34.4	8.57	34.05	116	84	Average
5500	101.25	92.33			34.4	8.57	34.05	116	84	Peak
5725	58.06	48.9	68.2	-10.14	34.62	8.65	34.11	116	84	Peak

Remarks:

- Emission Level = Read Level + Antenna Factor + Cable Loss - Preamp Factor
Margin value = Emission level – Limit value
- 5500 MHz: Fundamental frequency.
- 5470 MHz & 5725 MHz: Out of restricted band

EUT Test Condition		Measurement Detail	
Channel	Channel 116	Frequency Range	1 GHz ~ 40 GHz
Input Power	120 Vac, 60 Hz	Detector Function	Peak (PK) Average (AV)
Environmental Conditions	25 deg. C, 65 % RH	Tested By	Karl Lee

Antenna Polarity & Test Distance: Horizontal at 3 m										
Frequency (MHz)	Emission Level (dBuV/m)	Read Level (dBuV)	Limit (dBuV/m)	Margin (dB)	Antenna Factor (dB/m)	Cable Loss (dB)	Preamp Factor (dB)	Antenna Height (cm)	Table Angle (Degree)	Remark
5364	42.58	33.94	54	-11.42	34.29	8.38	34.03	225	296	Average
5364	56.85	48.21	74	-17.15	34.29	8.38	34.03	225	296	Peak
5470	55.56	46.73	68.2	-12.64	34.37	8.51	34.05	225	296	Peak
5580	93.57	84.58			34.47	8.6	34.08	225	296	Average
5580	100.29	91.3			34.47	8.6	34.08	225	296	Peak
5725	54.91	45.75	68.2	-13.29	34.62	8.65	34.11	225	296	Peak
Antenna Polarity & Test Distance: Vertical at 3 m										
Frequency (MHz)	Emission Level (dBuV/m)	Read Level (dBuV)	Limit (dBuV/m)	Margin (dB)	Antenna Factor (dB/m)	Cable Loss (dB)	Preamp Factor (dB)	Antenna Height (cm)	Table Angle (Degree)	Remark
5442	42.77	33.98	54	-11.23	34.35	8.48	34.04	112	56	Average
5442	57.58	48.79	74	-16.42	34.35	8.48	34.04	112	56	Peak
5470	54.59	45.76	68.2	-13.61	34.37	8.51	34.05	112	56	Peak
5580	94.17	85.18			34.47	8.6	34.08	112	56	Average
5580	101.37	92.38			34.47	8.6	34.08	112	56	Peak
5725	55.94	46.78	68.2	-12.26	34.62	8.65	34.11	112	56	Peak

Remarks:

- Emission Level = Read Level + Antenna Factor + Cable Loss - Preamp Factor
Margin value = Emission level – Limit value
- 5580 MHz: Fundamental frequency.
- 5470 MHz & 5725 MHz: Out of restricted band

EUT Test Condition		Measurement Detail	
Channel	Channel 140	Frequency Range	1 GHz ~ 40 GHz
Input Power	120 Vac, 60 Hz	Detector Function	Peak (PK) Average (AV)
Environmental Conditions	25 deg. C, 65 % RH	Tested By	Karl Lee

Antenna Polarity & Test Distance: Horizontal at 3 m										
Frequency (MHz)	Emission Level (dBuV/m)	Read Level (dBuV)	Limit (dBuV/m)	Margin (dB)	Antenna Factor (dB/m)	Cable Loss (dB)	Preamp Factor (dB)	Antenna Height (cm)	Table Angle (Degree)	Remark
5376	42.57	33.91	54	-11.43	34.29	8.41	34.04	231	299	Average
5376	56.71	48.05	74	-17.29	34.29	8.41	34.04	231	299	Peak
5470	56.03	47.2	68.2	-12.17	34.37	8.51	34.05	231	299	Peak
5700	93.63	84.5			34.59	8.64	34.1	231	299	Average
5700	100.15	91.02			34.59	8.64	34.1	231	299	Peak
5725	65.08	55.92	68.2	-3.12	34.62	8.65	34.11	231	299	Peak
Antenna Polarity & Test Distance: Vertical at 3 m										
Frequency (MHz)	Emission Level (dBuV/m)	Read Level (dBuV)	Limit (dBuV/m)	Margin (dB)	Antenna Factor (dB/m)	Cable Loss (dB)	Preamp Factor (dB)	Antenna Height (cm)	Table Angle (Degree)	Remark
5442	42.92	34.13	54	-11.08	34.35	8.48	34.04	105	10	Average
5442	58.69	49.9	74	-15.31	34.35	8.48	34.04	105	10	Peak
5470	55.11	46.28	68.2	-13.09	34.37	8.51	34.05	105	10	Peak
5700	94.63	85.5			34.59	8.64	34.1	105	10	Average
5700	101.18	92.05			34.59	8.64	34.1	105	10	Peak
5725	66.77	57.61	68.2	-1.43	34.62	8.65	34.11	105	10	Peak

Remarks:

- Emission Level = Read Level + Antenna Factor + Cable Loss - Preamp Factor
Margin value = Emission level – Limit value
- 5700 MHz: Fundamental frequency.
- 5470 MHz & 5725 MHz: Out of restricted band



EUT Test Condition		Measurement Detail	
Channel	Channel 149	Frequency Range	1 GHz ~ 40 GHz
Input Power	120 Vac, 60 Hz	Detector Function	Peak (PK) Average (AV)
Environmental Conditions	25 deg. C, 65 % RH	Tested By	Karl Lee

Antenna Polarity & Test Distance: Horizontal at 3 m										
Frequency (MHz)	Emission Level (dBuV/m)	Read Level (dBuV)	Limit (dBuV/m)	Margin (dB)	Antenna Factor (dB/m)	Cable Loss (dB)	Preamp Factor (dB)	Antenna Height (cm)	Table Angle (Degree)	Remark
*5714	59.53	50.38	68.2	-8.67	34.61	8.65	34.11	200	360	Peak
*5724	67.08	57.92	78.2	-11.12	34.62	8.65	34.11	200	360	Peak
5745	88.38	79.19			34.64	8.66	34.11	200	360	Average
5745	95.28	86.09			34.64	8.66	34.11	200	360	Peak
*5852	56.81	47.51	78.2	-21.39	34.74	8.7	34.14	200	360	Peak
*5868	56.1	46.77	68.2	-12.1	34.76	8.71	34.14	200	360	Peak
Antenna Polarity & Test Distance: Vertical at 3 m										
Frequency (MHz)	Emission Level (dBuV/m)	Read Level (dBuV)	Limit (dBuV/m)	Margin (dB)	Antenna Factor (dB/m)	Cable Loss (dB)	Preamp Factor (dB)	Antenna Height (cm)	Table Angle (Degree)	Remark
*5714	61.36	52.21	68.2	-6.84	34.61	8.65	34.11	112	337	Peak
*5722	69.61	60.45	78.2	-8.59	34.62	8.65	34.11	112	337	Peak
5745	91.74	82.55			34.64	8.66	34.11	112	337	Average
5745	98.34	89.15			34.64	8.66	34.11	112	337	Peak
*5858	55.66	46.34	78.2	-22.54	34.76	8.7	34.14	112	337	Peak
*5862	55.77	46.44	68.2	-12.43	34.76	8.71	34.14	112	337	Peak

Remarks:

- Emission Level = Read Level + Antenna Factor + Cable Loss - Preamp Factor
Margin value = Emission level – Limit value
- 5745 MHz: Fundamental frequency.
- *: Out of restricted band



EUT Test Condition		Measurement Detail	
Channel	Channel 157	Frequency Range	1 GHz ~ 40 GHz
Input Power	120 Vac, 60 Hz	Detector Function	Peak (PK) Average (AV)
Environmental Conditions	25 deg. C, 65 % RH	Tested By	Karl Lee

Antenna Polarity & Test Distance: Horizontal at 3 m										
Frequency (MHz)	Emission Level (dBuV/m)	Read Level (dBuV)	Limit (dBuV/m)	Margin (dB)	Antenna Factor (dB/m)	Cable Loss (dB)	Preamp Factor (dB)	Antenna Height (cm)	Table Angle (Degree)	Remark
*5708	56.12	46.97	68.2	-12.08	34.61	8.65	34.11	200	360	Peak
*5720	57.1	47.94	78.2	-21.1	34.62	8.65	34.11	200	360	Peak
5785	88.91	79.68			34.68	8.68	34.13	200	360	Average
5785	95.64	86.41			34.68	8.68	34.13	200	360	Peak
*5858	55.64	46.32	78.2	-22.56	34.76	8.7	34.14	200	360	Peak
*5870	55.29	45.96	68.2	-12.91	34.76	8.71	34.14	200	360	Peak
Antenna Polarity & Test Distance: Vertical at 3 m										
Frequency (MHz)	Emission Level (dBuV/m)	Read Level (dBuV)	Limit (dBuV/m)	Margin (dB)	Antenna Factor (dB/m)	Cable Loss (dB)	Preamp Factor (dB)	Antenna Height (cm)	Table Angle (Degree)	Remark
*5710	56.38	47.23	68.2	-11.82	34.61	8.65	34.11	112	342	Peak
*5722	56.77	47.61	78.2	-21.43	34.62	8.65	34.11	112	342	Peak
5785	91.46	82.23			34.68	8.68	34.13	112	342	Average
5785	98.39	89.16			34.68	8.68	34.13	112	342	Peak
*5856	55.76	46.44	78.2	-22.44	34.76	8.7	34.14	112	342	Peak
*5870	55.68	46.35	68.2	-12.52	34.76	8.71	34.14	112	342	Peak

Remarks:

- Emission Level = Read Level + Antenna Factor + Cable Loss - Preamp Factor
Margin value = Emission level – Limit value
- 5785 MHz: Fundamental frequency.
- *: Out of restricted band



EUT Test Condition		Measurement Detail	
Channel	Channel 165	Frequency Range	1 GHz ~ 40 GHz
Input Power	120 Vac, 60 Hz	Detector Function	Peak (PK) Average (AV)
Environmental Conditions	25 deg. C, 65 % RH	Tested By	Karl Lee

Antenna Polarity & Test Distance: Horizontal at 3 m										
Frequency (MHz)	Emission Level (dBuV/m)	Read Level (dBuV)	Limit (dBuV/m)	Margin (dB)	Antenna Factor (dB/m)	Cable Loss (dB)	Preamp Factor (dB)	Antenna Height (cm)	Table Angle (Degree)	Remark
*5706	58.14	48.99	68.2	-10.06	34.61	8.65	34.11	239	347	Peak
*5724	58.53	49.37	78.2	-19.67	34.62	8.65	34.11	239	347	Peak
5825	88.37	79.08			34.73	8.69	34.13	239	347	Average
5825	95.67	86.38			34.73	8.69	34.13	239	347	Peak
*5852	61.77	52.47	78.2	-16.43	34.74	8.7	34.14	239	347	Peak
*5866	60.26	50.93	68.2	-7.94	34.76	8.71	34.14	239	347	Peak
Antenna Polarity & Test Distance: Vertical at 3 m										
Frequency (MHz)	Emission Level (dBuV/m)	Read Level (dBuV)	Limit (dBuV/m)	Margin (dB)	Antenna Factor (dB/m)	Cable Loss (dB)	Preamp Factor (dB)	Antenna Height (cm)	Table Angle (Degree)	Remark
*5712	58.78	49.63	68.2	-9.42	34.61	8.65	34.11	116	59	Peak
*5722	57.63	48.47	78.2	-20.57	34.62	8.65	34.11	116	59	Peak
5825	90.04	80.75			34.73	8.69	34.13	116	59	Average
5825	98.31	89.02			34.73	8.69	34.13	116	59	Peak
*5854	64.01	54.69	78.2	-14.19	34.76	8.7	34.14	116	59	Peak
*5862	61.87	52.54	68.2	-6.33	34.76	8.71	34.14	116	59	Peak

Remarks:

- Emission Level = Read Level + Antenna Factor + Cable Loss - Preamp Factor
Margin value = Emission level – Limit value
- 5825 MHz: Fundamental frequency.
- *: Out of restricted band

802.11n (HT40)

EUT Test Condition		Measurement Detail	
Channel	Channel 38	Frequency Range	1 GHz ~ 40 GHz
Input Power	120 Vac, 60 Hz	Detector Function	Peak (PK) Average (AV)
Environmental Conditions	25 deg. C, 65 % RH	Tested By	Karl Lee

Antenna Polarity & Test Distance: Horizontal at 3 m

Frequency (MHz)	Emission Level (dBuV/m)	Read Level (dBuV)	Limit (dBuV/m)	Margin (dB)	Antenna Factor (dB/m)	Cable Loss (dB)	Preamp Factor (dB)	Antenna Height (cm)	Table Angle (Degree)	Remark
5146	49.25	41	54	-4.75	34.12	8.13	34	256	302	Average
5146	63.56	55.31	74	-10.44	34.12	8.13	34	256	302	Peak
5190	89.94	81.6			34.15	8.19	34	256	302	Average
5190	97.38	89.04			34.15	8.19	34	256	302	Peak
5392	42.47	33.79	54	-11.53	34.31	8.41	34.04	256	302	Average
5392	57.16	48.48	74	-16.84	34.31	8.41	34.04	256	302	Peak

Antenna Polarity & Test Distance: Vertical at 3 m

Frequency (MHz)	Emission Level (dBuV/m)	Read Level (dBuV)	Limit (dBuV/m)	Margin (dB)	Antenna Factor (dB/m)	Cable Loss (dB)	Preamp Factor (dB)	Antenna Height (cm)	Table Angle (Degree)	Remark
5150	52.25	44	54	-1.75	34.12	8.13	34	109	334	Average
5150	65.16	56.91	74	-8.84	34.12	8.13	34	109	334	Peak
5190	92.68	84.34			34.15	8.19	34	109	334	Average
5190	100.42	92.08			34.15	8.19	34	109	334	Peak
5444	42.92	34.13	54	-11.08	34.35	8.48	34.04	109	334	Average
5444	56.9	48.11	74	-17.1	34.35	8.48	34.04	109	334	Peak

Remarks:

- Emission Level = Read Level + Antenna Factor + Cable Loss - Preamp Factor
Margin value = Emission level – Limit value
- 5190 MHz: Fundamental frequency.

EUT Test Condition		Measurement Detail	
Channel	Channel 46	Frequency Range	1 GHz ~ 40 GHz
Input Power	120 Vac, 60 Hz	Detector Function	Peak (PK) Average (AV)
Environmental Conditions	25 deg. C, 65 % RH	Tested By	Karl Lee

Antenna Polarity & Test Distance: Horizontal at 3 m										
Frequency (MHz)	Emission Level (dBuV/m)	Read Level (dBuV)	Limit (dBuV/m)	Margin (dB)	Antenna Factor (dB/m)	Cable Loss (dB)	Preamp Factor (dB)	Antenna Height (cm)	Table Angle (Degree)	Remark
5060	43.19	35.09	54	-10.81	34.05	8.03	33.98	114	344	Average
5060	56.92	48.82	74	-17.08	34.05	8.03	33.98	114	344	Peak
5230	90.11	81.71			34.19	8.22	34.01	114	344	Average
5230	97.25	88.85			34.19	8.22	34.01	114	344	Peak
5454	43.92	35.1	54	-10.08	34.36	8.51	34.05	114	344	Average
5454	57	48.18	74	-17	34.36	8.51	34.05	114	344	Peak
Antenna Polarity & Test Distance: Vertical at 3 m										
Frequency (MHz)	Emission Level (dBuV/m)	Read Level (dBuV)	Limit (dBuV/m)	Margin (dB)	Antenna Factor (dB/m)	Cable Loss (dB)	Preamp Factor (dB)	Antenna Height (cm)	Table Angle (Degree)	Remark
5036	43.15	35.09	54	-10.85	34.03	8	33.97	107	31	Average
5036	57.2	49.14	74	-16.8	34.03	8	33.97	107	31	Peak
5230	93.65	85.25			34.19	8.22	34.01	107	31	Average
5230	100.43	92.03			34.19	8.22	34.01	107	31	Peak
5420	43.93	35.16	54	-10.07	34.33	8.48	34.04	107	31	Average
5420	58.19	49.42	74	-15.81	34.33	8.48	34.04	107	31	Peak

Remarks:

- Emission Level = Read Level + Antenna Factor + Cable Loss - Preamp Factor
Margin value = Emission level – Limit value
- 5230 MHz: Fundamental frequency.

EUT Test Condition		Measurement Detail	
Channel	Channel 54	Frequency Range	1 GHz ~ 40 GHz
Input Power	120 Vac, 60 Hz	Detector Function	Peak (PK) Average (AV)
Environmental Conditions	25 deg. C, 65 % RH	Tested By	Karl Lee

Antenna Polarity & Test Distance: Horizontal at 3 m										
Frequency (MHz)	Emission Level (dBuV/m)	Read Level (dBuV)	Limit (dBuV/m)	Margin (dB)	Antenna Factor (dB/m)	Cable Loss (dB)	Preamp Factor (dB)	Antenna Height (cm)	Table Angle (Degree)	Remark
5094	42.85	34.69	54	-11.15	34.08	8.07	33.99	100	281	Average
5094	57.05	48.89	74	-16.95	34.08	8.07	33.99	100	281	Peak
5270	90.55	82.06			34.21	8.29	34.01	100	281	Average
5270	97.31	88.82			34.21	8.29	34.01	100	281	Peak
5442	44.16	35.37	54	-9.84	34.35	8.48	34.04	100	281	Average
5442	57.25	48.46	74	-16.75	34.35	8.48	34.04	100	281	Peak
Antenna Polarity & Test Distance: Vertical at 3 m										
Frequency (MHz)	Emission Level (dBuV/m)	Read Level (dBuV)	Limit (dBuV/m)	Margin (dB)	Antenna Factor (dB/m)	Cable Loss (dB)	Preamp Factor (dB)	Antenna Height (cm)	Table Angle (Degree)	Remark
5128	42.97	34.75	54	-11.03	34.11	8.1	33.99	100	30	Average
5128	58.01	49.79	74	-15.99	34.11	8.1	33.99	100	30	Peak
5270	93.03	84.54			34.21	8.29	34.01	100	30	Average
5270	100.14	91.65			34.21	8.29	34.01	100	30	Peak
5356	44.1	35.47	54	-9.9	34.28	8.38	34.03	100	30	Average
5356	58.24	49.61	74	-15.76	34.28	8.38	34.03	100	30	Peak

Remarks:

- Emission Level = Read Level + Antenna Factor + Cable Loss - Preamp Factor
Margin value = Emission level – Limit value
- 5270 MHz: Fundamental frequency.

EUT Test Condition		Measurement Detail	
Channel	Channel 62	Frequency Range	1 GHz ~ 40 GHz
Input Power	120 Vac, 60 Hz	Detector Function	Peak (PK) Average (AV)
Environmental Conditions	25 deg. C, 65 % RH	Tested By	Karl Lee

Antenna Polarity & Test Distance: Horizontal at 3 m										
Frequency (MHz)	Emission Level (dBuV/m)	Read Level (dBuV)	Limit (dBuV/m)	Margin (dB)	Antenna Factor (dB/m)	Cable Loss (dB)	Preamp Factor (dB)	Antenna Height (cm)	Table Angle (Degree)	Remark
5048	42.95	34.89	54	-11.05	34.04	8	33.98	247	346	Average
5048	58.17	50.11	74	-15.83	34.04	8	33.98	247	346	Peak
5310	90.69	82.14			34.25	8.32	34.02	247	346	Average
5310	97.83	89.28			34.25	8.32	34.02	247	346	Peak
5350	47.06	38.43	54	-6.94	34.28	8.38	34.03	247	346	Average
5350	66.54	57.91	74	-7.46	34.28	8.38	34.03	247	346	Peak

Antenna Polarity & Test Distance: Vertical at 3 m										
Frequency (MHz)	Emission Level (dBuV/m)	Read Level (dBuV)	Limit (dBuV/m)	Margin (dB)	Antenna Factor (dB/m)	Cable Loss (dB)	Preamp Factor (dB)	Antenna Height (cm)	Table Angle (Degree)	Remark
5062	42.92	34.82	54	-11.08	34.05	8.03	33.98	200	353	Average
5062	57.2	49.1	74	-16.8	34.05	8.03	33.98	200	353	Peak
5310	92.69	84.14			34.25	8.32	34.02	200	353	Average
5310	100.91	92.36			34.25	8.32	34.02	200	353	Peak
5350	49.92	41.29	54	-4.08	34.28	8.38	34.03	200	353	Average
5350	63.3	54.67	74	-10.7	34.28	8.38	34.03	200	353	Peak

Remarks:

- Emission Level = Read Level + Antenna Factor + Cable Loss - Preamp Factor
Margin value = Emission level – Limit value
- 5310 MHz: Fundamental frequency.

EUT Test Condition		Measurement Detail	
Channel	Channel 102	Frequency Range	1 GHz ~ 40 GHz
Input Power	120 Vac, 60 Hz	Detector Function	Peak (PK) Average (AV)
Environmental Conditions	25 deg. C, 65 % RH	Tested By	Karl Lee

Antenna Polarity & Test Distance: Horizontal at 3 m										
Frequency (MHz)	Emission Level (dBuV/m)	Read Level (dBuV)	Limit (dBuV/m)	Margin (dB)	Antenna Factor (dB/m)	Cable Loss (dB)	Preamp Factor (dB)	Antenna Height (cm)	Table Angle (Degree)	Remark
5438	44.58	35.79	54	-9.42	34.35	8.48	34.04	158	125	Average
5438	57.12	48.33	74	-16.88	34.35	8.48	34.04	158	125	Peak
5470	60.36	51.53	68.2	-7.84	34.37	8.51	34.05	158	125	Peak
5510	90.69	81.78			34.4	8.57	34.06	158	125	Average
5510	98.68	89.77			34.4	8.57	34.06	158	125	Peak
5725	55.61	46.45	68.2	-12.59	34.62	8.65	34.11	158	125	Peak
Antenna Polarity & Test Distance: Vertical at 3 m										
Frequency (MHz)	Emission Level (dBuV/m)	Read Level (dBuV)	Limit (dBuV/m)	Margin (dB)	Antenna Factor (dB/m)	Cable Loss (dB)	Preamp Factor (dB)	Antenna Height (cm)	Table Angle (Degree)	Remark
5458	50.12	41.3	54	-3.88	34.36	8.51	34.05	132	126	Average
5458	61.71	52.89	74	-12.29	34.36	8.51	34.05	132	126	Peak
5470	66.97	58.14	68.2	-1.23	34.37	8.51	34.05	132	126	Peak
5510	88.26	79.35			34.4	8.57	34.06	132	126	Average
5510	95.26	86.35			34.4	8.57	34.06	132	126	Peak
5725	56.12	46.96	68.2	-12.08	34.62	8.65	34.11	132	126	Peak

Remarks:

- Emission Level = Read Level + Antenna Factor + Cable Loss - Preamp Factor
Margin value = Emission level – Limit value
- 5510 MHz: Fundamental frequency.
- 5470 MHz & 5725 MHz: Out of restricted band



EUT Test Condition		Measurement Detail	
Channel	Channel 110	Frequency Range	1 GHz ~ 40 GHz
Input Power	120 Vac, 60 Hz	Detector Function	Peak (PK) Average (AV)
Environmental Conditions	25 deg. C, 65 % RH	Tested By	Karl Lee

Antenna Polarity & Test Distance: Horizontal at 3 m										
Frequency (MHz)	Emission Level (dBuV/m)	Read Level (dBuV)	Limit (dBuV/m)	Margin (dB)	Antenna Factor (dB/m)	Cable Loss (dB)	Preamp Factor (dB)	Antenna Height (cm)	Table Angle (Degree)	Remark
5454	44.17	35.35	54	-9.83	34.36	8.51	34.05	225	296	Average
5454	59.53	50.71	74	-14.47	34.36	8.51	34.05	225	296	Peak
5470	63.17	54.34	68.2	-5.03	34.37	8.51	34.05	225	296	Peak
5550	91.04	82.07			34.45	8.59	34.07	225	296	Average
5550	98.62	89.65			34.45	8.59	34.07	225	296	Peak
5725	55.85	46.69	68.2	-12.35	34.62	8.65	34.11	225	296	Peak
Antenna Polarity & Test Distance: Vertical at 3 m										
Frequency (MHz)	Emission Level (dBuV/m)	Read Level (dBuV)	Limit (dBuV/m)	Margin (dB)	Antenna Factor (dB/m)	Cable Loss (dB)	Preamp Factor (dB)	Antenna Height (cm)	Table Angle (Degree)	Remark
5440	43.92	35.13	54	-10.08	34.35	8.48	34.04	100	56	Average
5440	57.94	49.15	74	-16.06	34.35	8.48	34.04	100	56	Peak
5470	57.43	48.6	68.2	-10.77	34.37	8.51	34.05	100	56	Peak
5550	92.16	83.19			34.45	8.59	34.07	100	56	Average
5550	99.75	90.78			34.45	8.59	34.07	100	56	Peak
5725	55.47	46.31	68.2	-12.73	34.62	8.65	34.11	100	56	Peak

Remarks:

- Emission Level = Read Level + Antenna Factor + Cable Loss - Preamp Factor
Margin value = Emission level – Limit value
- 5550 MHz: Fundamental frequency.
- 5470 MHz & 5725 MHz: Out of restricted band

EUT Test Condition		Measurement Detail	
Channel	Channel 134	Frequency Range	1 GHz ~ 40 GHz
Input Power	120 Vac, 60 Hz	Detector Function	Peak (PK) Average (AV)
Environmental Conditions	25 deg. C, 65 % RH	Tested By	Karl Lee

Antenna Polarity & Test Distance: Horizontal at 3 m										
Frequency (MHz)	Emission Level (dBuV/m)	Read Level (dBuV)	Limit (dBuV/m)	Margin (dB)	Antenna Factor (dB/m)	Cable Loss (dB)	Preamp Factor (dB)	Antenna Height (cm)	Table Angle (Degree)	Remark
5456	44.07	35.25	54	-9.93	34.36	8.51	34.05	222	298	Average
5456	57.71	48.89	74	-16.29	34.36	8.51	34.05	222	298	Peak
5470	56.6	47.77	68.2	-11.6	34.37	8.51	34.05	222	298	Peak
5670	91.1	82			34.57	8.63	34.1	222	298	Average
5670	98.76	89.66			34.57	8.63	34.1	222	298	Peak
5725	61.24	52.08	68.2	-6.96	34.62	8.65	34.11	222	298	Peak
Antenna Polarity & Test Distance: Vertical at 3 m										
Frequency (MHz)	Emission Level (dBuV/m)	Read Level (dBuV)	Limit (dBuV/m)	Margin (dB)	Antenna Factor (dB/m)	Cable Loss (dB)	Preamp Factor (dB)	Antenna Height (cm)	Table Angle (Degree)	Remark
5452	44.17	35.35	54	-9.83	34.36	8.51	34.05	105	10	Average
5452	57.74	48.92	74	-16.26	34.36	8.51	34.05	105	10	Peak
5470	55.62	46.79	68.2	-12.58	34.37	8.51	34.05	105	10	Peak
5670	92.9	83.8			34.57	8.63	34.1	105	10	Average
5670	99.8	90.7			34.57	8.63	34.1	105	10	Peak
5725	62.85	53.69	68.2	-5.35	34.62	8.65	34.11	105	10	Peak

Remarks:

- Emission Level = Read Level + Antenna Factor + Cable Loss - Preamp Factor
Margin value = Emission level – Limit value
- 5670 MHz: Fundamental frequency.
- 5470 MHz & 5725 MHz: Out of restricted band

EUT Test Condition		Measurement Detail	
Channel	Channel 151	Frequency Range	1 GHz ~ 40 GHz
Input Power	120 Vac, 60 Hz	Detector Function	Peak (PK) Average (AV)
Environmental Conditions	25 deg. C, 65 % RH	Tested By	Karl Lee

Antenna Polarity & Test Distance: Horizontal at 3 m										
Frequency (MHz)	Emission Level (dBuV/m)	Read Level (dBuV)	Limit (dBuV/m)	Margin (dB)	Antenna Factor (dB/m)	Cable Loss (dB)	Preamp Factor (dB)	Antenna Height (cm)	Table Angle (Degree)	Remark
*5714	66.41	57.26	68.2	-1.79	34.61	8.65	34.11	239	347	Peak
*5720	69.59	60.43	78.2	-8.61	34.62	8.65	34.11	239	347	Peak
5755	88.46	79.25			34.66	8.66	34.11	239	347	Average
5755	95.7	86.49			34.66	8.66	34.11	239	347	Peak
*5860	58.28	48.96	78.2	-19.92	34.76	8.7	34.14	239	347	Peak
*5866	57.93	48.6	68.2	-10.27	34.76	8.71	34.14	239	347	Peak
Antenna Polarity & Test Distance: Vertical at 3 m										
Frequency (MHz)	Emission Level (dBuV/m)	Read Level (dBuV)	Limit (dBuV/m)	Margin (dB)	Antenna Factor (dB/m)	Cable Loss (dB)	Preamp Factor (dB)	Antenna Height (cm)	Table Angle (Degree)	Remark
*5710	66.99	57.84	68.2	-1.21	34.61	8.65	34.11	105	59	Peak
*5724	69.43	60.27	78.2	-8.77	34.62	8.65	34.11	105	59	Peak
5755	90.49	81.28			34.66	8.66	34.11	105	59	Average
5755	98.26	89.05			34.66	8.66	34.11	105	59	Peak
*5858	57.48	48.16	78.2	-20.72	34.76	8.7	34.14	105	59	Peak
*5864	57.84	48.51	68.2	-10.36	34.76	8.71	34.14	105	59	Peak

Remarks:

- Emission Level = Read Level + Antenna Factor + Cable Loss - Preamp Factor
Margin value = Emission level – Limit value
- 5755 MHz: Fundamental frequency.
- *: Out of restricted band



EUT Test Condition		Measurement Detail	
Channel	Channel 159	Frequency Range	1 GHz ~ 40 GHz
Input Power	120 Vac, 60 Hz	Detector Function	Peak (PK) Average (AV)
Environmental Conditions	25 deg. C, 65 % RH	Tested By	Karl Lee

Antenna Polarity & Test Distance: Horizontal at 3 m										
Frequency (MHz)	Emission Level (dBuV/m)	Read Level (dBuV)	Limit (dBuV/m)	Margin (dB)	Antenna Factor (dB/m)	Cable Loss (dB)	Preamp Factor (dB)	Antenna Height (cm)	Table Angle (Degree)	Remark
*5710	56.82	47.67	68.2	-11.38	34.61	8.65	34.11	200	360	Peak
*5724	58.24	49.08	78.2	-19.96	34.62	8.65	34.11	200	360	Peak
5795	88.27	79.03			34.69	8.68	34.13	200	360	Average
5795	95.1	85.86			34.69	8.68	34.13	200	360	Peak
*5856	56.76	47.44	78.2	-21.44	34.76	8.7	34.14	200	360	Peak
*5870	58.63	49.3	68.2	-9.57	34.76	8.71	34.14	200	360	Peak
Antenna Polarity & Test Distance: Vertical at 3 m										
Frequency (MHz)	Emission Level (dBuV/m)	Read Level (dBuV)	Limit (dBuV/m)	Margin (dB)	Antenna Factor (dB/m)	Cable Loss (dB)	Preamp Factor (dB)	Antenna Height (cm)	Table Angle (Degree)	Remark
*5714	58.08	48.93	68.2	-10.12	34.61	8.65	34.11	110	342	Peak
*5724	62.91	53.75	78.2	-15.29	34.62	8.65	34.11	110	342	Peak
5795	91.77	82.53			34.69	8.68	34.13	110	342	Average
5795	98.4	89.16			34.69	8.68	34.13	110	342	Peak
*5856	63.93	54.61	78.2	-14.27	34.76	8.7	34.14	110	342	Peak
*5864	61.9	52.57	68.2	-6.3	34.76	8.71	34.14	110	342	Peak

Remarks:

- Emission Level = Read Level + Antenna Factor + Cable Loss - Preamp Factor
Margin value = Emission level – Limit value
- 5795 MHz: Fundamental frequency.
- *: Out of restricted band

802.11ac (VHT80)

EUT Test Condition		Measurement Detail	
Channel	Channel 42	Frequency Range	1 GHz ~ 40 GHz
Input Power	120 Vac, 60 Hz	Detector Function	Peak (PK) Average (AV)
Environmental Conditions	25 deg. C, 65 % RH	Tested By	Karl Lee

Antenna Polarity & Test Distance: Horizontal at 3 m

Frequency (MHz)	Emission Level (dBuV/m)	Read Level (dBuV)	Limit (dBuV/m)	Margin (dB)	Antenna Factor (dB/m)	Cable Loss (dB)	Preamp Factor (dB)	Antenna Height (cm)	Table Angle (Degree)	Remark
5150	51.65	43.4	54	-2.35	34.12	8.13	34	256	302	Average
5150	63.06	54.81	74	-10.94	34.12	8.13	34	256	302	Peak
5210	86.97	78.61			34.17	8.19	34	256	302	Average
5210	94.87	86.51			34.17	8.19	34	256	302	Peak
5384	42.42	33.74	54	-11.58	34.31	8.41	34.04	256	302	Average
5384	57.11	48.43	74	-16.89	34.31	8.41	34.04	256	302	Peak

Antenna Polarity & Test Distance: Vertical at 3 m

Frequency (MHz)	Emission Level (dBuV/m)	Read Level (dBuV)	Limit (dBuV/m)	Margin (dB)	Antenna Factor (dB/m)	Cable Loss (dB)	Preamp Factor (dB)	Antenna Height (cm)	Table Angle (Degree)	Remark
5150	52.85	44.6	54	-1.15	34.12	8.13	34	107	333	Average
5150	64.8	56.55	74	-9.2	34.12	8.13	34	107	333	Peak
5210	89.77	81.41			34.17	8.19	34	107	333	Average
5210	97.88	89.52			34.17	8.19	34	107	333	Peak
5414	42.89	34.16	54	-11.11	34.33	8.44	34.04	107	333	Average
5414	58.5	49.77	74	-15.5	34.33	8.44	34.04	107	333	Peak

Remarks:

- Emission Level = Read Level + Antenna Factor + Cable Loss - Preamp Factor
Margin value = Emission level – Limit value
- 5210 MHz: Fundamental frequency.



EUT Test Condition		Measurement Detail	
Channel	Channel 58	Frequency Range	1 GHz ~ 40 GHz
Input Power	120 Vac, 60 Hz	Detector Function	Peak (PK) Average (AV)
Environmental Conditions	25 deg. C, 65 % RH	Tested By	Karl Lee

Antenna Polarity & Test Distance: Horizontal at 3 m										
Frequency (MHz)	Emission Level (dBuV/m)	Read Level (dBuV)	Limit (dBuV/m)	Margin (dB)	Antenna Factor (dB/m)	Cable Loss (dB)	Preamp Factor (dB)	Antenna Height (cm)	Table Angle (Degree)	Remark
5144	45.41	37.16	54	-8.59	34.12	8.13	34	247	346	Average
5144	58.41	50.16	74	-15.59	34.12	8.13	34	247	346	Peak
5290	86.52	77.99			34.23	8.32	34.02	247	346	Average
5290	94.1	85.57			34.23	8.32	34.02	247	346	Peak
5352	50.95	42.32	54	-3.05	34.28	8.38	34.03	247	346	Average
5352	68.4	59.77	74	-5.6	34.28	8.38	34.03	247	346	Peak
Antenna Polarity & Test Distance: Vertical at 3 m										
Frequency (MHz)	Emission Level (dBuV/m)	Read Level (dBuV)	Limit (dBuV/m)	Margin (dB)	Antenna Factor (dB/m)	Cable Loss (dB)	Preamp Factor (dB)	Antenna Height (cm)	Table Angle (Degree)	Remark
5138	43.61	35.36	54	-10.39	34.11	8.13	33.99	200	353	Average
5138	57.84	49.59	74	-16.16	34.11	8.13	33.99	200	353	Peak
5290	89.11	80.58			34.23	8.32	34.02	200	353	Average
5290	97.48	88.95			34.23	8.32	34.02	200	353	Peak
5352	52.97	44.34	54	-1.03	34.28	8.38	34.03	200	353	Average
5352	64.55	55.92	74	-9.45	34.28	8.38	34.03	200	353	Peak

Remarks:

- Emission Level = Read Level + Antenna Factor + Cable Loss - Preamp Factor
Margin value = Emission level – Limit value
- 5290 MHz: Fundamental frequency.

EUT Test Condition		Measurement Detail	
Channel	Channel 106	Frequency Range	1 GHz ~ 40 GHz
Input Power	120 Vac, 60 Hz	Detector Function	Peak (PK) Average (AV)
Environmental Conditions	25 deg. C, 65 % RH	Tested By	Karl Lee

Antenna Polarity & Test Distance: Horizontal at 3 m										
Frequency (MHz)	Emission Level (dBuV/m)	Read Level (dBuV)	Limit (dBuV/m)	Margin (dB)	Antenna Factor (dB/m)	Cable Loss (dB)	Preamp Factor (dB)	Antenna Height (cm)	Table Angle (Degree)	Remark
5460	52.5	43.68	54	-1.5	34.36	8.51	34.05	231	350	Average
5460	62.39	53.57	74	-11.61	34.36	8.51	34.05	231	350	Peak
5470	65.49	56.66	68.2	-2.71	34.37	8.51	34.05	231	350	Peak
5530	87.16	78.23			34.42	8.58	34.07	231	350	Average
5530	95.79	86.86			34.42	8.58	34.07	231	350	Peak
5725	57.09	47.93	68.2	-11.11	34.62	8.65	34.11	231	350	Peak
Antenna Polarity & Test Distance: Vertical at 3 m										
Frequency (MHz)	Emission Level (dBuV/m)	Read Level (dBuV)	Limit (dBuV/m)	Margin (dB)	Antenna Factor (dB/m)	Cable Loss (dB)	Preamp Factor (dB)	Antenna Height (cm)	Table Angle (Degree)	Remark
5450	51.41	42.59	54	-2.59	34.36	8.51	34.05	116	84	Average
5450	62.01	53.19	74	-11.99	34.36	8.51	34.05	116	84	Peak
5470	66.33	57.5	68.2	-1.87	34.37	8.51	34.05	116	84	Peak
5530	88.25	79.32			34.42	8.58	34.07	116	84	Average
5530	96.52	87.59			34.42	8.58	34.07	116	84	Peak
5725	58.14	48.98	68.2	-10.06	34.62	8.65	34.11	116	84	Peak

Remarks:

- Emission Level = Read Level + Antenna Factor + Cable Loss - Preamp Factor
Margin value = Emission level – Limit value
- 5530 MHz: Fundamental frequency.
- 5470 MHz & 5725 MHz: Out of restricted band

EUT Test Condition		Measurement Detail	
Channel	Channel 122	Frequency Range	1 GHz ~ 40 GHz
Input Power	120 Vac, 60 Hz	Detector Function	Peak (PK) Average (AV)
Environmental Conditions	25 deg. C, 65 % RH	Tested By	Karl Lee

Antenna Polarity & Test Distance: Horizontal at 3 m										
Frequency (MHz)	Emission Level (dBuV/m)	Read Level (dBuV)	Limit (dBuV/m)	Margin (dB)	Antenna Factor (dB/m)	Cable Loss (dB)	Preamp Factor (dB)	Antenna Height (cm)	Table Angle (Degree)	Remark
5422	45.33	36.56	54	-8.67	34.33	8.48	34.04	221	300	Average
5422	57.93	49.16	74	-16.07	34.33	8.48	34.04	221	300	Peak
5470	57.71	48.88	68.2	-10.49	34.37	8.51	34.05	221	300	Peak
5610	88.97	79.94			34.5	8.61	34.08	221	300	Average
5610	95.4	86.37			34.5	8.61	34.08	221	300	Peak
5725	56.33	47.17	68.2	-11.87	34.62	8.65	34.11	221	300	Peak
Antenna Polarity & Test Distance: Vertical at 3 m										
Frequency (MHz)	Emission Level (dBuV/m)	Read Level (dBuV)	Limit (dBuV/m)	Margin (dB)	Antenna Factor (dB/m)	Cable Loss (dB)	Preamp Factor (dB)	Antenna Height (cm)	Table Angle (Degree)	Remark
5454	46.1	37.28	54	-7.9	34.36	8.51	34.05	113	46	Average
5454	57.72	48.9	74	-16.28	34.36	8.51	34.05	113	46	Peak
5470	57.79	48.96	68.2	-10.41	34.37	8.51	34.05	113	46	Peak
5610	88.97	79.94			34.5	8.61	34.08	113	46	Average
5610	96.33	87.3			34.5	8.61	34.08	113	46	Peak
5725	55.41	46.25	68.2	-12.79	34.62	8.65	34.11	113	46	Peak

Remarks:

- Emission Level = Read Level + Antenna Factor + Cable Loss - Preamp Factor
Margin value = Emission level – Limit value
- 5610 MHz: Fundamental frequency.
- 5470 MHz & 5725 MHz: Out of restricted band



EUT Test Condition		Measurement Detail	
Channel	Channel 155	Frequency Range	1 GHz ~ 40 GHz
Input Power	120 Vac, 60 Hz	Detector Function	Peak (PK) Average (AV)
Environmental Conditions	25 deg. C, 65 % RH	Tested By	Karl Lee

Antenna Polarity & Test Distance: Horizontal at 3 m										
Frequency (MHz)	Emission Level (dBuV/m)	Read Level (dBuV)	Limit (dBuV/m)	Margin (dB)	Antenna Factor (dB/m)	Cable Loss (dB)	Preamp Factor (dB)	Antenna Height (cm)	Table Angle (Degree)	Remark
*5714	61.04	51.89	68.2	-7.16	34.61	8.65	34.11	239	347	Peak
*5722	60.88	51.72	78.2	-17.32	34.62	8.65	34.11	239	347	Peak
5775	84.35	75.12			34.68	8.67	34.12	239	347	Average
5775	92.42	83.19			34.68	8.67	34.12	239	347	Peak
*5854	58.92	49.6	78.2	-19.28	34.76	8.7	34.14	239	347	Peak
*5866	58.79	49.46	68.2	-9.41	34.76	8.71	34.14	239	347	Peak
Antenna Polarity & Test Distance: Vertical at 3 m										
Frequency (MHz)	Emission Level (dBuV/m)	Read Level (dBuV)	Limit (dBuV/m)	Margin (dB)	Antenna Factor (dB/m)	Cable Loss (dB)	Preamp Factor (dB)	Antenna Height (cm)	Table Angle (Degree)	Remark
*5712	62.27	53.12	68.2	-5.93	34.61	8.65	34.11	116	68	Peak
*5724	65.37	56.21	78.2	-12.83	34.62	8.65	34.11	116	68	Peak
5775	87.46	78.23			34.68	8.67	34.12	116	68	Average
5775	95.53	86.3			34.68	8.67	34.12	116	68	Peak
*5858	58.41	49.09	78.2	-19.79	34.76	8.7	34.14	116	68	Peak
*5862	57.68	48.35	68.2	-10.52	34.76	8.71	34.14	116	68	Peak

Remarks:

- Emission Level = Read Level + Antenna Factor + Cable Loss - Preamp Factor
Margin value = Emission level – Limit value
- 5775 MHz: Fundamental frequency.
- *: Out of restricted band

<2TX>

802.11n (HT20)

EUT Test Condition		Measurement Detail	
Channel	Channel 36	Frequency Range	1 GHz ~ 40 GHz
Input Power	120 Vac, 60 Hz	Detector Function	Peak (PK) Average (AV)
Environmental Conditions	25 deg. C, 65 % RH	Tested By	Karl Lee

Antenna Polarity & Test Distance: Horizontal at 3 m										
Frequency (MHz)	Emission Level (dBuV/m)	Read Level (dBuV)	Limit (dBuV/m)	Margin (dB)	Antenna Factor (dB/m)	Cable Loss (dB)	Preamp Factor (dB)	Antenna Height (cm)	Table Angle (Degree)	Remark
5150	46.9	38.65	54	-7.1	34.12	8.13	34	211	324	Average
5150	61.64	53.39	74	-12.36	34.12	8.13	34	211	324	Peak
5180	88.52	80.21			34.15	8.16	34	232	358	Average
5180	97.13	88.82			34.15	8.16	34	232	358	Peak
5398	42.9	34.18	54	-11.1	34.32	8.44	34.04	232	358	Average
5398	57.75	49.03	74	-16.25	34.32	8.44	34.04	232	358	Peak

Antenna Polarity & Test Distance: Vertical at 3 m										
Frequency (MHz)	Emission Level (dBuV/m)	Read Level (dBuV)	Limit (dBuV/m)	Margin (dB)	Antenna Factor (dB/m)	Cable Loss (dB)	Preamp Factor (dB)	Antenna Height (cm)	Table Angle (Degree)	Remark
5150	45.6	37.35	54	-8.4	34.12	8.13	34	221	34	Average
5150	60.99	52.74	74	-13.01	34.12	8.13	34	221	34	Peak
5180	92.88	84.57			34.15	8.16	34	221	34	Average
5180	100.6	92.29			34.15	8.16	34	221	34	Peak
5404	42.83	34.11	54	-11.17	34.32	8.44	34.04	221	34	Average
5404	57.36	48.64	74	-16.64	34.32	8.44	34.04	221	34	Peak

Remarks:

- Emission Level = Read Level + Antenna Factor + Cable Loss - Preamp Factor
Margin value = Emission level – Limit value
- 5180 MHz: Fundamental frequency.

EUT Test Condition		Measurement Detail	
Channel	Channel 44	Frequency Range	1 GHz ~ 40 GHz
Input Power	120 Vac, 60 Hz	Detector Function	Peak (PK) Average (AV)
Environmental Conditions	25 deg. C, 65 % RH	Tested By	Karl Lee

Antenna Polarity & Test Distance: Horizontal at 3 m										
Frequency (MHz)	Emission Level (dBuV/m)	Read Level (dBuV)	Limit (dBuV/m)	Margin (dB)	Antenna Factor (dB/m)	Cable Loss (dB)	Preamp Factor (dB)	Antenna Height (cm)	Table Angle (Degree)	Remark
5090	42.81	34.64	54	-11.19	34.08	8.07	33.98	233	321	Average
5090	57.66	49.49	74	-16.34	34.08	8.07	33.98	233	321	Peak
5220	89.8	81.41			34.17	8.22	34	233	321	Average
5220	97.49	89.1			34.17	8.22	34	233	321	Peak
5458	43.07	34.25	54	-10.93	34.36	8.51	34.05	233	321	Average
5458	57.36	48.54	74	-16.64	34.36	8.51	34.05	233	321	Peak
Antenna Polarity & Test Distance: Vertical at 3 m										
Frequency (MHz)	Emission Level (dBuV/m)	Read Level (dBuV)	Limit (dBuV/m)	Margin (dB)	Antenna Factor (dB/m)	Cable Loss (dB)	Preamp Factor (dB)	Antenna Height (cm)	Table Angle (Degree)	Remark
5060	42.8	34.7	54	-11.2	34.05	8.03	33.98	101	38	Average
5060	56.43	48.33	74	-17.57	34.05	8.03	33.98	101	38	Peak
5220	92	83.61			34.17	8.22	34	101	38	Average
5220	100.39	92			34.17	8.22	34	101	38	Peak
5434	42.94	34.15	54	-11.06	34.35	8.48	34.04	101	38	Average
5434	56.7	47.91	74	-17.3	34.35	8.48	34.04	101	38	Peak

Remarks:

- Emission Level = Read Level + Antenna Factor + Cable Loss - Preamp Factor
Margin value = Emission level – Limit value
- 5220 MHz: Fundamental frequency.

EUT Test Condition		Measurement Detail	
Channel	Channel 48	Frequency Range	1 GHz ~ 40 GHz
Input Power	120 Vac, 60 Hz	Detector Function	Peak (PK) Average (AV)
Environmental Conditions	25 deg. C, 65 % RH	Tested By	Karl Lee

Antenna Polarity & Test Distance: Horizontal at 3 m										
Frequency (MHz)	Emission Level (dBuV/m)	Read Level (dBuV)	Limit (dBuV/m)	Margin (dB)	Antenna Factor (dB/m)	Cable Loss (dB)	Preamp Factor (dB)	Antenna Height (cm)	Table Angle (Degree)	Remark
5022	43.1	35.07	54	-10.9	34.03	7.97	33.97	233	308	Average
5022	55.74	47.71	74	-18.26	34.03	7.97	33.97	233	308	Peak
5240	89.5	81.06			34.19	8.26	34.01	233	308	Average
5240	97.28	88.84			34.19	8.26	34.01	233	308	Peak
5378	43.22	34.54	54	-10.78	34.31	8.41	34.04	233	308	Average
5378	57.53	48.85	74	-16.47	34.31	8.41	34.04	233	308	Peak
Antenna Polarity & Test Distance: Vertical at 3 m										
Frequency (MHz)	Emission Level (dBuV/m)	Read Level (dBuV)	Limit (dBuV/m)	Margin (dB)	Antenna Factor (dB/m)	Cable Loss (dB)	Preamp Factor (dB)	Antenna Height (cm)	Table Angle (Degree)	Remark
5090	42.75	34.58	54	-11.25	34.08	8.07	33.98	100	38	Average
5090	56.75	48.58	74	-17.25	34.08	8.07	33.98	100	38	Peak
5240	92.04	83.6			34.19	8.26	34.01	100	38	Average
5240	100.6	92.16			34.19	8.26	34.01	100	38	Peak
5448	42.97	34.14	54	-11.03	34.36	8.51	34.04	100	38	Average
5448	58.02	49.19	74	-15.98	34.36	8.51	34.04	100	38	Peak

Remarks:

- Emission Level = Read Level + Antenna Factor + Cable Loss - Preamp Factor
Margin value = Emission level – Limit value
- 5240 MHz: Fundamental frequency.

EUT Test Condition		Measurement Detail	
Channel	Channel 52	Frequency Range	1 GHz ~ 40 GHz
Input Power	120 Vac, 60 Hz	Detector Function	Peak (PK) Average (AV)
Environmental Conditions	25 deg. C, 65 % RH	Tested By	Karl Lee

Antenna Polarity & Test Distance: Horizontal at 3 m										
Frequency (MHz)	Emission Level (dBuV/m)	Read Level (dBuV)	Limit (dBuV/m)	Margin (dB)	Antenna Factor (dB/m)	Cable Loss (dB)	Preamp Factor (dB)	Antenna Height (cm)	Table Angle (Degree)	Remark
5050	42.22	34.16	54	-11.78	34.04	8	33.98	245	301	Average
5050	57.71	49.65	74	-16.29	34.04	8	33.98	245	301	Peak
5260	90.5	82.04			34.21	8.26	34.01	245	301	Average
5260	98.29	89.83			34.21	8.26	34.01	245	301	Peak
5382	42.59	33.91	54	-11.41	34.31	8.41	34.04	245	301	Average
5382	57.68	49	74	-16.32	34.31	8.41	34.04	245	301	Peak
Antenna Polarity & Test Distance: Vertical at 3 m										
Frequency (MHz)	Emission Level (dBuV/m)	Read Level (dBuV)	Limit (dBuV/m)	Margin (dB)	Antenna Factor (dB/m)	Cable Loss (dB)	Preamp Factor (dB)	Antenna Height (cm)	Table Angle (Degree)	Remark
5096	42.32	34.16	54	-11.68	34.08	8.07	33.99	107	8	Average
5096	56.85	48.69	74	-17.15	34.08	8.07	33.99	107	8	Peak
5260	92.51	84.05			34.21	8.26	34.01	107	8	Average
5260	100.82	92.36			34.21	8.26	34.01	107	8	Peak
5442	42.57	33.78	54	-11.43	34.35	8.48	34.04	107	8	Average
5442	57.99	49.2	74	-16.01	34.35	8.48	34.04	107	8	Peak

Remarks:

- Emission Level = Read Level + Antenna Factor + Cable Loss - Preamp Factor
Margin value = Emission level – Limit value
- 5260 MHz: Fundamental frequency.

EUT Test Condition		Measurement Detail	
Channel	Channel 60	Frequency Range	1 GHz ~ 40 GHz
Input Power	120 Vac, 60 Hz	Detector Function	Peak (PK) Average (AV)
Environmental Conditions	25 deg. C, 65 % RH	Tested By	Karl Lee

Antenna Polarity & Test Distance: Horizontal at 3 m										
Frequency (MHz)	Emission Level (dBuV/m)	Read Level (dBuV)	Limit (dBuV/m)	Margin (dB)	Antenna Factor (dB/m)	Cable Loss (dB)	Preamp Factor (dB)	Antenna Height (cm)	Table Angle (Degree)	Remark
5130	42.12	33.9	54	-11.88	34.11	8.1	33.99	245	301	Average
5130	57.41	49.19	74	-16.59	34.11	8.1	33.99	245	301	Peak
5300	91.66	83.12			34.24	8.32	34.02	245	301	Average
5300	98.09	89.55			34.24	8.32	34.02	245	301	Peak
5370	43.11	34.44	54	-10.89	34.29	8.41	34.03	245	301	Average
5370	57.3	48.63	74	-16.7	34.29	8.41	34.03	245	301	Peak
Antenna Polarity & Test Distance: Vertical at 3 m										
Frequency (MHz)	Emission Level (dBuV/m)	Read Level (dBuV)	Limit (dBuV/m)	Margin (dB)	Antenna Factor (dB/m)	Cable Loss (dB)	Preamp Factor (dB)	Antenna Height (cm)	Table Angle (Degree)	Remark
5100	42.36	34.2	54	-11.64	34.08	8.07	33.99	113	20	Average
5100	57.34	49.18	74	-16.66	34.08	8.07	33.99	113	20	Peak
5300	93.36	84.82			34.24	8.32	34.02	113	20	Average
5300	100.16	91.62			34.24	8.32	34.02	113	20	Peak
5442	43.96	35.17	54	-10.04	34.35	8.48	34.04	113	20	Average
5442	58.77	49.98	74	-15.23	34.35	8.48	34.04	113	20	Peak

Remarks:

- Emission Level = Read Level + Antenna Factor + Cable Loss - Preamp Factor
Margin value = Emission level – Limit value
- 5300 MHz: Fundamental frequency.

EUT Test Condition		Measurement Detail	
Channel	Channel 64	Frequency Range	1 GHz ~ 40 GHz
Input Power	120 Vac, 60 Hz	Detector Function	Peak (PK) Average (AV)
Environmental Conditions	25 deg. C, 65 % RH	Tested By	Karl Lee

Antenna Polarity & Test Distance: Horizontal at 3 m										
Frequency (MHz)	Emission Level (dBuV/m)	Read Level (dBuV)	Limit (dBuV/m)	Margin (dB)	Antenna Factor (dB/m)	Cable Loss (dB)	Preamp Factor (dB)	Antenna Height (cm)	Table Angle (Degree)	Remark
5074	42.6	34.48	54	-11.4	34.07	8.03	33.98	210	318	Average
5074	56.7	48.58	74	-17.3	34.07	8.03	33.98	210	318	Peak
5320	90.3	81.72			34.25	8.35	34.02	210	318	Average
5320	98.13	89.55			34.25	8.35	34.02	210	318	Peak
5350	45.66	37.03	54	-8.34	34.28	8.38	34.03	205	318	Average
5350	61.32	52.69	74	-12.68	34.28	8.38	34.03	205	318	Peak

Antenna Polarity & Test Distance: Vertical at 3 m										
Frequency (MHz)	Emission Level (dBuV/m)	Read Level (dBuV)	Limit (dBuV/m)	Margin (dB)	Antenna Factor (dB/m)	Cable Loss (dB)	Preamp Factor (dB)	Antenna Height (cm)	Table Angle (Degree)	Remark
5128	42.2	33.98	54	-11.8	34.11	8.1	33.99	100	34	Average
5128	58.19	49.97	74	-15.81	34.11	8.1	33.99	100	34	Peak
5320	92.1	83.52			34.25	8.35	34.02	100	34	Average
5320	100.2	91.62			34.25	8.35	34.02	100	34	Peak
5350	46.66	38.03	54	-7.34	34.28	8.38	34.03	100	34	Average
5350	59.02	50.39	74	-14.98	34.28	8.38	34.03	100	34	Peak

Remarks:

- Emission Level = Read Level + Antenna Factor + Cable Loss - Preamp Factor
Margin value = Emission level – Limit value
- 5320 MHz: Fundamental frequency.

EUT Test Condition		Measurement Detail	
Channel	Channel 100	Frequency Range	1 GHz ~ 40 GHz
Input Power	120 Vac, 60 Hz	Detector Function	Peak (PK) Average (AV)
Environmental Conditions	25 deg. C, 65 % RH	Tested By	Karl Lee

Antenna Polarity & Test Distance: Horizontal at 3 m										
Frequency (MHz)	Emission Level (dBuV/m)	Read Level (dBuV)	Limit (dBuV/m)	Margin (dB)	Antenna Factor (dB/m)	Cable Loss (dB)	Preamp Factor (dB)	Antenna Height (cm)	Table Angle (Degree)	Remark
5454	43.97	35.15	54	-10.03	34.36	8.51	34.05	195	296	Average
5454	58.35	49.53	74	-15.65	34.36	8.51	34.05	195	296	Peak
5470	66.9	58.07	68.2	-1.3	34.37	8.51	34.05	195	295	Peak
5500	89.27	80.35			34.4	8.57	34.05	195	296	Average
5500	97.44	88.52			34.4	8.57	34.05	195	296	Peak
5725	56.74	47.58	68.2	-11.46	34.62	8.65	34.11	195	296	Peak
Antenna Polarity & Test Distance: Vertical at 3 m										
Frequency (MHz)	Emission Level (dBuV/m)	Read Level (dBuV)	Limit (dBuV/m)	Margin (dB)	Antenna Factor (dB/m)	Cable Loss (dB)	Preamp Factor (dB)	Antenna Height (cm)	Table Angle (Degree)	Remark
5426	43.81	35.04	54	-10.19	34.33	8.48	34.04	147	353	Average
5426	57.71	48.94	74	-16.29	34.33	8.48	34.04	147	353	Peak
5470	64.43	55.6	68.2	-3.77	34.37	8.51	34.05	147	353	Peak
5500	90.17	81.25			34.4	8.57	34.05	147	353	Average
5500	98.46	89.54			34.4	8.57	34.05	147	353	Peak
5725	54.97	45.81	68.2	-13.23	34.62	8.65	34.11	147	353	Peak

Remarks:

- Emission Level = Read Level + Antenna Factor + Cable Loss - Preamp Factor
Margin value = Emission level – Limit value
- 5500 MHz: Fundamental frequency.
- 5470 MHz & 5725 MHz: Out of restricted band

EUT Test Condition		Measurement Detail	
Channel	Channel 116	Frequency Range	1 GHz ~ 40 GHz
Input Power	120 Vac, 60 Hz	Detector Function	Peak (PK) Average (AV)
Environmental Conditions	25 deg. C, 65 % RH	Tested By	Karl Lee

Antenna Polarity & Test Distance: Horizontal at 3 m										
Frequency (MHz)	Emission Level (dBuV/m)	Read Level (dBuV)	Limit (dBuV/m)	Margin (dB)	Antenna Factor (dB/m)	Cable Loss (dB)	Preamp Factor (dB)	Antenna Height (cm)	Table Angle (Degree)	Remark
5432	42.71	33.92	54	-11.29	34.35	8.48	34.04	230	300	Average
5432	57.77	48.98	74	-16.23	34.35	8.48	34.04	230	300	Peak
5470	55.63	46.8	68.2	-12.57	34.37	8.51	34.05	230	300	Peak
5580	88.71	79.72			34.47	8.6	34.08	230	300	Average
5580	97	88.01			34.47	8.6	34.08	230	300	Peak
5725	55.65	46.49	68.2	-12.55	34.62	8.65	34.11	230	300	Peak
Antenna Polarity & Test Distance: Vertical at 3 m										
Frequency (MHz)	Emission Level (dBuV/m)	Read Level (dBuV)	Limit (dBuV/m)	Margin (dB)	Antenna Factor (dB/m)	Cable Loss (dB)	Preamp Factor (dB)	Antenna Height (cm)	Table Angle (Degree)	Remark
5428	42.51	33.74	54	-11.49	34.33	8.48	34.04	120	33	Average
5428	57.41	48.64	74	-16.59	34.33	8.48	34.04	120	33	Peak
5470	56.16	47.33	68.2	-12.04	34.37	8.51	34.05	120	33	Peak
5580	90.37	81.38			34.47	8.6	34.08	120	33	Average
5580	98.69	89.7			34.47	8.6	34.08	120	33	Peak
5725	56.25	47.09	68.2	-11.95	34.62	8.65	34.11	120	33	Peak

Remarks:

- Emission Level = Read Level + Antenna Factor + Cable Loss - Preamp Factor
Margin value = Emission level – Limit value
- 5580 MHz: Fundamental frequency.
- 5470 MHz & 5725 MHz: Out of restricted band

EUT Test Condition		Measurement Detail	
Channel	Channel 140	Frequency Range	1 GHz ~ 40 GHz
Input Power	120 Vac, 60 Hz	Detector Function	Peak (PK) Average (AV)
Environmental Conditions	25 deg. C, 65 % RH	Tested By	Karl Lee

Antenna Polarity & Test Distance: Horizontal at 3 m										
Frequency (MHz)	Emission Level (dBuV/m)	Read Level (dBuV)	Limit (dBuV/m)	Margin (dB)	Antenna Factor (dB/m)	Cable Loss (dB)	Preamp Factor (dB)	Antenna Height (cm)	Table Angle (Degree)	Remark
5418	42.59	33.86	54	-11.41	34.33	8.44	34.04	230	302	Average
5418	57.25	48.52	74	-16.75	34.33	8.44	34.04	230	302	Peak
5470	56.27	47.44	68.2	-11.93	34.37	8.51	34.05	230	302	Peak
5700	89.34	80.21			34.59	8.64	34.1	230	302	Average
5700	97.76	88.63			34.59	8.64	34.1	230	302	Peak
5725	56.96	47.8	68.2	-11.24	34.62	8.65	34.11	230	302	Peak
Antenna Polarity & Test Distance: Vertical at 3 m										
Frequency (MHz)	Emission Level (dBuV/m)	Read Level (dBuV)	Limit (dBuV/m)	Margin (dB)	Antenna Factor (dB/m)	Cable Loss (dB)	Preamp Factor (dB)	Antenna Height (cm)	Table Angle (Degree)	Remark
5450	42.69	33.87	54	-11.31	34.36	8.51	34.05	118	34	Average
5450	57.33	48.51	74	-16.67	34.36	8.51	34.05	118	34	Peak
5470	57.41	48.58	68.2	-10.79	34.37	8.51	34.05	118	34	Peak
5700	90.19	81.06			34.59	8.64	34.1	118	34	Average
5700	98.1	88.97			34.59	8.64	34.1	118	34	Peak
5725	57.79	48.63	68.2	-10.41	34.62	8.65	34.11	118	34	Peak

Remarks:

- Emission Level = Read Level + Antenna Factor + Cable Loss - Preamp Factor
Margin value = Emission level – Limit value
- 5700 MHz: Fundamental frequency.
- 5470 MHz & 5725 MHz: Out of restricted band



EUT Test Condition		Measurement Detail	
Channel	Channel 149	Frequency Range	1 GHz ~ 40 GHz
Input Power	120 Vac, 60 Hz	Detector Function	Peak (PK) Average (AV)
Environmental Conditions	25 deg. C, 65 % RH	Tested By	Karl Lee

Antenna Polarity & Test Distance: Horizontal at 3 m										
Frequency (MHz)	Emission Level (dBuV/m)	Read Level (dBuV)	Limit (dBuV/m)	Margin (dB)	Antenna Factor (dB/m)	Cable Loss (dB)	Preamp Factor (dB)	Antenna Height (cm)	Table Angle (Degree)	Remark
*5708	57.4	48.25	68.2	-10.8	34.61	8.65	34.11	107	16	Peak
*5724	66.41	57.25	78.2	-11.79	34.62	8.65	34.11	107	16	Peak
5745	85.9	76.71			34.64	8.66	34.11	107	17	Average
5745	92.86	83.67			34.64	8.66	34.11	107	17	Peak
*5854	56.35	47.03	78.2	-21.85	34.76	8.7	34.14	107	17	Peak
*5868	57.53	48.2	68.2	-10.67	34.76	8.71	34.14	107	17	Peak
Antenna Polarity & Test Distance: Vertical at 3 m										
Frequency (MHz)	Emission Level (dBuV/m)	Read Level (dBuV)	Limit (dBuV/m)	Margin (dB)	Antenna Factor (dB/m)	Cable Loss (dB)	Preamp Factor (dB)	Antenna Height (cm)	Table Angle (Degree)	Remark
*5706	63.21	54.06	68.2	-4.99	34.61	8.65	34.11	110	58	Peak
*5724	68.69	59.53	78.2	-9.51	34.62	8.65	34.11	110	58	Peak
5745	88.3	79.11			34.64	8.66	34.11	124	356	Average
5745	95.49	86.3			34.64	8.66	34.11	124	356	Peak
*5852	58.89	49.59	78.2	-19.31	34.74	8.7	34.14	124	356	Peak
*5868	57.22	47.89	68.2	-10.98	34.76	8.71	34.14	124	356	Peak

Remarks:

- Emission Level = Read Level + Antenna Factor + Cable Loss - Preamp Factor
Margin value = Emission level – Limit value
- 5745 MHz: Fundamental frequency.
- *: Out of restricted band



A D T

EUT Test Condition		Measurement Detail	
Channel	Channel 157	Frequency Range	1 GHz ~ 40 GHz
Input Power	120 Vac, 60 Hz	Detector Function	Peak (PK) Average (AV)
Environmental Conditions	25 deg. C, 65 % RH	Tested By	Karl Lee

Antenna Polarity & Test Distance: Horizontal at 3 m										
Frequency (MHz)	Emission Level (dBuV/m)	Read Level (dBuV)	Limit (dBuV/m)	Margin (dB)	Antenna Factor (dB/m)	Cable Loss (dB)	Preamp Factor (dB)	Antenna Height (cm)	Table Angle (Degree)	Remark
*5714	56.43	47.28	68.2	-11.77	34.61	8.65	34.11	100	40	Peak
*5722	59.38	50.22	78.2	-18.82	34.62	8.65	34.11	100	40	Peak
5785	84.65	75.42			34.68	8.68	34.13	100	40	Average
5785	92.73	83.5			34.68	8.68	34.13	100	40	Peak
*5860	57.22	47.9	78.2	-20.98	34.76	8.7	34.14	100	40	Peak
*5866	56.82	47.49	68.2	-11.38	34.76	8.71	34.14	100	40	Peak

Antenna Polarity & Test Distance: Vertical at 3 m										
Frequency (MHz)	Emission Level (dBuV/m)	Read Level (dBuV)	Limit (dBuV/m)	Margin (dB)	Antenna Factor (dB/m)	Cable Loss (dB)	Preamp Factor (dB)	Antenna Height (cm)	Table Angle (Degree)	Remark
*5706	56.96	47.81	68.2	-11.24	34.61	8.65	34.11	111	360	Peak
*5720	57.1	47.94	78.2	-21.1	34.62	8.65	34.11	111	360	Peak
5785	87.59	78.36			34.68	8.68	34.13	111	360	Average
5785	95.76	86.53			34.68	8.68	34.13	111	360	Peak
*5856	56.41	47.09	78.2	-21.79	34.76	8.7	34.14	111	360	Peak
*5866	56.29	46.96	68.2	-11.91	34.76	8.71	34.14	111	360	Peak

Remarks:

- Emission Level = Read Level + Antenna Factor + Cable Loss - Preamp Factor
Margin value = Emission level – Limit value
- 5785 MHz: Fundamental frequency.
- *: Out of restricted band

EUT Test Condition		Measurement Detail	
Channel	Channel 165	Frequency Range	1 GHz ~ 40 GHz
Input Power	120 Vac, 60 Hz	Detector Function	Peak (PK) Average (AV)
Environmental Conditions	25 deg. C, 65 % RH	Tested By	Karl Lee

Antenna Polarity & Test Distance: Horizontal at 3 m										
Frequency (MHz)	Emission Level (dBuV/m)	Read Level (dBuV)	Limit (dBuV/m)	Margin (dB)	Antenna Factor (dB/m)	Cable Loss (dB)	Preamp Factor (dB)	Antenna Height (cm)	Table Angle (Degree)	Remark
*5714	56.85	47.7	68.2	-11.35	34.61	8.65	34.11	100	40	Peak
*5716	56.84	47.69	78.2	-21.36	34.61	8.65	34.11	100	40	Peak
5825	84.22	74.93			34.73	8.69	34.13	100	40	Average
5825	92.83	83.54			34.73	8.69	34.13	100	40	Peak
*5854	56.84	47.52	78.2	-21.36	34.76	8.7	34.14	100	40	Peak
*5870	57.56	48.23	68.2	-10.64	34.76	8.71	34.14	100	40	Peak
Antenna Polarity & Test Distance: Vertical at 3 m										
Frequency (MHz)	Emission Level (dBuV/m)	Read Level (dBuV)	Limit (dBuV/m)	Margin (dB)	Antenna Factor (dB/m)	Cable Loss (dB)	Preamp Factor (dB)	Antenna Height (cm)	Table Angle (Degree)	Remark
*5714	55.8	46.65	68.2	-12.4	34.61	8.65	34.11	103	360	Peak
*5720	57.35	48.19	78.2	-20.85	34.62	8.65	34.11	103	360	Peak
5825	87.72	78.43			34.73	8.69	34.13	103	360	Average
5825	95.92	86.63			34.73	8.69	34.13	103	360	Peak
*5856	57.83	48.51	78.2	-20.37	34.76	8.7	34.14	103	360	Peak
*5866	56.31	46.98	68.2	-11.89	34.76	8.71	34.14	103	360	Peak

Remarks:

- Emission Level = Read Level + Antenna Factor + Cable Loss - Preamp Factor
Margin value = Emission level – Limit value
- 5825 MHz: Fundamental frequency.
- *: Out of restricted band

802.11n (HT40)

EUT Test Condition		Measurement Detail	
Channel	Channel 38	Frequency Range	1 GHz ~ 40 GHz
Input Power	120 Vac, 60 Hz	Detector Function	Peak (PK) Average (AV)
Environmental Conditions	25 deg. C, 65 % RH	Tested By	Karl Lee

Antenna Polarity & Test Distance: Horizontal at 3 m

Frequency (MHz)	Emission Level (dBuV/m)	Read Level (dBuV)	Limit (dBuV/m)	Margin (dB)	Antenna Factor (dB/m)	Cable Loss (dB)	Preamp Factor (dB)	Antenna Height (cm)	Table Angle (Degree)	Remark
5148	50.34	42.09	54	-3.66	34.12	8.13	34	177	341	Average
5148	60.08	51.83	74	-13.92	34.12	8.13	34	177	341	Peak
5190	86.46	78.12			34.15	8.19	34	180	345	Average
5190	94.29	85.95			34.15	8.19	34	180	345	Peak
5372	43.76	35.09	54	-10.24	34.29	8.41	34.03	180	345	Average
5372	57.95	49.28	74	-16.05	34.29	8.41	34.03	180	345	Peak

Antenna Polarity & Test Distance: Vertical at 3 m

Frequency (MHz)	Emission Level (dBuV/m)	Read Level (dBuV)	Limit (dBuV/m)	Margin (dB)	Antenna Factor (dB/m)	Cable Loss (dB)	Preamp Factor (dB)	Antenna Height (cm)	Table Angle (Degree)	Remark
5149	52.55	44.3	54	-1.45	34.12	8.13	34	172	28	Average
5149	53.18	44.93	74	-20.82	34.12	8.13	34	172	28	Peak
5190	89.45	81.11			34.15	8.19	34	114	31	Average
5190	97.25	88.91			34.15	8.19	34	114	31	Peak
5340	42.78	34.19	54	-11.22	34.27	8.35	34.03	114	31	Average
5340	57.47	48.88	74	-16.53	34.27	8.35	34.03	114	31	Peak

Remarks:

- Emission Level = Read Level + Antenna Factor + Cable Loss - Preamp Factor
Margin value = Emission level – Limit value
- 5190 MHz: Fundamental frequency.



EUT Test Condition		Measurement Detail	
Channel	Channel 46	Frequency Range	1 GHz ~ 40 GHz
Input Power	120 Vac, 60 Hz	Detector Function	Peak (PK) Average (AV)
Environmental Conditions	25 deg. C, 65 % RH	Tested By	Karl Lee

Antenna Polarity & Test Distance: Horizontal at 3 m										
Frequency (MHz)	Emission Level (dBuV/m)	Read Level (dBuV)	Limit (dBuV/m)	Margin (dB)	Antenna Factor (dB/m)	Cable Loss (dB)	Preamp Factor (dB)	Antenna Height (cm)	Table Angle (Degree)	Remark
5106	43.36	35.19	54	-10.64	34.09	8.07	33.99	231	308	Average
5106	57.24	49.07	74	-16.76	34.09	8.07	33.99	231	308	Peak
5230	87.11	78.71			34.19	8.22	34.01	231	308	Average
5230	94.74	86.34			34.19	8.22	34.01	231	308	Peak
5434	43.12	34.33	54	-10.88	34.35	8.48	34.04	231	308	Average
5434	56.99	48.2	74	-17.01	34.35	8.48	34.04	231	308	Peak
Antenna Polarity & Test Distance: Vertical at 3 m										
Frequency (MHz)	Emission Level (dBuV/m)	Read Level (dBuV)	Limit (dBuV/m)	Margin (dB)	Antenna Factor (dB/m)	Cable Loss (dB)	Preamp Factor (dB)	Antenna Height (cm)	Table Angle (Degree)	Remark
5020	43.68	35.67	54	-10.32	34.01	7.97	33.97	100	38	Average
5020	55.99	47.98	74	-18.01	34.01	7.97	33.97	100	38	Peak
5230	90.71	82.31			34.19	8.22	34.01	100	38	Average
5230	97.21	88.81			34.19	8.22	34.01	100	38	Peak
5454	43.47	34.65	54	-10.53	34.36	8.51	34.05	100	38	Average
5454	57.32	48.5	74	-16.68	34.36	8.51	34.05	100	38	Peak

Remarks:

- Emission Level = Read Level + Antenna Factor + Cable Loss - Preamp Factor
Margin value = Emission level – Limit value
- 5230 MHz: Fundamental frequency.

EUT Test Condition		Measurement Detail	
Channel	Channel 54	Frequency Range	1 GHz ~ 40 GHz
Input Power	120 Vac, 60 Hz	Detector Function	Peak (PK) Average (AV)
Environmental Conditions	25 deg. C, 65 % RH	Tested By	Karl Lee

Antenna Polarity & Test Distance: Horizontal at 3 m										
Frequency (MHz)	Emission Level (dBuV/m)	Read Level (dBuV)	Limit (dBuV/m)	Margin (dB)	Antenna Factor (dB/m)	Cable Loss (dB)	Preamp Factor (dB)	Antenna Height (cm)	Table Angle (Degree)	Remark
5124	42.76	34.54	54	-11.24	34.11	8.1	33.99	245	301	Average
5124	57.05	48.83	74	-16.95	34.11	8.1	33.99	245	301	Peak
5270	87.88	79.39			34.21	8.29	34.01	245	301	Average
5270	95.3	86.81			34.21	8.29	34.01	245	301	Peak
5364	43.26	34.62	54	-10.74	34.29	8.38	34.03	245	301	Average
5364	58.01	49.37	74	-15.99	34.29	8.38	34.03	245	301	Peak

Antenna Polarity & Test Distance: Vertical at 3 m										
Frequency (MHz)	Emission Level (dBuV/m)	Read Level (dBuV)	Limit (dBuV/m)	Margin (dB)	Antenna Factor (dB/m)	Cable Loss (dB)	Preamp Factor (dB)	Antenna Height (cm)	Table Angle (Degree)	Remark
5108	42.86	34.66	54	-11.14	34.09	8.1	33.99	107	8	Average
5108	56.93	48.73	74	-17.07	34.09	8.1	33.99	107	8	Peak
5270	89.84	81.35			34.21	8.29	34.01	107	8	Average
5270	97.29	88.8			34.21	8.29	34.01	107	8	Peak
5430	43.28	34.49	54	-10.72	34.35	8.48	34.04	107	8	Average
5430	58.24	49.45	74	-15.76	34.35	8.48	34.04	107	8	Peak

Remarks:

- Emission Level = Read Level + Antenna Factor + Cable Loss - Preamp Factor
Margin value = Emission level – Limit value
- 5270 MHz: Fundamental frequency.

EUT Test Condition		Measurement Detail	
Channel	Channel 62	Frequency Range	1 GHz ~ 40 GHz
Input Power	120 Vac, 60 Hz	Detector Function	Peak (PK) Average (AV)
Environmental Conditions	25 deg. C, 65 % RH	Tested By	Karl Lee

Antenna Polarity & Test Distance: Horizontal at 3 m										
Frequency (MHz)	Emission Level (dBuV/m)	Read Level (dBuV)	Limit (dBuV/m)	Margin (dB)	Antenna Factor (dB/m)	Cable Loss (dB)	Preamp Factor (dB)	Antenna Height (cm)	Table Angle (Degree)	Remark
5084	42.73	34.57	54	-11.27	34.07	8.07	33.98	210	318	Average
5084	56.99	48.83	74	-17.01	34.07	8.07	33.98	210	318	Peak
5310	87.57	79.02			34.25	8.32	34.02	210	318	Average
5310	95.44	86.89			34.25	8.32	34.02	210	318	Peak
5350	47.66	39.03	54	-6.34	34.28	8.38	34.03	232	318	Average
5350	62.54	53.91	74	-11.46	34.28	8.38	34.03	232	318	Peak

Antenna Polarity & Test Distance: Vertical at 3 m										
Frequency (MHz)	Emission Level (dBuV/m)	Read Level (dBuV)	Limit (dBuV/m)	Margin (dB)	Antenna Factor (dB/m)	Cable Loss (dB)	Preamp Factor (dB)	Antenna Height (cm)	Table Angle (Degree)	Remark
5106	42.71	34.54	54	-11.29	34.09	8.07	33.99	107	34	Average
5106	57.05	48.88	74	-16.95	34.09	8.07	33.99	107	34	Peak
5310	84.67	76.12			34.25	8.32	34.02	107	34	Average
5310	97.12	88.57			34.25	8.32	34.02	107	34	Peak
5350	48.76	40.13	54	-5.24	34.28	8.38	34.03	107	34	Average
5350	62.47	53.84	74	-11.53	34.28	8.38	34.03	107	34	Peak

Remarks:

- Emission Level = Read Level + Antenna Factor + Cable Loss - Preamp Factor
Margin value = Emission level – Limit value
- 5310 MHz: Fundamental frequency.



A D T

EUT Test Condition		Measurement Detail	
Channel	Channel 102	Frequency Range	1 GHz ~ 40 GHz
Input Power	120 Vac, 60 Hz	Detector Function	Peak (PK) Average (AV)
Environmental Conditions	25 deg. C, 65 % RH	Tested By	Karl Lee

Antenna Polarity & Test Distance: Horizontal at 3 m										
Frequency (MHz)	Emission Level (dBuV/m)	Read Level (dBuV)	Limit (dBuV/m)	Margin (dB)	Antenna Factor (dB/m)	Cable Loss (dB)	Preamp Factor (dB)	Antenna Height (cm)	Table Angle (Degree)	Remark
5450	43.41	34.59	54	-10.59	34.36	8.51	34.05	100	360	Average
5450	57.14	48.32	74	-16.86	34.36	8.51	34.05	100	360	Peak
5470	57.39	48.56	68.2	-10.81	34.37	8.51	34.05	101	354	Peak
5510	87.11	78.2			34.4	8.57	34.06	100	360	Average
5510	95.26	86.35			34.4	8.57	34.06	100	360	Peak
5725	56.19	47.03	68.2	-12.01	34.62	8.65	34.11	100	360	Peak

Antenna Polarity & Test Distance: Vertical at 3 m										
Frequency (MHz)	Emission Level (dBuV/m)	Read Level (dBuV)	Limit (dBuV/m)	Margin (dB)	Antenna Factor (dB/m)	Cable Loss (dB)	Preamp Factor (dB)	Antenna Height (cm)	Table Angle (Degree)	Remark
5460	44.27	35.45	54	-9.73	34.36	8.51	34.05	135	20	Average
5460	60.46	51.64	74	-13.54	34.36	8.51	34.05	135	20	Peak
5470	66.17	57.34	68.2	-2.03	34.37	8.51	34.05	135	20	Peak
5510	88.66	79.75			34.4	8.57	34.06	102	20	Average
5510	96.33	87.42			34.4	8.57	34.06	102	20	Peak
5725	57	47.84	68.2	-11.2	34.62	8.65	34.11	102	20	Peak

Remarks:

1. Emission Level = Read Level + Antenna Factor + Cable Loss - Preamp Factor
Margin value = Emission level – Limit value
2. 5510 MHz: Fundamental frequency.
3. 5470 MHz & 5725 MHz: Out of restricted band



EUT Test Condition		Measurement Detail	
Channel	Channel 110	Frequency Range	1 GHz ~ 40 GHz
Input Power	120 Vac, 60 Hz	Detector Function	Peak (PK) Average (AV)
Environmental Conditions	25 deg. C, 65 % RH	Tested By	Karl Lee

Antenna Polarity & Test Distance: Horizontal at 3 m										
Frequency (MHz)	Emission Level (dBuV/m)	Read Level (dBuV)	Limit (dBuV/m)	Margin (dB)	Antenna Factor (dB/m)	Cable Loss (dB)	Preamp Factor (dB)	Antenna Height (cm)	Table Angle (Degree)	Remark
5460	44.01	35.19	54	-9.99	34.36	8.51	34.05	230	300	Average
5460	57.8	48.98	74	-16.2	34.36	8.51	34.05	230	300	Peak
5470	56.5	47.67	68.2	-11.7	34.37	8.51	34.05	230	300	Peak
5550	86.85	77.88			34.45	8.59	34.07	230	300	Average
5550	95.25	86.28			34.45	8.59	34.07	230	300	Peak
5725	56.86	47.7	68.2	-11.34	34.62	8.65	34.11	230	300	Peak
Antenna Polarity & Test Distance: Vertical at 3 m										
Frequency (MHz)	Emission Level (dBuV/m)	Read Level (dBuV)	Limit (dBuV/m)	Margin (dB)	Antenna Factor (dB/m)	Cable Loss (dB)	Preamp Factor (dB)	Antenna Height (cm)	Table Angle (Degree)	Remark
5458	45.65	36.83	54	-8.35	34.36	8.51	34.05	120	33	Average
5458	57.53	48.71	74	-16.47	34.36	8.51	34.05	120	33	Peak
5470	57.39	48.56	68.2	-10.81	34.37	8.51	34.05	120	33	Peak
5550	88.37	79.4			34.45	8.59	34.07	120	33	Average
5550	96.27	87.3			34.45	8.59	34.07	120	33	Peak
5725	57.66	48.5	68.2	-10.54	34.62	8.65	34.11	120	33	Peak

Remarks:

- Emission Level = Read Level + Antenna Factor + Cable Loss - Preamp Factor
Margin value = Emission level – Limit value
- 5550 MHz: Fundamental frequency.
- 5470 MHz & 5725 MHz: Out of restricted band

EUT Test Condition		Measurement Detail	
Channel	Channel 134	Frequency Range	1 GHz ~ 40 GHz
Input Power	120 Vac, 60 Hz	Detector Function	Peak (PK) Average (AV)
Environmental Conditions	25 deg. C, 65 % RH	Tested By	Karl Lee

Antenna Polarity & Test Distance: Horizontal at 3 m										
Frequency (MHz)	Emission Level (dBuV/m)	Read Level (dBuV)	Limit (dBuV/m)	Margin (dB)	Antenna Factor (dB/m)	Cable Loss (dB)	Preamp Factor (dB)	Antenna Height (cm)	Table Angle (Degree)	Remark
5428	43.12	34.35	54	-10.88	34.33	8.48	34.04	230	302	Average
5428	56.86	48.09	74	-17.14	34.33	8.48	34.04	230	302	Peak
5470	55.73	46.9	68.2	-12.47	34.37	8.51	34.05	230	302	Peak
5670	86.17	77.07			34.57	8.63	34.1	230	302	Average
5670	94.07	84.97			34.57	8.63	34.1	230	302	Peak
5725	57.13	47.97	68.2	-11.07	34.62	8.65	34.11	230	302	Peak
Antenna Polarity & Test Distance: Vertical at 3 m										
Frequency (MHz)	Emission Level (dBuV/m)	Read Level (dBuV)	Limit (dBuV/m)	Margin (dB)	Antenna Factor (dB/m)	Cable Loss (dB)	Preamp Factor (dB)	Antenna Height (cm)	Table Angle (Degree)	Remark
5356	42.84	34.21	54	-11.16	34.28	8.38	34.03	118	37	Average
5356	58.17	49.54	74	-15.83	34.28	8.38	34.03	118	37	Peak
5470	56.41	47.58	68.2	-11.79	34.37	8.51	34.05	118	37	Peak
5670	87.93	78.83			34.57	8.63	34.1	118	37	Average
5670	95.75	86.65			34.57	8.63	34.1	118	37	Peak
5725	58.59	49.43	68.2	-9.61	34.62	8.65	34.11	118	37	Peak

Remarks:

- Emission Level = Read Level + Antenna Factor + Cable Loss - Preamp Factor
Margin value = Emission level – Limit value
- 5670 MHz: Fundamental frequency.
- 5470 MHz & 5725 MHz: Out of restricted band



A D T

EUT Test Condition		Measurement Detail	
Channel	Channel 151	Frequency Range	1 GHz ~ 40 GHz
Input Power	120 Vac, 60 Hz	Detector Function	Peak (PK) Average (AV)
Environmental Conditions	25 deg. C, 65 % RH	Tested By	Karl Lee

Antenna Polarity & Test Distance: Horizontal at 3 m										
Frequency (MHz)	Emission Level (dBuV/m)	Read Level (dBuV)	Limit (dBuV/m)	Margin (dB)	Antenna Factor (dB/m)	Cable Loss (dB)	Preamp Factor (dB)	Antenna Height (cm)	Table Angle (Degree)	Remark
*5714	63.68	54.53	68.2	-4.52	34.61	8.65	34.11	107	18	Peak
*5722	66	56.84	78.2	-12.2	34.62	8.65	34.11	107	18	Peak
5755	81.43	72.22			34.66	8.66	34.11	107	17	Average
5755	89.42	80.21			34.66	8.66	34.11	107	17	Peak
*5852	56.77	47.47	78.2	-21.43	34.74	8.7	34.14	107	17	Peak
*5864	56.91	47.58	68.2	-11.29	34.76	8.71	34.14	107	17	Peak
Antenna Polarity & Test Distance: Vertical at 3 m										
Frequency (MHz)	Emission Level (dBuV/m)	Read Level (dBuV)	Limit (dBuV/m)	Margin (dB)	Antenna Factor (dB/m)	Cable Loss (dB)	Preamp Factor (dB)	Antenna Height (cm)	Table Angle (Degree)	Remark
*5710	64.12	54.97	68.2	-4.08	34.61	8.65	34.11	126	355	Peak
*5716	67.23	58.08	78.2	-10.97	34.61	8.65	34.11	126	355	Peak
5755	85.46	76.25			34.66	8.66	34.11	125	354	Average
5755	92.05	82.84			34.66	8.66	34.11	125	354	Peak
*5858	57.42	48.1	78.2	-20.78	34.76	8.7	34.14	125	354	Peak
*5868	56.79	47.46	68.2	-11.41	34.76	8.71	34.14	125	354	Peak

Remarks:

- Emission Level = Read Level + Antenna Factor + Cable Loss - Preamp Factor
Margin value = Emission level – Limit value
- 5755 MHz: Fundamental frequency.
- *: Out of restricted band

EUT Test Condition		Measurement Detail	
Channel	Channel 159	Frequency Range	1 GHz ~ 40 GHz
Input Power	120 Vac, 60 Hz	Detector Function	Peak (PK) Average (AV)
Environmental Conditions	25 deg. C, 65 % RH	Tested By	Karl Lee

Antenna Polarity & Test Distance: Horizontal at 3 m										
Frequency (MHz)	Emission Level (dBuV/m)	Read Level (dBuV)	Limit (dBuV/m)	Margin (dB)	Antenna Factor (dB/m)	Cable Loss (dB)	Preamp Factor (dB)	Antenna Height (cm)	Table Angle (Degree)	Remark
5710	57.32	48.17	68.2	-10.88	34.61	8.65	34.11	100	40	Peak
5722	57.22	48.06	78.2	-20.98	34.62	8.65	34.11	100	40	Peak
5795	82.37	73.13			34.69	8.68	34.13	100	40	Average
5795	89.14	79.9			34.69	8.68	34.13	100	40	Peak
5854	56.86	47.54	78.2	-21.34	34.76	8.7	34.14	100	40	Peak
5862	56.52	47.19	68.2	-11.68	34.76	8.71	34.14	100	40	Peak
Antenna Polarity & Test Distance: Vertical at 3 m										
Frequency (MHz)	Emission Level (dBuV/m)	Read Level (dBuV)	Limit (dBuV/m)	Margin (dB)	Antenna Factor (dB/m)	Cable Loss (dB)	Preamp Factor (dB)	Antenna Height (cm)	Table Angle (Degree)	Remark
5706	56.87	47.72	68.2	-11.33	34.61	8.65	34.11	111	360	Peak
5722	57.51	48.35	78.2	-20.69	34.62	8.65	34.11	111	360	Peak
5795	85.49	76.25			34.69	8.68	34.13	111	360	Average
5795	92.28	83.04			34.69	8.68	34.13	111	360	Peak
5858	57.13	47.81	78.2	-21.07	34.76	8.7	34.14	111	360	Peak
5866	56.73	47.4	68.2	-11.47	34.76	8.71	34.14	111	360	Peak

Remarks:

- Emission Level = Read Level + Antenna Factor + Cable Loss - Preamp Factor
Margin value = Emission level – Limit value
- 5795 MHz: Fundamental frequency.
- *: Out of restricted band

802.11ac (VHT80)

EUT Test Condition		Measurement Detail	
Channel	Channel 42	Frequency Range	1 GHz ~ 40 GHz
Input Power	120 Vac, 60 Hz	Detector Function	Peak (PK) Average (AV)
Environmental Conditions	25 deg. C, 65 % RH	Tested By	Karl Lee

Antenna Polarity & Test Distance: Horizontal at 3 m

Frequency (MHz)	Emission Level (dBuV/m)	Read Level (dBuV)	Limit (dBuV/m)	Margin (dB)	Antenna Factor (dB/m)	Cable Loss (dB)	Preamp Factor (dB)	Antenna Height (cm)	Table Angle (Degree)	Remark
5150	50.96	42.71	54	-3.04	34.12	8.13	34	175	340	Average
5150	60.95	52.7	74	-13.05	34.12	8.13	34	175	340	Peak
5210	84.21	75.85			34.17	8.19	34	170	342	Average
5210	92.14	83.78			34.17	8.19	34	170	342	Peak
5380	42.99	34.31	54	-11.01	34.31	8.41	34.04	170	342	Average
5380	56.15	47.47	74	-17.85	34.31	8.41	34.04	170	342	Peak

Antenna Polarity & Test Distance: Vertical at 3 m

Frequency (MHz)	Emission Level (dBuV/m)	Read Level (dBuV)	Limit (dBuV/m)	Margin (dB)	Antenna Factor (dB/m)	Cable Loss (dB)	Preamp Factor (dB)	Antenna Height (cm)	Table Angle (Degree)	Remark
5150	50.78	42.53	54	-3.22	34.12	8.13	34	180	33	Average
5150	61.75	53.5	74	-12.25	34.12	8.13	34	180	33	Peak
5210	87.06	78.7			34.17	8.19	34	120	30	Average
5210	95.11	86.75			34.17	8.19	34	120	30	Peak
5360	43.47	34.84	54	-10.53	34.28	8.38	34.03	120	30	Average
5360	58.07	49.44	74	-15.93	34.28	8.38	34.03	120	30	Peak

Remarks:

- Emission Level = Read Level + Antenna Factor + Cable Loss - Preamp Factor
Margin value = Emission level – Limit value
- 5210 MHz: Fundamental frequency.

EUT Test Condition		Measurement Detail	
Channel	Channel 58	Frequency Range	1 GHz ~ 40 GHz
Input Power	120 Vac, 60 Hz	Detector Function	Peak (PK) Average (AV)
Environmental Conditions	25 deg. C, 65 % RH	Tested By	Karl Lee

Antenna Polarity & Test Distance: Horizontal at 3 m										
Frequency (MHz)	Emission Level (dBuV/m)	Read Level (dBuV)	Limit (dBuV/m)	Margin (dB)	Antenna Factor (dB/m)	Cable Loss (dB)	Preamp Factor (dB)	Antenna Height (cm)	Table Angle (Degree)	Remark
5034	43.13	35.07	54	-10.87	34.03	8	33.97	226	301	Average
5034	57.71	49.65	74	-16.29	34.03	8	33.97	226	301	Peak
5290	85.74	77.21			34.23	8.32	34.02	226	301	Average
5290	93.22	84.69			34.23	8.32	34.02	226	301	Peak
5350	50.45	41.82	54	-3.55	34.28	8.38	34.03	226	300	Average
5350	63.78	55.15	74	-10.22	34.28	8.38	34.03	226	300	Peak

Antenna Polarity & Test Distance: Vertical at 3 m										
Frequency (MHz)	Emission Level (dBuV/m)	Read Level (dBuV)	Limit (dBuV/m)	Margin (dB)	Antenna Factor (dB/m)	Cable Loss (dB)	Preamp Factor (dB)	Antenna Height (cm)	Table Angle (Degree)	Remark
5080	43.22	35.1	54	-10.78	34.07	8.03	33.98	100	34	Average
5080	58.48	50.36	74	-15.52	34.07	8.03	33.98	100	34	Peak
5290	87.64	79.11			34.23	8.32	34.02	100	34	Average
5290	95.7	87.17			34.23	8.32	34.02	100	34	Peak
5350	51.56	42.93	54	-2.44	34.28	8.38	34.03	105	34	Average
5350	64.44	55.81	74	-9.56	34.28	8.38	34.03	105	34	Peak

Remarks:

- Emission Level = Read Level + Antenna Factor + Cable Loss - Preamp Factor
Margin value = Emission level – Limit value
- 5290 MHz: Fundamental frequency.



EUT Test Condition		Measurement Detail	
Channel	Channel 106	Frequency Range	1 GHz ~ 40 GHz
Input Power	120 Vac, 60 Hz	Detector Function	Peak (PK) Average (AV)
Environmental Conditions	25 deg. C, 65 % RH	Tested By	Karl Lee

Antenna Polarity & Test Distance: Horizontal at 3 m										
Frequency (MHz)	Emission Level (dBuV/m)	Read Level (dBuV)	Limit (dBuV/m)	Margin (dB)	Antenna Factor (dB/m)	Cable Loss (dB)	Preamp Factor (dB)	Antenna Height (cm)	Table Angle (Degree)	Remark
5441	49.36	40.57	54	-4.64	34.35	8.48	34.04	100	360	Average
5441	59.77	50.98	74	-14.23	34.35	8.48	34.04	100	360	Peak
5470	59.45	50.62	68.2	-8.75	34.37	8.51	34.05	123	156	Peak
5530	86.16	77.23			34.42	8.58	34.07	102	1	Average
5530	94.13	85.2			34.42	8.58	34.07	102	1	Peak
5725	55.84	46.68	68.2	-12.36	34.62	8.65	34.11	165	145	Peak
Antenna Polarity & Test Distance: Vertical at 3 m										
Frequency (MHz)	Emission Level (dBuV/m)	Read Level (dBuV)	Limit (dBuV/m)	Margin (dB)	Antenna Factor (dB/m)	Cable Loss (dB)	Preamp Factor (dB)	Antenna Height (cm)	Table Angle (Degree)	Remark
5460	52.35	43.53	54	-1.65	34.36	8.51	34.05	165	36	Average
5460	65.36	56.54	74	-8.64	34.36	8.51	34.05	165	36	Peak
5470	66.14	57.31	68.2	-2.06	34.37	8.51	34.05	166	215	Peak
5530	87.37	78.44			34.42	8.58	34.07	101	18	Average
5530	95.11	86.18			34.42	8.58	34.07	101	18	Peak
5725	55.99	46.83	68.2	-12.21	34.62	8.65	34.11	145	148	Peak

Remarks:

- Emission Level = Read Level + Antenna Factor + Cable Loss - Preamp Factor
Margin value = Emission level – Limit value
- 5530 MHz: Fundamental frequency.
- 5470 MHz & 5725 MHz: Out of restricted band



EUT Test Condition		Measurement Detail	
Channel	Channel 122	Frequency Range	1 GHz ~ 40 GHz
Input Power	120 Vac, 60 Hz	Detector Function	Peak (PK) Average (AV)
Environmental Conditions	25 deg. C, 65 % RH	Tested By	Karl Lee

Antenna Polarity & Test Distance: Horizontal at 3 m										
Frequency (MHz)	Emission Level (dBuV/m)	Read Level (dBuV)	Limit (dBuV/m)	Margin (dB)	Antenna Factor (dB/m)	Cable Loss (dB)	Preamp Factor (dB)	Antenna Height (cm)	Table Angle (Degree)	Remark
5458	45.13	36.31	54	-8.87	34.36	8.51	34.05	230	300	Average
5458	59.34	50.52	74	-14.66	34.36	8.51	34.05	230	300	Peak
5470	56.53	47.7	68.2	-11.67	34.37	8.51	34.05	230	300	Peak
5610	86.67	77.64			34.5	8.61	34.08	230	300	Average
5610	94.22	85.19			34.5	8.61	34.08	230	300	Peak
5725	58.21	49.05	68.2	-9.99	34.62	8.65	34.11	230	300	Peak
Antenna Polarity & Test Distance: Vertical at 3 m										
Frequency (MHz)	Emission Level (dBuV/m)	Read Level (dBuV)	Limit (dBuV/m)	Margin (dB)	Antenna Factor (dB/m)	Cable Loss (dB)	Preamp Factor (dB)	Antenna Height (cm)	Table Angle (Degree)	Remark
5454	44.63	35.81	54	-9.37	34.36	8.51	34.05	120	33	Average
5454	57.98	49.16	74	-16.02	34.36	8.51	34.05	120	33	Peak
5470	57.98	49.15	68.2	-10.22	34.37	8.51	34.05	120	33	Peak
5610	86.89	77.86			34.5	8.61	34.08	120	33	Average
5610	95.32	86.29			34.5	8.61	34.08	120	33	Peak
5725	57.09	47.93	68.2	-11.11	34.62	8.65	34.11	120	33	Peak

Remarks:

- Emission Level = Read Level + Antenna Factor + Cable Loss - Preamp Factor
Margin value = Emission level – Limit value
- 5610 MHz: Fundamental frequency.
- 5470 MHz & 5725 MHz: Out of restricted band



EUT Test Condition		Measurement Detail	
Channel	Channel 155	Frequency Range	1 GHz ~ 40 GHz
Input Power	120 Vac, 60 Hz	Detector Function	Peak (PK) Average (AV)
Environmental Conditions	25 deg. C, 65 % RH	Tested By	Karl Lee

Antenna Polarity & Test Distance: Horizontal at 3 m										
Frequency (MHz)	Emission Level (dBuV/m)	Read Level (dBuV)	Limit (dBuV/m)	Margin (dB)	Antenna Factor (dB/m)	Cable Loss (dB)	Preamp Factor (dB)	Antenna Height (cm)	Table Angle (Degree)	Remark
*5712	61.27	52.12	68.2	-6.93	34.61	8.65	34.11	106	17	Peak
*5722	62.26	53.1	78.2	-15.94	34.62	8.65	34.11	106	17	Peak
5775	80.25	71.02			34.68	8.67	34.12	107	17	Average
5775	88.21	78.98			34.68	8.67	34.12	107	17	Peak
*5858	57.97	48.65	78.2	-20.23	34.76	8.7	34.14	107	17	Peak
*5868	57.51	48.18	68.2	-10.69	34.76	8.71	34.14	107	17	Peak
Antenna Polarity & Test Distance: Vertical at 3 m										
Frequency (MHz)	Emission Level (dBuV/m)	Read Level (dBuV)	Limit (dBuV/m)	Margin (dB)	Antenna Factor (dB/m)	Cable Loss (dB)	Preamp Factor (dB)	Antenna Height (cm)	Table Angle (Degree)	Remark
*5710	64.95	55.8	68.2	-3.25	34.61	8.65	34.11	113	354	Peak
*5724	66.05	56.89	78.2	-12.15	34.62	8.65	34.11	113	354	Peak
5775	84.49	75.26			34.68	8.67	34.12	124	356	Average
5775	91.65	82.42			34.68	8.67	34.12	124	356	Peak
*5858	58.7	49.38	78.2	-19.5	34.76	8.7	34.14	124	356	Peak
*5868	57.96	48.63	68.2	-10.24	34.76	8.71	34.14	124	356	Peak

Remarks:

- Emission Level = Read Level + Antenna Factor + Cable Loss - Preamp Factor
Margin value = Emission level – Limit value
- 5775 MHz: Fundamental frequency.
- *: Out of restricted band

9 kHz ~ 30 MHz DATA:

The amplitude of spurious emissions attenuated more than 20 dB below the permissible value is not required to be report.

30 MHz ~ 1 GHz WORST-CASE DATA:
802.11ac (VHT80)

EUT Test Condition		Measurement Detail	
Channel	Channel 42	Frequency Range	30 MHz ~ 1 GHz
Input Power	120 Vac, 60 Hz	Detector Function	Peak (PK) Quasi-peak (QP)
Environmental Conditions	25 deg. C, 65 % RH	Tested By	Karl Lee

Antenna Polarity & Test Distance: Horizontal at 3 m

Frequency (MHz)	Emission Level (dBuV/m)	Read Level (dBuV)	Limit (dBuV/m)	Margin (dB)	Antenna Factor (dB/m)	Cable Loss (dB)	Preamp Factor (dB)	Antenna Height (cm)	Table Angle (Degree)	Remark
98.04	30.53	51.86	43.5	-12.97	9.54	1.28	32.15	154	147	Peak
147.99	34.29	55.06	43.5	-9.21	9.98	1.52	32.27	175	241	Peak
195.51	33.65	53.64	43.5	-9.85	10.68	1.61	32.28	145	261	Peak
414.8	18.23	30.17	46	-27.77	17.85	2.41	32.2	108	263	Peak
625.5	22.8	29.94	46	-23.2	22.1	2.93	32.17	164	111	Peak
918.8	28.09	29.94	46	-17.91	25.96	3.53	31.34	139	125	Peak

Antenna Polarity & Test Distance: Vertical at 3 m

Frequency (MHz)	Emission Level (dBuV/m)	Read Level (dBuV)	Limit (dBuV/m)	Margin (dB)	Antenna Factor (dB/m)	Cable Loss (dB)	Preamp Factor (dB)	Antenna Height (cm)	Table Angle (Degree)	Remark
32.43	35.43	50.98	40	-4.57	15.96	0.74	32.25	134	215	Peak
142.59	30.01	51.35	43.5	-13.49	9.55	1.38	32.27	121	244	Peak
199.02	29.36	49.16	43.5	-14.14	10.84	1.65	32.29	175	141	Peak
416.9	17.85	29.83	46	-28.15	17.81	2.41	32.2	114	185	Peak
664	24.17	30.56	46	-21.83	22.75	2.99	32.13	106	213	Peak
934.2	28.06	29.47	46	-17.94	26.2	3.62	31.23	124	211	Peak

Remarks:

- Emission Level = Read Level + Antenna Factor + Cable Loss - Preamp Factor
Margin value = Emission level – Limit value

802.11ac (VHT80)

EUT Test Condition		Measurement Detail	
Channel	Channel 58	Frequency Range	30 MHz ~ 1 GHz
Input Power	120 Vac, 60 Hz	Detector Function	Peak (PK) Quasi-peak (QP)
Environmental Conditions	25 deg. C, 65 % RH	Tested By	Karl Lee

Antenna Polarity & Test Distance: Horizontal at 3 m

Frequency (MHz)	Emission Level (dBuV/m)	Read Level (dBuV)	Limit (dBuV/m)	Margin (dB)	Antenna Factor (dB/m)	Cable Loss (dB)	Preamp Factor (dB)	Antenna Height (cm)	Table Angle (Degree)	Remark
97.5	26.53	47.9	43.5	-16.97	9.5	1.28	32.15	169	145	Peak
145.02	34.03	55.19	43.5	-9.47	9.73	1.38	32.27	134	211	Peak
195.24	32.34	52.33	43.5	-11.16	10.68	1.61	32.28	105	167	Peak
443.5	17.49	29.24	46	-28.51	17.92	2.49	32.16	106	114	Peak
667.5	23.64	29.75	46	-22.36	22.97	3.05	32.13	156	311	Peak
923	27.82	29.4	46	-18.18	26.2	3.53	31.31	128	231	Peak

Antenna Polarity & Test Distance: Vertical at 3 m

Frequency (MHz)	Emission Level (dBuV/m)	Read Level (dBuV)	Limit (dBuV/m)	Margin (dB)	Antenna Factor (dB/m)	Cable Loss (dB)	Preamp Factor (dB)	Antenna Height (cm)	Table Angle (Degree)	Remark
33.24	35.34	51.38	40	-4.66	15.47	0.74	32.25	168	241	Peak
146.1	29.45	50.55	43.5	-14.05	9.79	1.38	32.27	164	150	Peak
200.37	25.39	45.13	43.5	-18.11	10.9	1.65	32.29	157	211	Peak
416.2	17.37	29.35	46	-28.63	17.81	2.41	32.2	106	311	Peak
676.6	24.48	30.19	46	-21.52	23.36	3.05	32.12	157	245	Peak
867.7	27.15	30.79	46	-18.85	24.6	3.44	31.68	167	321	Peak

Remarks:

- Emission Level = Read Level + Antenna Factor + Cable Loss - Preamp Factor
Margin value = Emission level – Limit value

802.11n (HT20)

EUT Test Condition		Measurement Detail	
Channel	Channel 100	Frequency Range	30 MHz ~ 1 GHz
Input Power	120 Vac, 60 Hz	Detector Function	Peak (PK) Quasi-peak (QP)
Environmental Conditions	25 deg. C, 65 % RH	Tested By	Karl Lee

Antenna Polarity & Test Distance: Horizontal at 3 m

Frequency (MHz)	Emission Level (dBuV/m)	Read Level (dBuV)	Limit (dBuV/m)	Margin (dB)	Antenna Factor (dB/m)	Cable Loss (dB)	Preamp Factor (dB)	Antenna Height (cm)	Table Angle (Degree)	Remark
95.61	21.59	43.01	43.5	-21.91	9.34	1.28	32.04	164	184	Peak
148.53	30.66	51.43	43.5	-12.84	9.98	1.52	32.27	174	311	Peak
199.29	29.41	49.22	43.5	-14.09	10.84	1.65	32.3	124	216	Peak
414.8	18.53	30.47	46	-27.47	17.85	2.41	32.2	153	214	Peak
626.2	22.73	29.87	46	-23.27	22.1	2.93	32.17	128	164	Peak
887.3	27.39	30.54	46	-18.61	24.92	3.49	31.56	138	211	Peak

Antenna Polarity & Test Distance: Vertical at 3 m

Frequency (MHz)	Emission Level (dBuV/m)	Read Level (dBuV)	Limit (dBuV/m)	Margin (dB)	Antenna Factor (dB/m)	Cable Loss (dB)	Preamp Factor (dB)	Antenna Height (cm)	Table Angle (Degree)	Remark
32.97	32.78	48.7	40	-7.22	15.59	0.74	32.25	134	178	Peak
144.75	27.12	48.28	43.5	-16.38	9.73	1.38	32.27	106	213	Peak
192.54	23.71	43.86	43.5	-19.79	10.51	1.61	32.27	106	176	Peak
411.3	17.63	29.51	46	-28.37	17.92	2.41	32.21	132	164	Peak
668.2	24.91	30.81	46	-21.09	23.18	3.05	32.13	194	311	Peak
909	26.93	29.34	46	-19.07	25.48	3.53	31.42	157	321	Peak

Remarks:

- Emission Level = Read Level + Antenna Factor + Cable Loss - Preamp Factor
Margin value = Emission level – Limit value



802.11n (HT40)

EUT Test Condition		Measurement Detail	
Channel	Channel 151	Frequency Range	30 MHz ~ 1 GHz
Input Power	120 Vac, 60 Hz	Detector Function	Peak (PK) Quasi-peak (QP)
Environmental Conditions	25 deg. C, 65 % RH	Tested By	Karl Lee

Antenna Polarity & Test Distance: Horizontal at 3 m

Frequency (MHz)	Emission Level (dBuV/m)	Read Level (dBuV)	Limit (dBuV/m)	Margin (dB)	Antenna Factor (dB/m)	Cable Loss (dB)	Preamp Factor (dB)	Antenna Height (cm)	Table Angle (Degree)	Remark
96.69	24	45.4	43.5	-19.5	9.42	1.28	32.1	156	217	Peak
147.18	30.7	51.53	43.5	-12.8	9.92	1.52	32.27	139	217	Peak
223.32	28.19	46.93	46	-17.81	11.81	1.65	32.2	145	211	Peak
444.9	18.46	30.17	46	-27.54	17.95	2.49	32.15	175	210	Peak
664.7	24.13	30.3	46	-21.87	22.97	2.99	32.13	108	134	Peak
915.3	27.78	29.9	46	-18.22	25.72	3.53	31.37	167	125	Peak

Antenna Polarity & Test Distance: Vertical at 3 m

Frequency (MHz)	Emission Level (dBuV/m)	Read Level (dBuV)	Limit (dBuV/m)	Margin (dB)	Antenna Factor (dB/m)	Cable Loss (dB)	Preamp Factor (dB)	Antenna Height (cm)	Table Angle (Degree)	Remark
97.77	18.87	40.24	43.5	-24.63	9.5	1.28	32.15	106	194	Peak
154.74	22.56	42.86	43.5	-20.94	10.45	1.52	32.27	145	211	Peak
219.81	21.16	40.06	46	-24.84	11.67	1.65	32.22	176	114	Peak
406.4	18.72	30.6	46	-27.28	17.99	2.34	32.21	137	115	Peak
658.4	23.63	30.25	46	-22.37	22.53	2.99	32.14	108	311	Peak
919.5	29.31	31.16	46	-16.69	25.96	3.53	31.34	124	114	Peak

Remarks:

- Emission Level = Read Level + Antenna Factor + Cable Loss - Preamp Factor
Margin value = Emission level – Limit value

4.2 Conducted Emission Measurement

4.2.1 Limits of Conducted Emission Measurement

Frequency (MHz)	Conducted Limit (dBuV)	
	Quasi-peak	Average
0.15 - 0.5	66 - 56	56 - 46
0.50 - 5.0	56	46
5.0 - 30.0	60	50

Note: 1. The lower limit shall apply at the transition frequencies.

2. The limit decreases in line with the logarithm of the frequency in the range of 0.15 to 0.50 MHz.

4.2.2 Test Instruments

Description & Manufacturer	Model No.	Serial No.	Date Of Calibration	Due Date Of Calibration
Test Receiver ROHDE & SCHWARZ	ESCI	100613	Nov. 16, 2015	Nov. 15, 2016
RF signal cable (with 10dB PAD) Woken	5D-FB	Cable-cond1-01	Dec. 26, 2015	Dec. 25, 2016
LISN ROHDE & SCHWARZ (EUT)	ESH3-Z5	835239/001	Feb. 26, 2015	Feb. 25, 2016
LISN ROHDE & SCHWARZ (Peripheral)	ESH3-Z5	100311	Jul. 24, 2015	Jul. 23, 2016
Software ADT	BV ADT_Cond_ V7.3.7.3	NA	NA	NA

Note: 1. The calibration interval of the above test instruments is 12 months and the calibrations are traceable to NML/ROC and NIST/USA.

2. The test was performed in HwaYa Shielded Room 1.

3. The VCCI Site Registration No. is C-2040.

4.2.3 Test Procedures

- a. The EUT was placed 0.4 meters from the conducting wall of the shielded room with EUT being connected to the power mains through a line impedance stabilization network (LISN). Other support units were connected to the power mains through another LISN. The two LISNs provide 50 ohm/ 50uH of coupling impedance for the measuring instrument.
- b. Both lines of the power mains connected to the EUT were checked for maximum conducted interference.
- c. The frequency range from 150 kHz to 30 MHz was searched. Emission levels under (Limit -20 dB) was not recorded.

NOTE: All modes of operation were investigated and the worst-case emissions are reported.

4.2.4 Deviation from Test Standard

No deviation.

4.2.5 Test Setup

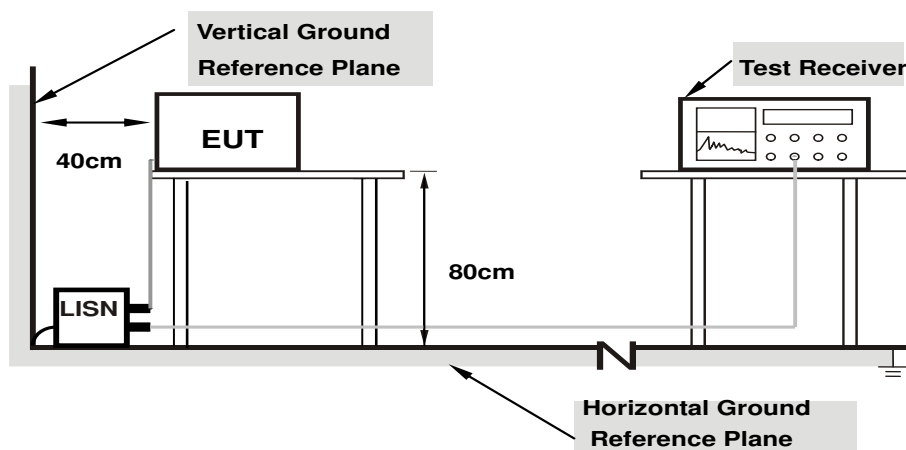

- Note: 1.Support units were connected to second LISN.**
2.Both of LISNs (AMN) are 80 cm from EUT and at least 80 from other units and other metal planes

For the actual test configuration, please refer to the attached file (Test Setup Photo).

4.2.6 EUT Operating Conditions

- a. Placed the EUT on a testing table.
- b. Use the software to control the EUT under transmission condition continuously at specific channel frequency.

4.2.7 Test Results

Frequency Range	150kHz ~ 30MHz	Detector Function & Resolution Bandwidth	Quasi-Peak (QP) / Average (AV), 9kHz
Input Power	120Vac, 60Hz	Environmental Conditions	25°C, 65%RH
Tested by	Toby Tian	Test Date	2016/1/22

Phase Of Power : Line (L)										
No	Frequency (MHz)	Correction Factor (dB)	Reading Value (dBuV)		Emission Level (dBuV)		Limit (dBuV)		Margin (dB)	
			Q.P.	AV.	Q.P.	AV.	Q.P.	AV.	Q.P.	AV.
1	0.15000	9.99	30.20	21.03	40.19	31.02	66.00	56.00	-25.81	-24.98
2	0.17737	10.00	27.06	14.58	37.06	24.58	64.61	54.61	-27.54	-30.02
3	0.20474	10.01	27.60	12.46	37.61	22.47	63.42	53.42	-25.80	-30.94
4	0.58010	10.12	22.09	12.05	32.21	22.17	56.00	46.00	-23.79	-23.83
5	1.12750	10.19	16.01	8.37	26.20	18.56	56.00	46.00	-29.80	-27.44
6	11.27786	10.72	16.20	8.47	26.92	19.19	60.00	50.00	-33.08	-30.81

Remarks:

1. Q.P. and AV. are abbreviations of quasi-peak and average individually.
2. The emission levels of other frequencies were very low against the limit.
3. Margin value = Emission level – Limit value
4. Correction factor = Insertion loss + Cable loss
5. Emission Level = Correction Factor + Reading Value

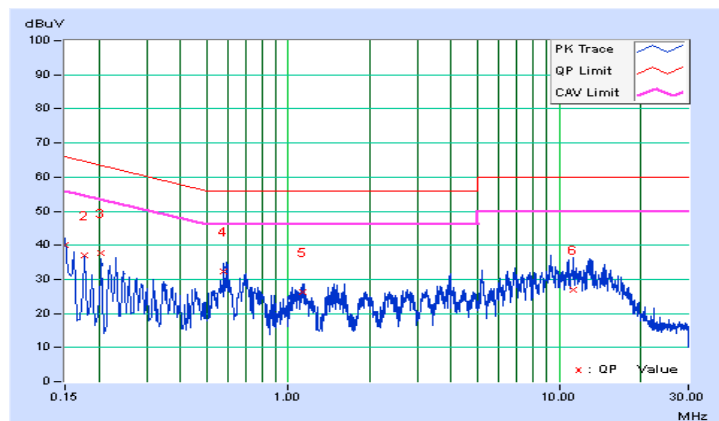

Frequency Range	150kHz ~ 30MHz	Detector Function & Resolution Bandwidth	Quasi-Peak (QP) / Average (AV), 9kHz
Input Power	120Vac, 60Hz	Environmental Conditions	25°C, 65%RH
Tested by	Toby Tian	Test Date	2016/1/22

Phase Of Power : Neutral (N)										
No	Frequency (MHz)	Correction Factor (dB)	Reading Value (dBuV)		Emission Level (dBuV)		Limit (dBuV)		Margin (dB)	
			Q.P.	AV.	Q.P.	AV.	Q.P.	AV.	Q.P.	AV.
1	0.15391	9.97	30.26	22.85	40.23	32.82	65.79	55.79	-25.56	-22.97
2	0.19692	9.98	28.00	12.82	37.98	22.80	63.74	53.74	-25.76	-30.94
3	0.23602	10.00	20.40	8.08	30.40	18.08	62.24	52.24	-31.84	-34.16
4	0.30640	10.03	19.76	5.64	29.79	15.67	60.07	50.07	-30.28	-34.40
5	0.58792	10.09	21.73	8.99	31.82	19.08	56.00	46.00	-24.18	-26.92
6	11.58284	10.59	15.57	7.74	26.16	18.33	60.00	50.00	-33.84	-31.67

Remarks:

1. Q.P. and AV. are abbreviations of quasi-peak and average individually.
2. The emission levels of other frequencies were very low against the limit.
3. Margin value = Emission level – Limit value
4. Correction factor = Insertion loss + Cable loss
5. Emission Level = Correction Factor + Reading Value

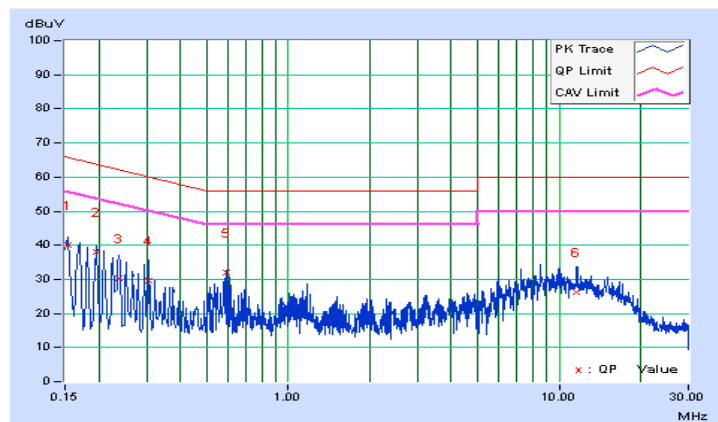

4.3 Transmit Power Measurement

4.3.1 Limits of Transmit Power Measurement

Operation Band	EUT Category	Limit
U-NII-1	Outdoor Access Point	1 Watt (30 dBm) (Max. e.i.r.p \leq 125 mW (21 dBm) at any elevation angle above 30 degrees as measured from the horizon)
	Fixed point-to-point Access Point	1 Watt (30 dBm)
	Indoor Access Point	1 Watt (30 dBm)
	√ Mobile and Portable client device	250 mW (24 dBm)
U-NII-2A	√	250 mW (24 dBm) or 11 dBm+10 log B*
U-NII-2C	√	250 mW (24 dBm) or 11 dBm+10 log B*
U-NII-3	√	1 Watt (30 dBm)

*B is the 26 dB emission bandwidth in megahertz

Per KDB 662911 Method of conducted output power measurement on IEEE 802.11 devices,

Array Gain = 0 dB (i.e., no array gain) for $N_{ANT} \leq 4$;

Array Gain = 0 dB (i.e., no array gain) for channel widths ≥ 40 MHz for any N_{ANT} ;

Array Gain = $5 \log(N_{ANT}/N_{SS})$ dB or 3 dB, whichever is less for 20 MHz channel widths with $N_{ANT} \geq 5$.

For power measurements on all other devices: Array Gain = $10 \log(N_{ANT}/N_{SS})$ dB.

4.3.2 Test Setup

<Power Output Measurement>

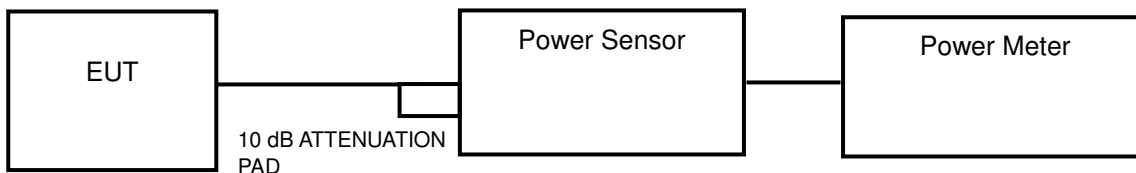

or

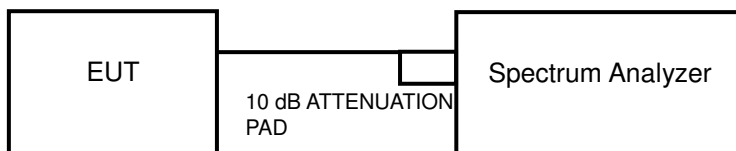

<26 dB Bandwidth>

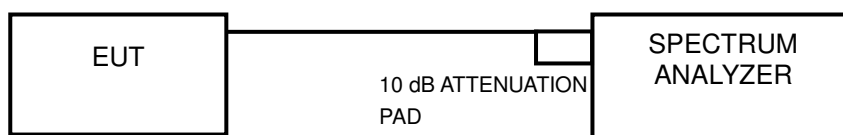

4.3.3 Test Instruments

Refer to section 4.1.2 to get information of above instrument.

4.3.4 Test Procedure

Average Power Measurement

<802.11a, 802.11n (HT20), 802.11n (HT40)>

Method PM is used to perform output power measurement, trigger and gating function of wide band power meter is enabled to measure max output power of TX on burst. Duty factor is not added to measured value.

<802.11ac (VHT80)>

Method SA-1 is used to perform output power measurement, trigger and gating function of spectrum analyzer is enabled to measure max output power of TX on burst. Duty factor is not added to measured value.

26 dB Bandwidth

- 1) Set RBW = approximately 1 % of the emission bandwidth.
- 2) Set the VBW > RBW.
- 3) Detector = Peak.
- 4) Trace mode = max hold.
- 5) Measure the maximum width of the emission that is 26 dB down from the peak of the emission. Compare this with the RBW setting of the analyzer. Readjust RBW and repeat measurement as needed until the RBW/EBW ratio is approximately 1 %.

4.3.5 Deviation from Test Standard

No deviation.

4.3.6 EUT Operating Conditions

The software provided by client to enable the EUT under transmission condition continuously at lowest, middle and highest channel frequencies individually.

4.3.7 Test Result

Power Output:

<1TX>

802.11a

Channel	Frequency (MHz)	Maximum Conducted Power (mW)	Maximum Conducted Power (dBm)	Power Limit (dBm)	Pass / Fail
36	5180	37.76	15.77	24	Pass
44	5220	38.99	15.91	24	Pass
48	5240	38.64	15.87	24	Pass
52	5260	38.73	15.88	24	Pass
60	5300	39.26	15.94	24	Pass
64	5320	38.11	15.81	24	Pass
100	5500	35.81	15.54	24	Pass
116	5580	36.39	15.61	24	Pass
140	5700	36.06	15.57	24	Pass
149	5745	38.82	15.89	30	Pass
157	5785	39.90	16.01	30	Pass
165	5825	38.55	15.86	30	Pass

NOTE:

For U-NII-2A, U-NII-2C Band:

1. $11 \text{ dBm} + 10\log(40.25) = 27.05 \text{ dBm} > 24 \text{ dBm}$.
2. $11 \text{ dBm} + 10\log(27.42) = 25.38 \text{ dBm} > 24 \text{ dBm}$.
3. $11 \text{ dBm} + 10\log(29.67) = 25.72 \text{ dBm} > 24 \text{ dBm}$.
4. $11 \text{ dBm} + 10\log(25.63) = 25.09 \text{ dBm} > 24 \text{ dBm}$.
5. $11 \text{ dBm} + 10\log(27.89) = 25.45 \text{ dBm} > 24 \text{ dBm}$.
6. $11 \text{ dBm} + 10\log(27.87) = 25.45 \text{ dBm} > 24 \text{ dBm}$.

802.11n (HT20)

Channel	Frequency (MHz)	Maximum Conducted Power (mW)	Maximum Conducted Power (dBm)	Power Limit (dBm)	Pass / Fail
36	5180	37.58	15.75	24	Pass
44	5220	38.46	15.85	24	Pass
48	5240	37.93	15.79	24	Pass
52	5260	37.50	15.74	24	Pass
60	5300	38.73	15.88	24	Pass
64	5320	37.84	15.78	24	Pass
100	5500	36.14	15.58	24	Pass
116	5580	36.64	15.64	24	Pass
140	5700	35.56	15.51	24	Pass
149	5745	37.84	15.78	30	Pass
157	5785	39.08	15.92	30	Pass
165	5825	37.76	15.77	30	Pass

NOTE:
For U-NII-2A, U-NII-2C Band:

1. $11 \text{ dBm} + 10\log(44.39) = 27.47 \text{ dBm} > 24 \text{ dBm}$.
2. $11 \text{ dBm} + 10\log(45.17) = 27.55 \text{ dBm} > 24 \text{ dBm}$.
3. $11 \text{ dBm} + 10\log(46.01) = 27.63 \text{ dBm} > 24 \text{ dBm}$.
4. $11 \text{ dBm} + 10\log(47.30) = 27.75 \text{ dBm} > 24 \text{ dBm}$.
5. $11 \text{ dBm} + 10\log(42.48) = 27.28 \text{ dBm} > 24 \text{ dBm}$.
6. $11 \text{ dBm} + 10\log(45.70) = 27.60 \text{ dBm} > 24 \text{ dBm}$.

802.11n (HT40)

Channel	Frequency (MHz)	Maximum Conducted Power (mW)	Maximum Conducted Power (dBm)	Power Limit (dBm)	Pass / Fail
38	5190	37.07	15.69	24	Pass
46	5230	37.41	15.73	24	Pass
54	5270	36.06	15.57	24	Pass
62	5310	37.67	15.76	24	Pass
102	5510	40.83	16.11	24	Pass
110	5550	40.18	16.04	24	Pass
134	5670	40.46	16.07	24	Pass
151	5755	38.11	15.81	30	Pass
159	5795	38.46	15.85	30	Pass

NOTE:
For U-NII-2A, U-NII-2C Band:

- $11 \text{ dBm} + 10\log(89.74) = 30.53 \text{ dBm} > 24 \text{ dBm}$.
- $11 \text{ dBm} + 10\log(85.18) = 30.30 \text{ dBm} > 24 \text{ dBm}$.
- $11 \text{ dBm} + 10\log(89.16) = 30.50 \text{ dBm} > 24 \text{ dBm}$.
- $11 \text{ dBm} + 10\log(90.93) = 30.59 \text{ dBm} > 24 \text{ dBm}$.
- $11 \text{ dBm} + 10\log(96.02) = 30.82 \text{ dBm} > 24 \text{ dBm}$.

802.11ac (VHT80)

Channel	Frequency (MHz)	Maximum Conducted Power (mW)	Maximum Conducted Power (dBm)	Power Limit (dBm)	Pass / Fail
42	5210	36.90	15.67	24	Pass
58	5290	37.33	15.72	24	Pass
106	5530	39.17	15.93	24	Pass
122	5610	37.67	15.76	24	Pass
155	5775	36.14	15.58	30	Pass

NOTE:
For U-NII-2A, U-NII-2C Band:

- $11 \text{ dBm} + 10\log(117.51) = 31.70 \text{ dBm} > 24 \text{ dBm}$.
- $11 \text{ dBm} + 10\log(123.82) = 31.93 \text{ dBm} > 24 \text{ dBm}$.
- $11 \text{ dBm} + 10\log(134.58) = 32.29 \text{ dBm} > 24 \text{ dBm}$.

<2TX>

802.11n (HT20)

Channel	Frequency (MHz)	Maximum Conducted Power (dBm)		Total Power (mW)	Total Power (dBm)	Power Limit (dBm)	Pass / Fail
		Chain 0	Chain 1				
36	5180	13.10	13.28	41.70	16.20	24	Pass
44	5220	13.05	13.27	41.42	16.17	24	Pass
48	5240	13.03	13.22	41.08	16.14	24	Pass
52	5260	13.11	13.24	41.55	16.19	24	Pass
60	5300	13.29	13.39	43.16	16.35	24	Pass
64	5320	13.12	13.29	41.84	16.22	24	Pass
100	5500	13.34	12.33	38.68	15.87	24	Pass
116	5580	13.36	12.38	38.98	15.91	24	Pass
140	5700	13.24	12.35	38.27	15.83	24	Pass
149	5745	12.89	13.14	40.06	16.03	30	Pass
157	5785	12.15	13.96	41.29	16.16	30	Pass
165	5825	12.43	13.75	41.21	16.15	30	Pass

NOTE:

For U-NII-2A, U-NII-2C Band:

CHAIN 0

1. $11 \text{ dBm} + 10\log(28.37) = 25.53 \text{ dBm} > 24 \text{ dBm}$.
2. $11 \text{ dBm} + 10\log(27.32) = 25.36 \text{ dBm} > 24 \text{ dBm}$.
3. $11 \text{ dBm} + 10\log(39.57) = 26.97 \text{ dBm} > 24 \text{ dBm}$.
4. $11 \text{ dBm} + 10\log(22.25) = 24.47 \text{ dBm} > 24 \text{ dBm}$.
5. $11 \text{ dBm} + 10\log(22.15) = 24.45 \text{ dBm} > 24 \text{ dBm}$.
6. $11 \text{ dBm} + 10\log(25.15) = 25.01 \text{ dBm} > 24 \text{ dBm}$.

CHAIN 1

1. $11 \text{ dBm} + 10\log(22.64) = 24.55 \text{ dBm} > 24 \text{ dBm}$.
2. $11 \text{ dBm} + 10\log(29.10) = 25.64 \text{ dBm} > 24 \text{ dBm}$.
3. $11 \text{ dBm} + 10\log(25.19) = 25.01 \text{ dBm} > 24 \text{ dBm}$.
4. $11 \text{ dBm} + 10\log(22.09) = 24.44 \text{ dBm} > 24 \text{ dBm}$.
5. $11 \text{ dBm} + 10\log(22.05) = 24.43 \text{ dBm} > 24 \text{ dBm}$.
6. $11 \text{ dBm} + 10\log(24.74) = 24.93 \text{ dBm} > 24 \text{ dBm}$.

802.11n (HT40)

Channel	Frequency (MHz)	Maximum Conducted Power (dBm)		Total Power (mW)	Total Power (dBm)	Power Limit (dBm)	Pass / Fail
		Chain 0	Chain 1				
38	5190	12.21	13.47	38.87	15.90	24	Pass
46	5230	12.21	13.53	39.18	15.93	24	Pass
54	5270	12.07	13.65	39.28	15.94	24	Pass
62	5310	12.50	13.55	40.43	16.07	24	Pass
102	5510	12.81	13.32	40.58	16.08	24	Pass
110	5550	12.76	13.04	39.02	15.91	24	Pass
134	5670	12.74	12.53	36.70	15.65	24	Pass
151	5755	11.48	13.76	37.83	15.78	30	Pass
159	5795	11.62	13.77	38.34	15.84	30	Pass

NOTE:

For U-NII-2A, U-NII-2C Band:

CHAIN 0

1. 11 dBm + 10log (57.78) = 28.62 dBm > 24 dBm.
2. 11 dBm + 10log (47.40) = 27.76 dBm > 24 dBm.
3. 11 dBm + 10log (81.66) = 30.12 dBm > 24 dBm.
4. 11 dBm + 10log (70.07) = 29.46 dBm > 24 dBm.
5. 11 dBm + 10log (74.42) = 29.72 dBm > 24 dBm.

CHAIN 1

1. 11 dBm + 10log (76.34) = 29.83 dBm > 24 dBm.
2. 11 dBm + 10log (80.16) = 30.04 dBm > 24 dBm.
3. 11 dBm + 10log (71.18) = 29.52 dBm > 24 dBm.
4. 11 dBm + 10log (69.66) = 29.43 dBm > 24 dBm.
5. 11 dBm + 10log (70.91) = 29.51 dBm > 24 dBm.

802.11ac (VHT80)

Channel	Frequency (MHz)	Maximum Conducted Power (dBm)		Total Power (mW)	Total Power (dBm)	Power Limit (dBm)	Pass / Fail
		Chain 0	Chain 1				
42	5210	12.13	13.21	37.27	15.71	24	Pass
58	5290	12.79	12.83	38.20	15.82	24	Pass
106	5530	12.87	13.33	40.89	16.12	24	Pass
122	5610	13.33	16.12	62.42	17.95	24	Pass
155	5775	11.87	14.30	42.30	16.26	30	Pass

NOTE:
For U-NII-2A, U-NII-2C Band:
CHAIN 0

1. $11 \text{ dBm} + 10\log(106.98) = 31.29 \text{ dBm} > 24 \text{ dBm}$.
2. $11 \text{ dBm} + 10\log(110.64) = 31.44 \text{ dBm} > 24 \text{ dBm}$.
3. $11 \text{ dBm} + 10\log(113.86) = 31.56 \text{ dBm} > 24 \text{ dBm}$.

CHAIN 1

1. $11 \text{ dBm} + 10\log(102.36) = 31.10 \text{ dBm} > 24 \text{ dBm}$.
2. $11 \text{ dBm} + 10\log(94.08) = 30.73 \text{ dBm} > 24 \text{ dBm}$.
3. $11 \text{ dBm} + 10\log(116.31) = 31.66 \text{ dBm} > 24 \text{ dBm}$.

26 dB Bandwidth:

<1TX>

802.11a

Channel	Frequency (MHz)	26 dBc Bandwidth (MHz)	Pass / Fail
36	5180	40.45	Pass
44	5220	27.48	Pass
48	5240	24.40	Pass
52	5260	40.25	Pass
60	5300	27.42	Pass
64	5320	29.67	Pass
100	5500	25.63	Pass
116	5580	27.89	Pass
140	5700	27.87	Pass

802.11n (HT20)

Channel	Frequency (MHz)	26 dBc Bandwidth (MHz)	Pass / Fail
36	5180	43.87	Pass
44	5220	44.74	Pass
48	5240	44.80	Pass
52	5260	44.39	Pass
60	5300	45.17	Pass
64	5320	46.01	Pass
100	5500	47.30	Pass
116	5580	42.48	Pass
140	5700	45.70	Pass

802.11n (HT40)

Channel	Frequency (MHz)	26 dBc Bandwidth (MHz)	Pass / Fail
38	5190	88.96	Pass
46	5230	86.68	Pass
54	5270	89.74	Pass
62	5310	85.18	Pass
102	5510	89.16	Pass
110	5550	90.93	Pass
134	5670	96.02	Pass

**802.11ac (VHT80)**

Channel	Frequency (MHz)	26 dBc Bandwidth (MHz)	Pass / Fail
42	5210	120.86	Pass
58	5290	117.51	Pass
106	5530	123.82	Pass
122	5610	134.58	Pass

<2TX>

802.11n (HT20)

Channel	Frequency (MHz)	26 dBc Bandwidth (MHz)		Pass / Fail
		Chain 0	Chain 1	
36	5180	27.03	27.32	Pass
44	5220	27.60	26.86	Pass
48	5240	26.32	41.70	Pass
52	5260	28.37	22.64	Pass
60	5300	27.32	29.10	Pass
64	5320	39.57	25.19	Pass
100	5500	22.25	22.09	Pass
116	5580	22.15	22.05	Pass
140	5700	25.15	24.74	Pass

802.11n (HT40)

Channel	Frequency (MHz)	26 dBc Bandwidth (MHz)		Pass / Fail
		Chain 0	Chain 1	
38	5190	59.37	80.98	Pass
46	5230	58.00	78.24	Pass
54	5270	57.78	76.34	Pass
62	5310	47.40	80.16	Pass
102	5510	81.66	71.18	Pass
110	5550	70.07	69.66	Pass
134	5670	74.42	70.91	Pass

802.11ac (VHT80)

Channel	Frequency (MHz)	26 dBc Bandwidth (MHz)		Pass / Fail
		Chain 0	Chain 1	
42	5210	104.17	104.71	Pass
58	5290	106.98	102.36	Pass
106	5530	110.64	94.08	Pass
122	5610	113.86	116.31	Pass

Spectrum Plot of Worst Value

802.11a

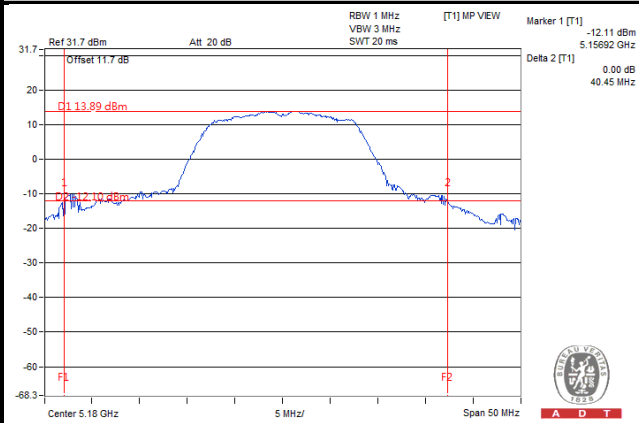

802.11n (HT20)

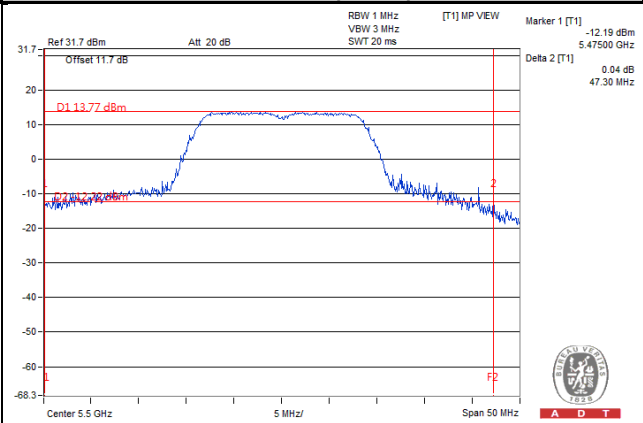

802.11n (HT40)

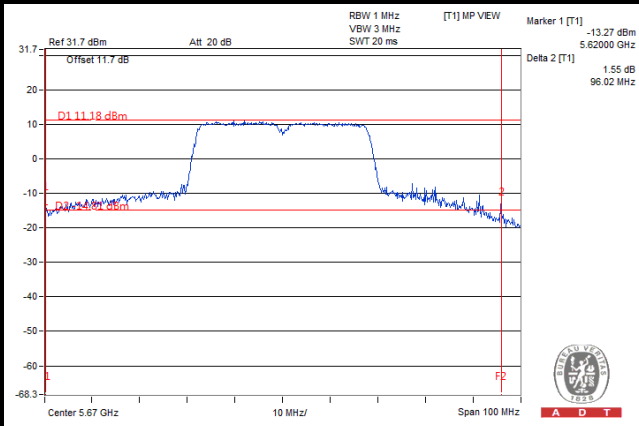

802.11ac (VHT80)

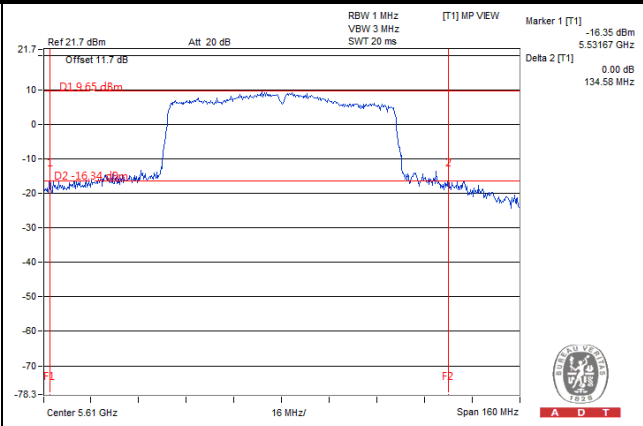

4.4 Peak Power Spectral Density Measurement

4.4.1 Limits of Peak Power Spectral Density Measurement

Operation Band	EUT Category		Limit
U-NII-1		Outdoor Access Point	17 dBm/MHz
		Fixed point-to-point Access Point	
		Indoor Access Point	
	√	Mobile and Portable client device	11 dBm/MHz
U-NII-2A		√	11 dBm/MHz
U-NII-2C		√	11 dBm/MHz
U-NII-3		√	30 dBm/500 kHz

4.4.2 Test Setup

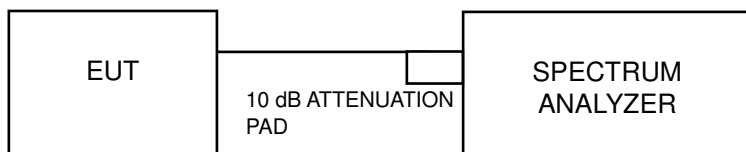

4.4.3 Test Instruments

Refer to section 4.1.3 to get information of above instrument.

4.4.4 Test Procedures

For U-NII-1, U-NII-2A, U-NII-2C band:

Using method SA-2

1. Set span to encompass the entire emission bandwidth (EBW) of the signal.
2. Set RBW = 1 MHz, Set VBW ≥ 3 MHz, Detector = RMS
3. Sweep time = auto, trigger set to “free run”.
4. Trace average at least 100 traces in power averaging mode.
5. Record the max value and add 10 log (1/duty cycle)

※For U-NII-3:

1. Set span to encompass the entire emission bandwidth (EBW) of the signal.
2. Set RBW = 300 kHz, Set VBW \geq 1 MHz, Detector = RMS
3. Use the peak marker function to determine the maximum power level in any 300 kHz band segment within the fundamental EBW.
4. Scale the observed power level to an equivalent value in 500 kHz by adjusting (reducing) the measured power by a bandwidth correction factor (BWCF) where $BWCF = 10\log(500 \text{ kHz}/300 \text{ kHz})$
5. Sweep time = auto, trigger set to "free run".
6. Trace average at least 100 traces in power averaging mode.
7. Record the max value and add $10 \log (1/\text{duty cycle})$

4.4.5 Deviation from Test Standard

No deviation.

4.4.6 EUT Operating Conditions

The software provided by client to enable the EUT under transmission condition continuously at lowest, middle and highest channel frequencies individually.

4.4.7 Test Results

<1TX>

802.11a

Channel	Frequency (MHz)	PSD w/o Duty Factor (dBm)	Duty Factor	PSD with Duty Factor (dBm)	Maximum Limit (dBm)	Pass / Fail
36	5180	5.04	0.25	5.29	11	Pass
44	5220	5.07	0.25	5.32	11	Pass
48	5240	5.16	0.25	5.41	11	Pass
52	5260	5.44	0.25	5.69	11	Pass
60	5300	5.60	0.25	5.85	11	Pass
64	5320	5.85	0.25	6.10	11	Pass
100	5500	5.24	0.25	5.49	11	Pass
116	5580	5.70	0.25	5.95	11	Pass
140	5700	5.84	0.25	6.09	11	Pass

NOTE: Refer to section 3.3 for duty cycle spectrum plot.

802.11n (HT20)

Channel	Frequency (MHz)	PSD w/o Duty Factor (dBm)	Duty Factor	PSD with Duty Factor (dBm)	Maximum Limit (dBm)	Pass / Fail
36	5180	3.33	0.25	3.58	11	Pass
44	5220	3.26	0.25	3.51	11	Pass
48	5240	3.19	0.25	3.44	11	Pass
52	5260	3.51	0.25	3.76	11	Pass
60	5300	3.39	0.25	3.64	11	Pass
64	5320	3.52	0.25	3.77	11	Pass
100	5500	3.57	0.25	3.82	11	Pass
116	5580	4.06	0.25	4.31	11	Pass
140	5700	3.11	0.25	3.36	11	Pass

NOTE: Refer to section 3.3 for duty cycle spectrum plot.

802.11n (HT40)

Channel	Frequency (MHz)	PSD w/o Duty Factor (dBm)	Duty Factor	PSD with Duty Factor (dBm)	Maximum Limit (dBm)	Pass / Fail
38	5190	2.74	0.60	3.34	11	Pass
46	5230	2.10	0.60	2.70	11	Pass
54	5270	2.05	0.60	2.65	11	Pass
62	5310	2.53	0.60	3.13	11	Pass
102	5510	2.77	0.60	3.37	11	Pass
110	5550	2.49	0.60	3.09	11	Pass
134	5670	1.90	0.60	2.50	11	Pass

NOTE: Refer to section 3.3 for duty cycle spectrum plot.

802.11ac (VHT80)

Channel	Frequency (MHz)	PSD w/o Duty Factor (dBm)	Duty Factor	PSD with Duty Factor (dBm)	Maximum Limit (dBm)	Pass / Fail
42	5210	-0.20	1.05	0.85	11	Pass
58	5290	-0.26	1.05	0.79	11	Pass
106	5530	-0.34	1.05	0.71	11	Pass
122	5610	-1.14	1.05	-0.09	11	Pass

NOTE: Refer to section 3.3 for duty cycle spectrum plot.

<2TX>

802.11n (HT20)

Channel	Frequency (MHz)	PSD (dBm)		Total PSD w/o Duty Factor (dBm)	Duty Factor	Total PSD with Duty Factor (dBm)	Maximum Limit (dBm)	Pass / Fail
		Chain 0	Chain 1					
36	5180	0.13	0.85	3.52	0.51	4.02	11	Pass
44	5220	0.01	1.15	3.63	0.51	4.14	11	Pass
48	5240	0.33	1.04	3.71	0.51	4.22	11	Pass
52	5260	0.38	0.57	3.49	0.51	3.99	11	Pass
60	5300	0.12	0.75	3.46	0.51	3.96	11	Pass
64	5320	0.26	0.66	3.47	0.51	3.98	11	Pass
100	5500	0.80	0.83	3.83	0.51	4.33	11	Pass
116	5580	0.52	0.54	3.54	0.51	4.05	11	Pass
140	5700	-0.06	0.33	3.15	0.51	3.66	11	Pass

NOTE:

1. Method 1 of power density measurement of KDB 662911 is using for calculating total power density. Total power density is summing entire spectra across corresponding frequency bins on the various outputs by computer.

2. For U-NII-1 Band:

Directional gain = $-3.5 \text{ dBi} + 10\log(2) = -0.49 \text{ dBi} < 6 \text{ dBi}$, so the power density limit no need to be reduced.

For U-NII-2A, U-NII-2C Band:

Directional gain = $-3 \text{ dBi} + 10\log(2) = 0.01 \text{ dBi} < 6 \text{ dBi}$, so the power density limit no need to be reduced.

3. Refer to section 3.3 for duty cycle spectrum plot.

802.11n (HT40)

Channel	Frequency (MHz)	PSD (dBm)		Total PSD w/o Duty Factor (dBm)	Duty Factor	Total PSD with Duty Factor (dBm)	Maximum Limit (dBm)	Pass / Fail
		Chain 0	Chain 1					
38	5190	-0.91	-0.81	2.15	1.19	3.34	11	Pass
46	5230	-0.79	-0.83	2.20	1.19	3.39	11	Pass
54	5270	-1.78	-1.02	1.63	1.19	2.82	11	Pass
62	5310	-1.52	-0.55	2.00	1.19	3.19	11	Pass
102	5510	-0.93	-0.27	2.42	1.19	3.61	11	Pass
110	5550	-1.20	-0.31	2.28	1.19	3.47	11	Pass
134	5670	-0.78	-1.75	1.77	1.19	2.96	11	Pass

NOTE:

- Method 1 of power density measurement of KDB 662911 is using for calculating total power density. Total power density is summing entire spectra across corresponding frequency bins on the various outputs by computer.
- For U-NII-1 Band:**
Directional gain = $-3.5 \text{ dBi} + 10\log(2) = -0.49 \text{ dBi} < 6 \text{ dBi}$, so the power density limit no need to be reduced.
For U-NII-2A, U-NII-2C Band:
Directional gain = $-3 \text{ dBi} + 10\log(2) = 0.01 \text{ dBi} < 6 \text{ dBi}$, so the power density limit no need to be reduced.
- Refer to section 3.3 for duty cycle spectrum plot.

802.11ac (VHT80)

Channel	Frequency (MHz)	PSD (dBm)		Total PSD w/o Duty Factor (dBm)	Duty Factor	Total PSD with Duty Factor (dBm)	Maximum Limit (dBm)	Pass / Fail
		Chain 0	Chain 1					
42	5210	-5.02	-4.21	-1.59	2.38	0.80	11	Pass
58	5290	-4.38	-4.26	-1.31	2.38	1.07	11	Pass
106	5530	-4.21	-3.76	-0.97	2.38	1.41	11	Pass
122	5610	-4.62	-4.55	-1.57	2.38	0.81	11	Pass

NOTE:

- Method 1 of power density measurement of KDB 662911 is using for calculating total power density. Total power density is summing entire spectra across corresponding frequency bins on the various outputs by computer.
- For U-NII-1 Band:**
Directional gain = $-3.5 \text{ dBi} + 10\log(2) = -0.49 \text{ dBi} < 6 \text{ dBi}$, so the power density limit no need to be reduced.
For U-NII-2A, U-NII-2C Band:
Directional gain = $-3 \text{ dBi} + 10\log(2) = 0.01 \text{ dBi} < 6 \text{ dBi}$, so the power density limit no need to be reduced.
- Refer to section 3.3 for duty cycle spectrum plot.

Spectrum Plot of Worst Value

802.11a

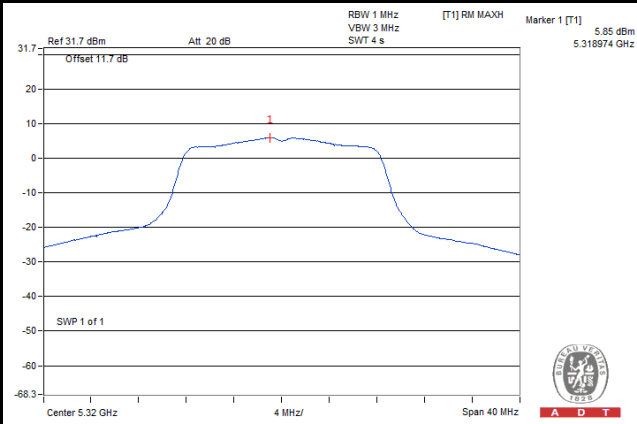

802.11n (HT20)

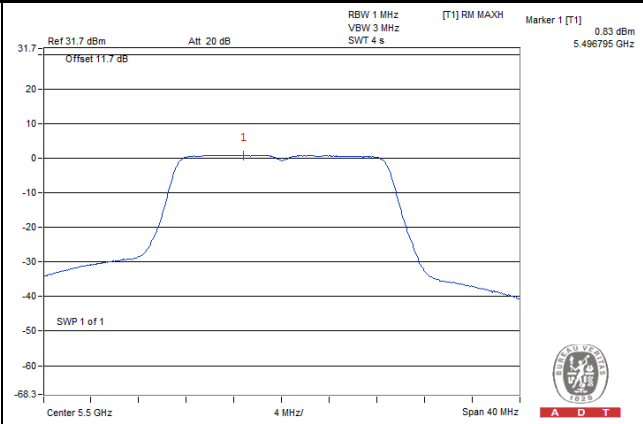

802.11n (HT40)

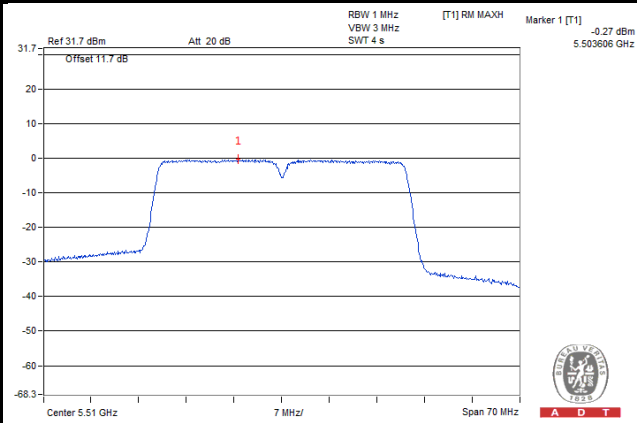

802.11ac (VHT80)

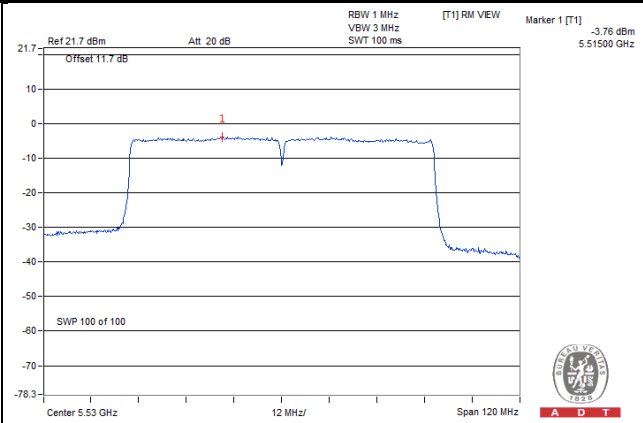

For U-NII-3 Band

<1TX>

802.11a

Channel	Frequency (MHz)	PSD w/o Duty Factor (dBm)	Duty Factor	PSD with Duty Factor (dBm)	Limit (dBm/500 kHz)	Pass / Fail
149	5745	2.17	0.25	2.42	30	Pass
157	5785	2.20	0.25	2.45	30	Pass
165	5825	2.51	0.25	2.76	30	Pass

NOTE: Refer to section 3.3 for duty cycle spectrum plot.

802.11n (HT20)

Channel	Frequency (MHz)	PSD w/o Duty Factor (dBm)	Duty Factor	PSD with Duty Factor (dBm)	Limit (dBm/500 kHz)	Pass / Fail
149	5745	1.86	0.25	2.11	30	Pass
157	5785	1.89	0.25	2.14	30	Pass
165	5825	2.18	0.25	2.43	30	Pass

NOTE: Refer to section 3.3 for duty cycle spectrum plot.

802.11n (HT40)

Channel	Frequency (MHz)	PSD w/o Duty Factor (dBm)	Duty Factor	PSD with Duty Factor (dBm)	Limit (dBm/500 kHz)	Pass / Fail
151	5755	-0.12	0.60	0.48	30	Pass
159	5795	0.56	0.60	1.16	30	Pass

NOTE: Refer to section 3.3 for duty cycle spectrum plot.

802.11ac (VHT80)

Channel	Frequency (MHz)	PSD w/o Duty Factor (dBm)	Duty Factor	PSD with Duty Factor (dBm)	Limit (dBm/500 kHz)	Pass / Fail
155	5775	-4.35	1.05	-3.30	30	Pass

NOTE: Refer to section 3.3 for duty cycle spectrum plot.

<2TX>

802.11n (HT20)

TX Chain	Channel	Frequency (MHz)	PSD (dBm/500 kHz)	10 log (N=2) dB	Total PSD without Duty Factor (dBm/500 kHz)	Duty Factor	Total PSD with Duty Factor (dBm/500 kHz)	Limit (dBm/500 kHz)	Pass / Fail
0	149	5745	-1.77	3.01	1.24	0.51	1.75	30	Pass
	157	5785	-1.95	3.01	1.06	0.51	1.57	30	Pass
	165	5825	-1.56	3.01	1.45	0.51	1.96	30	Pass
1	149	5745	-1.88	3.01	1.13	0.51	1.64	30	Pass
	157	5785	-1.66	3.01	1.35	0.51	1.86	30	Pass
	165	5825	-1.36	3.01	1.65	0.51	2.16	30	Pass

NOTE:

1. Method 1 of power density measurement of KDB 662911 is using for calculating total power density. Total power density is summing entire spectra across corresponding frequency bins on the various outputs by computer.
2. Directional gain = $-3.5 \text{ dBi} + 10\log(2) = -0.49 \text{ dBi} < 6 \text{ dBi}$, so the power density limit no need to be reduced.
3. Refer to section 3.3 for duty cycle spectrum plot.

802.11n (HT40)

TX Chain	Channel	Frequency (MHz)	PSD (dBm/500 kHz)	10 log (N=2) dB	Total PSD without Duty Factor (dBm/500 kHz)	Duty Factor	Total PSD with Duty Factor (dBm/500 kHz)	Limit (dBm/500 kHz)	Pass / Fail
0	151	5755	-6.34	3.01	-3.33	1.19	-2.14	30	Pass
	159	5795	-6.00	3.01	-2.99	1.19	-1.80	30	Pass
1	151	5755	-4.65	3.01	-1.64	1.19	-0.45	30	Pass
	159	5795	-3.92	3.01	-0.91	1.19	0.28	30	Pass

NOTE:

1. Method 1 of power density measurement of KDB 662911 is using for calculating total power density. Total power density is summing entire spectra across corresponding frequency bins on the various outputs by computer.
2. Directional gain = $-3.5 \text{ dBi} + 10\log(2) = -0.49 \text{ dBi} < 6 \text{ dBi}$, so the power density limit no need to be reduced.
3. Refer to section 3.3 for duty cycle spectrum plot.

802.11ac (VHT80)

TX Chain	Channel	Frequency (MHz)	PSD (dBm/500 kHz)	10 log (N=2) dB	Total PSD without Duty Factor (dBm/500 kHz)	Duty Factor	Total PSD with Duty Factor (dBm/500 kHz)	Limit (dBm/500 kHz)	Pass / Fail
0	155	5775	-10.05	3.01	-7.04	2.38	-4.66	30	Pass
1	155	5775	-8.17	3.01	-5.16	2.38	-2.78	30	Pass

NOTE:

- Method 1 of power density measurement of KDB 662911 is using for calculating total power density. Total power density is summing entire spectra across corresponding frequency bins on the various outputs by computer.
- Directional gain = $-3.5 \text{ dBi} + 10\log(2) = -0.49 \text{ dBi} < 6 \text{ dBi}$, so the power density limit no need to be reduced.
- Refer to section 3.3 for duty cycle spectrum plot.

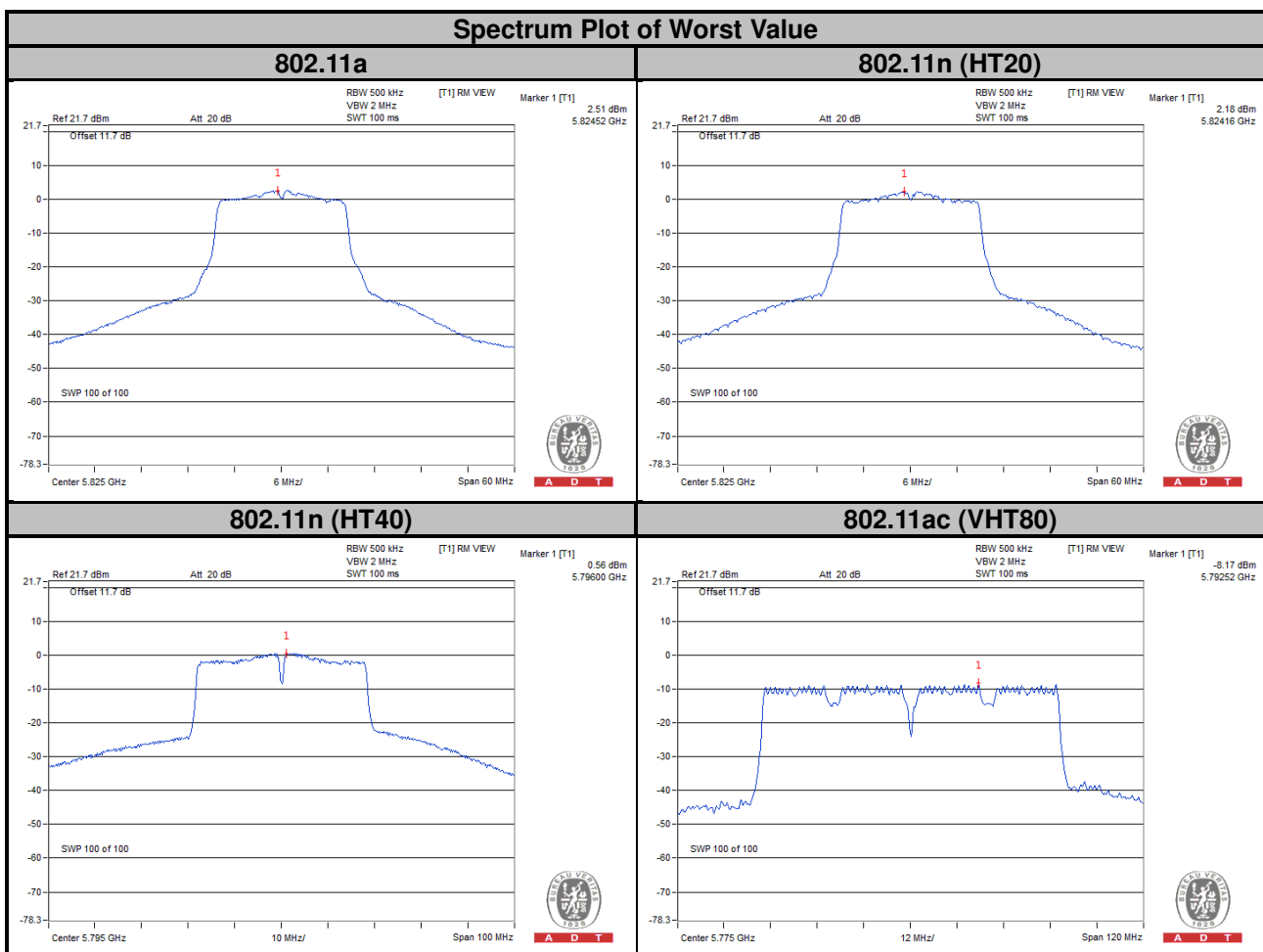

4.5 Frequency Stability

4.5.1 Limit of Frequency Stability Measurement

The frequency of the carrier signal shall be maintained within band of operation

4.5.2 Test Setup

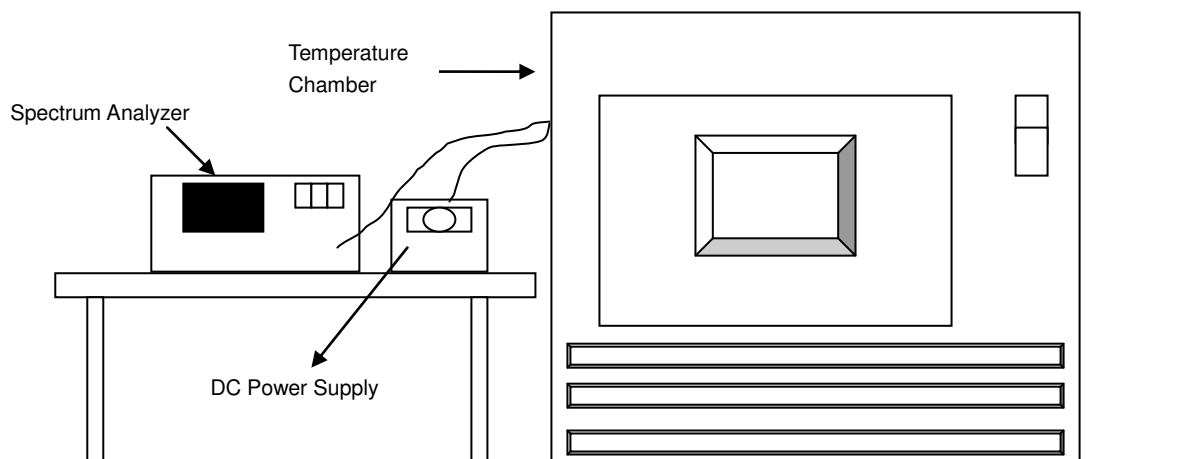

4.5.3 Test Instruments

Refer to section 4.1.3 to get information of above instrument.

4.5.4 Test Procedure

- a. To ensure emission at the band edge is maintained within the authorized band, those values shall be measured by radiation emissions at upper and lower frequency points, and finally compensated by frequency deviation as procedures below.
- b. The EUT was operated at the maximum output power, and connected to the spectrum analyzer, which is set to maximum hold function and peak detector. The peak value of the power envelope was measured and noted. The upper and lower frequency points were respectively measured relatively 10 dB lower than the measured peak value.
- c. The frequency deviation was calculated by adding the upper frequency point and the lower frequency point divided by two. Those detailed values of frequency deviation are provided in table below.

4.5.5 Deviation from Test Standard

No deviation.

4.5.6 EUT Operating Condition

Set the EUT transmit at un-modulation mode to test frequency stability.

4.5.7 Test Results

Frequency Stability Versus Temp.									
Operating Frequency: 5320 MHz									
Temp. (°C)	Power Supply (Vdc)	0 Minute		2 Minute		5 Minute		10 Minute	
		Measured Frequency (MHz)	Frequency Drift (ppm)	Measured Frequency (MHz)	Frequency Drift (ppm)	Measured Frequency (MHz)	Frequency Drift (ppm)	Measured Frequency (MHz)	Frequency Drift (ppm)
55	3.85	5320.016448	3.092	5320.017069	3.208	5320.016463	3.095	5320.016373	3.078
50	3.85	5320.017029	3.201	5320.017159	3.225	5320.017155	3.225	5320.016893	3.175
40	3.85	5320.017035	3.202	5320.017637	3.315	5320.017380	3.267	5320.016945	3.185
30	3.85	5320.018597	3.496	5320.018129	3.408	5320.018526	3.482	5320.018647	3.505
20	3.85	5320.019842	3.730	5320.019638	3.691	5320.019589	3.682	5320.019881	3.737
10	3.85	5320.021310	4.006	5320.020921	3.933	5320.020732	3.897	5320.020752	3.901
0	3.85	5320.019466	3.659	5320.019597	3.684	5320.019790	3.720	5320.019428	3.652
-10	3.85	5320.018106	3.403	5320.017837	3.353	5320.018236	3.428	5320.017986	3.381
-20	3.85	5320.017887	3.362	5320.017577	3.304	5320.017220	3.237	5320.017681	3.323
-30	3.85	5320.016110	3.028	5320.016585	3.117	5320.016355	3.074	5320.016390	3.081

Frequency Stability Versus Temp.									
Operating Frequency: 5320 MHz									
Temp. (°C)	Power Supply (Vdc)	0 Minute		2 Minute		5 Minute		10 Minute	
		Measured Frequency (MHz)	Frequency Drift (ppm)	Measured Frequency (MHz)	Frequency Drift (ppm)	Measured Frequency (MHz)	Frequency Drift (ppm)	Measured Frequency (MHz)	Frequency Drift (ppm)
20	3.6	5320.015312	2.878	5320.015116	2.841	5320.014857	2.793	5320.015038	2.827
	3.85	5320.019842	3.730	5320.019638	3.691	5320.019589	3.682	5320.019881	3.737
	4.4	5320.016807	3.159	5320.016514	3.104	5320.016322	3.068	5320.016924	3.181

4.6 6 dB Bandwidth Measurement

4.6.1 Limits of 6 dB Bandwidth Measurement

The minimum of 6 dB Bandwidth Measurement is 0.5 MHz.

4.6.2 Test Setup

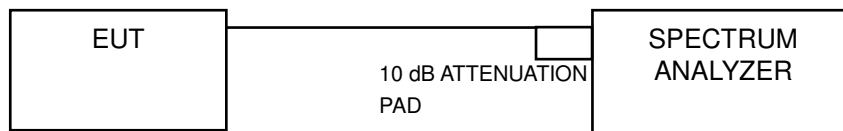

4.6.3 Test Instruments

Refer to section 4.1.3 to get information of above instrument.

4.6.4 Test Procedure

MEASUREMENT PROCEDURE REF

- Set resolution bandwidth (RBW) = 100 kHz
- Set the video bandwidth (VBW) $\geq 3 \times$ RBW, Detector = Peak.
- Trace mode = max hold.
- Sweep = auto couple.
- Measure the maximum width of the emission that is constrained by the frequencies associated with the two amplitude points (upper and lower) that are attenuated by 6 dB relative to the maximum level measured in the fundamental emission

4.6.5 Deviation from Test Standard

No deviation.

4.6.6 EUT Operating Condition

The software provided by client to enable the EUT under transmission condition continuously at lowest, middle and highest channel frequencies individually.

4.6.7 Test Results

<1TX>

802.11a

Channel	Frequency (MHz)	6 dB Bandwidth (MHz)	Minimum Limit (MHz)	Pass / Fail
149	5745	16.37	0.5	Pass
157	5785	16.36	0.5	Pass
165	5825	16.36	0.5	Pass

802.11n (HT20)

Channel	Frequency (MHz)	6 dB Bandwidth (MHz)	Minimum Limit (MHz)	Pass / Fail
149	5745	17.60	0.5	Pass
157	5785	17.60	0.5	Pass
165	5825	17.61	0.5	Pass

802.11n (HT40)

Channel	Frequency (MHz)	6 dB Bandwidth (MHz)	Minimum Limit (MHz)	Pass / Fail
151	5755	36.06	0.5	Pass
159	5795	36.34	0.5	Pass

802.11ac (VHT80)

Channel	Frequency (MHz)	6 dB Bandwidth (MHz)	Minimum Limit (MHz)	Pass / Fail
155	5775	76.00	0.5	Pass

<2TX>

802.11n (HT20)

Channel	Frequency (MHz)	6 dB Bandwidth (MHz)		Minimum Limit (MHz)	Pass / Fail
		Chain 0	Chain 1		
149	5745	17.66	17.67	0.5	Pass
157	5785	17.65	17.66	0.5	Pass
165	5825	17.65	17.64	0.5	Pass

802.11n (HT40)

Channel	Frequency (MHz)	6 dB Bandwidth (MHz)		Minimum Limit (MHz)	Pass / Fail
		Chain 0	Chain 1		
151	5755	36.44	36.45	0.5	Pass
159	5795	36.44	36.41	0.5	Pass

802.11ac (VHT80)

Channel	Frequency (MHz)	6 dB Bandwidth (MHz)		Minimum Limit (MHz)	Pass / Fail
		Chain 0	Chain 1		
155	5775	76.60	76.12	0.5	Pass

Spectrum Plot of Worst Value

802.11a

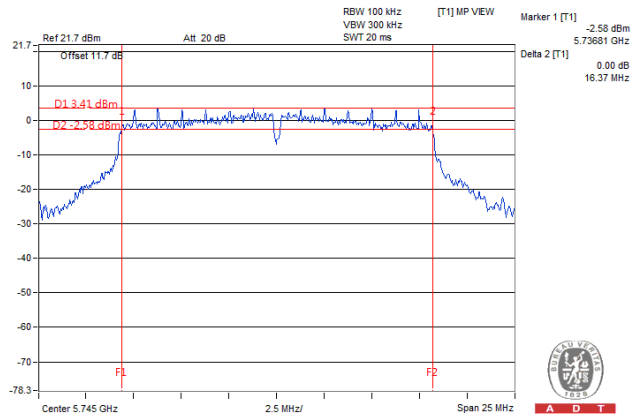

802.11n (HT20)

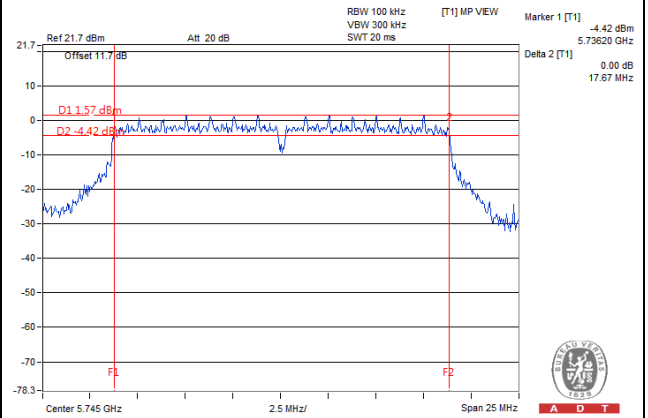

802.11n (HT40)

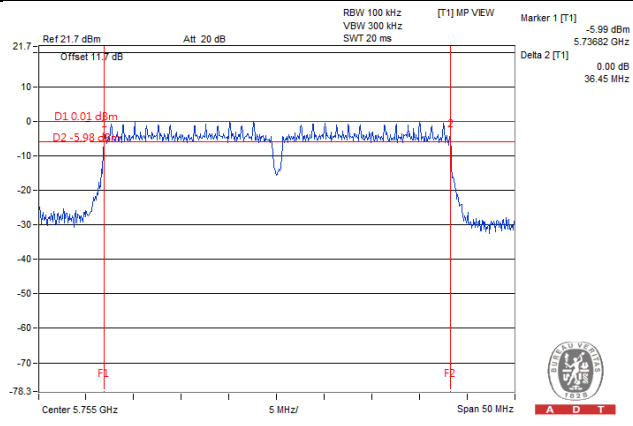

802.11ac (VHT80)

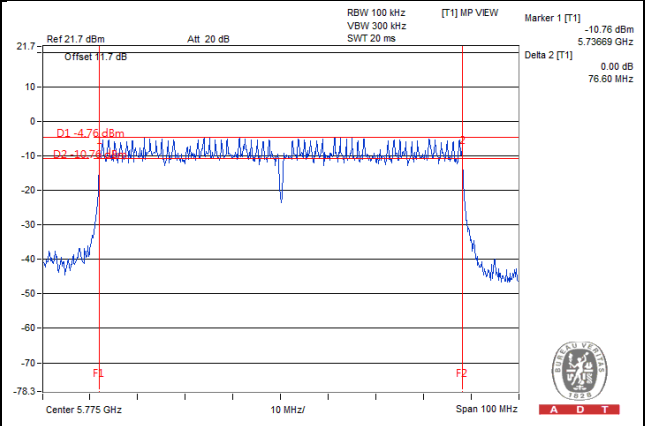



5 Pictures of Test Arrangements

Please refer to the attached file (Test Setup Photo).



Appendix – Information on the Testing Laboratories

We, Bureau Veritas Consumer Products Services (H.K.) Ltd., Taoyuan Branch, were founded in 1988 to provide our best service in EMC, Radio, Telecom and Safety consultation. Our laboratories are accredited and approved according to ISO/IEC 17025.

If you have any comments, please feel free to contact us at the following:

Linko EMC/RF Lab

Tel: 886-2-26052180

Fax: 886-2-26051924

Hsin Chu EMC/RF/Telecom Lab

Tel: 886-3-6668565

Fax: 886-3-6668323

Hwa Ya EMC/RF/Safety

Tel: 886-3-3183232

Fax: 886-3-3270892

Email: service.adt@tw.bureauveritas.com

Web Site: www.bureauveritas-adt.com

The address and road map of all our labs can be found in our web site also.

--- END ---