

FCC Test Report

Report No.: RF150727C10-10

FCC ID: NM82PQ9300

Test Model: 2PQ9300

Received Date: Jul. 27, 2015

Test Date: Aug. 05, 2015 ~ Aug. 29, 2015

Issued Date: Sep. 17, 2015

Applicant: HTC Corporation

Address: 1F, 6-3 Baoqiang Road, Xindian City, Taipei County 231, Taiwan

Issued By: Bureau Veritas Consumer Products Services (H.K.) Ltd., Taoyuan Branch

Lab Address: No. 47-2, 14th Ling, Chia Pau Vil., Lin Kou Dist., New Taipei City, Taiwan
(R.O.C)

Test Location: No. 19, Hwa Ya 2nd Rd, Wen Hwa Tsuen, Kwei Shan Hsiang, Taoyuan
Hsien 333, Taiwan, R.O.C.



This report is for your exclusive use. Any copying or replication of this report to or for any other person or entity, or use of our name or trademark, is permitted only with our prior written permission. This report sets forth our findings solely with respect to the test samples identified herein. The results set forth in this report are not indicative or representative of the quality or characteristics of the lot from which a test sample was taken or any similar or identical product unless specifically and expressly noted. Our report includes all of the tests requested by you and the results thereof based upon the information that you provided to us. You have 60 days from date of issuance of this report to notify us of any material error or omission caused by our negligence, provided, however, that such notice shall be in writing and shall specifically address the issue you wish to raise. A failure to raise such issue within the prescribed time shall constitute your unqualified acceptance of the completeness of this report, the tests conducted and the correctness of the report contents. Unless specific mention, the uncertainty of measurement has been explicitly taken into account to declare the compliance or non-compliance to the specification. The report must not be used by the client to claim product certification, approval, or endorsement by TAF or any government agencies.

Table of Contents

Release Control Record	4
1 Certificate of Conformity	5
2 Summary of Test Results.....	6
2.1 Measurement Uncertainty.....	6
2.2 Modification Record	6
3 General Information	7
3.1 General Description of EUT	7
3.2 Description of Test Modes.....	8
3.2.1 Test Mode Applicability and Tested Channel Detail.....	10
3.3 Duty Cycle of Test Signal	12
3.4 Description of Support Units	16
3.4.1 Configuration of System under Test	16
3.5 General Description of Applied Standards.....	16
4 Test Types and Results	17
4.1 Radiated Emission and Bandedge Measurement	17
4.1.1 Limits of Radiated Emission and Bandedge Measurement	17
4.1.2 Limits of Unwanted Emission Out of The Restricted Bands.....	17
4.1.3 Test Instruments	18
4.1.4 Test Procedures.....	19
4.1.5 Deviation from Test Standard	19
4.1.6 Test Set Up	20
4.1.7 EUT Operating Conditions.....	20
4.1.8 Test Results	21
4.2 Conducted Emission Measurement.....	63
4.2.1 Limits of Conducted Emission Measurement	63
4.2.2 Test Instruments	63
4.2.3 Test Procedures.....	64
4.2.4 Deviation from Test Standard	64
4.2.5 Test Setup.....	64
4.2.6 EUT Operating Conditions.....	64
4.2.7 Test Results	65
4.3 Transmit Power Measurement.....	67
4.3.1 Limits of Transmit Power Measurement	67
4.3.2 Test Setup.....	67
4.3.3 Test Instruments	68
4.3.4 Test Procedure	68
4.3.5 Deviation from Test Standard	68
4.3.6 EUT Operating Conditions.....	68
4.3.7 Test Result	69
4.4 Peak Power Spectral Density Measurement	74
4.4.1 Limits of Peak Power Spectral Density Measurement	74
4.4.2 Test Setup.....	74
4.4.3 Test Instruments	74
4.4.4 Test Procedures.....	75
4.4.5 Deviation from Test Standard	75
4.4.6 EUT Operating Conditions.....	75
4.4.7 Test Results	76
4.5 Frequency Stability	81
4.5.1 Limit of Frequency Stability Measurement	81
4.5.2 Test Setup.....	81
4.5.3 Test Instruments	81
4.5.4 Test Procedure	81
4.5.5 Deviation from Test Standard	81



4.5.6 EUT Operating Condition	81
4.5.7 Test Results	82
4.6 6dB Bandwidth Measurement.....	83
4.6.1 Limits of 6dB Bandwidth Measurement.....	83
4.6.2 Test Setup.....	83
4.6.3 Test Instruments	83
4.6.4 Test Procedure	83
4.6.5 Deviation from Test Standard	83
4.6.6 EUT Operating Condition	83
4.6.7 Test Results	84
5 Pictures of Test Arrangements.....	86
Appendix – Information on the Testing Laboratories	87



A D T

Release Control Record

Issue No.	Description	Date Issued
RF150727C10-10	Original Release	Sep. 17, 2015



1 Certificate of Conformity

Product: Smartphone
Brand: HTC
Test Model: 2PQ9300
Sample Status: Identical Prototype
Applicant: HTC Corporation
Test Date: Aug. 05, 2015 ~ Aug. 29, 2015
Standards: 47 CFR FCC Part 15, Subpart E (Section 15.407)
ANSI C63.10:2013

The above equipment has been tested by **Bureau Veritas Consumer Products Services (H.K.) Ltd., Taoyuan Branch**, and found compliance with the requirement of the above standards. The test record, data evaluation & Equipment Under Test (EUT) configurations represented herein are true and accurate accounts of the measurements of the sample's EMC characteristics under the conditions specified in this report.

Prepared by : Ivonne Wu , **Date:** Sep. 17, 2015
Ivonne Wu / Supervisor

Approved by : Kay Wu , **Date:** Sep. 17, 2015
Kay Wu / Supervisor

2 Summary of Test Results

47 CFR FCC Part 15, Subpart E (SECTION 15.407)			
FCC Clause	Test Item	Result	Remarks
15.407(b)(6)	AC Power Conducted Emissions	PASS	Meet the requirement of limit. Minimum passing margin is -9.14dB at 0.15391MHz.
15.407(b)(1/2/3/4/6)	Radiated Emissions & Band Edge Measurement	PASS	Meet the requirement of limit. Minimum passing margin is -2.82dB at 38.91MHz.
15.407(a)(1/2/3)	Max Average Transmit Power	PASS	Meet the requirement of limit.
15.407(a)(1/2/3)	Peak Power Spectral Density	PASS	Meet the requirement of limit.
15.407(e)	6dB bandwidth	PASS	Meet the requirement of limit. (U-NII-3 Band only)
15.407(g)	Frequency Stability	PASS	Meet the requirement of limit.
15.203	Antenna Requirement	PASS	No antenna connector is used.

2.1 Measurement Uncertainty

Where relevant, the following measurement uncertainty levels have been estimated for tests performed on the EUT as specified in CISPR 16-4-2:

Measurement	Frequency	Expanded Uncertainty (k=2) (\pm)
Conducted Emissions at mains ports	150kHz ~ 30MHz	2.44 dB
Radiated Emissions up to 1 GHz	30MHz ~ 200MHz	2.0153 dB
	200MHz ~ 1000MHz	2.0224 dB
Radiated Emissions above 1 GHz	1GHz ~ 18GHz	1.0121 dB
	18GHz ~ 40GHz	1.1508 dB

2.2 Modification Record

There were no modifications required for compliance.

3 General Information

3.1 General Description of EUT

Product	Smartphone
Brand	HTC
Test Model	2PQ9300
Status of EUT	Identical Prototype
Power Supply Rating	5.0Vdc (adapter or host equipment) 3.85Vdc (Li-ion battery)
Modulation Type	256QAM, 64QAM, 16QAM, QPSK, BPSK
Modulation Technology	OFDM
Transfer Rate	802.11a: 54.0/ 48.0/ 36.0/ 24.0/ 18.0/ 12.0/ 9.0/ 6.0Mbps 802.11n: up to MCS7 802.11ac: up to V9
Operating Frequency	5180 ~ 5240MHz, 5260 ~ 5320MHz, 5500 ~ 5700MHz, 5745 ~ 5825MHz
Number of Channel	5180 ~ 5240MHz: 4 for 802.11a, 802.11n (20MHz) 2 for 802.11n (40MHz) 1 for 802.11ac (80MHz) 5260 ~ 5320MHz: 4 for 802.11a, 802.11n (20MHz) 2 for 802.11n (40MHz) 1 for 802.11ac (80MHz) 5500 ~ 5700MHz: 8 for 802.11a, 802.11n (20MHz) 3 for 802.11n (40MHz) 2 for 802.11ac (80MHz) 5745 ~ 5825MHz: 5 for 802.11a, 802.11n (20MHz) 2 for 802.11n (40MHz) 1 for 802.11ac (80MHz)
Output Power	23.01mW for 5180 ~ 5240MHz 23.12mW for 5260 ~ 5320MHz 23.33mW for 5500 ~ 5700MHz 23.23mW for 5745 ~ 5825MHz
Antenna Type	PIFA antenna with -3dBi gain (5180 ~ 5240MHz) PIFA antenna with -2.42dBi gain (5260 ~ 5320MHz) PIFA antenna with -2dBi gain (5500 ~ 5700MHz) PIFA antenna with -3.2dBi gain (5745 ~ 5825MHz)
Antenna Connector	N/A
Accessory Device	Refer to Note as below
Data Cable Supplied	Refer to Note as below

Note:

1. The EUT's accessories list refers to Ext. Pho.
2. The above EUT information is declared by manufacturer and for more detailed features description, please refer to the manufacturer's specifications or user's manual.

3.2 Description of Test Modes

FOR 5180 ~ 5240MHz

4 channels are provided for 802.11a, 802.11n (20MHz):

Channel	Frequency	Channel	Frequency
36	5180 MHz	44	5220 MHz
40	5200 MHz	48	5240 MHz

2 channels are provided for 802.11n (40MHz):

Channel	Frequency	Channel	Frequency
38	5190 MHz	46	5230 MHz

1 channel is provided for 802.11ac (80MHz):

Channel	Frequency
42	5210MHz

FOR 5260 ~ 5320MHz

4 channels are provided for 802.11a, 802.11n (20MHz):

Channel	Frequency	Channel	Frequency
52	5260 MHz	60	5300 MHz
56	5280 MHz	64	5320 MHz

2 channels are provided for 802.11n (40MHz):

Channel	Frequency	Channel	Frequency
54	5270 MHz	62	5310 MHz

1 channel is provided for 802.11ac (80MHz):

Channel	Frequency
58	5290MHz

FOR 5500 ~ 5700MHz

11 channels are provided for 802.11a, 802.11n (20MHz):

Channel	Frequency	Channel	Frequency
100	5500 MHz	124	5620 MHz
104	5520 MHz	128	5640 MHz
108	5540 MHz	132	5660 MHz
112	5560 MHz	136	5680 MHz
116	5580 MHz	140	5700 MHz
120	5600 MHz		

5 channels are provided for 802.11n (40MHz):

Channel	Frequency	Channel	Frequency
102	5510 MHz	126	5630 MHz
110	5550 MHz	134	5670 MHz
118	5590 MHz		

2 channels are provided for 802.11ac (80MHz):

Channel	Frequency	Channel	Frequency
106	5530MHz	122	5610 MHz

FOR 5745 ~ 5825MHz:

5 channels are provided for 802.11a, 802.11n (20MHz):

Channel	Frequency	Channel	Frequency
149	5745MHz	161	5805MHz
153	5765MHz	165	5825MHz
157	5785MHz		

2 channels are provided for 802.11n (40MHz):

Channel	Frequency	Channel	Frequency
151	5755MHz	159	5795MHz

1 channel is provided for 802.11ac (80MHz):

Channel	Frequency
155	5775MHz

3.2.1 Test Mode Applicability and Tested Channel Detail

EUT Configure Mode	Applicable To				Description
	RE \geq 1G	RE $<$ 1G	PLC	APCM	
-	√	√	√	√	-

Where **RE \geq 1G**: Radiated Emission above 1GHz **RE $<$ 1G**: Radiated Emission below 1GHz
PLC: Power Line Conducted Emission **APCM**: Antenna Port Conducted Measurement

NOTE:

1. The EUT had been pre-tested on the positioned of each 3 axis. The worst case was found when positioned on **Y-plane** for 5180-5240MHz & 5260-5320MHz & 5500-5700MHz and **X-plane** for 5745-5825MHz.

Radiated Emission Test (Above 1GHz):

- Pre-Scan has been conducted to determine the worst-case mode from all possible combinations between available modulations, data rates and antenna ports (if EUT with antenna diversity architecture).
- Following channel(s) was (were) selected for the final test as listed below.

EUT Configure Mode	Mode	Frequency Band (MHz)	Available Channel	Tested Channel	Modulation Technology	Modulation Type	Data Rate (Mbps)
-	802.11a	5180-5240	36 to 48	36, 40, 48	OFDM	BPSK	6.0
-	802.11n (20MHz)		36 to 48	36, 40, 48	OFDM	BPSK	MCS0
-	802.11n (40MHz)		38 to 46	38, 46	OFDM	BPSK	MCS0
-	802.11ac (80MHz)		42	42	OFDM	BPSK	V0
-	802.11a	5260-5320	52 to 64	52, 60, 64	OFDM	BPSK	6.0
-	802.11n (20MHz)		52 to 64	52, 60, 64	OFDM	BPSK	MCS0
-	802.11n (40MHz)		54 to 62	54, 62	OFDM	BPSK	MCS0
-	802.11ac (80MHz)		58	58	OFDM	BPSK	V0
-	802.11a	5500-5700	100 to 140	100, 116, 140	OFDM	BPSK	6.0
-	802.11n (20MHz)		100 to 140	100, 116, 140	OFDM	BPSK	MCS0
-	802.11n (40MHz)		102 to 134	102, 110, 134	OFDM	BPSK	MCS0
-	802.11ac (80MHz)		106 to 122	106, 122	OFDM	BPSK	V0
-	802.11a	5745-5825	149 to 165	149, 157, 165	OFDM	BPSK	6.0
-	802.11n (20MHz)		149 to 165	149, 157, 165	OFDM	BPSK	MCS0
-	802.11n (40MHz)		151 to 159	151, 159	OFDM	BPSK	MCS0
-	802.11ac (80MHz)		155	155	OFDM	BPSK	V0

Radiated Emission Test (Below 1GHz):

- Pre-Scan has been conducted to determine the worst-case mode from all possible combinations between available modulations, data rates and antenna ports (if EUT with antenna diversity architecture).
- Following channel(s) was (were) selected for the final test as listed below.

EUT Configure Mode	Mode	Frequency Band (MHz)	Available Channel	Tested Channel	Modulation Technology	Modulation Type	Data Rate (Mbps)
-	802.11n (20MHz)	5180-5240	36 to 48	36	OFDM	BPSK	6.0
-	802.11n (20MHz)	5260-5320	52 to 64	60	OFDM	BPSK	6.0
-	802.11n (40MHz)	5500-5700	102 to 134	102	OFDM	BPSK	MCS0
-	802.11n (40MHz)	5745-5825	151 to 159	151	OFDM	BPSK	MCS0



Power Line Conducted Emission Test:

- Pre-Scan has been conducted to determine the worst-case mode from all possible combinations between available modulations, data rates and antenna ports (if EUT with antenna diversity architecture).
- Following channel(s) was (were) selected for the final test as listed below.

EUT Configure Mode	Mode	Frequency Band (MHz)	Available Channel	Tested Channel	Modulation Technology	Modulation Type	Data Rate (Mbps)
-	802.11n (40MHz)	5500-5700	102 to 134	102	OFDM	BPSK	MCS0

Antenna Port Conducted Measurement:

- This item includes all test value of each mode, but only includes spectrum plot of worst value of each mode.
- Pre-Scan has been conducted to determine the worst-case mode from all possible combinations between available modulations, data rates and antenna ports (if EUT with antenna diversity architecture).
- Following channel(s) was (were) selected for the final test as listed below.

EUT Configure Mode	Mode	Frequency Band (MHz)	Available Channel	Tested Channel	Modulation Technology	Modulation Type	Data Rate (Mbps)
-	802.11a	5180-5240	36 to 48	36, 40, 48	OFDM	BPSK	6.0
-	802.11n (20MHz)		36 to 48	36, 40, 48	OFDM	BPSK	MCS0
-	802.11n (40MHz)		38 to 46	38, 46	OFDM	BPSK	MCS0
-	802.11ac (80MHz)		42	42	OFDM	BPSK	V0
-	802.11a	5260-5320	52 to 64	52, 60, 64	OFDM	BPSK	6.0
-	802.11n (20MHz)		52 to 64	52, 60, 64	OFDM	BPSK	MCS0
-	802.11n (40MHz)		54 to 62	54, 62	OFDM	BPSK	MCS0
-	802.11ac (80MHz)		58	58	OFDM	BPSK	V0
-	802.11a	5500-5700	100 to 140	100, 116, 140	OFDM	BPSK	6.0
-	802.11n (20MHz)		100 to 140	100, 116, 140	OFDM	BPSK	MCS0
-	802.11n (40MHz)		102 to 134	102, 110, 134	OFDM	BPSK	MCS0
-	802.11ac (80MHz)		106 to 122	106, 122	OFDM	BPSK	V0
-	802.11a	5745-5825	149 to 165	149, 157, 165	OFDM	BPSK	6.0
-	802.11n (20MHz)		149 to 165	149, 157, 165	OFDM	BPSK	MCS0
-	802.11n (40MHz)		151 to 159	151, 159	OFDM	BPSK	MCS0
-	802.11ac (80MHz)		155	155	OFDM	BPSK	V0

Test Condition:

Applicable To	Environmental Conditions	Input Power	Tested by
RE≥1G	25deg. C, 65%RH	120Vac, 60Hz	Gavin Wu
RE<1G	25deg. C, 65%RH	120Vac, 60Hz	Gavin Wu
PLC	25deg. C, 65%RH	120Vac, 60Hz	Toby Tian
APCM	25deg. C, 65%RH	3.85Vdc	Carlos Chen

3.3 Duty Cycle of Test Signal

MODULATION TYPE: BPSK

Duty cycle of test signal is < 98%, duty factor is required.

802.11a: Duty cycle = 1.034/1.242 = 0.832, Duty factor = $10 \cdot \log(1/0.832) = 0.80$

802.11n (20MHz): Duty cycle = 961.54/1169.87 = 0.822, Duty factor = $10 \cdot \log(1/0.822) = 0.85$

802.11n (40MHz): Duty cycle = 456.73/689.10 = 0.663, Duty factor = $10 \cdot \log(1/0.663) = 1.79$

802.11ac (80MHz): Duty cycle = 216.35/448.72 = 0.482, Duty factor = $10 \cdot \log(1/0.482) = 3.17$

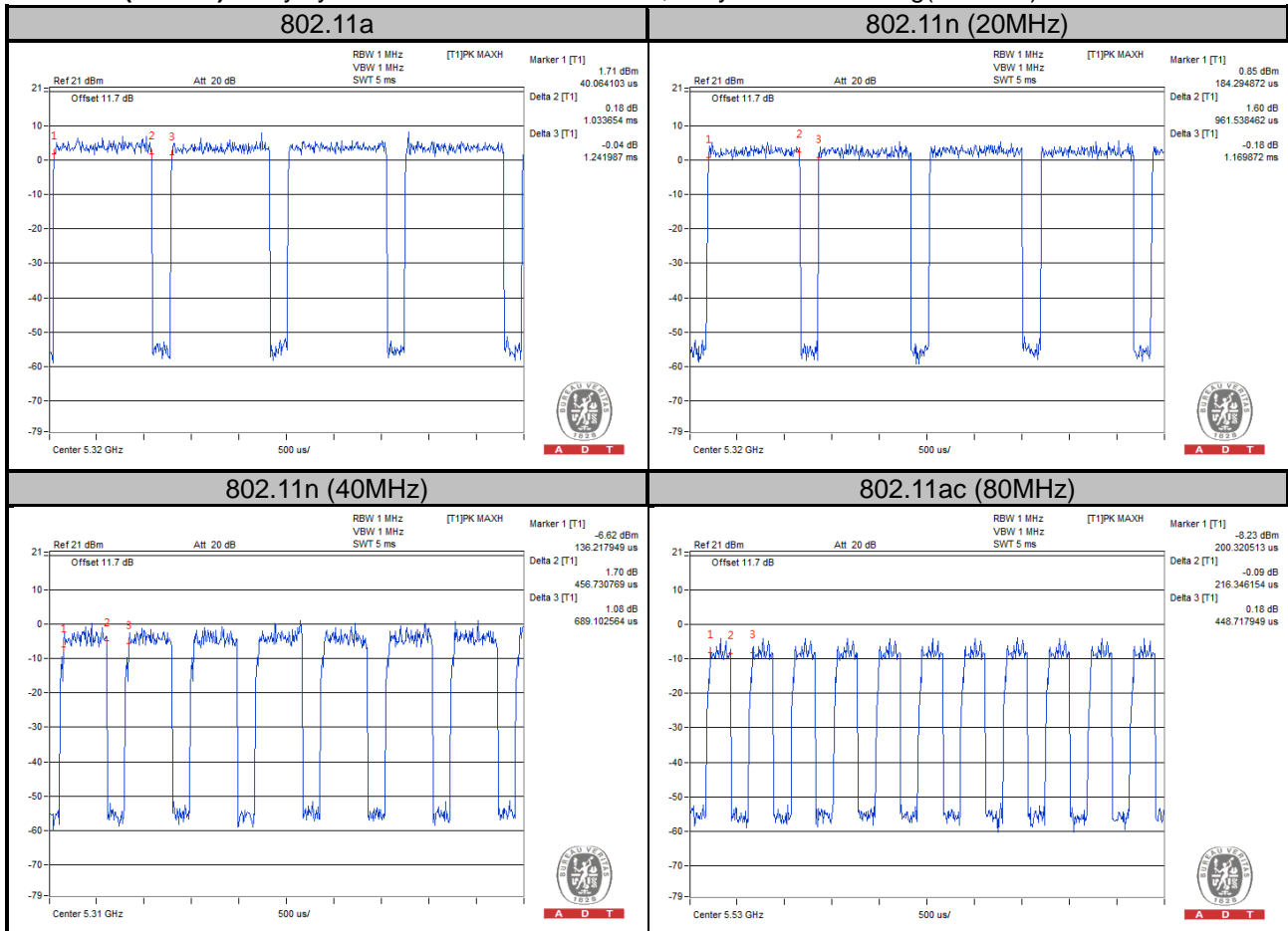

MODULATION TYPE: QPSK

Duty cycle of test signal is < 98%, duty factor is required.

802.11a: Duty cycle = $520.83/729.17 = 0.714$, Duty factor = $10 * \log(1/0.714) = 1.46$

802.11n (20MHz): Duty cycle = $496.79/705.13 = 0.705$, Duty factor = $10 * \log(1/0.705) = 1.52$

802.11n (40MHz): Duty cycle = $232.37/464.74 = 0.5$, Duty factor = $10 * \log(1/0.5) = 3.01$

802.11ac (80MHz): Duty cycle = $112.18/346.15 = 0.324$, Duty factor = $10 * \log(1/0.324) = 4.89$

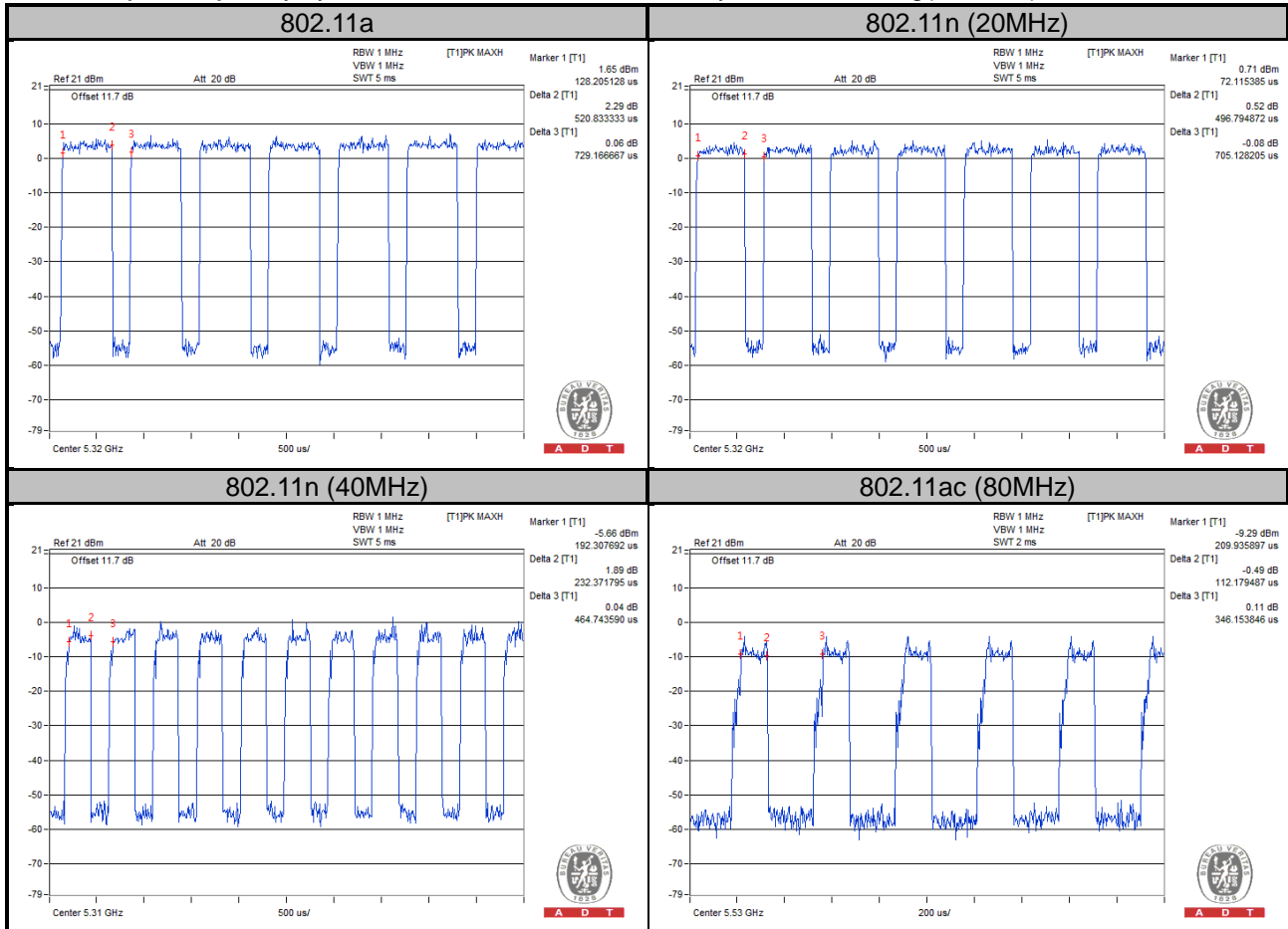

MODULATION TYPE: 16QAM

Duty cycle of test signal is < 98%, duty factor is required.

802.11a: Duty cycle = $256.41/464.74 = 0.552$, Duty factor = $10 * \log(1/0.552) = 2.58$

802.11n (20MHz): Duty cycle = $264.42/472.76 = 0.559$, Duty factor = $10 * \log(1/0.559) = 2.52$

802.11n (40MHz): Duty cycle = $120.19/352.56 = 0.341$, Duty factor = $10 * \log(1/0.341) = 4.67$

802.11ac (80MHz): Duty cycle = $57.69/294.87 = 0.196$, Duty factor = $10 * \log(1/0.196) = 7.09$

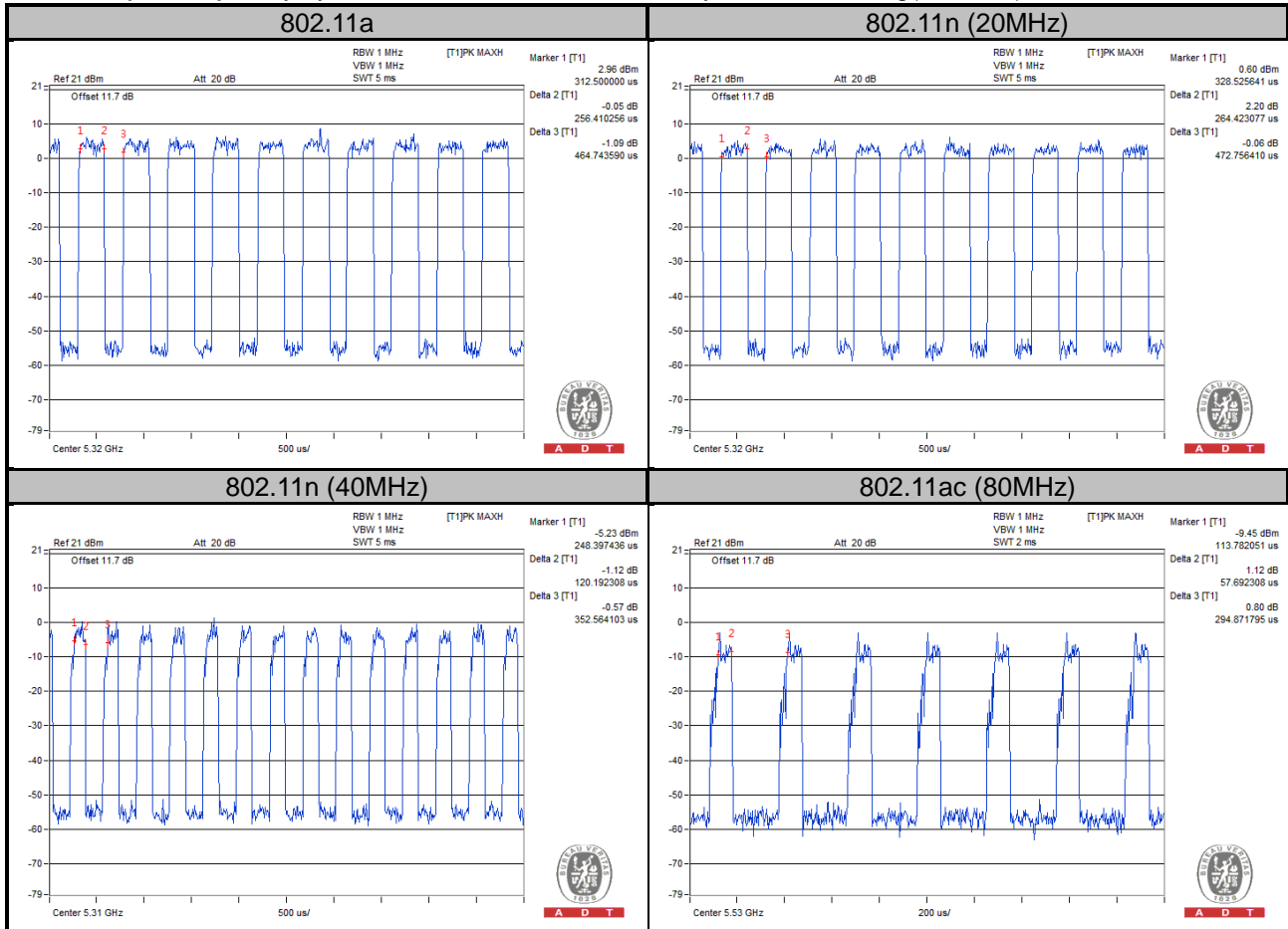

MODULATION TYPE: 64QAM

Duty cycle of test signal is < 98%, duty factor is required.

802.11a: Duty cycle = $120.19/336.54 = 0.357$, Duty factor = $10 * \log(1/0.357) = 4.47$

802.11n (20MHz): Duty cycle = $144.23/352.56 = 0.409$, Duty factor = $10 * \log(1/0.409) = 3.88$

802.11n (40MHz): Duty cycle = $64.10/296.47 = 0.216$, Duty factor = $10 * \log(1/0.216) = 6.65$

802.11ac (80MHz): Duty cycle = $38.46/272.44 = 0.141$, Duty factor = $10 * \log(1/0.141) = 8.50$



MODULATION TYPE: 256QAM

Duty cycle of test signal is < 98%, duty factor is required.

802.11ac (80MHz): Duty cycle = $24.04/261.22 = 0.092$, Duty factor = $10 * \log(1/0.092) = 10.36$

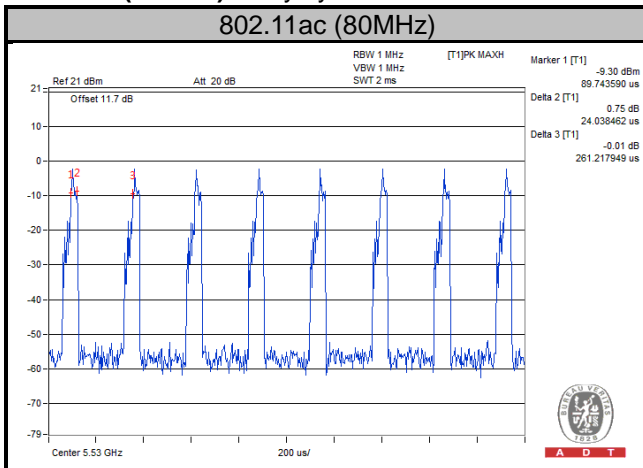

3.4 Description of Support Units

The EUT has been tested as an independent unit together with other necessary accessories or support units.

3.4.1 Configuration of System under Test

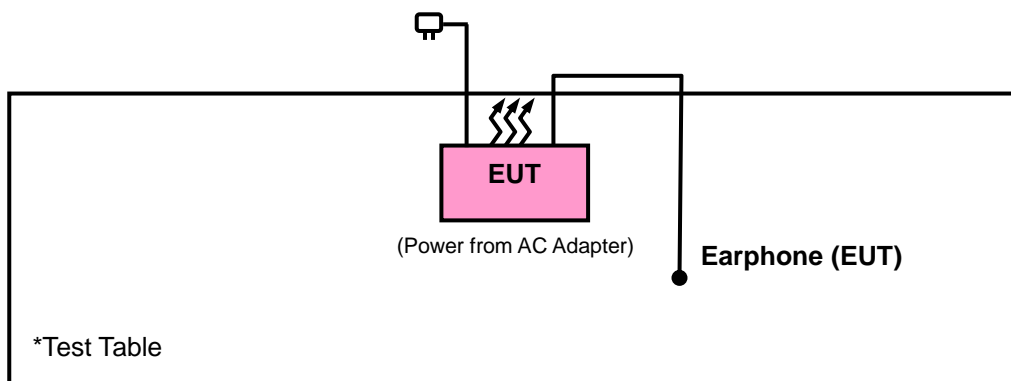

3.5 General Description of Applied Standards

The EUT is a RF Product. According to the specifications of the manufacturer, it must comply with the requirements of the following standards:

FCC Part 15, Subpart E (15.407)

789033 D02 General UNII Test Procedures New Rules v01

644545 D01 Guidance for IEEE 802 11ac v01r02

ANSI C63.10-2013

All test items have been performed and recorded as per the above standards.

NOTE: The EUT has been verified to comply with the requirements of FCC Part 15, Subpart B, Class B (DoC). The test report has been issued separately.

4 Test Types and Results

4.1 Radiated Emission and Bandedge Measurement

4.1.1 Limits of Radiated Emission and Bandedge Measurement

Radiated emissions which fall in the restricted bands must comply with the radiated emission limits specified as below table. Other emissions shall be at least 20dB below the highest level of the desired power:

Frequencies (MHz)	Field Strength (microvolts/meter)	Measurement Distance (meters)
0.009 ~ 0.490	2400/F(kHz)	300
0.490 ~ 1.705	24000/F(kHz)	30
1.705 ~ 30.0	30	30
30 ~ 88	100	3
88 ~ 216	150	3
216 ~ 960	200	3
Above 960	500	3

NOTE:

1. The lower limit shall apply at the transition frequencies.
2. Emission level (dBuV/m) = 20 log Emission level (uV/m).
3. For frequencies above 1000MHz, the field strength limits are based on average detector, however, the peak field strength of any emission shall not exceed the maximum permitted average limits, specified above by more than 20dB under any condition of modulation.

4.1.2 Limits of Unwanted Emission Out of The Restricted Bands

Applicable To	Limit	
789033 D02 General UNII Test Procedures New Rules v01	Field Strength AT 3m	
	PK:74 (dBµV/m)	AV:54 (dBµV/m)
Applicable To	EIRP Limit	Equivalent Field Strength At 3m
15.407(b)(1)	PK:-27 (dBm/MHz)	PK:68.2(dBµV/m)
15.407(b)(2)		
15.407(b)(3)		
15.407(b)(4)	PK:-27 (dBm/MHz) ^{*1} PK:-17 (dBm/MHz) ^{*2}	PK: 68.2(dBµV/m) ^{*1} PK:78.2 (dBµV/m) ^{*2}

NOTE: ^{*1} beyond 10MHz of the band edge ^{*2} within 10 MHz of band edge

The following formula is used to convert the equipment isotropic radiated power (eirp) to field strength:

$$E = \frac{1000000\sqrt{30P}}{3} \mu\text{V/m, where P is the eirp (Watts).}$$

4.1.3 Test Instruments

Description & Manufacturer	Model No.	Serial No.	Date of Calibration	Due Date of Calibration
Test Receiver Agilent	N9038A	MY51210203	Jan. 21, 2015	Jan. 21, 2016
Spectrum Analyzer Agilent	N9010A	MY52220314	Sep. 03, 2015	Sep. 02, 2016
Spectrum Analyzer ROHDE & SCHWARZ	FSU43	101261	Dec. 10, 2014	Dec. 09, 2015
BILOG Antenna SCHWARZBECK	VULB9168	9168-472	Feb. 04, 2015	Feb. 04, 2016
HORN Antenna SCHWARZBECK	BBHA 9120 D	9120D-969	Feb. 09, 2015	Feb. 09, 2016
HORN Antenna SCHWARZBECK	BBHA 9170	9170-480	Feb. 04, 2015	Feb. 04, 2016
Loop Antenna	EM-6879	269	Jul. 31, 2015	Jul. 30, 2016
Preamplifier EMCI	EMC 012645	980115	Dec. 12, 2014	Dec. 11, 2015
Preamplifier EMCI	EMC 184045	980116	Jan. 09, 2015	Jan. 08, 2016
Preamplifier EMCI	EMC 330H	980112	Dec. 27, 2014	Dec. 26, 2015
Power Meter Anritsu	ML2495A	1232002	Sep. 17, 2014	Sep. 16, 2015
Power Sensor Anritsu	MA2411B	1207325	Sep. 17, 2014	Sep. 16, 2015
RF signal cable HUBER+SUHNNER	SUCOFLEX 104	309219/4 2950114	Oct. 18, 2014	Oct. 17, 2015
RF signal cable HUBER+SUHNNER	SUCOFLEX 104	250130/4	Oct. 18, 2014	Oct. 17, 2015
RF Coaxial Cable Worken	8D-FB	Cable-Ch10-01	Nov. 07, 2014	Nov. 06, 2015
Software BV ADT	E3 6.120103	NA	NA	NA
Antenna Tower MF	MFA-440H	NA	NA	NA
Turn Table MF	MFT-201SS	NA	NA	NA
Antenna Tower & Turn Table Controller MF	MF-7802	NA	NA	NA

- Note: 1. The calibration interval of the above test instruments is 12 / 24 months and the calibrations are traceable to NML/ROC and NIST/USA.
2. The test was performed in HwaYa Chamber 10.
3. The horn antenna and preamplifier (model: EMC 184045) are used only for the measurement of emission frequency above 1GHz if tested.
4. The FCC Site Registration No. is 690701.
5. The IC Site Registration No. is IC7450F-10.

4.1.4 Test Procedures

- a. The EUT was placed on the top of a rotating table 0.8 meters (for below 1GHz) / 1.5 meters (for above 1GHz) above the ground at 3 meter chamber room for test. The table was rotated 360 degrees to determine the position of the highest radiation.
- b. The EUT was set 3 meters away from the interference-receiving antenna, which was mounted on the top of a variable-height antenna tower.
- c. The height of antenna is varied from one meter to four meters above the ground to determine the maximum value of the field strength. Both horizontal and vertical polarizations of the antenna are set to make the measurement.
- d. For each suspected emission, the EUT was arranged to its worst case and then the antenna was tuned to heights from 1 meter to 4 meters and the rotatable table was turned from 0 degrees to 360 degrees to find the maximum reading.
- e. The test-receiver system was set to quasi-peak detect function and specified bandwidth with maximum hold mode when the test frequency is below 1 GHz.
- f. The test-receiver system was set to peak and average detect function and specified bandwidth with maximum hold mode when the test frequency is above 1 GHz. If the peak reading value also meets average limit, measurement with the average detector is unnecessary.

Note:

1. The resolution bandwidth and video bandwidth of test receiver/spectrum analyzer is 120kHz for Quasi-peak detection (QP) at frequency below 1GHz.
2. The resolution bandwidth of test receiver/spectrum analyzer is 1 MHz and the video bandwidth is 3 MHz for Peak detection (PK) at frequency above 1GHz.
3. The resolution bandwidth of test receiver/spectrum analyzer is 1MHz and the video bandwidth is 3MHz for RMS Average (Duty cycle < 98%) for Average detection (AV) at frequency above 1GHz, then the measurement results was added to a correction factor ($10 \log(1/\text{duty cycle})$).
4. The resolution bandwidth of test receiver/spectrum analyzer is 1MHz and the video bandwidth is 10Hz (Duty cycle \geq 98%) for Average detection (AV) at frequency above 1GHz.
5. All modes of operation were investigated and the worst-case emissions are reported.

4.1.5 Deviation from Test Standard

No deviation.

4.1.6 Test Set Up

<Frequency Range below 1GHz>

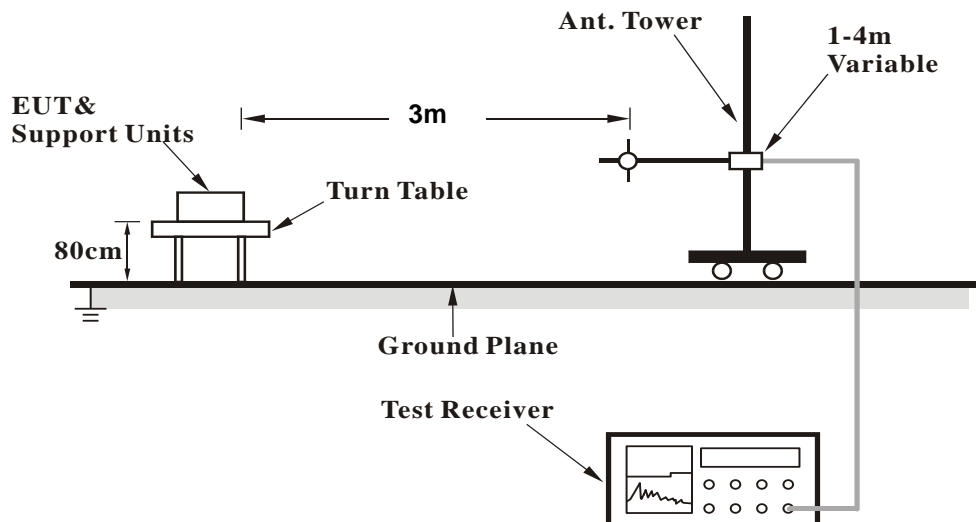

<Frequency Range above 1GHz>

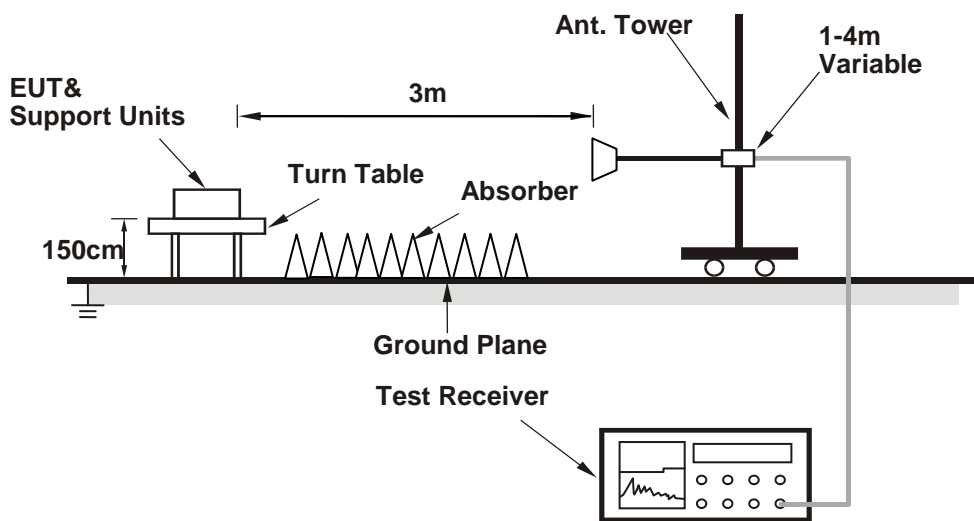

For the actual test configuration, please refer to the attached file (Test Setup Photo).

4.1.7 EUT Operating Conditions

- Placed the EUT on a testing table.
- Use the software to control the EUT under transmission condition continuously at specific channel frequency.

4.1.8 Test Results
ABOVE 1GHz DATA :
802.11a

EUT TEST CONDITION		MEASUREMENT DETAIL	
CHANNEL	Channel 36	FREQUENCY RANGE	1GHz ~ 40GHz
INPUT POWER	120Vac, 60 Hz	DETECTOR FUNCTION	Peak (PK) Average (AV)
ENVIRONMENTAL CONDITIONS	25deg. C, 65%RH	TESTED BY	Gavin Wu

ANTENNA POLARITY & TEST DISTANCE: HORIZONTAL AT 3 M										
FREQ. (MHz)	EMISSION LEVEL (dBuV/m)	READ LEVEL (dBuV)	LIMIT (dBuV/m)	MARGIN (dB)	ANTENNA FACTOR (dB/m)	CABLE LOSS (dB)	PREAMP FACTOR (dB)	ANTENNA HEIGHT (cm)	TABLE ANGLE (Degree)	REMARK
5012	42.94	42.83	54	-11.06	31.21	6.13	37.23	203	311	Average
5012	60.73	60.62	74	-13.27	31.21	6.13	37.23	203	311	Peak
5180	96.31	96.08			31.35	6.22	37.34	203	311	Average
5180	105.73	105.5			31.35	6.22	37.34	203	311	Peak
5444	38.64	37.88	54	-15.36	31.55	6.34	37.13	203	311	Average
5444	60.16	59.4	74	-13.84	31.55	6.34	37.13	203	311	Peak
ANTENNA POLARITY & TEST DISTANCE: VERTICAL AT 3 M										
FREQ. (MHz)	EMISSION LEVEL (dBuV/m)	READ LEVEL (dBuV)	LIMIT (dBuV/m)	MARGIN (dB)	ANTENNA FACTOR (dB/m)	CABLE LOSS (dB)	PREAMP FACTOR (dB)	ANTENNA HEIGHT (cm)	TABLE ANGLE (Degree)	REMARK
5028	39.01	38.87	54	-14.99	31.23	6.15	37.24	200	36	Average
5028	60.86	60.72	74	-13.14	31.23	6.15	37.24	200	36	Peak
5180	90.25	90.02			31.35	6.22	37.34	200	36	Average
5180	99.36	99.13			31.35	6.22	37.34	200	36	Peak
5370	38.5	37.88	54	-15.5	31.49	6.31	37.18	200	36	Average
5370	59.96	59.34	74	-14.04	31.49	6.31	37.18	200	36	Peak

REMARKS:

- Emission Level = Read Level + Antenna Factor + Cable Loss - Preamp Factor
Margin value = Emission level – Limit value
- 5180MHz: Fundamental frequency.



A D T

EUT TEST CONDITION		MEASUREMENT DETAIL	
CHANNEL	Channel 44	FREQUENCY RANGE	1GHz ~ 40GHz
INPUT POWER	120Vac, 60 Hz	DETECTOR FUNCTION	Peak (PK) Average (AV)
ENVIRONMENTAL CONDITIONS	25deg. C, 65%RH	TESTED BY	Gavin Wu

ANTENNA POLARITY & TEST DISTANCE: HORIZONTAL AT 3 M										
FREQ. (MHz)	EMISSION LEVEL (dBuV/m)	READ LEVEL (dBuV)	LIMIT (dBuV/m)	MARGIN (dB)	ANTENNA FACTOR (dB/m)	CABLE LOSS (dB)	PREAMP FACTOR (dB)	ANTENNA HEIGHT (cm)	TABLE ANGLE (Degree)	REMARK
5134	38.6	38.39	54	-15.4	31.31	6.2	37.3	198	325	Average
5134	60.75	60.54	74	-13.25	31.31	6.2	37.3	198	325	Peak
5220	96.84	96.59			31.37	6.24	37.36	198	325	Average
5220	106.41	106.16			31.37	6.24	37.36	198	325	Peak
5414	38.62	37.95	54	-15.38	31.53	6.32	37.18	198	325	Average
5414	61.01	60.34	74	-12.99	31.53	6.32	37.18	198	325	Peak

ANTENNA POLARITY & TEST DISTANCE: VERTICAL AT 3 M										
FREQ. (MHz)	EMISSION LEVEL (dBuV/m)	READ LEVEL (dBuV)	LIMIT (dBuV/m)	MARGIN (dB)	ANTENNA FACTOR (dB/m)	CABLE LOSS (dB)	PREAMP FACTOR (dB)	ANTENNA HEIGHT (cm)	TABLE ANGLE (Degree)	REMARK
5022	38.12	37.98	54	-15.88	31.23	6.15	37.24	197	29	Average
5022	60.34	60.2	74	-13.66	31.23	6.15	37.24	197	29	Peak
5220	90.76	90.51			31.37	6.24	37.36	197	29	Average
5220	99.93	99.68			31.37	6.24	37.36	197	29	Peak
5406	38.57	37.91	54	-15.43	31.52	6.32	37.18	197	29	Average
5406	59.73	59.07	74	-14.27	31.52	6.32	37.18	197	29	Peak

REMARKS:

1. Emission Level = Read Level + Antenna Factor + Cable Loss - Preamp Factor
Margin value = Emission level – Limit value
2. 5220MHz: Fundamental frequency.



A D T

EUT TEST CONDITION		MEASUREMENT DETAIL	
CHANNEL	Channel 48	FREQUENCY RANGE	1GHz ~ 40GHz
INPUT POWER	120Vac, 60 Hz	DETECTOR FUNCTION	Peak (PK) Average (AV)
ENVIRONMENTAL CONDITIONS	25deg. C, 65%RH	TESTED BY	Gavin Wu

ANTENNA POLARITY & TEST DISTANCE: HORIZONTAL AT 3 M										
FREQ. (MHz)	EMISSION LEVEL (dBuV/m)	READ LEVEL (dBuV)	LIMIT (dBuV/m)	MARGIN (dB)	ANTENNA FACTOR (dB/m)	CABLE LOSS (dB)	PREAMP FACTOR (dB)	ANTENNA HEIGHT (cm)	TABLE ANGLE (Degree)	REMARK
5046	38.55	38.41	54	-15.45	31.24	6.15	37.25	206	305	Average
5046	60.62	60.48	74	-13.38	31.24	6.15	37.25	206	305	Peak
5240	96.88	96.56			31.39	6.25	37.32	206	305	Average
5240	106.34	106.02			31.39	6.25	37.32	206	305	Peak
5458	39.09	38.27	54	-14.91	31.56	6.34	37.08	206	305	Average
5458	60.93	60.11	74	-13.07	31.56	6.34	37.08	206	305	Peak

ANTENNA POLARITY & TEST DISTANCE: VERTICAL AT 3 M										
FREQ. (MHz)	EMISSION LEVEL (dBuV/m)	READ LEVEL (dBuV)	LIMIT (dBuV/m)	MARGIN (dB)	ANTENNA FACTOR (dB/m)	CABLE LOSS (dB)	PREAMP FACTOR (dB)	ANTENNA HEIGHT (cm)	TABLE ANGLE (Degree)	REMARK
5028	38.26	38.12	54	-15.74	31.23	6.15	37.24	200	42	Average
5028	59.63	59.49	74	-14.37	31.23	6.15	37.24	200	42	Peak
5240	90.59	90.27			31.39	6.25	37.32	200	42	Average
5240	99.88	99.56			31.39	6.25	37.32	200	42	Peak
5444	38.77	38.01	54	-15.23	31.55	6.34	37.13	200	42	Average
5444	60.43	59.67	74	-13.57	31.55	6.34	37.13	200	42	Peak

REMARKS:

- Emission Level = Read Level + Antenna Factor + Cable Loss - Preamp Factor
Margin value = Emission level – Limit value
- 5240MHz: Fundamental frequency.



A D T

EUT TEST CONDITION		MEASUREMENT DETAIL	
CHANNEL	Channel 52	FREQUENCY RANGE	1GHz ~ 40GHz
INPUT POWER	120Vac, 60 Hz	DETECTOR FUNCTION	Peak (PK) Average (AV)
ENVIRONMENTAL CONDITIONS	25deg. C, 65%RH	TESTED BY	Gavin Wu

ANTENNA POLARITY & TEST DISTANCE: HORIZONTAL AT 3 M										
FREQ. (MHz)	EMISSION LEVEL (dBuV/m)	READ LEVEL (dBuV)	LIMIT (dBuV/m)	MARGIN (dB)	ANTENNA FACTOR (dB/m)	CABLE LOSS (dB)	PREAMP FACTOR (dB)	ANTENNA HEIGHT (cm)	TABLE ANGLE (Degree)	REMARK
5080	38.35	38.18	54	-15.65	31.27	6.17	37.27	196	312	Average
5080	60.31	60.14	74	-13.69	31.27	6.17	37.27	196	312	Peak
5260	95.91	95.52			31.41	6.25	37.27	196	312	Average
5260	104.92	104.53			31.41	6.25	37.27	196	312	Peak
5436	38.58	37.84	54	-15.42	31.55	6.32	37.13	196	312	Average
5436	61.22	60.48	74	-12.78	31.55	6.32	37.13	196	312	Peak

ANTENNA POLARITY & TEST DISTANCE: VERTICAL AT 3 M										
FREQ. (MHz)	EMISSION LEVEL (dBuV/m)	READ LEVEL (dBuV)	LIMIT (dBuV/m)	MARGIN (dB)	ANTENNA FACTOR (dB/m)	CABLE LOSS (dB)	PREAMP FACTOR (dB)	ANTENNA HEIGHT (cm)	TABLE ANGLE (Degree)	REMARK
5120	38.17	37.99	54	-15.83	31.29	6.19	37.3	192	281	Average
5120	60.88	60.7	74	-13.12	31.29	6.19	37.3	192	281	Peak
5260	90.64	90.25			31.41	6.25	37.27	192	281	Average
5260	99.47	99.08			31.41	6.25	37.27	192	281	Peak
5444	38.54	37.78	54	-15.46	31.55	6.34	37.13	192	281	Average
5444	61.32	60.56	74	-12.68	31.55	6.34	37.13	192	281	Peak

REMARKS:

- Emission Level = Read Level + Antenna Factor + Cable Loss - Preamp Factor
Margin value = Emission level – Limit value
- 5260MHz: Fundamental frequency.



A D T

EUT TEST CONDITION		MEASUREMENT DETAIL	
CHANNEL	Channel 60	FREQUENCY RANGE	1GHz ~ 40GHz
INPUT POWER	120Vac, 60 Hz	DETECTOR FUNCTION	Peak (PK) Average (AV)
ENVIRONMENTAL CONDITIONS	25deg. C, 65%RH	TESTED BY	Gavin Wu

ANTENNA POLARITY & TEST DISTANCE: HORIZONTAL AT 3 M										
FREQ. (MHz)	EMISSION LEVEL (dBuV/m)	READ LEVEL (dBuV)	LIMIT (dBuV/m)	MARGIN (dB)	ANTENNA FACTOR (dB/m)	CABLE LOSS (dB)	PREAMP FACTOR (dB)	ANTENNA HEIGHT (cm)	TABLE ANGLE (Degree)	REMARK
5136	38.48	38.27	54	-15.52	31.31	6.2	37.3	196	312	Average
5136	60.31	60.1	74	-13.69	31.31	6.2	37.3	196	312	Peak
5300	95.84	95.32			31.44	6.27	37.19	196	312	Average
5300	105.28	104.76			31.44	6.27	37.19	196	312	Peak
5364	42.12	41.5	54	-11.88	31.49	6.31	37.18	196	312	Average
5364	61.03	60.41	74	-12.97	31.49	6.31	37.18	196	312	Peak

ANTENNA POLARITY & TEST DISTANCE: VERTICAL AT 3 M										
FREQ. (MHz)	EMISSION LEVEL (dBuV/m)	READ LEVEL (dBuV)	LIMIT (dBuV/m)	MARGIN (dB)	ANTENNA FACTOR (dB/m)	CABLE LOSS (dB)	PREAMP FACTOR (dB)	ANTENNA HEIGHT (cm)	TABLE ANGLE (Degree)	REMARK
5008	38.06	37.95	54	-15.94	31.21	6.13	37.23	200	281	Average
5008	60.33	60.22	74	-13.67	31.21	6.13	37.23	200	281	Peak
5300	90.73	90.21			31.44	6.27	37.19	200	281	Average
5300	99.99	99.47			31.44	6.27	37.19	200	281	Peak
5424	39.72	39.05	54	-14.28	31.53	6.32	37.18	200	281	Average
5424	61.21	60.54	74	-12.79	31.53	6.32	37.18	200	281	Peak

REMARKS:

1. Emission Level = Read Level + Antenna Factor + Cable Loss - Preamp Factor
Margin value = Emission level – Limit value
2. 5300MHz: Fundamental frequency.



EUT TEST CONDITION		MEASUREMENT DETAIL	
CHANNEL	Channel 64	FREQUENCY RANGE	1GHz ~ 40GHz
INPUT POWER	120Vac, 60 Hz	DETECTOR FUNCTION	Peak (PK) Average (AV)
ENVIRONMENTAL CONDITIONS	25deg. C, 65%RH	TESTED BY	Gavin Wu

ANTENNA POLARITY & TEST DISTANCE: HORIZONTAL AT 3 M										
FREQ. (MHz)	EMISSION LEVEL (dBuV/m)	READ LEVEL (dBuV)	LIMIT (dBuV/m)	MARGIN (dB)	ANTENNA FACTOR (dB/m)	CABLE LOSS (dB)	PREAMP FACTOR (dB)	ANTENNA HEIGHT (cm)	TABLE ANGLE (Degree)	REMARK
5072	38.68	38.51	54	-15.32	31.27	6.17	37.27	186	313	Average
5072	60.53	60.36	74	-13.47	31.27	6.17	37.27	186	313	Peak
5320	95.49	94.94			31.45	6.29	37.19	186	313	Average
5320	104.81	104.26			31.45	6.29	37.19	186	313	Peak
5444	43.16	42.4	54	-10.84	31.55	6.34	37.13	186	313	Average
5444	60.74	59.98	74	-13.26	31.55	6.34	37.13	186	313	Peak
ANTENNA POLARITY & TEST DISTANCE: VERTICAL AT 3 M										
FREQ. (MHz)	EMISSION LEVEL (dBuV/m)	READ LEVEL (dBuV)	LIMIT (dBuV/m)	MARGIN (dB)	ANTENNA FACTOR (dB/m)	CABLE LOSS (dB)	PREAMP FACTOR (dB)	ANTENNA HEIGHT (cm)	TABLE ANGLE (Degree)	REMARK
5024	38.17	38.03	54	-15.83	31.23	6.15	37.24	200	281	Average
5024	62.13	61.99	74	-11.87	31.23	6.15	37.24	200	281	Peak
5320	91.02	90.47			31.45	6.29	37.19	200	281	Average
5320	100.77	100.22			31.45	6.29	37.19	200	281	Peak
5444	40.25	39.49	54	-13.75	31.55	6.34	37.13	200	281	Average
5444	60.53	59.77	74	-13.47	31.55	6.34	37.13	200	281	Peak

REMARKS:

- Emission Level = Read Level + Antenna Factor + Cable Loss - Preamp Factor
Margin value = Emission level – Limit value
- 5320MHz: Fundamental frequency.



A D T

EUT TEST CONDITION		MEASUREMENT DETAIL	
CHANNEL	Channel 100	FREQUENCY RANGE	1GHz ~ 40GHz
INPUT POWER	120Vac, 60 Hz	DETECTOR FUNCTION	Peak (PK) Average (AV)
ENVIRONMENTAL CONDITIONS	25deg. C, 65%RH	TESTED BY	Gavin Wu

ANTENNA POLARITY & TEST DISTANCE: HORIZONTAL AT 3 M										
FREQ. (MHz)	EMISSION LEVEL (dBuV/m)	READ LEVEL (dBuV)	LIMIT (dBuV/m)	MARGIN (dB)	ANTENNA FACTOR (dB/m)	CABLE LOSS (dB)	PREAMP FACTOR (dB)	ANTENNA HEIGHT (cm)	TABLE ANGLE (Degree)	REMARK
5448	43.85	43.08	54	-10.15	31.56	6.34	37.13	204	300	Average
5448	61.65	60.88	74	-12.35	31.56	6.34	37.13	204	300	Peak
5470	60.18	59.35	68.2	-8.02	31.57	6.34	37.08	204	300	Peak
5500	96.09	95.16			31.6	6.36	37.03	204	300	Average
5500	105.9	104.97			31.6	6.36	37.03	204	300	Peak
5725	61.57	60.29	68.2	-6.63	31.96	6.75	37.43	204	300	Peak
ANTENNA POLARITY & TEST DISTANCE: VERTICAL AT 3 M										
FREQ. (MHz)	EMISSION LEVEL (dBuV/m)	READ LEVEL (dBuV)	LIMIT (dBuV/m)	MARGIN (dB)	ANTENNA FACTOR (dB/m)	CABLE LOSS (dB)	PREAMP FACTOR (dB)	ANTENNA HEIGHT (cm)	TABLE ANGLE (Degree)	REMARK
5410	41.2	40.54	54	-12.8	31.52	6.32	37.18	196	287	Average
5410	60.03	59.37	74	-13.97	31.52	6.32	37.18	196	287	Peak
5470	58.22	57.39	68.2	-9.98	31.57	6.34	37.08	196	287	Peak
5500	93.09	92.16			31.6	6.36	37.03	196	287	Average
5500	102.93	102			31.6	6.36	37.03	196	287	Peak
5725	60.21	58.93	68.2	-7.99	31.96	6.75	37.43	196	287	Peak

REMARKS:

- Emission Level = Read Level + Antenna Factor + Cable Loss - Preamp Factor
Margin value = Emission level – Limit value
- 5500MHz: Fundamental frequency.
- 5470MHz & 5725MHz: Out of restricted band



A D T

EUT TEST CONDITION		MEASUREMENT DETAIL	
CHANNEL	Channel 116	FREQUENCY RANGE	1GHz ~ 40GHz
INPUT POWER	120Vac, 60 Hz	DETECTOR FUNCTION	Peak (PK) Average (AV)
ENVIRONMENTAL CONDITIONS	25deg. C, 65%RH	TESTED BY	Gavin Wu

ANTENNA POLARITY & TEST DISTANCE: HORIZONTAL AT 3 M										
FREQ. (MHz)	EMISSION LEVEL (dBuV/m)	READ LEVEL (dBuV)	LIMIT (dBuV/m)	MARGIN (dB)	ANTENNA FACTOR (dB/m)	CABLE LOSS (dB)	PREAMP FACTOR (dB)	ANTENNA HEIGHT (cm)	TABLE ANGLE (Degree)	REMARK
5450	38.81	37.99	54	-15.19	31.56	6.34	37.08	191	300	Average
5450	62.02	61.2	74	-11.98	31.56	6.34	37.08	191	300	Peak
5470	59.17	58.34	68.2	-9.03	31.57	6.34	37.08	191	300	Peak
5580	95.43	94.39			31.71	6.49	37.16	191	300	Average
5580	105.16	104.12			31.71	6.49	37.16	191	300	Peak
5725	61.29	60.01	68.2	-6.91	31.96	6.75	37.43	191	300	Peak

ANTENNA POLARITY & TEST DISTANCE: VERTICAL AT 3 M										
FREQ. (MHz)	EMISSION LEVEL (dBuV/m)	READ LEVEL (dBuV)	LIMIT (dBuV/m)	MARGIN (dB)	ANTENNA FACTOR (dB/m)	CABLE LOSS (dB)	PREAMP FACTOR (dB)	ANTENNA HEIGHT (cm)	TABLE ANGLE (Degree)	REMARK
5450	38.56	37.74	54	-15.44	31.56	6.34	37.08	199	288	Average
5450	61.17	60.35	74	-12.83	31.56	6.34	37.08	199	288	Peak
5470	58.28	57.45	68.2	-9.92	31.57	6.34	37.08	199	288	Peak
5580	92.83	91.79			31.71	6.49	37.16	199	288	Average
5580	102.25	101.21			31.71	6.49	37.16	199	288	Peak
5725	60.04	58.76	68.2	-8.16	31.96	6.75	37.43	199	288	Peak

REMARKS:

- Emission Level = Read Level + Antenna Factor + Cable Loss - Preamp Factor
Margin value = Emission level – Limit value
- 5580MHz: Fundamental frequency.
- 5470MHz & 5725MHz: Out of restricted band



EUT TEST CONDITION		MEASUREMENT DETAIL	
CHANNEL	Channel 140	FREQUENCY RANGE	1GHz ~ 40GHz
INPUT POWER	120Vac, 60 Hz	DETECTOR FUNCTION	Peak (PK) Average (AV)
ENVIRONMENTAL CONDITIONS	25deg. C, 65%RH	TESTED BY	Gavin Wu

ANTENNA POLARITY & TEST DISTANCE: HORIZONTAL AT 3 M

FREQ. (MHz)	EMISSION LEVEL (dBuV/m)	READ LEVEL (dBuV)	LIMIT (dBuV/m)	MARGIN (dB)	ANTENNA FACTOR (dB/m)	CABLE LOSS (dB)	PREAMP FACTOR (dB)	ANTENNA HEIGHT (cm)	TABLE ANGLE (Degree)	REMARK
5438	38.74	37.98	54	-15.26	31.55	6.34	37.13	207	300	Average
5438	60.4	59.64	74	-13.6	31.55	6.34	37.13	207	300	Peak
5470	59.62	58.79	68.2	-8.58	31.57	6.34	37.08	207	300	Peak
5700	95.08	93.89			31.9	6.69	37.4	207	300	Average
5700	105.2	104.01			31.9	6.69	37.4	207	300	Peak
5725	60.11	58.83	68.2	-8.09	31.96	6.75	37.43	207	300	Peak

ANTENNA POLARITY & TEST DISTANCE: VERTICAL AT 3 M

FREQ. (MHz)	EMISSION LEVEL (dBuV/m)	READ LEVEL (dBuV)	LIMIT (dBuV/m)	MARGIN (dB)	ANTENNA FACTOR (dB/m)	CABLE LOSS (dB)	PREAMP FACTOR (dB)	ANTENNA HEIGHT (cm)	TABLE ANGLE (Degree)	REMARK
5460	38.56	37.74	54	-15.44	31.56	6.34	37.08	199	288	Average
5460	61.11	60.29	74	-12.89	31.56	6.34	37.08	199	288	Peak
5470	59.87	59.04	68.2	-8.33	31.57	6.34	37.08	199	288	Peak
5700	92.84	91.65			31.9	6.69	37.4	199	288	Average
5700	102.56	101.37			31.9	6.69	37.4	199	288	Peak
5725	60.74	59.46	68.2	-7.46	31.96	6.75	37.43	199	288	Peak

REMARKS:

- Emission Level = Read Level + Antenna Factor + Cable Loss - Preamp Factor
Margin value = Emission level – Limit value
- 5700MHz: Fundamental frequency.
- 5470MHz & 5725MHz: Out of restricted band

EUT TEST CONDITION		MEASUREMENT DETAIL	
CHANNEL	Channel 149	FREQUENCY RANGE	1GHz ~ 40GHz
INPUT POWER	120Vac, 60 Hz	DETECTOR FUNCTION	Peak (PK) Average (AV)
ENVIRONMENTAL CONDITIONS	25deg. C, 65%RH	TESTED BY	Gavin Wu

ANTENNA POLARITY & TEST DISTANCE: HORIZONTAL AT 3 M										
FREQ. (MHz)	EMISSION LEVEL (dBuV/m)	READ LEVEL (dBuV)	LIMIT (dBuV/m)	MARGIN (dB)	ANTENNA FACTOR (dB/m)	CABLE LOSS (dB)	PREAMP FACTOR (dB)	ANTENNA HEIGHT (cm)	TABLE ANGLE (Degree)	REMARK
*5714	60.07	58.88	68.2	-8.13	31.93	6.69	37.43	222	330	Peak
*5725	59.48	58.2	78.2	-18.72	31.96	6.75	37.43	222	330	Peak
5745	93.79	92.52			31.99	6.75	37.47	222	330	Average
5745	103.98	102.71			31.99	6.75	37.47	222	330	Peak
*5850	59.82	58.3	78.2	-18.38	32.15	6.88	37.51	222	330	Peak
*5861	59.27	57.64	68.2	-8.93	32.18	6.95	37.5	222	330	Peak
ANTENNA POLARITY & TEST DISTANCE: VERTICAL AT 3 M										
FREQ. (MHz)	EMISSION LEVEL (dBuV/m)	READ LEVEL (dBuV)	LIMIT (dBuV/m)	MARGIN (dB)	ANTENNA FACTOR (dB/m)	CABLE LOSS (dB)	PREAMP FACTOR (dB)	ANTENNA HEIGHT (cm)	TABLE ANGLE (Degree)	REMARK
*5714	60.24	59.05	68.2	-7.96	31.93	6.69	37.43	211	21	Peak
*5725	61.3	60.02	78.2	-16.9	31.96	6.75	37.43	211	21	Peak
5745	95.08	93.81			31.99	6.75	37.47	211	21	Average
5745	104.36	103.09			31.99	6.75	37.47	211	21	Peak
*5850	60.43	58.91	78.2	-17.77	32.15	6.88	37.51	211	21	Peak
*5861	60.79	59.16	68.2	-7.41	32.18	6.95	37.5	211	21	Peak

REMARKS:

- Emission Level = Read Level + Antenna Factor + Cable Loss - Preamp Factor
Margin value = Emission level – Limit value
- 5745MHz: Fundamental frequency.
- *: Out of restricted band



A D T

EUT TEST CONDITION		MEASUREMENT DETAIL	
CHANNEL	Channel 157	FREQUENCY RANGE	1GHz ~ 40GHz
INPUT POWER	120Vac, 60 Hz	DETECTOR FUNCTION	Peak (PK) Average (AV)
ENVIRONMENTAL CONDITIONS	25deg. C, 65%RH	TESTED BY	Gavin Wu

ANTENNA POLARITY & TEST DISTANCE: HORIZONTAL AT 3 M										
FREQ. (MHz)	EMISSION LEVEL (dBuV/m)	READ LEVEL (dBuV)	LIMIT (dBuV/m)	MARGIN (dB)	ANTENNA FACTOR (dB/m)	CABLE LOSS (dB)	PREAMP FACTOR (dB)	ANTENNA HEIGHT (cm)	TABLE ANGLE (Degree)	REMARK
*5714	59.84	58.65	68.2	-8.36	31.93	6.69	37.43	220	330	Peak
*5725	60.15	58.87	78.2	-18.05	31.96	6.75	37.43	220	330	Peak
5785	93.64	92.32			32.04	6.82	37.54	220	330	Average
5785	103.09	101.77			32.04	6.82	37.54	220	330	Peak
*5850	59.5	57.98	78.2	-18.7	32.15	6.88	37.51	220	330	Peak
*5861	59.91	58.28	68.2	-8.29	32.18	6.95	37.5	220	330	Peak
ANTENNA POLARITY & TEST DISTANCE: VERTICAL AT 3 M										
FREQ. (MHz)	EMISSION LEVEL (dBuV/m)	READ LEVEL (dBuV)	LIMIT (dBuV/m)	MARGIN (dB)	ANTENNA FACTOR (dB/m)	CABLE LOSS (dB)	PREAMP FACTOR (dB)	ANTENNA HEIGHT (cm)	TABLE ANGLE (Degree)	REMARK
*5714	59.83	58.64	68.2	-8.37	31.93	6.69	37.43	209	22	Peak
*5725	59.33	58.05	78.2	-18.87	31.96	6.75	37.43	209	22	Peak
5785	94.23	92.91			32.04	6.82	37.54	209	22	Average
5785	104.13	102.81			32.04	6.82	37.54	209	22	Peak
*5850	61.8	60.28	78.2	-16.4	32.15	6.88	37.51	209	22	Peak
*5861	60.02	58.39	68.2	-8.18	32.18	6.95	37.5	209	22	Peak

REMARKS:

- Emission Level = Read Level + Antenna Factor + Cable Loss - Preamp Factor
Margin value = Emission level – Limit value
- 5785MHz: Fundamental frequency.
- *: Out of restricted band

EUT TEST CONDITION		MEASUREMENT DETAIL	
CHANNEL	Channel 165	FREQUENCY RANGE	1GHz ~ 40GHz
INPUT POWER	120Vac, 60 Hz	DETECTOR FUNCTION	Peak (PK) Average (AV)
ENVIRONMENTAL CONDITIONS	25deg. C, 65%RH	TESTED BY	Gavin Wu

ANTENNA POLARITY & TEST DISTANCE: HORIZONTAL AT 3 M										
FREQ. (MHz)	EMISSION LEVEL (dBuV/m)	READ LEVEL (dBuV)	LIMIT (dBuV/m)	MARGIN (dB)	ANTENNA FACTOR (dB/m)	CABLE LOSS (dB)	PREAMP FACTOR (dB)	ANTENNA HEIGHT (cm)	TABLE ANGLE (Degree)	REMARK
*5714	60.22	59.03	68.2	-7.98	31.93	6.69	37.43	204	331	Peak
*5725	60.94	59.66	78.2	-17.26	31.96	6.75	37.43	204	331	Peak
5825	93.27	91.8			32.12	6.88	37.53	204	331	Average
5825	103.11	101.64			32.12	6.88	37.53	204	331	Peak
*5850	60.41	58.89	78.2	-17.79	32.15	6.88	37.51	204	331	Peak
*5861	60.58	58.95	68.2	-7.62	32.18	6.95	37.5	204	331	Peak
ANTENNA POLARITY & TEST DISTANCE: VERTICAL AT 3 M										
FREQ. (MHz)	EMISSION LEVEL (dBuV/m)	READ LEVEL (dBuV)	LIMIT (dBuV/m)	MARGIN (dB)	ANTENNA FACTOR (dB/m)	CABLE LOSS (dB)	PREAMP FACTOR (dB)	ANTENNA HEIGHT (cm)	TABLE ANGLE (Degree)	REMARK
*5714	59.55	58.36	68.2	-8.65	31.93	6.69	37.43	217	15	Peak
*5725	59.51	58.23	78.2	-18.69	31.96	6.75	37.43	217	15	Peak
5825	94.23	92.76			32.12	6.88	37.53	217	15	Average
5825	104.65	103.18			32.12	6.88	37.53	217	15	Peak
*5850	59.5	57.98	78.2	-18.7	32.15	6.88	37.51	217	15	Peak
*5861	59.36	57.73	68.2	-8.84	32.18	6.95	37.5	217	15	Peak

REMARKS:

- Emission Level = Read Level + Antenna Factor + Cable Loss - Preamp Factor
Margin value = Emission level – Limit value
- 5825MHz: Fundamental frequency.
- *: Out of restricted band

802.11n (20MHz)

EUT TEST CONDITION		MEASUREMENT DETAIL	
CHANNEL	Channel 36	FREQUENCY RANGE	1GHz ~ 40GHz
INPUT POWER	120Vac, 60 Hz	DETECTOR FUNCTION	Peak (PK) Average (AV)
ENVIRONMENTAL CONDITIONS	25deg. C, 65%RH	TESTED BY	Gavin Wu

ANTENNA POLARITY & TEST DISTANCE: HORIZONTAL AT 3 M

FREQ. (MHz)	EMISSION LEVEL (dBuV/m)	READ LEVEL (dBuV)	LIMIT (dBuV/m)	MARGIN (dB)	ANTENNA FACTOR (dB/m)	CABLE LOSS (dB)	PREAMP FACTOR (dB)	ANTENNA HEIGHT (cm)	TABLE ANGLE (Degree)	REMARK
5110	43.34	43.14	54	-10.66	31.29	6.19	37.28	201	318	Average
5110	60.88	60.68	74	-13.12	31.29	6.19	37.28	201	318	Peak
5180	95.56	95.33			31.35	6.22	37.34	201	318	Average
5180	105	104.77			31.35	6.22	37.34	201	318	Peak
5426	38.47	37.75	54	-15.53	31.53	6.32	37.13	201	318	Average
5426	60.11	59.39	74	-13.89	31.53	6.32	37.13	201	318	Peak

ANTENNA POLARITY & TEST DISTANCE: VERTICAL AT 3 M

FREQ. (MHz)	EMISSION LEVEL (dBuV/m)	READ LEVEL (dBuV)	LIMIT (dBuV/m)	MARGIN (dB)	ANTENNA FACTOR (dB/m)	CABLE LOSS (dB)	PREAMP FACTOR (dB)	ANTENNA HEIGHT (cm)	TABLE ANGLE (Degree)	REMARK
5102	39.17	38.98	54	-14.83	31.28	6.19	37.28	198	39	Average
5102	60.12	59.93	74	-13.88	31.28	6.19	37.28	198	39	Peak
5180	89.19	88.96			31.35	6.22	37.34	198	39	Average
5180	98.67	98.44			31.35	6.22	37.34	198	39	Peak
5430	38.58	37.84	54	-15.42	31.55	6.32	37.13	198	39	Average
5430	60.21	59.47	74	-13.79	31.55	6.32	37.13	198	39	Peak

REMARKS:

- Emission Level = Read Level + Antenna Factor + Cable Loss - Preamp Factor
Margin value = Emission level – Limit value
- 5180MHz: Fundamental frequency.



A D T

EUT TEST CONDITION		MEASUREMENT DETAIL	
CHANNEL	Channel 44	FREQUENCY RANGE	1GHz ~ 40GHz
INPUT POWER	120Vac, 60 Hz	DETECTOR FUNCTION	Peak (PK) Average (AV)
ENVIRONMENTAL CONDITIONS	25deg. C, 65%RH	TESTED BY	Gavin Wu

ANTENNA POLARITY & TEST DISTANCE: HORIZONTAL AT 3 M										
FREQ. (MHz)	EMISSION LEVEL (dBuV/m)	READ LEVEL (dBuV)	LIMIT (dBuV/m)	MARGIN (dB)	ANTENNA FACTOR (dB/m)	CABLE LOSS (dB)	PREAMP FACTOR (dB)	ANTENNA HEIGHT (cm)	TABLE ANGLE (Degree)	REMARK
5086	38.65	38.48	54	-15.35	31.27	6.17	37.27	199	296	Average
5086	61.05	60.88	74	-12.95	31.27	6.17	37.27	199	296	Peak
5220	95.93	95.68			31.37	6.24	37.36	199	296	Average
5220	105.55	105.3			31.37	6.24	37.36	199	296	Peak
5368	38.74	38.12	54	-15.26	31.49	6.31	37.18	199	296	Average
5368	60.81	60.19	74	-13.19	31.49	6.31	37.18	199	296	Peak

ANTENNA POLARITY & TEST DISTANCE: VERTICAL AT 3 M										
FREQ. (MHz)	EMISSION LEVEL (dBuV/m)	READ LEVEL (dBuV)	LIMIT (dBuV/m)	MARGIN (dB)	ANTENNA FACTOR (dB/m)	CABLE LOSS (dB)	PREAMP FACTOR (dB)	ANTENNA HEIGHT (cm)	TABLE ANGLE (Degree)	REMARK
5024	38.14	38	54	-15.86	31.23	6.15	37.24	198	32	Average
5024	60.07	59.93	74	-13.93	31.23	6.15	37.24	198	32	Peak
5220	89.29	89.04			31.37	6.24	37.36	198	32	Average
5220	98.92	98.67			31.37	6.24	37.36	198	32	Peak
5426	38.56	37.84	54	-15.44	31.53	6.32	37.13	198	32	Average
5426	60.12	59.4	74	-13.88	31.53	6.32	37.13	198	32	Peak

REMARKS:

- Emission Level = Read Level + Antenna Factor + Cable Loss - Preamp Factor
Margin value = Emission level – Limit value
- 5220MHz: Fundamental frequency.



A D T

EUT TEST CONDITION		MEASUREMENT DETAIL	
CHANNEL	Channel 48	FREQUENCY RANGE	1GHz ~ 40GHz
INPUT POWER	120Vac, 60 Hz	DETECTOR FUNCTION	Peak (PK) Average (AV)
ENVIRONMENTAL CONDITIONS	25deg. C, 65%RH	TESTED BY	Gavin Wu

ANTENNA POLARITY & TEST DISTANCE: HORIZONTAL AT 3 M										
FREQ. (MHz)	EMISSION LEVEL (dBuV/m)	READ LEVEL (dBuV)	LIMIT (dBuV/m)	MARGIN (dB)	ANTENNA FACTOR (dB/m)	CABLE LOSS (dB)	PREAMP FACTOR (dB)	ANTENNA HEIGHT (cm)	TABLE ANGLE (Degree)	REMARK
5090	38.63	38.43	54	-15.37	31.28	6.19	37.27	198	303	Average
5090	60.94	60.74	74	-13.06	31.28	6.19	37.27	198	303	Peak
5240	95.68	95.36			31.39	6.25	37.32	198	303	Average
5240	105.29	104.97			31.39	6.25	37.32	198	303	Peak
5456	39.16	38.34	54	-14.84	31.56	6.34	37.08	198	303	Average
5456	60.97	60.15	74	-13.03	31.56	6.34	37.08	198	303	Peak

ANTENNA POLARITY & TEST DISTANCE: VERTICAL AT 3 M										
FREQ. (MHz)	EMISSION LEVEL (dBuV/m)	READ LEVEL (dBuV)	LIMIT (dBuV/m)	MARGIN (dB)	ANTENNA FACTOR (dB/m)	CABLE LOSS (dB)	PREAMP FACTOR (dB)	ANTENNA HEIGHT (cm)	TABLE ANGLE (Degree)	REMARK
5140	38.46	38.24	54	-15.54	31.32	6.2	37.3	190	16	Average
5140	60.56	60.34	74	-13.44	31.32	6.2	37.3	190	16	Peak
5240	89.29	88.97			31.39	6.25	37.32	190	16	Average
5240	98.71	98.39			31.39	6.25	37.32	190	16	Peak
5354	38.73	38.14	54	-15.27	31.48	6.29	37.18	190	16	Average
5354	60.39	59.8	74	-13.61	31.48	6.29	37.18	190	16	Peak

REMARKS:

- Emission Level = Read Level + Antenna Factor + Cable Loss - Preamp Factor
Margin value = Emission level – Limit value
- 5240MHz: Fundamental frequency.

EUT TEST CONDITION		MEASUREMENT DETAIL	
CHANNEL	Channel 52	FREQUENCY RANGE	1GHz ~ 40GHz
INPUT POWER	120Vac, 60 Hz	DETECTOR FUNCTION	Peak (PK) Average (AV)
ENVIRONMENTAL CONDITIONS	25deg. C, 65%RH	TESTED BY	Gavin Wu

ANTENNA POLARITY & TEST DISTANCE: HORIZONTAL AT 3 M										
FREQ. (MHz)	EMISSION LEVEL (dBuV/m)	READ LEVEL (dBuV)	LIMIT (dBuV/m)	MARGIN (dB)	ANTENNA FACTOR (dB/m)	CABLE LOSS (dB)	PREAMP FACTOR (dB)	ANTENNA HEIGHT (cm)	TABLE ANGLE (Degree)	REMARK
5106	38.39	38.19	54	-15.61	31.29	6.19	37.28	181	312	Average
5106	61.02	60.82	74	-12.98	31.29	6.19	37.28	181	312	Peak
5260	95.13	94.74			31.41	6.25	37.27	181	312	Average
5260	104.16	103.77			31.41	6.25	37.27	181	312	Peak
5418	38.43	37.76	54	-15.57	31.53	6.32	37.18	181	312	Average
5418	60.65	59.98	74	-13.35	31.53	6.32	37.18	181	312	Peak
ANTENNA POLARITY & TEST DISTANCE: VERTICAL AT 3 M										
FREQ. (MHz)	EMISSION LEVEL (dBuV/m)	READ LEVEL (dBuV)	LIMIT (dBuV/m)	MARGIN (dB)	ANTENNA FACTOR (dB/m)	CABLE LOSS (dB)	PREAMP FACTOR (dB)	ANTENNA HEIGHT (cm)	TABLE ANGLE (Degree)	REMARK
5050	38.03	37.89	54	-15.97	31.24	6.15	37.25	192	281	Average
5050	60.52	60.38	74	-13.48	31.24	6.15	37.25	192	281	Peak
5260	89.28	88.89			31.41	6.25	37.27	192	281	Average
5260	98.39	98			31.41	6.25	37.27	192	281	Peak
5446	38.58	37.81	54	-15.42	31.56	6.34	37.13	192	281	Average
5446	61.2	60.43	74	-12.8	31.56	6.34	37.13	192	281	Peak

REMARKS:

- Emission Level = Read Level + Antenna Factor + Cable Loss - Preamp Factor
Margin value = Emission level – Limit value
- 5260MHz: Fundamental frequency.



EUT TEST CONDITION		MEASUREMENT DETAIL	
CHANNEL	Channel 60	FREQUENCY RANGE	1GHz ~ 40GHz
INPUT POWER	120Vac, 60 Hz	DETECTOR FUNCTION	Peak (PK) Average (AV)
ENVIRONMENTAL CONDITIONS	25deg. C, 65%RH	TESTED BY	Gavin Wu

ANTENNA POLARITY & TEST DISTANCE: HORIZONTAL AT 3 M										
FREQ. (MHz)	EMISSION LEVEL (dBuV/m)	READ LEVEL (dBuV)	LIMIT (dBuV/m)	MARGIN (dB)	ANTENNA FACTOR (dB/m)	CABLE LOSS (dB)	PREAMP FACTOR (dB)	ANTENNA HEIGHT (cm)	TABLE ANGLE (Degree)	REMARK
5092	38.57	38.37	54	-15.43	31.28	6.19	37.27	181	312	Average
5092	60.77	60.57	74	-13.23	31.28	6.19	37.27	181	312	Peak
5300	95.15	94.63			31.44	6.27	37.19	181	312	Average
5300	103.9	103.38			31.44	6.27	37.19	181	312	Peak
5386	42.55	41.91	54	-11.45	31.51	6.31	37.18	181	312	Average
5386	61.05	60.41	74	-12.95	31.51	6.31	37.18	181	312	Peak

ANTENNA POLARITY & TEST DISTANCE: VERTICAL AT 3 M										
FREQ. (MHz)	EMISSION LEVEL (dBuV/m)	READ LEVEL (dBuV)	LIMIT (dBuV/m)	MARGIN (dB)	ANTENNA FACTOR (dB/m)	CABLE LOSS (dB)	PREAMP FACTOR (dB)	ANTENNA HEIGHT (cm)	TABLE ANGLE (Degree)	REMARK
5024	38.49	38.35	54	-15.51	31.23	6.15	37.24	200	266	Average
5024	61.07	60.93	74	-12.93	31.23	6.15	37.24	200	266	Peak
5300	89.59	89.07			31.44	6.27	37.19	200	266	Average
5300	99.73	99.21			31.44	6.27	37.19	200	266	Peak
5416	45.61	44.94	54	-8.39	31.53	6.32	37.18	200	266	Average
5416	61.02	60.35	74	-12.98	31.53	6.32	37.18	200	266	Peak

REMARKS:

- Emission Level = Read Level + Antenna Factor + Cable Loss - Preamp Factor
Margin value = Emission level – Limit value
- 5300MHz: Fundamental frequency.



A D T

EUT TEST CONDITION		MEASUREMENT DETAIL	
CHANNEL	Channel 64	FREQUENCY RANGE	1GHz ~ 40GHz
INPUT POWER	120Vac, 60 Hz	DETECTOR FUNCTION	Peak (PK) Average (AV)
ENVIRONMENTAL CONDITIONS	25deg. C, 65%RH	TESTED BY	Gavin Wu

ANTENNA POLARITY & TEST DISTANCE: HORIZONTAL AT 3 M										
FREQ. (MHz)	EMISSION LEVEL (dBuV/m)	READ LEVEL (dBuV)	LIMIT (dBuV/m)	MARGIN (dB)	ANTENNA FACTOR (dB/m)	CABLE LOSS (dB)	PREAMP FACTOR (dB)	ANTENNA HEIGHT (cm)	TABLE ANGLE (Degree)	REMARK
5014	38.46	38.33	54	-15.54	31.21	6.15	37.23	200	292	Average
5014	61.36	61.23	74	-12.64	31.21	6.15	37.23	200	292	Peak
5320	95.95	95.4			31.45	6.29	37.19	200	292	Average
5320	105.53	104.98			31.45	6.29	37.19	200	292	Peak
5426	43.99	43.27	54	-10.01	31.53	6.32	37.13	200	292	Average
5426	61.8	61.08	74	-12.2	31.53	6.32	37.13	200	292	Peak

ANTENNA POLARITY & TEST DISTANCE: VERTICAL AT 3 M										
FREQ. (MHz)	EMISSION LEVEL (dBuV/m)	READ LEVEL (dBuV)	LIMIT (dBuV/m)	MARGIN (dB)	ANTENNA FACTOR (dB/m)	CABLE LOSS (dB)	PREAMP FACTOR (dB)	ANTENNA HEIGHT (cm)	TABLE ANGLE (Degree)	REMARK
5144	38.37	38.17	54	-15.63	31.32	6.2	37.32	200	281	Average
5144	60.32	60.12	74	-13.68	31.32	6.2	37.32	200	281	Peak
5320	90.12	89.57			31.45	6.29	37.19	200	281	Average
5320	99.38	98.83			31.45	6.29	37.19	200	281	Peak
5452	40.52	39.7	54	-13.48	31.56	6.34	37.08	200	281	Average
5452	60.53	59.71	74	-13.47	31.56	6.34	37.08	200	281	Peak

REMARKS:

1. Emission Level = Read Level + Antenna Factor + Cable Loss - Preamp Factor
Margin value = Emission level – Limit value
2. 5320MHz: Fundamental frequency.



A D T

EUT TEST CONDITION		MEASUREMENT DETAIL	
CHANNEL	Channel 100	FREQUENCY RANGE	1GHz ~ 40GHz
INPUT POWER	120Vac, 60 Hz	DETECTOR FUNCTION	Peak (PK) Average (AV)
ENVIRONMENTAL CONDITIONS	25deg. C, 65%RH	TESTED BY	Gavin Wu

ANTENNA POLARITY & TEST DISTANCE: HORIZONTAL AT 3 M										
FREQ. (MHz)	EMISSION LEVEL (dBuV/m)	READ LEVEL (dBuV)	LIMIT (dBuV/m)	MARGIN (dB)	ANTENNA FACTOR (dB/m)	CABLE LOSS (dB)	PREAMP FACTOR (dB)	ANTENNA HEIGHT (cm)	TABLE ANGLE (Degree)	REMARK
5374	43.45	42.83	54	-10.55	31.49	6.31	37.18	200	298	Average
5374	60.47	59.85	74	-13.53	31.49	6.31	37.18	200	298	Peak
5470	59.55	58.72	68.2	-8.65	31.57	6.34	37.08	200	298	Peak
5500	94.2	93.27			31.6	6.36	37.03	200	298	Average
5500	103.94	103.01			31.6	6.36	37.03	200	298	Peak
5725	59.87	58.59	68.2	-8.33	31.96	6.75	37.43	200	298	Peak
ANTENNA POLARITY & TEST DISTANCE: VERTICAL AT 3 M										
FREQ. (MHz)	EMISSION LEVEL (dBuV/m)	READ LEVEL (dBuV)	LIMIT (dBuV/m)	MARGIN (dB)	ANTENNA FACTOR (dB/m)	CABLE LOSS (dB)	PREAMP FACTOR (dB)	ANTENNA HEIGHT (cm)	TABLE ANGLE (Degree)	REMARK
5422	41.38	40.71	54	-12.62	31.53	6.32	37.18	200	288	Average
5422	61.49	60.82	74	-12.51	31.53	6.32	37.18	200	288	Peak
5450	58.38	57.56	68.2	-9.82	31.56	6.34	37.08	200	288	Peak
5500	91.2	90.27			31.6	6.36	37.03	200	288	Average
5500	100.75	99.82			31.6	6.36	37.03	200	288	Peak
5725	60.06	58.78	68.2	-8.14	31.96	6.75	37.43	200	288	Peak

REMARKS:

- Emission Level = Read Level + Antenna Factor + Cable Loss - Preamp Factor
Margin value = Emission level – Limit value
- 5500MHz: Fundamental frequency.
- 5470MHz & 5725MHz: Out of restricted band



A D T

EUT TEST CONDITION		MEASUREMENT DETAIL	
CHANNEL	Channel 116	FREQUENCY RANGE	1GHz ~ 40GHz
INPUT POWER	120Vac, 60 Hz	DETECTOR FUNCTION	Peak (PK) Average (AV)
ENVIRONMENTAL CONDITIONS	25deg. C, 65%RH	TESTED BY	Gavin Wu

ANTENNA POLARITY & TEST DISTANCE: HORIZONTAL AT 3 M										
FREQ. (MHz)	EMISSION LEVEL (dBuV/m)	READ LEVEL (dBuV)	LIMIT (dBuV/m)	MARGIN (dB)	ANTENNA FACTOR (dB/m)	CABLE LOSS (dB)	PREAMP FACTOR (dB)	ANTENNA HEIGHT (cm)	TABLE ANGLE (Degree)	REMARK
5348	38.71	38.12	54	-15.29	31.48	6.29	37.18	204	300	Average
5348	60.63	60.04	74	-13.37	31.48	6.29	37.18	204	300	Peak
5470	58.58	57.75	68.2	-9.62	31.57	6.34	37.08	204	300	Peak
5580	94.11	93.07			31.71	6.49	37.16	204	300	Average
5580	103.85	102.81			31.71	6.49	37.16	204	300	Peak
5725	59.9	58.62	68.2	-8.3	31.96	6.75	37.43	204	300	Peak
ANTENNA POLARITY & TEST DISTANCE: VERTICAL AT 3 M										
FREQ. (MHz)	EMISSION LEVEL (dBuV/m)	READ LEVEL (dBuV)	LIMIT (dBuV/m)	MARGIN (dB)	ANTENNA FACTOR (dB/m)	CABLE LOSS (dB)	PREAMP FACTOR (dB)	ANTENNA HEIGHT (cm)	TABLE ANGLE (Degree)	REMARK
5370	38.33	37.71	54	-15.67	31.49	6.31	37.18	200	288	Average
5370	61.13	60.51	74	-12.87	31.49	6.31	37.18	200	288	Peak
5470	58.84	58.01	68.2	-9.36	31.57	6.34	37.08	200	288	Peak
5580	91.63	90.59			31.71	6.49	37.16	200	288	Average
5580	101.63	100.59			31.71	6.49	37.16	200	288	Peak
5725	59.75	58.47	68.2	-8.45	31.96	6.75	37.43	200	288	Peak

REMARKS:

1. Emission Level = Read Level + Antenna Factor + Cable Loss - Preamp Factor
Margin value = Emission level – Limit value
2. 5580MHz: Fundamental frequency.
3. 5470MHz & 5725MHz: Out of restricted band



A D T

EUT TEST CONDITION		MEASUREMENT DETAIL	
CHANNEL	Channel 140	FREQUENCY RANGE	1GHz ~ 40GHz
INPUT POWER	120Vac, 60 Hz	DETECTOR FUNCTION	Peak (PK) Average (AV)
ENVIRONMENTAL CONDITIONS	25deg. C, 65%RH	TESTED BY	Gavin Wu

ANTENNA POLARITY & TEST DISTANCE: HORIZONTAL AT 3 M										
FREQ. (MHz)	EMISSION LEVEL (dBuV/m)	READ LEVEL (dBuV)	LIMIT (dBuV/m)	MARGIN (dB)	ANTENNA FACTOR (dB/m)	CABLE LOSS (dB)	PREAMP FACTOR (dB)	ANTENNA HEIGHT (cm)	TABLE ANGLE (Degree)	REMARK
5438	38.64	37.88	54	-15.36	31.55	6.34	37.13	204	300	Average
5438	61.25	60.49	74	-12.75	31.55	6.34	37.13	204	300	Peak
5470	59.17	58.34	68.2	-9.03	31.57	6.34	37.08	204	300	Peak
5700	93.89	92.7			31.9	6.69	37.4	204	300	Average
5700	104.08	102.89			31.9	6.69	37.4	204	300	Peak
5725	60.62	59.34	68.2	-7.58	31.96	6.75	37.43	204	300	Peak

ANTENNA POLARITY & TEST DISTANCE: VERTICAL AT 3 M										
FREQ. (MHz)	EMISSION LEVEL (dBuV/m)	READ LEVEL (dBuV)	LIMIT (dBuV/m)	MARGIN (dB)	ANTENNA FACTOR (dB/m)	CABLE LOSS (dB)	PREAMP FACTOR (dB)	ANTENNA HEIGHT (cm)	TABLE ANGLE (Degree)	REMARK
5350	38.48	37.89	54	-15.52	31.48	6.29	37.18	199	288	Average
5350	61.5	60.91	74	-12.5	31.48	6.29	37.18	199	288	Peak
5470	58.69	57.86	68.2	-9.51	31.57	6.34	37.08	199	288	Peak
5700	91.68	90.49			31.9	6.69	37.4	199	288	Average
5700	101.13	99.94			31.9	6.69	37.4	199	288	Peak
5725	59.21	57.93	68.2	-8.99	31.96	6.75	37.43	199	288	Peak

REMARKS:

1. Emission Level = Read Level + Antenna Factor + Cable Loss - Preamp Factor
Margin value = Emission level – Limit value
2. 5700MHz: Fundamental frequency.
3. 5470MHz & 5725MHz: Out of restricted band

EUT TEST CONDITION		MEASUREMENT DETAIL	
CHANNEL	Channel 149	FREQUENCY RANGE	1GHz ~ 40GHz
INPUT POWER	120Vac, 60 Hz	DETECTOR FUNCTION	Peak (PK) Average (AV)
ENVIRONMENTAL CONDITIONS	25deg. C, 65%RH	TESTED BY	Gavin Wu

ANTENNA POLARITY & TEST DISTANCE: HORIZONTAL AT 3 M										
FREQ. (MHz)	EMISSION LEVEL (dBuV/m)	READ LEVEL (dBuV)	LIMIT (dBuV/m)	MARGIN (dB)	ANTENNA FACTOR (dB/m)	CABLE LOSS (dB)	PREAMP FACTOR (dB)	ANTENNA HEIGHT (cm)	TABLE ANGLE (Degree)	REMARK
*5714	59.29	58.1	68.2	-8.91	31.93	6.69	37.43	210	331	Peak
*5725	59.9	58.62	78.2	-18.3	31.96	6.75	37.43	210	331	Peak
5745	92.36	91.09			31.99	6.75	37.47	210	331	Average
5745	102.08	100.81			31.99	6.75	37.47	210	331	Peak
*5850	61.11	59.59	78.2	-17.09	32.15	6.88	37.51	210	331	Peak
*5861	60	58.37	68.2	-8.2	32.18	6.95	37.5	210	331	Peak
ANTENNA POLARITY & TEST DISTANCE: VERTICAL AT 3 M										
FREQ. (MHz)	EMISSION LEVEL (dBuV/m)	READ LEVEL (dBuV)	LIMIT (dBuV/m)	MARGIN (dB)	ANTENNA FACTOR (dB/m)	CABLE LOSS (dB)	PREAMP FACTOR (dB)	ANTENNA HEIGHT (cm)	TABLE ANGLE (Degree)	REMARK
*5714	59.01	57.82	68.2	-9.19	31.93	6.69	37.43	179	20	Peak
*5725	60.56	59.28	78.2	-17.64	31.96	6.75	37.43	179	20	Peak
5745	92.98	91.71			31.99	6.75	37.47	179	20	Average
5745	103.56	102.29			31.99	6.75	37.47	179	20	Peak
*5850	61.07	59.55	78.2	-17.13	32.15	6.88	37.51	179	20	Peak
*5861	60.66	59.03	68.2	-7.54	32.18	6.95	37.5	179	20	Peak

REMARKS:

- Emission Level = Read Level + Antenna Factor + Cable Loss - Preamp Factor
Margin value = Emission level – Limit value
- 5745MHz: Fundamental frequency.
- *: Out of restricted band



EUT TEST CONDITION		MEASUREMENT DETAIL	
CHANNEL	Channel 157	FREQUENCY RANGE	1GHz ~ 40GHz
INPUT POWER	120Vac, 60 Hz	DETECTOR FUNCTION	Peak (PK) Average (AV)
ENVIRONMENTAL CONDITIONS	25deg. C, 65%RH	TESTED BY	Gavin Wu

ANTENNA POLARITY & TEST DISTANCE: HORIZONTAL AT 3 M										
FREQ. (MHz)	EMISSION LEVEL (dBuV/m)	READ LEVEL (dBuV)	LIMIT (dBuV/m)	MARGIN (dB)	ANTENNA FACTOR (dB/m)	CABLE LOSS (dB)	PREAMP FACTOR (dB)	ANTENNA HEIGHT (cm)	TABLE ANGLE (Degree)	REMARK
*5714	59.94	58.75	68.2	-8.26	31.93	6.69	37.43	203	331	Peak
*5725	59.42	58.14	78.2	-18.78	31.96	6.75	37.43	203	331	Peak
5785	92.25	90.93			32.04	6.82	37.54	203	331	Average
5785	102.74	101.42			32.04	6.82	37.54	203	331	Peak
*5850	60.35	58.83	78.2	-17.85	32.15	6.88	37.51	203	331	Peak
*5861	59.42	57.79	68.2	-8.78	32.18	6.95	37.5	203	331	Peak
ANTENNA POLARITY & TEST DISTANCE: VERTICAL AT 3 M										
FREQ. (MHz)	EMISSION LEVEL (dBuV/m)	READ LEVEL (dBuV)	LIMIT (dBuV/m)	MARGIN (dB)	ANTENNA FACTOR (dB/m)	CABLE LOSS (dB)	PREAMP FACTOR (dB)	ANTENNA HEIGHT (cm)	TABLE ANGLE (Degree)	REMARK
*5714	59.12	57.93	68.2	-9.08	31.93	6.69	37.43	175	16	Peak
*5725	60.26	58.98	78.2	-17.94	31.96	6.75	37.43	175	16	Peak
5785	92.89	91.57			32.04	6.82	37.54	175	16	Average
5785	102.08	100.76			32.04	6.82	37.54	175	16	Peak
*5850	59.5	57.98	78.2	-18.7	32.15	6.88	37.51	175	16	Peak
*5861	60.22	58.59	68.2	-7.98	32.18	6.95	37.5	175	16	Peak

REMARKS:

- Emission Level = Read Level + Antenna Factor + Cable Loss - Preamp Factor
Margin value = Emission level – Limit value
- 5785MHz: Fundamental frequency.
- *: Out of restricted band



EUT TEST CONDITION		MEASUREMENT DETAIL	
CHANNEL	Channel 165	FREQUENCY RANGE	1GHz ~ 40GHz
INPUT POWER	120Vac, 60 Hz	DETECTOR FUNCTION	Peak (PK) Average (AV)
ENVIRONMENTAL CONDITIONS	25deg. C, 65%RH	TESTED BY	Gavin Wu

ANTENNA POLARITY & TEST DISTANCE: HORIZONTAL AT 3 M										
FREQ. (MHz)	EMISSION LEVEL (dBuV/m)	READ LEVEL (dBuV)	LIMIT (dBuV/m)	MARGIN (dB)	ANTENNA FACTOR (dB/m)	CABLE LOSS (dB)	PREAMP FACTOR (dB)	ANTENNA HEIGHT (cm)	TABLE ANGLE (Degree)	REMARK
*5714	58.35	57.16	68.2	-9.85	31.93	6.69	37.43	205	331	Peak
*5725	57.58	56.3	78.2	-20.62	31.96	6.75	37.43	205	331	Peak
5825	91.27	89.8			32.12	6.88	37.53	205	331	Average
5825	101.02	99.55			32.12	6.88	37.53	205	331	Peak
*5850	61.16	59.64	78.2	-17.04	32.15	6.88	37.51	205	331	Peak
*5861	58.4	56.77	68.2	-9.8	32.18	6.95	37.5	205	331	Peak
ANTENNA POLARITY & TEST DISTANCE: VERTICAL AT 3 M										
FREQ. (MHz)	EMISSION LEVEL (dBuV/m)	READ LEVEL (dBuV)	LIMIT (dBuV/m)	MARGIN (dB)	ANTENNA FACTOR (dB/m)	CABLE LOSS (dB)	PREAMP FACTOR (dB)	ANTENNA HEIGHT (cm)	TABLE ANGLE (Degree)	REMARK
*5714	59.77	58.58	68.2	-8.43	31.93	6.69	37.43	192	16	Peak
*5725	61.19	59.91	78.2	-17.01	31.96	6.75	37.43	192	16	Peak
5825	92.86	91.39			32.12	6.88	37.53	192	16	Average
5825	102.09	100.62			32.12	6.88	37.53	192	16	Peak
*5850	60.77	59.25	78.2	-17.43	32.15	6.88	37.51	192	16	Peak
*5861	60.88	59.25	68.2	-7.32	32.18	6.95	37.5	192	16	Peak

REMARKS:

- Emission Level = Read Level + Antenna Factor + Cable Loss - Preamp Factor
Margin value = Emission level – Limit value
- 5825MHz: Fundamental frequency.
- *: Out of restricted band

802.11n (40MHz)

EUT TEST CONDITION		MEASUREMENT DETAIL	
CHANNEL	Channel 38	FREQUENCY RANGE	1GHz ~ 40GHz
INPUT POWER	120Vac, 60 Hz	DETECTOR FUNCTION	Peak (PK) Average (AV)
ENVIRONMENTAL CONDITIONS	25deg. C, 65%RH	TESTED BY	Gavin Wu

ANTENNA POLARITY & TEST DISTANCE: HORIZONTAL AT 3 M

FREQ. (MHz)	EMISSION LEVEL (dBuV/m)	READ LEVEL (dBuV)	LIMIT (dBuV/m)	MARGIN (dB)	ANTENNA FACTOR (dB/m)	CABLE LOSS (dB)	PREAMP FACTOR (dB)	ANTENNA HEIGHT (cm)	TABLE ANGLE (Degree)	REMARK
5094	42.58	42.39	54	-11.42	31.28	6.19	37.28	201	310	Average
5094	60.12	59.93	74	-13.88	31.28	6.19	37.28	201	310	Peak
5190	92.86	92.63			31.35	6.22	37.34	201	310	Average
5190	102.74	102.51			31.35	6.22	37.34	201	310	Peak
5380	38.48	37.84	54	-15.52	31.51	6.31	37.18	201	310	Average
5380	59.81	59.17	74	-14.19	31.51	6.31	37.18	201	310	Peak

ANTENNA POLARITY & TEST DISTANCE: VERTICAL AT 3 M

FREQ. (MHz)	EMISSION LEVEL (dBuV/m)	READ LEVEL (dBuV)	LIMIT (dBuV/m)	MARGIN (dB)	ANTENNA FACTOR (dB/m)	CABLE LOSS (dB)	PREAMP FACTOR (dB)	ANTENNA HEIGHT (cm)	TABLE ANGLE (Degree)	REMARK
5142	39.47	39.25	54	-14.53	31.32	6.2	37.3	201	23	Average
5142	60.99	60.77	74	-13.01	31.32	6.2	37.3	201	23	Peak
5190	86.68	86.45			31.35	6.22	37.34	201	23	Average
5190	96.58	96.35			31.35	6.22	37.34	201	23	Peak
5458	38.81	37.99	54	-15.19	31.56	6.34	37.08	201	23	Average
5458	60.56	59.74	74	-13.44	31.56	6.34	37.08	201	23	Peak

REMARKS:

- Emission Level = Read Level + Antenna Factor + Cable Loss - Preamp Factor
Margin value = Emission level – Limit value
- 5190MHz: Fundamental frequency.



EUT TEST CONDITION		MEASUREMENT DETAIL	
CHANNEL	Channel 46	FREQUENCY RANGE	1GHz ~ 40GHz
INPUT POWER	120Vac, 60 Hz	DETECTOR FUNCTION	Peak (PK) Average (AV)
ENVIRONMENTAL CONDITIONS	25deg. C, 65%RH	TESTED BY	Gavin Wu

ANTENNA POLARITY & TEST DISTANCE: HORIZONTAL AT 3 M										
FREQ. (MHz)	EMISSION LEVEL (dBuV/m)	READ LEVEL (dBuV)	LIMIT (dBuV/m)	MARGIN (dB)	ANTENNA FACTOR (dB/m)	CABLE LOSS (dB)	PREAMP FACTOR (dB)	ANTENNA HEIGHT (cm)	TABLE ANGLE (Degree)	REMARK
5040	39.78	39.63	54	-14.22	31.24	6.15	37.24	201	316	Average
5040	60.43	60.28	74	-13.57	31.24	6.15	37.24	201	316	Peak
5230	93.14	92.83			31.39	6.24	37.32	201	316	Average
5230	102.95	102.64			31.39	6.24	37.32	201	316	Peak
5446	38.8	38.03	54	-15.2	31.56	6.34	37.13	201	316	Average
5446	60.57	59.8	74	-13.43	31.56	6.34	37.13	201	316	Peak

ANTENNA POLARITY & TEST DISTANCE: VERTICAL AT 3 M										
FREQ. (MHz)	EMISSION LEVEL (dBuV/m)	READ LEVEL (dBuV)	LIMIT (dBuV/m)	MARGIN (dB)	ANTENNA FACTOR (dB/m)	CABLE LOSS (dB)	PREAMP FACTOR (dB)	ANTENNA HEIGHT (cm)	TABLE ANGLE (Degree)	REMARK
5144	38.66	38.46	54	-15.34	31.32	6.2	37.32	199	38	Average
5144	60.12	59.92	74	-13.88	31.32	6.2	37.32	199	38	Peak
5230	86.68	86.37			31.39	6.24	37.32	199	38	Average
5230	96.57	96.26			31.39	6.24	37.32	199	38	Peak
5408	38.83	38.17	54	-15.17	31.52	6.32	37.18	199	38	Average
5408	60.19	59.53	74	-13.81	31.52	6.32	37.18	199	38	Peak

REMARKS:

- Emission Level = Read Level + Antenna Factor + Cable Loss - Preamp Factor
Margin value = Emission level – Limit value
- 5230MHz: Fundamental frequency.

EUT TEST CONDITION		MEASUREMENT DETAIL	
CHANNEL	Channel 54	FREQUENCY RANGE	1GHz ~ 40GHz
INPUT POWER	120Vac, 60 Hz	DETECTOR FUNCTION	Peak (PK) Average (AV)
ENVIRONMENTAL CONDITIONS	25deg. C, 65%RH	TESTED BY	Gavin Wu

ANTENNA POLARITY & TEST DISTANCE: HORIZONTAL AT 3 M										
FREQ. (MHz)	EMISSION LEVEL (dBuV/m)	READ LEVEL (dBuV)	LIMIT (dBuV/m)	MARGIN (dB)	ANTENNA FACTOR (dB/m)	CABLE LOSS (dB)	PREAMP FACTOR (dB)	ANTENNA HEIGHT (cm)	TABLE ANGLE (Degree)	REMARK
5148	38.99	38.79	54	-15.01	31.32	6.2	37.32	197	293	Average
5148	60.34	60.14	74	-13.66	31.32	6.2	37.32	197	293	Peak
5270	92.7	92.31			31.41	6.25	37.27	197	293	Average
5270	102.02	101.63			31.41	6.25	37.27	197	293	Peak
5444	40.29	39.53	54	-13.71	31.55	6.34	37.13	197	293	Average
5444	61.09	60.33	74	-12.91	31.55	6.34	37.13	197	293	Peak
ANTENNA POLARITY & TEST DISTANCE: VERTICAL AT 3 M										
FREQ. (MHz)	EMISSION LEVEL (dBuV/m)	READ LEVEL (dBuV)	LIMIT (dBuV/m)	MARGIN (dB)	ANTENNA FACTOR (dB/m)	CABLE LOSS (dB)	PREAMP FACTOR (dB)	ANTENNA HEIGHT (cm)	TABLE ANGLE (Degree)	REMARK
5094	38.59	38.4	54	-15.41	31.28	6.19	37.28	200	282	Average
5094	61.37	61.18	74	-12.63	31.28	6.19	37.28	200	282	Peak
5270	86.61	86.22			31.41	6.25	37.27	200	282	Average
5270	96.04	95.65			31.41	6.25	37.27	200	282	Peak
5434	39.15	38.41	54	-14.85	31.55	6.32	37.13	200	282	Average
5434	61.82	61.08	74	-12.18	31.55	6.32	37.13	200	282	Peak

REMARKS:

- Emission Level = Read Level + Antenna Factor + Cable Loss - Preamp Factor
Margin value = Emission level – Limit value
- 5270MHz: Fundamental frequency.



A D T

EUT TEST CONDITION		MEASUREMENT DETAIL			
CHANNEL	Channel 62	FREQUENCY RANGE	1GHz ~ 40GHz		
INPUT POWER	120Vac, 60 Hz	DETECTOR FUNCTION	Peak (PK) Average (AV)		
ENVIRONMENTAL CONDITIONS	25deg. C, 65%RH	TESTED BY	Gavin Wu		

ANTENNA POLARITY & TEST DISTANCE: HORIZONTAL AT 3 M										
FREQ. (MHz)	EMISSION LEVEL (dBuV/m)	READ LEVEL (dBuV)	LIMIT (dBuV/m)	MARGIN (dB)	ANTENNA FACTOR (dB/m)	CABLE LOSS (dB)	PREAMP FACTOR (dB)	ANTENNA HEIGHT (cm)	TABLE ANGLE (Degree)	REMARK
5054	38.67	38.51	54	-15.33	31.24	6.17	37.25	200	292	Average
5054	61.4	61.24	74	-12.6	31.24	6.17	37.25	200	292	Peak
5310	93.48	92.95			31.45	6.27	37.19	200	292	Average
5310	104.28	103.75			31.45	6.27	37.19	200	292	Peak
5394	41.77	41.13	54	-12.23	31.51	6.31	37.18	200	292	Average
5394	61.21	60.57	74	-12.79	31.51	6.31	37.18	200	292	Peak

ANTENNA POLARITY & TEST DISTANCE: VERTICAL AT 3 M										
FREQ. (MHz)	EMISSION LEVEL (dBuV/m)	READ LEVEL (dBuV)	LIMIT (dBuV/m)	MARGIN (dB)	ANTENNA FACTOR (dB/m)	CABLE LOSS (dB)	PREAMP FACTOR (dB)	ANTENNA HEIGHT (cm)	TABLE ANGLE (Degree)	REMARK
5112	38.65	38.45	54	-15.35	31.29	6.19	37.28	198	282	Average
5112	61.79	61.59	74	-12.21	31.29	6.19	37.28	198	282	Peak
5310	87.79	87.26			31.45	6.27	37.19	198	282	Average
5310	97.29	96.76			31.45	6.27	37.19	198	282	Peak
5456	39.5	38.68	54	-14.5	31.56	6.34	37.08	198	282	Average
5456	61.34	60.52	74	-12.66	31.56	6.34	37.08	198	282	Peak

REMARKS:

- Emission Level = Read Level + Antenna Factor + Cable Loss - Preamp Factor
Margin value = Emission level – Limit value
- 5310MHz: Fundamental frequency.

EUT TEST CONDITION		MEASUREMENT DETAIL	
CHANNEL	Channel 102	FREQUENCY RANGE	1GHz ~ 40GHz
INPUT POWER	120Vac, 60 Hz	DETECTOR FUNCTION	Peak (PK) Average (AV)
ENVIRONMENTAL CONDITIONS	25deg. C, 65%RH	TESTED BY	Gavin Wu

ANTENNA POLARITY & TEST DISTANCE: HORIZONTAL AT 3 M										
FREQ. (MHz)	EMISSION LEVEL (dBuV/m)	READ LEVEL (dBuV)	LIMIT (dBuV/m)	MARGIN (dB)	ANTENNA FACTOR (dB/m)	CABLE LOSS (dB)	PREAMP FACTOR (dB)	ANTENNA HEIGHT (cm)	TABLE ANGLE (Degree)	REMARK
5374	40.46	39.84	54	-13.54	31.49	6.31	37.18	200	300	Average
5374	60.86	60.24	74	-13.14	31.49	6.31	37.18	200	300	Peak
5470	60.64	59.81	68.2	-7.56	31.57	6.34	37.08	200	300	Peak
5510	91.88	90.98			31.6	6.36	37.06	200	300	Average
5510	101.66	100.76			31.6	6.36	37.06	200	300	Peak
5725	59.93	58.65	68.2	-8.27	31.96	6.75	37.43	200	300	Peak
ANTENNA POLARITY & TEST DISTANCE: VERTICAL AT 3 M										
FREQ. (MHz)	EMISSION LEVEL (dBuV/m)	READ LEVEL (dBuV)	LIMIT (dBuV/m)	MARGIN (dB)	ANTENNA FACTOR (dB/m)	CABLE LOSS (dB)	PREAMP FACTOR (dB)	ANTENNA HEIGHT (cm)	TABLE ANGLE (Degree)	REMARK
5438	39.46	38.7	54	-14.54	31.55	6.34	37.13	187	288	Average
5438	60.08	59.32	74	-13.92	31.55	6.34	37.13	187	288	Peak
5470	59.92	59.09	68.2	-8.28	31.57	6.34	37.08	187	288	Peak
5510	88.67	87.77			31.6	6.36	37.06	187	288	Average
5510	98.15	97.25			31.6	6.36	37.06	187	288	Peak
5725	59.52	58.24	68.2	-8.68	31.96	6.75	37.43	187	288	Peak

REMARKS:

- Emission Level = Read Level + Antenna Factor + Cable Loss - Preamp Factor
Margin value = Emission level – Limit value
- 5510MHz: Fundamental frequency.
- 5470MHz & 5725MHz: Out of restricted band



A D T

EUT TEST CONDITION		MEASUREMENT DETAIL	
CHANNEL	Channel 110	FREQUENCY RANGE	1GHz ~ 40GHz
INPUT POWER	120Vac, 60 Hz	DETECTOR FUNCTION	Peak (PK) Average (AV)
ENVIRONMENTAL CONDITIONS	25deg. C, 65%RH	TESTED BY	Gavin Wu

ANTENNA POLARITY & TEST DISTANCE: HORIZONTAL AT 3 M										
FREQ. (MHz)	EMISSION LEVEL (dBuV/m)	READ LEVEL (dBuV)	LIMIT (dBuV/m)	MARGIN (dB)	ANTENNA FACTOR (dB/m)	CABLE LOSS (dB)	PREAMP FACTOR (dB)	ANTENNA HEIGHT (cm)	TABLE ANGLE (Degree)	REMARK
5452	40.15	39.33	54	-13.85	31.56	6.34	37.08	200	298	Average
5452	61.36	60.54	74	-12.64	31.56	6.34	37.08	200	298	Peak
5470	59.43	58.6	68.2	-8.77	31.57	6.34	37.08	200	298	Peak
5550	91.8	90.79			31.68	6.42	37.09	200	298	Average
5550	101.67	100.66			31.68	6.42	37.09	200	298	Peak
5725	59.63	58.35	68.2	-8.57	31.96	6.75	37.43	200	298	Peak

ANTENNA POLARITY & TEST DISTANCE: VERTICAL AT 3 M										
FREQ. (MHz)	EMISSION LEVEL (dBuV/m)	READ LEVEL (dBuV)	LIMIT (dBuV/m)	MARGIN (dB)	ANTENNA FACTOR (dB/m)	CABLE LOSS (dB)	PREAMP FACTOR (dB)	ANTENNA HEIGHT (cm)	TABLE ANGLE (Degree)	REMARK
5434	39.58	38.84	54	-14.42	31.55	6.32	37.13	187	288	Average
5434	61.83	61.09	74	-12.17	31.55	6.32	37.13	187	288	Peak
5470	59.36	58.53	68.2	-8.84	31.57	6.34	37.08	187	288	Peak
5550	88.97	87.96			31.68	6.42	37.09	187	288	Average
5550	98.41	97.4			31.68	6.42	37.09	187	288	Peak
5725	59.51	58.23	68.2	-8.69	31.96	6.75	37.43	187	288	Peak

REMARKS:

1. Emission Level = Read Level + Antenna Factor + Cable Loss - Preamp Factor
Margin value = Emission level – Limit value
2. 5550MHz: Fundamental frequency.
3. 5470MHz & 5725MHz: Out of restricted band



A D T

EUT TEST CONDITION		MEASUREMENT DETAIL	
CHANNEL	Channel 134	FREQUENCY RANGE	1GHz ~ 40GHz
INPUT POWER	120Vac, 60 Hz	DETECTOR FUNCTION	Peak (PK) Average (AV)
ENVIRONMENTAL CONDITIONS	25deg. C, 65%RH	TESTED BY	Gavin Wu

ANTENNA POLARITY & TEST DISTANCE: HORIZONTAL AT 3 M										
FREQ. (MHz)	EMISSION LEVEL (dBuV/m)	READ LEVEL (dBuV)	LIMIT (dBuV/m)	MARGIN (dB)	ANTENNA FACTOR (dB/m)	CABLE LOSS (dB)	PREAMP FACTOR (dB)	ANTENNA HEIGHT (cm)	TABLE ANGLE (Degree)	REMARK
5450	39.02	38.2	54	-14.98	31.56	6.34	37.08	198	300	Average
5450	61.04	60.22	74	-12.96	31.56	6.34	37.08	198	300	Peak
5470	60.13	59.3	68.2	-8.07	31.57	6.34	37.08	198	300	Peak
5670	90.66	89.5			31.88	6.62	37.34	198	300	Average
5670	99.95	98.79			31.88	6.62	37.34	198	300	Peak
5725	59.63	58.35	68.2	-8.57	31.96	6.75	37.43	198	300	Peak
ANTENNA POLARITY & TEST DISTANCE: VERTICAL AT 3 M										
FREQ. (MHz)	EMISSION LEVEL (dBuV/m)	READ LEVEL (dBuV)	LIMIT (dBuV/m)	MARGIN (dB)	ANTENNA FACTOR (dB/m)	CABLE LOSS (dB)	PREAMP FACTOR (dB)	ANTENNA HEIGHT (cm)	TABLE ANGLE (Degree)	REMARK
5380	38.87	38.23	54	-15.13	31.51	6.31	37.18	197	288	Average
5380	59.96	59.32	74	-14.04	31.51	6.31	37.18	197	288	Peak
5470	59.66	58.83	68.2	-8.54	31.57	6.34	37.08	197	288	Peak
5670	88.71	87.55			31.88	6.62	37.34	197	288	Average
5670	98.66	97.5			31.88	6.62	37.34	197	288	Peak
5725	59.93	58.65	68.2	-8.27	31.96	6.75	37.43	197	288	Peak

REMARKS:

- Emission Level = Read Level + Antenna Factor + Cable Loss - Preamp Factor
Margin value = Emission level – Limit value
- 5670MHz: Fundamental frequency.
- 5470MHz & 5725MHz: Out of restricted band



A D T

EUT TEST CONDITION		MEASUREMENT DETAIL	
CHANNEL	Channel 151	FREQUENCY RANGE	1GHz ~ 40GHz
INPUT POWER	120Vac, 60 Hz	DETECTOR FUNCTION	Peak (PK) Average (AV)
ENVIRONMENTAL CONDITIONS	25deg. C, 65%RH	TESTED BY	Gavin Wu

ANTENNA POLARITY & TEST DISTANCE: HORIZONTAL AT 3 M										
FREQ. (MHz)	EMISSION LEVEL (dBuV/m)	READ LEVEL (dBuV)	LIMIT (dBuV/m)	MARGIN (dB)	ANTENNA FACTOR (dB/m)	CABLE LOSS (dB)	PREAMP FACTOR (dB)	ANTENNA HEIGHT (cm)	TABLE ANGLE (Degree)	REMARK
*5714	61.39	60.2	68.2	-6.81	31.93	6.69	37.43	221	332	Peak
*5725	61.4	60.12	78.2	-16.8	31.96	6.75	37.43	221	332	Peak
5755	90.08	88.79			32.01	6.75	37.47	221	332	Average
5755	99.72	98.43			32.01	6.75	37.47	221	332	Peak
*5850	59.74	58.22	78.2	-18.46	32.15	6.88	37.51	221	332	Peak
*5861	61.76	60.13	68.2	-6.44	32.18	6.95	37.5	221	332	Peak
ANTENNA POLARITY & TEST DISTANCE: VERTICAL AT 3 M										
FREQ. (MHz)	EMISSION LEVEL (dBuV/m)	READ LEVEL (dBuV)	LIMIT (dBuV/m)	MARGIN (dB)	ANTENNA FACTOR (dB/m)	CABLE LOSS (dB)	PREAMP FACTOR (dB)	ANTENNA HEIGHT (cm)	TABLE ANGLE (Degree)	REMARK
*5714	60.07	58.88	68.2	-8.13	31.93	6.69	37.43	228	21	Peak
*5725	61.74	60.46	78.2	-16.46	31.96	6.75	37.43	228	21	Peak
5755	90.92	89.63			32.01	6.75	37.47	228	21	Average
5755	100.38	99.09			32.01	6.75	37.47	228	21	Peak
*5850	60.68	59.16	78.2	-17.52	32.15	6.88	37.51	228	21	Peak
*5861	59.63	58	68.2	-8.57	32.18	6.95	37.5	228	21	Peak

REMARKS:

- Emission Level = Read Level + Antenna Factor + Cable Loss - Preamp Factor
Margin value = Emission level – Limit value
- 5755MHz: Fundamental frequency.
- *: Out of restricted band



EUT TEST CONDITION		MEASUREMENT DETAIL	
CHANNEL	Channel 159	FREQUENCY RANGE	1GHz ~ 40GHz
INPUT POWER	120Vac, 60 Hz	DETECTOR FUNCTION	Peak (PK) Average (AV)
ENVIRONMENTAL CONDITIONS	25deg. C, 65%RH	TESTED BY	Gavin Wu

ANTENNA POLARITY & TEST DISTANCE: HORIZONTAL AT 3 M										
FREQ. (MHz)	EMISSION LEVEL (dBuV/m)	READ LEVEL (dBuV)	LIMIT (dBuV/m)	MARGIN (dB)	ANTENNA FACTOR (dB/m)	CABLE LOSS (dB)	PREAMP FACTOR (dB)	ANTENNA HEIGHT (cm)	TABLE ANGLE (Degree)	REMARK
*5714	59.16	57.97	68.2	-9.04	31.93	6.69	37.43	211	330	Peak
*5725	59.36	58.08	78.2	-18.84	31.96	6.75	37.43	211	330	Peak
5795	90.6	89.25			32.07	6.82	37.54	211	330	Average
5795	99.96	98.61			32.07	6.82	37.54	211	330	Peak
*5850	59.13	57.61	78.2	-19.07	32.15	6.88	37.51	211	330	Peak
*5861	59.96	58.33	68.2	-8.24	32.18	6.95	37.5	211	330	Peak
ANTENNA POLARITY & TEST DISTANCE: VERTICAL AT 3 M										
FREQ. (MHz)	EMISSION LEVEL (dBuV/m)	READ LEVEL (dBuV)	LIMIT (dBuV/m)	MARGIN (dB)	ANTENNA FACTOR (dB/m)	CABLE LOSS (dB)	PREAMP FACTOR (dB)	ANTENNA HEIGHT (cm)	TABLE ANGLE (Degree)	REMARK
*5714	60.35	59.16	68.2	-7.85	31.93	6.69	37.43	201	20	Peak
*5725	60.5	59.22	78.2	-17.7	31.96	6.75	37.43	201	20	Peak
5795	90.54	89.19			32.07	6.82	37.54	201	20	Average
5795	100.75	99.4			32.07	6.82	37.54	201	20	Peak
*5850	61.22	59.7	78.2	-16.98	32.15	6.88	37.51	201	20	Peak
*5861	59.45	57.82	68.2	-8.75	32.18	6.95	37.5	201	20	Peak

REMARKS:

- Emission Level = Read Level + Antenna Factor + Cable Loss - Preamp Factor
Margin value = Emission level – Limit value
- 5795MHz: Fundamental frequency.
- *: Out of restricted band

802.11ac (80MHz)

EUT TEST CONDITION		MEASUREMENT DETAIL	
CHANNEL	Channel 42	FREQUENCY RANGE	1GHz ~ 40GHz
INPUT POWER	120Vac, 60 Hz	DETECTOR FUNCTION	Peak (PK) Average (AV)
ENVIRONMENTAL CONDITIONS	25deg. C, 65%RH	TESTED BY	Gavin Wu

ANTENNA POLARITY & TEST DISTANCE: HORIZONTAL AT 3 M

FREQ. (MHz)	EMISSION LEVEL (dBuV/m)	READ LEVEL (dBuV)	LIMIT (dBuV/m)	MARGIN (dB)	ANTENNA FACTOR (dB/m)	CABLE LOSS (dB)	PREAMP FACTOR (dB)	ANTENNA HEIGHT (cm)	TABLE ANGLE (Degree)	REMARK
5026	41.35	41.21	54	-12.65	31.23	6.15	37.24	198	320	Average
5026	60	59.86	74	-14	31.23	6.15	37.24	198	320	Peak
5210	89.38	89.13			31.37	6.24	37.36	198	320	Average
5210	99.14	98.89			31.37	6.24	37.36	198	320	Peak
5400	39.11	38.45	54	-14.89	31.52	6.32	37.18	198	320	Average
5400	60.98	60.32	74	-13.02	31.52	6.32	37.18	198	320	Peak

ANTENNA POLARITY & TEST DISTANCE: VERTICAL AT 3 M

FREQ. (MHz)	EMISSION LEVEL (dBuV/m)	READ LEVEL (dBuV)	LIMIT (dBuV/m)	MARGIN (dB)	ANTENNA FACTOR (dB/m)	CABLE LOSS (dB)	PREAMP FACTOR (dB)	ANTENNA HEIGHT (cm)	TABLE ANGLE (Degree)	REMARK
5130	38.9	38.69	54	-15.1	31.31	6.2	37.3	200	46	Average
5130	60.5	60.29	74	-13.5	31.31	6.2	37.3	200	46	Peak
5210	82.51	82.26			31.37	6.24	37.36	200	46	Average
5210	92.32	92.07			31.37	6.24	37.36	200	46	Peak
5460	39	38.18	54	-15	31.56	6.34	37.08	200	46	Average
5460	60.93	60.11	74	-13.07	31.56	6.34	37.08	200	46	Peak

REMARKS:

- Emission Level = Read Level + Antenna Factor + Cable Loss - Preamp Factor
Margin value = Emission level – Limit value
- 5210MHz: Fundamental frequency.



A D T

EUT TEST CONDITION		MEASUREMENT DETAIL	
CHANNEL	Channel 58	FREQUENCY RANGE	1GHz ~ 40GHz
INPUT POWER	120Vac, 60 Hz	DETECTOR FUNCTION	Peak (PK) Average (AV)
ENVIRONMENTAL CONDITIONS	25deg. C, 65%RH	TESTED BY	Gavin Wu

ANTENNA POLARITY & TEST DISTANCE: HORIZONTAL AT 3 M										
FREQ. (MHz)	EMISSION LEVEL (dBuV/m)	READ LEVEL (dBuV)	LIMIT (dBuV/m)	MARGIN (dB)	ANTENNA FACTOR (dB/m)	CABLE LOSS (dB)	PREAMP FACTOR (dB)	ANTENNA HEIGHT (cm)	TABLE ANGLE (Degree)	REMARK
5112	39.57	39.37	54	-14.43	31.29	6.19	37.28	201	293	Average
5112	61.45	61.25	74	-12.55	31.29	6.19	37.28	201	293	Peak
5290	88.78	88.31			31.43	6.27	37.23	201	293	Average
5290	98.21	97.74			31.43	6.27	37.23	201	293	Peak
5434	40.48	39.74	54	-13.52	31.55	6.32	37.13	201	293	Average
5434	61.43	60.69	74	-12.57	31.55	6.32	37.13	201	293	Peak
ANTENNA POLARITY & TEST DISTANCE: VERTICAL AT 3 M										
FREQ. (MHz)	EMISSION LEVEL (dBuV/m)	READ LEVEL (dBuV)	LIMIT (dBuV/m)	MARGIN (dB)	ANTENNA FACTOR (dB/m)	CABLE LOSS (dB)	PREAMP FACTOR (dB)	ANTENNA HEIGHT (cm)	TABLE ANGLE (Degree)	REMARK
5094	39.37	39.18	54	-14.63	31.28	6.19	37.28	197	290	Average
5094	61.31	61.12	74	-12.69	31.28	6.19	37.28	197	290	Peak
5290	83.27	82.8			31.43	6.27	37.23	197	290	Average
5290	92.29	91.82			31.43	6.27	37.23	197	290	Peak
5452	39.95	39.13	54	-14.05	31.56	6.34	37.08	197	290	Average
5452	61.94	61.12	74	-12.06	31.56	6.34	37.08	197	290	Peak

REMARKS:

- Emission Level = Read Level + Antenna Factor + Cable Loss - Preamp Factor
Margin value = Emission level – Limit value
- 5290MHz: Fundamental frequency.



A D T

EUT TEST CONDITION		MEASUREMENT DETAIL	
CHANNEL	Channel 106	FREQUENCY RANGE	1GHz ~ 40GHz
INPUT POWER	120Vac, 60 Hz	DETECTOR FUNCTION	Peak (PK) Average (AV)
ENVIRONMENTAL CONDITIONS	25deg. C, 65%RH	TESTED BY	Gavin Wu

ANTENNA POLARITY & TEST DISTANCE: HORIZONTAL AT 3 M										
FREQ. (MHz)	EMISSION LEVEL (dBuV/m)	READ LEVEL (dBuV)	LIMIT (dBuV/m)	MARGIN (dB)	ANTENNA FACTOR (dB/m)	CABLE LOSS (dB)	PREAMP FACTOR (dB)	ANTENNA HEIGHT (cm)	TABLE ANGLE (Degree)	REMARK
5454	44.86	44.04	54	-9.14	31.56	6.34	37.08	198	298	Average
5454	61.56	60.74	74	-12.44	31.56	6.34	37.08	198	298	Peak
5470	60.54	59.71	68.2	-7.66	31.57	6.34	37.08	198	298	Peak
5530	89.65	88.69			31.63	6.42	37.09	198	298	Average
5530	99.19	98.23			31.63	6.42	37.09	198	298	Peak
5725	60.52	59.24	68.2	-7.68	31.96	6.75	37.43	198	298	Peak

ANTENNA POLARITY & TEST DISTANCE: VERTICAL AT 3 M										
FREQ. (MHz)	EMISSION LEVEL (dBuV/m)	READ LEVEL (dBuV)	LIMIT (dBuV/m)	MARGIN (dB)	ANTENNA FACTOR (dB/m)	CABLE LOSS (dB)	PREAMP FACTOR (dB)	ANTENNA HEIGHT (cm)	TABLE ANGLE (Degree)	REMARK
5440	42.49	41.73	54	-11.51	31.55	6.34	37.13	197	288	Average
5440	60.61	59.85	74	-13.39	31.55	6.34	37.13	197	288	Peak
5470	60.99	60.16	68.2	-7.21	31.57	6.34	37.08	197	288	Peak
5530	86.76	85.8			31.63	6.42	37.09	197	288	Average
5530	96.48	95.52			31.63	6.42	37.09	197	288	Peak
5725	59.54	58.26	68.2	-8.66	31.96	6.75	37.43	197	288	Peak

REMARKS:

1. Emission Level = Read Level + Antenna Factor + Cable Loss - Preamp Factor
Margin value = Emission level – Limit value
2. 5530MHz: Fundamental frequency.
3. 5470MHz & 5725MHz: Out of restricted band



A D T

EUT TEST CONDITION		MEASUREMENT DETAIL	
CHANNEL	Channel 122	FREQUENCY RANGE	1GHz ~ 40GHz
INPUT POWER	120Vac, 60 Hz	DETECTOR FUNCTION	Peak (PK) Average (AV)
ENVIRONMENTAL CONDITIONS	25deg. C, 65%RH	TESTED BY	Gavin Wu

ANTENNA POLARITY & TEST DISTANCE: HORIZONTAL AT 3 M										
FREQ. (MHz)	EMISSION LEVEL (dBuV/m)	READ LEVEL (dBuV)	LIMIT (dBuV/m)	MARGIN (dB)	ANTENNA FACTOR (dB/m)	CABLE LOSS (dB)	PREAMP FACTOR (dB)	ANTENNA HEIGHT (cm)	TABLE ANGLE (Degree)	REMARK
5382	39.89	39.25	54	-14.11	31.51	6.31	37.18	200	299	Average
5382	60.78	60.14	74	-13.22	31.51	6.31	37.18	200	299	Peak
5470	59.36	58.53	68.2	-8.84	31.57	6.34	37.08	200	299	Peak
5610	90.15	89.04			31.77	6.56	37.22	200	299	Average
5610	99.66	98.55			31.77	6.56	37.22	200	299	Peak
5725	59.93	58.65	68.2	-8.27	31.96	6.75	37.43	200	299	Peak

ANTENNA POLARITY & TEST DISTANCE: VERTICAL AT 3 M										
FREQ. (MHz)	EMISSION LEVEL (dBuV/m)	READ LEVEL (dBuV)	LIMIT (dBuV/m)	MARGIN (dB)	ANTENNA FACTOR (dB/m)	CABLE LOSS (dB)	PREAMP FACTOR (dB)	ANTENNA HEIGHT (cm)	TABLE ANGLE (Degree)	REMARK
5408	39.59	38.93	54	-14.41	31.52	6.32	37.18	200	288	Average
5408	61.45	60.79	74	-12.55	31.52	6.32	37.18	200	288	Peak
5470	58.91	58.08	68.2	-9.29	31.57	6.34	37.08	200	288	Peak
5610	86.84	85.73			31.77	6.56	37.22	200	288	Average
5610	96.84	95.73			31.77	6.56	37.22	200	288	Peak
5725	60.34	59.06	68.2	-7.86	31.96	6.75	37.43	200	288	Peak

REMARKS:

1. Emission Level = Read Level + Antenna Factor + Cable Loss - Preamp Factor
Margin value = Emission level – Limit value
2. 5610MHz: Fundamental frequency.
3. 5470MHz & 5725MHz: Out of restricted band



EUT TEST CONDITION		MEASUREMENT DETAIL	
CHANNEL	Channel 155	FREQUENCY RANGE	1GHz ~ 40GHz
INPUT POWER	120Vac, 60 Hz	DETECTOR FUNCTION	Peak (PK) Average (AV)
ENVIRONMENTAL CONDITIONS	25deg. C, 65%RH	TESTED BY	Gavin Wu

ANTENNA POLARITY & TEST DISTANCE: HORIZONTAL AT 3 M										
FREQ. (MHz)	EMISSION LEVEL (dBuV/m)	READ LEVEL (dBuV)	LIMIT (dBuV/m)	MARGIN (dB)	ANTENNA FACTOR (dB/m)	CABLE LOSS (dB)	PREAMP FACTOR (dB)	ANTENNA HEIGHT (cm)	TABLE ANGLE (Degree)	REMARK
5714	59.07	57.88	68.2	-9.13	31.93	6.69	37.43	198	329	Peak
5725	61.27	59.99	78.2	-16.93	31.96	6.75	37.43	198	329	Peak
5775	84.46	83.1			32.04	6.82	37.5	198	329	Average
5775	95.9	94.54			32.04	6.82	37.5	198	329	Peak
5850	60.63	59.11	78.2	-17.57	32.15	6.88	37.51	198	329	Peak
5861	59.76	58.13	68.2	-8.44	32.18	6.95	37.5	198	329	Peak
ANTENNA POLARITY & TEST DISTANCE: VERTICAL AT 3 M										
FREQ. (MHz)	EMISSION LEVEL (dBuV/m)	READ LEVEL (dBuV)	LIMIT (dBuV/m)	MARGIN (dB)	ANTENNA FACTOR (dB/m)	CABLE LOSS (dB)	PREAMP FACTOR (dB)	ANTENNA HEIGHT (cm)	TABLE ANGLE (Degree)	REMARK
5714	59.94	58.75	68.2	-8.26	31.93	6.69	37.43	218	20	Peak
5725	60.23	58.95	78.2	-17.97	31.96	6.75	37.43	218	20	Peak
5775	86.52	85.16			32.04	6.82	37.5	218	20	Average
5775	96.37	95.01			32.04	6.82	37.5	218	20	Peak
5850	60.09	58.57	78.2	-18.11	32.15	6.88	37.51	218	20	Peak
5861	60.54	58.91	68.2	-7.66	32.18	6.95	37.5	218	20	Peak

REMARKS:

- Emission Level = Read Level + Antenna Factor + Cable Loss - Preamp Factor
Margin value = Emission level – Limit value
- 5775MHz: Fundamental frequency.
- *: Out of restricted band

9kHz ~ 30MHz DATA:

The amplitude of spurious emissions attenuated more than 20dB below the permissible value is not required to be report.

30MHz ~ 1GHz WORST-CASE DATA:
802.11n (20MHz)

EUT TEST CONDITION		MEASUREMENT DETAIL	
CHANNEL	Channel 36	FREQUENCY RANGE	30MHz ~ 1GHz
INPUT POWER	120Vac, 60 Hz	DETECTOR FUNCTION	Peak (PK) Quasi-peak (QP)
ENVIRONMENTAL CONDITIONS	25deg. C, 65%RH	TESTED BY	Gavin Wu

ANTENNA POLARITY & TEST DISTANCE: HORIZONTAL AT 3 M

FREQ. (MHz)	EMISSION LEVEL (dBuV/m)	READ LEVEL (dBuV)	LIMIT (dBuV/m)	MARGIN (dB)	ANTENNA FACTOR (dB/m)	CABLE LOSS (dB)	PREAMP FACTOR (dB)	ANTENNA HEIGHT (cm)	TABLE ANGLE (Degree)	REMARK
119.64	31.77	51.58	43.5	-11.73	10.93	1.15	31.89	108	307	Peak
183.36	32.67	52.7	43.5	-10.83	10.53	1.23	31.79	112	201	Peak
213.06	33.95	54.3	43.5	-9.55	9.93	1.35	31.63	126	322	Peak
316.1	20.73	37.63	46	-25.27	13.33	1.68	31.91	100	135	Peak
469.4	20.14	33.31	46	-25.86	16.71	2.02	31.9	117	297	Peak
544.3	21.53	32.85	46	-24.47	18.33	2.17	31.82	131	39	Peak

ANTENNA POLARITY & TEST DISTANCE: VERTICAL AT 3 M

FREQ. (MHz)	EMISSION LEVEL (dBuV/m)	READ LEVEL (dBuV)	LIMIT (dBuV/m)	MARGIN (dB)	ANTENNA FACTOR (dB/m)	CABLE LOSS (dB)	PREAMP FACTOR (dB)	ANTENNA HEIGHT (cm)	TABLE ANGLE (Degree)	REMARK
41.07	36.63	53.45	40	-3.37	13.55	0.65	31.02	122	211	Peak
64.83	30.62	50.02	40	-9.38	11.35	0.84	31.59	136	170	Peak
119.37	25.9	45.71	43.5	-17.6	10.93	1.15	31.89	100	173	Peak
383.3	18.44	33.62	46	-27.56	14.94	1.86	31.98	133	309	Peak
489	20.22	32.83	46	-25.78	17.1	2.07	31.78	124	24	Peak
603.1	23.64	33.93	46	-22.36	19.65	2.26	32.2	123	305	Peak

REMARKS: Emission Level = Read Level + Antenna Factor + Cable Loss - Preamp Factor

Margin value = Emission level – Limit value



802.11n (20MHz)

EUT TEST CONDITION		MEASUREMENT DETAIL	
CHANNEL	Channel 60	FREQUENCY RANGE	30MHz ~ 1GHz
INPUT POWER	120Vac, 60 Hz	DETECTOR FUNCTION	Peak (PK) Quasi-peak (QP)
ENVIRONMENTAL CONDITIONS	25deg. C, 65%RH	TESTED BY	Gavin Wu

ANTENNA POLARITY & TEST DISTANCE: HORIZONTAL AT 3 M

FREQ. (MHz)	EMISSION LEVEL (dBuV/m)	READ LEVEL (dBuV)	LIMIT (dBuV/m)	MARGIN (dB)	ANTENNA FACTOR (dB/m)	CABLE LOSS (dB)	PREAMP FACTOR (dB)	ANTENNA HEIGHT (cm)	TABLE ANGLE (Degree)	REMARK
121.26	31.64	51.29	43.5	-11.86	11.09	1.16	31.9	123	211	Peak
182.55	32.49	52.48	43.5	-11.01	10.6	1.22	31.81	122	236	Peak
214.14	34.57	54.89	43.5	-8.93	9.97	1.35	31.64	123	282	Peak
328	20.9	37.41	46	-25.1	13.61	1.71	31.83	133	128	Peak
422.5	20.7	35.01	46	-25.3	15.79	1.94	32.04	105	25	Peak
589.1	24.49	35.05	46	-21.51	19.34	2.24	32.14	102	88	Peak

ANTENNA POLARITY & TEST DISTANCE: VERTICAL AT 3 M

FREQ. (MHz)	EMISSION LEVEL (dBuV/m)	READ LEVEL (dBuV)	LIMIT (dBuV/m)	MARGIN (dB)	ANTENNA FACTOR (dB/m)	CABLE LOSS (dB)	PREAMP FACTOR (dB)	ANTENNA HEIGHT (cm)	TABLE ANGLE (Degree)	REMARK
41.34	36.51	53.35	40	-3.49	13.56	0.65	31.05	106	277	Peak
64.83	29.85	49.25	40	-10.15	11.35	0.84	31.59	130	96	Peak
119.64	25.09	44.9	43.5	-18.41	10.93	1.15	31.89	114	117	Peak
343.4	18.07	34.17	46	-27.93	13.98	1.75	31.83	103	236	Peak
497.4	20.71	33.02	46	-25.29	17.27	2.08	31.66	134	212	Peak
647.9	23.78	33.27	46	-22.22	20.19	2.35	32.03	130	128	Peak

REMARKS: Emission Level = Read Level + Antenna Factor + Cable Loss - Preamp Factor

Margin value = Emission level – Limit value



802.11n (40MHz)

EUT TEST CONDITION		MEASUREMENT DETAIL	
CHANNEL	Channel 102	FREQUENCY RANGE	30MHz ~ 1GHz
INPUT POWER	120Vac, 60 Hz	DETECTOR FUNCTION	Peak (PK) Quasi-peak (QP)
ENVIRONMENTAL CONDITIONS	25deg. C, 65%RH	TESTED BY	Gavin Wu

ANTENNA POLARITY & TEST DISTANCE: HORIZONTAL AT 3 M

FREQ. (MHz)	EMISSION LEVEL (dBuV/m)	READ LEVEL (dBuV)	LIMIT (dBuV/m)	MARGIN (dB)	ANTENNA FACTOR (dB/m)	CABLE LOSS (dB)	PREAMP FACTOR (dB)	ANTENNA HEIGHT (cm)	TABLE ANGLE (Degree)	REMARK
121.26	31.96	51.61	43.5	-11.54	11.09	1.16	31.9	138	250	Peak
182.55	32.64	52.63	43.5	-10.86	10.6	1.22	31.81	139	268	Peak
213.6	33.94	54.29	43.5	-9.56	9.93	1.35	31.63	112	276	Peak
324.5	20.71	37.32	46	-25.29	13.54	1.7	31.85	139	255	Peak
412	19.52	34.01	46	-26.48	15.58	1.93	32	104	120	Peak
641.6	23.49	33.11	46	-22.51	20.12	2.34	32.08	106	251	Peak

ANTENNA POLARITY & TEST DISTANCE: VERTICAL AT 3 M

FREQ. (MHz)	EMISSION LEVEL (dBuV/m)	READ LEVEL (dBuV)	LIMIT (dBuV/m)	MARGIN (dB)	ANTENNA FACTOR (dB/m)	CABLE LOSS (dB)	PREAMP FACTOR (dB)	ANTENNA HEIGHT (cm)	TABLE ANGLE (Degree)	REMARK
38.91	37.18	54.15	40	-2.82	13.39	0.64	31	122	311	Peak
64.56	29.72	49.12	40	-10.28	11.35	0.84	31.59	102	31	Peak
151.5	25.95	43.76	43.5	-17.55	12.71	1.12	31.64	133	117	Peak
309.1	17.71	34.82	46	-28.29	13.17	1.66	31.94	139	314	Peak
494.6	20.86	33.27	46	-25.14	17.21	2.08	31.7	104	285	Peak
591.2	22.61	33.12	46	-23.39	19.41	2.24	32.16	117	58	Peak

REMARKS: Emission Level = Read Level + Antenna Factor + Cable Loss - Preamp Factor

Margin value = Emission level – Limit value

**802.11n (40MHz)**

EUT TEST CONDITION		MEASUREMENT DETAIL	
CHANNEL	Channel 151	FREQUENCY RANGE	30MHz ~ 1GHz
INPUT POWER	120Vac, 60 Hz	DETECTOR FUNCTION	Peak (PK) Quasi-peak (QP)
ENVIRONMENTAL CONDITIONS	25deg. C, 65%RH	TESTED BY	Gavin Wu

ANTENNA POLARITY & TEST DISTANCE: HORIZONTAL AT 3 M

FREQ. (MHz)	EMISSION LEVEL (dBuV/m)	READ LEVEL (dBuV)	LIMIT (dBuV/m)	MARGIN (dB)	ANTENNA FACTOR (dB/m)	CABLE LOSS (dB)	PREAMP FACTOR (dB)	ANTENNA HEIGHT (cm)	TABLE ANGLE (Degree)	REMARK
120.72	31.82	51.47	43.5	-11.68	11.09	1.16	31.9	130	111	Peak
182.55	32.87	52.86	43.5	-10.63	10.6	1.22	31.81	130	330	Peak
213.06	34.06	54.41	43.5	-9.44	9.93	1.35	31.63	120	66	Peak
325.9	21.64	38.21	46	-24.36	13.57	1.7	31.84	128	98	Peak
405.7	20.17	34.85	46	-25.83	15.45	1.92	32.05	139	271	Peak
592.6	22.75	33.25	46	-23.25	19.43	2.24	32.17	132	294	Peak

ANTENNA POLARITY & TEST DISTANCE: VERTICAL AT 3 M

FREQ. (MHz)	EMISSION LEVEL (dBuV/m)	READ LEVEL (dBuV)	LIMIT (dBuV/m)	MARGIN (dB)	ANTENNA FACTOR (dB/m)	CABLE LOSS (dB)	PREAMP FACTOR (dB)	ANTENNA HEIGHT (cm)	TABLE ANGLE (Degree)	REMARK
39.45	36.86	53.67	40	-3.14	13.54	0.64	30.99	108	284	Peak
66.99	30.81	50.52	40	-9.19	11.12	0.85	31.68	124	185	Peak
152.85	26	43.85	43.5	-17.5	12.72	1.12	31.69	107	329	Peak
330.1	17.47	33.9	46	-28.53	13.66	1.72	31.81	129	229	Peak
471.5	19.76	32.87	46	-26.24	16.75	2.03	31.89	123	296	Peak
623.4	22.88	32.85	46	-23.12	19.89	2.3	32.16	125	147	Peak

REMARKS: Emission Level = Read Level + Antenna Factor + Cable Loss - Preamp Factor

Margin value = Emission level – Limit value

4.2 Conducted Emission Measurement

4.2.1 Limits of Conducted Emission Measurement

Frequency (MHz)	Conducted Limit (dBuV)	
	Quasi-peak	Average
0.15 - 0.5	66 - 56	56 - 46
0.50 - 5.0	56	46
5.0 - 30.0	60	50

Note: 1. The lower limit shall apply at the transition frequencies.

2. The limit decreases in line with the logarithm of the frequency in the range of 0.15 to 0.50MHz.

4.2.2 Test Instruments

Description & Manufacturer	Model No.	Serial No.	Date Of Calibration	Due Date Of Calibration
Test Receiver ROHDE & SCHWARZ	ESCI	100613	Nov. 11, 2014	Nov. 10, 2015
RF signal cable (with 10dB PAD) Woken	5D-FB	Cable-cond1-01	Dec. 26, 2014	Dec. 25, 2015
LISN ROHDE & SCHWARZ (EUT)	ESH3-Z5	835239/001	Feb. 26, 2015	Feb. 25, 2016
LISN ROHDE & SCHWARZ (Peripheral)	ESH3-Z5	100311	Jul. 24, 2015	Jul. 23, 2016
Software ADT	BV ADT_Cond_ V7.3.7.3	NA	NA	NA

- Note:**
1. The calibration interval of the above test instruments is 12 months and the calibrations are traceable to NML/ROC and NIST/USA.
 2. The test was performed in HwaYa Shielded Room 1.
 3. The VCCI Site Registration No. is C-2040.

4.2.3 Test Procedures

- a. The EUT was placed 0.4 meters from the conducting wall of the shielded room with EUT being connected to the power mains through a line impedance stabilization network (LISN). Other support units were connected to the power mains through another LISN. The two LISNs provide 50 ohm/ 50uH of coupling impedance for the measuring instrument.
- b. Both lines of the power mains connected to the EUT were checked for maximum conducted interference.
- c. The frequency range from 150kHz to 30MHz was searched. Emission levels under (Limit - 20dB) was not recorded.

NOTE: All modes of operation were investigated and the worst-case emissions are reported.

4.2.4 Deviation from Test Standard

No deviation.

4.2.5 Test Setup

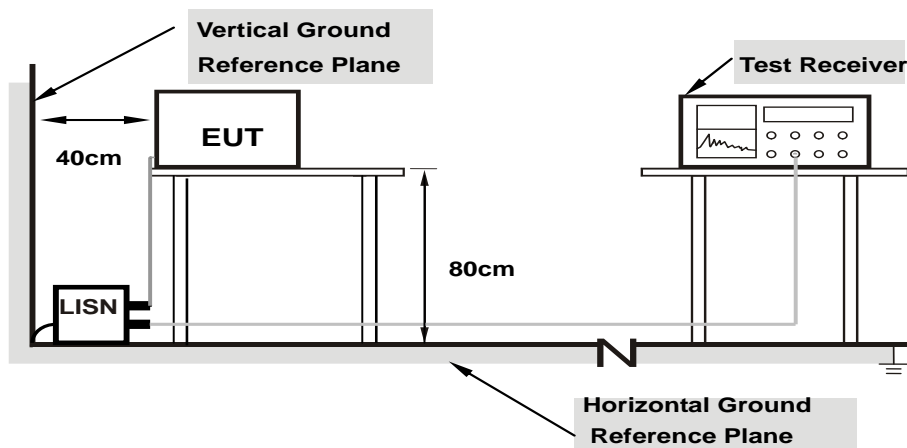

- Note:**
1. Support units were connected to second LISN.
 2. Both of LISNs (AMN) are 80 cm from EUT and at least 80 from other units and other metal planes

For the actual test configuration, please refer to the attached file (Test Setup Photo).

4.2.6 EUT Operating Conditions

Same as 4.1.6.

4.2.7 Test Results

Frequency Range	150kHz ~ 30MHz	Detector Function & Resolution Bandwidth	Quasi-Peak (QP) / Average (AV)
Input Power	120Vac, 60Hz	Environmental Conditions	25°C, 65%RH
Tested by	Toby Tian	Test Date	2015/8/25

Phase Of Power : Line (L)										
No	Frequency (MHz)	Correction Factor (dB)	Reading Value (dBuV)		Emission Level (dBuV)		Limit (dBuV)		Margin (dB)	
			Q.P.	AV.	Q.P.	AV.	Q.P.	AV.	Q.P.	AV.
1	0.15391	0.05	48.10	46.60	48.15	46.65	65.79	55.79	-17.64	-9.14
2	0.54491	0.06	43.47	31.03	43.53	31.09	56.00	46.00	-12.47	-14.91
3	0.96719	0.08	41.30	31.53	41.38	31.61	56.00	46.00	-14.62	-14.39
4	1.48722	0.10	40.52	31.13	40.62	31.23	56.00	46.00	-15.38	-14.77
5	2.57420	0.14	39.48	30.59	39.62	30.73	56.00	46.00	-16.38	-15.27
6	3.72374	0.18	40.37	31.47	40.55	31.65	56.00	46.00	-15.45	-14.35

Remarks:

1. Q.P. and AV. are abbreviations of quasi-peak and average individually.
2. The emission levels of other frequencies were very low against the limit.
3. Margin value = Emission level – Limit value
4. Correction factor = Insertion loss + Cable loss
5. Emission Level = Correction Factor + Reading Value

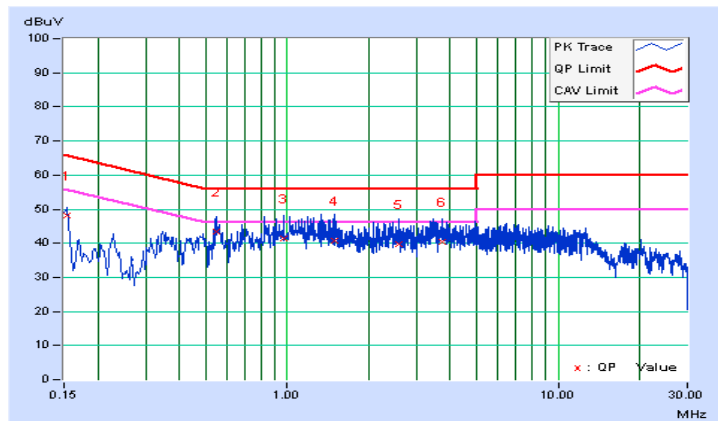

Frequency Range	150kHz ~ 30MHz	Detector Function & Resolution Bandwidth	Quasi-Peak (QP) / Average (AV)
Input Power	120Vac, 60Hz	Environmental Conditions	25°C, 65%RH
Tested by	Toby Tian	Test Date	2015/8/25

Phase Of Power : Neutral (N)										
No	Frequency (MHz)	Correction Factor (dB)	Reading Value (dBuV)		Emission Level (dBuV)		Limit (dBuV)		Margin (dB)	
			Q.P.	AV.	Q.P.	AV.	Q.P.	AV.	Q.P.	AV.
1	0.15000	0.05	47.02	45.57	47.07	45.62	66.00	56.00	-18.93	-10.38
2	0.22851	0.05	40.25	38.71	40.30	38.76	62.50	52.50	-22.20	-13.74
3	0.42670	0.06	38.91	29.59	38.97	29.65	57.32	47.32	-18.35	-17.67
4	0.94808	0.08	40.44	31.02	40.52	31.10	56.00	46.00	-15.48	-14.90
5	1.43248	0.09	38.19	29.50	38.28	29.59	56.00	46.00	-17.72	-16.41
6	3.69246	0.18	36.51	28.71	36.69	28.89	56.00	46.00	-19.31	-17.11

Remarks:

1. Q.P. and AV. are abbreviations of quasi-peak and average individually.
2. The emission levels of other frequencies were very low against the limit.
3. Margin value = Emission level – Limit value
4. Correction factor = Insertion loss + Cable loss
5. Emission Level = Correction Factor + Reading Value

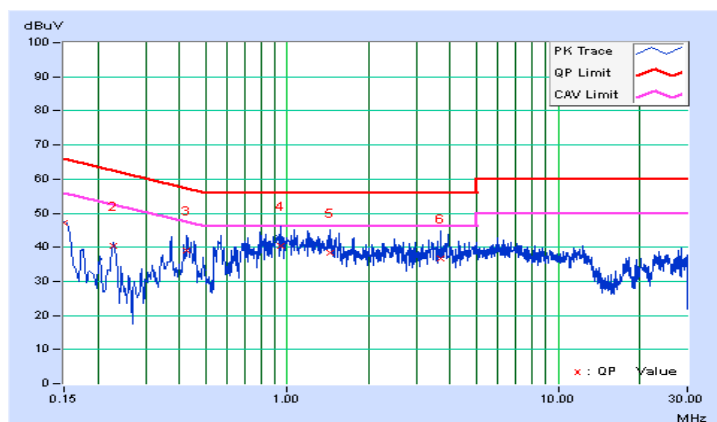

4.3 Transmit Power Measurement

4.3.1 Limits of Transmit Power Measurement

Operation Band	EUT Category		LIMIT
U-NII-1		Outdoor Access Point	1 Watt (30 dBm) (Max. e.i.r.p \leq 125mW(21 dBm) at any elevation angle above 30 degrees as measured from the horizon)
		Fixed point-to-point Access Point	1 Watt (30 dBm)
		Indoor Access Point	1 Watt (30 dBm)
	√	Mobile and Portable client device	250mW (24 dBm)
U-NII-2A		√	250mW (24 dBm) or 11 dBm+10 log B*
U-NII-2C		√	250mW (24 dBm) or 11 dBm+10 log B*
U-NII-3		√	1 Watt (30 dBm)

*B is the 26 dB emission bandwidth in megahertz

Per KDB 662911 Method of conducted output power measurement on IEEE 802.11 devices,

Array Gain = 0 dB (i.e., no array gain) for $N_{ANT} \leq 4$;

Array Gain = 0 dB (i.e., no array gain) for channel widths ≥ 40 MHz for any N_{ANT} ;

Array Gain = $5 \log(N_{ANT}/N_{SS})$ dB or 3 dB, whichever is less for 20-MHz channel widths with $N_{ANT} \geq 5$.

For power measurements on all other devices: Array Gain = $10 \log(N_{ANT}/N_{SS})$ dB.

4.3.2 Test Setup

FOR POWER OUTPUT MEASUREMENT

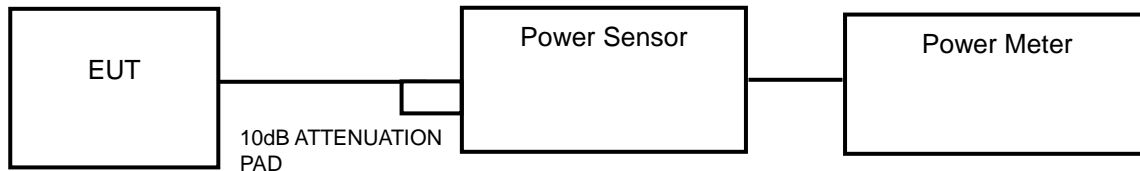

or

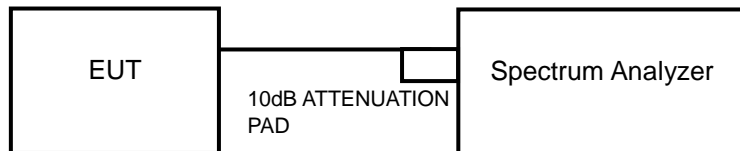

FOR 26dB BANDWIDTH

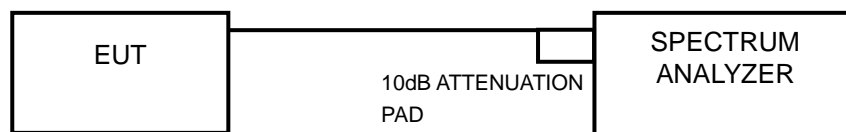

4.3.3 Test Instruments

Refer to section 4.1.2 to get information of above instrument.

4.3.4 Test Procedure

FOR AVERAGE POWER MEASUREMENT

<802.11a, 802.11n (20MHz), 802.11n (40MHz)>

Method PM is used to perform output power measurement, trigger and gating function of wide band power meter is enabled to measure max output power of TX on burst. Duty factor is not added to measured value.

<802.11ac (80MHz)>

Method SA-1 is used to perform output power measurement, trigger and gating function of spectrum analyzer is enabled to measure max output power of TX on burst. Duty factor is not added to measured value.

FOR 26dB BANDWIDTH

- 1) Set RBW = approximately 1% of the emission bandwidth.
- 2) Set the VBW > RBW.
- 3) Detector = Peak.
- 4) Trace mode = max hold.
- 5) Measure the maximum width of the emission that is 26 dB down from the peak of the emission. Compare this with the RBW setting of the analyzer. Readjust RBW and repeat measurement as needed until the RBW/EBW ratio is approximately 1%.

4.3.5 Deviation from Test Standard

No deviation.

4.3.6 EUT Operating Conditions

The software provided by client to enable the EUT under transmission condition continuously at lowest, middle and highest channel frequencies individually.

4.3.7 Test Result

POWER OUTPUT:

802.11a

Channel	Frequency (MHz)	Maximum Conducted Power (mW)	Maximum Conducted Power (dBm)	Power Limit (dBm)	Pass / Fail
36	5180	22.80	13.58	24	Pass
44	5220	23.01	13.62	24	Pass
48	5240	22.96	13.61	24	Pass
52	5260	23.12	13.64	24	Pass
60	5300	22.44	13.51	24	Pass
64	5320	22.65	13.55	24	Pass
100	5500	23.28	13.67	24	Pass
116	5580	23.33	13.68	24	Pass
140	5700	22.86	13.59	24	Pass
149	5745	22.18	13.46	30	Pass
157	5785	23.23	13.66	30	Pass
165	5825	22.54	13.53	30	Pass

NOTE:

For U-NII-2A, U-NII-2C Band:

1. $11\text{dBm} + 10\log(22.89) = 24.60\text{ dBm} > 24\text{dBm}$.
2. $11\text{dBm} + 10\log(22.80) = 24.58\text{ dBm} > 24\text{dBm}$.
3. $11\text{dBm} + 10\log(22.50) = 24.52\text{ dBm} > 24\text{dBm}$.
4. $11\text{dBm} + 10\log(22.56) = 24.53\text{ dBm} > 24\text{dBm}$.
5. $11\text{dBm} + 10\log(22.57) = 24.54\text{ dBm} > 24\text{dBm}$.
6. $11\text{dBm} + 10\log(22.84) = 24.59\text{ dBm} > 24\text{dBm}$.

802.11n (20MHz)

Channel	Frequency (MHz)	Maximum Conducted Power (mW)	Maximum Conducted Power (dBm)	Power Limit (dBm)	Pass / Fail
36	5180	17.95	12.54	24	Pass
44	5220	18.32	12.63	24	Pass
48	5240	18.24	12.61	24	Pass
52	5260	17.70	12.48	24	Pass
60	5300	17.91	12.53	24	Pass
64	5320	18.11	12.58	24	Pass
100	5500	18.07	12.57	24	Pass
116	5580	18.45	12.66	24	Pass
140	5700	17.99	12.55	24	Pass
149	5745	17.66	12.47	30	Pass
157	5785	16.75	12.24	30	Pass
165	5825	16.98	12.3	30	Pass

NOTE:
For U-NII-2A, U-NII-2C Band:

1. $11\text{dBm} + 10\log(22.85) = 24.59\text{ dBm} > 24\text{dBm}$.
2. $11\text{dBm} + 10\log(22.77) = 24.57\text{ dBm} > 24\text{dBm}$.
3. $11\text{dBm} + 10\log(22.73) = 24.57\text{ dBm} > 24\text{dBm}$.
4. $11\text{dBm} + 10\log(22.77) = 24.57\text{ dBm} > 24\text{dBm}$.
5. $11\text{dBm} + 10\log(22.75) = 24.57\text{ dBm} > 24\text{dBm}$.
6. $11\text{dBm} + 10\log(22.80) = 24.58\text{ dBm} > 24\text{dBm}$.

802.11n (40MHz)

Channel	Frequency (MHz)	Maximum Conducted Power (mW)	Maximum Conducted Power (dBm)	Power Limit (dBm)	Pass / Fail
38	5190	17.58	12.45	24	Pass
46	5230	17.66	12.47	24	Pass
54	5270	17.14	12.34	24	Pass
62	5310	17.26	12.37	24	Pass
102	5510	18.49	12.67	24	Pass
110	5550	17.54	12.44	24	Pass
134	5670	17.26	12.37	24	Pass
151	5755	17.42	12.41	30	Pass
159	5795	16.60	12.2	30	Pass

NOTE:
For U-NII-2A, U-NII-2C Band:

- $11\text{dBm} + 10\log(45.73) = 27.60\text{ dBm} > 24\text{dBm}$.
- $11\text{dBm} + 10\log(45.41) = 27.57\text{ dBm} > 24\text{dBm}$.
- $11\text{dBm} + 10\log(46.14) = 27.64\text{ dBm} > 24\text{dBm}$.
- $11\text{dBm} + 10\log(45.71) = 27.60\text{ dBm} > 24\text{dBm}$.
- $11\text{dBm} + 10\log(45.30) = 27.56\text{ dBm} > 24\text{dBm}$.

802.11ac (80MHz)

Channel	Frequency (MHz)	Maximum Conducted Power (mW)	Maximum Conducted Power (dBm)	Power Limit (dBm)	Pass / Fail
42	5210	9.44	9.75	24	Pass
58	5290	10.59	10.25	24	Pass
106	5530	10.26	10.11	24	Pass
122	5610	10.54	10.23	24	Pass
155	5775	10.05	10.02	30	Pass

NOTE:
For U-NII-2A, U-NII-2C Band:

- $11\text{dBm} + 10\log(86.02) = 30.35\text{ dBm} > 24\text{dBm}$.
- $11\text{dBm} + 10\log(84.71) = 30.28\text{ dBm} > 24\text{dBm}$.
- $11\text{dBm} + 10\log(85.34) = 30.31\text{ dBm} > 24\text{dBm}$.

26dB BANDWIDTH:
802.11a

Channel	Frequency (MHz)	26dBc Bandwidth (MHz)	Pass / Fail
36	5180	22.49	Pass
44	5220	22.36	Pass
48	5240	22.49	Pass
52	5260	22.89	Pass
60	5300	22.80	Pass
64	5320	22.50	Pass
100	5500	22.56	Pass
116	5580	22.57	Pass
140	5700	22.84	Pass

802.11n (20MHz)

Channel	Frequency (MHz)	26dBc Bandwidth (MHz)	Pass / Fail
36	5180	22.81	Pass
44	5220	22.95	Pass
48	5240	22.92	Pass
52	5260	22.85	Pass
60	5300	22.77	Pass
64	5320	22.73	Pass
100	5500	22.77	Pass
116	5580	22.75	Pass
140	5700	22.80	Pass

802.11n (40MHz)

Channel	Frequency (MHz)	26dBc Bandwidth (MHz)	Pass / Fail
38	5190	45.77	Pass
46	5230	46.18	Pass
54	5270	45.73	Pass
62	5310	45.41	Pass
102	5510	46.14	Pass
110	5550	45.71	Pass
134	5670	45.30	Pass

802.11ac (80MHz)

Channel	Frequency (MHz)	26dBc Bandwidth (MHz)	Pass / Fail
42	5210	85.97	Pass
58	5290	86.02	Pass
106	5530	84.71	Pass
122	5610	85.34	Pass

Spectrum Plot of Worst Value

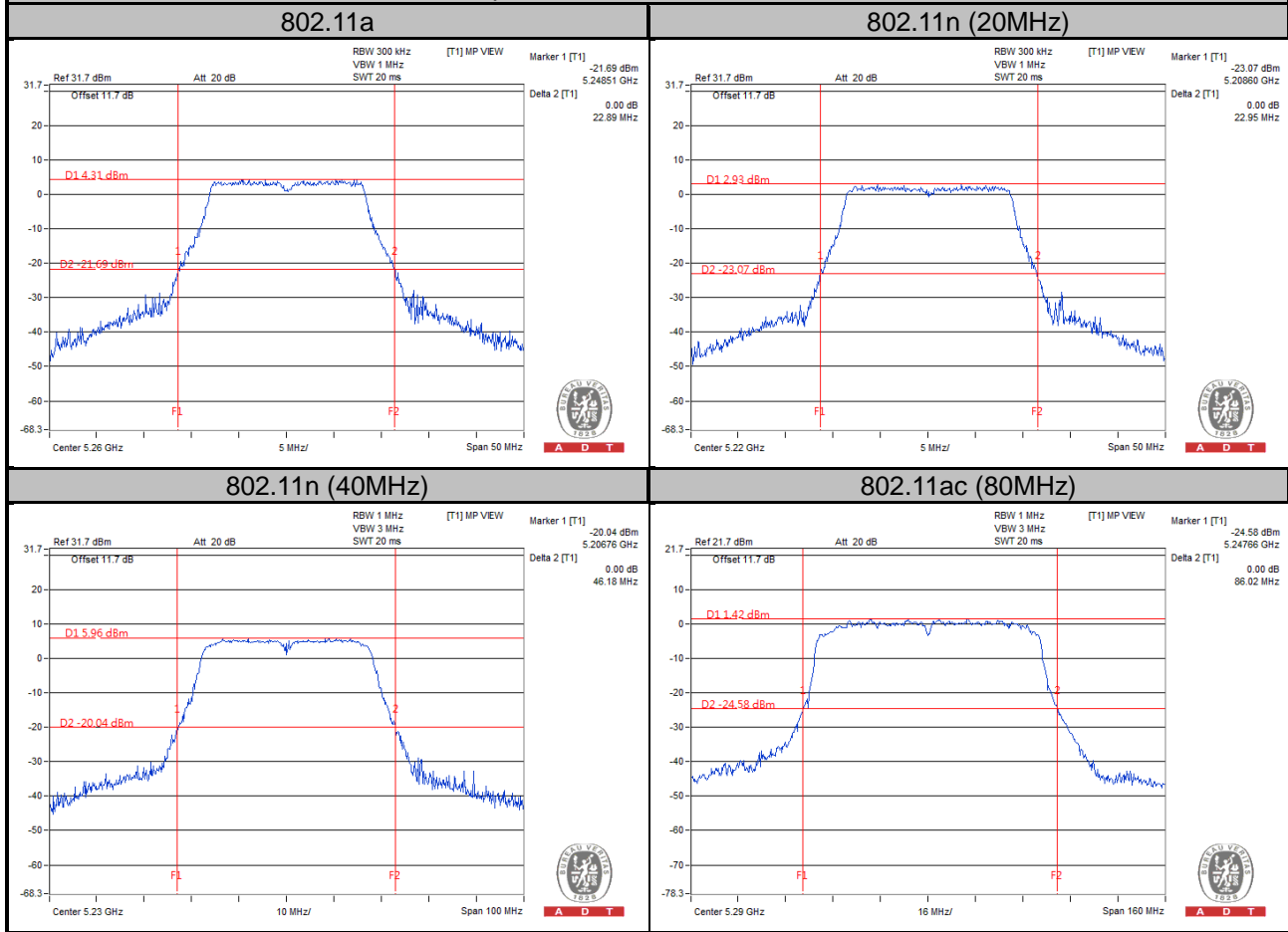

4.4 Peak Power Spectral Density Measurement

4.4.1 Limits of Peak Power Spectral Density Measurement

Operation Band	EUT Category		Limit
U-NII-1		Outdoor Access Point	17dBm/ MHz
		Fixed point-to-point Access Point	
		Indoor Access Point	
	√	Mobile and Portable client device	11dBm/ MHz
U-NII-2A	√		11dBm/ MHz
U-NII-2C	√		11dBm/ MHz
U-NII-3	√		30dBm/ 500MHz

4.4.2 Test Setup

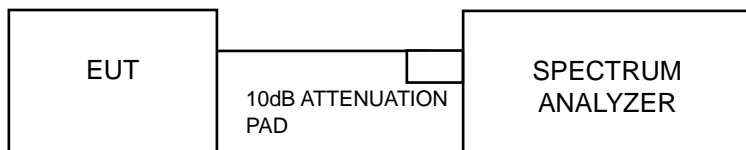

4.4.3 Test Instruments

Refer to section 4.1.3 to get information of above instrument.

4.4.4 Test Procedures

For U-NII-1, U-NII-2A, U-NII-2C band:

Using method SA-2

1. Set span to encompass the entire emission bandwidth (EBW) of the signal.
2. Set RBW = 1 MHz, Set VBW \geq 3 MHz, Detector = RMS
3. Sweep time = auto, trigger set to "free run".
4. Trace average at least 100 traces in power averaging mode.
5. Record the max value and add 10 log (1/duty cycle)

※For U-NII-3:

1. Set span to encompass the entire emission bandwidth (EBW) of the signal.
2. Set RBW = 300 kHz, Set VBW \geq 1 MHz, Detector = RMS
3. Use the peak marker function to determine the maximum power level in any 300 kHz band segment within the fundamental EBW.
4. Scale the observed power level to an equivalent value in 500 kHz by adjusting (reducing) the measured power by a bandwidth correction factor (BWCF) where $BWCF = 10\log(500\text{ kHz}/300\text{ kHz})$
5. Sweep time = auto, trigger set to "free run".
6. Trace average at least 100 traces in power averaging mode.
7. Record the max value and add 10 log (1/duty cycle)

4.4.5 Deviation from Test Standard

No deviation.

4.4.6 EUT Operating Conditions

Same as Item 4.3.6.

4.4.7 Test Results

802.11a

Channel	Frequency (MHz)	PSD w/o Duty Factor (dBm)	Duty Factor	PSD with Duty Factor (dBm)	Maximum Limit (dBm)	Pass / Fail
36	5180	0.50	0.80	1.30	11	Pass
44	5220	0.14	0.80	0.94	11	Pass
48	5240	0.46	0.80	1.26	11	Pass
52	5260	0.55	0.80	1.35	11	Pass
60	5300	0.84	0.80	1.64	11	Pass
64	5320	0.98	0.80	1.78	11	Pass
100	5500	1.51	0.80	2.31	11	Pass
116	5580	1.21	0.80	2.01	11	Pass
140	5700	0.30	0.80	1.10	11	Pass

NOTE: Refer to section 3.3 for duty cycle spectrum plot.

802.11n (20MHz)

Channel	Frequency (MHz)	PSD w/o Duty Factor (dBm)	Duty Factor	PSD with Duty Factor (dBm)	Maximum Limit (dBm)	Pass / Fail
36	5180	-1.14	0.85	-0.29	11	Pass
44	5220	-1.05	0.85	-0.20	11	Pass
48	5240	-0.71	0.85	0.14	11	Pass
52	5260	-0.47	0.85	0.38	11	Pass
60	5300	-0.42	0.85	0.43	11	Pass
64	5320	-0.21	0.85	0.64	11	Pass
100	5500	0.28	0.85	1.13	11	Pass
116	5580	-0.30	0.85	0.55	11	Pass
140	5700	-1.10	0.85	-0.25	11	Pass

NOTE: Refer to section 3.3 for duty cycle spectrum plot.

802.11n (40MHz)

Channel	Frequency (MHz)	PSD w/o Duty Factor (dBm)	Duty Factor	PSD with Duty Factor (dBm)	Maximum Limit (dBm)	Pass / Fail
38	5190	-3.62	1.79	-1.83	11	Pass
46	5230	-3.44	1.79	-1.65	11	Pass
54	5270	-3.15	1.79	-1.36	11	Pass
62	5310	-2.86	1.79	-1.07	11	Pass
102	5510	-2.80	1.79	-1.01	11	Pass
110	5550	-2.14	1.79	-0.35	11	Pass
134	5670	-3.12	1.79	-1.33	11	Pass

NOTE: Refer to section 3.3 for duty cycle spectrum plot.

802.11ac (80MHz)

Channel	Frequency (MHz)	PSD w/o Duty Factor (dBm)	Duty Factor	PSD with Duty Factor (dBm)	Maximum Limit (dBm)	Pass / Fail
42	5210	-13.13	3.17	-9.96	11	Pass
58	5290	-12.63	3.17	-9.46	11	Pass
106	5530	-11.93	3.17	-8.76	11	Pass
122	5610	-12.16	3.17	-8.99	11	Pass

NOTE: Refer to section 3.3 for duty cycle spectrum plot.

Spectrum Plot of Worst Value

802.11a

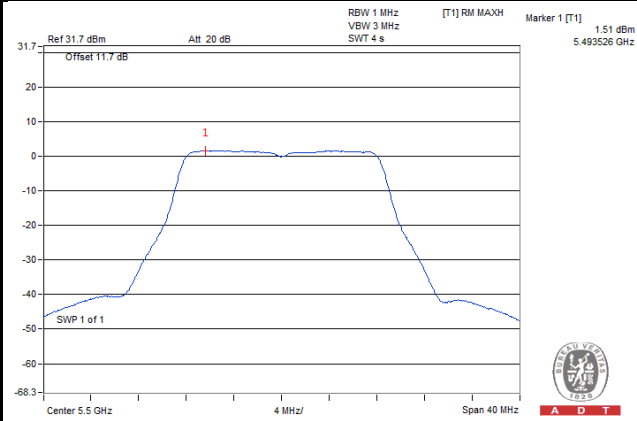

802.11n (20MHz)

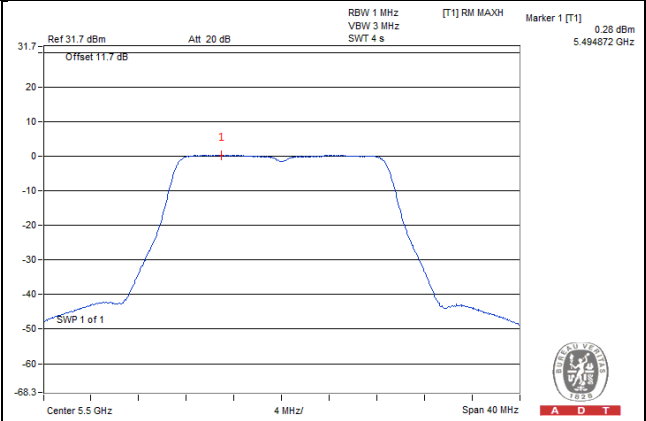

802.11n (40MHz)

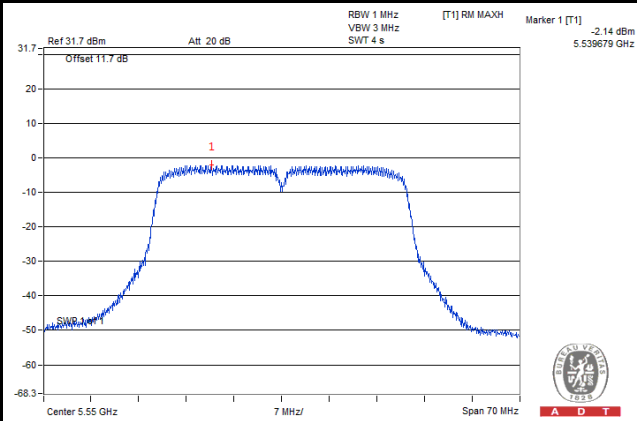

802.11ac (80MHz)

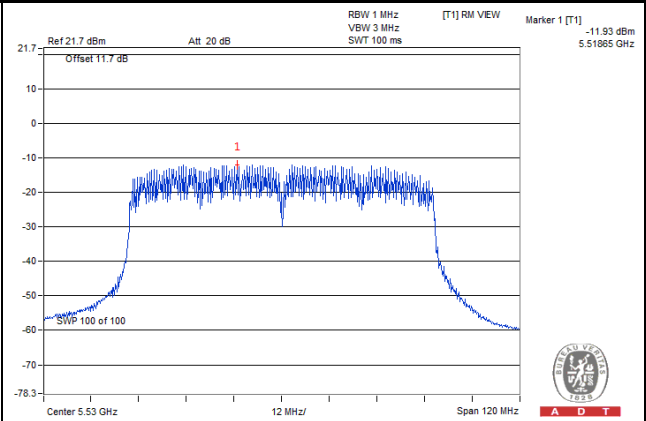

For U-NII-3 Band

802.11a

Channel	Frequency (MHz)	PSD w/o Duty Factor (dBm)	Duty Factor	PSD with Duty Factor (dBm)	Limit (dBm/500kHz)	Pass / Fail
149	5745	-3.27	0.80	-2.47	30	Pass
157	5785	-3.10	0.80	-2.30	30	Pass
165	5825	-2.65	0.80	-1.85	30	Pass

NOTE: Refer to section 3.3 for duty cycle spectrum plot.

802.11n (20MHz)

Channel	Frequency (MHz)	PSD w/o Duty Factor (dBm)	Duty Factor	PSD with Duty Factor (dBm)	Limit (dBm/500kHz)	Pass / Fail
149	5745	-3.90	0.88	-3.02	30	Pass
157	5785	-4.37	0.88	-3.49	30	Pass
165	5825	-3.74	0.88	-2.86	30	Pass

NOTE: Refer to section 3.3 for duty cycle spectrum plot.

802.11n (40MHz)

Channel	Frequency (MHz)	PSD w/o Duty Factor (dBm)	Duty Factor	PSD with Duty Factor (dBm)	Limit (dBm/500kHz)	Pass / Fail
151	5755	-8.21	2.27	-5.94	30	Pass
159	5795	-7.91	2.27	-5.64	30	Pass

NOTE: Refer to section 3.3 for duty cycle spectrum plot.

802.11ac (80MHz)

Channel	Frequency (MHz)	PSD w/o Duty Factor (dBm)	Duty Factor	PSD with Duty Factor (dBm)	Limit (dBm/500kHz)	Pass / Fail
155	5775	-13.61	3.37	-10.24	30	Pass

NOTE: Refer to section 3.3 for duty cycle spectrum plot.

Spectrum Plot of Worst Value

802.11a

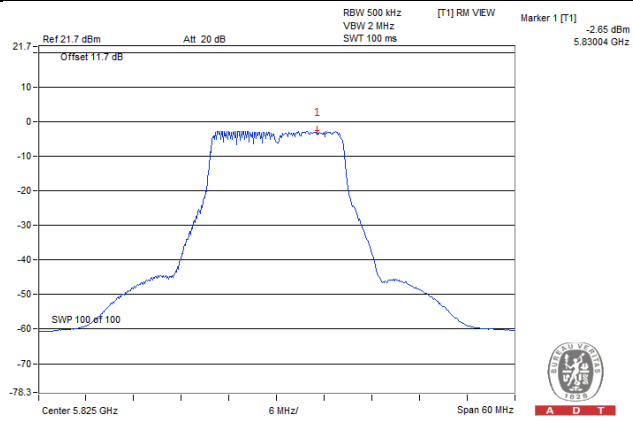

802.11n (20MHz)

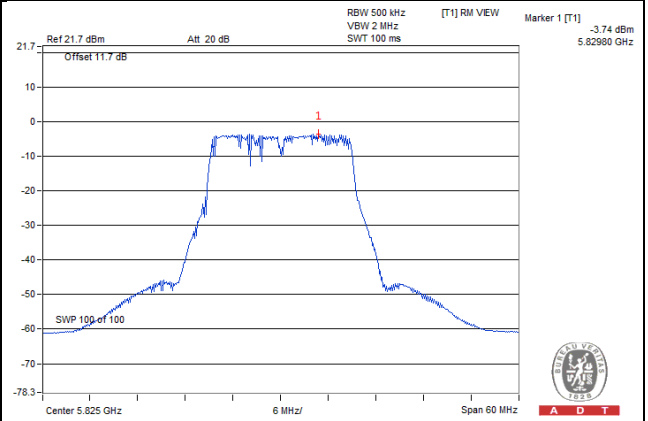

802.11n (40MHz)

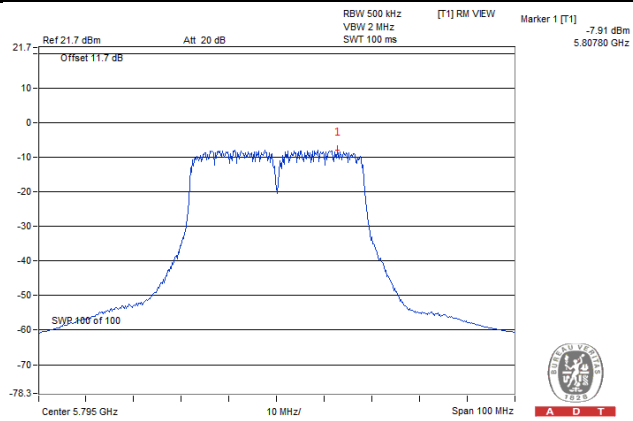

802.11ac (80MHz)

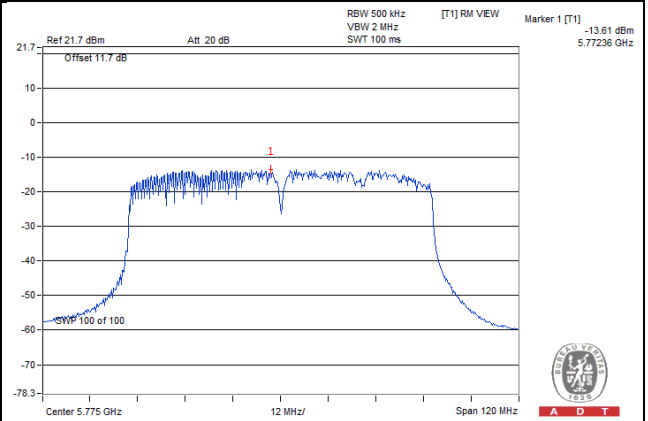

4.5 Frequency Stability

4.5.1 Limit of Frequency Stability Measurement

The frequency of the carrier signal shall be maintained within band of operation

4.5.2 Test Setup

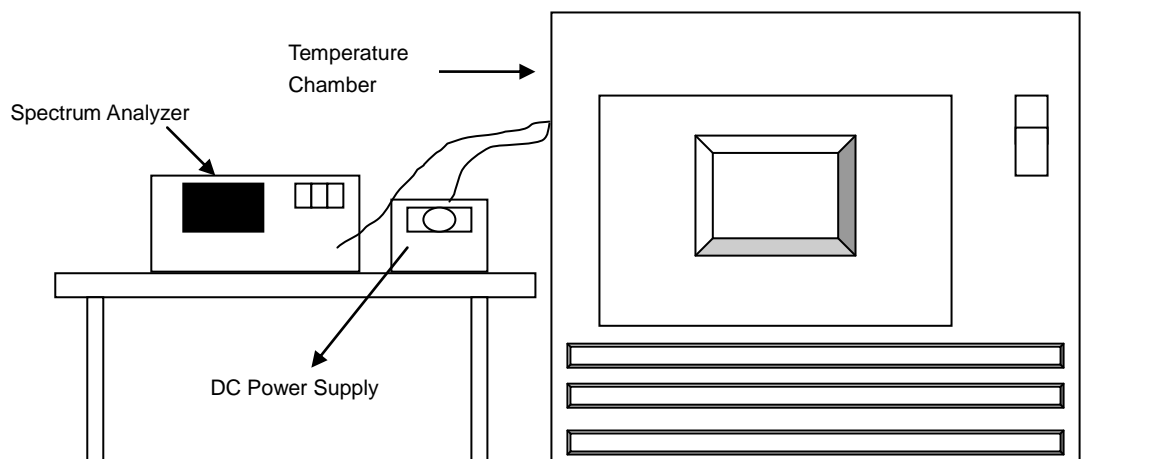

4.5.3 Test Instruments

Refer to section 4.1.3 to get information of above instrument.

4.5.4 Test Procedure

- To ensure emission at the band edge is maintained within the authorized band, those values shall be measured by radiation emissions at upper and lower frequency points, and finally compensated by frequency deviation as procedures below.
- The EUT was operated at the maximum output power, and connected to the spectrum analyzer, which is set to maximum hold function and peak detector. The peak value of the power envelope was measured and noted. The upper and lower frequency points were respectively measured relatively 10dB lower than the measured peak value.
- The frequency deviation was calculated by adding the upper frequency point and the lower frequency point divided by two. Those detailed values of frequency deviation are provided in table below.

4.5.5 Deviation from Test Standard

No deviation.

4.5.6 EUT Operating Condition

Set the EUT transmit at un-modulation mode to test frequency stability.

4.5.7 Test Results

Frequency Stability Versus Temp.									
Operating Frequency: 5320MHz									
Temp. (°C)	Power Supply (Vdc)	0 Minute		2 Minute		5 Minute		10 Minute	
		Measured Frequency (MHz)	Frequency Drift (%)	Measured Frequency (MHz)	Frequency Drift (%)	Measured Frequency (MHz)	Frequency Drift (%)	Measured Frequency (MHz)	Frequency Drift (%)
60	3.85	5320.035837	6.736	5320.036431	6.848	5320.036383	6.839	5320.036700	6.898
50	3.85	5320.036580	6.876	5320.037077	6.969	5320.037073	6.969	5320.036659	6.891
40	3.85	5320.036957	6.947	5320.037260	7.004	5320.036652	6.889	5320.036975	6.950
30	3.85	5320.038363	7.211	5320.038123	7.166	5320.038036	7.150	5320.038290	7.197
20	3.85	5320.038225	7.185	5320.037841	7.113	5320.037848	7.114	5320.038011	7.145
10	3.85	5320.040725	7.655	5320.040761	7.662	5320.040774	7.664	5320.040525	7.617
0	3.85	5320.039179	7.364	5320.039263	7.380	5320.039160	7.361	5320.039029	7.336
-10	3.85	5320.037382	7.027	5320.037643	7.076	5320.037653	7.078	5320.037422	7.034
-20	3.85	5320.037242	7.000	5320.037317	7.014	5320.037271	7.006	5320.037458	7.041
-30	3.85	5320.035511	6.675	5320.035598	6.691	5320.036175	6.800	5320.035908	6.750

Frequency Stability Versus Temp.									
Operating Frequency: 5320MHz									
Temp. (°C)	Power Supply (Vdc)	0 Minute		2 Minute		5 Minute		10 Minute	
		Measured Frequency (MHz)	Frequency Drift (%)	Measured Frequency (MHz)	Frequency Drift (%)	Measured Frequency (MHz)	Frequency Drift (%)	Measured Frequency (MHz)	Frequency Drift (%)
20	3.6	5320.037238	7.000	5320.037855	7.116	5320.037851	7.115	5320.037576	7.063
	3.85	5320.038225	7.185	5320.037841	7.113	5320.037848	7.114	5320.038011	7.145
	4.40	5320.039386	7.403	5320.039676	7.458	5320.039350	7.397	5320.039267	7.381

4.6 6dB Bandwidth Measurement

4.6.1 Limits of 6dB Bandwidth Measurement

The minimum of 6dB Bandwidth Measurement is 0.5MHz.

4.6.2 Test Setup

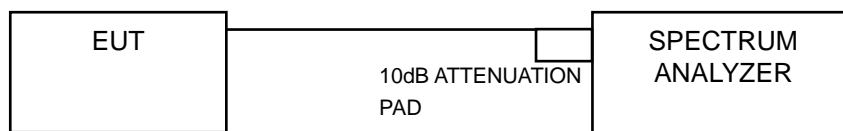

4.6.3 Test Instruments

Refer to section 4.1.3 to get information of above instrument.

4.6.4 Test Procedure

MEASUREMENT PROCEDURE REF

- Set resolution bandwidth (RBW) = 100kHz
- Set the video bandwidth (VBW) $\geq 3 \times$ RBW, Detector = Peak.
- Trace mode = max hold.
- Sweep = auto couple.
- Measure the maximum width of the emission that is constrained by the frequencies associated with the two amplitude points (upper and lower) that are attenuated by 6 dB relative to the maximum level measured in the fundamental emission

4.6.5 Deviation from Test Standard

No deviation.

4.6.6 EUT Operating Condition

The software provided by client to enable the EUT under transmission condition continuously at lowest, middle and highest channel frequencies individually.

4.6.7 Test Results

802.11a

Channel	Frequency (MHz)	6dB Bandwidth (MHz)	Minimum Limit (MHz)	Pass / Fail
149	5745	16.42	0.5	Pass
157	5785	16.42	0.5	Pass
165	5825	16.40	0.5	Pass

802.11n (20MHz)

Channel	Frequency (MHz)	6dB Bandwidth (MHz)	Minimum Limit (MHz)	Pass / Fail
149	5745	17.63	0.5	Pass
157	5785	17.63	0.5	Pass
165	5825	17.64	0.5	Pass

802.11n (40MHz)

Channel	Frequency (MHz)	6dB Bandwidth (MHz)	Minimum Limit (MHz)	Pass / Fail
151	5755	35.45	0.5	Pass
159	5795	35.31	0.5	Pass

802.11ac (80MHz)

Channel	Frequency (MHz)	6dB Bandwidth (MHz)	Minimum Limit (MHz)	Pass / Fail
155	5775	75.26	0.5	Pass

Spectrum Plot of Worst Value

802.11a

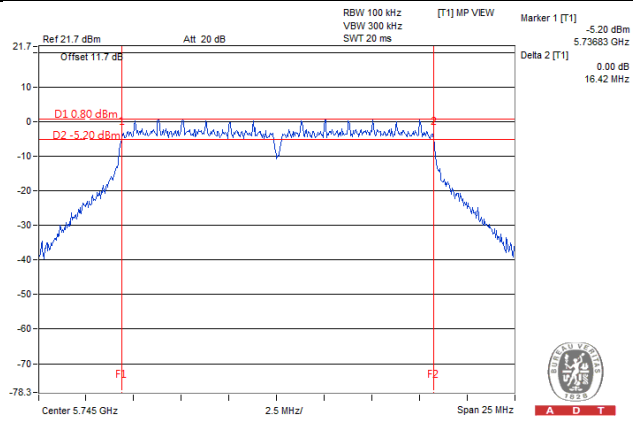

802.11n (20MHz)

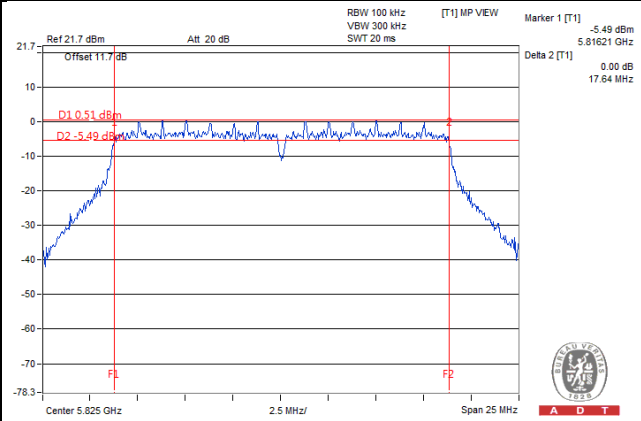

802.11n (40MHz)

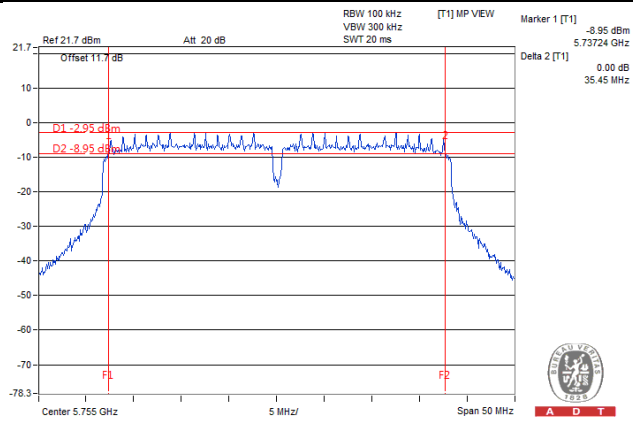

802.11ac (80MHz)

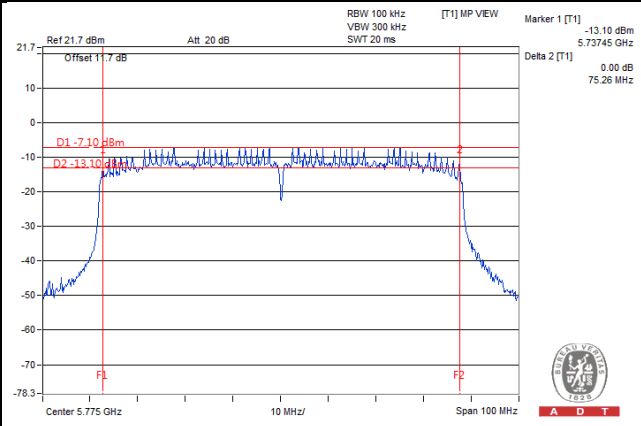



5 Pictures of Test Arrangements

Please refer to the attached file (Test Setup Photo).



Appendix – Information on the Testing Laboratories

We, Bureau Veritas Consumer Products Services (H.K.) Ltd., Taoyuan Branch, were founded in 1988 to provide our best service in EMC, Radio, Telecom and Safety consultation. Our laboratories are accredited and approved according to ISO/IEC 17025.

If you have any comments, please feel free to contact us at the following:

Linko EMC/RF Lab

Tel: 886-2-26052180

Fax: 886-2-26051924

Hsin Chu EMC/RF Lab/Telecom Lab

Tel: 886-3-5935343

Fax: 886-3-5935342

Hwa Ya EMC/RF/Safety

Tel: 886-3-3183232

Fax: 886-3-3270892

Email: service.adt@tw.bureauveritas.com

Web Site: www.bureauveritas-adt.com

The address and road map of all our labs can be found in our web site also.

--- END ---