

FCC Test Report

(PART 24)

Report No.: RF150727C10-1

FCC ID: NM82PQ9300

Test Model: 2PQ9300

Received Date: Jul. 27, 2015

Test Date: Jul. 29, 2015 ~ Sep. 01, 2015

Issued Date: Sep. 17, 2015

Applicant: HTC Corporation

Address: 1F, 6-3 Baoqiang Road, Xindian City, Taipei County 231, Taiwan

Issued By: Bureau Veritas Consumer Products Services (H.K.) Ltd., Taoyuan Branch

Lab Address: No. 47-2, 14th Ling, Chia Pau Vil., Lin Kou Dist., New Taipei City, Taiwan
(R.O.C)

Test Location: No. 19, Hwa Ya 2nd Rd, Wen Hwa Tsuen, Kwei Shan Hsiang, Taoyuan
Hsien 333, Taiwan, R.O.C.



This report is for your exclusive use. Any copying or replication of this report to or for any other person or entity, or use of our name or trademark, is permitted only with our prior written permission. This report sets forth our findings solely with respect to the test samples identified herein. The results set forth in this report are not indicative or representative of the quality or characteristics of the lot from which a test sample was taken or any similar or identical product unless specifically and expressly noted. Our report includes all of the tests requested by you and the results thereof based upon the information that you provided to us. You have 60 days from date of issuance of this report to notify us of any material error or omission caused by our negligence, provided, however, that such notice shall be in writing and shall specifically address the issue you wish to raise. A failure to raise such issue within the prescribed time shall constitute your unqualified acceptance of the completeness of this report, the tests conducted and the correctness of the report contents. Unless specific mention, the uncertainty of measurement has been explicitly taken into account to declare the compliance or non-compliance to the specification. The report must not be used by the client to claim product certification, approval, or endorsement by TAF or any government agencies.



Table of Contents

Release Control Record	3
1 Certificate of Conformity	4
2 Summary of Test Results	5
2.1 Measurement Uncertainty	5
2.2 Test Site And Instruments	6
3 General Information	7
3.1 General Description of EUT	7
3.2 Configuration Of System Under Test	9
3.2.1 Description of Support Units	9
3.3 Test Mode Applicability and Tested Channel Detail	10
3.4 EUT Operating Conditions	14
3.5 General Description of Applied Standards	14
4 Test Types and Results	15
4.1 Output Power Measurement	15
4.1.1 Limits of Output Power Measurement	15
4.1.2 Test Procedures	15
4.1.3 Test Setup	16
4.1.4 Test Results	17
4.2 Frequency Stability Measurement	30
4.2.1 Limits of Frequency Stability Measurement	30
4.2.2 Test Procedure	30
4.2.3 Test Setup	30
4.2.4 Test Results	31
4.3 Occupied Bandwidth Measurement	33
4.3.1 Test Procedure	33
4.3.2 Test Setup	33
4.3.3 Test Result	34
4.4 Band Edge Measurement	41
4.4.1 Limits of Band Edge Measurement	41
4.4.2 Test Setup	41
4.4.3 Test Procedures	41
4.4.4 Test Results	42
4.5 Peak To Average Ratio	54
4.5.1 Limits of Peak to Average Ratio Measurement	54
4.5.2 Test Setup	54
4.5.3 Test Procedures	54
4.5.4 Test Results	55
4.6 Conducted Spurious Emissions	62
4.6.1 Limits of Conducted Spurious Emissions Measurement	62
4.6.2 Test Setup	62
4.6.3 Test Procedure	62
4.6.4 Test Results	62
4.7 Radiated Emission Measurement	65
4.7.1 Limits of Radiated Emission Measurement	65
4.7.2 Test Procedure	65
4.7.3 Deviation from Test Standard	65
4.7.4 Test Setup	65
4.7.5 Test Results	66
5 Pictures of Test Arrangements	72
Appendix – Information on the Testing Laboratories	73



A O T

Release Control Record

Issue No.	Description	Date Issued
RF150727C10-1	Original Release	Sep. 17, 2015



1 Certificate of Conformity

Product: Smartphone
Brand: HTC
Test Model: 2PQ9300
Sample Status: Identical Prototype
Applicant: HTC Corporation
Test Date: Jul. 29, 2015 ~ Sep. 01, 2015
Standards: FCC Part 24, Subpart E

The above equipment has been tested by **Bureau Veritas Consumer Products Services (H.K.) Ltd., Taoyuan Branch**, and found compliance with the requirement of the above standards. The test record, data evaluation & Equipment Under Test (EUT) configurations represented herein are true and accurate accounts of the measurements of the sample's EMC characteristics under the conditions specified in this report.

Prepared by : Ivonne Wu , **Date:** Sep. 17, 2015
Ivonne Wu / Supervisor

Approved by : Kay Wu , **Date:** Sep. 17, 2015
Kay Wu / Supervisor

2 Summary of Test Results

Applied Standard: FCC Part 24 & Part 2			
FCC Clause	Test Item	Result	Remarks
2.1046 24.232	Effective Isotropic Radiated Power	PASS	Meet the requirement of limit.
2.1046 24.232(d)	Peak To Average Ratio	PASS	Meet the requirement of limit.
2.1055 24.235	Frequency Stability	PASS	Meet the requirement of limit.
2.1049 24.238(b)	Occupied Bandwidth	PASS	Meet the requirement of limit.
24.238(b)	Band Edge Measurements	PASS	Meet the requirement of limit.
2.1051 24.238	Conducted Spurious Emissions	PASS	Meet the requirement of limit.
2.1053 24.238	Radiated Spurious Emissions	PASS	Meet the requirement of limit. Minimum passing margin is -31.78dB at 40.53MHz.

2.1 Measurement Uncertainty

Where relevant, the following measurement uncertainty levels have been estimated for tests performed on the EUT as specified in CISPR 16-4-2:

Measurement	Frequency	Expanded Uncertainty (k=2) (\pm)
Conducted Emissions at mains ports	150kHz ~ 30MHz	2.44 dB
Radiated Emissions up to 1 GHz	30MHz ~ 200MHz	2.0153 dB
	200MHz ~ 1000MHz	2.0224 dB
Radiated Emissions above 1 GHz	1GHz ~ 18GHz	1.0121 dB
	18GHz ~ 40GHz	1.1508 dB



A O T

2.2 Test Site And Instruments

Description & Manufacturer	Model No.	Serial No.	Date of Calibration	Due Date of Calibration
Test Receiver Agilent	N9038A	MY51210203	Jan. 21, 2015	Jan. 21, 2016
Spectrum Analyzer Agilent	N9010A	MY52220314	Sep. 03, 2015	Sep. 02, 2016
Spectrum Analyzer ROHDE & SCHWARZ	FSU43	101261	Dec. 10, 2014	Dec. 09, 2015
BILOG Antenna SCHWARZBECK	VULB9168	9168-472	Feb. 04, 2015	Feb. 04, 2016
HORN Antenna SCHWARZBECK	BBHA 9120 D	9120D-969	Feb. 09, 2015	Feb. 09, 2016
HORN Antenna SCHWARZBECK	BBHA 9170	9170-480	Feb. 04, 2015	Feb. 04, 2016
Preamplifier EMCI	EMC 012645	980115	Dec. 12, 2014	Dec. 11, 2015
Preamplifier EMCI	EMC 184045	980116	Jan. 09, 2015	Jan. 08, 2016
Preamplifier EMCI	EMC 330H	980112	Dec. 27, 2014	Dec. 26, 2015
Power Meter Anritsu	ML2495A	1232002	Sep. 17, 2014	Sep. 16, 2015
Power Sensor Anritsu	MA2411B	1207325	Sep. 17, 2014	Sep. 16, 2015
RF signal cable HUBER+SUHNNER	SUCOFLEX 104	309219/4 2950114	Oct. 18, 2014	Oct. 17, 2015
RF signal cable HUBER+SUHNNER	SUCOFLEX 104	250130/4	Oct. 18, 2014	Oct. 17, 2015
RF Coaxial Cable Worken	8D-FB	Cable-Ch10-01	Nov. 07, 2014	Nov. 06, 2015
Software BV ADT	E3 6.120103	NA	NA	NA
Antenna Tower MF	MFA-440H	NA	NA	NA
Turn Table MF	MFT-201SS	NA	NA	NA
Antenna Tower & Turn Table Controller MF	MF-7802	NA	NA	NA
Communications Tester-Wireless Agilent	8960 Series 10	MY53201073	Jul. 03, 2015	Jul. 02, 2017
Radio Communication Analyzer Anritsu	MT8820C	6201240432	Jul. 06, 2015	Jul. 05, 2017

- Note: 1. The calibration interval of the above test instruments is 12 / 24 months and the calibrations are traceable to NML/ROC and NIST/USA.
2. The test was performed in HwaYa Chamber 10.
3. The horn antenna and preamplifier (model: EMC 184045) are used only for the measurement of emission frequency above 1GHz if tested.
4. The FCC Site Registration No. is 690701.
5. The IC Site Registration No. is IC7450F-10.



3 General Information

3.1 General Description of EUT

Product	Smartphone	
Brand	HTC	
Test Model	2PQ9300	
Status of EUT	Identical Prototype	
Power Supply Rating	5.0Vdc (adapter or host equipment) 3.85Vdc (Li-ion battery)	
Modulation Type	CDMA	QPSK, OQPSK, HPSK
	LTE	QPSK, 16QAM
Frequency Range	CDMA	1851.3 ~ 1908.8 MHz
	LTE Band 2 (Channel Bandwidth: 1.4MHz)	1850.7 ~ 1909.3 MHz
	LTE Band 2 (Channel Bandwidth: 3MHz)	1851.5 ~ 1908.5 MHz
	LTE Band 2 (Channel Bandwidth: 5MHz)	1852.5 ~ 1907.5 MHz
	LTE Band 2 (Channel Bandwidth: 10MHz)	1855.0 ~ 1905.0 MHz
	LTE Band 2 (Channel Bandwidth: 15MHz)	1857.5 ~ 1902.5 MHz
	LTE Band 2 (Channel Bandwidth: 20MHz)	1860.0 ~ 1900.0 MHz
	LTE Band 25 (Channel Bandwidth: 1.4MHz)	1850.7 ~ 1914.3 MHz
	LTE Band 25 (Channel Bandwidth: 3MHz)	1851.5 ~ 1913.5 MHz
	LTE Band 25 (Channel Bandwidth: 5MHz)	1852.5 ~ 1912.5 MHz
	LTE Band 25 (Channel Bandwidth: 10MHz)	1855.0 ~ 1910.0 MHz
	LTE Band 25 (Channel Bandwidth: 15MHz)	1857.5 ~ 1907.5 MHz
	LTE Band 25 (Channel Bandwidth: 20MHz)	1860.0 ~ 1905.0 MHz
Max. EIRP Power	CDMA	185.50mW
	LTE Band 2 (Channel Bandwidth: 1.4MHz)	70.96mW
	LTE Band 2 (Channel Bandwidth: 3MHz)	84.53mW
	LTE Band 2 (Channel Bandwidth: 5MHz)	81.85mW
	LTE Band 2 (Channel Bandwidth: 10MHz)	79.80mW
	LTE Band 2 (Channel Bandwidth: 15MHz)	72.61mW
	LTE Band 2 (Channel Bandwidth: 20MHz)	61.52mW
	LTE Band 25 (Channel Bandwidth: 1.4MHz)	82.41mW
	LTE Band 25 (Channel Bandwidth: 3MHz)	80.35mW
	LTE Band 25 (Channel Bandwidth: 5MHz)	73.79mW
	LTE Band 25 (Channel Bandwidth: 10MHz)	71.29mW
	LTE Band 25 (Channel Bandwidth: 15MHz)	66.22mW
LTE Band 25 (Channel Bandwidth: 20MHz)	69.18mW	

Emission Designator	CDMA	1M28F9W
	LTE Band 2 (Channel Bandwidth: 1.4MHz)	1M09G7D
	LTE Band 2 (Channel Bandwidth: 3MHz)	2M70G7D
	LTE Band 2 (Channel Bandwidth: 5MHz)	4M49G7D
	LTE Band 2 (Channel Bandwidth: 10MHz)	8M95G7D
	LTE Band 2 (Channel Bandwidth: 15MHz)	13M4G7D
	LTE Band 2 (Channel Bandwidth: 20MHz)	17M9W7D
	LTE Band 25 (Channel Bandwidth: 1.4MHz)	1M09G7D
	LTE Band 25 (Channel Bandwidth: 3MHz)	2M70G7D
	LTE Band 25 (Channel Bandwidth: 5MHz)	4M49G7D
	LTE Band 25 (Channel Bandwidth: 10MHz)	8M96W7D
	LTE Band 25 (Channel Bandwidth: 15MHz)	13M4G7D
	LTE Band 25 (Channel Bandwidth: 20MHz)	17M9W7D
	Antenna Type	Fixed Internal Antenna
Accessory Device	Refer to Note as below	
Data Cable Supplied	Refer to Note as below	

Note:

1. The EUT's accessories list refers to Ext. Pho.
2. The above EUT information is declared by manufacturer and for more detailed features description, please refer to the manufacturer's specifications or user's manual.

3.2 Configuration Of System Under Test

<Radiated Emission Test>

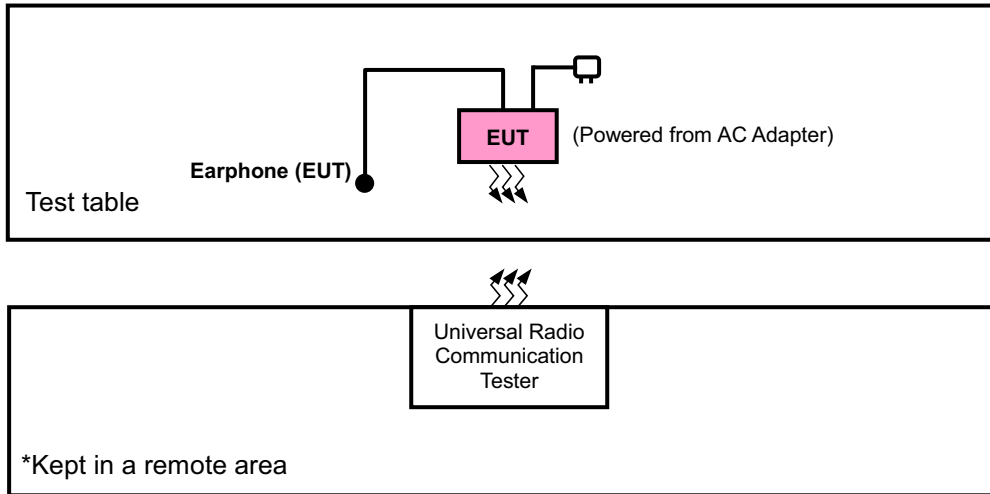

<E.I.R.P. Test>

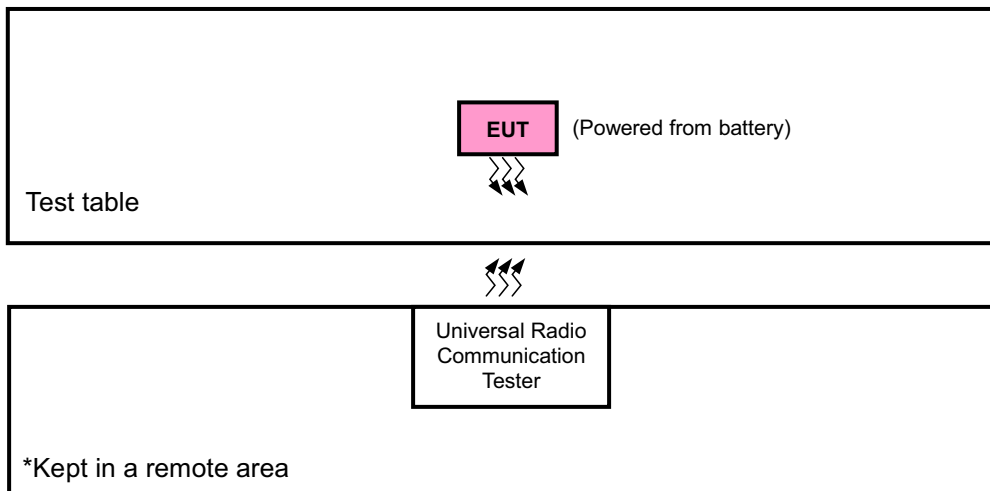

3.2.1 Description of Support Units

The EUT has been tested as an independent unit together with other necessary accessories or support units.

3.3 Test Mode Applicability and Tested Channel Detail

Pre-Scan has been conducted to determine the worst-case mode from all possible combinations between available modulations, data rates, XYZ axis and antenna ports

The worst case was found when positioned as the table below. Following channel(s) was (were) selected for the final test as listed below:

Band	EIRP	Radiated Emission
CDMA	Z-plane	Z-axis
LTE Band 2	Z-plane	Z-axis
LTE Band 25	Z-plane	Z-axis

CDMA MODE

EUT Configure Mode	Test Item	Available Channel	Tested Channel	Mode
-	ERP	25 to 1175	25, 600, 1175	1xRTT
-	Frequency Stability	25 to 1175	600	1xRTT
-	Occupied Bandwidth	25 to 1175	25, 600, 1175	1xRTT
-	Band Edge	25 to 1175	25, 600, 1175	1xRTT
-	Peak to Average Ratio	25 to 1175	25, 1175	1xRTT
-	Condcudeted Emission	25 to 1175	600	1xRTT
-	Radiated Emission	25 to 1175	600	1xRTT



LTE BAND 2 MODE

EUT Configure Mode	Test Item	Available Channel	Tested Channel	Channel Bandwidth	Modulation	Mode
-	EIRP	18607 to 19193	18607, 18900, 19193	1.4MHz	QPSK, 16QAM	1 RB / 0 RB Offset
		18615 to 19185	18615, 18900, 19185	3MHz	QPSK, 16QAM	1 RB / 0 RB Offset
		18625 to 19175	18625, 18900, 19175	5MHz	QPSK, 16QAM	1 RB / 0 RB Offset
		18650 to 19150	18650, 18900, 19150	10MHz	QPSK, 16QAM	1 RB / 0 RB Offset
		18675 to 19125	18675, 18900, 19125	15MHz	QPSK, 16QAM	1 RB / 0 RB Offset
		18700 to 19100	18700, 18900, 19100	20MHz	QPSK, 16QAM	1 RB / 0 RB Offset
-	Frequency Stability	18607 to 19193	18900	1.4MHz	QPSK	1 RB / 0 RB Offset
		18615 to 19185	18900	3MHz	QPSK	1 RB / 0 RB Offset
		18625 to 19175	18900	5MHz	QPSK	1 RB / 0 RB Offset
		18650 to 19150	18900	10MHz	QPSK	1 RB / 0 RB Offset
		18675 to 19125	18900	15MHz	QPSK	1 RB / 0 RB Offset
		18700 to 19100	18900	20MHz	QPSK	1 RB / 0 RB Offset
-	Occupied Bandwidth	18607 to 19193	18607, 18900, 19193	1.4MHz	QPSK, 16QAM	6 RB / 0 RB Offset
		18615 to 19185	18615, 18900, 19185	3MHz	QPSK, 16QAM	15 RB / 0 RB Offset
		18625 to 19175	18625, 18900, 19175	5MHz	QPSK, 16QAM	25 RB / 0 RB Offset
		18650 to 19150	18650, 18900, 19150	10MHz	QPSK, 16QAM	50 RB / 0 RB Offset
		18675 to 19125	18675, 18900, 19125	15MHz	QPSK, 16QAM	75 RB / 0 RB Offset
		18700 to 19100	18700, 18900, 19100	20MHz	QPSK, 16QAM	100 RB / 0 RB Offset
-	Peak to Average Ratio	18607 to 19193	18607, 18900, 19193	1.4MHz	QPSK, 16QAM	1 RB / 0 RB Offset
		18615 to 19185	18615, 18900, 19185	3MHz	QPSK, 16QAM	1 RB / 0 RB Offset
		18625 to 19175	18625, 18900, 19175	5MHz	QPSK, 16QAM	1 RB / 0 RB Offset
		18650 to 19150	18650, 18900, 19150	10MHz	QPSK, 16QAM	1 RB / 0 RB Offset
		18675 to 19125	18675, 18900, 19125	15MHz	QPSK, 16QAM	1 RB / 0 RB Offset
		18700 to 19100	18700, 18900, 19100	20MHz	QPSK, 16QAM	1 RB / 0 RB Offset
-	Band Edge	18607 to 19193	18607	1.4MHz	QPSK	1 RB / 0 RB Offset 6 RB / 0 RB Offset
			19193	1.4MHz	QPSK	1 RB / 5 RB Offset 6 RB / 0 RB Offset
		18615 to 19185	18615	3MHz	QPSK	1 RB / 0 RB Offset 15 RB / 0 RB Offset
			19185	3MHz	QPSK	1 RB / 14 RB Offset 15 RB / 0 RB Offset
		18625 to 19175	18625	5MHz	QPSK	1 RB / 0 RB Offset 25 RB / 0 RB Offset
			19175	5MHz	QPSK	1 RB / 24 RB Offset 25 RB / 0 RB Offset
		18650 to 19150	18650	10MHz	QPSK	1 RB / 0 RB Offset 50 RB / 0 RB Offset
			19150	10MHz	QPSK	1 RB / 49 RB Offset 50 RB / 0 RB Offset
		18675 to 19125	18675	15MHz	QPSK	1 RB / 0 RB Offset 75 RB / 0 RB Offset
			19125	15MHz	QPSK	1 RB / 74 RB Offset 75 RB / 0 RB Offset
		18700 to 19100	18700	20MHz	QPSK	1 RB / 0 RB Offset 100 RB / 0 RB Offset
			19100	20MHz	QPSK	1 RB / 99 RB Offset 100 RB / 0 RB Offset



EUT Configure Mode	Test Item	Available Channel	Tested Channel	Channel Bandwidth	Modulation	Mode
-	Conducted Emission	18607 to 19193	18900	1.4MHz	QPSK	1 RB / 0 RB Offset
		18615 to 19185	18900	3MHz	QPSK	1 RB / 0 RB Offset
		18625 to 19175	18900	5MHz	QPSK	1 RB / 0 RB Offset
		18650 to 19150	18900	10MHz	QPSK	1 RB / 0 RB Offset
		18675 to 19125	18900	15MHz	QPSK	1 RB / 0 RB Offset
		18700 to 19100	18900	20MHz	QPSK	1 RB / 0 RB Offset
-	Radiated Emission	18700 to 19100	18900	20MHz	QPSK	1 RB / 0 RB Offset

Note: This device was tested under all bandwidths, RB configurations and modulations. The worst case was found in QPSK modulation.

LTE BAND 25 MODE

EUT Configure Mode	Test Item	Available Channel	Tested Channel	Channel Bandwidth	Modulation	Mode
-	EIRP	26047 to 26683	26047, 26365, 26683	1.4MHz	QPSK / 16QAM	1 RB / 0 RB Offset
		26055 to 26675	26055, 26365, 26675	3MHz	QPSK / 16QAM	1 RB / 0 RB Offset
		26065 to 26665	26065, 26365, 26665	5MHz	QPSK / 16QAM	1 RB / 0 RB Offset
		26090 to 26640	26090, 26365, 26640	10MHz	QPSK / 16QAM	1 RB / 0 RB Offset
		26115 to 26615	26115, 26365, 26615	15MHz	QPSK / 16QAM	1 RB / 0 RB Offset
		26140 to 26590	26140, 26365, 26590	20MHz	QPSK / 16QAM	1 RB / 0 RB Offset
-	Frequency Stability	26047 to 26683	26365	1.4MHz	QPSK	1 RB / 0 RB Offset
		26055 to 26675	26365	3MHz	QPSK	1 RB / 0 RB Offset
		26065 to 26665	26365	5MHz	QPSK	1 RB / 0 RB Offset
		26090 to 26640	26365	10MHz	QPSK	1 RB / 0 RB Offset
		26115 to 26615	26365	15MHz	QPSK	1 RB / 0 RB Offset
		26140 to 26590	26365	20MHz	QPSK	1 RB / 0 RB Offset
-	Occupied Bandwidth	26047 to 26683	26047, 26365, 26683	1.4MHz	QPSK / 16QAM	6 RB / 0 RB Offset
		26055 to 26675	26055, 26365, 26675	3MHz	QPSK / 16QAM	15 RB / 0 RB Offset
		26065 to 26665	26065, 26365, 26665	5MHz	QPSK / 16QAM	25 RB / 0 RB Offset
		26090 to 26640	26090, 26365, 26640	10MHz	QPSK / 16QAM	50 RB / 0 RB Offset
		26115 to 26615	26115, 26365, 26615	15MHz	QPSK / 16QAM	75 RB / 0 RB Offset
		26140 to 26590	26140, 26365, 26590	20MHz	QPSK / 16QAM	100 RB / 0 RB Offset
-	Peak to Average Ratio	26047 to 26683	26047, 26365, 26683	1.4MHz	QPSK / 16QAM	1 RB / 0 RB Offset
		26055 to 26675	26055, 26365, 26675	3MHz	QPSK / 16QAM	1 RB / 0 RB Offset
		26065 to 26665	26065, 26365, 26665	5MHz	QPSK / 16QAM	1 RB / 0 RB Offset
		26090 to 26640	26090, 26365, 26640	10MHz	QPSK / 16QAM	1 RB / 0 RB Offset
		26115 to 26615	26115, 26365, 26615	15MHz	QPSK / 16QAM	1 RB / 0 RB Offset
		26140 to 26590	26140, 26365, 26590	20MHz	QPSK / 16QAM	1 RB / 0 RB Offset



EUT Configure Mode	Test Item	Available Channel	Tested Channel	Channel Bandwidth	Modulation	Mode		
-	Band Edge	26047 to 26683	26047	1.4MHz	QPSK	1 RB / 0 RB Offset 6 RB / 0 RB Offset		
			26683	1.4MHz	QPSK	1 RB / 5 RB Offset 6 RB / 0 RB Offset		
		26055 to 26675	26055	3MHz	QPSK	1 RB / 0 RB Offset 1 RB / 0 RB Offset		
			26675	3MHz	QPSK	1 RB / 14 RB Offset 15 RB / 0 RB Offset		
		26065 to 26665	26065	5MHz	QPSK	1 RB / 0 RB Offset 25 RB / 0 RB Offset		
			26665	5MHz	QPSK	1 RB / 24 RB Offset 25 RB / 0 RB Offset		
		26090 to 26640	26090	10MHz	QPSK	1 RB / 0 RB Offset 50 RB / 0 RB Offset		
			26640	10MHz	QPSK	1 RB / 49 RB Offset 50 RB / 0 RB Offset		
		26115 to 26615	26115	15MHz	QPSK	1 RB / 0 RB Offset 75 RB / 0 RB Offset		
			26615	15MHz	QPSK	1 RB / 74 RB Offset 75 RB / 0 RB Offset		
		26140 to 26590	26140	20MHz	QPSK	1 RB / 0 RB Offset 100 RB / 0 RB Offset		
			26590	20MHz	QPSK	1 RB / 99 RB Offset 100 RB / 0 RB Offset		
		-	Conducted Emission	26047 to 26683	26365	1.4MHz	QPSK	1 RB / 0 RB Offset
				26055 to 26675	26365	3MHz	QPSK	1 RB / 0 RB Offset
26065 to 26665	26365			5MHz	QPSK	1 RB / 0 RB Offset		
26090 to 26640	26365			10MHz	QPSK	1 RB / 0 RB Offset		
26115 to 26615	26365			15MHz	QPSK	1 RB / 0 RB Offset		
26140 to 26590	26365			20MHz	QPSK	1 RB / 0 RB Offset		
-	Radiated Emission	26140 to 26590	26365	20MHz	QPSK	1 RB / 0 RB Offset		

Note: This device was tested under all bandwidths, RB configurations and modulations. The worst case was found in QPSK modulation.

Test Condition:

Test Item	Environmental Conditions	Input Power	Tested By
EIRP	26deg. C, 58%RH	3.85Vdc	Anson Lin
Frequency Stability	26deg. C, 58%RH	3.85Vdc	Carlos Chen
Occupied Bandwidth	26deg. C, 58%RH	3.85Vdc	Carlos Chen
Band Edge	26deg. C, 58%RH	3.85Vdc	Carlos Chen
Peak To Average Ratio	26deg. C, 58%RH	3.85Vdc	Carlos Chen
Condcudeted Emission	26deg. C, 58%RH	3.85Vdc	Carlos Chen
Radiated Emission	25deg. C, 65%RH	120Vac, 60Hz	Anson Lin

3.4 EUT Operating Conditions

The EUT makes a call to the communication simulator. The communication simulator station system controlled a EUT to export maximum output power under transmission mode and specific channel frequency

3.5 General Description of Applied Standards

The EUT is a RF Product. According to the specifications of the manufacturer, it must comply with the requirements of the following standards:

FCC 47 CFR Part 2

FCC 47 CFR Part 24

ANSI/TIA/EIA-603-C 2004

NOTE: All test items have been performed and recorded as per the above standards.

4 Test Types and Results

4.1 Output Power Measurement

4.1.1 Limits of Output Power Measurement

Mobile / Portable station are limited to 2 watts e.i.r.p.

4.1.2 Test Procedures

EIRP / ERP Measurement:

- a. All measurements were done at low, middle and high operational frequency range. RBW and VBW is 1MHz for GSM, GPRS & EDGE, 5MHz for WCDMA and CDMA, and 10MHz for LTE mode.
- b. Substitution method is used for E.I.R.P measurement. In the semi-anechoic chamber, EUT placed on the 0.8m height of Turn Table, rotated the table around 360 degrees to search the maximum radiation power and receiver antenna shall be rotated vertical and horizontal polarization and moved height from 1m to 4m to find the maximum polar radiated power. The "Read Value" is the spectrum reading the maximum power value.
- c. The substitution horn antenna is substituted for EUT at the same position and signals generator export the CW signal to the substitution antenna via a tx cable. Rotated the Turn Table and moved receiving antenna to find the maximum radiation power. Adjust output power level of S.G to get a Value of spectrum reading equal to "Read Value" of step b. Record the power level of S.G
- d. $EIRP = \text{Output power level of S.G} - \text{TX cable loss} + \text{Antenna gain of substitution horn}$. E.R.P power can be calculated form E.I.R.P power by subtracting the gain of dipole, $E.R.P \text{ power} = E.I.P.R \text{ power} - 2.15\text{dBi}$.

Conducted Power Measurement:

The EUT was set up for the maximum power with GSM, GPRS, EDGE, WCDMA, CDMA, and LTE link data modulation and link up with simulator. Set the EUT to transmit under low, middle and high channel and record the power level shown on simulator.

4.1.3 Test Setup

EIRP / ERP MEASUREMENT:

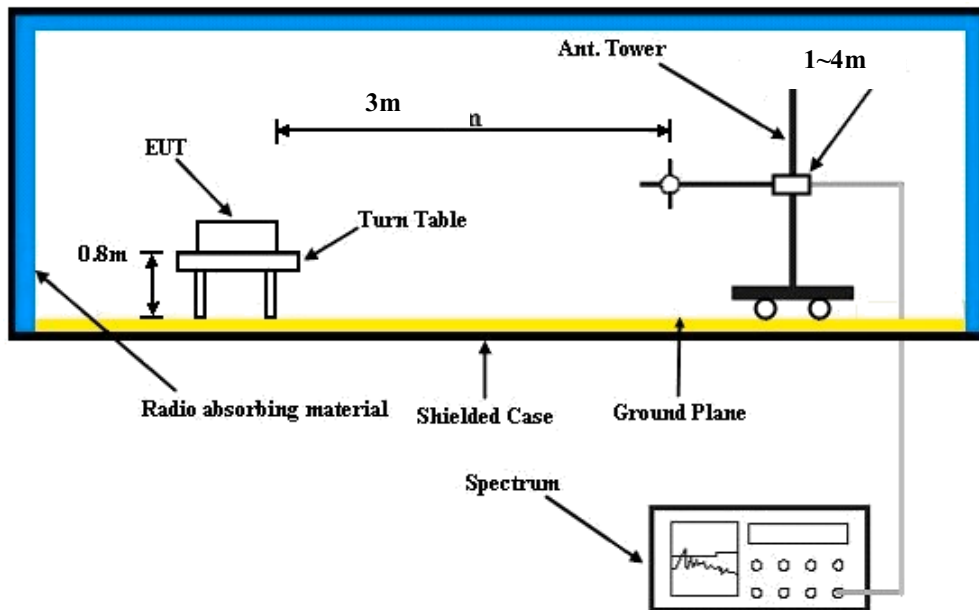

For the actual test configuration, please refer to the attached file (Test Setup Photo).

CONDUCTED POWER MEASUREMENT:





4.1.4 Test Results

CONDUCTED OUTPUT POWER (dBm)

Band	CDMA		
Channel	25	600	1175
Frequency (MHz)	1851.25	1880	1908.75
RC1+SO55	23.85	24.02	24.01
RC3+SO55	23.86	24.03	24.02
RC3+SO32(+ F-SCH)	23.80	23.97	23.96
RC3+SO32(+SCH)	23.75	23.92	23.91
RTAP 153.6	23.79	23.96	23.95
RETAP 4096	23.81	23.98	23.97

Band / BW	RB Size	RB Offset	QPSK			3GPP MPR (dB)	16QAM			3GPP MPR (dB)
			Low Ch 18607	Mid Ch 18900	High Ch 19193		Low Ch 18607	Mid Ch 18900	High Ch 19193	
			1850.7 MHz	1880.0 MHz	1909.3 MHz		1850.7 MHz	1880.0 MHz	1909.3 MHz	
2 / 1.4M	1	0	22.54	22.63	22.28	0	21.47	21.56	21.21	1
	1	2	22.42	22.51	22.16	0	21.35	21.44	21.09	1
	1	5	22.37	22.46	22.11	0	21.30	21.39	21.04	1
	3	0	21.36	21.45	21.10	0	20.29	20.38	20.03	1
	3	1	21.30	21.39	21.04	0	20.23	20.32	19.97	1
	3	3	21.18	21.27	20.92	0	20.11	20.20	19.85	1
	6	0	21.34	21.43	21.43	1	20.27	20.36	20.36	2

Band / BW	RB Size	RB Offset	QPSK			3GPP MPR (dB)	16QAM			3GPP MPR (dB)
			Low Ch 18615	Mid Ch 18900	High Ch 19185		Low Ch 18615	Mid Ch 18900	High Ch 19185	
			1851.5 MHz	1880.0 MHz	1908.5 MHz		1851.5 MHz	1880.0 MHz	1908.5 MHz	
2 / 3M	1	0	22.62	22.71	22.36	0	21.55	21.64	21.29	1
	1	7	22.50	22.59	22.24	0	21.43	21.52	21.17	1
	1	14	22.45	22.54	22.19	0	21.38	21.47	21.12	1
	8	0	21.44	21.53	21.18	1	20.37	20.46	20.11	2
	8	3	21.38	21.47	21.12	1	20.31	20.40	20.05	2
	8	7	21.26	21.35	21.00	1	20.19	20.28	19.93	2
	15	0	21.42	21.51	21.51	1	20.35	20.44	20.44	2

Band / BW	RB Size	RB Offset	QPSK			3GPP MPR (dB)	16QAM			3GPP MPR (dB)
			Low Ch 18625	Mid Ch 18900	High Ch 19175		Low Ch 18625	Mid Ch 18900	High Ch 19175	
			1852.5 MHz	1880.0 MHz	1907.5 MHz		1852.5 MHz	1880.0 MHz	1907.5 MHz	
2 / 5M	1	0	22.70	22.79	22.44	0	21.63	21.72	21.37	1
	1	12	22.58	22.67	22.32	0	21.51	21.60	21.25	1
	1	24	22.53	22.62	22.27	0	21.46	21.55	21.20	1
	12	0	21.52	21.61	21.26	1	20.45	20.54	20.19	2
	12	6	21.46	21.55	21.20	1	20.39	20.48	20.13	2
	12	13	21.34	21.43	21.08	1	20.27	20.36	20.01	2
	25	0	21.50	21.59	21.59	1	20.43	20.52	20.52	2



Band / BW	RB Size	RB Offset	QPSK			3GPP MPR (dB)	16QAM			3GPP MPR (dB)
			Low Ch 18650	Mid Ch 18900	High Ch 19150		Low Ch 18650	Mid Ch 18900	High Ch 19150	
			1855.0 MHz	1880.0 MHz	1905.0 MHz		1855.0 MHz	1880.0 MHz	1905.0 MHz	
2 / 10M	1	0	22.77	22.86	22.51	0	21.70	21.79	21.44	1
	1	24	22.65	22.74	22.39	0	21.58	21.67	21.32	1
	1	49	22.60	22.69	22.34	0	21.53	21.62	21.27	1
	25	0	21.59	21.68	21.33	1	20.52	20.61	20.26	2
	25	12	21.53	21.62	21.27	1	20.46	20.55	20.20	2
	25	25	21.41	21.50	21.15	1	20.34	20.43	20.08	2
	50	0	21.57	21.66	21.66	1	20.50	20.59	20.59	2

Band / BW	RB Size	RB Offset	QPSK			3GPP MPR (dB)	16QAM			3GPP MPR (dB)
			Low Ch 18675	Mid Ch 18900	High Ch 19125		Low Ch 18675	Mid Ch 18900	High Ch 19125	
			1857.5 MHz	1880.0 MHz	1902.5 MHz		1857.5 MHz	1880.0 MHz	1902.5 MHz	
2 / 15M	1	0	22.86	22.95	22.60	0	21.79	21.88	21.53	1
	1	37	22.74	22.83	22.48	0	21.67	21.76	21.41	1
	1	74	22.69	22.78	22.43	0	21.62	21.71	21.36	1
	36	0	21.68	21.77	21.42	1	20.61	20.70	20.35	2
	36	19	21.62	21.71	21.36	1	20.55	20.64	20.29	2
	36	39	21.50	21.59	21.24	1	20.43	20.52	20.17	2
	75	0	21.66	21.75	21.75	1	20.59	20.68	20.68	2

Band / BW	RB Size	RB Offset	QPSK			3GPP MPR (dB)	16QAM			3GPP MPR (dB)
			Low Ch 18700	Mid Ch 18900	High Ch 19100		Low Ch 18700	Mid Ch 18900	High Ch 19100	
			1860.0 MHz	1880.0 MHz	1900.0 MHz		1860.0 MHz	1880.0 MHz	1900.0 MHz	
2 / 20M	1	0	22.93	23.02	22.67	0	21.86	21.95	21.60	1
	1	50	22.81	22.90	22.55	0	21.74	21.83	21.48	1
	1	99	22.76	22.85	22.50	0	21.69	21.78	21.43	1
	50	0	21.75	21.84	21.49	1	20.68	20.77	20.42	2
	50	25	21.69	21.78	21.43	1	20.62	20.71	20.36	2
	50	50	21.57	21.66	21.31	1	20.50	20.59	20.24	2
	100	0	21.73	21.82	21.82	1	20.66	20.75	20.75	2



Band / BW	RB Size	RB Offset	QPSK			3GPP MPR (dB)	16QAM			3GPP MPR (dB)
			Low Ch 26047	Mid Ch 26365	High Ch 26683		Low Ch 26047	Mid Ch 26365	High Ch 26683	
			1850.7 MHz	1882.5 MHz	1914.3 MHz		1850.7 MHz	1882.5 MHz	1914.3 MHz	
25 / 1.4M	1	0	22.30	22.43	22.06	0	21.32	21.45	21.08	1
	1	2	22.25	22.38	22.01	0	21.27	21.40	21.03	1
	1	5	22.07	22.20	21.83	0	21.09	21.22	20.85	1
	3	0	21.28	21.41	21.04	0	20.30	20.43	20.06	1
	3	1	21.26	21.39	21.02	0	20.28	20.41	20.04	1
	3	3	21.06	21.19	20.82	0	20.08	20.21	19.84	1
	6	0	21.16	21.29	20.92	1	20.18	20.31	19.94	2

Band / BW	RB Size	RB Offset	QPSK			3GPP MPR (dB)	16QAM			3GPP MPR (dB)
			Low Ch 26055	Mid Ch 26365	High Ch 26675		Low Ch 26055	Mid Ch 26365	High Ch 26675	
			1851.5 MHz	1882.5 MHz	1913.5 MHz		1851.5 MHz	1882.5 MHz	1913.5 MHz	
25 / 3M	1	0	22.38	22.51	22.14	0	21.40	21.53	21.16	1
	1	7	22.33	22.46	22.09	0	21.35	21.48	21.11	1
	1	14	22.15	22.28	21.91	0	21.17	21.30	20.93	1
	8	0	21.36	21.49	21.12	1	20.38	20.51	20.14	2
	8	3	21.34	21.47	21.10	1	20.36	20.49	20.12	2
	8	7	21.14	21.27	20.90	1	20.16	20.29	19.92	2
	15	0	21.24	21.37	21.00	1	20.26	20.39	20.02	2

Band / BW	RB Size	RB Offset	QPSK			3GPP MPR (dB)	16QAM			3GPP MPR (dB)
			Low Ch 26065	Mid Ch 26365	High Ch 26665		Low Ch 26065	Mid Ch 26365	High Ch 26665	
			1852.5 MHz	1882.5 MHz	1912.5 MHz		1852.5 MHz	1882.5 MHz	1912.5 MHz	
25 / 5M	1	0	22.47	22.60	22.23	0	21.49	21.62	21.25	1
	1	12	22.42	22.55	22.18	0	21.44	21.57	21.20	1
	1	24	22.24	22.37	22.00	0	21.26	21.39	21.02	1
	12	0	21.45	21.58	21.21	1	20.47	20.60	20.23	2
	12	6	21.43	21.56	21.19	1	20.45	20.58	20.21	2
	12	13	21.23	21.36	20.99	1	20.25	20.38	20.01	2
	25	0	21.33	21.46	21.09	1	20.35	20.48	20.11	2

Band / BW	RB Size	RB Offset	QPSK			3GPP MPR (dB)	16QAM			3GPP MPR (dB)
			Low Ch 26090	Mid Ch 26365	High Ch 26640		Low Ch 26090	Mid Ch 26365	High Ch 26640	
			1855.0 MHz	1882.5 MHz	1910.0 MHz		1855.0 MHz	1882.5 MHz	1910.0 MHz	
25 / 10M	1	0	22.56	22.69	22.32	0	21.58	21.71	21.34	1
	1	24	22.51	22.64	22.27	0	21.53	21.66	21.29	1
	1	49	22.33	22.46	22.09	0	21.35	21.48	21.11	1
	25	0	21.54	21.67	21.30	1	20.56	20.69	20.32	2
	25	12	21.52	21.65	21.28	1	20.54	20.67	20.30	2
	25	25	21.32	21.45	21.08	1	20.34	20.47	20.10	2
	50	0	21.42	21.55	21.18	1	20.44	20.57	20.20	2



Band / BW	RB Size	RB Offset	QPSK			3GPP MPR (dB)	16QAM			3GPP MPR (dB)
			Low Ch 26115	Mid Ch 26365	High Ch 26615		Low Ch 26115	Mid Ch 26365	High Ch 26615	
			1857.5 MHz	1882.5 MHz	1907.5 MHz		1857.5 MHz	1882.5 MHz	1907.5 MHz	
25 / 15M	1	0	22.63	22.76	22.39	0	21.65	21.78	21.41	1
	1	37	22.58	22.71	22.34	0	21.60	21.73	21.36	1
	1	74	22.40	22.53	22.16	0	21.42	21.55	21.18	1
	36	0	21.61	21.74	21.37	1	20.63	20.76	20.39	2
	36	19	21.59	21.72	21.35	1	20.61	20.74	20.37	2
	36	39	21.39	21.52	21.15	1	20.41	20.54	20.17	2
	75	0	21.49	21.62	21.25	1	20.51	20.64	20.27	2

Band / BW	RB Size	RB Offset	QPSK			3GPP MPR (dB)	16QAM			3GPP MPR (dB)
			Low Ch 26140	Mid Ch 26365	High Ch 26590		Low Ch 26140	Mid Ch 26365	High Ch 26590	
			1860.0 MHz	1882.5 MHz	1905.0 MHz		1860.0 MHz	1882.5 MHz	1905.0 MHz	
25 / 20M	1	0	22.69	22.82	22.45	0	21.71	21.84	21.47	1
	1	50	22.64	22.77	22.40	0	21.66	21.79	21.42	1
	1	99	22.46	22.59	22.22	0	21.48	21.61	21.24	1
	50	0	21.67	21.80	21.43	1	20.69	20.82	20.45	2
	50	25	21.65	21.78	21.41	1	20.67	20.80	20.43	2
	50	50	21.45	21.58	21.21	1	20.47	20.60	20.23	2
	100	0	21.55	21.68	21.31	1	20.57	20.70	20.33	2



EIRP Power (dBm)

CDMA							
Plane	Channel	Frequency (MHz)	LVL (dBm)	Correction Factor(dB)	EIRP(dBm)	EIRP(mW)	Polarization (H/V)
Z	25	1851.25	-14.19	36.57	22.38	173.13	H
	600	1880.00	-14.71	37.22	22.51	178.27	
	1175	1908.75	-14.50	37.18	22.68	185.50	
	25	1851.25	-19.39	37.65	18.26	66.97	V
	600	1880.00	-18.40	37.58	19.18	82.86	
	1175	1908.75	-17.88	37.48	19.60	91.21	

LTE Band 2							
Channel Bandwidth: 1.4MHz / QPSK							
Plane	Channel	Frequency (MHz)	LVL (dBm)	Correction Factor(dB)	EIRP(dBm)	EIRP(mW)	Polarization (H/V)
Z	18607	1850.7	-19.49	36.57	17.08	51.05	H
	18900	1880.0	-18.71	37.22	18.51	70.96	
	19193	1909.3	-18.80	37.18	18.38	68.87	
	18607	1850.7	-22.77	37.65	14.88	30.76	V
	18900	1880.0	-21.69	37.58	15.89	38.82	
	19193	1909.3	-21.75	37.48	15.73	37.41	

LTE Band 2							
Channel Bandwidth: 1.4MHz / 16QAM							
Plane	Channel	Frequency (MHz)	LVL (dBm)	Correction Factor(dB)	EIRP(dBm)	EIRP(mW)	Polarization (H/V)
Z	18607	1850.7	-19.17	36.57	17.40	54.95	H
	18900	1880.0	-19.71	37.22	17.51	56.36	
	19193	1909.3	-20.54	37.18	16.64	46.13	
	18607	1850.7	-24.18	37.65	13.47	22.23	V
	18900	1880.0	-23.35	37.58	14.23	26.49	
	19193	1909.3	-22.59	37.48	14.89	30.83	



LTE Band 2							
Channel Bandwidth: 3MHz / QPSK							
Plane	Channel	Frequency (MHz)	LVL (dBm)	Correction Factor(dB)	EIRP(dBm)	EIRP(mW)	Polarization (H/V)
Z	18615	1851.5	-17.61	36.57	18.96	78.70	H
	18900	1880.0	-17.95	37.22	19.27	84.53	
	19185	1908.5	-18.20	37.18	18.98	79.07	
	18615	1851.5	-22.79	37.65	14.86	30.62	V
	18900	1880.0	-21.59	37.58	15.99	39.72	
	19185	1908.5	-21.34	37.48	16.14	41.11	

LTE Band 2							
Channel Bandwidth: 3MHz / 16QAM							
Plane	Channel	Frequency (MHz)	LVL (dBm)	Correction Factor(dB)	EIRP(dBm)	EIRP(mW)	Polarization (H/V)
Z	18615	1851.5	-18.52	36.57	18.05	63.83	H
	18900	1880.0	-19.66	37.22	17.56	57.02	
	19185	1908.5	-20.17	37.18	17.01	50.23	
	18615	1851.5	-23.64	37.65	14.01	25.18	V
	18900	1880.0	-23.33	37.58	14.25	26.61	
	19185	1908.5	-23.31	37.48	14.17	26.12	

LTE Band 2							
Channel Bandwidth: 5MHz / QPSK							
Plane	Channel	Frequency (MHz)	LVL (dBm)	Correction Factor(dB)	EIRP(dBm)	EIRP(mW)	Polarization (H/V)
Z	18625	1852.5	-17.95	36.57	18.62	72.78	H
	18900	1880.0	-18.09	37.22	19.13	81.85	
	19175	1907.5	-18.13	37.18	19.05	80.35	
	18625	1852.5	-23.12	37.65	14.53	28.38	V
	18900	1880.0	-21.79	37.58	15.79	37.93	
	19175	1907.5	-21.23	37.48	16.25	42.17	



LTE Band 2							
Channel Bandwidth: 5MHz / 16QAM							
Plane	Channel	Frequency (MHz)	LVL (dBm)	Correction Factor(dB)	EIRP(dBm)	EIRP(mW)	Polarization (H/V)
Z	18625	1852.5	-19.18	36.57	17.39	54.83	H
	18900	1880.0	-19.68	37.22	17.54	56.75	
	19175	1907.5	-18.91	37.18	18.27	67.14	
	18625	1852.5	-24.36	37.65	13.29	21.33	V
	18900	1880.0	-23.38	37.58	14.20	26.30	
	19175	1907.5	-22.01	37.48	15.47	35.24	

LTE Band 2							
Channel Bandwidth: 10MHz / QPSK							
Plane	Channel	Frequency (MHz)	LVL (dBm)	Correction Factor(dB)	EIRP(dBm)	EIRP(mW)	Polarization (H/V)
Z	18650	1855.0	-18.27	36.57	18.30	67.61	H
	18900	1880.0	-18.20	37.22	19.02	79.80	
	19150	1905.0	-18.57	37.18	18.61	72.61	
	18650	1855.0	-23.45	37.65	14.20	26.30	V
	18900	1880.0	-22.06	37.58	15.52	35.65	
	19150	1905.0	-21.67	37.48	15.81	38.11	

LTE Band 2							
Channel Bandwidth: 10MHz / 16QAM							
Plane	Channel	Frequency (MHz)	LVL (dBm)	Correction Factor(dB)	EIRP(dBm)	EIRP(mW)	Polarization (H/V)
Z	18650	1855.0	-19.10	36.57	17.47	55.85	H
	18900	1880.0	-19.93	37.22	17.29	53.58	
	19150	1905.0	-20.49	37.18	16.69	46.67	
	18650	1855.0	-24.26	37.65	13.39	21.83	V
	18900	1880.0	-23.78	37.58	13.80	23.99	
	19150	1905.0	-23.60	37.48	13.88	24.43	



LTE Band 2							
Channel Bandwidth: 15MHz / QPSK							
Plane	Channel	Frequency (MHz)	LVL (dBm)	Correction Factor(dB)	EIRP(dBm)	EIRP(mW)	Polarization (H/V)
Z	18675	1857.5	-18.70	36.57	17.87	61.24	H
	18900	1880.0	-18.61	37.22	18.61	72.61	
	19125	1902.5	-19.85	37.18	17.33	54.08	
	18675	1857.5	-23.87	37.65	13.78	23.88	V
	18900	1880.0	-22.55	37.58	15.03	31.84	
	19125	1902.5	-22.99	37.48	14.49	28.12	

LTE Band 2							
Channel Bandwidth: 15MHz / 16QAM							
Plane	Channel	Frequency (MHz)	LVL (dBm)	Correction Factor(dB)	EIRP(dBm)	EIRP(mW)	Polarization (H/V)
Z	18675	1857.5	-20.21	36.57	16.36	43.25	H
	18900	1880.0	-20.26	37.22	16.96	49.66	
	19125	1902.5	-20.71	37.18	16.47	44.36	
	18675	1857.5	-25.38	37.65	12.27	16.87	V
	18900	1880.0	-24.21	37.58	13.37	21.73	
	19125	1902.5	-23.86	37.48	13.62	23.01	

LTE Band 2							
Channel Bandwidth: 20MHz / QPSK							
Plane	Channel	Frequency (MHz)	LVL (dBm)	Correction Factor(dB)	EIRP(dBm)	EIRP(mW)	Polarization (H/V)
Z	18700	1860.0	-18.97	36.57	17.60	57.54	H
	18900	1880.0	-19.33	37.22	17.89	61.52	
	19100	1900.0	-20.41	37.18	16.77	47.53	
	18700	1860.0	-24.13	37.65	13.52	22.49	V
	18900	1880.0	-23.20	37.58	14.38	27.42	
	19100	1900.0	-23.74	37.48	13.74	23.66	



LTE Band 2							
Channel Bandwidth: 20MHz / 16QAM							
Plane	Channel	Frequency (MHz)	LVL (dBm)	Correction Factor(dB)	EIRP(dBm)	EIRP(mW)	Polarization (H/V)
Z	18700	1860.0	-20.33	36.57	16.24	42.07	H
	18900	1880.0	-20.86	37.22	16.36	43.25	
	19100	1900.0	-21.17	37.18	16.01	39.90	
	18700	1860.0	-25.49	37.65	12.16	16.44	V
	18900	1880.0	-24.72	37.58	12.86	19.32	
	19100	1900.0	-24.50	37.48	12.98	19.86	

LTE Band 25							
Channel Bandwidth: 1.4MHz / QPSK							
Plane	Channel	Frequency (MHz)	LVL (dBm)	Correction Factor(dB)	EIRP(dBm)	EIRP(mW)	Polarization (H/V)
Z	26047	1850.7	-17.41	36.57	19.16	82.41	H
	26365	1882.5	-18.34	37.22	18.88	77.27	
	26683	1914.3	-18.70	37.18	18.48	70.47	
	26047	1850.7	-22.45	37.65	15.20	33.11	V
	26365	1882.5	-21.84	37.58	15.74	37.50	
	26683	1914.3	-21.65	37.48	15.83	38.28	

LTE Band 25							
Channel Bandwidth: 1.4MHz / 16QAM							
Plane	Channel	Frequency (MHz)	LVL (dBm)	Correction Factor(dB)	EIRP(dBm)	EIRP(mW)	Polarization (H/V)
Z	26047	1850.7	-19.20	36.57	17.37	54.58	H
	26365	1882.5	-20.00	37.22	17.22	52.72	
	26683	1914.3	-19.59	37.18	17.59	57.41	
	26047	1850.7	-24.27	37.65	13.38	21.78	V
	26365	1882.5	-23.50	37.58	14.08	25.59	
	26683	1914.3	-22.54	37.48	14.94	31.19	



LTE Band 25							
Channel Bandwidth: 3MHz / QPSK							
Plane	Channel	Frequency (MHz)	LVL (dBm)	Correction Factor(dB)	EIRP(dBm)	EIRP(mW)	Polarization (H/V)
Z	26055	1851.5	-17.52	36.57	19.05	80.35	H
	26365	1882.5	-18.38	37.22	18.84	76.56	
	26675	1913.5	-19.09	37.18	18.09	64.42	
	26055	1851.5	-22.63	37.65	15.02	31.77	V
	26365	1882.5	-21.91	37.58	15.67	36.90	
	26675	1913.5	-21.84	37.48	15.64	36.64	

LTE Band 25							
Channel Bandwidth: 3MHz / 16QAM							
Plane	Channel	Frequency (MHz)	LVL (dBm)	Correction Factor(dB)	EIRP(dBm)	EIRP(mW)	Polarization (H/V)
Z	26055	1851.5	-19.42	36.57	17.15	51.88	H
	26365	1882.5	-20.13	37.22	17.09	51.17	
	26675	1913.5	-20.78	37.18	16.40	43.65	
	26055	1851.5	-24.46	37.65	13.19	20.84	V
	26365	1882.5	-23.64	37.58	13.94	24.77	
	26675	1913.5	-23.48	37.48	14.00	25.12	

LTE Band 25							
Channel Bandwidth: 5MHz / QPSK							
Plane	Channel	Frequency (MHz)	LVL (dBm)	Correction Factor(dB)	EIRP(dBm)	EIRP(mW)	Polarization (H/V)
Z	26065	1852.5	-17.96	36.57	18.61	72.61	H
	26365	1882.5	-18.54	37.22	18.68	73.79	
	26665	1912.5	-19.52	37.18	17.66	58.34	
	26065	1852.5	-23.07	37.65	14.58	28.71	V
	26365	1882.5	-22.07	37.58	15.51	35.56	
	26665	1912.5	-22.31	37.48	15.17	32.89	



LTE Band 25							
Channel Bandwidth: 5MHz / 16QAM							
Plane	Channel	Frequency (MHz)	LVL (dBm)	Correction Factor(dB)	EIRP(dBm)	EIRP(mW)	Polarization (H/V)
Z	26065	1852.5	-19.73	36.57	16.84	48.31	H
	26365	1882.5	-20.25	37.22	16.97	49.77	
	26665	1912.5	-20.33	37.18	16.85	48.42	
	26065	1852.5	-24.85	37.65	12.80	19.05	V
	26365	1882.5	-23.80	37.58	13.78	23.88	
	26665	1912.5	-23.13	37.48	14.35	27.23	

LTE Band 25							
Channel Bandwidth: 10MHz / QPSK							
Plane	Channel	Frequency (MHz)	LVL (dBm)	Correction Factor(dB)	EIRP(dBm)	EIRP(mW)	Polarization (H/V)
Z	26090	1855.0	-18.37	36.57	18.20	66.07	H
	26365	1882.5	-18.69	37.22	18.53	71.29	
	26640	1910.0	-18.79	37.18	18.39	69.02	
	26090	1855.0	-23.51	37.65	14.14	25.94	V
	26365	1882.5	-22.31	37.58	15.27	33.65	
	26640	1910.0	-21.83	37.48	15.65	36.73	

LTE Band 25							
Channel Bandwidth: 10MHz / 16QAM							
Plane	Channel	Frequency (MHz)	LVL (dBm)	Correction Factor(dB)	EIRP(dBm)	EIRP(mW)	Polarization (H/V)
Z	26090	1855.0	-20.25	36.57	16.32	42.85	H
	26365	1882.5	-20.58	37.22	16.64	46.13	
	26640	1910.0	-20.65	37.18	16.53	44.98	
	26090	1855.0	-25.37	37.65	12.28	16.90	V
	26365	1882.5	-24.20	37.58	13.38	21.78	
	26640	1910.0	-23.68	37.48	13.80	23.99	



LTE Band 25							
Channel Bandwidth: 15MHz / QPSK							
Plane	Channel	Frequency (MHz)	LVL (dBm)	Correction Factor(dB)	EIRP(dBm)	EIRP(mW)	Polarization (H/V)
Z	26115	1857.5	-18.78	36.57	17.79	60.12	H
	26365	1882.5	-19.01	37.22	18.21	66.22	
	26615	1907.5	-19.16	37.18	18.02	63.39	
	26115	1857.5	-23.92	37.65	13.73	23.60	V
	26365	1882.5	-22.75	37.58	14.83	30.41	
	26615	1907.5	-22.03	37.48	15.45	35.08	

LTE Band 25							
Channel Bandwidth: 15MHz / 16QAM							
Plane	Channel	Frequency (MHz)	LVL (dBm)	Correction Factor(dB)	EIRP(dBm)	EIRP(mW)	Polarization (H/V)
Z	26115	1857.5	-20.73	36.57	15.84	38.37	H
	26365	1882.5	-20.76	37.22	16.46	44.26	
	26615	1907.5	-19.86	37.18	17.32	53.95	
	26115	1857.5	-25.87	37.65	11.78	15.07	V
	26365	1882.5	-24.57	37.58	13.01	20.00	
	26615	1907.5	-22.90	37.48	14.58	28.71	

LTE Band 25							
Channel Bandwidth: 20MHz / QPSK							
Plane	Channel	Frequency (MHz)	LVL (dBm)	Correction Factor(dB)	EIRP(dBm)	EIRP(mW)	Polarization (H/V)
Z	26140	1860.0	-19.10	36.57	17.47	55.85	H
	26365	1882.5	-18.82	37.22	18.40	69.18	
	26590	1905.0	-20.33	37.18	16.85	48.42	
	26140	1860.0	-24.24	37.65	13.41	21.93	V
	26365	1882.5	-22.73	37.58	14.85	30.55	
	26590	1905.0	-23.42	37.48	14.06	25.47	



LTE Band 25							
Channel Bandwidth: 20MHz / 16QAM							
Plane	Channel	Frequency (MHz)	LVL (dBm)	Correction Factor(dB)	EIRP(dBm)	EIRP(mW)	Polarization (H/V)
Z	26140	1860.0	-19.85	36.57	16.72	46.99	H
	26365	1882.5	-20.71	37.22	16.51	44.77	
	26590	1905.0	-21.90	37.18	15.28	33.73	
	26140	1860.0	-24.98	37.65	12.67	18.49	V
	26365	1882.5	-24.63	37.58	12.95	19.72	
	26590	1905.0	-24.98	37.48	12.50	17.78	

4.2 Frequency Stability Measurement

4.2.1 Limits of Frequency Stability Measurement

The frequency stability shall be sufficient to ensure that the fundamental emission stays within the authorized frequency block.

4.2.2 Test Procedure

- Device is placed at the oven room. The oven room could control the temperatures and humidity. Power warm up is at least 15 min and power applied should perform before recording frequency error.
- EUT is connected the external power supply to control the DC input power. The test voltage range is from minimum to maximum working voltage. Each step shall be record the frequency error rate.
- The temperature range step is 10 degrees in this test items. All temperature levels shall be hold the ± 0.5 °C during the measurement testing. The each temperature step shall be at least 0.5 hours, consider the EUT could be test under the stability condition.

NOTE: The frequency error was recorded frequency error from the communication simulator.

4.2.3 Test Setup

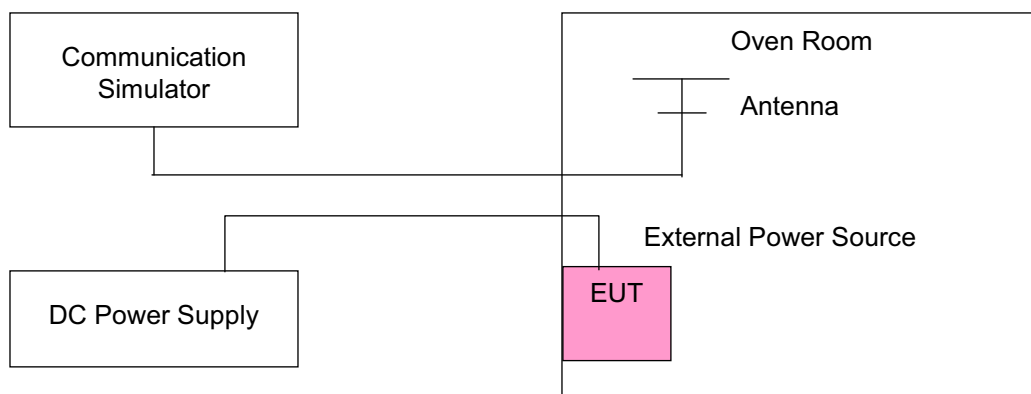



4.2.4 Test Results

Frequency Error vs. Voltage

Voltage (Volts)	Frequency Error (ppm)							Limit (ppm)
	CDMA	LTE Band 2						
		1.4MHz	3MHz	5MHz	10MHz	15MHz	20MHz	
3.85	0.001	0.00138	0.00155	0.00155	0.00057	0.00034	0.00039	2.5
3.6	0.001	0.00189	0.00002	0.00106	0.00120	0.00004	0.00082	2.5
4.4	-0.001	0.00148	0.00074	0.00178	0.00081	0.00097	0.00051	2.5

NOTE: The applicant defined the normal working voltage of the battery is from 3.6Vdc to 4.4Vdc.

Frequency Error vs. Temperature

Temp. (°C)	Frequency Error (ppm)							Limit (ppm)
	CDMA	LTE Band 2						
		1.4MHz	3MHz	5MHz	10MHz	15MHz	20MHz	
-30	0.001	0.00206	0.00093	0.00131	0.00055	0.00006	0.00137	2.5
-20	-0.001	0.00156	0.00020	0.00204	0.00098	0.00011	0.00006	2.5
-10	0.001	0.00210	0.00014	0.00055	0.00081	0.00154	0.00156	2.5
0	0.001	0.00202	0.00210	0.00207	0.00093	0.00043	0.00054	2.5
10	-0.001	0.00055	0.00028	0.00035	0.00014	0.00007	0.00004	2.5
20	-0.002	-0.00040	-0.00158	-0.00112	-0.00098	-0.00061	-0.00046	2.5
30	0.002	-0.00141	-0.00085	-0.00022	-0.00071	-0.00089	-0.00179	2.5
40	-0.001	-0.00052	-0.00039	-0.00128	-0.00122	-0.00067	-0.00212	2.5
50	-0.001	-0.00076	-0.00171	-0.00152	-0.00059	-0.00173	-0.00209	2.5
60	-0.001	-0.00207	-0.00188	-0.00139	-0.00173	-0.00199	-0.00048	2.5



Frequency Error vs. Voltage

Voltage (Volts)	Frequency Error (ppm)						Limit (ppm)
	LTE Band 25						
	1.4MHz	3MHz	5MHz	10MHz	15MHz	20MHz	
3.85	0.00114	0.00063	0.00141	0.00002	0.00155	0.00004	2.5
3.6	0.00183	0.00018	0.00114	0.00001	0.00108	0.00063	2.5
4.4	0.00070	0.00042	0.00099	0.00039	0.00078	0.00028	2.5

NOTE: The applicant defined the normal working voltage of the battery is from 3.6Vdc to 4.4Vdc.

Frequency Error vs. Temperature

Temp. (°C)	Frequency Error (ppm)						Limit (ppm)
	LTE Band 25						
	1.4MHz	3MHz	5MHz	10MHz	15MHz	20MHz	
-30	0.00082	0.00180	0.00018	0.00195	0.00018	0.00159	2.5
-20	0.00026	0.00173	0.00017	0.00108	0.00124	0.00168	2.5
-10	0.00155	0.00075	0.00048	0.00064	0.00073	0.00002	2.5
0	0.00121	0.00194	0.00052	0.00129	0.00179	0.00147	2.5
10	0.00122	0.00202	0.00084	0.00155	0.00128	0.00006	2.5
20	-0.00161	-0.00206	-0.00206	-0.00156	-0.00177	-0.00011	2.5
30	-0.00155	-0.00198	-0.00160	-0.00199	-0.00119	-0.00211	2.5
40	-0.00166	-0.00105	-0.00055	-0.00189	-0.00180	-0.00044	2.5
50	-0.00026	-0.00186	-0.00159	-0.00184	-0.00031	-0.00189	2.5
60	-0.00193	-0.00205	-0.00161	-0.00140	-0.00037	-0.00203	2.5

4.3 Occupied Bandwidth Measurement

4.3.1 Test Procedure

The EUT makes a call to the communication simulator. All measurements were done at low, middle and high operational frequency range. The communication simulator station system controlled a EUT to export maximum output power under transmission mode and specific channel frequency. Use OBW measurement function of Spectrum analyzer to measure 99 % occupied bandwidth.

4.3.2 Test Setup

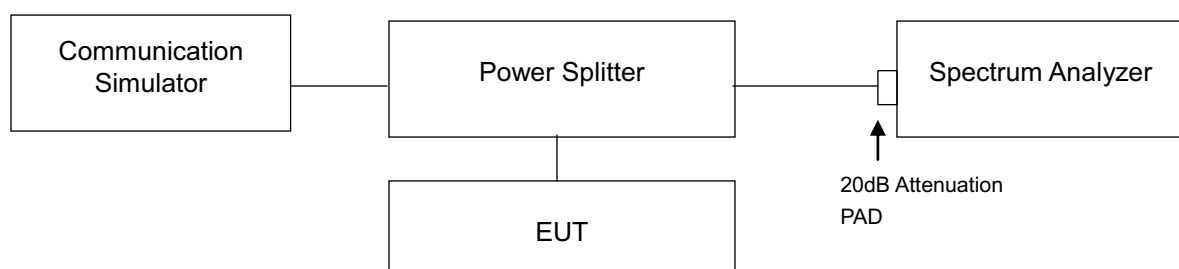

4.3.3 Test Result

Channel	Frequency (MHz)	99% Occupied Bandwidth (kHz)
		CDMA
25	1851.25	1.2753
600	1880.00	1.2718
1175	1908.75	1.2742

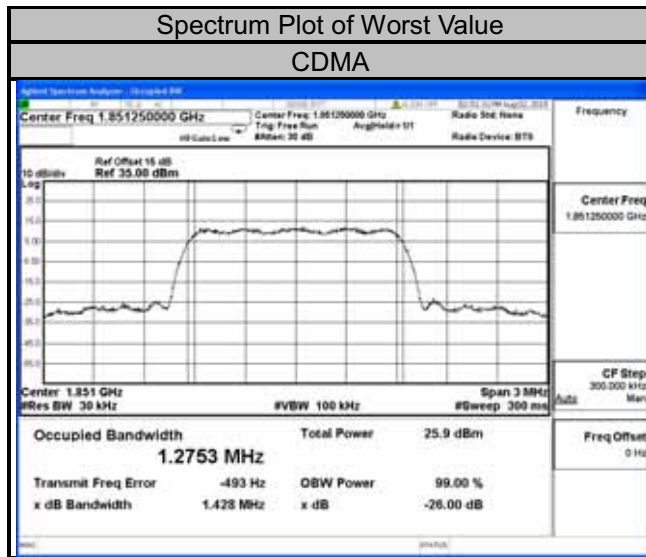



LTE Band 2							
Channel Bandwidth: 1.4MHz				Channel Bandwidth: 3MHz			
Channel	Frequency (MHz)	99% Occupied Bandwidth (MHz)		Channel	Frequency (MHz)	99% Occupied Bandwidth (MHz)	
		QPSK	16QAM			QPSK	16QAM
18607	1850.7	1.0896	1.0871	18615	1851.5	2.6941	2.6956
18900	1880.0	1.0900	1.0892	18900	1880.0	2.6967	2.6946
19193	1909.3	1.0909	1.0881	19185	1908.5	2.6953	2.6943

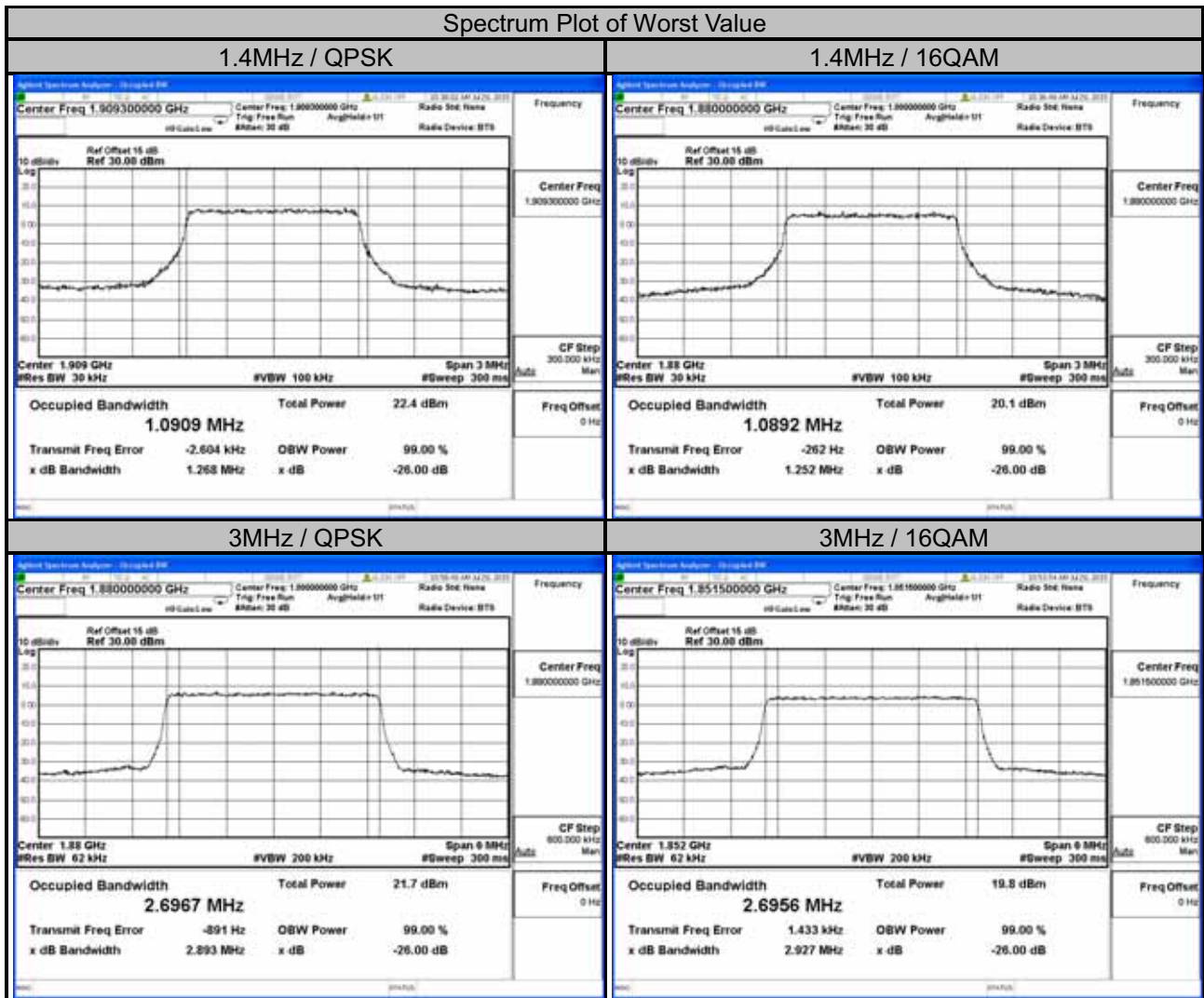



LTE Band 2							
Channel Bandwidth: 5MHz				Channel Bandwidth: 10MHz			
Channel	Frequency (MHz)	99% Occupied Bandwidth (MHz)		Channel	Frequency (MHz)	99% Occupied Bandwidth (MHz)	
		QPSK	16QAM			QPSK	16QAM
18625	1852.5	4.4919	4.4839	18650	1855.0	8.9494	8.9459
18900	1880.0	4.4889	4.4855	18900	1880.0	8.9548	8.9511
19175	1907.5	4.4860	4.4852	19150	1905.0	8.9468	8.9482

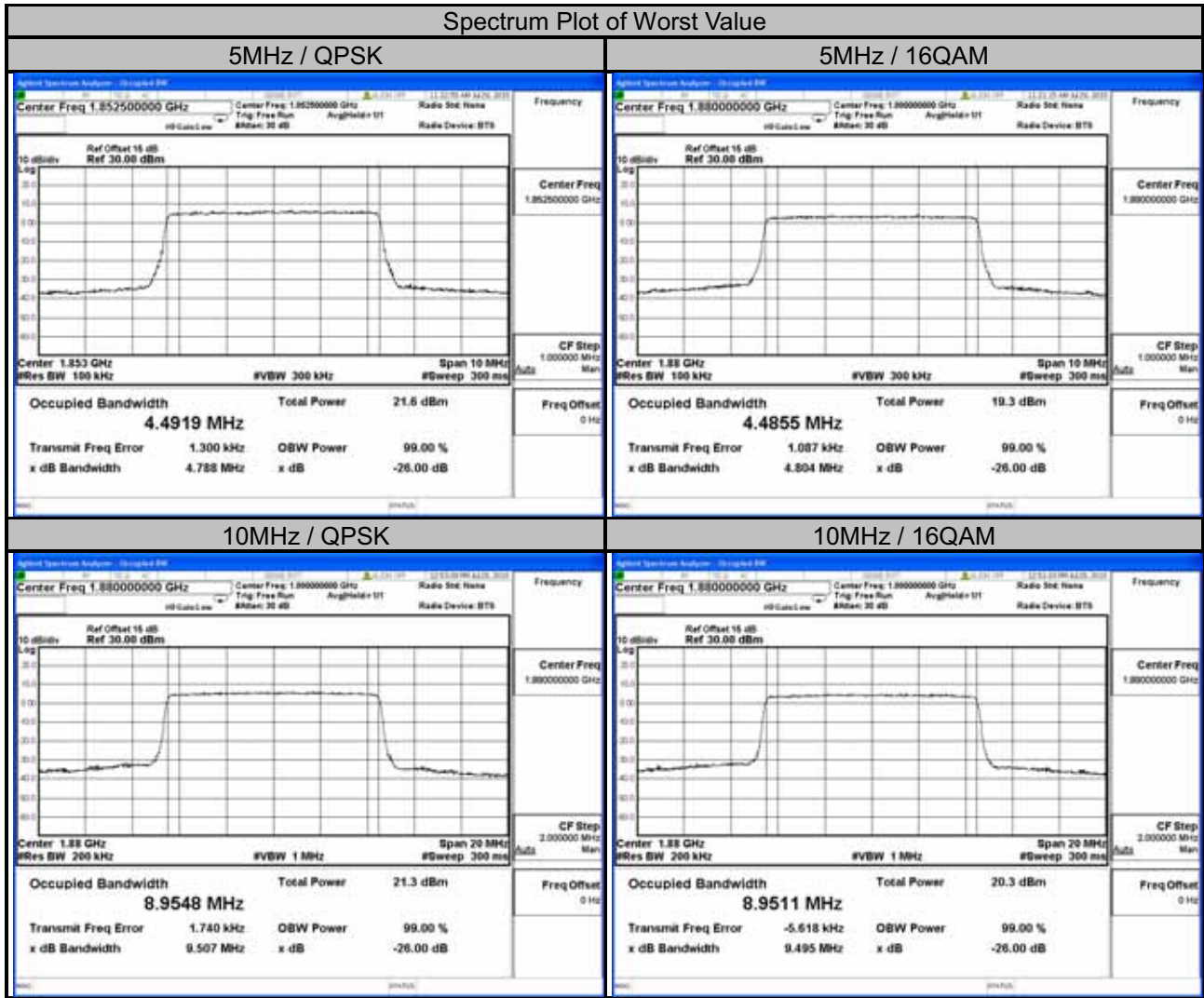



LTE Band 2							
Channel Bandwidth: 15MHz				Channel Bandwidth: 20MHz			
Channel	Frequency (MHz)	99% Occupied Bandwidth (MHz)		Channel	Frequency (MHz)	99% Occupied Bandwidth (MHz)	
		QPSK	16QAM			QPSK	16QAM
18675	1857.5	13.403	13.395	18700	1860.0	17.846	17.859
18900	1880.0	13.416	13.399	18900	1880.0	17.872	17.888
19125	1902.5	13.402	13.397	19100	1900.0	17.845	17.860

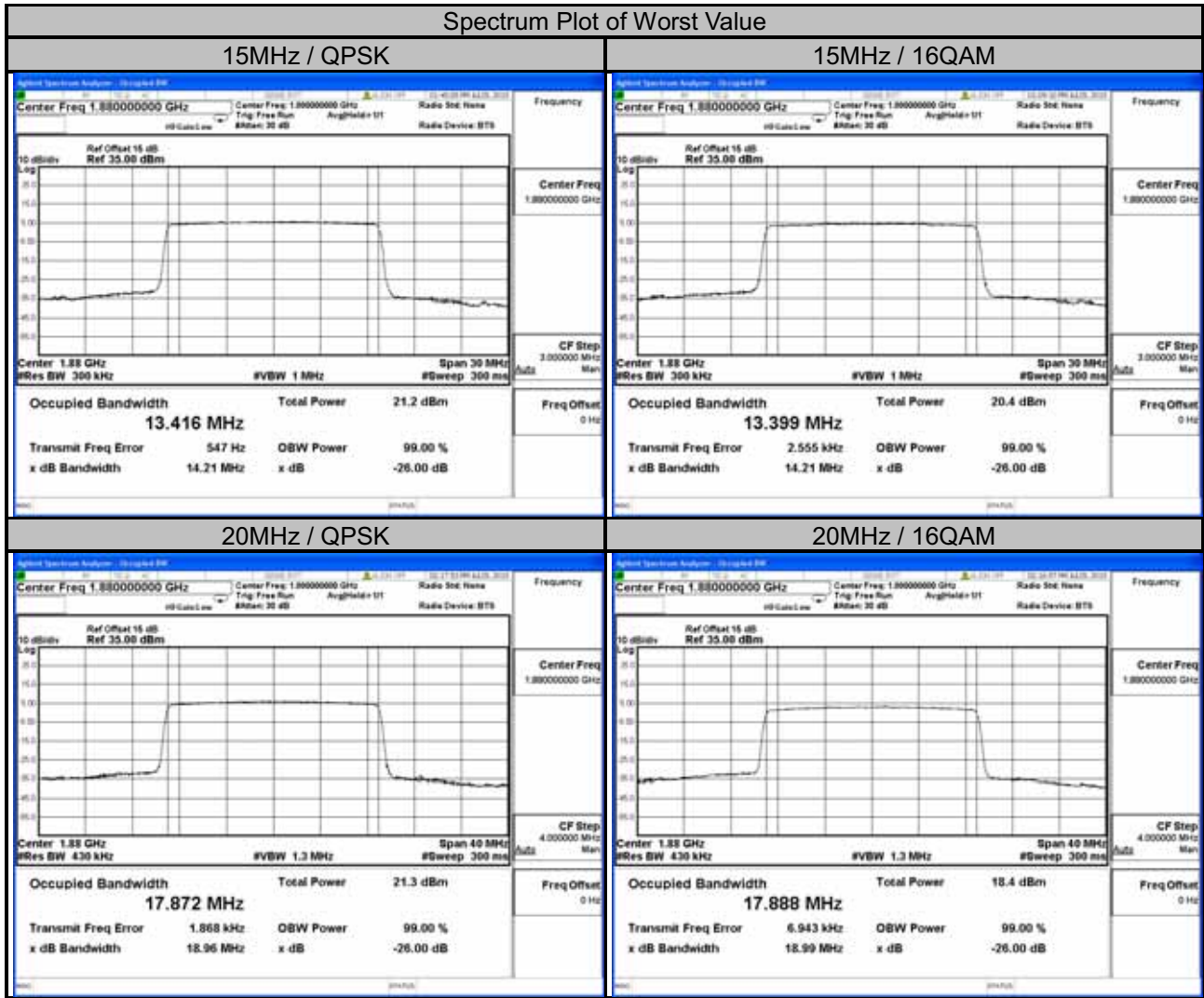



LTE Band 25							
Channel Bandwidth: 1.4MHz				Channel Bandwidth: 3MHz			
Channel	Frequency (MHz)	99% Occupied Bandwidth (MHz)		Channel	Frequency (MHz)	99% Occupied Bandwidth (MHz)	
		QPSK	16QAM			QPSK	16QAM
26047	1850.7	1.0929	1.0905	26055	1851.5	2.6934	2.6956
26365	1882.5	1.0924	1.0893	26365	1882.5	2.6952	2.6955
26683	1914.3	1.0919	1.0893	26675	1913.5	2.6964	2.6948

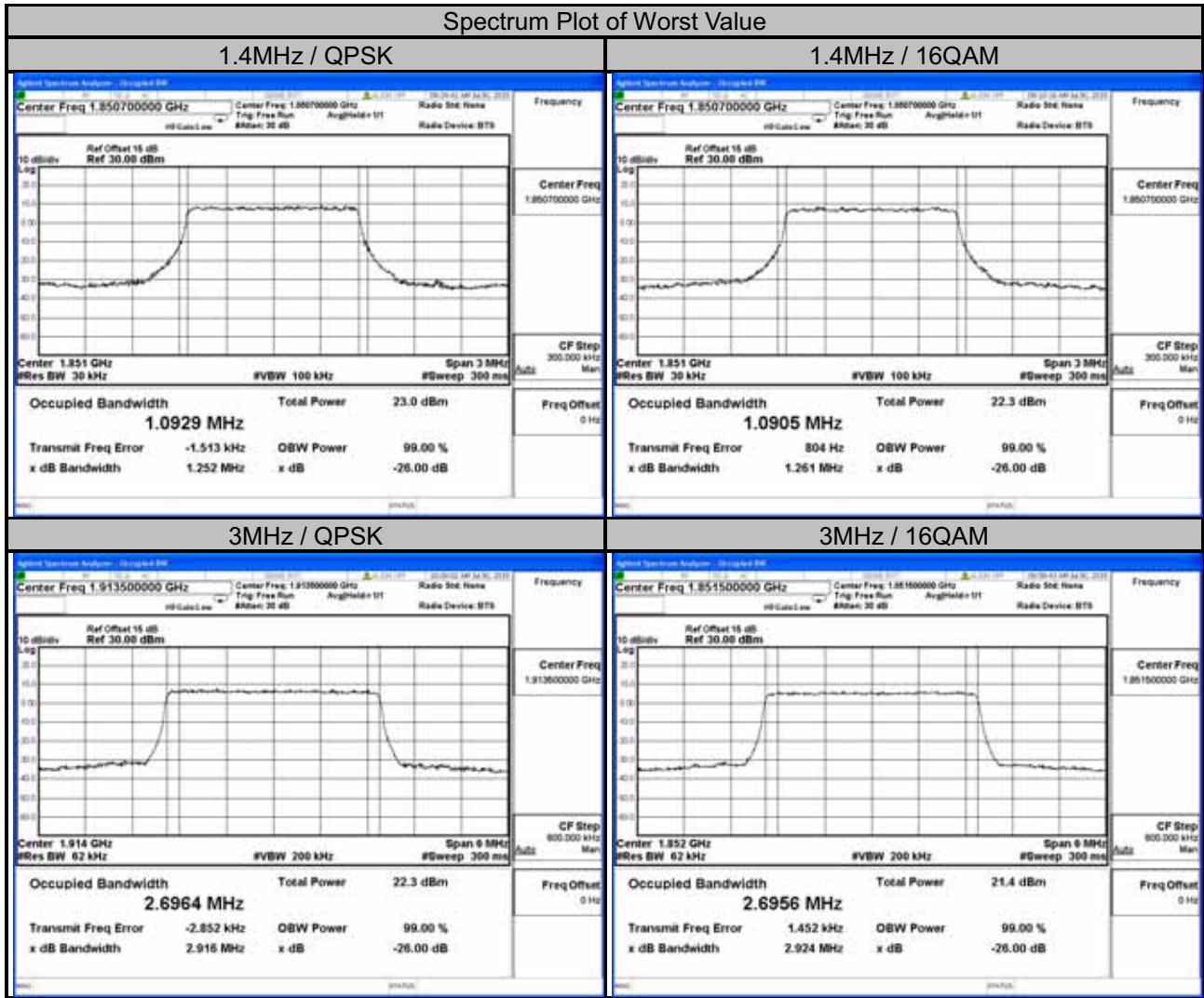



LTE Band 25							
Channel Bandwidth: 5MHz				Channel Bandwidth: 10MHz			
Channel	Frequency (MHz)	99% Occupied Bandwidth (MHz)		Channel	Frequency (MHz)	99% Occupied Bandwidth (MHz)	
		QPSK	16QAM			QPSK	16QAM
26065	1852.5	4.4854	4.4845	26090	1855.0	8.9471	8.9497
26365	1882.5	4.4874	4.4837	26365	1882.5	8.9532	8.9583
26665	1912.5	4.4841	4.4833	26640	1910.0	8.9469	8.9419

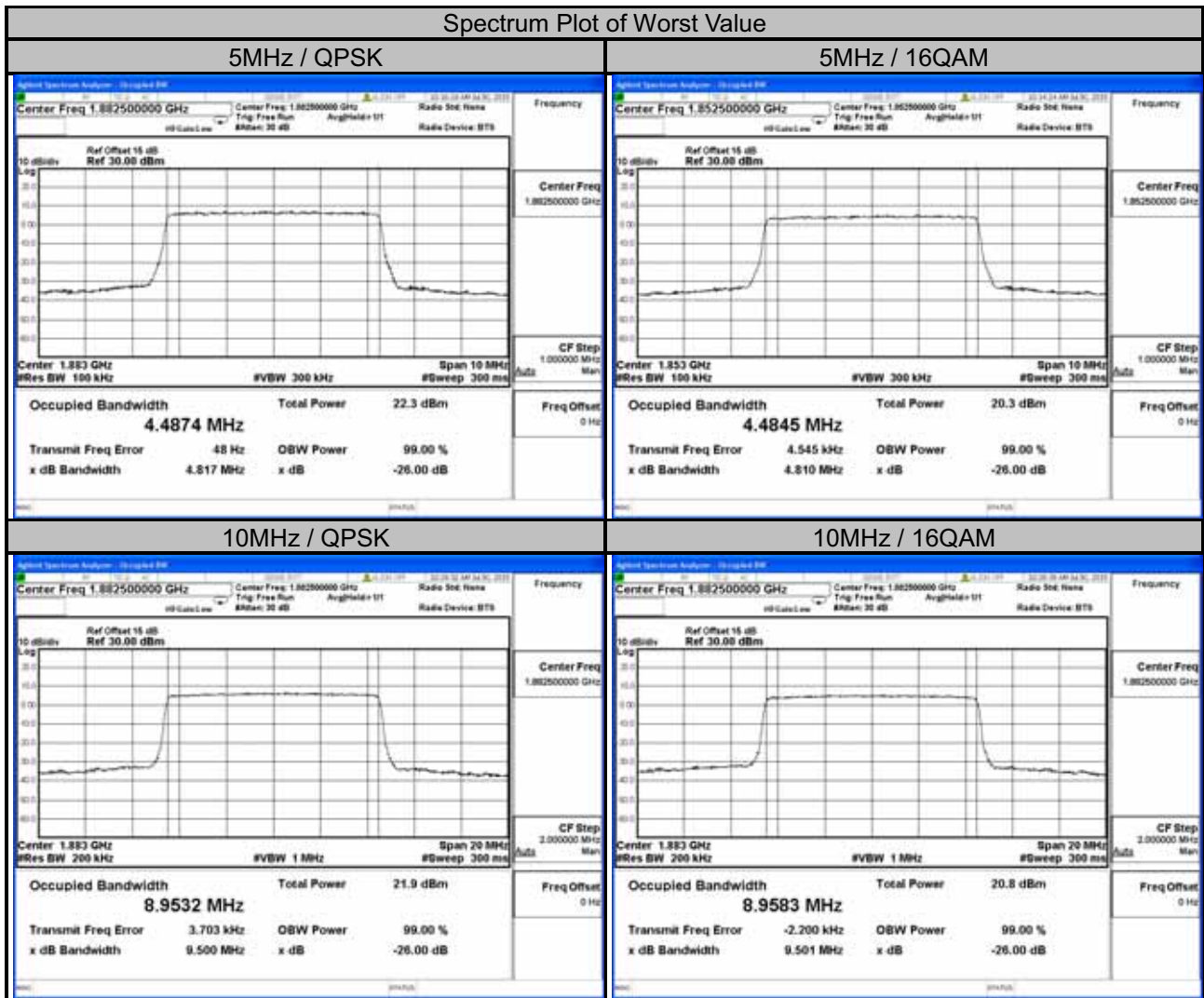



LTE BAND 25							
Channel Bandwidth: 15MHz				Channel Bandwidth: 20MHz			
Channel	Frequency (MHz)	99% Occupied Bandwidth (MHz)		Channel	Frequency (MHz)	99% Occupied Bandwidth (MHz)	
		QPSK	16QAM			QPSK	16QAM
26115	1857.5	13.407	13.399	26140	1860	17.851	17.856
26365	1882.5	13.414	13.400	26365	1882.5	17.869	17.885
26615	1907.5	13.402	13.399	26590	1905	17.866	17.878

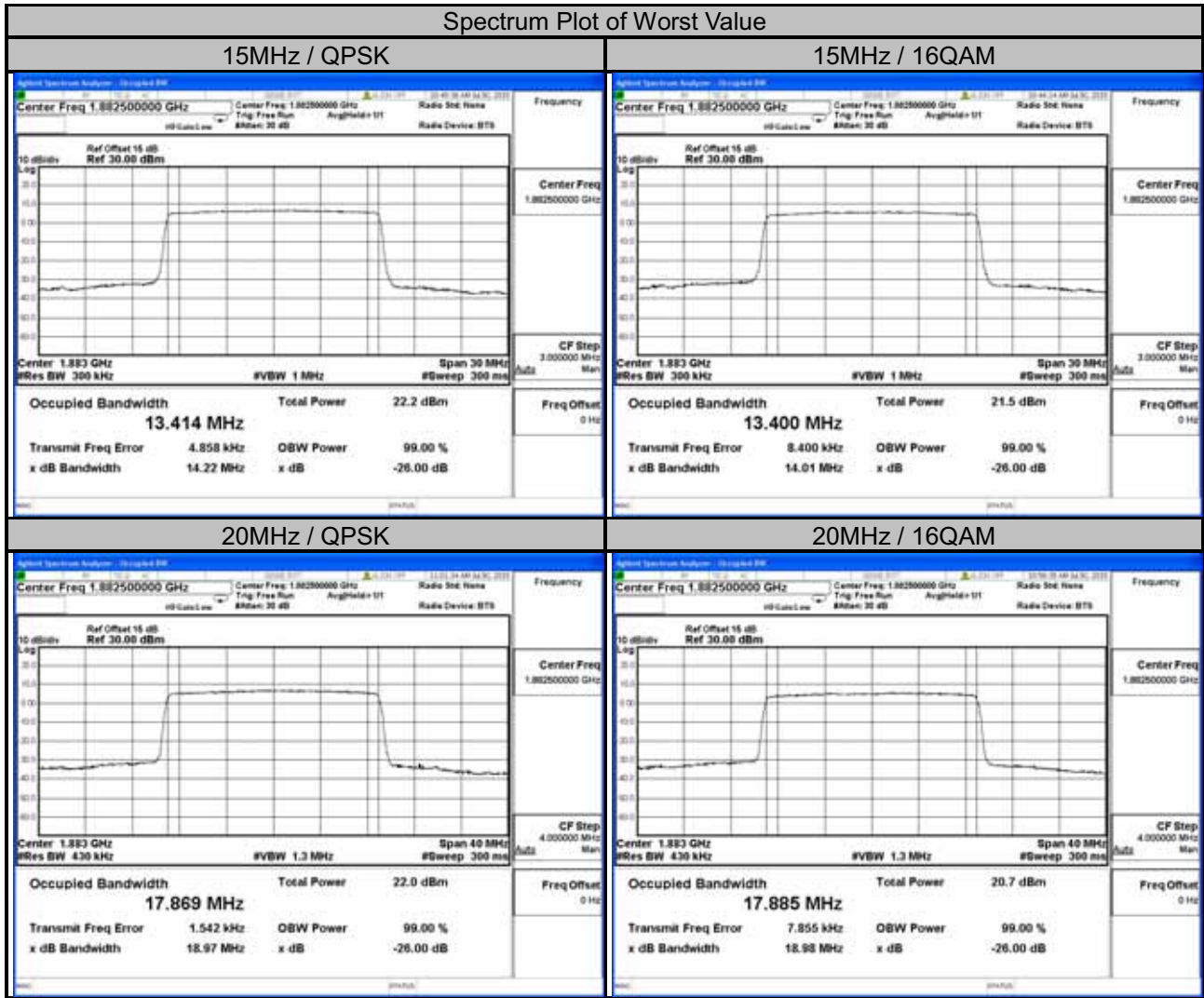

4.4 Band Edge Measurement

4.4.1 Limits of Band Edge Measurement

Power of any emission outside of the authorized operating frequency ranges must be attenuated below the transmitting power (P) by a factor of at least $43 + 10 \log(P)$ dB. In the 1 MHz bands immediately outside and adjacent to the frequency block a resolution bandwidth of at least one percent of the emission bandwidth of the fundamental emission of the transmitter may be employed.

4.4.2 Test Setup

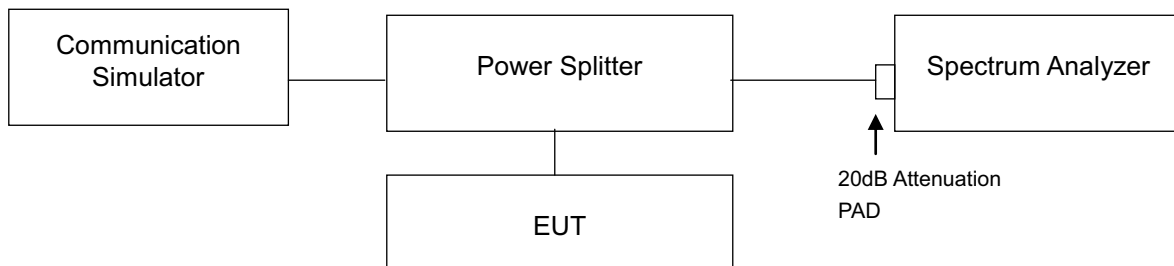

4.4.3 Test Procedures

- All measurements were done at low and high operational frequency range.
- The center frequency of spectrum is the band edge frequency and span is 1MHz. RB of the spectrum is 13kHz and VB of the spectrum is 51kHz (CDMA / LTE Bandwidth 1.4MHz).
- The center frequency of spectrum is the band edge frequency and span is 1MHz. RB of the spectrum is 30kHz and VB of the spectrum is 100kHz (LTE Bandwidth 3MHz).
- The center frequency of spectrum is the band edge frequency and span is 1MHz. RB of the spectrum is 100kHz and VB of the spectrum is 300kHz (LTE Bandwidth 5MHz/10MHz).
- The center frequency of spectrum is the band edge frequency and span is 1MHz. RB of the spectrum is 150kHz and VB of the spectrum is 470kHz (LTE Bandwidth 15MHz).
- The center frequency of spectrum is the band edge frequency and span is 1MHz. RB of the spectrum is 180kHz and VB of the spectrum is 560kHz (LTE Bandwidth 20MHz).
- Record the max trace plot into the test report.



A O T

4.4.4 Test Results

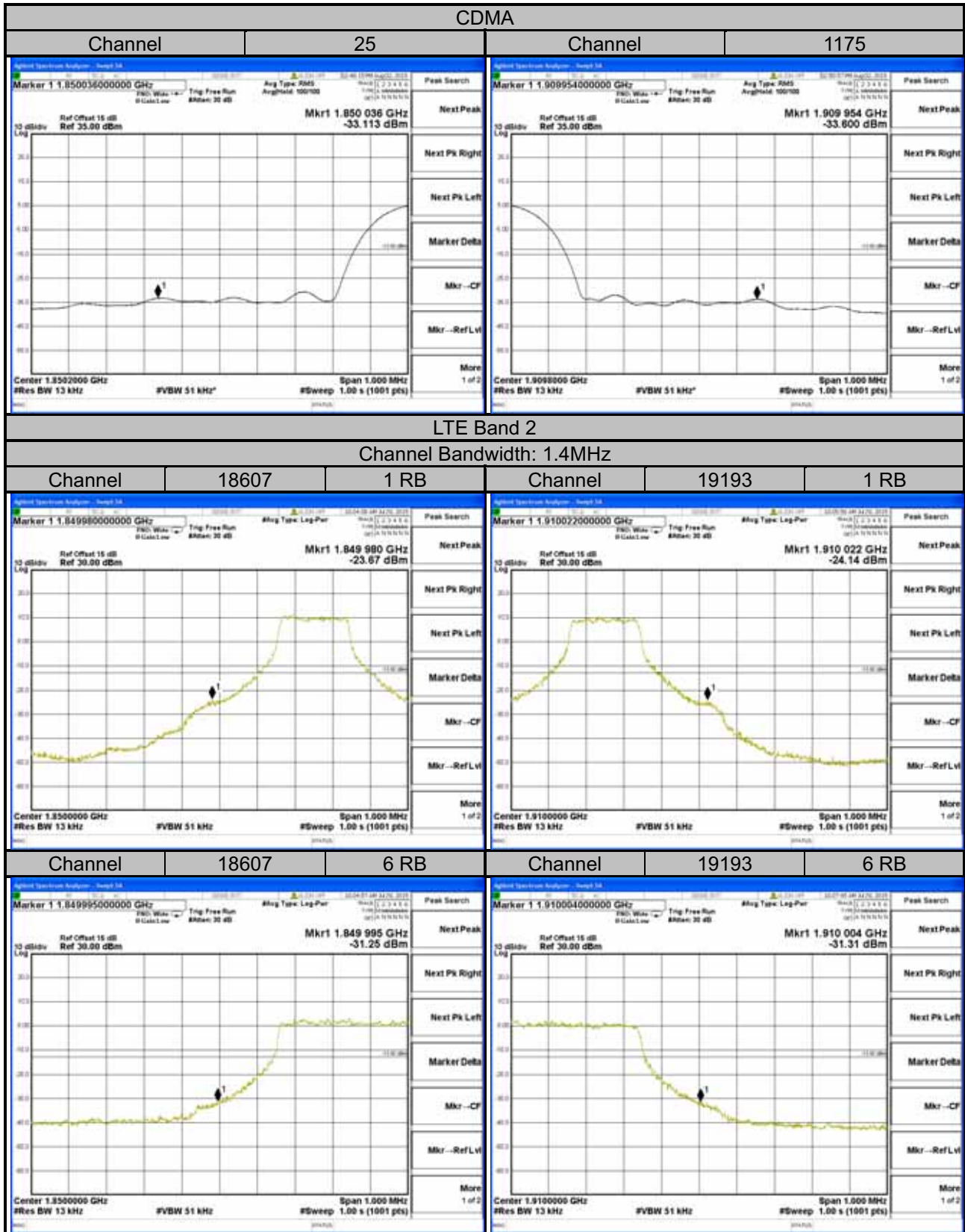



A O T

LTE Band 2

Channel Bandwidth: 3MHz

Channel	18615	1 RB	Channel	19185	1 RB
---------	-------	------	---------	-------	------



Channel	18615	15 RB	Channel	19185	15 RB
---------	-------	-------	---------	-------	-------





A O T

LTE Band 2

Channel Bandwidth: 5MHz

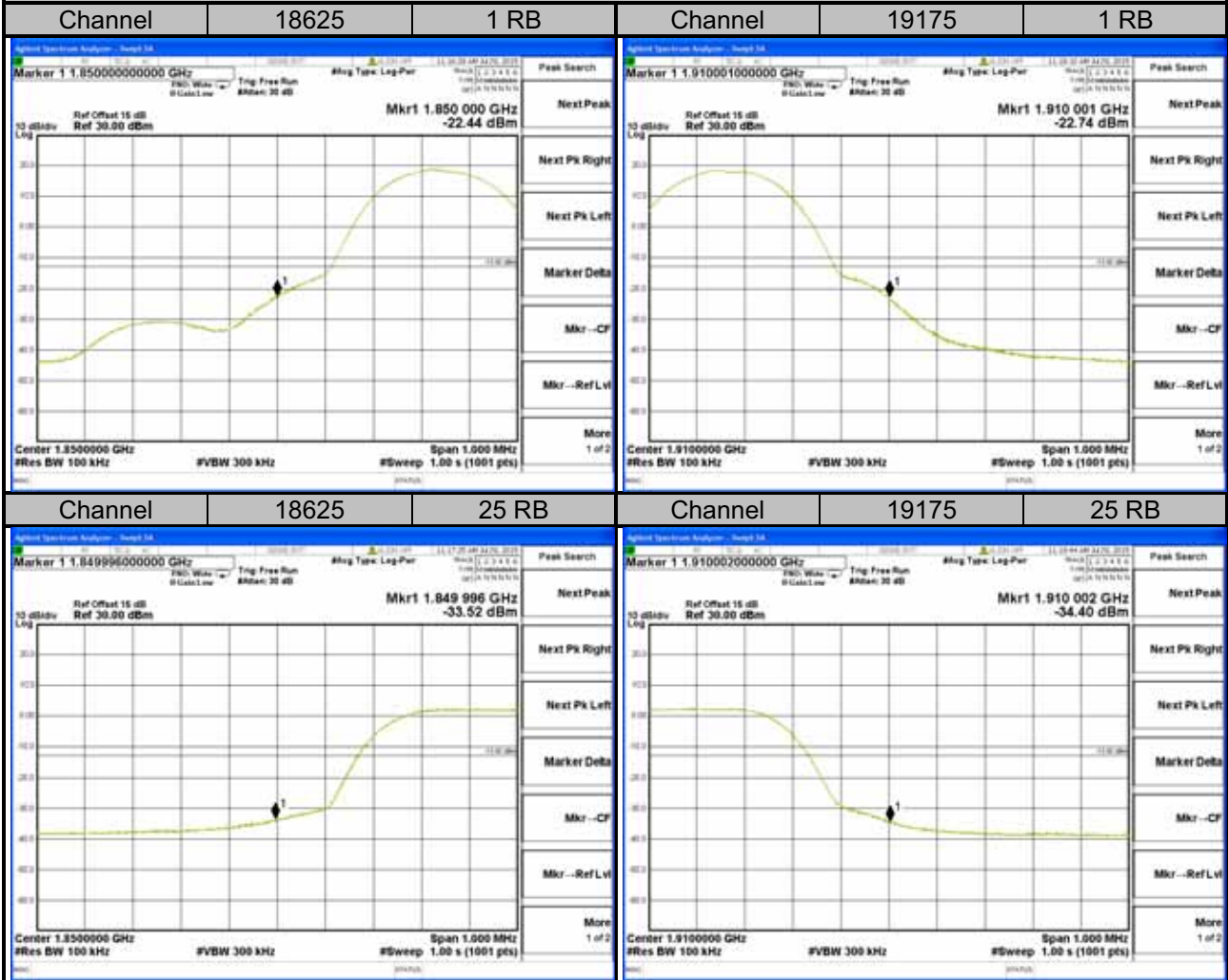



A O T

LTE Band 2

Channel Bandwidth: 10MHz

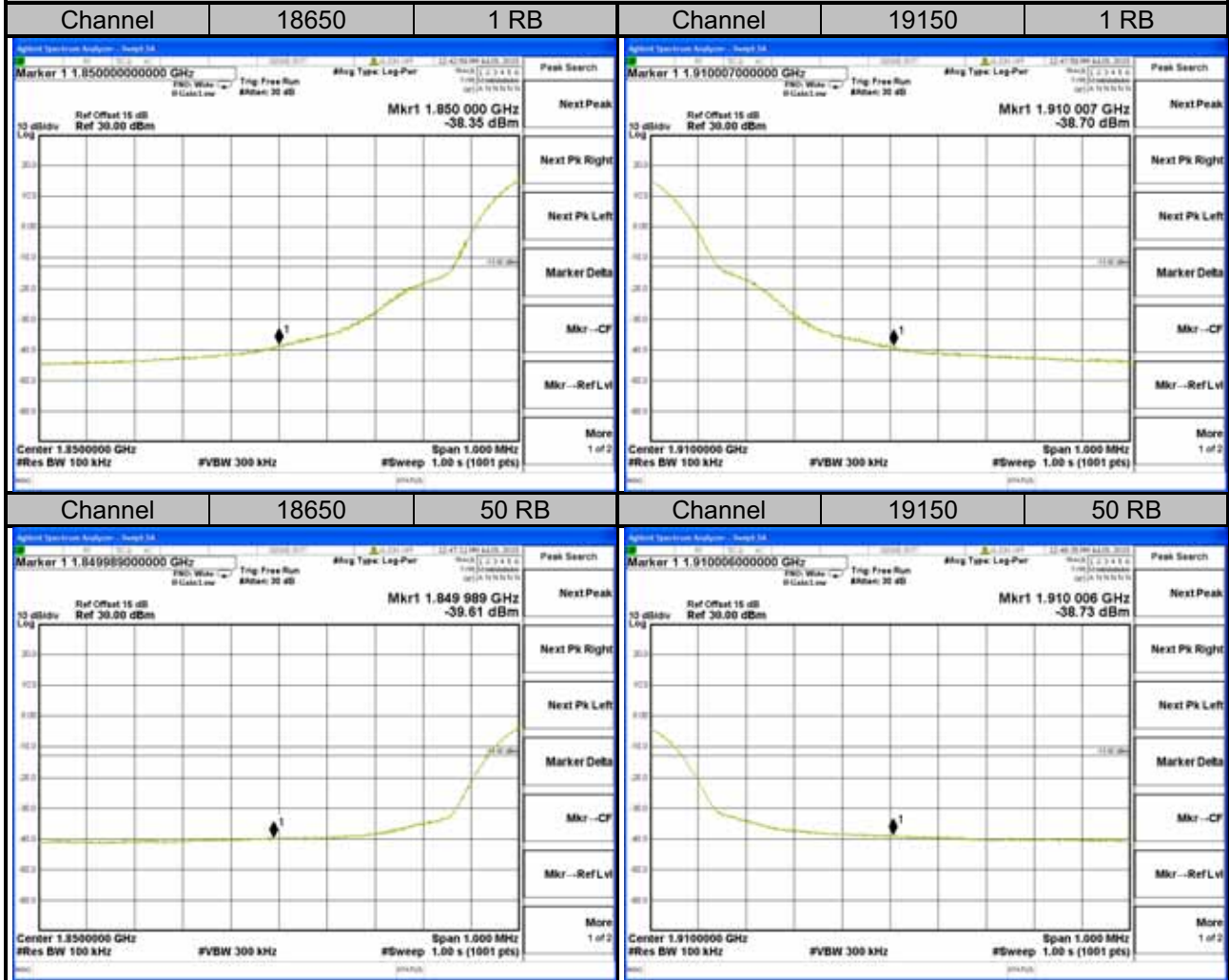



A O T

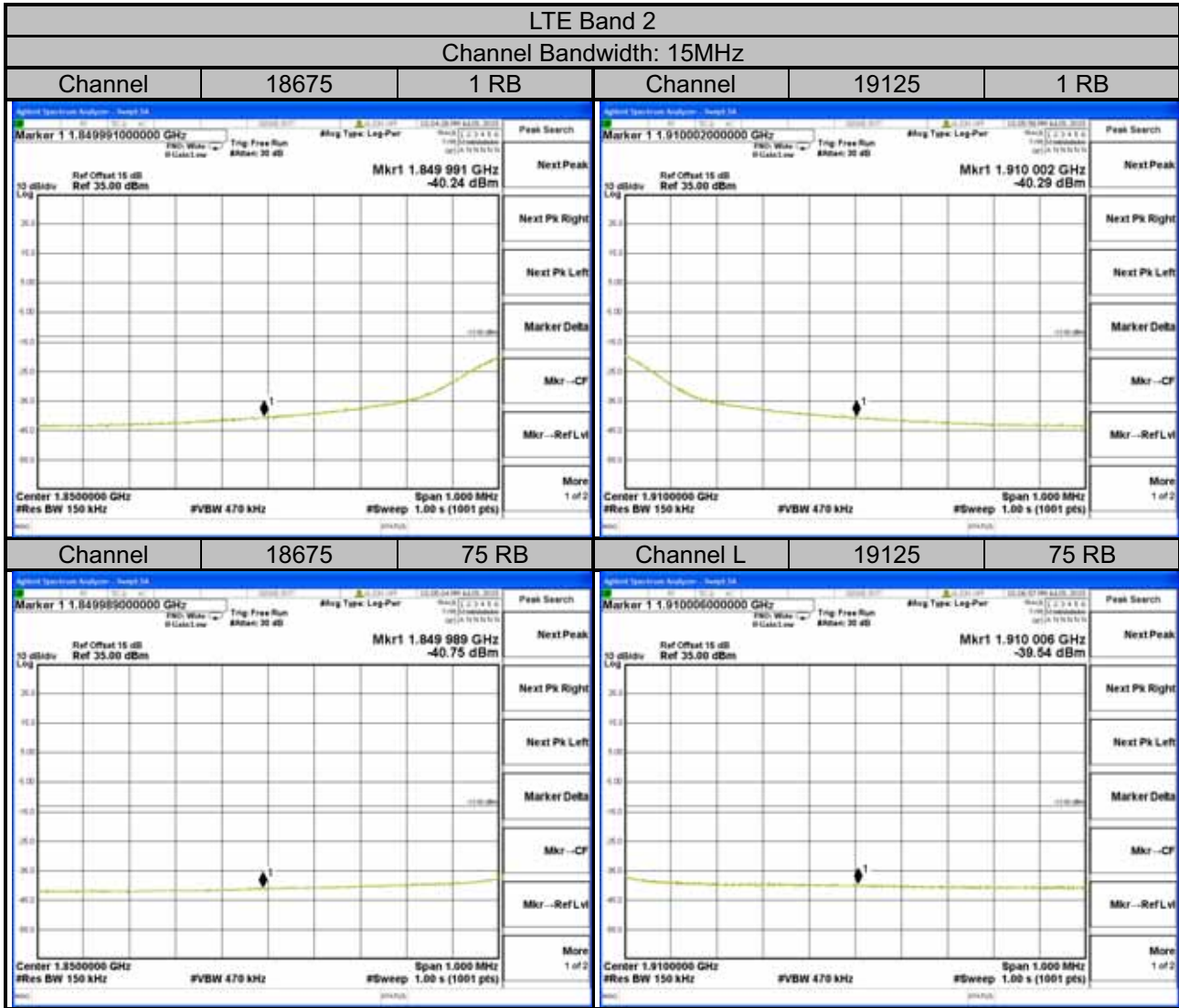



A O T

LTE Band 2

Channel Bandwidth: 20MHz

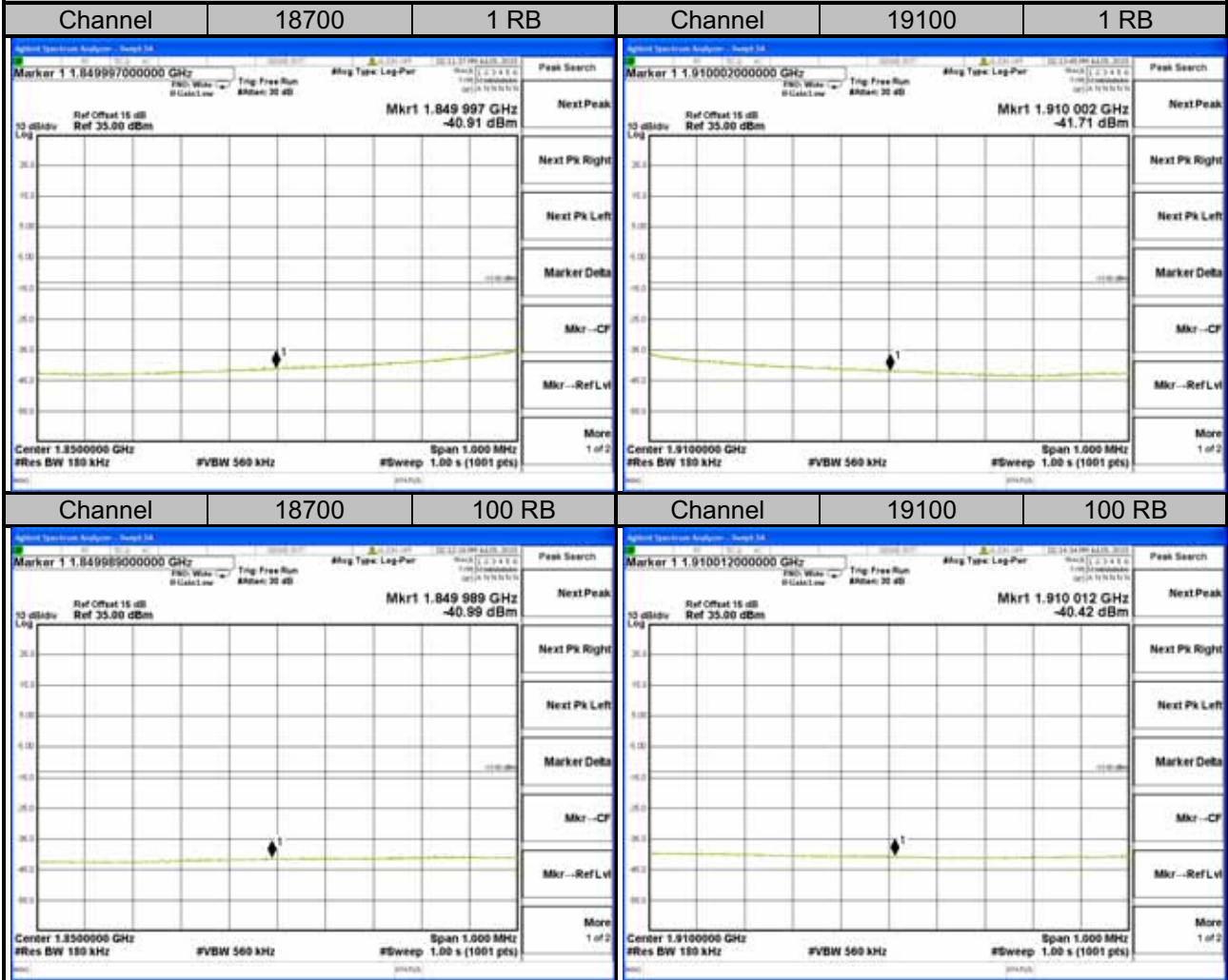



A O T

LTE Band 25

Channel Bandwidth: 1.4MHz

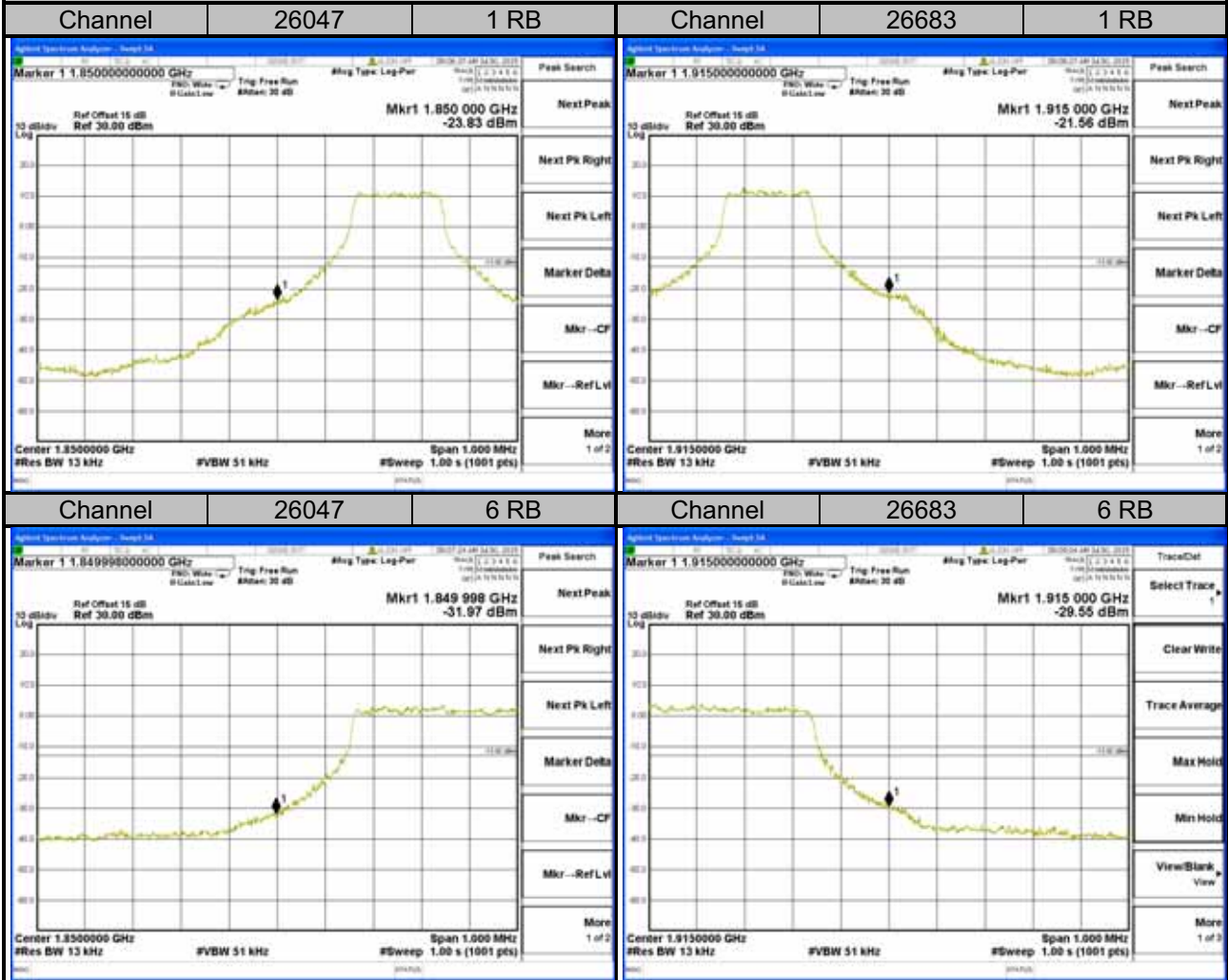



A O T

LTE Band 25

Channel Bandwidth: 3MHz

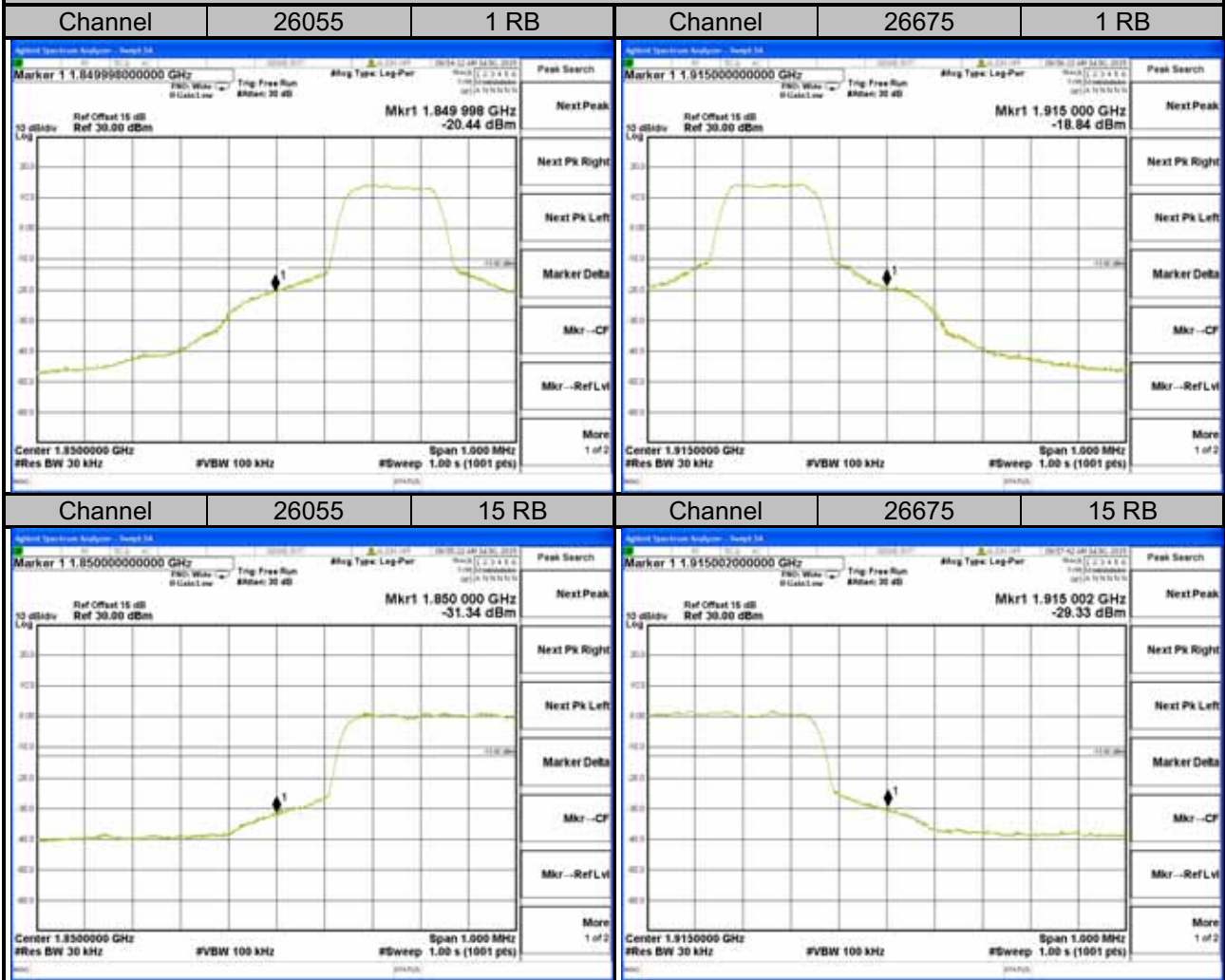



A O T

LTE Band 25

Channel Bandwidth: 5MHz

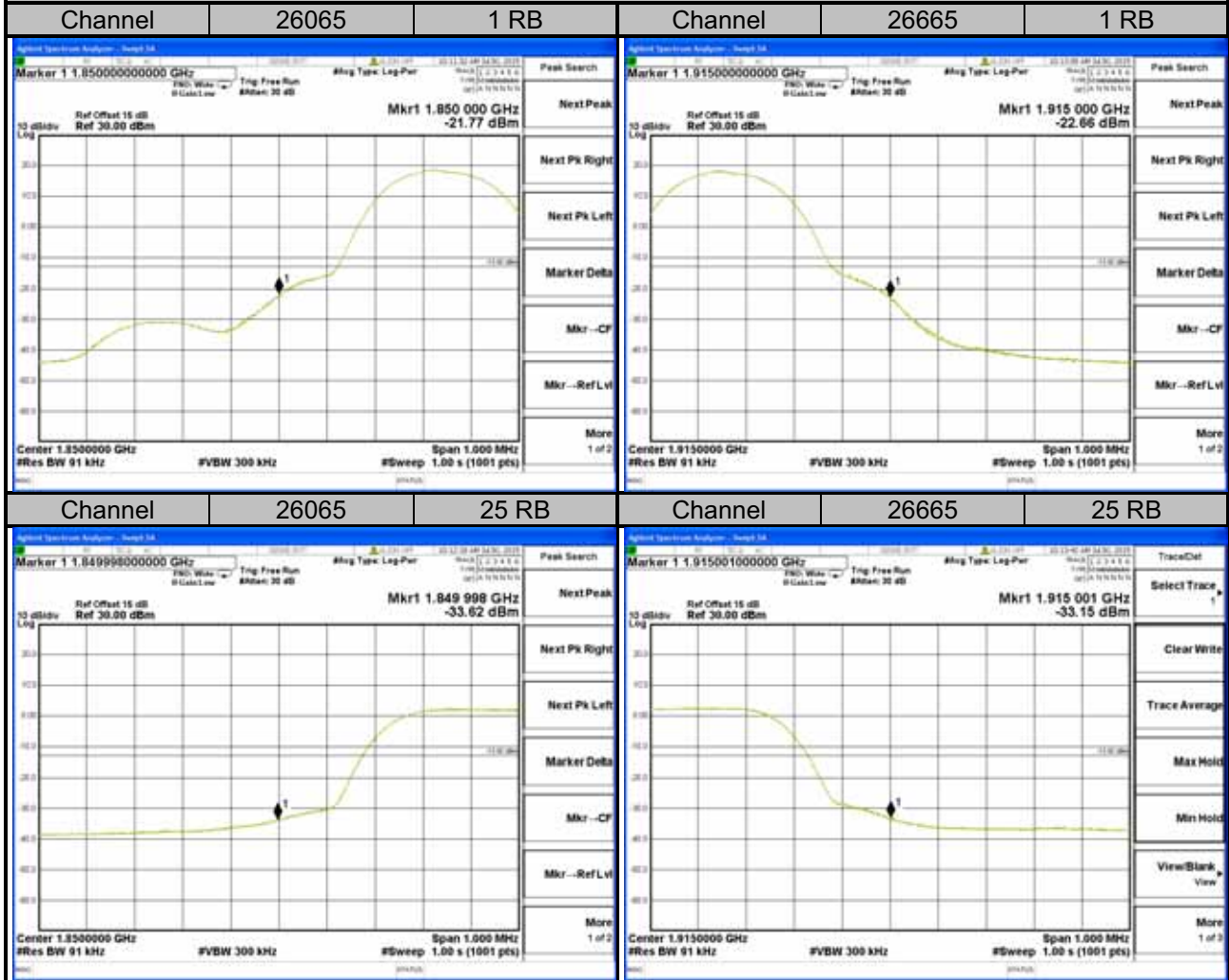



A O T

LTE Band 25

Channel Bandwidth: 10MHz

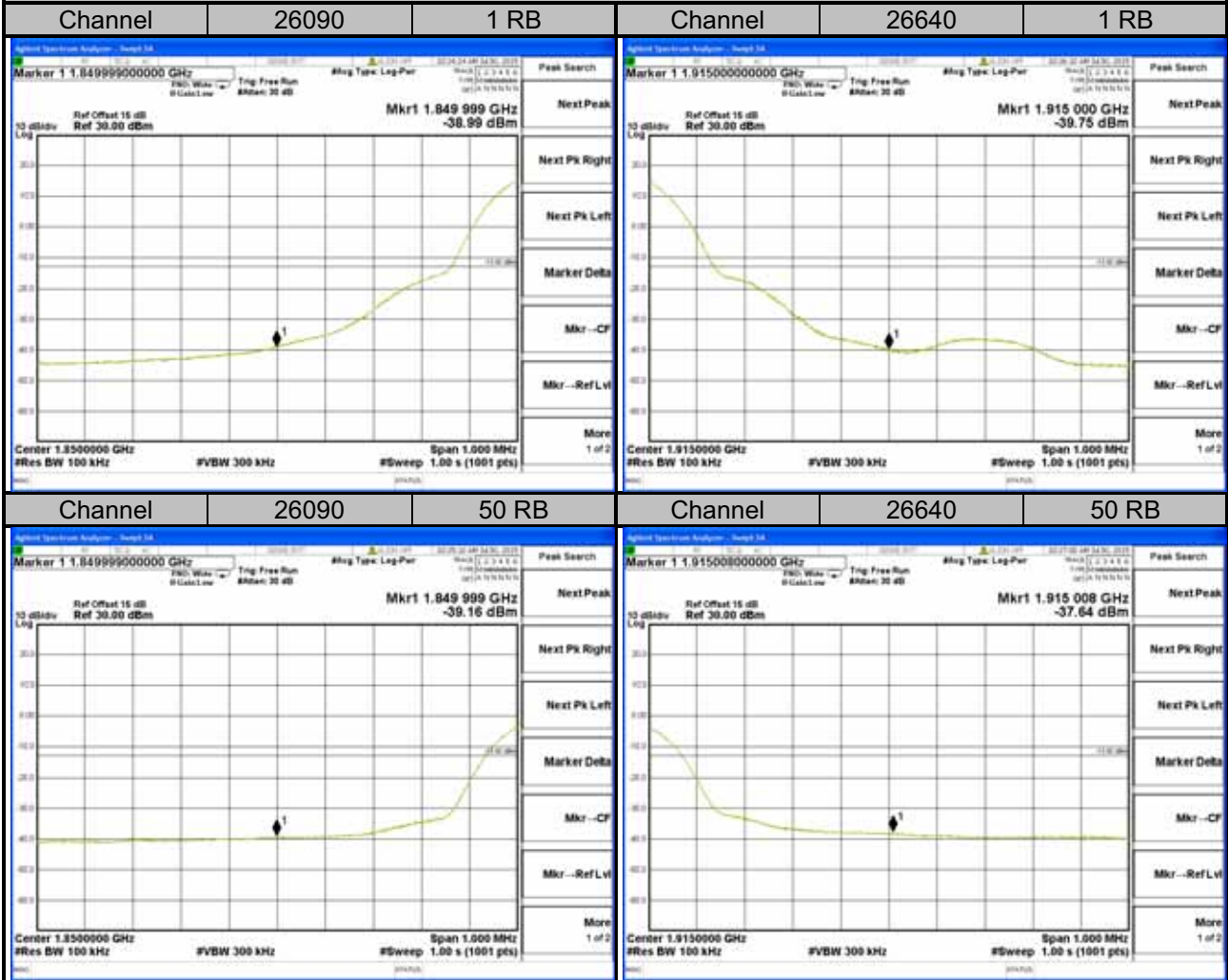



A O T

LTE Band 25

Channel Bandwidth: 15MHz

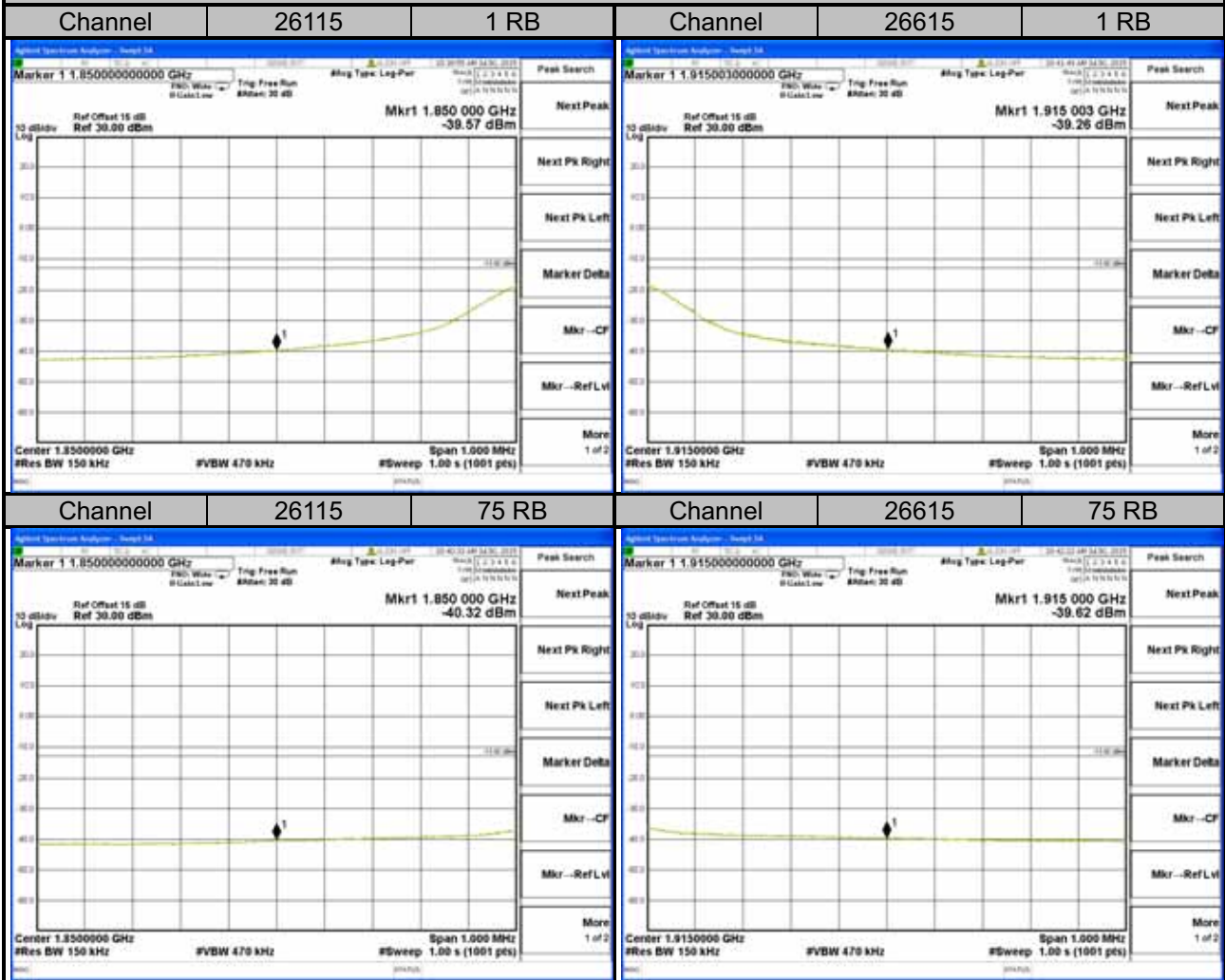



A O T

LTE Band 25

Channel Bandwidth: 20MHz

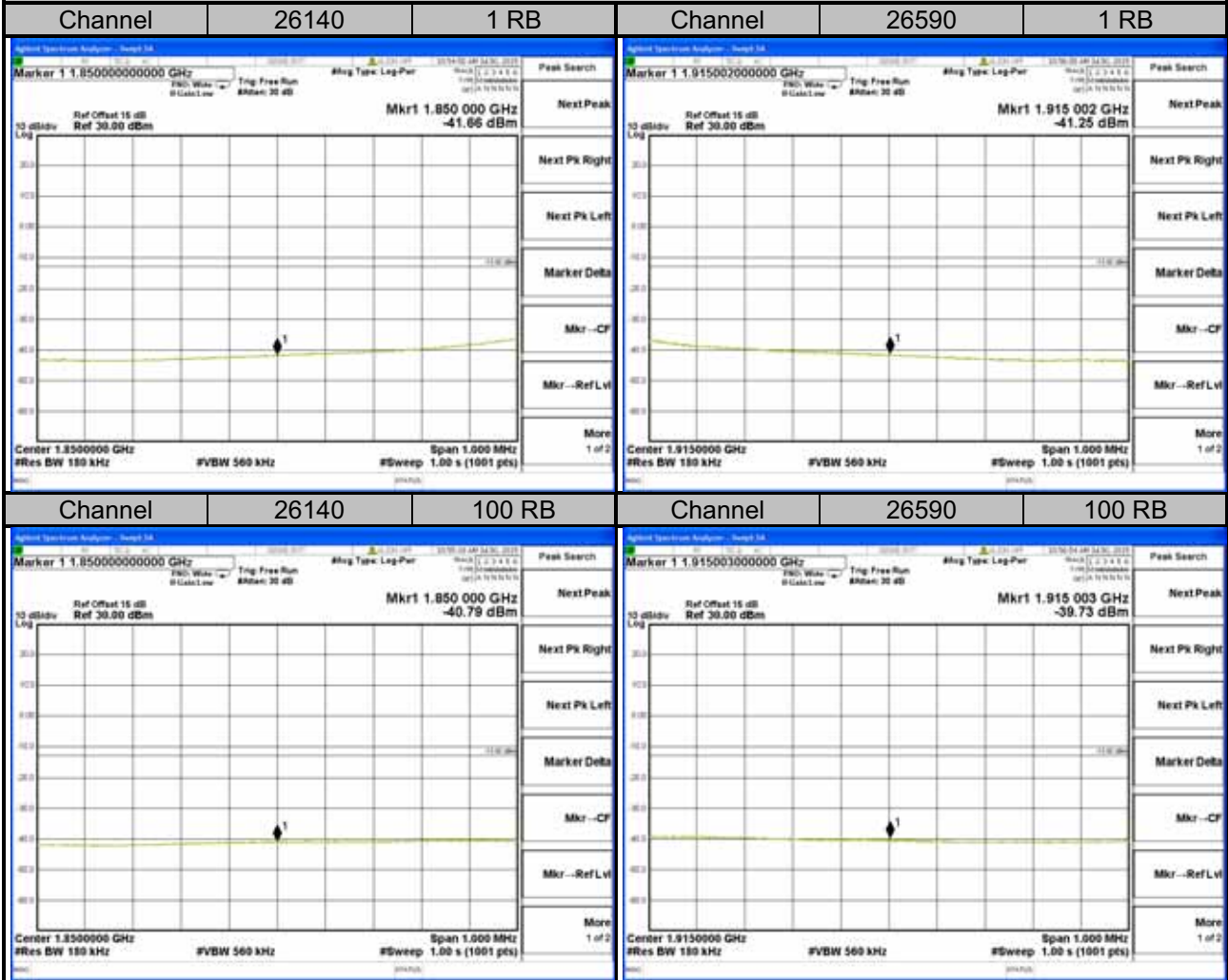

4.5 Peak To Average Ratio

4.5.1 Limits of Peak to Average Ratio Measurement

In measuring transmissions in this band using an average power technique, the peak to-average ratio (PAR) of the transmission may not exceed 13 dB

4.5.2 Test Setup

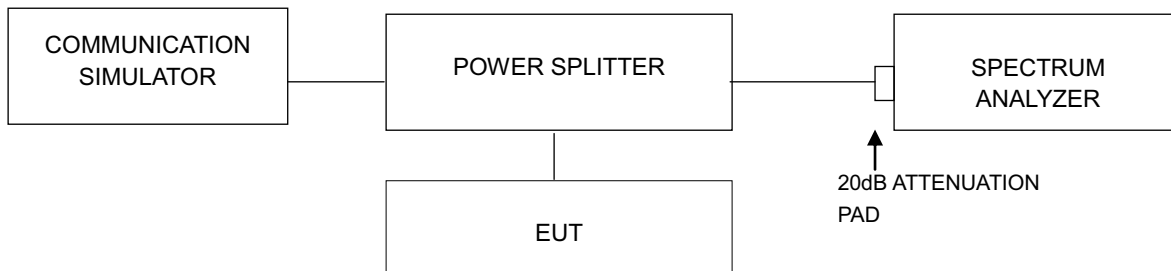

4.5.3 Test Procedures

1. Set resolution/measurement bandwidth \geq signal's occupied bandwidth;
2. Set the number of counts to a value that stabilizes the measured CCDF curve;
3. Record the maximum PAPR level associated with a probability of 0.1%.

4.5.4 Test Results

Channel	Frequency (MHz)	Peak to Average Ratio (dB)
		CDMA
25	1851.25	3.14
600	1880.00	3.62
1175	1908.75	3.34

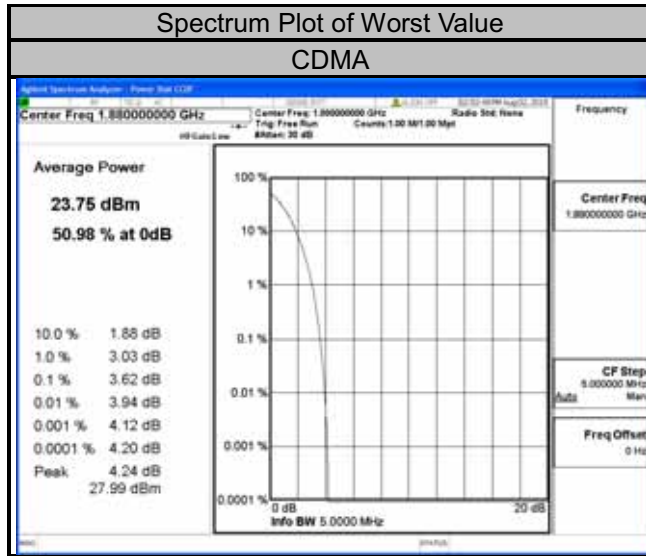



LTE Band 2							
Channel Bandwidth: 1.4MHz				Channel Bandwidth: 3MHz			
Channel	Frequency (MHz)	Peak to Average Ratio (dB)		Channel	Frequency (MHz)	Peak to Average Ratio (dB)	
		QPSK	16QAM			QPSK	16QAM
18607	1850.7	5.06	6.40	18615	1851.5	4.99	6.34
18900	1880.0	5.60	6.67	18900	1880.0	5.35	6.67
19193	1909.3	5.62	6.69	19185	1908.5	5.25	6.80

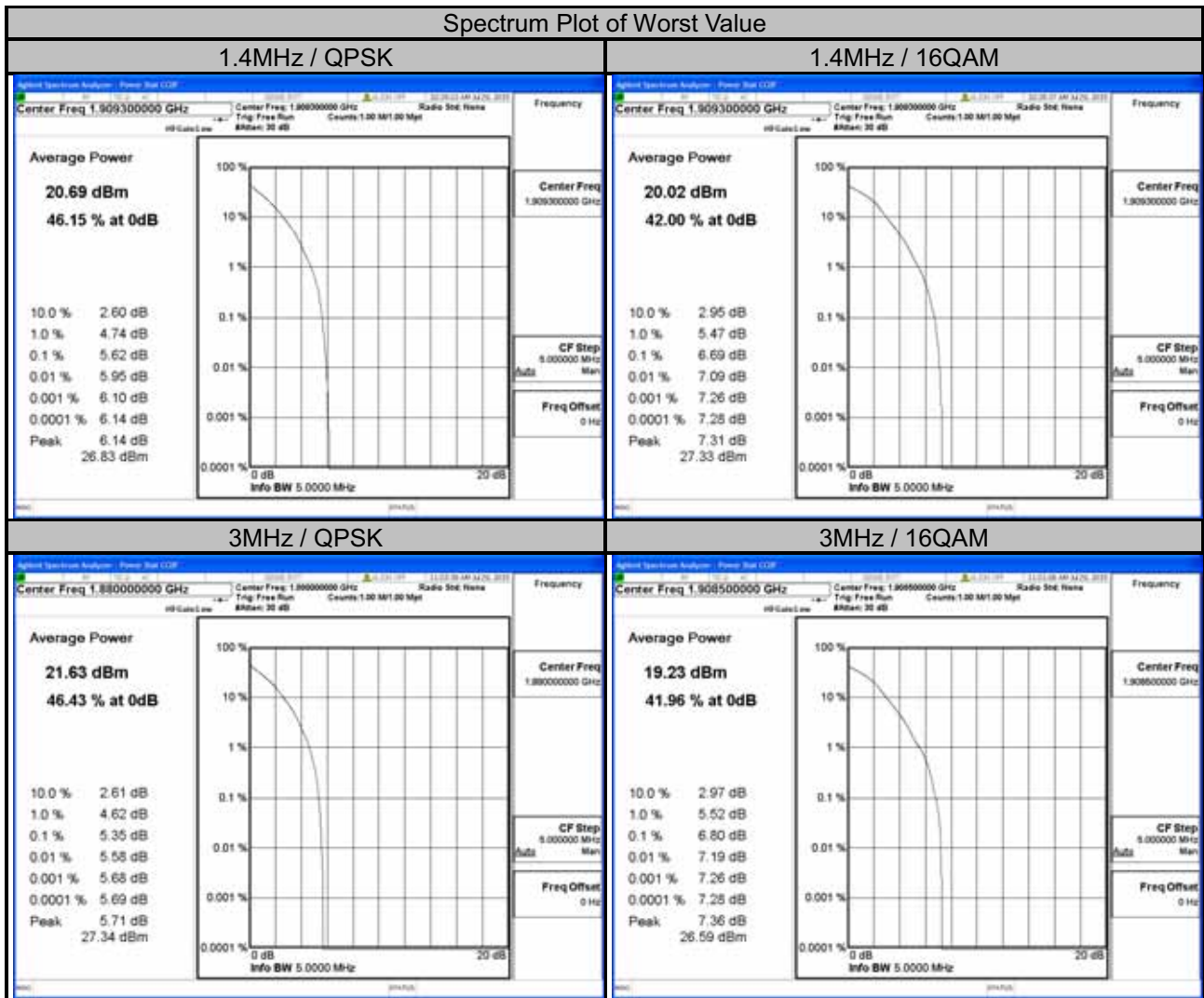



LTE Band 2							
Channel Bandwidth: 5MHz				Channel Bandwidth: 10MHz			
Channel	Frequency (MHz)	Peak to Average Ratio (dB)		Channel	Frequency (MHz)	Peak to Average Ratio (dB)	
		QPSK	16QAM			QPSK	16QAM
18625	1852.5	5.13	6.34	18650	1855.0	5.25	6.47
18900	1880.0	5.40	6.61	18900	1880.0	5.39	6.74
19175	1907.5	5.22	6.49	19150	1905.0	5.17	6.34

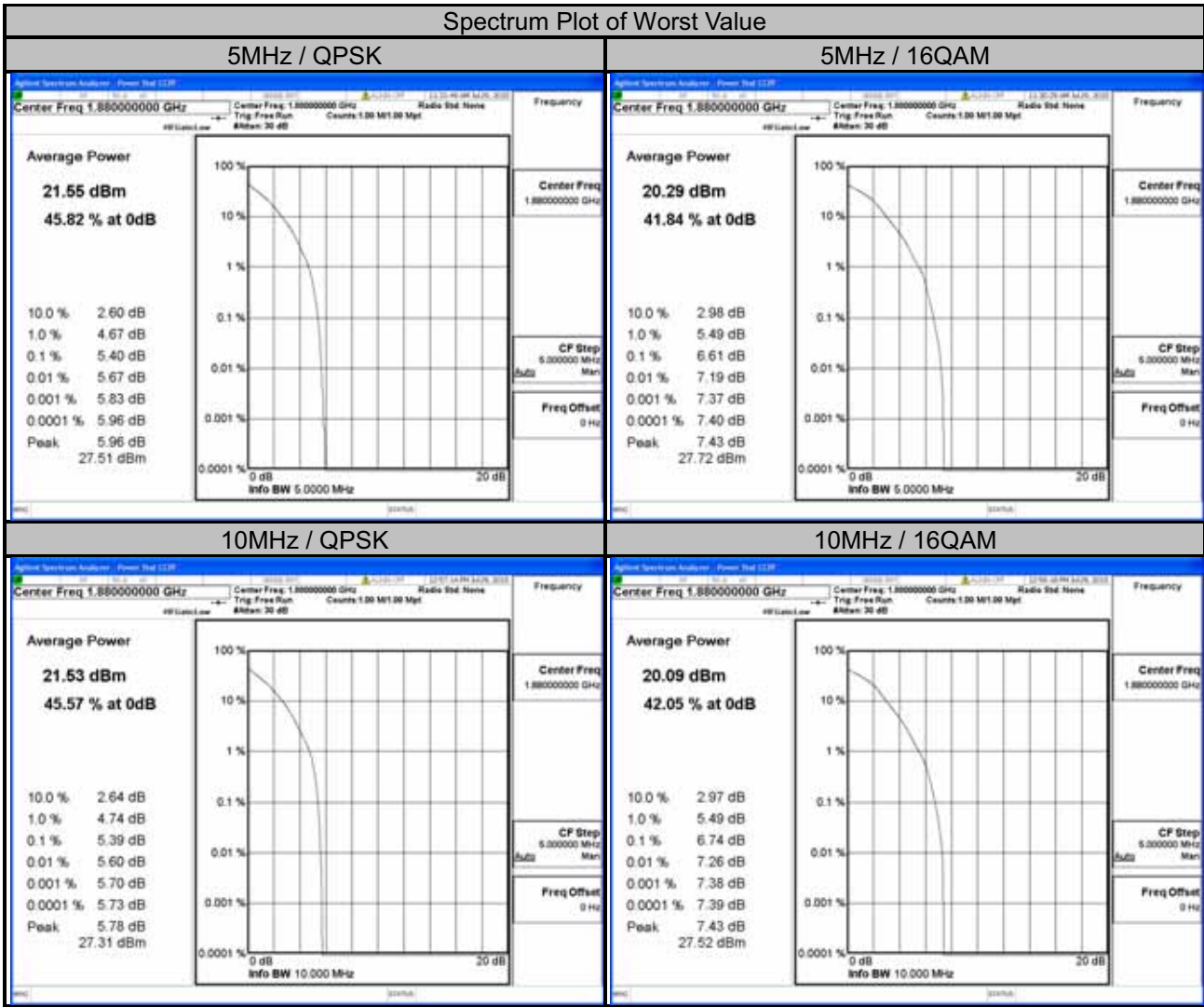



LTE Band 2							
Channel Bandwidth: 15MHz				Channel Bandwidth: 20MHz			
Channel	Frequency (MHz)	Peak to Average Ratio (dB)		Channel	Frequency (MHz)	Peak to Average Ratio (dB)	
		QPSK	16QAM			QPSK	16QAM
18675	1857.5	5.14	6.56	18700	1860.0	5.07	7.25
18900	1880.0	5.25	7.15	18900	1880.0	5.12	7.10
19125	1902.5	5.12	7.06	19100	1900.0	5.42	6.71

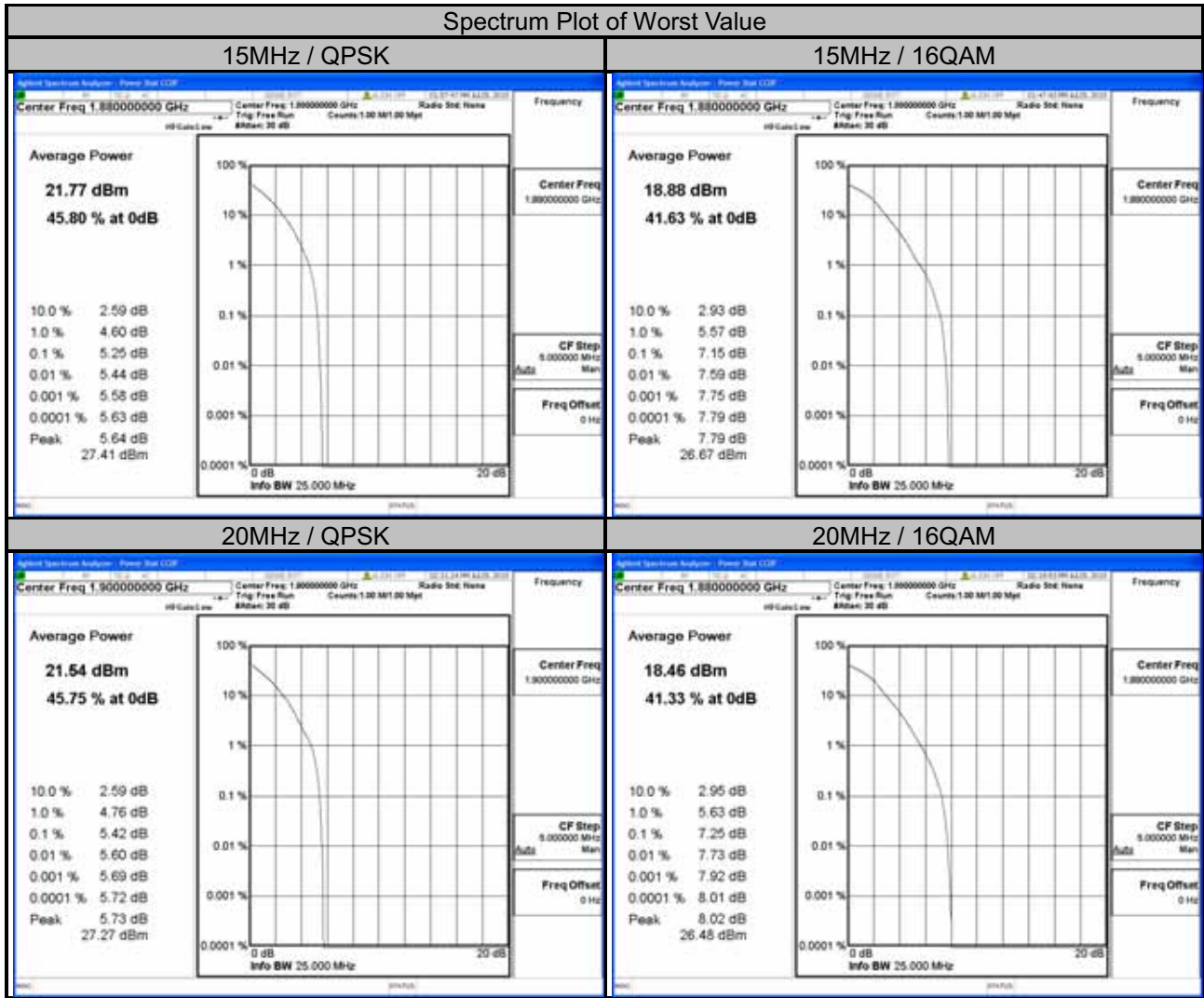



LTE Band 25							
Channel Bandwidth: 1.4MHz				Channel Bandwidth: 3MHz			
Channel	Frequency (MHz)	Peak to Average Ratio (dB)		Channel	Frequency (MHz)	Peak to Average Ratio (dB)	
		QPSK	16QAM			QPSK	16QAM
26047	1850.7	4.91	6.32	26055	1851.5	4.70	6.24
26365	1882.5	5.17	6.66	26365	1882.5	5.06	6.59
26683	1914.3	4.76	6.14	26675	1913.5	4.38	6.26

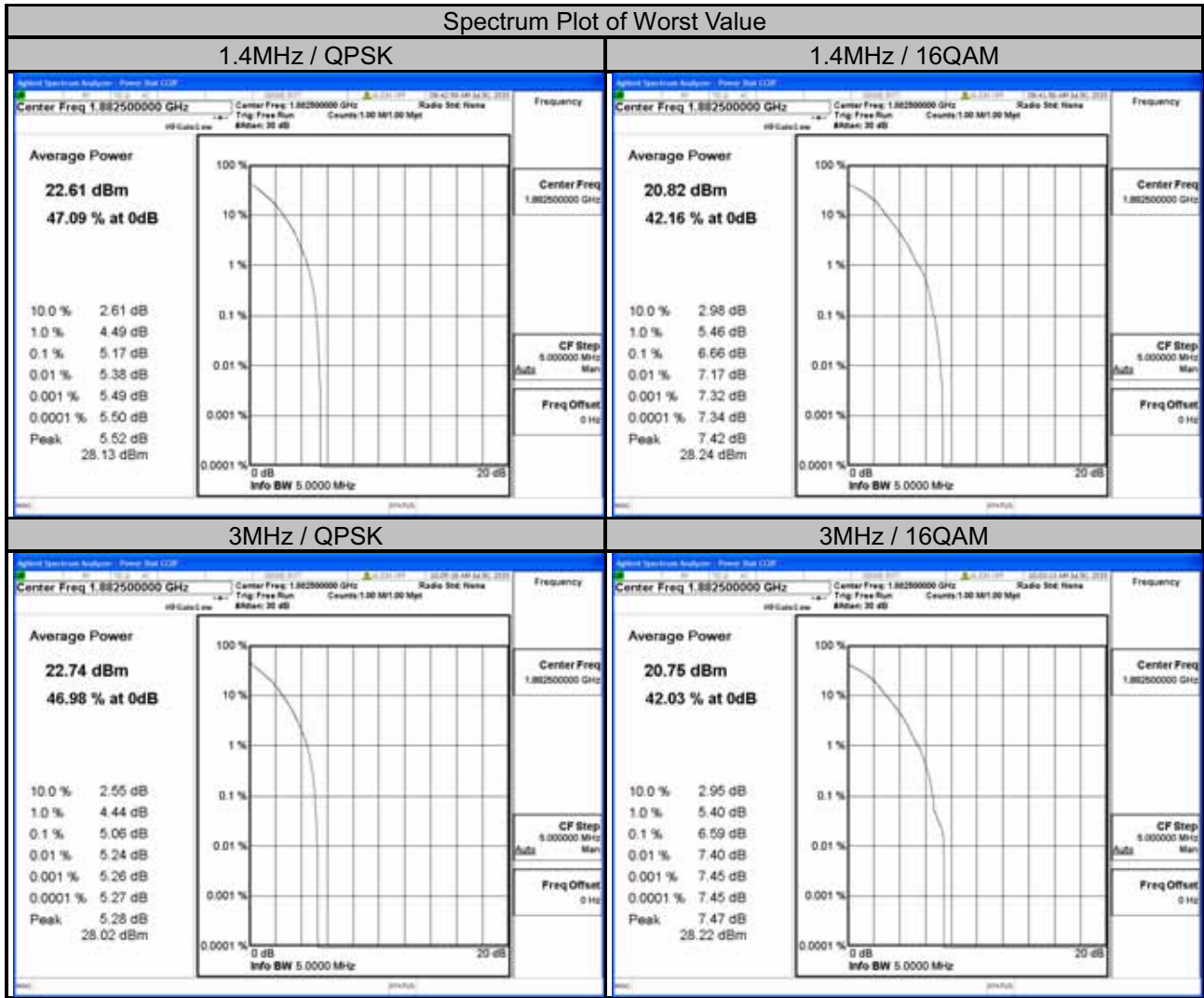



LTE Band 25							
Channel Bandwidth: 5MHz				Channel Bandwidth: 10MHz			
Channel	Frequency (MHz)	Peak to Average Ratio (dB)		Channel	Frequency (MHz)	Peak to Average Ratio (dB)	
		QPSK	16QAM			QPSK	16QAM
26065	1852.5	4.69	6.48	26090	1855.0	4.84	6.00
26365	1882.5	5.19	6.17	26365	1882.5	5.15	6.41
26665	1912.5	4.80	6.06	26640	1910.0	5.03	6.12

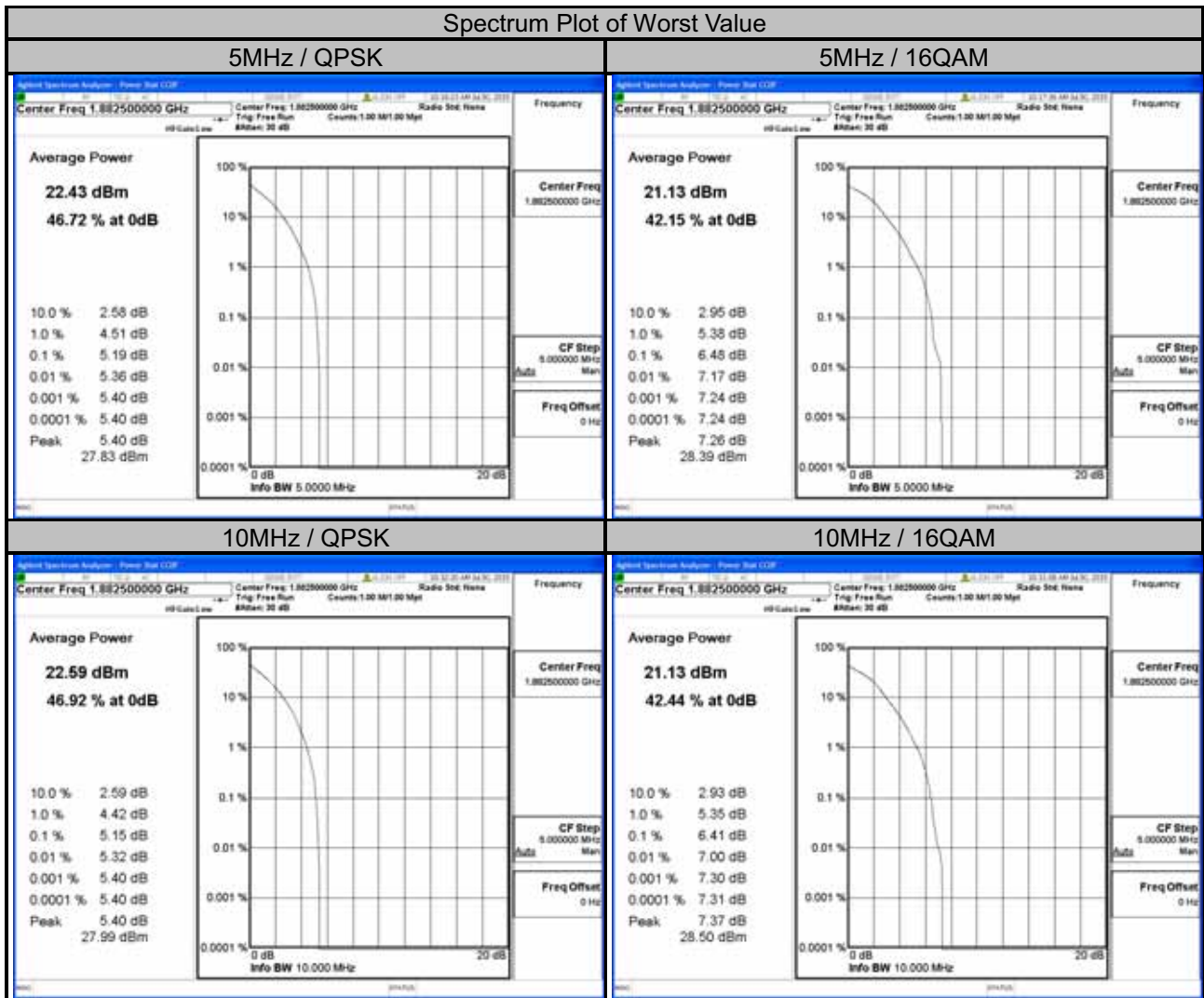



LTE BAND 25							
Channel Bandwidth: 15MHz				Channel Bandwidth: 20MHz			
Channel	Frequency (MHz)	Peak to Average Ratio (dB)		Channel	Frequency (MHz)	Peak to Average Ratio (dB)	
		QPSK	16QAM			QPSK	16QAM
26115	1857.5	5.15	5.94	26140	1860	5.21	6.14
26365	1882.5	5.44	6.38	26365	1882.5	5.55	6.39
26615	1907.5	5.31	6.09	26590	1905	5.48	6.35

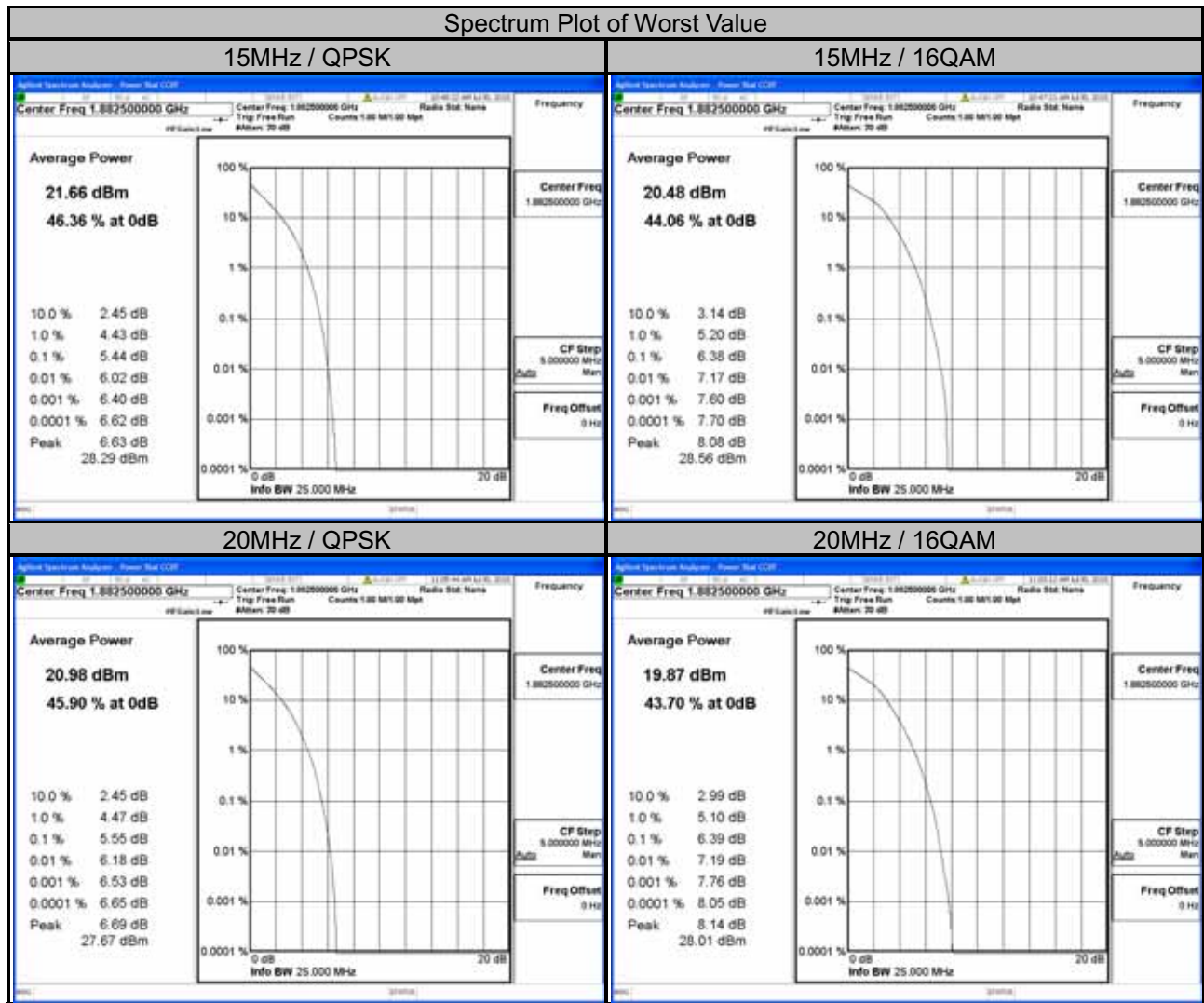

4.6 Conducted Spurious Emissions

4.6.1 Limits of Conducted Spurious Emissions Measurement

The power of any emission outside of the authorized operating frequency ranges must be attenuated below the transmitting power (P) by a factor of at least $43 + 10 \log(P)$ dB. The emission limit equal to -13dBm .

4.6.2 Test Setup

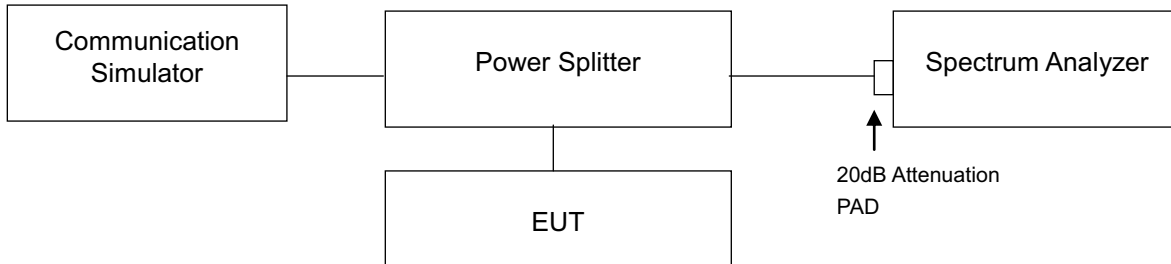

4.6.3 Test Procedure

- The EUT makes a phone call to the communication simulator. All measurements were done at low, middle and high operational frequency range.
- Measuring frequency range is from 9 kHz to 9GHz. 20dB attenuation pad is connected with spectrum. RBW=1MHz and VBW=3MHz is used for conducted emission measurement.

4.6.4 Test Results

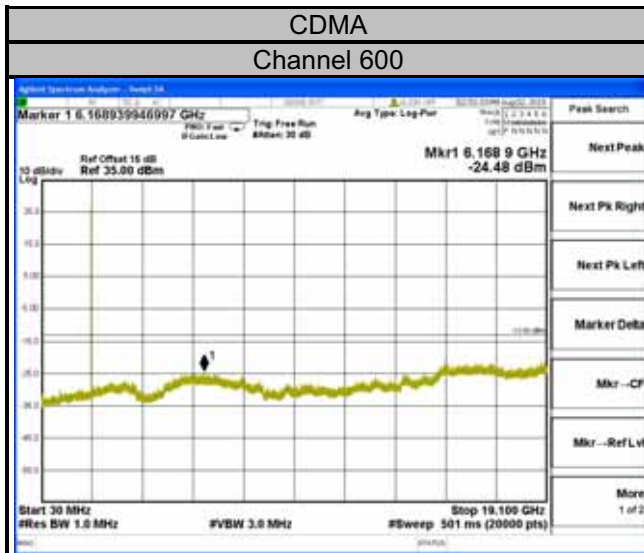



A O T

LTE Band 2
Channel 18900

Channel Bandwidth: 1.4MHz

Channel Bandwidth: 3MHz



Channel Bandwidth: 5MHz

Channel Bandwidth: 10MHz

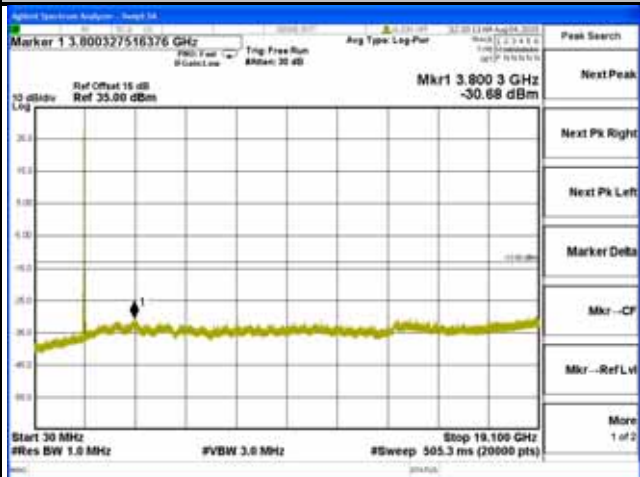
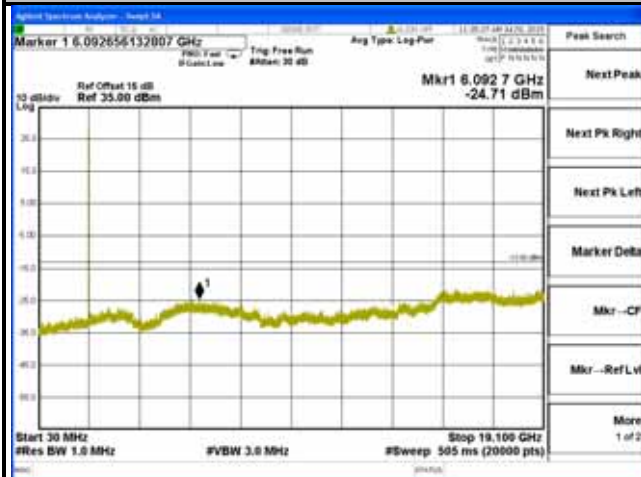

Channel Bandwidth: 15MHz

Channel Bandwidth: 20MHz





A O T

LTE Band 25
Channel 26365

Channel Bandwidth: 1.4MHz

Channel Bandwidth: 3MHz



Channel Bandwidth: 5MHz

Channel Bandwidth: 10MHz



Channel Bandwidth: 15MHz

Channel Bandwidth: 20MHz

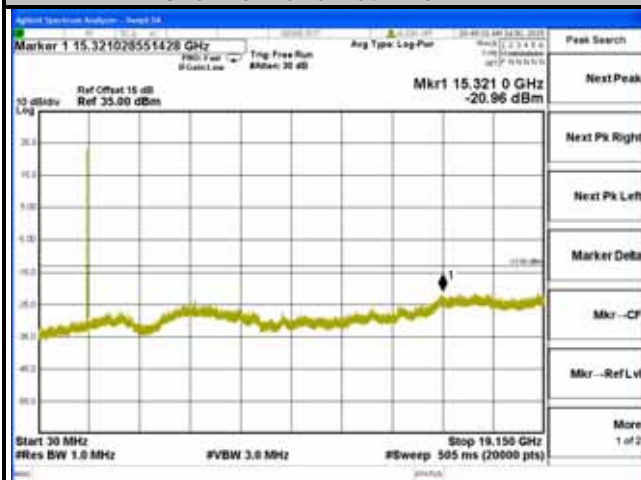

4.7 Radiated Emission Measurement

4.7.1 Limits of Radiated Emission Measurement

The power of any emission outside of the authorized operating frequency ranges must be attenuated below the transmitting power (P) by a factor of at least $43 + 10 \log(P)$ dB. The emission limit equal to -13dBm .

4.7.2 Test Procedure

- Substitution method is used for E.I.R.P measurement. In the semi-anechoic chamber, EUT placed on the 0.8m height of Turn Table, rotated the table around 360 degrees to search the maximum radiation power and receiver antenna shall be rotated vertical and horizontal polarization and moved height from 1m to 4m to find the maximum polar radiated power. The "Read Value" is the spectrum reading the maximum power value.
- The substitution horn antenna is substituted for EUT at the same position and signals generator export the CW signal to the substitution antenna via a TX cable. Rotated the Turn Table and moved receiving antenna to find the maximum radiation power. Adjust output power level of S.G to get a Value of spectrum reading equal to "Read Value" of step a. Record the power level of S.G
- $\text{EIRP} = \text{Output power level of S.G} - \text{TX cable loss} + \text{Antenna gain of substitution horn}$.
- E.R.P power can be calculated form E.I.R.P power by subtracting the gain of dipole, $\text{E.R.P power} = \text{E.I.P.R power} - 2.15\text{dBi}$.

NOTE: The resolution bandwidth and video bandwidth of test receiver/spectrum analyzer is 1MHz/3MHz.

4.7.3 Deviation from Test Standard

No deviation.

4.7.4 Test Setup

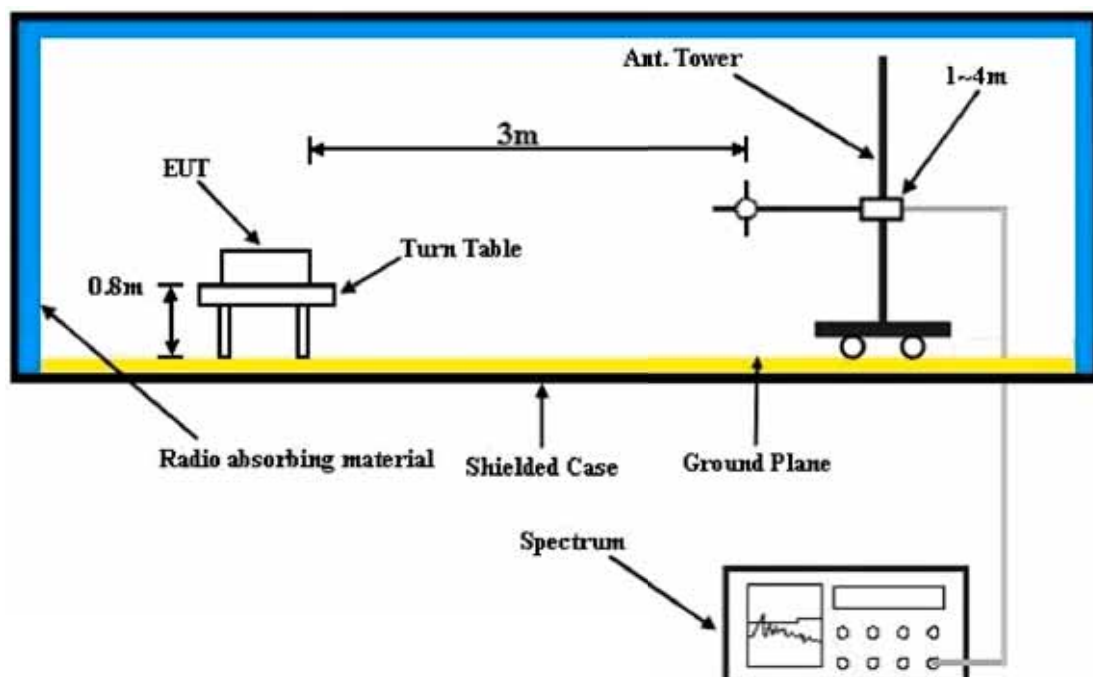

For the actual test configuration, please refer to the attached file (Test Setup Photo).

4.7.5 Test Results

CDMA:



Bureau Veritas Consumer Products Services Ltd., Taoyuan Branch

A D T

Data: 9

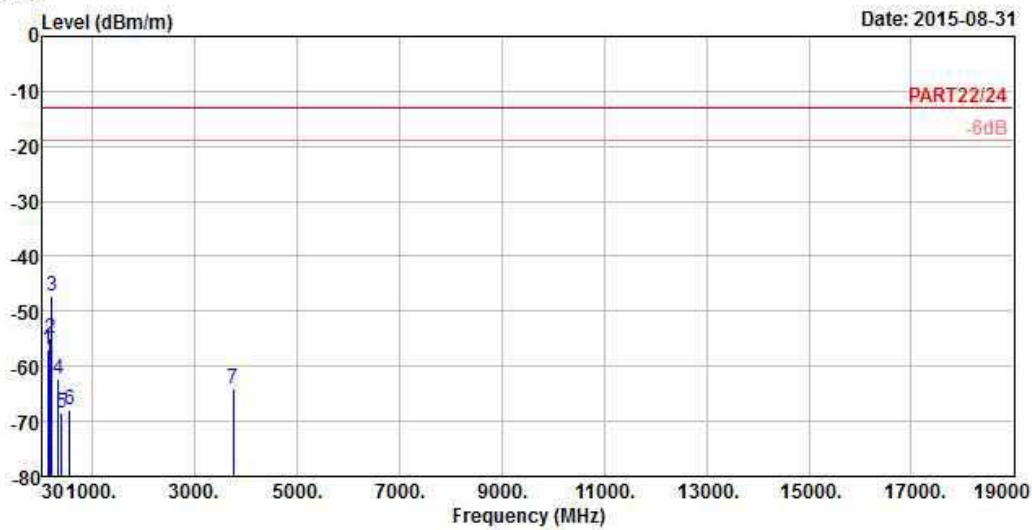

Site : 966 Chamber 5
 Condition: PART22/24 3m HORIZONTAL
 Remark : CDMA BC1 Link
 Tested by: Anson Lin
 Plane : Z

	Freq	Level	Read Level	Limit Line	Over Limit	Factor	Remark
	MHz	dBm/m	dBm	dBm/m	dB	dB/m	
1	126.39	-56.94	-47.79	-13.00	-43.94	-9.15	Peak
2	174.99	-54.95	-48.57	-13.00	-41.95	-6.38	Peak
3 pp	212.52	-47.21	-39.70	-13.00	-34.21	-7.51	Peak
4	335.70	-62.38	-55.92	-13.00	-49.38	-6.46	Peak
5	400.10	-68.41	-62.47	-13.00	-55.41	-5.94	Peak
6	554.80	-67.78	-65.13	-13.00	-54.78	-2.65	Peak
7	3760.00	-64.19	-56.13	-13.00	-51.19	-8.06	Peak



A O T



Bureau Veritas Consumer Products Services Ltd., Taoyuan Branch

A D T

Data: 10

Date: 2015-08-31

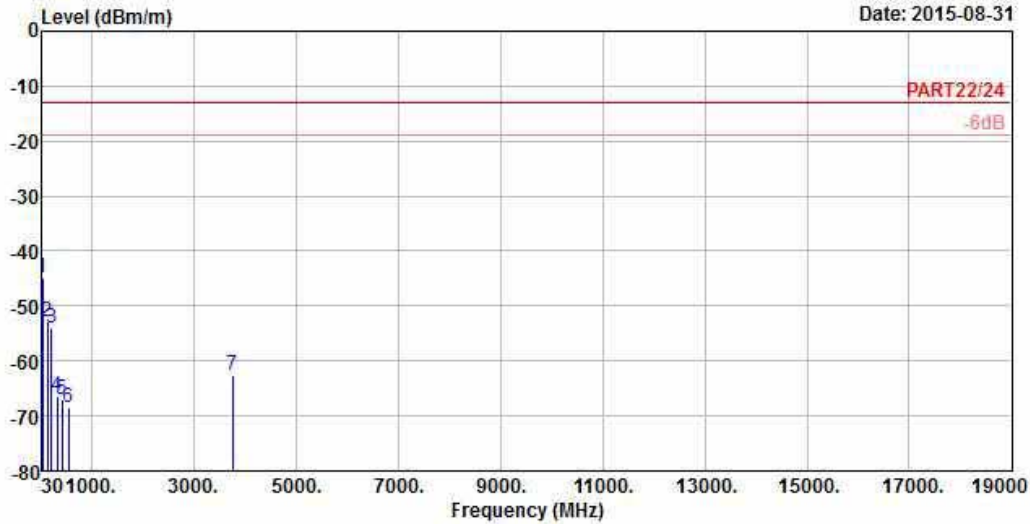

Site : 966 Chamber 5
 Condition: PART22/24 3m VERTICAL
 Remark : CDMA BC1 Link
 Tested by: Anson Lin
 Plane : Z

	Freq	Level	Read Level	Limit Line	Over Limit	Factor	Remark
	MHz	dBm/m	dBm	dBm/m	dB	dB/m	
1	pp	40.53	-44.78	-44.90	-13.00	-31.78	0.12 Peak
2		122.34	-52.76	-43.14	-13.00	-39.76	-9.62 Peak
3		212.25	-54.10	-46.59	-13.00	-41.10	-7.51 Peak
4		314.00	-66.44	-59.65	-13.00	-53.44	-6.79 Peak
5		417.60	-67.06	-61.26	-13.00	-54.06	-5.80 Peak
6		545.00	-68.43	-65.41	-13.00	-55.43	-3.02 Peak
7		3760.00	-62.73	-54.67	-13.00	-49.73	-8.06 Peak

LTE Band 2
 Channel Bandwidth: 20MHz / QPSK



Bureau Veritas Consumer Products Services Ltd., Taoyuan Branch

A D T

Data: 13

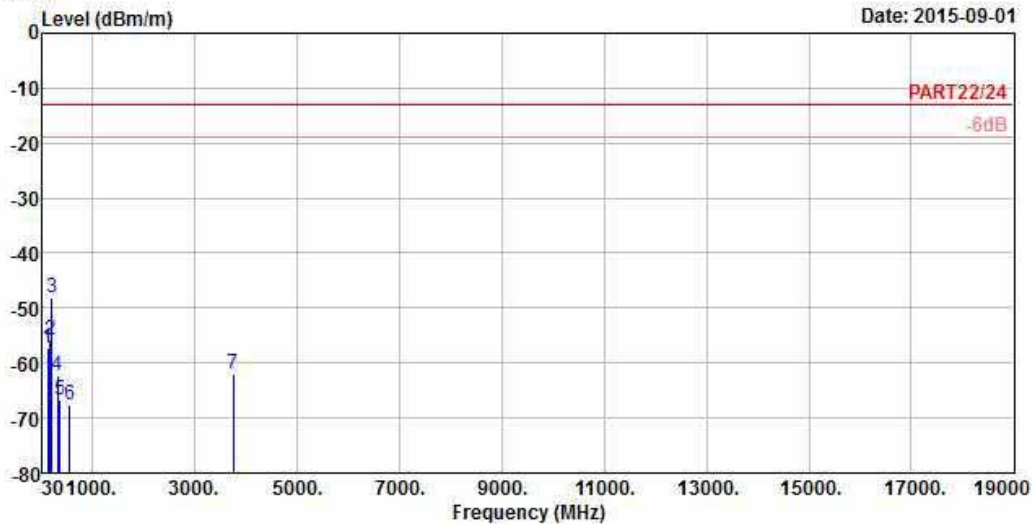

Site : 966 Chamber 5
 Condition: PART22/24 3m HORIZONTAL
 Remark : LTE Band 2_QPSK_20M_(1,0)
 Tested by: Anson Lin
 Plane : Z

	Freq	Level	Read Level	Limit Line	Over Limit	Factor	Remark
	MHz	dBm/m	dBm	dBm/m	dB	dB/m	
1	128.01	-57.40	-48.48	-13.00	-44.40	-8.92	Peak
2	182.28	-55.70	-48.36	-13.00	-42.70	-7.34	Peak
3 pp	213.87	-47.98	-40.54	-13.00	-34.98	-7.44	Peak
4	328.00	-62.35	-55.77	-13.00	-49.35	-6.58	Peak
5	376.30	-66.75	-60.67	-13.00	-53.75	-6.08	Peak
6	555.50	-67.72	-65.11	-13.00	-54.72	-2.61	Peak
7	3760.00	-62.05	-53.99	-13.00	-49.05	-8.06	Peak



Bureau Veritas Consumer Products Services Ltd., Taoyuan Branch

A D T

Data: 14

Date: 2015-09-01

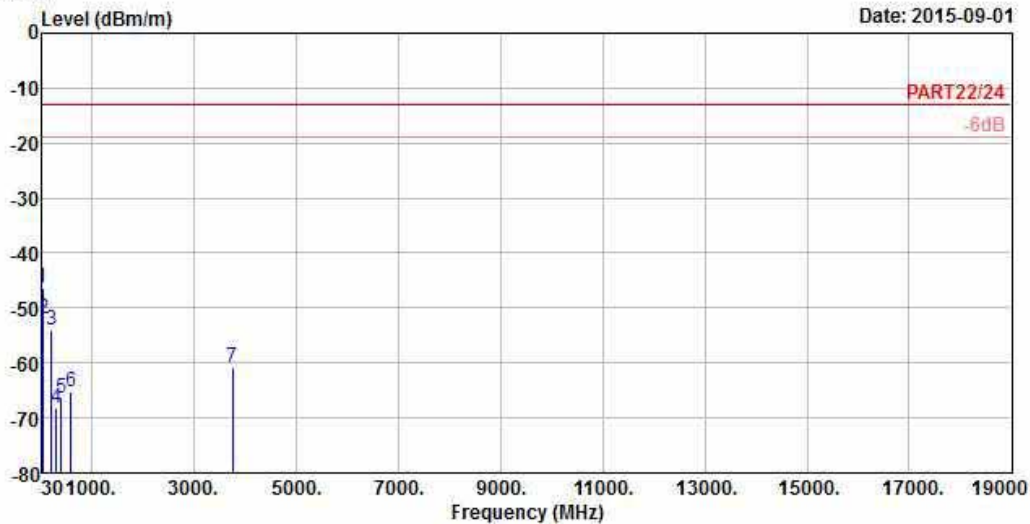

Site : 966 Chamber 5
 Condition: PART22/24 3m VERTICAL
 Remark : LTE Band 2_QPSK_20M_(1,0)
 Tested by: Anson Lin
 Plane : Z

	Freq	Level	Read Level	Limit Line	Over Limit	Factor	Remark
	MHz	dBm/m	dBm	dBm/m	dB	dB/m	
1	pp	42.15	-46.47	-45.53	-13.00	-33.47	-0.94 Peak
2		56.46	-52.06	-45.46	-13.00	-39.06	-6.60 Peak
3		216.30	-54.01	-46.65	-13.00	-41.01	-7.36 Peak
4		301.40	-68.33	-61.35	-13.00	-55.33	-6.98 Peak
5		405.70	-66.41	-60.51	-13.00	-53.41	-5.90 Peak
6		596.80	-65.29	-64.38	-13.00	-52.29	-0.91 Peak
7		3760.00	-60.70	-52.64	-13.00	-47.70	-8.06 Peak

LTE Band 25
 Channel Bandwidth: 20MHz / QPSK



Bureau Veritas Consumer Products Services Ltd., Taoyuan Branch

A D T

Data: 13

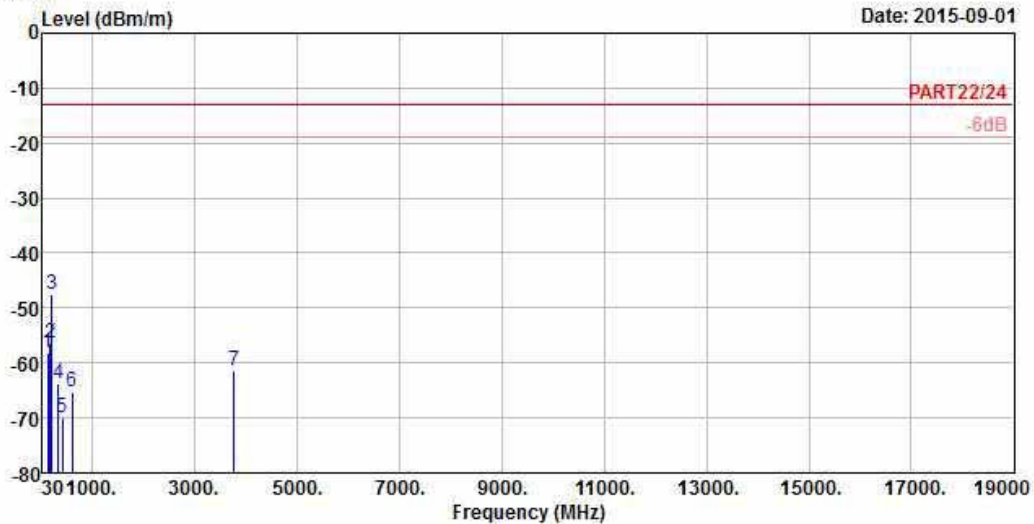

Site : 966 Chamber 5
 Condition: PART22/24 3m HORIZONTAL
 Remark : LTE Band 25_QPSK_20M_(1,0)
 Tested by: Anson Lin
 Plane : Z

	Freq	Level	Read Level	Limit Line	Over Limit	Factor	Remark
	MHz	dBm/m	dBm	dBm/m	dB	dB/m	
1	128.01	-58.11	-49.19	-13.00	-45.11	-8.92	Peak
2	176.88	-56.28	-49.56	-13.00	-43.28	-6.72	Peak
3 pp	207.12	-47.42	-39.71	-13.00	-34.42	-7.71	Peak
4	331.50	-63.67	-57.15	-13.00	-50.67	-6.52	Peak
5	423.90	-69.95	-64.19	-13.00	-56.95	-5.76	Peak
6	601.70	-65.14	-64.38	-13.00	-52.14	-0.76	Peak
7	3765.00	-61.41	-53.44	-13.00	-48.41	-7.97	Peak



Bureau Veritas Consumer Products Services Ltd., Taoyuan Branch

A D T

Data: 14

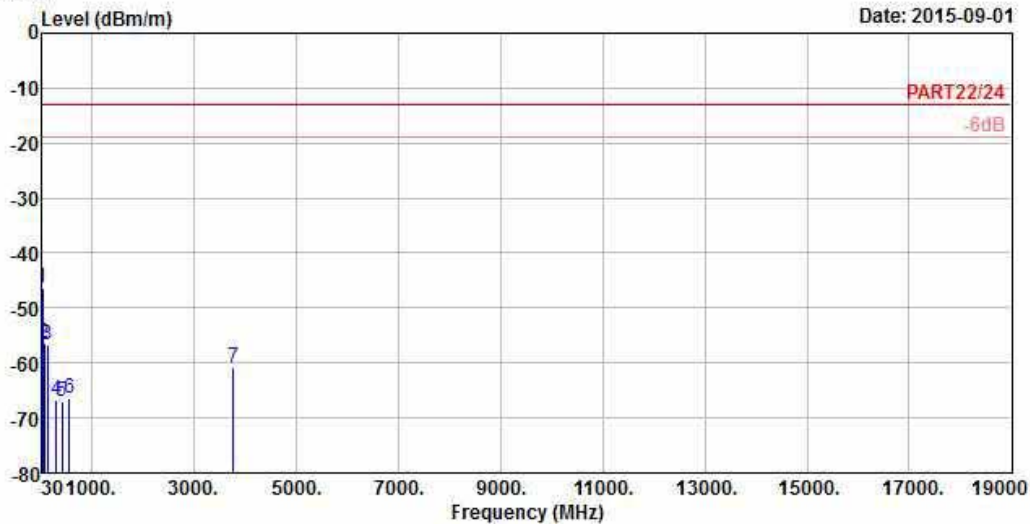

Site : 966 Chamber 5
 Condition: PART22/24 3m VERTICAL
 Remark : LTE Band 25_QPSK_20M_(1,0)
 Tested by: Anson Lin
 Plane : Z

	Freq	Level	Read Level	Limit Line	Over Limit	Factor	Remark
	MHz	dBm/m	dBm	dBm/m	dB	dB/m	
1	pp	41.34	-46.34	-45.93	-13.00	-33.34	-0.41 Peak
2		64.02	-56.25	-48.29	-13.00	-43.25	-7.96 Peak
3		126.93	-56.70	-47.66	-13.00	-43.70	-9.04 Peak
4		307.70	-66.85	-59.96	-13.00	-53.85	-6.89 Peak
5		413.40	-66.95	-61.11	-13.00	-53.95	-5.84 Peak
6		566.00	-66.43	-64.27	-13.00	-53.43	-2.16 Peak
7		3765.00	-60.89	-52.92	-13.00	-47.89	-7.97 Peak



5 Pictures of Test Arrangements

Please refer to the attached file (Test Setup Photo).



Appendix – Information on the Testing Laboratories

We, Bureau Veritas Consumer Products Services (H.K.) Ltd., Taoyuan Branch, were founded in 1988 to provide our best service in EMC, Radio, Telecom and Safety consultation. Our laboratories are accredited and approved according to ISO/IEC 17025.

If you have any comments, please feel free to contact us at the following:

Linko EMC/RF Lab

Tel: 886-2-26052180

Fax: 886-2-26051924

Hsin Chu EMC/RF Lab/Telecom Lab

Tel: 886-3-5935343

Fax: 886-3-5935342

Hwa Ya EMC/RF/Safety

Tel: 886-3-3183232

Fax: 886-3-3270892

Email: service.adt@tw.bureauveritas.com

Web Site: www.bureauveritas-adt.com

The address and road map of all our labs can be found in our web site also.

--- END ---