

FCC Test Report

Report No.: RF150729C03-9

FCC ID: NM82PQ9120

Test Model: 2PQ9120

Received Date: Jul. 29, 2015

Test Date: Aug. 03, 2015 ~ Spe. 04, 2015

Issued Date: Sep. 16, 2015

Applicant: HTC Corporation

Address: 1F, 6-3 Baoqiang Road, Xindian City, Taipei County 231, Taiwan

Issued By: Bureau Veritas Consumer Products Services (H.K.) Ltd., Taoyuan Branch

Lab Address: No. 47-2, 14th Ling, Chia Pau Vil., Lin Kou Dist., New Taipei City, Taiwan (R.O.C)

Test Location (1): No. 19, Hwa Ya 2nd Rd, Wen Hwa Tsuen, Kwei Shan Hsiang, Taoyuan Hsien 333, Taiwan, R.O.C.

Test Location (2): No.215, Sec. 3, Beixin Rd., Xindian Dist., New Taipei City 231, Taiwan, R.O.C



This report is for your exclusive use. Any copying or replication of this report to or for any other person or entity, or use of our name or trademark, is permitted only with our prior written permission. This report sets forth our findings solely with respect to the test samples identified herein. The results set forth in this report are not indicative or representative of the quality or characteristics of the lot from which a test sample was taken or any similar or identical product unless specifically and expressly noted. Our report includes all of the tests requested by you and the results thereof based upon the information that you provided to us. You have 60 days from date of issuance of this report to notify us of any material error or omission caused by our negligence, provided, however, that such notice shall be in writing and shall specifically address the issue you wish to raise. A failure to raise such issue within the prescribed time shall constitute your unqualified acceptance of the completeness of this report, the tests conducted and the correctness of the report contents. Unless specific mention, the uncertainty of measurement has been explicitly taken into account to declare the compliance or non-compliance to the specification. The report must not be used by the client to claim product certification, approval, or endorsement by TAF or any government agencies.

Table of Contents

Release Control Record	4
1 Certificate of Conformity	5
2 Summary of Test Results	6
2.1 Measurement Uncertainty	6
2.2 Modification Record	6
3 General Information	7
3.1 General Description of EUT	7
3.2 Description of Test Modes	8
3.2.1 Test Mode Applicability and Tested Channel Detail	10
3.3 Duty Cycle of Test Signal	12
3.4 Description of Support Units	16
3.4.1 Configuration of System under Test	16
3.5 General Description of Applied Standards	16
4 Test Types and Results	17
4.1 Radiated Emission and Bandedge Measurement	17
4.1.1 Limits of Radiated Emission and Bandedge Measurement	17
4.1.2 Limits of Unwanted Emission Out of The Restricted Bands	17
4.1.3 Test Instruments	18
4.1.4 Test Procedures	19
4.1.5 Deviation from Test Standard	19
4.1.6 Test Set Up	20
4.1.7 EUT Operating Conditions	20
4.1.8 Test Results	21
4.2 Conducted Emission Measurement	63
4.2.1 Limits of Conducted Emission Measurement	63
4.2.2 Test Instruments	63
4.2.3 Test Procedures	64
4.2.4 Deviation from Test Standard	64
4.2.5 Test Setup	64
4.2.6 EUT Operating Conditions	64
4.2.7 Test Results	65
4.3 Transmit Power Measurement	67
4.3.1 Limits of Transmit Power Measurement	67
4.3.2 Test Setup	67
4.3.3 Test Instruments	68
4.3.4 Test Procedure	68
4.3.5 Deviation from Test Standard	68
4.3.6 EUT Operating Conditions	68
4.3.7 Test Result	69
4.4 Peak Power Spectral Density Measurement	74
4.4.1 Limits of Peak Power Spectral Density Measurement	74
4.4.2 Test Setup	74
4.4.3 Test Instruments	74
4.4.4 Test Procedures	75
4.4.5 Deviation from Test Standard	75
4.4.6 EUT Operating Conditions	75
4.4.7 Test Results	76
4.5 Frequency Stability	81
4.5.1 Limit of Frequency Stability Measurement	81
4.5.2 Test Setup	81
4.5.3 Test Instruments	81
4.5.4 Test Procedure	81
4.5.5 Deviation from Test Standard	81



4.5.6 EUT Operating Condition	81
4.5.7 Test Results	82
4.6 6dB Bandwidth Measurement.....	83
4.6.1 Limits of 6dB Bandwidth Measurement.....	83
4.6.2 Test Setup.....	83
4.6.3 Test Instruments	83
4.6.4 Test Procedure	83
4.6.5 Deviation from Test Standard	83
4.6.6 EUT Operating Condition	83
4.6.7 Test Results	84
5 Pictures of Test Arrangements.....	86
Appendix – Information on the Testing Laboratories	87



A D T

Release Control Record

Issue No.	Description	Date Issued
RF150729C03-9	Original Release	Sep. 16, 2015

2 Summary of Test Results

47 CFR FCC Part 15, Subpart E (SECTION 15.407)			
FCC Clause	Test Item	Result	Remarks
15.407(b)(6)	AC Power Conducted Emissions	PASS	Meet the requirement of limit. Minimum passing margin is -7.47dB at 0.50972MHz.
15.407(b)(1/2/3/4/6)	Radiated Emissions & Band Edge Measurement	PASS	Meet the requirement of limit. Minimum passing margin is -2.59dB at 33.24MHz.
15.407(a)(1/2/3)	Max Average Transmit Power	PASS	Meet the requirement of limit.
15.407(a)(1/2/3)	Peak Power Spectral Density	PASS	Meet the requirement of limit.
15.407(e)	6dB bandwidth	PASS	Meet the requirement of limit. (U-NII-3 Band only)
15.407(g)	Frequency Stability	PASS	Meet the requirement of limit.
15.203	Antenna Requirement	PASS	No antenna connector is used.

2.1 Measurement Uncertainty

Where relevant, the following measurement uncertainty levels have been estimated for tests performed on the EUT as specified in CISPR 16-4-2:

Measurement	Frequency	Expanded Uncertainty (k=2) (\pm)
Conducted Emissions at mains ports	150kHz ~ 30MHz	2.44 dB
Radiated Emissions up to 1 GHz	30MHz ~ 200MHz	2.0153 dB
	200MHz ~ 1000MHz	2.0224 dB
Radiated Emissions above 1 GHz	1GHz ~ 18GHz	1.0121 dB
	18GHz ~ 40GHz	1.1508 dB

2.2 Modification Record

There were no modifications required for compliance.

3 General Information

3.1 General Description of EUT

Product	Smartphone
Brand	HTC
Test Model	2PQ9120
Status of EUT	Identical Prototype
Power Supply Rating	5.0Vdc (adapter or host equipment) 3.85Vdc (Li-ion battery)
Modulation Type	256QAM, 64QAM, 16QAM, QPSK, BPSK
Modulation Technology	OFDM
Transfer Rate	802.11a: 54.0/ 48.0/ 36.0/ 24.0/ 18.0/ 12.0/ 9.0/ 6.0Mbps 802.11n: up to MCS7 802.11ac: up to V9
Operating Frequency	5180 ~ 5240MHz, 5260 ~ 5320MHz, 5500 ~ 5700MHz, 5745 ~ 5825MHz
Number of Channel	5180 ~ 5240MHz: 4 for 802.11a, 802.11n (20MHz) 2 for 802.11n (40MHz) 1 for 802.11ac (80MHz) 5260 ~ 5320MHz: 4 for 802.11a, 802.11n (20MHz) 2 for 802.11n (40MHz) 1 for 802.11ac (80MHz) 5500 ~ 5700MHz: 8 for 802.11a, 802.11n (20MHz) 3 for 802.11n (40MHz) 2 for 802.11ac (80MHz) 5745 ~ 5825MHz: 5 for 802.11a, 802.11n (20MHz) 2 for 802.11n (40MHz) 1 for 802.11ac (80MHz)
Output Power	21.88mW for 5180 ~ 5240MHz 20.70mW for 5260 ~ 5320MHz 21.83mW for 5500 ~ 5700MHz 21.93mW for 5745 ~ 5825MHz
Antenna Type	PIFA antenna with -3dBi gain (5180 ~ 5240MHz) PIFA antenna with -2.42dBi gain (5260 ~ 5320MHz) PIFA antenna with -2dBi gain (5500 ~ 5700MHz) PIFA antenna with -3.2dBi gain (5745 ~ 5825MHz)
Antenna Connector	N/A
Accessory Device	Refer to Note as below
Data Cable Supplied	Refer to Note as below

Note:

1. The EUT's accessories list refers to Ext. Pho.
2. The above EUT information is declared by manufacturer and for more detailed features description, please refer to the manufacturer's specifications or user's manual.

3.2 Description of Test Modes

FOR 5180 ~ 5240MHz

4 channels are provided for 802.11a, 802.11n (20MHz):

Channel	Frequency	Channel	Frequency
36	5180 MHz	44	5220 MHz
40	5200 MHz	48	5240 MHz

2 channels are provided for 802.11n (40MHz):

Channel	Frequency	Channel	Frequency
38	5190 MHz	46	5230 MHz

1 channel is provided for 802.11ac (80MHz):

Channel	Frequency
42	5210MHz

FOR 5260 ~ 5320MHz

4 channels are provided for 802.11a, 802.11n (20MHz):

Channel	Frequency	Channel	Frequency
52	5260 MHz	60	5300 MHz
56	5280 MHz	64	5320 MHz

2 channels are provided for 802.11n (40MHz):

Channel	Frequency	Channel	Frequency
54	5270 MHz	62	5310 MHz

1 channel is provided for 802.11ac (80MHz):

Channel	Frequency
58	5290MHz

FOR 5500 ~ 5700MHz

11 channels are provided for 802.11a, 802.11n (20MHz):

Channel	Frequency	Channel	Frequency
100	5500 MHz	124	5620 MHz
104	5520 MHz	128	5640 MHz
108	5540 MHz	132	5660 MHz
112	5560 MHz	136	5680 MHz
116	5580 MHz	140	5700 MHz
120	5600 MHz		

5 channels are provided for 802.11n (40MHz):

Channel	Frequency	Channel	Frequency
102	5510 MHz	126	5630 MHz
110	5550 MHz	134	5670 MHz
118	5590 MHz		

2 channels are provided for 802.11ac (80MHz):

Channel	Frequency	Channel	Frequency
106	5530MHz	122	5610 MHz

FOR 5745 ~ 5825MHz:

5 channels are provided for 802.11a, 802.11n (20MHz):

Channel	Frequency	Channel	Frequency
149	5745MHz	161	5805MHz
153	5765MHz	165	5825MHz
157	5785MHz		

2 channels are provided for 802.11n (40MHz):

Channel	Frequency	Channel	Frequency
151	5755MHz	159	5795MHz

1 channel is provided for 802.11ac (80MHz):

Channel	Frequency
155	5775MHz

3.2.1 Test Mode Applicability and Tested Channel Detail

EUT Configure Mode	Applicable To				Description
	RE \geq 1G	RE $<$ 1G	PLC	APCM	
-	√	√	√	√	-

Where **RE \geq 1G**: Radiated Emission above 1GHz **RE $<$ 1G**: Radiated Emission below 1GHz
PLC: Power Line Conducted Emission **APCM**: Antenna Port Conducted Measurement

NOTE:

1. The EUT had been pre-tested on the positioned of each 3 axis. The worst case was found when positioned on **Y-plane** for 5180-5240MHz & 5260-5320MHz & 5500-5700MHz and **X-plane** for 5745-5825MHz.

Radiated Emission Test (Above 1GHz):

- Pre-Scan has been conducted to determine the worst-case mode from all possible combinations between available modulations, data rates and antenna ports (if EUT with antenna diversity architecture).
- Following channel(s) was (were) selected for the final test as listed below.

EUT Configure Mode	Mode	Frequency Band (MHz)	Available Channel	Tested Channel	Modulation Technology	Modulation Type	Data Rate (Mbps)
-	802.11a	5180-5240	36 to 48	36, 40, 48	OFDM	BPSK	6.0
-	802.11n (20MHz)		36 to 48	36, 40, 48	OFDM	BPSK	MCS0
-	802.11n (40MHz)		38 to 46	38, 46	OFDM	BPSK	MCS0
-	802.11ac (80MHz)		42	42	OFDM	BPSK	V0
-	802.11a	5260-5320	52 to 64	52, 60, 64	OFDM	BPSK	6.0
-	802.11n (20MHz)		52 to 64	52, 60, 64	OFDM	BPSK	MCS0
-	802.11n (40MHz)		54 to 62	54, 62	OFDM	BPSK	MCS0
-	802.11ac (80MHz)		58	58	OFDM	BPSK	V0
-	802.11a	5500-5700	100 to 140	100, 116, 140	OFDM	BPSK	6.0
-	802.11n (20MHz)		100 to 140	100, 116, 140	OFDM	BPSK	MCS0
-	802.11n (40MHz)		102 to 134	102, 110, 134	OFDM	BPSK	MCS0
-	802.11ac (80MHz)		106 to 122	106, 122	OFDM	BPSK	V0
-	802.11a	5745-5825	149 to 165	149, 157, 165	OFDM	BPSK	6.0
-	802.11n (20MHz)		149 to 165	149, 157, 165	OFDM	BPSK	MCS0
-	802.11n (40MHz)		151 to 159	151, 159	OFDM	BPSK	MCS0
-	802.11ac (80MHz)		155	155	OFDM	BPSK	V0

Radiated Emission Test (Below 1GHz):

- Pre-Scan has been conducted to determine the worst-case mode from all possible combinations between available modulations, data rates and antenna ports (if EUT with antenna diversity architecture).
- Following channel(s) was (were) selected for the final test as listed below.

EUT Configure Mode	Mode	Frequency Band (MHz)	Available Channel	Tested Channel	Modulation Technology	Modulation Type	Data Rate (Mbps)
-	802.11ac (80MHz)	5180-5240	42	42	OFDM	BPSK	V0
-	802.11n (40MHz)	5260-5320	54 to 62	62	OFDM	BPSK	MCS0
-	802.11a	5500-5700	100 to 140	100	OFDM	BPSK	6.0
-	802.11a	5745-5825	149 to 165	149	OFDM	BPSK	6.0

Power Line Conducted Emission Test:

- Pre-Scan has been conducted to determine the worst-case mode from all possible combinations between available modulations, data rates and antenna ports (if EUT with antenna diversity architecture).
- Following channel(s) was (were) selected for the final test as listed below.

EUT Configure Mode	Mode	Frequency Band (MHz)	Available Channel	Tested Channel	Modulation Technology	Modulation Type	Data Rate (Mbps)
-	802.11a	5745-5825	149 to 165	149, 157, 165	OFDM	BPSK	6.0

Antenna Port Conducted Measurement:

- This item includes all test value of each mode, but only includes spectrum plot of worst value of each mode.
- Pre-Scan has been conducted to determine the worst-case mode from all possible combinations between available modulations, data rates and antenna ports (if EUT with antenna diversity architecture).
- Following channel(s) was (were) selected for the final test as listed below.

EUT Configure Mode	Mode	Frequency Band (MHz)	Available Channel	Tested Channel	Modulation Technology	Modulation Type	Data Rate (Mbps)
-	802.11a	5180-5240	36 to 48	36, 40, 48	OFDM	BPSK	6.0
-	802.11n (20MHz)		36 to 48	36, 40, 48	OFDM	BPSK	MCS0
-	802.11n (40MHz)		38 to 46	38, 46	OFDM	BPSK	MCS0
-	802.11ac (80MHz)		42	42	OFDM	BPSK	V0
-	802.11a	5260-5320	52 to 64	52, 60, 64	OFDM	BPSK	6.0
-	802.11n (20MHz)		52 to 64	52, 60, 64	OFDM	BPSK	MCS0
-	802.11n (40MHz)		54 to 62	54, 62	OFDM	BPSK	MCS0
-	802.11ac (80MHz)		58	58	OFDM	BPSK	V0
-	802.11a	5500-5700	100 to 140	100, 116, 140	OFDM	BPSK	6.0
-	802.11n (20MHz)		100 to 140	100, 116, 140	OFDM	BPSK	MCS0
-	802.11n (40MHz)		102 to 134	102, 110, 134	OFDM	BPSK	MCS0
-	802.11ac (80MHz)		106 to 122	106, 122	OFDM	BPSK	V0
-	802.11a	5745-5825	149 to 165	149, 157, 165	OFDM	BPSK	6.0
-	802.11n (20MHz)		149 to 165	149, 157, 165	OFDM	BPSK	MCS0
-	802.11n (40MHz)		151 to 159	151, 159	OFDM	BPSK	MCS0
-	802.11ac (80MHz)		155	155	OFDM	BPSK	V0

Test Condition:

Applicable To	Environmental Conditions	Input Power	Tested by
RE \geq 1G	25deg. C, 65%RH	120Vac, 60Hz	Charles Hsiao
RE<1G	25deg. C, 65%RH	120Vac, 60Hz	Charles Hsiao
PLC	25deg. C, 65%RH	120Vac, 60Hz	Toby Tian
APCM	25deg. C, 65%RH	3.85Vdc	Howard Kao

3.3 Duty Cycle of Test Signal

MODULATION TYPE: BPSK

Duty cycle of test signal is < 98%, duty factor is required.

802.11a: Duty cycle = 1.033/1.241 = 0.832, Duty factor = $10 * \log(1/0.832) = 0.80$

802.11n (20MHz): Duty cycle = 976.60/1181.73 = 0.826, Duty factor = $10 * \log(1/0.826) = 0.83$

802.11n (40MHz): Duty cycle = 488.78/689.10 = 0.709, Duty factor = $10 * \log(1/0.709) = 1.49$

802.11ac (80MHz): Duty cycle = 248.40/448.72 = 0.554, Duty factor = $10 * \log(1/0.554) = 2.57$

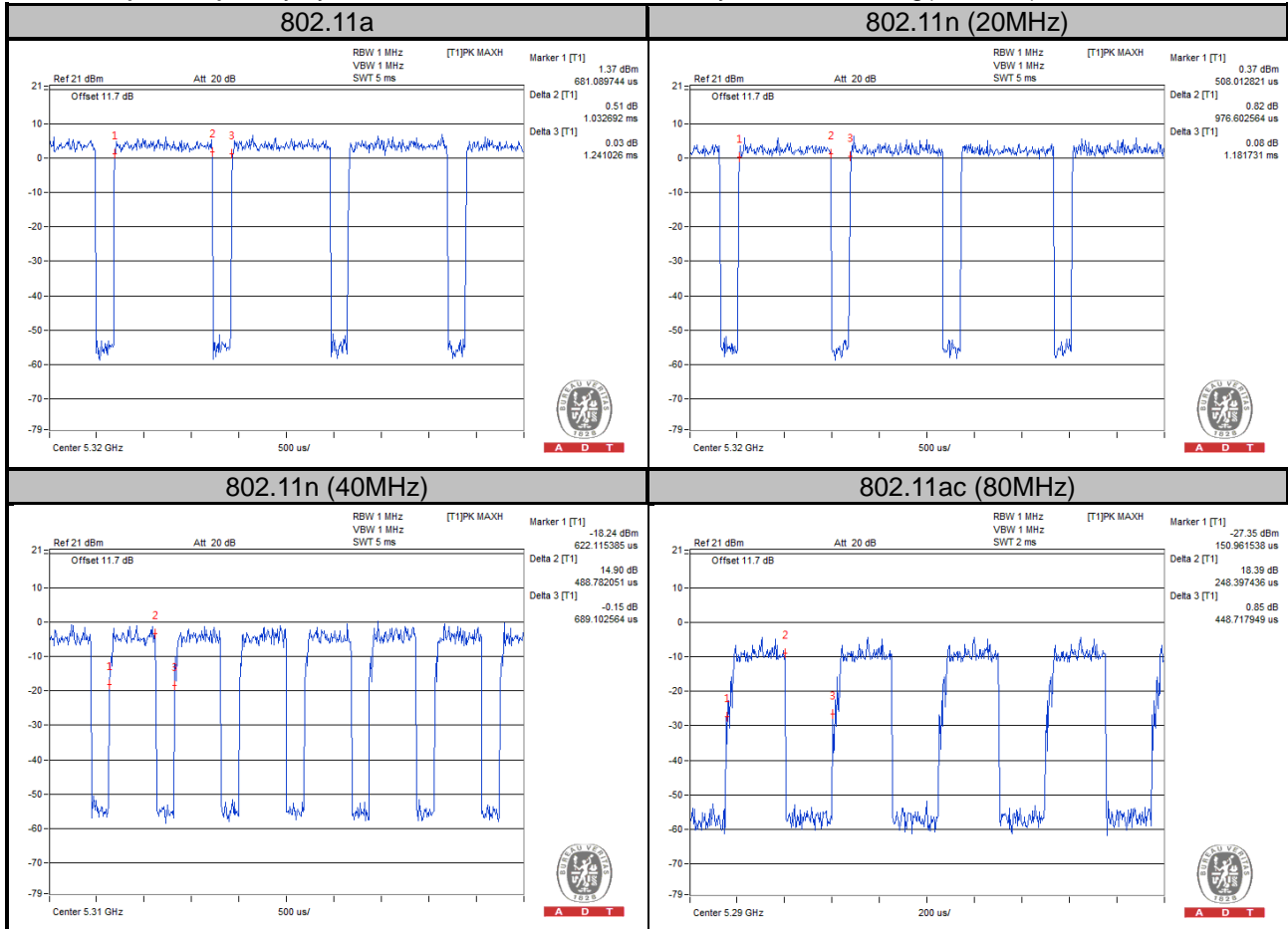

MODULATION TYPE: QPSK

Duty cycle of test signal is < 98%, duty factor is required.

802.11a: Duty cycle = $527.88/736.22 = 0.717$, Duty factor = $10 * \log(1/0.717) = 1.44$

802.11n (20MHz): Duty cycle = $499.04/707.69 = 0.705$, Duty factor = $10 * \log(1/0.705) = 1.52$

802.11n (40MHz): Duty cycle = $267.63/467.95 = 0.572$, Duty factor = $10 * \log(1/0.572) = 2.43$

802.11ac (80MHz): Duty cycle = $146.15/346.47 = 0.422$, Duty factor = $10 * \log(1/0.422) = 3.75$

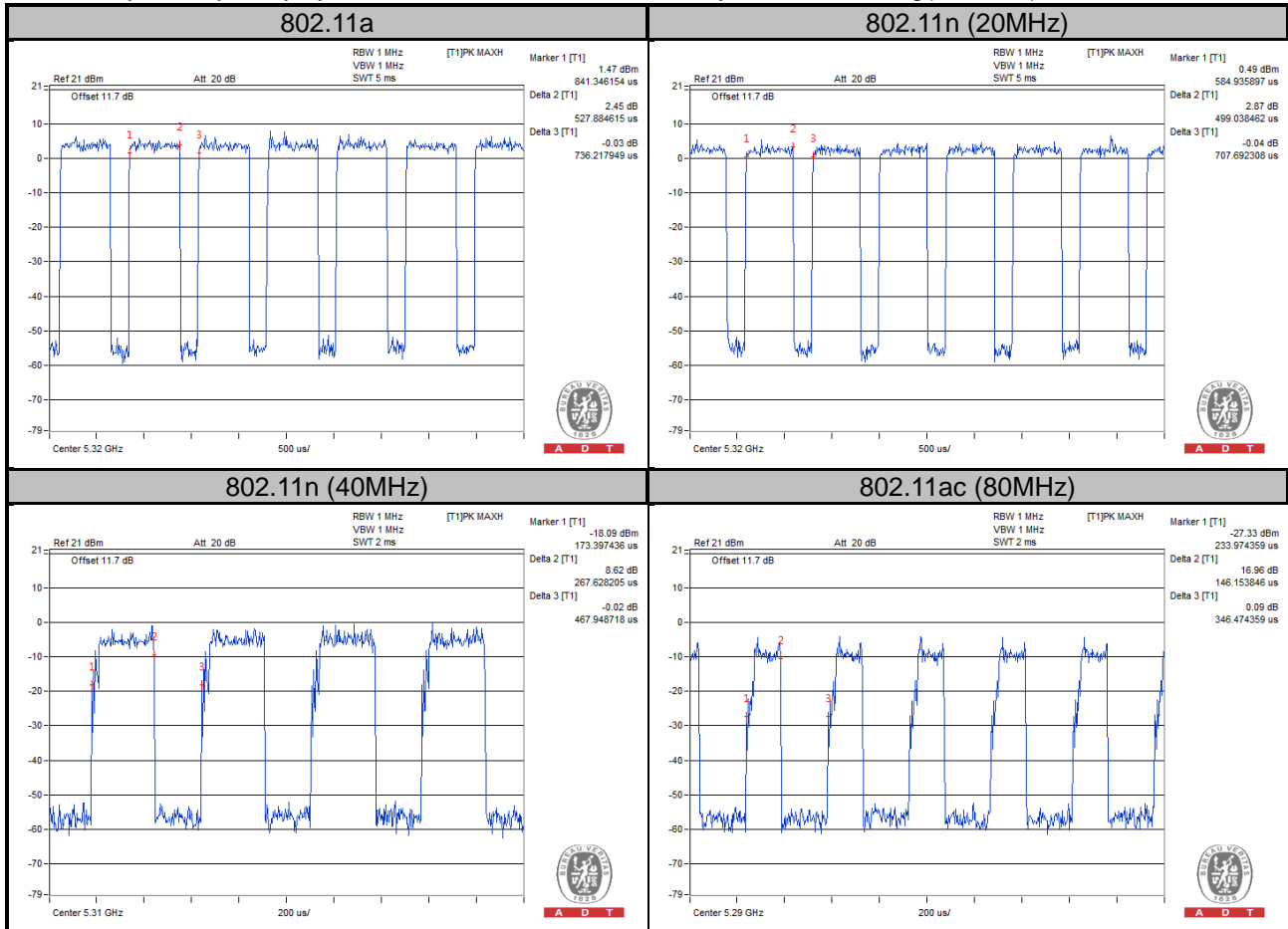

MODULATION TYPE: 16QAM

Duty cycle of test signal is < 98%, duty factor is required.

802.11a: Duty cycle = $271.47/479.81 = 0.566$, Duty factor = $10 * \log(1/0.566) = 2.47$

802.11n (20MHz): Duty cycle = $268.27/473.72 = 0.566$, Duty factor = $10 * \log(1/0.566) = 2.47$

802.11n (40MHz): Duty cycle = $152.24/352.56 = 0.432$, Duty factor = $10 * \log(1/0.432) = 3.65$

802.11ac (80MHz): Duty cycle = $91.67/291.99 = 0.314$, Duty factor = $10 * \log(1/0.314) = 5.03$

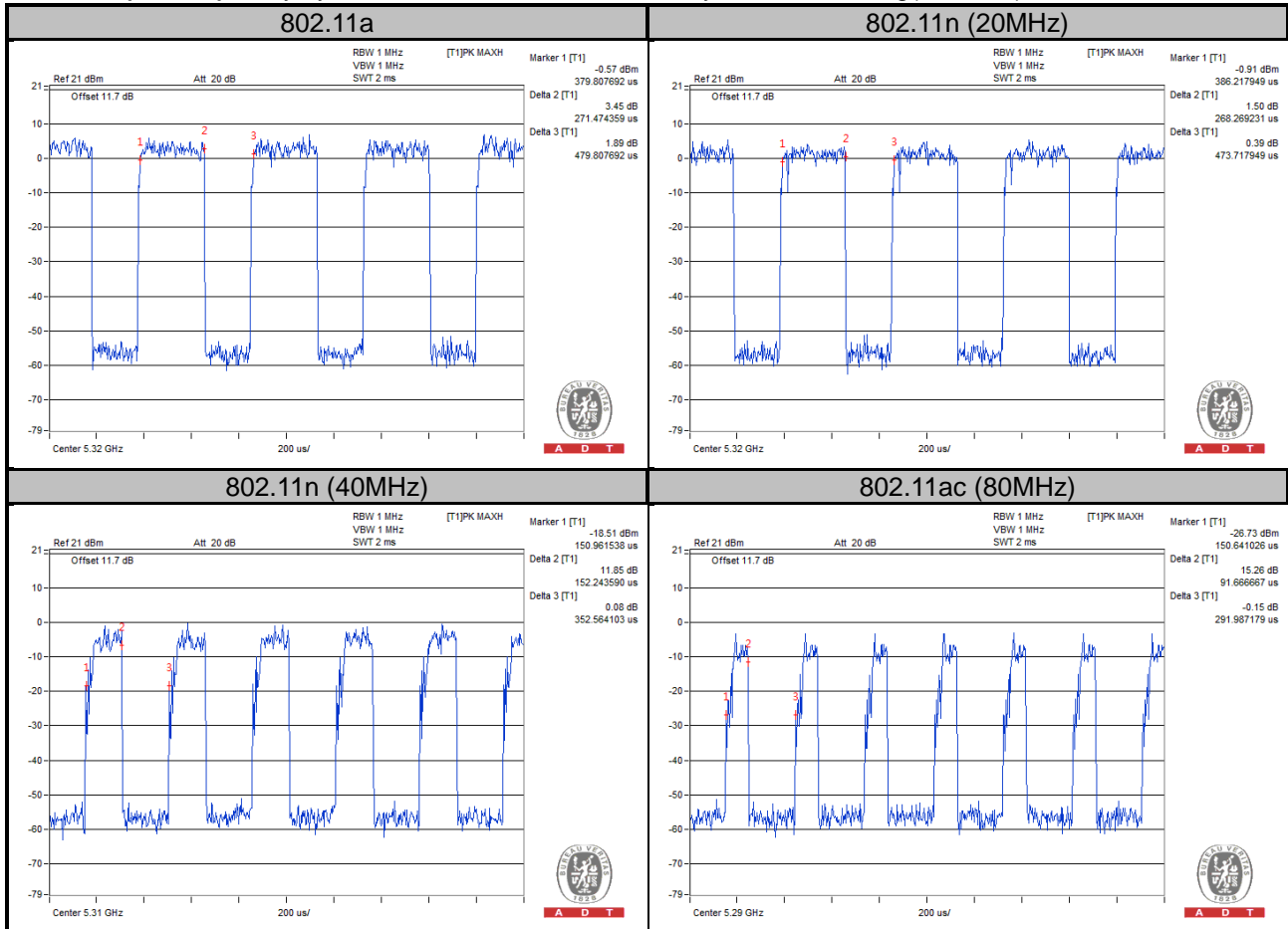

MODULATION TYPE: 64QAM

Duty cycle of test signal is < 98%, duty factor is required.

802.11a: Duty cycle = $143.27/348.40 = 0.411$, Duty factor = $10 * \log(1/0.411) = 3.86$

802.11n (20MHz): Duty cycle = $156.09/361.54 = 0.432$, Duty factor = $10 * \log(1/0.432) = 3.65$

802.11n (40MHz): Duty cycle = $94.55/294.87 = 0.321$, Duty factor = $10 * \log(1/0.321) = 4.94$

802.11ac (80MHz): Duty cycle = $70.51/272.44 = 0.259$, Duty factor = $10 * \log(1/0.259) = 5.87$

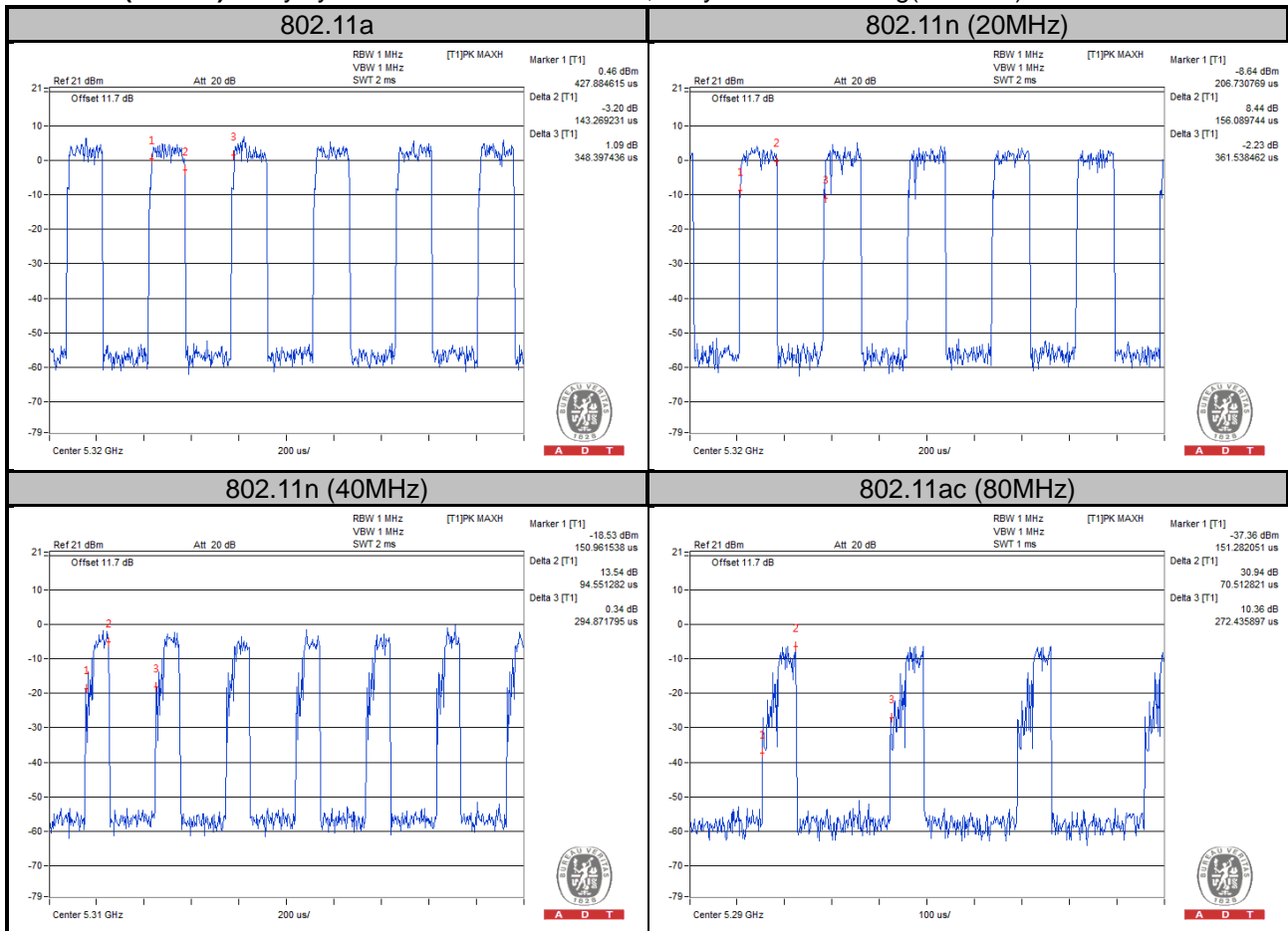

MODULATION TYPE: 256QAM

Duty cycle of test signal is < 98%, duty factor is required.

802.11ac (80MHz): Duty cycle = $62.50/261.22 = 0.239$, Duty factor = $10 * \log(1/0.239) = 6.21$

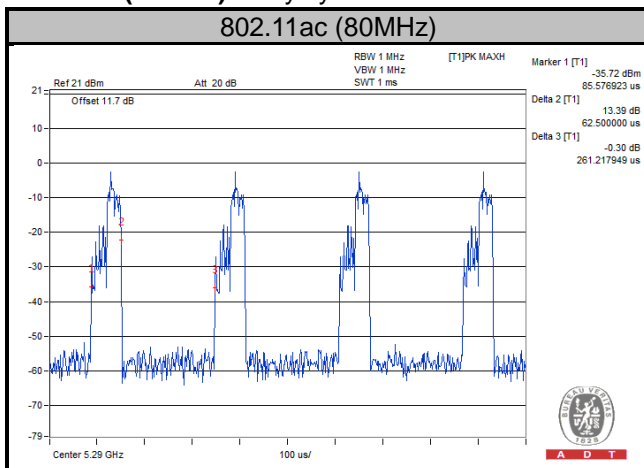

3.4 Description of Support Units

The EUT has been tested as an independent unit together with other necessary accessories or support units.

3.4.1 Configuration of System under Test

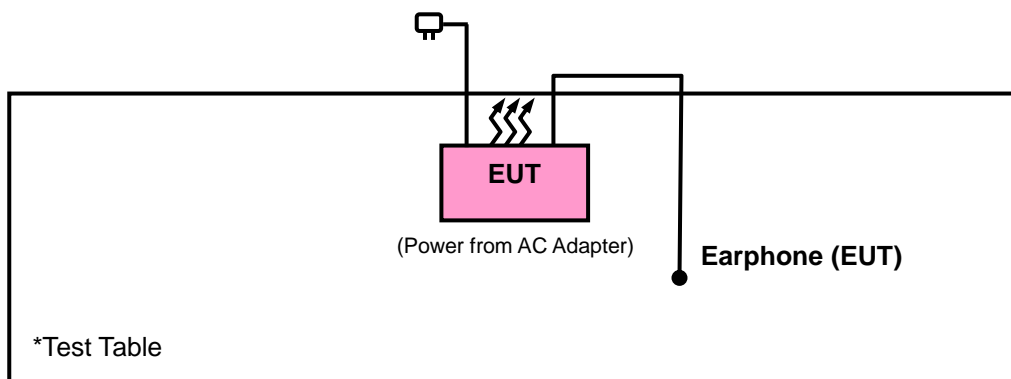

3.5 General Description of Applied Standards

The EUT is a RF Product. According to the specifications of the manufacturer, it must comply with the requirements of the following standards:

FCC Part 15, Subpart E (15.407)

789033 D02 General UNII Test Procedures New Rules v01

644545 D01 Guidance for IEEE 802 11ac v01r02

ANSI C63.10-2013

All test items have been performed and recorded as per the above standards.

NOTE: The EUT has been verified to comply with the requirements of FCC Part 15, Subpart B, Class B (DoC).
The test report has been issued separately.

4 Test Types and Results

4.1 Radiated Emission and Bandedge Measurement

4.1.1 Limits of Radiated Emission and Bandedge Measurement

Radiated emissions which fall in the restricted bands must comply with the radiated emission limits specified as below table. Other emissions shall be at least 20dB below the highest level of the desired power:

Frequencies (MHz)	Field Strength (microvolts/meter)	Measurement Distance (meters)
0.009 ~ 0.490	2400/F(kHz)	300
0.490 ~ 1.705	24000/F(kHz)	30
1.705 ~ 30.0	30	30
30 ~ 88	100	3
88 ~ 216	150	3
216 ~ 960	200	3
Above 960	500	3

NOTE:

1. The lower limit shall apply at the transition frequencies.
2. Emission level (dBuV/m) = 20 log Emission level (uV/m).
3. For frequencies above 1000MHz, the field strength limits are based on average detector, however, the peak field strength of any emission shall not exceed the maximum permitted average limits, specified above by more than 20dB under any condition of modulation.

4.1.2 Limits of Unwanted Emission Out of The Restricted Bands

Applicable To	Limit	
789033 D02 General UNII Test Procedures New Rules v01	Field Strength AT 3m	
	PK:74 (dBµV/m)	AV:54 (dBµV/m)
Applicable To	EIRP Limit	Equivalent Field Strength At 3m
15.407(b)(1)	PK:-27 (dBm/MHz)	PK:68.2(dBµV/m)
15.407(b)(2)		
15.407(b)(3)		
15.407(b)(4)	PK:-27 (dBm/MHz) ^{*1} PK:-17 (dBm/MHz) ^{*2}	PK: 68.2(dBµV/m) ^{*1} PK:78.2 (dBµV/m) ^{*2}

NOTE: ^{*1} beyond 10MHz of the band edge ^{*2} within 10 MHz of band edge

The following formula is used to convert the equipment isotropic radiated power (eirp) to field strength:

$$E = \frac{1000000\sqrt{30P}}{3} \mu\text{V/m, where P is the eirp (Watts).}$$

4.1.3 Test Instruments

Description & Manufacturer	Model No.	Serial No.	Date of Calibration	Due Date of Calibration
Spectrum Analyzer Agilent Technologies	N9038A	MY52260177	May 19, 2015	May 18, 2016
Spectrum Analyzer ROHDE & SCHWARZ	FSU43	101261	Dec. 10, 2014	Dec. 09, 2015
BILOG Antenna SCHWARZBECK	VULB9168	9168-472	Feb. 04, 2015	Feb. 04, 2016
HORN Antenna ETS-Lindgren	3117	00143293	Jan. 05, 2015	Jan. 04, 2016
HORN Antenna SCHWARZBECK	BBHA 9170	9170-480	Feb. 04, 2015	Feb. 04, 2016
Loop Antenna	EM-6879	269	Jul. 31, 2015	Jul. 30, 2016
Bluetooth Tester	CBT	100980	Apr. 27, 2015	Apr. 26, 2017
Agilent Communications Tester-Wireless	8960 Series 10	MY53201073	Jul. 03, 2015	Jul. 02, 2017
Preamplifier Agilent	310N	187226	Jun. 29, 2015	Jun. 28, 2016
Preamplifier Agilent	83017A	MY39501357	Jun. 29, 2015	Jun. 28, 2016
Power Meter Anritsu	ML2495A	1232002	Sep. 17, 2014	Sep. 16, 2015
Power Sensor Anritsu	MA2411B	1207325	Sep. 17, 2014	Sep. 16, 2015
RF signal cable ETS-LINDGREN	5D-FB	Cable-CH1-01(R FC-SMS-100-SM S-120+RFC-SMS -100-SMS-400)	Jun. 27, 2015	Jun. 26, 2016
RF signal cable ETS-LINDGREN	8D-FB	Cable-CH1-02(R FC-SMS-100-SM S-24)	Jun. 27, 2015	Jun. 26, 2016
Software BV ADT	E3 8.130425b	NA	NA	NA
Antenna Tower MF	NA	NA	NA	NA
Turn Table MF	NA	NA	NA	NA
Antenna Tower & Turn Table Controller MF	MF-7802	NA	NA	NA

- Note: 1. The calibration interval of the above test instruments is 12 months and the calibrations are traceable to NML/ROC and NIST/USA.
2. The test was performed in HsinTien Chamber 1.
3. The horn antenna and preamplifier (model: 83017A) are used only for the measurement of emission frequency above 1GHz if tested.
4. The FCC Site Registration No. is 149147.
5. The IC Site Registration No. is IC7450I-1.

4.1.4 Test Procedures

- a. The EUT was placed on the top of a rotating table 0.8 meters (for below 1GHz) / 1.5 meters (for above 1GHz) above the ground at 3 meter chamber room for test. The table was rotated 360 degrees to determine the position of the highest radiation.
- b. The EUT was set 3 meters away from the interference-receiving antenna, which was mounted on the top of a variable-height antenna tower.
- c. The height of antenna is varied from one meter to four meters above the ground to determine the maximum value of the field strength. Both horizontal and vertical polarizations of the antenna are set to make the measurement.
- d. For each suspected emission, the EUT was arranged to its worst case and then the antenna was tuned to heights from 1 meter to 4 meters and the rotatable table was turned from 0 degrees to 360 degrees to find the maximum reading.
- e. The test-receiver system was set to quasi-peak detect function and specified bandwidth with maximum hold mode when the test frequency is below 1 GHz.
- f. The test-receiver system was set to peak and average detect function and specified bandwidth with maximum hold mode when the test frequency is above 1 GHz. If the peak reading value also meets average limit, measurement with the average detector is unnecessary.

Note:

1. The resolution bandwidth and video bandwidth of test receiver/spectrum analyzer is 120kHz for Quasi-peak detection (QP) at frequency below 1GHz.
2. The resolution bandwidth of test receiver/spectrum analyzer is 1 MHz and the video bandwidth is 3 MHz for Peak detection (PK) at frequency above 1GHz.
3. The resolution bandwidth of test receiver/spectrum analyzer is 1MHz and the video bandwidth is 3MHz for RMS Average (Duty cycle < 98%) for Average detection (AV) at frequency above 1GHz, then the measurement results was added to a correction factor ($10 \log(1/\text{duty cycle})$).
4. The resolution bandwidth of test receiver/spectrum analyzer is 1MHz and the video bandwidth is 10Hz (Duty cycle $\geq 98\%$) for Average detection (AV) at frequency above 1GHz.
5. All modes of operation were investigated and the worst-case emissions are reported.

4.1.5 Deviation from Test Standard

No deviation.

4.1.6 Test Set Up

<Frequency Range below 1GHz>

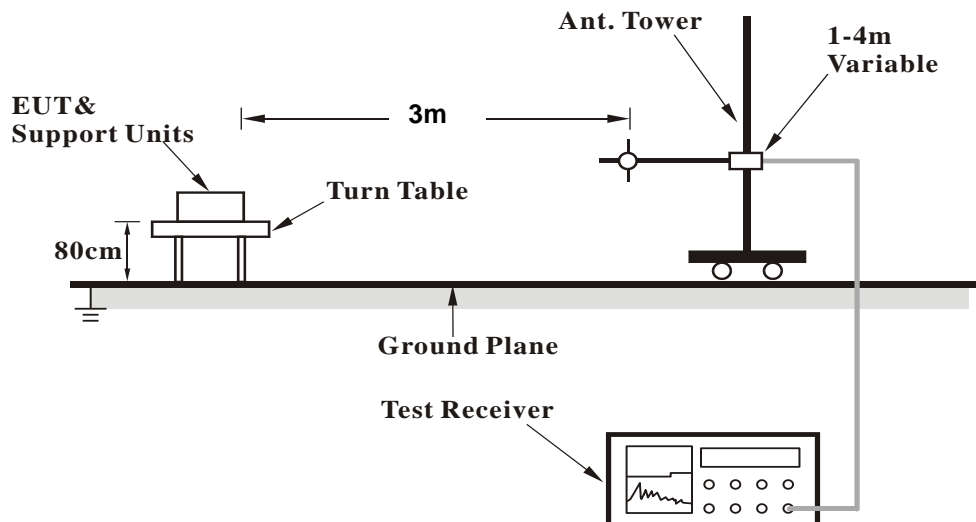

<Frequency Range above 1GHz>

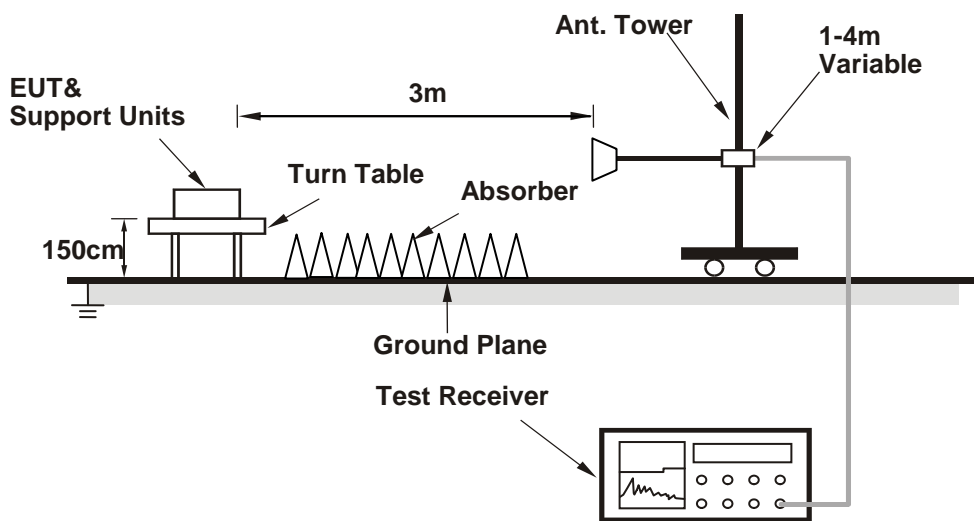

For the actual test configuration, please refer to the attached file (Test Setup Photo).

4.1.7 EUT Operating Conditions

- Placed the EUT on a testing table.
- Use the software to control the EUT under transmission condition continuously at specific channel frequency.

4.1.8 Test Results
ABOVE 1GHz DATA :
802.11a

EUT TEST CONDITION		MEASUREMENT DETAIL	
CHANNEL	Channel 36	FREQUENCY RANGE	1GHz ~ 40GHz
INPUT POWER	120Vac, 60 Hz	DETECTOR FUNCTION	Peak (PK) Average (AV)
ENVIRONMENTAL CONDITIONS	25deg. C, 65%RH	TESTED BY	Charles Hsiao

ANTENNA POLARITY & TEST DISTANCE: HORIZONTAL AT 3 M										
FREQ. (MHz)	EMISSION LEVEL (dBuV/m)	READ LEVEL (dBuV)	LIMIT (dBuV/m)	MARGIN (dB)	ANTENNA FACTOR (dB/m)	CABLE LOSS (dB)	PREAMP FACTOR (dB)	ANTENNA HEIGHT (cm)	TABLE ANGLE (Degree)	REMARK
5150	48.32	40.07	54	-5.68	34.12	8.13	34	212	301	Average
5150	62.87	54.62	74	-11.13	34.12	8.13	34	212	301	Peak
5180	99.51	91.2			34.15	8.16	34	212	301	Average
5180	106.33	98.02			34.15	8.16	34	212	301	Peak
5442	42.92	34.13	54	-11.08	34.35	8.48	34.04	212	301	Average
5442	57.59	48.8	74	-16.41	34.35	8.48	34.04	212	301	Peak
ANTENNA POLARITY & TEST DISTANCE: VERTICAL AT 3 M										
FREQ. (MHz)	EMISSION LEVEL (dBuV/m)	READ LEVEL (dBuV)	LIMIT (dBuV/m)	MARGIN (dB)	ANTENNA FACTOR (dB/m)	CABLE LOSS (dB)	PREAMP FACTOR (dB)	ANTENNA HEIGHT (cm)	TABLE ANGLE (Degree)	REMARK
5150	43.56	35.31	54	-10.44	34.12	8.13	34	213	274	Average
5150	57.55	49.3	74	-16.45	34.12	8.13	34	213	274	Peak
5180	93.24	84.93			34.15	8.16	34	213	274	Average
5180	101.34	93.03			34.15	8.16	34	213	274	Peak
5404	42.74	34.02	54	-11.26	34.32	8.44	34.04	213	274	Average
5404	57.51	48.79	74	-16.49	34.32	8.44	34.04	213	274	Peak

REMARKS:

- Emission Level = Read Level + Antenna Factor + Cable Loss - Preamp Factor
Margin value = Emission level – Limit value
- 5180MHz: Fundamental frequency.



EUT TEST CONDITION		MEASUREMENT DETAIL	
CHANNEL	Channel 44	FREQUENCY RANGE	1GHz ~ 40GHz
INPUT POWER	120Vac, 60 Hz	DETECTOR FUNCTION	Peak (PK) Average (AV)
ENVIRONMENTAL CONDITIONS	25deg. C, 65%RH	TESTED BY	Charles Hsiao

ANTENNA POLARITY & TEST DISTANCE: HORIZONTAL AT 3 M										
FREQ. (MHz)	EMISSION LEVEL (dBuV/m)	READ LEVEL (dBuV)	LIMIT (dBuV/m)	MARGIN (dB)	ANTENNA FACTOR (dB/m)	CABLE LOSS (dB)	PREAMP FACTOR (dB)	ANTENNA HEIGHT (cm)	TABLE ANGLE (Degree)	REMARK
5012	42.6	34.59	54	-11.4	34.01	7.97	33.97	212	301	Average
5012	57.79	49.78	74	-16.21	34.01	7.97	33.97	212	301	Peak
5220	99.71	91.32			34.17	8.22	34	212	301	Average
5220	106.09	97.7			34.17	8.22	34	212	301	Peak
5360	42.83	34.2	54	-11.17	34.28	8.38	34.03	212	301	Average
5360	57.93	49.3	74	-16.07	34.28	8.38	34.03	212	301	Peak
ANTENNA POLARITY & TEST DISTANCE: VERTICAL AT 3 M										
FREQ. (MHz)	EMISSION LEVEL (dBuV/m)	READ LEVEL (dBuV)	LIMIT (dBuV/m)	MARGIN (dB)	ANTENNA FACTOR (dB/m)	CABLE LOSS (dB)	PREAMP FACTOR (dB)	ANTENNA HEIGHT (cm)	TABLE ANGLE (Degree)	REMARK
5090	42.61	34.44	54	-11.39	34.08	8.07	33.98	213	274	Average
5090	57.8	49.63	74	-16.2	34.08	8.07	33.98	213	274	Peak
5220	93.45	85.06			34.17	8.22	34	213	274	Average
5220	101.31	92.92			34.17	8.22	34	213	274	Peak
5362	42.61	33.97	54	-11.39	34.29	8.38	34.03	213	274	Average
5362	57.48	48.84	74	-16.52	34.29	8.38	34.03	213	274	Peak

REMARKS:

- Emission Level = Read Level + Antenna Factor + Cable Loss - Preamp Factor
Margin value = Emission level – Limit value
- 5220MHz: Fundamental frequency.



A D T

EUT TEST CONDITION		MEASUREMENT DETAIL	
CHANNEL	Channel 48	FREQUENCY RANGE	1GHz ~ 40GHz
INPUT POWER	120Vac, 60 Hz	DETECTOR FUNCTION	Peak (PK) Average (AV)
ENVIRONMENTAL CONDITIONS	25deg. C, 65%RH	TESTED BY	Charles Hsiao

ANTENNA POLARITY & TEST DISTANCE: HORIZONTAL AT 3 M										
FREQ. (MHz)	EMISSION LEVEL (dBuV/m)	READ LEVEL (dBuV)	LIMIT (dBuV/m)	MARGIN (dB)	ANTENNA FACTOR (dB/m)	CABLE LOSS (dB)	PREAMP FACTOR (dB)	ANTENNA HEIGHT (cm)	TABLE ANGLE (Degree)	REMARK
5050	42.93	34.87	54	-11.07	34.04	8	33.98	212	301	Average
5050	58.17	50.11	74	-15.83	34.04	8	33.98	212	301	Peak
5240	99.55	91.11			34.19	8.26	34.01	212	301	Average
5240	106.44	98			34.19	8.26	34.01	212	301	Peak
5416	42.9	34.17	54	-11.1	34.33	8.44	34.04	212	301	Average
5416	57.89	49.16	74	-16.11	34.33	8.44	34.04	212	301	Peak

ANTENNA POLARITY & TEST DISTANCE: VERTICAL AT 3 M										
FREQ. (MHz)	EMISSION LEVEL (dBuV/m)	READ LEVEL (dBuV)	LIMIT (dBuV/m)	MARGIN (dB)	ANTENNA FACTOR (dB/m)	CABLE LOSS (dB)	PREAMP FACTOR (dB)	ANTENNA HEIGHT (cm)	TABLE ANGLE (Degree)	REMARK
5146	42.59	34.34	54	-11.41	34.12	8.13	34	221	274	Average
5146	56.85	48.6	74	-17.15	34.12	8.13	34	221	274	Peak
5240	93.46	85.02			34.19	8.26	34.01	221	274	Average
5240	101.58	93.14			34.19	8.26	34.01	221	274	Peak
5440	43.02	34.23	54	-10.98	34.35	8.48	34.04	221	274	Average
5440	57.42	48.63	74	-16.58	34.35	8.48	34.04	221	274	Peak

REMARKS:

- Emission Level = Read Level + Antenna Factor + Cable Loss - Preamp Factor
Margin value = Emission level – Limit value
- 5240MHz: Fundamental frequency.



EUT TEST CONDITION		MEASUREMENT DETAIL	
CHANNEL	Channel 52	FREQUENCY RANGE	1GHz ~ 40GHz
INPUT POWER	120Vac, 60 Hz	DETECTOR FUNCTION	Peak (PK) Average (AV)
ENVIRONMENTAL CONDITIONS	25deg. C, 65%RH	TESTED BY	Charles Hsiao

ANTENNA POLARITY & TEST DISTANCE: HORIZONTAL AT 3 M										
FREQ. (MHz)	EMISSION LEVEL (dBuV/m)	READ LEVEL (dBuV)	LIMIT (dBuV/m)	MARGIN (dB)	ANTENNA FACTOR (dB/m)	CABLE LOSS (dB)	PREAMP FACTOR (dB)	ANTENNA HEIGHT (cm)	TABLE ANGLE (Degree)	REMARK
5116	42.94	34.74	54	-11.06	34.09	8.1	33.99	203	298	Average
5116	57.01	48.81	74	-16.99	34.09	8.1	33.99	203	298	Peak
5260	99.82	91.36			34.21	8.26	34.01	203	298	Average
5260	106.27	97.81			34.21	8.26	34.01	203	298	Peak
5452	43.01	34.19	54	-10.99	34.36	8.51	34.05	203	298	Average
5452	58.82	50	74	-15.18	34.36	8.51	34.05	203	298	Peak
ANTENNA POLARITY & TEST DISTANCE: VERTICAL AT 3 M										
FREQ. (MHz)	EMISSION LEVEL (dBuV/m)	READ LEVEL (dBuV)	LIMIT (dBuV/m)	MARGIN (dB)	ANTENNA FACTOR (dB/m)	CABLE LOSS (dB)	PREAMP FACTOR (dB)	ANTENNA HEIGHT (cm)	TABLE ANGLE (Degree)	REMARK
5098	42.72	34.56	54	-11.28	34.08	8.07	33.99	210	274	Average
5098	57.39	49.23	74	-16.61	34.08	8.07	33.99	210	274	Peak
5260	93.73	85.27			34.21	8.26	34.01	210	274	Average
5260	101.71	93.25			34.21	8.26	34.01	210	274	Peak
5450	42.92	34.1	54	-11.08	34.36	8.51	34.05	210	274	Average
5450	58.11	49.29	74	-15.89	34.36	8.51	34.05	210	274	Peak

REMARKS:

- Emission Level = Read Level + Antenna Factor + Cable Loss - Preamp Factor
Margin value = Emission level – Limit value
- 5260MHz: Fundamental frequency.

EUT TEST CONDITION		MEASUREMENT DETAIL	
CHANNEL	Channel 60	FREQUENCY RANGE	1GHz ~ 40GHz
INPUT POWER	120Vac, 60 Hz	DETECTOR FUNCTION	Peak (PK) Average (AV)
ENVIRONMENTAL CONDITIONS	25deg. C, 65%RH	TESTED BY	Charles Hsiao

ANTENNA POLARITY & TEST DISTANCE: HORIZONTAL AT 3 M										
FREQ. (MHz)	EMISSION LEVEL (dBuV/m)	READ LEVEL (dBuV)	LIMIT (dBuV/m)	MARGIN (dB)	ANTENNA FACTOR (dB/m)	CABLE LOSS (dB)	PREAMP FACTOR (dB)	ANTENNA HEIGHT (cm)	TABLE ANGLE (Degree)	REMARK
5124	42.94	34.72	54	-11.06	34.11	8.1	33.99	203	300	Average
5124	57.42	49.2	74	-16.58	34.11	8.1	33.99	203	300	Peak
5300	98.56	90.02			34.24	8.32	34.02	203	300	Average
5300	106.3	97.76			34.24	8.32	34.02	203	300	Peak
5352	47.25	38.62	54	-6.75	34.28	8.38	34.03	203	300	Average
5352	58.67	50.04	74	-15.33	34.28	8.38	34.03	203	300	Peak
ANTENNA POLARITY & TEST DISTANCE: VERTICAL AT 3 M										
FREQ. (MHz)	EMISSION LEVEL (dBuV/m)	READ LEVEL (dBuV)	LIMIT (dBuV/m)	MARGIN (dB)	ANTENNA FACTOR (dB/m)	CABLE LOSS (dB)	PREAMP FACTOR (dB)	ANTENNA HEIGHT (cm)	TABLE ANGLE (Degree)	REMARK
5060	42.55	34.45	54	-11.45	34.05	8.03	33.98	217	274	Average
5060	57.57	49.47	74	-16.43	34.05	8.03	33.98	217	274	Peak
5300	93.26	84.72			34.24	8.32	34.02	217	274	Average
5300	101.38	92.84			34.24	8.32	34.02	217	274	Peak
5420	43.96	35.19	54	-10.04	34.33	8.48	34.04	217	274	Average
5420	58.39	49.62	74	-15.61	34.33	8.48	34.04	217	274	Peak

REMARKS:

- Emission Level = Read Level + Antenna Factor + Cable Loss - Preamp Factor
Margin value = Emission level – Limit value
- 5300MHz: Fundamental frequency.



EUT TEST CONDITION		MEASUREMENT DETAIL	
CHANNEL	Channel 64	FREQUENCY RANGE	1GHz ~ 40GHz
INPUT POWER	120Vac, 60 Hz	DETECTOR FUNCTION	Peak (PK) Average (AV)
ENVIRONMENTAL CONDITIONS	25deg. C, 65%RH	TESTED BY	Charles Hsiao

ANTENNA POLARITY & TEST DISTANCE: HORIZONTAL AT 3 M										
FREQ. (MHz)	EMISSION LEVEL (dBuV/m)	READ LEVEL (dBuV)	LIMIT (dBuV/m)	MARGIN (dB)	ANTENNA FACTOR (dB/m)	CABLE LOSS (dB)	PREAMP FACTOR (dB)	ANTENNA HEIGHT (cm)	TABLE ANGLE (Degree)	REMARK
5100	43	34.84	54	-11	34.08	8.07	33.99	214	300	Average
5100	57.7	49.54	74	-16.3	34.08	8.07	33.99	214	300	Peak
5320	99.46	90.88			34.25	8.35	34.02	214	300	Average
5320	106.97	98.39			34.25	8.35	34.02	214	300	Peak
5350	47.3	38.67	54	-6.7	34.28	8.38	34.03	214	300	Average
5350	61.61	52.98	74	-12.39	34.28	8.38	34.03	214	300	Peak
ANTENNA POLARITY & TEST DISTANCE: VERTICAL AT 3 M										
FREQ. (MHz)	EMISSION LEVEL (dBuV/m)	READ LEVEL (dBuV)	LIMIT (dBuV/m)	MARGIN (dB)	ANTENNA FACTOR (dB/m)	CABLE LOSS (dB)	PREAMP FACTOR (dB)	ANTENNA HEIGHT (cm)	TABLE ANGLE (Degree)	REMARK
5078	42.44	34.32	54	-11.56	34.07	8.03	33.98	217	274	Average
5078	56.64	48.52	74	-17.36	34.07	8.03	33.98	217	274	Peak
5320	93.58	85			34.25	8.35	34.02	217	274	Average
5320	101.07	92.49			34.25	8.35	34.02	217	274	Peak
5362	43.82	35.18	54	-10.18	34.29	8.38	34.03	217	274	Average
5362	57.01	48.37	74	-16.99	34.29	8.38	34.03	217	274	Peak

REMARKS:

- Emission Level = Read Level + Antenna Factor + Cable Loss - Preamp Factor
Margin value = Emission level – Limit value
- 5320MHz: Fundamental frequency.



A D T

EUT TEST CONDITION		MEASUREMENT DETAIL	
CHANNEL	Channel 100	FREQUENCY RANGE	1GHz ~ 40GHz
INPUT POWER	120Vac, 60 Hz	DETECTOR FUNCTION	Peak (PK) Average (AV)
ENVIRONMENTAL CONDITIONS	25deg. C, 65%RH	TESTED BY	Charles Hsiao

ANTENNA POLARITY & TEST DISTANCE: HORIZONTAL AT 3 M										
FREQ. (MHz)	EMISSION LEVEL (dBuV/m)	READ LEVEL (dBuV)	LIMIT (dBuV/m)	MARGIN (dB)	ANTENNA FACTOR (dB/m)	CABLE LOSS (dB)	PREAMP FACTOR (dB)	ANTENNA HEIGHT (cm)	TABLE ANGLE (Degree)	REMARK
5446	45.27	36.44	54	-8.73	34.36	8.51	34.04	130	340	Average
5446	57.48	48.65	74	-16.52	34.36	8.51	34.04	130	340	Peak
5470	56.32	47.49	68.2	-11.88	34.37	8.51	34.05	130	340	Peak
5500	97.07	88.15			34.4	8.57	34.05	130	340	Average
5500	104.27	95.35			34.4	8.57	34.05	130	340	Peak
5725	57.2	48.04	68.2	-11	34.62	8.65	34.11	130	340	Peak
ANTENNA POLARITY & TEST DISTANCE: VERTICAL AT 3 M										
FREQ. (MHz)	EMISSION LEVEL (dBuV/m)	READ LEVEL (dBuV)	LIMIT (dBuV/m)	MARGIN (dB)	ANTENNA FACTOR (dB/m)	CABLE LOSS (dB)	PREAMP FACTOR (dB)	ANTENNA HEIGHT (cm)	TABLE ANGLE (Degree)	REMARK
5446	44.87	36.04	54	-9.13	34.36	8.51	34.04	196	293	Average
5446	57.38	48.55	74	-16.62	34.36	8.51	34.04	196	293	Peak
5470	57.09	48.26	68.2	-11.11	34.37	8.51	34.05	196	293	Peak
5500	95.07	86.15			34.4	8.57	34.05	196	293	Average
5500	102	93.08			34.4	8.57	34.05	196	293	Peak
5725	56.03	46.87	68.2	-12.17	34.62	8.65	34.11	196	293	Peak

REMARKS:

- Emission Level = Read Level + Antenna Factor + Cable Loss - Preamp Factor
Margin value = Emission level – Limit value
- 5500MHz: Fundamental frequency.
- 5470MHz & 5725MHz: Out of restricted band



A D T

EUT TEST CONDITION		MEASUREMENT DETAIL	
CHANNEL	Channel 116	FREQUENCY RANGE	1GHz ~ 40GHz
INPUT POWER	120Vac, 60 Hz	DETECTOR FUNCTION	Peak (PK) Average (AV)
ENVIRONMENTAL CONDITIONS	25deg. C, 65%RH	TESTED BY	Charles Hsiao

ANTENNA POLARITY & TEST DISTANCE: HORIZONTAL AT 3 M										
FREQ. (MHz)	EMISSION LEVEL (dBuV/m)	READ LEVEL (dBuV)	LIMIT (dBuV/m)	MARGIN (dB)	ANTENNA FACTOR (dB/m)	CABLE LOSS (dB)	PREAMP FACTOR (dB)	ANTENNA HEIGHT (cm)	TABLE ANGLE (Degree)	REMARK
5460	42.76	33.94	54	-11.24	34.36	8.51	34.05	172	340	Average
5460	57.84	49.02	74	-16.16	34.36	8.51	34.05	172	340	Peak
5470	56.68	47.85	68.2	-11.52	34.37	8.51	34.05	172	340	Peak
5580	99.67	90.68			34.47	8.6	34.08	172	340	Average
5580	106.75	97.76			34.47	8.6	34.08	172	340	Peak
5725	55.53	46.37	68.2	-12.67	34.62	8.65	34.11	172	340	Peak
ANTENNA POLARITY & TEST DISTANCE: VERTICAL AT 3 M										
FREQ. (MHz)	EMISSION LEVEL (dBuV/m)	READ LEVEL (dBuV)	LIMIT (dBuV/m)	MARGIN (dB)	ANTENNA FACTOR (dB/m)	CABLE LOSS (dB)	PREAMP FACTOR (dB)	ANTENNA HEIGHT (cm)	TABLE ANGLE (Degree)	REMARK
5416	42.68	33.95	54	-11.32	34.33	8.44	34.04	201	293	Average
5416	57.62	48.89	74	-16.38	34.33	8.44	34.04	201	293	Peak
5470	56.12	47.29	68.2	-12.08	34.37	8.51	34.05	201	293	Peak
5580	96.45	87.46			34.47	8.6	34.08	201	293	Average
5580	104.55	95.56			34.47	8.6	34.08	201	293	Peak
5725	56.4	47.24	68.2	-11.8	34.62	8.65	34.11	201	293	Peak

REMARKS:

1. Emission Level = Read Level + Antenna Factor + Cable Loss - Preamp Factor
Margin value = Emission level – Limit value
2. 5580MHz: Fundamental frequency.
3. 5470MHz & 5725MHz: Out of restricted band



A D T

EUT TEST CONDITION		MEASUREMENT DETAIL	
CHANNEL	Channel 140	FREQUENCY RANGE	1GHz ~ 40GHz
INPUT POWER	120Vac, 60 Hz	DETECTOR FUNCTION	Peak (PK) Average (AV)
ENVIRONMENTAL CONDITIONS	25deg. C, 65%RH	TESTED BY	Charles Hsiao

ANTENNA POLARITY & TEST DISTANCE: HORIZONTAL AT 3 M										
FREQ. (MHz)	EMISSION LEVEL (dBuV/m)	READ LEVEL (dBuV)	LIMIT (dBuV/m)	MARGIN (dB)	ANTENNA FACTOR (dB/m)	CABLE LOSS (dB)	PREAMP FACTOR (dB)	ANTENNA HEIGHT (cm)	TABLE ANGLE (Degree)	REMARK
5454	42.77	33.95	54	-11.23	34.36	8.51	34.05	106	338	Average
5454	57.49	48.67	74	-16.51	34.36	8.51	34.05	106	338	Peak
5470	56.59	47.76	68.2	-11.61	34.37	8.51	34.05	106	338	Peak
5700	98.03	88.9			34.59	8.64	34.1	106	338	Average
5700	106.1	96.97			34.59	8.64	34.1	106	338	Peak
5725	56.26	47.1	68.2	-11.94	34.62	8.65	34.11	106	338	Peak
ANTENNA POLARITY & TEST DISTANCE: VERTICAL AT 3 M										
FREQ. (MHz)	EMISSION LEVEL (dBuV/m)	READ LEVEL (dBuV)	LIMIT (dBuV/m)	MARGIN (dB)	ANTENNA FACTOR (dB/m)	CABLE LOSS (dB)	PREAMP FACTOR (dB)	ANTENNA HEIGHT (cm)	TABLE ANGLE (Degree)	REMARK
5364	42.57	33.93	54	-11.43	34.29	8.38	34.03	257	293	Average
5364	58.03	49.39	74	-15.97	34.29	8.38	34.03	257	293	Peak
5470	56.73	47.9	68.2	-11.47	34.37	8.51	34.05	257	293	Peak
5700	95.23	86.1			34.59	8.64	34.1	257	293	Average
5700	103.91	94.78			34.59	8.64	34.1	257	293	Peak
5725	56.81	47.65	68.2	-11.39	34.62	8.65	34.11	257	293	Peak

REMARKS:

- Emission Level = Read Level + Antenna Factor + Cable Loss - Preamp Factor
Margin value = Emission level – Limit value
- 5700MHz: Fundamental frequency.
- 5470MHz & 5725MHz: Out of restricted band

EUT TEST CONDITION		MEASUREMENT DETAIL	
CHANNEL	Channel 149	FREQUENCY RANGE	1GHz ~ 40GHz
INPUT POWER	120Vac, 60 Hz	DETECTOR FUNCTION	Peak (PK) Average (AV)
ENVIRONMENTAL CONDITIONS	25deg. C, 65%RH	TESTED BY	Charles Hsiao

ANTENNA POLARITY & TEST DISTANCE: HORIZONTAL AT 3 M										
FREQ. (MHz)	EMISSION LEVEL (dBuV/m)	READ LEVEL (dBuV)	LIMIT (dBuV/m)	MARGIN (dB)	ANTENNA FACTOR (dB/m)	CABLE LOSS (dB)	PREAMP FACTOR (dB)	ANTENNA HEIGHT (cm)	TABLE ANGLE (Degree)	REMARK
*5708	56.57	47.42	68.2	-11.63	34.61	8.65	34.11	216	311	Peak
*5724	64.63	55.47	78.2	-13.57	34.62	8.65	34.11	216	311	Peak
5745	98.07	88.88			34.64	8.66	34.11	216	311	Average
5745	106.69	97.5			34.64	8.66	34.11	216	311	Peak
*5852	57.91	48.61	78.2	-20.29	34.74	8.7	34.14	216	311	Peak
*5864	56.5	47.17	68.2	-11.7	34.76	8.71	34.14	216	311	Peak
ANTENNA POLARITY & TEST DISTANCE: VERTICAL AT 3 M										
FREQ. (MHz)	EMISSION LEVEL (dBuV/m)	READ LEVEL (dBuV)	LIMIT (dBuV/m)	MARGIN (dB)	ANTENNA FACTOR (dB/m)	CABLE LOSS (dB)	PREAMP FACTOR (dB)	ANTENNA HEIGHT (cm)	TABLE ANGLE (Degree)	REMARK
*5706	57.39	48.24	68.2	-10.81	34.61	8.65	34.11	199	26	Peak
*5724	65.26	56.1	78.2	-12.94	34.62	8.65	34.11	199	26	Peak
5745	97.5	88.31			34.64	8.66	34.11	199	26	Average
5745	104.65	95.46			34.64	8.66	34.11	199	26	Peak
*5856	57.51	48.19	78.2	-20.69	34.76	8.7	34.14	199	26	Peak
*5868	57.8	48.47	68.2	-10.4	34.76	8.71	34.14	199	26	Peak

REMARKS:

- Emission Level = Read Level + Antenna Factor + Cable Loss - Preamp Factor
Margin value = Emission level – Limit value
- 5745MHz: Fundamental frequency.
- *: Out of restricted band



A D T

EUT TEST CONDITION		MEASUREMENT DETAIL	
CHANNEL	Channel 157	FREQUENCY RANGE	1GHz ~ 40GHz
INPUT POWER	120Vac, 60 Hz	DETECTOR FUNCTION	Peak (PK) Average (AV)
ENVIRONMENTAL CONDITIONS	25deg. C, 65%RH	TESTED BY	Charles Hsiao

ANTENNA POLARITY & TEST DISTANCE: HORIZONTAL AT 3 M										
FREQ. (MHz)	EMISSION LEVEL (dBuV/m)	READ LEVEL (dBuV)	LIMIT (dBuV/m)	MARGIN (dB)	ANTENNA FACTOR (dB/m)	CABLE LOSS (dB)	PREAMP FACTOR (dB)	ANTENNA HEIGHT (cm)	TABLE ANGLE (Degree)	REMARK
*5710	57.46	48.31	68.2	-10.74	34.61	8.65	34.11	216	311	Peak
*5722	57.07	47.91	78.2	-21.13	34.62	8.65	34.11	216	311	Peak
5785	98.56	89.33			34.68	8.68	34.13	216	311	Average
5785	106.21	96.98			34.68	8.68	34.13	216	311	Peak
*5860	57.72	48.4	78.2	-20.48	34.76	8.7	34.14	216	311	Peak
*5862	57.73	48.4	68.2	-10.47	34.76	8.71	34.14	216	311	Peak
ANTENNA POLARITY & TEST DISTANCE: VERTICAL AT 3 M										
FREQ. (MHz)	EMISSION LEVEL (dBuV/m)	READ LEVEL (dBuV)	LIMIT (dBuV/m)	MARGIN (dB)	ANTENNA FACTOR (dB/m)	CABLE LOSS (dB)	PREAMP FACTOR (dB)	ANTENNA HEIGHT (cm)	TABLE ANGLE (Degree)	REMARK
*5714	56.64	47.49	68.2	-11.56	34.61	8.65	34.11	206	26	Peak
*5722	55.61	46.45	78.2	-22.59	34.62	8.65	34.11	206	26	Peak
5785	96.86	87.63			34.68	8.68	34.13	206	26	Average
5785	104.02	94.79			34.68	8.68	34.13	206	26	Peak
*5856	57.65	48.33	78.2	-20.55	34.76	8.7	34.14	206	26	Peak
*5866	56.39	47.06	68.2	-11.81	34.76	8.71	34.14	206	26	Peak

REMARKS:

- Emission Level = Read Level + Antenna Factor + Cable Loss - Preamp Factor
Margin value = Emission level – Limit value
- 5785MHz: Fundamental frequency.
- *: Out of restricted band



EUT TEST CONDITION		MEASUREMENT DETAIL	
CHANNEL	Channel 165	FREQUENCY RANGE	1GHz ~ 40GHz
INPUT POWER	120Vac, 60 Hz	DETECTOR FUNCTION	Peak (PK) Average (AV)
ENVIRONMENTAL CONDITIONS	25deg. C, 65%RH	TESTED BY	Charles Hsiao

ANTENNA POLARITY & TEST DISTANCE: HORIZONTAL AT 3 M										
FREQ. (MHz)	EMISSION LEVEL (dBuV/m)	READ LEVEL (dBuV)	LIMIT (dBuV/m)	MARGIN (dB)	ANTENNA FACTOR (dB/m)	CABLE LOSS (dB)	PREAMP FACTOR (dB)	ANTENNA HEIGHT (cm)	TABLE ANGLE (Degree)	REMARK
*5714	56.78	47.63	68.2	-11.42	34.61	8.65	34.11	210	311	Peak
*5720	57	47.84	78.2	-21.2	34.62	8.65	34.11	210	311	Peak
5825	98.06	88.77			34.73	8.69	34.13	210	311	Average
5825	106.55	97.26			34.73	8.69	34.13	210	311	Peak
*5856	57.14	47.82	78.2	-21.06	34.76	8.7	34.14	210	311	Peak
*5870	57.54	48.21	68.2	-10.66	34.76	8.71	34.14	210	311	Peak
ANTENNA POLARITY & TEST DISTANCE: VERTICAL AT 3 M										
FREQ. (MHz)	EMISSION LEVEL (dBuV/m)	READ LEVEL (dBuV)	LIMIT (dBuV/m)	MARGIN (dB)	ANTENNA FACTOR (dB/m)	CABLE LOSS (dB)	PREAMP FACTOR (dB)	ANTENNA HEIGHT (cm)	TABLE ANGLE (Degree)	REMARK
*5714	56.51	47.36	68.2	-11.69	34.61	8.65	34.11	239	26	Peak
*5722	56.43	47.27	78.2	-21.77	34.62	8.65	34.11	239	26	Peak
5825	97.62	88.33			34.73	8.69	34.13	239	26	Average
5825	104.77	95.48			34.73	8.69	34.13	239	26	Peak
*5852	60.31	51.01	78.2	-17.89	34.74	8.7	34.14	239	26	Peak
*5870	56.5	47.17	68.2	-11.7	34.76	8.71	34.14	239	26	Peak

REMARKS:

- Emission Level = Read Level + Antenna Factor + Cable Loss - Preamp Factor
Margin value = Emission level – Limit value
- 5825MHz: Fundamental frequency.
- *: Out of restricted band

802.11n (20MHz)

EUT TEST CONDITION		MEASUREMENT DETAIL	
CHANNEL	Channel 36	FREQUENCY RANGE	1GHz ~ 40GHz
INPUT POWER	120Vac, 60 Hz	DETECTOR FUNCTION	Peak (PK) Average (AV)
ENVIRONMENTAL CONDITIONS	25deg. C, 65%RH	TESTED BY	Charles Hsiao

ANTENNA POLARITY & TEST DISTANCE: HORIZONTAL AT 3 M

FREQ. (MHz)	EMISSION LEVEL (dBuV/m)	READ LEVEL (dBuV)	LIMIT (dBuV/m)	MARGIN (dB)	ANTENNA FACTOR (dB/m)	CABLE LOSS (dB)	PREAMP FACTOR (dB)	ANTENNA HEIGHT (cm)	TABLE ANGLE (Degree)	REMARK
5150	48.15	39.9	54	-5.85	34.12	8.13	34	212	301	Average
5150	64.02	55.77	74	-9.98	34.12	8.13	34	212	301	Peak
5180	98.17	89.86			34.15	8.16	34	212	301	Average
5180	106.25	97.94			34.15	8.16	34	212	301	Peak
5430	42.86	34.07	54	-11.14	34.35	8.48	34.04	212	301	Average
5430	58.59	49.8	74	-15.41	34.35	8.48	34.04	212	301	Peak

ANTENNA POLARITY & TEST DISTANCE: VERTICAL AT 3 M

FREQ. (MHz)	EMISSION LEVEL (dBuV/m)	READ LEVEL (dBuV)	LIMIT (dBuV/m)	MARGIN (dB)	ANTENNA FACTOR (dB/m)	CABLE LOSS (dB)	PREAMP FACTOR (dB)	ANTENNA HEIGHT (cm)	TABLE ANGLE (Degree)	REMARK
5088	43.35	35.19	54	-10.65	34.07	8.07	33.98	213	274	Average
5088	57.21	49.05	74	-16.79	34.07	8.07	33.98	213	274	Peak
5180	93.03	84.72			34.15	8.16	34	213	274	Average
5180	101.51	93.2			34.15	8.16	34	213	274	Peak
5430	42.86	34.07	54	-11.14	34.35	8.48	34.04	213	274	Average
5430	57.85	49.06	74	-16.15	34.35	8.48	34.04	213	274	Peak

REMARKS:

- Emission Level = Read Level + Antenna Factor + Cable Loss - Preamp Factor
Margin value = Emission level – Limit value
- 5180MHz: Fundamental frequency.



A D T

EUT TEST CONDITION		MEASUREMENT DETAIL	
CHANNEL	Channel 44	FREQUENCY RANGE	1GHz ~ 40GHz
INPUT POWER	120Vac, 60 Hz	DETECTOR FUNCTION	Peak (PK) Average (AV)
ENVIRONMENTAL CONDITIONS	25deg. C, 65%RH	TESTED BY	Charles Hsiao

ANTENNA POLARITY & TEST DISTANCE: HORIZONTAL AT 3 M										
FREQ. (MHz)	EMISSION LEVEL (dBuV/m)	READ LEVEL (dBuV)	LIMIT (dBuV/m)	MARGIN (dB)	ANTENNA FACTOR (dB/m)	CABLE LOSS (dB)	PREAMP FACTOR (dB)	ANTENNA HEIGHT (cm)	TABLE ANGLE (Degree)	REMARK
5150	42.9	34.65	54	-11.1	34.12	8.13	34	212	301	Average
5150	57.57	49.32	74	-16.43	34.12	8.13	34	212	301	Peak
5220	98.52	90.13			34.17	8.22	34	212	301	Average
5220	106.18	97.79			34.17	8.22	34	212	301	Peak
5440	42.79	34	54	-11.21	34.35	8.48	34.04	212	301	Average
5440	57.62	48.83	74	-16.38	34.35	8.48	34.04	212	301	Peak
ANTENNA POLARITY & TEST DISTANCE: VERTICAL AT 3 M										
FREQ. (MHz)	EMISSION LEVEL (dBuV/m)	READ LEVEL (dBuV)	LIMIT (dBuV/m)	MARGIN (dB)	ANTENNA FACTOR (dB/m)	CABLE LOSS (dB)	PREAMP FACTOR (dB)	ANTENNA HEIGHT (cm)	TABLE ANGLE (Degree)	REMARK
5076	42.64	34.52	54	-11.36	34.07	8.03	33.98	213	274	Average
5076	57.09	48.97	74	-16.91	34.07	8.03	33.98	213	274	Peak
5220	93.19	84.8			34.17	8.22	34	213	274	Average
5220	101.16	92.77			34.17	8.22	34	213	274	Peak
5440	42.73	33.94	54	-11.27	34.35	8.48	34.04	213	274	Average
5440	58.81	50.02	74	-15.19	34.35	8.48	34.04	213	274	Peak

REMARKS:

- Emission Level = Read Level + Antenna Factor + Cable Loss - Preamp Factor
Margin value = Emission level – Limit value
- 5220MHz: Fundamental frequency.



EUT TEST CONDITION		MEASUREMENT DETAIL	
CHANNEL	Channel 48	FREQUENCY RANGE	1GHz ~ 40GHz
INPUT POWER	120Vac, 60 Hz	DETECTOR FUNCTION	Peak (PK) Average (AV)
ENVIRONMENTAL CONDITIONS	25deg. C, 65%RH	TESTED BY	Charles Hsiao

ANTENNA POLARITY & TEST DISTANCE: HORIZONTAL AT 3 M										
FREQ. (MHz)	EMISSION LEVEL (dBuV/m)	READ LEVEL (dBuV)	LIMIT (dBuV/m)	MARGIN (dB)	ANTENNA FACTOR (dB/m)	CABLE LOSS (dB)	PREAMP FACTOR (dB)	ANTENNA HEIGHT (cm)	TABLE ANGLE (Degree)	REMARK
5058	42.78	34.68	54	-11.22	34.05	8.03	33.98	212	301	Average
5058	57.63	49.53	74	-16.37	34.05	8.03	33.98	212	301	Peak
5240	98.46	90.02			34.19	8.26	34.01	212	301	Average
5240	106.23	97.79			34.19	8.26	34.01	212	301	Peak
5430	43.04	34.25	54	-10.96	34.35	8.48	34.04	212	301	Average
5430	58.55	49.76	74	-15.45	34.35	8.48	34.04	212	301	Peak
ANTENNA POLARITY & TEST DISTANCE: VERTICAL AT 3 M										
FREQ. (MHz)	EMISSION LEVEL (dBuV/m)	READ LEVEL (dBuV)	LIMIT (dBuV/m)	MARGIN (dB)	ANTENNA FACTOR (dB/m)	CABLE LOSS (dB)	PREAMP FACTOR (dB)	ANTENNA HEIGHT (cm)	TABLE ANGLE (Degree)	REMARK
5054	42.39	34.33	54	-11.61	34.04	8	33.98	221	274	Average
5054	56.65	48.59	74	-17.35	34.04	8	33.98	221	274	Peak
5240	94.37	85.93			34.19	8.26	34.01	221	274	Average
5240	101.55	93.11			34.19	8.26	34.01	221	274	Peak
5360	42.62	33.99	54	-11.38	34.28	8.38	34.03	221	274	Average
5360	57.49	48.86	74	-16.51	34.28	8.38	34.03	221	274	Peak

REMARKS:

- Emission Level = Read Level + Antenna Factor + Cable Loss - Preamp Factor
Margin value = Emission level – Limit value
- 5240MHz: Fundamental frequency.



A D T

EUT TEST CONDITION		MEASUREMENT DETAIL	
CHANNEL	Channel 52	FREQUENCY RANGE	1GHz ~ 40GHz
INPUT POWER	120Vac, 60 Hz	DETECTOR FUNCTION	Peak (PK) Average (AV)
ENVIRONMENTAL CONDITIONS	25deg. C, 65%RH	TESTED BY	Charles Hsiao

ANTENNA POLARITY & TEST DISTANCE: HORIZONTAL AT 3 M										
FREQ. (MHz)	EMISSION LEVEL (dBuV/m)	READ LEVEL (dBuV)	LIMIT (dBuV/m)	MARGIN (dB)	ANTENNA FACTOR (dB/m)	CABLE LOSS (dB)	PREAMP FACTOR (dB)	ANTENNA HEIGHT (cm)	TABLE ANGLE (Degree)	REMARK
5082	42.88	34.72	54	-11.12	34.07	8.07	33.98	203	298	Average
5082	57.64	49.48	74	-16.36	34.07	8.07	33.98	203	298	Peak
5260	98.35	89.89			34.21	8.26	34.01	203	298	Average
5260	106.28	97.82			34.21	8.26	34.01	203	298	Peak
5440	43.16	34.37	54	-10.84	34.35	8.48	34.04	203	298	Average
5440	58.34	49.55	74	-15.66	34.35	8.48	34.04	203	298	Peak

ANTENNA POLARITY & TEST DISTANCE: VERTICAL AT 3 M										
FREQ. (MHz)	EMISSION LEVEL (dBuV/m)	READ LEVEL (dBuV)	LIMIT (dBuV/m)	MARGIN (dB)	ANTENNA FACTOR (dB/m)	CABLE LOSS (dB)	PREAMP FACTOR (dB)	ANTENNA HEIGHT (cm)	TABLE ANGLE (Degree)	REMARK
5086	42.51	34.35	54	-11.49	34.07	8.07	33.98	210	274	Average
5086	58.08	49.92	74	-15.92	34.07	8.07	33.98	210	274	Peak
5260	92.52	84.06			34.21	8.26	34.01	210	274	Average
5260	100.46	92			34.21	8.26	34.01	210	274	Peak
5432	42.91	34.12	54	-11.09	34.35	8.48	34.04	210	274	Average
5432	58.42	49.63	74	-15.58	34.35	8.48	34.04	210	274	Peak

REMARKS:

- Emission Level = Read Level + Antenna Factor + Cable Loss - Preamp Factor
Margin value = Emission level – Limit value
- 5260MHz: Fundamental frequency.



EUT TEST CONDITION		MEASUREMENT DETAIL	
CHANNEL	Channel 60	FREQUENCY RANGE	1GHz ~ 40GHz
INPUT POWER	120Vac, 60 Hz	DETECTOR FUNCTION	Peak (PK) Average (AV)
ENVIRONMENTAL CONDITIONS	25deg. C, 65%RH	TESTED BY	Charles Hsiao

ANTENNA POLARITY & TEST DISTANCE: HORIZONTAL AT 3 M										
FREQ. (MHz)	EMISSION LEVEL (dBuV/m)	READ LEVEL (dBuV)	LIMIT (dBuV/m)	MARGIN (dB)	ANTENNA FACTOR (dB/m)	CABLE LOSS (dB)	PREAMP FACTOR (dB)	ANTENNA HEIGHT (cm)	TABLE ANGLE (Degree)	REMARK
5026	42.7	34.67	54	-11.3	34.03	7.97	33.97	203	300	Average
5026	57.6	49.57	74	-16.4	34.03	7.97	33.97	203	300	Peak
5300	98.32	89.78			34.24	8.32	34.02	203	300	Average
5300	106.12	97.58			34.24	8.32	34.02	203	300	Peak
5368	47.05	38.38	54	-6.95	34.29	8.41	34.03	203	300	Average
5368	57.03	48.36	74	-16.97	34.29	8.41	34.03	203	300	Peak

ANTENNA POLARITY & TEST DISTANCE: VERTICAL AT 3 M										
FREQ. (MHz)	EMISSION LEVEL (dBuV/m)	READ LEVEL (dBuV)	LIMIT (dBuV/m)	MARGIN (dB)	ANTENNA FACTOR (dB/m)	CABLE LOSS (dB)	PREAMP FACTOR (dB)	ANTENNA HEIGHT (cm)	TABLE ANGLE (Degree)	REMARK
5024	42.5	34.47	54	-11.5	34.03	7.97	33.97	217	274	Average
5024	57.22	49.19	74	-16.78	34.03	7.97	33.97	217	274	Peak
5300	92.17	83.63			34.24	8.32	34.02	217	274	Average
5300	99.98	91.44			34.24	8.32	34.02	217	274	Peak
5436	44.17	35.38	54	-9.83	34.35	8.48	34.04	217	274	Average
5436	57.63	48.84	74	-16.37	34.35	8.48	34.04	217	274	Peak

REMARKS:

- Emission Level = Read Level + Antenna Factor + Cable Loss - Preamp Factor
Margin value = Emission level – Limit value
- 5300MHz: Fundamental frequency.



EUT TEST CONDITION		MEASUREMENT DETAIL	
CHANNEL	Channel 64	FREQUENCY RANGE	1GHz ~ 40GHz
INPUT POWER	120Vac, 60 Hz	DETECTOR FUNCTION	Peak (PK) Average (AV)
ENVIRONMENTAL CONDITIONS	25deg. C, 65%RH	TESTED BY	Charles Hsiao

ANTENNA POLARITY & TEST DISTANCE: HORIZONTAL AT 3 M

FREQ. (MHz)	EMISSION LEVEL (dBuV/m)	READ LEVEL (dBuV)	LIMIT (dBuV/m)	MARGIN (dB)	ANTENNA FACTOR (dB/m)	CABLE LOSS (dB)	PREAMP FACTOR (dB)	ANTENNA HEIGHT (cm)	TABLE ANGLE (Degree)	REMARK
5130	42.85	34.63	54	-11.15	34.11	8.1	33.99	214	300	Average
5130	57.15	48.93	74	-16.85	34.11	8.1	33.99	214	300	Peak
5320	98.37	89.79			34.25	8.35	34.02	214	300	Average
5320	105.82	97.24			34.25	8.35	34.02	214	300	Peak
5368	47.14	38.47	54	-6.86	34.29	8.41	34.03	214	300	Average
5368	58.08	49.41	74	-15.92	34.29	8.41	34.03	214	300	Peak

ANTENNA POLARITY & TEST DISTANCE: VERTICAL AT 3 M

FREQ. (MHz)	EMISSION LEVEL (dBuV/m)	READ LEVEL (dBuV)	LIMIT (dBuV/m)	MARGIN (dB)	ANTENNA FACTOR (dB/m)	CABLE LOSS (dB)	PREAMP FACTOR (dB)	ANTENNA HEIGHT (cm)	TABLE ANGLE (Degree)	REMARK
5100	42.51	34.35	54	-11.49	34.08	8.07	33.99	217	274	Average
5100	56.64	48.48	74	-17.36	34.08	8.07	33.99	217	274	Peak
5320	92.31	83.73			34.25	8.35	34.02	217	274	Average
5320	99.93	91.35			34.25	8.35	34.02	217	274	Peak
5436	43.95	35.16	54	-10.05	34.35	8.48	34.04	217	274	Average
5436	58.31	49.52	74	-15.69	34.35	8.48	34.04	217	274	Peak

REMARKS:

- Emission Level = Read Level + Antenna Factor + Cable Loss - Preamp Factor
Margin value = Emission level – Limit value
- 5320MHz: Fundamental frequency.



A D T

EUT TEST CONDITION		MEASUREMENT DETAIL	
CHANNEL	Channel 100	FREQUENCY RANGE	1GHz ~ 40GHz
INPUT POWER	120Vac, 60 Hz	DETECTOR FUNCTION	Peak (PK) Average (AV)
ENVIRONMENTAL CONDITIONS	25deg. C, 65%RH	TESTED BY	Charles Hsiao

ANTENNA POLARITY & TEST DISTANCE: HORIZONTAL AT 3 M										
FREQ. (MHz)	EMISSION LEVEL (dBuV/m)	READ LEVEL (dBuV)	LIMIT (dBuV/m)	MARGIN (dB)	ANTENNA FACTOR (dB/m)	CABLE LOSS (dB)	PREAMP FACTOR (dB)	ANTENNA HEIGHT (cm)	TABLE ANGLE (Degree)	REMARK
5448	42.97	34.14	54	-11.03	34.36	8.51	34.04	130	340	Average
5448	57.11	48.28	74	-16.89	34.36	8.51	34.04	130	340	Peak
5470	55.39	46.56	68.2	-12.81	34.37	8.51	34.05	130	340	Peak
5500	97.87	88.95			34.4	8.57	34.05	130	340	Average
5500	105.02	96.1			34.4	8.57	34.05	130	340	Peak
5725	56.7	47.54	68.2	-11.5	34.62	8.65	34.11	130	340	Peak
ANTENNA POLARITY & TEST DISTANCE: VERTICAL AT 3 M										
FREQ. (MHz)	EMISSION LEVEL (dBuV/m)	READ LEVEL (dBuV)	LIMIT (dBuV/m)	MARGIN (dB)	ANTENNA FACTOR (dB/m)	CABLE LOSS (dB)	PREAMP FACTOR (dB)	ANTENNA HEIGHT (cm)	TABLE ANGLE (Degree)	REMARK
5454	42.67	33.85	54	-11.33	34.36	8.51	34.05	196	293	Average
5454	57.1	48.28	74	-16.9	34.36	8.51	34.05	196	293	Peak
5470	56.1	47.27	68.2	-12.1	34.37	8.51	34.05	196	293	Peak
5500	95.37	86.45			34.4	8.57	34.05	196	293	Average
5500	103	94.08			34.4	8.57	34.05	196	293	Peak
5725	55.74	46.58	68.2	-12.46	34.62	8.65	34.11	196	293	Peak

REMARKS:

- Emission Level = Read Level + Antenna Factor + Cable Loss - Preamp Factor
Margin value = Emission level – Limit value
- 5500MHz: Fundamental frequency.
- 5470MHz & 5725MHz: Out of restricted band

EUT TEST CONDITION		MEASUREMENT DETAIL	
CHANNEL	Channel 116	FREQUENCY RANGE	1GHz ~ 40GHz
INPUT POWER	120Vac, 60 Hz	DETECTOR FUNCTION	Peak (PK) Average (AV)
ENVIRONMENTAL CONDITIONS	25deg. C, 65%RH	TESTED BY	Charles Hsiao

ANTENNA POLARITY & TEST DISTANCE: HORIZONTAL AT 3 M										
FREQ. (MHz)	EMISSION LEVEL (dBuV/m)	READ LEVEL (dBuV)	LIMIT (dBuV/m)	MARGIN (dB)	ANTENNA FACTOR (dB/m)	CABLE LOSS (dB)	PREAMP FACTOR (dB)	ANTENNA HEIGHT (cm)	TABLE ANGLE (Degree)	REMARK
5356	42.61	33.98	54	-11.39	34.28	8.38	34.03	172	340	Average
5356	57.42	48.79	74	-16.58	34.28	8.38	34.03	172	340	Peak
5470	56.39	47.56	68.2	-11.81	34.37	8.51	34.05	172	340	Peak
5580	97.27	88.28			34.47	8.6	34.08	172	340	Average
5580	105.83	96.84			34.47	8.6	34.08	172	340	Peak
5725	55.16	46	68.2	-13.04	34.62	8.65	34.11	172	340	Peak
ANTENNA POLARITY & TEST DISTANCE: VERTICAL AT 3 M										
FREQ. (MHz)	EMISSION LEVEL (dBuV/m)	READ LEVEL (dBuV)	LIMIT (dBuV/m)	MARGIN (dB)	ANTENNA FACTOR (dB/m)	CABLE LOSS (dB)	PREAMP FACTOR (dB)	ANTENNA HEIGHT (cm)	TABLE ANGLE (Degree)	REMARK
5430	42.72	33.93	54	-11.28	34.35	8.48	34.04	201	293	Average
5430	58	49.21	74	-16	34.35	8.48	34.04	201	293	Peak
5470	56.01	47.18	68.2	-12.19	34.37	8.51	34.05	201	293	Peak
5580	95.67	86.68			34.47	8.6	34.08	201	293	Average
5580	103.66	94.67			34.47	8.6	34.08	201	293	Peak
5725	56.54	47.38	68.2	-11.66	34.62	8.65	34.11	201	293	Peak

REMARKS:

- Emission Level = Read Level + Antenna Factor + Cable Loss - Preamp Factor
Margin value = Emission level – Limit value
- 5580MHz: Fundamental frequency.
- 5470MHz & 5725MHz: Out of restricted band



EUT TEST CONDITION		MEASUREMENT DETAIL	
CHANNEL	Channel 140	FREQUENCY RANGE	1GHz ~ 40GHz
INPUT POWER	120Vac, 60 Hz	DETECTOR FUNCTION	Peak (PK) Average (AV)
ENVIRONMENTAL CONDITIONS	25deg. C, 65%RH	TESTED BY	Charles Hsiao

ANTENNA POLARITY & TEST DISTANCE: HORIZONTAL AT 3 M										
FREQ. (MHz)	EMISSION LEVEL (dBuV/m)	READ LEVEL (dBuV)	LIMIT (dBuV/m)	MARGIN (dB)	ANTENNA FACTOR (dB/m)	CABLE LOSS (dB)	PREAMP FACTOR (dB)	ANTENNA HEIGHT (cm)	TABLE ANGLE (Degree)	REMARK
5426	42.7	33.93	54	-11.3	34.33	8.48	34.04	106	338	Average
5426	57.18	48.41	74	-16.82	34.33	8.48	34.04	106	338	Peak
5470	56.15	47.32	68.2	-12.05	34.37	8.51	34.05	106	338	Peak
5700	97.01	87.88			34.59	8.64	34.1	106	338	Average
5700	105.04	95.91			34.59	8.64	34.1	106	338	Peak
5725	55.54	46.38	68.2	-12.66	34.62	8.65	34.11	106	338	Peak
ANTENNA POLARITY & TEST DISTANCE: VERTICAL AT 3 M										
FREQ. (MHz)	EMISSION LEVEL (dBuV/m)	READ LEVEL (dBuV)	LIMIT (dBuV/m)	MARGIN (dB)	ANTENNA FACTOR (dB/m)	CABLE LOSS (dB)	PREAMP FACTOR (dB)	ANTENNA HEIGHT (cm)	TABLE ANGLE (Degree)	REMARK
5452	42.73	33.91	54	-11.27	34.36	8.51	34.05	257	293	Average
5452	57.42	48.6	74	-16.58	34.36	8.51	34.05	257	293	Peak
5470	56.08	47.25	68.2	-12.12	34.37	8.51	34.05	257	293	Peak
5700	95.03	85.9			34.59	8.64	34.1	257	293	Average
5700	103.16	94.03			34.59	8.64	34.1	257	293	Peak
5725	56.81	47.65	68.2	-11.39	34.62	8.65	34.11	257	293	Peak

REMARKS:

- Emission Level = Read Level + Antenna Factor + Cable Loss - Preamp Factor
Margin value = Emission level – Limit value
- 5700MHz: Fundamental frequency.
- 5470MHz & 5725MHz: Out of restricted band



EUT TEST CONDITION		MEASUREMENT DETAIL	
CHANNEL	Channel 149	FREQUENCY RANGE	1GHz ~ 40GHz
INPUT POWER	120Vac, 60 Hz	DETECTOR FUNCTION	Peak (PK) Average (AV)
ENVIRONMENTAL CONDITIONS	25deg. C, 65%RH	TESTED BY	Charles Hsiao

ANTENNA POLARITY & TEST DISTANCE: HORIZONTAL AT 3 M										
FREQ. (MHz)	EMISSION LEVEL (dBuV/m)	READ LEVEL (dBuV)	LIMIT (dBuV/m)	MARGIN (dB)	ANTENNA FACTOR (dB/m)	CABLE LOSS (dB)	PREAMP FACTOR (dB)	ANTENNA HEIGHT (cm)	TABLE ANGLE (Degree)	REMARK
*5710	57.45	48.3	68.2	-10.75	34.61	8.65	34.11	216	311	Peak
*5724	66.75	57.59	78.2	-11.45	34.62	8.65	34.11	216	311	Peak
5745	97.3	88.11			34.64	8.66	34.11	216	311	Average
5745	105.66	96.47			34.64	8.66	34.11	216	311	Peak
*5854	57.58	48.26	78.2	-20.62	34.76	8.7	34.14	216	311	Peak
*5870	57.54	48.21	68.2	-10.66	34.76	8.71	34.14	216	311	Peak
ANTENNA POLARITY & TEST DISTANCE: VERTICAL AT 3 M										
FREQ. (MHz)	EMISSION LEVEL (dBuV/m)	READ LEVEL (dBuV)	LIMIT (dBuV/m)	MARGIN (dB)	ANTENNA FACTOR (dB/m)	CABLE LOSS (dB)	PREAMP FACTOR (dB)	ANTENNA HEIGHT (cm)	TABLE ANGLE (Degree)	REMARK
*5710	57.6	48.45	68.2	-10.6	34.61	8.65	34.11	199	26	Peak
*5722	64.25	55.09	78.2	-13.95	34.62	8.65	34.11	199	26	Peak
5745	96.3	87.11			34.64	8.66	34.11	199	26	Average
5745	103.11	93.92			34.64	8.66	34.11	199	26	Peak
*5858	56.67	47.35	78.2	-21.53	34.76	8.7	34.14	199	26	Peak
*5870	56.83	47.5	68.2	-11.37	34.76	8.71	34.14	199	26	Peak

REMARKS:

- Emission Level = Read Level + Antenna Factor + Cable Loss - Preamp Factor
Margin value = Emission level – Limit value
- 5745MHz: Fundamental frequency.
- *: Out of restricted band

EUT TEST CONDITION		MEASUREMENT DETAIL	
CHANNEL	Channel 157	FREQUENCY RANGE	1GHz ~ 40GHz
INPUT POWER	120Vac, 60 Hz	DETECTOR FUNCTION	Peak (PK) Average (AV)
ENVIRONMENTAL CONDITIONS	25deg. C, 65%RH	TESTED BY	Charles Hsiao

ANTENNA POLARITY & TEST DISTANCE: HORIZONTAL AT 3 M										
FREQ. (MHz)	EMISSION LEVEL (dBuV/m)	READ LEVEL (dBuV)	LIMIT (dBuV/m)	MARGIN (dB)	ANTENNA FACTOR (dB/m)	CABLE LOSS (dB)	PREAMP FACTOR (dB)	ANTENNA HEIGHT (cm)	TABLE ANGLE (Degree)	REMARK
*5706	56.37	47.22	68.2	-11.83	34.61	8.65	34.11	216	311	Peak
*5720	56.52	47.36	78.2	-21.68	34.62	8.65	34.11	216	311	Peak
5785	98.18	88.95			34.68	8.68	34.13	216	311	Average
5785	105.28	96.05			34.68	8.68	34.13	216	311	Peak
*5854	57.6	48.28	78.2	-20.6	34.76	8.7	34.14	216	311	Peak
*5862	56.87	47.54	68.2	-11.33	34.76	8.71	34.14	216	311	Peak
ANTENNA POLARITY & TEST DISTANCE: VERTICAL AT 3 M										
FREQ. (MHz)	EMISSION LEVEL (dBuV/m)	READ LEVEL (dBuV)	LIMIT (dBuV/m)	MARGIN (dB)	ANTENNA FACTOR (dB/m)	CABLE LOSS (dB)	PREAMP FACTOR (dB)	ANTENNA HEIGHT (cm)	TABLE ANGLE (Degree)	REMARK
*5708	56.63	47.48	68.2	-11.57	34.61	8.65	34.11	206	26	Peak
*5720	57.25	48.09	78.2	-20.95	34.62	8.65	34.11	206	26	Peak
5785	96.16	86.93			34.68	8.68	34.13	206	26	Average
5785	103.09	93.86			34.68	8.68	34.13	206	26	Peak
*5856	56.63	47.31	78.2	-21.57	34.76	8.7	34.14	206	26	Peak
*5868	56.7	47.37	68.2	-11.5	34.76	8.71	34.14	206	26	Peak

REMARKS:

- Emission Level = Read Level + Antenna Factor + Cable Loss - Preamp Factor
Margin value = Emission level – Limit value
- 5785MHz: Fundamental frequency.
- *: Out of restricted band

EUT TEST CONDITION		MEASUREMENT DETAIL	
CHANNEL	Channel 165	FREQUENCY RANGE	1GHz ~ 40GHz
INPUT POWER	120Vac, 60 Hz	DETECTOR FUNCTION	Peak (PK) Average (AV)
ENVIRONMENTAL CONDITIONS	25deg. C, 65%RH	TESTED BY	Charles Hsiao

ANTENNA POLARITY & TEST DISTANCE: HORIZONTAL AT 3 M										
FREQ. (MHz)	EMISSION LEVEL (dBuV/m)	READ LEVEL (dBuV)	LIMIT (dBuV/m)	MARGIN (dB)	ANTENNA FACTOR (dB/m)	CABLE LOSS (dB)	PREAMP FACTOR (dB)	ANTENNA HEIGHT (cm)	TABLE ANGLE (Degree)	REMARK
*5706	56.94	47.79	68.2	-11.26	34.61	8.65	34.11	210	311	Peak
*5716	58.05	48.9	78.2	-20.15	34.61	8.65	34.11	210	311	Peak
5825	97.12	87.83			34.73	8.69	34.13	210	311	Average
5825	105.33	96.04			34.73	8.69	34.13	210	311	Peak
*5852	57.49	48.19	78.2	-20.71	34.74	8.7	34.14	210	311	Peak
*5862	57.59	48.26	68.2	-10.61	34.76	8.71	34.14	210	311	Peak
ANTENNA POLARITY & TEST DISTANCE: VERTICAL AT 3 M										
FREQ. (MHz)	EMISSION LEVEL (dBuV/m)	READ LEVEL (dBuV)	LIMIT (dBuV/m)	MARGIN (dB)	ANTENNA FACTOR (dB/m)	CABLE LOSS (dB)	PREAMP FACTOR (dB)	ANTENNA HEIGHT (cm)	TABLE ANGLE (Degree)	REMARK
*5710	57.39	48.24	68.2	-10.81	34.61	8.65	34.11	239	26	Peak
*5720	56.77	47.61	78.2	-21.43	34.62	8.65	34.11	239	26	Peak
5825	96.02	86.73			34.73	8.69	34.13	239	26	Average
5825	103.45	94.16			34.73	8.69	34.13	239	26	Peak
*5856	57.44	48.12	78.2	-20.76	34.76	8.7	34.14	239	26	Peak
*5868	57.41	48.08	68.2	-10.79	34.76	8.71	34.14	239	26	Peak

REMARKS:

- Emission Level = Read Level + Antenna Factor + Cable Loss - Preamp Factor
Margin value = Emission level – Limit value
- 5825MHz: Fundamental frequency.
- *: Out of restricted band

802.11n (40MHz)

EUT TEST CONDITION		MEASUREMENT DETAIL	
CHANNEL	Channel 38	FREQUENCY RANGE	1GHz ~ 40GHz
INPUT POWER	120Vac, 60 Hz	DETECTOR FUNCTION	Peak (PK) Average (AV)
ENVIRONMENTAL CONDITIONS	25deg. C, 65%RH	TESTED BY	Charles Hsiao

ANTENNA POLARITY & TEST DISTANCE: HORIZONTAL AT 3 M

FREQ. (MHz)	EMISSION LEVEL (dBuV/m)	READ LEVEL (dBuV)	LIMIT (dBuV/m)	MARGIN (dB)	ANTENNA FACTOR (dB/m)	CABLE LOSS (dB)	PREAMP FACTOR (dB)	ANTENNA HEIGHT (cm)	TABLE ANGLE (Degree)	REMARK
5148	49.28	41.03	54	-4.72	34.12	8.13	34	212	301	Average
5148	64.35	56.1	74	-9.65	34.12	8.13	34	212	301	Peak
5190	95.57	87.23			34.15	8.19	34	212	301	Average
5190	103.16	94.82			34.15	8.19	34	212	301	Peak
5370	43.41	34.74	54	-10.59	34.29	8.41	34.03	212	301	Average
5370	57.36	48.69	74	-16.64	34.29	8.41	34.03	212	301	Peak

ANTENNA POLARITY & TEST DISTANCE: VERTICAL AT 3 M

FREQ. (MHz)	EMISSION LEVEL (dBuV/m)	READ LEVEL (dBuV)	LIMIT (dBuV/m)	MARGIN (dB)	ANTENNA FACTOR (dB/m)	CABLE LOSS (dB)	PREAMP FACTOR (dB)	ANTENNA HEIGHT (cm)	TABLE ANGLE (Degree)	REMARK
5148	44.61	36.36	54	-9.39	34.12	8.13	34	213	274	Average
5148	58.63	50.38	74	-15.37	34.12	8.13	34	213	274	Peak
5190	90.06	81.72			34.15	8.19	34	213	274	Average
5190	98.32	89.98			34.15	8.19	34	213	274	Peak
5412	43.27	34.54	54	-10.73	34.33	8.44	34.04	213	274	Average
5412	58.28	49.55	74	-15.72	34.33	8.44	34.04	213	274	Peak

REMARKS:

- Emission Level = Read Level + Antenna Factor + Cable Loss - Preamp Factor
Margin value = Emission level – Limit value
- 5190MHz: Fundamental frequency.



A D T

EUT TEST CONDITION		MEASUREMENT DETAIL	
CHANNEL	Channel 46	FREQUENCY RANGE	1GHz ~ 40GHz
INPUT POWER	120Vac, 60 Hz	DETECTOR FUNCTION	Peak (PK) Average (AV)
ENVIRONMENTAL CONDITIONS	25deg. C, 65%RH	TESTED BY	Charles Hsiao

ANTENNA POLARITY & TEST DISTANCE: HORIZONTAL AT 3 M										
FREQ. (MHz)	EMISSION LEVEL (dBuV/m)	READ LEVEL (dBuV)	LIMIT (dBuV/m)	MARGIN (dB)	ANTENNA FACTOR (dB/m)	CABLE LOSS (dB)	PREAMP FACTOR (dB)	ANTENNA HEIGHT (cm)	TABLE ANGLE (Degree)	REMARK
5080	44.72	36.6	54	-9.28	34.07	8.03	33.98	212	301	Average
5080	58.98	50.86	74	-15.02	34.07	8.03	33.98	212	301	Peak
5230	95.59	87.19			34.19	8.22	34.01	212	301	Average
5230	103.09	94.69			34.19	8.22	34.01	212	301	Peak
5458	43.5	34.68	54	-10.5	34.36	8.51	34.05	212	301	Average
5458	57.73	48.91	74	-16.27	34.36	8.51	34.05	212	301	Peak

ANTENNA POLARITY & TEST DISTANCE: VERTICAL AT 3 M										
FREQ. (MHz)	EMISSION LEVEL (dBuV/m)	READ LEVEL (dBuV)	LIMIT (dBuV/m)	MARGIN (dB)	ANTENNA FACTOR (dB/m)	CABLE LOSS (dB)	PREAMP FACTOR (dB)	ANTENNA HEIGHT (cm)	TABLE ANGLE (Degree)	REMARK
5038	42.98	34.91	54	-11.02	34.04	8	33.97	221	274	Average
5038	57.63	49.56	74	-16.37	34.04	8	33.97	221	274	Peak
5230	90.12	81.72			34.19	8.22	34.01	221	274	Average
5230	98.15	89.75			34.19	8.22	34.01	221	274	Peak
5454	43.3	34.48	54	-10.7	34.36	8.51	34.05	221	274	Average
5454	58.1	49.28	74	-15.9	34.36	8.51	34.05	221	274	Peak

REMARKS:

- Emission Level = Read Level + Antenna Factor + Cable Loss - Preamp Factor
Margin value = Emission level – Limit value
- 5230MHz: Fundamental frequency.



A D T

EUT TEST CONDITION		MEASUREMENT DETAIL	
CHANNEL	Channel 54	FREQUENCY RANGE	1GHz ~ 40GHz
INPUT POWER	120Vac, 60 Hz	DETECTOR FUNCTION	Peak (PK) Average (AV)
ENVIRONMENTAL CONDITIONS	25deg. C, 65%RH	TESTED BY	Charles Hsiao

ANTENNA POLARITY & TEST DISTANCE: HORIZONTAL AT 3 M										
FREQ. (MHz)	EMISSION LEVEL (dBuV/m)	READ LEVEL (dBuV)	LIMIT (dBuV/m)	MARGIN (dB)	ANTENNA FACTOR (dB/m)	CABLE LOSS (dB)	PREAMP FACTOR (dB)	ANTENNA HEIGHT (cm)	TABLE ANGLE (Degree)	REMARK
5054	43.1	35.04	54	-10.9	34.04	8	33.98	203	298	Average
5054	57.74	49.68	74	-16.26	34.04	8	33.98	203	298	Peak
5270	95.42	86.93			34.21	8.29	34.01	203	298	Average
5270	103.73	95.24			34.21	8.29	34.01	203	298	Peak
5384	43.89	35.21	54	-10.11	34.31	8.41	34.04	203	298	Average
5384	57.86	49.18	74	-16.14	34.31	8.41	34.04	203	298	Peak

ANTENNA POLARITY & TEST DISTANCE: VERTICAL AT 3 M										
FREQ. (MHz)	EMISSION LEVEL (dBuV/m)	READ LEVEL (dBuV)	LIMIT (dBuV/m)	MARGIN (dB)	ANTENNA FACTOR (dB/m)	CABLE LOSS (dB)	PREAMP FACTOR (dB)	ANTENNA HEIGHT (cm)	TABLE ANGLE (Degree)	REMARK
5060	42.91	34.81	54	-11.09	34.05	8.03	33.98	210	274	Average
5060	56.66	48.56	74	-17.34	34.05	8.03	33.98	210	274	Peak
5270	90.15	81.66			34.21	8.29	34.01	210	274	Average
5270	97.15	88.66			34.21	8.29	34.01	210	274	Peak
5392	43.27	34.59	54	-10.73	34.31	8.41	34.04	210	274	Average
5392	57.01	48.33	74	-16.99	34.31	8.41	34.04	210	274	Peak

REMARKS:

- Emission Level = Read Level + Antenna Factor + Cable Loss - Preamp Factor
Margin value = Emission level – Limit value
- 5270MHz: Fundamental frequency.



EUT TEST CONDITION		MEASUREMENT DETAIL	
CHANNEL	Channel 62	FREQUENCY RANGE	1GHz ~ 40GHz
INPUT POWER	120Vac, 60 Hz	DETECTOR FUNCTION	Peak (PK) Average (AV)
ENVIRONMENTAL CONDITIONS	25deg. C, 65%RH	TESTED BY	Charles Hsiao

ANTENNA POLARITY & TEST DISTANCE: HORIZONTAL AT 3 M										
FREQ. (MHz)	EMISSION LEVEL (dBuV/m)	READ LEVEL (dBuV)	LIMIT (dBuV/m)	MARGIN (dB)	ANTENNA FACTOR (dB/m)	CABLE LOSS (dB)	PREAMP FACTOR (dB)	ANTENNA HEIGHT (cm)	TABLE ANGLE (Degree)	REMARK
5098	43.21	35.05	54	-10.79	34.08	8.07	33.99	214	300	Average
5098	56.28	48.12	74	-17.72	34.08	8.07	33.99	214	300	Peak
5310	95.48	86.93			34.25	8.32	34.02	214	300	Average
5310	102.96	94.41			34.25	8.32	34.02	214	300	Peak
5350	47.83	39.2	54	-6.17	34.28	8.38	34.03	214	300	Average
5350	60.99	52.36	74	-13.01	34.28	8.38	34.03	214	300	Peak
ANTENNA POLARITY & TEST DISTANCE: VERTICAL AT 3 M										
FREQ. (MHz)	EMISSION LEVEL (dBuV/m)	READ LEVEL (dBuV)	LIMIT (dBuV/m)	MARGIN (dB)	ANTENNA FACTOR (dB/m)	CABLE LOSS (dB)	PREAMP FACTOR (dB)	ANTENNA HEIGHT (cm)	TABLE ANGLE (Degree)	REMARK
5082	42.96	34.8	54	-11.04	34.07	8.07	33.98	217	274	Average
5082	56.79	48.63	74	-17.21	34.07	8.07	33.98	217	274	Peak
5310	89.57	81.02			34.25	8.32	34.02	217	274	Average
5310	96.79	88.24			34.25	8.32	34.02	217	274	Peak
5350	44.57	35.94	54	-9.43	34.28	8.38	34.03	217	274	Average
5350	57.92	49.29	74	-16.08	34.28	8.38	34.03	217	274	Peak

REMARKS:

- Emission Level = Read Level + Antenna Factor + Cable Loss - Preamp Factor
Margin value = Emission level – Limit value
- 5310MHz: Fundamental frequency.

EUT TEST CONDITION		MEASUREMENT DETAIL	
CHANNEL	Channel 102	FREQUENCY RANGE	1GHz ~ 40GHz
INPUT POWER	120Vac, 60 Hz	DETECTOR FUNCTION	Peak (PK) Average (AV)
ENVIRONMENTAL CONDITIONS	25deg. C, 65%RH	TESTED BY	Charles Hsiao

ANTENNA POLARITY & TEST DISTANCE: HORIZONTAL AT 3 M										
FREQ. (MHz)	EMISSION LEVEL (dBuV/m)	READ LEVEL (dBuV)	LIMIT (dBuV/m)	MARGIN (dB)	ANTENNA FACTOR (dB/m)	CABLE LOSS (dB)	PREAMP FACTOR (dB)	ANTENNA HEIGHT (cm)	TABLE ANGLE (Degree)	REMARK
5440	43.47	34.68	54	-10.53	34.35	8.48	34.04	130	340	Average
5440	57.3	48.51	74	-16.7	34.35	8.48	34.04	130	340	Peak
5470	58.57	49.74	68.2	-9.63	34.37	8.51	34.05	130	340	Peak
5510	96.07	87.16			34.4	8.57	34.06	130	340	Average
5510	104.86	95.95			34.4	8.57	34.06	130	340	Peak
5725	56.41	47.25	68.2	-11.79	34.62	8.65	34.11	130	340	Peak
ANTENNA POLARITY & TEST DISTANCE: VERTICAL AT 3 M										
FREQ. (MHz)	EMISSION LEVEL (dBuV/m)	READ LEVEL (dBuV)	LIMIT (dBuV/m)	MARGIN (dB)	ANTENNA FACTOR (dB/m)	CABLE LOSS (dB)	PREAMP FACTOR (dB)	ANTENNA HEIGHT (cm)	TABLE ANGLE (Degree)	REMARK
5456	42.97	34.15	54	-11.03	34.36	8.51	34.05	196	293	Average
5456	56.88	48.06	74	-17.12	34.36	8.51	34.05	196	293	Peak
5470	56.67	47.84	68.2	-11.53	34.37	8.51	34.05	196	293	Peak
5510	94.37	85.46			34.4	8.57	34.06	196	293	Average
5510	102.63	93.72			34.4	8.57	34.06	196	293	Peak
5725	55	45.84	68.2	-13.2	34.62	8.65	34.11	196	293	Peak

REMARKS:

- Emission Level = Read Level + Antenna Factor + Cable Loss - Preamp Factor
Margin value = Emission level – Limit value
- 5510MHz: Fundamental frequency.
- 5470MHz & 5725MHz: Out of restricted band



A D T

EUT TEST CONDITION		MEASUREMENT DETAIL	
CHANNEL	Channel 110	FREQUENCY RANGE	1GHz ~ 40GHz
INPUT POWER	120Vac, 60 Hz	DETECTOR FUNCTION	Peak (PK) Average (AV)
ENVIRONMENTAL CONDITIONS	25deg. C, 65%RH	TESTED BY	Charles Hsiao

ANTENNA POLARITY & TEST DISTANCE: HORIZONTAL AT 3 M										
FREQ. (MHz)	EMISSION LEVEL (dBuV/m)	READ LEVEL (dBuV)	LIMIT (dBuV/m)	MARGIN (dB)	ANTENNA FACTOR (dB/m)	CABLE LOSS (dB)	PREAMP FACTOR (dB)	ANTENNA HEIGHT (cm)	TABLE ANGLE (Degree)	REMARK
5456	43.87	35.05	54	-10.13	34.36	8.51	34.05	172	340	Average
5456	57.03	48.21	74	-16.97	34.36	8.51	34.05	172	340	Peak
5470	57.1	48.27	68.2	-11.1	34.37	8.51	34.05	172	340	Peak
5550	96.54	87.57			34.45	8.59	34.07	172	340	Average
5550	104.8	95.83			34.45	8.59	34.07	172	340	Peak
5725	55.56	46.4	68.2	-12.64	34.62	8.65	34.11	172	340	Peak
ANTENNA POLARITY & TEST DISTANCE: VERTICAL AT 3 M										
FREQ. (MHz)	EMISSION LEVEL (dBuV/m)	READ LEVEL (dBuV)	LIMIT (dBuV/m)	MARGIN (dB)	ANTENNA FACTOR (dB/m)	CABLE LOSS (dB)	PREAMP FACTOR (dB)	ANTENNA HEIGHT (cm)	TABLE ANGLE (Degree)	REMARK
5448	43.37	34.54	54	-10.63	34.36	8.51	34.04	201	293	Average
5448	58.07	49.24	74	-15.93	34.36	8.51	34.04	201	293	Peak
5470	56.52	47.69	68.2	-11.68	34.37	8.51	34.05	201	293	Peak
5550	94.04	85.07			34.45	8.59	34.07	201	293	Average
5550	102.64	93.67			34.45	8.59	34.07	201	293	Peak
5725	56.11	46.95	68.2	-12.09	34.62	8.65	34.11	201	293	Peak

REMARKS:

- Emission Level = Read Level + Antenna Factor + Cable Loss - Preamp Factor
Margin value = Emission level – Limit value
- 5550MHz: Fundamental frequency.
- 5470MHz & 5725MHz: Out of restricted band

EUT TEST CONDITION		MEASUREMENT DETAIL	
CHANNEL	Channel 134	FREQUENCY RANGE	1GHz ~ 40GHz
INPUT POWER	120Vac, 60 Hz	DETECTOR FUNCTION	Peak (PK) Average (AV)
ENVIRONMENTAL CONDITIONS	25deg. C, 65%RH	TESTED BY	Charles Hsiao

ANTENNA POLARITY & TEST DISTANCE: HORIZONTAL AT 3 M										
FREQ. (MHz)	EMISSION LEVEL (dBuV/m)	READ LEVEL (dBuV)	LIMIT (dBuV/m)	MARGIN (dB)	ANTENNA FACTOR (dB/m)	CABLE LOSS (dB)	PREAMP FACTOR (dB)	ANTENNA HEIGHT (cm)	TABLE ANGLE (Degree)	REMARK
*5354	43.14	34.51	54	-10.86	34.28	8.38	34.03	100	338	Average
*5354	57.18	48.55	74	-16.82	34.28	8.38	34.03	100	338	Peak
5470	56.14	47.31	68.2	-12.06	34.37	8.51	34.05	100	338	Peak
5670	96.2	87.1			34.57	8.63	34.1	100	338	Average
*5670	104.32	95.22			34.57	8.63	34.1	100	338	Peak
*5725	55.65	46.49	68.2	-12.55	34.62	8.65	34.11	100	338	Peak
ANTENNA POLARITY & TEST DISTANCE: VERTICAL AT 3 M										
FREQ. (MHz)	EMISSION LEVEL (dBuV/m)	READ LEVEL (dBuV)	LIMIT (dBuV/m)	MARGIN (dB)	ANTENNA FACTOR (dB/m)	CABLE LOSS (dB)	PREAMP FACTOR (dB)	ANTENNA HEIGHT (cm)	TABLE ANGLE (Degree)	REMARK
*5438	43.22	34.43	54	-10.78	34.35	8.48	34.04	250	293	Average
*5438	57.55	48.76	74	-16.45	34.35	8.48	34.04	250	293	Peak
5470	56.43	47.6	68.2	-11.77	34.37	8.51	34.05	250	293	Peak
5670	94.14	85.04			34.57	8.63	34.1	250	293	Average
*5670	102.21	93.11			34.57	8.63	34.1	250	293	Peak
*5725	56.9	47.74	68.2	-11.3	34.62	8.65	34.11	250	293	Peak

REMARKS:

- Emission Level = Read Level + Antenna Factor + Cable Loss - Preamp Factor
Margin value = Emission level – Limit value
- 5670MHz: Fundamental frequency.
- 5470MHz & 5725MHz: Out of restricted band



A D T

EUT TEST CONDITION		MEASUREMENT DETAIL			
CHANNEL	Channel 151	FREQUENCY RANGE	1GHz ~ 40GHz		
INPUT POWER	120Vac, 60 Hz	DETECTOR FUNCTION	Peak (PK) Average (AV)		
ENVIRONMENTAL CONDITIONS	25deg. C, 65%RH	TESTED BY	Charles Hsiao		

ANTENNA POLARITY & TEST DISTANCE: HORIZONTAL AT 3 M										
FREQ. (MHz)	EMISSION LEVEL (dBuV/m)	READ LEVEL (dBuV)	LIMIT (dBuV/m)	MARGIN (dB)	ANTENNA FACTOR (dB/m)	CABLE LOSS (dB)	PREAMP FACTOR (dB)	ANTENNA HEIGHT (cm)	TABLE ANGLE (Degree)	REMARK
*5710	56.72	47.57	68.2	-11.48	34.61	8.65	34.11	201	300	Peak
*5720	59.17	50.01	78.2	-19.03	34.62	8.65	34.11	201	300	Peak
5755	96.18	86.97			34.66	8.66	34.11	201	300	Average
5755	104.13	94.92			34.66	8.66	34.11	201	300	Peak
*5860	56.71	47.39	78.2	-21.49	34.76	8.7	34.14	201	300	Peak
*5868	56.63	47.3	68.2	-11.57	34.76	8.71	34.14	201	300	Peak

ANTENNA POLARITY & TEST DISTANCE: VERTICAL AT 3 M										
FREQ. (MHz)	EMISSION LEVEL (dBuV/m)	READ LEVEL (dBuV)	LIMIT (dBuV/m)	MARGIN (dB)	ANTENNA FACTOR (dB/m)	CABLE LOSS (dB)	PREAMP FACTOR (dB)	ANTENNA HEIGHT (cm)	TABLE ANGLE (Degree)	REMARK
*5714	56.48	47.33	68.2	-11.72	34.61	8.65	34.11	155	265	Peak
*5724	58.67	49.51	78.2	-19.53	34.62	8.65	34.11	155	265	Peak
5755	94.18	84.97			34.66	8.66	34.11	155	265	Average
5755	102.59	93.38			34.66	8.66	34.11	155	265	Peak
*5854	56.71	47.39	78.2	-21.49	34.76	8.7	34.14	155	265	Peak
*5870	56.32	46.99	68.2	-11.88	34.76	8.71	34.14	155	265	Peak

REMARKS:

- Emission Level = Read Level + Antenna Factor + Cable Loss - Preamp Factor
Margin value = Emission level – Limit value
- 5755MHz: Fundamental frequency.
- *: Out of restricted band

EUT TEST CONDITION		MEASUREMENT DETAIL	
CHANNEL	Channel 159	FREQUENCY RANGE	1GHz ~ 40GHz
INPUT POWER	120Vac, 60 Hz	DETECTOR FUNCTION	Peak (PK) Average (AV)
ENVIRONMENTAL CONDITIONS	25deg. C, 65%RH	TESTED BY	Charles Hsiao

ANTENNA POLARITY & TEST DISTANCE: HORIZONTAL AT 3 M										
FREQ. (MHz)	EMISSION LEVEL (dBuV/m)	READ LEVEL (dBuV)	LIMIT (dBuV/m)	MARGIN (dB)	ANTENNA FACTOR (dB/m)	CABLE LOSS (dB)	PREAMP FACTOR (dB)	ANTENNA HEIGHT (cm)	TABLE ANGLE (Degree)	REMARK
*5712	56.91	47.76	68.2	-11.29	34.61	8.65	34.11	201	300	Peak
*5718	57.18	48.02	78.2	-21.02	34.62	8.65	34.11	201	300	Peak
5795	96.94	87.7			34.69	8.68	34.13	201	300	Average
5795	104.45	95.21			34.69	8.68	34.13	201	300	Peak
*5852	55.99	46.69	78.2	-22.21	34.74	8.7	34.14	201	300	Peak
*5868	57.56	48.23	68.2	-10.64	34.76	8.71	34.14	201	300	Peak
ANTENNA POLARITY & TEST DISTANCE: VERTICAL AT 3 M										
FREQ. (MHz)	EMISSION LEVEL (dBuV/m)	READ LEVEL (dBuV)	LIMIT (dBuV/m)	MARGIN (dB)	ANTENNA FACTOR (dB/m)	CABLE LOSS (dB)	PREAMP FACTOR (dB)	ANTENNA HEIGHT (cm)	TABLE ANGLE (Degree)	REMARK
*5706	56.14	46.99	68.2	-12.06	34.61	8.65	34.11	156	251	Peak
*5724	56.76	47.6	78.2	-21.44	34.62	8.65	34.11	156	251	Peak
5795	94.26	85.02			34.69	8.68	34.13	156	251	Average
5795	102.75	93.51			34.69	8.68	34.13	156	251	Peak
*5854	56.8	47.48	78.2	-21.4	34.76	8.7	34.14	156	251	Peak
*5866	56.24	46.91	68.2	-11.96	34.76	8.71	34.14	156	251	Peak

REMARKS:

- Emission Level = Read Level + Antenna Factor + Cable Loss - Preamp Factor
Margin value = Emission level – Limit value
- 5795MHz: Fundamental frequency.
- *: Out of restricted band

802.11ac (80MHz)

EUT TEST CONDITION		MEASUREMENT DETAIL	
CHANNEL	Channel 42	FREQUENCY RANGE	1GHz ~ 40GHz
INPUT POWER	120Vac, 60 Hz	DETECTOR FUNCTION	Peak (PK) Average (AV)
ENVIRONMENTAL CONDITIONS	25deg. C, 65%RH	TESTED BY	Charles Hsiao

ANTENNA POLARITY & TEST DISTANCE: HORIZONTAL AT 3 M

FREQ. (MHz)	EMISSION LEVEL (dBuV/m)	READ LEVEL (dBuV)	LIMIT (dBuV/m)	MARGIN (dB)	ANTENNA FACTOR (dB/m)	CABLE LOSS (dB)	PREAMP FACTOR (dB)	ANTENNA HEIGHT (cm)	TABLE ANGLE (Degree)	REMARK
5146	49.65	41.4	54	-4.35	34.12	8.13	34	215	301	Average
5146	61.62	53.37	74	-12.38	34.12	8.13	34	215	301	Peak
5210	91.78	83.42			34.17	8.19	34	215	301	Average
5210	99.53	91.17			34.17	8.19	34	215	301	Peak
5444	44.07	35.28	54	-9.93	34.35	8.48	34.04	215	301	Average
5444	58.04	49.25	74	-15.96	34.35	8.48	34.04	215	301	Peak

ANTENNA POLARITY & TEST DISTANCE: VERTICAL AT 3 M

FREQ. (MHz)	EMISSION LEVEL (dBuV/m)	READ LEVEL (dBuV)	LIMIT (dBuV/m)	MARGIN (dB)	ANTENNA FACTOR (dB/m)	CABLE LOSS (dB)	PREAMP FACTOR (dB)	ANTENNA HEIGHT (cm)	TABLE ANGLE (Degree)	REMARK
5028	45.42	37.39	54	-8.58	34.03	7.97	33.97	213	274	Average
5028	57.77	49.74	74	-16.23	34.03	7.97	33.97	213	274	Peak
5210	86.48	78.12			34.17	8.19	34	213	274	Average
5210	94.48	86.12			34.17	8.19	34	213	274	Peak
5352	43.8	35.17	54	-10.2	34.28	8.38	34.03	213	274	Average
5352	58.2	49.57	74	-15.8	34.28	8.38	34.03	213	274	Peak

REMARKS:

- Emission Level = Read Level + Antenna Factor + Cable Loss - Preamp Factor
Margin value = Emission level – Limit value
- 5210MHz: Fundamental frequency.



A D T

EUT TEST CONDITION		MEASUREMENT DETAIL	
CHANNEL	Channel 58	FREQUENCY RANGE	1GHz ~ 40GHz
INPUT POWER	120Vac, 60 Hz	DETECTOR FUNCTION	Peak (PK) Average (AV)
ENVIRONMENTAL CONDITIONS	25deg. C, 65%RH	TESTED BY	Charles Hsiao

ANTENNA POLARITY & TEST DISTANCE: HORIZONTAL AT 3 M										
FREQ. (MHz)	EMISSION LEVEL (dBuV/m)	READ LEVEL (dBuV)	LIMIT (dBuV/m)	MARGIN (dB)	ANTENNA FACTOR (dB/m)	CABLE LOSS (dB)	PREAMP FACTOR (dB)	ANTENNA HEIGHT (cm)	TABLE ANGLE (Degree)	REMARK
5108	44.23	36.03	54	-9.77	34.09	8.1	33.99	204	300	Average
5108	56.85	48.65	74	-17.15	34.09	8.1	33.99	204	300	Peak
5290	91.7	83.17			34.23	8.32	34.02	204	300	Average
5290	98.37	89.84			34.23	8.32	34.02	204	300	Peak
5350	46.65	38.02	54	-7.35	34.28	8.38	34.03	204	300	Average
5350	57.76	49.13	74	-16.24	34.28	8.38	34.03	204	300	Peak

ANTENNA POLARITY & TEST DISTANCE: VERTICAL AT 3 M										
FREQ. (MHz)	EMISSION LEVEL (dBuV/m)	READ LEVEL (dBuV)	LIMIT (dBuV/m)	MARGIN (dB)	ANTENNA FACTOR (dB/m)	CABLE LOSS (dB)	PREAMP FACTOR (dB)	ANTENNA HEIGHT (cm)	TABLE ANGLE (Degree)	REMARK
5064	43.75	35.65	54	-10.25	34.05	8.03	33.98	217	274	Average
5064	56.74	48.64	74	-17.26	34.05	8.03	33.98	217	274	Peak
5290	85.67	77.14			34.23	8.32	34.02	217	274	Average
5290	92.9	84.37			34.23	8.32	34.02	217	274	Peak
5360	44.39	35.76	54	-9.61	34.28	8.38	34.03	217	274	Average
5360	57.42	48.79	74	-16.58	34.28	8.38	34.03	217	274	Peak

REMARKS:

- Emission Level = Read Level + Antenna Factor + Cable Loss - Preamp Factor
Margin value = Emission level – Limit value
- 5290MHz: Fundamental frequency.

EUT TEST CONDITION		MEASUREMENT DETAIL	
CHANNEL	Channel 106	FREQUENCY RANGE	1GHz ~ 40GHz
INPUT POWER	120Vac, 60 Hz	DETECTOR FUNCTION	Peak (PK) Average (AV)
ENVIRONMENTAL CONDITIONS	25deg. C, 65%RH	TESTED BY	Charles Hsiao

ANTENNA POLARITY & TEST DISTANCE: HORIZONTAL AT 3 M										
FREQ. (MHz)	EMISSION LEVEL (dBuV/m)	READ LEVEL (dBuV)	LIMIT (dBuV/m)	MARGIN (dB)	ANTENNA FACTOR (dB/m)	CABLE LOSS (dB)	PREAMP FACTOR (dB)	ANTENNA HEIGHT (cm)	TABLE ANGLE (Degree)	REMARK
5436	44.87	36.08	54	-9.13	34.35	8.48	34.04	108	340	Average
5436	57.34	48.55	74	-16.66	34.35	8.48	34.04	108	340	Peak
5470	55.93	47.1	68.2	-12.27	34.37	8.51	34.05	108	340	Peak
5530	95.77	86.84			34.42	8.58	34.07	108	340	Average
5530	103.97	95.04			34.42	8.58	34.07	108	340	Peak
5725	55.9	46.74	68.2	-12.3	34.62	8.65	34.11	108	340	Peak
ANTENNA POLARITY & TEST DISTANCE: VERTICAL AT 3 M										
FREQ. (MHz)	EMISSION LEVEL (dBuV/m)	READ LEVEL (dBuV)	LIMIT (dBuV/m)	MARGIN (dB)	ANTENNA FACTOR (dB/m)	CABLE LOSS (dB)	PREAMP FACTOR (dB)	ANTENNA HEIGHT (cm)	TABLE ANGLE (Degree)	REMARK
5358	44.26	35.63	54	-9.74	34.28	8.38	34.03	195	293	Average
5358	57	48.37	74	-17	34.28	8.38	34.03	195	293	Peak
5470	57.11	48.28	68.2	-11.09	34.37	8.51	34.05	195	293	Peak
5530	93	84.07			34.42	8.58	34.07	195	293	Average
5530	101.68	92.75			34.42	8.58	34.07	195	293	Peak
5725	55.88	46.72	68.2	-12.32	34.62	8.65	34.11	195	293	Peak

REMARKS:

- Emission Level = Read Level + Antenna Factor + Cable Loss - Preamp Factor
Margin value = Emission level – Limit value
- 5530MHz: Fundamental frequency.
- 5470MHz & 5725MHz: Out of restricted band



A D T

EUT TEST CONDITION		MEASUREMENT DETAIL	
CHANNEL	Channel 122	FREQUENCY RANGE	1GHz ~ 40GHz
INPUT POWER	120Vac, 60 Hz	DETECTOR FUNCTION	Peak (PK) Average (AV)
ENVIRONMENTAL CONDITIONS	25deg. C, 65%RH	TESTED BY	Charles Hsiao

ANTENNA POLARITY & TEST DISTANCE: HORIZONTAL AT 3 M										
FREQ. (MHz)	EMISSION LEVEL (dBuV/m)	READ LEVEL (dBuV)	LIMIT (dBuV/m)	MARGIN (dB)	ANTENNA FACTOR (dB/m)	CABLE LOSS (dB)	PREAMP FACTOR (dB)	ANTENNA HEIGHT (cm)	TABLE ANGLE (Degree)	REMARK
5438	43.82	35.03	54	-10.18	34.35	8.48	34.04	115	340	Average
5438	57.63	48.84	74	-16.37	34.35	8.48	34.04	115	340	Peak
5470	55.94	47.11	68.2	-12.26	34.37	8.51	34.05	115	340	Peak
5610	95.61	86.58			34.5	8.61	34.08	115	340	Average
5610	103.21	94.18			34.5	8.61	34.08	115	340	Peak
5725	55.19	46.03	68.2	-13.01	34.62	8.65	34.11	115	340	Peak
ANTENNA POLARITY & TEST DISTANCE: VERTICAL AT 3 M										
FREQ. (MHz)	EMISSION LEVEL (dBuV/m)	READ LEVEL (dBuV)	LIMIT (dBuV/m)	MARGIN (dB)	ANTENNA FACTOR (dB/m)	CABLE LOSS (dB)	PREAMP FACTOR (dB)	ANTENNA HEIGHT (cm)	TABLE ANGLE (Degree)	REMARK
5376	43.38	34.72	54	-10.62	34.29	8.41	34.04	200	293	Average
5376	58.13	49.47	74	-15.87	34.29	8.41	34.04	200	293	Peak
5470	54.62	45.79	68.2	-13.58	34.37	8.51	34.05	200	293	Peak
5610	93.61	84.58			34.5	8.61	34.08	200	293	Average
5610	101.11	92.08			34.5	8.61	34.08	200	293	Peak
5725	56.21	47.05	68.2	-11.99	34.62	8.65	34.11	200	293	Peak

REMARKS:

- Emission Level = Read Level + Antenna Factor + Cable Loss - Preamp Factor
Margin value = Emission level – Limit value
- 5610MHz: Fundamental frequency.
- 5470MHz & 5725MHz: Out of restricted band



EUT TEST CONDITION		MEASUREMENT DETAIL	
CHANNEL	Channel 155	FREQUENCY RANGE	1GHz ~ 40GHz
INPUT POWER	120Vac, 60 Hz	DETECTOR FUNCTION	Peak (PK) Average (AV)
ENVIRONMENTAL CONDITIONS	25deg. C, 65%RH	TESTED BY	Charles Hsiao

ANTENNA POLARITY & TEST DISTANCE: HORIZONTAL AT 3 M										
FREQ. (MHz)	EMISSION LEVEL (dBuV/m)	READ LEVEL (dBuV)	LIMIT (dBuV/m)	MARGIN (dB)	ANTENNA FACTOR (dB/m)	CABLE LOSS (dB)	PREAMP FACTOR (dB)	ANTENNA HEIGHT (cm)	TABLE ANGLE (Degree)	REMARK
*5706	57.07	47.92	68.2	-11.13	34.61	8.65	34.11	201	298	Peak
*5724	59.75	50.59	78.2	-18.45	34.62	8.65	34.11	201	298	Peak
5775	95.66	86.43			34.68	8.67	34.12	201	298	Average
5775	103.95	94.72			34.68	8.67	34.12	201	298	Peak
*5854	57.67	48.35	78.2	-20.53	34.76	8.7	34.14	201	298	Peak
*5864	56.89	47.56	68.2	-11.31	34.76	8.71	34.14	201	298	Peak
ANTENNA POLARITY & TEST DISTANCE: VERTICAL AT 3 M										
FREQ. (MHz)	EMISSION LEVEL (dBuV/m)	READ LEVEL (dBuV)	LIMIT (dBuV/m)	MARGIN (dB)	ANTENNA FACTOR (dB/m)	CABLE LOSS (dB)	PREAMP FACTOR (dB)	ANTENNA HEIGHT (cm)	TABLE ANGLE (Degree)	REMARK
*5708	57.01	47.86	68.2	-11.19	34.61	8.65	34.11	156	251	Peak
*5724	58.34	49.18	78.2	-19.86	34.62	8.65	34.11	156	251	Peak
5775	93.91	84.68			34.68	8.67	34.12	156	251	Average
5775	101.18	91.95			34.68	8.67	34.12	156	251	Peak
*5860	56.8	47.48	78.2	-21.4	34.76	8.7	34.14	156	251	Peak
*5866	56.86	47.53	68.2	-11.34	34.76	8.71	34.14	156	251	Peak

REMARKS:

- Emission Level = Read Level + Antenna Factor + Cable Loss - Preamp Factor
Margin value = Emission level – Limit value
- 5775MHz: Fundamental frequency.
- *: Out of restricted band



9kHz ~ 30MHz DATA:

The amplitude of spurious emissions attenuated more than 20dB below the permissible value is not required to be report.

30MHz ~ 1GHz WORST-CASE DATA:

802.11ac (80MHz)

EUT TEST CONDITION		MEASUREMENT DETAIL	
CHANNEL	Channel 42	FREQUENCY RANGE	30MHz ~ 1GHz
INPUT POWER	120Vac, 60 Hz	DETECTOR FUNCTION	Peak (PK) Quasi-peak (QP)
ENVIRONMENTAL CONDITIONS	25deg. C, 65%RH	TESTED BY	Charles Hsiao

ANTENNA POLARITY & TEST DISTANCE: HORIZONTAL AT 3 M										
FREQ. (MHz)	EMISSION LEVEL (dBuV/m)	READ LEVEL (dBuV)	LIMIT (dBuV/m)	MARGIN (dB)	ANTENNA FACTOR (dB/m)	CABLE LOSS (dB)	PREAMP FACTOR (dB)	ANTENNA HEIGHT (cm)	TABLE ANGLE (Degree)	REMARK
39.18	20.58	40.28	40	-19.42	11.79	0.74	32.23	142	127	Peak
96.15	24.82	46.2	43.5	-18.68	9.38	1.28	32.04	195	284	Peak
187.41	29.6	49.84	43.5	-13.9	10.4	1.61	32.25	145	273	Peak
409.9	18.1	29.98	46	-27.9	17.92	2.41	32.21	130	258	Peak
703.2	24.31	30.15	46	-21.69	23.14	3.11	32.09	144	270	Peak
919.5	28.11	29.96	46	-17.89	25.96	3.53	31.34	126	358	Peak
ANTENNA POLARITY & TEST DISTANCE: VERTICAL AT 3 M										
FREQ. (MHz)	EMISSION LEVEL (dBuV/m)	READ LEVEL (dBuV)	LIMIT (dBuV/m)	MARGIN (dB)	ANTENNA FACTOR (dB/m)	CABLE LOSS (dB)	PREAMP FACTOR (dB)	ANTENNA HEIGHT (cm)	TABLE ANGLE (Degree)	REMARK
55.11	33.76	57.82	40	-6.24	7.27	0.9	32.23	165	257	Peak
98.58	20.28	41.63	43.5	-23.22	9.58	1.28	32.21	103	238	Peak
190.11	22.5	42.74	43.5	-21	10.4	1.61	32.25	178	248	Peak
396.6	18.18	30.11	46	-27.82	17.95	2.34	32.22	139	238	Peak
631.8	23.31	30.45	46	-22.69	22.1	2.93	32.17	145	275	Peak
875.4	25.89	29.23	46	-20.11	24.8	3.49	31.63	176	214	Peak

REMARKS: Emission Level = Read Level + Antenna Factor + Cable Loss - Preamp Factor
Margin value = Emission level – Limit value



802.11n (40MHz)

EUT TEST CONDITION		MEASUREMENT DETAIL	
CHANNEL	Channel 62	FREQUENCY RANGE	30MHz ~ 1GHz
INPUT POWER	120Vac, 60 Hz	DETECTOR FUNCTION	Peak (PK) Quasi-peak (QP)
ENVIRONMENTAL CONDITIONS	25deg. C, 65%RH	TESTED BY	Charles Hsiao

ANTENNA POLARITY & TEST DISTANCE: HORIZONTAL AT 3 M

FREQ. (MHz)	EMISSION LEVEL (dBuV/m)	READ LEVEL (dBuV)	LIMIT (dBuV/m)	MARGIN (dB)	ANTENNA FACTOR (dB/m)	CABLE LOSS (dB)	PREAMP FACTOR (dB)	ANTENNA HEIGHT (cm)	TABLE ANGLE (Degree)	REMARK
38.37	21.87	41.2	40	-18.13	12.16	0.74	32.23	132	225	Peak
98.85	25.11	46.46	43.5	-18.39	9.58	1.28	32.21	145	127	Peak
189.84	29.91	50.15	43.5	-13.59	10.4	1.61	32.25	186	237	Peak
422.5	19.43	31.47	46	-26.57	17.74	2.41	32.19	174	284	Peak
674.5	24.48	30.15	46	-21.52	23.4	3.05	32.12	139	238	Peak
924.4	28.25	29.82	46	-17.75	26.2	3.53	31.3	147	241	Peak

ANTENNA POLARITY & TEST DISTANCE: VERTICAL AT 3 M

FREQ. (MHz)	EMISSION LEVEL (dBuV/m)	READ LEVEL (dBuV)	LIMIT (dBuV/m)	MARGIN (dB)	ANTENNA FACTOR (dB/m)	CABLE LOSS (dB)	PREAMP FACTOR (dB)	ANTENNA HEIGHT (cm)	TABLE ANGLE (Degree)	REMARK
31.62	30.3	45.25	40	-9.7	16.57	0.74	32.26	135	127	Peak
96.96	19.26	40.62	43.5	-24.24	9.46	1.28	32.1	186	341	Peak
190.92	22.36	42.61	43.5	-21.14	10.4	1.61	32.26	124	127	Peak
470.8	19.16	30.01	46	-26.84	18.72	2.56	32.13	114	186	Peak
874	26.46	29.87	46	-19.54	24.8	3.44	31.65	108	237	Peak
952.4	28.82	30.09	46	-17.18	26.12	3.67	31.06	124	127	Peak

REMARKS: Emission Level = Read Level + Antenna Factor + Cable Loss - Preamp Factor

Margin value = Emission level – Limit value



A D T

802.11a

EUT TEST CONDITION		MEASUREMENT DETAIL	
CHANNEL	Channel 100	FREQUENCY RANGE	30MHz ~ 1GHz
INPUT POWER	120Vac, 60 Hz	DETECTOR FUNCTION	Peak (PK) Quasi-peak (QP)
ENVIRONMENTAL CONDITIONS	25deg. C, 65%RH	TESTED BY	Charles Hsiao

ANTENNA POLARITY & TEST DISTANCE: HORIZONTAL AT 3 M

FREQ. (MHz)	EMISSION LEVEL (dBuV/m)	READ LEVEL (dBuV)	LIMIT (dBuV/m)	MARGIN (dB)	ANTENNA FACTOR (dB/m)	CABLE LOSS (dB)	PREAMP FACTOR (dB)	ANTENNA HEIGHT (cm)	TABLE ANGLE (Degree)	REMARK
97.77	24.72	46.09	43.5	-18.78	9.5	1.28	32.15	105	217	Peak
191.73	29.28	49.47	43.5	-14.22	10.46	1.61	32.26	139	241	Peak
251.4	17.12	34.24	46	-28.88	13.04	1.94	32.1	125	271	Peak
478.5	19.22	29.87	46	-26.78	18.91	2.56	32.12	100	132	Peak
738.2	24.81	30.48	46	-21.19	23.3	3.16	32.13	126	230	Peak
902.7	29.31	32	46	-16.69	25.24	3.53	31.46	175	124	Peak

ANTENNA POLARITY & TEST DISTANCE: VERTICAL AT 3 M

FREQ. (MHz)	EMISSION LEVEL (dBuV/m)	READ LEVEL (dBuV)	LIMIT (dBuV/m)	MARGIN (dB)	ANTENNA FACTOR (dB/m)	CABLE LOSS (dB)	PREAMP FACTOR (dB)	ANTENNA HEIGHT (cm)	TABLE ANGLE (Degree)	REMARK
49.98	24.49	48.01	40	-15.51	7.8	0.9	32.22	128	124	Peak
98.04	20.33	41.66	43.5	-23.17	9.54	1.28	32.15	139	327	Peak
193.62	22.32	42.41	43.5	-21.18	10.57	1.61	32.27	135	234	Peak
475.7	19.18	29.84	46	-26.82	18.9	2.56	32.12	145	127	Peak
634.6	22.8	29.93	46	-23.2	22.1	2.93	32.16	103	235	Peak
853	25.97	30.51	46	-20.03	23.8	3.44	31.78	139	237	Peak

REMARKS: Emission Level = Read Level + Antenna Factor + Cable Loss - Preamp Factor

Margin value = Emission level – Limit value



A D T

802.11a

EUT TEST CONDITION		MEASUREMENT DETAIL	
CHANNEL	Channel 149	FREQUENCY RANGE	30MHz ~ 1GHz
INPUT POWER	120Vac, 60 Hz	DETECTOR FUNCTION	Peak (PK) Quasi-peak (QP)
ENVIRONMENTAL CONDITIONS	25deg. C, 65%RH	TESTED BY	Charles Hsiao

ANTENNA POLARITY & TEST DISTANCE: HORIZONTAL AT 3 M

FREQ. (MHz)	EMISSION LEVEL (dBuV/m)	READ LEVEL (dBuV)	LIMIT (dBuV/m)	MARGIN (dB)	ANTENNA FACTOR (dB/m)	CABLE LOSS (dB)	PREAMP FACTOR (dB)	ANTENNA HEIGHT (cm)	TABLE ANGLE (Degree)	REMARK
96.96	24.15	45.51	43.5	-19.35	9.46	1.28	32.1	132	326	Peak
193.89	29.26	49.35	43.5	-14.24	10.57	1.61	32.27	124	128	Peak
268.14	16.14	32.77	46	-29.86	13.54	1.94	32.11	103	245	Peak
433	18.56	30.43	46	-27.44	17.81	2.49	32.17	105	175	Peak
625.5	22.68	29.82	46	-23.32	22.1	2.93	32.17	136	234	Peak
836.9	25.27	30.1	46	-20.73	23.65	3.38	31.86	102	127	Peak

ANTENNA POLARITY & TEST DISTANCE: VERTICAL AT 3 M

FREQ. (MHz)	EMISSION LEVEL (dBuV/m)	READ LEVEL (dBuV)	LIMIT (dBuV/m)	MARGIN (dB)	ANTENNA FACTOR (dB/m)	CABLE LOSS (dB)	PREAMP FACTOR (dB)	ANTENNA HEIGHT (cm)	TABLE ANGLE (Degree)	REMARK
33.24	37.41	53.45	40	-2.59	15.47	0.74	32.25	104	128	Peak
159.6	17.44	37.45	43.5	-26.06	10.74	1.52	32.27	145	212	Peak
193.08	22.75	42.9	43.5	-20.75	10.51	1.61	32.27	139	238	Peak
456.1	19.21	30.68	46	-26.79	18.18	2.49	32.14	139	328	Peak
692.7	24.27	30.07	46	-21.73	23.19	3.11	32.1	105	128	Peak
915.3	27.34	29.46	46	-18.66	25.72	3.53	31.37	145	112	Peak

REMARKS: Emission Level = Read Level + Antenna Factor + Cable Loss - Preamp Factor

Margin value = Emission level – Limit value

4.2 Conducted Emission Measurement

4.2.1 Limits of Conducted Emission Measurement

Frequency (MHz)	Conducted Limit (dBuV)	
	Quasi-peak	Average
0.15 - 0.5	66 - 56	56 - 46
0.50 - 5.0	56	46
5.0 - 30.0	60	50

Note: 1. The lower limit shall apply at the transition frequencies.

2. The limit decreases in line with the logarithm of the frequency in the range of 0.15 to 0.50MHz.

4.2.2 Test Instruments

Description & Manufacturer	Model No.	Serial No.	Date Of Calibration	Due Date Of Calibration
Test Receiver ROHDE & SCHWARZ	ESCI	100613	Nov. 11, 2014	Nov. 10, 2015
RF signal cable (with 10dB PAD) Woken	5D-FB	Cable-cond1-01	Dec. 26, 2014	Dec. 25, 2015
LISN ROHDE & SCHWARZ (EUT)	ESH3-Z5	835239/001	Feb. 26, 2015	Feb. 25, 2016
LISN ROHDE & SCHWARZ (Peripheral)	ESH3-Z5	100311	Jul. 24, 2015	Jul. 23, 2016
Software ADT	BV ADT_Cond_ V7.3.7.3	NA	NA	NA

- Note:**
1. The calibration interval of the above test instruments is 12 months and the calibrations are traceable to NML/ROC and NIST/USA.
 2. The test was performed in HwaYa Shielded Room 1.
 3. The VCCI Site Registration No. is C-2040.

4.2.3 Test Procedures

- a. The EUT was placed 0.4 meters from the conducting wall of the shielded room with EUT being connected to the power mains through a line impedance stabilization network (LISN). Other support units were connected to the power mains through another LISN. The two LISNs provide 50 ohm/ 50uH of coupling impedance for the measuring instrument.
- b. Both lines of the power mains connected to the EUT were checked for maximum conducted interference.
- c. The frequency range from 150kHz to 30MHz was searched. Emission levels under (Limit - 20dB) was not recorded.

NOTE: All modes of operation were investigated and the worst-case emissions are reported.

4.2.4 Deviation from Test Standard

No deviation.

4.2.5 Test Setup

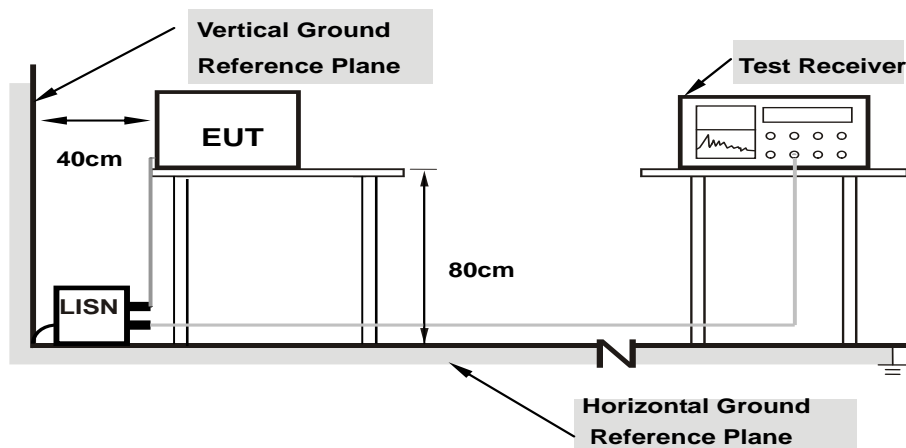

- Note:**
- 1.Support units were connected to second LISN.
 - 2.Both of LISNs (AMN) are 80 cm from EUT and at least 80 from other units and other metal planes

For the actual test configuration, please refer to the attached file (Test Setup Photo).

4.2.6 EUT Operating Conditions

Same as 4.1.6.

4.2.7 Test Results

Frequency Range	150kHz ~ 30MHz	Detector Function & Resolution Bandwidth	Quasi-Peak (QP) / Average (AV)
Input Power	120Vac, 60Hz	Environmental Conditions	25°C, 65%RH
Tested by	Toby Tian	Test Date	2015/8/29

Phase Of Power : Line (L)										
No	Frequency (MHz)	Correction Factor (dB)	Reading Value (dBuV)		Emission Level (dBuV)		Limit (dBuV)		Margin (dB)	
			Q.P.	AV.	Q.P.	AV.	Q.P.	AV.	Q.P.	AV.
1	0.15391	0.05	41.27	30.11	41.32	30.16	65.79	55.79	-24.47	-25.63
2	0.19978	0.06	35.92	25.59	35.98	25.65	63.62	53.62	-27.64	-27.97
3	0.42445	0.06	35.19	23.90	35.25	23.96	57.36	47.36	-22.11	-23.40
4	0.50972	0.06	46.11	38.47	46.17	38.53	56.00	46.00	-9.83	-7.47
5	0.83425	0.07	37.38	29.90	37.45	29.97	56.00	46.00	-18.55	-16.03
6	2.36697	0.13	35.70	26.11	35.83	26.24	56.00	46.00	-20.17	-19.76

Remarks:

1. Q.P. and AV. are abbreviations of quasi-peak and average individually.
2. The emission levels of other frequencies were very low against the limit.
3. Margin value = Emission level – Limit value
4. Correction factor = Insertion loss + Cable loss
5. Emission Level = Correction Factor + Reading Value

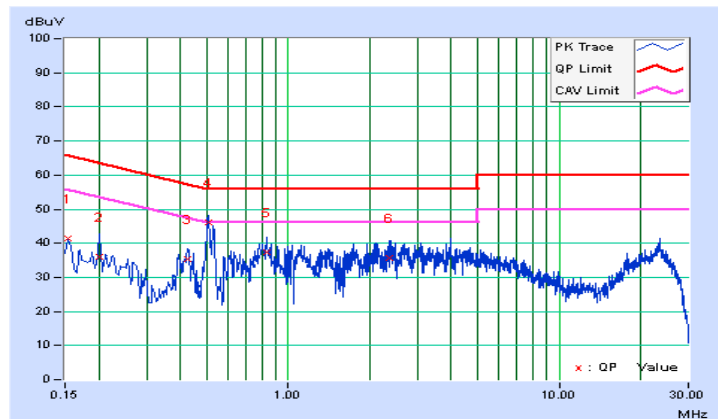

Frequency Range	150kHz ~ 30MHz	Detector Function & Resolution Bandwidth	Quasi-Peak (QP) / Average (AV)
Input Power	120Vac, 60Hz	Environmental Conditions	25°C, 65%RH
Tested by	Toby Tian	Test Date	2015/8/29

Phase Of Power : Neutral (N)										
No	Frequency (MHz)	Correction Factor (dB)	Reading Value (dBuV)		Emission Level (dBuV)		Limit (dBuV)		Margin (dB)	
			Q.P.	AV.	Q.P.	AV.	Q.P.	AV.	Q.P.	AV.
1	0.15000	0.05	41.43	29.74	41.48	29.79	66.00	56.00	-24.52	-26.21
2	0.22429	0.05	34.91	21.55	34.96	21.60	62.66	52.66	-27.70	-31.06
3	0.41233	0.06	31.69	20.77	31.75	20.83	57.60	47.60	-25.85	-26.77
4	0.51363	0.06	38.03	26.13	38.09	26.19	56.00	46.00	-17.91	-19.81
5	0.79906	0.07	31.18	19.87	31.25	19.94	56.00	46.00	-24.75	-26.06
6	3.07468	0.15	32.38	22.61	32.53	22.76	56.00	46.00	-23.47	-23.24

Remarks:

1. Q.P. and AV. are abbreviations of quasi-peak and average individually.
2. The emission levels of other frequencies were very low against the limit.
3. Margin value = Emission level – Limit value
4. Correction factor = Insertion loss + Cable loss
5. Emission Level = Correction Factor + Reading Value

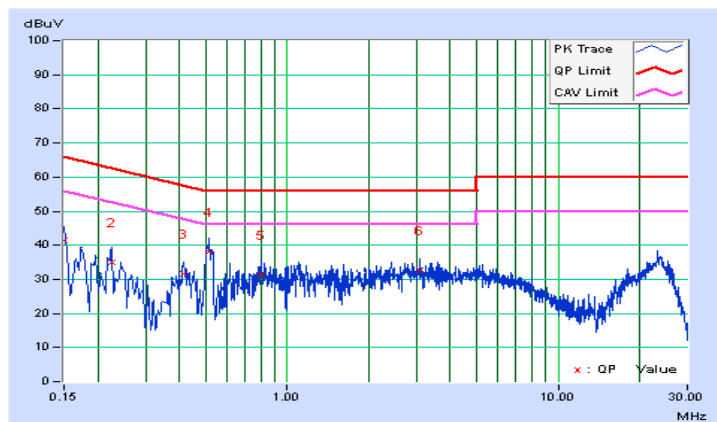

4.3 Transmit Power Measurement

4.3.1 Limits of Transmit Power Measurement

Operation Band	EUT Category		LIMIT
U-NII-1		Outdoor Access Point	1 Watt (30 dBm) (Max. e.i.r.p \leq 125mW(21 dBm) at any elevation angle above 30 degrees as measured from the horizon)
		Fixed point-to-point Access Point	1 Watt (30 dBm)
		Indoor Access Point	1 Watt (30 dBm)
	√	Mobile and Portable client device	250mW (24 dBm)
U-NII-2A		√	250mW (24 dBm) or 11 dBm+10 log B*
U-NII-2C		√	250mW (24 dBm) or 11 dBm+10 log B*
U-NII-3		√	1 Watt (30 dBm)

*B is the 26 dB emission bandwidth in megahertz

Per KDB 662911 Method of conducted output power measurement on IEEE 802.11 devices,

Array Gain = 0 dB (i.e., no array gain) for $N_{ANT} \leq 4$;

Array Gain = 0 dB (i.e., no array gain) for channel widths ≥ 40 MHz for any N_{ANT} ;

Array Gain = $5 \log(N_{ANT}/N_{SS})$ dB or 3 dB, whichever is less for 20-MHz channel widths with $N_{ANT} \geq 5$.

For power measurements on all other devices: Array Gain = $10 \log(N_{ANT}/N_{SS})$ dB.

4.3.2 Test Setup

FOR POWER OUTPUT MEASUREMENT

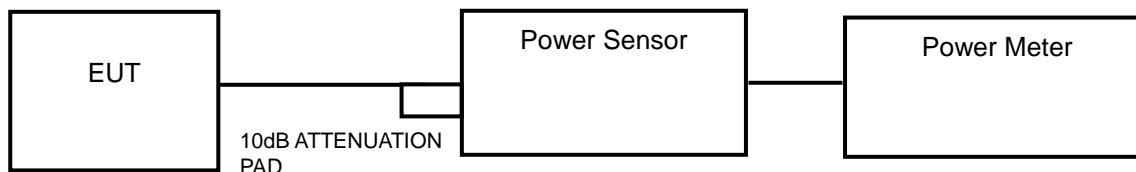

or

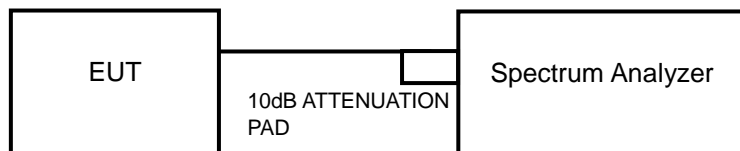

FOR 26dB BANDWIDTH

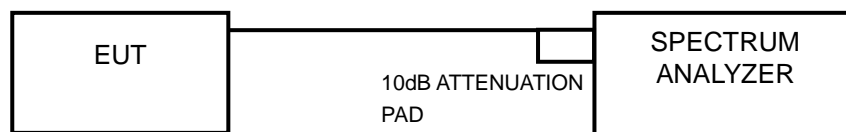

4.3.3 Test Instruments

Refer to section 4.1.2 to get information of above instrument.

4.3.4 Test Procedure

FOR AVERAGE POWER MEASUREMENT

<802.11a, 802.11n (20MHz), 802.11n (40MHz)>

Method PM is used to perform output power measurement, trigger and gating function of wide band power meter is enabled to measure max output power of TX on burst. Duty factor is not added to measured value.

<802.11ac (80MHz)>

Method SA-1 is used to perform output power measurement, trigger and gating function of spectrum analyzer is enabled to measure max output power of TX on burst. Duty factor is not added to measured value.

FOR 26dB BANDWIDTH

- 1) Set RBW = approximately 1% of the emission bandwidth.
- 2) Set the VBW > RBW.
- 3) Detector = Peak.
- 4) Trace mode = max hold.
- 5) Measure the maximum width of the emission that is 26 dB down from the peak of the emission. Compare this with the RBW setting of the analyzer. Readjust RBW and repeat measurement as needed until the RBW/EBW ratio is approximately 1%.

4.3.5 Deviation from Test Standard

No deviation.

4.3.6 EUT Operating Conditions

The software provided by client to enable the EUT under transmission condition continuously at lowest, middle and highest channel frequencies individually.

4.3.7 Test Result

POWER OUTPUT:

802.11a

Channel	Frequency (MHz)	Maximum Conducted Power (mW)	Maximum Conducted Power (dBm)	Power Limit (dBm)	Pass / Fail
36	5180	21.88	13.40	24	Pass
44	5220	21.18	13.26	24	Pass
48	5240	20.70	13.16	24	Pass
52	5260	20.65	13.15	24	Pass
60	5300	20.70	13.16	24	Pass
64	5320	20.61	13.14	24	Pass
100	5500	21.63	13.35	24	Pass
116	5580	21.83	13.39	24	Pass
140	5700	20.09	13.03	24	Pass
149	5745	21.93	13.41	30	Pass
157	5785	21.58	13.34	30	Pass
165	5825	21.28	13.28	30	Pass

NOTE:

For U-NII-2A, U-NII-2C Band:

1. $11\text{dBm} + 10\log(22.67) = 24.55\text{ dBm} > 24\text{dBm}$.
2. $11\text{dBm} + 10\log(22.36) = 24.49\text{ dBm} > 24\text{dBm}$.
3. $11\text{dBm} + 10\log(22.53) = 24.53\text{ dBm} > 24\text{dBm}$.
4. $11\text{dBm} + 10\log(22.73) = 24.57\text{ dBm} > 24\text{dBm}$.
5. $11\text{dBm} + 10\log(22.76) = 24.57\text{ dBm} > 24\text{dBm}$.
6. $11\text{dBm} + 10\log(22.64) = 24.55\text{ dBm} > 24\text{dBm}$.

802.11n (20MHz)

Channel	Frequency (MHz)	Maximum Conducted Power (mW)	Maximum Conducted Power (dBm)	Power Limit (dBm)	Pass / Fail
36	5180	17.42	12.41	24	Pass
44	5220	17.06	12.32	24	Pass
48	5240	16.87	12.27	24	Pass
52	5260	16.94	12.29	24	Pass
60	5300	16.41	12.15	24	Pass
64	5320	16.44	12.16	24	Pass
100	5500	17.46	12.42	24	Pass
116	5580	16.41	12.15	24	Pass
140	5700	15.38	11.87	24	Pass
149	5745	17.46	12.42	30	Pass
157	5785	17.22	12.36	30	Pass
165	5825	16.90	12.28	30	Pass

NOTE:
For U-NII-2A, U-NII-2C Band:

1. $11\text{dBm} + 10\log(22.88) = 24.59\text{ dBm} > 24\text{dBm}$.
2. $11\text{dBm} + 10\log(22.78) = 24.58\text{ dBm} > 24\text{dBm}$.
3. $11\text{dBm} + 10\log(23.20) = 24.65\text{ dBm} > 24\text{dBm}$.
4. $11\text{dBm} + 10\log(22.84) = 24.59\text{ dBm} > 24\text{dBm}$.
5. $11\text{dBm} + 10\log(22.54) = 24.53\text{ dBm} > 24\text{dBm}$.
6. $11\text{dBm} + 10\log(22.87) = 24.59\text{ dBm} > 24\text{dBm}$.

802.11n (40MHz)

Channel	Frequency (MHz)	Maximum Conducted Power (mW)	Maximum Conducted Power (dBm)	Power Limit (dBm)	Pass / Fail
38	5190	16.33	12.13	24	Pass
46	5230	16.00	12.04	24	Pass
54	5270	16.37	12.14	24	Pass
62	5310	15.45	11.89	24	Pass
102	5510	16.67	12.22	24	Pass
110	5550	16.37	12.14	24	Pass
134	5670	15.56	11.92	24	Pass
151	5755	16.33	12.13	30	Pass
159	5795	16.79	12.25	30	Pass

NOTE:
For U-NII-2A, U-NII-2C Band:

1. $11\text{dBm} + 10\log(45.78) = 27.61\text{ dBm} > 24\text{dBm}$.
2. $11\text{dBm} + 10\log(46.19) = 27.65\text{ dBm} > 24\text{dBm}$.
3. $11\text{dBm} + 10\log(46.26) = 27.65\text{ dBm} > 24\text{dBm}$.
4. $11\text{dBm} + 10\log(45.72) = 27.60\text{ dBm} > 24\text{dBm}$.
5. $11\text{dBm} + 10\log(46.01) = 27.63\text{ dBm} > 24\text{dBm}$.

802.11ac (80MHz)

Channel	Frequency (MHz)	Maximum Conducted Power (mW)	Maximum Conducted Power (dBm)	Power Limit (dBm)	Pass / Fail
42	5210	9.18	9.63	24	Pass
58	5290	10.91	10.38	24	Pass
106	5530	10.94	10.39	24	Pass
122	5610	9.38	9.72	24	Pass
155	5775	9.46	9.76	30	Pass

NOTE:
For U-NII-2A, U-NII-2C Band:

1. $11\text{dBm} + 10\log(85.77) = 30.33\text{ dBm} > 24\text{dBm}$.
2. $11\text{dBm} + 10\log(84.69) = 30.28\text{ dBm} > 24\text{dBm}$.
3. $11\text{dBm} + 10\log(85.61) = 30.33\text{ dBm} > 24\text{dBm}$.

26dB BANDWIDTH:
802.11a

Channel	Frequency (MHz)	26dBc Bandwidth (MHz)	Pass / Fail
36	5180	22.79	Pass
44	5220	22.75	Pass
48	5240	22.53	Pass
52	5260	22.67	Pass
60	5300	22.36	Pass
64	5320	22.53	Pass
100	5500	22.73	Pass
116	5580	22.76	Pass
140	5700	22.64	Pass

802.11n (20MHz)

Channel	Frequency (MHz)	26dBc Bandwidth (MHz)	Pass / Fail
36	5180	23.10	Pass
44	5220	22.83	Pass
48	5240	23.15	Pass
52	5260	22.88	Pass
60	5300	22.78	Pass
64	5320	23.20	Pass
100	5500	22.84	Pass
116	5580	22.54	Pass
140	5700	22.87	Pass

802.11n (40MHz)

Channel	Frequency (MHz)	26dBc Bandwidth (MHz)	Pass / Fail
38	5190	45.65	Pass
46	5230	46.20	Pass
54	5270	45.78	Pass
62	5310	46.19	Pass
102	5510	46.26	Pass
110	5550	45.72	Pass
134	5670	46.01	Pass

802.11ac (80MHz)

Channel	Frequency (MHz)	26dBc Bandwidth (MHz)	Pass / Fail
42	5210	85.72	Pass
58	5290	85.77	Pass
106	5530	84.69	Pass
122	5610	85.61	Pass

Spectrum Plot of Worst Value

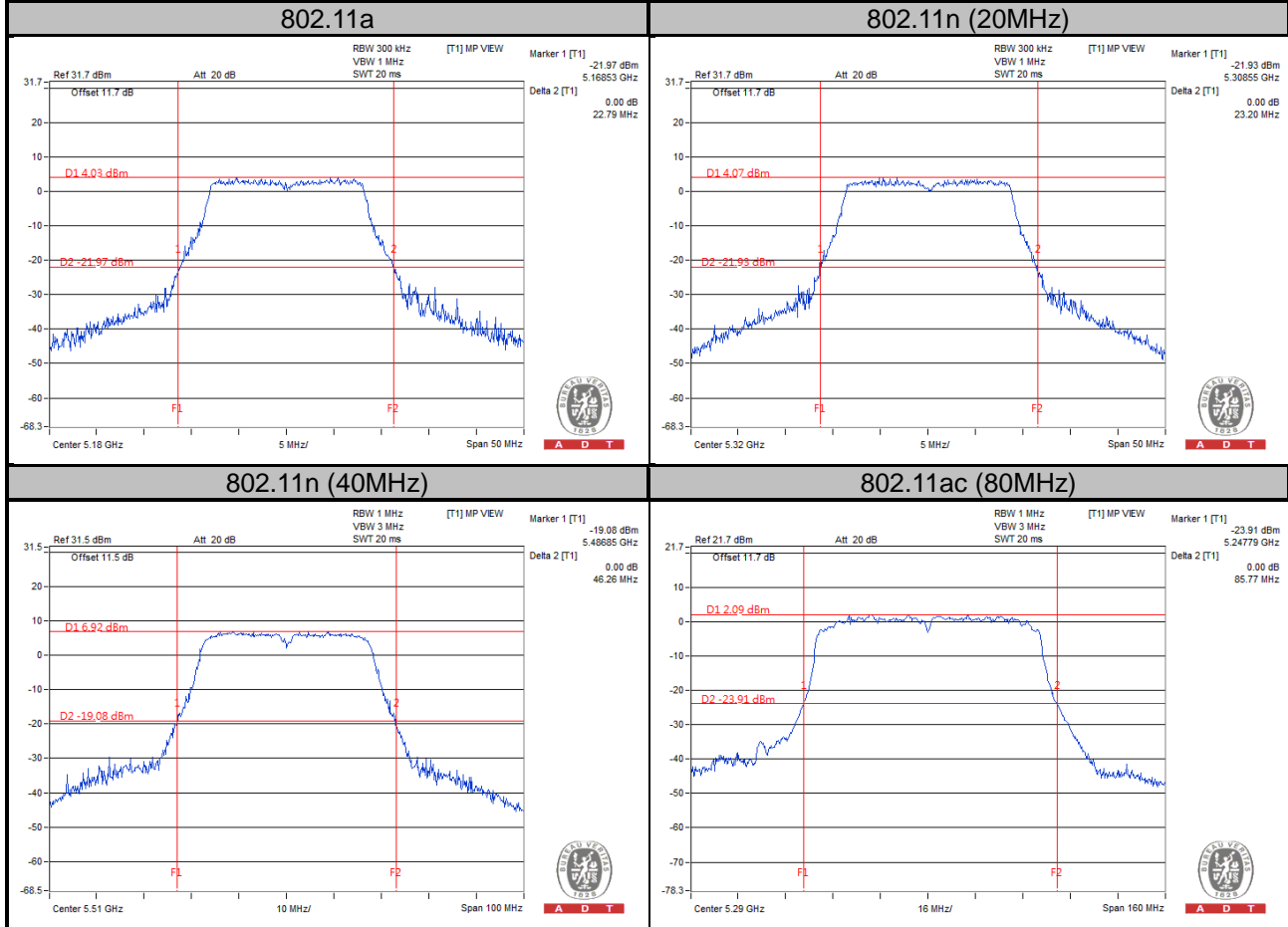

4.4 Peak Power Spectral Density Measurement

4.4.1 Limits of Peak Power Spectral Density Measurement

Operation Band	EUT Category		Limit
U-NII-1		Outdoor Access Point	17dBm/ MHz
		Fixed point-to-point Access Point	
		Indoor Access Point	
	√	Mobile and Portable client device	11dBm/ MHz
U-NII-2A	√		11dBm/ MHz
U-NII-2C	√		11dBm/ MHz
U-NII-3	√		30dBm/ 500MHz

4.4.2 Test Setup

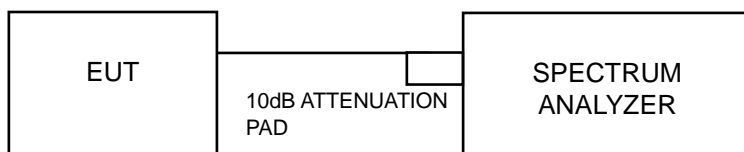

4.4.3 Test Instruments

Refer to section 4.1.3 to get information of above instrument.

4.4.4 Test Procedures

For U-NII-1, U-NII-2A, U-NII-2C band:

Using method SA-2

1. Set span to encompass the entire emission bandwidth (EBW) of the signal.
2. Set RBW = 1 MHz, Set VBW \geq 3 MHz, Detector = RMS
3. Sweep time = auto, trigger set to "free run".
4. Trace average at least 100 traces in power averaging mode.
5. Record the max value and add 10 log (1/duty cycle)

※For U-NII-3:

1. Set span to encompass the entire emission bandwidth (EBW) of the signal.
2. Set RBW = 300 kHz, Set VBW \geq 1 MHz, Detector = RMS
3. Use the peak marker function to determine the maximum power level in any 300 kHz band segment within the fundamental EBW.
4. Scale the observed power level to an equivalent value in 500 kHz by adjusting (reducing) the measured power by a bandwidth correction factor (BWCF) where $BWCF = 10\log(500 \text{ kHz}/300\text{kHz})$
5. Sweep time = auto, trigger set to "free run".
6. Trace average at least 100 traces in power averaging mode.
7. Record the max value and add 10 log (1/duty cycle)

4.4.5 Deviation from Test Standard

No deviation.

4.4.6 EUT Operating Conditions

Same as Item 4.3.6.

4.4.7 Test Results

802.11a

Channel	Frequency (MHz)	PSD w/o Duty Factor (dBm)	Duty Factor	PSD with Duty Factor (dBm)	Maximum Limit (dBm)	Pass / Fail
36	5180	-0.05	0.80	0.75	11	Pass
44	5220	0.10	0.80	0.90	11	Pass
48	5240	0.36	0.80	1.16	11	Pass
52	5260	0.44	0.80	1.24	11	Pass
60	5300	0.70	0.80	1.50	11	Pass
64	5320	0.76	0.80	1.56	11	Pass
100	5500	1.53	0.80	2.33	11	Pass
116	5580	1.11	0.80	1.91	11	Pass
140	5700	0.16	0.80	0.96	11	Pass

NOTE: Refer to section 3.3 for duty cycle spectrum plot.

802.11n (20MHz)

Channel	Frequency (MHz)	PSD w/o Duty Factor (dBm)	Duty Factor	PSD with Duty Factor (dBm)	Maximum Limit (dBm)	Pass / Fail
36	5180	-1.80	0.83	-0.97	11	Pass
44	5220	-1.50	0.83	-0.67	11	Pass
48	5240	-0.96	0.83	-0.13	11	Pass
52	5260	-0.71	0.83	0.12	11	Pass
60	5300	-0.57	0.83	0.26	11	Pass
64	5320	-0.39	0.83	0.44	11	Pass
100	5500	0.27	0.83	1.10	11	Pass
116	5580	-0.27	0.83	0.56	11	Pass
140	5700	-1.24	0.83	-0.41	11	Pass

NOTE: Refer to section 3.3 for duty cycle spectrum plot.

802.11n (40MHz)

Channel	Frequency (MHz)	PSD w/o Duty Factor (dBm)	Duty Factor	PSD with Duty Factor (dBm)	Maximum Limit (dBm)	Pass / Fail
38	5190	-5.10	1.49	-3.61	11	Pass
46	5230	-4.72	1.49	-3.23	11	Pass
54	5270	-4.44	1.49	-2.95	11	Pass
62	5310	-4.37	1.49	-2.88	11	Pass
102	5510	-3.58	1.49	-2.09	11	Pass
110	5550	-3.77	1.49	-2.28	11	Pass
134	5670	-4.70	1.49	-3.21	11	Pass

NOTE: Refer to section 3.3 for duty cycle spectrum plot.

802.11ac (80MHz)

Channel	Frequency (MHz)	PSD w/o Duty Factor (dBm)	Duty Factor	PSD with Duty Factor (dBm)	Maximum Limit (dBm)	Pass / Fail
42	5210	-12.61	2.57	-10.04	11	Pass
58	5290	-12.22	2.57	-9.65	11	Pass
106	5530	-12.52	2.57	-9.95	11	Pass
122	5610	-12.96	2.57	-10.39	11	Pass

NOTE: Refer to section 3.3 for duty cycle spectrum plot.

Spectrum Plot of Worst Value

802.11a

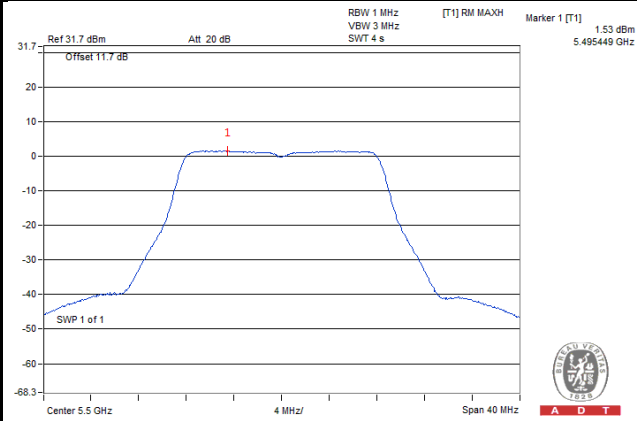

802.11n (20MHz)

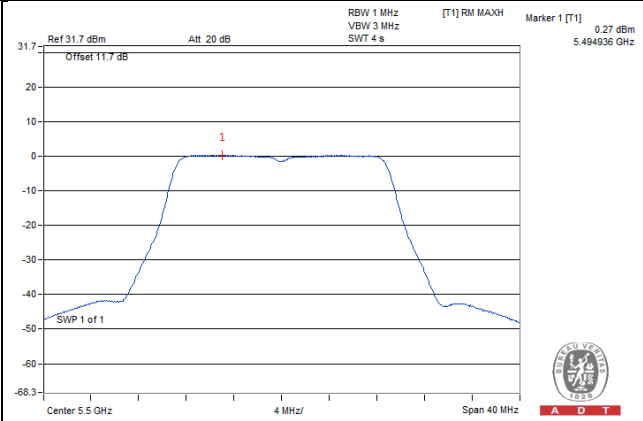

802.11n (40MHz)

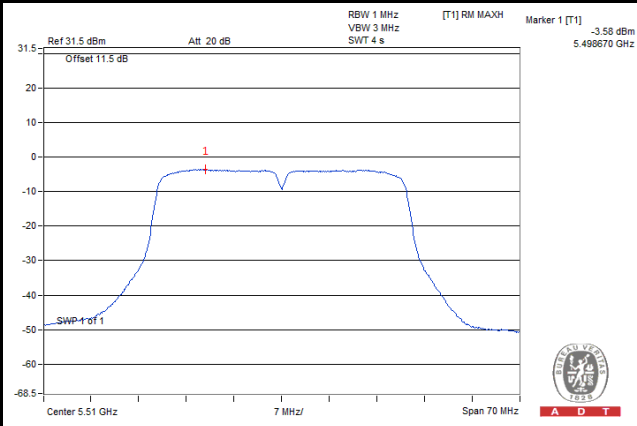

802.11ac (80MHz)

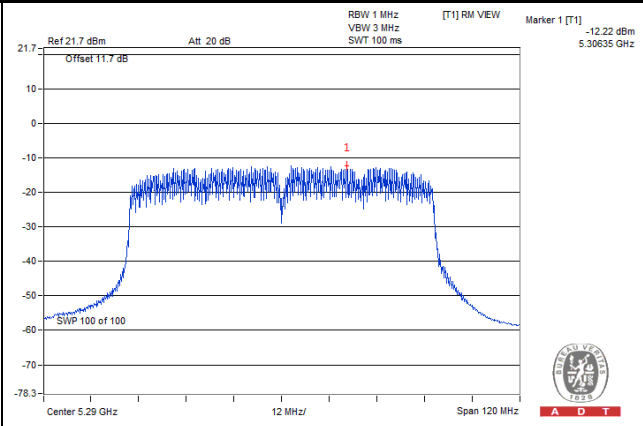

For U-NII-3 Band

802.11a

Channel	Frequency (MHz)	PSD w/o Duty Factor (dBm)	Duty Factor	PSD with Duty Factor (dBm)	Limit (dBm/500kHz)	Pass / Fail
149	5745	-2.61	0.80	-1.81	30	Pass
157	5785	-2.44	0.80	-1.64	30	Pass
165	5825	-2.12	0.80	-1.32	30	Pass

NOTE: Refer to section 3.3 for duty cycle spectrum plot.

802.11n (20MHz)

Channel	Frequency (MHz)	PSD w/o Duty Factor (dBm)	Duty Factor	PSD with Duty Factor (dBm)	Limit (dBm/500kHz)	Pass / Fail
149	5745	-4.15	0.83	-3.32	30	Pass
157	5785	-3.88	0.83	-3.05	30	Pass
165	5825	-3.51	0.83	-2.68	30	Pass

NOTE: Refer to section 3.3 for duty cycle spectrum plot.

802.11n (40MHz)

Channel	Frequency (MHz)	PSD w/o Duty Factor (dBm)	Duty Factor	PSD with Duty Factor (dBm)	Limit (dBm/500kHz)	Pass / Fail
151	5755	-7.45	1.49	-5.96	30	Pass
159	5795	-7.35	1.49	-5.86	30	Pass

NOTE: Refer to section 3.3 for duty cycle spectrum plot.

802.11ac (80MHz)

Channel	Frequency (MHz)	PSD w/o Duty Factor (dBm)	Duty Factor	PSD with Duty Factor (dBm)	Limit (dBm/500kHz)	Pass / Fail
155	5775	-13.36	2.57	-10.79	30	Pass

NOTE: Refer to section 3.3 for duty cycle spectrum plot.

Spectrum Plot of Worst Value

802.11a

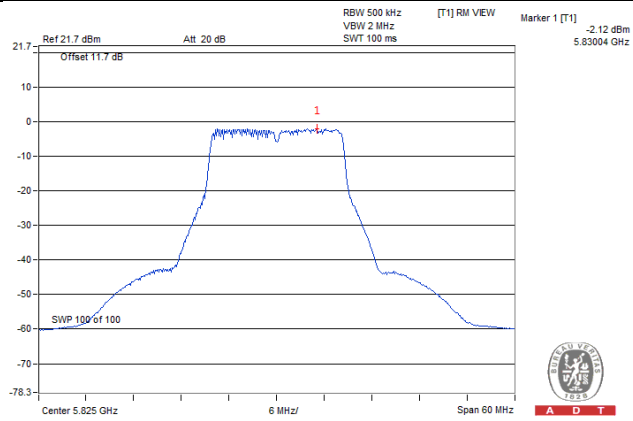

802.11n (20MHz)

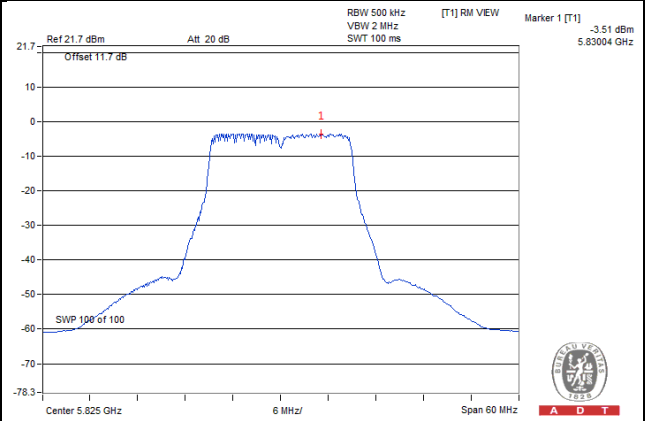

802.11n (40MHz)

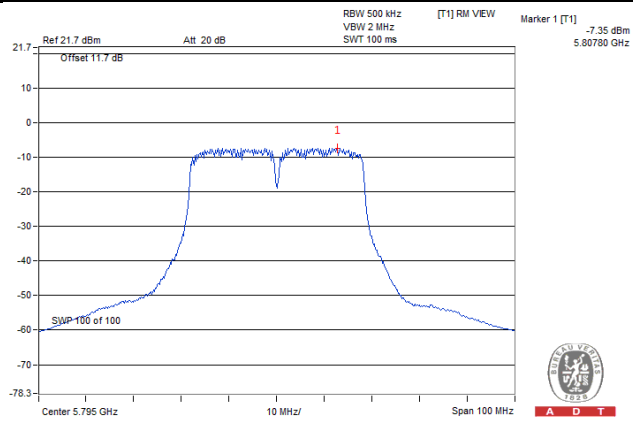

802.11ac (80MHz)

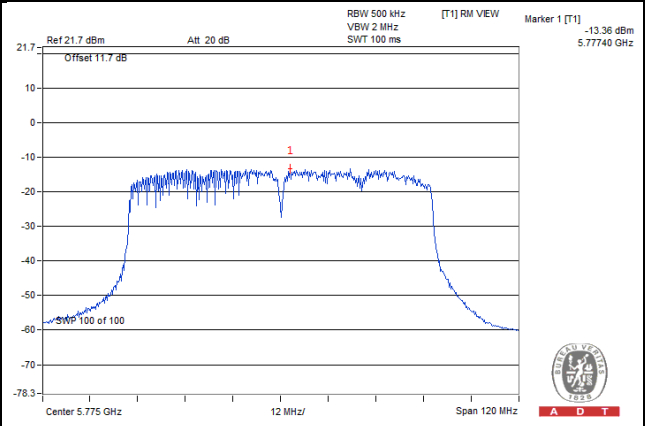

4.5 Frequency Stability

4.5.1 Limit of Frequency Stability Measurement

The frequency of the carrier signal shall be maintained within band of operation

4.5.2 Test Setup

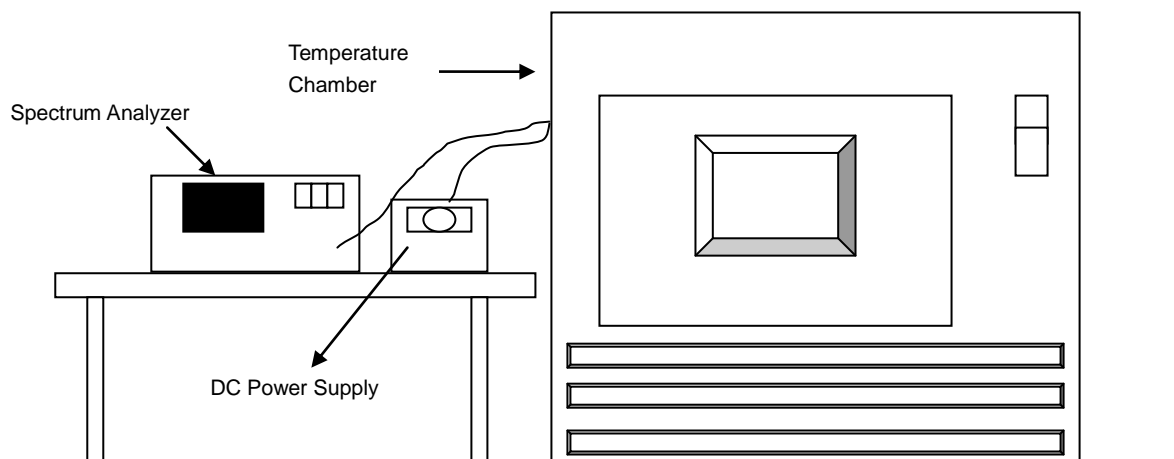

4.5.3 Test Instruments

Refer to section 4.1.3 to get information of above instrument.

4.5.4 Test Procedure

- To ensure emission at the band edge is maintained within the authorized band, those values shall be measured by radiation emissions at upper and lower frequency points, and finally compensated by frequency deviation as procedures below.
- The EUT was operated at the maximum output power, and connected to the spectrum analyzer, which is set to maximum hold function and peak detector. The peak value of the power envelope was measured and noted. The upper and lower frequency points were respectively measured relatively 10dB lower than the measured peak value.
- The frequency deviation was calculated by adding the upper frequency point and the lower frequency point divided by two. Those detailed values of frequency deviation are provided in table below.

4.5.5 Deviation from Test Standard

No deviation.

4.5.6 EUT Operating Condition

Set the EUT transmit at un-modulation mode to test frequency stability.

4.5.7 Test Results

Frequency Stability Versus Temp.									
Operating Frequency: 5320MHz									
Temp. (°C)	Power Supply (Vdc)	0 Minute		2 Minute		5 Minute		10 Minute	
		Measured Frequency (MHz)	Frequency Drift (%)	Measured Frequency (MHz)	Frequency Drift (%)	Measured Frequency (MHz)	Frequency Drift (%)	Measured Frequency (MHz)	Frequency Drift (%)
60	3.85	5320.036399	6.842	5320.035870	6.742	5320.036179	6.801	5320.036605	6.881
50	3.85	5320.037201	6.993	5320.037152	6.983	5320.037045	6.963	5320.037042	6.963
40	3.85	5320.037306	7.012	5320.036807	6.919	5320.036653	6.890	5320.036983	6.952
30	3.85	5320.037915	7.127	5320.038002	7.143	5320.037698	7.086	5320.038289	7.197
20	3.85	5320.038057	7.154	5320.038299	7.199	5320.037819	7.109	5320.037857	7.116
10	3.85	5320.040428	7.599	5320.040434	7.600	5320.040793	7.668	5320.040667	7.644
0	3.85	5320.039301	7.387	5320.039167	7.362	5320.039220	7.372	5320.039404	7.407
-10	3.85	5320.037472	7.044	5320.037369	7.024	5320.037335	7.018	5320.037575	7.063
-20	3.85	5320.037152	6.983	5320.037136	6.980	5320.037216	6.995	5320.037336	7.018
-30	3.85	5320.036129	6.791	5320.035904	6.749	5320.036076	6.781	5320.035733	6.717

Frequency Stability Versus Temp.									
Operating Frequency: 5320MHz									
Temp. (°C)	Power Supply (Vdc)	0 Minute		2 Minute		5 Minute		10 Minute	
		Measured Frequency (MHz)	Frequency Drift (%)	Measured Frequency (MHz)	Frequency Drift (%)	Measured Frequency (MHz)	Frequency Drift (%)	Measured Frequency (MHz)	Frequency Drift (%)
20	3.6	5320.037598	7.067	5320.037401	7.030	5320.037635	7.074	5320.038104	7.162
	3.85	5320.038057	7.154	5320.038299	7.199	5320.037819	7.109	5320.037857	7.116
	4.40	5320.039129	7.355	5320.039365	7.399	5320.039718	7.466	5320.039365	7.399

4.6 6dB Bandwidth Measurement

4.6.1 Limits of 6dB Bandwidth Measurement

The minimum of 6dB Bandwidth Measurement is 0.5MHz.

4.6.2 Test Setup

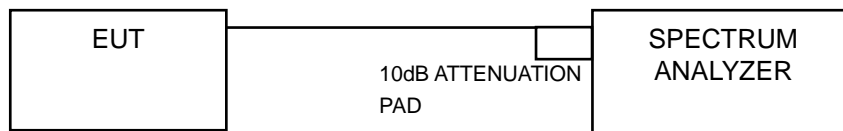

4.6.3 Test Instruments

Refer to section 4.1.3 to get information of above instrument.

4.6.4 Test Procedure

MEASUREMENT PROCEDURE REF

- Set resolution bandwidth (RBW) = 100kHz
- Set the video bandwidth (VBW) $\geq 3 \times$ RBW, Detector = Peak.
- Trace mode = max hold.
- Sweep = auto couple.
- Measure the maximum width of the emission that is constrained by the frequencies associated with the two amplitude points (upper and lower) that are attenuated by 6 dB relative to the maximum level measured in the fundamental emission

4.6.5 Deviation from Test Standard

No deviation.

4.6.6 EUT Operating Condition

The software provided by client to enable the EUT under transmission condition continuously at lowest, middle and highest channel frequencies individually.

4.6.7 Test Results

802.11a

Channel	Frequency (MHz)	6dB Bandwidth (MHz)	Minimum Limit (MHz)	Pass / Fail
149	5745	16.41	0.5	Pass
157	5785	16.41	0.5	Pass
165	5825	16.41	0.5	Pass

802.11n (20MHz)

Channel	Frequency (MHz)	6dB Bandwidth (MHz)	Minimum Limit (MHz)	Pass / Fail
149	5745	17.64	0.5	Pass
157	5785	17.62	0.5	Pass
165	5825	17.63	0.5	Pass

802.11n (40MHz)

Channel	Frequency (MHz)	6dB Bandwidth (MHz)	Minimum Limit (MHz)	Pass / Fail
151	5755	35.31	0.5	Pass
159	5795	35.28	0.5	Pass

802.11ac (80MHz)

Channel	Frequency (MHz)	6dB Bandwidth (MHz)	Minimum Limit (MHz)	Pass / Fail
155	5775	75.31	0.5	Pass

Spectrum Plot of Worst Value

802.11a

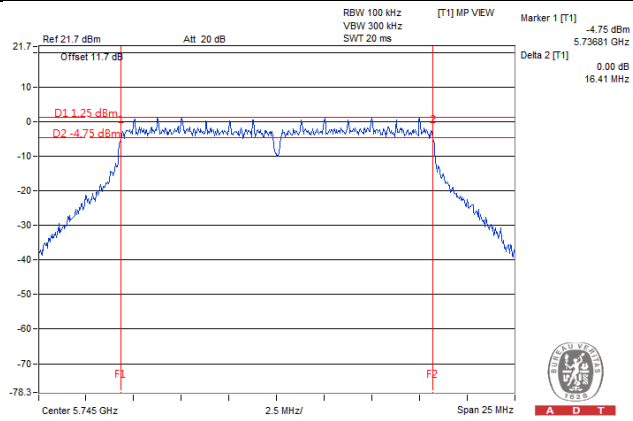

802.11n (20MHz)

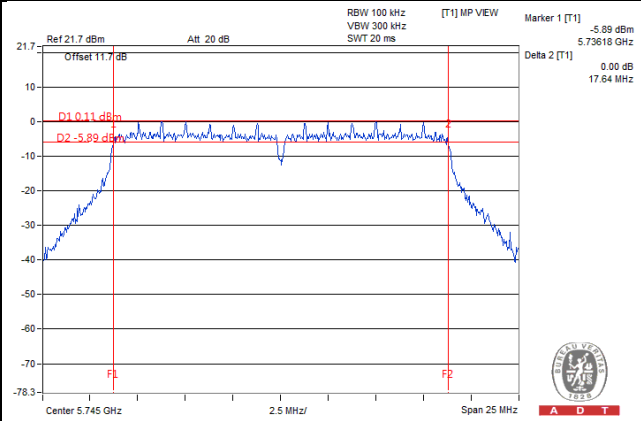

802.11n (40MHz)

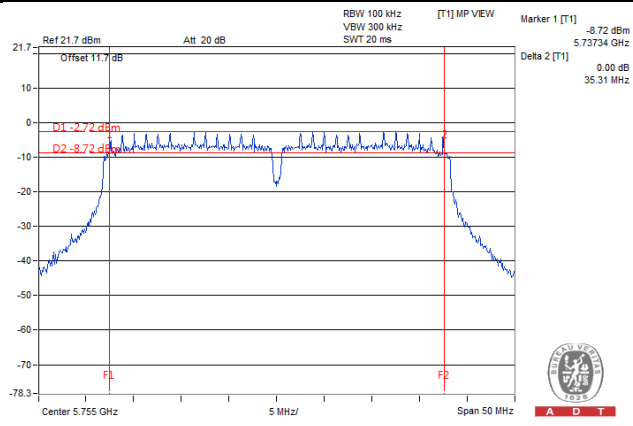

802.11ac (80MHz)

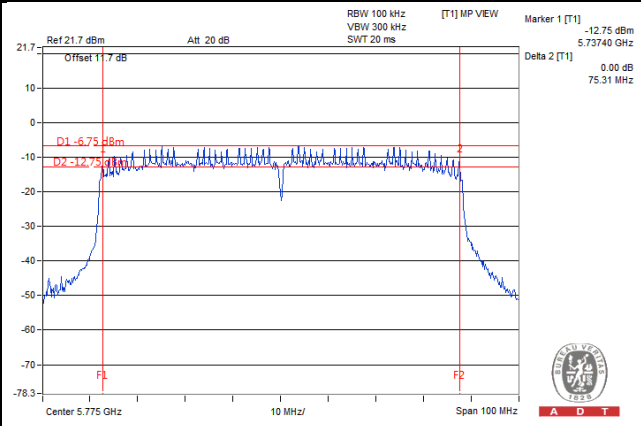



5 Pictures of Test Arrangements

Please refer to the attached file (Test Setup Photo).



Appendix – Information on the Testing Laboratories

We, Bureau Veritas Consumer Products Services (H.K.) Ltd., Taoyuan Branch, were founded in 1988 to provide our best service in EMC, Radio, Telecom and Safety consultation. Our laboratories are accredited and approved according to ISO/IEC 17025.

If you have any comments, please feel free to contact us at the following:

Linko EMC/RF Lab

Tel: 886-2-26052180

Fax: 886-2-26051924

Hsin Chu EMC/RF Lab/Telecom Lab

Tel: 886-3-5935343

Fax: 886-3-5935342

Hwa Ya EMC/RF/Safety

Tel: 886-3-3183232

Fax: 886-3-3270892

Email: service.adt@tw.bureauveritas.com

Web Site: www.bureauveritas-adt.com

The address and road map of all our labs can be found in our web site also.

--- END ---