

## FCC Test Report

**Report No.:** RF150730C47-3

**FCC ID:** NM82PQ9100

**Test Model:** 2PQ9100

**Received Date:** Jul. 30, 2015

**Test Date:** Aug. 07, 2015 ~ Aug. 30, 2015

**Issued Date:** Sep. 17, 2015

**Applicant:** HTC Corporation

**Address:** 1F, 6-3 Baoqiang Road, Xindian City, Taipei County 231, Taiwan

**Issued By:** Bureau Veritas Consumer Products Services (H.K.) Ltd., Taoyuan Branch

**Lab Address:** No. 47-2, 14th Ling, Chia Pau Vil., Lin Kou Dist., New Taipei City, Taiwan ( R.O.C )

**Test Location (1):** No. 19, Hwa Ya 2nd Rd, Wen Hwa Tsuen, Kwei Shan Hsiang, Taoyuan Hsien 333, Taiwan, R.O.C.

**Test Location (2):** No.215, Sec. 3, Beixin Rd., Xindian Dist., New Taipei City 231, Taiwan, R.O.C



This report is for your exclusive use. Any copying or replication of this report to or for any other person or entity, or use of our name or trademark, is permitted only with our prior written permission. This report sets forth our findings solely with respect to the test samples identified herein. The results set forth in this report are not indicative or representative of the quality or characteristics of the lot from which a test sample was taken or any similar or identical product unless specifically and expressly noted. Our report includes all of the tests requested by you and the results thereof based upon the information that you provided to us. You have 60 days from date of issuance of this report to notify us of any material error or omission caused by our negligence, provided, however, that such notice shall be in writing and shall specifically address the issue you wish to raise. A failure to raise such issue within the prescribed time shall constitute your unqualified acceptance of the completeness of this report, the tests conducted and the correctness of the report contents. Unless specific mention, the uncertainty of measurement has been explicitly taken into account to declare the compliance or non-compliance to the specification.

## Table of Contents

<b>Release Control Record</b> .....	<b>4</b>
<b>1 Certificate of Conformity</b> .....	<b>5</b>
<b>2 Summary of Test Results</b> .....	<b>6</b>
2.1 Measurement Uncertainty .....	6
2.2 Modification Record .....	6
<b>3 General Information</b> .....	<b>7</b>
3.1 General Description of EUT .....	7
3.2 Description of Test Modes .....	8
3.2.1 Test Mode Applicability and Tested Channel Detail .....	9
3.3 Duty Cycle of Test Signal .....	11
3.4 Description of Support Units .....	12
3.4.1 Configuration of System under Test .....	12
3.5 General Description of Applied Standards .....	12
<b>4 Test Types and Results</b> .....	<b>13</b>
4.1 Radiated Emission and Bandedge Measurement .....	13
4.1.1 Limits of Radiated Emission and Bandedge Measurement .....	13
4.1.2 Test Instruments .....	14
4.1.3 Test Procedures .....	15
4.1.4 Deviation from Test Standard .....	15
4.1.5 Test Set Up .....	16
4.1.6 EUT Operating Conditions .....	16
4.1.7 Test Results .....	17
4.2 Conducted Emission Measurement .....	27
4.2.1 Limits of Conducted Emission Measurement .....	27
4.2.2 Test Instruments .....	27
4.2.3 Test Procedures .....	28
4.2.4 Deviation from Test Standard .....	28
4.2.5 Test Setup .....	28
4.2.6 EUT Operating Conditions .....	28
4.2.7 Test Results .....	29
4.3 6dB Bandwidth Measurement .....	31
4.3.1 Limits of 6dB Bandwidth Measurement .....	31
4.3.2 Test Setup .....	31
4.3.3 Test Instruments .....	31
4.3.4 Test Procedure .....	31
4.3.5 Deviation from Test Standard .....	31
4.3.6 EUT Operating Conditions .....	31
4.3.7 Test Result .....	32
4.4 Conducted Output Power Measurement .....	34
4.4.1 Limits of Conducted Output Power Measurement .....	34
4.4.2 Test Setup .....	34
4.4.3 Test Instruments .....	34
4.4.4 Test Procedures .....	34
4.4.5 Deviation from Test Standard .....	34
4.4.6 EUT Operating Conditions .....	34
4.4.7 Test Results .....	35
4.5 Power Spectral Density Measurement .....	36
4.5.1 Limits of Power Spectral Density Measurement .....	36
4.5.2 Test Setup .....	36
4.5.3 Test Instruments .....	36
4.5.4 Test Procedure .....	36
4.5.5 Deviation from Test Standard .....	36
4.5.6 EUT Operating Condition .....	36



4.5.7 Test Results .....	37
4.6 Conducted Out of Band Emission Measurement .....	39
4.6.1 Limits of Conducted Out of Band Emission Measurement.....	39
4.6.2 Test Setup.....	39
4.6.3 Test Instruments .....	39
4.6.4 Test Procedure .....	39
4.6.5 Deviation from Test Standard .....	39
4.6.6 EUT Operating Condition .....	39
4.6.7 Test Results .....	40
<b>5 Pictures of Test Arrangements.....</b>	<b>46</b>
<b>Appendix – Information on the Testing Laboratories .....</b>	<b>47</b>



A D T

### Release Control Record

Issue No.	Description	Date Issued
RF150730C47-3	Original Release	Sep. 17, 2015



## 2 Summary of Test Results

47 CFR FCC Part 15, Subpart C (SECTION 15.247)			
FCC Clause	Test Item	Result	Remarks
15.207	AC Power Conducted Emission	PASS	Meet the requirement of limit. Minimum passing margin is -12.46 dB at 0.69108 MHz.
15.205 / 15.209 / 15.247(d)	Radiated Emissions and Band Edge Measurement	PASS	Meet the requirement of limit. Minimum passing margin is -1.73 dB at 2484.00 MHz.
15.247(d)	Antenna Port Emission	PASS	Meet the requirement of limit.
15.247(a)(2)	6dB bandwidth	PASS	Meet the requirement of limit.
15.247(b)	Conducted power	PASS	Meet the requirement of limit.
15.247(e)	Power Spectral Density	PASS	Meet the requirement of limit.
15.203	Antenna Requirement	PASS	No antenna connector is used.

### 2.1 Measurement Uncertainty

Where relevant, the following measurement uncertainty levels have been estimated for tests performed on the EUT:

The listed uncertainties are the worst case uncertainty for the entire range of measurement. Please note that the uncertainty values are provided for informational purposes only and are not used in determining the PASS/FAIL results.

Measurement	Frequency	Expanded Uncertainty (k=2) ( $\pm$ )
Conducted Emissions at mains ports	150kHz ~ 30MHz	2.44 dB
Radiated Emissions up to 1 GHz	30MHz ~ 200MHz	2.0153 dB
	200MHz ~ 1000MHz	2.0224 dB
Radiated Emissions above 1 GHz	1GHz ~ 18GHz	1.0121 dB
	18GHz ~ 40GHz	1.1508 dB

### 2.2 Modification Record

There were no modifications required for compliance.

### 3 General Information

#### 3.1 General Description of EUT

Product	Smartphone
Brand	HTC
Test Model	2PQ9100
Status of EUT	Identical Prototype
Power Supply Rating	5.0Vdc (adapter or host equipment) 3.85Vdc (Li-ion battery)
Modulation Type	CCK, DQPSK, DBPSK for DSSS 64QAM, 16QAM, QPSK, BPSK for OFDM
Modulation Technology	DSSS, OFDM
Transfer Rate	802.11b: 11.0 / 5.5 / 2.0 / 1.0 Mbps 802.11g: 54.0 / 48.0 / 36.0 / 24.0 / 18.0 / 12.0 / 9.0 / 6.0 Mbps 802.11n: up to MCS7
Operating Frequency	2412 ~ 2462MHz
Number of Channel	11
Output Power	147.23mW
Antenna Type	PIFA antenna with 0 dBi gain
Antenna Connector	N/A
Accessory Device	Refer to Note as below
Data Cable Supplied	Refer to Note as below

Note:

1. The EUT's accessories list refers to Ext. Pho.
2. The above EUT information is declared by manufacturer and for more detailed features description, please refer to the manufacturer's specifications or user's manual.

### 3.2 Description of Test Modes

11 channels are provided for 802.11b, 802.11g and 802.11n (20MHz):

Channel	Frequency (MHz)	Channel	Frequency (MHz)
1	2412	7	2442
2	2417	8	2447
3	2422	9	2452
4	2427	10	2457
5	2432	11	2462
6	2437		



### 3.2.1 Test Mode Applicability and Tested Channel Detail

EUT Configure Mode	Applicable To				Description
	RE $\geq$ 1G	RE<1G	PLC	APCM	
-	√	√	√	√	-

Where **RE $\geq$ 1G**: Radiated Emission above 1GHz      **RE<1G**: Radiated Emission below 1GHz  
**PLC**: Power Line Conducted Emission      **APCM**: Antenna Port Conducted Measurement

**NOTE:** The EUT had been pre-tested on the positioned of each 3 axis. The worst case was found when positioned on **Y-plane**.

#### **Radiated Emission Test (Above 1GHz):**

- Pre-Scan has been conducted to determine the worst-case mode from all possible combinations between available modulations, data rates and antenna ports (if EUT with antenna diversity architecture).
- Following channel(s) was (were) selected for the final test as listed below.

EUT Configure Mode	Mode	Available Channel	Tested Channel	Modulation Technology	Modulation Type	Data Rate (Mbps)
-	802.11b	1 to 11	1, 6, 11	DSSS	DBPSK	1.0
-	802.11g	1 to 11	1, 6, 11	OFDM	BPSK	6.0
-	802.11n (20MHz)	1 to 11	1, 6, 11	OFDM	BPSK	7.2

#### **Radiated Emission Test (Below 1GHz):**

- Pre-Scan has been conducted to determine the worst-case mode from all possible combinations between available modulations, data rates and antenna ports (if EUT with antenna diversity architecture).
- Following channel(s) was (were) selected for the final test as listed below.

EUT Configure Mode	Mode	Available Channel	Tested Channel	Modulation Technology	Modulation Type	Data Rate (Mbps)
-	802.11g	1 to 11	11	OFDM	BPSK	6.0

#### **Power Line Conducted Emission Test:**

- Pre-Scan has been conducted to determine the worst-case mode from all possible combinations between available modulations, data rates and antenna ports (if EUT with antenna diversity architecture).
- Following channel(s) was (were) selected for the final test as listed below.

EUT Configure Mode	Mode	Available Channel	Tested Channel	Modulation Technology	Modulation Type	Data Rate (Mbps)
-	802.11g	1 to 11	11	OFDM	BPSK	6.0

**Bandedge Measurement:**

- Pre-Scan has been conducted to determine the worst-case mode from all possible combinations between available modulations, data rates and antenna ports (if EUT with antenna diversity architecture).
- Following channel(s) was (were) selected for the final test as listed below.

EUT Configure Mode	Mode	Available Channel	Tested Channel	Modulation Technology	Modulation Type	Data Rate (Mbps)
-	802.11b	1 to 11	1, 11	DSSS	DBPSK	1.0
-	802.11g	1 to 11	1, 11	OFDM	BPSK	6.0
-	802.11n (20MHz)	1 to 11	1, 11	OFDM	BPSK	7.2

**Antenna Port Conducted Measurement:**

- This item includes all test value of each mode, but only includes spectrum plot of worst value of each mode.
- Pre-Scan has been conducted to determine the worst-case mode from all possible combinations between available modulations, data rates and antenna ports (if EUT with antenna diversity architecture).
- Following channel(s) was (were) selected for the final test as listed below.

EUT Configure Mode	Mode	Available Channel	Tested Channel	Modulation Technology	Modulation Type	Data Rate (Mbps)
-	802.11b	1 to 11	1, 6, 11	DSSS	DBPSK	1.0
-	802.11g	1 to 11	1, 6, 11	OFDM	BPSK	6.0
-	802.11n (20MHz)	1 to 11	1, 6, 11	OFDM	BPSK	7.2

**Test Condition:**

Applicable To	Environmental Conditions	Input Power	Tested by
RE $\geq$ 1G	25deg. C, 65%RH	120Vac, 60Hz	Karl Lee
RE<1G	25deg. C, 65%RH	120Vac, 60Hz	Karl Lee
PLC	25deg. C, 65%RH	120Vac, 60Hz	Toby Tian
APCM	25deg. C, 65%RH	3.85Vdc	Howard Kao

### 3.3 Duty Cycle of Test Signal

Duty cycle of test signal is 100 %

Duty cycle of test signal is > 98 %

Duty cycle of test signal is < 98%

**802.11b:** Duty cycle of test signal is > 98 %

**802.11g:** Duty cycle =  $1.355/1.563 = 0.867$ , Duty factor =  $10 * \log(1/0.867) = 0.62$

**802.11n (20MHz):** Duty cycle =  $1.263/1.472 = 0.858$ , Duty factor =  $10 * \log(1/0.858) = 0.67$

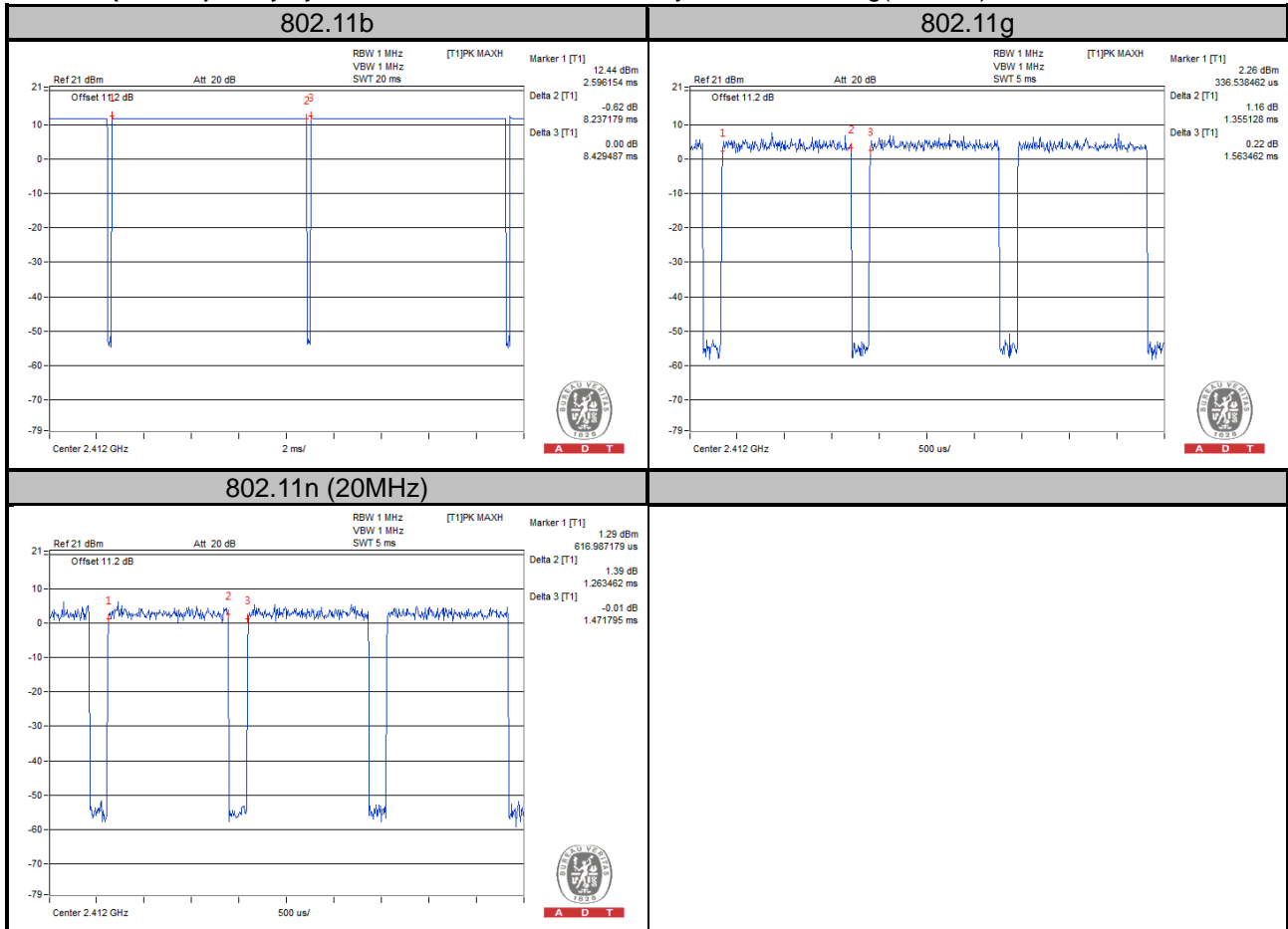

### 3.4 Description of Support Units

The EUT has been tested as an independent unit together with other necessary accessories or support units.

#### 3.4.1 Configuration of System under Test

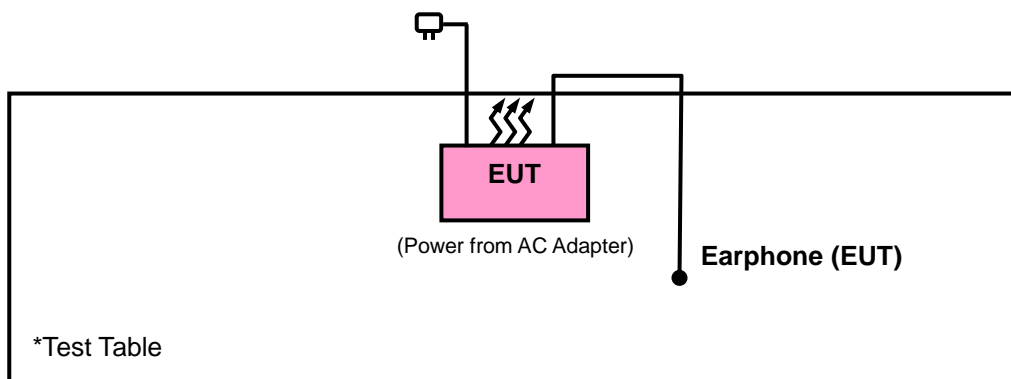

### 3.5 General Description of Applied Standards

The EUT is a RF Product. According to the specifications of the manufacturer, it must comply with the requirements of the following standards:

**FCC Part 15, Subpart C (15.247)**

**558074 D01 DTS Meas Guidance v03r03**

ANSI C63.10-2013

All test items have been performed and recorded as per the above standards.

**NOTE:** The EUT has been verified to comply with the requirements of FCC Part 15, Subpart B, Class B (DoC).  
The test report has been issued separately.

## 4 Test Types and Results

### 4.1 Radiated Emission and Bandedge Measurement

#### 4.1.1 Limits of Radiated Emission and Bandedge Measurement

Radiated emissions which fall in the restricted bands must comply with the radiated emission limits specified as below table. Other emissions shall be at least 20dB below the highest level of the desired power:

Frequencies (MHz)	Field Strength (microvolts/meter)	Measurement Distance (meters)
0.009 ~ 0.490	2400/F(kHz)	300
0.490 ~ 1.705	24000/F(kHz)	30
1.705 ~ 30.0	30	30
30 ~ 88	100	3
88 ~ 216	150	3
216 ~ 960	200	3
Above 960	500	3

**NOTE:**

1. The lower limit shall apply at the transition frequencies.
2. Emission level (dBuV/m) = 20 log Emission level (uV/m).
3. For frequencies above 1000MHz, the field strength limits are based on average detector, however, the peak field strength of any emission shall not exceed the maximum permitted average limits, specified above by more than 20dB under any condition of modulation.

**4.1.2 Test Instruments**

Description & Manufacturer	Model No.	Serial No.	Date of Calibration	Due Date of Calibration
Spectrum Analyzer Agilent Technologies	N9038A	MY52260177	May 19, 2015	May 18, 2016
Spectrum Analyzer ROHDE & SCHWARZ	FSU43	101261	Dec. 10, 2014	Dec. 09, 2015
BILOG Antenna SCHWARZBECK	VULB9168	9168-472	Feb. 04, 2015	Feb. 04, 2016
HORN Antenna ETS-Lindgren	3117	00143293	Jan. 05, 2015	Jan. 04, 2016
HORN Antenna SCHWARZBECK	BBHA 9170	9170-480	Feb. 04, 2015	Feb. 04, 2016
Bluetooth Tester	CBT	100980	Apr. 27, 2015	Apr. 26, 2017
Agilent Communications Tester-Wireless	8960 Series 10	MY53201073	Jul. 03, 2015	Jul. 02, 2017
Preamplifier Agilent	310N	187226	Jun. 29, 2015	Jun. 28, 2016
Preamplifier Agilent	83017A	MY39501357	Jun. 29, 2015	Jun. 28, 2016
Power Meter Anritsu	ML2495A	1232002	Sep. 17, 2014	Sep. 16, 2015
Power Sensor Anritsu	MA2411B	1207325	Sep. 17, 2014	Sep. 16, 2015
RF signal cable ETS-LINDGREN	5D-FB	Cable-CH1-01(R FC-SMS-100-SM S-120+RFC-SMS -100-SMS-400)	Jun. 27, 2015	Jun. 26, 2016
RF signal cable ETS-LINDGREN	8D-FB	Cable-CH1-02(R FC-SMS-100-SM S-24)	Jun. 27, 2015	Jun. 26, 2016
Software BV ADT	E3 8.130425b	NA	NA	NA
Antenna Tower MF	NA	NA	NA	NA
Turn Table MF	NA	NA	NA	NA
Antenna Tower & Turn Table Controller MF	MF-7802	NA	NA	NA

- Note: 1. The calibration interval of the above test instruments is 12 months and the calibrations are traceable to NML/ROC and NIST/USA.
2. The test was performed in HsinTien Chamber 1.
3. The horn antenna and HP preamplifier (model: 8449B) are used only for the measurement of emission frequency above 1GHz if tested.
4. The FCC Site Registration No. is 149147.
5. The IC Site Registration No. is IC7450I-1.

#### 4.1.3 Test Procedures

- a. The EUT was placed on the top of a rotating table 0.8 meters (for below 1GHz) / 1.5 meters (for above 1GHz) above the ground at 3 meter chamber room for test. The table was rotated 360 degrees to determine the position of the highest radiation.
- b. The EUT was set 3 meters away from the interference-receiving antenna, which was mounted on the top of a variable-height antenna tower.
- c. The height of antenna is varied from one meter to four meters above the ground to determine the maximum value of the field strength. Both horizontal and vertical polarizations of the antenna are set to make the measurement.
- d. For each suspected emission, the EUT was arranged to its worst case and then the antenna was tuned to heights from 1 meter to 4 meters and the rotatable table was turned from 0 degrees to 360 degrees to find the maximum reading.
- e. The test-receiver system was set to quasi-peak detect function and specified bandwidth with maximum hold mode when the test frequency is below 1 GHz.
- f. The test-receiver system was set to peak and average detect function and specified bandwidth with maximum hold mode when the test frequency is above 1 GHz. If the peak reading value also meets average limit, measurement with the average detector is unnecessary.

**Note:**

1. The resolution bandwidth and video bandwidth of test receiver/spectrum analyzer is 120 kHz for Quasi-peak detection (QP) at frequency below 1 GHz.
2. The resolution bandwidth of test receiver/spectrum analyzer is 1 MHz and the video bandwidth is 3 MHz for Peak detection (PK) at frequency above 1 GHz.
3. The resolution bandwidth of test receiver/spectrum analyzer is 1 MHz and the video bandwidth is 3 MHz for RMS Average (Duty cycle < 98%) for Average detection (AV) at frequency above 1GHz, then the measurement results was added to a correction factor ( $10 \log(1/\text{duty cycle})$ ).
4. The resolution bandwidth of test receiver/spectrum analyzer is 1MHz and the video bandwidth is 10 Hz (Duty cycle  $\geq 98\%$ ) for Average detection (AV) at frequency above 1 GHz.
5. All modes of operation were investigated and the worst-case emissions are reported.

#### 4.1.4 Deviation from Test Standard

No deviation.

#### 4.1.5 Test Set Up

##### <Frequency Range below 1GHz>

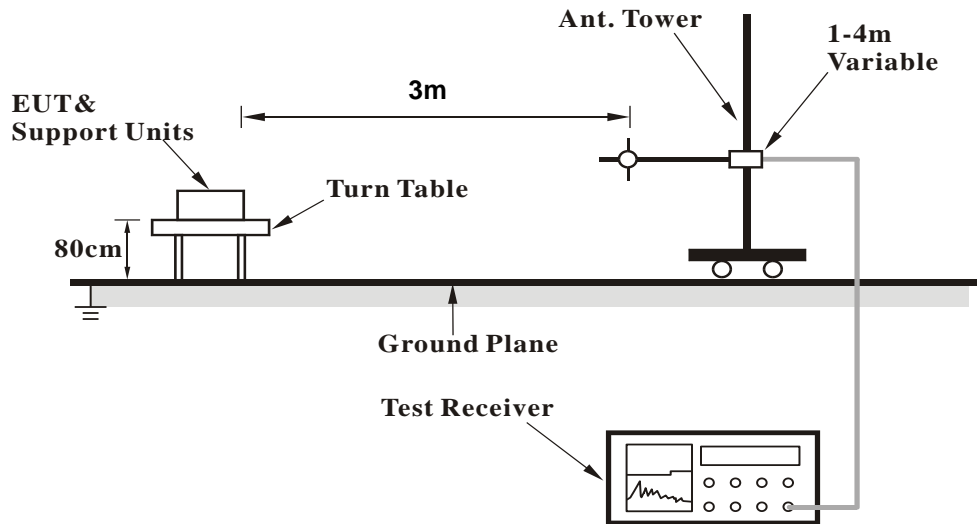

##### <Frequency Range above 1GHz>

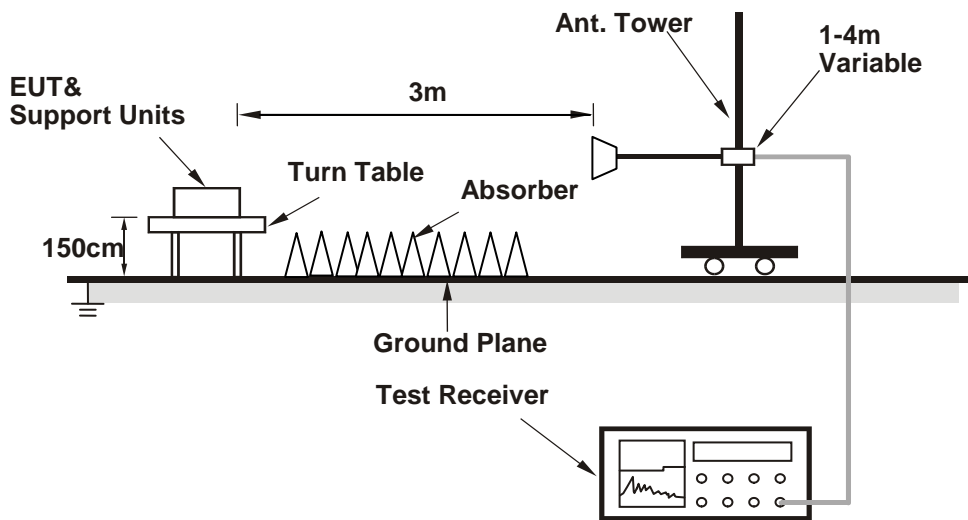

For the actual test configuration, please refer to the attached file (Test Setup Photo).

#### 4.1.6 EUT Operating Conditions

- a. Placed the EUT on a testing table.
- b. Use the software to control the EUT under transmission condition continuously at specific channel frequency.



**4.1.7 Test Results**
**Above 1GHz Data :**
**802.11b**

EUT TEST CONDITION		MEASUREMENT DETAIL	
CHANNEL	Channel 1	FREQUENCY RANGE	1GHz ~ 25GHz
INPUT POWER	120Vac, 60 Hz	DETECTOR FUNCTION	Peak (PK) Average (AV)
ENVIRONMENTAL CONDITIONS	25deg. C, 65%RH	TESTED BY	Karl Lee

ANTENNA POLARITY & TEST DISTANCE: HORIZONTAL AT 3 M										
FREQ. (MHz)	EMISSION LEVEL (dBuV/m)	READ LEVEL (dBuV)	LIMIT (dBuV/m)	MARGIN (dB)	ANTENNA FACTOR (dB/m)	CABLE LOSS (dB)	PREAMP FACTOR (dB)	ANTENNA HEIGHT (cm)	TABLE ANGLE (Degree)	REMARK
2356	40.66	39.03	54	-13.34	31.76	5.37	35.5	178	131	Average
2356	56.46	54.83	74	-17.54	31.76	5.37	35.5	178	131	Peak
2412	107.12	105.35			31.81	5.43	35.47	178	131	Average
2412	109.79	108.02			31.81	5.43	35.47	178	131	Peak
2494	40.94	38.92	54	-13.06	31.9	5.53	35.41	178	131	Average
2494	56.12	54.1	74	-17.88	31.9	5.53	35.41	178	131	Peak

ANTENNA POLARITY & TEST DISTANCE: VERTICAL AT 3 M										
FREQ. (MHz)	EMISSION LEVEL (dBuV/m)	READ LEVEL (dBuV)	LIMIT (dBuV/m)	MARGIN (dB)	ANTENNA FACTOR (dB/m)	CABLE LOSS (dB)	PREAMP FACTOR (dB)	ANTENNA HEIGHT (cm)	TABLE ANGLE (Degree)	REMARK
2390	41.55	39.82	54	-12.45	31.8	5.4	35.47	102	97	Average
2390	55.75	54.02	74	-18.25	31.8	5.4	35.47	102	97	Peak
2412	110.41	108.64			31.81	5.43	35.47	102	97	Average
2412	113.31	111.54			31.81	5.43	35.47	102	97	Peak
2492	41.41	39.39	54	-12.59	31.9	5.53	35.41	102	97	Average
2492	56.19	54.17	74	-17.81	31.9	5.53	35.41	102	97	Peak

**REMARKS:**

- Emission Level = Read Level + Antenna Factor + Cable Loss - Preamp Factor  
Margin value = Emission level – Limit value
- 2412MHz: Fundamental frequency.



A D T

EUT TEST CONDITION		MEASUREMENT DETAIL	
CHANNEL	Channel 6	FREQUENCY RANGE	1GHz ~ 25GHz
INPUT POWER	120Vac, 60 Hz	DETECTOR FUNCTION	Peak (PK) Average (AV)
ENVIRONMENTAL CONDITIONS	25deg. C, 65%RH	TESTED BY	Karl Lee

ANTENNA POLARITY & TEST DISTANCE: HORIZONTAL AT 3 M										
FREQ. (MHz)	EMISSION LEVEL (dBuV/m)	READ LEVEL (dBuV)	LIMIT (dBuV/m)	MARGIN (dB)	ANTENNA FACTOR (dB/m)	CABLE LOSS (dB)	PREAMP FACTOR (dB)	ANTENNA HEIGHT (cm)	TABLE ANGLE (Degree)	REMARK
2356	39.25	37.62	54	-14.75	31.76	5.37	35.5	178	131	Average
2356	55.54	53.91	74	-18.46	31.76	5.37	35.5	178	131	Peak
2437	107.13	105.28			31.85	5.46	35.46	178	131	Average
2437	109.82	107.97			31.85	5.46	35.46	178	131	Peak
2494	40.36	38.34	54	-13.64	31.9	5.53	35.41	178	131	Average
2494	55.86	53.84	74	-18.14	31.9	5.53	35.41	178	131	Peak

ANTENNA POLARITY & TEST DISTANCE: VERTICAL AT 3 M										
FREQ. (MHz)	EMISSION LEVEL (dBuV/m)	READ LEVEL (dBuV)	LIMIT (dBuV/m)	MARGIN (dB)	ANTENNA FACTOR (dB/m)	CABLE LOSS (dB)	PREAMP FACTOR (dB)	ANTENNA HEIGHT (cm)	TABLE ANGLE (Degree)	REMARK
2390	39.49	37.76	54	-14.51	31.8	5.4	35.47	102	97	Average
2390	56.02	54.29	74	-17.98	31.8	5.4	35.47	102	97	Peak
2437	110.97	109.12			31.85	5.46	35.46	102	97	Average
2437	113.72	111.87			31.85	5.46	35.46	102	97	Peak
2494	43.06	41.04	54	-10.94	31.9	5.53	35.41	102	97	Average
2494	56.59	54.57	74	-17.41	31.9	5.53	35.41	102	97	Peak

## REMARKS:

- Emission Level = Read Level + Antenna Factor + Cable Loss - Preamp Factor  
Margin value = Emission level – Limit value
- 2437MHz: Fundamental frequency.



A D T

EUT TEST CONDITION		MEASUREMENT DETAIL	
CHANNEL	Channel 11	FREQUENCY RANGE	1GHz ~ 25GHz
INPUT POWER	120Vac, 60 Hz	DETECTOR FUNCTION	Peak (PK) Average (AV)
ENVIRONMENTAL CONDITIONS	25deg. C, 65%RH	TESTED BY	Karl Lee

ANTENNA POLARITY & TEST DISTANCE: HORIZONTAL AT 3 M										
FREQ. (MHz)	EMISSION LEVEL (dBuV/m)	READ LEVEL (dBuV)	LIMIT (dBuV/m)	MARGIN (dB)	ANTENNA FACTOR (dB/m)	CABLE LOSS (dB)	PREAMP FACTOR (dB)	ANTENNA HEIGHT (cm)	TABLE ANGLE (Degree)	REMARK
2388	39.32	37.61	54	-14.68	31.8	5.4	35.49	156	131	Average
2388	55.42	53.71	74	-18.58	31.8	5.4	35.49	156	131	Peak
2462	106.76	104.83			31.87	5.5	35.44	156	131	Average
2462	109.38	107.45			31.87	5.5	35.44	156	131	Peak
2484	43.22	41.26	54	-10.78	31.88	5.5	35.42	156	131	Average
2484	56.23	54.27	74	-17.77	31.88	5.5	35.42	156	131	Peak

ANTENNA POLARITY & TEST DISTANCE: VERTICAL AT 3 M										
FREQ. (MHz)	EMISSION LEVEL (dBuV/m)	READ LEVEL (dBuV)	LIMIT (dBuV/m)	MARGIN (dB)	ANTENNA FACTOR (dB/m)	CABLE LOSS (dB)	PREAMP FACTOR (dB)	ANTENNA HEIGHT (cm)	TABLE ANGLE (Degree)	REMARK
2352	39.36	37.77	54	-14.64	31.76	5.33	35.5	102	97	Average
2352	56.32	54.73	74	-17.68	31.76	5.33	35.5	102	97	Peak
2462	110.42	108.49			31.87	5.5	35.44	102	97	Average
2462	113.27	111.34			31.87	5.5	35.44	102	97	Peak
2484	47.58	45.62	54	-6.42	31.88	5.5	35.42	102	97	Average
2484	59.18	57.22	74	-14.82	31.88	5.5	35.42	102	97	Peak

## REMARKS:

- Emission Level = Read Level + Antenna Factor + Cable Loss - Preamp Factor  
Margin value = Emission level – Limit value
- 2462MHz: Fundamental frequency.



802.11g

EUT TEST CONDITION		MEASUREMENT DETAIL	
CHANNEL	Channel 1	FREQUENCY RANGE	1GHz ~ 25GHz
INPUT POWER	120Vac, 60 Hz	DETECTOR FUNCTION	Peak (PK) Average (AV)
ENVIRONMENTAL CONDITIONS	25deg. C, 65%RH	TESTED BY	Karl Lee

ANTENNA POLARITY & TEST DISTANCE: HORIZONTAL AT 3 M

FREQ. (MHz)	EMISSION LEVEL (dBuV/m)	READ LEVEL (dBuV)	LIMIT (dBuV/m)	MARGIN (dB)	ANTENNA FACTOR (dB/m)	CABLE LOSS (dB)	PREAMP FACTOR (dB)	ANTENNA HEIGHT (cm)	TABLE ANGLE (Degree)	REMARK
2390	42.49	40.76	54	-11.51	31.8	5.4	35.47	178	131	Average
2390	57.59	55.86	74	-16.41	31.8	5.4	35.47	178	131	Peak
2412	97.35	95.58			31.81	5.43	35.47	178	131	Average
2412	104.86	103.09			31.81	5.43	35.47	178	131	Peak
2488	40.77	38.76	54	-13.23	31.9	5.53	35.42	178	131	Average
2488	56.31	54.3	74	-17.69	31.9	5.53	35.42	178	131	Peak

ANTENNA POLARITY & TEST DISTANCE: VERTICAL AT 3 M

FREQ. (MHz)	EMISSION LEVEL (dBuV/m)	READ LEVEL (dBuV)	LIMIT (dBuV/m)	MARGIN (dB)	ANTENNA FACTOR (dB/m)	CABLE LOSS (dB)	PREAMP FACTOR (dB)	ANTENNA HEIGHT (cm)	TABLE ANGLE (Degree)	REMARK
2390	45.62	43.89	54	-8.38	31.8	5.4	35.47	103	97	Average
2390	61.29	59.56	74	-12.71	31.8	5.4	35.47	103	97	Peak
2412	101.06	99.29			31.81	5.43	35.47	103	97	Average
2412	108.65	106.88			31.81	5.43	35.47	103	97	Peak
2486	41.4	39.41	54	-12.6	31.88	5.53	35.42	103	97	Average
2486	56.32	54.33	74	-17.68	31.88	5.53	35.42	103	97	Peak

REMARKS:

- Emission Level = Read Level + Antenna Factor + Cable Loss - Preamp Factor  
Margin value = Emission level – Limit value
- 2412MHz: Fundamental frequency.



A D T

EUT TEST CONDITION		MEASUREMENT DETAIL	
CHANNEL	Channel 6	FREQUENCY RANGE	1GHz ~ 25GHz
INPUT POWER	120Vac, 60 Hz	DETECTOR FUNCTION	Peak (PK) Average (AV)
ENVIRONMENTAL CONDITIONS	25deg. C, 65%RH	TESTED BY	Karl Lee

ANTENNA POLARITY & TEST DISTANCE: HORIZONTAL AT 3 M										
FREQ. (MHz)	EMISSION LEVEL (dBuV/m)	READ LEVEL (dBuV)	LIMIT (dBuV/m)	MARGIN (dB)	ANTENNA FACTOR (dB/m)	CABLE LOSS (dB)	PREAMP FACTOR (dB)	ANTENNA HEIGHT (cm)	TABLE ANGLE (Degree)	REMARK
2360	40.01	38.38	54	-13.99	31.76	5.37	35.5	174	131	Average
2360	55.72	54.09	74	-18.28	31.76	5.37	35.5	174	131	Peak
2437	95.76	93.91			31.85	5.46	35.46	174	131	Average
2437	104.15	102.3			31.85	5.46	35.46	174	131	Peak
2486	44.78	42.79	54	-9.22	31.88	5.53	35.42	174	131	Average
2486	56.39	54.4	74	-17.61	31.88	5.53	35.42	174	131	Peak

ANTENNA POLARITY & TEST DISTANCE: VERTICAL AT 3 M										
FREQ. (MHz)	EMISSION LEVEL (dBuV/m)	READ LEVEL (dBuV)	LIMIT (dBuV/m)	MARGIN (dB)	ANTENNA FACTOR (dB/m)	CABLE LOSS (dB)	PREAMP FACTOR (dB)	ANTENNA HEIGHT (cm)	TABLE ANGLE (Degree)	REMARK
2386	40.25	38.54	54	-13.75	31.8	5.4	35.49	102	97	Average
2386	55.87	54.16	74	-18.13	31.8	5.4	35.49	102	97	Peak
2437	100.18	98.33			31.85	5.46	35.46	102	97	Average
2437	108.15	106.3			31.85	5.46	35.46	102	97	Peak
2490	46.66	44.65	54	-7.34	31.9	5.53	35.42	102	97	Average
2490	58.81	56.8	74	-15.19	31.9	5.53	35.42	102	97	Peak

## REMARKS:

- Emission Level = Read Level + Antenna Factor + Cable Loss - Preamp Factor  
Margin value = Emission level – Limit value
- 2437MHz: Fundamental frequency.



EUT TEST CONDITION		MEASUREMENT DETAIL	
CHANNEL	Channel 11	FREQUENCY RANGE	1GHz ~ 25GHz
INPUT POWER	120Vac, 60 Hz	DETECTOR FUNCTION	Peak (PK) Average (AV)
ENVIRONMENTAL CONDITIONS	25deg. C, 65%RH	TESTED BY	Karl Lee

ANTENNA POLARITY & TEST DISTANCE: HORIZONTAL AT 3 M										
FREQ. (MHz)	EMISSION LEVEL (dBuV/m)	READ LEVEL (dBuV)	LIMIT (dBuV/m)	MARGIN (dB)	ANTENNA FACTOR (dB/m)	CABLE LOSS (dB)	PREAMP FACTOR (dB)	ANTENNA HEIGHT (cm)	TABLE ANGLE (Degree)	REMARK
2390	40.16	38.43	54	-13.84	31.8	5.4	35.47	156	131	Average
2390	55.36	53.63	74	-18.64	31.8	5.4	35.47	156	131	Peak
2462	97.34	95.41			31.87	5.5	35.44	156	131	Average
2462	104.97	103.04			31.87	5.5	35.44	156	131	Peak
2484	47.7	45.74	54	-6.3	31.88	5.5	35.42	156	131	Average
2484	67.2	65.24	74	-6.8	31.88	5.5	35.42	156	131	Peak
ANTENNA POLARITY & TEST DISTANCE: VERTICAL AT 3 M										
FREQ. (MHz)	EMISSION LEVEL (dBuV/m)	READ LEVEL (dBuV)	LIMIT (dBuV/m)	MARGIN (dB)	ANTENNA FACTOR (dB/m)	CABLE LOSS (dB)	PREAMP FACTOR (dB)	ANTENNA HEIGHT (cm)	TABLE ANGLE (Degree)	REMARK
2390	40.06	38.33	54	-13.94	31.8	5.4	35.47	102	97	Average
2390	55.69	53.96	74	-18.31	31.8	5.4	35.47	102	97	Peak
2462	100.17	98.24			31.87	5.5	35.44	102	97	Average
2462	108.11	106.18			31.87	5.5	35.44	102	97	Peak
2484	52.27	50.31	54	-1.73	31.88	5.5	35.42	102	97	Average
2484	71.39	69.43	74	-2.61	31.88	5.5	35.42	102	97	Peak

REMARKS:

- Emission Level = Read Level + Antenna Factor + Cable Loss - Preamp Factor  
Margin value = Emission level – Limit value
- 2462MHz: Fundamental frequency.

**802.11n (20MHz)**

EUT TEST CONDITION		MEASUREMENT DETAIL	
CHANNEL	Channel 1	FREQUENCY RANGE	1GHz ~ 25GHz
INPUT POWER	120Vac, 60 Hz	DETECTOR FUNCTION	Peak (PK) Average (AV)
ENVIRONMENTAL CONDITIONS	25deg. C, 65%RH	TESTED BY	Karl Lee

**ANTENNA POLARITY & TEST DISTANCE: HORIZONTAL AT 3 M**

FREQ. (MHz)	EMISSION LEVEL (dBuV/m)	READ LEVEL (dBuV)	LIMIT (dBuV/m)	MARGIN (dB)	ANTENNA FACTOR (dB/m)	CABLE LOSS (dB)	PREAMP FACTOR (dB)	ANTENNA HEIGHT (cm)	TABLE ANGLE (Degree)	REMARK
2362	42.09	40.46	54	-11.91	31.76	5.37	35.5	178	131	Average
2362	55.97	54.34	74	-18.03	31.76	5.37	35.5	178	131	Peak
2412	95.02	93.25			31.81	5.43	35.47	178	131	Average
2412	103.03	101.26			31.81	5.43	35.47	178	131	Peak
2500	40.74	38.72	54	-13.26	31.9	5.53	35.41	178	131	Average
2500	55.34	53.32	74	-18.66	31.9	5.53	35.41	178	131	Peak

**ANTENNA POLARITY & TEST DISTANCE: VERTICAL AT 3 M**

FREQ. (MHz)	EMISSION LEVEL (dBuV/m)	READ LEVEL (dBuV)	LIMIT (dBuV/m)	MARGIN (dB)	ANTENNA FACTOR (dB/m)	CABLE LOSS (dB)	PREAMP FACTOR (dB)	ANTENNA HEIGHT (cm)	TABLE ANGLE (Degree)	REMARK
2390	45.68	43.95	54	-8.32	31.8	5.4	35.47	103	97	Average
2390	62.12	60.39	74	-11.88	31.8	5.4	35.47	103	97	Peak
2412	99.83	98.06			31.81	5.43	35.47	103	97	Average
2412	107.57	105.8			31.81	5.43	35.47	103	97	Peak
2498	41.26	39.24	54	-12.74	31.9	5.53	35.41	103	97	Average
2498	55.54	53.52	74	-18.46	31.9	5.53	35.41	103	97	Peak

**REMARKS:**

- Emission Level = Read Level + Antenna Factor + Cable Loss - Preamp Factor  
Margin value = Emission level – Limit value
- 2412MHz: Fundamental frequency.



A D T

EUT TEST CONDITION		MEASUREMENT DETAIL	
CHANNEL	Channel 6	FREQUENCY RANGE	1GHz ~ 25GHz
INPUT POWER	120Vac, 60 Hz	DETECTOR FUNCTION	Peak (PK) Average (AV)
ENVIRONMENTAL CONDITIONS	25deg. C, 65%RH	TESTED BY	Karl Lee

ANTENNA POLARITY & TEST DISTANCE: HORIZONTAL AT 3 M										
FREQ. (MHz)	EMISSION LEVEL (dBuV/m)	READ LEVEL (dBuV)	LIMIT (dBuV/m)	MARGIN (dB)	ANTENNA FACTOR (dB/m)	CABLE LOSS (dB)	PREAMP FACTOR (dB)	ANTENNA HEIGHT (cm)	TABLE ANGLE (Degree)	REMARK
2382	40.19	38.5	54	-13.81	31.78	5.4	35.49	174	131	Average
2382	55.43	53.74	74	-18.57	31.78	5.4	35.49	174	131	Peak
2437	95.44	93.59			31.85	5.46	35.46	174	131	Average
2437	103.44	101.59			31.85	5.46	35.46	174	131	Peak
2490	44.78	42.77	54	-9.22	31.9	5.53	35.42	174	131	Average
2490	57.12	55.11	74	-16.88	31.9	5.53	35.42	174	131	Peak

ANTENNA POLARITY & TEST DISTANCE: VERTICAL AT 3 M										
FREQ. (MHz)	EMISSION LEVEL (dBuV/m)	READ LEVEL (dBuV)	LIMIT (dBuV/m)	MARGIN (dB)	ANTENNA FACTOR (dB/m)	CABLE LOSS (dB)	PREAMP FACTOR (dB)	ANTENNA HEIGHT (cm)	TABLE ANGLE (Degree)	REMARK
2388	40.18	38.47	54	-13.82	31.8	5.4	35.49	102	97	Average
2388	55.96	54.25	74	-18.04	31.8	5.4	35.49	102	97	Peak
2437	99.11	97.26			31.85	5.46	35.46	102	97	Average
2437	107.59	105.74			31.85	5.46	35.46	102	97	Peak
2484	46.86	44.9	54	-7.14	31.88	5.5	35.42	102	97	Average
2484	60	58.04	74	-14	31.88	5.5	35.42	102	97	Peak

## REMARKS:

- Emission Level = Read Level + Antenna Factor + Cable Loss - Preamp Factor  
Margin value = Emission level – Limit value
- 2437MHz: Fundamental frequency.





A D T

EUT TEST CONDITION		MEASUREMENT DETAIL	
CHANNEL	Channel 11	FREQUENCY RANGE	1GHz ~ 25GHz
INPUT POWER	120Vac, 60 Hz	DETECTOR FUNCTION	Peak (PK) Average (AV)
ENVIRONMENTAL CONDITIONS	25deg. C, 65%RH	TESTED BY	Karl Lee

ANTENNA POLARITY & TEST DISTANCE: HORIZONTAL AT 3 M										
FREQ. (MHz)	EMISSION LEVEL (dBuV/m)	READ LEVEL (dBuV)	LIMIT (dBuV/m)	MARGIN (dB)	ANTENNA FACTOR (dB/m)	CABLE LOSS (dB)	PREAMP FACTOR (dB)	ANTENNA HEIGHT (cm)	TABLE ANGLE (Degree)	REMARK
2390	40.06	38.33	54	-13.94	31.8	5.4	35.47	156	131	Average
2390	55.7	53.97	74	-18.3	31.8	5.4	35.47	156	131	Peak
2462	94.95	93.02			31.87	5.5	35.44	156	131	Average
2462	103.32	101.39			31.87	5.5	35.44	156	131	Peak
2486	47.53	45.54	54	-6.47	31.88	5.53	35.42	156	131	Average
2486	65.85	63.86	74	-8.15	31.88	5.53	35.42	156	131	Peak

ANTENNA POLARITY & TEST DISTANCE: VERTICAL AT 3 M										
FREQ. (MHz)	EMISSION LEVEL (dBuV/m)	READ LEVEL (dBuV)	LIMIT (dBuV/m)	MARGIN (dB)	ANTENNA FACTOR (dB/m)	CABLE LOSS (dB)	PREAMP FACTOR (dB)	ANTENNA HEIGHT (cm)	TABLE ANGLE (Degree)	REMARK
2366	40.08	38.44	54	-13.92	31.76	5.37	35.49	102	97	Average
2366	55.48	53.84	74	-18.52	31.76	5.37	35.49	102	97	Peak
2462	99.22	97.29			31.87	5.5	35.44	102	97	Average
2462	107.42	105.49			31.87	5.5	35.44	102	97	Peak
2484	52.22	50.26	54	-1.78	31.88	5.5	35.42	102	97	Average
2484	71.18	69.22	74	-2.82	31.88	5.5	35.42	102	97	Peak

## REMARKS:

- Emission Level = Read Level + Antenna Factor + Cable Loss - Preamp Factor  
Margin value = Emission level – Limit value
- 2462MHz: Fundamental frequency.

**9kHz ~ 30MHz DATA:**

The amplitude of spurious emissions attenuated more than 20dB below the permissible value is not required to be report.

**30MHz ~ 1GHz WORST-CASE DATA:**
**802.11g**

EUT TEST CONDITION		MEASUREMENT DETAIL	
CHANNEL	Channel 11	FREQUENCY RANGE	30MHz ~ 1GHz
INPUT POWER	120Vac, 60 Hz	DETECTOR FUNCTION	Peak (PK) Quasi-peak (QP)
ENVIRONMENTAL CONDITIONS	25deg. C, 65%RH	TESTED BY	Karl Lee

**ANTENNA POLARITY & TEST DISTANCE: HORIZONTAL AT 3 M**

FREQ. (MHz)	EMISSION LEVEL (dBuV/m)	READ LEVEL (dBuV)	LIMIT (dBuV/m)	MARGIN (dB)	ANTENNA FACTOR (dB/m)	CABLE LOSS (dB)	PREAMP FACTOR (dB)	ANTENNA HEIGHT (cm)	TABLE ANGLE (Degree)	REMARK
99.12	27.43	48.74	43.5	-16.07	9.62	1.28	32.21	175	121	Peak
190.92	30.05	50.3	43.5	-13.45	10.4	1.61	32.26	139	238	Peak
257.34	17.2	34.15	46	-28.8	13.21	1.94	32.1	145	127	Peak
402.9	18.18	30.03	46	-27.82	18.03	2.34	32.22	105	128	Peak
729.1	24.21	29.8	46	-21.79	23.37	3.16	32.12	185	321	Peak
883.8	26.54	29.75	46	-19.46	24.88	3.49	31.58	175	274	Peak

**ANTENNA POLARITY & TEST DISTANCE: VERTICAL AT 3 M**

FREQ. (MHz)	EMISSION LEVEL (dBuV/m)	READ LEVEL (dBuV)	LIMIT (dBuV/m)	MARGIN (dB)	ANTENNA FACTOR (dB/m)	CABLE LOSS (dB)	PREAMP FACTOR (dB)	ANTENNA HEIGHT (cm)	TABLE ANGLE (Degree)	REMARK
47.28	30.43	53.1	40	-9.57	8.65	0.9	32.22	194	310	Peak
98.58	21.34	42.69	43.5	-22.16	9.58	1.28	32.21	128	124	Peak
152.31	22.22	42.69	43.5	-21.28	10.28	1.52	32.27	139	314	Peak
503	19.97	30.25	46	-26.03	19.19	2.63	32.1	105	128	Peak
717.2	24.33	30.02	46	-21.67	23.31	3.11	32.11	100	108	Peak
974.1	28.78	30.02	54	-25.22	25.8	3.67	30.71	175	217	Peak

**REMARKS:**

- Emission Level = Read Level + Antenna Factor + Cable Loss - Preamp Factor  
Margin value = Emission level – Limit value

## 4.2 Conducted Emission Measurement

### 4.2.1 Limits of Conducted Emission Measurement

Frequency (MHz)	Conducted Limit (dBuV)	
	Quasi-peak	Average
0.15 - 0.5	66 - 56	56 - 46
0.50 - 5.0	56	46
5.0 - 30.0	60	50

Note: 1. The lower limit shall apply at the transition frequencies.

2. The limit decreases in line with the logarithm of the frequency in the range of 0.15 to 0.50MHz.

### 4.2.2 Test Instruments

Description & Manufacturer	Model No.	Serial No.	Date of Calibration	Due Date of Calibration
Test Receiver ROHDE & SCHWARZ	ESCI	100613	Nov. 11, 2014	Nov. 10, 2015
RF signal cable (with 10dB PAD) Woken	5D-FB	Cable-cond1-01	Dec. 26, 2014	Dec. 25, 2015
LISN ROHDE & SCHWARZ (EUT)	ESH3-Z5	835239/001	Feb. 26, 2015	Feb. 25, 2016
LISN ROHDE & SCHWARZ (Peripheral)	ESH3-Z5	100311	Jul. 24, 2015	Jul. 23, 2016
Software ADT	BV ADT_Cond_ V7.3.7.3	NA	NA	NA

Note: 1. The calibration interval of the above test instruments is 12 months and the calibrations are traceable to NML/ROC and NIST/USA.

2. The test was performed in HwaYa Shielded Room 1.

3. The VCCI Site Registration No. is C-2040.

#### 4.2.3 Test Procedures

- a. The EUT was placed 0.4 meters from the conducting wall of the shielded room with EUT being connected to the power mains through a line impedance stabilization network (LISN). Other support units were connected to the power mains through another LISN. The two LISNs provide 50 ohm / 50uH of coupling impedance for the measuring instrument.
- b. Both lines of the power mains connected to the EUT were checked for maximum conducted interference.
- c. The frequency range from 150 kHz to 30MHz was searched. Emission levels under (Limit - 20dB) was not recorded.

**NOTE:** All modes of operation were investigated and the worst-case emissions are reported.

#### 4.2.4 Deviation from Test Standard

No deviation.

#### 4.2.5 Test Setup

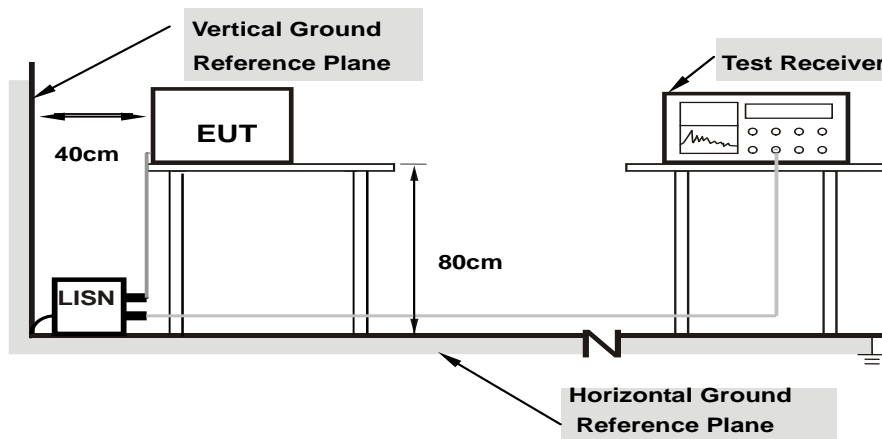

**Note:** 1.Support units were connected to second LISN.

For the actual test configuration, please refer to the attached file (Test Setup Photo).

#### 4.2.6 EUT Operating Conditions

Same as 4.1.6.

4.2.7 Test Results

Frequency Range	150kHz ~ 30MHz	Detector Function & Resolution Bandwidth	Quasi-Peak (QP) / Average (AV)
Input Power	120Vac, 60Hz	Environmental Conditions	25°C, 65%RH
Tested by	Toby Tian	Test Date	2015/8/25
Test Mode	Mode 1		

Phase Of Power : Line (L)										
No	Frequency (MHz)	Correction Factor (dB)	Reading Value (dBuV)		Emission Level (dBuV)		Limit (dBuV)		Margin (dB)	
			Q.P.	AV.	Q.P.	AV.	Q.P.	AV.	Q.P.	AV.
1	0.15391	0.05	38.91	30.05	38.96	30.10	65.79	55.79	-26.83	-25.69
2	0.69108	0.07	42.37	33.47	42.44	33.54	56.00	46.00	-13.56	-12.46
3	1.09231	0.08	42.56	33.28	42.64	33.36	56.00	46.00	-13.36	-12.64
4	1.43639	0.10	40.03	30.80	40.13	30.90	56.00	46.00	-15.87	-15.10
5	2.39058	0.13	39.34	30.29	39.47	30.42	56.00	46.00	-16.53	-15.58
6	3.89578	0.19	39.38	30.31	39.57	30.50	56.00	46.00	-16.43	-15.50

Remarks:

1. Q.P. and AV. are abbreviations of quasi-peak and average individually.
2. The emission levels of other frequencies were very low against the limit.
3. Margin value = Emission level – Limit value
4. Correction factor = Insertion loss + Cable loss
5. Emission Level = Correction Factor + Reading Value

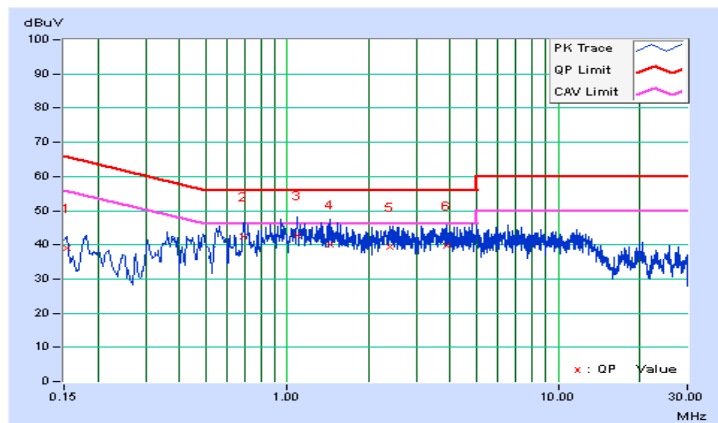

Frequency Range	150kHz ~ 30MHz	Detector Function & Resolution Bandwidth	Quasi-Peak (QP) / Average (AV)
Input Power	120Vac, 60Hz	Environmental Conditions	25°C, 65%RH
Tested by	Toby Tian	Test Date	2015/8/25
Test Mode	Mode 1		

Phase Of Power : Neutral (N)										
No	Frequency (MHz)	Correction Factor (dB)	Reading Value (dBuV)		Emission Level (dBuV)		Limit (dBuV)		Margin (dB)	
			Q.P.	AV.	Q.P.	AV.	Q.P.	AV.	Q.P.	AV.
1	0.15391	0.05	38.44	32.03	38.49	32.08	65.79	55.79	-27.30	-23.71
2	0.43809	0.06	39.97	30.91	40.03	30.97	57.10	47.10	-17.07	-16.13
3	0.58010	0.07	39.88	29.83	39.95	29.90	56.00	46.00	-16.05	-16.10
4	0.70522	0.07	37.64	29.75	37.71	29.82	56.00	46.00	-18.29	-16.18
5	1.24042	0.09	38.64	29.44	38.73	29.53	56.00	46.00	-17.27	-16.47
6	2.60548	0.13	35.34	27.06	35.47	27.19	56.00	46.00	-20.53	-18.81

Remarks:

1. Q.P. and AV. are abbreviations of quasi-peak and average individually.
2. The emission levels of other frequencies were very low against the limit.
3. Margin value = Emission level – Limit value
4. Correction factor = Insertion loss + Cable loss
5. Emission Level = Correction Factor + Reading Value

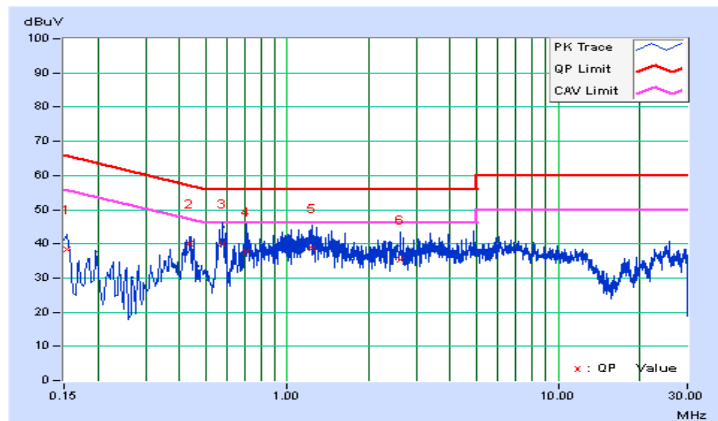

### 4.3 6dB Bandwidth Measurement

#### 4.3.1 Limits of 6dB Bandwidth Measurement

The minimum of 6dB Bandwidth Measurement is 0.5 MHz.

#### 4.3.2 Test Setup

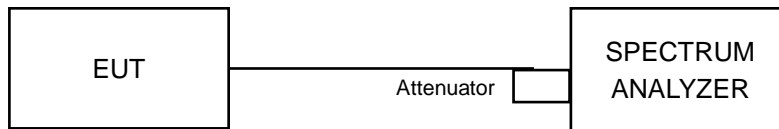

#### 4.3.3 Test Instruments

Refer to section 4.1.2 to get information of above instrument.

#### 4.3.4 Test Procedure

- Set resolution bandwidth (RBW) = 100kHz
- Set the video bandwidth (VBW)  $\geq 3 \times$  RBW, Detector = Peak.
- Trace mode = max hold.
- Sweep = auto couple.
- Measure the maximum width of the emission that is constrained by the frequencies associated with the two amplitude points (upper and lower) that are attenuated by 6 dB relative to the maximum level measured in the fundamental emission

#### 4.3.5 Deviation from Test Standard

No deviation.

#### 4.3.6 EUT Operating Conditions

The software provided by client to enable the EUT under transmission condition continuously at lowest, middle and highest channel frequencies individually.

## 4.3.7 Test Result

## 802.11b

Channel	Frequency (MHz)	6db Bandwidth (MHz)	Minimum Limit (MHz)	Pass / Fail
1	2412	8.58	0.5	Pass
6	2437	8.09	0.5	Pass
11	2462	9.05	0.5	Pass

## 802.11g

Channel	Frequency (MHz)	6db Bandwidth (MHz)	Minimum Limit (MHz)	Pass / Fail
1	2412	16.35	0.5	Pass
6	2437	16.39	0.5	Pass
11	2462	16.36	0.5	Pass

## 802.11n (20MHz)

Channel	Frequency (MHz)	6db Bandwidth (MHz)	Minimum Limit (MHz)	Pass / Fail
1	2412	17.56	0.5	Pass
6	2437	17.61	0.5	Pass
11	2462	17.34	0.5	Pass



### Spectrum Plot of Worst Value

#### 802.11b

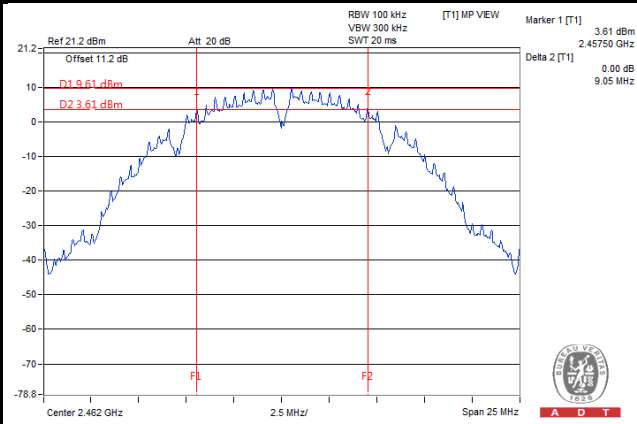

#### 802.11g

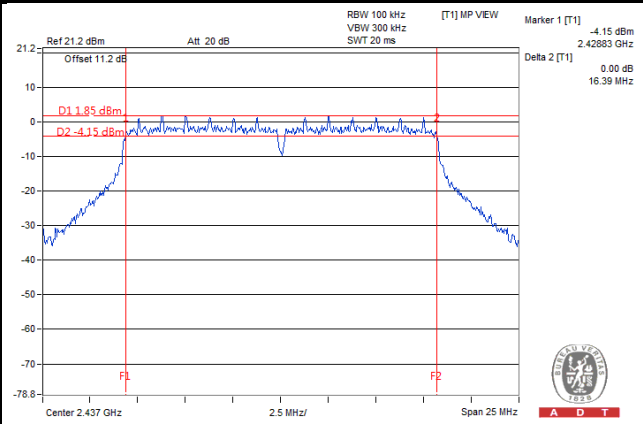

#### 802.11n (20MHz)

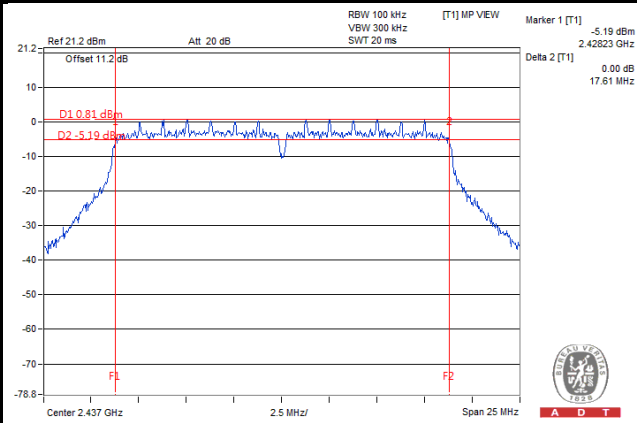

#### 4.4 Conducted Output Power Measurement

##### 4.4.1 Limits of Conducted Output Power Measurement

For systems using digital modulation in the 2400–2483.5 MHz bands: 1 Watt (30dBm)

##### 4.4.2 Test Setup

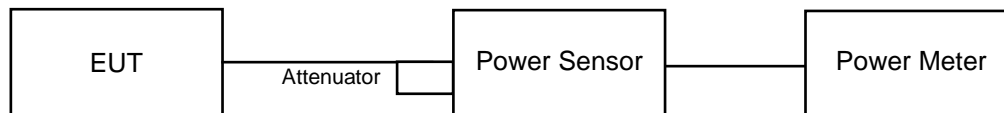

##### 4.4.3 Test Instruments

Refer to section 4.1.2 to get information of above instrument.

##### 4.4.4 Test Procedures

A peak power sensor was used on the output port of the EUT. A power meter was used to read the response of the peak power sensor. Record the power level.

##### 4.4.5 Deviation from Test Standard

No deviation.

##### 4.4.6 EUT Operating Conditions

Same as 4.3.6.

## 4.4.7 Test Results

## 802.11b

Channel	Frequency (MHz)	Peak Power (mW)	Peak Power (dBm)	Limit (dBm)	Pass / Fail
1	2412	112.46	20.51	30	Pass
6	2437	115.88	20.64	30	Pass
11	2462	111.17	20.46	30	Pass

## 802.11g

Channel	Frequency (MHz)	Peak Power (mW)	Peak Power (dBm)	Limit (dBm)	Pass / Fail
1	2412	146.22	21.65	30	Pass
6	2437	147.23	21.68	30	Pass
11	2462	142.56	21.54	30	Pass

## 802.11n (20MHz)

Channel	Frequency (MHz)	Peak Power (mW)	Peak Power (dBm)	Limit (dBm)	Pass / Fail
1	2412	112.46	20.51	30	Pass
6	2437	119.67	20.78	30	Pass
11	2462	115.35	20.62	30	Pass

## 4.5 Power Spectral Density Measurement

### 4.5.1 Limits of Power Spectral Density Measurement

The Maximum of Power Spectral Density Measurement is 8dBm.

### 4.5.2 Test Setup

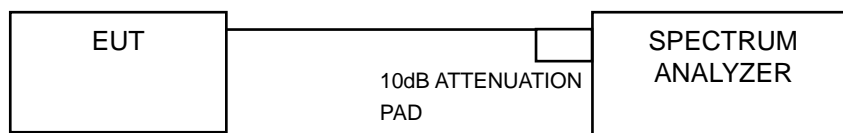

### 4.5.3 Test Instruments

Refer to section 4.1.2 to get information of above instrument.

### 4.5.4 Test Procedure

- a. Set analyzer center frequency to DTS channel center frequency.
- b. Set the span to 1.5 times the DTS bandwidth.
- c. Set the RBW to:  $3 \text{ kHz} \leq \text{RBW} \leq 100 \text{ kHz}$ .
- d. Set the VBW  $\geq 3 \times \text{RBW}$ .
- e. Detector = peak.
- f. Sweep time = auto couple.
- g. Trace mode = max hold.
- h. Allow trace to fully stabilize.
- i. Use the peak marker function to determine the maximum amplitude level within the RBW.

### 4.5.5 Deviation from Test Standard

No deviation.

### 4.5.6 EUT Operating Condition

Same as Item 4.3.6

## 4.5.7 Test Results

## 802.11b

Channel	Frequency (MHz)	PSD (dBm)	Limit (dBm)	Pass / Fail
1	2412	-4.43	8	Pass
6	2437	-5.40	8	Pass
11	2462	-4.89	8	Pass

## 802.11g

Channel	Frequency (MHz)	PSD (dBm)	Limit (dBm)	Pass / Fail
1	2412	-11.51	8	Pass
6	2437	-12.37	8	Pass
11	2462	-12.22	8	Pass

## 802.11n (20MHz)

Channel	Frequency (MHz)	PSD (dBm)	Limit (dBm)	Pass / Fail
1	2412	-13.61	8	Pass
6	2437	-14.30	8	Pass
11	2462	-13.94	8	Pass

### Spectrum Plot of Worst Value

#### 802.11b

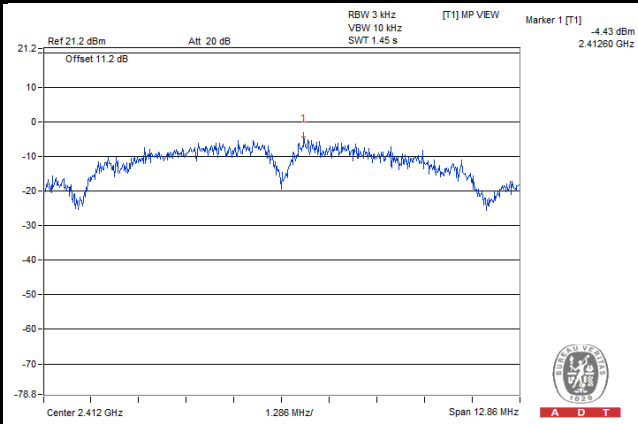

#### 802.11g

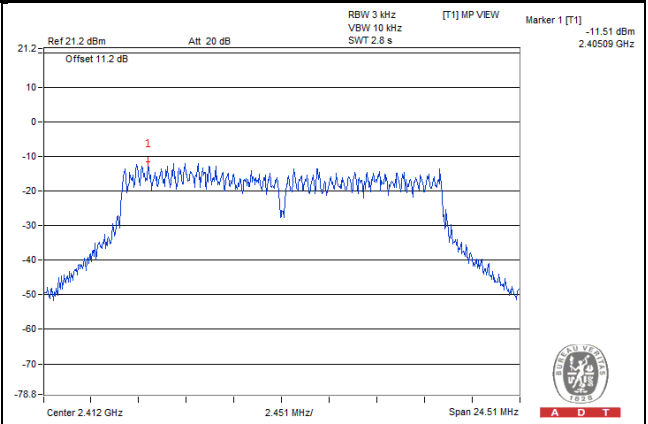

#### 802.11n (20MHz)

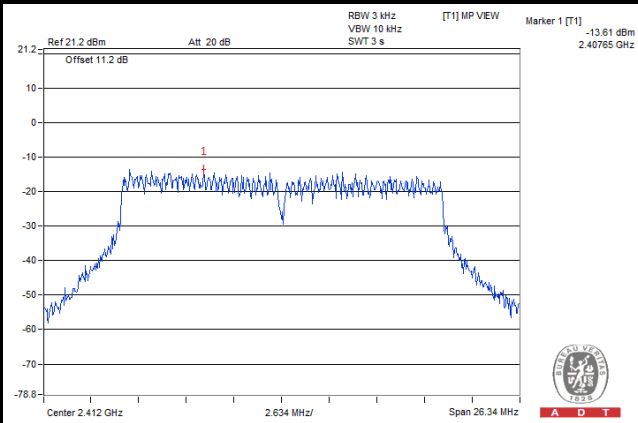

## 4.6 Conducted Out of Band Emission Measurement

### 4.6.1 Limits of Conducted Out of Band Emission Measurement

Below 20dB of the highest emission level of operating band (in 100kHz Resolution Bandwidth).

### 4.6.2 Test Setup

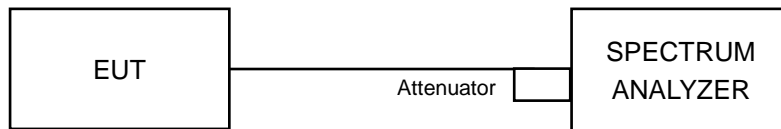

### 4.6.3 Test Instruments

Refer to section 4.1.2 to get information of above instrument.

### 4.6.4 Test Procedure

#### MEASUREMENT PROCEDURE REF

1. Set the RBW = 100 kHz.
2. Set the VBW  $\geq$  300 kHz.
3. Detector = peak.
4. Sweep time = auto couple.
5. Trace mode = max hold.
6. Allow trace to fully stabilize.
7. Use the peak marker function to determine the maximum power level in any 100 kHz band segment within the fundamental EBW.

#### MEASUREMENT PROCEDURE OOB

1. Set RBW = 100 kHz.
2. Set VBW  $\geq$  300 kHz.
3. Detector = peak.
4. Sweep = auto couple.
5. Trace Mode = max hold.
6. Allow trace to fully stabilize.
7. Use the peak marker function to determine the maximum amplitude level.

### 4.6.5 Deviation from Test Standard

No deviation.

### 4.6.6 EUT Operating Condition

Same as Item 4.3.6

### 4.6.7 Test Results

The spectrum plots are attached on the following images. D1 line indicates the highest level, and D2 line indicates the 20dB offset below D1. It shows compliance with the requirement.

#### 802.11b

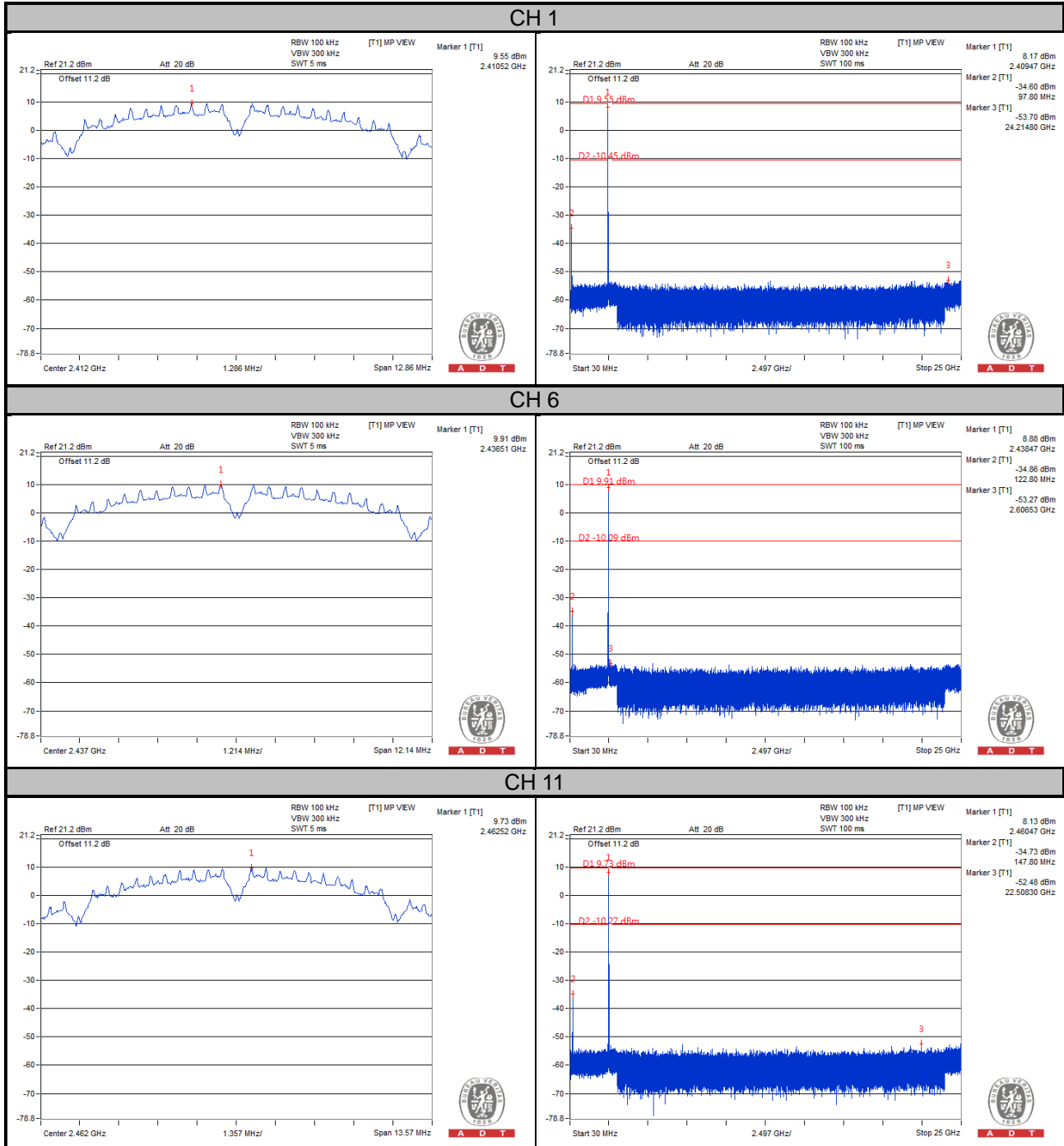



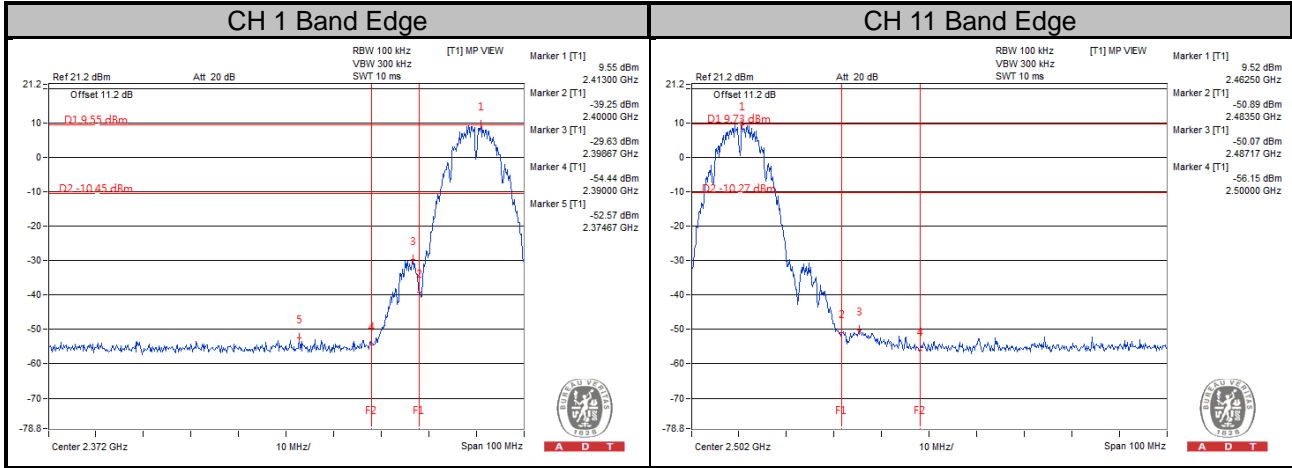

802.11g

CH 1

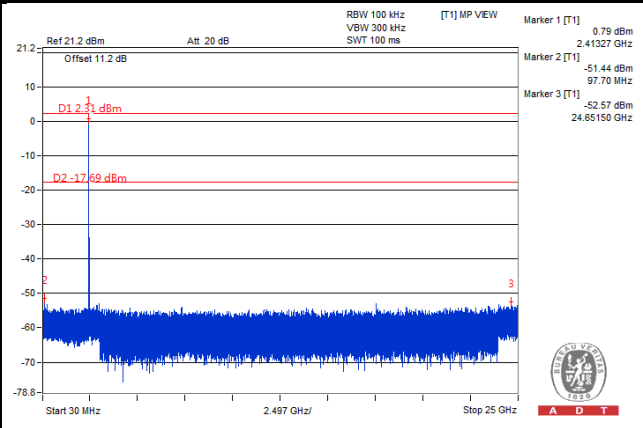
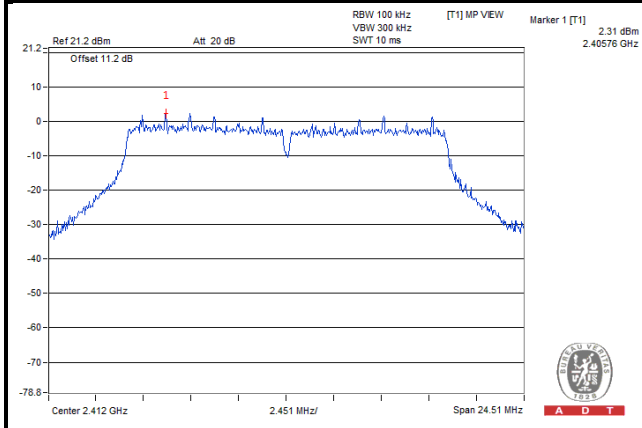

CH 6

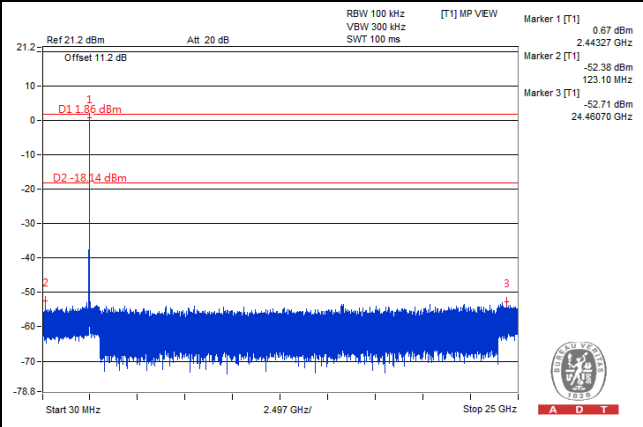
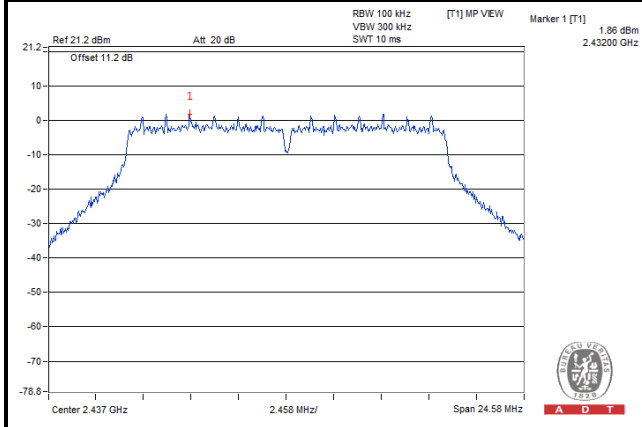

CH 11

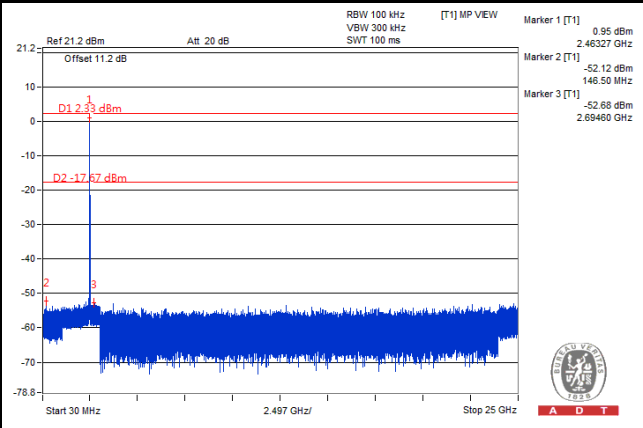
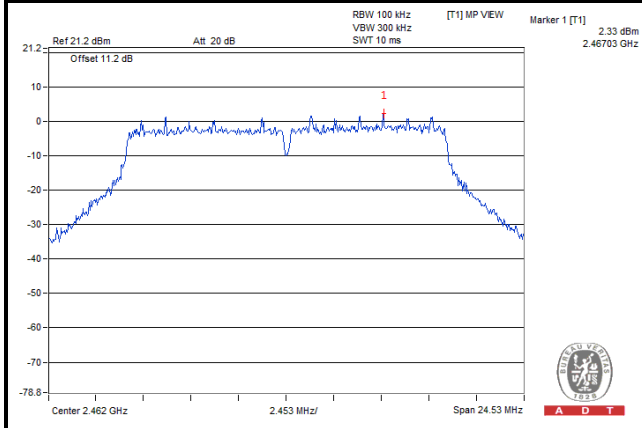

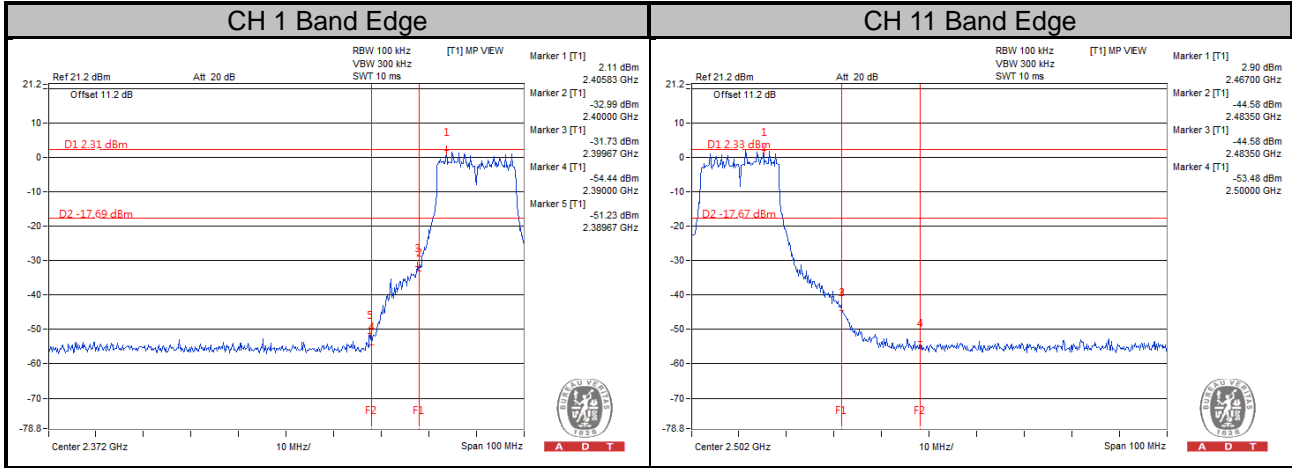

802.11n (20MHz)

CH 1

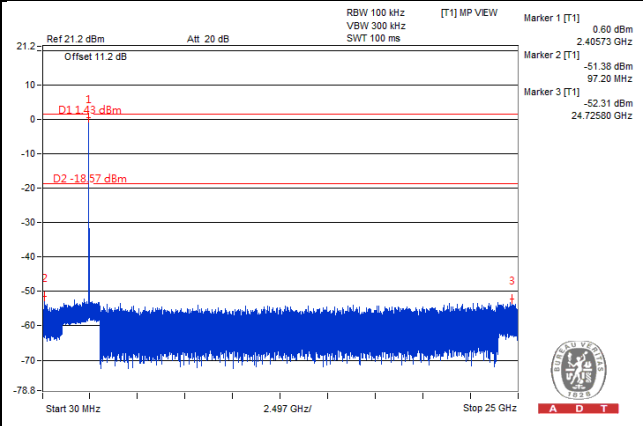
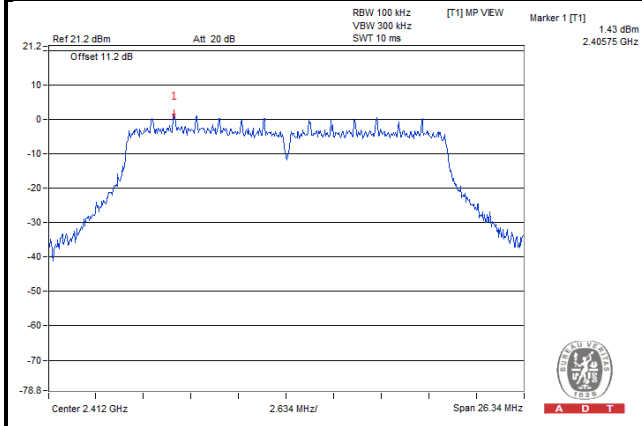

CH 6

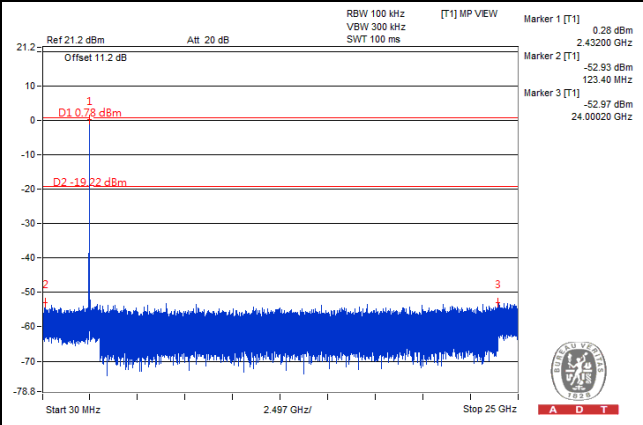
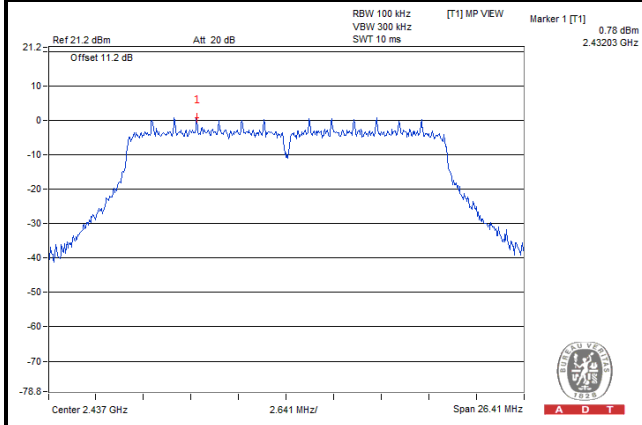

CH 11

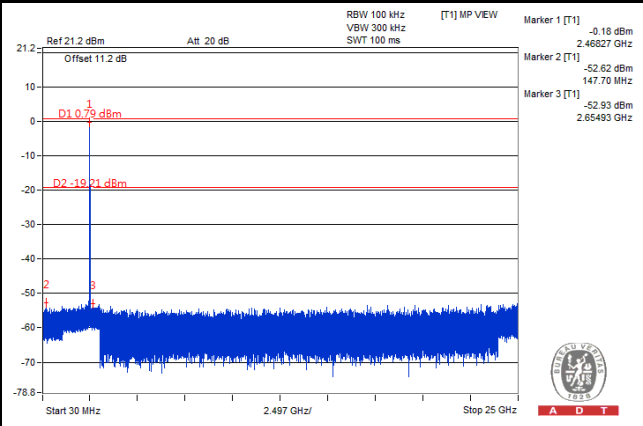
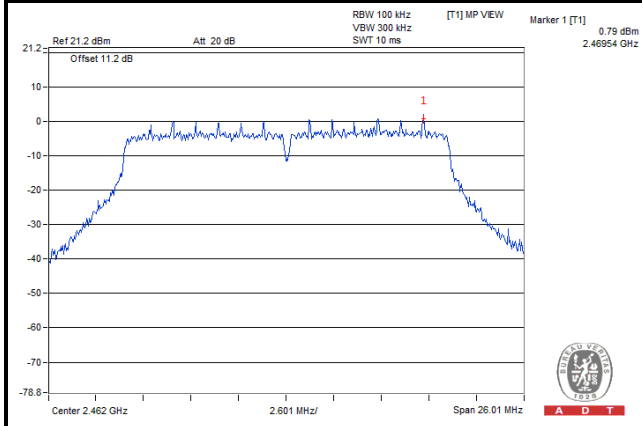

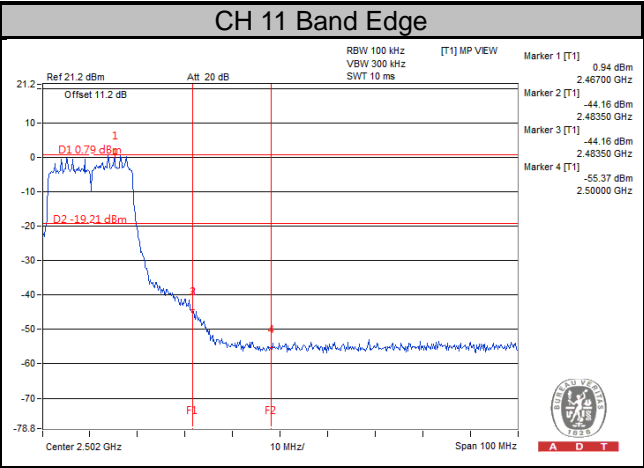
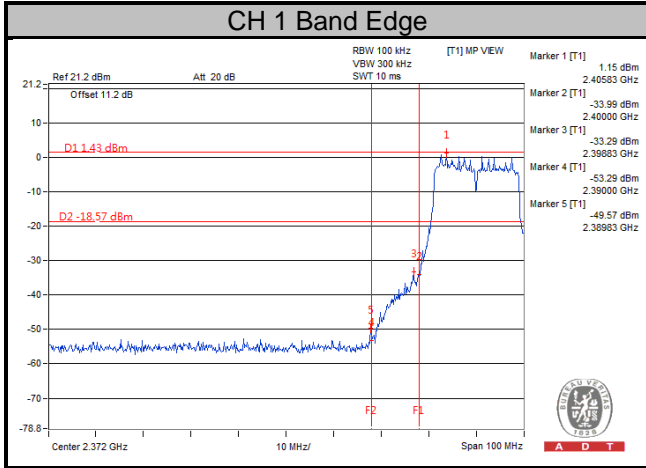



## 5 Pictures of Test Arrangements

Please refer to the attached file (Test Setup Photo).



A D T

## Appendix – Information on the Testing Laboratories

We, Bureau Veritas Consumer Products Services (H.K.) Ltd., Taoyuan Branch, were founded in 1988 to provide our best service in EMC, Radio, Telecom and Safety consultation. Our laboratories are accredited and approved according to ISO/IEC 17025.

If you have any comments, please feel free to contact us at the following:

### **Linko EMC/RF Lab**

Tel: 886-2-26052180

Fax: 886-2-26051924

### **Hsin Chu EMC/RF/Telecom Lab**

Tel: 886-3-5935343

Fax: 886-3-5935342

### **Hwa Ya EMC/RF/Safety Lab**

Tel: 886-3-3183232

Fax: 886-3-3270892

**Email:** [service.adt@tw.bureauveritas.com](mailto:service.adt@tw.bureauveritas.com)

**Web Site:** [www.bureauveritas-adt.com](http://www.bureauveritas-adt.com)

The address and road map of all our labs can be found in our web site also.

--- END ---